

# RADIO NEWS

REG. U.S. PAT. OFF.

20 Cents  
February  
1921

Over 100 Illustrations  
Edited by H. GERNSBACK

INDUCTANCE AT  
LAFAYETTE STATION  
SEE PAGE 514

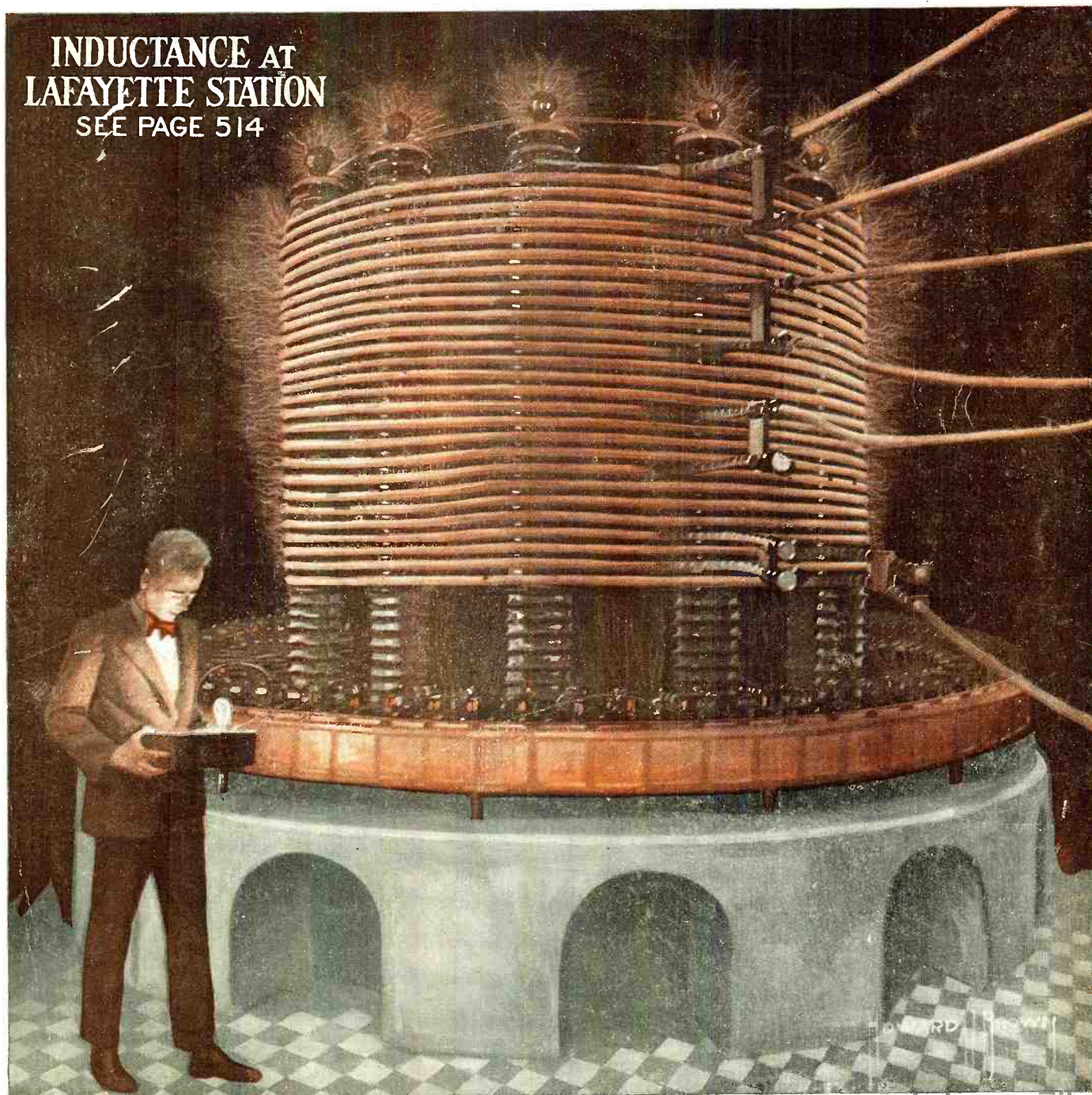

"THE 100% WIRELESS MAGAZINE"

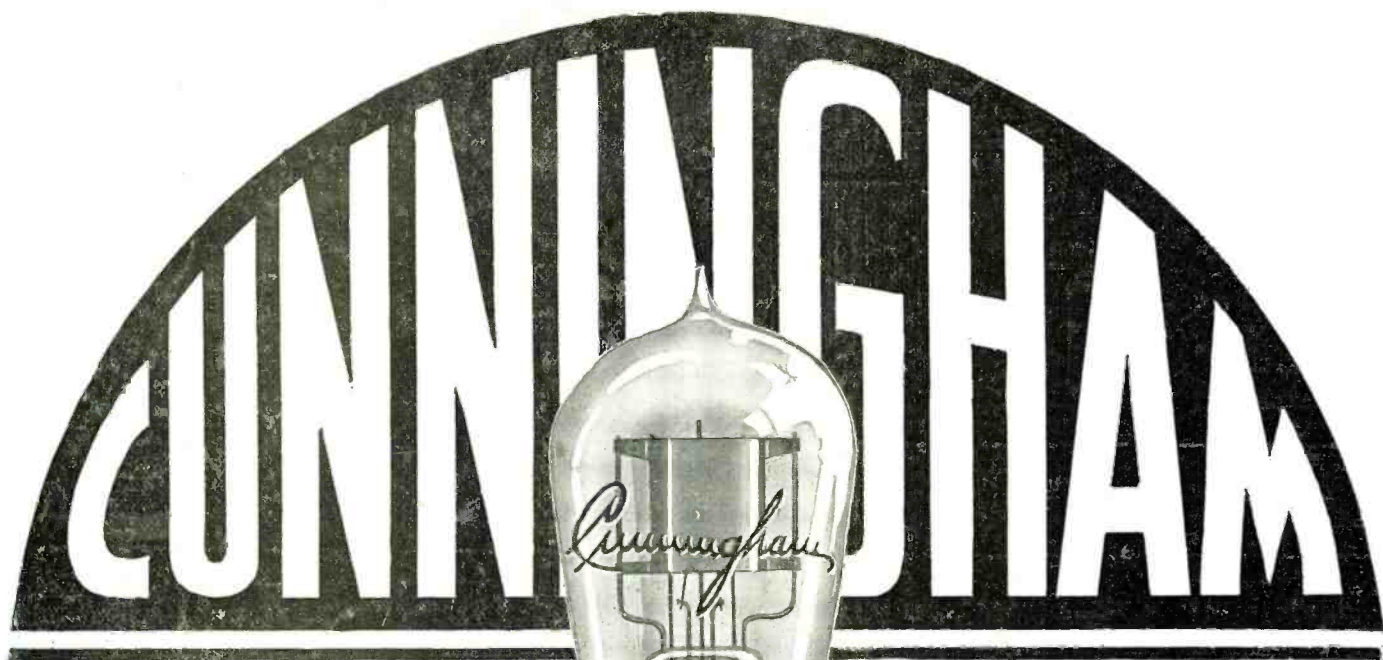

**DETECTOR  
TYPE**

**WITH STANDARD**



**TUBE  
C-300**

**FOUR PRONG BASE**

**T**YPE C300 invites comparison. Amateur requirements decided its design. Many years research of vacuum tube properties have made Type C300 the Ideal Amateur Receiving Tube. Detector sensitiveness at low plate voltages requires that gas action be combined with the electron emission and by a *wonderful new process of manufacture* this gas action is so controlled that the plate voltage for maximum signal audibility is always within the limits 18—22½ volts. Only a single block cell is needed in the plate circuit—a big saving in battery investment. Type C300 is completely silent in operation—a decided advantage in receiving weak signals.

Any three member vacuum tube is necessarily an amplifier, but the results obtained from Type C300 as a tone frequency amplifier with only 22½ volt plate battery proved a surprise. Again Type C300 invites comparison. Competitive tests show this tube to excel any tone frequency amplifier previously developed. For power amplification in operating loud speaking telephones and in complex and multi-stage circuits use the special Pliotron amplifier Type C301 for freedom from distortion. Write for special Bulletin C301.

**TYPE C-300**  
**\$5.00**

Type C300 is a free and persistent oscillator for regenerative amplification and C. W. reception.

The pleasure and satisfaction from operating Type C300 cannot be described. See your dealer today—or write for his name and a copy of Bulletin C300.

TRADING AS

**AUDIOTRON MFG. COMPANY**

**35 Montgomery Street**

**San Francisco**

# CONNECTICUT

## RADIO

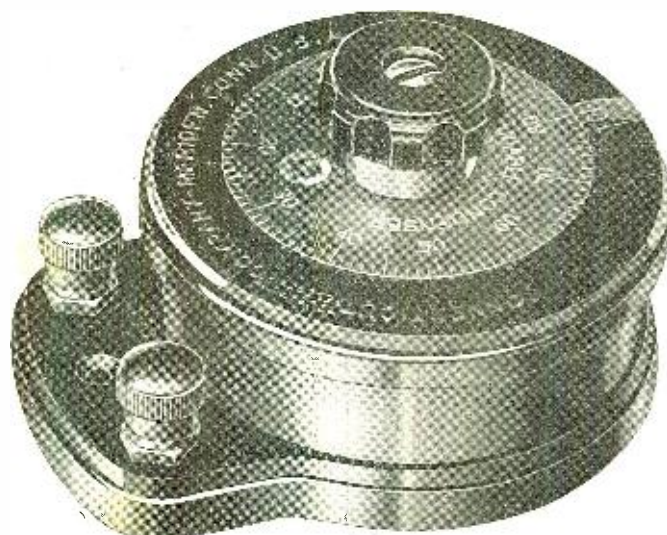
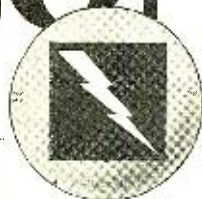

## This Amateur "found it far superior"

Read this letter (from Pennsylvania) on the CONNECTICUT Variable Condenser

"Have been using your unique two plate condenser for several weeks. Have tried it on a number of crystal hook-ups and have found it to be far superior in actions and stability than a \* \* \* condenser which I am also using in my present hook-up.

"I have also been able to cut out entirely N A A and other stations with your condenser, while it is impossible with the other.

"I can sincerely say that this instrument for its size and work cannot be equalled. It is also a very fine addition to a Radio Outfit as it not only increases the receiving capacity, but also adds to the fine appearance of many outfits.

"Wishing you the best success with your new condenser, I remain,"

*Your results can be just as good. Our booklet tells all about the new Condenser — Send for it.*

*Mention Your Dealer's Name*

**CONNECTICUT TELEPHONE & ELECTRIC COMPANY**  
Meriden Connecticut

# RADIO NEWS

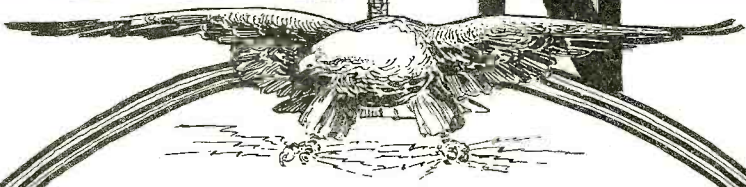

## CONTENTS

VOL. 2

FOR FEBRUARY

NO. 8

| PAGE   | PAGE   |
|--|--|
| Editorial.....By H. Gernsback 509  | An Undamp Wave Method of Determining Dielectric Constants of Liquids, By W. H. Hyslop and A. P. Carman 522 |
| The Lafayette Radio Station..... 510   | Controlling by Wireless, By Everett Leo Deeter 523   |
| A Detector and Three-Stage Amplifier for Fifty Dollars, By E. A. White and F. L. Hopkins 512 | Sparks and Spark Frequency, By Vincent Tassi 523   |
| New German Radio Sets..... 513   | Notes on Modulated Tube Transmitters, By A. S. Blatterman 524  |
| A Unique Vacuum Tube Control Panel. 513  | A Simple and Efficient Short Wave Regenerative Receiver, By Frederick J. Rumford 526                       |
| Awards of \$100 Portable Radio Prize Contest ..... 514                                       | A Spark Coil Panel Type Transmitter, By Marion W. Taylor 527   |
| A New 2-K.W. Panel Transmitter..... 515  | Using an Amplifier as a Detector of Long Waves.....By H. K. Dunn 528                                       |
| New Amplifying Transformers..... 515   | A New Thermionic Vacuum Tube, By John Scott-Taggart 528  |
| A True Undamp Wave Receptor, By Ernest C. Mignon 516   | Fading of Signals....By S. R. Winters 529  |
| A New Type of "B" Battery, By Harry Boyce, Jr. 517   | Who's Who in Radio..... 530  |
| Two Practical Radio Telephone Circuits, By John Scott-Taggart 518                            | Club Gossip ..... 531  |
| How to Wind Duo-Lateral Coils, By Wm. T. Prather 518   | Radio Digest ..... 532   |
| Amateur Radio and Its Future, By P. H. Boucheron 519   | The Radio Constructor..... 533   |
| An Old Idea Exploded, By Gordon D. Robinson 519  | With the Amateurs..... 534   |
| The Arc or Continuous Wave Transmitter.....By J. Donald Haig 520                             | Correspondence from Readers..... 536   |
| An Amplifier Employing Thermionic Interval Couplings, By John Scott-Taggart 522              | The Phantom Call.....By R. A. Chath 537  |
|  | Junior Section ..... 538   |
|  | Junior Constructor ..... 539   |
|  | I-Want-To-Know ..... 540   |

RADIO NEWS is published on the 25th of each month at 233 Fulton Street, New York. There are 12 numbers per year. Subscription price is \$2.00 a year in U. S. and possessions. Canada and foreign countries, \$2.50 a year. U. S. coin as well as U. S. Stamps accepted (no foreign coins or stamps) Single copies, 20 cents each. A sample copy will be sent gratis on request. Checks and money orders should be drawn to order of EXPERIMENTER PUBLISHING CO., INC. If you should change your address notify us promptly, in order that copies be not mis-carried or lost. No copies sent after expiration. All communications and contributions to this journal should be addressed to: Editor, RADIO NEWS, 233 Fulton Street, New York. Unaccepted contributions cannot be returned unless full postage has been

included. ALL accepted contributions are paid for on publication. A special rate is paid for novel experiments; good photographs accompanying them are highly desirable.

RADIO NEWS, Monthly. Entered as second-class matter June 6th, 1919, at the Post Office at New York, N. Y., under the Act of March 3, 1897. Title registered U. S. Patent Office. Copyright, 1921, by E. P. Co., Inc., New York. The Experimenter Publishing Co., 233 Fulton Street, N. Y., N. Y. The Contents of this magazine are copyrighted and must not be reproduced without giving full credit to the publication.

RADIO NEWS is for sale at all newsstands in the United States and Canada; also at Brentano's, 37 Avenue de l'Opera, Paris.

Published by EXPERIMENTER PUBLISHING CO., INC.  
H. GERNSBACK, President

233 Fulton Street, New York City  
S. GERNSBACK, Treasurer  
R. W. DE MOTT, Secretary

# Learn Mechanical Drawing

Men Wanted—

**SALARIES**  
\$35 to \$100  
**Per Week**



Are you earning less than \$35 a week? Can you reasonably expect your present position to pay you \$35 to \$100 a week in the near future? If not, this offer will interest you. We offer to qualify you for a profession which, at the very start, pays higher salaries than the average man receives. We offer you the best personal service obtainable. We offer you personal instruction in mechanical drawing and teach you expert Draftsmanship in your spare time, at your home, by mail, in the same

practical way that you would learn it in any big Drafting department. We offer to qualify you for one of the many high salaried positions in the Drafting field, and to keep you in touch with openings for Draftsmen in big machine shops, industrial plants, manufacturing concerns and United States Government Departments. We guarantee to start you on real Drafting work at once qualifying you as a thoroughly trained professional Draftsman, capable of succeeding from the very start. We offer to do all of this at a low cost for such service and in a comparatively short time.

I personally stand back of the Columbia School of Drafting—founded, directed and owned by myself—and guarantee the training given by it to be absolutely as represented. The work of each one of our students has my personal supervision. We seek "Quality" students rather than "Quantity," as our proposition is of the highest character in every respect.

*Roy C. Claflin*  
President

## Become a Chief Draftsman

You cannot make a mistake by taking up mechanical drawing. The field is not crowded, nor can it be. No single profession today offers better opportunities. The great need for trained Draftsmen continues to increase. Each step forward in mechanical development creates a need for more trained Draftsmen. Promotion in this field is sure and certain. Men who start as Draftsmen are often advanced to Chief Draftsman, Chief Engineer, Production Manager or other high salaried positions. There is a constant demand for our graduates. We cannot supply them rapidly enough. Many of them are accepted even before they complete their training. This unusual demand for "Columbia Trained Men" is explained by the fact that our students enter upon actual drawing work the day they receive their first lesson. They spend no time with unnecessary preparation or useless theory.

## One of the Finest and Best Equipped Institutions in America Teaches You Mechanical Drawing at Your Home

This is the mechanical age in world history. The day of big opportunities for technically trained men is here. Especially is this true in the case of Draftsmen, on whom the mechanical industries of America and the entire world depend. On no one profession does the continued development of machinery so nearly center. With the training which we can give you at your home, your service will always be in demand, at a premium, in this permanent, highly paid field.

### Drawing Instruments Furnished

We supply our students with complete drawing equipment. A professional drawing outfit is furnished, together with a highest grade set of Drafting instruments for your permanent use.

### No Previous Training Necessary

As our students are put into actual practice at the beginning, they grasp the essentials of drawing quickly. The lessons supplied are thorough, clear, and easily understood even by those who have had no previous technical training of any kind. No previous experience or special education is necessary.

## COLUMBIA SCHOOL OF DRAFTING

ROY C. CLAFLIN, *President*

Dept. 1366, 14th & T Sts., Washington, D. C.

### RETURN THE COUPON TODAY

It brings to you a valuable book of information FREE. Your future depends upon what you do now. We cannot begin to tell you here, in so few words, of the advantages afforded you by this unusually practical course in up-to-date mechanical drawing. If you are in earnest and desire to learn a big-paying profession, we urge you to act now by returning the following coupon. We will immediately send you our valuable book free, "Your Future in Drafting" which tells of our new method of teaching mechanical drawing and outlines our offer to you fully.

### FREE COUPON—RETURN TODAY

#### COLUMBIA SCHOOL OF DRAFTING

Dept. 1366, 14th & T Streets  
Washington, D. C.

Without obligation to me please send me your illustrated book on Drafting, telling how I can secure your complete home study course (with which is furnished the professional set of drawing instruments and equipment), and your help in securing a position as Draftsman.

Name .....

Address .....

City..... State.....



*The Recognized Symbol of Superior Performance.*

**Modern  
Relay  
Receiver**

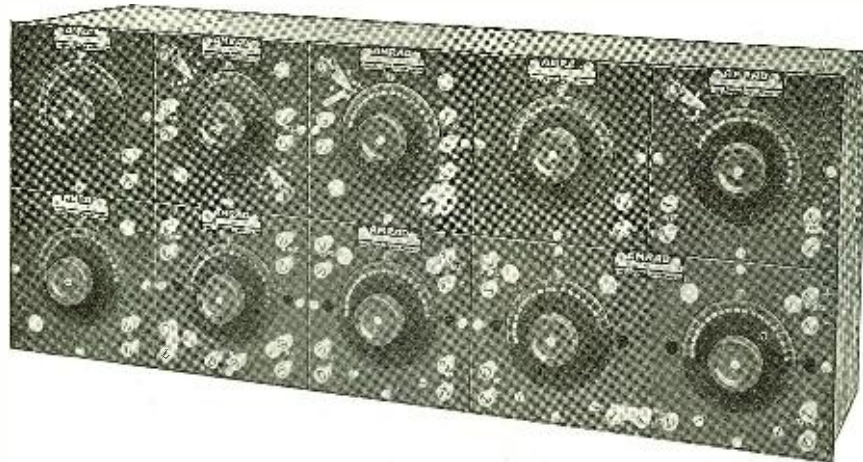

**One of  
Fifteen  
Combinations**



**Crystal Receiver**  
\$23.50

## Amrad Unit System Includes

Ten practical Receiving Units for the wireless experimenter who wishes to obtain the acme in radio receiving. Each unit complete, but so designed as to work with extreme efficiency in combination.

Economical, commercial, good-looking, easily connected, dust-proof, fool-proof—these are characteristics of the Amrad Unit System.

Couplers and variometers offered in two types, short and medium wave (mounted and unmounted). Amplifiers contain regulation Amrad Ampliformers, Rheostats and Tube Bases.

*Descriptive Bulletin V sent free. Complete Amrad Catalog furnished upon receipt of 10 cents in stamps.*



**Amrad Coupler**  
\$17.50



**Amrad Variometer**  
\$14.50



**VT 1 Stage Amplifier**  
\$21.00



**Amrad VT Detector Amplifier**  
\$34.50



**Amrad VT Detector**  
\$15.00

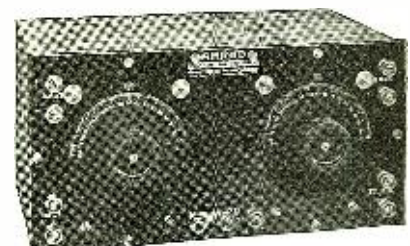

**Amrad VT 2 Stage Amplifier**  
\$39.50

Free to Amrad Quenched Gap Users—Complete Set of new leak-proof gaskets. Send Type and Serial numbers and 10c to cover postage. If you haven't an Amrad Quenched, you need one to transmit more miles per watt.

# AMERICAN RADIO AND RESEARCH CORPORATION

15 Park Row  
New York

Address all Communications  
to New York Office

Factory and Laboratory  
Medford Hillside, Mass.



# RADIO NEWS

H. GERNSBACK—Editor  
ROBERT E. LACAULT—Associate Editor



Vol. 2

FEBRUARY, 1921

No. 8

## WHAT IS COMING

**N**OT so long ago a number of manufacturers of radio instruments met at a certain hotel in New York City and talked shop. All of these men have had long experience in the radio field, having built radio apparatus for many years. They are all successful men in their lines. As the talk progressed, it became apparent that they were not at all satisfied with the radio business as a whole. They seemed to be of the opinion—and rightly so—that selling radio apparatus is a fickle undertaking. They thought that there was too much change of style in the various instruments, and as the radio amateur is notoriously fickle in buying everything of the latest and newest, it happens not infrequently that a well-meaning manufacturer becomes loaded with unsaleable material which moves no longer, due to the newer designs on the market.

The radio business, it was the consensus of these men, is worse than selling women's dresses or men's straw hats, with the difference that the radio business is perhaps more uncertain. There is always a market for women's dresses and straw hats for men, even though out of season, but for antiquated radio instruments there is little or no demand, and frequently such apparatus become a total loss to the man who manufactures or sells them.

It was always thus in the radio business, ever since its inception. The writer well remembers the days of the coherer when a New York manufacturer used to turn them out by the thousands. Suddenly the electrolytic detector sprung up and overnight the coherer went out of business. He could not sell these coherers any longer, as a matter of fact, he could not even give them away.

The same fate met the manufacturer of the electrolytic detector when the crystal detector suddenly came into vogue. He had left on his hands a great many thousands of electrolytic detectors, not mentioning the many thousands parts which go into the making of them. Examples such as these might be quoted indefinitely, and if the manufacturer does not lose out, it often happens that the dealer must bear the loss. Frequently it becomes necessary for him to dispose of antiquated radio apparatus at a price much below what he originally paid.

What is the remedy? Apparently none as far as we can see. The amateur—the ultimate consumer—certainly cannot be blamed for only wishing to buy the very latest and the most up-to-date. You cannot expect him to invest ten dollars in a long wave loading coil that stands six feet high, when he can get the same result with a little concentrated inductance that costs about two dollars. He is not at all concerned that the manufacturer of the aforesaid loading coil may have lost a thousand dollars in the transaction because he has a young carloadful of woodwork on his hands, as well as forms and dies formerly used to make those coils.

It seems to be the penalty of any young art that things take precisely such a turn as pictured here. It was thus in the photographic business when it was young. Until the trade became pretty well established there was no end of styles and no end of changes, and many manufacturers lost a fortune in these transactions. But the art seems to work out its own salvation as always happens.

At the aforementioned meeting, the writer ventured the prediction that the radio business would in time settle down into much the same lines as the photographic business today. The chances are that during the next decade, most of the radio apparatus will be sold by all up-to-date drug stores, the same as photographic cameras and supplies are now. By that time a radio receiving outfit will have been compressed into a space as small as the present-day cameras, pocket cameras not excepted. These outfits will comprise a one- or two-step amplifier, and there will be no fones with such an outfit, but very likely the sounds will come right from a horn similar to our phonograph today, only built along miniature lines. The aerial will probably be of the loop type, collapsible, and made to fit right into the box itself. Such a loop aerial could be extended into its full shape within a few seconds. The vacuum tubes used in the outfit will possibly be even smaller than the ones made now, and described in these columns not so long ago. These vacuum tubes are about the thickness of a fountain pen and are from one to one and one-half inches long. There is no doubt that in time vacuum tubes will be made even smaller.

We have often mentioned in these columns that the small outfit is *the* thing, and we cannot urge manufacturers too much to pay attention to this phase. Amateurs want compact apparatus these days, particularly for receiving. The radio amateur today is considered more or less in the crank class, exactly as the amateur photographer was considered a crank thirty-five or forty years ago. When you can take a neat little box fashioned along the lines of a kodak, set it up in your parlor, and when dance music, originated some five hundred miles distant, begins to pour forth from it by radio, then we can truly say that the hey-day of amateur radio has really arrived. If anyone is incredulous as to the small outfit, the reader's attention is called to our December issue where the first prize was won by a young man who constructed a most marvelously small radio outfit that actually fits into the pocket. That is exactly what we are coming to, and the manufacturer who sees the wonderful possibilities of such a thing first, will do much towards standardizing amateur radio apparatus.

Of course, the large apparatus will probably always be with us, the same as the large photographic camera is with us today. There will always be large apparatus for the laboratory, but they are distinct from the popular apparatus, mentioned above.

What can be accomplished in receiving outfits can also be achieved in sending outfits. It is not at all impossible that we will have a small outfit less than a foot square for sending radiophone messages. As a matter of fact, it has been accomplished already in an experimental way. With the vacuum tube for sending purposes and with a few dry cells or a concentrated storage battery, much that was thought impossible is a reality today. It is simply a matter of designing the apparatus correctly, and taking advantage of every bit of room at hand, just exactly as the portable camera people have been doing so successfully for many years. The battle cry for the next decade should be small portable outfits, the smaller the better. There is no doubt that many fortunes will be made from them.

H. GERNSBACK.

# The Lafayette Radio Station

By the Paris Correspondent of Radio News

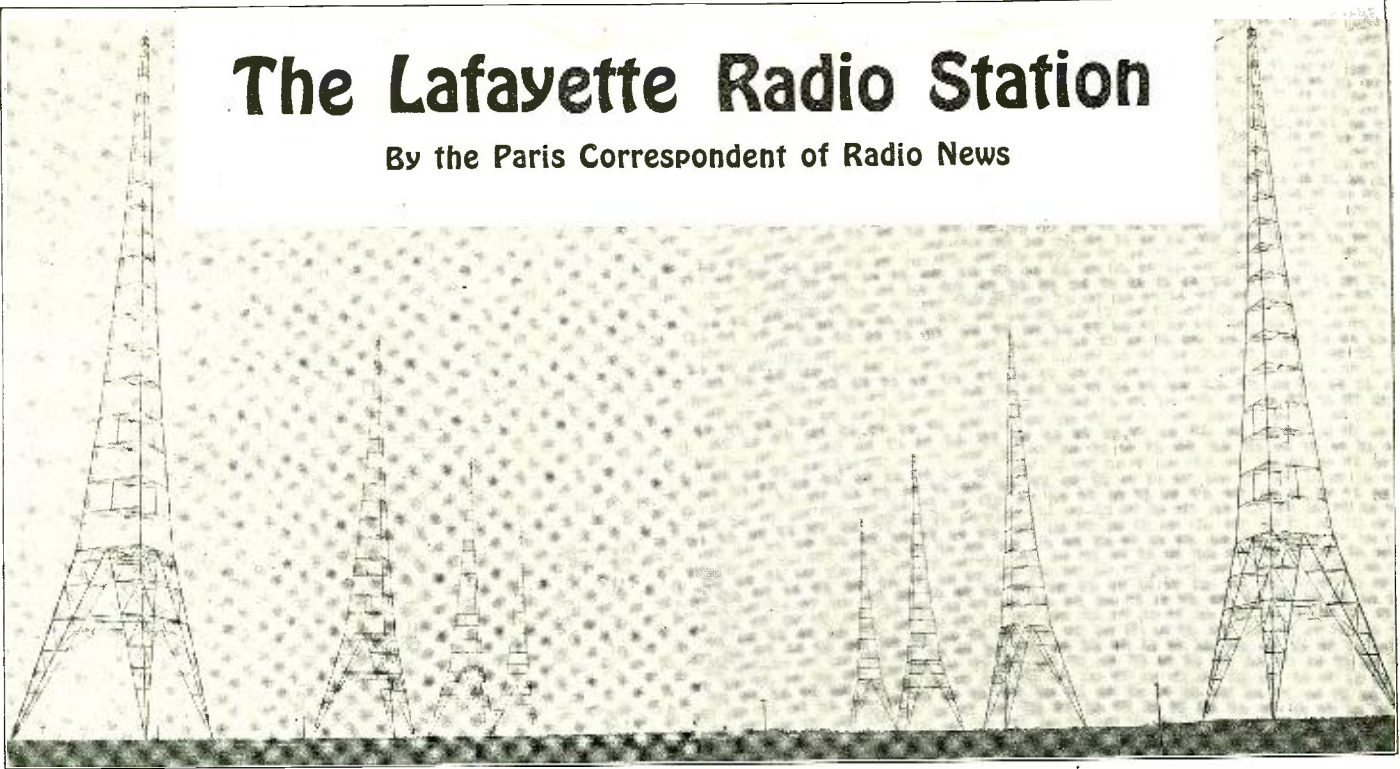

General View of the Lafayette Station Erected at Bordeaux, France. The Eight 835-Foot Towers Were Furnisht and Erected by the American Navy. Note the Building in the Background.

**T**HE Lafayette Radio Station which is erected at Croix D'Hins, near Bordeaux, France, was built by collaboration of the American Navy, and the French Signal Corps, whose well-known chief is General Ferrié. This station, which is actually the most powerful in the world, started its regular service on November 15th, 1920, and great credit must be given to those who conceived and built it. It will remain as another material proof of the Franco-American friendship.

We shall first give a short historical notice on the construction of the station, a description of its different parts, and end by giving the very interesting results obtained up until the present. We shall also discuss the important rôle to be played by this powerful radio station in the future.

Since it was sure at the beginning of 1917 that the U. S. would fight with France, the necessity of a constant radio liaison between the two countries was felt. Cables could be cut by the German submarines, and only radio communication seemed to be safe against any enemy enterprise. The two biggest radio stations in existence in France, immediately started some tests with the American stations. These two powerful radio stations were the Eiffel Tower in Paris, and La Doua Radio near Lyon; Poulsen arcs delivering 40 kilowatts in the aerial were used. The Lyon station gave a better reception, owing to its aerial which was erected in the direction of the United States. During the spring months, the reception of Lyon was as good as Nauen on this side of the Atlantic, but in the summer time, the statics were so strong that it was practically impossible to receive any messages. Even the German stations which used more power had much trouble to secure constant communication.

Since it was necessary to insure liaison between the two countries, General Ferrié offered two solutions: one, to immediately raise the Lyon Towers, which were only 400 feet high, to a height of 670 feet; the other one, which required much more time, was the construction of an ultra-powerful station, delivering 500 kilowatts in the aerial. The aerial was to be of the inverted L type, supported by eight 835-foot

towers. The characteristics given in September, 1917, are those of the actual station today. At the same time it was decided to raise the towers of the Lyon station. As a consequence of this the Franco-American relations were possible in 1918. As soon as the summer came, communication was almost constant, and a great number of telegrams could be sent during the static-less hours of the day.

At the end of 1917, when the construction of the Lafayette station was decided,

General Pershing asked for a station that could communicate with the U. S. at any hour of the day and in any season. It was, therefore, necessary to erect the big station General Ferrié had urged since September. At a meeting of the most prominent radio engineers of the two countries, it was decided that the station would be erected in France, near Bordeaux, and fitted with the most powerful apparatus that could be built at that time. This station, which of course would use undamp waves, would be connected to the aerial designed by General Ferrié, and which has been previously described.

As generators of undamp waves, only the arcs were known at that time. All the French factories were being used for the fabrication of ammunition; the U. S. only was able to quickly furnish the arcs and towers. The part of each nation was then determined. The American Technic furnished and erected eight 835-foot towers of the same type as those used at Arlington Station. It furnished and built two ultra-powerful arcs of the Federal Co., fed by a 1,000-kilowatt motor generator, and delivering 5,000 amperes into the aerial, which had a resistance of 1.6 ohm. The French Engineers designed the aerial, the ground and the buildings and then constructed them; they also had to make the concrete foundation for the towers. This was not an easy job, owing to the soft ground in which they had to be built. More than that, during the construction, it was decided that in the same building, a high frequency Bethenod-Latour alternator of the same power as the arcs would be installed. These decisions being made, the construction started.

During the first six months of 1918, the preparatory work was completed. The work began effectively during the summer of 1918. At the end of October, four of the eight towers were built up to 200 feet. Almost all of the American material had reached France, and it was hoped that transmission could take place as soon as March, 1919, using only four of the eight towers to support a smaller aerial. When the armistice was signed, work stopt, for the station lost its military significance. It was necessary to find a new use for it, and



Photograph of the Memorial Tablet Placed Above the Door of the Lafayette Station.



it was only in February, 1919, after long discussions, that it was decided the Lafayette station would be used for commercial traffic.

The agreement signed by both governments stated that the radio station should be constructed according to the previous plans. The U. S. agreed to sell to the French government all the furnisht material at cost price.

The work started again with greater activity and the eight towers were completed in November, 1919. The arcs and all of the electrical installation were in working order for a local test in January, 1920. During the spring of the same year, the antenna made in three parts was erected. It will be described later.

At last in August, the first transmission with full power was made, very successfully. All the work was conducted with remarkable activity and very competently by an American force of men who have very good standing with the French authorities.

The French post-office to whom the station has been given, has installed a device, allowing the transmission of the messages from Bordeaux; a receiving set with a static barrage device built by the French Signal Corps was also erected in the station. The station was opened on December 18th, which was a notable Franco-American event, showing the unbreakable friendship between the two great republics.

How is this station now, and what results are to be expected from it? Also where is Croix D'Hins? It is a station on the railway line Bordeaux-Bayonne. Sixteen miles southwest of Bordeaux, the earth is very wet and this seems to promise a good ground. In this vast field are erected the eight towers built by the Pittsburgh & Des Moines Steel Co., which can be seen at a great distance.

In front of the towers, which cover a surface of 1,350 by 4,000 feet, is built the station itself, in which are the inductance, the two powerful arcs of the Federal Telegraph Co., and all the electrical machinery necessary to supply the power. In some other little buildings are the work-shop, the stock-room and the quarter for the operators.

Near the entrance is a transformer station receiving the current of 50,000 volts from Bordeaux. Two stepdown transformers of 2,500 kilowatts each, lower this tension to 2,200 volts, which supply the current to the various motors used for oper-

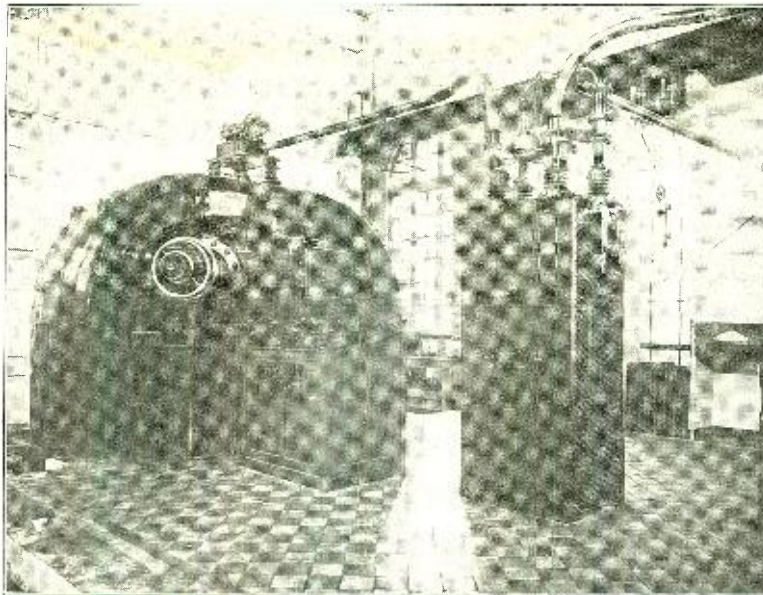

Photograph of One of the Arcs Built by the Federal Co., Delivering 500 K.W. in the Aerial. These Arcs are Supplied With 1,250 Volts D.C. by a 1,000-K.W. Motor Generator and are the Largest Ever Built.

ating the arcs, another transformation lowers this current to 220 volts for the lighting, the motors of the work-shop and other purposes.

If we enter the great building and follow the circuit from the first transformer station up to the aerial, we find a series of

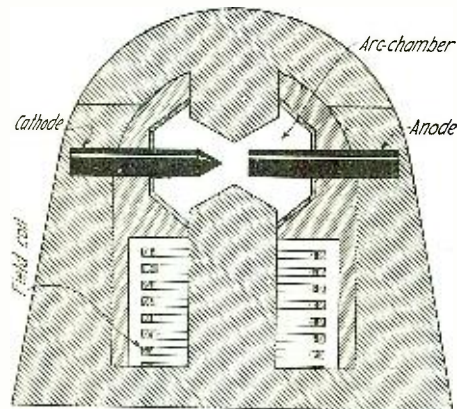

Diagram of the Arc Having a Closed Core and Only One Field Coil.

apparata and machinery that we will now describe.

The largest machines are the generators furnishing the high tension current for the arc. These are 1,000-kilowatt dynamos delivering D. C. at 1,250 volts. They are run by synchronous motors which are fed with

three phase 2,200 volts current. To these machines which are four in number (two in service and two at rest) are added some 30-kilowatt motor generators which furnish 65 volts D. C. for the magnetic field in the arcs, and also some 20-kilowatt motor generators, delivering 575 volts used in the manipulating device; and last, some 5-kilowatt motor generators, delivering 115 volts D. C. for the field of the

20- and 30-kilowatt dynamos. The motors running these dynamos are designed to run with 220 volts, all the other motors running with 2,200 volts.

The 1,000-kilowatt motor generators feed the two arcs which are of the same type and which are the most powerful ever built, delivering 500 kilowatts into the antenna. Figure 5 is a photograph of these arcs, in which only one coil is used to produce the magnetic field. One electrode is made of copper with a water-cooling device, the other one is of carbon; the latter turns slowly. The compartment in which the arc burns is filled with alcoholic vapors, and is cooled by a water circulation.

After the arcs, we see the inductance which is erected in a special room, whose walls are covered with wires forming a Faraday cage. This inductance is made of heavy stranded cable, each wire being insulated from the others. This cable is wound on 12 insulators built on a concrete base; five taps are taken which can be connected at will to the antenna, allowing an easy change of the wave-length.

The total resistance of this inductance is 1/4 of an ohm. At the bottom is the manipulating device, composed of 78 relays, which cut and connect a few turns of a cable not connected to the inductance itself. The opening of this separate circuit causes a detuning of the aerial circuit, and this allows the station to work with a counter wave.

Those 78 relays are controlled in turn by 28 other relays, themselves operated from Bordeaux by another relay, which is actioned by a Kleinschmidt transmitter using a perforated strip of paper for a fast automatic transmission. This device allows the operation of the Lafayette station from Paris.

The aerial is made of 16 wires with a 10-wire lead-in. It is supported by the eight towers which are 1,350 feet apart in each direction. The towers are fixt 2 x 2 by guys supporting a traction of six tons, and which are insulated from the tower by heavy porcelain insulators, furnisht by the U. S. These insulators are 5 feet long and weigh about 400 pounds each. The capacity of such an aerial is about .05 microfarad, its natural wave-length being 8,000 meters.

At the beginning of the construction, the shape of the aerial was discuss at length by French and American engineers.

The latter wanted to use an umbrella

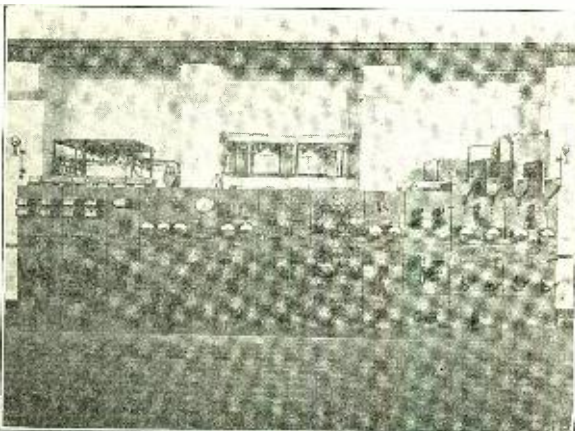

View of the General Switchboard of the Station, With All the Control Apparatus.

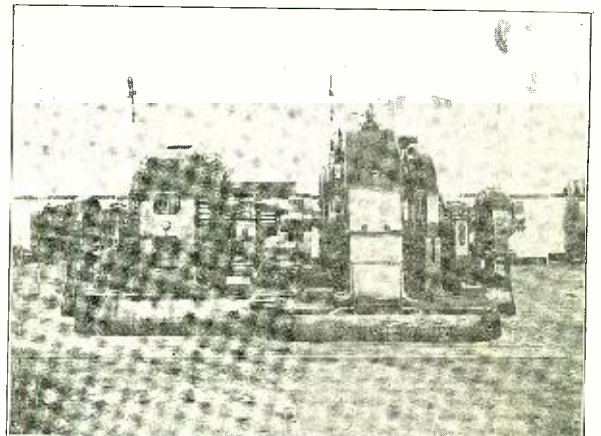

One of the Four General Electric Co.'s 1,000-K.W. Motor Generators Supplying the Current for the Arcs. On the Right is the D.C. Dynamo and on the Left the A.C. Motor.

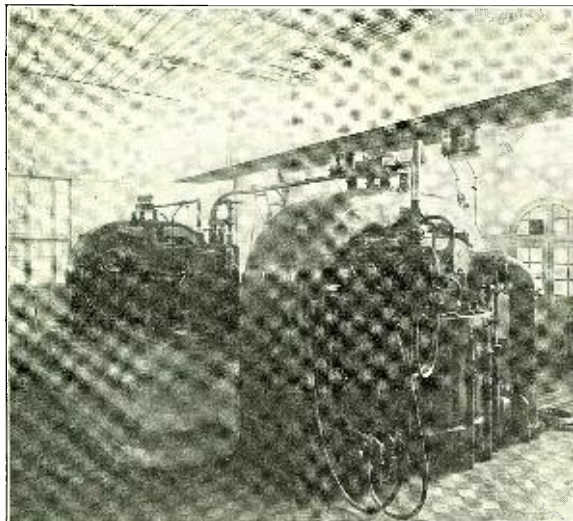

These Two Arcs Used at the Lafayette Station Permit a Continuous Service. Note the Numerous Pipes Used for Cooling the Various Parts.

circumference and are soldered 6 by 6 to copper pipes three inches in diameter and 60 feet long, buried in the ground vertically; all the ground connection is buried about two feet deep. This ground has been connected also to the towers and this lowered the resistance of the aerial circuit about 30 per cent. The resistance of the circuit being about 1 ohm 5, it is possible to put 600 amperes into the aerial.

The results obtained by the Lafayette station are fully satisfactory. Its signals are heard at the most favorable hours by all the receiving stations in the world. It

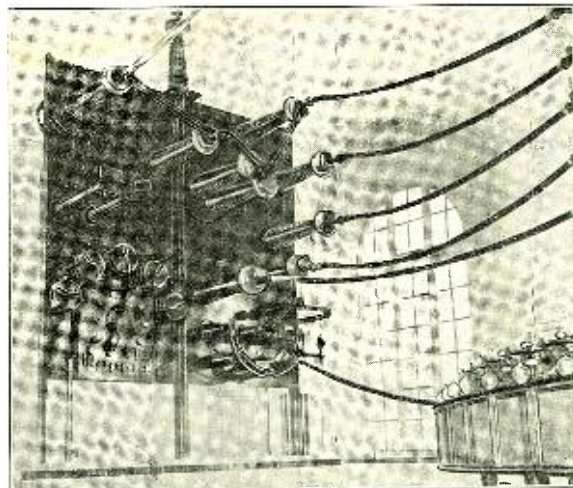

This is the Switchboard for Changing the Wave-Length. The Cables From This Board are Connected to the Big Inductance Shown on the Front Cover of This Magazine.

aerial, using only seven towers, but the inverted L aerial that the French wished to build had already given excellent results, and so was erected in the direction of Washington. The ground is made of 300 sq. ft. of copper plates buried under the arcs. From this plate are soldered in a star shape, 40 copper strips, four inches wide and 200 feet long. A circle made of copper wire is connected to the end of these strips. Then 12 No. 12 B. S. wires are connected to this

is heard 24 hours a day by the American stations. Permanent communication is thus insured with the United States. To the receiving stations of the whole world it will be possible to send messages, during several hours each day and the greater part of the night. This has been proved by the experiment carried out by the American Navy, during the months of August and September.

It can truthfully be said that this station

spreading waves over the world compares in grandeur with the Statue of Liberty on the other side of the Atlantic. Like the Goddess, it will be a perpetual reminder to other nations of the friendship between France and the United States and how they fought shoulder to shoulder during the war, and how their collaboration produced this masterpiece of the peace—the Lafayette Radio Station, the most powerful in the world.

## A Detector and Three-Stage Amplifier for Fifty Dollars

An Instrument Assembled from Standard Parts

By E. A. WHITE and F. L. HOPKINS

THE accompanying photographs, Figs. 1 and 2, show respectively the front and rear views of a neat and efficient detector and three-stage audio frequency amplifier made of the best materials at a total cost of only fifty dollars. The interesting feature of this instrument is that all the parts, including the cabinet, were bot at retail in a finisht condition and then assembled so that with the itemized list which follows, anyone can duplicate it.

**MATERIAL REQUIRED AND ACTUAL PRICE PAID FOR THESE PARTS.**

- 1 Formica panel 9" x 12" x 1/4"..... \$2.00
- 1 Natural finish oak cabinet 9" x 12" x 4".. 6.00
- 8 Federal Tel. Co. amplifier transformers.... 21.30

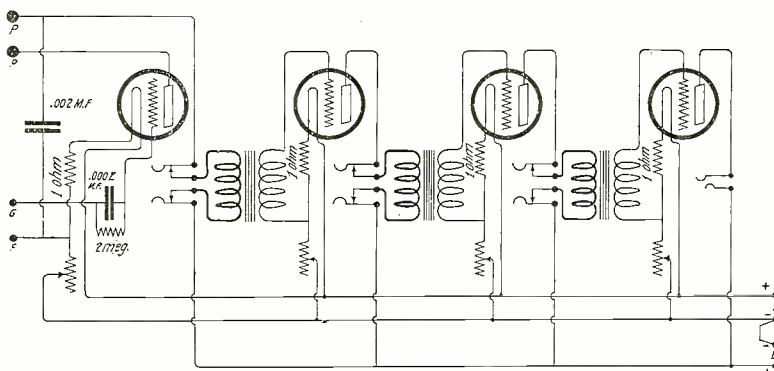

Diagram of the Detector and Three-Stage Amplifier. Note the 1-Ohm Resistances in the Filament Circuits to Provide the Proper Negative Potential to the Grids and the Shunting .002 Mfd. Condenser for the Use of a Regenerative Circuit.

- 4 Federal Tel. No. 36012 jacks at 85c..... 3.40
- 4 Paragon rheostats for back mounting..... 7.00
- 4 Murdock sockets at \$1..... 4.00

- 8 Tresco binding posts at 12c..... .96
- Miscellaneous .... 5.34

- 1 Fixt bridging condenser, .002 mfd.
- 1 Fixt grid condenser, .0002 mfd.
- 1 Grid leak, 2 meg-ohms.
- 1 Formica strip, 3 1/2" x 10" x 1/8" for shelf.
- 2 Small brass brackets of strip brass.
- 16 Small brass machine screws.
- 16 Small brass machine bolts.
- 4 Woodscrews, half-round, nickel-plated.
- Connecting wire, a few feet of No. 10 bare copper.
- Engraving panel as described.

Total ..... \$50.00

of the panel. This makes a much more

(Continued on page 564)

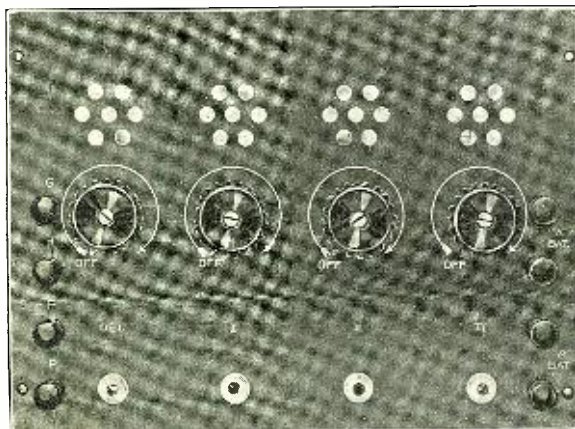

Front View of the Well Planned Amplifier Designed by Mr. E. A. White and Mr. F. L. Hopkins.

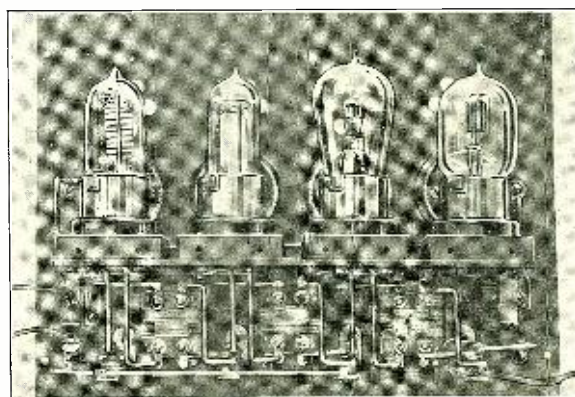

Back View of the Panel Supporting All the Parts. Note the Compactness and Neatness of the Work.

# New German Radio Sets

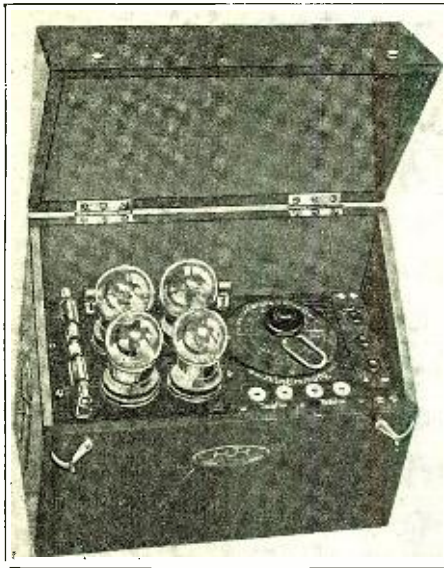

A Very Compact Receiver and Three-Step Amplifier Especially Designed to Receive Time Signals on a Small Indoor Loop Aerial.

SINCE the war, German Radio engineers have developed new instruments, especially C. W. transmitters, a few of which are shown in the accompanying photographs.

Fig. 1 shows a 2-kilowatt set, consisting of three sending units, each of which, according to the requirements and the room available, can be arranged in any desired relation to each other. On the left, the first case contains the high tension transformer, the rectifier along with the regulation organs for regulating the heating current, and the grid circuit. The latter has a solid Glimmer condenser and a self-induction variometer, which can be tuned up to given wave-lengths by means of a knob on the outside, and a scale directly calibrated for wave-lengths. The scale of the grid circuit has two divisions, the smaller going from 300 to 600 meters and the larger from 600 to 1,500 meters.

The middle case contains four power tubes in its upper part, all connected in parallel. The heating

of the four tubes and of the rectifier is done by A. C., so that only a single source of power such as a 500- or 600-cycle machine of about 2½ k.w. is necessary. In the lower part of the middle case there is a block condenser, such as previously described; also the heating transformer, which by three independent secondary windings gives the heating current for the rectifier and power tubes; the regulating apparatus; the hot wire ammeter, used for the control of the heating current, and finally the so called compensation transformer.

This transformer is so designed that the filament current is kept constant in spite of the changes of load which happen when the key is pressed.

The third cabinet contains, finally, the antenna coil constructed as a variometer, a transformer for the shorter wave-lengths, as well as the coupling and wave connections.

Fig. 2 represents a complete 1-k.w. set. The transmitter is of the same type already described but is contained in only one cabinet. On the right of the photograph is the receiver and fixed on the wall is the control panel. Under the table is the 1,000-watt motor generator supplying power to the transmitter.

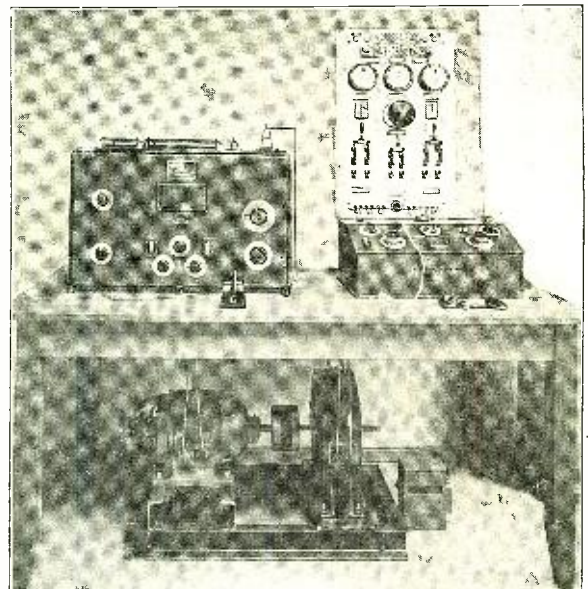

Fig. 2. A Complete 1 K.W. Undamped Wave Set. On the Right is the Receiver and Under the Table the H.T. D.C. Generator.

control panel. Under the table is the 1,000-watt motor generator supplying power to the transmitter.

The photograph, Fig. 3, shows a very sensitive receiver of unique design and absolutely foolproof. It is designed especially for reception, by amateurs, of time signals on a loop aerial four feet square. The receiver, which is tuned by merely adjusting the variable condenser, is hooked up with a V. T. detector and 3-stage amplifier, making possible the reception of signals at a great distance from the big stations sending the time signals, press and weather reports.

The amplifier requires no adjustment at all; a small switch is simply turned on to light the filaments which are connected in series with small fixed resistances of the correct value, insuring the maximum sensibility.

Everything is contained in the receiver set except the loop aerial and batteries.—Photos courtesy of Dr. Erich F. Huth.

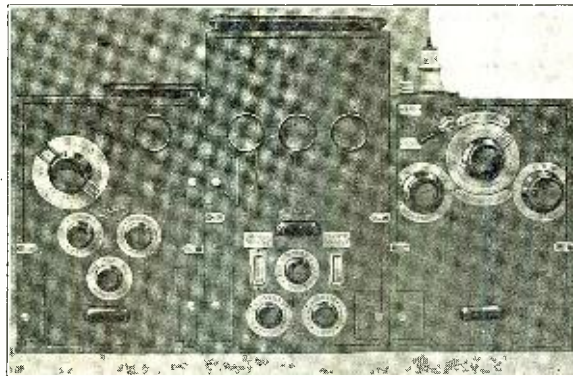

Fig. 1. Here is a 2-K.W. C.W. Transmitter Equipped With Four 500-Watt Tubes. The Three Cabinets From Left to Right Contain the Rectifier, the Power Tubes and the Wave-Length Control.

## A Unique Vacuum Tube Control Panel

THE family of the vacuum tube control panels has annexed a new member, which in fact is very good looking and fitted with the latest improvements. A photograph of this new instrument appears on this page and, as can be seen, it may be fixed on any type of receiver or used separately.

The connections are such that the tube may be used as a detector with any tuner, or as an oscillator. Used in conjunction with an amplifying transformer, this panel allows an accurate control of the amplifying tube.

On this panel unit, the base of which is made of moulded black "condensite," are fixed a mica grid condenser of the proper value, an adjustable grid leak, a rheostat, a standard socket and 9 binding posts. The connections made in the base are shown in the diagram, Fig. 2.

The rheostat is particularly well made, and wound on an insulating core. The special wire is wound in such a way that it cannot be short circuited neither will the

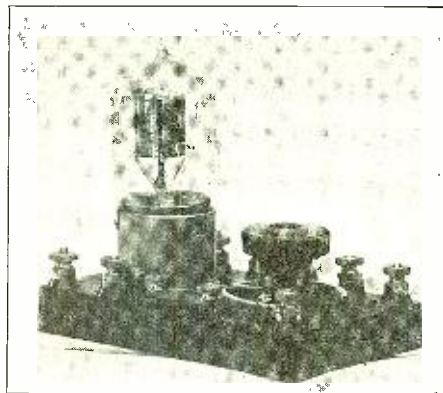

A Very Efficient Instrument of a New Design, More Compact Than the Other Type of V.T. Control Panel. It is Made of Insulating Material and Moulded in One Piece.

turns loosen when used. The resistance of the unit is 6 ohms and its current carrying capacity 1½ amperes.

The grid leak of the pencil mark type can be easily varied by the operator to suit the characteristics of the tube used, it being necessary to provide sufficient low resistance to enable excessive grid charges to leak off and thereby prevent paralyzation of the tube. The grid leak should be adjusted by drawing lines across between the two binding posts with a soft lead pencil or India ink until the proper resistance value is obtained. A tickler coil may be connected for regeneration or reception of undamped waves at will.

The amateurs will certainly be interested in this new apparatus which can be incorporated in any circuit and which measures only 5" x 3¼". All metallic parts are heavily nickel plated and this unit will be found very useful, especially in the portable sets, owing to its compactness.—Photo courtesy Adams Morgan Co.

# Awards of \$100 Portable Radio Prize Contest

## THIRD PRIZE WINNER

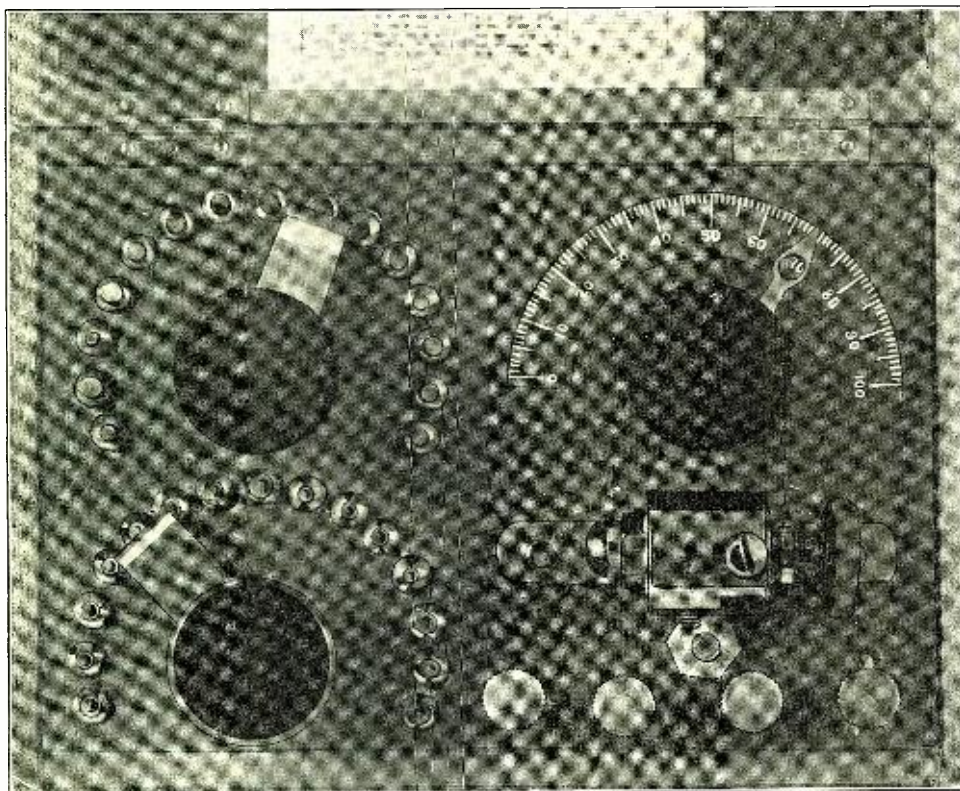

Full Size View of Mr. Toran's Portable Receiver. This Little Set is Fitted With a Small Variable Condenser Which May Be Seen in the Upper Right Hand Corner and a Steady Contact Detector, Which is Particularly Useful in this Kind of Receiving Set.

**Editor's Note:**

We are pleased to present this month the portable set, which has been awarded the third prize in our portable receiver contest.

This set, which was built by Mr. Robert I. Toran, of Cambridge, Mass., is really an efficient instrument. It was tested in the laboratory of RADIO NEWS and found to be very good, a great number of amateur stations being heard as well as several ships at sea.

The new feature in this receiver is the steady contact crystal detector, which is now as extensively used as it should be by the amateurs. The crystal used has a flat face on which is pressed a thin mica washer; the contacts on the crystal are made in several points by a rack like piece, which is shown in the diagram, Fig. 2, and which

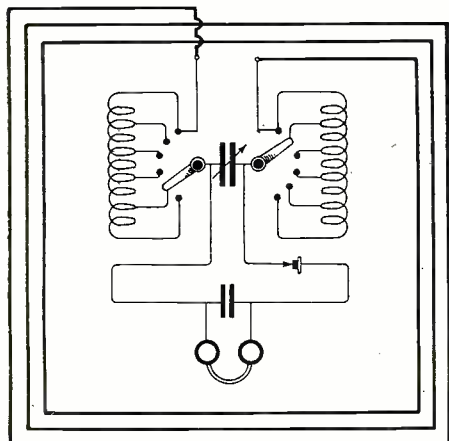
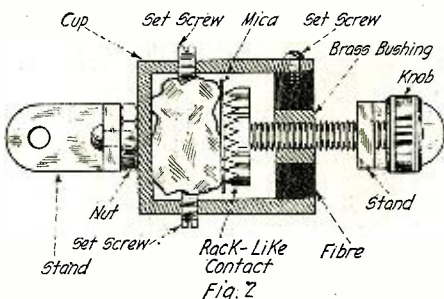

Fig. 3

Connections of the Set When Used With a Loop Aerial.



Inside View of the Steady Contact Crystal Detector Used in the Portable Set. Note the System of Contact on the Crystal.

may be firmly applied on the crystal by means of a screw. When fixed, the sharp points of the rack just drill a small hole thru the mica washer, thus making steady contacts on the galena. This type of detector, when adjusted cannot get out of order and it is very convenient, especially in a portable set.

On a two-wire L aerial, 60 feet long and 60 feet high, the reception is very strong. The hook-up used by Mr. Toran is an exceptionally good static eliminator and permits quite a sharp tuning.

We extend our congratulations to the constructor of this well planned little receiver, a description of which is given below by Mr. Toran himself.

**A PORTABLE RECEIVING SET.**

By Robert I. Toran.

This portable set is entirely home-made and consists of a spool 2 3/4" in diameter by 1 1/4", wound with a primary of 250 turns of No. 26 wire, taking 10 turns each for the first five points, 15 turns each for the next five points and 20 turns for the last five points. The secondary is wound the same way.

A variable condenser, also home-made, consisting of 17 plates 2" in diameter, is shunted across the primary, and a fixed condenser, made of three strips of tinfoil 10" long and 1" wide and sealed in wax, is connected across the fones.

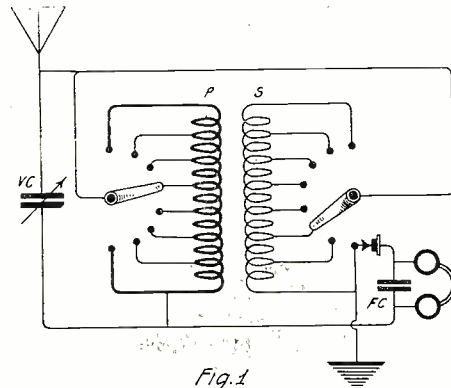

Fig. 1

Diagram of Connections in the Receiver Designed by Mr. Toran. This Hook-up is a Very Good Static Eliminator.

The permanent detector, which is of my own design, is shown in Fig. 2.

Several points of contact are obtained on the crystal by means of a special piece fitted with conical protuberances, applied on the flat face of a good crystal of galena, thru a piece of thin mica. When compressed the sharp tips of the cones pass thru the mica, making contacts of very small surface as a cat whisker would, but with the great advantage that it doesn't get out of order. The pressure is adjusted by means of a screw. The hook-up of this is somewhat novel and I have not seen it duplicated as yet. It was discovered by me while making experiments with different hook-ups.

The tuning of this set is extremely fine and the variable condenser, shunted across the primary as shown in the diagram in Fig. 1, eliminates any undesirable messages coming in, while listening for a particular station.

The aerial consists of 20 feet of six fine threads of wire and is enclosed in the core of the spool when not in use.

(Continued on page 570)



Photograph of Mr. Robert I. Toran, Who Designed and Built the Little Portable Receiver Which Was Awarded the Third Prize.

# A New 2-K.W. Panel Transmitter

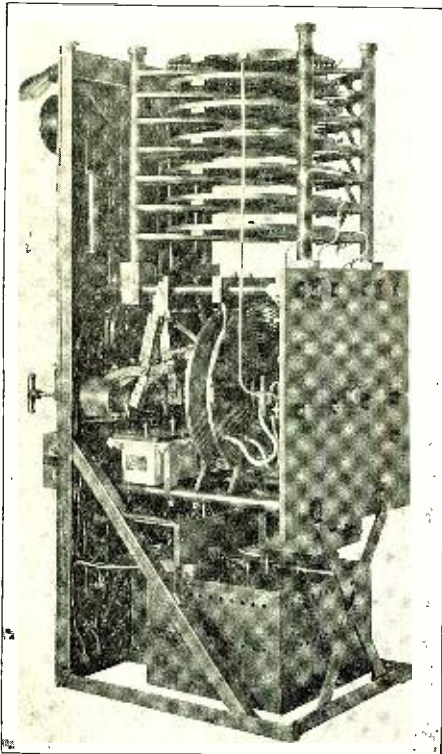

The Upper Photograph is a Rear View of the Transmitter, While the Lower One Shows the Control Panel From Which All Operations in the Set are Effected.

The photographs reproduced here depict a new type transmitter, which represents a decided advance in radio transmitter design. The development of this transmitter has just recently been completed. The striking feature of the equipment is the Priess-Barth magnetic wave changer which permits remote control of the transmitter, and allows the operator to shift instantaneously to any one of four different wave-lengths.

The transmitter can be adjusted for any four wave-lengths up to 2,000 meters. Complete control is obtained by a small desk panel shown in photograph. This panel controls wave changing mechanism, starts and stops the motor generator, or permits continuous running of the machine as the operator desires, operates the magnetic antenna transfer switch, and is equipped with small and large keys for current thru a relay key or direct. This transmitter requires no more space than present designs now in use, and in several instances requires considerably less.

The time required to shift from one wave-length to another is approximately one-quarter of a second, so for all practical purposes this shift is instantaneous. It is believed that the use of this transmitter in commercial work will greatly speed up the handling of traffic.

This remote control system has been carefully studied and it has proved absolutely constant in operation avoiding all troubles for the operators who have to give very little attention to keep this transmitter in good working order.

The quenched spark gap, which is built in sections, has a large cooling surface and does not heat even when constant heavy traffic is handled. It does not require frequent cleaning as is the case with most of the quenched gaps actually in use.

The complete transmitter is built on the panel, making a compact unit, and only the small wave-length, manipulating control panel, and the motor generator are located elsewhere, in the operating room or in the most convenient place.

The wave-length may be changed by hand, simply by pulling one of the four handles in the middle of the panel, making the necessary connections on both the O.T. and the aerial inductances which are of the pancake type.

*Photos courtesy Wireless Specialty Co.*

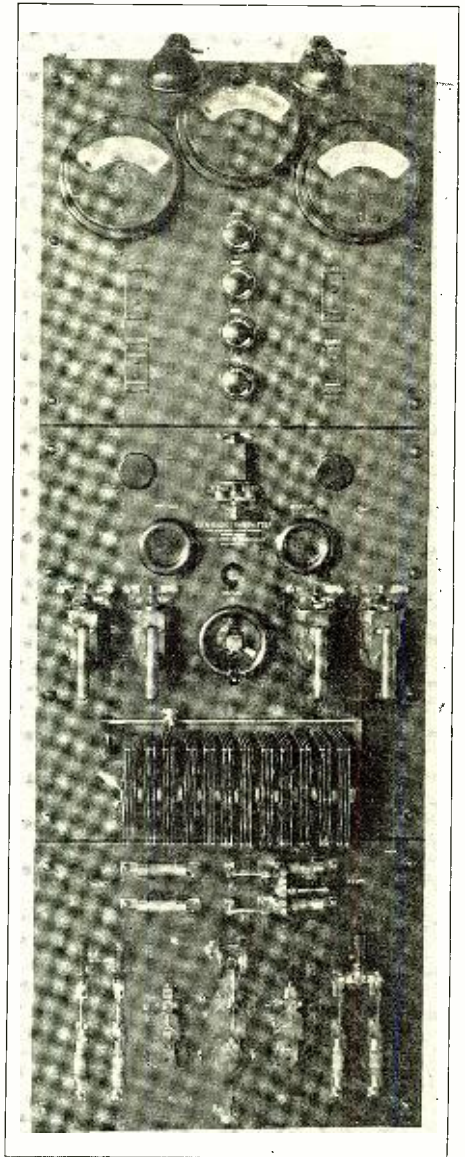

Front View of the New 2-K.W. Set. Note the New Quenched Gap Built in Sections and the General Arrangement of the Panel.

## New Amplifying Transformers

Two new models of amplifying transformers of which photographs appear on this page, have recently been developed by two well known firms, who have already specialized in the construction of very efficient receiving apparatus and amplifiers. These transformers, if they are not yet, will soon be placed on the market. As can be seen, there is a great difference in size between the two models, one of which is English make, while the other is manufactured by an American concern.

The small one which is only 2" x 2" weighs about three ounces and is especially useful in portable sets since it saves space and weight. The big one is about 4½" square and weighs about four pounds; it is enclosed in a cast iron case and fitted with heavy binding posts. It is absolutely weatherproof and the metallic case may be connected to a point of the circuit to avoid

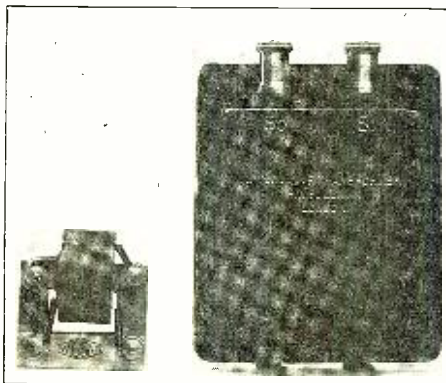

In Spite of the Difference in Size These Two Transformers Give the Same Results.

capacity effect which may occur when the transformer is used in regenerative circuits.

In order to know what results could be obtained with both of these, they were tested in the laboratory of RADIO NEWS with various tubes, including Western Electric's.

Altho it seems that the results should be better with the larger type, it has been found that the ratio of amplification is the same in both, the smaller transformer, however, giving a clearer note.

This interesting experiment shows that it is not necessary to use such large sizes of transformers in an amplifier since the little American model gives the same results. In designing this newest model the American radio engineers were successful in getting rid of cumbersome and heavy instruments still in general use in Europe.

*Photo Courtesy Pacent Co.*

# A True Undampt Wave Receptor

By ERNEST C. MIGNON

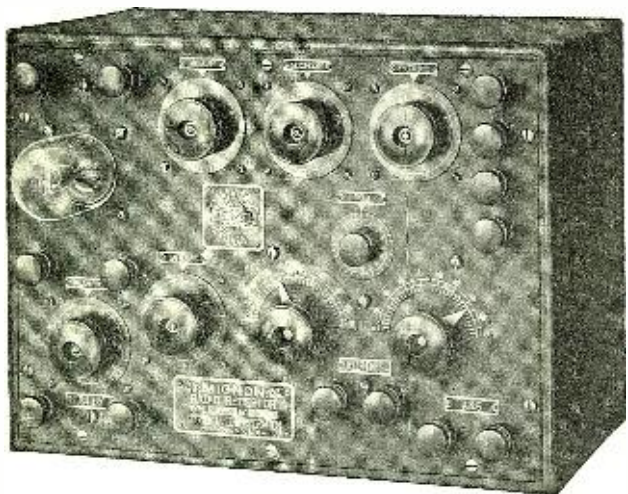

A Compact Receiving Set for the Reception of Undampt Waves Only Embodying Electro-Magnetic Field Control.

THE accompanying photograph illustrates the compactness of this receptor, the size of the cabinet being 12" x 9" x 6½". The instrument receives undampt wave signals only. No loose couplers, vario-meters, loading coils, etc., are used in this cabinet.

Figure No. 1 gives the general layout and schematic diagram of the set, showing the undampt tuner consisting of three ring type coils of equal capacity, wound with No. 32 D.S.C. magnet wire. These coils are placed edgewise to each other, the "clover leaf" way, as a true undampt wave receptor requires only a remarkably small coupling inductance, but considerable self inductance.

These inductances are adjustable to the finest degree by the use of a magnetic field control, attached to one of the two closed circuit coils. This control consists of a metallic ring of variable circumference or surface and controls the electro-magnetic field of the undampt tuner.

This control or variable short circuiting device, simple as it may seem, is one of the most important improvements in undampt wave reception, as it enables the operator to tune out interference by signals of almost the same wavelength as the one he desires

to read. All three coils are physically or metallically inter-connected.

It may be well to state that this receptor has absolutely nothing in common with the ordinary type in general use, which consists of Primary, Secondary and so-called tickler circuits. These tickler circuits are not required in this receptor as it is an instantaneous and permanent oscillator. It can be depended upon to bring in every signal emitted by any undampt transmitters, clearly and distinctly, including transatlantic signals of any wave length now in use. Dampt wave interference is impossible. Static and other noises are considerably eliminated.

The condenser is of the

variable duplex type preferably of a ferrous metal.

It is the opinion of the inventor that it will be impossible to build an undampt wave receptor that will receive dampt wave signals as well as one of the standard dampt wave receptors, since they function on two distinctive principles.

In general practice it is customary to tune in arc signals on the common dampt wave receptor by simply adding large enough inductances and by changing one of the tuner leads in the plate and phone circuit, causing an oscillating circuit of a freakish and unreliable nature. Such an arrangement permits both dampt and undampt signals to come in together with strong electrostatic interferences especially during the summer months, rendering the reception of clear and distinct signals a difficult task.

\* Photo by courtesy of Mignon Mfg. Corp.

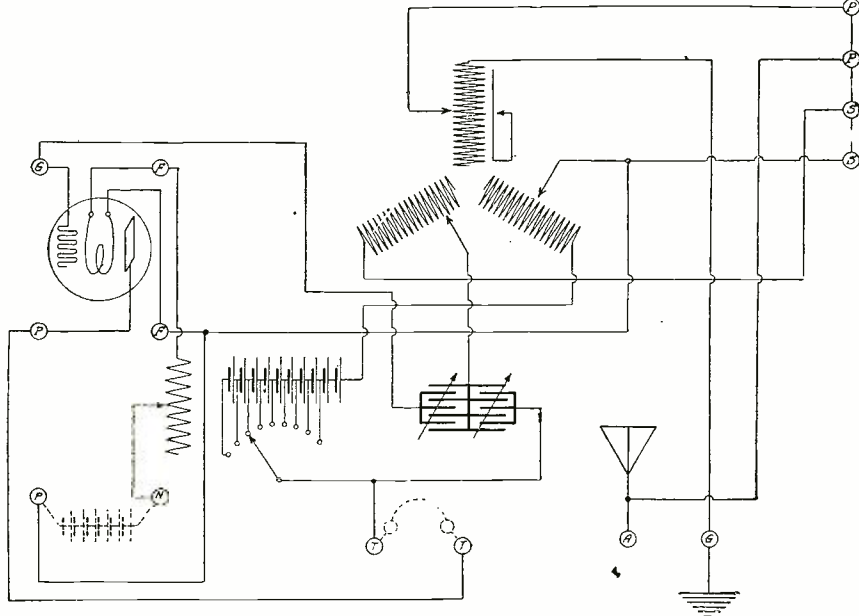

Fig. 1. General Layout and Wing Diagram of the True Undampt Wave Receptor Described by Mr. Mignon.

## "A Word to the Wise Is Sufficient"

The U. S. Government receives many complaints from different sources, especially from foreign governments, regarding the great amount of interference caused by American ships and stations not complying with the rules for the method of calling as shown in the proceedings of the Radio Telegraph Convention, London, 1912.

The majority of operators very seldom confine their calls and signs to three (3), as called for in Article XXV of the proceedings, as nearly everyone signs off with "AR" or "K," which is uncalled for. By careful reading of Article XXV you will see that no sign-off is necessary other than the call letters of your own station made three times. The station called, in answering, calls the same way, but uses the letter "K" to signify they have heard and are ready to receive. When actual communica-

tion has been established between two stations the signals "AR" and "K" can be used as set forth in Article XXXI.

*Editor's Note to Commercial Operators: Boys, our heart is with you. We congratulate you on the excellent progress you have made in recent years towards the betterment of your living and remunerating conditions. We believe it is due you who sail the seven seas and who are helping make the U. S. Merchant Marine a success. We want to see you advance in every way. But, above all, take your profession seriously and operate like professionals. Learn well and strictly follow the "Rules of the Road." Take unto yourselves the serious purpose and intent of those two excellent guides, "Commercial Traffic Regulations" and "Radio Communication Laws of the U. S." Digest them well. Most operating com-*

*panies furnish them to each ship station as part of the equipment. If you have not a copy of either book Uncle Sam will mail you "Radio Communication Laws of the U. S." by writing to the Government Printing Office, Washington, D. C. The price is fifteen cents per copy. Better yet, your local radio inspector will furnish you with the book.*

### DIRECTIONAL FORECASTING OF WEATHER BY RADIO.

Radio is now used by the official weather prophet in England. By means of directional equipment at two listening-in stations the exact position and track of a thunderstorm can be quickly calculated.

Warnings are sent out to farmers and others directly interested in the weather at six cents per message.

# A New Type of "B" Battery

By HARRY BOYCE, Jr.

**I**N the operation of an Audion receiving set, the "B" Battery is one of the most important points and in this article I am going to describe one I made several months ago, and which is the most successful I have ever used. The cost of building is not excessive, and the maintenance cost after it has been constructed is practically nothing.

The one feature of this battery, which marks it as being different from others of the same type using the same solution and test tube design, is the incorporation of plugs and jacks, by means of which the battery may be charged at a relatively low rate, yet discharged at sixty volts or more, according to the number of test tubes used.

### CONSTRUCTION

The battery itself is composed of 30 test tubes whose dimensions are 1" by 6"; this number is sufficient for a sixty volt battery. After a rack has been made, these tubes should be grouped in sets of five, making six groups. If the voltage is to be increased, more tubes should be added, but always in sets of five, each set giving an increase of ten volts. Also a corresponding number of plugs and jacks must be added to take care of the additional cells.

Any amateur can construct a suitable rack for the tubes, but I am including dimensions of the one I used for the sake of those who lack the time to figure out the details. This rack was primarily designed to hold fifty tubes, but by leaving the 20 holes vacant, the tubes are nicely spaced, and necessary room is also provided in case an addition should be made. However, if the builder wishes to provide space for only 30 tubes, 15 on each side, he should alter these dimensions accordingly.

For the base use a board  $\frac{1}{2}$ " x 6" x 3'. About 1" from each end secure two uprights  $\frac{5}{8}$ " x 4" x 6". Each of these two uprights should have two grooves about  $\frac{3}{8}$ " wide and  $\frac{3}{4}$ " deep, cut in about  $\frac{1}{2}$ " from each end. For the supporting crosspieces use two boards each  $\frac{3}{8}$ " x 4" x  $32\frac{5}{8}$ ". Divide both lengthwise with a pencil line into two equal parts, and on each side of this line bore twenty-five holes 1" in diameter. Place these two boards in the grooves of the end pieces and then fasten the latter to the base. After completion the rack should be painted, any good stain will do, and when dry given a thoro coat of hot paraffine to insure perfect insulation and to prevent leakage.

Now procure 50 lead strips  $\frac{1}{8}$ " x  $\frac{11}{16}$ " x 13". These strips may be wider and thicker than the dimensions, but should not be narrower or shorter. Brighten both sides

Photograph of the switchboard and storage "B" Battery built by Mr. Harry Boyce, Jr. This may easily be duplicated by the amateur to supply the H.T. to the V.T.'s of either the transmitter or receiver. It is a very economical way to obtain D.C. and get rid of the dry batteries.

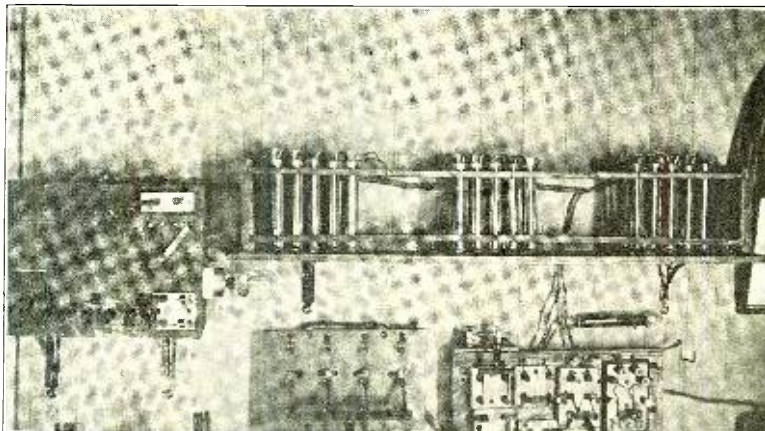

and edges of each strip with emery paper. This is a rather tedious job, but may be facilitated by attaching the emery to a rotary gap motor. Then with a sharp knife cut slits crosswise in the surface of the lead. Run these lines both directions and on both sides of each strip, so that the acid may have the best possible surface to act upon.

Cut six of the strips in halves, for the end plates of the six sections, and drill a small hole in one end of each to be used for connection. Bend the remaining strips in the shape of a U and insert one leg in each tube, thus eliminating connection between cells. As stated before, after completion of this part the 30 tubes should be divided into six sections with five tubes in each section, the purpose of which will become apparent in another paragraph.

For the solution to be used in the tubes, dilute pure sulphuric acid with water until its specific gravity becomes 1.210. Always pour the acid into the water. The gravity should be tested with a hydrometer. Fill each tube within  $\frac{1}{2}$ " of the top, and pour a thin film of oil on top of the acid to prevent evaporation. I experienced a slight difficulty in keeping some of the plates apart, especially the end plates, and to overcome this I placed pieces of glass  $\frac{1}{8}$ " x  $\frac{3}{4}$ " x 5" between them.

The next part to be constructed is the charging unit. This battery is intended to charge in multiple and discharge in series, thus allowing it to be charged with a much lower rate than usual, with consequent better service. To accomplish this, a system of plugs and jacks is used. Procure six two-contact plugs and jacks, four of the latter having a third point by means of which they are short-circuited when the plugs are removed. If this type of jack

cannot be procured, bend the two contacts so that they are shorted whenever the plug is removed. As indicated in the accompanying diagram, when all the plugs are out, jacks 1 and 6 are open and the other four short-circuited, which places the entire battery in series, the manner in which it discharges. These jacks should be mounted in a box of some kind, large enough to hold the plugs and the slack cord attached to them when they are not in use. Holes should be bored about six inches below the jacks for the plugs. A D.P.S.T., S.P.S.T., and a 5-point switch should also be mounted on the front of the box, numbers 8, 7 and 9 in the diagram.

All connections on the jacks, plugs, tubes should be thoroly soldered to prevent leakage. Also the conductor wires and the inside of the box should be coated with paraffine.

Any good kind of paired wire may be used to connect the jacks to the tubes, providing there is some convenient manner of distinguishing between the positive and negative sides. I used No. 22 flame-proof jumper wire which I secured from the local telephone office. It has one white and one black strand, the white always being the positive and the black the negative side. If the battery is to be made successfully, the polarity of the wires must be closely watched, or the battery will be a failure. The easiest way to remember is to always keep the tips of the plugs and jacks positive, connecting the latter with the white or positive strands of the conductor wires, and the sleeves negative, using the black strands. The tipside is the front contact, and the sleeve the rear contact. The best method of wiring is to number each jack, place the corresponding number on a small piece of cardboard and fasten this to the pair terminating in that particular jack. Then the sets of tubes should be numbered the same way and each pair of wires brot to the proper set of tubes. This will become a great deal clearer upon a close study of the diagram. If the diagram is closely followed, the builder should have no trouble in connecting the different parts correctly.

Now as to the charging power: Each cell is to receive 2 volts, 3 amps., and if the following directions are followed, either of two charging rates may be used, these two being 10 v., 3 amp., or 20 v., 6 amp. If the first of these is used, they are charged six sets of five each in multiple, and if the second is used, they are charged three sets of 10 in multiple. The following three paragraphs explain how this is done, and how the discharge is arranged:

(Continued on page 577)

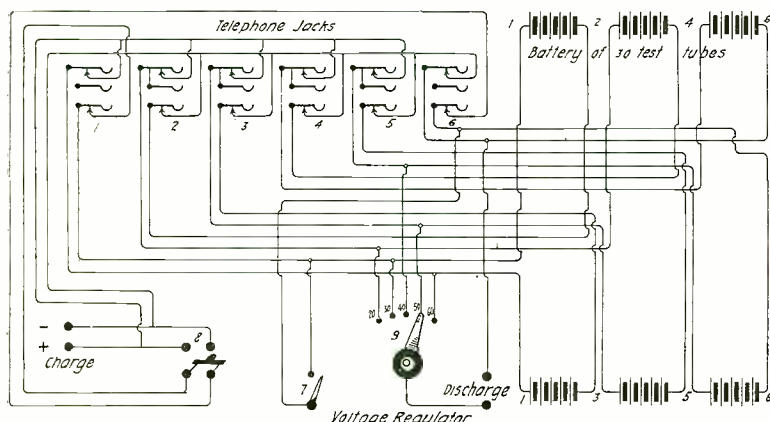

# Two Practical Radio Telephone Circuits

By JOHN SCOTT-TAGGART

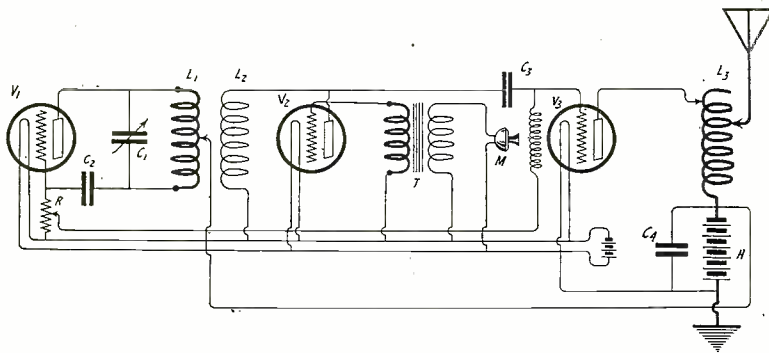

Fig. 1. A very efficient radio-telephone circuit in which a master oscillator is used in conjunction with an amplifier and modulator tube. The same A and B batteries are used for all tubes.

**T**HE subject of radio telephony is coming so much to the front that it needs no introduction in articles giving accounts of apparatus which has proved successful in establishing communication over comparatively long ranges, as for example a distance of 300 miles.

The principles on which the circuits here described are based, are at this date not new, but the circuits themselves will, no doubt, be of interest to those whose knowledge of the subject from a practical point of view, is not extensive.

Both the circuits employ the principle of using a three-electrode valve as an amplifier whose output circuit is coupled to an aerial system. This use of the valve is an obvious development of the high frequency amplifying properties of the triode vacuum tube, and the arrangement is frequently employed in radio telephone work.

The circuit of Fig. 1 depends for its action on the use of a three-electrode valve as an absorbing element connected across the input side of an amplifying tube. If steady, continuous oscillations are induced into the grid circuit of such a tube unmodulated amplification takes place. If, however, we cause the microphone in conjunction with another valve, to divert some of the oscillatory energy in a manner proportional to the microphonic potentials, the E.M.F. of the oscillations, in the grid circuit will vary. Consequently, the oscillatory circuit in the aerial will be correspondingly modulated.

In Fig. 1, the vacuum tube  $V_1$  acts as the primary course of continuous oscillations or, as it is sometimes called, the *master oscillator*. The circuits shown for this oscillator are rarely used in England altho they have been frequently employed in France and the United States. A single inductance coil  $L_1$  is shunted by a variable condenser  $C_1$ , and the frequency of the oscillations produced is practically equal to the natural frequency of this single circuit. A tapping is taken from about the middle point along  $L_1$  to the anode or plate battery or D.C. generator H and thence to the filament. The condenser  $C_2$  is the grid condenser.

The grid leak R has a value of about 10,000 ohms. It should preferably be wound with resistance wire and have tap-

pings. When such a system oscillates, the grid at every positive H.F. half-cycle absorbs an electron current of several milliamps which results in a comparatively steady potential drop along the resistance R. This potential drop gives the grid of the first valve a suitable negative operating potential.

The oscillations in  $L_1$  are now passed on to a coil  $L_2$ , constituting the grid input circuit of the amplifying tube  $V_2$ . The condenser  $C_3$  acts as a blocking condenser. The grid of  $V_2$  is connected thru a choke-coil Z to a point on the grid leak R of the first valve. A suitable negative potential is in this way communicated to the grid of  $V_2$ . The choke-coil Z is to prevent this potential communicating circuit shorting the oscillatory current in  $L_2$ . The coil Z is preferably an air-core choke of high inductance. Its natural period of oscillation should preferably equal the frequency of the oscillations supplied by  $V_1$ . Under these conditions, the choke will have a maximum impedance. Auto-transformer connections are shown in the anode of plate circuit of  $V_2$ . The tapping from the anode to the coil  $L_3$  enables the output impedance to be varied and the maximum power to be obtained. The tapping from the aerial will vary the tuning of the aerial circuit which, of course, should correspond to the oscillation frequency employed.

The circuit, so far considered, would act as a continuous wave transmitter and a key might be inserted so as to break either

(Continued on page 552)

Fig. 2. In this circuit using only two tubes the output of the amplifier is controlled microphonically and gives a clear modulation. An experimental set of this type may easily be built by the amateur.

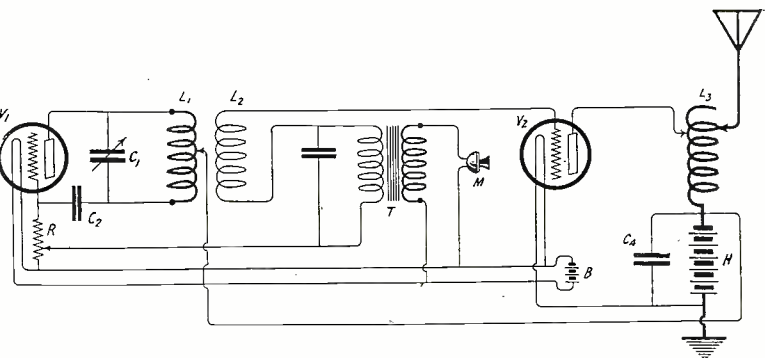

# How to Wind Duo-Lateral Coils

By WM. T. PRATHER

**A**S is well known, the difference between honeycomb coils and duo-lateral coils is in their winding. In winding honeycombs, consecutive layers are spaced so that the turns of the second layer fall directly over the turns of the first layer, while in the duo-lateral wound coils the turns of the second layer fall over the space between the turns of the first layer. The turns of the third layer then fall di-

rectly over those of the first layer and those of the fourth layer over those of the second and so on. Like honeycombs these coils may be wound around pins fixt in a tube, but in the case of the duo-laterals twice the number of pins must be used.

First purchase a two-inch mailing tube from a bookstore. Make a wooden dowel to fit into the tube or, if the tube has fairly thick walls, this will not be necessary as the pins will be held firmly enough by the tube. Next determine the position of the pins.

For a tube  $1\frac{7}{8}$  inches in diameter 96 pins are needed, 48 on each side. An easy method of dividing the circumference into the desired number of spaces is shown in Fig. 1. Draw a rectangle whose length is the exact circumference of the tube and whose width is the width of the coil to be made. In this case it is one inch. From one corner draw a line as shown and mark

off 48 equal spaces on it with a ruler or compass. Connect the last mark with the corresponding corner of the rectangle. When lines parallel to this line have been drawn from the equally spaced marks to the bottom of the rectangle and lines continued from these marks have been drawn across the rectangle as shown in the figure it will be found that the rectangle has been divided into 48 equal parts. This method will serve for any size rectangle to be divided into any number of parts.

The drawing is then placed on the tube and the pins put in their places. By winding the coil at one end of the tube the remainder will serve as a handle while winding. Start the winding by taking a turn around one of the pins. Then lead the wire around the 25th pin on the opposite side, then back to the second pin on the first side, then to the 24th pin on the other

(Continued on page 553)

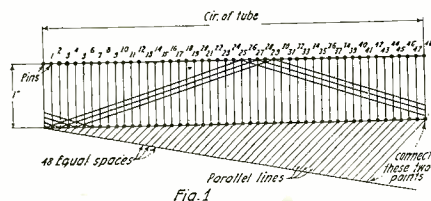

For the Ham Who Builds His Own, But Has No Winding Machine, Here is How to Wind Duo-Lateral Coils by Hand.



# Amateur Radio and Its Future

BY PIERRE H. BOUCHERON

**T**WELVE years ago while traveling on one of the New York "L" lines I gazed for the first time upon one of the few amateur aerials in New York City. Alas, my doom was sealed and the next day I was stricken by the violent sting of the "radio bug."

Back in those "early ages" of amateur radio there was something like five or six stations in New York City. Indeed, they were few and far between. Perhaps some of you may have heard of these pioneers. There was Vermilyea who signed "VN," Cannon who signed "CC," Eltz who signed "GE," Lemmon, Runyon and the dear old "Dad of Radio," Dr. Hudson, who died recently.

Amateur radio lost a great friend, for he had been intensely interested in this

subject up to the time of his unfortunate death.

Amateur radio of 1907-1908 was of an entirely different aspect from the radio of today. There being so few amateurs in the United States they were not considered very seriously by the authorities for neither the Navy nor the commercial companies had enough stations in operation to bother about the use of special non-interfering wave-lengths.

Those were indeed the good old days of radio. The ether was used in a happy-go-lucky fashion with no thot of tuning or bothering about the decrement and the larger amount of power available the better. If one had a thousand dollars or more to spend for a transmitter, very well, it would be a 5-kilowatt "coffin-type" transformer and the more interference it caused the more notorious became the owner.

In other words, the more etheric noise he made the more prominent he was in the locality.

### AMATEURS OF EARLY RADIO DAYS

I particularly recall a set of wealthy amateurs residing in the upper part of New York all equipt with powerful transmitters ranging from 1/2 to 5-kilowatts and who so controlled the air in the vicinity of New York as to have the few commercial stations completely at their mercy, so to speak.

If John Smith felt that he had not asked enough "How is my spark now, old man?" that particular evening, the Old United Wireless Station, "N. Y." would simply have to wait until the agony was over before the operator could proceed with the clearing of traffic between the few incoming and outgoing vessels.

Finally a much needed change came about. More and more young boys and young men were attracted to the fascination and romance of radio until there was such a large number of them as to cause serious interference with naval and commercial radio stations which, of course, were also increasing in numbers.

My word! what work we used to do in those days with a one-inch spark coil connected directly to aerial and earth with no capacity and inductance other than the natural one existing between the antenna and ground, and yet we were able to cover what in those days was considered very good distances of 40 miles or more.

As for receiving—our Perikons and Galena detectors and our poor receiving equip-

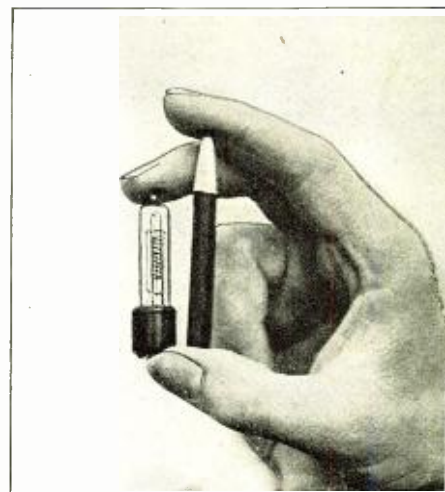

This Lilliputian V.T. Represents the Latest Development in Detector Tubes. Note the Difference in Size Between This One and the Power Tube of Fig. 1.

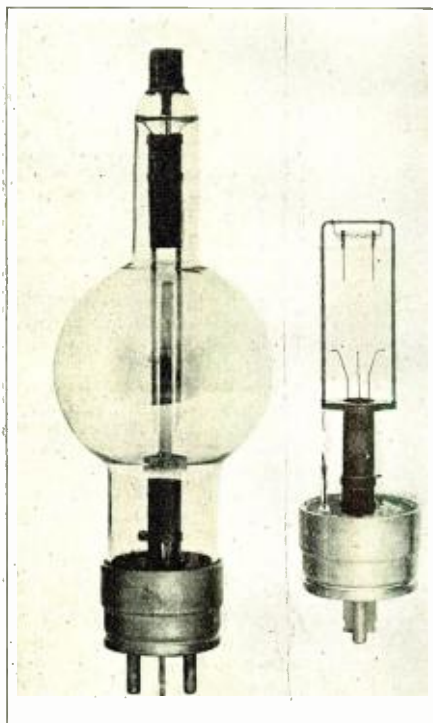

Fig. 1. The Last Word is Power Tubes. This One, Which is 15 Inches Long, is of the 250 Watts Type and Will in the Near Future Replace the Spark Sets of Medium Power. On the Right is a View of the Frame Supporting the Filament and Grid.

ment brot in signals within audibility up to 1,000 miles distant and more. Meanwhile our friend Dr. DeForest was plugging along upon the development of his world-famous audion.

Very few thot seriously of radio in those days, that is to say, it was considered an excellent pastime, but as for choosing it as a future career—not many entertained the thot seriously.

The more adventurous spirits, however, used it as a means to an end for the sea held out plenty of excitement and thrills. Secretly, if not openly, it was the desire of most of these pioneer amateur men to become seagoing operators.

Then came the more stringent laws which regulated both the amateur body as well as the commercial operators. A great deal of cramming of radio books was done in order to pass the much dreaded examinations. Our friends in the Brooklyn Navy Yard dismantled ponderous and obsolete radio sets including the armatures of their motor-generators, short circuited hot wire ammeters, plugged in a few burned-out fuses here and there, criss-crossed connections, inserted a few extra and misleading pieces of apparatus for good measure and told us to go to it and make the set work.

(Continued on page 542)

## An Old Idea Exploded

BY Dr. GORDON D. ROBINSON\*

**I**T is a matter of common knowledge that the "soft" vacuum tube is an excellent detector. Many people believe that on the contrary the "hard" tube is much superior as an amplifier. The following article tells of a series of tests which indicate that at least one of the soft tubes recently offered for sale to the amateur gives excellent results as an amplifier.

The circuit used was substantially that of Fig. 1, the only difference being that the circuit shown was supplemented by a three-pole double-throw switch which permitted the audibility meter and fones to be inserted in the position shown or to be substituted

for the primary of the amplifier transformer. This permitted the set-up to be changed from simple detector to detector and one-step amplifier almost instantaneously, and at the same time avoided errors which might have crept in if different fones had been used. The soft tubes under test were provided with standard four-point bases so that they were readily interchanged with a number of hard tubes.

High amplification in this circuit depended upon critical adjustment. It was found that the value of filament current used was not highly critical. Various values from the 0.5 amperes recommended by the manufacturers down to 0.47 amperes

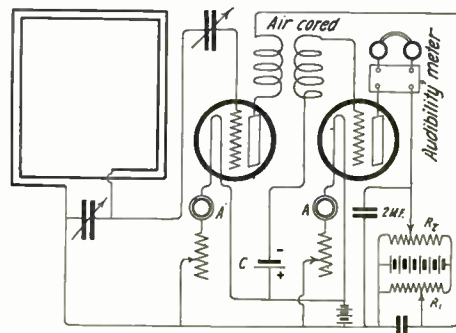

Hook-up Used During the Test Made by Dr. G. D. Robinson on the Efficiency of Soft Tubes Used as Amplifiers.

\*Asst. Prof. Dept. Elect. Eng. and Physics, U. S. Naval Academy.

(Continued on page 553)

# The Arc or Continuous Wave Transmitter

By J. DONALD HAIG

## An Elementary Talk on Arc Transmission

A GREAT deal has been said about undamp receiving in the various radio periodicals but I have noticed but very few articles touching on arc transmitters, and these have been of a highly technical nature; so in the following I will try and start in on the ground floor.

In the first place the word CONTINUOUS wave is confusing, as a matter of fact, is erroneous and UN-DAMP is more suitable for the waves are not continuous.

The wave trains are continuous, however, in that they are of undying amplitude. The frequency of the oscillations is around one hundred thousand cycles per second while the audibility of the human ear only reaches a frequency of in the neighborhood of twenty thousand cycles per second. It is said that there are some species of tropical birds that can hear sounds out of audibility of the human ear.

Those of you who have operated an undamp receiver know how the pitch of the incoming arc signals can be varied to suit the ear of the person receiving and how, on a certain adjustment of the tuner coupling and tickler coil, the pitch will go up until finally it fades out altogether or in other words goes out of audibility of the ear. Incidentally it goes out of range of the natural period, or rate of mechanical vibration of the telephone receiver diaphragms, which after the frequency reaches a certain high rate, fail to keep in step with it and do not respond at all. Therefore in order to receive arc it is necessary to lower the frequency by the use of either a tikker which is a machine for making and breaking the detector circuit at a slow rate or an oscillating audion which gives a much better tone and is a great deal more efficient.

In the arc receiver, the audion is used as a generator of undamp waves; that is it sets up high frequency oscillations in the receiver which are superimposed upon the incoming high frequency oscillations. The difference between the two frequencies will be the pitch heard by the receiving oper-

ator providing of course it is within the range of audibility. For instance say the distant arc station sends out impulses of the order of one hundred thousand cycles per second, and you tune your receiver circuits so that your audion generates a frequency

shows several oscillations running up and down the antenna circuit. In this example the maximum potential comes at the free end of the oscillator. This is often the case in actual practice and the reason that commercial wireless companies put additional

insulators in the free end or the end opposite the rat tail end or in the case of a T antenna there is equal strain on each end of the flat top. The greatest strain occurs at points where there is a potential loop. This fact is noticeable by brush discharges taking place across turns of inductance or other points in the open circuit that continually break down. Sometimes by changing the tuning these weak points can be changed to another point in the circuit which will not break down as easily. Let us step aside and look at Fig. 5 which shows mechanical vibrations set up in a reed or in a steel wire stretched between two points, and also shows graphically the oscillations set up in an electric wire of a certain electrical length. In radio the practice is to express this length in meters, but it can just as well be expressed in feet. The points at which there is no movement are called nodes, while the points at which there is maximum movement are called loops or anti-nodes. It will be noted that the point of support of the vibrating member where it cannot move must in every case be a node. In other words, the point at which the open circuit of a radio is grounded is a node. Since the electrical impulses consist of variations of current and potential which succeed each other at intervals, and since at a given point we find a loop of potential and a node of current, we must, at a quarter wavelength distant, find a node of potential and an anti-node of current. The longer the mechanical length or electrical wavelength, the longer time it will take the oscillations to traverse the path of the oscillator. Just the same as the longest string on a piano gives the lowest note or vibrates at a lower frequency than any of the rest, while the shorter strings give off the high pitch notes, the mechanical oscil-

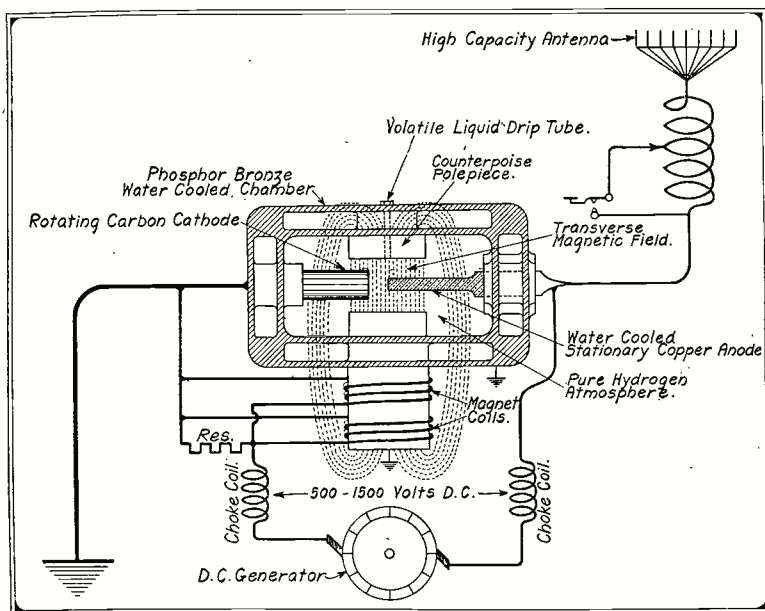

Elementary Circuit Diagram of a Continuous Wave Transmitter Employing the Arc. During Transmission the Arc Is Constantly Radiating, and Telegraphing Is Accomplished by Means of a Key Which Rapidly Changes the Emitted Wavelength.

of ninety nine thousand cycles per second, then the frequency in the phones will be one thousand cycles per second. This resultant frequency is called the *beat frequency*. In this instance the two frequencies were in step one thousand times or one hundred cycles apart. This is the reason that arc signals can be received at almost any desired note. The frequency of the audion circuit can be altered by varying the coupling and tickler feed-back coil. The faster the audion oscillates the lower will be the received note and visa versa.

### THE TRANSMITTING SIDE.

Now to get back to the transmitting side of it, let us refer to Figs. 1 and 2. Fig. 1 shows a very elementary circuit of a direct current generator supplying current to an arc; this is an impossible hook-up but serves as a starter.

Fig. 2 shows a vertical oscillator with a spark gap in the circuit: The base of both vertical oscillators are grounded. According to an old theory introduced by Professor Hertz, if this vertical oscillator is excited by an induction coil or other agency the current values and potential strain at points along this antenna or oscillator will be represented as shown graphically in Fig. 2, wherein the dotted line represents the potential values and the solid line the current value at each point along the oscillator. For this reason hot wire ammeters are always put in the ground lead as near as possible to the ground which is to protect the instrument against excessive potentials and this is the point at which there is maximum current. This is proven by the fact that one can grasp the ground lead at the point at which it is grounded and not experience a shock and yet the radiation ammeter will give a reading.

Now let us take a higher oscillator or aerial circuit as illustrated in Fig. 4 which

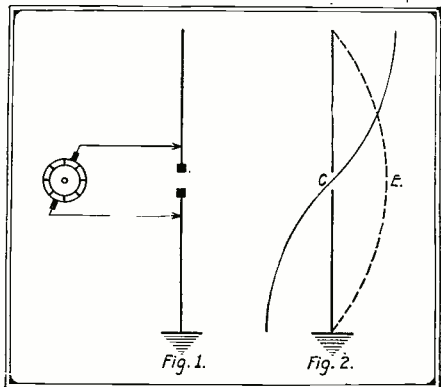
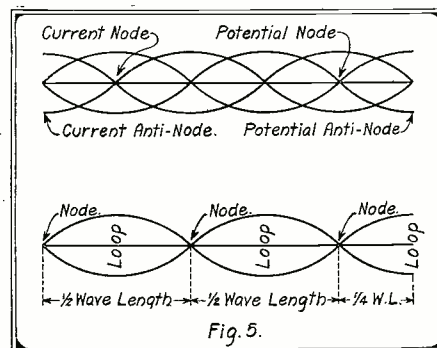

Fig. 1 Illustrates a Very Elementary Circuit of a Direct-Current Generator Supplying Current to an Arc, While Fig. 2 Shows a Vertical Oscillator with a Spark Gap in the Circuit.



Graphic Illustrations of the Oscillations Set Up in a Charged Wire of a Certain Electrical Length. The Points at Which There is no Electrical Movement Are Called Nodes, While Those of Maximum Movement Are Called Anti-Nodes.

lations can run up and down them in a much shorter period of time. When we speak of time in radio, especially arc oscillations, we divide our time into one hundred thousandths of one second.

This is the principle that underlies the arc transmitting oscillating circuit, and explains the tuning of the radiating circuit by adding or decreasing inductance, thus altering the length of the path over which the oscillations travel, not only changing the wavelength but also the frequency of the circuit. The frequency after all is the time required for one oscillation to travel from the ground to the free end of the antenna and back to earth again. This whip-like action at the free end is the cause of the high strain on the insulation at the free end of the aerial.

**AERIAL FORMS ONE SIDE OF CONDENSER.**

Fig. 6 shows a simple arc circuit and arc antenna which consists of a greater number of wires in the flat top portion than in the spark type. This is to give a greater value of capacity and to form one plate of a condenser, the ground being the opposite plate and the intervening air space the dielectric of this huge condenser. On ship-board arc installations the antenna generally consists of a ten wire flat top aerial swung between twenty-foot spreaders, while for spark work either four wires on fifteen-foot spars or for a two wire aerial ten-foot spreaders are the standard. On some battleships the small diameter cage sometimes known as sausage type aeriels are used. These have the advantage of occupying a relatively small space without much loss of capacity. Also for the arc it is necessary to employ more than twice as much insulation in the aerial halliards to hold the pressure of the high voltage high frequency power than it is for spark transmitters.

From the foregoing it is seen that the arc antenna is a well insulated condenser plate and the earth or steel ship underneath it is the other plate. Inserted in the path between these two plates is the tuning inductance or loading coil.

Upon applying power to the arc electrodes this huge condenser is charged by the direct current which is supplied to the arc terminals; that is, by direct current at the first impulse of the arc when it is struck or lit. This, however, changes instantly to a high frequency oscillating current. By instantly we mean something less than one hundred thousandth of a second.

Now let us look at the power and high tension circuits. The prime power source generally consists of a 500 volt or higher direct current generator, both the positive and negative feeders are run thru iron choke coils and also thru arc magnet coils which aid the chokes in holding back the high frequency surges and also produce the transverse magnetic field in which the arc burns. The negative lead is secured to the ground side of the arc or to the cathode which is a carbon electrode. I might mention that the negative lead is always the grounded side in all electrical work where a ground is used. For instance, on electric traction lines the rail is the negative side,

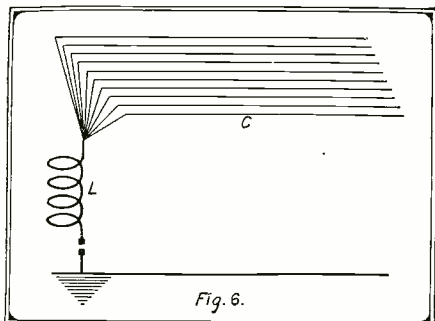

Fig. 6.

Simple Arc Circuit, Having Large Antenna Sufficient to Form One Side of the Condenser, While Ground Forms Other Side.

also on telephone and telegraph common returns, etc., or in other words it is standard practice to consider the ground as the negative quantity. The positive lead goes to the antenna side of the arc gap which is a copper electrode and is called the anode. The high tension circuit, as you see, has capacity between aerial and ground and inductance in the tuning coil. It is a circuit having capacity and inductance and is therefore a natural oscillatory circuit. There have been many theories advanced concerning just what action causes an oscillatory action to be set up by the direct current arc, but I believe there has been no acknowledged explanation accepted to date, as there is no way of finding out exactly what takes place. In the following I will set forth one which seems as feasible as any.

**WHY THE ARC TRANSMITS.**

When direct current is fed to the arc the antenna and ground also accumulates a charge and this robs the arc of a part of its current, since the supply current is kept constant and cannot reverse back into the generator on account of the choke coils which protect the direct current generator. If the current in the arc decreases, it is clear that the voltage at its terminals must increase. Figure 2 shows maximum voltage at E and minimum current at the arc C. Consequently as long as the charging of the antenna-ground continues, the voltage will rise. As soon as the condenser becomes fully charged, the arc voltage becomes stationary. Then the condenser begins to discharge itself through the arc, thereby increasing the arc current again and reducing the arc voltage. This will continue until

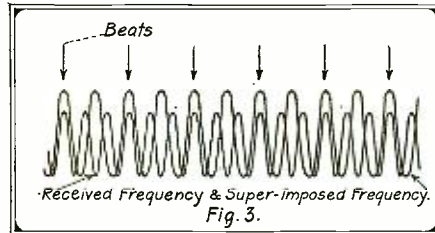

When an External Frequency Is Super-imposed Upon the Received Frequency the Phenomena of "Beats" Occurs, Providing the Two Frequencies Have Different Values.

we have a minimum voltage and a maximum current in the arc. The discharge of the condenser will continue or swing past the point of zero current. Thus the condenser will become charged in the negative direction until the arc voltage falls so far that the supply voltage of the direct current supply leads causes a reversal of the whole action or cycle. Thus high frequency oscillations are built up, this whole process only occupying one hundred thousandth of a second.

The name *arc converter* is derived from the fact that direct current is converted into high frequency alternating oscillating currents. The arc is very efficient considering the fact that the signals have the same audibility at over four times the distance of an equivalent input of spark transmitter. The arc can be used to far better advantage for long wave transmission and is far more selective than spark. The absorption by the sun's rays is practically negligible, there not being really much difference between daylight and night time transmission. The circuits of the arc are comparatively simple, tuning being effected by adding or decreasing series loading inductance, there being no closed circuit. With this system it will be seen that after power is applied to the arc electrodes and the arc is struck, opened up until the proper gap is obtained, that the direct current circuit cannot be opened up without extinguishing the arc.

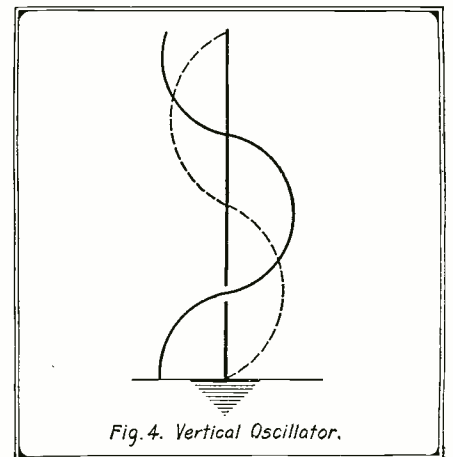

Fig. 4. Vertical Oscillator.

In This Instance Several Oscillations Run Up and Down the Antenna Circuit. Maximum Potential Comes at the Free End of the Oscillator.

**THE KEY CIRCUIT.**

As long as the arc must be struck and adjusted each time, it is obvious that the key cannot be inserted in the supply leads, but that the arc must burn continuously thru the transmission period. This is accomplished by two telegraphing methods called the *wave changing* and *absorbing* systems, the names of which are almost self explanatory. In the former a relay key is used to short-circuit a small portion of the antenna inductance and thus reduce the wave each time the key is depressed. As the wave emitted by the arc is exceedingly sharp, the receiving operator tunes in the low wave or *telegraph wave* and does not hear the back wave at all which sounds like "Chinese." Some arcs are arranged so as to increase the number of turns of inductance when the key is pressed, and in this case the receiving operator has to tune up in order to get the signals that make sense. This system is rapidly giving way to the absorbing system which consists of a dummy antenna or by-pass for the back wave. The oscillations in between the dots and dashes are absorbed to ground thru a dummy inductance and bank of condensers. When the hand telegraph key is prest, it operates a highly insulated relay key which opens up this dummy antenna circuit and allows the current to traverse the main antenna circuit, thus radiating the power into space.

**WHY IT IS SOMETIMES POSSIBLE TO RECEIVE ARC ON CRYSTAL DETECTOR.**

It is an interesting fact that arc signals can sometimes be copied on low wavelengths when the receiving station is in very close proximity to the arc transmitter. This is probably on account of the reflection or re-radiation of the energy on a lower wave or harmonic. In the case of a ship installation from the steel shrouds which retransmit the signals on a lower wave. This also seems to produce a heterodyne effect making the signals audible on crystal detectors. Amateurs living in the rural districts where there is a chance for stringing a one wire antenna thru trees for several thousand feet, or perchance make use of an old telegraph line or phone wire can pick up some of the long wave arcs by the use of a high frequency interrupter in the detector circuit. However, the natural period of the receiving antenna must nearly approximate that of the transmitting undamp't station to obtain results with the *tikker*, as nothing short of an audion will bring in the signals if a short antenna is used, too much loading being required. But with the long antenna enough energy can be gathered to be

(Continued on page 562)

# An Amplifier Employing Thermionic Intervalve Resistance Couplings

By JOHN SCOTT-TAGGART

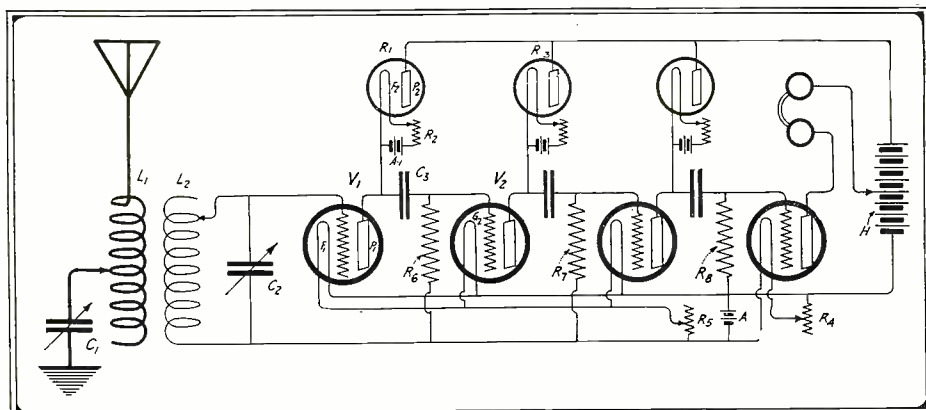

This Amplifying System is Unique in That it Employs Vacuum Tubes as a Means of Coupling Between Each Stage of Amplification.

THE author has devised a large number of amplifying devices in which the coupling between the valves consists not in the usual form of resistances or transformers, but in thermionic couplings. In place of ordinary conductors of high impedance, it is proposed to use a conductive path between the cathode and anode of a vacuum tube such as the Fleming valve.

One form of the arrangement is shown in the accompanying figure, which shows the application of the arrangement to the reception of wireless signals.

An aerial circuit  $L_1$   $C_1$  is coupled to a closed receiving circuit,  $L_2$   $C_2$ , which is connected across the grid and filament of the three-electrode vacuum tube  $V_1$ . The plate circuit of  $V_1$  contains a two-electrode vacuum tube  $R_1$  and the plate battery  $H$ . The valve  $R_1$  may conveniently consist of an ordinary three-electrode valve in which the grid and anode are connected together. The filament, it will be noticed, is heated by means of an accumulator  $A_1$ , preferably thru the five-ohm rheostat  $R_2$ . The electron current from the filament  $F_1$  of the vacuum tube  $V_1$  flows to the plate  $P_1$ , to the filament  $F_2$  of the vacuum tube  $R_1$ , thence to the plate  $P_2$ , and so back to the filament  $F_1$  via the battery  $H$ . The valve  $R_1$  acts as a resistance of the order of

100,000 ohms, which value, however, may be conveniently varied by altering the emission from the filament  $F_2$  by adjusting  $R_2$ . We thus conveniently obtain a non-inductive resistance whose value may be very readily varied, and whose normal value approximates to that of the valve  $V_1$ —a most desirable condition for effective amplification. By this means the voltage on the grid of  $V_1$  will vary the resistance of  $V_1$ , and, consequently, vary the current in the circuit  $F_1$ ,  $P_1$ ,  $F_2$ ,  $P_2$ ,  $H$ ,  $F_1$ . Since the current thru  $R_1$  is increased, the potential across  $P_2$  and  $F_2$  will also increase. If the grid of  $V_1$  is positive,  $F_2$  will become negative with respect to  $P_2$ . By connecting  $P_1$  thru the condenser  $C_3$  to the grid of the second valve, the potential variations across  $R_1$  are impressed on the grid  $G_2$ , the condenser  $C_3$  insuring that Grid  $G_2$  is insulated from the high positive value which would otherwise be given to it by the battery  $H$ . The momentary negative potential on  $G_2$  increases the resistance of the tube  $V_2$ , and so lessens the current in the circuit  $V_2$ ,  $R_2$  and  $H$ . Since the current thru  $R_2$  is decreased, the potential across  $R_2$  decreases, and, consequently, the grid of the third three-electrode valve is given a positive pulse. The third three-electrode vacuum tube acts in a manner comparable to the

first. The last vacuum tube is intended to act not as a high-frequency amplifier, but as a detector, and a pair of telephones is included in its plate circuit, a suitable tapping being taken from the battery  $H$ .

To assist us in arranging that the last valve shall act as a detector, we can conveniently make its filament current variable by the use of a separate rheostat,  $R_4$ . The current thru the filament of the first three vacuum tubes may be varied by means of a rheostat,  $R_2$ . These three valves act as amplifiers of the high-frequency oscillations, and are not intended to act as detectors. Resistances  $R_5$  and  $R_7$ , having a value of about 4 megohms, are connected as shown and are intended primarily to prevent the accumulation of electrons on the grids of the second and third vacuum tubes. It is to be noted that the grids of the first three valves are connected to the negative side of the filament-heating accumulator; moreover, the rheostat  $R_5$  is so connected that the grids will always have a potential negative with respect to the negative end of the filament. This will tend to prevent the establishment of grid currents in the first three valves.

If desired, the same effect could be produced by using a fixed resistance of about 1.5 ohms in place of the rheostat,  $R_2$ , the filament currents being then regulated by means of a rheostat connected between the positive side of the filament and the positive terminal of the accumulator. This latter arrangement is probably preferable.

A high resistance  $R_5$  of about 4 megohms is connected between the grid of the last valve, and either the positive or negative side of the filament accumulator, according to which connection gives the best results.

In addition to the advantages gained by being able to vary each of the plate circuit resistances, the valve resistances  $R_1$ ,  $R_2$ , &c., may be arranged to act as a limiting device, in which case the strength of signals may be easily controlled, and exceedingly loud signals or atmospherics may be cut down by suitably adjusting the rheostats  $R_2$ , &c.

The writer hopes in the near future to present a paper on further applications of thermionic intervalve resistances, including devices of practical importance and value. —London Electrical Review.

# An Undamped Wave Method of Determining Dielectric Constants of Liquids

By W. H. HYSLOP and A. P. CARMAN

THE method makes use of two circuits of the "ultra-audion" type, one operating at a definite frequency and the other tuned to such a frequency that a definite number of beats per second is obtained. The accompanying sketch shows one arrangement of the circuits. Circuit 1, very loosely coupled with Circuit 2, is operated at one frequency thruout a test. Circuit 2, shown in sketch, differs from Circuit 1 in the use of three condensers  $C_1$ ,  $C_2$  and  $C_3$ , instead of a single condenser. The condenser  $C$  is inserted in order to keep the resultant capacity of the group at the proper value. The condensers  $C_2$  and  $C_3$  are air condensers of the Korda type. They were designed and built in the department machine shop especially for this work, and can be reset to any required ca-

capacity with high accuracy. The calibration also showed that the capacity from the minimum to the maximum values, varies directly as the angular displacement of the plates. The test condenser  $C_x$  consists of two concentric cylinders, and its value is known in terms of the angular displacement of the plates of  $C_3$ .

In determining the dielectric constant of a given liquid, the condenser  $C_x$  is disconnected,  $C_3$  is set to some value near its maximum, and  $C$  is adjusted until a beat note of convenient frequency (512) is obtained. This beat note is determined by ear thru comparison with a standard tuning fork.  $C_x$  is filled and connected in the circuit;  $C_3$  is decreased until the same beat note is heard. The ratio of this angular

displacement to that for  $C_x$  as an air condenser gives the dielectric constant of the substance tested. For values beyond the

(Continued on page 562)

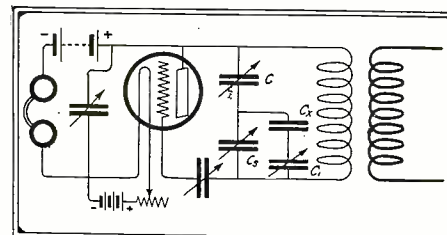

In This Hook-Up Circuit 1 is That Shown to the Extreme Right Consisting of Heavy Outline, While Circuit 2 is That Outlined to the Left.

# Controlling By Wireless

By EVERETT LEO DEETER

THE long winter months are again with us and Radio Clubs and individuals are devoting much more time to their instruments and to giving instructive and scientific programs.

Probably one of the most important parts of such programs, and the one presenting the most difficulty, is that of controlling apparatus by wireless. Several methods have been presented by Radio enthusiasts, some of which were very difficult in construction and quite expensive.

Having experimented considerably in connection with Radio controlling apparatus, and having constructed several outfits of varying design, I am presenting one of the simplest of the most successful outfits, with which almost any number of machines or apparatus may be controlled at a distance, by radio telegraphy.

The transmitter, which is to control the display, is illustrated by Figure 1. P is a commutator, made up of any number of segments, each of which is connected in circuit by the switches, k. When any switch is closed and the arm makes contact with that segment to which it is connected, the relay R closes and the spark radiates waves from the sending antenna.

Figure 2, the receiving relay, is the method by which the radiations are received and amplified by the Audion Amplifying Circuit, which actuates the sensitive polarized relay R'. This in turn operates the relays (r), respective to which the segment of the commutator on which is the contact arm.

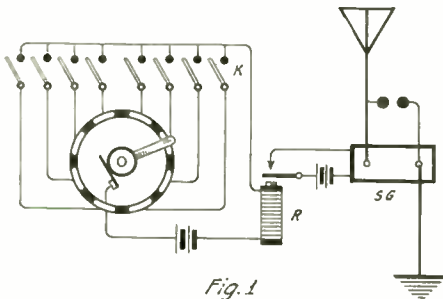

Fig. 1

The Control System at the Transmitting Station is Shown in This Diagram. The Rotary Commutator is Made of Any Number of Segments.

Diagram of the receiver and relay by means of which any machine may be controlled by radio.

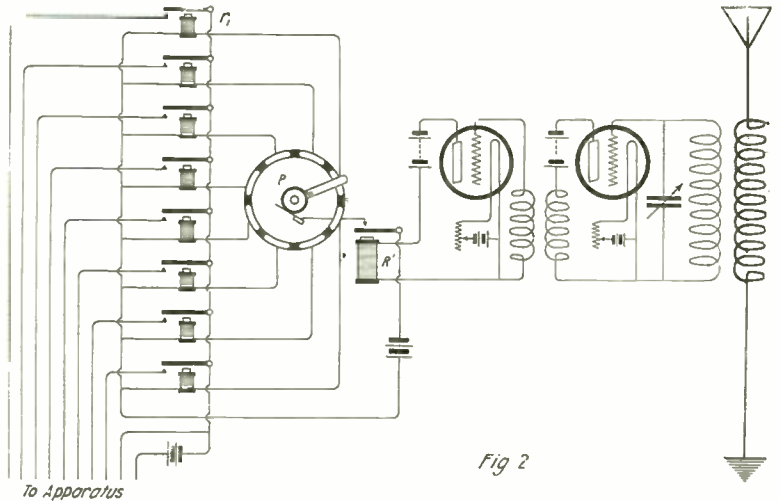

Fig 2

ment of the commutator on which is the contact arm.

The relays r, are constructed as shown in Figure 3. A portion of the core is drilled out and a steel bar, B, replaces it, as shown in the sectional view H and C. The insulation I is secured to the post S by a screw, P is a piece of spring steel. When current passes thru the relay the steel bar becomes permanently magnetized and holds the arm down a short time until it loses its flux. The time should be about one second, and the steel bar in the core can be annealed accordingly.

The arms on the commutators, P, are to run in step, and may be geared to clock-works or a phonograph motor and set to run about one revolution per second. A starter for the receiver may be made by using an electro-magnet to pull back a catch, when magnetized, which turns loose the wheel on the arm shaft. The one on the transmitter may be made the same and connected directly with a convenient switch attached to the commutator. Thus the two arms will start and stop together, or at the same corresponding segment. The receiving starter is connected in circuit with one of the relays r.

A switch closed at the transmitter sends out radiations at the instant the arm passes onto a segment which is connected to a closed switch. This received at the relay end, amplified until it closes the relay connected to the segment of the commutator over which it is passing, is the corresponding one to that of the transmitter. The

(Continued on page 570)

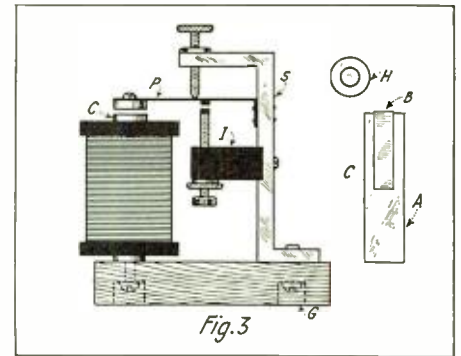

Fig. 3

Constructional Detail of the Relays Closing Each Separate Circuit.

# Sparks and Spark Frequency

A Few Notes on the Improvement of Transmitters By Calculation of the Correct Spark Frequency to Be Used  
By VINCENT TASSI

WE have heard a great deal and have seen countless articles on the raising of our efficiency and the spreading out of our transmission range by cutting down our resistance losses, by improving our quenching thru the quenched gap or a better designed rotary. We are told to improve our antenna and get better tuning and resonance. But all these factors, no

matter to what degree of efficiency you may bring them, do not determine your power output, and that is what we are interested in.

The big trouble is that amateurs have been misled into the belief that a low spark frequency is the thing for best work. The conclusion that the low note was better is due to two main causes. First, the low note from a near-by station makes more noise in the receivers, has more of a tendency to "blow" the bulb, and gives all the signs of having more power than the high pitched spark. Secondly, we hear many "DX" stations using the favorite low note, coming thru very QSA. But aren't these fellows using one kilowatt, high voltage transformers? All are not so fortunate as to have a 30,000-40,000 volt transformer, so we must use the superior high note with our conditions. If you think the high note does not come thru, just listen some night for distance. You'll probably find the half-K.W. high notes coming thru over the one-K.W. low ones. We all know the superiority of the high tone in working thru all forms of interference.

Now for the "dope" showing how grossly inefficient the low frequency spark is on lower voltage, lower power transformers. We have the formula for the power input in the secondary condenser

$$P = \frac{NCE^2}{2 \times 10^8} \text{ watts}$$

Where N is the number of sparks per second, C is the condenser capacity in microfarads, E is the secondary voltage of the transformer.

Now let us take the case of an attempt to use a 120-spark note with a quarter-kilowatt transformer having a secondary voltage of 7,000. On all calculations, herein discuss. C will be made .007 microfarads as this is the best capacity for radiation on 200 meters and is the capacity usually found in amateur transmitters.

Substituting the values above we get:

$$P = \frac{120 \times .007 \times 49 \times 10^8}{2 \times 10^8} = 20.58 \text{ watts}$$

(Continued on page 578)

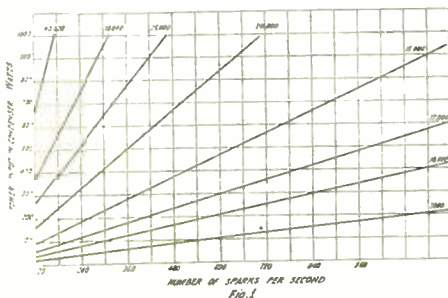

From These Curves it May Be Seen That There is an Advantage in Using Low Notes for High Secondary Voltage and High Notes for Low Secondary Voltage.

# Notes on Modulated Tube Transmitters

A. S. BLATTERMAN\*

IN a previous article the writer discusses the relative advantages of different methods of modulation available for use in tube transmitting circuits. The questions there answered contain some which should be of special importance to the amateur. Such for instance is the most pressing one—"Suppose I have two tubes; how shall I connect them for a telephone set in order to get the greatest range? Shall I use both as oscillators in parallel and talk on their grids, or shall I use one as oscillator and one as modulator according to the constant current system?" Or again, "Which is the better, to modulate an oscillator and then amplify the modulated output, or to amplify the output of a single oscillator and then modulate?"

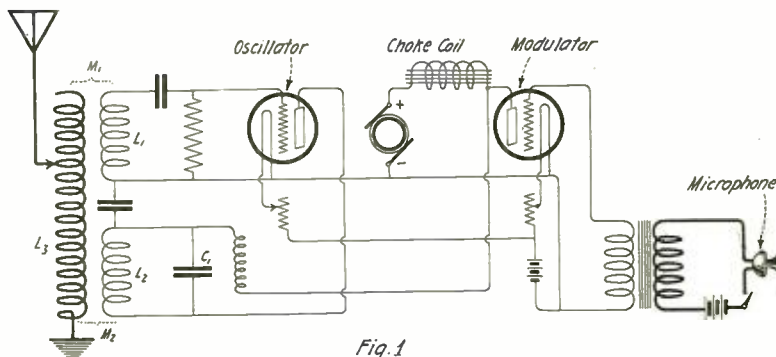

Fig. 1  
A Radiofone Circuit Using One Tube Modulator and One Tube Oscillator, and Giving a Uniform Output on the Entire Range of Wave-Length.

seen that the wave-length may be set by adjusting the variometer in the master oscillator circuit. The oscillations in this circuit are amplified by the amplifier circuit and then passed to the antenna. Any variation in antenna conditions cannot affect the wave-length radiated because this is fixed by the master oscillator circuit. The antenna is tuned to this wave-length by means of its variometer and should its capacity change, the antenna current simply falls slightly, due to the detuning; but the wave-length remains unaltered.

The question will at once be raised, "Can as much power be obtained from this arrangement as if both the oscillator and amplifier tubes were used in parallel oscillating directly into the antenna?" The an-

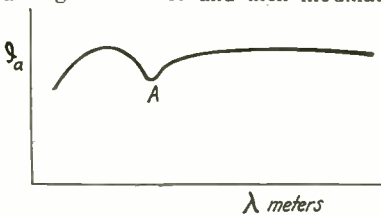

FIG. 2.

Output Characteristic of the Circuit of Fig. 1. The Dip in the Antenna Current at A May Be Shifted to Any Wave-Length.

The amateur, like every engineer, is after efficiency. He wants the greatest range and the clearest talk with smallest money outlay both originally and for upkeep; and generally since he is not hindered by such matters, as patent considerations, organization policies, production troubles, questions of portability, weight, extreme ruggedness, waterproofness, antenna visibility, good earth connections, etc., he ought to have it.

### THE BEST TYPE OF CIRCUIT

In the article above referred to, it was shown that the constant current system of modulation was superior to other systems there classified as, diverting or detuning systems, absorption systems, grid modulation; and these theoretical conclusions are entirely in accord with the latest practice of the U. S. Signal Corps, the Navy and commercial companies whose best sets use

the constant current type of modulation. When only two tubes are available it is best, without question, to use one as an oscillator and one as modulator. In this case the circuit shown in Fig. 1 will be found to be somewhat better than the usual split capacity or inductance circuits. The output is more nearly uniform over the entire range of wave-lengths for which the set is designed and somewhat greater than that from the above mentioned circuits unless the different elements of the latter are all made adjustable. The circuit of Fig. 1 requires only one adjustment which is that on the antenna inductance. This automatically takes care of the required changes in coupling as the wave-length is changed if the coils are properly designed.

The output characteristic of this circuit is shown on Fig. 2. The dip in the antenna current at A may be shifted to any wave-length by adjustment of the condenser  $C_1$  and if desired may thus be thrown entirely out of the range of wave-lengths to be used. Once  $C_1$  has been adjusted it is left fixed.

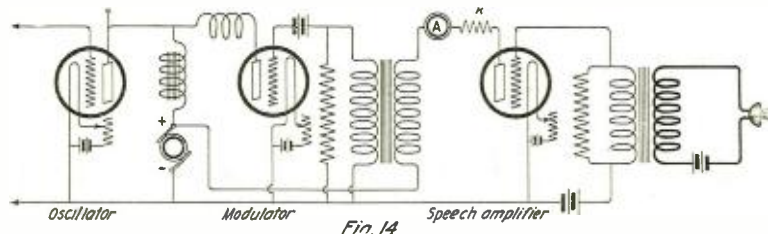

Diagram Showing How a Speech Amplifier is Connected in the Circuit to Give the Necessary Modulation Amplitude When Several Tubes Are Used as Oscillators.

The coils  $L_1$  and  $L_2$  are wound on the same form, as shown on Fig. 3.  $L_2$  is wound on another form within  $L_1$  and  $L_3$ .

This type of circuit, in common with all others in which the antenna forms part of the main oscillating circuit, has the serious drawback that the frequency or wave-length is effected by variations in the antenna circuit such as swaying of the antenna in the wind or even movements of the operator's body or hands in the vicinity of the circuits. When telegraphing by the heterodyne method at such short wave-lengths as 200 meters this is particularly noticeable and troublesome, since it causes the beat note to waver, and even for telephony it may be serious in causing swinging or fading of the signals.

It is much better, especially for amateur working where relatively short wave-lengths are involved, to use a type of circuit in which the antenna has no effect upon the frequency or wave-length radiated. The scheme for such a circuit is shown upon Fig. 4 and suitable details in Fig. 5. It is

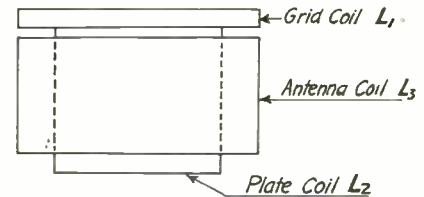

FIG. 3.

Diagram Showing the Method of Coupling of the Different Circuits of the Hook-up in Fig. 1.

swer to this very pertinent question is in the affirmative. If two tubes are to be used, the same power can be obtained by the master-oscillator-amplifier connection as if both tubes are used in parallel as oscillators. If more than two tubes are to be used then the oscillator-amplifier arrangement will give more power than if all tubes are used as oscillators. One of the tubes in this case will serve to excite three or four others as amplifiers. In addition it is possible to secure better modulation by the oscillator-amplifier arrangement, as in Fig. 5, than by modulating a self-excited oscillator.

These considerations therefore indicate the most satisfactory type of circuit as one comprising a master oscillator, an amplifier, and constant current modulation applied to the plate circuit of the latter. This is the type of circuit which will now be discussed more in detail. There are a number of

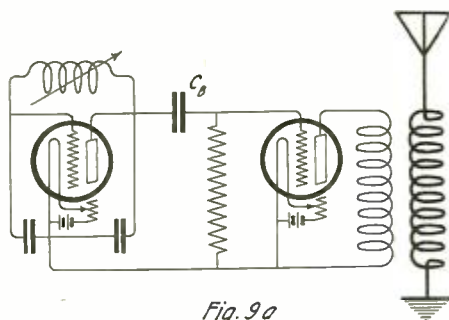

Fig. 9a

This Shows How the Amplifier is Coupled to the Master Oscillator. The Condenser  $C_b$  is to Keep the Plate Voltage Off the Grid of the Amplifier.

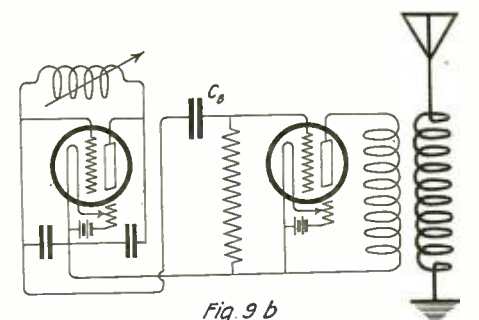

Fig. 9b

This Circuit as Well as in Fig. 9A is Especially Efficient When Only One Wave-Length is Used.

\*Radio Engineer, Camp Alfred Vail, N5.  
†Radio News, Dec., 1920; Jan., 1921.

points concerning the practical design and adjustment which must be understood in order to secure proper operation.

**AMPLIFIER EXCITATION**

By the term "Amplifier Excitation" is meant the alternating voltage impressed upon the grid of the amplifier from the master oscillator circuit. For telegraphing the value of this excitation voltage is not of great importance provided of course it is sufficient to get all the possible output from the amplifier. For telephony, however, the proper excitation must be provided or distortion and reduced effectiveness will result. With under-excitation the modulation will be more downward than upward

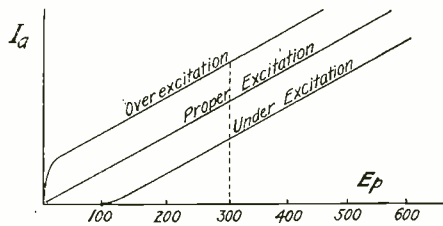

FIG. 8.

Three Conditions That May Exist in the Radio-telephone Circuit. With Both Over and Under Excitation Distortion of Speech Happens.

as indicated in Fig. 6. With over-excitation the modulation will not drop to zero as rapidly as it should. There is a certain value of excitation which will give uniform modulation upward and downward as shown in Fig. 7, and this is the condition which is most desirably produced.

The best way to determine whether or not the proper excitation is being used is, of course, to look at the modulated antenna current by means of an oscillograph. Before this is done, however, a certain curve about to be described may be taken which will give important indications as to the correctness of the excitation. In order to take this curve, arrangements should be provided for changing the amplifier plate voltage while maintaining that on the oscillator constant. In this way the oscillator high frequency current may be kept substantially constant while the amplifier plate voltage is varied. The curve in question is plotted between antenna current and amplifier plate voltage under the condition of constant excitation. Fig. 8 shows three possible conditions which may be found to exist, corresponding to over-excitation, under-excitation and proper-excitation. The action of the modulator is to vary the plate voltage of the amplifier and the utility of a curve such as those of Fig. 8 thus become apparent. If the normal operation is at 300 volts, then the modulator will cause

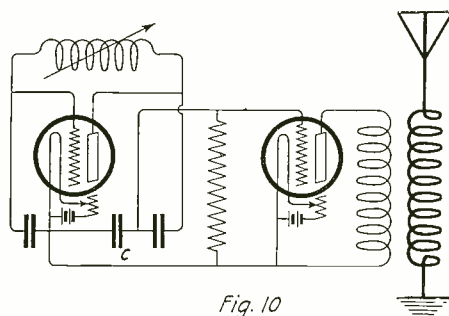

Fig. 10

In This Circuit the Correct Value of Coupling is Obtained by Adjusting the Value of the Condenser C Until the Amplifier Excitation Remains Constant for All Wave-Lengths.

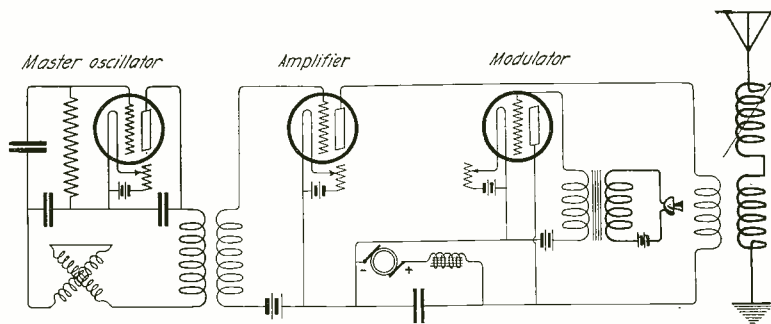

Fig 5

Here is the Hook-up of the Different Parts Arranged as in Fig. 4. The Wave-length is Adjusted by the Variometer in the Master Oscillator Circuit.

the plate voltage to vary (approximately) from 0 to 600 volts and for proper modulation the antenna current should change in direct proportion. If there is not sufficient excitation it will be seen that the antenna current will reach zero long before the plate voltage, causing distortion. Similarly if the excitation is too great, distortion will also be present and the modulation generally incomplete. The straight line characteristic is the one to be sought for.

There are numerous obvious ways of coupling the amplifier grid circuit to the master oscillator. Thus, assuming that the split capacity type of oscillator is used, the grid-filament circuit of the amplifier may be tapped off across the plate condenser of the oscillator (Fig. 9a) using a blocking condenser CB to keep the positive plate voltage off the grid of the amplifier and give the right coupling for proper excitation of the latter. Or, as in Fig. 9b, the voltage across the grid condenser may be used. For one particular wave-length,

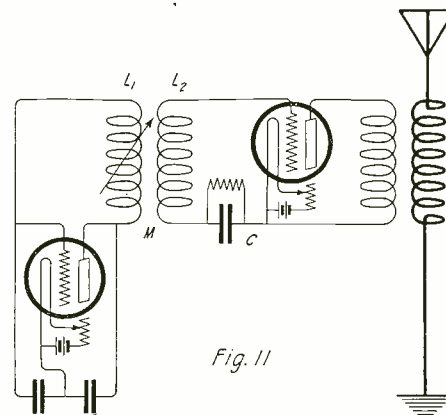

Fig. 11

Another Arrangement by Which Constant Proper Excitation May Be Had for All Wave-Lengths.

either of these arrangements may be satisfactorily employed but when a set is to cover a range of wave-lengths it will generally be found, on account of the reactance of the condenser CB (which condenser must be relatively small to avoid serious short-circuiting effect on the oscillator by the grid circuit of the amplifier) that the excitation voltage between grid and filament of the amplifier changes when the wave-length is changed. An adjustment giving proper excitation for one wave-length may therefore not give at all the proper value for another wave-length.

This difficulty may be overcome by the connection of Fig. 10. Here the necessary looseness of coupling obtained in the previous circuits by condenser CB is now provided by correctly adjusting the condenser C. If now the oscillator circuit is adjusted so that the high frequency current generated increases and decreases in direct proportion as the frequency is increased and decreased, the voltage across C, i. e., the amplifier excitation, will remain con-

stant for all wave-lengths. Such adjustment can be made in practice without difficulty and this circuit is therefore to be recommended for telephony.

Another arrangement by which constant proper excitation may be had for all wave-lengths is that of Fig. 11. Condenser C in this circuit is made very large so as to have negligible reactance at all radio frequencies. Similarly coil  $L_2$  is given small inductance so that its reactance is negligible. It is wound in inductive relation to  $L_1$  which latter is in the form of a variometer. The excitation voltage is then  $2 \pi f M I$  and to remain constant with changes in  $f$  there must be a compensating

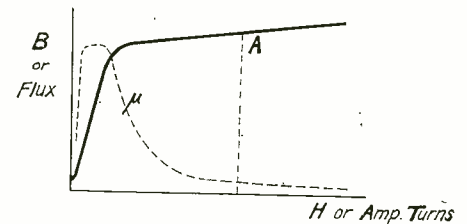

FIG. 12.

Curve of the Flux and Permeability in the Iron Core of a Choke Coil.

change made in  $M$ . By proper design this can automatically be taken care of, since the frequency is increased by opposing the coils of variometer  $L_1$  and this reduces the mutual inductance  $M$  on the secondary  $L_2$ . Similarly when the coils of  $L_1$  are added the frequency is lowered and the mutual inductance on  $L_2$  increased. In practice this arrangement is somewhat superior to those previously described since the load (amplifier grid circuit) is introduced into the oscillator circuit more advantageously and without disturbing the relative phases of grid and plate voltages of the latter. Still other devices for securing the desired proper excitation for telephony and correct functioning of the circuits independent of wave-length, are available and are in use by the Signal Corps at their Camp Vail laboratories, tho legal considerations prevent their description at the present time.

**CONSTANT CURRENT CHOKE COIL**

A popular idea has arisen that the iron core choke coil, used in the so-called constant current modulation system, is in fact a device which actually maintains the total current to oscillator and modulator substantially constant, or at least should do so and hence should have as large an inductance as possible. This idea is fallacious. If  $R_o$  represents the internal plate-filament resistance of the oscillator and  $R_m$  the similar resistance of the modulator, it may be

(Continued on page 573)

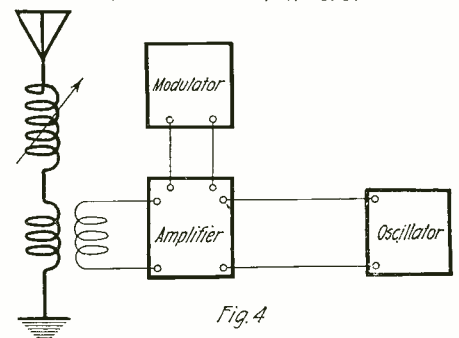
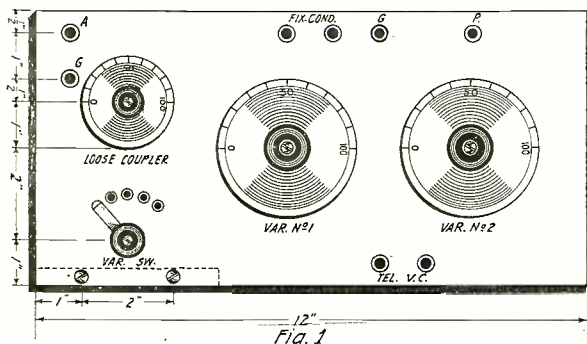

Fig. 4

For Short Wave C.W. Transmission This Arrangement Avoids the Antenna to Have Any Effect Upon the Frequency of the Wave-length Radiated.

# A Simple and Efficient Short Wave Regenerative Receiver

By FREDERICK J. RUMFORD, R.E.



Front View of the Short Wave Receiver. The Arrangement of the Dials and Switch Gives to This Apparatus a Very Commercial-Like Appearance.

At last it is here—a short wave regenerative receiver which can be constructed by the amateur very economically. When the outfit described below is carefully made up, it is a credit to an operating table and is one that the most exacting of radio fans will take great delight in showing his friends and fellow bugs. It is easily made up, requires but very few parts, and is so assembled that it is easily accessible at all times for the changing of hook-ups. The builder has his choice of mounting the outfit, which is designed along the lines of the famous Paragon short wave regenerative receiver, in cabinet form or assembling it upon a pair of braces or brackets. It has not been put to any extensive test but has worked on 100 to 400 meters with very good results, and I feel sure that the builder can get still better results by further experimentation.

### ARTICLES NEEDED

In making the outfit one needs two 3" Bakelite dials engraved as shown on the cut and one 2" dial also engraved. These dials must have knobs attached to them. Eight brass or copper binding posts, as are used with any radio receiving apparatus, are also required and one complete variable switch assembly with five contacts and their necessary nuts and washers. These would look best if they were nickel plated. The switch lever will swing within a radius of one inch. This switch is for the purpose of tapping the primary of the loose coupler. One of the contacts on the switch is left idle. Now, we will start on the panel and continue until the whole outfit is ready for instant use.

### THE PANEL

Fig. 1 shows the exterior view, or front of the panel with the necessary articles mounted in their respective places, and the symbols indicating them.

Fig. 2 represents the interior view, showing the variometers and loose coupler mounted in their places, and the method of mounting them.

Fig. 3 shows a side view of the loose coupler with the method of mounting it three inches from the back of the panel, and, also, the method of placing the braces for the holding of the coil form.

Fig. 4 shows both the internal and external hooking-up of the outfit. The builder following this hook-up should get very good results.

The symbols used in this receiver were adopted by five of the leading radio manufacturers of the country. The meaning of the symbols follows: Ant, antenna; Gnd, ground; Tel, telephone receivers; V. C., variable condenser P, plate; G, grid; Fx C.

fixt condenser; Vmr, variometer; Var Sw, variable switch; LSCPR, loose coupler.

The panel may be bakelite, rubber, oak or boxwood and should be 12" long, 6" wide and from 1/8" to 3/8" thick. The measuring and drilling for the necessary holes should be done first, then the panel sandpapered and given two or three coats of varnish or paint. The panel described was oak and had three coats of black, glossy varnish. For the shafts of the variometers there should be 1/4" holes drilled; for the binding posts, 3/8" holes and for the switch contacts and switch lever 3/8" holes.

After the drilling and painting are done the panel is ready to be engraved. The symbols should be neatly engraved on the front of the panel with a sharp-pointed slender tool and filled in with white putty or a similar substance. The panel is now ready for the mounting of the binding posts and switch assembly.

### MAKING THE COILS

We will pass to the making of the different coils necessary for the successful operation of this outfit. The amateur must procure six winding forms in the following sizes: two, 4" in outside diameter and 2" long with a wall 1/8" thick; one form, 3" in outside diameter and 2" long with a wall 1/8" thick; two, 2 3/4" in outside diameter and 2" long with a wall 1/8" thick; one, 4" in outside diameter and 3 1/2" long with a wall 1/8" thick. All forms that are 4" in outside diameter are the different primaries for the different variometer assemblies, and the forms smaller in outside diameter are for the secondaries. Now take the two primaries that are 2" long and drill a hole in the center of them to allow a loose fit of a 1/4" shaft. This shaft is the means by which the secondary is revolved within the primary and the hole to be drilled in the secondary forms should be small enough to allow for a snug fit on the same size shaft. After this has been done, the four coil forms should be given a couple of coats of some good insulating compound. After they have dried they are ready for the wire to be wound upon them.

In this instance, the writer has used No. 24 D. C. C. magnet wire. On the primary form of variometer number one, the winding should start in 1/8" and continue over for 5/8"; then skip a space of 1/2" and continue winding until 1/8" from the end. (The writer thinks it advisable to have a little machine screw on both ends of each of the coils with suitable nuts and washers to which to attach the wire upon the starting and finishing of the winding. It also provides means of hooking the primary and secondary in series.) This will make about 42 turns in all on the primaries of variometer No. 1 and No. 2, making 21 turns to a section. Both primaries are wound alike. As the reader will note in Fig. 2, the coils are all wound in two sections; the space in the center is left to allow room for fastening the shaft securely. After be-

ing wound, the primaries should be given a coat of shellac, but care taken not to get too much on them as it would cause energy losses.

### THE SECONDARIES

Now comes the making of the secondaries for variometers No. 1 and No. 2. These coil forms are 2 3/4" in outside diameter and 2" long. The winding on the coils starts 1/8" in and continues over for 3/4", leaving a 1/4" space. It again continues over 3/4", leaving 1/8" at the end. These coils are fastened at both ends by the same means as used on the primaries. The secondaries should also be shellacked.

### THE LOOSE COUPLER

The next step is making the loose coupler. The primary is 4" in outside diameter and 3 1/2" long with a wall 1/8" thick. The primary should have a lip on it, as shown in Fig. 2, the purpose being a means of fastening the shaft. This coil form should be treated like the others. After it has dried, the winding will start on the lip end by attaching the wire upon the machine screw or post as was mentioned above, same as was done on the other coils. It should be wound 2" down with No. 24 D. C. C. magnet wire. In fact, all the coils are wound with this size wire and must also be wound in the same direction. After this coil has been wound, it is ready for the shellacking. On this coil four taps will be taken off. As the two inches of winding will equal 66 turns of wire, the taps will be taken off on the 16th, 33rd, 49th, and the 66th turns. A good way to take them off is to scrape the insulation back on the wire on the above numbered taps or turns and solder short pieces of No. 14 bare copper wire upon the scraped section, which will in turn connect to the different contacts on the panel.

We are now ready to make the secondary coil for the loose coupler. This coil form is 3" in outside diameter and 2" long with a wall 1/8" thick. It should have a hole drilled in the center to allow for the passing thru of the shaft.

This shaft is fastened to the secondary and should be fastened to the primary. The same as in the primary, the secondary will continue 1/4" and continue over for 3/4". The secondary will be fastened at both ends with No. 24 D. C. C. magnet wire. The secondaries should be shellacked.

As was said above, the primaries on the loose coupler have 42 turns.

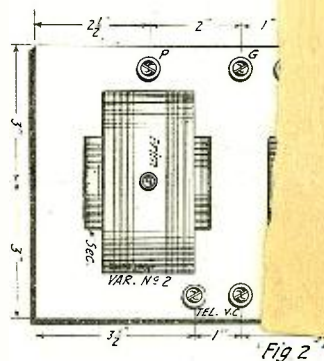

Back View of the Panel on Which All Parts Are Constructed. Note That the Coupling Between the Variometers is Tighter Than in Some Similar Receivers.



will be 21 turns per section, making a total of about 45 feet of wire to each primary, or 90 feet for the two. The two secondaries of variometers one and two will have 50 turns each, with 25 turns to a section. Each coil will take about 36 feet of wire or 72 feet for both. The loose coupler primary has 66 turns of wire, which would equal about 71 feet. The loose coupler secondary has 50 turns of wire, 25 turns to a section, which would equal about 40 feet. In all it requires 273 feet or close to one-half pound of the wire.

**ASSEMBLING THE PARTS**

The outfit is now ready to be assembled. The binding posts and switch assembly have already been mounted. Now mount the primaries of variometers No. 1 and No. 2 by four little wood screws, two to a coil, which will screw in thru the coil form into the back of the panel, so as the shaft hole on the coil form will come in line with the hole in the panel. After that, get the necessary shafts, which should be threaded their whole length. Each one of these shafts should be 5" long and 3/4" in diameter. One end of the shafts should be screwed into the knob on the dial and soldered so it won't work loose. It is then in turn pushed thru the panel from the front, thru the primary coil and nuts run on it so there will be a nut on the front and back of the secondary at each end, and

on the inside and outside of the primary, which, when drawn up tight to the forms, will hold them securely. The above operation should be executed on both variometer assemblies. In hooking the primaries and secondaries in series, take pieces of No. 18 flexible lamp cord of sufficient length and connect the ends of it upon the screws or posts that are already provided in the coils.

In assembling the loose coupler: There is a rest made 8" long, 4" wide and 3/8" thick, which in turn is secured to the back of the panel by two wood screws, which go thru the panel from the front. This rest in turn will support the primary of the loose coupler. The primary is then mounted upon the rest and held there by four little braces, two of them angle form and the other two straight. These braces may be copper, brass or iron. The builder must bear in mind that between the back of the panel and the front of the primary coil form, there must be just three inches of space. This is absolutely essential or otherwise, when the secondary on variometer No. 1 is rotated, it would in turn rub against or strike the primary on the loose coupler. After this has been done the secondary of the loose coupler is mounted, the same as the secondaries on the two variometers. The wiring for the back of the panel is done with No. 14 stiff bare copper wire, which can be bent into the different

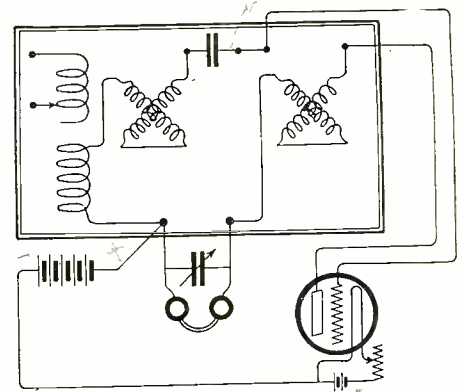

Fig. 4

Complete Diagram of the Regenerative Set.

shapes desired by the builder. Figure 3 shows the true method of mounting the primary of the loose coupler. The taps on the primary are hooked to their respective contacts on the panel. Figure 4 shows the method of hooking-up the outfit. Any trouble I have encountered in the working of this receiver, I have found to be due mostly to run down "B" batteries. There should be little or no trouble for the amateur in building this receiver as the drawings are self-explanatory.

## A Spark Coil Panel-Type Transmitter

By MARION W. TAYLOR

**M**ANY amateurs who do not live in a city or large town are denied the pleasure of a transmitting station because of lack of power supply.

As I am in this class of amateurs, I have designed and constructed a panel-type spark transmitter shown in the photograph, which operates successfully on 24 watts. This transmitter can be constructed at a reasonable cost, and will satisfy the requirements of the average amateur for short distance work.

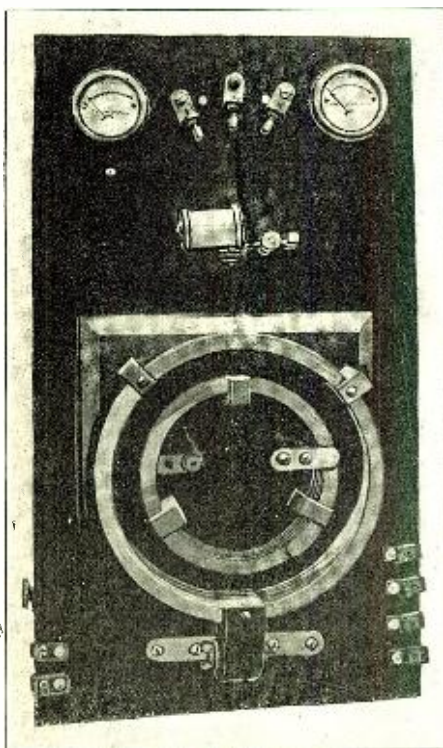

Front View of the Well-Designed Panel Transmitter. Note the Electro-Magnet and Electrodes of the New Gap.

The instruments used are as follows: 2" Superior spark coil, Murdock oscillation transformer, plate glass condenser, Columbia pocket volt meter and ammeter, Fahnestock clamps, and "Oscillation" spark gap.

The condenser is made of two glass plates 4" x 5" with tin foil sheets 3" x 4" between each plate. (As spark coils vary in strength, it is advisable that the reader build up his condenser until the right capacity is found.)

To build any size of condenser, photographic plates may be used and are to be recommended for they are generally free from flaws.

The film may be removed from the plates by immersing them in two solutions; the first one is made up in the proportion of 3/4 ounce of sodium fluoride to 16 ounces of water. The second solution consists of 3/4 ounce of sulphuric acid and 16 ounces of water.

After the plates have been placed in the first solution for a few minutes and then in the second solution the film comes off easily.

To arrange the tin foil sheets on the glass plates, the latter are coated with vaseline, then the armature put in position and rolled with a "squeegee." When the plates are all piled up they may be wound with tape and placed in a box which should preferably be boiled in paraffine for a few minutes.

To determine the capacity of this type of condensers the following formula may be used.

$$C = 0.088 \frac{S}{rK}$$

in which C is measured in micro-microfarad. S is the surface area of one armature in square centimeters. r is the thickness of dielectric in centimeters, and K a constant which for the glass may be taken as 7.

The spark gap is a buzzer arrangement, with the exception that the vibrator is made from thin tin-covered sheet iron (the kind used to make tin cans) 2" long and

1/2" wide, to which is soldered a piece of spring steel 1 1/2" long and 1/4" wide. The electro-magnet is made by re-winding a 350 ohm ringer magnet with No. 28 D.C.C. wire. When in operation, the spring passes three equally spaced electrodes from which the sparks jump, producing the same effect as a rotary gap.

The panel is sheet Formica, 10" x 18" x 1/4"; 1/8" holes are drilled. No. 2 are then punched out for the volt and ammeter; 3, for the gap electrodes; 3, for the electro-magnet, vibrator, and contact screw respectively; 1 and 2, for the primary leads; 11 and 12 are screw holes for mounting the oscillation transformer; 13 and 14 are for clamps to volt meter; 15 and 16, power input; 17 and 18, key; 19 and 20, screw holes for mounting panel to top of spark coil by means of brackets.

Under favorable conditions, this transmitter has an approximate range of twenty miles or more.

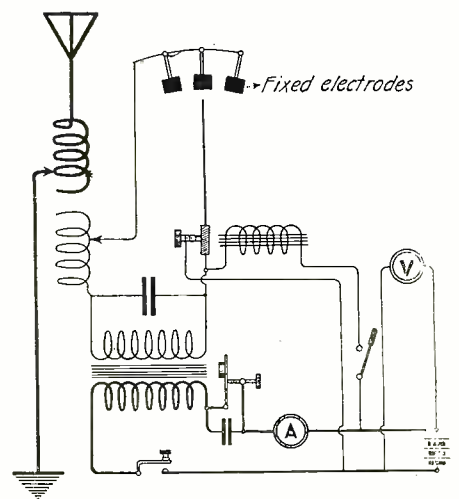

Hook-up of the Spark Coil Panel Transmitter. Note the Vibrating Spark Gap Used as a Substitute for the Rotary.

# Using an Amplifier as a Detector of Long Waves

By H. K. DUNN

I WONDER how many amateurs know that long wireless waves may be received directly on their two-step amplifier, without the use of an extra detecting bulb and large inductances. The fact that this can be done should be of interest to those who have short wave receivers and amplifiers, but no long wave receivers. It should also be of interest to anyone who has experimented to any extent in radio, no matter what equipment he may have. Of course, nothing but the very longest waves can be so received, but it was very surprising to me, and will be I think to most of you, to learn that any signals at all could be received in this way. In the following paragraphs I will tell of my experience in discovering this phenomenon.

Mr. Myron Bunnell and I were working with the set at 8YR, Miami University, Oxford, Ohio. We were testing out the circuit of Fig. 1, where a regenerative set employing a single variometer is shown connected to a two-stage audio-frequency amplifier. I think it was the fact that

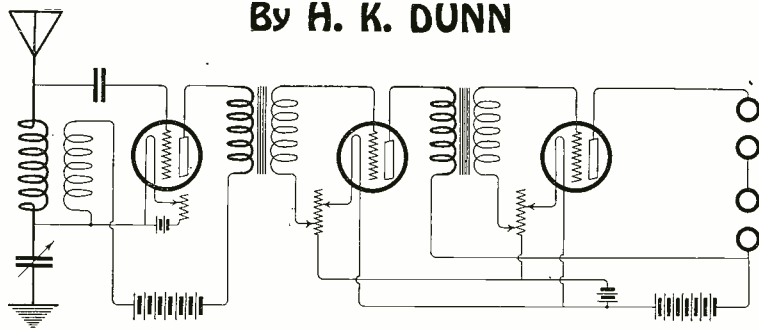

Fig. 1. Hook-up for Short Waves, Using Only One Variometer Designed by Mr. H. K. Dunn. Experiments With This Hook-up Led to the Discovery of the Possibility of Receiving Long Waves Without a V.T. Detector.

conductive coupling was used that enabled us to make the discovery. After hooking up the circuit and throwing in the antenna switch we began to hear 200-meter stations by the dozen, a few of them using CW. We heard one, with a rather low pitch, which we did not seem to be able to tune out. This is unusual for CW, so I copied a little of what he was sending and soon found out it was WSO, coming in where 200 meters should come in. We then tried a number of changes, finally turning the filament of the detector entirely out, and still we could hear him.

From this it was very evident that our short wave set did not have much to do with the reception of these signals. We therefore removed it, connecting the aerial and ground directly to the amplifier thru a variable condenser, as in Fig. 2. We did not need to wait long for results, for by turning the variable we immediately tuned in WSO, NPL, and NSS. NSS was sending their evening press and we copied it without any difficulty. In fact, NSS was quite loud. The other two were not so loud and tuned in near the minimum of the variable, yet we could easily read both of them.

To complete the test I wanted to receive a foreign station. I waited until the next day at 5:00 P. M. (central time) when I knew LY (Bordeaux, France) would be

on. At first I heard nothing at all. Then I happened to remember that the evening before we had been using two sets of fones in series. I plugged in the other fone and in they came, the same as before. Later I found that I could get them with only one fone by adjusting the filament temperatures. In any case the filament temperature seemed to need rather critical adjustment, that of the second tube especially being higher than I had been accustomed to burning it.

I tuned in LY at about the maximum of the variable. Then I tried taking out the condenser. This left me without a means of tuning, but it seemed to fit LY, altho their note was rather high pitched. Then I tried the circuit of Fig. 3 and got by far the best results yet, at least with such high wave-lengths as LY. By turning the condenser I could adjust their note to any desired pitch and got them louder than I had

(Continued on page 557)

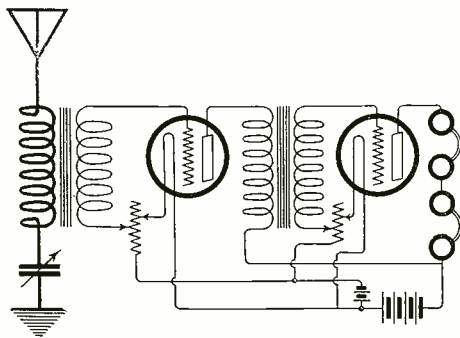

Fig. 2. Connecting the Aerial and Ground to the Primary of the Amplifying Transformer, Long Wave Stations Are Easily Picked Up.

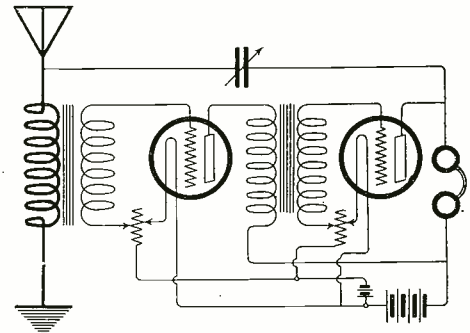

Fig. 3. This Diagram Shows an Improvement on the One of Fig. 2. The Variable Condenser Connected to the Aerial and Fones Makes a Reaction Effect in the Circuit.

## A New Thermionic Vacuum Tube

By JOHN SCOTT-TAGGART

THE present writer evolved the type of vacuum tube described below, while carrying out some experiments on grid control during September, 1919. As is well known, the usual modern three-electrode valve consists of a filament surrounded by a cylindrical anode, a helical grid being placed between filament and anode. A positive potential on the grid will produce an increase in the anode current, while a negative potential will produce a decrease.

The writer's valve is shown in illustration. As will be seen, the form and relative positions of the electrodes are novel. The filament F is vertically arranged, the top support being a nickel-iron spring which keeps the filament taut when the latter is incandescent. The anode takes the form of a small metal plate placed preferably at a considerable distance from F. The control electrode, corresponding to the grid of an ordinary valve, takes the form of a metal plate G, preferably of larger dimensions than F and situated within a few millimetres of the filament F. The particular valve with which the curves, Fig. 2, were taken possess the following dimensions: plate P 10 mm. by 10

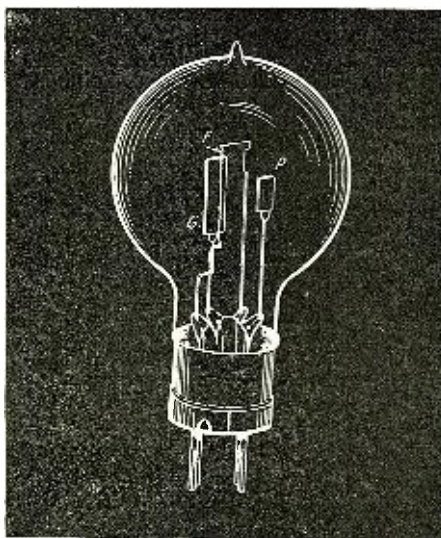

The New Type of V.T. Fitted With a French Mounting. Note the Size of the Two Plates Acting as the Anode and Control Electrode.

mm. by 0.008 in. nickel sheet; plate G 22 mm. by 10 mm. by 0.008 in. nickel sheet; filament F crimped, 25 mm. by 2.3 mils, tungsten; distance F to P 9 mm.; distance F to G 2 mm.

A series of characteristic curves are shown in Fig. 2, and illustrate the effect of the control electrode potential on the anode current to P. It will be seen from the curves A, B, and C that the vacuum tube operates in a very similar manner to an ordinary three-electrode valve; that is to say, an increase of control potential causes an increase of anode current, while the reverse applies if the control potential is decreased. It will be noticed that the portions of the curves lying to the left of the ordinate thru zero potential on the control electrode are very regular and similar to those obtained with an ordinary valve. The bends at the lower ends of the curves are present, as usual. When, however, the control electrode is made positive, we notice that the curves commence to lean over rapidly to the right. This is attributable to the fact that G is now drawing to itself a considerable portion of the electrons emitted.

(Continued on page 558)

# Fading of Signals

By S. R. Winters

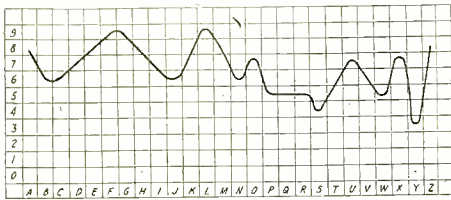

Fig. 1

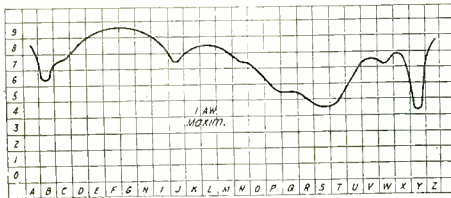

Fig. 2

Curve of the Same Transmission as Received by Two Operators. Note the Similar Shape of Both Curves.

**T**HAT radio signal fading and swinging is a long distance phenomenon attributable to a varying reflection and refraction of waves, and that there is no intimate connection between weather conditions and radio transmission, are the outstanding conclusions of the most comprehensive series of tests relating to this subject ever conducted. The investigations were negotiated jointly by the Radio Communication Section of the National Bureau of Standards and the American Radio Relay League, the tests resolving themselves into two installments covering the months of July, August, and October of 1920.

While the utilitarian or man of affairs might inquire "What are you going to do about it?" as he would ask of any phenomenon, the absence of a remedy does not detract from the interesting details developed by this series of tests embracing the northeastern section of the United States. The theories unfolded as the experiments progress, the anomalies discovered in respective sections of the country, the methods employed in conducting the tests, and the conclusions deduced, have engaging interest to radio operators everywhere. The 3,800 licensed amateur stations in the United States should peruse the results with peculiar interest. The original installment involved the active use of six sending and 45 receiving sets, while the second series employed six senders and 160 recorders. The northeastern territory was selected as the base of investigations by reason of the numerical strength of the amateur stations. Naturally, local conditions, the absence of interest, and the unsatisfactory service of scattering stations, served to eliminate about thirty recorders. The finish saw 130 recorders on the job.

Swinging or fading of signals is defined as a condition which interrupts the continuous transmission of a wireless message, the signals becoming so weak as to make receiving inaudible. To illustrate, the radio laboratory of the Bureau of Standards is listening to the station at Hartford, Conn., the call of the latter being received at normal intensity. The preamble of the message is recorded without any weakening of the signals, and as he begins to send the body of the message the signals become so strong that they can be heard all over the room. Then as the transmission of the text gets under way the signals become faint, unreadable for a group of words. Again they rise to distinctness and by the time the station signs off the signals

are very loud. Obviously, fading contributes to the perplexities of radio communication and renders difficult and even impossible the copying of an unbroken message. The swinging of signals is so characteristic in amateur communication that the abbreviated warning "QSS"—signifying a fading of signals—is issued with quite the frequency that the indications of interruptions from "interference" and "atmospherics." Commercial wireless communication being done on long wave-lengths swinging is not so severe and rapid. The employment of short wave sets, with increasing popularity, by airplanes, in military operations, and in low-power ship communications, attaches significance to fading other than the difficulties experienced by amateurs.

The plan for the sweeping tests was suggested by S. Kruse, assistant electrical engineer of the Bureau of Standards, the idea receiving hearty approval at a conference of government officials and representatives from the American Radio Relay League. The sending stations selected included Hartford, Conn., Woodhaven, L. I., the Naval Aircraft Radio Laboratory at Anacostia, D. C., the station of the Westinghouse Electric and Manufacturing Company at Pittsburgh, Pa., St. Mary's, Ohio, and St. Louis, Mo. "The amount of work involved in handling the 1,260 curves which were received can hardly be appreciated by anyone who has not attempted a job of this kind," emphasizes Mr. Kruse.

Brief descriptions of the sending stations are herewith presented: Station at Hartford, operated by H. P. Maxim, is situated directly to the east of a commanding hill toward which the antenna is directive. There is an absence of hills to the north and south and the country is level to the east for two miles after which it drops abruptly to the Connecticut River. The antenna is a bent fan of 17 wires spaced three feet apart at the high end and which is elevated 80 feet. All wires are continued thru the spreader at the low end to the anchor gap at the transmitting apparatus which is in the basement. The ground system is of a network of buried wires as well as wires to ground rods and to all the metal pipes in the building. The radiating system has a resistance of 5 ohms, and the sending set is of the 60-cycle non-synchronous rotary gap type. The normal antenna current is 5½ amperes. The station in Woodhaven, L. I., operated by C. J. Goette, is not clustered with large buildings or trees. The

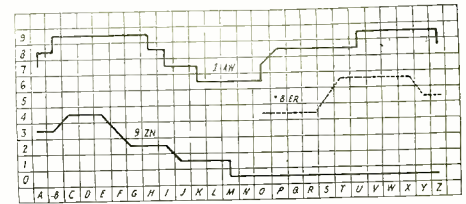

Fig. 3

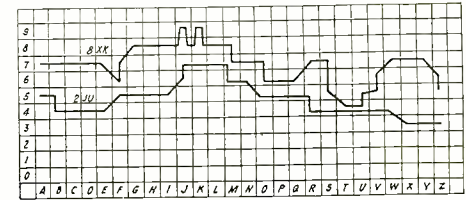

Fig. 4

Curves Taken 150 Miles East of Cape May Aboard the U. S. S. Ohio, and Showing Fading of Signals at Sea.

antenna is a four-wire L, 50 feet high, 85 feet long, and 10 feet wide. The ground system consists of a lead to the water pipe and an eight-wire fan buried immediately under the antenna. The sending set employs a one kilowatt open-core transformer with a 30,000 volt secondary. It is picturesquely known among amateur operators as "the coffin," taking the designation from the resemblance of the box. The Naval Aircraft Radio Laboratory, under the guidance of Commander A. Hoyt Taylor, has a transmitting set which employs two electron tubes of the General Electric type P operating in parallel. The filament and plate circuits are fed by the same motor generator set, and the total input to the tubes is one kilowatt. The antenna is a multiple tuned, one 75 feet high and 235 feet long with three down-leads to the center of one of which the sending set is coupled. The station at Pittsburgh, operated by F. Conrad, of the Westinghouse Electric Company, has an antenna system consisting of a 6-wire L antenna 120 feet long, suspended 50 feet from the ground over a similar counterpoise elevated 12 feet. The station at Chicago, operated by R. H. G. Matthews, is too well known to permit of description, because of its war work. It is located within 30 feet of the sea wall of Lake Michigan. The station at St. Mary's, Ohio, operated by Mr. and Mrs. Charles Candler, has an antenna of a six-wire L, 55 feet high and 65 feet long. The grounding system consists of a group of 7-foot ground rods also connected to the water pipes and to a cistern. The station at St. Louis was the only one-half kilowatt unit employed in the network of sending stations. The antenna is a five-wire L, 55 feet high, 65 feet long, and 12 feet wide. The sending set is composed of an Acme one-half-kilowatt transformer, six Murdock condenser sections, of 0.0017 capacity each, connected in parallel and oil immersed to prevent brushing between leads.

Barring one, all of the recording stations identified with the radio signal fading tests employed a short wave regenerative receiving set. The recorders used a "soft" or gas tube as the detector and "hard" or high vacuum tubes for the amplifier. Likewise the recorders were in unison, with few exceptions, in using four or six wire L antennas about 60 feet high and equally as long, and made of copper wire No. 12, or 7-strand phosphor bronze.

(Continued on page 554)

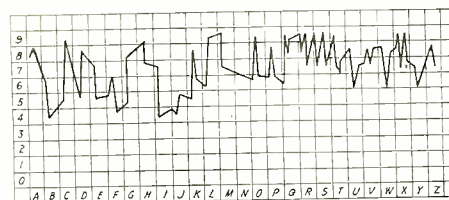

Fig. 5

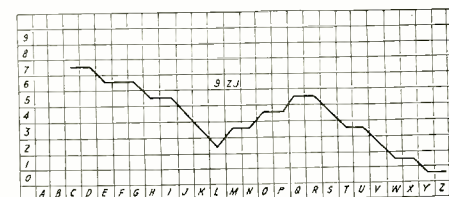

Fig. 6

Top Curve Indicates the Way New England Stations Act Toward Each Other, While Curve in Fig. 6 Shows How New England Acts Toward Outside Stations.

# Who's Who in Radio

No. 1

## DR. LEE DE FOREST

**D**R. LEE DE FOREST, one of the pioneers in wireless telegraphy, whose genius created the Audion and the Audion Amplifier, an instrument that made possible transcontinental telephony and transoceanic radio telephony has during his entire lifetime been one of the most indefatigable and successful workers in this branch of electrical science. He has, in all, taken out over one hundred patents here and abroad on radio telegraphy and telephony, each one of which has materially aided in the world development of radio. His crowning achievement probably is the Audion Amplifier, which has accomplished what the scientists of the world have vainly endeavored to do for a score of years.

Dr. De Forest is a native of Council Bluffs, Iowa, where he was born August 26, 1873. He was educated at the Mt. Hermon (Mass.) Boys' High School. He then entered the Sheffield Scientific School of Yale University for the electrical and mechanical engineering course, graduating in 1896. In 1899 he received from Yale University the degree of Ph.D. for work in physics and mathematics. For a time after leaving college he was attached to the Western Electric Company's Telephone Department in research work, when he began business for himself. From early youth he had determined to devote his energies to electricity and inventions, and he followed this inclination consistently by carefully educating himself for research along the lines selected for his life work.

### RADIO TELEGRAPH SYSTEM DEVELOPED.

His first important work was the development of the Radio Telegraph System, which bore his name from 1902 until 1910. In 1906 he began work on the Radio Telephone. For over a score of years telephone engineers had sought in vain a repeater or amplifying relay which should be at once extremely sensitive, free from delicate and frequent adjustments, and yet which would amplify every modulation or variation of the human voice without distortion. Without such a relay the telephone, at that time, was limited to a few hundred miles. The problem was a baffling one to the inventors and engineers in the telephone industry, and to stimulate action along this line of research an Eastern telephone company, in the late nineties, offered "one million dollars" for a successful telephone relay. This prize was never claimed nor awarded. The engineers still continued to work along the same lines, numberless patents were issued and untold thousands of dollars were spent on the problem. Meanwhile, thru all those years, the long distance telephone was halted, stopt effectively by that trifling little barrier—the repeater relay.

Prof. Pupin, of Columbia University, had discovered and patented the inductance coils which alone made it possible to speak intelligibly on overhead lines one thousand miles or over cable twenty miles in length. He sold his patents to the Bell Telephone Company many years ago, but the transcontinental telephone still remained a commercial impossibility. Theoretically, it was possible to build a line with very large copper conductors and plentifully spaced with Pupin coils, which would enable one, by using large electrical currents in the transmitter, to telephone across the continent; but, commercially, the staggering cost of

such a line put this method absolutely out of consideration—it was impossible. So the telephone world waited hopefully for that yet unfound—the relay which could alone enable one to send, clear and audible, the infinitely delicate variations of the voice across North America.

### AUDION AMPLIFIER EVOLVED.

At last that result was attained—not by telephone engineers, whose minds had for years spun in the old rut of receiver-microphone "Siamesed" together, but by De Forest, who beginning his pioneer experiments with wireless detectors, way back in 1902, discovered that a heated gas was "sensitive" to the weak "wireless" waves and could constitute a new detector for use in radio telegraphy.



Dr. Lee De Forest. Inventor of the Audion.

In 1903-4 Dr. De Forest made on this principle a genuine practical detector, possessing a sensitiveness far in excess of any hitherto known wireless receiver. Indefatigable in his efforts to further improve and apply his "Audion," this little incandescent lamp (which made *audible* the action of the "ions", or sub-atoms of the heated gas around the filament). Dr. De Forest discovered that these "ions" responded to telephonic currents as well as to those of the far higher frequencies used in wireless. He found that when this strange device, so utterly new to the telephone field, was properly connected in the line between a transmitter and a receiver, the Audion actually amplified the voice currents, giving a reproduction of perfect fidelity without a trace of lag or distortion, yet with an increase in volume, or intensity.

He patented the Audion Amplifier in 1907, but it was not until 1912 that he had brot it to such a state of perfection that he felt justified in bringing it to the attention of the engineering staff of the American Telephone and Telegraph Company. Three times this company has purchased patent rights under the Au-

dion and other patents, paying nearly a half million dollars for them.

The Audion Amplifier proved to be the long-sought telephone repeater, or relay, of almost infinite sensitiveness and power, free of adjustment and distortion. Its use made possible, in 1915, the opening of the first transcontinental telephone service. Since then its introduction into long distance telephone service in this country and abroad has been almost universal.

By use of large oscillating Audions, wireless telephony from Washington to Honolulu has been achieved, and the detector is now used exclusively for long-distance signalling the world over—especially in the U. S. Navy Service. A work devoted to the progress of electrical science would be as

incomplete without a description of Dr. De Forest's wonderful invention as it would be were the discoveries of Professors Moore and Bell left out; hence a few words about the Audion Amplifier.

### DESCRIPTION OF AUDION AMPLIFIER.

This instrument consists of a small incandescent lamp bulb exhausted of air, containing, in addition to the usual filament, two thin plates of nickel about one-eighth of an inch from the filament on either side. Between the filament and the plates are two pieces of nickel wire bent grid-shaped. That is all. Can you imagine anything more simple, more utterly unlikely to operate as a repeater of telephone currents? Yet this little lamp was the one thing missing in the successful system of transcontinental and transoceanic communication. It links the Eastern with the Central, the Central with the Mountain, and that with the Pacific Coast.

In the Amplifier, the incoming current, to be repeated and amplified, is conducted to the "grid" wire. The outgoing line is connected, one terminal to the plates, the other to the filament. In this circuit is found a battery. A separate battery lights the filament to incandescence. The heated gas becomes then a conductor of the local current from the battery, which can pass from the cold plates to the hot filament. In other words, negatively charged "carriers," "ions," or "thermions," as they may be termed, speed in invisible streams of almost infinite tenuity from filament to plates passing in their migration thru the spaces between the wires of the "grids." Now, the slightest electrical potential, or charge, of electricity impresses upon these "grids" from the incoming telephonic currents deflects or retards some of these tiny carriers of negative electricity. This effect is always proportional to the cause, so that the current changes produced in the outgoing, or "plate", circuit are similar to those current changes or electrical charges, upon the "grid" wire which produced them. But the changes in current thus produced are many times in volume or intensity the changes in current which caused them. In other words a unit electrical charge delivered upon the "grid" produces a deflection, or stoppage, of six to ten unit electrical charges passing from the filament to the plates. Hence the strange amplifying properties of the Audion.

### THE BIRTH OF THE GRID.

The one most essential and completely novel element in the whole strange device

(Continued on page 560)

# CLUB GOSSIP

## UNION COLLEGE RADIO CLUB

Perhaps a few of those who chance to read this article will recall having heard the spark of the old 2YU station, of pre-war days, with its 60-cycle rotary jazz, and its 240-cycle synchronous Marconi whine. The latter set was more pleasing to the ear, but severe in its treatment of condensers, the log book tells us; hence it was out of commission a very large part of the time. However, the club at that time was a pioneer organization at Union and a worthy predecessor.

The present Radio Club was organized at the beginning of the college year along somewhat novel lines, inasmuch as it attempts to combine with the attractiveness of the undergraduate club, the effectiveness of the commercial corporation. Those who have had anything to do with the administration of an amateur radio organization realize the peculiar difficulties connected with such a concern. Suffice it to say that the system in use here aims to supply a job for every man; and there are forty-eight members in good standing who subscribe heartily to this policy.

The electrical laboratory of the college is used as a station, the operator's cabin adjoining the laboratory proper. A fan-type antenna is used, having a maximum height of 70 feet, and spread of 90 feet, with seven down leads, nearly vertical. The geography of the situation is such as to prohibit the use of a counterpoise; so the old ground system was again used, consisting of ten 3-inch iron pipes driven eight feet into the ground. The effective resistance of the entire system is about ten ohms at 300 meters.

The regular transmitting set consists of a General Electric 60 cycle transformer, 110-13,200 volts, taking an input of 850 watts on full power; Dubilier condenser of .007 mfd. capacity, enclosed non-synchronous rotary gap and pancake type oscillation transformer. A six ampere scale thermocouple ammeter is always in the antenna circuit and reads five amperes for normal operation. This set is tuned to a wavelength of 260 meters. There is also a 6 U-tube set, with voice and buzzer control, operating on 360 meters. Power is furnished from a one kilowatt 1,000 volt generator, which gives an antenna current of 4 amperes. The Meissner oscillating circuit and "plate-modulation" are characteristic of this set. A third transmitter is being installed for the use of those who like to talk with local amateurs during the early hours of the evening. It will consist of a small spark coil and loose coupler. For regular receiving work the club uses an Adams-Morgan Paragon, with two steps of amplification and Baldwin tones.

The club is to have an appropriation of two hundred dollars from the college authorities for the purchase of a new sending set, enabling the organization to reach practically any of the larger cities in this country. The addition of this large continuous wave set will put the Union club far ahead of most of the other college organizations in the matter of wireless equipment.

Needless to say, the activities of the club are limited to the school year, approximately Oct. 1 to June 1. There is an experienced operator on watch each evening from 10.30 to 12.30, Eastern Standard Time, to handle regular traffic. In addition, the club makes a special effort to transmit returns of local games and meets, both by radiofane and spark. Every Thursday evening a radiofane concert is sent out from 8 to 8.30, and from 9 to 9.30. A local dealer has taken sufficient interest in the scheme to supply a pro-

gram of the latest records each week. The club has received a large amount of correspondence in regard to these concerts and feels that popular interest is sufficient to fully justify the effort.

## SPRINGFIELD RADIO ASSOCIATION

Mr. F. Clifford Estey, president of the Essex County Radio Association, was entertained recently by the members of the Springfield Radio Association in an open meeting held in their club rooms at 19 Orleans St.

The subject of Mr. Estey's address was "County Radio Organizations." He spoke at length on the need of getting together and combining the amateurs into one large national body to escape commercialism.

In part he said: "The amateurs *must* get together to live. Big business is falling hard for radio telephony and when big business gets hold of a thing, it's pretty hard to make him let go."

Upon request Mr. Estey then gave a brief outline of the policy of the American Radio and Research Corporation, with which he is connected. Instructor Creaser and President Cushing of

erning body has had the situation in hand and we all hope for better conditions to come.

## SACRAMENTO RADIO CLUB

At a recent meeting of the Sacramento Radio Club, the following officers were elected to serve for a term of six months: Pres., Jack Irving; Vice-Pres., Lester Cate; Secretary, C. F. Mason; Treasurer, Edward Pitt; Radio Inspectors, Rad Coover and Will Yeaw.

Meetings are held on the second and fourth Thursdays of each month at the homes of the members. Plans are well under way now for permanent club rooms.

The membership at the present time is about thirty-five. We hope to make a notable addition to this number in the coming season.

The photograph at the bottom of this page is that of the 1-K.W. station, 6BAC, run by the club at the California State Fair held in this city last September.

Address all communications to the secretary, C. F. Mason, 2530 N St., Sacramento, Cal.

## RADIO RESEARCH MERGES WITH RADIO CLUB OF THE BRONX

Owing to the lack of facilities and to the fact that the Radio Club of the Bronx needed members, the members of the Radio Research Club unanimously decided to merge with the former organization. This was done with the intention of forming one strong organization which would combine the advantages of both organizations for the advancement of amateur radio.

The Radio Club of the Bronx at present has thirty members and is able to accommodate a much larger membership. The meetings are held every Saturday night at 8 o'clock at 852 Manida St., Bronx. All those interested are cordially invited to attend.

As the Radio Research Club is now a thing of the past and will only be referred to in connection with the Radio Club of the Bronx, the members take this opportunity to thank those who have co-operated with them in managing the affairs of the R. R. C.

## RADIO CLUB OF BROOKLYN

The Radio Club of Brooklyn, N. Y., announces that its meetings are now being held on the second and fourth Wednesdays of each month at its new headquarters, 2211 Bedford Ave.

The club has investigated traffic conditions in its vicinity and as a result is laying out local traffic lines thru Brooklyn connecting with 2RK thru the medium of a central traffic station, not yet appointed, for both incoming and outgoing traffic. Non-member stations are included as well as club stations, the routes being really an extension of the A.R.R.L. trunk lines, and all Brooklyn amateurs are asked to co-operate.

At the meeting held on January 12, the following officers were elected: C. Hild, president; H. Bierschenk, first vice-president; Chas. Porter, second vice-president; Elmer Baier, treasurer; C. Knudsen, sergeant-at-arms. The past officers were: C. Hild, acting chairman and first vice-president; Harold Knight, second vice-president; D. Langon, treasurer; L. Jaquet, secretary.

The R. C. B. expects to soon be in the magazine section of some Sunday papers. We want to inform our friends that a stag will be held at the

(Continued on page 560.)



This Very Efficient Station is Owned by the Union College Radio Club. On the Left is the 6-Tube C.W. Set Used for Undamp Wave Transmission or Radifone Concerts.

the Connecticut Valley Radio Club of Springfield, then discuss the advisability of combining the two clubs of Springfield, but it was decided to wait some time before doing this. These talks were followed by the serving of light refreshment.

P. S.—Be prepared for the grand crash from the S. R. A.'s 1 K.W. soon.

## YONKERS RADIO CLUB

The Yonkers Radio Club has the largest attendance of any radio club in Westchester County, having the good fortune to have in its membership such enthusiasts as Mr. Troupe of DX fame, whom we no doubt all know well; Mr. Cloue 2HZ, the famous C.W. ham; also Mr. Hobe, another one of the C.W. bunch.

At one of the recent meetings of the club we had the good fortune to hear Major Armstrong deliver one of his famous lectures on the functioning of the Armstrong circuit. The meeting was largely attended.

One of the many topics of interest to all was recently thrashed out and a happy ending was the culmination of what at first appeared to be a sensitive subject; we all no doubt know that it was QRM.

The Junior members of the club were represented by Mr. J. S. Cornell, who let the older members know just exactly where they stood on the question of spark coil QRM. We all extend congratulations to Mr. Cornell. We think that many members of radio clubs are wont to disregard the junior members and thereby cause a great deal of hard feeling which should not be manifested in any organization, much less a radio one.

The club has the good fortune to have the use of the complete 200-watt C.W. transmitter of the Westchester Radio School, as also the complete rooms for code instruction of the members who are so interested. Call 2AYH.

Mr. Cloue, Mr. Remy and Mr. Troupe have been appointed as the representatives of the Yonkers Radio Club to represent us at the Executive Radio Council, held for the purpose of reducing the QRM trouble in this immediate vicinity. Great improvements have been noticeable since this gov-

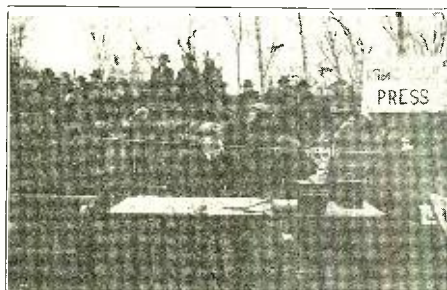

This Field Station Installed by the Union College Radio Club at the Ball Game, Was Used to Send the Results to the Press.

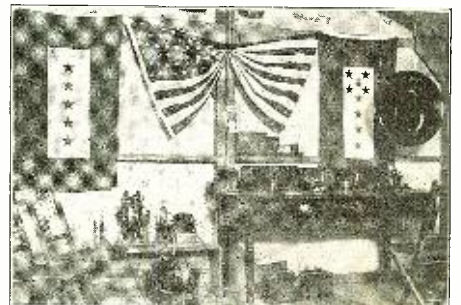

This is the Station 6BAC Which Was Run at the California State Fair by the Sacramento Radio Club. Note the Complete and Well Planned Receiver.

# Radio Digest

## THEORY OF ANTENNA RADIATION.

A. PRESS.—After considering the previous investigations of antenna radiation the author attacks this problem, taking into account the sinusoidal distribution of current and voltage along the antenna. The vertical grounded antenna only is considered. A detailed mathematical investigation of radiation and field strengths at remote points follows. Formulas resembling the Eccles radiation formula and the Cohen dispersion and diffraction factor formula are obtained and interpreted.—*Proceedings Institute of Radio Engineers*, December, 1920.

## MULTIPLEX RADIO TELEGRAPHY AND TELEFONY.

FRANCIS M. RYAN, J. R. TOLMIE and ROY O. BACH.—The authors classify the chief methods of multiplex radio communication. Duplex and quintuplex radio-telephony and radio-telegraphy over 5 miles (8 km.) at wave-lengths around 2,000 m. were experimentally accomplished and are described.—*Proceedings Institute of Radio Engineers*, December, 1920.

## SOME CHARACTERISTICS OF THE FREQUENCY DOUBLER AS APPLIED TO RADIO TRANSMISSION.

T. MINOHARA.—A general analysis is given of the theory of the ferromagnetic frequency doubler. The production of secondary circuit energy is secured either by the introduction of a sinusoidal secondary emf. or by the production of a sharply peaked "impulsive" secondary emf. In each case secondary resonance is employed to emphasize the desired double frequency. The sinusoidal-wave and impulsive-wave systems are oscillographically studied and compared for different types of secondary load. The impulsive system is recommended as having higher efficiency wherever the frequency is sufficiently low to avoid excessive iron-core losses with that form of wave.—*Proceedings Institute of Radio Engineers*, December, 1920.

## THE NEW GENEVA WIRELESS STATION.

Many thousands of words are being sent out daily from the temporary Marconi Station at Geneva for the special use of journalists attending the Conference of the League of Nations, and over 10,000 words were handled on the 15th inst. within a few hours of the close of the first sitting of the Conference. Naturally, the Marconi Company is gratified with this excellent performance by a station which was completed only a few hours before the opening for commercial traffic. Rapid automatic transmission is being employed, the train of clear-cut signals, which cannot be understood aurally without special apparatus, being received at the British station at Witham, Essex, on rapidly revolving phonograph records. From Witham the signals are re-transmitted by Creed high-speed gear to London.

The station, which was erected in agreement with the Swiss Federal Government, is a 6 kw. continuous wave valve one, and the service commenced on the day the Conference opened. In addition to the primary service to the Witham station, communication has now been effected with Csepel (Hungary) Nauen (Germany), Centocelle (Italy) and Barcelona (Spain). The transmitting apparatus comprises one Marconi standard 6 kw. continuous wave valve telegraph set of the coupled circuit type, fitted with 6 "power" and 4 "rectify-

ing" valves. The power is taken from the Geneva Supply Company and supplied to a 30 B.H.P. 500 volt two-phase motor, which drives by belt a 23 kw. 100 volt direct-current dynamo. An emergency power plant is provided, consisting of one 18 kw. 110 volts direct-current Austin oil-engine generator. One 6 kw. motor alternator is installed, taking supply from the 110-volt direct-current circuit, giving a single-phase supply at 500 volts 300 cycles. The voltage is raised to 7,500 by a step-up transformer, at which pressure it is fed to the valve transmitter panel. The signalling circuit comprises special high-speed keys operated by a Wheatstone transmitter, the tape for which is "punched" on a Gell keyboard type perforator. The aerial is of the umbrella cage type with six radial members, supported by a single lattice steel self-supporting tower 200 ft. high, each radial member being carried out to a 50 ft. pole at a distance of 300 ft. from the central tower. The earth system consists of the usual galvanized iron plates and earth wires buried in the ground. Five miles from the transmitting station is a separate receiving station erected so as to permit of duplex working. This station is provided with a special aerial constructed on the latest direc-

ed by Rear Admiral W. H. G. Bullard, is named to make the arrangement.

In addition to the wireless service two huge megaphones placed in the reviewing stand in front of the White House will be connected by wires to the amplifying device at the Capitol permitting crowds unable to be at the Capitol to hear the address.

## FRANCE PROJECTS GIANT RADIO PLANT.

Louis Deschamps, Secretary of State for Posts and Telegraphs, laid on January 8 the cornerstone of what is designed to be the most powerful radio station in the world, capable of transmitting with two sending instruments 24,000 words hourly or receiving and deciphering 60,000 words hourly on five instruments.

The Lafayette Station, which is now the most powerful, has a maximum range of 15,000 miles, but experience has shown, according to the Ministry, that it cannot be depended upon for more than 6,000 miles regularly. The Sainte Assise Station when completed, in 1923, will, it is calculated, work easily and regularly with all stations in the world.

The striking physical features of the plant will be sixteen steel towers 800 feet high. A number of special telegraph wires will connect the station with the central telegraph offices.

## AIRPLANE FLIGHT DIRECTED BY RADIO.

A French inventor named Detables has succeeded in getting financial support which will enable him to perfect an invention he has developed of an airplane which can be directed without a pilot over long distances by means of radio control much on the same principle as that employed for the direction of seagoing vessels by John Hays Hammond, Jr. In the early days of November, 1918, he says, he even succeeded in guiding an airplane at a height of 700 meters for a distance of nearly 125 miles. He is confident he can devise an apparatus for the control of bomb-dropping machinery and also that he can extend the scope of his airplane's flight area to at least 500 miles without a pilot.

## RADIOTELEFONIA ESPANOLA

Radiotelegrafia con onda continua

By Rufino Gea y Sacasa

This little manual entitled "Spanish Radio Telephony and Undamped Waves' Radio," describes the functioning of the V. T. and gives many details on its application to radio telegraphy and telephony in Spain. Description and constructional details of the Spanish instruments are given in the various chapters, which are illustrated by good photographs and diagrams, making this little book a very complete manual of radio telephony.

Messrs. Rufino Gea and Sacasa, the authors, are well-known radio engineers in Europe and their work is to be classified among the best practical manuals on the subject.

Radiotelefonía española is published by the Publicaciones de el telegrafo español Madrid, and sold for four pesetas a copy.

## Radio Articles in the February Issue of Science and Invention

Grand Opera by Radio. *With special story of Madame Tetrazzini who sang by wireless telephone to U. S. sailors at sea.*

By Nelly E. Gardner.

Sending Radio Weather Reports to Farmers.

New Loud Speaking Telephone Suitable for Use with Audion Amplifiers or Ordinary Telephone Circuits.

The Hall Jet Relay for Recording Radio Signals—*Complete Theory and Practical Details Described and Illustrated.*

By Prof. Ralph D. Doner.

100 Words Per Minute by Radio Typewriter.

Stock Brokers Find Radio Useful.

tional principles, and is connected to the transmitting station by landline.

The receiving station at Witham, near Chelmsford, is equipped with the latest type of directional aerial and, in addition to up-to-date valve receivers, is provided with dictafone apparatus for the reception of high-speed messages. For transmitting the necessary acknowledgments, service messages, etc., a 15 kw. valve transmitter at the Marconi Works, Chelmsford, is operated direct from the receiving station at Witham by landline connection. Witham is also in direct landline communication with the Marconi Company's London Office to which the messages are finally transmitted by high-speed automatic apparatus. Many thousands of words are daily handled by this service.

## PRESIDENT HARDING'S ADDRESS TO BE SENT BY RADIOFONE.

A Special Radiofone will transmit President Harding's inaugural address to every battleship and to halls in various cities where "inaugural parties" will be held. A committee of army and navy officers, head-

## ROBINSON'S MANUAL OF RADIO TELEGRAPHY AND TELEFONY

We wish to inform our readers that the price of Robinson's Manual of Radio Telegraphy and Telephony, which was reviewed in the December issue of RADIO NEWS, has been changed to \$2.50 a copy.



# Practical Construction of an Amplifying Transformer

By ROBERT E. LACAULT

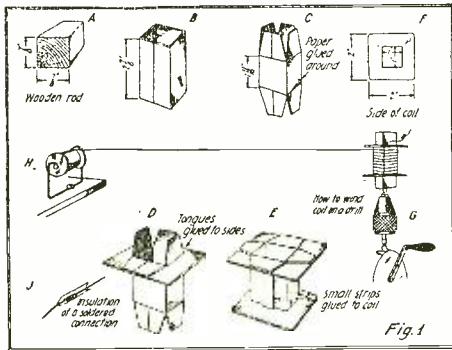

Constructional Details of the Form on Which the Transformer is Wound. For Winding, a Drill May Be Used as Shown in G.

**M**ANY amateurs dream of a sensitive amplifier and take a great interest in looking at the display of apparatus exposed in the various radio stores. The chief trouble with these sensitive receivers is the price. Amateurs, here is a means to fight the high cost of radio apparatus. You, can build yourself a two or three stage amplifier without spending a great deal of money. Building your amplifier yourself, you will have a sensitive apparatus fitted with many steps of amplification for the same price as one you buy ready made, having but one step.

Many diagrams of audio frequency amplifiers have been published in this magazine, and the type of transformers described in this article may be used in these circuits. The construction of this audio frequency transformer does not present great difficulties and all amateurs having a little hand practice will turn this out successfully.

At first secure about 3300 yards of No. 44 silk cord covered wire and some sheet iron for the iron core. The core is made of 56 strips  $1\frac{1}{8}$ " wide,  $9\frac{1}{2}$ " long and about 0.014" thick (No. 29). They are then cut to the correct size with a snip. For shown in Fig. 3 they are not all of the same length. The eight strips in the center of the core are  $9\frac{1}{2}$ " long, the next eight strips are  $8\frac{1}{2}$ " long, the following  $7\frac{1}{2}$ " long and those placed outside are only  $6\frac{1}{2}$ " long. This iron core is placed in the center of the coil after the latter is wound.

The coil is made of cardboard  $1/24$ " thick, to make it of the proper size it is necessary to make it on a form. This form is only a wooden rod 3" long and of a square section  $3/8$ ", with a file the edges are smoothed, this, to allow the coil to be taken easily out of the rod when finish and to avoid sharp edges. See Fig. 1-A. This form being held at one end in a jaw, a piece of cardboard  $2-4/16$ " wide is wound around, only one turn is made and the two ends joined on a face of the square form. See Fig. 1-B.C. To hold it in place a strip of paper of the same width is glued around. After this is dried the corners of this

square cardboard form are cut as shown in Fig. 1-C.

The two sides of the coil are made of the same kind of cardboard as in Fig. 1-F. They consist of two squares of two inches with a one inch square hole cut in the center, then introduced onto the center part and the four tongues at each end are bent and glued on the two sides which must be parallel and distant of  $1-1/8$ " as in Fig. 1-D.

To obtain this easily and in order to give a better shape to the coil for the winding, four little strips of the same cardboard  $3/8$ " large and  $1-1/8$ " long are stuck on the four faces. See Fig. 1-E. When this coil is completed and dried it must be coated with shellac to give good insulation.

In order to give the proper shape to the center of the coil, one layer of very thin silk ribbon about  $3/8$ " wide is wound around, and then another coat of light shellac varnish applied over it. The winding will be preferably made on a lathe but the amateurs who do not possess this machine may wind the transformer easily, using a Goodell drill or a phonograph motor run at low speed. A special mounting must be made for the spool of wire which should be placed far enough from the lathe or winding machine (4 or 5 yards), the wire being very small cannot support a heavy strain and this length of wire reduces it. A simple bearing supporting the spool, can be made of straight wire fixt in the center, and supported by another wire bent in the form of a fork as shown in H, of Fig. 1, and fitted with an eye at the end of each arm.

During the operation of winding, if the wire breaks a good soldered connection must be made and placed in a little folded piece of silk ribbon, as in Fig. 1-J. The connection to the wire running in or out of the coil will be also soldered and insulated in the same manner. These connections will preferably be made of a piece of "Litz" wire entering the coil by little holes bored in the sides. A length of about 4" is kept outside and two turns are made around the core to fix it firmly. The No. 44 wire is then soldered to it and the winding begins.

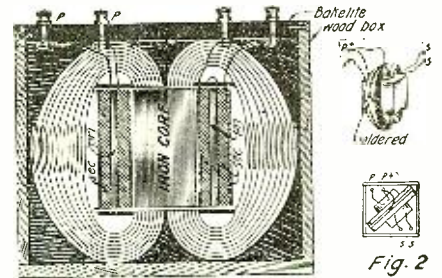

The Transformer When Completed is Enclosed in a Box and the Space Around it Filled With Paraffine. Note the Method of Winding the Primary Between Two Parts of the Secondary.

As will be noticed, in Fig. 2, the primary is sandwiched between two parts of the secondary. After the first half of the secondary winding consisting of 7,500 turns is made, a connection is taken out, then two layers of the same silk ribbon already used is wound over, and finally the primary wound the same way. In order to recognize the wires coming out from the coil some small labels will be fixt at their ends. After the 4,000 turns of the primary are wound with the same No. 44 wire, two other layers of silk ribbon are placed on top as a covering insulation and then the other 7,500 turns of the second half of the secondary are wound over this. When this is finish the same silk ribbon is applied to cover the winding and the finish coil is then shellacked.

When the coil is dried the iron core is then introduced in the center hole and the iron strips bent as shown in Fig. 3. Beginning with the outside ones, each end of a strip is put in contact with the other, thus closing the magnetic circuit on each side of the coil. To keep all the strips in place the last one to be bent over is soldered. When both sides are fixt in this manner, a few turns of copper wire are wound over the iron cores, and also soldered on each side where the iron strips are themselves soldered.

The last operation consists of enclosing the transformer in a little box fitted with a hard rubber or bakelite top in which four binding posts are inserted. The transformer being placed in the box and the connections taken out, the box is then filled with boiling paraffine which is poured slowly into the box with a spoon. The four binding posts in the top of the box are used for the primary and secondary circuits. The copper wire wound around the iron core is also soldered to one binding post of the primary which must be marked accordingly and which is connected to the positive (+) of the B battery. This avoids hauling or detrimental noises.

Tho this may seem complicated to the amateurs, it is in fact simple and worth the work and time devoted to the construction of this piece of apparatus. Besides the saving of many dollars it will be worth more in the eyes of the amateur who will have had the satisfaction gained by personal accomplishment.

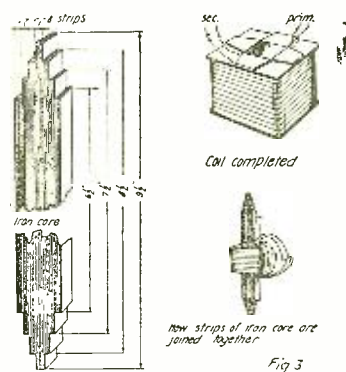

Details of the Iron Core, Made of No. 29 Laminated Steel.

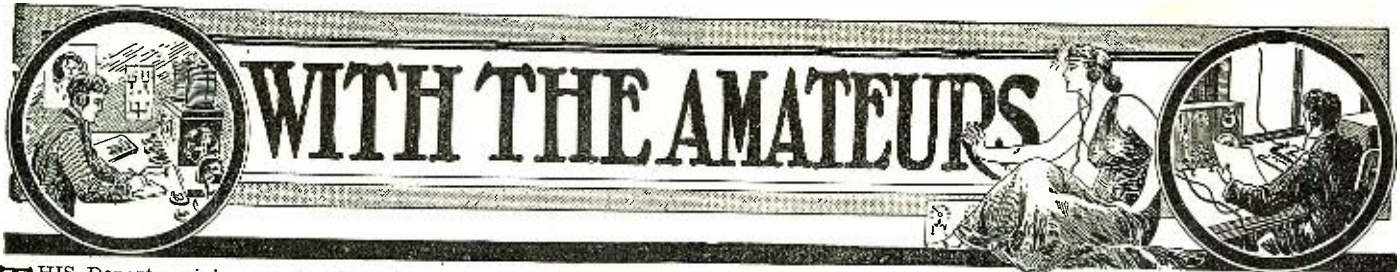

**T**HIS Department is open to all readers. It matters not whether subscribers or not. All photos are judged for best arrangement and efficiency of the apparatus, neatness of connections and general appearance. In order to increase the interest in this department, we make it a rule not to publish photographs of stations unaccompanied by a picture of the owner. We prefer dark photos to light ones. The prize winning pictures must be on prints not smaller than 5 x 7". We cannot reproduce pictures smaller than 3½ x 3½". All pictures must bear name and address written in ink on the back. A letter of not less than 100 words giving full description of the station, aerial equipment, etc., must accompany the pictures.

**PRIZES:** One first monthly prize of \$5.00. All other pictures published will be paid for at the rate of \$2.00.

## Louis Falconi's Station THIS MONTH'S PRIZE WINNER

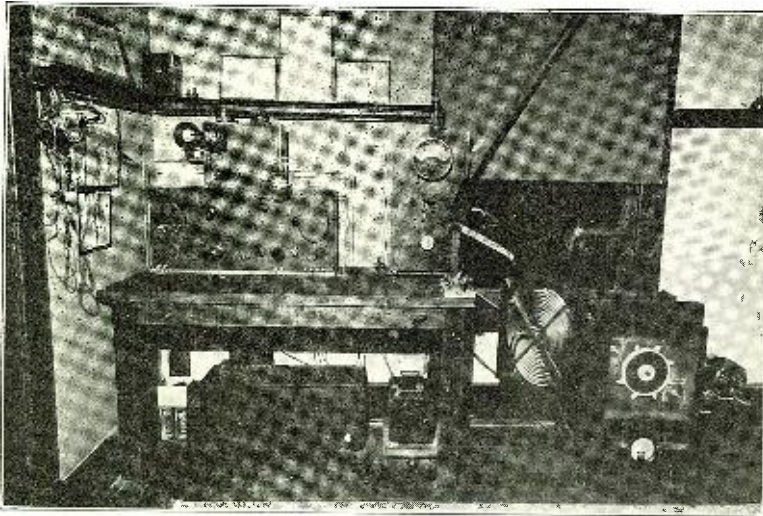

Here is a very good and efficient "ham" station. We extend our compliments to the owner and wish to see more like this one.

small motor on the right of the sending unit runs the rotary. The OT is plainly visible and is of the ribbon type, the secondary being hinged. The condenser is immediately behind the front panel and is made of plate glass and copper sheet immersed in oil. The transformer rests on the condenser. The frame of the transmitter unit is made of angle-iron and the panel is bolted to it. All wiring is lead covered. The radiation meter is below the rotary gap.

On the table, the switchboard controls the power circuit. The large meter indicates the amperes in the transformer primary. The change-over switch is just in front of switchboard.

Under the table may be seen the A battery and B battery box. A vibrating rectifier just above storage battery under the table, charges the A battery.

A wavemeter on the shelf on the wall completes the equipment.

The aerial is composed of four wires 80 ft. long on poles 55 and 65 ft. high.

5ZA is one of the relay stations between the east and west. Many messages are sent from one coast to the other. Signals from 5ZA have been reported from Fort Pierce, Fla., Portland, Ore., Princeton College, N. J., Billings, Mont., and many other far distant points.

The radiofane at Catalina and Long Beach, Cal. is heard all over the room on good nights.

LOUIS FALCONI, Radio 5ZA,  
Box 421, Roswell, N. M.

**B**ELOW is a description of Radio 5ZA in Roswell, N. M.:

The receiving equipment consists of a long wave receiver using honeycomb coils and a short wave receiver of the variometer regenerative type. The upper small cabinet contains the long wave units and the lower larger cabinet houses the short wave units and a two-step amplifier. The amplifier is so connected that it can be used either in connection with the long wave set or with short wave set by the

throw of a switch shown on panel of large cabinet. Plug and jack system is used for plugging any step of the amplifier and also for plugging in fones.

The transmitter is at the right of the photo and standing on the floor.

It is built as a complete unit. The rotary gap and quenched gap may be seen mounted on the front panel, the quenched gap just appearing over the panel since it is mounted on the back of the panel. The rotary gap is housed by a box with glass front. The

## Station of Ralph O. Martin

**T**HE station of Ralph O. Martin, Kenosha, Wis., is in a one-story frame building, located at the east end of the antenna. The antenna is an "L" 75 ft. long and 50 ft. high, with four wires.

The receiver needs no detail as it is of the Chicago Radio Laboratory, a "Paragon" and "Amplifogon" combination, which works very fine. The receivers are a one-time pair of German fones.

The transmitter consists of an "Acme" 1-k.w., and a special gap designed by 9JT, altho the picture shows one of "Signal" make. The condenser is a Thordarson, while the OT is homemade. The radiation is seven amps on high power and four on low. The record transmission is to 3GO, while 9GP has been heard at 6ZH, Richfield, Utah, who reported sigs QSA. The ground is of the counterpoise type, rods

also being buried in the ground.

Up to this writing 182 messages have been handled since Sept. 1st, 9GP being on the "Lake Shore Route" in the Central District.

Another well planned 1-K.W. station. No wonder he gets them with this kind of a receiver!

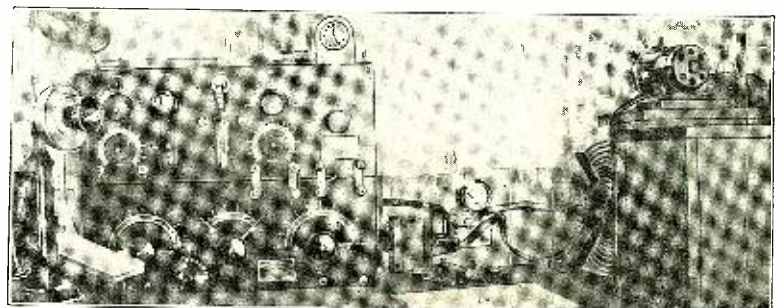

I find RADIO NEWS very interesting and instructive and lay no small part of 9GP's increasing success to its excellent qualities.

RALPH O. MARTIN, 9GP,  
818 Sheridan Road, Kenosha, Wis.



## Jos. L. Telmosse's Station

HERE is a photo of my homemade reception and transmission set. The system is honeycomb coils of four different sizes, 50—110—350—650 turns each, tickler circuit. I hear all sorts of wave-lengths from 100 to 20,000 meters damp and undamp waves. I have two amplifiers and also telefontic transmission which I use with one of my valves, taking 4 watts, and go as far as five miles, without switching anything on my set, either to speak or receive.

My telegraph transmission is also a homemade transformer of about 750 watts. 60 cycles, 110 volts, variable condenser submerged in oil and helix.

A special rotary switch enables me to connect and disconnect all in one movement, the reception and transmission set, also to keep them both disconnected together.

I have caught stations from San Diego, Cal. to Nauen, Germany. I often receive

.....  
This one is a real experimental station, including a small radiofone and a good looking homemade panel receiving set.  
.....

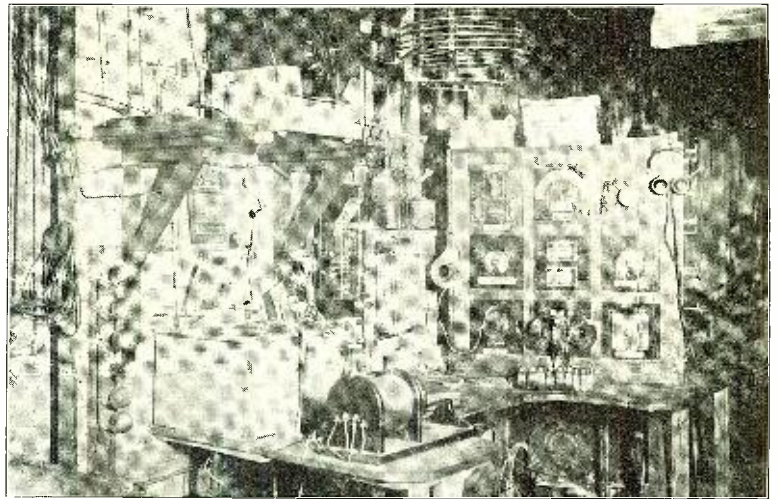

gramophone music, very clear and strong, played by a station at Green Harbor. They work at about 350 meter wave-length. When using my amplifiers I cannot keep my fone set on my head for some stations, signals

being too loud. I have about 800 feet wire for aerial antennae, 75 ft. from the ground and about 400 feet above mean sea level.

JOS. L. TELMOSSE,  
Shawinigan Falls, Que., Canada.

## Station of W. L. Stannard

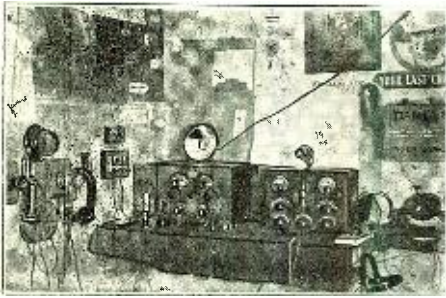

Leon Doesn't Trouble the Ether for He Has No Sending Set, Only a Very Sensitive Receiver.

HERE is a photograph of my station, which as yet, is for receiving only. The two large cabinets are the Mignon RLC5 and Audion panel ET1. I have added a one-step amplifier, as you will note, above the audion panel. The panel on the extreme left is for controlling either a 23 or 43 plate Illinois condenser into series or shunt with aerial and ground.

Western Electric and Holtzer Cabot fones are used. The intercommunication fones are used to advantage in the house. Over the audion panel is a wiring diagram of the room. An A.C. arc can be seen on the extreme right with its reflector. This is used successfully for searchlight communication.

Dash lamps are used to illuminate the set at night and are supplied with current from a step-down transformer. The current is regulated by the rheostat shown on the switchboard on the wall.

Press is received extremely clear every day and the majority of stations on the coast are audibly received. No difficulty is encountered in tuning any one in or out. Among other stations, NAT, NAJ, NAR are clearly heard, also numerous ship stations.

W. LEON STANNARD,  
379 Allen St., Springfield, Mass.

## Station of Cyril T. Atkinson

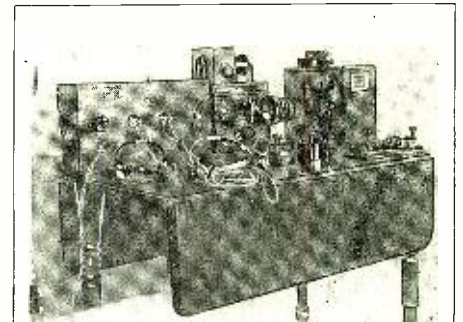

Boy, What Do You Think of This 10-Watt Station? It is the Maximum Power They Are Allowed Over There and Yet They Do Some Good Work.

waves. At the right is the transmitter consisting of a tuned spark set. The coil just absorbs the allowed 10 watts and radiates 180 meter waves. Since taking the photo inductive coupling has been applied.

My receiving results are good as on the small aerial I have a single wire inverted "L" 35' flat top, 45' lead in. I get all the British and European stations of fair size and one or two of the very high powered American ones.

CYRIL T. ATKINSON, 2CZ,  
17 Beaumont Road, Leicester, Eng.

### STATION OF CYRIL T. ATKINSON.

HAVING been a subscriber to RADIO NEWS for the past two years and as I always enjoy reading about the other stations, I am sending you a small photo of my radio set, feeling that perhaps it will be of interest, showing as it does a typical English station with its low power transmitting set.

The case at the left contains the valves, three in number, together with their condensers, transformers, etc. The first valve is arranged as a detector, together with two low frequency magnifiers. Next comes the tuner consisting of a small tubular coil for waves from 150 to 1,500 meters, and the well-known honeycomb set for all other

## Station of Emery D. Austin

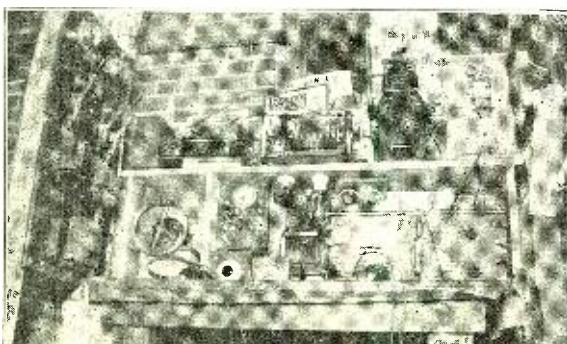

Yours is a Good One, Em, and We Are Pleased to See That You Used a Quenched Gap. Tell the Others to Do the Same.

THE photo is the station 1TK. The receiving cabinet on the right is a homemade one, containing the following apparatus: Resco tuner, three variable condensers, audiotron and controls, 3,000-ohm receivers Murdock. This will tune to around 3,400 meters.

The transmitting set consists of a 1-K.W. Thordarson 20,000 volts transformer, pancake helix, home-made condenser, Amrad Quenched, and home-made aerotone rotary, with necessary switches to change from rotary to quenched. The antenna is

70 feet high and 70 feet long and is composed of three wires.

The wave-meter belongs to our club; switch board consists of amp. meter, volt meter, one automatic switch and necessary fuses.

With this set altho I do not use any amplifier I hear many distant stations and some of them come in very loud. Among there are NAA, NAH, WBF and many others; also many amateurs. I belong to the American Radio Relay League, Radio Relay League of America, and the Central Maine Radio Club. Am assistant traffic manager of the American Radio Relay League and secretary of the Central Maine Radio Club.

EMERY D. AUSTIN,  
Waterville, Me.

# CORRESPONDENCE FROM READERS

## SOME REAL SUGGESTIONS

Editor RADIO NEWS:

I note the letter in the December issue of the RADIO NEWS written by Mr. F. L. Woolsey and wish to express my opinion of the same. There are today about eight magazines on the market that print literature and editorials exclusively on the various branches of radio science in addition to about four other scientific publications which may or may not refer to radio articles. Out of the eight radio magazines, only two can be classed as high grade amateur periodicals, these two being RADIO NEWS and "Q. S. T.," and of these two I believe there is no doubt in the majority of amateurs' minds that RADIO NEWS is far superior in every respect. I feel that a bi-monthly publication would be too often, for the reason that a number of the articles printed require time and thought in reading. I would like to see more of these articles printed and feel that in addition to being an asset to the radio world in general, they would increase the sterling qualities of RADIO NEWS.

Now may I make a few suggestions which I believe would be beneficial to RADIO NEWS and also of interest to my fellow readers? Occasionally some condensed article is printed from the abstracts of the I. of R. E. proceedings. Why not have more of this? I would also like to see a few more pages devoted to "Correspondence From Readers," in which may be incorporated written discussions of radio experimenting with conclusions as worked out by the readers of RADIO NEWS. I would also like to see more "Digest" articles, particularly on what the Bureau of Standards is developing.

If you think well of these suggestions, I believe my fellow readers would be interested in reading them. Do not misunderstand me in thinking I am trying to make RADIO NEWS too technical for the radio beginner, as I feel that the elementary articles should still be continued for the benefit of the amateur starting into the game.

What do other readers think of these suggestions?

E. E. FREY, 2AJK,

50 Renner Ave., Newark, N. J.

(Righto, 2AJK! We want those amateur letters. You know how we feel about that "human interest" stuff. But of all the gosh-darn lazy birds, you amateurs take the cake. You like to sit in your ether-atic puffing away at your pipe while you read RADIO NEWS—YOUR magazine, YOURS, but it's more difficult to get a letter out of you case-hardened ether-slingers than to coax a signal out of a burnt-out spark plug. You never seem to get the idea into your Q.R.M.—ether-soaked—V.T.'s—otherwise known as your skulls—that RADIO NEWS was created for the radio fraternity, that it's YOUR stamping ground, that Amateur Radio can only live and be a great institution if all of us work and pull together. That means we must exchange ideas, tell the other fellow what we are doing and how. There is altogether too much false secrecy, too much bashfulness, too much hiding "one's-own-light" among present day amateurs.

Come out in the light, fellows, open up the rotary and give us a few real-to-goodness flashes. Who'll be the first to get off that letter to-night? —Editor.)

## WHY THE HIGH COST OF V. T.'S?

Editor RADIO NEWS:

Concerning the article in the latest issue of RADIO NEWS by Mr. Mason on the high cost of V.T. tubes, I wish to say that the situation is indeed deplorable. Many amateurs are forced to rely exclusively upon the old crystal detector, simply because

their financial standing will not permit their investing in a V.T.

Mr. Mason, in my opinion, best illustrates the absurdity of such an exorbitant profit as is realized on a tube: Take for instance the bulb and disassemble it. First you have a vacuum bulb which can be constructed at a cost not exceeding ten cents; second you have a filament which costs about, say, another ten cents. Third and last your grid or plate enters, costing about five cents; now taking all together your complete outlay amounts to twenty-five cents. Compare the cost with the retail price and the profit shows twenty-eight hundred per cent!

It is not the retail dealers who extort the profits on this article. It is the manufacturer. Of course the money expended in the settlement of patent troubles would naturally increase the cost a little but still not enough to cause such a profit.

There are the blessings of a million amateurs awaiting man or boy who successfully solves the problem of placing a cheaper yet equally efficient vacuum tube on the market.

S. M. BODDINGTON,

Scranton, Pa.

## QUESTIONS VERNON'S STATEMENTS

Editor RADIO NEWS:

In your December issue you publish an article on the Radio Compass Stations in San Francisco Bay, contributed by Phil Vernon. The article was good in itself, but it contained some misleading statements.

As a commercial operator, I have made frequent use of the R. C. stations located up and down the Atlantic Coast, also those in France and England, and I would like to ask Mr. Vernon some questions.

He says in his article: "Vessels have also been instructed to use maximum power, broad coupling and low decrement, . . . etc." I would be interested in knowing the source of these "instructions."

Are we to infer from the above statement that irrespective of distance, we must open up on full power (in my case 2-k.w.) whether we are five or fifty miles from the R.C. stations giving bearings?

In entering the Virginia Capes in thick weather, I could easily interfere with NSD giving bearings to another ship if I worked on high power with NCZZ.

Does not the law of "minimum power necessary for communication" apply equally to a QTE as to commercial traffic? In actual practice, I have been told to QRP more often than to QRO—and I very seldom use more than 1-k.w. for an R.C. bearing unless some distance off shore, and conditions are bad at the moment. Personally I do my testing with the same amount of power and the same degree of coupling as I use for calling the station with. I am of the opinion that the majority of operators do the same, tho' I may be wrong and would like to be informed.

THOMAS B. CRONE,

Portland, Me.

## WANTS RADIO NEWS A BI-MONTHLY

Editor RADIO NEWS:

Hurray!!! I second Mr. F. L. Woolsey's motion. Let's have the RADIO NEWS a bi-monthly. He is right; one nearly goes crazy waiting for the next issue. Even if we have to pay 50c. a copy, it's worth it!

You'll hear from me again later. You ought to see the nifty combination two-step amplifier and C.W. transmission cabinet I'm going to send in soon. But seriously—please consider that bi-monthly idea.

and let's hear the verdict in an article in the RADIO NEWS.

RUSSELL MORRIS,

Madison, Wis.

(A bi-monthly at present is an impossibility, mainly for economical conditions prevailing just now. Due to tremendous paper prices, nearly every publisher loses money at present, we included. Till conditions change, fellows, we're mighty glad to come out once a month, and that's tough sledding!—Editor.)

## ABOUT RELAY WORK

Editor RADIO NEWS:

Read your comment on my letter in the January number.

It was not my intention to start a scrap of any kind, but when I wrote the letter, I was feeling quite "hot under the collar" after reading an article, "Let's Go," on page 288 of the November number. In this article, just about the middle of the center column, the writer says: "We waste too much time, all of us 'QST'ing and 'CQ'ing when, etc.—when all that 'we' amateurs say to each other in the course of a year amounts to just about nothing. Nine million: 'How is my spark's.'" The writer of that article cannot amateur himself. "Amou ts to just about nothing," indeed! Well, i just amounts to this; one of the United States radio relaying associations found it necessary to refuse to accept messages for transmission on their routes between the large cities, unless they contained something of value, as they handled so many messages that serious delay might occur if too many were handled. I listen in nearly every night myself, and nearly every message that I hear is something like "Leaving 6:30 P. M. tonight" or "Write immediately." I have a sneaking suspicion that contents like those that I have just mentioned amount to "just something," if not a good deal more, and this variety of message predominates over the "greetings" class, which doesn't amount to a great deal. If your associates did not find that article with the spectroheliograph, they had better send the said spectroheliograph back to the blacksmith shop for repairs, as it was so QSA (the article) up here that my bulb slipt on its charcoalistic curve and skidded into the V.C. and made the grid leak and I couldn't finish reading it until I borrowed the mop and wiped the leakage up and then went down into the cellar, 19 stories below, where I could hear it good without any amplification. I'll say so. It made me see vermilion (pardon me, I meant red) and visions of sledge hammers floated in the air before my eyes, and I had a great wish to have the author of that article within range. . . .

Once in a while I noticed a "dig" at relay work, taken in some articles in RADIO NEWS, but I presume that they slipt in without being noticed, but the author of "Let's Go" must certainly have it in for the great amateur body.

Regarding the publishing of "Calls Heard" lists, etc., I think you have the right idea. The way the subjects are handled by the various radio magazines just about suits me, and I cannot see how anyone else can find fault. I like RADIO NEWS because it has interesting news about commercial stations and very interesting articles written by the foremost personalities in the radio profession. Please understand that the only thing that I didn't like was this "relay-experimental" affair, but I hope it will be all cleared up by now. Well, Mr. Editor, thanks for this space in your magazine. I shall now QRT and let some other fellow amateur use the space for his grievances.

H. S. GOWAN,

Kitchener, Ontario.

# The Phantom Call

By R. A. CHATH

"HEY, Muller,"  
"Yeah?"  
Say, Mayer fell down on that article, 'Signals From Mars,' for the *Sunday Illustrated*; sheet's about as full o' pep as a dead fish; haven't a darn thing snappy enough to fill in with. You were a wireless man when you were in the Navy, weren't you?"

"Uh huh."  
"Well, see if you can dig up a live one along that line, will you? Fleet's up the river for a visit. Ought to be an operator or somebody aboard one of those battle wagons, who can give you some material; and don't forget, we go to press at eight P. M."

Claude Muller, one time naval radio operator and now special writer for *The Hemisphere*, walked disconsolately back to his desk and dropt into the chair.

"Doggone it all," he exclaimed, "here I've been roosting all day long, with nothing to do but gaze at this bunch of would-be scribes grinding out jazz copy, and now, at half-past four, that pie-eyed zebra of a Sunday editor has to hand me an assignment about as concrete as a hunk of Hudson River mist; and I've got a date with Vita for supper at six. However, I reckon I'll have to get him his story somehow or other."

\* \* \*  
"Hello, Sparks! Pretty classy set this old destroyer's got."

Operator Bill Clement of the U. S. S. *Roosevelt* turned to survey his questioner. "Yes, it's one of the latest types," he replied with a smile.

"Busy?"  
"No, sir. I'm off watch now. Just lookin' for the makin's. I'm sure I left 'em here right by the fones, but hanged if I can find—a cigar? Sure! Thanks! Beats the makin's any day. How's that?"

Well, yes, radio is mighty interesting. I've been in the game—that is the navy end of it—ever since the coherer days and it's gettin' better all the time, and now this new fone stuff—huh? No-o-o, haven't struck much that's mysterious. There's one thing that's always been a mystery to me—why some Limey with a spark like a steak fryin' asks for three QTA's, when you're about thirty leagues away, usin' five K.W., and shootin' it to 'em at ten words a minute, thru clear air. Jokin' aside tho, I guess the most mysterious thing I ever heard was down off Guantanamo.

"It was about three years before the war, while the fleet was havin' Spring manoeuvres. I was 'op' on the old *Bentley*, which at that time was one of the class A destroyers. The department was just beginnin' to take an interest in direction finders or goniometers as they called 'em then. The *Bentley* and her sister ship, the *Rockman*, had both been fitted with these compasses and ordered out on a three day practice cruise to see how good we was at findin' each other. Sort'a like a game of tag. First she'd signal and we'd try and find her by usin' the goniometer, and then we'd signal and she'd come hoppin' after us.

"Well, the contraption works out O. K.

and we both heads about and makes for port.

"Now, after evenin' mess gear, I was up in the shack listenin' with one ear and chewin' the fat with the bo's'n. I'd been sittin' there, I guess, p'r'aps half an hour, when the skipper rings m'bell and hollers down the voice tube, that we'll make port by three bells and to shoot the glad tidings to the base. I throws the main line and antenna switches and while waitin' for the generator to get up to speed, I reaches up and closes the port-light over the receivin' set for the sea's actin' up some nasty and some spray's startin' to come in.

"Well, I sits down again and starts to call NAW. No sooner'n I press the key, but for some unknown reason, the bo's'n hauls off with both fists an' belts me an awful crack on each side of the head. Of course, I'm some resentful and turns around to lay him out cold, when I hears a guy with a peach of a five hundred cycle note callin' SOS. Lettin' the bo's'n go for the time bein', I turns back to the set and copies down this bird's call. Seems he's S. S. *Lloyd George* on fire in latitude

sition this Limey's chirpin'. Sure enough, it does, right to the dot.

"Well, after scootin' along for a while, we finally reaches the scene of the trouble. Nary a ship is in sight except the *Rockman*. No rockets, no lights, nothin'. Skipper orders the search-lights manned and starts com'bin' the water for small boats. Pretty soon, about a half a mile to lee'ard, we spots a dinghy of some sort and there's somethin' sittin' in it. We mosey's over at half speed and what do you think we finds? An old dinghy from some fishin' boat or other and perched in the stern sheets is the biggest green parrot I ever see. An' that there bloomin' bird is whistlin' SOS an' latitude twenty-two degrees, thirty-one minutes, nine seconds north—longitude seventy-five degrees, twenty minutes, nineteen seconds west—as neat as any human 'op' could do it.

"I'm so surprised I gets sort of dizzy. First thing I knows, I hears somebody say, 'he's comin' to.' I opens my eyes an' there I am layin' in a bed in the sick bay, and it's broad daylight.

"Hello there, Billy," says the orderly, "how you feel?"

"Pretty good, except my head hurts," I replies, "What the hell am I doin' here?"

"Why, seems when you reached up to close the port light las' night, you got a bight of your fone cord fouled around the antenna switch an' when you went to send that message for the old man, you got a flock of juice thru your bean."

"Shucks," I says, disgusted, "I thot that was the bo's'n's fist."

"Say, that high potential juice is worse than wood alcohol, Jimmy! Gosh! What a nightmare it gave me!"

"Another cigar—yes, thanks, they're mighty good smokes. Going? That's too bad, I just thot of another little incident—some other time, maybe."

\* \* \* \* \*

"Here's that story you wanted," said Muller, as he laid the copy on the editor's desk.

"Huh, you sure didn't lose any time, did you?"

"Couldn't afford to, got a date at six."

"Looks pretty good, hm—hm-m. Yes, that'll do," he growled.

"Hey, boy—here, take this down to Johnson and tell him to rush a proof."

"Say, by the way, Muller, how did you get that stuff so quick?"

"Used my head."

"Huh?"

"Used my head. Wrote it out of my think tank."

"You son-of-a-gun, I thot you made that trip darn quick. Go on, beat it, it's a quarter of six. If you keep her waiting, she'll get sore.

"An' say," as an afterthot, "give her my love."

"You bet," yelled Muller, as he streaked it for the elevator.

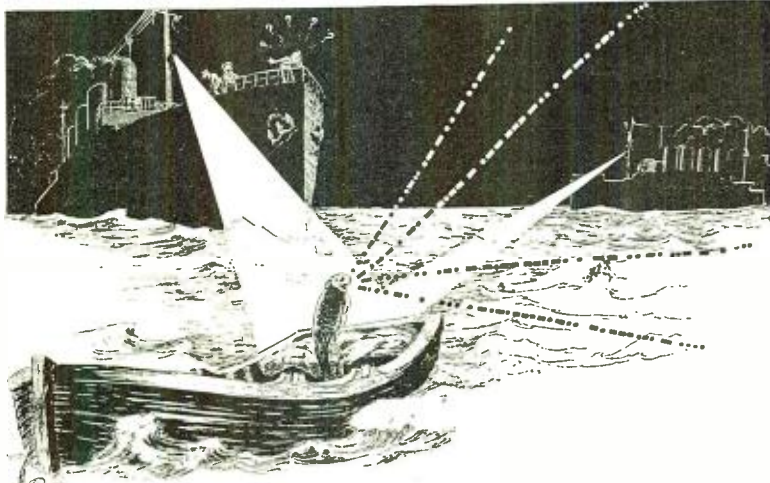

"In an Old Fishing Boat Was a Green Parrot Whistling SOS. Latitude 23 Degrees, 31 Minutes, 9 Seconds North—Longitude 75 Degrees, 20 Minutes, 19 Seconds, West, as Neat as Any Human 'Op' Could Do It."

twenty-two degrees, thirty-one minutes, nine seconds north, longitude seventy-five degrees, twenty minutes, nineteen seconds west. I rings up the bridge and gives the skipper the dope. He damn near yanks the engine room telegraph out by the roots and away we goes.

"Pokin' my head out the door, and glancin' aft, I sees the *Rockman* from the course she's layin', and the speed she's makin', has got the call too.

"Well, soon's I clears the bridge, I opens up on six hundred, with full power and informs this bird that we're headed his way and hittin' the high spots. No comeback. 'Guess he didn't hear me,' I says. I tries it again. Nothin' doin'. I switches to three hundred with just as bad results. Then young Fricke on the *Rockman* tries his luck at it and gets as much satisfaction as me. Meanwhile, this jazbo is squirtin' the ether full of yells for help at about two minute intervals.

"I'm beginnin' to get a suspicion there's somethin' phony goin' on, so I tells Fricke to get this guy's true bearin' with his radio compass, whilst I do the same. After gettin' the angles. I rings up the bridge again—tells the skipper my suspicions and asks him if he'll stick the angles on his chart and see if the, 'fix,' checks up with the po-



# Junior Radio Course

## The Three-Element Vacuum Tube—Third Part

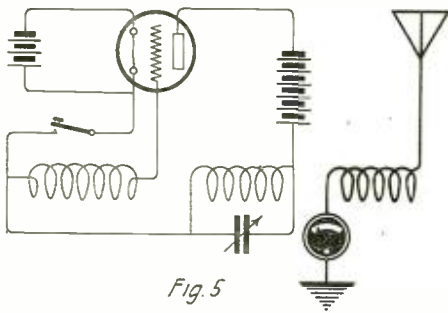

Fig. 5  
Practical Circuit of an Undamped Wave Transmitter. The Aerial is Coupled to the Oscillating Circuit.

**I**N this lesson, the third on the subject of the three-element vacuum tube, the functioning of the V. T. as an oscillator will be described. We will at first explain the principle; then its application in the transmitting circuits as generator of undamped oscillations and in the receiving circuit as a detector-oscillator connected in a regenerative circuit.

The diagram, Fig. 1, is one typical hook-up of an oscillating circuit in which sustained oscillations are produced by a V. T.; there again the same phenomenon, as explained in the previous lesson, happens, that is, *the grid acts as an interrupter*, opening and closing the circuit a tremendous number of times per second.

To understand what follows, we must remember the induction laws which are so that if in one of two circuits placed close together, an interrupted current flows, a current of *same direction* is induced in the second circuit *at make*, while *at break* this induced current flows in the opposite direction.

This is what happens in a spark coil, which is well known by every radio amateur.

This being understood, we can see in Fig. 1 that, according to the theory already explained, the D. C. of the battery B flows suddenly in the circuit, P. F. O. L<sub>2</sub>, when the filament is lit up, but this current passing thru the coil L<sub>2</sub> induces a current in the coil L<sub>1</sub>, which is connected to the filament and the grid. This induced current flows as shown by the arrow in Fig. 1, consequently impressing a negative voltage on the grid which at this negative potential stops the electrons flowing from the filament to the plate. The current from the battery B, traveling from the plate to the

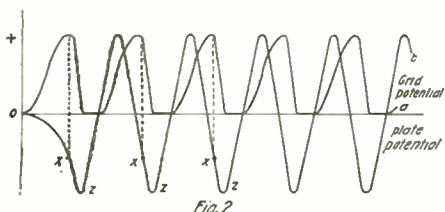

Fig. 2  
Curves Showing the Variations of the Grid and Plate Potential in a V.T. Oscillator.

filament, is therefore stopped, for it has no more the flow of the electrons on which to travel.

At this point, which corresponds to a break in the plate circuit, a current flowing in the other direction being induced in the grid coil L<sub>1</sub>, the grid is made positive and *helps* the electrons to reach the plate, and the same phenomenon is reproduced, keeping in the circuit oscillations of constant amplitude.

The curves in Fig. 2 make this very clear; curve A shows the variation of potential in the plate circuit. When the filament is lit up, the current starts to flow in the plate filament circuit; while this current in-

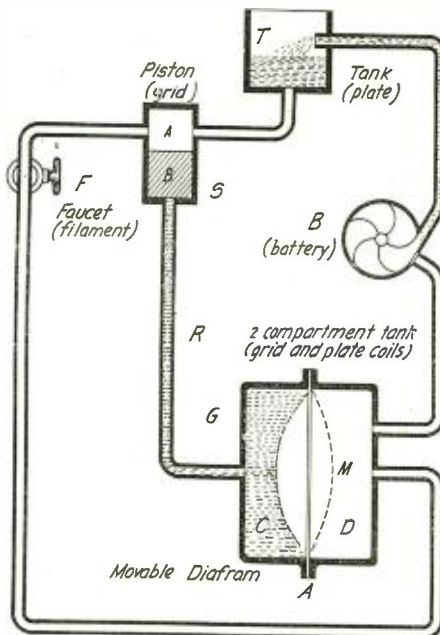

Fig. 3  
Simple Analogy Explaining the Functioning of a Vacuum Tube as an Oscillator.

creases, the current inducted into the coil L<sub>1</sub> (curve b) increases also, but not at the same time owing to the self-inductance of the coil. It was explained in the previous lesson that a small change of potential of the grid is sufficient to cut out the flow of electrons; therefore we may see that at point X corresponds the grid potential for which the plate filament current stops, but still owing to the same self-inductance effect, the grid current doesn't stop at once but increases again down to point Z, while the plate filament current rapidly falls to 0. This sudden drop induces a stronger current flowing in the opposite direction in the grid coil, which makes the grid positive. The grid being positive not only lets the electrons flow, but at the same time *helps* them to reach the plate. As the current on the grid is only momentary, it falls again to zero and the same process is repeated for each impulse.

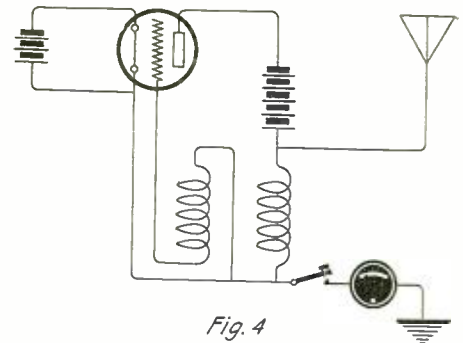

Fig. 4  
The Elementary Circuit of a C.W. Transmitter.

### ANALOGY

In order to explain the phenomenon happening in the vacuum tube oscillator, we shall use the same analogy as in our previous lesson.

In Fig. 3 the plate circuit is represented by the endless pipe, while the grid circuit consists of the compartment C of the big tank and the pipe R, which is connected to the cylinder S.

If the faucet F is open, the water from the tank T flows suddenly into the pipe and the diafram, separating the two compartments C and D in the tank G, is deflected to the left; the water contained in C being compressed pushes the piston B up to position A, thus stopping the flow of water. The elastic diafram then comes back to its normal position and goes farther to the right, up to position M, pulling by suction effect the piston B down on the cylinder, thus helping the water to flow again. The same play continues, making the diafram vibrate constantly.

### PRINCIPLE OF THE C. W. TRANSMITTER.

If we connect a capacity to the circuit in which sustained oscillations are produced, it will be noted that a current flows in this circuit. We may therefore use an aerial and ground as a capacity and send undamped signals by connecting or cutting out this capacity by means of a key, Fig. 4.

(Continued on page 571)

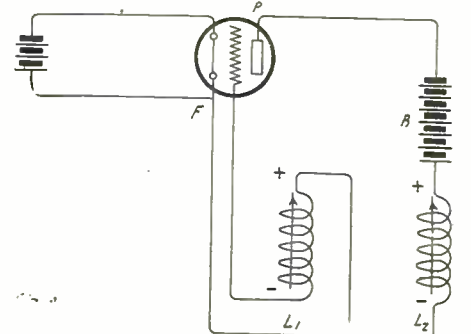
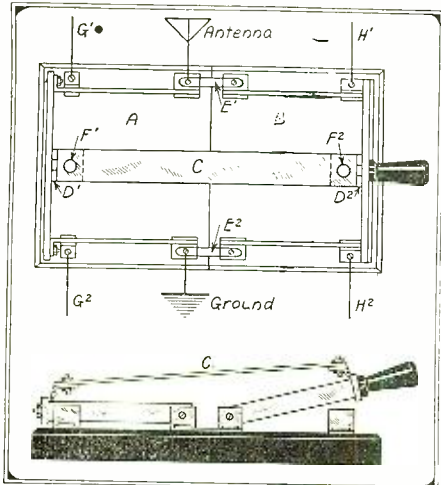

Fig. 5  
The Typical Circuit for Producing High Frequency Undamped Oscillations With a V.T.

# Junior Constructor



Don't Waste Your Energy Throwing Your Antenna Switch. Make it This Way and Save Time.

## A SMALL "THROW" AERIAL SWITCH.

Here is an original design for an antenna switch.

The switch is designed from an amateur's point of view, taking cost of material and simplicity in construction into consideration. It consists, primarily, of two double-pole, single-throw switches, the bases of which can be of porcelain or, if a more elaborate switch is desired, slate bases are recommended.

The main feature of this switch is its quick action and small "throw." The angle of throw can be reduced to a minimum and can be adjusted from a throw of 10 degrees or 15 degrees to a full throw of 90 degrees or even more. When using the switch with only a small angle of throw, 40 degrees or less, it can be placed in a neat mahogany box with only the handle protruding. Adjustment of the angle of throw is accomplished by either lengthening or shortening the brass strip C. By lengthening the strip the angle of throw is lessened and shortening increases the angle.

My experience has shown that an angle of 20 or 30 degrees is about right for quick action and ease of operation. The angle of throw is so much reduced in this type of switch that the change from sending to receiving, or vice versa, can be made almost instantly.

The switch handle of one of the switches is removed and the same bolt used to fasten the brass strip C to the switch crossarm.

A and B, double-pole, throw switches; C, flat brass strip,  $3/32 \times 1/2$  inches times length of switches; D<sub>1</sub> and D<sub>2</sub>, brass hinges  $1/2$  inch long; E<sub>1</sub> and E<sub>2</sub>, small brass strips, hole in each end; F<sub>1</sub> and F<sub>2</sub>,  $1/2$  inch brass bolt,  $8/32$  thread; G<sub>1</sub> and G<sub>2</sub>, transmitting; H<sub>1</sub> and H<sub>2</sub>, receiving.

I think that without any further description I have made things clear, as the draw-

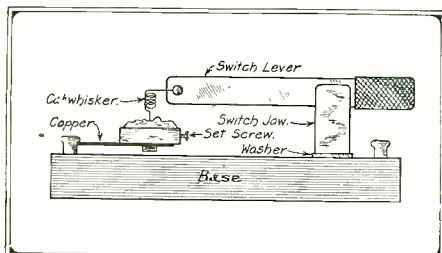

Here it is Boys, a Real Cheap Detector Made From an Old Switch.

ing is practically self-explanatory, and I hope this will meet with approval.  
Contributed by EDWARD J. WURTZ.

## A SIMPLE BUT EFFICIENT ADAPTER.

This adapter for audiotron and other tabular bulbs may be best suited for inside mounting of bulbs altho it may also be used for outside mounting. All of the parts used in the construction of this adapter can be readily found in the experimenter's workshop.

First, two pieces of wood each three inches long, one inch wide, and three-fourths of an inch thick are required. Two holes are then drilled one-half inch from the end in each piece to receive the binding posts or machine screws. The heads of the screws should be countersunk below the surface of the wood so as to avoid their touching the panel. Next two pieces of tin each three inches long by one-half inch are cut and formed into a U shape. One is screwed to each piece of wood and they form the holders for the bulb. On the opposite sides from these a slot one and one-fourth inch wide is cut in each piece to hold the glass which covers the hole in the panel. Two holes are then drilled in the panel and

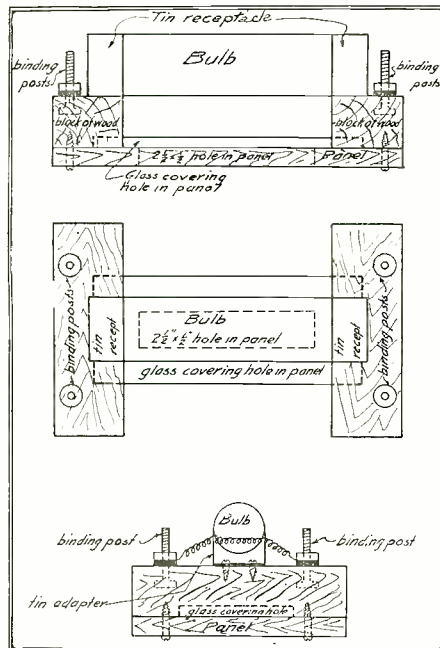

Here is an Easily Built Adapter for Your Audiotron. A Good Idea for Mr. Smallpocketbook.

the two blocks of wood are mounted. The adapter is then ready for use.

If the amateur is compelled to buy all the parts it should not cost over ten or fifteen cents, while he would be obliged to pay a dollar or a dollar and a half for a receptacle if he bot it.

Contributed by

HAROLD W. KAPPELER.

## A PANEL DETECTOR

This detector is made for panel use only, as many sets are built without a detector. The back is cut out of an old phonograph record cut to size on drawing. The holder for the crystal is a small brass cup bolted onto a copper strip which is fastened to a battery binding post extending thru back. The rod is held by a binding post held out by four washers to keep the knob off the panel. This post is connected thru the back to another post on the other side. A

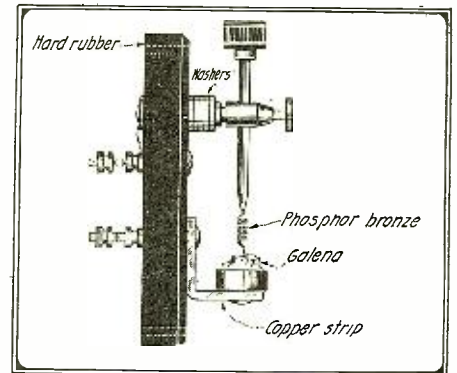

A Phosphor Bronze Wire is Soldered to Brass Rod for Contact with Crystal

crystal of galena is held in the cup by a soft metal known as hugonum.

Contributed by F. G. CAMPBELL.

## A SIMPLE DETECTOR FOR THE BEGINNER.

An inexpensive and finely adjustable detector can be made from a baby knife switch with very little difficulty. The base is  $2'' \times 4'' \times 1/2''$  on which is mounted a switch jaw with washer between it and base so that it will move freely and make good contact. The switch lever with insulated handle is removed from the pivoted jaw and a bolt run thru the hole. The cat whisker is fastened to this bolt. The cup is taken from the top of the carbon of an old dry cell and threaded for set screw. The cup is fastened to a strip of copper which in turn is connected to binding post and connection made. This detector can be used for galena or silicon by using a stiff point for silicon or the cat whisker for galena. If the detector is nickel-plated, it will make a fine looking instrument.

With a little experimenting it will be found that many angles of adjustment can be obtained.

Contributed by W. E. MERCK, JR.

## AUDION CRYSTAL HOOK-UP

Having had very good success with the hook-up, shown in the accompanying illustration, which describes a simple method of changing from audion to crystal reception, I believe other amateurs will be pleased with the result they get if the directions shown in the sketch are followed. To make the change, the filament rheostat is turned off and switch A is closed. As only one switch is used in the operation, it is unnecessary to have an elaborate system of change-over switches, which is an advantage for the amateur.

FRANCIS S. WILLIAMS.

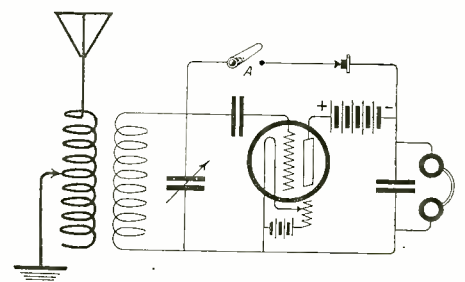

A Simple Way to Change From Audion to Crystal Detector; Only One Switch is Necessary.

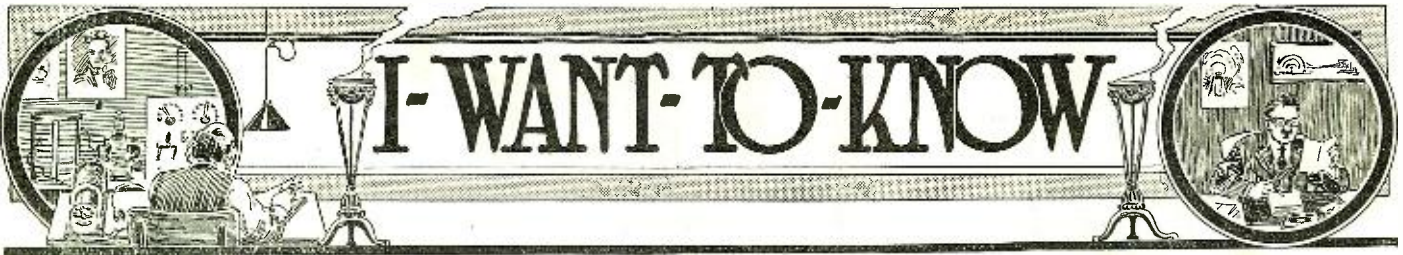

**ELECTROLYTIC RECTIFIER.**

(158) Mr. William Feustel, Passaic, N. J., asks:

Q. 1. Can a bank of four electrolytic rectifiers as described on page 117, in the September, 1919, issue of RADIO NEWS be used to supply the D. C. on the plate of a V. T.?

A. 1. Yes, such a rectifier may be used providing a fixt condenser of about .008 mf. is connected across the D. C. source. A diagram of it appears on this page.

Q. 2. How can this current be regulated down to about 50 volts?

A. 2. This may be accomplished by means of a carbon potentiometer of the same type as those used with B batteries.

**RADIOFONE OPERATING ON A. C.**

(159) Mr. Clifford Hansen, of Chicago, Ill., asks:

Q. 1. Please show a hook-up of a radiofone operating on A. C. with a rectifying device delivering 500 volts for the plates.

A. 1. A hook-up for the radiofone is published on this page.

**BUZZER TRANSMISSION.**

(160) Mr. Joseph McCarthy, of Newtown, Conn., inquires:

Q. 1. Where can I get phonograph records for learning the code?

A. 1. We suggest that you write to the Wireless Press, 68 Broad Street, New York City, which sells such records.

Q. 2. Would a buzzer directly connected in an aerial be suitable for short range transmission?

A. 2. A simple and efficient buzzer transmitter diagram is published on this page.

**LOOSE COUPLER DATA.**

(161) Mr. Andre Freich, of St. Pierre-Miquelon, asks the following:

Q. 1. May a galena detector be used in connection with a V. T. as an amplifier?

A. 1. Certainly. The primary of the amplifying transformer is connected in place of the fones in the detector circuit. This hook-up has been published several times in the pages of RADIO NEWS.

Q. 2. Can a loose coupler be built for a wave-length of from 600 to 2,500 meters? If so, kindly give data.

A. 2. Such a loose coupler should be built as follows:

Primary coil 5" in diameter and 4" long wound with 200 turns of No. 24 D. S. C. wire; secondary coil 4" in diameter and 4"

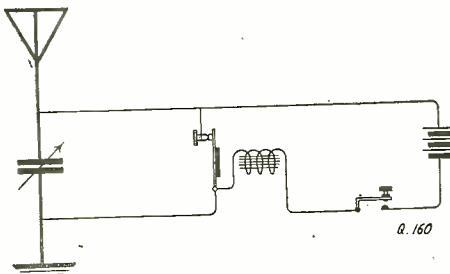

Here is an Efficient Hook-up for Buzzer Transmission. The Aerial Circuit May Be Tuned by Means of the Variable Condenser.

long, wound with 325 turns of No. 28 D. S. C. wire.

**AERIAL WAVE-LENGTH.**

(162) Mr. George Malone, of San Rafael, Cal., wants to know:

Q. 1. What would be the wave-length of an aerial 200 feet long and 50 feet high, composed of two No. 14 wires spaced six feet apart?

A. 1. The natural wave-length of such an aerial would be about 300 meters.

Q. 2. In a diagram published for question 117 in the November issue of RADIO NEWS, what are the battery and transform-

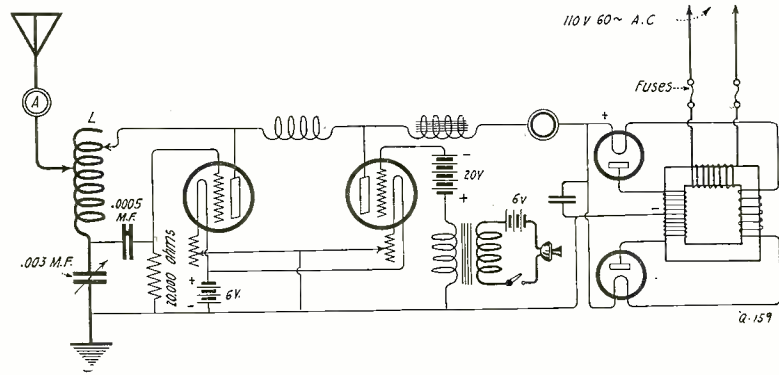

Diagram of an Efficient Radiofone With One Tube Modulator and One Oscillator. The H.T. D.C. is Furnishd by a Rectifying Device Composed of a Transformer and Two Rectifier Tubes.

er in the microfone circuit?

A. 2. The transformer is a modulation transformer and the battery, connected in series with the primary and microfone, is about four volts.

**FORD COIL TRANSMITTER.**

(163) Mr. Charles Martini, Jr., of Philadelphia, wants the following information:

Q. 1. Is it permitted to send with a Ford spark coil when the station is located about eight miles from the border of another state?

A. 1. Yes, it is permitted to send messages so long as you don't interfere with the radio traffic of other states. The transmitting set should be tuned to 200 meters maximum and radio laws should be observed in transmitting any messages.

Q. 2. Is it possible to use A. C. step down to six volts for filament of a V. T.?

A. 2. Yes, such a device was described on page 447 of the January, 1921, issue of RADIO NEWS.

Q. 3. Please publish a diagram of a receiver using a V. T. detector for the reception of undampd waves and a crystal detector for the reception of dampd waves.

A. 3. A hook-up for such a set is published on this page.

**BURNT OUT V.T.**

(164) Mr. Charles R. Cosse, of Mt. Vernon, N. Y., desires to know:

Q. 1. Is it possible to repair a burnt-out V. T.?

A. 1. It is possible to repair a burnt-out V. T. by fixing a new filament and enclosing the electrodes in a new glass bulb. This is rather difficult work to be done by an amateur not having the necessary tools and we suggest that you write to the Vacuum Tube Repair Co., 511 Perry Building, Oakland, Cal., which makes a specialty of repairing broken tubes.

**CONDENSER CAPACITY.**

(165) Mr. F. C. Start, of Toronto, Can., asks the following questions:

Q. 1. What is the capacity of a condenser section composed of six sheets of thin brass 8" x 6", separated by seven glass plates, 8" x 10" x 1/8"?

A. 1. The capacity of such a section is about .002 mf.

Q. 2. How many of the above sections should I use with 1/4-k.w. transformer with a sending voltage of 8,000?

A. 2. One section is sufficient with a transformer of this power.

**GRID CONDENSER.**

(166) Mr. Elmer Johnson, of Wausau, Wis., wants to know:

Q. 1. What is the correct grid condenser capacity for a Marconi V.T. Class I?

A. 1. The capacity suitable for a Marconi V. T. varies with the circuit employed. A grid leak should be used, shunted across the condenser. Grid leaks of various resistances should be tried, but if a variable condenser is used a resistance of about two megohms is suitable.

Q. 2. What is the wave-length of an aerial 60 feet long and 55 feet high, composed of four wires? The wire used is No. 12 gauge.

A. 2. The wave-length of an aerial of this type would be about 150 meters.

**STEP-DOWN TRANSFORMER**

(167) Mr. Richard L. Rohrer, of Lititz, Pa., asks:

Q. 1. May a step-down transformer be used to supply the current to an audion bulb instead of the batteries?

A. 1. Yes. See the article on this subject which appeared on page 447 in the January issue of RADIO NEWS.

Q. 2. May a detector and one-step amplifier be combined with a two-step amplifier to form a detector and three-step amplifier?

A. 2. Yes. The primary of the first transformer in the two-step amplifier is connected in place of the fone to the detector and one-step amplifier cabinet.

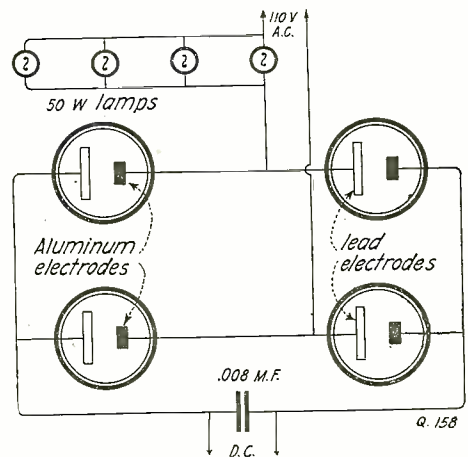

With This Electrolytic Rectifier D.C. is Obtained for Charging Batteries or Supplying the Plate of a V.T. Detector.

# MURDOCK No. 55

The Prices  
Are Unus-  
ually Low.

The Qual-  
ity is Re-  
markably  
High.



**2000  
OHM  
DOUBLE SET  
\$4.50**

**3000  
OHM  
DOUBLE SET  
\$5.50**

## REAL RADIO RECEIVERS

backed by a liberal trial offer and an absolute money-back guarantee. No written argument in their favor can compare with the convincing proof of their actual performance. We simply urge a TRIAL, for we know that their sensitive operation will tell more surely than verbal claims, their exceptional value. Ask your dealer for them.

*BULLETIN No. 20 will be sent on request.*

### WM. J. MURDOCK CO.

50 CARTER STREET  
CHELSEA, 50, MASS.

509 MISSION STREET

SAN FRANCISCO, CALIF.

# DON'T READ THIS

if you are indifferent to accurate work.

By turning a disc you can find CUBE ROOTS, square roots, cubes and squares, to four decimal places. CHARLIE also has a protractor, a centimeter and millimeter rule, and an inch rule. He is of unlimited value in Arithmetic, Algebra, Geometry, Trigonometry, etc. Charlie works faster and easier than any slide rule. He surprises every one. Charlie is pocket size.

Orders for more than one Charlie cannot be accepted. We are rushed with hundreds of orders a day, so

## MAIL THIS COUPON NOW TO

Charlie Box 548 Yale Station  
Yale University  
New Haven Connecticut  
Kindly send me one Charlie for which I enclose fifty cents.  
Name .....  
Address .....

Immediate delivery guaranteed.

## LEARN ELECTRICITY

Make your successful future a certainty. We teach by practical work and scientific methods under practical working conditions. Specialists for 15 years in training young men for



**Electrical Engineering**  
with B. S. Degree in 3 Years  
A place for every student regardless of age or education. Up-to-date laboratories—faculty of 90 experts; individual instruction. "Earn while you learn" system. Low tuition; athletics and student activities. Write for latest catalog and full details. New term soon starting.  
**SCHOOL OF ENGINEERING OF MILWAUKEE**  
Dept. RN2 373 Broadway, Milwaukee, Wis.

**What a Dime will bring You From the Nations Capital**  
The little matter of 10 cts. will bring you the Pathfinder eight weeks on trial. The Pathfinder is an illustrated weekly, published at the Nation's center, for all the Nation; an independent home paper that prints all the news of the world and tells the truth; now in its 28th year. This paper fills the bill without emptying the purse; it costs but \$1 a year. If you want to keep posted on what is going on in the world, at the least expense of time or money, this is your means. If you want a paper in your home which is sincere, reliable, entertaining, wholesome, the Pathfinder is yours. If you would appreciate a paper which puts everything clearly, strongly, briefly—here it is. Send 10c to show that you might like such a paper, and we will send the Pathfinder on probation eight weeks. The 10c does not repay us, but we are glad to invest in new friends. Address: **THE PATHFINDER, 487 Lanndon Sta., Washington, D. C.**

## Army Auction Bargains

Tents . . . \$4.25 up  
Saddles . . . 6.50  
Knapsacks . . . 7.50  
Slickers . . . 1.85  
Spring Rem. cal. 30 single shot rifle for model 1906 cart., \$7.77. Ball cart., \$3.50 per 100.  
**15 acres army goods.** Large illustrated cyclopaedia reference catalog—400 pages—issue 1920, mailed 50c. **New Circular 10c.**  
Francis Bannerman Sons, 501 Broadway, New York

## \$150 to \$300 a Month Profit FROM I.B. BATTERY CHARGING

Thousands of men, with no previous experience, now making big steady profits with I.B. Chargers. Universal demand for reliable battery charging—the I.B. kind. Get started NOW. Sizes for charging 10, 16, 22 or 70 batteries at once. Write for information about size you need. Small cash payment, balance long, easy terms. Money-back guarantee.

Hobart Brothers Company  
Box N37 Troy, Ohio



**You can be quickly cured, if you STAMMER**  
Send 10 cents for 288-page book on Stammering and Stuttering, "Its Cause and Cure." It tells how I cured myself after stammering 20 yrs. B. N. Bogue, 267 Bogue Bldg., 1147 N. 11th St., Indianapolis.

# Amateur Radio and Its Future

(Continued from page 519)

The idea seemed to be to discourage candidates rather than to help them along as is done today. A few brave souls after a day or so of hard work eventually had the sets almost running, but the great majority gave it up and were afterwards told to go home and study up on wireless.

## RADIO GETS IN PUBLIC EYE

These may be said to have been the "Middle Ages" of radio; the awakening point, we might say. Amateur, as well as commercial radio, was being recognized as an important factor in the development of this great country; that is why our law makers saw to it that some of us did not break our necks in attempts to outdo each other. As you all know, amateurs were allocated wave-lengths of 200 meters and the commercial boys were assigned to 600 meters and above.

More attention was paid to tuning. The straight coupled sets were junked and the tuning transformer or "jigger" became law. Still there was no great need to worry for the number of amateur and commercial stations had not reached the great number we have today.

Slowly but surely, the insidious bite of the radio bug began to have its effect. Thousands of boys and young men who previously had had nothing better to do than to spend their evenings at the corner poolroom became infected with these most prolific germs.

Radio magazines began to appear on the news-stands and were published far and wide until today there are no less than seven of them in the United States alone, each one of which has a rapidly increasing circulation. These magazines, by the way, have done a great deal to spread the glad news concerning amateur radio.

## IMPORTANT PART OF AMATEURS

It is perhaps interesting to know that many of our leading engineers began as amateurs, while the great majority of the commercial operators and commercial men in general, likewise began as amateurs.

A short time ago I had the good fortune to be sent to the great Radio Corporation transmission station at Marion, Mass. The marvelous work that this station is doing is another feat to the great monument of radio science. I was awed by the sight of the ponderous 200-kilowatt alternators which deliver an antenna current of 425 amperes and which work continuously each twenty-four hours of the day with Nauen and Stavanger, Norway.

I was equally impressed by the spectacle of the fourteen 395-ft. masts which hold the flat top antennae.

I was still further impressed when informed that of the 17 persons attached to the station, no less than five were formerly amateurs, in fact, one of them was one of the boys who used five kilowatts of power to make himself heard while in upper New York back in the happy days of 1908.

Thus you are faced with the importance which government and private radio organizations place upon the beginners and amateurs.

The war probably did more than anything else to bring this important fact before the attention of the authorities as we shall soon see.

## WAR BIG CHANCE FOR AMATEURS

Following closely upon the so-called "Middle Ages" of radio came the war. Here indeed is where the amateur proved his worth and all future legislation whether favorable or unfavorable to the amateur must fully realize and take into account

(Continued on page 546)

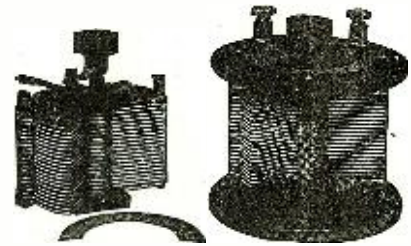

## THE "ILLINOIS" VARIABLE CONDENSER

The Condenser with "Star Spring" Tension  
MADE RIGHT - STAYS RIGHT  
Hard Rolled Aluminum Plates

These condensers are made by a watch mechanic schooled in accurate workmanship and who can't get over the habit of critical inspection.

Three Styles; No. 1, Panel; No. 2, Open Type as shown; No. 3, Fully Encased. Anti-Profitteer. Less than pre-war prices. Fully assembled and tested.

|                   |       |       |   |
|-------------------|-------|-------|---|
| Style No. 1       | No. 2 | No. 3 | Money back if not satisfied. Just return condenser within 10 days by insured Parcel Post. |
| 67 Plates, \$7.00 | \$    | \$    |   |
| 43 "              | 3.50  | 4.50  |   |
| 23 "              | 2.75  | 3.75  |   |
| 13 "              | 2.25  | 3.25  | 3.50  |

With Style No. 1, we will, if desired, furnish 3 inch Dial with large knob, instead of Scale and Pointer.

Extra Price 75 cents.

Sent Prepaid on Receipt of Price.

Except: Pacific States, Alaska, Hawaii, Philippines and Canal Zone, add 10c. Canada add 25c.

Foreign Orders other than Canada not solicited.

The "ILLINOIS" is rapidly adding to the number of its friends. The bouquets they fling only spur us to still more careful work, and more rigid inspection. It is a matter of pride that among the thousands of instruments sent out, not a single complaint has been received of bad condition. This may possibly be because every instrument is subjected to the scrutiny of the "old man's" eyeglass.

Patent is pending on the "Star Spring" feature, which is very valuable. The action of this spring produces an unvarying friction that holds the "rotor" in any position to which it may be set, and at the same time automatically centers the plates in relation to each other, and prevents any possibility of "endshake."

The plates are in proper relation by construction, and will remain so, obviating any necessity of readjustment. Once right, always right. Once mounted on your panel, there is one thing that you can depend upon to never give you trouble.

We thank our friends for their letters of generous appreciation.

Kindly note: We issue no Catalog, and make no "trade discounts." We set our prices at the lowest limit, and leave the "middle man" out for the sole benefit of the "consumer."

G. F. JOHNSON

625 Black Ave. Springfield, Ill.

## Canadian Radio Experimenters

### Lateral Wound Coils.

| Turns | Wave-Length | Price  |
|-------|-------------|--------|
| 25    | 130-375     | \$0.55 |
| 40    | 225-575     | .60    |
| 75    | 240-740     | .70    |
| 100   | 460-1480    | .80    |
| 175   | 750-2400    | 1.00   |
| 325   | 1375-4500   | 1.25   |
| 550   | 2250-7700   | 1.50   |
| 750   | 3000-11200  | 1.75   |
| 1200  | 6000-20000  | 2.50   |

### Special sizes to order

Plugs for these coils . . . . . \$0.60  
AudioTrons, two film . . . . . 8.50  
AudioTrons, one film . . . . . 7.50

Send for our catalogue

J. M. PAQUIN

The Electrical Shop

787 Queen St. West, Toronto, Ont.



# Eveready

—the big name in batteries

**T**HE heart of your wireless outfit is the *battery*. It follows, therefore, that you should use the battery that has the greatest energy—a battery that is known for its power and endurance.

Eveready Batteries are packed and crammed with electrical energy that is eager to send your message vibrating through space. The success of your outfit may depend on that energy.

Take no chances. Get the genuine Eveready Vacuum Tube Plate Battery that is plainly marked "Eveready", because its makers are proud of the trade-mark that safeguards battery-users everywhere.

Sold by leading dealers everywhere.

AMERICAN EVER READY WORKS.  
*of National Carbon Company, Inc.*

200 Thompson Avenue

Long Island City, New York

Chicago

Atlanta

San Francisco

# EVEREADY

VACUUM TUBE PLATE BATTERIES

# LEARN

## -at home-

You can become a Wireless Operator—you can study this fascinating and profitable profession, in your own home in your spare time. The New York Wireless Institute Course offers you an opportunity to become an operator quickly and easily. No previous experience is required—even if you have no knowledge of electricity, we can train you. Our home study course was prepared by Mr. L. R. Krumm, formerly Chief Radio Inspector, Bureau of Navigation, New York. He resigned last August to accept a position of still greater responsibility with one of the largest Radio Corporations in the United States.

You too can assure yourself of an independent position and income for life. We will teach you how. Radio experts able to impart their practical and technical knowledge to you in an easy to understand way will direct your entire course. The graded lessons with questions and answers which we send to you will prove so fascinating that you will be eager for the next one. The instruments furnished free will make it as easy for you to learn the Code, as it was to learn to talk. All you will have to do is to listen.

### The Demand for Good Wireless Operators Far Exceeds the Supply

Positions are open right now and will be for some time to come for good radio operators. Activities in the Radio Industry indicate a still greater demand for trained men. The New York Wireless Institute will train you quickly so that you can take one of these positions. These positions pay good salaries and you have the opportunity to travel if you wish and see the world, and you get paid while you travel. This gives you the opportunity to save nearly every cent you earn.

### TRAVEL around the world

### U. S. Government Gives Credit

The Department of Commerce of the U. S. recognizing the value of the instructions given by us, allow to our graduates a five point credit, in their examination for first grade license—the maximum credit allowed to a Correspondence Institute. The United States Shipping Board will also advise you as to the value of our instruction. We have adopted the best Course in theory available; we furnish the best instruments, and issue the best text books and diagrams published.

# FREE

INSTRUMENTS

We furnish the wonderful instruments in the illustration given to you. One cent only. No additional charge. The world's best Text Book.

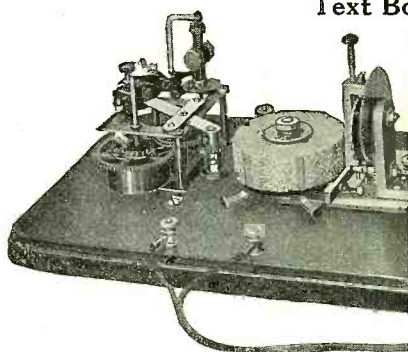

The Transmitter pictured is the celebrated of the U. S. Government and by the leading Technical Schools throughout the United States. Thousands have learned telegraphy with and this remarkable invention will send messages, the same as though you were receiving hundreds of miles away.

When you apply for your license the United States model Omnigraph as we furnish to our students.

# New York

Rush Coupon to  
New York Wireless Institute  
Dept. 111  
258 Broadway, New York

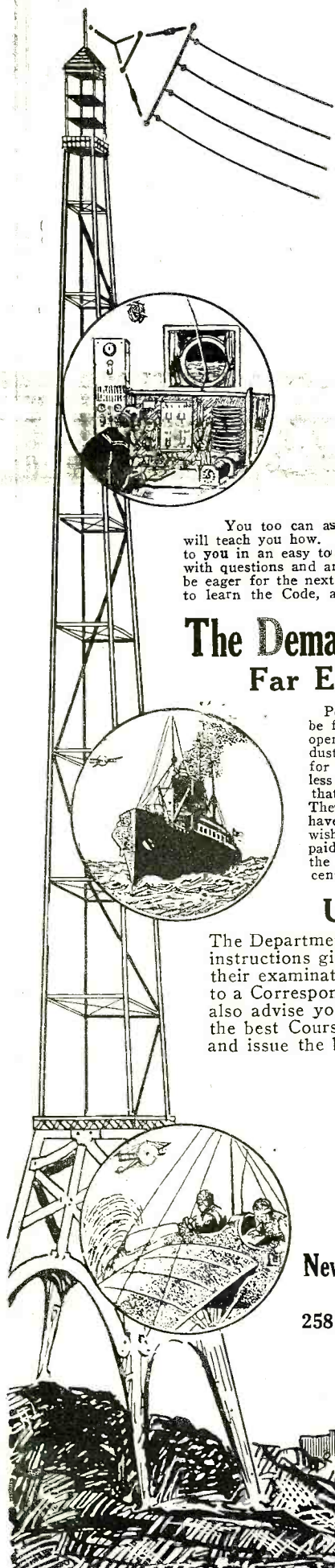

# WIRELESS

## ~big salaries~

### SETS AND TEXT BOOKS

to all students, during the Course, *receiving and sending set exactly as shown*. This set is not loaned, but students completing the Course, receive battery all that is required. All wiring, aerials, etc., needed. Full Receiving and Sending Set, etc., all become your property on completing the course.

also include an up to date and complete course in Wireless Telephony written by our Chief Instructor, Mr. L. R. Krumm.

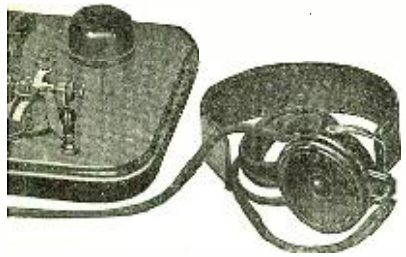

Omnigraph, used by several Departments of Universities, Colleges, Wireless and Technical Canada.

Omnigraph. Place the phone to your ear and receive wireless messages, thousands of different messages thru the air from a wireless station.

Our instrument will test you with the Omnigraph—the same as used by United States Radio Inspector to verify this.

Wireless operators receive excellent salaries ranging from \$125 to \$200 a month and it is only a stepping stone to better positions. There is practically no limit to your earning power. Men who but yesterday were Wireless Operators are now holding positions as Radio Engineers, Radio Inspectors, Radio Salesmen at salaries up to \$5,000 a year. Any of these positions can be yours if you will let us train you and start you on the road to success.

## FREE Post Graduate Course

Another feature of the New York Wireless Institute Course is that you can take a one month's Post Graduate Course, if you so desire, at one of the largest and best equipped wireless schools in New York City, absolutely free. This is not necessary to become an expert, but it would give you an opportunity

to see New York—The Wonder City—The largest port in the world, and headquarters of every leading Wireless and Steamship Company.

## Easy Payment Plan

A small payment down will enroll you. We will make the payments so easy that anyone ambitious to enter the fastest growing profession—Wireless—may do so.

Send for free booklet right now before you forget; fill in the coupon at the bottom of this page and send for our free booklet "How to Become an Expert Wireless Operator." Do it now. It might mean the turning point in your entire business career.

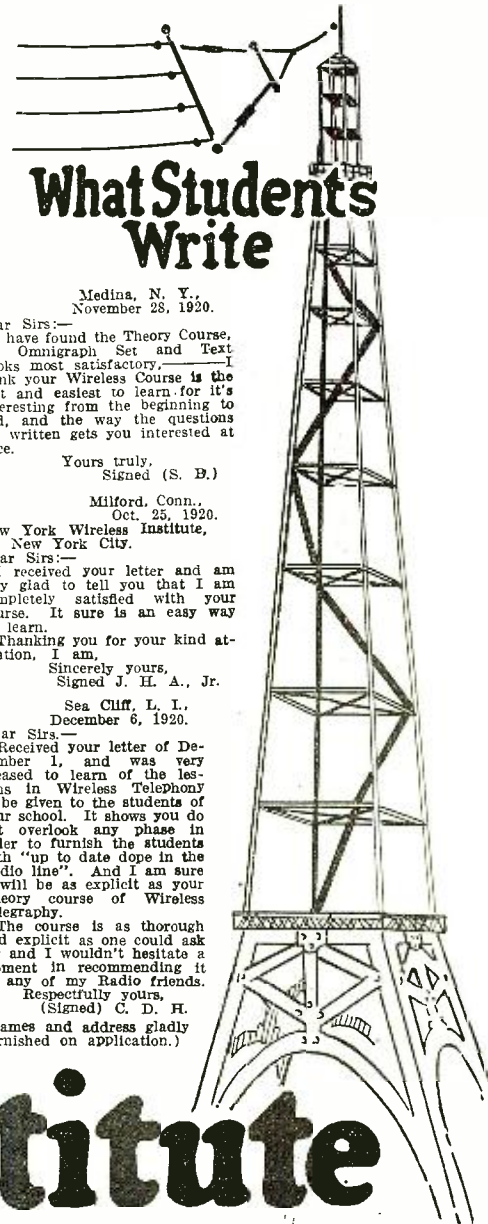

## What Students Write

Medina, N. Y.,  
November 28, 1920.  
Dear Sirs:—  
I have found the Theory Course, the Omnigraph Set and Text Books most satisfactory. I think your Wireless Course is the best and easiest to learn for it's interesting from the beginning to end, and the way the questions are written gets you interested at once.

Yours truly,  
Signed (S. B.)

Milford, Conn.,  
Oct. 25, 1920.  
New York Wireless Institute,  
New York City.

Dear Sirs:—  
I received your letter and am very glad to tell you that I am completely satisfied with your course. It sure is an easy way to learn. Thanking you for your kind attention, I am,  
Sincerely yours,  
Signed J. H. A., Jr.

Sea Cliff, L. I.,  
December 6, 1920.

Dear Sirs:—  
Received your letter of December 1, and was very pleased to learn of the lessons in Wireless Telephony to be given to the students of your school. It shows you do not overlook any phase in order to furnish the students with "up to date dope in the Radio line". And I am sure it will be as explicit as your Theory course of Wireless Telephony.

The course is as thorough and explicit as one could ask for and I wouldn't hesitate a moment in recommending it to any of my Radio friends.

Respectfully yours,  
(Signed) C. D. H.  
(Names and address gladly furnished on application.)

# Wireless Institute

Rush Coupon to  
New York Wireless Institute  
Dept. 111  
258 Broadway New York

## RUSH COUPON

New York Wireless Institute,  
Department 111, 258 Broadway, N. Y.  
Gentlemen: Send me free of charge and without any obligation on my part your booklet "How to Become an Expert Wireless Operator." Also full particulars regarding your course, your easy payment plan, and free instrument offer.

Name .....

Address .....

State .....

City or Town .....

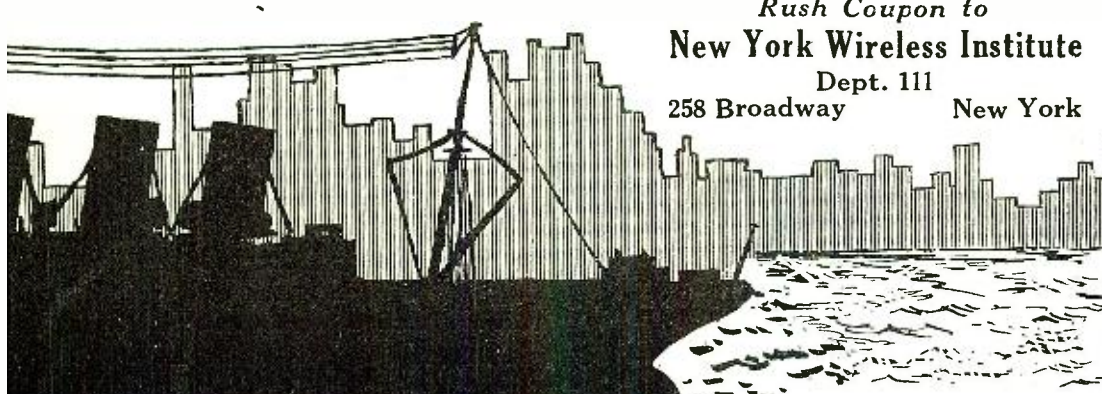

**TUSKA C. W. INDUCTANCE**

Type 181  
Unmounted



PRICE  
\$5

Use a Tuska C. W. Inductance in your new tube set. Send your dealer's name and 5 cents for our illustrated C. W. Booklet.

**THE C. D. TUSKA COMPANY**  
HARTFORD, 3 - CONN.

(Continued from page 542)

the potential assistance he is in a position to render during moments of emergency.

The government called upon the radio amateurs to fill the ranks of both the Navy and Army Signal Units, and all those who could possibly do so, that is, those who were not too young or who did not have dependents, quickly responded.

As a matter of fact some of the most important positions were filled by amateurs who had never had either governmental or commercial radio experience. I myself have nearly one hundred friends and acquaintances who rose quite high in army and navy rank, such as captains and majors in the army and junior and senior lieutenants in the navy.

Even so, there were not enough amateur or professional operators to fill the ranks of a great army and a great navy, so many additional newcomers were trained.

I understand that the U. S. Signal Corps alone trained something like 50,000 men in the theory and operation of the modern radio installation, while the Navy probably instructed 20,000.

These young men are now back in civilian life and are scattered over all parts of the country and cities. Needless to say

every one of them in a more or less degree has experienced the keen fascination and the many thrills known to the radio enthusiast. Incidentally the greater part of them became amateurs, they set up complete receiving and transmitting sets in all parts of the country and are now keeping in touch with the game, advancing with the art of radio telegraphy and telephony.

**CONSIDERING INTERFERENCE**

Now we come to the most important part—that of interference. With such a great number of amateurs there is bound to be constantly increasing interference, and the amateur wave-length of 200 meters has really become too small to hold them, so to speak. This is particularly evident in thickly populated districts such as New York, Boston, Chicago and elsewhere. One has only to "listen-in" any evening to hear the medley of sparks and fone "hellos" to become fully convinced.

This subject of interference is an old one and I am not the first one to think of it by any means. I understand that it is being seriously considered by the powers-that-be and we may soon expect a re-arrangement of amateur wave-lengths and possibly a stricter method of supervision.

The bill known as S4038 which Senator Poindexter introduced at the last session of Congress would seem at first glance to be out for the suppression of amateur transmitters located too close to coastal, transoceanic, or government radio stations, and this bill has received considerable objection from amateur quarters. I hardly think this measure is as severe as may be imagined. The fact that "no land station, amateur, experimental or training school shall be located in such a manner as to interfere with coastal, transoceanic, or government stations" does not necessarily spell the doom of the amateur; it is merely a precautionary measure for future occasions and with the practical radio tuning of today there is little danger of an experimenter's 200 meter wave interfering with the 600 or 1200 meter waves of commercial or government stations unless, of course, the amateur is situated next door to the commercial station which is hardly ever the case in practice.

**LEGAL ATTEMPTS AGAINST AMATEURS**

These attempts to squelch the amateur are no new wrinkle. Every so often, a representative or senator at Washington will introduce a "trick" bill of some sort designed to curb our activities. As far back as 1900, which is nearly twelve years ago, this interesting pastime of introducing bills against amateur radio began with the so-called Depew bill. Of course, in those days there was absolutely no regulation or laws of any kind for the control of amateurs and even tho the number of experimenters was comparatively small, there was beginning to be need of some sort of government control.

At any rate, today we must be very careful and conscientious in the manner in which we operate our transmitters. No broad tuning mind you, and a sharp eye must be kept on the happy side of 200 meters.

Receiving, of course, is different. If every one of the one hundred and ten million inhabitants of the United States set up solely receiving sets and did not use transmitters there would be no trouble and no need of supervision unless, of course, someone comes along and tells us that the combined energies radiated by so many vacuum tube receiving circuits would jam the American ether to the choking point.

**AMERICAN AMATEURS FORTUNATE**

We are very fortunate in this country not to be hindered as are our less fortunate European brothers. We are free to send and receive to our heart's content provid-

(Continued on page 548)

**PIGEONS PAY** Easy raised, any small building, very little space required. Build their own nests, feed their own young. Very profitable business. Get your start with a few good pairs. Write today for 1921 Circular.

Pigeon Supply House, Hanover, Pa.

**Free for 10 Days' Wear**

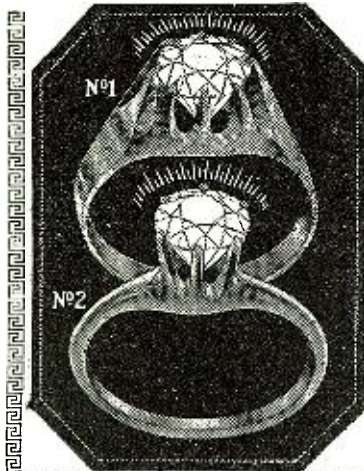

Send no money—just your name and address. We will then send you one of these genuine Tifnite gems to wear for 10 days. Note its dazzling brilliancy. Put it alongside the costliest diamond. If you can tell the Tifnite from a real diamond send it back.

**Like a REAL Diamond**

A genuine Tifnite has all the fire and flash of a real diamond. And like a real diamond, every Tifnite is set in a beautiful solid gold mounting.

**Gents' Ring No. 1**

Genuine Tifnite gem. Almost 1 karat in weight. Solid gold mtg. Wide flat band. 8-prong setting to hold stone securely.

**Ladies' Ring No. 2**

Newest style mounting. Solid gold and hand-made, guaranteed. Genuine Tifnite gem, almost 1 karat weight, in exquisitely rich setting.

**Order Quick**

We have only 5,000 of these rings to quickly introduce ourselves to new customers. Prices specially low, terms very easy. Everything on pre-war basis. Send strip of paper fitting around second joint of finger for your ring size. We will send you your choice of these Tifnite rings. When it arrives, deposit \$3.50 with postmaster. Wear it 10 days at our expense. If anyone can tell it from diamond, send it back and we will refund your deposit. If you decide to buy, merely pay the balance at \$3.00 per month until the special price of \$22.00 is paid. Write today.

**THE TIFNITE COMPANY**

511 S. Plymouth Ct., Dept. 1255, Chicago, Ill.

**SOMETHING NEW!**



At last—a carefully planned Radio Log to keep daily records of your experience in sending and receiving in a logical and orderly manner.

Each page contains a tabulated form with proper headings. There are also several charts upon which you can easily make curves that will give you at a glance some facts of your work over a period of time that will be both interesting and valuable.

The book contains 100 pages and is printed on high grade bond paper. The size is 8½ by 10½ inches.

Introductory price \$1.50. Send for this valuable book which will add new pleasure to your work.

**RAVENSWOOD RADIO CO.**  
2044 WAVELAND AVE. CHICAGO, ILLINOIS

# RADIO APPARATUS

*Distributors of Reliable Radio Apparatus  
to Schools, Colleges and Experimenters  
All Over the World!*



**"PITTS CO"**

The sign of service and prompt delivery.

Why not let us prove it!

**"SPECIAL"**

Our New Catalog No. 22 is just out.

Insist upon your copy!

|   |        |
|---|--------|
| <b>AMPLIFYING TRANSFORMERS</b>  |        |
| No. A-2 Acme, mounted.....  | \$7.00 |
| No. A-2 Acme, semi-mounted.....   | 5.00   |
| No. A-2 Acme, unmounted.....  | 4.50   |
| No. 226-W Federal.....  | 7.50   |
| F. D. PITTS CO., BOSTON, MASS.  |        |
| <b>AUDION CONTROL PANELS</b>  |        |
| No. RORA Grebe, in cabinet.....   | 12.50  |
| No. BOBE Grebe with tickler connections.....                            | 17.00  |
| No. ZRD Clapp-Eastham (new type).....                                   | 12.00  |
| No. Y-1 Acme (latest model).....  | 10.00  |
| No. P-500 DeForest audion ultra-audion type with 45 V. "B" battery..... | 24.00  |
| No. P-1 Adams-Morgan "Paragon special," just out.....                   | 6.00   |
| F. D. PITTS CO., BOSTON, MASS.  |        |
| <b>"B" BATTERIES</b>  |        |
| No. 7623 Standard 23.5 V., small.....                                   | 1.50   |
| No. 7625 Standard 22.5 V., large.....                                   | 2.85   |
| No. 7650 Standard 22.5 V., variable.....                                | 3.50   |
| No. 766 Eveready 22.5 V., large.....                                    | 3.50   |
| No. 763 Eveready 22.5 V., small.....                                    | 2.25   |
| No. 703 Eveready flashlight cells, set of 10, 45 V.....                 | 3.50   |
| F. D. PITTS CO., BOSTON, MASS.  |        |
| <b>BOOKS</b>  |        |
| Practical Wireless. By Bucher.....                                      | 2.25   |
| Experimenter's Manual. By Bucher.....                                   | 2.25   |
| Vacuum Tubes. By Bucher.....  | 2.25   |
| How to Pass U. S. Exams. By Bucher.....                                 | .75    |
| How to Conduct Radio Club. By Bucher.....                               | .75    |
| Practical Wireless Stations. By Bucher.....                             | .75    |
| Radio Telephony. By Goldsmith.....                                      | 2.50   |
| Radio Inst. and Measurements.....                                       | 1.75   |
| Elem. Princ. of Wireless. By Bangay.....                                | 1.75   |
| Part 1.....   | 1.75   |
| Part 2.....   | 1.75   |
| Both for.....   | 3.25   |
| Robinson's Manual of Wireless Tel.....                                  | 2.50   |
| Consolidated Call-Book (new edition when issued).....                   | 1.80   |
| F. D. PITTS CO., BOSTON, MASS.  |        |
| <b>C. W. INDUCTANCES</b>  |        |
| No. 181 Tuska C. W. Inductance, unassembled.....                        | 7.50   |
| No. 181 Tuska C. W. Inductance, assembled.....                          | 5.00   |
| No. 182 Tuska C. W. Inductance, unassembled.....                        | 10.00  |
| No. 182 Tuska C. W. Inductance, assembled.....                          | 7.50   |
| No. 183 Tuska C. W. Inductance, unassembled.....                        | 12.50  |
| No. 183 Tuska C. W. Inductance, assembled.....                          | 10.00  |
| F. D. PITTS CO., BOSTON, MASS.  |        |
| <b>CHOKE COILS</b>  |        |
| Acme 1 1/2 Henry, 500 MA Single coll.....                               | 6.00   |
| Acme 1 1/2 Henry, 500 MA Double coll.....                               | 8.00   |
| Acme 1 1/2 Henry, 150 MA Single coll.....                               | 4.00   |
| Acme 1 1/2 Henry, 150 MA Double coll.....                               | 6.00   |
| F. D. PITTS CO., BOSTON, MASS.  |        |
| <b>TELEPHONE TRANSMITTERS</b>   |        |
| No. 323-V W. E. Transmitter only.....                                   | 4.00   |
| No. 5175-A Conn. Transmitter only.....                                  | 8.00   |
| No. 5176-A Conn. Transmitter with extension arm.....                    | 4.25   |
| F. D. PITTS CO., BOSTON, MASS.  |        |

|   |        |
|---|--------|
| <b>RESISTANCES (Ward Leonard)</b>                               |        |
| Ward Leonard Resistance, 5000 ohm.....                          | \$1.70 |
| Ward Leonard Resistance 10000 ohm.....                          | 2.95   |
| (Suitable for wireless telephone work.)                         |        |
| F. D. PITTS CO., BOSTON, MASS.                                  |        |
| <b>MODULATION TRANSFORMERS</b>                                  |        |
| Acme A-3 unmounted.....   | 7.00   |
| Acme A-3 semi-mounted.....                                      | 5.00   |
| Acme A-3 unmounted.....   | 4.50   |
| F. D. PITTS CO., BOSTON, MASS.                                  |        |
| <b>GRID LEAKS</b>   |        |
| No. MW-1 Marconi, 1, 2, 3 or 5 megohms.....                     | 1.25   |
| No. C-21 Chelsea Variable 1/2 to 5 megohms, 10 values.....      | 3.00   |
| No. C-22 Chelsea Oscillator, makes any circuit oscillate.....   | 3.00   |
| F. D. PITTS CO., BOSTON, MASS.                                  |        |
| <b>LOOSE COUPLERS</b>   |        |
| No. A-1 Arnold 3500 meters.....                                 | 22.00  |
| No. Y-673 Clapp-Eastham 3000 meters.....                        | 14.00  |
| No. 344 Murdock 1500 meters.....                                | 8.00   |
| No. HKAB Grebe Variometer-coupler, 1000 meters, in cabinet..... | 25.00  |
| F. D. PITTS CO., BOSTON, MASS.                                  |        |
| <b>METERS (Weston Model 301)</b>                                |        |
| Model 301 0-3 amperes flush.....                                | 8.50   |
| Model 301 0-5 amperes flush.....                                | 8.50   |
| Model 301 0-50 Volts flush.....                                 | 8.50   |
| Model 301 0-100 Milli-amperes flush.....                        | 8.50   |
| Model 301 0-300 Milli-amperes flush.....                        | 8.50   |
| Model 301 0-500 Milli-amperes flush.....                        | 8.50   |
| Model 301 0-800 Milli-amperes flush.....                        | 8.50   |
| F. D. PITTS CO., BOSTON, MASS.                                  |        |
| <b>METERS (Hot Wire)</b>  |        |
| No. 127 Gen. Radio flush 0-1 Amp.....                           | 7.75   |
| No. 127 Gen. Radio flush 0-3 Amp.....                           | 7.75   |
| No. 127 Gen. Radio flush 0-10 Amp.....                          | 7.75   |
| No. 127 Gen. Radio flush 0-5 Amp.....                           | 7.75   |
| F. D. PITTS CO., BOSTON, MASS.                                  |        |
| <b>TRANSFORMERS (Acme, new type)</b>                            |        |
| Acme 250 Watt, mounted.....                                     | 16.00  |
| Acme 250 Watt, unmounted.....                                   | 13.00  |
| Acme 500 Watt, mounted.....                                     | 22.00  |
| Acme 500 Watt, unmounted.....                                   | 18.00  |
| Acme 1000 Watt, mounted.....                                    | 33.00  |
| Acme 1000 Watt, unmounted.....                                  | 28.00  |
| F. D. PITTS CO., BOSTON, MASS.                                  |        |
| <b>TRANSFORMERS (For CW Work)</b>                               |        |
| Acme 200 Watt, mounted.....                                     | 20.00  |
| Acme 200 Watt, unmounted.....                                   | 16.00  |
| Acme 50 Watt, mounted.....                                      | 18.00  |
| Acme 50 Watt, unmounted.....                                    | 12.00  |
| F. D. PITTS CO., BOSTON, MASS.                                  |        |
| <b>ROTARY GAPS</b>  |        |
| No. 443 Murdock 4000 R.P.M.....                                 | 18.50  |
| No. 124 Klitzgen (latest type).....                             | 26.00  |
| Benwood (Noiseless).....  | 30.00  |
| Benwood rotors, 8, 10 or 14 point.....                          | 8.00   |
| Hyrad rotors.....   | 10.50  |
| Thordarson rotors.....  | 6.00   |
| Murdock rotors, 3/16 or 1/4 inch shafts.....                    | 3.00   |
| F. D. PITTS CO., BOSTON, MASS.                                  |        |

|  |         |
|--|---------|
| <b>QUENCH GAPS</b>   |         |
| Amrad 1 KW. Type.....  | \$41.50 |
| Amrad 1/2 KW. Type.....  | 24.50   |
| Amrad 1/4 KW. Type.....  | 12.00   |
| F. D. PITTS CO., BOSTON, MASS.   |         |
| <b>REGENERATIVE RECEIVERS</b>  |         |
| No. CR-1 Grebe, 170-600 meters, tube-control self-contained. Complete set.....   | 90.00   |
| No. CR-2 Grebe 170-600 meters.....   | 51.00   |
| No. CR-3 Grebe "Relay Special" 170-600 meters.....   | 65.00   |
| No. CR-3A Grebe 170-375 meters, the latest Grebe short wave receiver.....  | 45.50   |
| No. CR-3A Grebe 170-375 meters, detector and two step amplifier self contained. A complete set. Ideal for Wireless phone reception. A masterpiece..... | 200.00  |
| No. CR-7 Grebe 500-2000 meters. "Long wave special." A complete set. Ideal for long waves. A wonderful set.....  | 210.00  |
| F. D. PITTS CO., BOSTON, MASS.   |         |
| <b>RHEOSTATS</b>   |         |
| No. 214 Gen. Radio Back mts.....   | 2.50    |
| No. F-2 Paragon Back mts.....  | 1.75    |
| No. R-1 Remler Back mts.....   | 1.75    |
| No. F-200 DeForest Porcelain.....  | 4.00    |
| F. D. PITTS CO., BOSTON, MASS.   |         |
| <b>TELEPHONES</b>  |         |
| No. 55 Murdocks 2000 ohms.....   | 4.50    |
| No. 55 Murdocks 3000 ohms.....   | 5.50    |
| Brandes "Superior" 2000 ohms.....  | 8.00    |
| Brandes "Trans-atlantic" 2800 ohms.....  | 12.00   |
| Brandes "Navy Type" 3200 ohms.....   | 14.00   |
| Baldwins Type C. Navy Standard.....  | 16.50   |
| Baldwins, Type E, Super-sensitive.....   | 20.00   |
| Century 2200 ohms Govt. standard.....  | 12.50   |
| Century 3200 ohms Govt. standard.....  | 14.00   |
| Brown 4000 ohm Imported, super-sensitive, double armature.....   | 20.00   |
| F. D. PITTS CO., BOSTON, MASS.   |         |
| <b>VACUUM TUBES</b>  |         |
| Radotron U. V. 200 Detector Tube, just out.....  | 5.00    |
| Radotron U. V. 201 Amplifying Tube, just out.....  | 6.50    |
| No. M-1 Electron Relay.....  | 5.00    |
| No. M-2 Moorhead Amplifier.....  | 7.00    |
| No. M-3 Moorhead extra hard Trans.....   | 7.50    |
| No. A-1 Audiotron.....   | 6.00    |
| F. D. PITTS CO., BOSTON, MASS.   |         |
| <b>VACUUM TUBE SOCKETS</b>   |         |
| No. R-300 DeForest.....  | 1.50    |
| No. MW-1 Marconi.....  | 1.50    |
| No. 55 Murdock.....  | 1.00    |
| No. 156 Gen. Radio.....  | 1.75    |
| No. R-400 Inverted type.....   | 2.40    |
| F. D. PITTS CO., BOSTON, MASS.   |         |

**Important!** Our new catalogue No. 22 illustrating, describing and pricing our immense stock of radio apparatus sent upon receipt of 10 cents. Insist upon receiving your copy! Pittsco service reaches all over the world! Why not let it reach you!

**F. D. PITTS CO., Inc.**

12 Park Square

Dept. C

Boston, Mass., U. S. A.

Cable address "PITTS CO" Boston

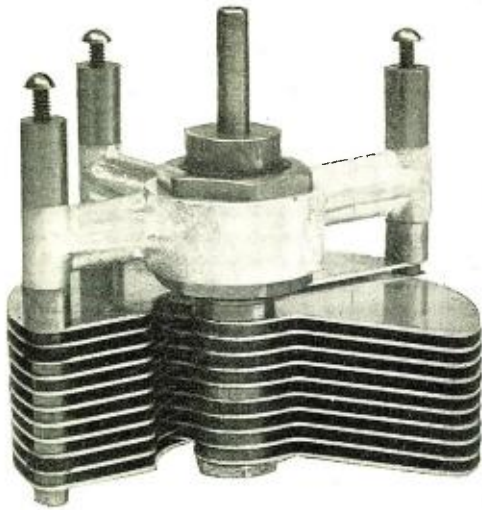

# THE CONDENSER WITH A BACKBONE

Our new variable air condenser is ready for the market—for you. It is built—not assembled—with a rigid aluminum casting for a foundation. The plates are of .032 half hard aluminum sheet. The entering edge of the rotary plates is rounded off so that the calibration curve is practically straight. This condenser has but one bearing, of spring controlled double-cone type, which insures smooth, uniform rotation and also automatically takes care of any wear. This condenser can be mounted in either horizontal or vertical position.

Price Unmounted as shown **\$5.00**

We also have in stock for immediate shipment 20/38 S. C. C. Litz—Price, per 100 ft. . . . . 40c.

*The above articles shipped postpaid upon receipt of remittance. To avoid delay or possible loss, remit by Postal Money Order.*

**COTO-COIL CO.,** 87 Willard Avenue  
Providence, R. I.

## GALENA :- SILICON

|   |         |                 |
|---|---------|-----------------|
| Galena Crystal Mounted in Fusible Metal Button  | - -     | Postpaid \$5.50 |
| Silicon Crystal Mounted in Fusible Metal Button | - -     | “ .50           |
| Galena Crystal Unmounted                        | - - - - | “ .25           |
| Silicon Crystal Unmounted                       | - - - - | “ .25           |

*Every Crystal Tested Under Actual Working Conditions and GUARANTEED SENSITIVE*

**R. BROWNLIE, 27 Oakland Ave, EVERETT, MASS.**

“EVERYTHING IN RADIO”

## WESTERN RADIO ELECTRIC COMPANY

SEND FOR OUR LATEST

**STOCK BULLETIN AND PRICE LIST**

550 South Flower Street

Los Angeles, Cal.

ing we obey certain laws and regulations.

Our Canadian brothers are somewhat less fortunate, for what can one do in the line of transmission with 50 meters?

England and Australia, I understand, are beginning to loosen up with their amateurs, but still their laws are far from favorable when compared to ours.

France limits its amateurs to the reception of time signals and meteorological reports only, and one must not copy commercial or government messages, for this is against the law. However, there will need to be a great number of radio detectives to censor what an amateur is receiving.

Holland also permits amateur reception but no transmission.

Germany, on the other hand, does not permit any amateur activity whatever.

So you see, fellow amateurs, how fortunate we really are in this country of the brave and the free.

Let us now say a few words concerning the future of radio amateurs. While editor of RADIO NEWS, I often received letters from amateurs in all walks of life asking just how one could use his amateur knowledge and experience to advantage, that is to say, realize some commercial value out of it. Unfortunately we cannot all be Marconis, DeForests, Alexandersons and Pickards. Some of us must of necessity remain radio wall-flowers.

### OPPORTUNITIES IN RADIO FIELD INCREASE

In spite of this distressing fact, however, there is no need to despair. There are at present thousands of opportunities in the radio field which did not exist five, ten and twelve years ago. This game has become an exact science and there are many sub-divisions of it. In other words, one must specialize in any given branch of it in order to really be someone.

We have today specialists in radio reception and radio transmission. These are subdivided into specialists in low-power transmission, high-power transmission, short wave and long wave reception; spark, arc and alternator experts, vacuum tube experts, loop antenna experts and so on. Any one of these subjects holds the possibility of further research and development and will be the task of our future radio engineers.

There are some who say “this radio is a great game to play with but there is no money in it.” There is money in it but you must work for it. There is as much remuneration, if not more, in the commercial radio industry of today as there is in many highly specialized professions. Not only that, but the pay is rising instead of falling.

### GOOD PAY FOR OPERATORS

Just think of it; back in the old days, six years ago let us say, an operator went to sea for \$25 and \$30 a month; today he is paid \$100 and \$125. Surely the cost of living has not increased five times what it was in those days. Don't forget, by the way, that in addition to the present good pay there are included food and living quarters as well.

One does not necessarily have to go to sea. There are plenty of opportunities on shore, be they in construction, inspection, manufacturing, selling and even operating fields of radio.

It would be foolish to say, of course, that every individual amateur should strive to secure a berth in commercial radio. There are surely too many amateurs, and not enough positions to go around. Furthermore, there are many types of amateurs and the number who find their way into the commercial ranks are very few indeed in comparison. The greater part use radio as a hobby and at the same time it is an excellent mind trainer. There are some, of course, who are in the allied branches, such as the electrical, the telegraph and telephone fields.

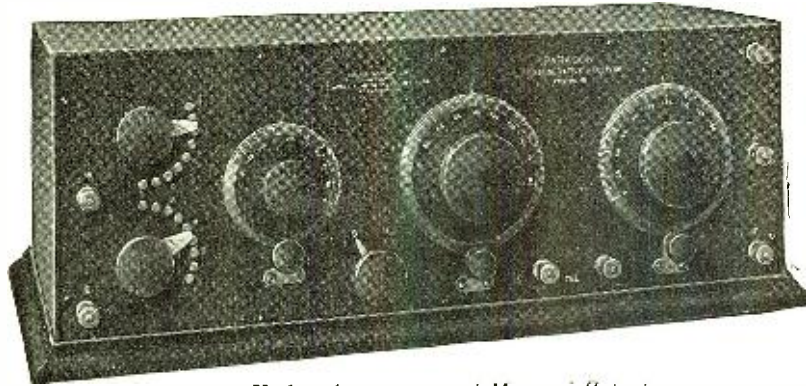

Licensed Under Armstrong and Marconi Patents

Be Sure  
it's a *real* PARAGON  
Look for the phrase,  
Type R.A. TEN,  
engraved in the  
Bakelite panel

# If it isn't an R.A. TEN,— it isn't a PARAGON!

Outstanding features of the Genuine  
**PARAGON R.A. TEN**  
(Reg. U. S. Pat Off.)

*Amplifying Short Wave Receiver*

- Wave length, 160 to 1000 meters.
- Amplification 100 times.
- No dead end losses whatever.
- Vernier attachments on all controls.
- Coupling has scale of 180°.
- Free from all body capacity effects.
- Guaranteed for two years.
- "The weaker the signal, the stronger the amplification."

*Price, Eighty-five Dollars*

**T**HIS ADVERTISEMENT is published more for your protection than for ours.

Of course, we have known all along that imitators were using the PARAGON name, but only recently did we realize how Radio men were being deceived. Letters have come in, however, from a number of amateurs who bought these fake PARAGONS, and were tremendously disappointed.

Probably there are hundreds more who do not realize the real situation.

The genuine PARAGON R. A. TEN (*use full name*), is manufactured only by Adams-Morgan Co.; and is sold exclusively by Continental and affiliated dealers. The complete name is copyrighted, and the use of the PARAGON name on other instruments is therefore not only unfair and deceptive, but also illegal. (Two previous models of Adams-Morgans Co.; the PARAGON R. A. 6 and the PARAGON R. A. 200 Universal Range receiver, are, of course, genuine.) However, these models are now discontinued and the PARAGON R. A. TEN is the only genuine PARAGON on the market.

Be sure to get a PARAGON,—a *real* PARAGON,—the only receiver with a wave length range up to 1,000 meters, combined with no decrease in amplification.

Send in your remittance now, and your PARAGON will be shipped at once.

Or let us send you our FREE bulletin, describing, in detail, the features of the PARAGON R. A. TEN.

**T**HE SAME courtesy,—the same helpful attention that has pleased our customers here in the store, extends to our mail order department. We ship exactly what you order, the day you order it—and its packed to arrive in perfect condition. Our new 112-page catalogue, now out, contains probably the widest assortment of radio goods ever assembled together. The appendix contains tables for easily figuring all radio calculations, also conventional signals and abbreviations, etc. This valuable catalogue mailed anywhere in the world for 25c. Send for your copy today.

*Partial list of our mail order specialties follows. Order direct from this ad, and then send for complete catalogue.*

|  |  |  |  |
|--|--|--|--|
| <b>RADIOTRON DETECTOR TUBES</b> .....\$5.00  | <b>BUZZERS</b><br>No. 55 Mesco ..... 2.25<br>No. 251 Mesco ..... .80<br>No. 168 Century ..... 2.50   | <b>LINE PROTECTORS</b><br>No. 379 Murdock Line Protector ..... 9.00<br>No. AM888 Dubilier Line Protector ..... 4.00<br>No. CD888 Dubilier Line Protector ..... 6.00        | <b>BURGESS "B" BATTERIES</b><br>22½ Volts Large "B" Battery ..... 3.50<br>22½ Volts Small "B" Battery ..... 2.50 |
| <b>ELECTRON RELAY DETECTOR TUBES</b> ..... 6.00  | <b>AMRAD GAPS</b><br>No. G-1 1 K.W. Gap.. 41.50<br>No. G-2 ½ K.W. Gap.. 24.50<br>No. G-3 ¼ K.W. Gap.. 16.00  | <b>TUNGAR RECTIFIERS</b><br>Two Ampere Tungar complete ..... 18.00<br>Five Ampere Tungar complete ..... 28.00<br>Two Ampere Extra Lamp 4.00<br>Five Ampere Extra Lamp 8.00 | <b>PARAGON CONTROL PANEL</b><br>No. 5 Paragon Control Panel ..... 6.00   |
| <b>ELECTRON RELAY AMPLIFIER TUBES</b> ..... 7.00   | <b>BENWOOD GAPS</b><br>No. 1 Benwood Gap complete ..... 30.00<br>No. 8 8 Stud Rotor.. 8.00<br>No. 10 10 Stud Rotor.. 8.00<br>No. 14 14 Stud Rotor.. 8.00 | <b>RHEOSTATS</b><br>No. 2110 Porcelain Base 1.40<br>Paragon Back Mounted. 1.75<br>G. R. Back Mounted... 2.50   | <b>ANTENNA SWITCHES</b><br>No. 463 Murdock..... 4.50<br>F. 658 Clapp-Eastham.. 12.50                             |
| <b>OMNIGRAPHS</b><br>No. 313 Omnigraph, complete .....\$20.00<br>No. 2 Jr., complete..... 28.00<br>Extra Dials, each..... .20<br>No. 342 Practice Set, with battery ..... 4.00 |  |  |  |

## CONTINENTAL RADIO AND ELECTRIC CORPORATION

J. DI BLASI, Secretary      Our word of honor to you is our guarantee. *Let us prove it.*      J. STANTLEY, Treasurer  
DEPT. C-31      6 WARREN STREET      NEW YORK

# Build your own apparatus Use Parts



All prices post paid.  
Catalog sent for 5c.

Reliable dealers  
wanted.



**Type 101 Panel Switch**

A beautiful and efficient rotary switch for general use. Furnished in two sizes. 1" radius brass finish 40c. Nickel finish 50c. 1 1/2" radius brass finish 50c. Nickel finish 60c.

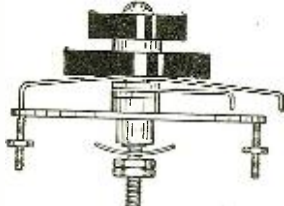

**Type 102 Panel Switch**

A compound switch consisting of two electrically independent switches mounted with concentric knobs. 1 1/2" radius brass finish \$1.10. Nickel finish \$1.25.



**Type 103 Panel Switch**

A rotary panel switch which is double pole and double throw. Will change variable condenser from series to parallel, etc. 1 1/2" radius brass finish 75c. Nickel finish 85c.



**Type 104 Panel Switch**

A complete unit for back of panel mounting. The latest and best in rotary panel switches. Better looking, more efficient and easier to mount. Complete with Type 116 Dial and 6 contacts \$2.25. Complete with Type 116 Dial and 11 contacts \$2.50.

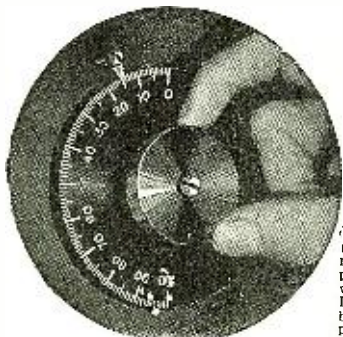

**Type 116 Indicating Dials**

Of polished hard rubber accurately engraved, filled with brilliant white, furnished complete with knob and bushing to fit 3/16" shaft. 90° scale 0-50 or 150° scale 0-100. 2" diameter \$1.25. 3" diameter \$1.50.



**Type 121 Rheostat**

Portable for table or back of panel mounting. Has turned aluminum case, convenient binding posts and 6 ohm resistance unit with all off and all on positions. Long bearing and special designed blade insure smooth running and positive contact. Only occupies space 2" in diam. on your panel. No. 121A with Type 116 Dial \$2.50. No. 121B with Knob and Pointer \$1.75.



**Type 14B Rotary Disk**

The same style rotor as used on our famous belt driven gap, only with bakelite center and brass bushing to fit your motor shaft. Size is 4 1/2" diam. and 9/16" thick. This rotor being light and perfectly balanced will give excellent results on any small high speed motor. State size of shaft when ordering. No. 14B Rotary Disk \$6.00.



**Variocoupler Rotor**

A carefully turned hardwood form for the secondary coils of variocouplers, etc. Size is 3 1/2" in diameter and 2" wide. No. 101 Rotor \$1.00.



**Type 5A Varometer**

Made from Wilcox Variometer parts, completely assembled as illustrated, may easily be mounted on panel if you wish. Wave length range in average circuit with coils in series about 175-450 meters. No. 5A Variometer \$8.

**THE WILCOX LABORATORIES, INC.**  
LANSING "Manufacturers" MICHIGAN

**PLENTY OF ROOM FOR AMATEURS**

The point I am trying to get at is, that if you are really desirous of entering the commercial ranks of radio there is plenty of room for you, and no doubt you will secure as much success here as in any other branch.

Remember, that altho radio is a highly specialized science, there remain many problems to be solved and as the art advances and it becomes more and more a complex subject there will be plenty of work to do and plenty of fame to be gained for future radio men.

Fig. 1 shows a miniature tho practical instrument which has done more for the advancement and development of radio than any other instrument. It is the vacuum tube which has rightly been called the modern Aladdin Lamp. It is certainly wonderful, for it is capable of more feats than any other electrical appliance.

Mr. E. F. W. Alexanderson, who developed the high frequency alternator making long distance transmission possible, recently voiced some thots in connection with the vacuum tube which are vivid and interesting. "Scientists tell us that electricity is no longer the mysterious power fluid that we have imagined flowing smoothly in our wires. Instead it is composed of miniature planets or comets of condensed material electriciv of definite charge and mass shooting across a miniature universe inside of a glass bulb and following orbits that can be calculated as accurately as the orbits of the planets."

**IMPORTANCE OF VACUUM TUBES**

Fellow amateurs, this little bulb which is hardly larger in size than a cigarette, or any one of its mates of possibly larger dimensions is destined to revolutionize future radio and it will not take very many years either. It will not only benefit and change present systems of commercial radio but it will prove an excellent stimulus to amateur radio. A word of advice—go easy on the purchase of spark equipment.

Amateur radio is on the way to become even more popular than amateur photography. As you see the man or woman promenading in the park on Sunday afternoon carrying the inevitable little camera case, so will you see the future amateur carrying his little case which will contain sufficient apparatus to communicate by radio over comparatively long distances within the city or country.

There is no reason why every home and hamlet cannot in the future have a parlor radio-phonograph arrangement which will furnish music at regular stated times, in other words, "radio-à-la-victrola."

These prophesies may sound rather far fetched and they may not possibly come to pass next year, but they will eventually.

**OVER 200,000 AMATEURS IN U. S.**

I have tried to secure some authentic information concerning the number of amateurs in the United States today. As near as I am able to ascertain there are over 200,000 amateurs of all classes and the number is constantly increasing, due probably to the excellent publicity that is being given to radio, not only thru the medium of the radio magazines themselves but in the daily press of the country.

**FIGHT FOR YOUR RIGHTS**

In closing I can give you no better counsel than to ask you to keep closely in touch with radio not only thru reading but experimenting as well. Invest a few dollars occasionally in apparatus, particularly in the latest equipment. It is an excellent investment whether you intend to remain an amateur or whether you have aspirations to become a professional.

And last but not least, whenever you hear or read of any individual attempt on the part of misinformed gentlemen to seriously

## Canadian Amateurs

Write to our nearest branch for Price List "B" of Radio Apparatus, Supplies and Publications.

### Scientific Experimenter Limited

Dominion Bldg.,  
Vancouver, B. C.

Arcade Bldg.,  
Halifax, N. S.

Head Office,  
11 St. Sacramento St.

Confederation Life Bldg.,  
Winnipeg, Man.

Vaughan Electric Co.,  
94 Germain Street  
St. John, N. B.

**MONTREAL, QUEBEC**

93 King St. E.,  
Toronto, Ont.

Board of Trade,  
St. John's, N'f'd

Show Rooms,  
33 McGill College Avenue

READ the CLASSIFIED ADVERTISEMENTS on PAGES 580-583. YOU'LL FIND MANY GOOD THINGS THERE.



# Radisco BETTER "B" BATTERIES are back—

FOR THE PAST few months, manufacturing difficulties and inferior materials made it advisable to limit the production of Radisco Better "B" Batteries.

In the meantime, however, our research work has developed new methods, better materials, and more economical manufacturing principles.

**NOW, the NEW Radisco Better "B" Batteries are ready!**

Powerful batteries with an operating life of 600 to 1,000 hours—sturdy and well-built thruout—no batteries at the price are as good—no batteries at any price are better.

The Radisco dealer in your district has a complete stock of the NEW Better "B" batteries. *Get your supply from him!*

No. 1  $3\frac{1}{4}'' \times 2'' \times 2\frac{1}{2}''$  \$1.50 Shipping Wt. 2 lbs.  
No. 2  $6\frac{1}{2}'' \times 4'' \times 3''$  2.65 Shipping Wt. 5 lbs.

Both 15 cells, 22½ volts. Larger size has exclusive Variable Voltage feature. Ask your dealer to explain it.

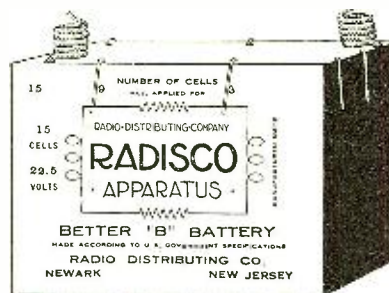

### Special Notice to Radio Phone Experimenters

Do you know that Radisco Better "B" Batteries make a very reliable and satisfactory source of high voltage for Radio Phone and other CW work? A Radio Phone operating on Radisco "B" Batteries is exceptionally quiet and free from the disagreeable hum of a motor generator or the rectified 60 cycle tone.

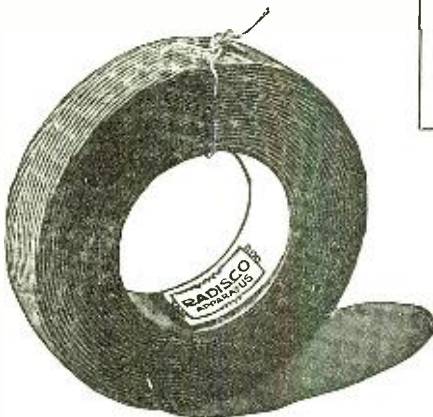

### Radisco Coils:

The deserved popularity of these famous coils continues to increase daily, in spite of the many freakish coil windings that are now flooding the market. Most experienced Radio men are glad to recommend universal wound coils, with their minimum high frequency resistance and low distributed capacity. Users of Radisco Coils have found, without exception, that they give better service, in direct comparison with coils that cost much more.

Radisco Coils are made in 17 sizes, tapped and plain, with wave length range from 200 to 20,000 meters. Your Radisco dealer has a complete stock of all sizes, and will be glad to help you select a combination that will give good results and will work well with the rest of your equipment.

### THESE PROGRESSIVE DEALERS CARRY THE ENTIRE RADISCO LINE

ALBANY, N. Y.  
Shotton Radio Mfg. Co.  
8 Market St.

ASHVILLE, N. C.  
Hi-Grade Wireless Instrument  
Co.

ATLANTIC CITY, N. J.  
Paramount Radio Supply  
518 N. Connecticut Ave.

BALTIMORE, MD.  
Radio Engineering Co.  
614 No. Calvert St.

BEINVILLE QUEBEC, CAN.  
Canadian Radio Mfg. Co.

BOSTON, MASS.  
Atlantic Radio Co.  
88 Broad St.

BROOKLYN, N. Y.  
Kelly & Phillips  
312 Flatbush Ave.

CHARLOTTE, N. C.  
Smith Novotoy Electric

CHICAGO, ILL.  
Chicago Radio Laboratories  
1316 Carmen Ave.

EUREKA, ILL.  
Klaus Radio Co.  
Branch, Peoria, Ill.

KANSAS CITY, MO.  
McCreary Radio Supply  
4th and Delaware Sts.

LOS ANGELES, CALIF.  
The Wireless Shop  
511 W. Washington St.

MONTREAL, P. Q., CANADA  
J. B. Miller  
136 Vendome Ave., N. D. G.

NEW BRUNSWICK, N. J.  
Geo. N. DeLaplaine  
306 George St., and 8th and  
Magnolia Sts.

NEW ORLEANS, LA.  
Rose Radio Supply  
604 Gravier St.

NEWARK, N. J.  
A. H. Corwin & Co.  
4 West Park St.

NEWCASTLE, PENN.  
Pennsylvania Wireless Mfg.  
Co., "8HA"  
507 Florence Ave.

OMAHA, NEBRASKA  
O-B Radio Supply Co.  
406 Brown Building

PHILADELPHIA, PENN.  
Philadelphia School of Wire-  
less Telegraphy  
Broad and Cherry Sts.

PROVIDENCE, R. I.  
Rhode Island Elec. Equip. Co.  
45 Washington St.

PITTSBURGH, PENN.  
Radio Electric Co.  
3807 Fifth Ave.

PORTLAND, ME.  
Atlantic Radio Co.  
15 Temple St.

SEATTLE, WASH.  
Northwest Radio Service Co.  
609 Fourth Ave.

SCRANTON, PENN.  
Shotton Radio Mfg. Co.  
P. O. Box 3  
Branch, 8 Kingsbury St.  
Jamestown, N. Y.

ST. LOUIS, MO.  
The Benwood Co., Inc.  
3424 Olive St.

TORONTO, ONT., CAN.  
The Vimy Supply Co.  
567 College St.

WICHITA, KAN.  
The Cosradio Co.  
1725 Fairmount Ave.

## RADIO DISTRIBUTING CO., Newark, N. J.

This Mark



Your Guarantee



899 Boylston St.  
Boston, Mass.

## DO YOU KNOW ???

That the EASTERN RADIO INSTITUTE offers more undeniable advantages to those interested in studying Commercial Radio than any other school in New England, if not in the country?

**DO YOU KNOW** that the EASTERN RADIO INSTITUTE is the **OLDEST, LARGEST** and **BEST EQUIPPED** radio and telegraph school in New England?

To make this unmistakably clear we can give the following facts:

The EASTERN RADIO INSTITUTE was founded in 1913 and is now **OVER SIX YEARS OLDER** than ANY OTHER Radio and Telegraph school in New England! All schools starting before us are **NO LONGER IN EXISTENCE!** WE ARE THE PIONEER SCHOOL.

The EASTERN RADIO INSTITUTE actually has **HUNDREDS** of earnest and intelligent students now in attendance. We have given instruction at this date to over 4,000 different students and have actually enrolled, graduated and placed more Commercial operators than **ALL OTHER SCHOOLS IN NEW ENGLAND COMBINED!**

The EASTERN RADIO INSTITUTE is equipped with **THOUSANDS** and **THOUSANDS** of dollars worth of splendid panel spark sets, Federal Arc apparatus, panel receiving sets, storage battery equipment, etc.

**DO YOU KNOW** that the EASTERN RADIO INSTITUTE has **ALWAYS** placed every graduate in a good position, kept them employed and can actually **GUARANTEE** these positions?

**DO YOU KNOW** that our graduates may be found all over the world as Chief Operators, Teachers in other Radio Schools, Chief Radio Inspectors, Engineers, Directors of Corporations, Superintendents etc?

**DO YOU KNOW** that we are the **ONLY** school in New England giving instruction upon actual Federal arc apparatus?

**DO YOU KNOW** that our systematically planned and thoroughly executed course of practical instruction positively brings **RESULTS**—Your Commercial first grade license.

Certainly these advantages must be apparent to you. Besides it costs no more to take our course, thus availing yourself of our **YEARS** of **RESULTS** and **SUCCESS**. **SUCCESSFUL** graduates of the EASTERN RADIO INSTITUTE are found all over the world! Why not be one?

**DAY AND EVENING CLASSES. START ANY MONDAY**

Our latest, illustrated prospectus is free. If you cannot visit the Institute send for one. If there is any further information or assistance our organization can give you please command me!  
Sincerely yours, F. D. PITTS, Director

## USE A CHELSEA OSCILLATOR



PRICE \$3.00

For undamped reception on long wavelengths. Oscillates on 3,500 to 20,000 meters. Eliminates tickler coils. Simplifies tuning. Is inexpensive.

Consists of two feed back and one grid mica dielectric mica condensers enclosed in bakelite base.

WE STAND BACK OF EVERY PRODUCT WE  
DISTRIBUTE AND GUARANTEE SATISFACTION  
PROMPT ATTENTION GIVEN ALL ORDERS AND INQUIRIES

### DOUBLEDAY-HILL ELECTRIC CO.

RADIO DEPT.—DESK 13

715-12th St., N. W. Washington, D. C. 719-21 Liberty Ave., Pittsburgh, Pa.

A welcome addition to your library! Send \$2.00 today, plus postage for 8 lbs., and your copy of bound volume No. 1 of Radio Amateur News will come forward by return mail.  
Experimenter Publishing Company 236a Fulton Street, New York City

curb the activities of American Amateur Radio, rise as one and fight to the last ditch against such measures. In this connection your radio magazines and the officers of your associations and clubs will always do their utmost to keep you informed on such propositions as they may present themselves and, therefore, give you ample time to vigorously resent it by writing strong protests to your representative at Washington. Remember the unreasonable curbing of amateur radio is un-American and certainly not symbolic of liberty and freedom.

Keep your ears well glued to your receivers and don't be caught napping. Remember that others are constantly listening-in.

## Two Practical Radio- phone Circuits

(Continued from page 518)

the anode circuits of  $V_1$  or  $V_3$  or both. By connecting a third valve  $V_2$  in the position shown, radio telephony may be obtained. The valve  $V_2$  will damp the oscillations in  $L_2$  since it will conduct when the oscillations make the anode of  $V_2$  positive. The degree to which  $V_2$  will conduct will be approximately proportional to the grid potential of  $V_2$ . This grid potential is varied during speech transmission by the E.M.F.'s supplied by the microphone  $M$  and the step-up transformer  $T$ . From this we will see that the oscillatory potentials applied to the grid of  $V_3$  will be modulated. The circuit of Fig. 1 may be varied experimentally in various directions. The anode of  $V_2$  may be given a positive potential by including a source of potential between the foot of  $L_2$  and the filament. Another variation is to connect its foot of the secondary winding of  $T$  to a point on the grid leak  $R$ , so as to give the grid of  $V_2$  a negative potential. The method of using single filament and anode batteries is frequently employed. The filament battery is also made to act as a microphone battery.

### ANOTHER PRACTICAL RADIOPHONE CIRCUIT

The second radio telephone circuit which is capable of giving very excellent speech depends on an entirely different principle. The actual high frequency oscillations are not modulated or interfered with, but the output of the amplifier tube is controlled microphonically. Fig. 2 shows the arrangement. A master oscillator tube  $V_1$  is again used. The input circuit  $L_2$  of the amplifier tube  $V_2$  is coupled to  $L_1$ . The grid of  $V_2$  is given a high negative value by taking a connection from the grid leak  $R$ . The microphone transformer  $T$  is so connected that the normal or "base-line" grid potential of  $V_2$  is continuously varied when speaking into  $M$ . Let us assure that—E volts are required to cut down the anode current of  $V_2$  to zero, so that the tube  $V_2$  is being used at the foot of its grid-potential—anode-current curve. Let us now consider that the amplitude of the induced oscillations in  $L_2$  is E volts. If the grid base-line potential be made—E-e volts, the induced oscillations will never produce any oscillatory current in the outfit circuit of  $V_2$  since even the positive peaks of the oscillations only bring the operating point to the foot of the curve. If, however, we apply additional positive potentials to the grid, the grid-base-line potential will become less negative, and the oscillations will cause the operating point to travel up and down a portion of the anode current curve. Oscillatory currents will be generated in the anode and aerial circuits having an amplitude corresponding to the amount of the curve used. This will depend upon the magnitude of the added potentials which are in practice the low-frequency potentials supplied by the microphone transformer  $T$ .

Both of these circuits, particularly the second, have proved of considerable value for medium powers and can be recommended for this purpose. The present writer has produced some distinctively original radio telephone systems which have produced particularly pure articulation and it is hoped that an opportunity to discuss these will occur in the near future.

### How to Wind Duo-Lateral Coils

(Continued from page 518)

side and so on. Only the first three turns are shown in the figure. Wind the first layer in this way, omitting every other pin all the way around. When the second layer has been reached take the next pin to the last one for one turn only around the tube and then start omitting every other pin again. Thus the second layer will be wound on an entirely different set of pins and this will bring the turns of the second layer exactly over the space between the turns of the first layer. When the third layer has been reached switch back to the row of pins the first layer is wound upon, and so on for all the rest of the layers. On the top row of pins shown in the figure the odd numbered layers will be wound on the odd numbered pins and the even numbered layers on the even numbered pins. There will be a slight irregularity on one turn of each layer, but this is not objectionable as it is only one turn in twenty-five and cannot be noticed.

When finish the coil is shellacked, cut off the tube, the pins pulled out and is ready for mounting. If the coil has been carefully wound it presents a very neat appearance.

### An Old Idea Exploded

(Continued from page 519)

gave about the same results after the other adjustments were completed. The same was found to be true of the steady voltage introduced into the grid circuit of the amplifier circuit at C. This voltage was obtained from one Edison battery cell. Its value was a little over one volt. The principal critical adjustment made was that of the potentiometer  $R_2$ . Best results were obtained with plate voltages in the neighborhood of 35 to 40. After obtaining the best possible results from these a further small, but appreciable, increase was obtained by *partially* inserting an iron wire core into the "air-cored" amplifier transformer. This last gain is that to be due to audio frequency tuning, and probably in part to audio frequency regeneration.

In the tests with the preceding circuit two soft tubes of the same make were compared with four different hard tubes. Of these hard tubes, three are commonly used as detectors and amplifiers, the fourth as a (five watt) power tube. The two soft tubes were found to be very nearly alike in spite of the fact that prior to the experiment one of them was carelessly allowed to roll off of a desk and drop nearly three feet onto a linoleum floor.

In comparing the best results obtained from the soft tubes with the results obtained from the hard tubes it was found that the soft tubes were giving higher amplification than the three hard amplifier tubes. The results from the power tube closely approached those from the soft. Testing weak signals from a buzzer set about 100 yards away, an amplification as high as fifty (audibility) was frequently indicated. On detuning the receiving loop just enough so that the signal in the detector circuit became totally inaudible, a readable signal of audibility six was found in the amplifier circuit.

# Last Call =

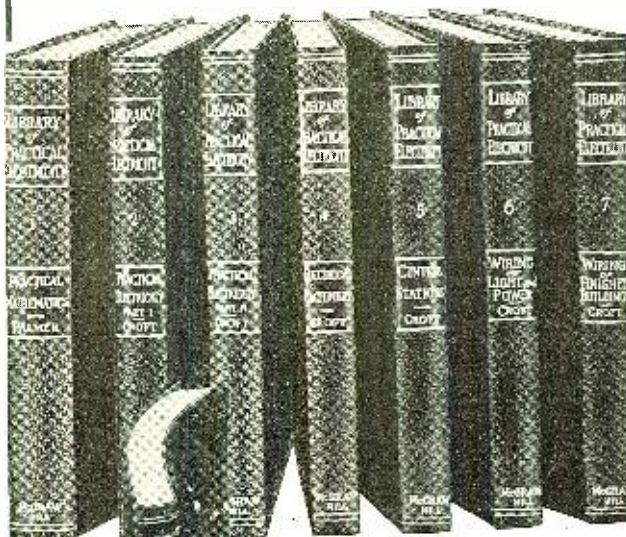

8 vols. flexibly bound

to procure the Famous Croft Library of Practical Electricity at the present price.

A steady decline in the prices of nearly all commodities can now be looked for. But it is different in the publishing business. Paper has gone up 300% and is still advancing. Considering that our forests are being rapidly depleted, and that pulp from which paper is made is getting scarcer every year, it may be only a short time until the price of every piece of literature of any kind will be doubled or trebled.

## Electricity as experts know it—NOT ONE CENT DOWN

Terrell Croft is not a wonder-worker. He is merely a man who has climbed up in the world of electricity to the lowest paid apprentice. He possesses the happy combination of ability to both do a thing and then explain how it is done, in clearest English and in simplest mathematics. Probably no other author or instructor has more fully and understandingly covered the practical side of electrical work as it is actually done.

There have been so many instances where these books have helped men quickly to bigger positions with bigger pay, that they are the best and most widely known electrical books in existence. The most intimate personal instruction could not be more effective in enabling the student or the experienced man to "know electricity as experts know it."

If you want to get out of the amateur class you must know the practical side of Electricity.

#### Read This—

- Electricity, from the simplest principles to complete and economical operation of a central station—Motors, generators, armatures, commutators, transformers, circuits, currents, switchboards, distribution systems.
- Electrical machinery of every type, installation, operation and repair.
- Wiring for light and power. How to do it mechanically perfect in accordance with the National Electrical Code.
- Wiring of finished buildings, Underwriters' and municipal requirements. How to do the complete job, from estimating it to completion.
- Illumination in its every phase. The latest and most improved methods of lighting. Lamps and lighting effects.
- A complete course in mathematics as applied to work. A course which refreshes your mind, and gives you mastery of all the short-cuts in figuring.
- Electrical practice complete. Electrical practice as experts know it. Electrical practice by experts.

Send no money now—merely the coupon



Price \$27.50 after Feb. 15, 1921.

McGraw-Hill Book Co., Inc.,  
370 7th Ave., New York.

Gentlemen—Please send me the Library of Practical Electricity (shipping charges prepaid) for 10 days' free examination. If satisfactory I will send \$2 in ten days and \$3 per month until \$20 has been paid. If not wanted, I will write you for return shipping instructions.

Name .....

Home Address .....

City and State .....

Where Employed .....

Occupation ..... R. N. 2-21

# Let Corwin Service Serve You

LETTERS continue to pour in from hundreds more amateurs, thanking us for the promptness and carefulness with which their orders were filled. If

you want shipments the day your order is received, and apparatus that arrives in perfect condition, send your next order to Corwin. See if you need anything in this list.

## Universal Coil-Mounting Plugs

Anyone can easily make smooth-running mountings with these plugs. Exceedingly accurate! Made to fit Radisco and all hand wound coils.

Price, 80 cents, postpaid

### VARIABLE CONDENSERS

|                              |        |
|------------------------------|--------|
| A. R. Co., .001.....         | \$6.25 |
| A. R. Co., .0005.....        | 5.00   |
| With No. 67 Dial add \$1.00. |        |
| Murdock 366.....             | 4.75   |
| Murdock 367.....             | 4.75   |
| Murdock 368.....             | 3.75   |
| Clapp-Eastham 800.....       | 7.50   |
| Clapp-Eastham 800A.....      | 9.50   |
| Clapp-Eastham 800B.....      | 11.50  |

Complete with dial.  
Shipping weight One Pound

### GRID CONDENSERS

|                               |     |
|-------------------------------|-----|
| Radisco, Postage 3 cents..... | .35 |
|-------------------------------|-----|

### ANTENNA SWITCHES

|                            |       |
|----------------------------|-------|
| Murdock, 3 lbs.....        | 4.50  |
| Clapp-Eastham, 10 lbs..... | 12.50 |

### OSCILLATION TRANSFORMERS

|                    |       |
|--------------------|-------|
| Radisco No. 5..... | 15.00 |
|--------------------|-------|

Via Express collect only.

### RADIO CRAFT PRODUCTS

|                          |       |
|--------------------------|-------|
| Detector.....            | 15.00 |
| Two Step Amplifier.....  | 50.00 |
| Detector and 1 step..... | 45.00 |
| Detector and 2 step..... | 70.00 |

Postage paid.

### "B" BATTERIES

|                           |      |
|---------------------------|------|
| Radisco No. 1, 2 lbs..... | 1.50 |
| Radisco No. 5, 5 lbs..... | 2.65 |

Eveready Storage battery prices on application.

### TUSKA C. W. APPARATUS

|                       |       |
|-----------------------|-------|
| 181 Coil, 2 lbs.....  | 7.50  |
| 182 Coil, 2 lbs.....  | 10.00 |
| 183 Coil, 3 lbs.....  | 12.50 |
| 170 Filt., 8 lbs..... | 16.00 |

### AERIAL WIRE

|                      |      |
|----------------------|------|
| 7 x 22 tinned copper |      |
| 100 feet, 2 lbs..... | 1.25 |
| 200 feet, 4 lbs..... | 2.40 |
| 500 feet, 8 lbs..... | 6.00 |

### AMPLIFYING TRANSFORMERS

|                      |      |
|----------------------|------|
| A. R. Co., 1 lb..... | 5.00 |
| Federal, 1 lb.....   | 7.50 |

### JACKS AND PLUGS

|                             |      |
|-----------------------------|------|
| Federal Closed Circuit..... | .85  |
| Federal Open Circuit.....   | .70  |
| Federal Double Circuit..... | 1.00 |
| Federal Plug.....           | 2.00 |

Postpaid.

### ALL RADISCO COILS and Wireless Press Books.

### ROTARY SWITCHES

|                             |      |
|-----------------------------|------|
| Clapp-Eastham, No. 19.....  | 1.00 |
| Clapp-Eastham, No. 19A..... | .35  |
| Our Own, No. 1.....         | .40  |
| Our Own, No. 2.....         | .55  |

Postage..... .05

### CORWIN DIALS

|                               |      |
|-------------------------------|------|
| No. 66, 3".....               | .75  |
| No. 67, 3" with knob.....     | 1.30 |
| No. 68, 3 3/4".....           | 1.00 |
| No. 69, 3 3/4" with knob..... | 1.70 |

Postpaid.

### RECEIVERS

|                                |       |
|--------------------------------|-------|
| Murdock No. 55, 2000 ohm.....  | 4.50  |
| Murdock, No. 55, 3000 ohm..... | 5.50  |
| Brandes Superior.....          | 7.00  |
| Baldwin C.....                 | 16.50 |
| Baldwin E, improved.....       | 20.00 |
| Brownlie, New.....             | 12.50 |

Shipping weight 2 Pounds

### CONTACT POINTS

|                                 |     |
|---------------------------------|-----|
| CP-No. 1 Brass, dozen.....      | .25 |
| CP-4 Brass, dozen.....          | .35 |
| CP-5, Nickel Plated, dozen..... | .45 |

Postpaid.

### VARIOMETERS

|                     |      |
|---------------------|------|
| Radisco No. 1.....  | 7.00 |
| Radisco No. 1D..... | 8.50 |

3 pounds.

### VARIO-COUPLER

|                     |      |
|---------------------|------|
| Radisco No. 2.....  | 8.50 |
| Radisco No. 2D..... | 9.50 |

3 pounds.

All orders for apparatus not listed as postpaid must be accompanied by postage charges.

## A. H. CORWIN & COMPANY

Dept. B2                      4 West Park Street,                      Newark, N. J.

# HOT WIRE AMMETER

Special Flush Mounting \$ **8**

Hot wire ammeter Roller Smith with scale 0-1, 0-2 1/2, 0-5.

Sent postpaid for \$8, while they last.

PHILADELPHIA SCHOOL OF WIRELESS TELEGRAPHY  
PARKWAY BLDG. BROAD AND CHERRY STREETS

## MONEY for You

Add to your Salary—Make extra Pin Money. Spend an hour each day taking subscriptions for the "Radio News." We'll pay you well and you'll enjoy the work. Write for full particulars. Circulation Dept., RADIO NEWS, 236A Fulton St., New York City.

A 500-cycle dynamic test of the tubes used gave amplification factors ranging from five to twelve, that of the soft tubes being about ten.

## Fading of Signals

(Continued from page 529)

Once having got under way, after the elapse of two days, all stations transmitted their test schedules regularly. The average distance of communication was 400 miles. No station used an input in excess of one kilowatt and the communication was at 250 meters where static is most pronounced. An average of 26 recorders were faithful in the performance of duty each night, with 20 observers being the minimum on any occasion. Half of the schedules listened for were copied in the form of 1,260 curves of sufficient merit for tabulation in the final count. The test schedule consisted of the alphabet, each letter sent five times at a speed equal to 18 words a minute, allowing three minutes for communicating the entire alphabet. As each letter was received the operator noted on a chart the intensity at which it was heard, so that when the schedule was complete a curve had been secured showing the swinging during the three-minute period. Mr. Kruse admits that the intensity scale employed was not all that was to be desired. The method used was: Buzzer transmission of the actual schedule was sent thru the primary of an ordinary coupler to the secondary of

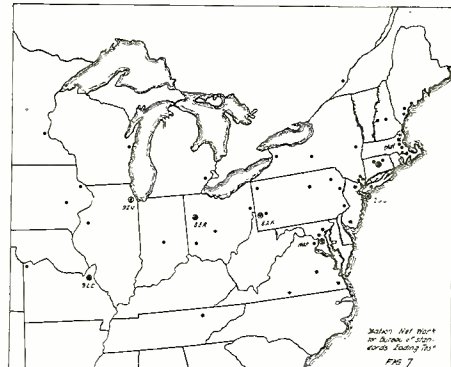

Map Showing the Location of the Stations Which Were Used for the Test of the Bureau of Standards on the Fading of Signals.

which two headsets were connected in series. The operators independently recorded the intensity of the signals which was varied during transmission by altering the coupling. The curves were alike with reservation for difference of judgment as to the average strength of the signals. The Bureau of Standards describes an actual test as follows: At 10 p. m., eastern standard time, all the sending stations listened for time from Arlington. At 10:10 the first station at Hartford, Conn., made a long QST call, saying repeatedly, "Bureau of Standards—A.R.R.L. Fading Test." Both the call and notice were repeated, then the stations started to send the test schedule, repeating each letter five times. Tests were made three evenings of each week, each recorder on duty filling out one curve sheet for each sender he could hear. L. C. Young, of the Radio Laboratory of the Naval Air Station, suggested the method of using dots for each letter and drawing in the curve at a subsequent time. In practice, attention is thus riveted on each letter and the inclination for the pencil to drift is forestalled. Weather conditions are revealed by the charts when checking the proper words at the lower left corner of the sheet. The first impression that atmospheric conditions could be recorded by use of symbols was discarded as impractical, inasmuch as the recorder was unable to note signal and static strength at the same

# WANTED — FOR CASH

## Used Radio Apparatus of all Standard Makes

Our used wireless apparatus department, connected with our local retail store at 233 Fulton Street, New York City, is anxious to buy any radio instruments you may have for sale. These goods are for our New York customers only—we **sell no used radio apparatus by mail.** But we do have a tremendous call at our store for fine class goods and we will be glad to hear from you if you have any that you would like to dispose of.

## WE PAY CASH

for all such merchandise that we buy, and this is an invitation extended to the radio fraternity to sell us their radio apparatus for which they have no further use. Write us in your first letter what make apparatus you have to sell, and **your lowest spot cash price.** It must be understood that all transportation is to be paid for by you. All goods to be sent to us prepaid either by parcelpost, express, or freight.

We can use only standard apparatus, no obscure instruments or home-made apparatus can be considered in any event.

If you have friends who wish to dispose of such apparatus, show them this advertisement. Also please note that your letter must state in just what condition the instruments are and that no goods must be sent to us unless we send you a written order to do so.

We invite amateurs residing in New York or vicinity to call at our store and inspect the used radio apparatus which will be placed on sale shortly after this advertisement appears.

Address all letters

**to Used Apparatus Department**

**ELECTRO IMPORTING COMPANY**

(Established 1904)

**231 Fulton Street**

**New York City**

# SOMETHING NEW— 200 M. Resonance Coil

## The Wonder Tuner



Built on the principle of the recent discovery of the U. S. SIGNAL CORPS—Resonance coils. Primary wound with pure copper strip 1/4 inch wide—thoroly insulated and with a split-phase coil inside and outside diameter. No way to connect it wrong. No way to hurt it—foolproof. Coil waxed in heavy box with Formica top and our standard binding posts. Nothing like it anywhere. This tuner will revolutionize the building of tuners. No tuning is done with tuner—merely turn the condenser in series with ground wire. It functions only with an audion and will not work satisfactorily with mineral detector. Wiring diagram furnished with each tuner. Put one in your panel. One of our ELLIPTIC VARIOMETERS in series with the grid wire amplifies sigs about 50 times, another in the plate circuit gives you about 100 amplifications. Build your own Paragon with it. It weighs but 2 pounds and is really the wonder tuner.

It takes the place of any single, double or triple-slide tuner or coupler made. It is more efficient, being inductively coupled. Just the thing for Wireless phone work. To tune above 300 meters take condenser out of ground lead and shunt it across aerial and ground. Just the thing for the beginner—or advanced amateur to listen in with as you will hear more signals than with any tuner you have ever used. Special introductory price \$6.00. Add parcel post.



## Special Tuners

- 5000 M to 20000 M—\$10.00—add P. P.—Type B. S.
- 700 M to 5000 M— 10.00—add P. P.—Type A. S.
- 300 M to 700 M— 10.00—add P. P.—Type C. S.

These tuners need no advertising as they are used all over the world.

## Knocked-Down Condensers

Assemble them and save money.

- 11 Plate.....\$1.80
- 21 Plate..... 2.25
- 41 Plate..... 3.20 Add P. P.

If you want us to assemble them for you add \$1.00, plus P. P., to above prices. Shipping weight 2 lbs.

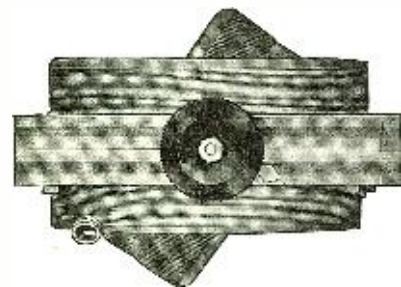

## Elliptic Variometers

Use them in your set or with our tuner  
\$5.00, add P. P. Weight 3 lbs.

10c brings a wonderful  
catalog of 16  
pages.

# TRESCO, Davenport, Iowa

## Why You Should Demand RTS Grid Condensers

The RTS Grid Condenser is the best Grid Condenser obtainable. It is as far above others in quality, workmanship, and design, as the Aeroplane, compared to a Horse for speed.

WHY?—Because we have designed and constructed different types until we produced the only reliable Grid Condenser. It is constructed with lead and copper foil, completely mounted on heavy insulating material.

DON'T FAIL— to look for the sign RTS when buying your Grid Condensers. If your dealer has not already stocked RTS Grid Condensers, order direct from us.

SAY—Have you ever tried an RTS Grid Condenser? Try one and note the results.

YOUR ORDER for one of our condensers will bring our SPECIAL MONTHLY LETTERS, and circulars.

- RTS—.0005 M. F. GRID CONDENSERS—ea. 30c., postage 3c.
- RTS—.0013 M. F. FIXED CONDENSERS—ea. 40c., postage 3c.

WE GUARANTEE

Each RTS Grid Condenser to prove satisfactory, and to do better work than any types now on the market. We guarantee this condenser to give 5 years' service under ordinary use, and will gladly replace or refund your money if you are not satisfied.

RADIO TESTING STATION, - Binghamton, N. Y.

WHETHER YOU ARE IN THE MARKET TO BUY OR SELL, THE CLASSIFIED COLUMNS OF RADIO NEWS WILL GET RESULTS FOR YOU. TRY THEM.

time. Swinging of the radio signals was frequently more rapid than at first anticipated, and the idea of using a check mark for each group of letters proved inadequate.

After the first week of the operations—the curves of the initial seven days being meaningless—results of the tests began to unfold. Anomalies peculiar to various sections of the United States developed. Notably, the fading of signals in New England was violent and rapid. The severity of the swinging lessened as one went south or southwest and in Pennsylvania, Ohio, Indiana, Illinois and Michigan the fading was not nearly so pronounced. According to types the Bureau of Standards outlines three classifications of swing: A very rapid and abrupt fading which seems as if the sender were skipping one or two letters. Another kind of swing is where moderation obtains and a more gradual type which gives curved lines almost entirely, the period being from ten seconds to five minutes. This manner of swinging is common. Still another classification is that of a very gradual drift of all stations in one direction from the recorder, a cycle consuming from five minutes to a number of hours. The first-mentioned type of swing is interpreted as a one-station phenomenon. The second kind of fading is most exasperating, one unit swings in while another is going out. The station being copied is blanketed before it goes out of audibility. In the third type of swinging, all sending stations not far removed from each other fade slowly together. Where the fading is extremely slow it was observed that in the early portion of the evening stations in one direction will be heard more clearly while units in another direction are inaudible. The latter condition is characteristic of the Mississippi Valley.

Fading of radio signals is not restricted to land, as indicated by a test over water. Curves were obtained at Fort Pierce, Fla., on board the U. S. S. Ohio, then 150 miles east of Cape May, N. J. Then, too, there are traveling curves; that is, one which appears successively at different recording stations. The same "dip" in the curve which appeared in New York City reached Buffalo, N. Y., Norfolk, Va., Woodhaven, L. I., and Clifton, N. J. Such an anomaly occurred at different times and where there was a well-defined direction of travel of the curve it was away from the sending station.

Here is the theory evolved by the Bureau of Standards as to the cause of swinging or fading signals: The variations are caused by varying reflections and refraction of the waves. A cloud, fog bank, or a mass of fumes from an industrial plant may operate in the capacity of interference bands. To illustrate, the tests revealed rapid and erratic swinging of the Pittsburgh station. The assumption is that fumes from smelters or steel plants may congregate in such masses as to act as reflectors. However, stations at Salem, Ohio, and at Wheeling, West Virginia, located in a district not altogether dissimilar from that of Pittsburgh, did not duplicate these rapid fading signals. The Pittsburgh station swinging is not attributable to the sending apparatus, as one recorder may note from 15 to 28 swings from the Smoky City, others will hear three or four. The conclusion of Mr. Kruse is: "Reflecting need not necessarily be involved in the production of interference bands. Refraction will answer just as well to change the direction of the waves if we can find a mass of vapor whose dielectric constant differs from that of the normal atmosphere thru which the waves are traveling. Neither the reflecting nor the refracting body need be at high altitudes. They may be at the elevation of the sending and recording sta-

tions and to one side of the line joining them."

It is repeated that fading is a long distance phenomenon. Persistent efforts to secure fading between Bristol and Hartford, Conn., only 12 miles apart, were futile. The intensity remained uniform and the signal did not evidence the slightest trace of weakening. Like observations were noted in the transmission of messages from New York to Woodhaven, L. I., and from Washington to Anacostia. It is not to be assumed that fading is subject to fixed distances. Transmission conditions may influence short distances as illustrated in wireless communications between Baltimore and Washington, only 40 miles apart. Violent signals render difficult radio operations between these two cities on wave-lengths below 500 meters. Similarly, successful communication is not obtainable between Lawrence, Kan., and St. Louis, Mo., 120 miles distant. The opinion is expressed that fading does not occur in general within the daylight range of a station, the Washington-Baltimore example being an exception to the rule.

The massed opinion of the recorders, whose voluntary services made the radio swinging tests a success, is that fading is not a variation in signal strength but a shift of wave-lengths. They explained that a station which had swung out could be recovered by retuning the receiving set. A request was issued to desist from this practice inasmuch as it would be impossible to tell whether the variations in receiving signal strength were due to a change in incoming power or attributable to mistuning. A laboratory check of this practice gave positive evidence that two observers could not get results even approaching similarity if the receiving apparatus was retuned during the test. Therefore, tuning was finished before the tests were undertaken.

By way of summary, the story of the tests of short wave radio signal fading is: Tests were conducted three nights each week during June and July, six sending stations operating at 250 meters' wave-length. Observations of the intensity of the signals were duly noted by 50 recording stations. For 21 evenings an average of 28 recorders listened for the test schedules, obtaining for examination 1,260 curves of signal intensity variation. Traveling curves were positively identified; while no intimate relations between weather conditions and transmission were established. Three types of fading were unfolded, with abrupt fading being characteristic of New England. Sending sets do not lend themselves to any particular manner of fading although a damp wave that has faded out can frequently be recovered by retuning. Finally, there is a preponderance of evidence that radio signal variations such as fading and swinging are caused by varying reflection and refraction of waves.

### Using an Amplifier as a Detector of Long Waves

(Continued from page 528)

when using honeycombs and three bulbs. I copied their "communique" and their press to 9ZN without missing a letter. I could also tune in another station or two with this hook-up.

The explanation of this phenomenon is not hard to find. The open circuit consisted of the aerial, the primary of the first amplifying transformer, and the ground. The first amplifying tube became a detector, and the second tube acted both as amplifier and as heterodyne oscillator. Or, rather, the local oscillations were produced by an interaction between the two amplifying circuits. At any rate I could hear

The new Turney Circuit, used exclusively on Turney Units, produces as much amplification with a one-step amplifier as has formerly been secured with a three-step! Our new booklet explains it.

Actual Size

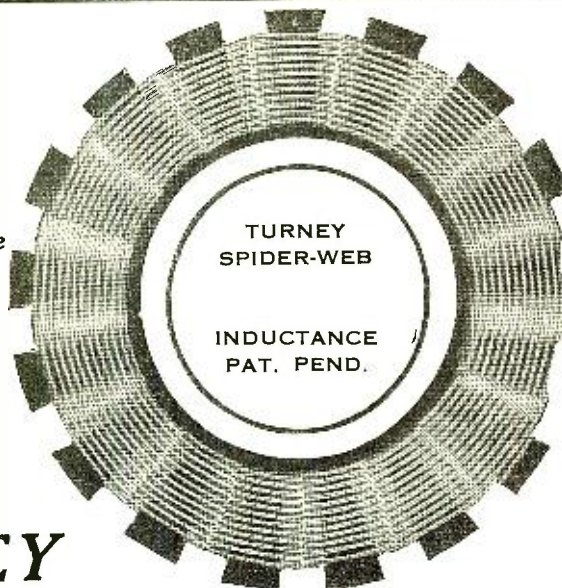

# TURNEY SPIDER-WEB INDUCTANCE COILS

## Built at Radio Hill—

UP AT the foot of the Berkshires, amid inspiring surroundings, nestles Radio Hill. This ideal radio location is the scene of the development of the Turney Spider-web Inductance Coils. Here, far from any outside influence, Eugene T. Turney, *Radio Engineer*, the man who developed the Crystal Detector, has brought forth a sensational improvement in machine wound coils.

Below is shown the Turney complete receiving unit. It contains three Spider-Web Coils, the secondary and tickler being adjustable to the primary. The doors are capable of exceedingly fine adjustment. Six Binding posts allow for almost any type of circuit. With two condensers, of .0005 m.f., this unit will respond to wave-lengths of 175 to 400 meters. The results will give you a new idea of radio efficiency.

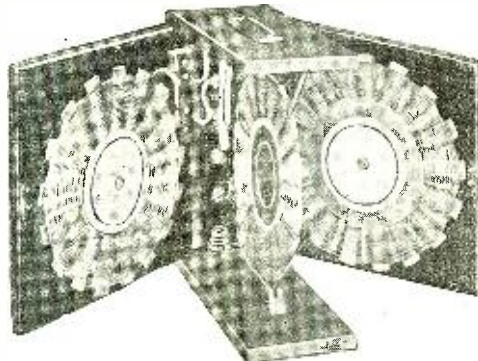

Illustration shows front of cabinet removed  
Formica Insulation Thru'out Patent Pending  
Dimensions, 4 1/4 x 5 x 1 3/4

**PRICE SIX DOLLARS COMPLETE**

Order direct from this advertisement. Send check or money order for \$6.00 plus postage, and your Spider Web Unit will come forward at once. OR write us for circular, explaining the Spider Web principle in detail.

Progressive dealers are invited to write for our interesting sales offer on Turney Complete Receiving Units.



### THE WINDING

showing angle at crossing. This style of winding has four distinct and exclusive advantages.

- MORE INDUCTANCE—** There is no magnetic leakage in coupling. The coils are flat, and the entire magnetic area is available.
- LESS DISTRIBUTED CAPACITY.** The wire runs parallel for a greater distance, and crosses itself less frequently than in any other coil known.
- LOWER HIGH FREQUENCY RESISTANCE.** There being no interior magnetic field, or air core, high frequency resistance is reduced to a minimum.
- OCCUPIES LESS SPACE.** The coils are so thin that three of them are less than 3/4 inch in width.
- MORE AMPLIFICATION.** Repeater action, caused by tickler flux passing thru Primary to excite Secondary.

# Eugene T. Turney Laboratories, Inc.

RADIO HILL, HOLMES, NEW YORK

# THE "SUPER" BENWOOD

## Rotary Quenched Spark Gap

EFFICIENT AND PRACTICAL

SILENT IN OPERATION

A Real DX Gap

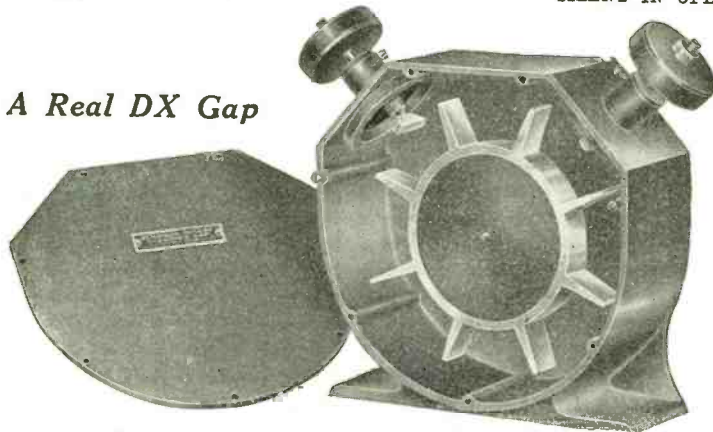

A SOLID ONE PIECE BAKELITE CASTING  
HIGHLY POLISHED

Something entirely original in spark gap design,  
at a price that you can afford to pay.

Stronger and lighter than aluminum. No metal being used in casting thus eliminating any and all electrical losses. Scientifically correct in every detail. Impossible for insulation to ever break down. Guaranteed for life.

Disc weighs only 1/2 pound, yet it has the same sparking surface as the larger BENWOOD discs that are so well known thruout the country. Dimensions are, 6 inches in diameter, 3/4 inch in width and the teeth or sparking surface are tapered down to less than 1/8 inch in thickness. This gives the "quick break" that is theoretically proper and so highly desirable. Smallest fractional H/P/ motor will drive the gap with ease. Furnished complete with flexible coupling all ready to connect to any motor, regardless of size. Furnished with 4, 8, 12 and 16 point rotors, merely specify type desired.

Price as shown, \$25.00

THE BENWOOD COMPANY, Inc.

13th and Olive Streets

ST. LOUIS, MO.

nothing using one stage alone. The condenser in Fig. 3 increased the feedback, and by the way, a condenser connected in this way between the plate of the last amplifier and the aerial will often increase the audibility of signals in other circuits, such as that of Fig. 1.

The most surprising thing about the experiment is that coils with iron cores are used in the radio-frequency circuits. This proves that waves 15,000 meters or more in length have a low frequency, that iron cores do not materially decrease the efficiency, and in fact that they may increase it with waves as long as that of LY (23,500 meters).

I would be glad if others would try this, and see what they can find. It may be that a better built amplifier would not have the necessary interaction between the circuits, and that other makes of transformers would act differently. Those used in the set at Miami are Federals.

## A New Thermionic Vacuum Tube

(Continued from page 528)

ted from F. A millimetre in the G circuit corroborates this assumption. This effect is far more markt than in the case of an ordinary valve, since the plate is more suitable for the absorption of electrons. The G current, however, does not build up immediately, but only becomes important when the G potential is higher than about +2 volts. We consequently see why the anode current curves of Fig. 2 only commence to lean over to the right when the control potential passes +2 volts. To the right of the zero ordinate, the curves, it will be noticed, become less regular. When the control potentials reach higher values than those shown, the anode currents reach a saturation value, and then begin to de-

## REDUCED PRICES

We are pleased to announce that we have made substantial reductions in the price of RADIO SERVICE PRODUCTS, to meet the general demand for readjustment in prices of dependable radio apparatus.

In buying now you get the full benefit of lower prices. Some of our revised prices are given below:

- Type S-11—Audion Control Panel.....\$6.00  
(as illustrated)
- Genuine Bakelite Panel, Navy cage type rheostat and socket.
- Type S-14—Navy Cage Type Rheostat..... 2.00
- Type S-27—Insulate Knob Binding Post....6 for .60
- Type S-23—1 1/8" Bakelite Knob, tapped 8/32"..... .15
- Type S-17—Nickel Plated Crystal Cup..... .25

Have you received our new circular?

### SPECIAL—SPECIAL

#### FOR YOUR NEW RADIOTRON—A VARIABLE GRID LEAK

of the proper resistance is indispensable for operating efficiency with any vacuum tube detector. Our radio engineer has designed a variable grid leak which will help you get increased signal audibility. Every radio man will want at least one of these leaks. Order today to insure prompt delivery. Does the work of six ordinary grid leaks at less than the usual price of one.

- TYPE S-40 VARIABLE GRID LEAK..... 75c  
(From .5 to 3 Megohms)

#### REVISED PRICES ON VT SOCKETS

- Type S-24—Aluminum Socket only..... \$ .50
- Type S-10—Single Tube..... 1.10
- Type S-3—Double Tube..... 2.50
- Type S-4—Triple Tube..... 3.50

All leading dealers or by mail from  
RADIO SERVICE & MFG. CO.  
Lynbrook, L. I. New York

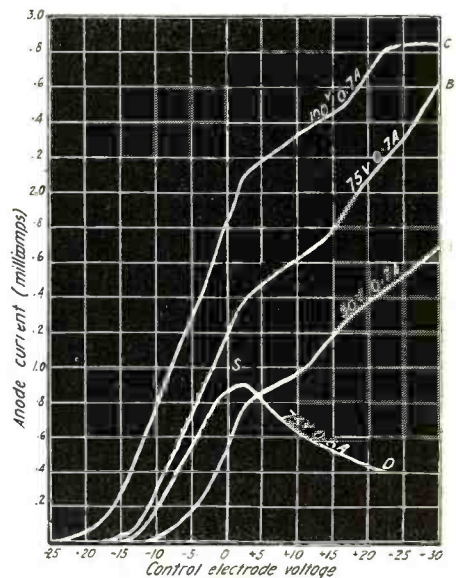
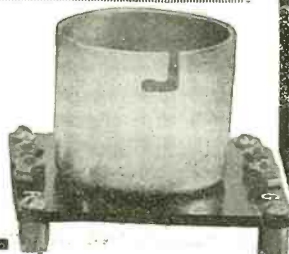

Characteristic Curves Obtained With the New Type of Vacuum Tube Having 2 Plates Acting as the Grid and Plate of a Normal Type V.T.

crease. This effect is shown in Fig. 2 by the D curve obtained by applying 75 volts to the anode and lessening the filament current from 0.7 amp. to 0.6 amp. The maximum anode current is reached at S. As the control electrode is given higher positive potentials, the anode current falls. Electrons which formerly went to the anode are now being drawn to the control electrode. It will be seen from the curves that an increase of anode potential displaces the anode current curve bodily to the left. In several other ways, the curves obey laws similar to those governing the characteris-



tics of valves having grids placed between filament and anode.

It might at first be thought that the result of placing the control electrode behind the filament would be that an increase of control potential would partially neutralize the attraction of the anode, and so cause a decrease of anode current. This is what happens in the case of a valve described by Mr. J. Erskine-Murray, but the very opposite occurs in the writer's type of valve, which operates in the normal way. We may explain the action of the valve as follows: The filament  $F$  working at, say, 0.7 amp., is emitting a certain number of electrons per second. The anode  $A$  is capable of drawing to itself a certain proportion of these electrons. The remainder would be wasted, and would float around the filament and the inside of the bulb, especially behind the filament. These spare electrons would constitute a negative space-charge around the filament, and would tend to lessen the number of electrons passing to the anode. The effect now of applying a negative voltage to the control electrode  $G$  would be to repel many of the free electrons back into the neighborhood of the filament, and so concentrate the space-charge; this in turn would lessen the anode current. When the control electrode is positive it will attract to itself most of the electrons constituting the space-charge, and so cause an increase in the anode current. It is also certain that the electrostatic field of the control electrode extends itself on the other side of the filament, and this helps to explain the action of the valve.

A special condition is shown in the  $D$  curve. The anode current is now saturated, and practically all the electrons emitted from the filament are being drawn to the anode. By placing a positive potential on the control electrode an opposing attraction will be exerted on electrons actually on their way, or intending to proceed, to the anode. These electrons will be deflected to the control electrode, and the anode current will suffer in consequence. The anode current curve, therefore falls, and it is to be noted that in this valve the anode current only decreases with an increase of control potential, when the latter potential is positive, and when the sum of the anode and control electrode currents is equal to the total emission from the filament. The same effect is obtainable with an ordinary valve, but the comparatively sharp bend at  $S$  is far more marked in the case of the writer's valve. This is easily explained by the fact that  $G$  is a large metal plate, far more capable of absorbing a large electron current than a very fine wire open helix.

Judging from the curves given, the amplification obtainable with this valve is not as high as in the case of the more usual pattern, altho the actual results in a three-valve amplifier were almost as good. The representative point should preferably move only along the left-hand portion of the curve. The valve operates well as a detector, the point  $S$  being especially suitable for strong signals, both half oscillations producing a decrease of anode current. The vacuum tube also operates excellently as an oscillator and self-heterodyne receiver with 100 volts on the anode and 6 volts across the filament. No doubt, the characteristics and general properties of the valve could be greatly improved by further research on the sizes and relative positions of the electrodes.—*Abstracted Electrical Review.*

#### HE OUGHT TO BREAK ALL "RECORDS"

Spark: I wonder why gXYZ has such a musical note.

Lark: Why, he's using a phonograph record for his rotary disc.

WILLIAM SOEURT.

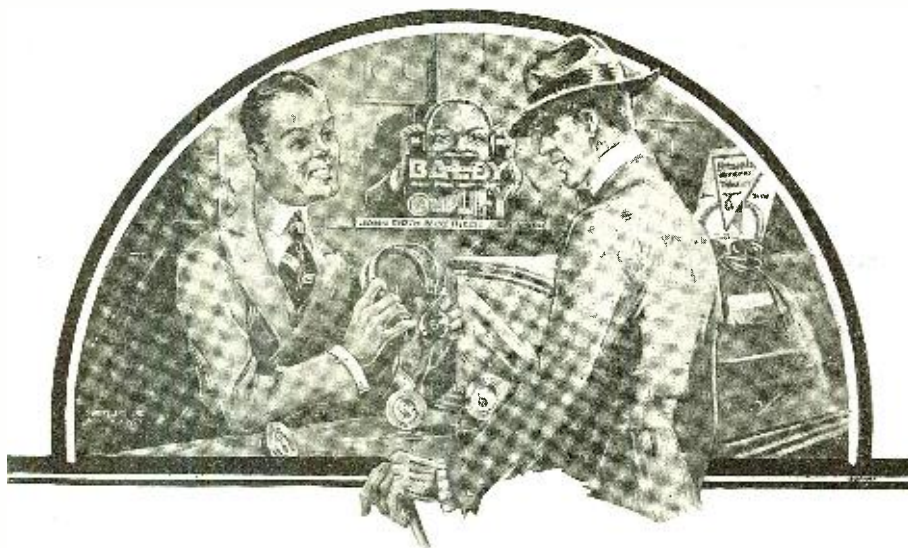

## Your Dealer's Salesman Will Show You— "BALDY" Phones

Ask him to open up one unit.

You'll see the equivalent of a phonograph reproducer in conjunction with the famous Baldwin balanced armature movement.

You'll see why it costs more to build one "Baldy" unit than a complete headset of ordinary design.

You'll see why a pair of Baldwins often equal one and two stages of amplification—why you cannot afford to be without them.

Type C, \$16.50 (1-unit, \$8.50); Improved Type E, \$20.00 (1-unit, \$10.00); Type F, \$21.00.

Baldwin headbands fit most types of phones, \$1.75.

Described fully in booklet R1.

### Eldredge Meters

They are actually *hand-calibrated* to absolute accuracy—yet, are low priced.

All ranges in flush type finished in highly polished nickel. They match one another and are the neatest and most accurate miniature meters made.

Hot wire type 0-600 M. A., 0-1, 0.3, 0-5 amps., \$7.00.

D. C. and A. C. meters in many ranges as shown in booklet R3.

### Brownlie Adjustable Phones

If you can't afford a pair of Baldwins this season, we recommend Brownlies.

Ask the salesman to remove one ear cap.

You'll see, among other things, the 8 supporting springs, the 1000 ohm solenoid under the exact *center* of the diaphragm.

One professional operator says about his Brownlies:

"I find it possible to cut out interfering stations by making a slight adjustment. I was anchored at Paagamene, Caledonia, and copied Balboa time sigs—approximately 7000 miles—on one audion."

"Letter on file."

Brownlies are sensitive, light in weight and rugged.

Price complete with Baldwin Headband, \$12.50. Loud speaker unit with cord, \$6.00.

Described fully in booklet R2.

If your dealer cannot supply you, write direct, giving his name and address. We will gladly supply you with literature and tell you where you can see the entire line.

**JOHN FIRTH & CO., Inc.**  
18 Broadway - - - New York

*Sole distributors of*

Eldredge Measuring Instruments.

Kolster Decremeter.

U. S. Bureau of Standards Wavemeter.

Navy Standard Leyden Jars.

Brownlie Adjustable Telephones.

# Firth <sup>wireless</sup> Products

## REYNRAD SPECIALTIES

*The Best in Their Line.*

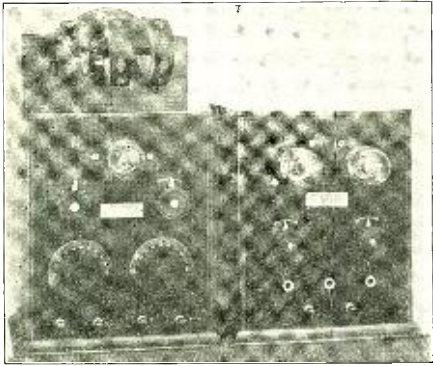

**RR-74**

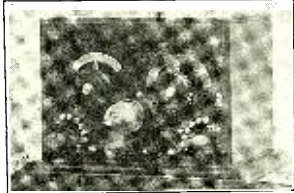

**RA-72**

The Reynrad RR-74 Multiwave Tuner and Audion Detector, used in conjunction with our RA-72 Two Step Amplifier makes an exceptionally sensitive and efficient receiving equipment. The RCR-30 Crystal Detector receiving set is the ideal equipment for those who do not wish to purchase the more expensive outfit.

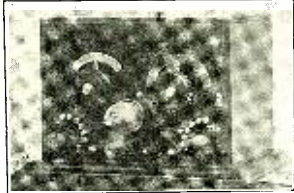

**RCR-30**

|  |         |
|--|---------|
| The RR-74 Receiver, \$55.00; with Audion Bulb..... | \$60.00 |
| The RA-72 Two Step Amplifier, with bulbs.....      | 55.00   |
| The RCR-30 Crystal Detector Set.....               | 25.00   |
| With 3,000 ohm phones.....                         | 30.00   |

### REYNRAD SHORT WAVE COILS

Wound on 4-inch Bakelite tubing with standard De Forest Plugs to fit your DeForest Coil Mountings. A set of three will bring in amateur stations and an additional secondary coil will make your receiving outfit equally efficient up to 600 meters. State wave length desired, 150-300 or 300-600. Short Wave Coils \$2.00 each.

We carry in stock a large supply of standard apparatus such as phones, condensers, rheostats, bulbs, sockets, amplifying transformers, etc. Complete stock of DeForest Coils. 6 cents in stamps brings our catalog and places you on our mailing list.

### REYNOLDS RADIO SPECIALTY COMPANY

729 South Prospect Street - - Colorado Springs, Colorado

ACE
ACE

## C. W. EQUIPMENT

**788 miles on nine-tenths of an ampere!**

In test of our C. W. Transmitter, signals were copied at this distance. (Details on request.)

Complete transmitter mounted on grained formica panel 10 x 14 x 3/8, including motor generator, 4 A-P transmitting tubes, filter device, filament heating transformer, microphone, antenna current ammeter, plate current milliammeter and all necessary controls, etc., \$395.00 f. o. b. Cincinnati. Complete transmitter less motor-generator, \$285.00.

Equipment so designed that either voice, buzzer modulated C. W. or straight C. W. transmission may be used by throwing single switch on panel. Construction of apparatus and material employed is of usual "ACE" quality.

"You may pay more, but you can't buy better."

## THE PRECISION EQUIPMENT CO.

2437 Gilbert Avenue  
Cincinnati Dept. A Oh'o



Send 25c for a Copy of Our Manual of  
**Wireless Telegraphy M 12**

We now have ready for distribution our Manual of Wireless Telegraphy. It contains 200 pages, fully illustrating and describing the many instruments used in Radio. 45 pages cover general instructions, diagrams, station calls, tables, codes and other information identified with the art.

The book is printed on high finished paper with a two-color cover and measures 9x5 3/4 inches.

Due to the scarcity of paper, the high cost of publication, and in order that the Manual may get into the hands of those most interested in Wireless, we ask 25 cents for it, give a coupon receipt for the amount, which coupon can be applied on a future purchase.

Get Your Copy Before the Edition Is Exhausted

### MANHATTAN ELECTRICAL SUPPLY CO. INC.

|                           |                             |                            |                                  |
|---------------------------|-----------------------------|----------------------------|----------------------------------|
| 17 Park Place<br>New York | 114 S. Wells St.<br>Chicago | 1106 Pine St.<br>St. Louis | 604 Mission St.<br>San Francisco |
|---------------------------|-----------------------------|----------------------------|----------------------------------|

## Who's Who in Radio

(Continued from page 530)

is the "grid" member, interposed across the path of the traveling ions ("wanderers," as their Greek name implies.) Dr. De Forest chose to deal then with "ions," gas atoms or sub-atoms—matter in its most tenuous form, what Prof. Crookes well styled the "fourth state of matter." Try to imagine one of these ionic carriers of the voice, or electric charges and contrast it with a carbon granule of a microfone transmitter of the early "telephonic relays." Compare a soap bubble with a load of coal, and you will have some relative idea of the difference between the delicacy and elegance of the Audion and that of the old microfone relay.

Transoceanic telephony by submarine cable, with numerous Pupin coils and the Audion Amplifier, is theoretically possible; commercially, an utter impossibility. The cost of such a cable would be prohibitive. But transoceanic wireless telephony is within reach. The De Forest Audion and Amplifier, extending, as they have, the range of wireless and making loud those signals which otherwise are inaudible, makes this result possible.

DE FOREST'S WORK REWARDED.

Dr. De Forest's work in wireless telegraphy was recognized by the St. Louis Exposition Jury of Awards in 1904 by the bestowal of a gold medal for his research work and discoveries along that line. He was also awarded a gold medal by the Panama Pacific International Exposition held at San Francisco in 1915 for the part his Audion Amplifier played in the transcontinental telephone service opening that year, as well as for the Oscillation and Audion Detector, which made possible the transoceanic radio telephone communication from Arlington to Honolulu and Paris in November, 1915. He is a member of the Yale Club, the American Institute of Electrical Engineers, the Institute of Radio Engineers, Franklin Institute of Philadelphia, and the Radio League of America. He is president of the De Forest Radio Telephone and Telegraph Company. He resides at 232nd Street and the Hudson River, and his laboratory is located at 1391 Sedgwick Avenue, in the factory of his company.

## Club Gossip

(Continued from page 531)

club rooms, 2211 Bedford Ave., on Saturday, February 5. Tickets can be purchased from J. Phillips, 312 Flatbush Ave., Brooklyn, or from any of the club members.

RADIO CLUB OF SAVANNAH

The reorganization of the Radio Club of Savannah, Ga., took place October 13, 1920, and the following officers were elected: President, T. W. Hughes; vice-president, B. Rockwell; secretary, A. R. Foy; treasurer, F. E. Johnston; sergeant-at-arms, R. R. Brewin.

The purposes of the club are to avoid interference with government stations; keep amateur transmitting stations on a wave-length of 200 meters or less; get the radio amateurs in and around Savannah into closer fellowship with each other so that they may study radio telegraphy and telephony to a greater advantage. The club will be glad to communicate with anybody interested in radio work in this section of the country. Address Albert R. Foy, Secretary, 5 40th St., East Savannah.

BAY COUNTIES' RADIO CLUB

The Bay Counties' Radio Club of Oakland, Cal., was organized in the spring of 1920 and now claims to have the largest membership of any radio club of its kind, boasting of over 200 active members and new members coming in strong every meeting night.

The purpose of the club is to organize the amateurs of the city and thereby control the QRM question. This has been successful to a marked degree.

# Newest Ideas in De Forest Unit System Receiving Apparatus

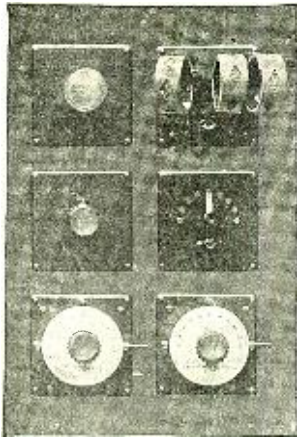

**Six Panel Unit Set**

Comprising a combined Tuner and Detector to receive all local stations and practically any large station in the world. Everything necessary for the operation of the set, including detector tube, "B" battery, head phones and a set of 11 coils, can be had for \$75.00 complete. (Purchaser to furnish panel board and "A" battery.) This set will give greater satisfaction than any outfit at anywhere near this price. Expansion possibilities unlimited.

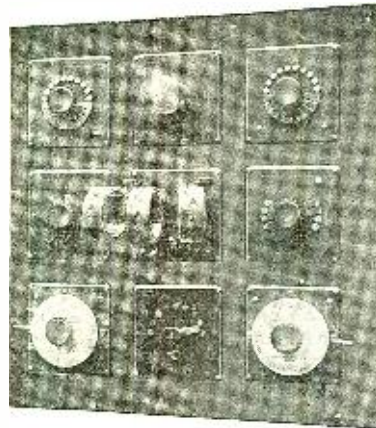

**Nine Panel Unit Set**

Comprising the same six panels shown above, and either three additional panels to give one step of amplification, or three panels to increase the efficiency of the original six. The former will add about \$23.70 to the cost of the original six; the latter about \$12.10.

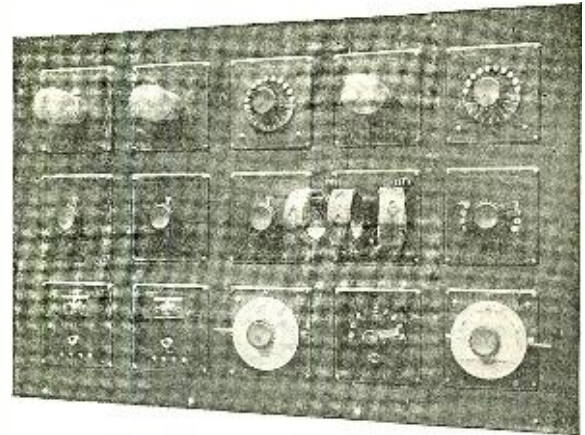

**Fifteen Panel Unit Set**

Comprising the original six panels, with either of the additional three panels included in the Nine Panel Set, and also two additional steps of amplification. Thus for a total of about \$134.50, or \$146.10, a full Fifteen Panel Set that will outdo any other receiving apparatus may be had.

**DE FOREST RADIO TEL. AND TEL. CO.**

Manufacturers and Inventors of High-Grade Radio Apparatus  
1415 Sedgwick Avenue, New York, N. Y.  
LEE DE FOREST, Inc., Western Distributors  
351 Third Street, San Francisco

"The Greatest Radio Catalog in the World—" *The Universal Verdict of Tens of Thousands of Radio Amateurs*  
**DUCK'S No. 14 Big 200 Page Wireless Catalog**

A Veritable Treasure House of Everything Worth While and Dependable in Radio. The largest, most comprehensive, artistic and educational wireless catalog published. The Beacon Light to guide you right in the se-

lection of your radio purchases, and at prices that will command your attention. Every instrument guaranteed with privilege of return if not satisfied.

## Mail 12 cents

in stamps or coin (not sent otherwise), which amount you are privileged to deduct on first dollar purchase. Revised price list to first edition of catalog, with prevailing prices, mailed on request.

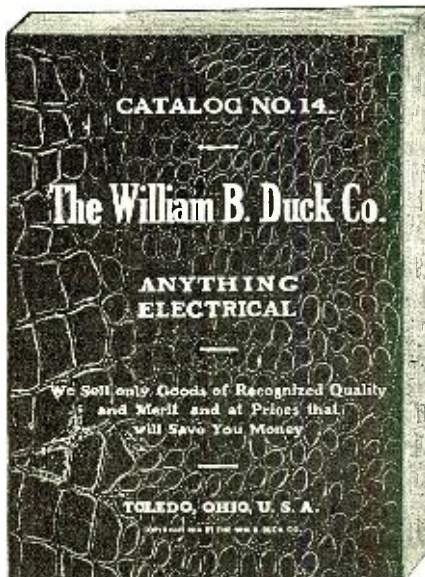

### Announcing Permanent Reductions on 3 of our most popular Radio Instrument

The demand last month for our Navy Type, Arlington, and No. 7721 Receiving Transformers at the greatly reduced prices convinced us that with large quantity production, because of the exceedingly attractive prices on these instruments, we can continue to maintain these low prices. We therefore announce the following permanent reductions on these instruments.

- Model 588 Navy Type Receiving Transformer, Former Price \$27.50. **New Price \$21.95**
- No. 1091 Improved Type Arlington Receiving Transformer, Regular Price \$15.00. **New Price \$11.95**
- No. 7721 Receiving Transformer, Regular Price \$9.00. **New Price \$7.50**

Send your order immediately for your choice of these popular instruments.

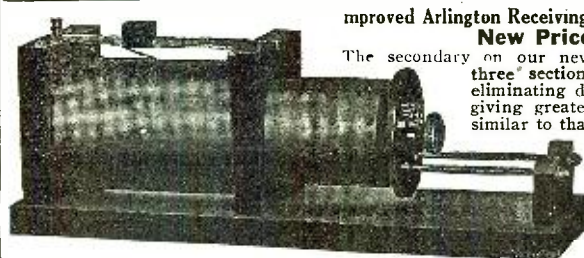

**Improved Arlington Receiving Transformer, Regular Price \$15.00  
New Price, Only \$11.95**

The secondary on our new type Arlington is divided into three sections, with two dead end switches, eliminating dead end effect and harmonics and giving greater selectivity. The end support is similar to that on our Navy, permitting a looser coupling. The base and primary end pieces have a spline to prevent warping or damage in transit. This feature is also on our Navy. It is a beautifully finished instrument.

### Improved Type Sayville Rotary Gap

Embodies the latest and best features in Spark Gap Construction

Our New Type Sayville Rotary Gap is, we believe, far in advance of any rotary gap on the market within a range even of twice the price. It is the final development of many different types made in our experimental Radio Laboratory. It fulfills every requirement of the ideal rotary gap. It is neat and attractive in appearance; simple and durable in construction; possesses a wonderful motor; has a cast aluminum rotary wheel, beautifully polished; every part is in perfect alignment; there is no wobbling of the rotor; produces and maintains a clear and pure 500-cycle note; is instantaneous in action; permits of no dragging of the spark; has contacts of tempered flat copper of proper length and width, easily and quickly removable, and inexpensively renewable; the stationary contacts are adjustable to any length.—\$27.50

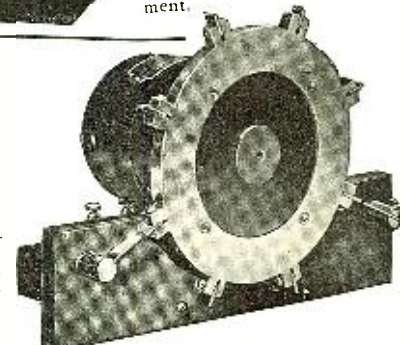

**THE WILLIAM B. DUCK COMPANY, 231-233 Superior Street, TOLEDO, OHIO.**

**T**HE only thing we know of, more complete than our radio stocks, is our new 84-page catalogue, now out. It lists every worth-while make of radio goods, every new development in the radio field, every instrument that you could possibly want. And in addition to this advantage, the prices clearly reflect the savings of low rent and expense. Send for your copy of this new catalogue today. Tomorrow may be too late. Please enclose 10c. to cover cost of mailing, etc.

Anything in the line of Aluminum VT Sockets, Radiotrons and Audiotrons, etc.

Special Offer: A fine lot of brand new, unused variometers at big savings. Prices, \$4.50, \$6.00, \$7.00 and \$9.00.

D. C. Voltmeters, 500 to 600 volts, \$14.00.

*American Electro Technical Appliance Co.  
235 Fulton St. Dept. E. New York*

## MASTER WIRELESS APPARATUS MADE RIGHT PRICED RIGHT

The Apparatus Supreme. Designed by Leading Radio Engineers, made by Expert Electricians, in a REAL Factory, at prices that are within the reach of ALL, while our SERVICE is the BEST in the Country on all Apparatus. The Monthly Bulletins will save you money.

## A Catalog That is Different

Its a wonderful book for the REAL Experimenter, full of photographs, bargains and surprises and shows a complete line of WIRELESS INSTRUMENTS, SCIENTIFIC APPARATUS, CHEMICALS, LABORATORIES, GLASSWARE, Etc. Edition Limited. Send 12 cents (refunded on \$1.50 order) for YOUR copy TO-DAY. We handle a complete line of Apparatus made by the leading Manufacturers. Service, Quality and Satisfaction or your money back.

**PALMERS ELECTRICAL EQUIPMENT CO.**  
Palmers, Minn.

We Pay All Shipping Charges. We Are As Near As Your Mail Box.



(GHEGAN PATENT)

**Bunnell** INSTRUMENTS  
Always Reliable

### JOVE DETECTOR

Handiest, Handsomest, Best  
Sample by Mail, \$2.00  
Tested Galena Crystal, 25c

We are distributors of the Standard Electric Novelty Co.'s Type B "Cyclone" Audion Batteries. Also of De Forest and all the leading manufacturers of High Class Wireless Apparatus. Send stamp for new edition 42RN Catalog.

**J. H. BUNNELL & CO., 32 Park Place, New York**

### HAVE YOU SOMETHING TO SELL OR EXCHANGE?

A classified ad in Radio News will reach 40,000 at a cost of only cents a word.

The new "bugs" are given help and advice by the "old-timers" and L. D. hours are highly respected by them. Good talks on radio are provided at every meeting.

The headquarters is at the Alden library club rooms in Oakland. Every one is invited to attend the lectures given Friday evenings at 8 o'clock.

The officers of the club are: President, B. F. McNamee; first vice-president, George V. Tudhope; second vice-president, C. H. Grubbs; third vice-president, Mr. Hudd; recording secretary, Mr. Carroll; financial secretary, Mr. Wood; treasurer, Mr. Peterson; trustees, George V. Tudhope, B. F. McNamee, A. C. Adams; chief operator, Mr. Cornell; sergeant-at-arms, Mr. Sollie.

Correspondence is invited from eastern clubs.

(Continued on Page 578.)

## The Arc or Continuous Wave Transmitter

(Continued from page 521)

audible, especially if the grooved wheel type of *tikker* is used. This consists of a small high speed motor driving a hard rubber pulley, the periphery of which has a steel time which is grooved. Secured to an insulating base and resting over into the pulley groove is a small steel wire. When the motor is driven at high speed, the groove being so very smooth the centrifugal force throws the wire off from the surface of the wheel at a tremendous frequency. This motor chopper being inserted in the receiving circuit breaks up the incoming undamp oscillations and brings them within the audibility of the human ear. A long wave antenna is especially efficient for receiving long wave spark stations also. Amateurs in the city can try this out by raising a box kite and using small hard drawn copper wire in the lower portion of the kite string. Of course, you must be very careful not to pay out too much wire and let the kite fall across the trolley feeders.

## An Undamp Wave Method of Determining Dielectric Constants of Liquids

(Continued from page 522)

ordinary range of  $C_1$ , the condenser  $C_2$  is inserted in series with  $C_1$ .

Preliminary measurements for a number of liquids give the following results for a wave-length of approximately 5,000 meters, and a temperature of 21° C.

| Substance                 | Diel. Const. |
|---------------------------|--------------|
| Kerosene .....            | 2.12         |
| Toluol .....              | 2.39         |
| Ether (abs. ethyl) .....  | 4.32         |
| Olive oil .....           | 3.11         |
| (a good commercial grade) |              |
| Petrol ether .....        | 1.86         |
| (boiling point 50-60° C.) |              |

The readings are accurate to about 1 per cent. Further refinements in determining condenser settings will increase the accuracy of the results. The method is easy and rapid of manipulation, and its accuracy can be increased to any desired extent by using variable condensers of sufficient accuracy.

Abstract of a paper presented at the St. Louis meeting of the American Physical Society, December 30, 1919.

### Help, Police!

Hem: Did you hear about the holdup on Sam's roof?

Haw: What was it?

Hem: Two poles held up his aerial.

W. DITZENBERGER.

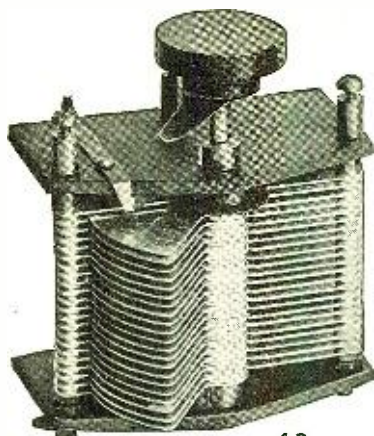

43

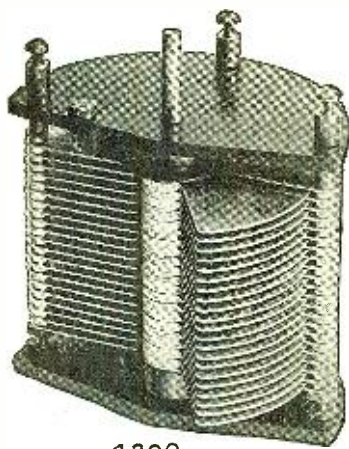

4300

## Entire Satisfaction

is what our customers say.

## ARE YOU

GETTING ENTIRE SATISFACTION from condensers you have purchased elsewhere?

IF NOT, we are sure you will be pleased with what we are offering, *because, we manufacture only the BEST.*

*All we ask is GIVE US A TRIAL.*

This month we wish to announce a NEW MODEL of VARIABLE CONDENSER, which will be known as SERIES "T". It is of the same general construction as our SERIES "S" condenser, but is built of heavier material, the aluminum plates being die stamped from 1/32" hard rolled stock. The spacers are also of heavier stock, and the general assembly insures a very rigid instrument. At the present time we are unable to fill orders for the SERIES "S" condenser, as we cannot obtain materials, but can ship the NEW SERIES "T" or the SERIES "L" condenser from stock.

### SERIES "T".

|         |                             |       |        |
|---------|-----------------------------|-------|--------|
| No. 20  | 2 plate Vernier.            | ..... | \$2.00 |
| No. 70  | 7 plate, approx. .0001 m.f. | ..... | \$2.35 |
| No. 130 | 13 " " .0002 m.f.           | ..... | \$2.75 |
| No. 170 | 17 " " .0003 m.f.           | ..... | \$3.15 |
| No. 230 | 23 " " .0005 m.f.           | ..... | \$3.60 |
| No. 310 | 31 " " .0007 m.f.           | ..... | \$4.30 |
| No. 430 | 43 " " .001 m.f.            | ..... | \$5.25 |
| No. 630 | 63 " " .0015 m.f.           | ..... | \$7.50 |

*Include postage for one pound to your city.*

### PRICES

### SERIES "L".

|          |                  |       |         |
|----------|------------------|-------|---------|
| No. 2300 | 23 plate, .00075 | ..... | \$6.00  |
| No. 4300 | 43 plate, .0013  | ..... | \$8.00  |
| No. 6300 | 63 plate, .002   | ..... | \$10.00 |

*Include postage for two pounds.*

Prices include knob and pointer and mounting screws. Specify whether brass or nickel pointer and screws, and thickness of your panel.

Either style of condenser, fitted with indicating dial at additional cost of 75c.

## THE WIRELESS SHOP

511 West Washington St.

A. J. EDGCOMB

Los Angeles, Cal.

# Your Duo-Lateral Wound Coils Are Ready



"SERVIMUS"

JUST a word of explanation: Our first advertisement caused such an upheaval in radio circles that we were swamped with inquiries. Indeed, one large manufacturer of radio apparatus immediately placed his contract with us, taking over our entire output. As a result, we were obliged to turn down orders.

THAT was up till a short while ago. Now we have succeeded in doubling our productive capacity, and Duo-Lateral Coils are available to everyone in the radio field. We can make prompt shipments from stock. *Your DUO-LATERAL COILS are ready to be shipped the moment your order is received*

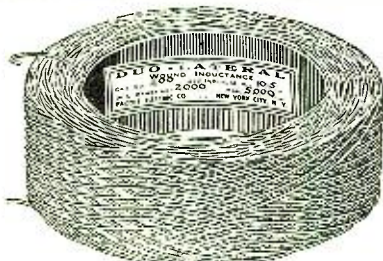

### REMEMBER: DUO-LATERAL COILS are recognized for:

1. Lower natural period.
2. Lower high-frequency resistance.
3. Very low distributed capacity.
4. Lower direct current resistance.
5. Higher self-inductance.
6. Mechanically stronger.

Bulletin P-IR, containing valuable engineering data, constants and prices of numerous sizes of Duo-Lateral Coils, covering practically every wave-length used, is yours for the asking.

TO DEALERS: OUR DISCOUNTS ARE GENEROUS

## PACENT ELECTRIC COMPANY, Inc.

LOUIS GERARD PACENT, President

We now represent the WIRELESS IMPROVEMENT CO. exclusively

Representing: A. H. Grebe & Co., Dubilier Condenser Co., Electrical Products Mfg. Co., Richter-Schottler Co., H. W. Sullivan of London, Rawson Elec. Inst. Co., and others.

150 NASSAU STREET

Telephone Beekman 5810

NEW YORK CITY

## The CHICAGO RADIO LABORATORY Announce

THAT the products of this company will hereafter be known, advertised and distributed as the "Z-NITH" apparatus, the mark of highest success.

The broadening field that has been opened up through the perfection of these products and through the adoption of more intensive methods of merchandising make the establishment of this name necessary.

The most popular and widely known of these products, the C. R. L. Paragon Short Wave Regenerative Receiver, will now be known as the

### "Z-NITH" REGENERATOR

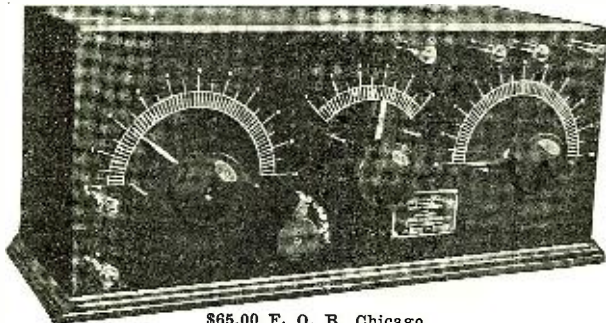

\$65.00 F. O. B. Chicago

There is a Z-NITH product for your every need. Our Engineering Department has been built up by years of effort and embodies a wealth of knowledge and experience in the design and production of special apparatus and installations.

**THE CHICAGO RADIO LABORATORY CHICAGO**  
Offices: 1316 Carmen Avenue Testing Station: 9 ZN-5525 Sheridan Rd.

## ACME AMPLIFYING TRANSFORMER

\$5.00

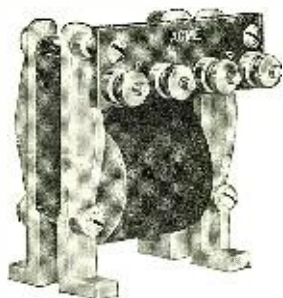

\$5.00

### INCREASED IMPEDANCE RATIO

We have found that a gain in efficiency may be obtained by increasing the impedance ratio of our Amplifying Transformer, especially on the new tubes. Our latest transformers have this increased ratio.

CARRIED IN STOCK BY LEADING DEALERS

ACME APPARATUS COMPANY, 25 Windsor St., Cambridge 39, Mass.  
UP-TO-DATE TRANSFORMER AND RADIO ENGINEERS AND MANUFACTURERS

## IMPORTANT ECONOMY RADIO SPECIALS FOR FEBRUARY

**PLATE BATTERIES**—The brass strip soldered, brass strip terminal kind. Terminals drilled for bolt and nut connections. No wires to break or corrode. Large sized, long lived 4½ volt flashlight batteries, the best obtainable, soldered together forming units that are hard to beat and harder to kill.

**ERSCO NO. 503 PLATE BATTERY**, 22½ volts, adjustable, price \$2. **ERSCO NO. 803 PLATE BATTERY**, 36 volts, adjustable, price \$3.20. We have sold many hundreds of our batteries in our own home city and every customer is now a booster.

**PANELS**—Are you building your own set? Our panels are what you are looking for. Black fibre panels ¼ in. thick, easy to work with and take a nice finish.

The No. 1 panel is 7 x 20 x ¼ inches, just the right size for a Paragon, price \$3.00.

**PANELS CUT TO MEET YOUR INDIVIDUAL REQUIREMENTS, PRICE 2½ CENTS PER SQUARE INCH. ALL EDGES MACHINE CUT AND ABSOLUTELY SQUARE. WE SHIP PARCEL POST PAID ANYWHERE IN THE UNITED STATES**

Mail orders should be accompanied by remittance. Reference Merchants and Manufacturers National Bank, Newark, N. J.

**ECONOMY RADIO SUPPLIES CO., 232 Sanford St., EAST ORANGE, N. J.**

## A 15 MILE RADIOPHONE OPERATING ON "B" BATTERIES

Out of a large stock of genuine double filament, double life AudioTrons, we have carefully selected and tested a limited number of tubes which are especially adapted to be incorporated in Mr. H. D. Selvage's 15-mile radiophone operating on "B" batteries. His circuits, together with directions for assembling, advertised elsewhere in this magazine, has been thoroughly tried and proven by a large number of amateurs who are now talking over remarkable distances.

We are offering you an excellent bargain by cutting the price of these specially selected genuine double filament AudioTrons from \$6 to \$5 each.

Results are positively guaranteed when our tubes are used in connection with Mr. H. D. Selvage's radiophone circuit.

The Kehler Radio Laboratories, 901 W. 1st St., Abilene, Kansas

## A Detector and Three-Stage Amplifier for Fifty Dollars

(Continued from page 512)

handsome appearing instrument, altho it requires great care in drilling, not to break thru the front surface. Because of this fact it would be better to use a ⅜" panel rather than ¼", but ¼" was used in this case.

The only holes drilled thru are for the four rheostat shafts, four telephone jacks, eight binding posts, and twenty-eight ventilating holes with a ventilating area of 2.15 sq. in. equivalent to a single hole nearly 1½" square. The only adjustments are by the four rheostat knobs controlling the filaments of the four tubes.

The four binding posts at the left, Fig. 1, as indicated by the engraved letters, reading from the top down, are, grid condenser and leak, negative side of filaments, detector plate, and plate jack. Those at the right, reading down, are, positive side of filament rheostats, negative side of filaments, and one side of telephone jacks. Three of the eight binding posts are thus connected to the negative side of the filaments. The four binding posts at the left go to the tuner secondary and tickler; those at the right go to the storage battery and plate battery, tho there is room for a plate battery in the cabinet. All the tubes use the same filament and plate battery, tho the filaments have individually adjustable rheostats—the only adjustment to be made in operation, and even this adjustment may be left fixed after being once regulated. Individual tube filaments are turned off by turning the rheostats to the "off" position. The rheostat knobs showing on the front of the panel, Fig. 1, are for the detector, first, second, and third stage amplifier, respectively.

The first step in assembling the complete instrument is to drill the panel from the front. The binding posts are all mounted with their centers ⅜" from the edge and 1¼" center to center. The four rheostats are located half way between the top and bottom of the panel, that is, 4½" from top or bottom. The end rheostats are centered 2" from the edge, and the others are spaced uniformly between these, 2½" from center to center.

Like the binding posts, the four telephone jacks are centered ⅜" from the bottom edge of the panel, and are placed symmetrically with the rheostats, and directly under them; that is, the end jacks are centered 2" from the edge of the panel, and the other two are uniformly spaced between these, with 2½" between centers.

The holes above the rheostats give the necessary ventilation, as before mentioned, and also serve as windows thru which the brightness of the filaments may be observed. The center hole in each group is symmetrical with both the telephone jacks and the rheostats, being directly above them; the first and last center holes at left and right are centered 2" from the edge of the panel, and the other two are uniformly spaced between these, with 2½" between centers.

The holes above the rheostats give the necessary ventilation, as before mentioned, and also serve as windows thru which the brightness of the filaments may be observed. The center hole in each group is symmetrical with both the telephone jacks and the rheostats, being directly above them; the first and last center holes at left and right are centered 2" from the ends of the panel, and the other two center holes between these have 2½" between centers.

Bound Volume No. 1, Radio Amateur News, 12 issues, July, 1919—June, 1920. Attractively Bound. Only \$2.00 plus postage for 8 lbs. A most valuable asset to your library. Order today.

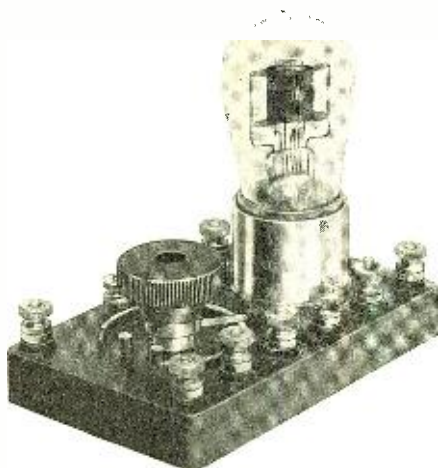

# A VACUUM TUBE OUTFIT

*SIMPLE, EFFICIENT—YET INEXPENSIVE*

The illustration at the left shows the new Radiotron U.V. 200 vacuum tube and the A.M. "Paragon" Detector Unit—complete with tube socket, grid leak, condenser, rheostat, etc., all molded in a solid Bakelite composition base.

Price, as shown  
Postage  
10 cents

**\$11.00**

With "B" Battery \$13.65  
Radiotron U V 200 5.00  
Paragon Detector Unit 6.00

## TWO SUGGESTED RECEIVING OUTFITS

### VACUUM TUBE SET

- 1 Murdock Receiving Transformer.....\$9.00
- 1 No. 1 Chelsea Condenser, .001 m.f..... 5.00
- 1 No. 2 Chelsea Condenser, .0005 m.f..... 4.50
- 1 A.M. Paragon Detector Unit..... 6.00
- 1 Radiotron U.V. 200 Vacuum Tube..... 5.00
- 1 Block 22.5V. "B" Battery..... 2.65
- 1 No. 55 2000 ohm Tel. Head Set..... 4.50

### CRYSTAL DETECTOR SET

- 1 Murdock Receiving Transformer.....\$9.00
- 1 No. 1 Chelsea Condenser, .001 m.f..... 5.00
- 1 No. 2 Chelsea Condenser, .0005 m.f..... 4.50
- 1 A.M. Crystal Detector ..... 1.75
- 1 No. 55 2000 ohm Tel. Head Set..... 4.50

## ATLANTIC RADIO CO.

INCORPORATED

88 Broad Street,  
Boston 9, Mass.

Branch:  
15 Temple St.,  
Portland, Me.

*Request Bulletin 14*

## Here's a Sure Winner—

For long distance work you can find nothing to beat the



Type CR-3A

Short-Wave Regenerative Receiver  
and  
Vacuum Tube Unit

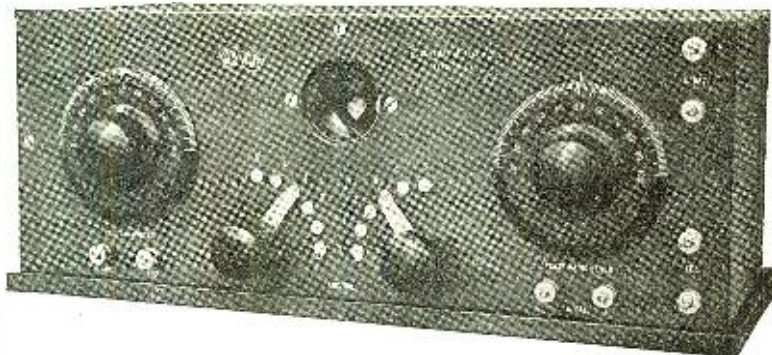

Compact, complete, dependable, with a wave-length range running up to 375 meters, it fills the need for a moderate-priced regenerative receiver. Built in every way up to the Grebe standard.

The CR-3A includes a variable antenna circuit, continuously variable grid and plate circuits, a specially designed coupling circuit and a standard vacuum-tube mounting with a grid condenser and leakage element. All binding posts are conveniently located on the front of the panel. The price \$45.50 is within the reach of all.

Be sure to ask your dealer about the CR-3A.

*GREBE RADIO apparatus is licensed under the original Armstrong and Marconi patents.*

Central Radio Institute, Independence, Mo.  
Continental Radio and Electric Corp., New York.  
Detroit Electrical Co., Detroit, Mich.  
Doubleday-Hill Electric Co., Pittsburgh, Pa.  
Electrical Specialty Co., Columbus, Ohio.  
Holt Electric Utilities Co., Jacksonville, Fla.  
Hurlburt Still Electrical Co., Houston, Texas  
Kelly and Phillips, Brooklyn, N. Y.

U. of I. Supply Store, Champaign, Ill.  
Klaus Radio Company, Eureka, Ill.  
Manhattan Electrical Supply Co., New York, Chicago, St. Louis.  
Leo. J. Meyberg Co., San Francisco, Cal.  
Pacent Electric Co., Inc., New York City.  
F. D. Pitts Co., Inc., Boston, Mass.  
Philadelphia School of Wireless Telegraphy, Philadelphia, Pa.  
Western Radio Electric Co., Los Angeles, Cal.

**A. H. GREBE & CO., Inc.,**

**72 Van Wyck Blvd., Richmond Hill, N. Y.**

## CO-OPERATIVE RADIO BUYING

Co-operate with thousands of other amateurs. Buy your equipment from a single source and get immediate delivery on everything radio you need. We fill orders the day they arrive. In addition to service, this association being co-operative, you will participate in a division of its profits. Send order for any of the following items, or other articles needed, and see for yourself how this plan operates; or send stamp for details.

| STORAGE BATTERIES          |         |
|----------------------------|---------|
| No. 1 Marko 4 v. 40 a.     | \$ 9.70 |
| No. 2 Marko 4 v. 60 a.     | 13.00   |
| No. 3 Marko 4 v. 80 a.     | 16.00   |
| No. 4 Marko 6 v. 40 a.     | 14.00   |
| No. 5 Marko 6 v. 60 a.     | 18.00   |
| No. 6 Marko 6 v. 80 a.     | 23.50   |
| No. 7 Ford Auto 6 v. 60 a. | 17.10   |
| No. 8 Ford Auto 6 v. 80 a. | 21.00   |

| B. BATTERIES               |      |
|----------------------------|------|
| 7623 Standard 22½ v. Small | 1.50 |
| 7625 Standard 22½ v. large | 2.00 |
| 7650 Standard 22½ variable | 3.50 |
| 766 Eveready 22½ v. large  | 3.60 |
| 763 Eveready 22½ v. small  | 2.25 |
| Cyclone 22½ v. small       | 1.25 |
| Cyclone 22½ v. large       | 2.40 |

| AUDION CONTROLS        |       |
|------------------------|-------|
| RORA Grebe in cabinet  | 12.50 |
| Y-1 Acme in cabinet    | 10.00 |
| New Adams Morgan panel | 6.00  |

| REGENERATIVE RECEIVERS   |       |
|--------------------------|-------|
| Paragon RA-10 short wave | 85.00 |
| Grebe CR-3a 375 meter    | 45.50 |
| Grebe CR-2 700 meter     | 51.00 |
| Grebe CR-3 700 meter     | 65.00 |

| VACUUM TUBES               |        |
|----------------------------|--------|
| A. P. Electron relay       | \$6.00 |
| A. P. Amplifier            | 7.00   |
| A. P. Power tube           | 7.50   |
| Radiotron UV-200 Detector  | 5.00   |
| Radiotron UV-201 Amplifier | 6.60   |

| TELEPHONES                  |       |
|-----------------------------|-------|
| Brandes Superior, new style | 8.00  |
| Murdock 2000 ohm headset    | 4.50  |
| Murdock 3000 ohm headset    | 5.50  |
| Baldwin Type "C"            | 16.50 |
| Baldwin Type "E"            | 20.00 |
| Baldwin Type "F"            | 21.00 |

| AMPLIFYING TRANSFORMERS  |      |
|--------------------------|------|
| Acme, new style mounting | 6.00 |
| Federal, fully mounted   | 7.50 |
| Radisco, mounted         | 6.60 |

| JACKS AND PLUGS               |      |
|-------------------------------|------|
| Federal single closed circuit | .25  |
| Federal single open circuit   | .70  |
| Federal double closed circuit | 1.00 |
| Federal plug                  | 2.00 |
| General Electric Plug         | 1.35 |

| VT RECEPTABLES       |      |
|----------------------|------|
| Murdock moulded base | 1.00 |

## MUTUAL PURCHASERS ASSOCIATION

2 &amp; 4 Stone Street

Dept. J-1

New York City

## REMLER No. 93 A—BATTERY — POTENTIOMETER



Pat. Applied For.

- No. 93—Remler A-Battery Potentiometer Unit only, with studs for panel mounting ..... **.75c**
- No. 94—Remler Rotary Lever Switch for use with No. 93 Unit ..... **.45c**

Increases detector sensitiveness and signal audibility.

THE plate voltage of any detector tube must be carefully adjusted for maximum sensitiveness and signal audibility. Potentiometer control provides close adjustment with ease of operation. This new Remler Unit with metal inserts provides positive definite electrical contact and eliminates the uncertainty of carbon to graphite contact. This Remler Unit is not brittle and is connected across the A-Battery to control the plate potential over a six volt range by half-volt steps. Circuit diagram furnished with each unit.

"Apparatus that Radiates Quality."

## REMLER RADIO MFG. COMPANY

163 Sutter Street

E. T. CUNNINGHAM, Sales Mgr.

San Francisco

## SORALA METER SERVICE

Orders Filled by Return Mail  
and We'll Pay Postage

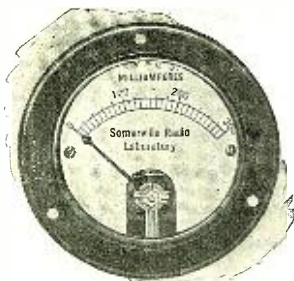

We pay postage on 90% of our shipments. Just try Sorala quality, price and service, which includes all apparatus of standard makes.

|                         |         |
|-------------------------|---------|
| <b>BULLETINS</b>        | .40     |
| Grebe CR-3A             | \$45.50 |
| Paragon RA-10           | 85.00   |
| Paragon V.T. Control    | 6.00    |
| 22½ v. Eveready B. Bat. | 2.00    |

- Type J Ammeter (D.C.) \$7.00  
Ranges 0-3 and 0-5 amps.
- Type J Milliammeter (D.C.) .....\$7.00  
Ranges 0-100, 0-300 and 0-500 M. A.
- Type J 0-500 Voltmeter, \$16.00  
Includes External Resistor.
- General Radio Flush Type A. C. Hot Wire Ammeters .....\$7.75  
Ranges 0-¼, 0-½, 0-1, 0-2½ and 0-5.

- 12-18c Insulated Binding Posts as shown in cut, only.....\$1.65
- 2-12c Binding Posts as shown ..... 1.25
- Sorala V.T. Socket..... 1.10
- Radiotron UV-200..... 5.00
- G-R "A" Bat. Potentiometer 4.00
- 350 Ohms. for Plate Voltage Control on Radiotrons.



Sorala Honeycomb Coil Adaptor

The arms may be fitted to any pair of binding posts, as they are adjustable. Used on variable condensers with DeForest coils to make wave meters, radio frequency amplifiers, tuning units, etc. Also as mounting plugs on Coto Coils.

75c Postpaid

## SOMERVILLE RADIO LABORATORY,

102 Heath St., Somerville, 45, Mass.

This line of holes is 2¼" from the top and 2¼" above the line of rheostats, being thus half way between the rheostats and the edge of the panel. Around each center hole is drilled a circle of six similar holes on a radius of 1" from the center. For all these window holes a ⅜" drill was used.

The four corner holes for securing the panel in the cabinet were made with a ⅜" drill, and countersunk to take the half-round heads of the screws mentioned in the list of material. They are centered ¼" from the end edges of the panel, the upper holes being 1" from the top edge of the panel, and the bottom holes 1" from the bottom edge.

This symmetrical mounting of parts, as well as the freedom of the front of the panel from screw heads, gives the instrument a very neat and beautiful appearance, simple and workmanlike. An additional advantage of this particular spacing is the greater ease and simplicity of wiring at the back. The binding posts are engraved with identifying letters, the jacks with Roman numerals, and the rheostats with circular arrows and the word "OFF," as is clearly seen in the photograph, Fig. 1.

Before drilling the panel the location of all holes should be laid out on a sheet of paper the exact size of the panel. The paper is laid on the panel after the graining is finished, and the center of each hole pricked thru the paper into the face of the panel with a center punch. Furthermore, after the front of the panel is completed as to graining and drilling, it should be protected from scratching by a covering of paper made larger than the panel so that it can be folded over all the edges and temporarily secured on the back side with glue or shellac, and should not be removed until all the work on the back of the panel and all the mounting of parts on the back, even the wiring has been done. One careless scratch will ruin the appearance of this very fine instrument, and no precaution should be neglected to secure its freedom from blemishes.

Turning now to the back of the panel, as shown in Fig. 2, it will be noted that with the exception of the single wire from the positive filament ("A") battery binding post to one side of all the filament rheostats, no wiring appears on the upper half of the panel. The four tube sockets are mounted on a shelf which divides the panel into two parts, in the upper one of which appear only the rheostats, tubes, and sockets, and in the lower one of which are mounted the three amplifier transformers, the four telephone jacks, the grid and bridging condensers and grid leak, and the necessary wiring. The only concealed parts are the grid polarizing resistances inside the bases of the tube sockets, which will be noted later.

The shelf is 3½" wide by 10" long, of ⅜" Formica, and is fastened to the back of the panel with small machine screws holding small brass angles made of sheet brass ½" wide, 2½" long, and ⅜" thick, bent at a right angle 1¼" from one end, and drilled for the four round head machine screws, as shown in the illustration. As the shelf is 10" long, 2" shorter than the panel, a space of 1" is left between each end of the shelf and the adjacent edge of the panel, so that the whole panel, with mounted apparatus, will slip into the cabinet as a complete unit. The shelf is so placed that the bottom edge of it is 3" above the bottom edge of the panel, a position which will bring the tip of a Marconi V.T. 2" from the top of the panel, and thus clear the inside of the cabinet by about 1¾" if the cabinet is made of ½" stock, like the present one.

The three transformers are centered between and above the line of jacks underneath the shelf, but fastened to the panel, with the terminals marked "P, S," down,



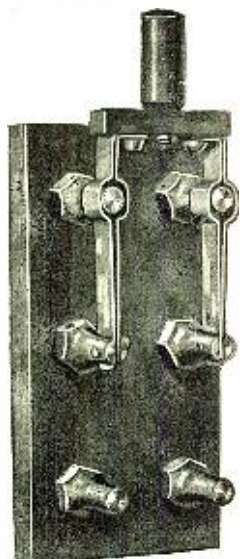

(Illustration exact full size)

Z. R. S. Miniature knife switch is supplied unmounted only, for panel mounting and will harmonize with other fine products of the instrument maker. There is nothing else like it on the market.

Double pole, single throw - - - - 80c  
 Double pole, double throw - - - - 90c

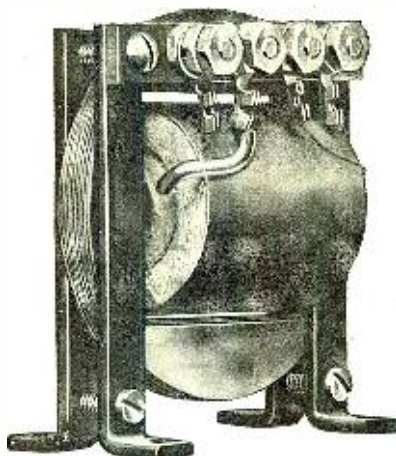

Modulation transformer - - - - \$4.50  
 Choke coil .8 Henry - - - - \$3.75  
 Amplifying transformer - - - - \$4.00

All these are mounted as shown in the illustration and will give you results second to none.

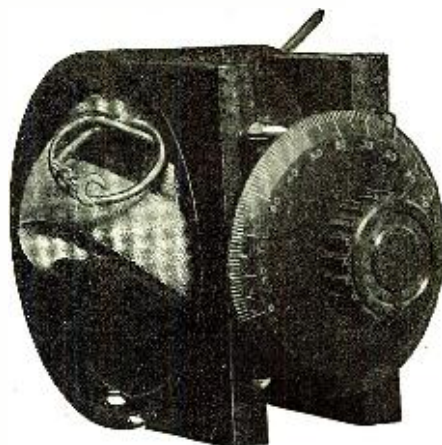

Type Z.R.V. Variometer has unit construction with bakelite shell and hard wood ball. Has low dielectric losses and a range of inductance of 1.25 mil henry maximum to .1 mil henry minimum. Is readily used on table or mounted on panels.

Complete with 3" dial and knob - \$6.50  
 Without dial or knob - - - - \$5.75  
 Variocoupler of same construction - \$7.50  
 Complete Regenerative set - - \$38.00  
 Regenerative panel set with detector - \$85.00  
 Regenerative set detector and 2 stage amplifier, combined panel - \$140.00

Complete Catalogs  
 6c Stamps

## CLAPP EASTHAM COMPANY

120 Main Street,

Cambridge Mass.

ALL GOOD DEALERS CARRY OUR PRODUCTS IN STOCK

## AUDION BULBS—ALL MAKES

We handle audion tubes of every reputable make and are ready to make immediate shipment. All bulbs sent postpaid and packed so as to insure safe arrival undamaged. Prices are as follows:

**RADIOTRON U.V.200** is a gas content detector of unusual capabilities and of novel manufacture. It has been designed to meet an insistent demand for a detector and audio frequency amplifier tube which operates from a single standard 221/2 volt plate battery. The U.V.200 type is particularly adapted for amateur regenerative circuit in which it provides more uniform action than any vacuum tube yet devised.

PRICE...\$5.00 postpaid

All Radiotron tubes mounted with 4 prong bases and instruction booklet sent with each tube.

**RADIOTRON U.V.201** is an unexcelled amplifier of the Pliotron type designed for detection and for radio and audio frequency amplification. Normal plate voltage, 40 (two standard B batteries). Plate voltages up to 100 may be used with increased amplification. Amplification constant 6.5 to 8 at 40 volts, 8 to 10 at 100 volts. Impedance 15,000 to 25,000 ohms at 40 volts on the plate, 10,000 to 15,000 ohms at 100 volts on the plate.

PRICE .....\$6.50 postpaid

## ATLANTIC-PACIFIC MOOREHEAD TUBES

**ELECTRON RELAY.** This bulb was originated by the Moorehead laboratories in 1915 and was the first tubular vacuum valve ever manufactured. Now manufactured with 4 prong base and still retaining familiar copper grid and aluminum plate of the old type relay. The E-R has the familiar hissing point and low B battery potential requirement characteristic of the efficient detector tube. PRICE.....\$6.00 postpaid

**VT-Amplifier-Oscillator.** This is the Navy SE 1444 tube, designed for amplification and undamped wave reception by the regenerative method. It is highly exhausted to insure efficient performance as a generator and amplifier. It may be used singly for receiving continuous waves or in cascade as a two or more step amplifier. Recent navy tests show that this tube has a higher amplification constant than any other tube known to the radio art. PRICE.....\$7.00 postpaid

**THE MOOREHEAD TRANSMITTING TUBE.** This tube has been developed as an undamped wave transmitter for the amateur. It is exhausted to the highest possible vacuum in order to operate at the high B battery potential necessary for transmitting purposes. From 150 to 600 volts may be used on the plate of the tube, and can be obtained from flashlight batteries or by vacuum tube rectified alternating current from a 110 volt, 60 cycle supply. The grid in this tube is made of molybdenum in accordance with British government specifications. The Moorehead Transmitting tube fills a long felt want in bringing the radio telephone and undamped wave transmitter to the amateur at a low price. PRICE .....\$7.50 postpaid

Send 15c for our illustrated catalogue and supplement. This amount will be refunded on your first order for \$1.50 or over. High printing costs make free distribution impossible.

## Electrical Speciality Company

Dept. R, 48-50 S. Front St., Columbus, Ohio

Dept. R, 20 N. 9th St., Philadelphia, Pa.

**RAY-DI-CO SPECIALTIES**  
(RAY-DEE-KO)  
**MOTOR GENERATOR UNITS**  
Voltages 6 to 1000 — Capacities 15 to 175 watts  
**FRACTIONAL H. P. MOTORS TO ¼ H. P.**  
**GENERATORS -- DYNAMOTORS**  
Generators built to order  
**LOW POWERED ROTARY CONVERTERS**  
**SYNCHRONOUS SPARK GAPS**  
**RAY-DI-CO**  
Radio Supplies  
2653 A. N. CLARK ST. CHICAGO, ILL.  
*Specializing in the designing and construction of radiophones to your specifications.*

**Averaged 82% out of a possible 90%**

Practical course on the application of Vacuum Tubes to all forms of C-W Transmission and Reception start Thursday February Tenth.

Ten graduates of the MASSACHUSETTS RADIO and TELEGRAPH SCHOOL during the Six Weeks' examination period between November 1st and December 15th, 1920, established this record on their U. S. Government Examinations for First Grade Commercial Operator's license. Their average attendance was 5.1 Months.

The fact that a new United States Radio Inspector did the examining, using new and original questions unfamiliar to the graduates, speaks all the more favorably of our system and methods.

To produce Ten graduates, who, within the short period averaging a little Over Five Months, obtained such a high average, is the best way we know of to convince you of the merits of this school. Results Count.

Names, addresses and full data sent on request to anyone. Why not avail yourself of this service. It costs no more. SEND FOR FREE LITERATURE.

**MASSACHUSETTS RADIO AND TELEGRAPH SCHOOL**  
18 Boylston Street, Boston, Mass. Tel. Beach 7168  
R. F. TROP G. R. ENTWISTLE

**TYPE 215**  
**2 STAGE AMPLIFIER**

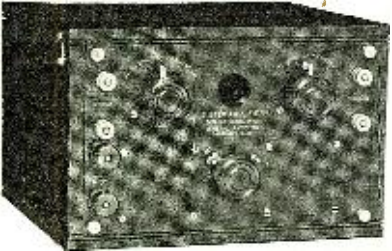

An efficient, attractive, and reliable amplifier unit. By means of a special drum switch shift may be made from two stages of amplification to one stage or to detector. Switch controls both filament and telephone circuits. No plugs and jacks to bother with. Cabinet includes compartment for plate battery.

PRICE \$50. Described in Bulletin 906N

**GENERAL RADIO CO. CAMBRIDGE 39, MASS.**

**VACUUM TUBE CONTROL UNIT**  
Type MW

Adaptable to any modern hook-up. Best appearing and highest type Vacuum Tube Unit at the price in the market.

Grained formica panel, 5½" x 6¾", lettered in white, graduated rheostat dial, variable plate control. Tube socket (stand-ard 4 prong). Grid condenser and leak mounted in back of panel and so wired that it can be adapted to any modern hook-up.

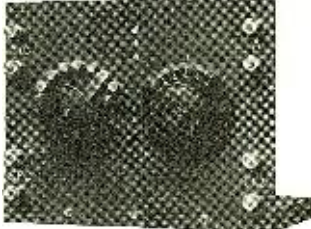

**Price \$10**  
Parcel post prepaid in U. S. A. Immediate shipment.

WRITE for descriptive Booklet MW. Sent free on request.

**THE MIDWEST RADIO CO., 3423 Dury Ave., CINCINNATI, O.**

and the terminals marked "P<sub>2</sub> S<sub>2</sub>" uppermost, next to the shelf, to make the wiring as neat as possible. In this position the transformers are 1¼" wide, measured horizontally.

The four tube sockets, which are 2¼" square, are mounted along the back edge of the shelf, the end sockets being flush with the shelf ends, and far enough from the panel to give good clearance to the moving contacts of the rheostats. This position leaves ⅜" between socket bases. As shown in the photograph, Fig. 2, the sockets are placed with the plate and grid side toward the back, away from the panel, and with the filament side next to the panel. The positive filament terminals of the sockets are all connected to one wire running beneath the shelf, and each individual negative filament terminal goes to one side of its individual rheostat, the other side of all rheostats going to the common wire running above the shelf, as already mentioned. Inserted between each negative filament terminal and its rheostat, however, is a short length of resistance wire having a resistance of 1 ohm, coiled inside the socket base of each tube, for the purpose of giving the proper negative potential to the grids. The contact screws in the sockets are run down thru holes drilled in the shelf, as small machine bolts with nuts (shown in photograph, Fig. 2), and these serve as securing screws and also leave the space above the shelf free of connecting wires.

The four jacks, connected on one side to the individual plates and on the other side to a common wire leading to a binding post, with back connections to the transformer primaries (see Fig. 3) allow the telephones to be plugged into the detector plate circuit with no amplification, for strong signals, or into the plate circuit of any amplifier, thus permitting any desired degree of amplification for weak signals, and at the same time cut out all the transformer and tube circuits not in use. It is suggested that the plug for the telephones be connected not directly to the telephones, but by a short cord to a terminal block screwed low down on the outside of the cabinet at the end away from the tuner to which block any number of pairs of telephones may be connected without interfering with the plug.

The small copper foil and mica fixt condensers, the construction of which has already been explained in another article,\* are of .002 mfd. for bridging the negative filament and common plate jack binding posts, and of .0002 mfd. for the grid. These, with the 2 megohm grid leak, are mounted under the detector end of the shelf, adjacent to the binding posts leading to the tuner. This is the left end looking at the front of the panel (Fig. 1), and the right end looking at the rear (Fig. 2). The condensers and leak show plainly in the photograph of Fig. 2. In the latter figure the tubes, from right to left, are, detector, first stage amplifier, second stage amplifier, and third stage amplifier; the rheostats, transformers, and jacks correspond to this arrangement, as noted in connection with Fig. 1.

All connections are soldered, and all wiring is done with No. 10 bare copper wire run as directly and neatly as possible. The ingenious arrangement of all the parts makes the leads all short and direct, and the wiring extremely simple.

The diagram of connections is shown in Fig. 3, and without special comment will be readily understood from the photographs and from the data already given. The lettering and numbering on the diagram are the same as those on the front of the panel. In wiring, to show the connections looking at the rear of the panel this dia-

\*See Elliott A. White, "The Simplest Long Wave Receiver," in Science and Invention for October and November, 1920.

# -a ways remember

The A-P Electron Relay and the A-P VT Amplifier-Oscillator constitute the one proven vacuum tube combination on the market to-day. Perfected in May, 1920, this combination has *made good in actual use*. AND A-P tubes are the only tubes equipped with the SHAW *bakelite* base—the base that prevents surface leakage, the base that prevents the tube from absorbing atmospheric moisture, the base adopted by the U. S. Navy Department—an exclusive patented feature of A-P tubes.

When you want an *efficient* amplifier in which none of the amplifier qualities are sacrificed to make it also a detector, use the *A-P VT Amplifier-Oscillator*. When you want an *efficient* detector in which none of the detector qualities are sacrificed to make it also an amplifier, use the *A-P Electron Relay*.

The A-P Electron Relay is the most sensitive spark detector known to the radio art. It is a soft tube. It contains the right *quantity* of gas and, equally important, the right *kind* of gas. The electrodes are correctly designed. On the market since May, 1920, it has *made good in actual use*.

*For sure results, for better results use A-P tubes and only A-P tubes. Licensed by the Radio Corporation of America under DeForest Audion and Fleming patents, for amateur and experimental use in radio communication. Equipped with the SHAW bakelite (four-prong) base.*

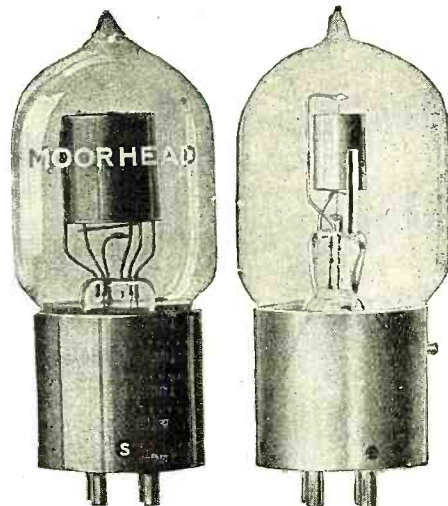

The A-P Electron Relay, equipped with the SHAW standard four-prong base. Price \$6 and worth it. Order from your dealer.

The A-P VT Amplifier-Oscillator, equipped with the SHAW standard four-prong base. Price \$7 and worth it. At dealers.

A combination of two or more A-P VT tubes as amplifiers with an A-P Electron Relay as the initial detector or oscillator is the ideal receiving combination for long distance amateur or long wave reception. *Only with such a combination can full efficiency be attained.*

**The Atlantic Radio Supplies Co.**  
8 Kirk Place, Newark, N. J.

**The Pacific Radio Supplies Co.**  
638 Mission St., San Francisco, Cal.

Distributors for Moorhead Laboratories, Inc., Manufacturers of

## The A-P VACUUM TUBE Combination

TRANSMITTER

**RADIOPHONE HEARD  
JERSEY to SCOTLAND**

HAND TRANSMITTER

TONE ARM PRICE

**MAGNAVOX**

**TRANSMITTERS WERE USED IN THIS TEST**

ORDER YOURS NOW — THE MAGNAVOX CO. — OAKLAND, CALIF.

PRICE

\$37.50

\$25.50

**Build Your Own Apparatus**  
Small Parts at Reasonable Prices  
*Look Them Over*

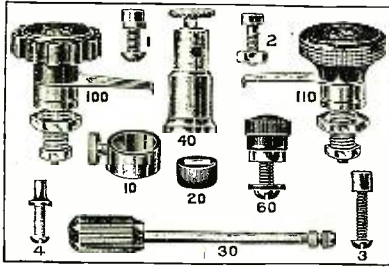

**SWITCH POINTS**

- All switch points are furnished in polished nickel.  
List No. Price Each
- 1 Switch point 3/16 x 1/4 inch head with 6-32 brass screw .05
  - 2 Switch point 3/32 x 1/4 inch head with 6-32 brass nut .05
  - 3 Switch point 7/32 x 7/32 inch head with 4-36 screw .05
  - 4 Switch stop 3/8 inch high with 4-36 screw .06
  - 5 Switch point 3/16 x 3/16 inch head with brass screw .04
  - 6 Switch point 1/4 x 1/4 inch head with brass screw .05

**PARTS FOR CRYSTAL DETECTORS**

These parts are furnished in polished nickel, and may be combined to form a fine detector for panel use, or for mounting on a base.

- 10 Detector Cup 5/8 inch in diameter with knurled set screw for fastening crystal .35
- 20 Crystal, very sensitive, tested galena, mounted in Woods metal .40
- 30 Detector rod, equipped with chuck allowing the use of any size cat-whisker .35
- 40 Detector standard, for use with No. 30 detector rod .35

**SWITCHES AND BINDING POSTS**

- 60 Binding post, polished nickel, with hard rubber top .12
- 100 Switch lever, heavily knurled bakelite knob, furnished with bushing, ready to mount on panel, all metal parts are nickel plated and polished .60
- 110 Switch lever, same as No. 100, but furnished with finely knurled knob as shown in cut .60
- 130 Switch, Marconi knob, laminated lever 1/2 inch radius, furnished with bushing .75

Let us give you our estimate on your special set.

*Attractive Offer to Dealers.*

**EMPIRE RADIO EQUIPMENT CO.**  
271 W. 125 St., New York, N. Y.

**NEW ORLEANS**  
**RADIO**  
**APPARATUS**  
**and SUPPLIES**  
**ROSE RADIO SUPPLY**  
604 Gravier St., New Orleans, La.  
*Send 10c for Latest Catalog*

**HEY!! 'BUGS'**

Here's Something NEW. It's the GUSTAFSON VERNIER DIAL CONTROL. A neat little device and a necessity on every receiving outfit, gives a fine vernier or micrometer adjustment to your dials. NO CAPACITY EFFECT, rapid adjustment, cannot get out of order; can be applied to your present cabinet in two minutes. The vernier indicating dial is graduated in hundredths, giving very fine adjustment; long handles permitting adjustment without "body effect."

Everyone that sees it says: "It's the grandest thing I ever saw, don't see how I ever got along without it, and so simple, practical and neat; you ought to sell a million!" AND WE WILL! at the price—SPECIAL INTRODUCTORY OFFER \$1.00 ea. 3 for \$2.50 or \$9.00 a dozen postpaid.

Better get yours now, before we are swamped with orders. Orders strictly filled in rotation as received. We have a large supply, but they won't last long. Order yours NOW.

**GUSTAFSON BROS.** Quality Apparatus  
1402 N. Hickory St. Joliet, Ill.  
**WATCH FOR THE BIG ANNOUNCEMENT !!**

gram may be looked at reflected in a mirror; or looked thru from the opposite side of the page by being held to the light; or traced over by putting a sheet of paper under the page, and under that a piece of carbon paper face up. The tracing will then show the reverse of Fig. 3. (This method is always useful in getting the reverse side of the drawing of a wired panel.)

It will be noted that as all the apparatus is fastened to the panel, and as all connections to the instrument are made by binding posts on the front, everything may be removed for inspection or for renewal of tubes, merely by undoing the four wood screws and slipping the panel out of the cabinet. A further suggestion is that the panel be hinged to the cabinet at one end by brass pin hinges, so that the panel may be merely swung out, or lifted off the hinges for complete removal. The hinge arrangement is very neat.

The cabinet, with dimensions of 9" x 12" x 4" to take this panel and attached apparatus, was made especially for it, of natural finish oak, 1/2" stock, and was quite expensive. It could be built at home with much less expense, but was included for consistency in using thruout only parts that could be bot complete at retail.

The salient points about the instrument described are its neatness, compactness; fine finish, workmanlike construction, efficiency, and moderate price; to appreciate the effectiveness and cheapness of the set, it should be compared with similar apparatus, say detector and only three-stage amplifier, now on the market and costing considerably more. Furthermore, no one need hesitate at the construction of so simple a set, for the only work is to assemble parts already widely advertised and procurable anywhere.

**Awards of \$100 Radio Prize Contest**

*(Continued from page 514)*

All the different parts are fixt on a fiber panel 1/4" thick and the overall dimensions of the box containing the complete set are 5" x 3 1/2" x 3".

This set also gives excellent results with a loop antenna of two or four turns of fine wire (Fig. 3), concealed inside of an overcoat and reception may be successfully practiced this way while walking in the street. A ground is not necessary as messages come in very clearly without, but one can be easily connected as the set has four binding posts—two for the fone, one for the aerial and one for the ground.

**Controlling by Wireless**

*(Continued from page 523)*

relay closes the circuit to the display apparatus. If the sending switch is still closed, when the arm again passes over the corresponding one at the receiver, more current passes thru the relay and it continues to stay closed. Thus any or all of the display apparatus is at instant control by this selective system.

In regard to this control there are many interesting and novel stunts that may be performed, and numerous machines and apparatus operated with this outfit.

Battleships can be blown up by small submarines, camouflaged by waves of water cut from tin; toy street cars and locomotives can be operated thru mountains and tunnels, while light circuits, motors and numerous mechanical devices can be quite easily controlled.

**BALDWIN PHONES**  
**Special Reduction**

The U. S. Navy, the British, French and several other European Governments, in addition to most professional operators, have adopted BALDWIN PHONES as their standard of electromagnetic receiver excellence.

The reason for this preference is apparent. Exceptional sensitiveness combined with ruggedness gives BALDWIN PHONES their popularity. The diaphragm is made of the finest quality selected mica with the force concentrated at the exact center as in high grade phonograph reproducers. This feature is highly important in the reception of radiophone music.

The small armature is pivoted and designed to act as a fulcrum when connected to the diaphragm by a small link. There is no tension or springing of metal as in ordinary receivers. Four pole pieces of a single solenoid act upon both sides of a highly balanced armature.

Signals that cannot be heard with the best types of ordinary receivers become easily readable with the BALDWIN PHONES.

- Original Type "C".....\$15.50  
Regular Price ..... 16.50
- Improved Type "E"..... 19.00  
Regular Price ..... 20.00
- Lighter Type "F"..... 21.00  
Regular Price ..... 21.00

All types are supplied with the standard Baldwin self-adjusting, self-locking headband which is most comfortable to wear.

These BALDWIN MICA DIAPHRAM AMPLIFYING TELEPHONES, which are shipped direct to us from John Firth & Co., Inc., are absolutely guaranteed to prove fully satisfactory.

**The Kehler Radio Laboratories**  
901 West First St., Dept. R, Abilene, Kansas

**CONSOLIDATION ANNOUNCEMENT**

This is to announce that the MILTON SPECIALTY COMPANY OF COLUMBUS, OHIO is now affiliated with the ELECTRICAL SPECIALTY COMPANY OF THE SAME CITY and will henceforth trade under that name. The policy of the company, which has always stood for high quality and service, will remain the same.

Under the Consolidation agreement this company will continue to handle the Radio Operators' emblems which have proven themselves tremendously popular in the short time that they have been on the market. In addition the company is prepared to supply Radio Clubs with individual pins for their organizations.



This cut represents our popular 14 karat gold-plated coat emblem beautifully finished with a blue-enamelled edge. A truly artistic button that you will be glad to wear.

Prices (Postpaid)

- Emblem coat button.....\$1.00
- 14 Kt. Gold-Filled ring—20-year guarantee... 3.75
- 14 Kt. solid gold ring..... 9.50

**ELECTRICAL SPECIALTY COMPANY**

*Two Offices for Your Convenience*  
Dept. Q, 48-50 So. Front St., Columbus, Ohio  
Dept. Q, 20 N. Ninth St., Philadelphia, Pa.

**SPECIAL FOR THIS MONTH**

- Variable grid condenser, with pointer, scale and knob ready to mount on panel.....\$2.50
  - Variable grid leak ..... 3.00
  - Tube socket ..... 1.00
  - Radio equipment built to order. Amrad, Grebe, Acme and all prominent makes of apparatus in stock. Send five cents for catalogue, this will be deducted from first order of \$1.00 or over.
- A. C. PENFIELD, Conneautville, Penna.

**STANDARD RADIO EQUIPMENT**

AGENTS FOR  
MURDOCK FEDERAL TEL.  
BRANDES AMERICAN RADIO  
BURGESS AUDIO TRON.  
GREBE CHICAGO RADIO LAB.  
BENWOOD SPEC. DUBLIER  
DE-FOREST TRESCO AND OTHERS  
U. of I. SUPPLY STORE, Inc.  
627-29-31 SOUTH WRIGHT STREET  
CHAMPAIGN, ILLINOIS

**ROLLER-SMITH COMPANY**

*Manufacturers of*

**Electrical Measuring Instruments**  
**Meters and Circuit Breakers**

15 Barclay Street New York, N. Y.

## Junior Radio Course

(Continued from page 538)

In practice, to avoid the production of unused oscillatory current during the time no signals are sent, the key is placed at such a point in the circuit that the V. T. oscillates only when the circuit is closed. In order to keep the wave-length constant, a condenser replaces the aerial, the latter being only coupled to the oscillatory circuit, Fig. 5.

We will explain, in the next lesson, how the V. T. oscillator is used in the regenerative circuit at the reception and as separate heterodyne.

Questions for this lesson:

1. Explain the use of the coils in the grid and plate circuit of a V. T. oscillator.
2. What happens in the circuits when the filament is lit up?
3. Where is the key connected in a C. W. transmitter and explain why it is best to make and break the circuit at a certain point?



### PARAGON RHEOSTAT

\$1.75 POST PAID

For back of panel or table mounting. 2 1/4 in. dia., 6 ohms. 1 1/2 amps.

De Forest CV500A Variable Condenser (No knob or pointer). A few left, at \$3.75

\$10 General Radio Hot Wire Ammeters (flush type) \$7.75

### ANTENNA WIRE 1c PER FOOT

7 strands, No. 22 copper, tinned to prevent corrosion. Include Postage on 15 lbs. per 1000 ft.  
Young & McCombs Rotary Gap.....\$16.00  
Cunningham No. C300 Detector VT.....\$5.00



### HONEYCOMB COIL ADAPTORS

\$1.50 Per Pair

Attach to binding posts of any Variable Condenser—insert H-C Coil—making a Tuning Unit. Two Units make a Loose Couple, a third makes a Ticker Coil. One makes a first class Wavemeter.

**RADIO EQUIPMENT CO., 630 WASHINGTON ST. BOSTON, 11, MASS.**  
4th FLOOR

## ROTARY QUENCHED GAP

\$20 POSTPAID

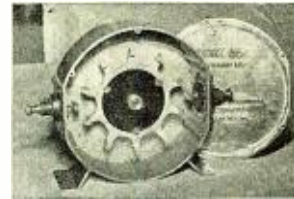

"The Efficiency of the Rotary Gap with the Silence of the Quenched Gap is what you have always wanted and now, the Obstacle of High Price is Removed."

Specifications—Cast Aluminum Housing. Real Bakelite Insulation, on both Rotor and Bushings. Rotor Points, Aluminum; Stationary Point, Copper—For Best Quenching Effect. Extremely Lightweight and Compact. The Smallest Universal Motor Will Run It.

Place your order now, while we are well stocked.

## 44 VOLT VARIABLE B BATTERY

\$3.60

(Plus Postage on 4 lbs.)

Complete in handy wooden case with adjustable phosphor bronze "Jiffy" Connectors. Better than block batteries. If one 4.4 volt unit weakens prematurely, it can be removed and replaced, thereby not impairing the total voltage—making this the best battery value on the market; fresh 4.4V renewal units always in stock. 40c each, or \$3.10 per 10, plus 4 lbs. postage

## FADA Audion Control Panel—With the Automatic Filament Control

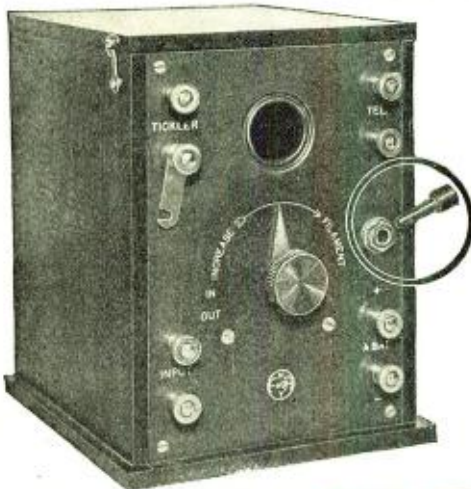

IT REMAINED for Frank A. D. Andrea to design and produce an audion control panel of supreme workmanship, and then add this long-wanted feature—a built-in automatic filament control. With the new FADA Panel, you can leave your set, all tuned up, all ready to go right ahead when you come back, simply by disconnecting that little control plug. It's features like this that give the distinguishing touch between Fada apparatus and all the rest. Of course, you naturally expect the utmost in materials, design and workmanship from instruments produced under the personal direction of Mr. Andrea. These are the definite standards, however, that have been set for every Fada instrument:

- Genuine Grade XX Hand-Grained, milled edge panels. Quartered oak, hand rubbed.
- Ebony finish cabinets with hinged top for inspection. No moulded parts.
- Hand-drawn nickel-plated copper bus-bar wiring.
- Exposed parts hand-buffed and polished nickel.
- Workmanship by instrument makers, not shoemakers.

### Frank A. D. Andrea

1882 Jerome Ave. New York City

Progressive dealers are invited to write for the FADA dealer plan. A cleancut, man size, profitable proposition.

|   |
|---|
| <b>CONTROL PANEL</b><br>(As illustrated)<br>Automatic filament control. Grid-Leak-Condenser. Ticker connections. Cabinet for "B" Battery. Dimensions, 7 1/2" x 5 1/2" x 6 1/2" \$17.50  |
| <b>DETECTOR AND TWO-STAGE AMPLIFIER</b><br>Automatic filament control. Quartered oak cabinet. Ebony oak finish. (Less batteries) \$65.00<br>Extra binding posts for loud speaker connections.   |
| <b>FADA UNIVERSAL BINDING POSTS</b><br>Heavily nickel plated and polished. Identical with those used on Fada instruments. Complete with nut and terminal. 16c   |
| <b>IN STOCK AT</b><br>H. I. Sackett, Buffalo, N. Y.;<br>American Electro Technical Appliance Co., N. Y. C.; Northwest Radio Co., Seattle; Manhattan Electrical Supply Co., N. Y. C.;<br>Continental Radio and Electric Corp., N. Y. C.; General Apparatus Co., N. Y. C. |

### To the Radio Experimenters:

The next time you go to your Radio Dealer's, ask him to show you the G. A. Laboratory Type Detector and Amplifier controls. They were designed to be the handy units that every Experimenter needs in trying out new circuits or making measurements and experiments. The sort that fit into every laboratory.

Condensite Celloron is a new material, distributed by the G. A. Company, which Experimenters who have used it consider the only kind of tubing for inductances. It is specially good for short wave sets and C. W. transmitters. You will find it very strong, perfectly round, impervious to moisture. If your dealer doesn't carry C-C, he can get it for you from the G. A.

M. B. SLEEPER,  
President,

THE GENERAL APPARATUS CO., INC.

|               |  |         |
|---------------|--|---------|
| C-C           | ALL INDUCTANCES should be wound on Condensite-Celloron tubing. 5" lengths, 3/32" wall, 3" diam., \$1.47; 3 1/2", \$1.66; 4", \$1.82; 4 1/2", \$1.97; 5" \$2.09 | 2.09    |
| Litz          | LOUDER SIGNALS, SHARPER TUNING on coils wound with litz, per 100 ft. 10—No. 38, D. S. C., \$7.75; 20—No. 38, \$1.15; 3 x 16—No. 38 \$2.25                      | 2.25    |
| GLC           | SPEND YOUR MONEY effectively. The G. A. Grid Leak and Grid condenser is equal to the expensive types and costs only \$0.50                                     | .50     |
| Chelsea       | VARIABLE AIR CONDENSERS are just right for panel mounting. Fully balanced. 0.0011 mfd., \$2.75; 0.0006 mfd. \$4.25   | 4.25    |
| Bakelite      | STANDARDIZED PANELS, cut true and square, are listed in the G. A. Bulletin. Special price on 5 x 5 x 3/16" \$0.60  | .60     |
| Detector      | G. A. LABORATORY TYPE CONTROL, the prettiest little unit you ever saw, simply made of the finest parts..... \$5.95   | \$ 5.95 |
| Amplifier     | G. A. LABORATORY TYPE, has Federal transformer. Three in a row will not howl on any adjustment..... \$13.95  | 13.95   |
| Transformer   | NEW FEDERAL for Radiotrons and Audiotrons. You can't question their superiority when you test them against other types..... \$7.50                             | 7.50    |
| Switch Parts  | FINELY FINISHED switch points, 3/16 x 1/4" high, 6-32 screw, 05c; 50c doz. Switch 1" radius, separate bearing..... \$0.60                                      | .60     |
| Plate Battery | G. A. STANDARDIZED plate batteries are the ones which give you service. 22 1/2 volts. Signal Corps size, \$1.25; Navy size..... \$2.00                         | 2.00    |
| Time Receiver | YOUR OPPORTUNITY to get a 200 to 2,500 meter cabinet set, with antenna materials and 1,000-ohm Murdock phone for..... \$20.00                                  | 20.00   |

Did you get your new G. A. Bulletin of Standardized Supplies? If not, Send 3c for it.



The General Apparatus Company, Inc.  
570-N West 184th Street, at St. Nicholas Avenue, New York

# The Third Edition of the Consolidated Radio Call Book Very Greatly Enlarged

192 pages. (32 pages more than 2nd edition,) better paper, stiff covers etc.

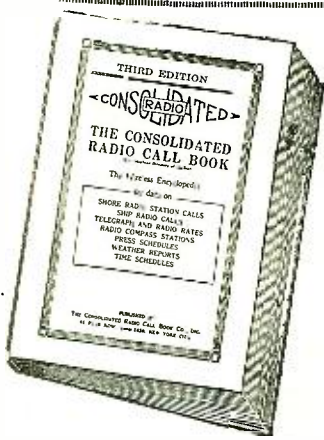

Some of the special information contained in the new book: Radio rate sheet (charges to and from vessels, etc.); Cable rates; Table for finding cable charges to various points; Weather reports and hydrographic reports of the world; Time signal section of the world; American radio compass stations; French radio compass stations; British radio compass stations; Canadian radio compass stations; General information section; International abbreviations; High power radio stations of the world; Press schedules of spark stations.

The Consolidated Radio Call Book is the only book in print officially listing all the Radio calls as issued by the Bureau of Commerce. Every vessel and land station in the world is represented and listed alphabetically, according to names of vessels or land stations, and according to call letters; Revision of American coastal stations under U. S. Naval control, and their new calls.

## Every New Amateur Call Is Listed

### SPECIAL—Given Free with Each Copy

A Wireless Map of the World in colors is given absolutely free with each copy. This map shows the locations of all the high powered RADIO stations in the world, including the time signal stations. In addition it tells at a glance how far away any of these stations are. Of greater interest are the time zones, which enable the amateur to compute instantly the correct time for the zone in which he is located from any time signal station.

The second edition of 10,000 copies was exhausted in ten days. The third edition is selling just as quickly. Don't wait until it is all gone. Order at once, either direct from us or from your favorite dealer.

**Price \$1.50 Prepaid**

**Order Direct from us or for sale by the following responsible Dealers:**

- |  |  |  |
|--|--|--|
| American Electro Tech. Appliance Co.,<br>New York City | Krause & Co. A. F.,<br>Detroit Mich.                       | Radio Equipment Co.,<br>Boston, Mass.                    |
| American Hardware Stores,<br>Bridgeport, Conn          | Manhattan Electric Supply Co.,<br>New York, Chicago        | Radioelectric Shop,<br>Cleveland, Ohio                   |
| Atlantic Radio Co.,<br>Boston, Mass.                   | McCarthy Bros. & Ford,<br>Buffalo, N. Y.                   | Ray-Di-Co.,<br>Chicago, Ill.                             |
| Bamberger & Co. L.,<br>Newark, N. J.                   | McClurg & Co. A. C.,<br>Chicago, Ill.                      | Reuter Electric Co.,<br>Cincinnati, Ohio                 |
| Benwood Specialty Co.,<br>St. Louis, Mo.               | Meter Electrical Construction Co.,<br>Oshkosh, Wis.        | Riverside Laboratory,<br>Milwaukee, Wis.                 |
| Brode Electric Co.,<br>Los Angeles, Cal.               | Meyberg Co., Leo J.,<br>San Francisco, Cal.                | Rose Radio Supply,<br>New Orleans, La.                   |
| Bunnell & Co., J. H.,<br>New York City                 | Mohawk Electrical Supply Co.,<br>Syracuse, N. Y.           | Saunders Co., Geo. S.,<br>Boston, Mass.                  |
| California Electric Co.,<br>San Francisco, Cal.        | New Era Shop,<br>Milwaukee, Wis.                           | Schmidt & Co., Rudolph,<br>Rochester, N. Y.              |
| Catton, Neill & Co.,<br>Honolulu, T. H.                | Newman-Stern Co.,<br>Cleveland, Ohio                       | Shaffers',<br>Norfolk, Va.                               |
| Chicago Radio Apparatus Co.,<br>Chicago, Ill.          | Nola Radio Co.,<br>New Orleans, La.                        | Shotton Radio Mfg. Co.,<br>Scranton, Pa.                 |
| Continental Radio & Electric Corp.,<br>New York City   | Noll & Co., E. P.,<br>Philadelphia, Pa.                    | Smith Novotoy Electric, Inc.,<br>Charlotte, N. C.        |
| Cutting & Washington Radio Corp.,<br>New York City     | Northwest Radio Service Co.,<br>Seattle, Wash.             | Southern Electrical Supply Co.,<br>San Diego, Cal.       |
| Detroit Radio Laboratories,<br>Detroit, Mich.          | N. S. W. Bookstall Co.,<br>Sydney, Australia               | United Radio Telegraphers' Assoc.,<br>Baltimore, Md.     |
| Dewey Sporting Goods Co.,<br>Milwaukee, Wis.           | Pacent Electric Co.,<br>New York City                      | Western Radio Electric Co.,<br>Los Angeles, Cal.         |
| Doubleday-Hill Electric Co.,<br>Pittsburgh, Pa.        | Paramount Radio Supply Co.,<br>Atlantic City, N. J.        | Whitall Electric Co.,<br>Westerly, R. I.                 |
| Electro Importing Co.,<br>New York City                | Parks, Henry Francis,<br>Butte, Mont.                      | White & Boyer Co.,<br>Washington, D. C.                  |
| Findley Electric Co.,<br>Minneapolis, Minn.            | Pearlman's Book Shop,<br>Washington, D. C.                 | Williamson Electric Co.,<br>H. E.,<br>Seattle, Wash.     |
| Fuller Co., Seth W.,<br>Boston, Mass.                  | Penn Radio Apparatus Co.,<br>Reading, Pa.                  | Wilmington Electrical Specialty Co.,<br>Wilmington, Del. |
| Gurd & Co., Wm.,<br>London, Canada                     | Pennsylvania Marconi Wireless School,<br>Philadelphia, Pa. | Wireless Mfg. Co.,<br>Canton, Ohio                       |
| Holt Electric Utilities Co.,<br>Jacksonville, Fla.     | Piedmont Electric Co.,<br>Asheville, N. C.                 | Wireless Press,<br>New York City                         |
| Hovey, A. T.,<br>Boston, Mass.                         | Pioneer Electric Co.,<br>St. Paul, Minn.                   | Wireless Shop,<br>Los Angeles, Cal.                      |
| Jenkins, Lester L.,<br>New Bedford, Mass.              | Pitts Co., F. D.,<br>Boston, Mass.                         | Young & McCombs,<br>Rock Island, Ill.                    |
| Katzenbach & Co., F. S.,<br>Trenton, N. J.             | Post Office News Co.,<br>Chicago, Ill.                     | Young Men's Christian Assoc.,<br>Los Angeles, Cal.       |
| Kendall Co., W. D.,<br>Worcester, Mass.                | Precision Equipment Co.,<br>Cincinnati, Ohio               | Zamoiski Co., Jos. M.,<br>Baltimore, Md.                 |
| Killoch Co., David,<br>New York City                   | Radio Distributing Co.,<br>Newark, N. J.                   |  |
| Kluge, Arno A.,<br>Los Angeles Cal.                    | Radio Electric Co.,<br>Pittsburgh, Pa.                     |  |

Published by

# Consolidated Radio Call Book Co., Inc.

41 Park Row, New York City

## Notes on Modulated Tube Transmitters

(Continued from page 525)

shown that very little is gained by making the choke coil reactance greater than twice the resistance of  $R_o$  and  $R_m$  in parallel. That is, the value of choke coil inductance may be determined from the formula

$$L = \frac{2 R_o R_m}{R_o + R_m} \times \frac{1}{2 \pi f}$$

$$= \frac{R_o R_m}{\pi f (R_o + R_m)}$$

It is not at all necessary, therefore, to make the choke coil as large as has been popularly supposed. In fact, increasing the coil reactance from twice the parallel resistance of oscillator and modulator to infinity only increases the modulation about ten per cent. The frequency used in the above formula for determining  $L$  should be the lowest that is apt to be encountered in talking. This is about 200 cycles. The current thru the choke coil will not be con-

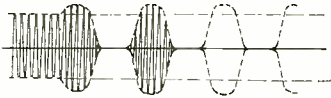

FIG. 6.

Curve Showing the Distortion Produced When Working With Under Excitation.

stant and indeed it is this very variation in current which produces the changes in voltage across the choke coil and causes modulation.

From considerations of space, weight, resistance and cost, the choke will practically always be of the iron core type. The design problem presented in this case is somewhat different from that of the ordinary iron core choke coil because of the fact that the winding always carries a direct current, this being the combined current to the oscillator and modulator. The magnetizing effect of this current tends to saturate the iron core reducing thereby its permeability and hence the inductance of the coil. The conditions encountered may be explained by reference to Fig. 12. This figure shows the normal B-H curve for the iron core and also the way in which the permeability varies with the magnetizing force. The direct current from the high voltage source in flowing thru the wind-

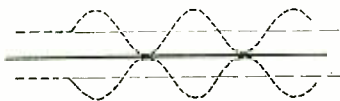
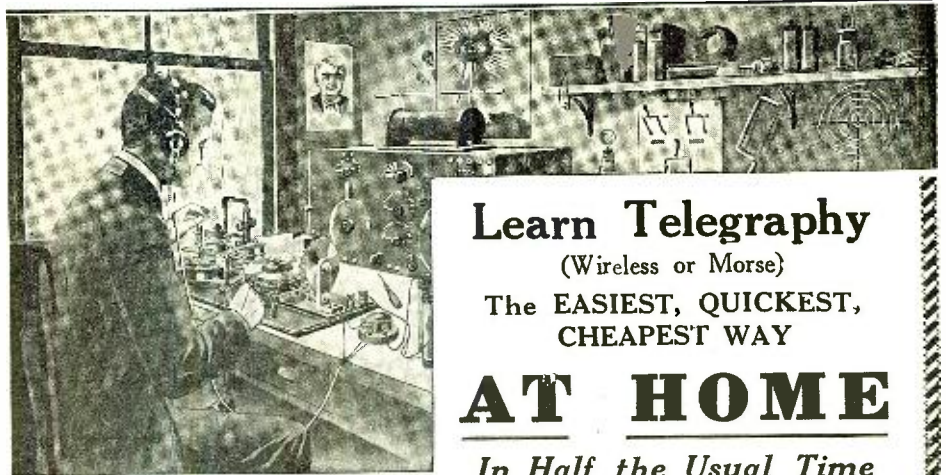

FIG. 7.

With a Proper Value of Excitation the Current is Completely Modulated.

ing of the coil, quickly saturates the core and the flux density reaches some such value as A on the curve. The permeability is then very low; it may in fact be nearly unity so that the iron is not at all effective and the inductance of the coil is not much greater than would exist were the iron entirely removed. The whole device becomes a choke in name only and the modulation qualities of the system are lost.

In order to prevent this effect an air gap must be cut in the magnetic circuit of the core. This flattens out the magnetization curve as shown in Fig. 13 and the permeability at the working magnetization is higher and more nearly constant for vary-



## Learn Telegraphy

(Wireless or Morse)

The EASIEST, QUICKEST, CHEAPEST WAY

# AT HOME

In Half the Usual Time

## WITH THE OMNIGRAPH

"Just Listen—The Omnigraph will do the teaching"

The Omnigraph is an *Automatic* Transmitter that teaches you both the Wireless and Morse Codes, at home, without any expense except the cost of the machine itself. Merely connect to battery and your Buzzer, or Buzzer and Head Phones, or to your Sounder and the Omnigraph will send unlimited messages by the hour, at any speed you desire.

USED BY THE U. S. GOVERNMENT

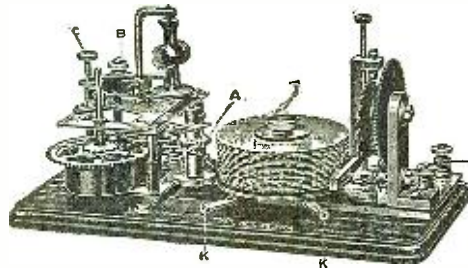

The Omnigraph is used by the Government in testing all applicants applying for a Radio License. It is also used extensively by the large Universities, Colleges and Telegraph Schools throughout the Country for teaching Wireless and Morse. Hundreds of the Army's skilled operators who served during the war learned with the Omnigraph.

## Let The OMNIGRAPH Teach You Wireless

For a few dollars you can have a complete outfit that will make you an experienced operator in the shortest possible time. No hard, laborious work—just learn by listening. The Omnigraph is adjustable so you can start receiving messages slowly, gradually increasing the speed as you become proficient.

You'll be surprised how quickly you will attain speed. Even if you are already an operator the Omnigraph will help you. It will make you more proficient, more accurate and more confident. Thousands of Omnigraphs are in use today and thousands of operators owe their success to them.

### Write for Free Catalog

Send for a catalog today, showing the 3 different models, \$14 to \$30. Every Omnigraph is sold with the absolute guarantee that you must be satisfied or your money back for the asking. Mail the coupon today—the catalog will come to you by return mail.

**The Omnigraph Mfg. Co.**  
26 F. Cortlandt St., New York City

**The Omnigraph Mfg. Co.**  
26 F Cortlandt St.,  
New York City

Gentlemen:—

As per your ad in RADIO NEWS please mail me your free catalog of Omnigraphs.

Name .....

Address .....

City..... State.....

Condenser  
No.  
3 B. D.

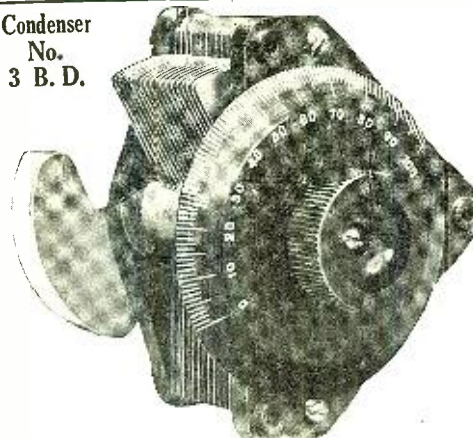

## CHELSEA

Variable Condensers

(Die-Cast Type)

No. 1.—0011 m. f. mounted ..... \$5.00  
No. 2.—0006 m. f. mounted ..... \$4.50  
No. 3. B. D.—0011 m. f. unmounted.... \$4.75  
No. 4. B. D.—0006 m. f. unmounted.... \$4.25  
Bakelite Dials only ..... .75

Top, bottom and knob are genuine bakelite, shaft of steel running in bronze bearings, adjustable tension on movable plates, large bakelite dial reading in hundredths, high capacity, amply separated and accurately spaced plates.

Unmounted types will fit any panel and are equipped with counterweight.

Purchase from your dealer; if he does not carry it, send to us.

Bulletin upon request.

**CHELSEA RADIO COMPANY**  
17 FIFTH STREET, CHELSEA, MASS.  
Manufacturers of Radio Apparatus and Moulders of Bakelite

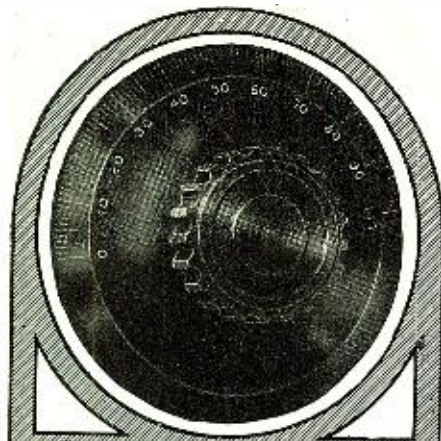

## CORWIN DIALS

There are two kinds of amateurs, those who get real pleasure and satisfaction out of their radio work, by using dependable equipment, and the rest.

There are two kinds of dials, Corwin Dials, and the rest.

The first class of radio men almost invariably choose Corwin Dials.

3" Dial, 75c—with knob, \$1.30

3 7/8" Dial, \$1.00—with knob, \$1.70

At all Radisco agencies, or sent postpaid anywhere

**A. H. CORWIN & CO.**  
4 West Park St., Newark, N. J.

## —INTRODUCING—

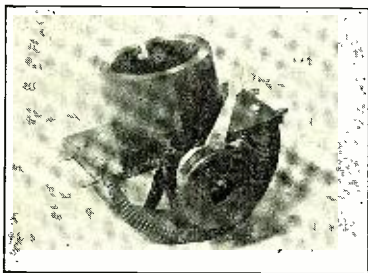

# THE RHEOSOC

Combination Rheostat and Socket. For back panel mounting. BAKELITE throughout.

Type A 9 ohm 1.2 Amp.  
Type B 6 ohm 1.8 Amp.

Price \$2.25

With Radiotron UV200, \$7.

Postage EXTRA—Loose-Leaf Catalog 5c

**A. K. LAING, RADIO SUPPLIES**  
Pelham Manor, N. Y.

**1/4** H. P., 110 volts, A. C., 60 cycle, single phase, 1750 R. P. M.

## MOTORS

LARGE QUANTITIES NEW WASHING MACHINE MOTORS

These are of standard manufacture and carry the full factory guarantee. Shipped in original boxes. Complete as sent. Suitable for operating Coffee Grind or Crock Separators, Bottle Washers, Air Compressors, Small Lathe, Etc.

Mail \$2.00 each or Money order. We will send C.O.D. subject to full examination. Money Back Guarantee.

Write for Catalogue. Special Quantity Prices \$22.50

**\$22.75** Each

MANUFACTURER'S DISTRIBUTOR  
CHAS. H. JOHNSTON - Box 10, W. E., Pittsburgh, Pa.

ing currents. The proper length of air gap depends of course upon the inductance required, the direct current thru the winding to the oscillator and modulator plates, the characteristics of the iron in the core, and economic considerations in design. Low resistance is desirable in the winding in order not to cause too great a loss in voltage furnish to the tubes.

### LIMITATIONS OF TUBE AS MODULATOR

For the best functioning of a tube as modulator it is desirable that its internal plate resistance should drop to a low value when the grid goes a very small amount positive. This condition, however, is far from being met in most practical cases, especially where the same type of tube is used for modulator as for oscillator. Usually it is necessary to drive the grid to an extremely large positive value in order to sufficiently reduce the tube resistance to get maximum modulation. When the grid becomes positive a current flows from it to the filament inside the tube. This current must be supplied from the speech transformer stepping up from the microfone transmitter. Now the transformer must have a very high step-up ratio, in fact its

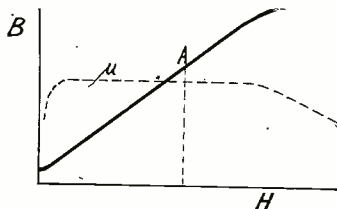

FIG. 13.

This Curve Shows How to Flatten the Magnetization of the Choke Coil Core by Cutting a Gap in the Latter.

secondary impedance will be in the neighborhood of several hundred thousand ohms. Even a very small grid current (which must of course pass thru the transformer secondary) will therefore cause considerable loss in the winding. The microfone itself can only supply a few hundredths of a watt of power on the loudest talk, so the result is that there may not be enough power available to drive the grid to the necessary positive potential to give complete modulation. With the type of tubes supplied in the amateur market, however, it is not hard to get 80 or 85 per cent. modulation when one oscillator and one modulator are used.

When the number of modulator tubes is increased, as is necessary when more oscillators are used, the power required to drive their grids is increased proportionally and for more than two tubes it is necessary to

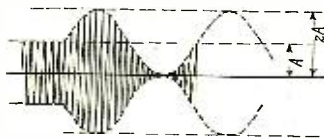

FIG. 15.

Curve of Perfect Modulation Showing the Variations in the Antenna Current.

use a speech amplifier between the microfone and the modulators in order to get good modulation amplitude. A circuit for this purpose is shown in Fig. 14.

A resistance R of several thousand ohms should be inserted in the plate circuit of the amplifier in order to reduce distortion and the ammeter at A will indicate whether or not distortion is present. Its reading will not change when talking into the microfone if there is no distortion.

### BLOCKING

Certain types of tubes when used as modulators produce distorted speech as a result of what is known as blocking. This is due to secondary emission from the grid

## RHAMSTINE\* Radio Products



### PLUG and JACK

Complete - \$1.50 Add Postage - 4c

An efficient and attractive nickel-plated plug and jack is now available at a moderate price. Phone cords easily attached to the connections in the plug—the Jack possesses contacts which automatically place the amplifying transformer in the circuit. Phone Plugs and Jacks can be used in any set and are indispensable in one- and two-step amplifiers.

Order yours today and do away with binding posts and switches. Circular upon request.

### RHAMSTINE\*

2152 E. Larned St. Detroit, Mich.

An especially attractive proposition for Dealers.

\*Radio Plugs and Jacks.

## COMBINATION No. 4

Our Combination No. 4 is the greatest offer we have had the opportunity to offer to the trade for some time.

|   | Reg. Price |
|---|------------|
| 8 "Electrose" Ball Insulators, at 50c each                    | \$4.00     |
| 2 "Electrose" 10" Strain Insulators at \$1 each               | 2.00       |
| 400 ft. No. 13 B. & S. gauge Aerial Wire, at 85c. per 100 ft. | 3.40       |
|   | \$9.40     |

COMBINATION OFFER  
Good until March 15th... } \$7.00  
Allow postage for 12 lbs.

Our new catalog, listing and illustrating an array of the latest and best apparatus is now ready. Send 10c for your copy. The 10c will be refunded on your first purchase of \$1.00 or more.



**Penn Radio Apparatus Co.**  
Dept. 4, Reading, Pa.

## STORAGE BATTERIES

Another lot of the same kind of cells we advertised in December RADIO NEWS; 35 ampere hour Exide, new. Another good buy enables us to offer this lot at only \$2.00 per cell, about a quarter of their worth. This first lot went quick, but this lot is going quicker and you will have to hurry to get in on this once-in-a-life-time bargain. *Every cell is guaranteed to be as represented or your money back.* Net weight, 4 lbs. per cell; size, 1" x 6" x 7". Shipped without electrolyte or wooden trays. Include postage.

**T. & R. ELECTRIC CO.**

2220 Waterman Ave., Detroit, Mich.



and is most pronounced if the plate voltage on the tube is kept high when the grid goes positive. If the plate voltage is kept low the secondary emission is greatly reduced or even altogether absent. Now in the operation of the modulation system in practice, the plate voltage is never constant but in general falls when the speech voltages send the grid positive, and increases when the grid goes negative. If the plate voltage falls at the same instant that the grid goes positive, that is if the grid and plate voltages act in phase, then the likelihood of blocking will be much reduced because when the grid gets over into the dangerous positive region the plate voltage will be very low and there will be no secondary emission. If there is a phase difference between the grid and plate voltages then trouble may be expected because when the grid reaches its maximum positive value the plate voltage will still be relatively high.

Whether or not this phase difference exists to a serious extent depends upon the reactance of the constant current choke coil in relation to the internal resistance of the oscillator. Thus, if these are equal there will be a 45° phase displacement between grid and plate voltages which may be sufficient to cause serious trouble. Increasing the inductance of the choke coil reduces the difference in phase and is hence favorable for the prevention of blocking.

Another precaution which should be taken when the type of tube showing the blocking characteristic is used is to connect a high resistance between the secondary terminals of the speech transformer between grid and filament of the modulator. If this resistance is reduced below a certain value the tube cannot be made to block even with full voltage on the plate when the grid goes positive. With some tubes a hundred thousand ohms or so will suffice while with a certain type of tube with which the author is familiar the resistance must be reduced to only 6,000 ohms to prevent blocking on normal plate voltage.

The blocking phenomenon when present may be very serious endangering the tubes and badly distorting the speech. The two remedies, as first pointed out, are to increase the inductance of the constant current circuit with a high resistance.

**TELL-TALE CONDITIONS IN OPERATING**

*Antenna Current.* One of the most important criteria of operation of the constant current type of telephone circuit is the behavior of the antenna ammeter when talking. It is now generally understood that when the constant current system of modulation is used and is operating properly the antenna current alternately increases and decreases about the average steady value obtained when there is no speech impressed upon the modulator. For 100 per cent modulation the current first reaches double its normal value and then falls to zero. Under such circumstances one's first impression might be that the antenna ammeter should read the same regardless of whether talking were going on or not. (See Fig. 15.) As a matter of fact, however, since the ammeter reads the effective (R. M. S.) current, it should go up when the microphone is spoken into, because the effective value of the modulated wave is greater than that of the unmodulated one. If the modulation is 100 per cent upward and downward and is sinusoidal the antenna ammeter reading should increase 22½ per cent. For other percentages of sine modulation the percent increase in antenna current is given in the following table:

| Per cent. Modulation | Per cent. Increase Antenna Current |
|----------------------|------------------------------------|
| 100%                 | 22.5%                              |
| 90                   | 18.5                               |
| 80                   | 15.0                               |
| 70                   | 11.0                               |
| 60                   | 8.5                                |
| 50                   | 6.0                                |



**RADIO CORPORATION of AMERICA**

**RADIOTRON U. V. 200**  
NEW VACUUM TUBE DETECTOR AND CASCADE AMPLIFIER  
FOR  
AMATEUR AND EXPERIMENTAL WIRELESS STATIONS

**TON of AMERICA**  
**ON U. V. 201**  
OF THE PILOTION TYPE  
FOR  
EXPERIMENTAL WIRELESS STATIONS

**HAVE YOU RECEIVED YOUR COPIES?**

Two descriptive bulletins covering the detector tube—Radiotron U.V. 200; and the amplifier—Radiotron U.V. 201, are now available to every amateur and experimenter in the United States.

These important bulletins contain practical circuits and detailed instructions which will enable the experimenter to obtain the maximum results from Radiotrons. If you have not already received copies, visit your local radio dealer and ask for them or write us direct—they are free.

**DEPENDABLE PRODUCTS**

Radiotron U. V. 200 . . . \$5.00

Radiotron U. V. 201 . . . 6.50

Standard Tube Sockets . . . 1.50

Grid Leaks, Mounted . . . 1.25

Grid Leak Units Only . . . .75

Grid Leak Mountings . . . .50

Interval Transformers . . . 7.50

Burgess "B" Batteries . . . 3.50

The Radio Corporation's tubes are covered by patents dated November 7th, 1905, January, 1907, and February 18th, 1908, as well as by other patents issued and pending. Tubes licensed for amateur and experimental use only. Any other use will constitute an infringement.

Dealers: Let us send you our selling proposition

Address all orders and inquiries to:

SALES DIVISION, COMMERCIAL DEPARTMENT

**RADIO CORPORATION OF AMERICA**

233 Broadway, New York City

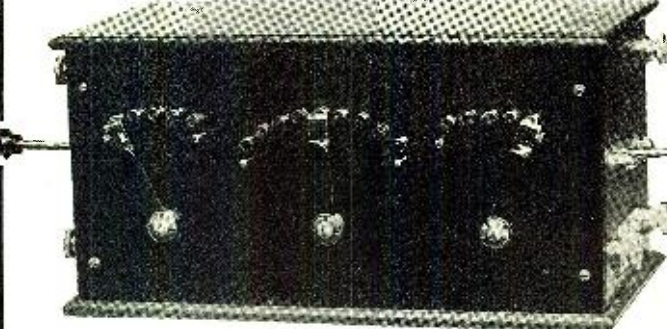

**\$1800**

**A Wonderful Regenerative, 200-600 meter Tuner**

If you want a wider range of distinct tuning—clear, readable signals—buy this efficient tuner with variable primary, secondary and wing circuits. It's the finest and best tuner on the market, and costs only \$18.00. "It's fine for Radio phone work."

Send a 2-cent stamp for bulletins of short and long wave tuners.

**COLBY'S TELEGRAPH SCHOOL** **AUBURN, N. Y.**

## Old-Time Radio Men

Will tell you that Radisco universal wound coils are still way ahead of all the freakish inductances now flooding the market. Don't waste money on experiments. Buy Radisco moderate-priced Coils, and be sure of worth-while service. Kelly and Phillips have a complete stock of Radisco Coils, and will give your orders the benefit of personal attention from members of the firm.

|                          |        |
|--------------------------|--------|
| Radisco Coils:           |        |
| No. 40 .....             | \$ .70 |
| No. 100 .....            | .95    |
| No. 175 .....            | 1.15   |
| No. 325 .....            | 1.40   |
| No. 550 .....            | 1.65   |
| No. 750 .....            | 2.00   |
| No. 1200 .....           | 2.65   |
| Radisco Coils with Taps: |        |
| No. 325-3 .....          | 1.70   |
| No. 750-3 .....          | 2.30   |
| No. 1200-3 .....         | 2.90   |

**Kelly and Phillips**  
312 Flatbush Ave., Brooklyn, N. Y.

## RADIOTRONS!

Positively the last word in vacuum detectors. Unexcelled for use in amateur regenerative circuits.

|   |        |
|---|--------|
| Radiotron U.V. 200 (Detector and amplifier) ..... | \$5.00 |
| Radiotron U.V. 201 (Plotron type) .....           | 6.50   |

Send for special bulletins, and price list of accessories TODAY. We can supply your wants immediately. Give us a trial and be convinced.

**Independent Radio Supply Co.**

1426 S. Clifton Pk. Ave., Chicago, Ill.

## !-MARVELOUS-! ?-MIDGET-?

Smallest of its kind on earth. Practical in every respect. Invention of a Wizard Genius of whom you will hear more of in later copies of this Magazine. Amateurs and Dealers Write Now.

**DETROIT RADIO LABORATORIES, INC.**  
3661 Gratiot Ave., Detroit, Mich.

Order your 3rd edition call book  
Mailed anywhere in U. S. A. \$1.40

## MASTER CONTINENTAL CODE DODGE SHORT CUT ONE HOUR METHOD INSURES SUCCESS

Thousands have. Everybody can. Testimonials free. Investigate and win. Costs 50 cents, Saves 50 dollars.  
C. K. Dodge, Box 200, Mamaroneck, N. Y.

## TELEGRAPHY

(Both Morse and Wireless) and RAILWAY ACCOUNTING taught thoroughly and quickly. Big salaries now paid. Great opportunities for advancement. Oldest and largest school; established 46 years. Endorsed by Telegraph, Railway, Radio, and Government officials. Expenses low—opportunities to earn large portion. Catalog free.

DODGE'S INSTITUTE

Street, Valparaiso, Ind.

A rough indication of how the set is operating and the amount of modulation present may therefore be had by singing a loud sustained note into the microphone and noting the change in the reading of the antenna ammeter. It is hardly possible to produce a pure sine wave from the throat so that the full 22½ per cent. increase in current is not to be expected. The current should, however, increase from 10 to 15 per cent. if everything is working right.

If the antenna current does not increase as it should, or if it remains steady, or decreases when talking, one or more of the following conditions may be suspected:

(a) Bias voltage on modulator grid too negative.

(b) Insufficient amplifier excitation.

(c) Detuning of master oscillator due to talking.

(d) Instability of master oscillator.

(a) In practical operation the bias voltage on the grid of the modulator will always be set somewhere relatively low on the bend of the characteristic curve. When the grid voltage is varied by talking, therefore, the plate current on the positive swing of grid voltage will increase much more than it decreases on the negative swing of grid voltage. If the bias voltage is too far negative the decreases in plate current may be insignificant in comparison with the large increases on the positive grid alternations so that the modulator practically does nothing but abstract power from the system on the average and the antenna output therefore falls. Such condition can be improved by using smaller grid bias on the modulator. It should be of interest to state, in this connection, that by using very small bias on the modulator or even none at all, the peak value of antenna current can be made to considerably exceed double the normal value. Such adjustment is not of course generally desirable since it is attended by distortion and overheating of the modulator.

(b) Insufficient amplifier excitation will cause a decrease in antenna current when talking and may generally be suspected when several tubes are used as amplifiers or the wave-length is long for the circuits used. The situation existing has been explained above under the heading "Amplifier Excitation."

(c) Detuning of the master oscillator due to talking: This is an effect which is very often present in circuits of the oscillator amplifier type and is generally more serious at short wave-lengths than at long ones and where the amplifier is a multiple tube unit. Its existence may be discovered by the following test. Leave the antenna tuning fixt and adjust the wave-length of the master oscillator circuit for maximum antenna current without talking. Upon talking, note that the antenna current does not increase, or even decrease slightly. Now overture the master oscillator slightly; that is, increase the wave-length very slightly until the antenna current just begins to fall due to the mis-tuning. If the effect under discussion is present the antenna current will now fall very sharply upon talking into the microphone. As further evidence, under-tune the master oscillator that is, shorten the wave-length to a value just below that giving maximum radiation without talking. If the effect under discussion is present the antenna current will now rise upon speaking into the microphone. The exact reason for these phenomena and remedial or corrective means for improving the conditions are subject matters of a patent application which cannot yet be disclosed. When present, however, it may be said that it is always best from the standpoint of effective output and quality of modulation to under-tune the oscillator, as described, so as to secure an increase in antenna current when talking.



NEW YORK BOSTON

Offers a thorough course in all branches of wireless telegraphy. Radio Operators earn at the start \$125.00 per month, and first class board, etc., free.

Our school prepares you for your license in three to four months. Positions guaranteed to first grade licensed operators.

Day and evening classes.

The leading Nautical School in U. S. A. Established 1804.

CAPTAIN F. E. UTTMARK, Principal

Write, call or phone for illustrated booklet.

8 STATE ST., NEW YORK, N. Y.

Facing Battery Park, N. Y.  
Telephone, Bowling Green 8079

UTTMARK'S for Nautical Education

## Canadian Amateurs

BUY in CANADA and save \$\$\$\$\$\$

Here are a few additions to our stock Variometers and Variocouplers:

|   |        |
|---|--------|
| Transmitters for Wireless Telephone ..... | \$2.65 |
| Transmitters, Spoon Type, with cord ..... | 7.25   |
| Inductances for Wireless Telephone .....  | 2.25   |
| Marconi V24 Vacuum Tubes .....            | 7.50   |
| Marconi Q Vacuum Tubes .....              | 7.50   |
| Stands for above .....                    | 1.50   |
| Adapters for Standard sockets .....       | 1.75   |

We carry a large assorted stock, and if your requirements are not on our list, write us, as we are daily adding to our stock.

Send .05c. for list.

**THE VIMY SUPPLY CO.**  
567 College Street TORONTO, ONT.



The Midget "FIVE-IN-ONE" Slide Rule is a combination Mannheim, Log-Log, Add and Subtract, Polyphase and Binary Slide Rule. It will instantly add, subtract, multiply and divide any combination involving whole numbers, fractions, decimals and mixed numbers. Gives every possible root and power of every quantity. The graduations are printed on metal coated with white celluloid and are grease and waterproof. While it is the most versatile calculator ever invented, its operation is simple and easily understood. Diameter 4".

Price with 16-page Instruction Book, \$1.50. Leatherette carrying case 50c extra. Catalog free. Your money back if you are not satisfied. Gilson Slide Rule Co., Niles, Mich.

## JUST OFF THE PRESS RADIO TELEPHONE

Simple description of the Radio Telephone with complete circuits of a Transmitter, Receiver and Amplifier. With this data anyone can construct a Radio Telephone capable of talking fifty miles. The Amplifier used with a loud speaker intensifies the voice very clearly. 25 cents postpaid.

FOREST PUBLISHING CO.  
19 Myrtle Street Boston, Mass.

## NOTICE THESE CHANGES IN PRICE

|                      |           |           |
|----------------------|-----------|-----------|
|                      | Old Price | New Price |
| Arnold Coupler       | \$25.00   | \$20.00   |
| Arnold Control Panel | 21.00     | 19.50     |

Write for your copy of our catalog—Free Watch for our March Ad.

DAVID KILLOCH CO., 57 Murray St., N. Y.

(d) Instability of Oscillator: This is characterized by a sharp falling off of antenna current upon talking. It may or may not be accompanied by complete stalling of the oscillator. In any case a hot wire ammeter in the master oscillator circuit or an ammeter in the grid leak or in the d. c. plate lead of same will indicate the existence of the condition. None of these meters should show any variation when talking. If they do, the indications point to instability of the oscillator and the simplest procedure is to readjust the constants of its circuit.

### A New Type of "B" Battery

(Continued from page 517)

When charging with 10 v., 3 amp., insert all plugs, open switch No. 7, and close switch No. 8.

When charging with 10 v., 3 amp., insert all plugs with the exception of Nos. 3 and 4. Open switch No. 8. Close switch No. 7.

To discharge the battery, shut off the charging current, and remove all plugs. Close switch No. 7. Regulate switch No. 9 until the correct voltage is obtained.

The charging current must be *direct current*. Nearly every amateur has a means of providing direct current as low as 10 v., 3 amp.

A battery of this type has a great advantage over one where all tubes are charged in series, in that it makes a rectifier unnecessary, and that it can be charged at a much lower rate with less loss of power, and with much better results. At the first charge the battery should be charged until the positive plates turn dark brown, which usually takes about 48 hours. After the initial charge, the battery only needs to be freshened up occasionally by a charge of five or 10 minutes. The battery should never be left fully discharged as this cuts down its life. I usually have to freshen the charge about twice a week, and sometimes less, but the voltage never gets much below 60. I find that the voltage is much steadier than any battery that I have ever used. Just after I had given my battery a charge of about five minutes, I placed a 15 watt lamp across the discharge terminals, and let it burn for three days while I was not using my set, at the end of which time the lamp had shown not the slightest diminution of brilliancy.

My battery has been in constant operation for over four months and I have not observed the slightest deterioration of any of the parts, nor has the battery ever given me any trouble, or dropt in voltage. I have several "B" Batteries on hand which I purchased and I have found that the battery I have just described gives better results than any of them. I do not think that any one who constructs a battery of this type is wasting either his time or his money, for its life is practically unlimited. The only parts likely to wear out in time are the plates, and these may be easily renewed. Altho the cost of building this battery is much greater than the cost of a factory made battery using flashlight cells, the length of its operating life more than compensates for the higher cost. I would like to hear from any one who is going to, or has already built a battery of this kind, and will be glad to furnish any additional details which I may have neglected to include.

#### THE LONG AND SHORT OF IT

"I see they're not going to have wireless towers any longer at Arlington."

"How's that?"

"They're long enough."

L. FENN VOGT.

## Why we recommend our Navy Type Headset for exacting use

Our Navy Type Headset will produce audible signals from the least amount of current. Since the action is direct on the diaphragm they work at the best mechanical ratio and there is no loss of current necessary to operate intervening mechanical movements. This diaphragm has a natural high pitch which enables the operator to



"Navy Type, 50,000 Ohms A. C. Weight 9 oz., complete with head band and polarity indicating cord. Price \$14.00.

read high pitch signals more readily through static interference.

The Navy Type is wound to an A. C. resistance of 50,000 Ohms and is peculiarly adapted to vacuum tube reception. Then there is the exclusive Brandes feature of perfectly matched tone, which brings in the faintest signals in one clean, clear note.

## Brandes Matched-Tone Headsets

The sensitiveness and matched-tone features of Brandes headsets are permanent. The diaphragm is the only moving part, and as the headsets are of rugged construction for every-day use the adjustment is not easily disturbed. Brandes headsets require no tender care to keep them in perfect condition and no extra strong signal will make them inoperative.

You can pay more for a headset and you can buy a heavier one but you cannot buy a better one than the Navy on the basis of sensitiveness, comfort or price. Send us \$14, and we will send you a Navy Type Headset. Try it for 10 days. If you aren't satisfied, return the headset and we will refund your money without question.

**C. Brandes, Inc., Room 823**  
32 Union Square, New York City

Also makers of

Trans-Atlantic Headsets, 25,000 ohms A.C. .... \$12.00  
Superior Headsets, 2,000 ohms, D.C. .... 8.00

Send 5c for catalog G

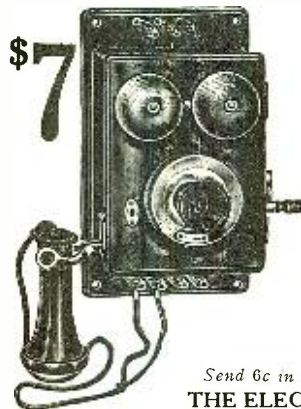

**For Homes, Offices, Factories, Farms**

### Complete Wall Set Magneto Telephone

Western Electric Type

This is a complete commercial telephone station. They were bought from telephone exchanges who put in Central battery types. Slightly used but guaranteed to be in A1 working order.

Will work perfectly at all distances up to 20 miles.

**Long Distance Telephone Set— \$7.00**  
One station  
Shipping weight, 15 lbs.

**Two stations \$13.00**  
Shipping weight, 25 lbs.

Send 6c in stamps for our big 160 page Wireless and Electrical Catalog No. 22.  
**THE ELECTRO IMPORTING CO., 236-a Fulton Street, New York**

Insure your copy reaching you each month. Subscribe to Radio News— \$2.00 a year. Experimenter Pub. Co., 236-A Fulton St., N. Y. C.

# KLAUS RADIO

"The Guarantee of Satisfaction"

When you see this mark you will know that it signifies Service, Reliability—the Indelible Stamp of Superior Quality.

Our hundreds of customers and dealers know that "KLAUS RADIO" is synonymous with Square Dealing.

We take this opportunity to extend to our friends and patrons, Best Wishes for a Happy and Prosperous New Year.

**KLAUS RADIO CO.**  
Eureka Illinois



## Learners "HYTONE" KEY AND BUZZER SETS

With Code and Instructions.  
Easily tuned buzzer (2 adjusting screws), silver contacts.

**Price \$1.75**  
WITH FLAT SPRING KEY \$1.25

|   |             |
|---|-------------|
| Buzzers, unmounted  | .....\$0.50 |
| Lever keys unmounted  | ..... 1.00  |
| High grade lever type sending key, Bakelite base and knob     | ..... 1.50  |
| 20 amp. Batt. switches, machine made. Bakelite base and knob. | ..... .40   |
| Single Throw  | ..... .50   |
| Double Throw  | ..... .50   |

(All postpaid)

**AJAX ELECTRIC CO.**  
Palmer St. Cambridge, 38, Mass.

## INDICATING DIALS

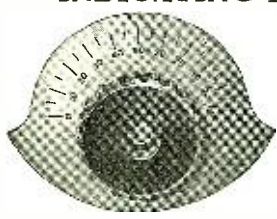

Lacquered brass, 2 1/2" in diameter, genuine bakelite knob 1 1/4" in diameter. Offset shoulders act as stops. Same dial used by U. S. Signal Corps. Your money refunded if not satisfied. Price, three for one dollar, postpaid.

**The Factory Distributing Co.**  
130 N. Wells Street Chicago, Ill.

## RADIO CLUB PINS

Special folder of designs and prices in addition to regular school pin and ring catalog free on request. Be sure to see these new numbers which will put new life in your club

Metal Arts Co., Dept. 11, Rochester, N. Y.



## Sparks and Spark Frequency

(Continued from page 523)

And this with a rating of 250 watts! Efficiency here, omitting all other losses, (and there are many of them) is equal to 8.2 per cent. Yet there are many stations where this very condition exists, altho this might be called an extreme case. You can readily see the effect of spark frequency on efficiency. Every time the number of sparks per second is doubled (the other factors remaining constant), the power going into the condenser is doubled. Substitute 960 for our 120 sparks above and our power becomes 164.64 watts, much nearer full power than the low note. This frequency would give a note approximating 500 cycles (of course we cannot duplicate a 500-cycle spark on 60-cycle supply and altho you may not be able to obtain this frequency, you can see the advantage of approaching as near it as mechanical conditions and conditions of resonance between transformer, primary and secondary will allow.

Don't forget there is a limit to the speed. If we substitute a value for N, that is, give our gap such speed, that according to the formula, gives a result of greater power than we can actually put in, it simply means that the condenser will not charge sufficiently to produce a spark every time a rotary electrode passes a stationary, and a rough, uneven tone will result.

The curves of Fig. 1 should be of great value in the design of a transmitter. From them we can determine just what gap speed and how many electrodes will give highest power for given conditions. Suppose we have a quarter-K.W. with a 10,000 volt secondary. Follow the curve for 10,000 volts to the point where it passes 250 watts, our maximum input. We find that this corresponds to a spark frequency of 720. This means we must have a ten stud gap going at 4,320 r.p.m. or an eight stud gap going at 5,400 r.p.m.

In the same manner, you may find the best frequency for maximum operation of any of the transformers shown. If your voltage is not represented, or if you are using another size condenser a simple calculation from the formula will give your frequency.

From the curves we readily see that with the high voltages we have highest efficiency on 120-360 sparks, the favorite low note, while on the lower voltages highest efficiency is on the high static cutting frequencies. There may be variations in the actual spark frequency used, to suit special cases. A frequency slightly below the value given for full power, may give smooth operation because of the sparks taking place at more desirable intervals on the secondary 60-cycle current wave.

In conclusion, remember high secondary voltage, low note; low secondary voltage, high note. I hope this may be of help to those who want to "spread out" this season.

## Club Gossip

(Continued from page 562)

### RADIO CLUB OF FRANCE.

At the beginning of this year the Radio Club of France was formed in Paris, which was the first of its kind in that country. It was organized for the advantage of the amateurs interested in all branches of Radio.

The club house is equipt with a complete library, a laboratory and a large room where lectures with lantern slides are given quite often by radio engineers and members of the club.

The Radio Club of France will be glad to hear from American clubs and all correspondence should be address to the Secretary, 95 Rue de Monceau, Paris, France.

## Quality WEACO Service

Standardized parts ready to assemble

|              |             |                              |       |
|--------------|-------------|------------------------------|-------|
| DET UNIT     | .....\$4.70 | SPECIAL                      |       |
| DET & 1 STEP | .....14.80  | 6 V, 60-80 A Storage Battery | 20.00 |
| DET & 2 STEP | .....26.40  | year guarantee.              |       |
| 2 Step Amp.  | .....18.80  |                              |       |

### RADIO-CRAFT PRODUCTS

|                     |            |            |            |
|---------------------|------------|------------|------------|
| DET                 | .....15.00 | RHEOSTATS  |            |
| DET & 1 STEP        | .....45.00 | Remler     | ..... 1.25 |
| DET & 2 STEP        | .....70.00 | Paragon    | ..... 1.75 |
| 2 Stage Amp.        | .....50.00 |            |            |
| Short Wave Receiver | .....65.00 | VT SOCKETS |            |
| Variometers         | ..... 6.00 | AMRAD      | ..... .90  |

### BULBS

|                    |            |               |            |
|--------------------|------------|---------------|------------|
| Genuine 2 filament | ..... 6.00 | Radio Service | ..... 1.20 |
| Audiotrons         | ..... 6.00 | Marconi       | ..... 1.50 |
| Electron Relays    | ..... 6.00 | DeForest      | ..... 1.50 |
| Radiotrons, Det.   | ..... 5.00 | Murdock       | ..... 1.00 |
| Radiotron, Amp.    | ..... 6.50 | General Radio | ..... 1.75 |
| Rectifying Tubes   | ..... 7.00 |               |            |

### SPECIAL

|  |                                 |
|--|---------------------------------|
| Navy Type Regenerative receiver complete | .....\$37.50                    |
| Distributors for Cyclon B Batteries 22V. | \$1.20, \$1.40, \$2.40, \$2.75. |

**WESTCHESTER RADIO SERVICE**  
253 So. B'way, YONKERS, NEW YORK

## SIXES & SEVENS

Save time and freight by getting your apparatus from us. We carry full AMRAD and RADISCO stocks. Order from their catalogs. Also DeFOREST, TRESKO, MURDOCK, THORADSON and others.

|                      |             |
|----------------------|-------------|
| A-P Amplifier Tubes  | .....\$7.00 |
| A-P Detector Tubes   | ..... 6.00  |
| Federal Transformers | ..... 7.50  |
| Tube Bases           | ..... 1.00  |
| Grid Condensers      | ..... .34   |
| Rheostats            | ..... 1.50  |
| 2-Stage Amplifiers   | ..... 40.00 |
| 45-Volt B Batteries  | ..... 5.00  |

**NORTHWEST RADIO SERVICE CO.**  
609 Fourth Ave., Seattle, Wash.

## New 1920 RED HEAD PHONES

\$12.50

We announce the new model of the famous Red Head Radio Receivers greatly improved, 3200 ohms, \$12.50 the pair. Distributors for DeForest, Murdock, Signal, Bunnell and other famous lines.

**The Newman-Stern Co.**  
Dept. Q.S.T. Cleveland, O.

## ARLINGTON TESTED CRYSTALS

For over five years the accepted standard for crystal detectors, Galena or Silicon, individually tested and packed in tin containers, postpaid, 35c crystal.

**35c**

We are distributors for Murdock, DeForest, Signal, Amrad and all standard lines.

**THE NEWMAN-STERN CO.**  
Dept. R.N. Cleveland, O.

## A Complete Tuner

and Audion Detector that gets everything from 150 to 600 meters. All enclosed in Walnut case, with bakelite panel and 40-volt B battery.

Price .....\$35.00

Variable B Batteries

|                            |             |          |              |
|----------------------------|-------------|----------|--------------|
| 22 1/2 volts               | .....\$3.00 | 45 volts | ..... \$5.50 |
| 3.500 meter Loose Couplers | .....\$9.00 | up       |              |

Postage Extra - Circular for Stamp  
Jeffery, Crawford, Co., 2173 Hillger Ave., Detroit, Mich.

## -:- EXPERIMENTERS -:-

If you are constructing any type of C. W. apparatus you should see our bulletin No. 8. We offer a complete list of C. W. Apparatus at prices that will meet with your approval.

Send stamp for our lists of Radio and Scientific Apparatus.

**ENOLA SCIENTIFIC COMPANY**  
3326 17th Street Washington, D. C.

## LEARN WIRELESS

at the largest radio school in the Central States. Modern complete equipment. Experienced instructors. Dormitory in connection. Students may earn expenses if necessary. Write today for catalogue and full information.

**CENTRAL RADIO SCHOOL**  
Independence, Mo.



# SPECIAL PREMIUM OFFER

With a Year's Subscription to Radio News or Science and Invention (Electrical Experimenter)

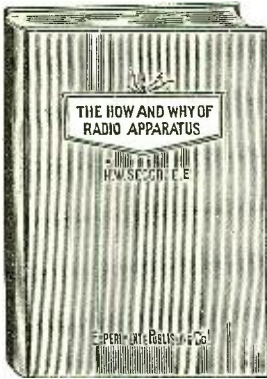

This newest of Radio works, bound in flexible velum and hand sewed, has 160 pages. Size of book 6 x 9 inches.

**Offer A**  
 Science and Invention  
 (Electrical Experimenter)  
 for one (1) year with  
 The How and Why  
 of Radio Apparatus

|            |               |
|------------|---------------|
| REG. PRICE | \$3.00        |
|            | <u>\$1.75</u> |
|            | \$4.75        |

**SPECIAL PRICE OFFER, A or C, \$3.75**

**Offer C**  
 Science and Invention  
 (Electrical Experimenter)  
 for one (1) year with  
 A Thousand and  
 One Formulas

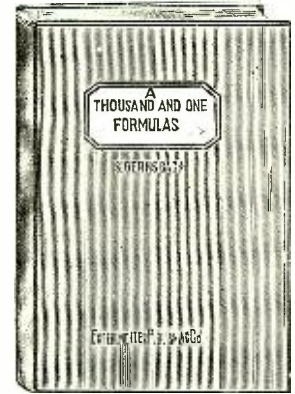

A Laboratory Hand-book for the Experimenter. Bound in flexible velum. 160 pages. Size 6 x 9 inches.

**Offer B**  
 Radio News  
 for one (1) year with  
 The How and Why  
 of Radio Apparatus

|            |               |
|------------|---------------|
| REG. PRICE | \$2.00        |
|            | <u>\$1.75</u> |
|            | \$3.75        |

**SPECIAL PRICE OFFER, B or D, \$2.75**

**Offer D**  
 Radio News  
 for one (1) year with  
 A Thousand and  
 One Formulas

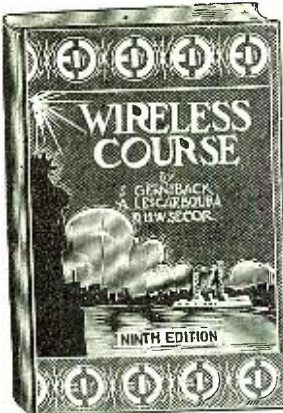

Book is bound in flexible Velum; has 160 pp. Size 7 x 12 inches.

**Offer E**  
 Science and Invention  
 (Electrical Experimenter)  
 for one (1) year with  
 Wireless Course in 20  
 Lessons

|            |               |
|------------|---------------|
| REG. PRICE | \$3.00        |
|            | <u>\$1.25</u> |
|            | \$4.25        |

**SPECIAL PRICE OFFER, E or G, \$3.50**

**Offer G**  
 Science and Invention  
 (Electrical Experimenter)  
 for one (1) year with  
 Experimental  
 Electricity Course



Book is bound in flexible Velum; has 160 pp. Size 5 x 9 in.

**Offer F**  
 Radio News  
 for one (1) year with  
 Wireless Course in 20  
 Lessons

|            |               |
|------------|---------------|
| REG. PRICE | \$2.00        |
|            | <u>\$1.25</u> |
|            | \$3.25        |

**SPECIAL PRICE OFFER, F or H, \$2.50**

**Offer H**  
 Radio News  
 for one (1) year with  
 Experimental  
 Electricity Course



Printed on heavy paper, paper bound. Size 5 x 7 inches. Fully illustrated. The latest book out.



Book has 100 pages. Size 5 x 7 inches. 88 illustrations. Paper cover printed in two colors.



Book has 100 pages. Size 5 x 7 inches. 90 illustrations. Paper bound, in two colors..

**Offer K**  
 Science and Invention  
 (Electrical Experimenter)  
 for one (1) year with  
 Design and Construction of  
 Audion Amplifying-Trans-  
 formers.  
 How to Make Wireless Send-  
 ing Apparatus.  
 How to Make Wireless Re-  
 ceiving Apparatus.

|            |               |                      |
|------------|---------------|----------------------|
| Reg. Price | \$3.00        | Special Price to you |
|            |               | <b>\$3.25</b>        |
|            | .95           |                      |
|            | <u>\$3.95</u> |                      |

**Offer L**  
 Radio News  
 for one (1) year with  
 Same Books as Offer (K)

|  |               |               |
|--|---------------|---------------|
|  | \$2.00        | <b>\$2.25</b> |
|  | .95           |               |
|  | <u>\$2.95</u> |               |

EXPERIMENTER PUBLISHING COMPANY, Inc.  
 236-A Fulton Street, New York City, N. Y.

Dear Sir:

I accept your offer ..... Enclosed find \$.....  
 in payment of premium and one year subscription.

Name .....

Address ..... Town ..... State .....

# OPPORTUNITY AD-LETS

Follow these advertisements every month. Reliable advertisers from all over the country offer you their most attractive specials in these columns.

Classified advertising rate six cents a word for each insertion. Ten per cent discount for 6 issues. 20 per cent discount for 12 issues. Name and address must be included at the above rate. Cash should accompany all classified advertisements unless placed by an accredited advertising agency. No advertisement for less than 10 words accepted.

Objectionable or misleading advertisements not accepted. Advertisements for the April issue must reach us not later than March 10.

## THE CIRCULATION OF RADIO NEWS IS OVER 40,000

EXPERIMENTER PUBLISHING CO., INC., 233 and 236 Fulton Street, New York, N. Y.

### Automobiles.

Six Gold Inittals for your auto, 25c coin. Lafave, 134 W. Park St., Watertown, N. Y.

### Automobile Accessories.

Auto Motors Supplies.—Buick, Michigan, Stoddard-Dayton, E. M. F., Cadillac, Overland, Continental and Buda Motors. All types \$50 each and up. Special High Tension Magnets 2 and 4 cylinder, \$9.50 each. Electric & Gas Head Lamps, Coils, Carburetors, Air Compressors, Generators, Starters, etc. Write for catalog. Address Motor Sales Dept. 16, West End, Pittsburgh, Penna.

### Aeronautics.

Aviation—Motor 30-40 H.P. 2 cyl. oppose air cooled, weight 128 lbs., ideal motor for light aeroplanes, motor sleds, wind wagons, hydroplanes, etc. Price only \$325 complete, with propeller ready to run. Aircraft Service, 338 Coney Island Ave., Brooklyn, N. Y.

Boys Make a Model Aeroplane that will fly. Easily made at small cost. Write for circular. Aero Shop, 658½ Hurlburt Ave., Detroit, Mich.

### Motor Engines and Dynamos.

Special Garage Motors: New; manufactured by General Electric Co. ¼-Hp., \$22.75; 1-Hp., \$88.50; 2-Hp., \$126.50; 3-Hp., \$146.50; 5-Hp., \$188.50. All sizes both single and Polyphase Motors for immediate delivery. Special charging generators all voltages. Write for catalog. Motor Sales Dept. 16, West End, Pittsburgh, Penna.

### Motorcycles—Bicycles.

Don't Buy a Bicycle Motor Attachment until you get our catalogue and prices. Shaw Mfg. Co., Dept. 1602, Galesburg, Kans.

### American Made Toys.

An Opportunity for Home Workers on small scale and manufacturers on large scale to make American Metal Toys, Army, Navy, Machine Guns, Cannons, Warships, Indians, Cowboys, Wild Animals, Whistles, Bird-Whistles, Religious designs and other toys and novelties. Greatest chance for industrious people to have an independent business. Enormous demand for cheap toys offers unlimited field and great future all over United States and foreign countries. Experience, or tools not necessary. Hundreds and more made complete per hour. Casting forms, complete outfit from \$3.00 up. We buy these goods paying fixed prices. Attractive prices offered for painted goods. A strictly business proposition. No one need apply unless he means business. Booklet and information furnished free. We have no sales agents and we warn against worthless and cheap imitations. Toy Soldier Manufacturing Co., 1696 Boston Road, New York.

Enter a Good Business for \$50. Must sacrifice new outfit of toy soldier manufacturing company's molds. A real opportunity. T. P. Hagerman, 1929 McCausland Avenue, St. Louis, Mo.

### Stammering.

St-Stu-t-t-tering and Stammering cured at home. Instructive booklet free. Walter McDonnell, 121 Potomac Bank Bldg., Washington, D. C.

### Help Wanted.

Stop Daily Grind. Start silvering mirrors, auto headlights, tableware, etc. Plans free. Clarence Sprinkle, Dept. 48, Marion, Indiana.

Earn \$25 Weekly, spare time, writing for newspapers, magazines. Experience unnecessary; details free. Press Syndicate, 5665, St. Louis, Mo.

Be a Mirror Expert. \$3-\$10 a day; spare time home at first; no capital; we train, start you making and silvering mirrors, French method. Free prospectus. W. R. Derr, Pres., 579 Decatur St., Brooklyn, N. Y.

Detectives Earn Big Money. Excellent opportunity. Travel. Great demand everywhere. Fascinating work. Experience unnecessary. Particulars free. Write, American Detective System, 1968 Broadway, New York, N. Y.

### Agents Wanted.

Young Men (with electrical knowledge preferred) to establish branches everywhere for our new service. (No capital required.) If you are ambitious and wish to make big money it will pay you to investigate. We have no time for curiosity seekers and time wasters. If you are in earnest and mean business send 25c coin for proposition and contract. Mr. Young, manager, 148 Dorrance Street, Halkyard Building, Providence, R. I.

### Business Opportunities.

Good Money, eventually independence. Learn metal plating, silvering mirrors, allied crafts. Prospectus free. Decie Laboratories, Suite 206B, 286 Fifth Ave., New York.

Make Money at Home making toys. We show you how. Send 50c postoffice order, "no stamps" for complete working drawings and instructions. DeKalb Designing Co., 320 So. McDonough St., Decatur, Ga.

25c Coin brings household necessity and wholesale price. Wonderful seller. Lafave, 134 W. Park St., Watertown, N. Y.

Substantial Manufacturing Corporation wants capable men to establish branch and manage salesmen; \$300 to \$2,000 necessary. Will allow expenses to Baltimore as explained. Address Mr. Clemmer, 603 N. Eutaw St., Baltimore, Md.

Boys! Boys! Send 25c at Once for my unequalled plan of turning your spare time into money. You will be glad you did. Curtis Bourne, Omaha, Nebr., Box 619.

If You Want to Sell or Exchange your farm, unimproved land, city property or patent, write me. John J. Black, 194th St., Chippewa Falls, Wis.

Own Your Own Business—Spare time at home. Instructions for manufacturing two "good sellers" at home; postpaid, 10c coin. Auburn Novelty House, 148 Dorrance St., Providence, R. I.

### Books.

The Amateur Electrician. Pocket size, 20c (coin). Joe Tillberg, Proctor, Vermont.

Electricity, Magnetism, induction, experiments, dynamos, armature windings, all explained in 22 chapters, 348 pages, in Hawking Electrical Guide, Vol. 1; postpaid, \$1.00. Stratton Electric Co., 215 Federal Street, Greenfield, Mass.

Advertise in 100 Magazines. Words 9c each; three times 18c each. Concordia Magazine, 9A Water, York, Penna.

We Buy and Sell back issues of Radio Amateur News and Electrical Experimenter. Boston Magazine Exchange, 109 Mountfort St., Boston, Mass.

How to Make Wireless Sending Apparatus. 100 pages—88 illustrations. Written and published entirely for the wireless enthusiast who wants to make his own radio apparatus. Contains more information on "how to make it" than any other book we know of. Paper bound, 35c. postpaid. Experimenter Publishing Co., Book Dept., 236-A Fulton St., New York City.

How to Make Wireless Receiving Apparatus. 100 pages—90 illustrations. Only strictly modern radio apparatus are described in this book and the illustrations and descriptions are so clear and simple that no trouble will be experienced in making the instruments. Paper covered, 35c. postpaid. Experimenter Publishing Co., Book Dept., 236-A Fulton St., New York City.

### Chemistry

Chemistry at a Glance. Learn qualitative analysis by the modern simplified chart method. Charts complete, U. S. and Canada, \$1. Foreign countries, \$2. Address Technical Charts, Dept. C-1, 1038 West Chicago Ave., Chicago, Ill.

### Miscellaneous.

Big Mail Free! Just send your name. W. E. Fitzpatrick, Box 722, Chicago, Illinois.

### News Correspondents

Earn \$25 Weekly, spare time, writing for newspapers, magazines. Experience unnecessary; details free. Press Syndicate, 566 St. Louis, Mo.

### Patent Attorneys.

Mr. Inventor! Investigate the possibilities of obtaining your own patent. Save \$40 to \$100. We prepare drawings, specifications and claims you file. Quicker action. Let us explain. Enclose stamp. The Plan Bureau, 1929 McCausland Ave., St. Louis, Mo.

Patents Secured—Prompt service. Avoid dangerous delays. Send for our "Record of Invention" form and free book telling "How to Obtain a Patent." Send sketch or model of your invention for preliminary examination and advice free. Charges reasonable. Write today. J. L. Jackson & Co., 133 Ouray Bldg., Washington, D. C.

Millions Spent Annually for Ideas. Hundreds now wanted. Patent yours and profit. Write today for free books, tell how to protect yourself, how to invent, ideas wanted, how we help you sell, etc. 301 Patent Dept., American Industries, Inc., Washington, D. C.

### Correspondence Courses.

Dollars Saved. All kinds of used correspondence courses sold. (Courses bought). Lee Mountain, Pisgah, Alabama.

### Electrical Supplies and Appliances.

Water Locating by Mansfield's water finder is interesting and profitable. Particulars from Edwin Mansfield & Co., 94 Victoria Road, New Brighton, England.

Storage Batteries, 35 ampere hour, standard make, new, without acid or wooden tray, \$2 per cell plus transportation. Supply limited. T. & R. Electric Co., 2220 Waterman Ave., Detroit, Mich.

### For Advertisers.

Don't Wait for Business.—Advertise and get it. We will help you. Jacobus Service, 41 Bruen, Irvington, N. J.

Sales Letters that pull results, \$2. Advertisements and circulars. Write for free suggestions on your sales problem. P. Jeffery, 484 Palisade Ave., West New York, N. J.

### Formulas.

Formulas Worth While. Aluminum solder, etc. Profitable, operative, effective. Florasynth Co., 1409 Chemical Bldg., St. Louis.

### Health.

Pyorrhea (Kigg's disease—bleeding or swollen gums)—hundreds have been helped by "Pyorrdent" the successful home pyorrhea treatment. Purifying, healing, preventative. Full month's treatment, consisting of a very beneficial massage paste and an antiseptic tooth-cleansing paste to be used in place of your ordinary dentrifice, together with full directions for treatment. \$1 postpaid. Or write for free booklet "R." Pyorrdent Mfg. Co., 439 Seventh St., Brooklyn, N. Y.

Tobacco or Snuff Habit Cured or no pay; \$1 if cured. Remedy sent on trial. Superba Co., SB, Baltimore, Md.

"The New Treatment for Blood." Latest treatise on how to cure and prevent all sickness. Literature free. Cimino, 339 Leonard St., Brooklyn, N. Y.

### Jewelry

Watches and Jewelry repaired by experts. Prompt service. Low prices; perfect work. Satisfaction absolutely guaranteed. Send by registered mail. We will write you cost. Your property returned immediately if price not acceptable. Send to Turpish & Sons, 104 Stapleton, New York City.

### Mailing Lists.

Canadian Lists of automobile owners, agents, garages, repairers, dealers, \$3 per 1,000. Lasnier Agency, Bathurst, N. B., Canada.

### Novelties.

Genuine Indian Baskets. Wholesale catalogue. Marion Gilhams, Highland Springs, California.

(Continued on page 581)

(Continued from page 580)

**Office Devices.**

**We Buy for Cash, Rebuild and Sell** for about half new price, multigraphs, addressing machines, duplicators, etc. Don't be misled by firms infringing on our name. We are the original Office Device Company, 154-C West Randolph, Chicago.

**Printing.**

**5,000 1 1/4 x 2" labels, \$2.50.** Save 30%. Wolf, Sta. E., Desk J, Philadelphia, Pa.

**Photography**

**Dollar Note Brings Formula** and simple instructions. Practical developer, cuts exposures one half. No more underexposed plates. A winner to manufacture or sell recipe. Guaranteed. Manufacturing formulas, trade secrets, processes. Florasynth Company, 1409 Chemical Bldg., St. Louis.

**Lucky Thirteen**—Beautiful 5x7 enlargements from your films 13 cents each postpaid; 8x10, 30 cents. Keep me busy. Paul Wood, 3815 Draper Place, Erie, Pa.

**Phonographs.**

**Build Your Own Phonograph.** Big Saving. Blue prints, parts price list, instructions free. Associated Phonograph Co., Dept. R-N, Cincinnati.

**Postcards**

**Everything in Postcards**—Live-wire list free. Worth while samples, 25c. Mention subjects preferred. Mutual Supply Co., Bradford, Pa.

**Blue Bird Correspondence Club.** "To promote happiness." Club magazine dime. Swap Bulletin, New York—Detroit.

**Rubber Stamps**

**Your Name and Address** on a neat rubber stamp, 25c., postpaid. Inkpads, 20c. W. E. McMillan Co., Industry, Ill.

**Stamps and Coins.**

**California Gold Quarter** size and Colombia nickel coin 30c; Italy 10 Centimes and catalog 10c. Homer Shultz, King City, Mo.

**500 Different Stamps,** \$1.40; 200, 30c.; 100, 13c.; approval. Michaels, 5600 Prairie, Chicago.

**100 Different Stamps,** Nicaragua, Salvador, Victoria, Brazil, Chile, large pictorial French Colonies, etc., album with perforation gauge, only 10c silver. Stamp collections and accumulations bought. Clarence Gibbs, 8932 Juniper, Los Angeles, Calif.

**25 Different War Stamps** 25c. Buckey, 712B Bowen, Dayton, Ohio.

**Sell Stamp Collection,** \$25. Monroe Block, 1369 Washington Avenue, Bronx, New York.

**Scenery for Hire.**

**Collapsible Scenery** for all plays. Amelia Grain, Philadelphia, Pa.

**Song Poems.**

**Song Writer's Manual and Guide** sent free. Contains valuable instructions and advice. Submit song-poems for examination. We will furnish music, copyright and facilitate publication or sale. Knickerbocker Studios, 311 Gaiety Bldg., New York.

**Telegraphy.**

**Telegraphy** (both Morse and Wireless) and Railway Accounting taught quickly. Tremendous demand. Big salaries. Great opportunities. Oldest and largest school; established 46 years. All expenses low—can earn large part. Catalog free. Dodge's Institute, M. St., Valparaiso, Ind.

**Wireless.**

**Bargains**—Audion detector and two-stage amplifier, and other wireless apparatus. Write or call for particulars. Hyman Heller, 134 Amboy Street, Brooklyn, N. Y.

**All Amateur Apparatus** bought or made in accordance with The Radio Buyers' and Builders' Handbook invariably re-sells very profitably. Study my June and July display advertisements in Q. S. T., see why, and get your copy now. R. Clark, Barnes Rd., Newton, Mass.

**For Sale**—Limited number of new old style 2-filament audiotrons, \$6.50; 1/2 K.W. transformer coil with vibrator, \$7; long wave inductances 42 inches long, 4 inches diameter, \$5; two-step amplifier with VT's, \$35. Include postage. Urban Worner, 1052 City Park Ave., New Orleans, La.

(Wireless continued)

**Loud Talkers**—Phonograph horns for sale, 10% discount before March 1st. Price \$5. Rembert Wurlitzer, Madison and Bedford, Cincinnati, Ohio.

**6,000 Miles On a Single Bulb.** 175 to 20,000 meters. Simple diagram of a complete short and long wave receiver, both arc and spark, with which we read Honolulu 6,000 miles, Germany 4,000 miles, San Diego, Calif., British Stations, and practically all the high powered foreign and domestic stations. Amateur and spark stations together with telephone and music come in good. Diagram and complete instructions mailed for 50c in coin or stamps. Virginia Novelty Co., Martinsburg, W. Va.

**For Sale**—Baldwin phones, type E, \$15.50; Federal amp. transformers, \$5.75; Duck's new loose coupler, \$13. Many other apparatus, brand new, as honeycomb coils, keys, condensers, etc. Write for list and prices. Wm. Volkammer, 48 Windsor Place, Brooklyn, N. Y.

**Radio Phonists Attention**—The same as last month, money refunded if this set does not work. A short distance radio phone operating on "B" batteries. The tube can be obtained from the Kehler Radio Labs. Their ad appears on another page. Enclose \$1 for hook-up and directions. H. D. Selvaige, 1096 Clinton Ave., Dept. R, Irvington, N. J.

**Radio Phonists Attention:** High voltage generators. We supply motor generator units in various capacities especially designed for radio phone work. Low powered rotary converters, dynamotors, fractional H.P. motors, storage batteries. Various types of meters, condensers, navy type 4" nickel finish brass engraved dials, spark gap rotors, synchronous spark gaps. RAY-DI-CO radio phone sets furnished knocked down ready for assembling and your connection. Become acquainted with our service. RAY-DI-CO, 2653A N. Clark St., Chicago, Ill.

**Operators Look!** Special—Limited number of real "seagoing" license frames, neatly and strongly constructed with bulkhead screwholes. Order early and make sure of yours. Price \$2.00. The "commercial set" of neatly printed signs needed in every amateur or commercial station sent postpaid, 20c silver. Radio station data cards (something new), sample postpaid, 10c silver. Radiogram blanks per hundred, 45c postpaid. Radio Dept., The Auburn Novelty House, Halkyard Building, 148 Dorrance St., Providence, R. I.

**Ammeters,** new, read 5 amperes charge and discharge, \$1. Postpaid. The Recto Mfg. Co., Inc., 23 W. Third St., Cincinnati, Ohio.

**For Sale**—Duck Co. coupler, condenser, crystal detector, in perfect condition, mounted on mahogany board, \$10. Leon Nettleton, South Lee, Mass.

**Rare Bargain**—New Ace, type T.T. regenerative receiver, 150 to 2,500 meters. A fine instrument. Cost \$80. Left with us to sell for \$45. Meltzer Lightning Rod Co., Rays Crossing, Ind.

**Good Radio Receiving Sets, \$8.50 and Up.** Panel transmitting sets, \$30.95 and up. Radio-phonograph apparatus, wire supplies of all kinds. Catalog 6R for two-cent stamp. Pocket code card free. Jenkins, 923 Purchase St., New Bedford, Mass.

**Electrolytic Rectifiers**—Will operate your audion tube circuits on A.C. perfectly when used with ordinary filter circuit. Half pint size, extra charge of chemicals, renewal electrodes, per set of four, \$2. No objectionable noise even in amplifier sets. Satisfaction guaranteed. Free circular. Geo. M. Gilbert, 746 Chenango St., Binghamton, N. Y.

**Beginners** memorize Continental Code in one hour. Thousands have. You can. Testimonials free. Investigate. Method costs fifty cents. Saves fifty dollars' time. C. K. Dodge, Box 200, Maranoneck, N. Y.

**Water Jet Vacuum Pump**—Radio experimenter, make vacuum tubes and evacuate them with this efficient pump. Screw to ordinary water faucet. Pump with instructions, \$1, postpaid. J. Ciuzio, North Bergen, N. J.

**New Haven V.T. Hounds**—We save you money on "A" batteries; guaranteed. R. H. Campbell, proprietor, Boulevard Garage, 995 Congress Ave., New Haven, Conn.

**QST de I H B H** used DeForest unit panels at year old prices. UF 100 rheostat, \$3; U 100 condenser and grid leak, \$6.50; UCV 500 condenser, \$6; CV 500 condenser, \$4.50; all in best condition. Immediate delivery upon receipt of remittance. Laurence B. Cheney, Southbridge, Mass.

**Our Special for This Month.** This month we are making a special offer on Chelsea Apparatus, and for one month we are making an offer of 5% less than list prices and all good fully guaranteed and will be shipped by insured parcel post paid. We handle all the best grades of radio apparatus and practically make shipment the same day the order is received. Radio Mail Order Supply Co., 533 West End Ave., New York City, N. Y.

(Wireless continued)

**Blue Prints**—Twelve proven receiving circuits, each on separate sheet, all for 40c. Ten proven radio phone and two combination VT hookups for transmitting, 50c. Wireless code on large blue print 25c. The Plan Bureau, 1929 McCausland Ave., St. Louis, Mo.

**State Panels** for that set. Bases for honeycomb mounting switches, in fact any kind of panels or bases that the Radio bird desires. Special panel 16" x 6" x 1/2" sent p.p. for \$2. State size and thickness in first letter. The Panel Shop, Box 16, Monson, Maine.

**Build Your Own Variocoupler.** Grey seamless cardboard tubes 4 3/8" diameter, 4 1/2" long and 3 7/8" diameter 2" long are ideal sizes for building it. Mailed postpaid for 35c. per set. Order today. The Taylor Company, Box 1043B, Lowell, Mass.

**CW Units,** variocouplers, bakelite construction, \$6; variometers, inside windings, \$5; oak cabinets, all sizes, with or without bakelite panels, VT control units, series-parallel panel switch, 50c. Mead Bakelite Radio Apparatus, 975 Putnam Ave., Brooklyn, N. Y.

**W. E. Carbon Cup Transmitters** used by U. S. Signal Corps, 60c; tel. jack and plug with cord, 65c; standard 11 ohm porcelain rheostat, 55c.; postage extra on all goods; immediate refund if not satisfied. Send for catalog. Haupt Elec. Supply Co., 2442 Ogden Ave., Chicago, Ill.

**Phone Transmitters** for VT sets, \$1.50 postpaid. Rare bargain, only a few. Act quick. T. P. Hagerman, 1929 McCausland Ave., St. Louis, Mo.

**Build Your Own Variometer.** Let us send you tubes for winding it. Fine grey seamless, cardboard tubes 4 3/8" diameter, 2 1/2" long and 3 7/8" diameter 2" long. Ideal sizes. Thousands in use. Mailed postpaid for 25c per set. Order today. The Taylor Company, Box 1043B, Lowell, Mass.

**Grid Condensers** prepaid anywhere, 50c each. Ingenious invention makes it possible to hermetically seal very small capacitances in very small compartments. Not exposed to changes of atmosphere. 100% efficiency performance test. Works with any type tube. Crescent City Radio Company, Dept. D, P. O. Box 1104, New Orleans, La.

**5,000 Six Volt Miniature Lamps Sacrificed.** Must sell out immediately at extremely low price of ten cents each. P. O. Box 1104, New Orleans, Louisiana.

**Experimental Electricity Course in 20 Lessons.** By S. Gernsback and H. W. Secor, E. E. A course of the theory and practice of Electricity for the Experimenter. Every phase of experimental electricity is treated comprehensively in plain English. New experiments are described and explained and nearly every application of Electricity in modern life is given. 160 pages—400 illustrations. Flexible cloth cover, 75c postpaid. Stiff cloth cover, \$1.25 postpaid. Experimenter Publishing Co., Book Dept., 236-A Fulton Street, New York.

**Just Off the Press.** Design and Construction of Audion Amplifying Transformers (Radio and Audio-Frequency Types). By Edward T. Jones, late Associate Editor Radio Amateur News. The transformers shown in this book have never been described in print before and have usually been considered a manufacturer's secret. The designs are very rugged and simple. A book that every radio "bug" should have. Written so you will understand every word. Price 25c postpaid. Experimenter Publishing Co., Book Dept., 236-A Fulton St., New York City.

**The How and Why of Radio Apparatus,** by H. W. Secor, E. E. This newest book on radio matters fulfills a distinct gap in wireless literature in that, while the treatment is made as understandable and as free from mathematics as possible, it at the same time incorporates a wealth of technique and instruction for the Radio Amateur—the Radio Operator—the Installation and Designing Expert—as well as teachers and students of the subject in general. A very broad field has been covered by the author, at the same time giving a great deal of information not found in other text books. If you are engaged in any branch of the Radio or allied arts at all, you will surely need this latest contribution to radio literature, which is destined to be found on every radio man's book shelf before long. A glance at the following list of chapters gives but a very scant idea of the extensive and useful radio knowledge provided in its text: The Induction Coil; The Alternating Current Transformer; Radio Transmitting Condensers; The Spark-Gaps; Radio-Transmitting Inductances; Radio Receiving Tuners; Radio Receiving Condensers; Detectors; Telephone Receivers; Radio Amplifiers; Construction of a Direct Reading Wavemeter and Decimeter; Antenna Construction; The Calculation and Measurement of Inductances; Appendix containing very useful tables, covering all subjects treated in this very unusual book. This newest of Radio Works, cloth bound in Velum de luxe. Gold stamp and Hand Sewed, has 160 pages. Size of book 6x9 inches. "The How and Why of Radio Apparatus," postpaid, \$1.75. Experimenter Publishing Co., Book Dept., 236A Fulton St., New York City.

(Continued on page 582)

(Continued from page 581)

**Wanted to Buy**

Send to Cleveland by mail or express any old or broken watches, base teeth, old or broken jewelry, brooches, bracelets, old gold, silver, platinum, diamonds, magnet points, platinum wire, contact points or crucibles, mercury, and anything valuable. We pay the highest prices in cash by return mail. Goods returned in ten days if you're not satisfied. The Ohio Smelting & Refining Company, 207 Lennox Bldg., Cleveland, Ohio.

**Exchange.**

**Sale, \$85.**—One kilowatt X-ray transformer, sell, \$25. L. Windom, 1375 Franklin Ave., Columbus, Ohio.

**Bridges, Used**—38 coils, 10 to 4,000 ohms, \$6.50, measure resistance and capacity yourself. 2,000 ohm relays, \$3; plugs, 50c. Following, new: closed and open circuit jacks, 50c. Fahnestock phone connection blocks, 20c; bakelite knob with pointer, 15c. Postage extra. Western Instrument Repair, 314 N. Fairfield, Chicago, Ill.

**Sacrific**—Robbins & Myers rotary gap motor, 2,000 to 8,000 revolutions per minute, variable speed, reversible, 110 volt, A.C. or D.C.; new, cost \$15; this motor, somewhat out of condition, but will run, \$5. Write immediately. Francis H. Pratt, 705 Main St., Whitewater, Wis.

**Sell**—DeForest receiving set, geared coil mounting, condensers on unit panels, 3/4 inch spark coil, wireless course, \$15. Send stamp, R. Wm. Tanner, General Delivery, Bridgeport, Conn.

**Will Sell Complete** loose coupler, receiving set, with bulb and crystal detectors, cheap. Write. Walter Scholz, La Crosse, Wash.

**For Sale**—Corona typewriter in traveling case, used six months, \$30. Rollin H. Stewart, 3023 Boulevard Place, Indianapolis, Ind.

**New Storage Batteries**, 6V 50A, \$15; 6V 60A, \$20; 6V 120A, \$35; 12V 50A, \$30; DeForest two-step amplifier, \$46; Baldwin phones, \$10; 3/4 K.W. rotary converter, \$30. F. J. Suchanek, 1400 Ave. A, New York City.

**Let's Swap Buy! Sell! What've got? What'd'ye want?** Dime quarterly. Swap Bulletin, New York—Detroit.

**For Sale or Trade**—15 inch induction coil cabinet, mounted, with ammeter 0-25 voltmeter 0-125, Wehnelt interrupter (bad anode). Can be used for X-ray, violet ray or radio experiments, gives 500 cycles on 110 volts D.C. M. Siebert, 119 50th St., Corona, Long Island City, N. Y.

**For Sale**—Receiving apparatus. Write for list. Henry Schrier, 1127 S. Park St., Kalamazoo, Michigan.

**For Sale**—Radio and Electrical apparatus. New and slightly used. Prepaid. Communicate with Walter Soderman, Aitkin, Minn.

**For Sale**—Loose coupler, \$5. New Jove detector with crystal, \$1.50. Roger Shaw, Concord, Mass.

**Sell**—15 dial omnigraph, new, Christmas; Westinghouse 3/4 H.P. D.C. motor. Rust, E. State St., Ithaca, N. Y.

**Complete Panel Receiving Set**, phones, battery, bulb, etc, \$35. Write for description. Ridge Radio Co., Park Ridge, Illinois.

**For Sale**—Complete DeForest 12 panels with panel board, Holtzer-Cabot phones and 200 feet aerial wire, \$60. Panels, board, \$50. Andrew Potter, 213 Westminster Ave., Syracuse, N. Y.

**Sale**—One variometer type regenerative receiver, \$30. Also complete set parts including assembled variometer, \$20. Two stage amplifier, \$28. Two K.W. 15,000 volt transformer, \$25. Samuel Place, 622 Stanbridge St., Norristown, Pa.

**For Sale**—Clapp-Eastham 1,500 meter loading coil, \$3.25 postpaid. Auto starting motor, 6 volt D.C. A powerful boy. \$8 F. O. B. Frank Peterson, Muscoda, Wis.

**Exchange**—Indian bicycle, cost \$70, for a short wave regenerative receiver and a storage battery. Chas. Peterson, 2727 So. Sheridan St., South Philadelphia, Pa.

**5 Dial Omnigraph**, \$12. \$10 Bunnel straight line radio key, \$5. Small complete set \$5. Philip Orein, 54 Cook St., Brooklyn, N. Y.

**Navy Type Coupler**, cost \$20; sell, \$14. DeForest audion cabinet, cost \$14.25, sell \$11. Unit panels. All new. Emanuel Nyman, 525 W. 160th St., New York City.

**Wanted**—3/4 H.P. motor, 110 volts A.C. D. Nelson, 403 Beacon St., Lowell, Mass.

**For Sale**—Two large 43 plate condensers (.0015) in glass cases. Price \$4.50 each. Radioson detector \$4. Dustproof Galena detector \$2. Fixed variable condenser \$1. All for \$15. Daryl McClung, 1221 Ninth Ave., Huntington, W. Va.

**Quitting Radio**—Will sacrifice magnificent receiver, described page 355 December "Radio News" in fine shipping chest, complete coils, no tubes, only \$94. Thirty dollars with order, balance C. O. D. Volney Mathison, 1411 Castro St., Oakland, California.

(Exchange continued)

**Audion Panel Complete**, \$18.75; Arlington coupler, \$7.50; laboratory variable condenser, \$5.00; ground switch, \$3.75; all new. Robert McCracken, 46 South Third, Cuyahoga Falls, Ohio.

**For Sale**—Holtzer-Cabot phones, \$6; Arnold coupler, 3,000 M., \$14; Murdock coupler (new), \$7.50; Clapp-Eastham coupler, \$10; Radio Service audion panel, \$5; 43 plate V. Con., \$2; 2 fond. spark coils, 75c each. DeForest crystal det., \$1.50. Chas. N. MacPherson, 98 Spencer Ave., Lynbrook, L. I., N. Y.

**Sell**—Radio and electrical apparatus. Write. Markham, 521 N. Second, Saginaw, Mich.

**Sell**—One K.W. Amrad quenched gap and resistance for same. Guaranteed good as new. Edwin Moore, 309 Sherman St., Joliet, Ill.

**Bargain**—First \$30 money order take these two cabinets: 4,300 meter receiving and one mile transmitting. Both practically new. Must sell. M. R. Long, Rainier, Oregon.

**For Sale**—Murdock .001 mfd. condenser (interior), \$2.75; Marconi VT 1 used about 100 hours, \$5.50, cash. Rubert Lewis, 625 S. Church, Princeton, Ill.

**For Sale**—3/4 K.W. wireless transmitting set without key, buy parts. Also repaired audiotron cheap. Norbert Leach, 1205 Rialto Ave., San Bernardino, California.

**Wanted**—Omnigraph in good condition. State lowest price. Louis C. King, 2933 Washington St., Wilmington, Delaware.

**For Sale**—Two .001 mfd. Murdock variable condensers unmounted, \$4 each; navy type, 4,000 meter loose coupler, \$16; aerial switch, \$3.50; Western Electric service telephone, \$7. Detector fitted with inverted tube receptacle, rheostat, potentiometer, phone jack, A and B battery switches, resistance and grid condenser, bakelite panel size 3-16" x 11" x 16" with space for mounting filament ammeter and two variable condensers, also two navy dials and knobs included, \$20. Everything sacrificed. For particulars address R. L. Lennart, Hamburg, Pa.

**For Sale**—Laboratory step down transformer in finished oak cabinet. All controls including meters on black fibre panel engraved with white letters. Transformer windings in steel case. Input 110 volts 60 cycles. Output variable 3/4 115 volts A.C. and includes D.C. rectifying bulb for currents up to 10 amperes. Will light audions, charge storage batteries, electro-plate and control A.C. motors up to 1.10 H.P. Highly finished throughout. Price \$90. Write Lloyd V. Berkner, 117 Summit St., Sleepy Eye, Minnesota.

**For Sale**—Short wave regenerative receiver, \$20; audion control panel, \$12.50; variable condenser, \$2; 5 volume set automobile engineering, \$16.50. Perfect condition. Write for list. R. L. Kunau, Sabula, Iowa.

**Sell**—Wireless set made up of 3,000 ohm Murdock phones, 3,500 meter loose coupler, fixed condenser, small detector, variable condenser, and a few other things. First money order for \$17.50 takes it; parcel post charges collect. Judge, 151 West 1st St., Salida, Colorado.

**Buy or Sell**—You can do either just by sending us names of articles. 10c each article per month. We send you names of persons wanting to buy or sell these articles twice monthly. Let us convince you. International Advertising Agency, 1307 Chartres St., Houston, Texas.

**Will Exchange** a complete Chem. "lab." includes a sensitive balance and weights, for wireless apparatus or \$60. Write for description. H. Isaacson, 900 Riverside Drive, New York.

**For Sale**—Ace type T.T. regenerative tuner 150-2,500 meters, and home-made audion control cabinet with bulb and B batteries and Brandes navy type phones. Complete, \$70. H. Halvorson, 513 4th St., S. E., Watertown, S. Dak.

**Wanted**—Receiving set with sensitive relay and standard recorder to record Arlington time anywhere in U. S. This set must be well made and work reliable with a minimum antenna space, also should be compact and supplied with storage battery, standards, V.T. and antenna materials. Give full particulars and price in your first letter. H. Haefliger, 107 Kirkwood Hotel, Des Moines, Ia.

**Exchange**—Mignon U.W. 1 undamped tuner, \$5; 1 BD1 detector, \$15; both \$47.50; 1 Tresco long wave tuner, \$5; 1 DeForest SCR 54, short wave tuner, \$3.50; 2 .0005 DeForest variables, \$2.50 each; 1 rheostat, \$1; 2 1/2 switches, 75c each; 1 motor 43 plate variable, \$2.50. What have you? E. F. Key, Charleston, Wash.

**For Sale**—DeForest ULC 100, \$8; ULC 300, \$4; coils L25, 2L50, L100, 2L150, L200, 2L250, 2L400, \$18; detector D101, \$1.50; \$28 takes it all. All the apparatus in perfect condition. Address Homer Hatch, Plano, Ill.

**For Sale**—Used auto generators suitable for battery charging or experiment, 6 and 12 volts, perfect condition. Reasonable prices. Enclose stamp for particulars. Lynn Goodnough, 44 Lydia St., Binghamton, N. Y.

**New Sears-Roebuck** navy coupler, \$14. Write Whitney Gilliland, Glenwood, Ia.

Radio News for February, 1921

(Exchange continued)

**Variometers \$5.**—6,000 meter navy loose coupler, \$10. Two stage amplifier with detector, \$50. 700 meter regenerator, \$30. Want transmitter bulbs. Wm. Govern, Edwardsville, Penna.

**For Sale**—Navy type receiving transformer, \$18; E. I. Co. "government" phones, \$7; audion-Ultraudion control panel, \$9; 800 ft. antenium aerial wire, 60c per 100 ft.; 100 ampere 600 volt lightning switch, \$3.50; E. I. Co. chemical laboratory, never used, \$5; 12 high grade glass chemical beakers, all sizes, cheap. Address Lloyd V. Berkner, 117 Summit St., Sleepy Eye, Minnesota.

**Will Sell** one pair 2,000w French army phones complete, \$8; one pair 4,000w French army phones without band, \$6; transformer from French 3ter amplifier, excellent, \$6; double element tubular rectifying bulb, \$5; Yale frame and tank without fork \$5; last model Yale two-speed clutch, \$8; canoe paddle, \$2; half-h.p. horizontal steam engine, worth double, \$50; express collect and mail prepaid. Offer me trades in the line of 1 k.w. sending apparatus, transformer, OS transformer condenser, switches, gaps, etc. L. E. Felker, Madison, Maine.

**Lightning Switch, \$3;** control panel with bulb, \$10; half kilowatt key, \$3; Galena set, \$3; DeForest detector, \$1.50; also other apparatus. James Zimmer, Lynbrook, New York.

**For Sale**—F-F magnetic rectifier, Arnold coupler, three sections Murdock sending condenser, new audiotron. Bud Hartmann, 73 Liberty St., Meriden, Conn.

**For Sale**—Half-kilowatt Thordarson, \$14; 4 sections. Murdock, \$7.50; oscillation transformer, \$3.50; Amrad wavemeter, \$5; Amrad quenched gap, never used, \$17; hot wire, \$6; antenna switch, \$2.50; Electro lead in, \$3.50; kick-back preventer, \$3.50; Eveready 6 volt, \$14; lightning switch, \$2.50; 100 feet, \$2; copper, \$7.50; 10 Electro antenna insulators, \$3.50. Chas. MacCarron, 250 Radde St., Long Island City, N. Y.

**Attention—Amateurs**—Complete audion detector and two stage amplifier, 12-unit panel, with four variable condensers, 3-coil mounting, amplifying transformers, jacks, plug, etc., all mounted and wired ready to use. No coils, batteries, bulbs, or phones. Worth \$125; first check for \$63.25 takes it, express prepaid. Want one K.W. transformer. Charles Daly, 824 E. Platte, Colorado Springs, Colorado.

**For Sale**—Two-stage amplifiers with cabinet and B batteries, \$50; with detector, \$65. A. Greenberg, R. 2, Hackensack, N. J.

**Exchange Bureau**—Get listed, send details, no charge. We forward the address of parties who want what you have or have what you want. Also cash deals. Negotiate then pay dime. McDonnells, 1612 Sedgwick St., Pittsburgh, Pa.

**Sell**—15 dials omnigraph with buzzer, key and single phone. N. G. Rehnstrom, 230 East 84th St., New York City.

**C.W.**—Complete 3/4 K.W. arc phone set for sale. Consists of radiation meter, oscillation transformer, arc, condenser, microphone, rheostat and choke coil, works on 110 D.C., mounted on bakelite panel. Description and photos on request. Terms \$50 C. O. D.; cash back guarantee. E. Brown, 301 College Ave., Ithaca, N. Y.

**For Sale**—110 volt motor, good for rotary, \$4.50; Murdock 43 plate condenser, \$2; Marconi socket, 75c; Victor phonograph, \$10; Mescro key with large contacts, \$2.50. Write to H. Van Dohlin, 348 W. 36th St., New York City.

**For Sale**—Complete receiving outfit, VT detector and amplifier with "B" batteries. VT tubes, honeycomb coils with pedestal mounting, Meteor 3,200 ohm phones, Baldwin type E phones, storage battery and other instruments. Earl H. Miller, 614 Grace St., Williamsport, Pa.

**For Sale Cheap**—Several good sending instruments. What have you? Lester Fawcett, Janesville, Wis.

**Bargains**—3,500 meter loose coupler, \$8; audiotron cabinet bulb, \$15; set of 3 loading inductances, \$15; detector, \$1.50; Meccano motor, reversible, \$2.75; big electric track, \$2.25. Jacob Eder, Aurora, Ill.

**For Sale**—Audion receiving outfit, mounted on bakelite panel. oak cabinet, has been used two months. Guaranteed first class condition; cost \$60; sell for \$40. Jas H. Elder, Marshall, Ind.

**Bargain**—3/4 K.W. Thordarson transformer, Murdock O.T. rotary gap, oil condenser, panel mounted, \$45. Jack DeLorme, 235 Menomonee St., Chicago.

**For Sale**—One CR-2 Grebe receiving set, two months old. Am installing lone wave receiver. Wm. J. Callahan, 158 9th St., L. I. C., N. Y.

**Bargains**—One Murdock receiving transformer, \$6.50; 1 Murdock 43 plate variable condenser, \$4; 1 Robbins & Myers 110 volt A.C. motor (for motor generator), \$18; 1 audiotron (double fil.) with panel fixtures, \$9; 1 e. No. 200, No. 100 and No. 25 DeForest Honeycomb Coils, 35% off. Used about two months and in A No. 1 condition. Wayne Caton, Clarksville, Texas.

(Continued on page 583)



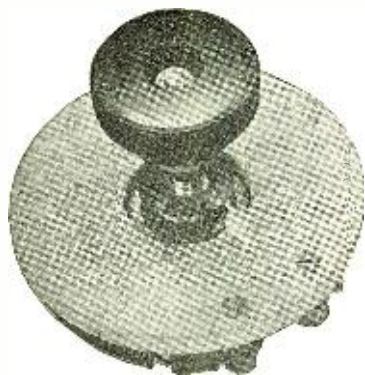

"Licensed Under Marsh Patent No. 811859."

# "SHRAMCO REO"

A 6-ohm Nickel-Chromium Resistance element mounted on electrical asbestos makes the ideal combination in a filament rheostat. Arranged for panel mounting by use of locknut. All metal parts brass. No soldered connections. Spring Phosphor Bronze blade. Even regulation and smooth operation. Complete with knob and pointer as shown. Base 3" dia. Overall height 2 1/2". Shipping weight 1 lb. Will control 3 tubes.

Cat. No. 90 — "SHRAMCO REO"  
— 6 ohms - \$2.00 each

Special Resistance made to order

Send 5c in stamps for our catalog K

## SHOTTON RADIO MFG. COMPANY

P. O. Box No. 3  
SCRANTON, PA.

### BOUND VOLUME No. 1

Radio Amateur News  
12 Issues  
July, 1919 - June, 1920  
Attractively Bound

Only **\$2.00**

(Plus Postage)  
Shipping Weight 6 lbs.

A Most Valuable Asset to Your Library

Order Today

Experimenter Pub. Co.

236a Fulton Street New York City

(Continued from page 582)

(Exchange continued)

1,500 Mile Receiving Set, complete, \$25; also switches, motors, etc. All letters answered. Alva Flippin, Rainier, Oregon.

Sell or Exchange for radio apparatus, McGraw-Hill Machine Shop Course, never used. Cunningham, 280 East 155th St., New York.

For Sale—Wireless apparatus audion, loose coupler, etc. For information phone Chelsea 5944, Leonard Beck.

For Sale—Camera, 4 x 5 Premo No. 8. Write to Arthur Bryn, Devil's Lake, North Dakota.

For Sale—15 panel DeForest unit set, perfect condition, 2 stage-amplifier, finely finished back-board. Gets foreign ARC and DX200 on indoor antenna. Price reasonable. Write. Frank Bryant, 778 Main St., Worcester, Mass.

Bargain—Paragon regenerative tuner, 20,000 volt oil condenser; rotary disc, step-down transformer and erector No. 6. P. Barrett, 222 N. Dunn St., Bloomington, Ind.

For Sale—A high grade beginner's cabinet receiving set, made to order. Has a "Tewno" bank-wound coupler, DeForest galena and Marconi carbonium detectors, Murdock .001 variable condenser, potentiometer and buzzer test, etc., mounted in a portable hardwood cabinet. Bargain, \$30; 5c (stamps) for photograph. Letters answered. E. G. Baier, 253 Ninth St., Brooklyn, N. Y.

Bargain—Brand new Tungar rectifier, 6 cell, 6 amp. charging rate, for 115 volt, 60 cycle current. Cost \$32; complete with bulb, directions and 12-ft. cord; sacrifice at \$26. D. Burnham, 35 Commonwealth Ave., Springfield, Mass.

For Sale—Radiophone 500V.-250W. generator. C. Brewer, 185 Harker St., Mansfield, Ohio.

Exchange or Sell old type Disco electric Ford starter and generator, fair condition; 20,000 M. C. W. tuner, never used, \$6; 2 slightly used storage batteries, 1 4V. 50A., \$12; 1 4V. 40A., \$10; both are in excellent condition; 2 44V. variable "B" batteries, never used, \$2.50 each. Want Grebe two-step amplifier or good regenerative set. Galen Baker, Clay City, Indiana.

Wanted—Small 110 to 500V. 120 or 240 cycle generator. State condition. W. T. Alstead, 617 Western Ave., Topeka, Kansas.

For Sale—Complete receiving panel and two step amplifier, including set of honeycomb coils and bulbs. Apparatus guaranteed. Write for full description. Also key, rheostats, Murdock and Brandes phones, receiving transformer, etc. Earl Atkinson, 1301 University Ave., Urbana, Illinois.

Big Offer—Phones, ammeters, keys, transformers, etc., at great reductions. List on request. Nathan Sameth, 240 Varet St., Brooklyn, N. Y.

Trans-Atlantic 3,000 ohm phones, \$10; Solar bicycle light, \$2.50; aluminum canteen (5 pieces), \$2.50; tel. sounder, \$1.50; new set of taps and dies, \$1.50. Guaranteed in good condition. Alva Flippin, Rainier, Oregon.

New Amrad Induction Coil outfit complete, \$35. Cr-3, \$45; 350 volt motor generator, \$80; 15 panel DeForest unit set complete with bulbs and varniers. Prescott Smith, 35 N. Maple Ave., Ridge-wood, New Jersey.

Exchange—New auto knitter. Also No. 3 camera and outfit for wireless receiving set. Wade Griffin, Portland, Tenn.

Wanted—Western Electric loud speaker with or without transformer. Albert J. Higson, 84 Romaine Ave., Jersey City, N. J.

Trade—Have \$75 Howard R-A watch, new. Want wireless receiving set. No junk. What have you. L. L. Davenport, 547 East 7th St., North, Portland, Ore.

For Sale—4,500 meter navy type loose coupler, excellent condition; price, \$18. J. W. Weaver, 1326 Leighton Ave., Anniston, Ala.

Bargain—Receiving cabinet and audion ultra-audion cabinet, \$35; navy phones, \$10; lightning switch and 30 feet ground wire, \$3; D.C. fan motor, \$10; Murdock transmitting condenser, \$2; new key, \$2; gap. 50c. Almost all worth double. Cohen, 248 East 121st St., New York.

New \$60 DeForest radiophone transmitting bulb and panel; new \$27.50 General Radio wavemeter; new \$10 aerial ammeter; 1,000 feet new 42-strand phosphor bronze aerial wire, cost 5c per foot; condensers, grounding switch and other apparatus. Sell for one half cost. 120 Christie St., Ridgefield Park, N. J.

Amateurs—Write for my list on new and used radio goods, including complete sets couplers, transformers, etc. Chas. F. Goodley, 811 Shipby St., Wilmington, Del.

## THE BEST—at Prices That Save You at Least 20%

|   |       |
|---|-------|
| Binding Posts, brass.....                     | Each  |
| Switch Points, nickled, 1/4 in. diam...       | \$.05 |
| Helix Clips for flat wire.....                | .18   |
| Helix Clips for round wire.....               | .18   |
| "B" Batteries.....                            | 1.20  |
| Variable Condensers, unmounted, 11 plate..... | 2.60  |
| Variable Condensers, unmounted, 21 plate..... | 3.28  |
| Variable Condenser, unmounted, 43 plate.....  | 3.85  |
| Switch Units, complete, small.....            | .35   |
| Switch Units, complete, large.....            | .55   |
| Aluminum Aerial Wire, a lb.....               | .85   |
| Audiotron Tubes, each.....                    | 6.00  |

We do not publish a catalogue.

We can save you money on your wireless supplies.

In writing for prices, give numbers of other catalogues and we will quote our lowest price.

Amateurs come to see us. Make our office your meeting place. You don't have to buy.

### DREYFUSS SALES CORP.

4th Floor, 150-152 Chambers Street  
NEW YORK, N. Y.

### CANADIAN AMATEURS ATTENTION!

Have you sent for our new price-list on wireless telegraph and wireless telephone supplies. If not, send 5c. in stamps to

SMITH BROTHERS  
302 S. Christina St. SARNIA, ONT.  
Manufacturers of Radio Instruments Since 1901.

### New and Popular Books

#### The How and Why of Radio Apparatus

By H. W. SECOR, E. E.

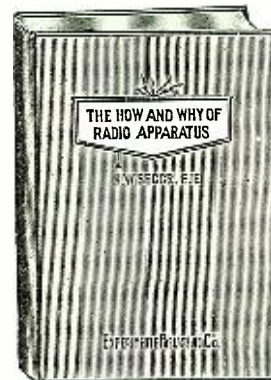

The newest book on radio matters. The treatment is made as understandable and as free from mathematics as possible, it at the same time, incorporates a wealth of technique and instruction for the Radio Amateur—the Radio Operator—the Installer and Designing Expert—as well as teachers and students of the subject in general. Cloth bound in Velum de Luxe, Gold stamped and Hand Sewed has 160 pages. Size of Book 6 x 9 inches. The How and Why of Radio Apparatus Postpaid .....\$1.75

#### A Thousand and One Formulas

By S. GERNSBACK

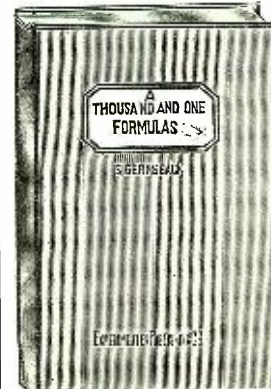

A Laboratory Hand Book for the Experimenter and for Everybody who wants to "do things." The recipes and formulas are classified in such a manner as to be available at once, without long research. Besides there are a score of tables and hundreds of Illustrations and Diagrams. Book is cloth bound in Velum de Luxe, Gold stamped and hand sewed. It contains 160 pages. The paper has been especially selected to stand rough handling in laboratories. Size 6 x 9 inches. A Thousand and One Formulas as Described. Postpaid, \$1.75

The Experimenter Publishing Co.  
Book Dept. 236A Fulton St., New York

**GEORGE A. KENT COMPANY,**  
**CIGAR MANUFACTURERS,** WHOLESALE ONLY.  
 CHENANGO STREET

GEORGE A. KENT, JOHN N. BOBERT, THE PRODUCE, GEORGE A. KENT, JR., ARTHUR E. KENT, SECRETARIES.

PETER THE GREAT THAT KILLED HAVANA CIGAR ESTABLISHED 1874 INCORPORATED 1907

Birmingham, Ala. Nov 23

Dear Sirs, Here is a couple of record breakers for your "Vibratone". I have only your set for transmission and these cards are straight goods. Yours truly  
 A. L. Kent

# VIBRATONE JR.

TRADE MARK

Complete Radio Transmitter

## Copied Over 500 Miles Away

HERE is the proof.—Mr. Kent, a prominent amateur, made these records with a stock Vibratone Jr. He sent in these cards unrequested, with no idea of seeing them reproduced. Read what they say!

## Send Messages Yourself!

Don't be satisfied with receiving—

## Get a VIBRATONE, JR.

THE VIBRATONE, JR., is a complete, compact sending outfit. It operates on any 110 volt circuit, at a cost of 2 cents per day. You simply make your aerial and ground connections, hook up to any electric light socket and go ahead.

These post cards show what Mr. Kent has done with a stock Vibratone, Jr.—identical in every respect with the one we send you. Since these cards were reproduced, Mr. Kent has received a similar card from another amateur in Athens, Georgia.

There's no reason in the world why you should not be just as successful as Mr. Kent. Remember, the Vibratone, Jr. set is complete, no extras to buy whatever! Its simple and easy to operate, and makes practically no noise! It is produced by the makers of ABC apparatus, and is backed by an absolute guarantee for one year. *Your Money's Worth or Your Money Back!* And—best of all—the price is only \$20.

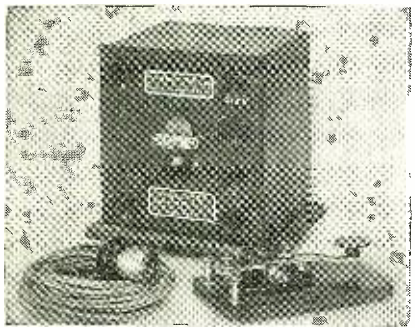

The VIBRATONE JR. is a high voltage buzzer type radio transmitting set which operates directly on any 110 volt circuit, either A.C. or D.C. It requires no spark gap, condenser, etc., but is complete, ready to operate, as shown. It fully complies with all Federal regulations, in regard to emitting a sharp-wave. Operates all day for less than 2 cents. Equipped with Mesco transmitting key. Guaranteed for one year, built to last indefinitely. Normal range up to five miles, but the above cards show what it has done.

Cabinet is hard wood, polished, special composition black fibre panel, metal parts heavily nickel plated. Size 5 3/4" x 6 1/4" x 7 1/4".

Radio 8AC - 11/7/20  
 200 East Ninth Street, Rome, Ga.

Your signals ARE HEARD HERE 11/6/20

Audibility G.S.M. Character Clear

# 4BQ

Receiving set consists of: Shoenberger two stage amplifier. Long wave DeForester phone. Two stage amplifier. Transmitter 1/2 Kw. Clapp Eastham High frequency. What does your equipment consist of? Will Q. S. R. at any time.

Will be glad to receive report on 4 B Q signals.

Yours truly,  
 G. S. Wright

AN OFFICIAL A, B, R. L. STATION

8AC Your Station heard - Nov 14 1920

My receiving set consists of the following:  
 A Grebe CR-3, a homemade detector and two-step amplifier  
 Brandes Trans Atlantic phones.

Best regards from  
 Radio IUAG - MILTON H. CORSON  
 (MEMBER OF A. R. R. L.)  
 643 County St  
 New Bedford  
 Mass

# \$20

## Don't Wait—Act Now!

Get in on the real fun! Make up your mind to install a Vibratone, Jr. right away. We have them here in stock—ready to ship the day we receive your order.

Order your Vibratone, Jr. today. Don't wait any longer for the real fun of radio—sending. Send check, P. O. Money Order, Express Money Order, Cash or anyway you choose—just \$20. That covers postage and all incidentals. You'll get the biggest \$20 worth in your life, just as quickly as the mails will bring it to you.

Professional Radio Equipment at Amateur Prices

**WIRELESS EQUIPMENT CO.** INC. Pres. **AB Cole**

188 GREENWICH ST. NEW YORK CITY

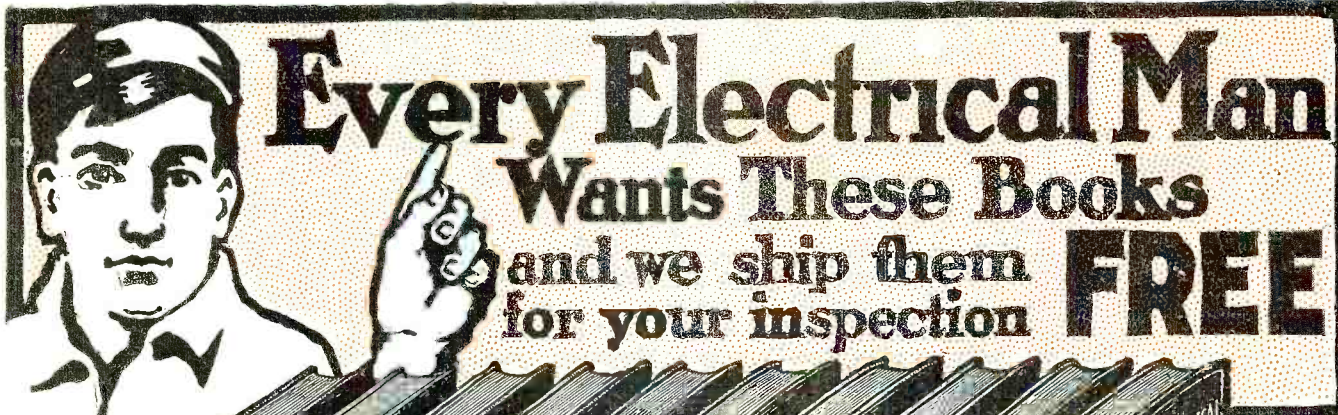

Flexible Covers  
—  
Handy Pocket-Size Volumes

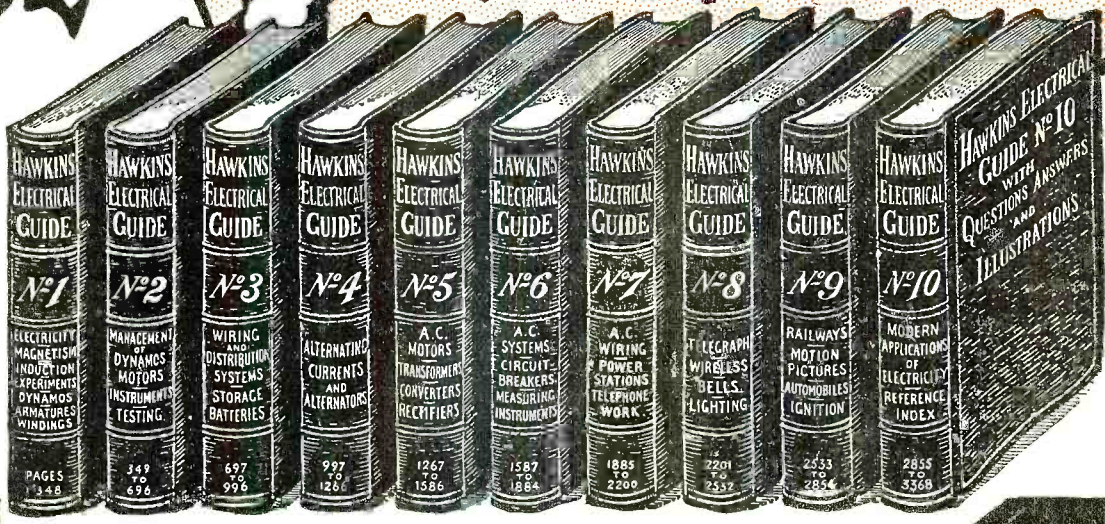

10 Volumes  
3500 Pages  
4700 Pictures  
\$1 Per Volume  
\$1 Per Month

## Just what you need to know to succeed in ELECTRICITY

EVERY electrician, every engineer, every mechanic should know about these wonderfully helpful instructive books, which give in plain words a complete working knowledge of electrical engineering in all its phases.

You run into some new electrical problem almost every day. The information you need to help you in your every day work is in

# HAWKINS ELECTRICAL GUIDES

These books place electricity at your finger ends. They cover every imaginable subject, principle, theory, problem, trouble, and way of doing things electrically. Every subject is indexed so that you can turn right to it. They are a study course and a reference guide in one, written in plain every day language—no wasted words—only what you need to know—chock full of up-to-the-minute electrical knowledge. The guides are a complete course in electrical engineering. They will help you in every detail of the day's electrical work. You can't ask an electrical question that Hawkins Guides can't answer.

### Pocket-Size Flexible Covers

The books are small enough to slip into your coat pocket—handsomely bound in flexible black covers. You can carry each volume with you until you have mastered its contents. 3,500 pages of actual information and 4,700 illustrations. Once you see these books and put them into actual use you will never again want to be without them. Try it at our expense.

## SEND NO MONEY

It will cost you nothing to receive these books—to look them over—ask them all the questions you can think of—use them in your work—study them—pick up some information that will increase your earning ability. We will ship you the entire set of 10 volumes entirely FREE.

This is a sign of our confidence in the guides. Pure gold does not object to being tested. Keep them for seven days and if you do not decide that you can't get along without them, return them to us and owe us nothing.

When you decide to keep them you only have to pay \$1.00 down and remit the balance of \$9.00 on the easy payment of \$1.00 a month till paid for.

Use this coupon to get the books. It will pay you many times over

**THEO. AUDEL & CO.**  
72 Fifth Ave. New York, N. Y.



### READ THIS PARTIAL LIST OF CONTENTS

- No. 1** Contains 348 pages, 388 illustrations. Electrical signs and symbols—static and current electricity—primary cells—conductors and insulators—resistance and conductivity—magnetism—induction coils—dynamo principles—classes of dynamos—armatures—windings—commutation—brushes, etc.
- No. 2** Contains 348 pages, 394 illustrations. Motor principles—armature reaction—motor starting—calculations—brake horsepower—selection and installation of dynamo and motors—galvanometers—standard cells—current measurement—resistance measurement—voltmeters—wattmeters—watt hour meters—operation of dynamos—operation of motors, etc.
- No. 3** Contains 300 pages, 423 illustrations. Distribution systems—wires and wire calculations—inside, outside and underground wiring—sign flashers—lightning protection—rectifiers—storage battery systems, etc.
- No. 4** Contains 270 pages, 379 illustrations. Alternating current principles—alternating current diagrams—the power factor—alternator principles—alternator construction—windings, etc.
- No. 5** Contains 320 pages, 614 illustrations. A. C. Motors—synchronous and induction—motor principles—A. C. commutator motors—induction motors, transformers; losses, construction, connections, tests—converters—rectifiers, etc.
- No. 6** Contains 298 pages, 472 illustrations. Alternating current systems—switching devices—circuit breakers—relays—lighting protector apparatus—regulating devices—synchronous condensers—indicating devices—meters—power factor indicators—wave form measurement—switch boards, etc.
- No. 7** Contains 316 pages, 379 illustrations. Alternating current, wiring power stations—turbines; management, selection, location, erection, testing, running, care and repair—telephony, etc.
- No. 8** Contains 332 pages, 436 illustrations. Telegraph—simultaneous telegraphy and telephony—wireless—electric bells—electric lighting—photometry, etc.
- No. 9** Contains 322 pages, 627 illustrations. Electric railways—electric locomotives—car lighting—trolley car operation—miscellaneous applications—motion pictures—gas engine ignition—automobile starters and lighting systems, electric vehicles, etc.
- No. 10** Contains 513 pages, 599 illustrations. Elevators—cranes—pumps—air compressors—electric heating—electric welding—soldering and brazing—industrial electrolysis—electro plating—electro-therapeutic—X-rays, etc.

Also a complete 126-page ready reference index of the complete library. This index has been planned to render easily accessible all the vast information contained in the 10 electrical guides. There are over 13,500 cross references. You find what you want instantly.

**THEO. AUDEL & CO.**  
72 Fifth Ave.  
New York, N. Y.

### What Electrical Men Say

**Helped Him Make Good**  
"It is only right for me to recommend highly the Hawkins Guides, for they have been of the greatest assistance to me in placing me in my present position as Superintendent of Construction Department of one of Ohio's largest Electrical Companies. I would like to see every man have a set of Hawkins Guides."  
Geo. Knecht, Columbus, Ohio.

**In the Naval Electrical Dept.**  
"The Hawkins Guides are a great help to me in the Naval Electrical Department, which they cover very thoroughly."  
C. J. Cornell, U. S. Receiving Ship, Brooklyn, N. Y.

**Superintendent**  
"I am now superintendent of the Danville Hydro-Electric Systems, and Hawkins Guides were a great help to me in holding down a responsible position."  
W. E. Swartz, Dunnville, Ontario.

**Wireless Operators**  
"I have worked wireless for ten years—but I wish I had these books years ago, as they have saved me a great deal of trouble."  
H. Marshall, Steamer M & B No. 2, Walkerville, Ont.

Signature.....  
Occupation.....  
Employed by.....  
Residence.....  
Reference..... R. N., Feb.

# LEARN WIRELESS At Home By Mail

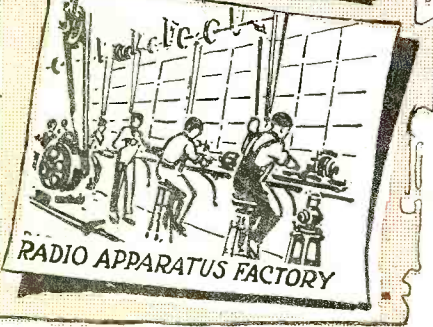
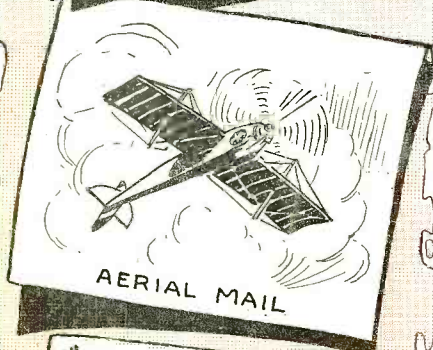
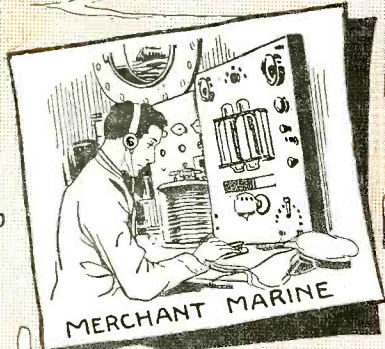

**W**IRELESS Operators Wanted at Once—For Merchant Marine, Commercial Land Radio Service, Radio Supply Factories, U. S. Navy Government Service and Aerial Mail. National Radio Institute experts will teach you Wireless at your home by mail, through fascinating course of copyrighted lessons and our famous Automatic Natrometer.

Read About This Splendid Opportunity for the Young Men of America.

**Salaries up to \$3,500**

At the very start our graduates are paid \$125 a month which with their allowance for room and board is the equivalent of about \$200 a month. Promotion is sure and steady for the well-trained Wireless man. One of our graduates has risen to \$6,000 a year. Positions and pay are as follows: Supercargo and Wireless Operator—\$175 a month; Radio Mechanic \$1,500 to \$2,000 a year; Radio Aid—\$6 to \$8 a day; Radio Inspector—\$1,500 to \$3,000 a year; Radio Engineer—\$6,000 a year up; Radio Draftsman—\$7 to \$10 a day.

**Travel Without Expense**

As a Wireless Operator you can travel, visit foreign countries, increase your knowledge of world affairs while drawing excellent pay. On shipboard you are rated as an officer with fine living quarters. If you do not care to travel, there are positions nearer home at Land Radio Stations and Offices.

**Experts of Nation's Capital Teach You Wireless at Home**

The National Radio Institute is headed by experts of the Nation's Capital who have been closely allied with government training of men for wireless positions. Instruction of students is under direction of Jas. E. Smith, former director of Radio Dept. Howard University, and E. R. Haas, formerly of the Radio Division of Yale University. These experts, assisted by a large staff of well-known Radio men, will teach you Wireless by mail, in your home, quickly and easily, in a fascinating practical way, just as they have already taught hundreds of students throughout the world.

**Remarkable Automatic Wireless Instrument FREE**

In addition to all necessary text books, including a full set of our up-to-date, copyrighted Lesson Pamphlets, for home study, we present FREE to each student, while taking the course, our remarkable Automatic Wireless Instrument—The Natrometer. It transmits messages in 600 different combinations just as though coming from thousands of miles away. It can be regulated to any speed from 1 to 30 words a minute, works automatically without use of aerials, and comes to you complete with phones, etc., in a neat carrying case. Teaches you practical Wireless at home in a simple though scientific way. It is yours to keep upon completion of the course.

**Pay as You Learn**

A small first payment will start these practical lessons on their way to you. You pay as you learn. Many of our students secure wireless positions before completing the course.

**Oldest and Largest Correspondence School of Wireless in America**

The National Radio Institute, established in 1914, is today the oldest and largest Wireless School in America teaching Wireless by mail. Our graduates are making good all over the world. We are fully recognized by the U. S. Department of Commerce which allows our graduates five to ten points credit when taking First Grade Government License examinations. The National Radio Institute heads the printed list of Wireless Schools recommended by the U. S. Shipping Board.

**Special Free Offer**

Students who enroll promptly receive in addition to our complete course in Wireless Telegraphy, a complete Special Course in Wireless Telephony, and if you wish, a one month Post Graduate Course at our big Washington School. These special privileges are free only to N. R. I. Home Study Students.

**NATIONAL RADIO INSTITUTE**  
Dept. 450 WASHINGTON, D. C.

**FREE**

**Write Today for FREE BOOK**

Send the following coupon, or a post card today for a copy of our interesting book "Wireless, The Opportunity of Today."

**MAIL THIS COUPON TODAY**

National Radio Institute,  
Dept. 450, Washington, D. C.  
Send me your FREE book, "Wireless the Opportunity of Today." Tell me about your Home Study Course in Wireless Telegraphy and Telephony—and free post-graduate course—and your Special Instrument offer.  
Name .....  
Age ..... Occupation.....  
Address .....  
City ..... State.....