

RADIO AMATEUR NEWS

REG. U.S. PAT. OFF.

15 Cents
OCTOBER
1919

OVER 100
ILLUSTRATIONS

Edited by
H. Gernsback

"The 100% Wireless Magazine"

HIS FIRST WIRELESS MESSAGE



**In This
Issue:**

ARC UNDAMPT TRANSMISSION
By Ensign Pierre H. Boucheron
FUNDAMENTAL OPERATION OF VACUUM TUBES
By David S. Brown

RADIO PRIZE CONTEST AWARDS
SELECTOR SWITCH FOR THE ROGERS
UNDERGROUND SYSTEM By J. Stanley Brown

PUBLISHED BY EXPERIMENTER PUBLISHING CO., 233 FULTON ST., N. Y. C.

www.americanradiohistory.com

"ASK ANYONE WHO HAS USED IT"

SUBMARINED THREE TIMES AND STILL IN USE

Said an Englishman: "I've been submarined three times—and put my Brandes Headset in my pocket each time. You bet I saved it. I wouldn't have any other make." (Name on request.) Think of the help to wireless operators, that the perfect sensitiveness and dependability of Brandes Headsets provided during the war. Life and death depended upon hearing correctly. They are made today just the same, and give the same quality of service.

BRANDES WIRELESS HEADSET



CLEAR TONE
LIGHT WEIGHT
DEPENDABLE SERVICE

"Superior" Set—2000 ohms, \$7.

Score 100% efficiency in actual use. Sharp, Unblurred, Readable Signals assured by

"BRANDES MATCHED TONE"—

Exactly matching the tone of both receivers in each set and thus eliminating all confusion due to unmatched harmonics.

TRIAL OFFER

Buy a Brandes Superior Headset and use it critically for ten days. Then, if it doesn't come up to our claims or your expectations, return it and your money will be cheerfully refunded. Test it—compare it with others—for sensitiveness, clearness, distance. Prove for yourself the fine quality, the "matched tone." The two diaphragms, toned exactly alike, strengthen the signals and prevent blurring. Used by many U. S. Government experts, and experts abroad; by colleges and technical schools; and by professionals and amateurs everywhere.

SEND 4c FOR CATALOGUE "G"

C. BRANDES, Inc., Room 823 32 Union Square, New York, U. S. A.
WIRELESS RECEIVER SPECIALISTS

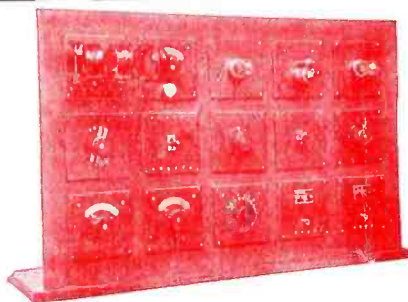

This is a picture of a 15 panel Typical De Forest Unit Receiving Set consisting of a tuner with a wave length range of 150 to 25,000 meters, a crystal and audion detector and a one-step amplifier. Price of all the necessary units \$133.57. You can buy any of these units separately, and make just the kind of set you want for any and all wave lengths of any preferred circuit and design, at a cost ranging from \$30.00 and up. The tuning system is the most novel and efficient placed on the market. Designed and built for the De

Forest audion and amplifier as only the makers of the audion can build it. Use one receiver for all wave lengths at maximum efficiency.



Audion Control Box type P-100, combining in a single compact set the Peerless De Forest audion detector, oscillator and audion amplifier. No other instrument like it has ever been built to sell for less than \$150.00. Our price without the bulb \$65.00. Descriptions of lower priced models sent on application.



Type P-200—2-Step Amplifier—sufficient to give amplifications up to 200 times. The very latest in design—workmanship of the highest grade. Panel quickly removable making all parts accessible, and the replacing of the new type en block "B" batteries but a moment's work. Price without the bulbs \$69.50.

Wireless Manual and Catalog Mailed Upon Receipt of 10c to Cover Postage

DE FOREST RADIO TEL. & TEL. CO., 1397 Sedgwick Ave., New York City

You benefit by mentioning the "Radio Amateur News" when writing to advertisers.

AMPLIFY YOUR RADIO SIGNALS

ONE of the greatest drawbacks since the invention of wireless telegraphy is the receiving of weak signals at the receiving station. Many devices were proposed to improve this condition, but without success, on account of the mechanical difficulties encountered in these amplifying devices.

However, this was recently solved by the introduction of an exceedingly sensitive microphone transmitter, which is known to detect sound waves with great accuracy and magnify them through an intermediate telephone circuit.

By the employment of the new DETECTAGRAPH-TRANSMITTER, the amateur can amplify the radio signals to such an intensity that he can hear the signals about his station without the need of the telephone head set.

By the addition of a loud talking telephone he is able to hear the messages many feet away from the instrument. He is also able to demonstrate the operation of his wireless apparatus to his friends.

The super-sensitive DETECTAGRAPH-

TRANSMITTER herewith shown is two and three-eighths inches in diameter, five-eighths of an inch thick and weighs less than three ounces. It is the most sensitive sound detecting device ever brought before the public.

The manner in which the amplifying process is attained is by attaching with tape the DETECTAGRAPH - TRANSMITTER to the regular wireless receiver as indicated in the diagram.



Practical Instruments for Commercial and Scientific Purposes.

Other Uses

Not only is this instrument applicable

for amplifying radio signals, but it can be used with equal satisfaction for magnifying other sounds. Phonograph music can be transmitted from one place to another by means of this instrument, and those who are afflicted with deafness will find enormous benefit by using this transmitter.

It is the greatest device for building your own loud talking telephone, detectograph and other de-

vices. Model "B" Horn, with high grade Loud Talking Receiver, Cord Plugs and Desk Stand Base. Price, \$15.00 Complete. Adjusted Model "C" Horn, with high grade Loud Talking Wall Receiver. Price, \$15.00 Complete.



Our Super-Sensitive Detectograph Transmitter. Price, \$8.00 Complete

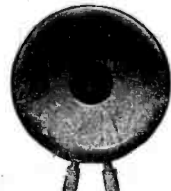

Our Special No. 25 Loud Talking Receiver Price, \$4.50 Complete

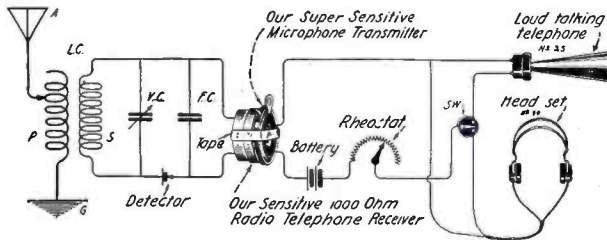

DETECTAGRAPHS

FOR THE EXPERIMENTER FOR THE DEAF FOR DETECTIVES

DETECTAGRAPH

This detecting instrument of marvelous sensitivity can be used for detecting secret conversations. Outfit consists of Sensitive Transmitter, 25-ft. Black Cord, Receiver, Headband, Case and Battery. **\$18.00** Complete



DETECTAGRAPH JUNIOR DEAF-PHONE

The outfit consists of a Super-Sensitive Transmitter, with a cord connector; Super-Sensitive Ear Piece with small black cord; Black Single Headband; Black Case and two small Batteries. Transmitter 2 3/8 inches in diameter, 5/8 of an inch thick, and weighs less than three ounces. **\$18.00** Complete



Detectograph Rheostat, especially made for amplifying circuits. **\$2.00** Complete



Super Sensitive No. 40 Receivers to be used in connection with Detectograph Transmitters. **\$10.50**

G. Boissonnault Co., 25 Church St., N. Y. C.

As per your ad in Radio Amateur News, please send me free circulars and full particulars about your Detectograph Devices.

G. BOISSONNAULT COMPANY

25 CHURCH STREET NEW YORK CITY

Makers of Super-Sensitive Microphone Devices

NAME
ADDRESS
CITY
STATE

You benefit by mentioning the "Radio Amateur News" when writing to advertisers.

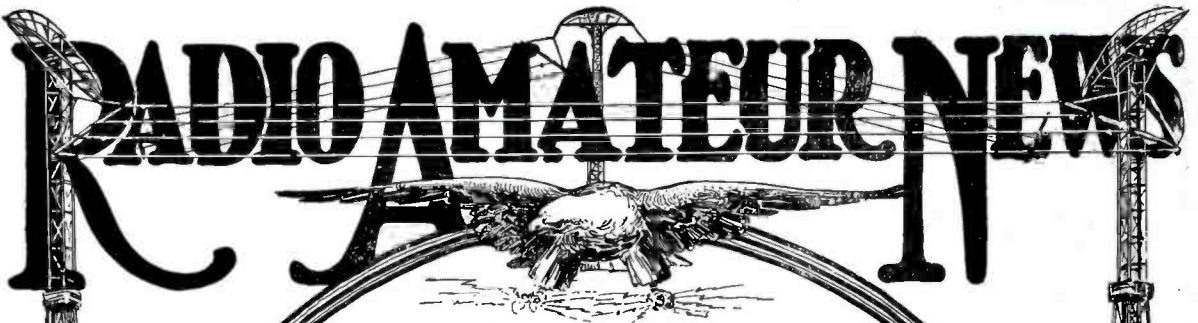

CONTENTS FOR OCTOBER

	PAGE		PAGE
"The Future of Radio"	157	"Magnet Control for Vacuum Tubes"	176
By H. Gernsback		By Herbert Webb	
"Arc Undampt Transmission"	158	"Design of the Leading Coil"	177
By Ensign P. H. Boucheron		By Ralph Langley	
"Latest Developments in Audio Frequency Amplifiers"	161	"Copying Thru Static"	177
By Walter J. Henry		By Edgar Terrain Johnstone	
"An Undampt Transmitter of the De Forest Type"	162	"A Wireless Telegraph Receiver"	178
By E. Dynner		By Ray T. Foster	
"Government Control"	164	"Construction of Mica Receiving Condensers"	178
"An Exceptionally Well Designed One-half KW. Transmitter"	166	By L. R. Jewett	
By W. H. Pries		"How to Make a Good Variable Condenser"	179
"W. C. G."	167	By A. Warr	
Radio Contest. Award of Prizes.	168	"A Radio Goniometer"	175
"Fundamental Operation of Vacuum Tubes"	170	By Edgar Terrain Johnstone	
By David S. Brown		"Improving the Rotary Gap"	180
"Short Wave Receiving Transformer of Novel Design"	172	By C. H. Biron	
By Raymond Evans		"A Variable Grid Leak"	180
"Long Wave Receiving"	173	By Arno A. Kluge	
By H. L. Beedenbender		"New Radio Apparatus"	181
"Selector Switch for the Rogers Underground System"	174	Club Gossip	182
By Stanley J. Brown		Radio Digest	183
"Audion Protective Device"	175	With the Amateurs	184
By E. T. Jones		"An Amateur's Retrospect"	185
"Cascade Amplification at Radio Frequencies"	176	By Scott E. Vance	
By Thomas Benson		"Prize Contest." Award of Prizes	186
		"Junior Radio Course—Lesson Two"	188
		By E. T. Jones	
		"I Want to Know"	190

RADIO AMATEUR NEWS is published on the 25th of each month at 233 Fulton Street, New York. There are 12 numbers per year. Subscription price is \$1.50 a year in U. S. and possessions. Canada and foreign countries, \$2.00 a year. U. S. coin as well as U. S. stamps accepted (no foreign coins or stamps). Single copies, 16 cents each. A sample copy will be sent gratis on request. Checks and money orders should be drawn to order of EXPERIMENTER PUBLISHING CO., INC. If you change your address notify us promptly, in order that copies be not mis-carried or lost. A red wrapper indicates expiration. No copies sent after expiration.

All communications and contributions to this journal should be addressed to: Editor, RADIO AMATEUR NEWS, 233 Fulton Street, New York.

H. GERNSBACK, President.

S. GERNSBACK, Treasurer.

R. W. DE MOTT, Secretary.

Unaccepted contributions cannot be returned unless full postage has been included. ALL accepted contributions are paid for on publication. A special rate is paid for novel experiments; good photographs accompanying them are highly desirable.

RADIO AMATEUR NEWS, Monthly. Application for entry at the Post Office, New York City, as second class matter. Title registered U. S. Patent Office. Copyright, 1919, by E. P. Co., Inc., New York. The Contents of this magazine are copyrighted and must not be reproduced without giving full credit to the publication.

RADIO AMATEUR NEWS is for sale at all newsstands in the United States and Canada; also at Brentano's, 37 Avenue de l'Opéra, Paris.

NOTICE. Due to the great printer's strike in New York which began on October 1st, and which has held up all periodicals, this issue has been greatly delayed. As the strike is on for an indefinite period, this number was printed out of town. We anticipate a delay for our next issue as well. Therefore, kindly be patient.—The Publishers.

TWO STEP AMPLIFIERS TYPE TRIODE-B



This amplifier is a compact unit of the resonance low frequency type, and provides a maximum of amplification.

Its compactness, efficiency and simplicity render it an attractive investment to the progressive radio experimenter.

Immediate Delivery.
Particulars and price on application.

TYPE TRIODE-E

This instrument is equally efficient with the Type Triode-B Amplifier, but is made with all wiring and connections visible and easily accessible to facilitate experimenting. It is also of less expensive construction.

The design of both these instruments is such that they will not "squeal," "howl," "roar," or "fry," as is the case with so many amplifiers now on the market.

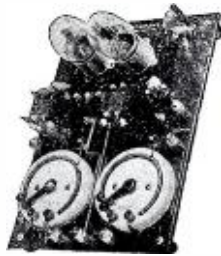

THE EATON OSCILLATOR FOR EXPERIMENTERS



Designed to transform receiving circuits to receive arc and other undamped signals.

It will oscillate over a wave length range of 250-25,000 meters.

Requires no adjustments of any kind.

This instrument plus a loose coupler or other receiving inductance, a vacuum tube, and a single variable condenser, constitutes a complete system for receiving undamped signals.

The simplest and cheapest way of receiving arc tube, high frequency, alternator and other undamped signals.

Price \$14.90 *Immediate Delivery*

WIRELESS SPECIALTY APPARATUS CO.,

*ENGINEERS, DESIGNERS, MANUFACTURERS
BOSTON, MASS., U. S. A.*

Federal Audio-Frequency Transformers



No. 226-W
Type A
PRICE
\$7.10 Each

For Use with Marconi V. T. Class I and II are Pronounced Unexcelled by Experts.

Especially Efficient for One or Two Stage Amplification — and Regenerative Circuits —

All Amateurs, Laboratories, Schools and Experimenters who wish to obtain the best results should have this transformer.

WRITE FOR
BULLETIN No. 102-W

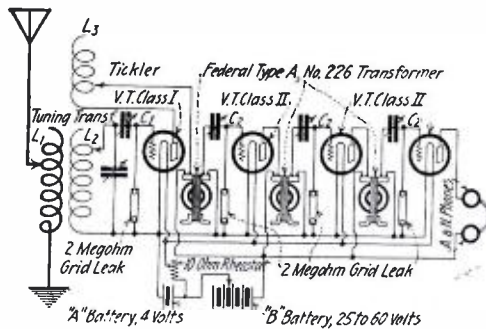

Fig. 3. Regenerative Circuit with Three-Stage Amplifier

FEDERAL TELEPHONE AND TELEGRAPH CO.

BUFFALO, N. Y.

Distributors for Marconi Vacuum Tubes—Standard Sockets and Leak Resistances

MANUFACTURERS OF

Standard Air Core Audio Transformers—Navy Type "Liberty" Head Telephones.

Famous "Century" High Frequency Buzzers—Anti-Capacity Switches.

Standard Jacks, Plugs and Accessories.

THE HEART OF THE WIRELESS

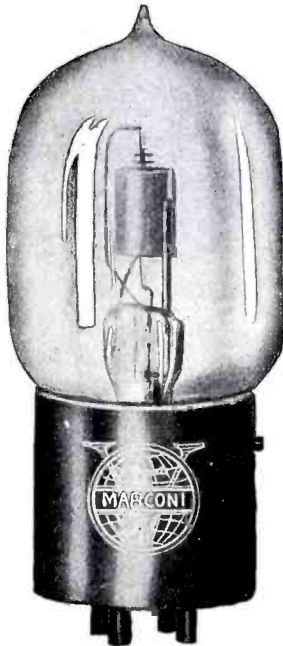

Fleming Pat. No. 803684
De Forest Pat. Nos. 841387-879532

*An Amateur Station
Without a Vacuum Tube
is Years Behind the Times*

MARCONI V.T. \$7.00 each

Under agreements recently effected the Marconi V. T. is the only vacuum tube, or audion, which may be sold to amateurs, laboratories, schools of instruction and experimenters.

The approximate operating life of the MARCONI V. T. is 1,500 hours.

Class I.—Designed for use as a detector; operates with plate potential of 20 to 60 volts.

Class II.—Designed for use as an amplifier; plate potentials from 60 to 110 volts may be applied.

Tubes in either class may be used for detection or amplification, but those of Class I are best as detectors, and Class II tubes are superior as amplifiers.

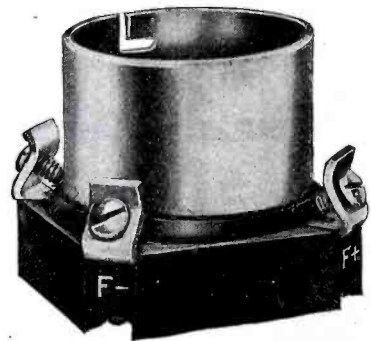

Standardized Socket \$1.50 additional

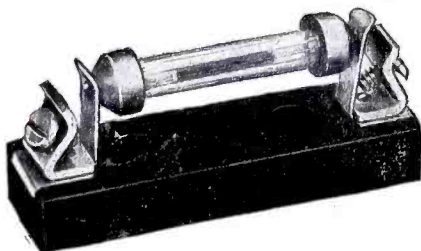

Standard Resistance, Complete \$1.00

The Marconi Resistance, connected in the circuit between the grid and the filament of the Marconi V. T., is made in the following standard sizes:

½ megohm, 1 megohm, 2 megohms, 4 megohms, 6 megohms.

Resistances of any special fractional values up to 6 megohms can be supplied.

Send all remittances with order to **COMMERCIAL DEPARTMENT**

MARCONI WIRELESS TELEGRAPH CO. OF AMERICA 225 BROADWAY, NEW YORK

Retail Office and Exhibition Rooms—25 Elm St., New York
Sole Distributors for De Forest Radio Telephone & Telegraph Co.

BRANCH OFFICES:

Schofield Bldg., Cleveland, Ohio
American Bldg., Baltimore, Md.

Insurance Exch. Bldg., San Francisco, Cal.
136 Federal St., Boston, Mass.

301 Commercial Bank Annex, New Orleans, La.
109 South 2nd St., Philadelphia, Pa.

Arc Undampnt Transmission

By PIERRE H. BOUCHERON

Ensign, U. S. N. R. F.

WHILE waiting for the Government to take the "lid" off amateur transmission, many of us are confining our attention to undampnt long-wave reception—that is, those of us who are fortunate enough to

larger sets and consequent increase power.

NECESSARY APPARATUS.

There are three general circuits in a Poulsen arc transmitter: the direct current power circuit of 500 or more volts

to cut in or out the compensating inductance by means of a direct current supply.

THEORY OF THE ARC AS A GENERATOR OF UNDAIMPNT OSCILLATIONS.

The various explanations advanced by

own a vacuum tube or two. There is a great deal to be said in favor of this type of wave, for it usually involves distances of several thousand miles as against the few hundred miles incidental with dampnt-wave reception, and thus the matter becomes an international instead of a national or local one with interest and fascination increased a hundred-fold. Under this inducement it is at once timely and important that amateurs be familiar with some of the most important methods of producing undampnt waves, which, by the way, are also referred to as sustained or continuous waves.

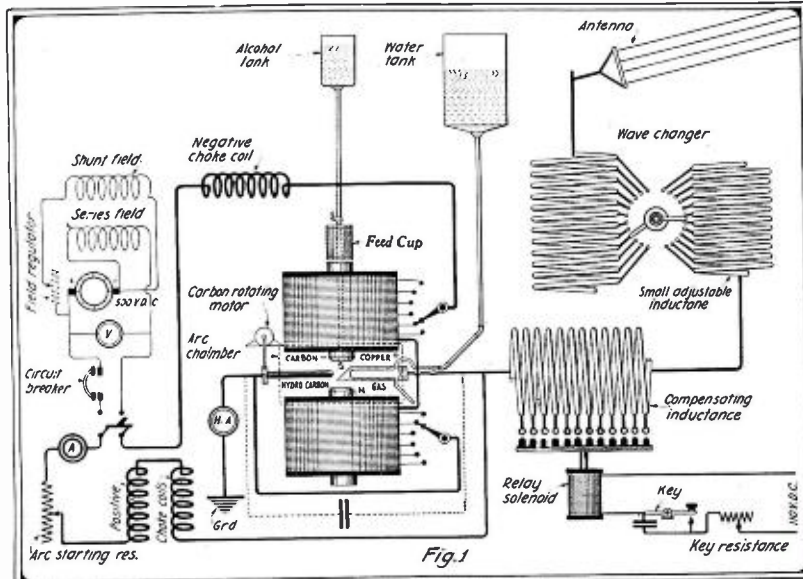

Connections of the Poulsen Arc Used Almost Exclusively in the U. S. Naval Radio Service— Note the Method of Shorting the Inductance in Order to Send Intelligent Signals.

As many of us already know, there are several ways of creating undampnt waves of radio frequencies, namely and in the order of their importance:

1. The Poulsen or Federal arc transmitter.
2. The vacuum tube transmitter.
3. The Goldschmidt alternator.
4. Alexanderson alternator.
5. The Marconi "Timed Spark" discharger.

For the present, however, we shall concern ourselves with a general explanation and description of the Poulsen arc, since this system is at present the most successful and practical one in use in this country, and for the benefit of the beginner or the average experimenter we shall avoid involved technical or mathematical definitions thruout this article.

Figure 1 shows a schematic diagram of a standard Poulsen arc transmitting system similar to the types used by the United States Navy for long distance work. Figure 2 shows a photographic sketch of a 60-KW. Poulsen arc pedestal transmitter with the names of some of the main parts directly connected with the arc proper. Figure 1 differs from the usual ones in that the essential appliances directly connected with the operation of the arc proper have been included so that with a careful tracing of the circuits a clearer understanding of the electrical as well as the mechanical functioning may be obtained. This diagram and the following descriptions and explanations, unless otherwise specified, do not refer to any specific type of the Poulsen arc, but it may be said that in general the principles involved in the standard 15, 20, 60, 100 and 500 KW. sets are the same except that the higher power transmitters are so constructed as to overcome the greater mechanical and electrical difficulties encountered in dealing with the

necessary for the ignition and regulation of the arc, the radio frequency tuned oscillatory circuit connected to antenna and ground, and the compensating relay key circuit. The direct current circuit may consist of a motor-generator set or a steam turbine driven, 500-volt generator; a suitable switchboard fitted with switches, fuses, circuit-breaker, volt and ammeter; a variable resistance to control the starting of the arc; two sets of choke coils, one on the positive and one on the negative side of the circuit; two large "blow-out" magnets mounted on the arc pedestal above and below the arc electrodes, with means of regulating the magnetic strength of each coil separately; a copper anode for the positive electrode and a carbon cathode for the negative electrode with a spring device to enable the operator to strike the electrodes together when starting the arc; a small motor to slowly rotate the carbon tip; a feed cup filled with alcohol so arranged as to drip slowly into the arc chamber, and a water circulating system to cool, primarily, the copper tip as well as the walls and door of the air-tight arc chamber. Concerning the "blow-out" magnets it may be well to mention that with some types of arcs there is but one large electro-magnet mounted below the arc electrodes, its yoke or core being constructed to form the opposite pole directly above the arc.

The oscillatory or antenna circuit may consist of a main antenna inductance, a small adjustable inductance in the form of a variometer, a wave changing device, a compensating inductance, a hot-wire ammeter placed either in the ground or aerial circuit, and in some cases a high potential condenser shunted across the arc electrodes.

The key or telegraphing circuit may consist of a magnetic solenoid relay arranged

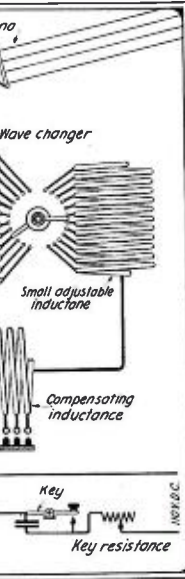

point, the potential difference, i. e., the voltage across the arc, begins to increase, and therefore further assists the condenser in charging itself. This potential increase is due to a peculiar characteristic of the arc in that when its current supply is reduced its voltage immediately rises and when its voltage is decreased the current flow is consequently increased; the direction of the current thru the arc, however, always remains the same. The charging of the condenser therefore continues until a point is reached where its voltage is equal to that of the arc. At this stage the condenser charging current is practically nil, and the arc therefore once more is supplied with its normal current and consequent drop of voltage. Now begins the discharging of the condenser backwards thru the arc, at the same time increasing the arc current above its normal value and incidentally decreasing its voltage. From this it may be seen that the condenser is assisted in its discharging because of the above mentioned decrease of voltage across the arc, and the shunted or antenna circuit being an oscillatory one, it has the effect of keeping the current flowing to the point where the condenser will have completely discharged itself; in fact, it will pass that point of zero value of the one sine or polarity and proceed to recharge the condenser, this time, however, in the opposite direction. This action continues until the original charging current of the first instance gradually nears the end of its strength, at which point the arc voltage again rises enabling the condenser to again

* In the case of some high power sets, having considerable antennae capacity and inductance, the shunt condenser is sometimes eliminated, but the operation is assumed to be the same; the charging and discharging process, in this case, taking place in the antenna circuit.

charge itself fully as in the first instance. In a sense, the arc may be said to be acting as a trigger in releasing the condenser charge which rushes or oscillates back and forth thru the arc, and while doing this causing the shunted or antenna circuit to oscillate at its periodic or natural frequency.

This cycle of events is thus constantly repeated, and while it has taken ten minutes or more to describe it on paper, the whole series of action is actually accomplished in an infinitesimal part of a second. The result of this remarkable behavior on the part of the arc is that the continuous oscillations taking place in the shunt circuit will, when inductively or directly coupled to the antenna, result in undamp radiation.

PRACTICAL OPERATION.

The voltage of the direct current generator of modern arc sets is usually 500 volts, but some installations employ voltages up to 1,500 with satisfactory results, and these machines are compound-wound in order to secure maximum stability of the current supply. When it is desired to start the arc, the current supply to the arc is closed, the starting resistance properly adjusted, and the operator "strikes" the carbon tip against the copper tip by pushing the starting button located on the adjusting handle of the carbon electrode. As soon as the arc is lighted the carbon tip resumes its normal position and the distance between the two electrodes is regulated for the proper action of the arc, care having been taken to properly connect the antenna in the circuit. Since the direct current arc supply must travel thru the windings of the field magnets, there is immediately produced a strong magnetic field at right angles to the arc electrodes. In the larger sets the respective strength of either of these two electro-magnets may be varied at will by cutting in or out any section of their windings. The lines of force of the magnetic field travel from north to south, and therefore have the tendency of blowing the arc flame in the direction in which they pass. This causes a quenching effect on the arc, increases its length and volume, and greatly assists the rapid charging and discharging of the oscillatory circuit. Meanwhile, a constant dripping of alcohol is taking place within the airtight arc chamber; the drops reaching the intense heat are immediately vaporized and converted into hydro-carbon gas. The presence of this gas increases the general efficiency of the arc by cooling the ionized flame space between the arcs, and the detonated particles being in turn blown out of the way of the arc by the strong magnetic field, the energy of the oscillations are therefore greatly increased. In order to avoid overflowing of the carbon tip and possibly cause a short-circuit across

the arc, it is caused to slowly rotate by means of a small motor, and the carbon thus burns evenly and remains comparatively cooled. The hollowed copper tip is stationary and is cooled by means of a water circulating system in the manner shown in Figure 1. The walls and door of the arc chamber are also cooled by the same water system. The choke coils inserted on both sides of the arc circuit, between the generator and the arc proper, are for the purpose of preventing high frequency oscillations from passing thru to the generator and possibly burning out its windings. As may be noted in Figure 1, this choke is usually greater on the opposite of the field windings so that proper balance of the arc supply circuit may be secured.

Now we come to the oscillating or antenna circuit. While the arc is in operation and the signal key open, there is a constant source of high frequency energy being radiated on a certain wave length called the "compensating wave," and if a distant receiver is tuned to this wave, a constant or steady dash will be heard. As soon as it is desired to transmit signals, however, the key circuit leading to the solenoid is closed, its armature opens the compensating inductance, which then becomes part of the antenna circuit, thereby

increasing the wave length anywhere from 50 to 400 meters, according to conditions which will be explained in another paragraph. The distant receiving operator having tuned his receiver to the higher or signalling wave length will thus hear the signal at each depression of the key only.

This manner of receiving may be reversed; that is, the solenoid relay may be adjusted to operate in the reverse direction, in which case the lower wave length will be used for signalling and the higher one for the compensating wave. The first method, however, is the one usually employed. In either case, and in order that maximum energy may be radiated on the signalling wave, this wave must be tuned to resonance with the arc circuit. The wave changer enables the operator to quickly change to any desired wave length, providing, of course, that the arc is not in operation at the time, while the small adjustable inductance or variometer is used to make up for any slight difference of inductance which may occur with various general adjustments.

OTHER MEANS OF INTERRUPTING COMPENSATING INDUCTANCE.

Unlike the regular spark system of radio telegraphy it is not possible to make and break rapidly the source of current supply leading to the arc without greatly reducing its efficiency so other means are employed to interrupt the continuous antenna oscillations besides the one referred to in the previous paragraph. The following are two additional methods.

THE ABSORBING CIRCUIT.

By referring to Figure 3 it will be seen that when the signalling key circuit is open the solenoid relay armature normally closes the absorbing circuit, consisting of an inductance and a condenser, thereby allowing all oscillatory circuit energy to pass thru to the ground, and altho the antenna is in the circuit, no appreciable energy will be radiated. As soon as the sending key is closed, however, the solenoid armature will be forced down, incidentally opening the absorbing circuit, and the oscillatory circuit energy will be deflected from the ground path and radiated into space thru the antenna and signalling is thus carried on. The absorbing circuit method has not been found very efficient, and is seldom used in high power sets, owing to the difficulty experienced in securing proper balance between it and the antenna circuit. It has, however, the advantage over other methods in that there is no compensating wave for the receiving operator to tune out, the high frequency oscillations being absorbed and led to ground while the sending key is open.

INDUCTIVELY COUPLED COMPENSATING CIRCUIT.

This method, sometimes referred to as the "Pearl Harbor Relay," is usually employed in high power

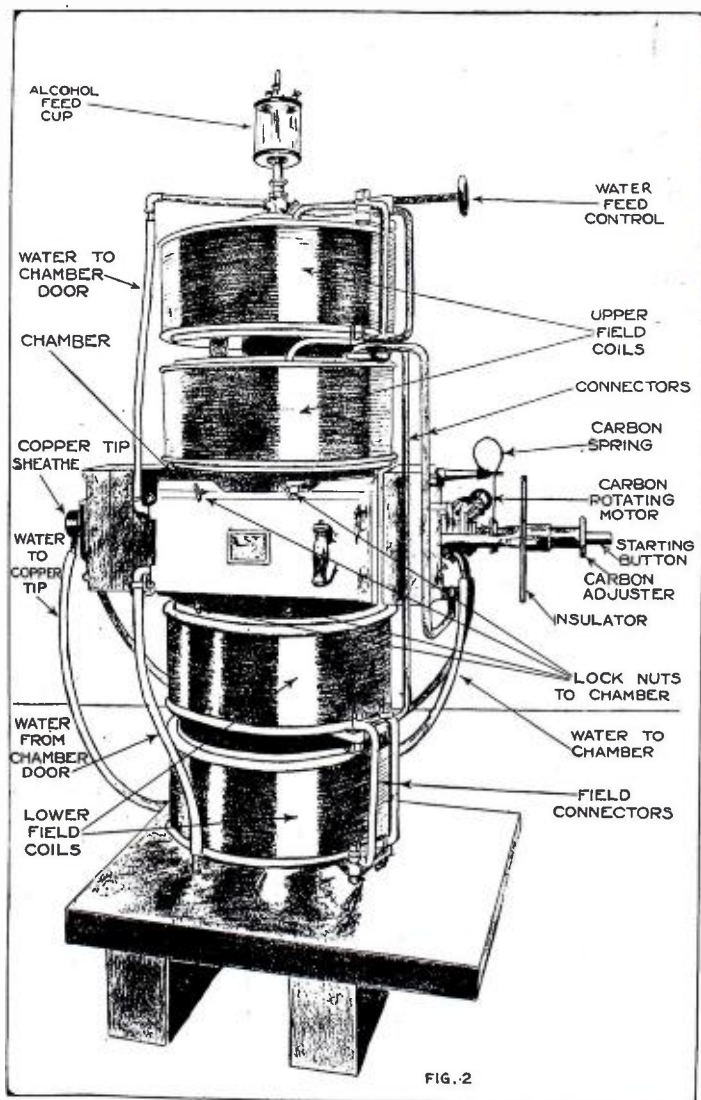
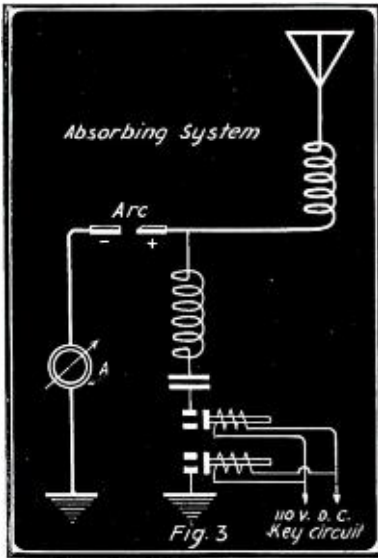

FIG. 2
The Complete Arc Generator of the Poulsen Type—Each Part is Indicated by Arrows.

sets such as the 60 to 500 KW. types, for then the amount of radiated energy is so great that it is often impracticable to attempt to interrupt it directly, altho one high power naval arc station has used the direct break method successfully on a 60-KW. set, employing fans for the purpose of cooling the contacts, which numbered twenty-four and were made of hard-drawn copper measuring 1 inch by 1½ inches. Figure 1 shows a schematic diagram of this circuit, which



Another Method of Signaling With Arc Transmitters. The Absorbing System.

is inductively coupled to the main antenna inductance. Coil A represents the antenna inductance, while coil B is really a series of small inductances sectioned off in such manner that all sections may be simultaneously closed or opened by closing or opening the key circuit controlling the solenoids. One end of these small inductances meet in a common core in the inside of the main inductance, while the other ends lead to the numerous make-and-break relays. These coils thus bear an inductive relation to the antenna inductance, and, having a periodic circuit of their own when closed, will absorb part of the radiated energy, thereby throwing the main oscillating circuit out of resonance with a consequent decrease of wave length. The receiving operator in this case may also be tuned for the higher or signalling wave.

The problem of securing the most effective compensating wave is not as simple as may be thought, particularly when dealing with high power installations of 100 KW. or more. Interrupting radiation by short-circuiting a certain amount of inductance is comparatively easy with small sets, as the amount of current to be broken by the solenoid relay contacts is then small and arcing negligible, but with the high power sets the antenna current is quite high and there is need of numerous large contacts, as many as twenty-four contactors having been found necessary in some instances to short-circuit 50 meters of compensating inductance. This involves increased weight and other mechanical difficulties resulting in loss of speed in the relay action which naturally reduces the telegraphing speed considerably. The difference between the signalling and the compensating waves therefore must be kept at a minimum in order to reduce heavy sparking at the contact points. On the other hand, if this difference is too small the two waves will radiate too near each other and the receiving operator at the distant point will

be unable to properly "tune in" the signalling wave, the two waves tending to "blend" with each other, resulting in a continuous dash. In present practice the difference between the two waves may vary from 200 to 400 meters, proper adjustments being made in each individual case to suit existing conditions.

PRECAUTIONS OBSERVED IN ARC OPERATION.

Great care must be taken by operators working about an arc in operation, and any part of the oscillatory circuit starting from the copper tip must be avoided. An operator at a certain high power station on the Atlantic Coast once started to refill the alcohol feed cup from a large metal can while the arc was in operation—he never did it again. Another stunt to be avoided is the opening of the arc chamber door immediately after the arc has been extinguished, for the sudden contact of the internal heated hydrogen with the external atmosphere will cause an outburst of flame which may result in severe burns to any one within range. With large arcs a period of ten minutes should elapse before the door is opened. Care must also be taken that the water cooling system is properly circulating. At land stations this is usually accomplished by gravity circulation, while at sea on shipboard a small pump operated by a motor furnishes a constant water supply thru the copper tip as well as thru the walls of the arc chamber.

The gradual burning away of the carbon and copper electrodes must be frequently observed, especially the latter, as otherwise the copper may burn thru to the hollow section, whereupon the circulating water will rush out into the arc chamber and extinguish the arc.

At least one fatality and several serious injuries have come to the attention of the writer owing to the operator having "struck" the arc when the carbon had not been properly fastened in its receptacle. In these instances, the hydro-carbon gas having reached a sufficiently great pressure, the loosened carbon was blown out of its holder followed by a stream of flame, proving disastrous to the operator, who invariably stands on that side of the arc when starting it.

Finally, and if the reader ever has occasion to visit an arc installation of high power let him leave his good Swiss watch at home, otherwise when he approaches the powerful magnetic field surrounding the arc pedestal while it is in operation the watch will be most effectively magnetized and rendered useless.

While the foregoing will give a fair idea of the theory and operation of the Poulsen arc, some of the statements are to be regarded as general, for in practice a multiplicity of operating conditions peculiar to every specific installation will be encountered, necessitating most careful and studied adjustment of the various appliances directly and indirectly connected with the arc proper.

DATA ON A FEW ARC INSTALLATIONS.

In general, ship sets of the U. S. Navy range from 15 to 30 KW., depending on the size of the vessel. The following is a list of some of the naval shore stations:

Annapolis, Md.	500 KW.
San Diego, Cal.	500 "
Cavite, Philippine Islands.	500 "
Pearl Harbor, Alaska.	500 "
Darien, Canal Zone.	200 "
Sayville, L. I. (N. Y.)	200 "
Tuckerton, N. J.	60 and 100 "
Arlington (Radio), Va.	50 "
San Francisco, Cal.	50 "
Key West, Fla.	30 "
New Orleans, La.	30 "
Boston, Mass.	30 "
Charleston, S. C.	30 "

APPROXIMATE ANTENNA RADIATION OF ARC SETS.

15 KW. radiates	20 to 25 amperes
20 " "	25 to 30 "
30 " "	35 to 45 "
50 " "	50 to 60 "
60 " "	60 to 75 "
100 " "	80 to 100 "
500 " "	250 to 275 "

ADVANTAGES OF THE ARC.

There is considerable difference of opinion as to the relative advantages of the arc transmitter compared to the high frequency alternator method, such as the Goldsmidt and Alexanderson systems. Some authorities concede, however, that the Poulsen arc with the same amount of power will, under equal conditions, transmit a greater distance than the alternator system. This is attributed to the perfect oscillation frequency secured by the arc as compared to the instability of the alternator frequency, altho it is quite probable that this disadvantage will be eliminated in future machines. On long distance work, the high frequency alternator does not hold its own as well as the arc for the reason that it is almost a mechanical impossibility to maintain its revolutions at an exact and absolutely constant speed. For this reason, even a very slight rise or fall of alternator speed increases or decreases the frequency of the emitted oscillations and consequently affects the wave lengths making reception difficult at the receiving end. For instance, the signals of the German station at Nauen, which employs a high frequency alternator, are clearly readable in New York under normal conditions, and altho the signals are quite capable of reaching San Francisco, accurate reception at this place becomes more difficult. Many assertions are heard nowadays from globe-trotting operators to the effect that they have heard "POZ" (Nauen) while near the South Sea Islands, or while at Sitka, Alaska, or off the coast of China. Certainly they have; and so will anyone else if they take the trouble to set up a reliable long-wave receiver. Nauen's signals may be effectively intercepted up to several thousand miles, but beyond 3,000 miles or so it is difficult to copy four consecutive words without some of them "fading out" entirely, and this fact is due to the variation of the alternator frequency.

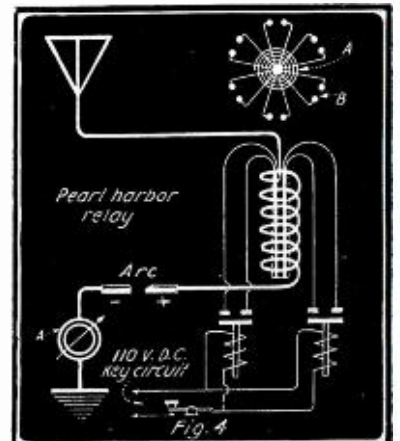

The System Employed for Transmitting With the Larger Sets from 60 to 500 Kw.

ARC VS. ALTERNATOR.

Several years ago official tests were made between Cavite, P. I., and Arlington, Va., a distance of approximately 11,400 miles, and between Auckland, New Zealand, and Nauen, Germany, in order to determine the relative efficiencies of the arc and alternator systems; the same amount

(Continued on page 194)

Latest Developments in Audio Frequency Amplifiers

By WALTER J. HENRY*

A WELL known Boston concern has recently developed and produced two very attractive and efficient models of the Two Step Amplifier. Both models function in an identi-



Fig. 1. A Commercial Type of Two Step Amplifier Designed by a Well-Known Expert Radio Engineer Which Helped Uncle Sam Win the War.

cal manner, and operate with equal efficiency.

The amplifier unit is of the enclosed type and designed to produce a maximum of beauty and finish.

The amplifier shown in Figs. 1 and 2 contains all the necessary apparatus mounted upon a bakelite dielecto panel board supported by four rubber feet. This unit was designed with all wirings openly visible and with terminal connections unsoldered

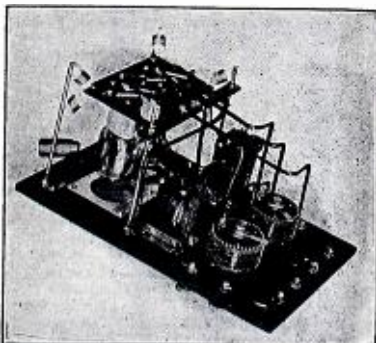

Fig. 2. Taking a Peep at the "Works" Isn't It Pleasing to the Eye to Note Such Refined Workmanship and Exceptional Design, Especially the Cage Type Filament Rheostats and Shock Proof Mountings for the Bulbs.

to produce a unit adaptable to experimentation with different connections and circuits. Both these units were designed by Mr. William H. Priests.¹

A second type Two Step Amplifier which is a compact unit of the resonance low frequency type is shown in Figs. 3 and 4. It provides a maximum of amplification due to the transformer design, which is greatly superior for radio reception to the flat amplifying transformers. The input impedance of each tube is automatically controlled by the filament rheostat.

The apparatus consists of two vacuum tube receptacles, two filament rheostats and two amplifying transformers. Shock-proof mountings protect the vacuum tubes from "noise" due to mechanical vibrations.

The apparatus is mounted in the rear of a bakelite dielecto panel and enclosed by an oak box. At the bottom of the panel are terminals for connecting six-volt filament and the 40-volt plate batteries. At the lower left of the panel are the two input binding posts for connection to the receiver equipment. At the right of the panel are two binding posts for connecting telephones which register the amplified signals.

This amplifier will provide a greater degree of signal amplification. It is compact, simple, and efficient.

The type of amplifier shown in Figs. 3 and 4 was designed to provide an instrument in which all connections would be visible and easily accessible, and thus facilitate experimenting with different circuits and connections. It functions in a manner identical with the amplifier just described. It is equally efficient, and differs only in its less expensive construction.

All the necessary apparatus is mounted upon a bakelite dielecto panel supported by four rubber feet. The amplifier consists of two vacuum tube receptacles, two closed-core audio frequency amplifying transformers, and two porcelain base circular control rheostats.

The tube receptacles are designed to receive standard tubes of the four-prong type. The two receptacles are mounted on a bakelite dielecto piece supported and held away from the panel board by eight coil springs, stuffed with cotton. This arrangement effectively supports the two vacuum tubes and eliminates all "noise" by a spring support system that has a high damping, thus quickly eliminating vibration. The leads from the vacuum tube receptacles are brought out to binding posts on a small strip terminal board which has engraved upon it an identifying letter for each terminal. The grid terminal is marked "G," the plate terminal is marked "P," and the filament terminals respectively F+ and F-.

All wiring in the filament circuits is enclosed in yellow varnished cambric tubing. The wires of the grid circuit are baked with red enamel, and the connecting wires in the plate circuits with green enamel. In this way the various wires may be easily identified. No solder is used in connecting the wires at the various terminals. Firm connection is established at each terminal by a special locking nut. Upon loosening these nuts the wires may be disconnected, making it easy to experiment with different circuits.

At the left of the panel board are two "input" binding posts and at the right are the "telephone" binding posts. At the bottom of the panel are three binding posts for connecting the six-volt filament and

the 40-volt plate batteries. The middle post is common to both circuits. The input impedance of each tube is automatically controlled by its filament rheostat.

This instrument will provide the same



Fig. 3. Rear View. This Instrument Was Designed to Permit the Experimenter to Delve into the Audion Circuits With a Possibility of Finding Better Ones Than We Have To-day—if Such a Thing is Possible.

maximum amplification accomplished with the first mentioned amplifier. The design of this unit is such that it will not "squeal," "fry," "roar," or "howl."

The type shown in Fig. 1 was used at practically every naval receiving station during the war, with the exception that radio frequency air core transformers were employed thruout. This type, as is clearly shown, employs the iron core audio fre-

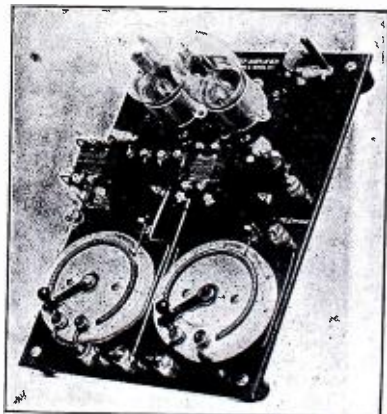

Fig. 4. This Type, Also Shown Above, Was Designed Less Expensively With the Object of Providing an Efficient Two Step Amplifier For Those Without Fat Pocketbooks.

quency amplifying transformers. The only difference between this and Fig. 3 is the rheostats and method of supporting the base of the vacuum tubes.

* Sales Manager, Wireless Specialty Apparatus Co.
¹ Chief Eng., Wireless Specialty Apparatus Co.

An Undampt Transmitter of the De Forest Type

By EUGENE DYNNER

UNDoubtedly practically all the amateurs worthy of the name in the United States have already constructed their apparatus for the reception of radio signals and they are even now doing wonders with these sets. We are hearing every day of new feats in long-distance receiving accomplished with old apparatus used in a new way and new apparatus used in the old way, and accounts vary as to the specific reason for the great distances covered. Very few amateurs, however, have taken into consideration that the great ranges covered in receiving are due as much to the vast improvements made in sending apparatus as to the improvements in methods of reception—methods in both having been revolutionized during the two years of warfare which were mainly instrumental in bringing the long period of hostilities to a successful close for the forces of democracy, etc.

In receiving apparatus we have been literally deluged with the "best" schemes for receiving—generally accompanied by involved and highly unworkable circuits for vacuum tubes, valves, electron tubes, and what not. In the sending end of the game there has been one long silence since nineteen seventeen, and it is the purpose of the present paper to describe a transmitter which should find a place in the station of any amateur who considers it worth his while to get the greatest pleasure out of the hobby.

The principal development in radio transmission has been in the realm of the undampt or continuous wave transmitter. The transmitter described herewith will therefore be an arc transmitter generating continuous waves and operating on the regular 110 volt A. C. house current. The instrument described is designed for telegraphy and not telephony, as the bulk of commercial traffic is still being handled by telegraphic methods rather than telephonic, and altho tremendous strides have been made in telephonic work, the conditions at present do not warrant the construction of a permanent telephonic transmitter.

In the author's paper in the August issue of this journal, in the course of description of the radio receptor, he stated that: "In the design of the modern receiving instrument these prime factors are to be borne in mind: the highest efficiency and the most precise adjustments are to be obtained at the lowest possible cost, within the most practicable compactness." These conditions are also being observed in the design of this transmitter, as no one is more considerate of the financial aspect of construction for the amateur than the author. Some descriptions of equipment carry to the reader the impression that he must needs be a veritable Croesus to construct an efficient instrument. And nothing

is further from the truth than the assertion that highly efficient apparatus must be expensive.

So I say, fellows, go to it; and be ready on "opening night!"

The complete transmitter is somewhat on

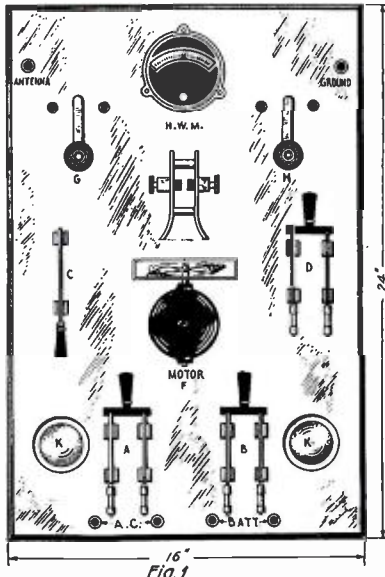

Fig. 1
A Transmitter of Both Dampt and Undampt Waves. It is One of Extreme Simplicity and Compactness, and is Particularly Adapted to Modern Experimental Needs.

the order of the excellent De Forest arc transmitter which the author had the pleasure of operating aboard several ships, including the Wm. E. Chapman, the Frieda, and the New Jersey. This set was another proof of the ability in radio engineering along new lines of Dr. De Forest and his associates, among whom may be numbered

volts D. C. is very seldom available to the amateur, the writer has caused the arc to operate by means of stepping up the 110-volt A. C. current generally found in every home to the required voltage, and then rectifying it by means of the rectifying bulbs now on the market. There is also no reason why the constructor may not make use of any ordinary lamp which has a plate inserted within it and then re-exhausted. A very fruitful field for experiment is also offered by placing an exterior plate around an ordinary bulb, and in that manner making rectification take place.

The constructor will note that the completed transmitter is contained in very small space; in fact, the rear of the panel is sufficient to hide all instruments not mounted directly on the panel. This panel may be constructed of either marble or any other insulating substance which is available to the constructor. On the panel are mounted all the controls, the arc, and the meter.

The two rectifier bulbs are mounted in their respective sockets on the lower part of the panel, one on each side. Between the two bulbs the two primary control switches are mounted. Of these, one controls the 110 A. C. current which feeds the transformer, whereas the second switch controls the motor which cools the arc. This cooler may be an ordinary fan run either by the 110 A. C. or from batteries. In fact, if it is desired an extra winding may be added to the transformer to reduce the current in such a manner that the low voltage motor on the fan can be run by the same character of current as that which supplies the filaments of the rectifying bulbs.

The arc consists of two tungsten electrode terminals mounted on copper or other metal vanes between which the cooled arc can be forced by the fan directly under the arc. Construction of the arc is indicated in Figure 3. It will be apparent from the illustration that the arc electrodes, three-quarters of an inch in diameter, are mounted in the center of the cooling vanes,

which are four inches square and turned in the manner indicated to allow a free passage of air between the electrodes. If the electrodes are made of tungsten steel, as stated, they need not be very thick. In fact, the thinnest obtainable will be quite satisfactory, as they are not very apt to disappear. The thickness of the tungsten electrode offers one source of economy. In order to assure concentration of the arc on the tungsten electrodes it is advisable to have them mounted on brass washers about a quarter of an inch in thickness. The heat radiators,

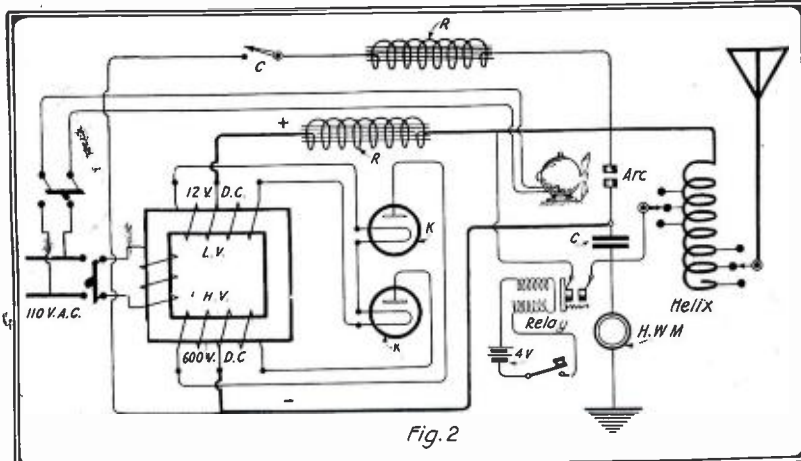

Fig. 2
600 Volts for the Arc is Delivered from the Transformer Secondary and Then Rectified by the Vacuum Tubes. The Entire Transmitter is a Marvel of Simplicity.

Mr. Logwood, who was chiefly responsible for the design of the arc to transmit on 600 volts D. C. This was found to give excellent results, and has been adapted by the writer to the needs of the amateur. As 600

P, are separated by hard rubber or bakelite washers, H, at four points; and these are of such thickness that the normal separation of the electrodes will be about an eighth of an inch. The whole arc is held

by the two thumb screws, A, mounted on the supporting pillars, S, which are secured to the front of the panel. By adjusting the tension of the screws, A, the arc may be adjusted to various distances at which operation will be most efficient.

The switch C is a single-pole single-throw affair, preferably of the quick-action

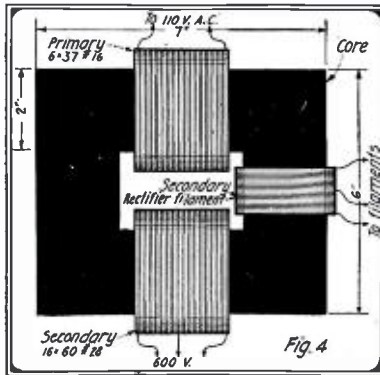

The Transformer With Secondary Windings to Light the Rectifier Filaments and Furnish High Voltage for the Arc.

spring type, and is used to start the arc. Switch D controls the 600-volt D. C. current which is fed to the arc. G and H are the wave changing switches which are connected to the two movable contacts on the helix mounted on the rear of the panel. A hot wire ammeter is mounted at the top of the panel to indicate the point of adjustment which is giving the highest radiation. It may be said here that as much as six amperes has been obtained with this transmitter, when transmitting undamp't. This apparatus may also be used to transmit slightly damp't signals with a variation in frequency of transmitted signals constantly under control of the operator.

The transformer employed for raising the voltage to that required for the operation of the arc and simultaneously lowering the voltage to that required for the filament of the rectifying bulbs, is indicated in detail in Figure 4. The core is constructed from silicon-iron sheeting of about No. 24 B. & S. thickness, or any other thickness that is available. The sheets are six by seven inches, and when ready for use the sheets are cut to a width of two inches in the manner indicated on

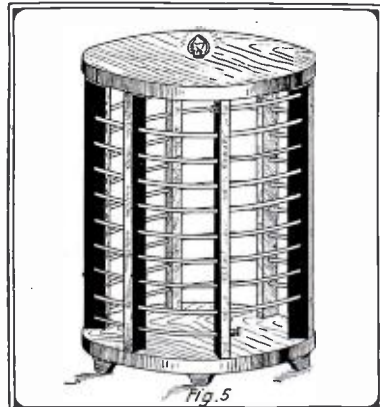

The Old Type Helix is Once Again Reurrected to Take its Place Among Ultra-Modern Apparatus.

the drawing. The thickness of the core is one and three-quarter inches.

The primary winding, which is connected to the A. C. source, consists of six layers of thirty-seven turns each of No. 16 single cotton covered copper wire. The rectifier

filament secondary consists of two layers of twelve turns each of No. 18 double cotton covered wire. Ordinary annunciator wire is excellent. This winding is tapped at the twelfth turn; that is, there is a lead from each layer of the winding. And the high voltage secondary consists of 25 layers of sixty turns each of No. 28 D. C. wire. The secondary is also tapped at the center.

In assembling the core it is desirable that each sheet should receive an individual coat of thin shellac, and the entire core, when assembled be bound together with empire cloth. This empire cloth winding is absolutely essential between the different windings on the core and between the layers of the primary winding.

The choke coils necessary for operation of the arc, shown at R in Figure 2, are built of five layers of No. 14 D. C. wire on an iron wire core seven and a half inches long and one inch in diameter. A pound of the No. 24 annealed iron core wire on the market today is sufficient for the construction of the core.

Figure 5 illustrates the tuning inductance. This is nothing more than the old style helix, which may be picked up at a very low cost. It is, of course, not necessary that it be constructed exactly as shown. It may be in any of the numberless forms which are within the scope of any amateur to construct, and the design of this is therefore left to the ingenuity of the constructor. Six clips are used to provide for three different wavelengths to which the transmitter may be adjusted; say 200, 150 and

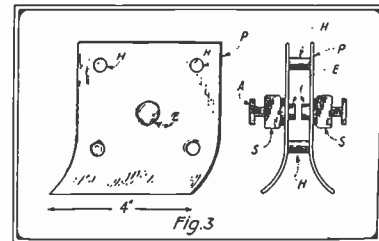

The Prime Feature of the Set is the Arc, Consisting of Two Tungsten Electrodes.

100 meters, thus providing a range of wavelengths which should make intercommunication possible under difficult conditions such as those caused by the simultaneous transmission of several transmitters on an identical wavelength.

The details of the condenser are shown in Figure 6. Ordinary 7" x 8" photographic plates, to the number of twelve, are used in the construction of this condenser. The conducting surfaces are of heavy tinfoil 6 x 7 inches with lugs of sufficient length to allow easy working. The plates are coated on both sides with the tinfoil sheets with the lugs protruding beyond the edge of the glass plates in the position shown at A in Figure 6.

Two sides of a case provided as a housing for the condenser are slotted so that the plates may be slid in or out of the condenser and punctured plates replaced at will. These slots are separated at a distance of an eighth of an inch.

In preparing the plates, A, it is necessary that six of them should be as shown in the illustration and six with the lugs on the opposite side. That is, there should be six "rights" and six "lefts." This is necessary because in mounting if the plates were left with all connection lugs near each other it would be a very simple matter for the sparks to jump across the condenser. It will be evident, then, that when the plates are placed in the case, rights and lefts in consecutive order, all the leads at one side of the condenser will be connected to one terminal. At the opposite side, the first and last tinfoil sheet is connected to con-

tact points on a switch mounted on the top of the case. The other tinfoil sheets, as indicated at C in Figure 6, are connected to their respective contacts on the switch, thus giving seven points of capacity variation. This makes a very flexible condenser, and is just the thing necessary in low wavelength work, where the amount of capacity in a circuit must be very flexible, so that

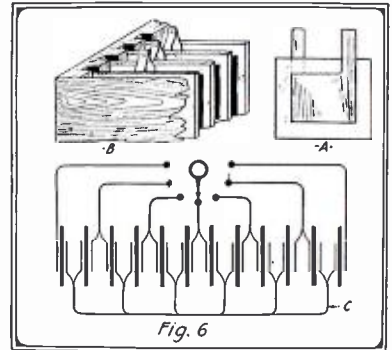

A Very Meritorious Transmitting Condenser of Continuously Variable Capacity.

there will be no surplus of capacity in the circuit.

When sending it is necessary that the key make contact when the key knob is released, and not when it is depressed, and as the current carried here is rather heavy, the author has designed a special relay for the purpose. As shown at Figure 7, the relay consists essentially of two silver contacts which are closed normally, but when a current is applied to the electromagnets, M, they draw the cross-bar, C, upon which is mounted one of the contact points toward themselves, thus opening the circuit at L. Contact Q is made fast to the standard B. Two steel pins, P, are fastened to the cross-bar, and slide within the holes provided for them in the half-inch square brass standards, A. The ends of these pins are normally held in position by the springs, T, which draw them toward the posts, E. Contact R is connected to binding post, H, by a flexible conductor. The two electromagnets are constructed on a core 1/4" in diameter. The windings consist of No. 24 D. C. wire laid in five layers of forty turns each. The two magnets are connected in series and operated by an ordinary telegraph key and a sufficient number of dry batteries to assure rapid action from the relay when the

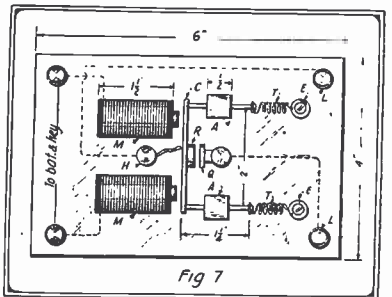

The Relay is Needed to Make Contact When the Key is Released.

springs, T, are of the proper tension. The proper adjustment of the relay and the current necessary will have to be determined by experiment after the arc transmitter is completed, as it will be evident to any one who has had wide experience in radio that the conditions under load in an arc transmitter are different than when no load is applied.

(Continued on page 196)

Government Radio Control

66th Congress, First Session.
HOUSE OF REPRESENTATIVES.
Document No. 159.

Radio Stations under Control of the Navy
Department for Commercial Purposes.

Letter from
THE SECRETARY OF THE NAVY,
Transmitting

A Proposed Bill authorizing the use of
Radio Stations under the Control of the
Navy Department for Commercial Pur-
poses.

July 23, 1919.—Referred to the Committee
on Naval Affairs and ordered to be
printed.

Navy Department,
Washington, July 19, 1919.

My Dear Mr. Speaker: I have the honor
to transmit herewith a proposed bill, the
enactment of which I consider vitally essen-
tial to the furtherance of the business in-
terests of the country. The reasons for
such legislation are given in considerable
detail, as follows:

The subject of communication between
the United States and foreign countries,
for the benefit of American business inter-
ests, as well as for the promotion of a bet-
ter understanding between nations, has
been made the subject of careful study by
this department with a view to placing the
facilities of the Navy Department, so far
as can possibly be done, at the disposal of
the general public in the resumption of
commercial competition with foreign en-
terprises and in the development of the
commerce of the Nation to that point to
which it should rightly attain.

The ability to transact business depends
upon communications, and unless the sys-
tems of communication are effective, the
transaction of business is made difficult in
direct proportion to the facility with which
the communications are handled. This is
a well-recognized fact and its truth has
been made so apparent by the numerous
letters and dispatches that have come to
my office recently on the subject of the
inadequacy of the cables to handle the present
(not to mention the contemplated)
very large amount of commercial message
traffic, that I am convinced the Navy De-
partment can assist materially in prevent-
ing what promises (under present laws)
to be an intolerable situation in the busi-
ness world, by using the communication
facilities of this department which are now
available and which, logically, should be
so used.

The fact is that this department has an
organization already in excellent operating
condition capable of handling all classes of
commercial messages between ships and
shore, and between points in the United
States and trans-Atlantic and trans-Pacific
points, and a large number of these mes-
sages are actually being handled. On the
proclaiming of peace the handling of this
business by the naval radio stations will
automatically cease, according to the present
law, and the result will, very probably,
be disastrous to American business inter-
ests.

The present organization of the naval
communication service was built up along
carefully studied lines, and while it was
designed primarily for the service of the
Government, the fact that the commercial
interests of the Nation should likewise be
served to the utmost of its capacity was a
determining factor in its formation and
development. Such a system was necessary
for purposes of national defense and con-
currently for the benefit of American ship-
ping, as in many localities along our coasts

the naval radio stations were the only
stations thru which communication was
available to mariners.

As a result of the gradual development
of this service the Government now has
at its disposal a means for remedying the
very serious condition existing in our
transoceanic communications, and the lack
of authority from Congress for the em-
ployment of this service is the only obsta-
cle in the way of affording the commercial
interests of the country relief from the
delays already experienced in their com-
munications with foreign commercial
firms.

In the Pacific, the Chambers of Com-
merce of San Francisco and Seattle are
seeking to employ the services of the naval
radio stations for their business with Ha-
waii, the Philippines, and the Orient. At
present the delay on cable messages in that
ocean (Pacific) is about 7 days, and this
despite the fact that the naval radio high-
power stations are handling approximately
20,000 words a day, not counting Govern-
ment messages. Unless authority is ob-

In this bill Secretary Daniels
pleads for Government control of
all U. S. Radio stations, giving as a
reason that business now suffers
heavily because of the delay of
all messages, be they cable or radio.

The argument, however, is ob-
viously fallacious. The Navy could
no more hope to improve the situa-
tion immediately than it could im-
prove the unprecedented housing
condition which now exists in all
large cities.

What we need is more commer-
cial radio stations everywhere.
And these will be built quickly by
private interests as soon as our
officials stop advocating Government
control.

tained for the naval stations to continue
the handling of commercial messages, the
delay will no doubt be doubled. This is
clearly a situation that needs relief. It
seriously affects all business between the
United States and countries of the Orient.
There is, in fact, sufficient business for
the cable, commercial radio stations, and
naval radio stations. In a short time a
new circuit (by radio) to Siberia (Vladi-
vostok) via naval radio stations in Alaska
will be in operation, and this should relieve
the situation in that ocean very materially,
provided, of course, the authority for naval
radio stations to handle commercial mes-
sages is granted by the Congress.

On the Pacific coast of the United States
the Navy Department owns and operates
the following stations:

San Diego, transmitting and receiving,
to Hawaiian Islands and Siberia.

San Francisco, transmitting, to Hawaiian
Islands.

Yerba Buena, receiving, from Hawaiian
Islands.

Puget Sound (Keyport), transmitting, to
Alaska.

Puget Sound (Navy Yard), receiving,
from Alaska.

Astoria, transmitting and receiving,
Ketchikan (Alaska only).

Cordova, transmitting and receiving,
from Puget Sound and Alaskan stations.
Relay to Siberia via St. Paul.

St. Paul (Pribilof), transmitting and re-
ceiving, to Siberia (Vladivostok).

The Marconi Co. has the following sta-
tions on the Pacific coast:

Bolinas, Calif., transmitting, to Hawaiian
Islands.

Marshall, Calif., receiving, from Hawai-
ian Islands.

Kahuku, transmits to Pacific coast and
Japan.

Koho Head, receives from Pacific coast
and Japan.

The Navy owns and operates a high
power station at Guam, which receives and
transmits from and to the Philippines and
Hawaiian Islands. There is no commer-
cially owned radio station at Guam.

In the Philippines the Navy owns and
operates one high power station at Cavite.
This station transmits to and receives from
Guam, Hawaii, and Siberia, and transmits
to China. There is no commercially owned
high-power station in the Philippines.

The above stations are the only ones in
the Pacific, on United States territory, cap-
able of handling long-distance work—that
is, messages that would ordinarily have to
be placed on the cable. The cable suffers
frequent interruptions, due to weather,
character of bottom, etc., and especially is
this the case between Guam and the Phil-
ippines. During such interruptions the
naval radio stations have handled this traf-
fic so far as they were able.

It will be noted that the Marconi radio
circuit reaches Japan only by radio, while
the naval radio stations reach Guam, Phil-
ippines, Japan, and is capable of working
with China and Siberia, and does, in fact,
transmit to Vladivostok, Siberia. The
press association news of the world is suf-
fering delays now in transmission to those
countries in the Orient, and unless author-
ity to continue the naval radio circuit for
commercial business is granted, this news
matter will, of course, suffer in the same
degree as the ordinary commercial mes-
sages.

In the Atlantic, cable traffic is also de-
layed and upon the abolition of cable cen-
sorship on July 23 the amount of traffic
will be so heavy, especially to the Central
Powers of Europe, that it is estimated that
a message will probably experience from
two to three weeks' delay in reaching its
destination. The situation promises to be
so serious that business interests have made
inquiries of this department as to the pos-
sibility of giving priority to purely business
messages on the cables. Here, again, this
department's communication service can be
utilized if the Congress grants the neces-
sary authority. There are a number of
high-power radio stations in the Atlantic
capable of trans-Atlantic work, but no
station will be ready to handle this com-
mercial traffic satisfactorily for a number
of months, if at all, except those high-
power stations owned and controlled by the
Navy Department.

The high-power naval radio stations in
the Atlantic are: Annapolis, Md., transmits
to Italy, France, England, Germany, and
to all countries in western Europe.

Sayville, N. Y., transmits to Italy, France,
England, Germany, and to all countries
in western Europe.

Otter Cliffs, Me., receives from Italy,
France, England, Germany, and from all
countries in western Europe.

Navy Department, Washington, D. C.,
received from Italy, France, England, Ger-
many, and from all countries in western
Europe.

NOTE.—The Bolinas station is equipt with
antiquated apparatus and causes very seri-
ous interference with other stations in its
vicinity.

In the Hawaiian Islands the Navy De-
partment owns and operates the following
stations:

Pearl Harbor, transmits to Pacific coast,
Guam, Philippines, Japan.

Heeia Point, transmits to Pacific coast. Wailupe, receives simultaneously from Japan, Guam, Philippines, Pacific coast. The Marconi Co. has stations in the Hawaiian Islands.

As an indication of the ability of the naval communication service to handle this transoceanic traffic, it is a fact that approximately 2,000,000 words have been handled by stations in which Navy apparatus has been installed during the past six months. This example alone should be sufficient to demonstrate the possibilities for the commercial world in the use of this department's system of radio communication. A pertinent fact in this connection is that many of the cables to countries of central, southern, and northern Europe pass via England or France, whereas the naval radio stations can work direct with high-power stations in the immediate European country concerned, and any delays that may be occasioned by our commercial messages having to pass thru cable offices of foreign countries will thus be obviated.

The only commercially owned radio station on the Atlantic coast of the United States that will be able to handle trans-Atlantic messages is owned by foreign interests (French), altho the company is incorporated under the laws of one of the United States. This is the station at Tuckerton, N. J., and its ability to handle the traffic continuously and efficiently is very doubtful.

The Marconi Co. have the following stations on the Atlantic coast, designed for trans-Atlantic work:

- Glace Bay, Canada.
- Marion, Mass., transmitting station.
- Chatham, Mass., receiving station.
- New Brunswick, N. J., transmitting station.
- Belmar, N. J., receiving station.

The station at Glace Bay, Canada, is equip with antiquated apparatus, and as a result causes much interference to other stations.

The Marion station is equip with a new type of apparatus, but this station has never been successfully operated. Marconi engineers have been in this station in the employ of the Marconi Co. during the war in an attempt to put the apparatus in operating condition, but without success. The most recent information on this station is to the effect that its date of completion and readiness for operation is problematical—certainly not for a number of months.

The station at New Brunswick will, from

present information, have no apparatus in it on conclusion of peace capable of operating with trans-Atlantic stations, and months will probably be required before suitable apparatus can be installed.

The resultant condition of the trans-Atlantic communications upon the conclusion of peace and abolition of the cable censorship promises to handicap seriously the commercial interests of the Nation unless relief is furnished by granting authority to naval radio stations to handle commercial business.

As an actual fact, the Navy Department owns and operates 85 per cent of all radio stations in the country, and the organization is in existence to take up and continue the work so badly needed and which no commercial company is now in a position to accomplish.

The Navy maintains and owns a chain of coast stations along the United States coast which is capable of handling commercial messages between ships and the shore and has been handling this class of traffic for a number of years. Should any commercial company erect a radio station within 100 miles of a naval radio station and operate such commercial station 24 hours of the day, the naval station must, according to the present law, cease handling commercial messages. Considering the fact that there are at present only five commercial stations within the continental limits of the United States maintaining continuous service, there will be no hardship worked on commercial operating companies by the proposed legislation.

On the Atlantic coast there is one commercial station in New York, Bush Terminal, available for handling commercial business that is now taxing to capacity six stations operated by the Navy Department: Navy Yard, N. Y.; Mantoloking, N. J.; Fire Island, N. Y.; Sea Gate, N. Y., and Bush Terminal, N. Y. These stations are remote, controlled from the city of New York, and can be operated with a minimum of interference with each other, thus enabling them to handle efficiently the enormous amount of ship-to-shore traffic in that very congested district. A single station, or six single stations, operating under the control of six individual commercial companies, could not possibly handle the amount of traffic, as they necessarily could not have the same control over their individual stations as is now exercised over all by the Navy Department.

In the vicinity of Boston there is one commercial station available for handling ship-to-shore traffic. This station would

have to perform the work now done by the naval radio station, Boston, and the naval radio station, Filene Building, Boston, both of which are now controlled from the Boston Navy Yard, as are the New York stations from New York City.

Newport, R. I., is in the same status; that is, there is one commercial station available to do the work now done by the naval radio station, Newport, and the naval radio station, Siasconset.

The radio stations in the first district—that is, from Bar Harbor to Newport—are so controlled that if one station can not handle business with ships, then this business is immediately transferred to another station in the district at no extra cost to the sender. No commercial organization is equip to give similar service.

The only other congested area in the United States having commercial radio stations is New Orleans, La. Here there is one small station and one large station operated by the Tropical Radio Co., and these two stations will have to perform the work formerly handled by four stations under control of the Navy Department.

The whole subject of furnishing adequate and efficient means of communication seems to me so very urgent that I hope you will give it your favorable consideration and I hope that the Congress may act favorably on the proposed measure at the earliest opportunity.

Sincerely yours,

JOSEPHUS DANIELS.

The Speaker, House of Representatives.

A BILL Authorizing the use of radio stations under the control of the Navy Department for commercial purposes.

Be it enacted by the Senate and House of Representatives of the United States of America in Congress assembled, That the Secretary of the Navy is hereby authorized and directed, so far as consistent with the transaction of Government business, to permit the use of radio stations under the control of the Navy Department for the transmission and reception of commercial messages for the immediate benefit of American maritime, press, and other interests, under regulations prescribed by him, and he shall fix the rates for such service. The receipts from such service, less an amount not to exceed 25 per centum for expenses, shall be turned into the Treasury as miscellaneous receipts.

Another New Radio Bill—S. 2523

66th Congress—1st Session
IN THE SENATE OF THE UNITED STATES

JULY 17, 1919

Mr. Calder introduced the following bill, which was read twice and referred to the Committee on Commerce:

A BILL

To amend section 3 of an Act entitled "An Act to regulate radio communication," approved August 13, 1912.

Be it enacted by the Senate and House of Representatives of the United States of America in Congress assembled, That section 3 of an Act entitled "An Act to regulate radio communication," approved August 13, 1912, is amended to read as follows:

"Sec. 3. That every such apparatus shall at all times while in use and operation as aforesaid be in charge or under the supervision of a person or persons licensed for that purpose by the Secretary of Commerce and Labor. Such license shall be issued only to a citizen of the United States or Porto Rico who has attained the age of

twenty years. Every person so licensed who, in the operation of any radio apparatus, shall fail to observe and obey regu-

It never rains, but that it pours. The present seems to be a particularly fertile season for new radio bills. There are so many of them coming up lately that it is hard to keep track of them. One of the latest ones, S. 2523 is an example of the trend of the times.

Fundamentally there is no objection to this bill with the exception that it is foolish. If it is aimed at aliens, it will not accomplish its purpose. Witness the fact that the Germans used the Sayville Radio Station in spite of the fact that it was taken over by our Government.

There should, however, be a law preventing aliens from planting wireless stations on our shores. That would be a sensible law in view of our very disagreeable experience with the erstwhile imperial German government.

lations contained in or made pursuant to this Act or subsequent Acts or treaties of the United States, or any one of them, or

who shall fail to enforce obedience thereto by an unlicensed person while serving under his supervision, in addition to the punishments and penalties herein prescribed, may suffer the suspension of the said license for a period to be fixed by the Secretary of Commerce and Labor, not exceeding one year. It shall be unlawful to employ any unlicensed person or for any unlicensed person to serve in charge or in supervision of the use and operation of such apparatus, and any person violating this provision shall be guilty of a misdemeanor, and on conviction thereof shall be punished by a fine of not more than \$100 or imprisonment for not more than two months, or both, in the discretion of the court, for each and every such offense: *Provided,* That in case of emergency the Secretary of Commerce and Labor may authorize a collector of customs to issue a temporary permit in lieu of a license to the operator on a vessel subject to the Radio Ship Act of June 24, 1910."

(Continued on page 190)

An Exceptionally Well-Designed $\frac{1}{2}$ K. W. Transmitter

By WILLIAM H. PRIESS*

THIS $\frac{1}{2}$ K.W. transmitter is a complete, compact panel transmitter of the 500 cycle quenched spark type. It combines lightness, simplicity, durability, and high radio efficiency in the most desir-

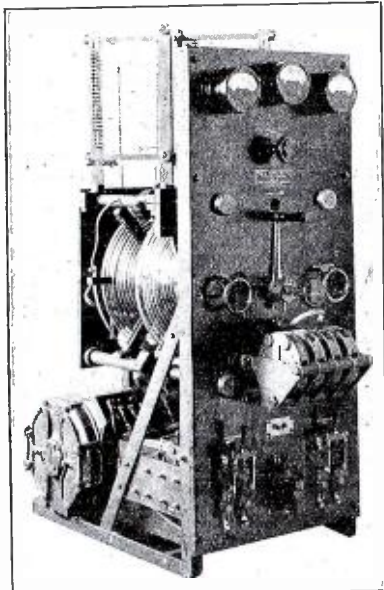

Front View of $\frac{1}{2}$ Kw. Panel Transmitter. Note the New Design in Quenched Gap Units.

able combination. This transmitter has a normal daylight transmission range of approximately 400 miles. At night and under favorable conditions this distance is greatly exceeded. Its extreme simplicity, ruggedness, and high electrical safety factor will be quickly appreciated by the ship owner who has experienced endless trouble with complicated, short-lived, inefficient equipment. This transmitter is an ideal installation for yachts, commercial vessels, colleges, and research laboratories. We have successfully installed this transmitter on the vessels of a deep-water fishing fleet where the equipment is giving satisfactory service under the extremely rigorous conditions met in this service.

The apparatus is mounted on a bakelite diletco panel, braced with angle iron. All

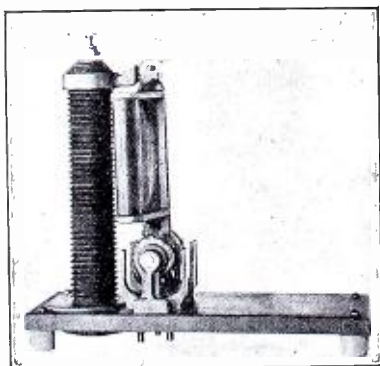

The Latest Thing in Antenna Control Switches.

the controls, the meters and the quenched spark gap are mounted on the front of the panel. The motor-generator and other low tension units are supported by the angle iron framework at the lower rear of the panel. Above the low tension equipment and at the rear of the panel are the radio frequency circuits occupying about two-thirds of the space of the entire set. This liberal allowance of space in the design of these circuits is a big factor in the reliable and efficient operation of the set. Heavy bakelite diletco tubes furnish a solid and well insulated support for these circuits.

Low Tension Apparatus.

The motor-generator is a two-bearing machine. The motor is a 110-volt D. C. machine of the shunt and interpole type. It drives a 500 cycle inductor type alternator at 2,500 R.P.M. A resistance mounted at the rear of the panel is thrown in series with the D.C. armature on starting, and when the machine reaches proper speed is automatically cut out by the one-step starter mounted at the lower center of the panel front. Placed at either side of this starter are double pole knife switches with fuses, controlling the D.C. line and the A.C. generator line. The motor-generator windings and the lines are thoroly protected from radio frequency surges by Faradon mica protective condensers. The 500 cycle wattmeter, the voltmeter, and the antenna ammeter are mounted at the top of the panel. A voltmeter switch mounted directly above the auto-starter permits the reading of either the D.C. line voltage or the 500 cycle voltage.

Transformer and Reactance.

The output of the generator is fed into a combined reactance and minimum leakage transformer. This transformer has a high insulation safety factor and an overall efficiency of 92%.

High Tension Radio Equipment.

The secondary of the transformer charges a .004 mfd. Faradon mica condenser unit. The quenched spark gap is of a new and highly efficient design. It is of the self-cooled type built in four units of three gaps each. Each of these units is easily removable. Excellent contact is secured by broad phosphor bronze strips. A new and novel feature of this gap, and a big factor in its high efficiency is the use of a solid silver plug for the sparking surface. This plug is welded into a copper disc without the use of solder. This process makes the silver an integral part of the copper and does away with the buckling found in gaps where the sparking surfaces are riveted or soldered. Only two metals are present in the construction, namely, copper and silver. The design produces a gap in which no distortion occurs with temperature changes and consequently the quenching action of the gap is unimpaired by long periods of use. The number of gaps in the circuit may be varied and the power thus controlled through the medium of a flexible copper braid with a clip arranged so as to conveniently connect any desired number of gaps in series.

In the center and directly behind the panel are mounted the primary and secondary coils of pancake type design. A handle projecting through the front of the panel permits continuous coupling variation.

A wave-changer switch is located concentrically with the coupling coil handle and varies simultaneously the inductance in the primary the coupling between the

primary and secondary circuits, and the loading inductance in the antenna circuit. This arrangement permits instantaneous shifting to any one of three wavelengths. A wave indicator with wavelengths en-

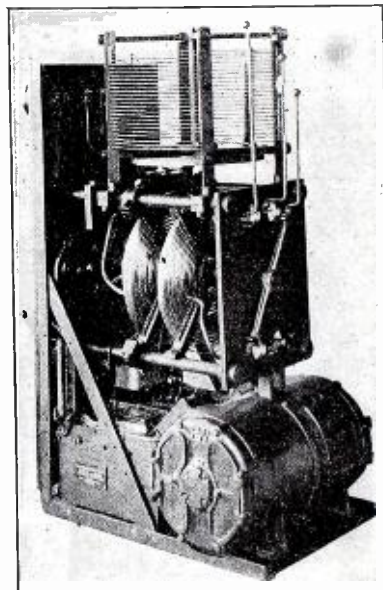

Rear View of the Transmitter Panel. Note the Method of Supporting the High Tension Tuning Units on the Generator.

graved upon it shows through a window directly above the wavechanger switch. Each of the three wavelengths is engraved on a separate piece of sheet diletco which is easily removable from the indicator. Any one of these may therefore be removed and a new wavelength indicator inserted. This arrangement is greatly superior to the conventional method of engraving wavelengths directly upon the panel.

The loading inductance consists of a pancake coil in series with a helical coil of edge-wise wound copper ribbon. It is located directly above the primary and coupling coils. The load from the coupling coil to the loading inductance passes through one of the heavy bakelite diletco tubes supporting the antenna coils system.

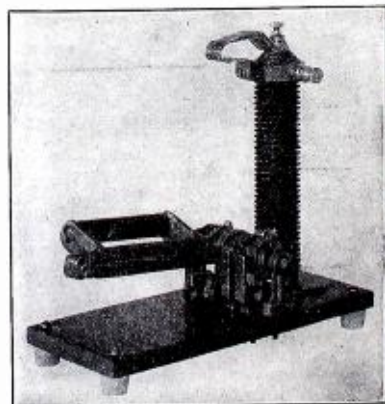

The Same Switch in the "Down" Position.

* Chief Engineer, Wireless Specialty Apparatus Co.

This effectively prevents this lead from making accidental contact with other high tension leads, and also adds to the appearance of the set. The amount of inductance in the helical coil necessary for a given wavelength is automatically controlled by the wave-changer switch. Fine tuning is permitted by continuous variation of the pancake coil controlled by a handle on the panel located directly below the meters.

This set is suitable for operation on antennae whose capacities lie between .0015 and .0004 mfd. and has a wavelength range of 300-800 meters. Five wavelengths are calibrated, namely, 300, 450, 575, 600, and 750 meters.

The antenna ammeter is a radio-frequency thermo-ammeter type located at the top of the panel in the center. It has a scale reading from 0-10 amperes. With 500

watts input into the transformer and at 600 meters on a normal antenna the radiation is approximately eight amperes.

Antenna Switch,

The antenna switch is furnished with the transmitter. Adequate insulation is afforded by a tall corrugated bakelite dielecto insulator. The base is heavy bakelite dielecto supported by four rubber feet.

In sending position this switch accomplishes the following:

- 1—Connects the antenna to the transmitter.
 - 2—Starts the motor-generator.
 - 3—Short circuits the detector.
- In the receiving position this switch:
- 1—Connects the antenna to the receiver.
 - 2—Applies a magnetic brake to the motor-generator and thus brings the machine to a quick stop.
 - 3—Opens the short circuit across the detector.

General.

A light hand key is provided, and equip with flexible leads for connection to the primary terminal board. A lightning switch is also provided with this equipment. The terminal board on the lower left side of the transmitter provides easily accessible connection for the ship's mains, key, and the send-receive switch. Both the ground and the antenna connections are taken off at the left of the transmitter. All low tension wiring is enclosed in lead cable, with the cable cleated to the rear of the panel and grounded.

With proper care the parts provided are sufficient for five years' operation. These parts include spare fields for the motor and generator, spare brushes for the motor and spares for the spark gap and key.

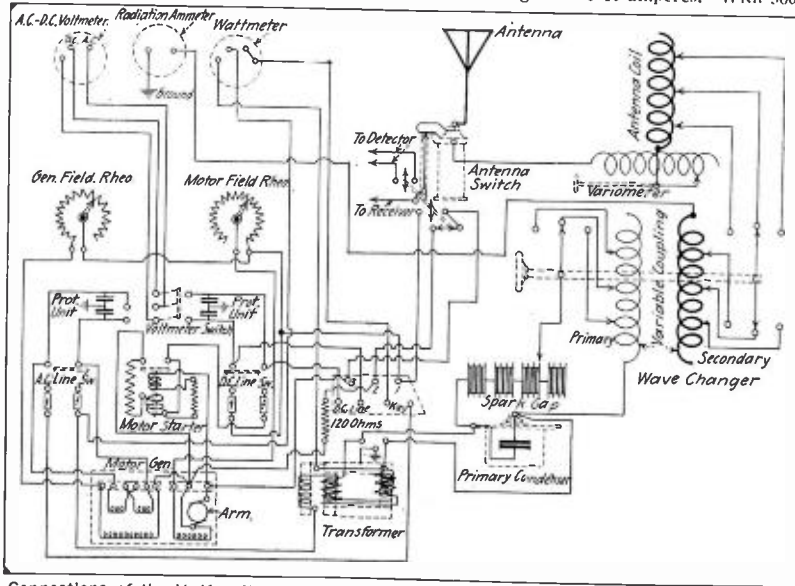

Connections of the 1/2 Kw. Transmitter Showing the Circuits of the Switchboard Likewise.

W. C. G.
By EUGENE DYNNER

Many readers of these pages are undoubtedly acquainted with the beautiful, high pitched note of W. C. G.—the station of the International Radio Telegraph Company at Brooklyn, N. Y. Among the characteristic land marks of New York's kaleidoscopic harbor, are the two lofty tall Bush Terminal Buildings in which the station is located. Radiomen arriving at New York instinctively look toward the north shore of the Bay to assure themselves that W. C. G. is still standing. For the permanent removal from the operator's world of the chance of hearing W. C. G. would be considered with some disinay by the great mass of wireless men to whom New York means "our home port." You see, when a fellow is bound far out to sea, it seems almost like a voice from home to hear one's home port station sending. We Radiomen have a strain of sentimentalism within us—inspired by the human "game" in which we are engaged.

Now, W. C. G. can be heard at a longer distance than any other station in the vicinity of New York; in fact Radiomen tell me that they have heard W. C. G. as far as six thousand five hundred miles. And let me say, it sounds good to hear W. C. G.'s clear, piercing whistle—a pure 500 cycle note—on a hot night in the Gulf when your ports are shut to exclude the heat, and the perspiration drips from you as from a sponge. On occasions like these W. C. G.'s sending feels like a cooling breath of your home "up north." And if the youth in you has not been choked by the cynicism that comes with world-wisdom, you become home-sick.

To get back to W. C. G.—our illustration shows the interior of the transmitting room. There are two transmitting sets here: the big 10 K.W. set on the right, which on the photograph is very clearly

shown, and the 2 H.W. equipment—similar to the set which was supplied to many naval and commercial stations.

These sets are both of the highly efficient 500 cycle synchronous type which
(Continued on page 194)

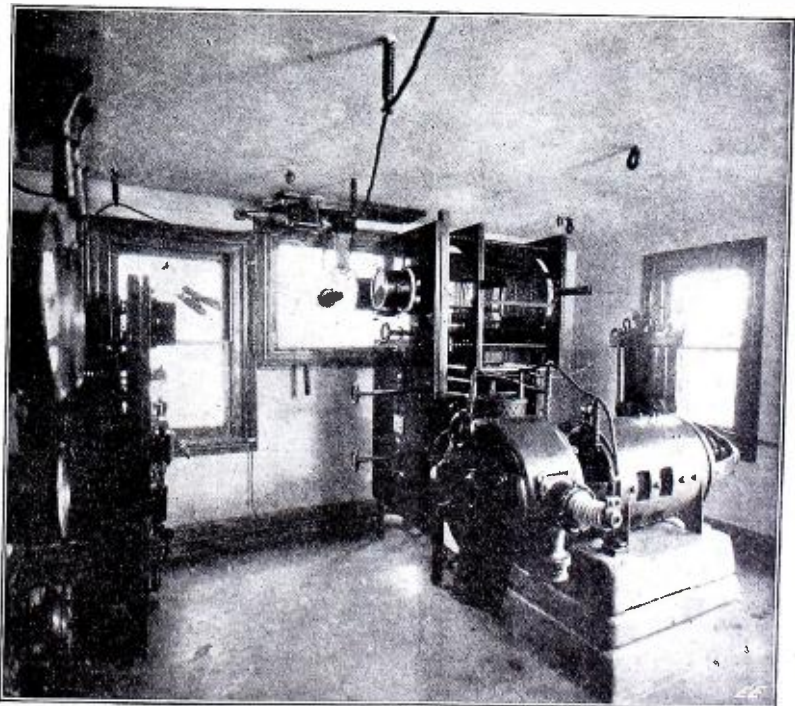

A Rear View of W. C. G.'s 500 Cycle Synchronous Transmitters.

Awards of \$100 Radio Prize Contest

1st Prize Winner

WE are pleased to announce in this issue the prize winners of our \$100.00 Radio Prize Contest. "An Ideal Receiving Outfit," as announced in our July issue.

In our September issue we mentioned the fact that the contest would close on September 12th, but due to Postoffice ruling this statement was incorrect and it became necessary to close the contest as of August 12th. The prizes as announced here were therefore awarded to all entries received up to that date.

Furthermore, the Transmitting Prize Contest as announced in the August issue of RADIO AMATEUR NEWS will positively close on October 12th, and prizes will be awarded on the manuscripts submitted up to that date, when the entries will be delivered to the judges for the awarding of the prizes to the first, second, third and fourth best entries.

The Editors have been very much disappointed in the lack of interest shown in our contests. In the first contest, "An Ideal Receiving Outfit," only very few entries were received,—disappointingly few. This is surprising because \$50.00 prizes, and even \$10.00 prizes, for a mere photograph of a wireless receiving outfit are not to be obtained every day.

We also wish to correct here a misprint which appeared in our September issue, where we mention that a few entries had been received for the second Radio Contest, "An Ideal Sending Outfit." This statement is erroneous, as not a single entry has been received so far, and we are afraid no

Prize Winners

First Prize \$50.00 in Gold.
John H. Miller, 420 Wisconsin Avenue, Oak Park, Ill. Mr. Miller won on 550 points.

Second Prize \$25.00 in Gold.
Arthur C. Burroway, No. 643 Y. M. C. A., Cincinnati, Ohio. Mr. Burroway won on 400 points.

Third Prize \$15.00 in Gold.
Ralph Smith, 2213 Avenue K, Galveston, Tex. Mr. Smith won on 275 points.

Fourth Prize \$10.00 in Gold.
Urban Wornor, 1052 City Park Avenue, New Orleans, La. Mr. Wornor won on 250 points.

that Mr. Miller led by one hundred points over the others. Four judges, Dr. De Forest, Dr. Pickard, Mr. Lowenstein and Mr. Gernsback, ranked Mr. Miller as first prize winner. Two judges, Dr. Louis Cohen and Mr. Secor, awarded one hundred points to Mr. Burroway, whose points, it will be noted, come up to 400. We are printing the description and photographs, etc., in full of Mr. Miller's station in this issue. The others will be published in the forthcoming numbers of RADIO AMATEUR NEWS. Checks have been mailed to all Prize Winners.

THE PUBLISHERS.

The set designed and constructed by the writer along these lines is shown in the photographs, and its actual use shows it to have the above characteristics in a marked degree.

Briefly, the set is an inductively coupled receiver, with the usual tickler coil for regenerative or heterodyne reception. No taps are brought out from the inductances, the tuning being accomplished entirely with condensers, the wide wave length range being obtained by changing the inductances when necessary. Four sets of inductance coils will suffice for the range of wave lengths above, when used with the average variable condenser having a capacity ratio of about 15 to 1.

The panel itself is 12 inches square, of hard rubber $\frac{1}{4}$ inch thick. No cabinet is used, as accessibility is desired, so the panel is supported by brass angle pieces bent up out of $\frac{1}{2}$ by $\frac{3}{8}$ brass rod.

The variable condensers may be obtained from a supply house, or built up, as shown. The fixed plates are 4 inches in diameter, the rotary plates somewhat less. The maximum capacity of each should be about .0015 microfarads, with a minimum at least as low as .0001 microfarad. They should be firmly secured to the panel and operated from graduated knobs on the front.

The mounting of the inductances may be seen in the photograph and is further shown in the sketch. In the photograph, one of the coils is removed to show the construction. The central inductance is the secondary, the right-hand one looking at the rear of the panel is the primary, and the left-hand one is the tickler. All of these coils are removable, being attached by metal clips, which also serve as contacts. The two outside coils may be rotated 90° to vary the coupling. The central inductance being stationary, its shoulder screws are attached directly to the panel; for the rotating coils, these contacting screws are attached to a small piece of bakelite, which is carried on a small brass shaft, working through a bushing in the panel and operated by a knob from the front. Flexible leads carry the current to these rotating coils. The result is an arrangement whereby the set may be equipped with coils to work on most any wave length, the change being effected in a few seconds and not requiring an elaborate preliminary layout of apparatus.

The middle or secondary coil is wound on a bakelite or cardboard tube $4\frac{1}{2}$ inches in diameter and $1\frac{3}{4}$ inches long. The side coils are wound on tubes $4\frac{1}{2}$ inches in diameter and $1\frac{3}{4}$ inches long.

The windings of the inductances will depend on the condenser values, the wave length range desired, and the antenna characteristics. These windings should be made after the set is completed, and with the antenna with which the set will be used. The best procedure for this work follows.

Wind a secondary coil with one layer of, say, number 18 cotton or enamel wire. Set it in place and with a wavemeter find the range of wave lengths that can be tuned to by varying the condenser. This will be about 200 to 800 meters. The coil should have its turns adjusted until the range is that desired. Then wind a primary coil with a few less turns, connect the aerial circuit and excite it with a buzzer. This primary coil should then be adjusted until with the primary and secondary circuits in tune, as indicated by the detector, the condensers are in approximately the same angular position.

After the first set of coils is complete, the other coils may be wound to overlap

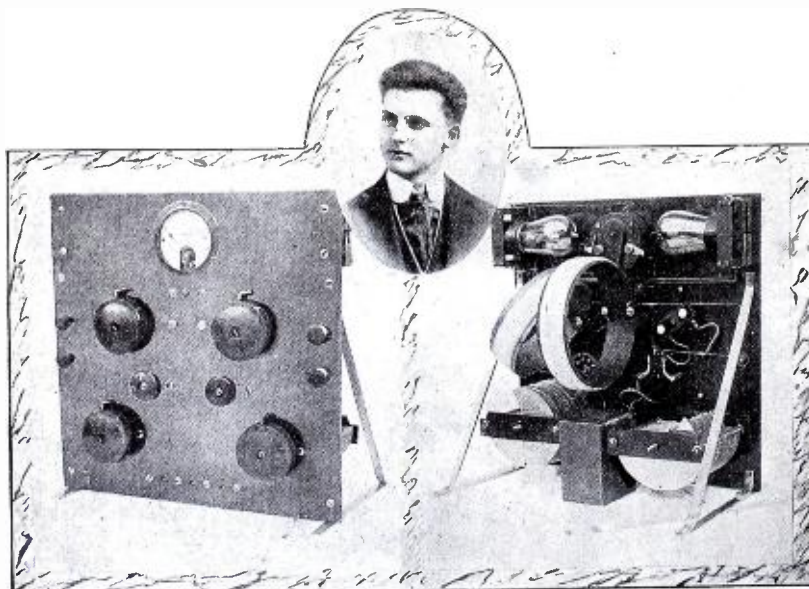

Mr. Miller and His Highly Efficient Receiving Set Which Won First Prize in the Contest for "An Ideal Receiving Set."

one will obtain a prize unless some entries are received before October 12th. Here is a good chance for you wide-awake radio enthusiasts, as there certainly will not be much competition.

In announcing the prize winners of the first contest, "An Ideal Receiving Outfit," we would state that the awards have been made from the valuation put upon the photographs and manuscripts of the contestants by the various judges. It will be noted

"AN IDEAL RECEIVING SET."

By JOHN H. MILLER

ARADIO receiving set for amateur use during at least the next few years should be FLEXIBLE, and be able to tune to any wave length from 100 to 16,000 meters; it should be SIMPLE, both in operation and in construction; and it should be EFFICIENT, having all losses reduced to a minimum.

each other slightly and give a very wide range of tuning. For the longer wave lengths it will be found necessary to use smaller wire and bank the windings in three or four layers. Cotton enameled wire should be used, unvarnished, this arrangement giving a coil with high insulation, consequently low leakage, and a small value of distributed capacity between turns. No special tickler coils are necessary; the writer uses one of the extra primary coils and it is perfectly satisfactory.

A switch in the primary circuit consisting of four upright phosphor bronze strips, connected as shown, allows the primary condenser to be thrown either in series or in parallel with the inductance coil. Normally, the center two arms touch, giving the series connection, but when the oblong arm is rotated, the arms are spread and each outside pair is in contact, giving the parallel connection.

Two standard four-contact bayonet base vacuum tube sockets are mounted at the upper corners of the panel. These bases were built up, as they could not be bought at the time the set was made, but they can probably be obtained on the open market at the present time.

The filament rheostat is made of a small bakelite plate with ten contacts and a switch arm controlled from the front of the panel. Resistance wire is soldered between the contact points, about 1/2 ohm between each point, giving the desired control for use with a 6-volt battery.

The instrument at the top of the panel is a millivoltmeter with a shunt to read 2.5 amperes full scale, and a resistance to read 25 volts. The shunt is connected directly in the filament circuit as shown, and the resistance in series with the high voltage battery. The push button is so arranged that the meter reads amperes normally, pushing it gives the value of the "B" battery. Accurate filament control and proper plate voltage are essential to the proper operation of the three-electrode vacuum tube, and with the meter connected as shown, it is easy to read these values and make the necessary adjustments.

The grid condensers and leaks are assembled on small pieces of bakelite 1/2 by 1 1/2 inches, 1/8 inch thick. A screw is placed through each end of the plate, a piece of

bond paper previously soaked in India ink and dried is connected across these screws for the leak, and then the miniature condenser is assembled, consisting of three sheets of mica and two of tinfoil connected to the two sides. This assembly is connect-

right being for the filament battery. Three telephone jacks are provided at the base of the panel to take the standard two-contact plug which was much used by the Signal Corps in their outfits. One jack is open and the other two are of the closed contact

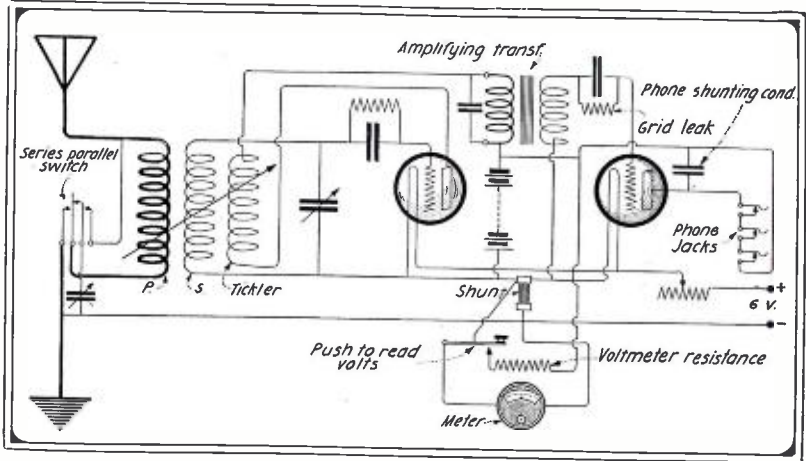

Diagram of Connections Employed by Mr. Miller in His Prize Winning Set.

ed in series with the grid of the vacuum tube, one such assembly being necessary for each bulb in use.

The transformer between the two bulbs is an ordinary amplifying transformer such as has been described in many previous articles.

Leads are brought out to be attached to the high voltage battery, which in this case is one of the new 15-cell dry batteries especially made for this work.

Connections are made with number 16 solid copper bare wire, all high voltage and grid connections being covered with varnished cambric tubing. Connections are soldered and lacquered to prevent possible corrosion. External connections are made to the set by large hard rubber binding posts on the face of the panel, those on the left being antenna and ground, those on the

right being for the filament battery. Three telephone jacks are provided at the base of the panel to take the standard two-contact plug which was much used by the Signal Corps in their outfits. One jack is open and the other two are of the closed contact

type, all connected in series, thus allowing from one to three sets of phones to be used at any time.

The Utility and Practical Purposes of This Set

The set described has a practically unlimited wave length range, due to the ability to change inductances easily and quickly, at the same time eliminating unused portions of wire. The control is simple and the set being extremely accessible, it is of value to the amateur, who will undoubtedly wish to make changes later on in connections and in general arrangement. The general design is neat and will appeal to those looking for high-grade apparatus, with large controlling knobs and the meter for getting the proper values of filament current and plate voltage for the vacuum tubes.

Hark Ye Amateurs

NAVY DEPARTMENT
 UNITED STATES NAVAL COMMUNICATION SERVICE
 OFFICE OF
 DISTRICT COMMUNICATION SUPERINTENDENT
 THIRD NAVAL DISTRICT
 44 WHITEHALL STREET
 NEW YORK CITY

September 2nd, 1919.

Editor Radio Amateur News:
 233 Fulton Street,
 N. Y. City.

DEAR SIR:—By authority of the Director Naval Communications, commencing October 5th, a code broadcast schedule, addressed to all amateurs, will be transmitted by the Naval Radio Station, 44 Whitehall Street, on 1,500 meters. This broadcast will be transmitted immediately following the 9:00 P.M. press schedule.

Various items of interest to amateurs, such as the establishment of new stations, changes in wave lengths of high power stations, etc., will be transmitted in this broadcast schedule.

Copies of the code to be used may be obtained by any amateur

by writing a request to the District Communication Superintendent, 44 Whitehall Street, New York City. When writing this request an amateur should give the following information:

1. Name.
2. Address.
3. Age.
4. Data concerning any military service.
5. Commercial experience, if any performed.
6. Class of operator's license, if any.
7. Number of words per minute he can copy.
8. Education.
9. Size and power of transmitting set, if any erected.
10. Type of undamp't wave receiver, if one installed.
11. Name of any radio organization or club to which he may belong.

The object of this radio broadcast is to maintain the interest of radio amateurs and to train them in receiving code.

As it is the policy of the Navy Department to co-operate in every way with radio amateurs, we would be pleased to receive any suggestions you might desire to make.

Yours very truly,

C. R. ROCKWELL,

Acting.

MWA

Fundamental Operations of Vacuum Tubes

(CONTINUED)

By DAVID S. BROWN

WHEN a vacuum tube is in operation, two separate and distinct actions occur simultaneously. Of these two actions, one, amplification, was explained in the last issue of the RADIO AMATEUR NEWS. The other action is rectification, and it is necessary to understand the "electron theory" of the tube in order to see plainly how rectification takes place.

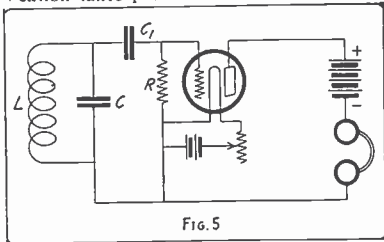

Fig. 5
Simple Circuit of the Vacuum Tube with a Grid Leak Resistance.

According to the "electron theory" electricity is composed of small unit charges of electricity. Negative charges are called "electrons." Each atom of mass is supposed to consist of a positive electrical charge and various negative electrons. The electrons are free to move about. If a copper wire carry current, altho we say that the current flows from the positive to the negative terminals of the battery or generator, in reality it is now supposed that the electrical current is a stream of electrons moving in the conductor from negative to positive. This may be somewhat confusing at first, but a little thought will soon give the idea of an electrical current actually consisting of small negative charges moving from negative to positive. It is easily conceivable that a positive current could be considered as a negative current in the other direction.

If the conductor is heated to a certain temperature, not only will the electrons flow as before, but also will some of the electrons break thru the surface of the conductor and fly off into space in all directions. However, it is known that positive charges attract negative charges, and, therefore, if we place a positively charged conducting body near the conductor which is

giving off electrons, some of the radiating (negative) electrons will be attracted to it.

This brings us back to Figures 1 and 2. In Figure 1, a filament is heated by its battery current of 1_f amperes. Under normal conditions (and at the proper temperatures) electrons will be given off by the filament. The plate is connected to the positive terminal of the "Plate (B) Battery," as shown. Hence the plate is positive with respect to the filament and will attract the negative electrons from the filament; the electrons will, of course, pass to the plate thru the vacuum inside of the tube. Thus occurs a flow of electrons from filament to plate and, conventionally, a current of electricity is said to flow thru the plate battery, the plate and the filament. If the plate were negatively charged, no electrons would be attracted to it, and no current would flow in the circuit. The tube is, then, conductive in one direction only and is a *rectifier*.

It is obvious that what happens in the filament-plate circuit will also happen in any similar circuits, such as that of the filament and grid. If the grid is positively charged, it will allow a current to pass

remove the negative charge from the grid condenser after each group of oscillations has been rectified.

Old type audions contained a certain

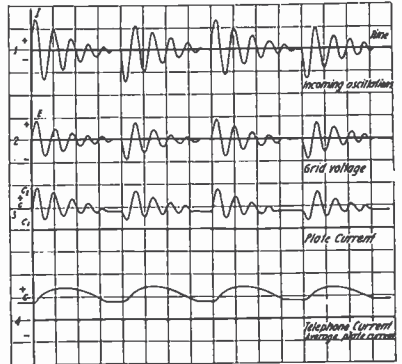

Fig. 6
The Form of Variations for Different Circuits for this Type of Detector.

amount of gas which acted as a conductor and permitted the negative charges to leak off the grid to the filament and neutralize themselves with the positive charges on the other plate of the condenser C. The new high vacuum tubes do not permit this action because of the absence of any gas. A conductor of some kind must be connected from the grid to the filament over which the charges can flow. This conductor should be of such a resistance that no current will flow in it until the condenser C₁ has been fully charged, i. e., not until the end of the group of oscillations. If the resistance is too high, or else entirely absent, the charges will accumulate until they are large enough to pass thru the vacuum of the tube. This action will be noticed by a constant "put, put, put" sound in the telephones. The resistance just described is called the "grid leak." It is shown as "R" in Figure 5. The actual value of it depends upon various things, but it is almost always between one and four million ohms. Both the Marconi vacuum tube and the V T 1 are supposed to operate best on two million ohms, altho the writer has generally had better results using four or five million ohms with the V T 1.

We assume that the reader understands the distinction between radio frequencies

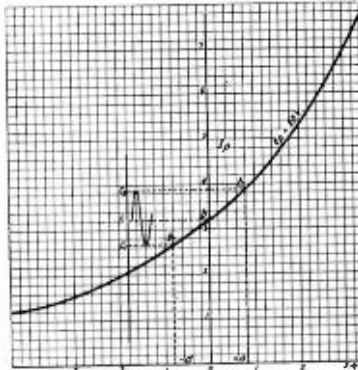

Fig. 7
Enlarged Portion of Curve "A" Shown in Figure 14.

from filament to grid; if negatively charged, it will prevent any current. Refer now to Figure 5. Incoming oscillations will induce an alternating current in the circuit L C. The charges of electricity in C will cause the grid to become alternately positive and negative, decreasing and increasing by the same amount. When the grid is negative (with respect to the filament), no current can flow in its circuit, as was just explained. But when the grid is positive, negative electrons will flow to the grid and will be stored up in the grid condenser C. The next oscillation will repeat this process and add a negative charge to the grid condenser C. Thus the grid condenser stores up more and more negative charges as long as the oscillations continue. It will be plainly seen that as the grid condenser becomes more negative the grid itself becomes more and more negative with respect to the filament.

Now, Figure 3 shows the relation between plate current and grid potential. As the grid becomes negative, the plate current decreases. Therefore, it may be said that by means of the grid condenser incoming oscillations cause a gradual decrease in the plate current. If the oscillations were to continue, the grid would become so negative that the plate current would be stopped. So it is necessary to

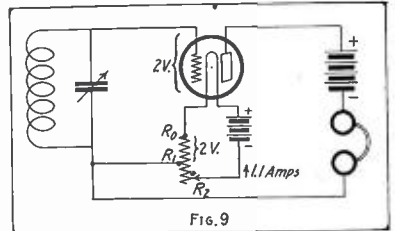

Fig. 9
By Utilizing the Drop of Potential of the Filament Rheostat the Grid Voltage May Be Obtained.

and audio frequencies, and also the fact that neither the telephone receivers nor the ear will respond to radio frequency variations. It must also be understood that damped radio waves are transmitted in groups. Each wave (or oscillation) will be of a radio frequency while the wave train consists of groups of the radio frequency waves. Such a wave train is illus-

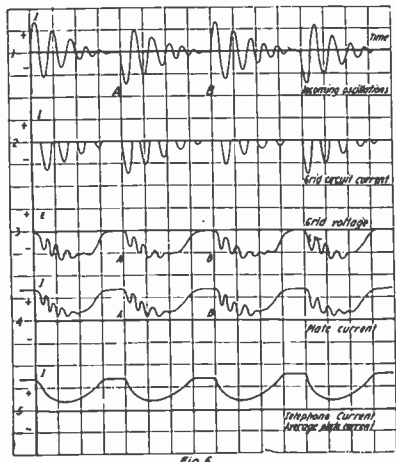

Fig. 8
Graph Showing Incoming Oscillations, Grid Circuit Current, Grid Voltage, Plate Current and Resultant Telephone Current.

trated by curve (1) of Figure 6. In the case of a 500-cycle set working on 600 meters wave length, there will be 2×500 , or 1,000 groups of oscillations per second. And each group will consist of oscillations of a frequency of 500,000 cycles per second. For example, in curve (1) from *O* to *A* will be 1/1000 of a second, and will contain oscillations of radio frequency (say 1,000,000 per second).

These incoming oscillations in the antenna circuit will induce similar oscillations in the circuit *LC* of Figure 5. They will then be rectified by the tube and will cause a current in the grid-filament circuit, as shown in (2) Figure 6, and, according to the discussion above, will cause the grid voltage to vary, as shown by curve (3). At point *O* in (3) the grid is at zero volts. It then becomes more and more negative until the oscillations cease, when the negative charge leaks off by means of the "grid leak" and the grid again becomes zero potential. Such action occurs as at points *A* and *B*.

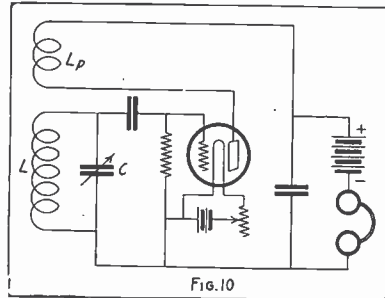

Fig. 10

Circuit Employed for Beat Reception. It is the Well Known "Tickler" Method.

tions in the circuit *LC* of Figure 5. They will then be rectified by the tube and will cause a current in the grid-filament circuit, as shown in (2) Figure 6, and, according to the discussion above, will cause the grid voltage to vary, as shown by curve (3). At point *O* in (3) the grid is at zero volts. It then becomes more and more negative until the oscillations cease, when the negative charge leaks off by means of the "grid leak" and the grid again becomes zero potential. Such action occurs as at points *A* and *B*.

With no incoming oscillations, the plate current has a certain constant positive value. But the negative charges on the grid reduce the plate current according to curve (4) in Figure 6. When the grid charge leaks off and the grid becomes zero again, the plate current also becomes normal, as at *A* and *B*.

It will be noted that the plate current varies at a radio frequency, following faithfully the radio frequent incoming oscillations. However, the average current in the plate circuit varies just once for each group of oscillations. If the groups are of a frequency of one thousand (for a 500-cycle set) then the average current in the plate circuit will show just one thousand variations per second also. As the tele-

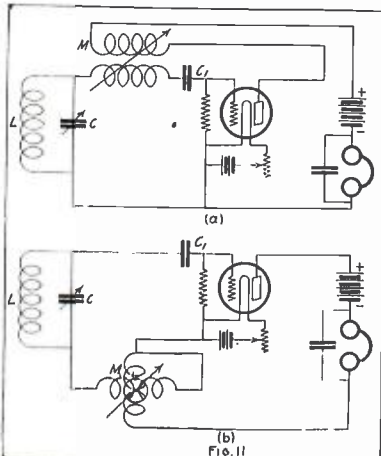

Fig. 11

Here Are Two of the Well Known Feed Back Circuits.

phone receivers respond to this average plate current, it will be seen that the phones will be acted on by a current varying one

thousand times per second, and will produce the well-known 500-cycle note.

This so-called "detector action" may also be obtained without a grid condenser by making use of the shape of the characteristic curve. Figure 7 shows an enlarged view of the lower portion of curve "a" of Figure 14. As noted, the E_g is 20 volts while the grid is (without incoming oscillations) at zero volts. I_p is a steady current of 3.2 milliamperes (as shown). If a train of oscillations is impressed on the grid, the grid voltage will vary, becoming alternately positive and negative as the impressed voltage varies. Suppose the first variation causes the grid to go from zero to +3 volts, to zero to -a volts and back to zero again. This will cause first an increase and then a decrease in the plate current (as described in the discussion of the amplifier). Referring to Figure 7, when the grid is at zero volts, I_p is b milliamperes; when E_g becomes +a volts I_p becomes b_2 milliamperes, and E_g -a volts shows I_p as b milliamperes.

If we project the points b, b_1, b_2 onto a vertical line (corresponding to the I_p axis) we get the points C, C_1, C_2 as representing the exact values of I_p as E_g varies from zero to +a, to -a volts. But altho the variation of grid voltage was assumed equally as great each side of zero, i. e., zero to +a equals -a to zero, it will be plainly seen that, due to the shape of the curve C_2 is greater than C_1 . Therefore the average value of I_p has been increased from C to value $C_1 + C_2$. The next change

2

in grid voltage will not be as great as + and -a because the oscillation in I_p will not be as great as from C_1 to C_2 . Nevertheless, the average plate current will remain greater than C as long as oscillations continue in the grid circuit. (Note that the value C is the same as b , which was given as normal I_p for zero voltage on the grid).

Fig. 8 shows the form of variations of the different circuits for this type of detector action. As before, curve (1) is the incoming oscillation. Curve (2) shows the voltage impressed on the grid by the incoming oscillations. Curve (3) shows the variations in plate current while curve (4) shows the average plate current. The small letters correspond to the letters of Fig. 7. Here again we have an average plate current with the number of variations per second corresponding exactly to the number of incoming wave trains per second. And the telephones again give us the note of the transmitting set.

Analytically, in order to work our tube as a detector without grid condenser, we must operate it on the bend, or "knee," of the curve. And, as with the amplifier, it is necessary to adjust the voltage on the grid so that the tube actually is operating at the "knee" of the curve. Fig. 14 shows us that we can obtain detector action with the Marconi-Moorehead tube using 20 volts plate by making the grid -2v; using 40 volts by making the grid -5v; etc.

Obviously, the advantage of such a detector set is the elimination of the grid condenser and the grid leak. The grid voltage may be obtained by actually inserting a battery of the required E.M.F. in series with the grid, or, more practically, by utilizing the drop in potential of the filament rheostat. For example, in Fig. 9, suppose we wish to make the grid two volts negative, and the tube consumes 1.1 amperes.

$$E = 2.1$$

By Ohm's Law $R = \frac{E}{I} = \frac{2.1}{1.1} = 1.82$ ohms.

$$I = 1.1$$

We connect our grid lead to point R_1 of the filament rheostat where $R_1 R_2$ equals 1.82 ohms. Then when 1.1 ampere flows in the filament circuit, the potential drop across $R_1 R_2$ will be 2 volts and the grid will be 2

volts negative with respect to the filament. Should we merely reverse the direction of the filament battery, the grid would become 2 volts positive with respect to the filament.

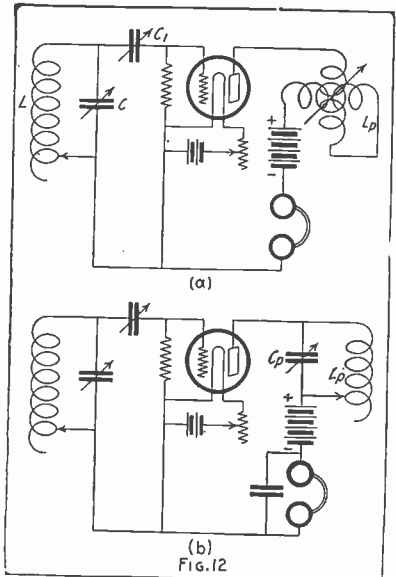

Fig. 12

Here Advantage is Made of Tuning the Plate Circuits.

The question of oscillating audions brings up several principles which are not involved in either detection or amplification. The first thing which must be clearly understood is "coupling." The reader is so familiar with the term that there should be no necessity for more than reminding him that energy may be transferred from one circuit to another by "coupling," whether it be conductive, inductive or capacity. The next thing of importance is the phenomenon of "beats." The theory of beats is too lengthy to be given here; and the reader is referred to any text book on Physics. Beats are explained also in many radio texts and in the Proceedings of the Institute of Radio Engineers, Vol. 1, No. 3.*

Let us arrange an ordinary detector set as shown in Fig. 5 and add to it an inductance in the plate circuit. Such an arrangement is illustrated in Fig. 10, where L_p is the plate inductance. Consider the filament lighted normally and no oscillations coming in on the grid (thru *LC*). As we

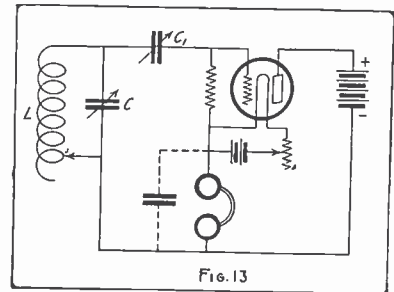
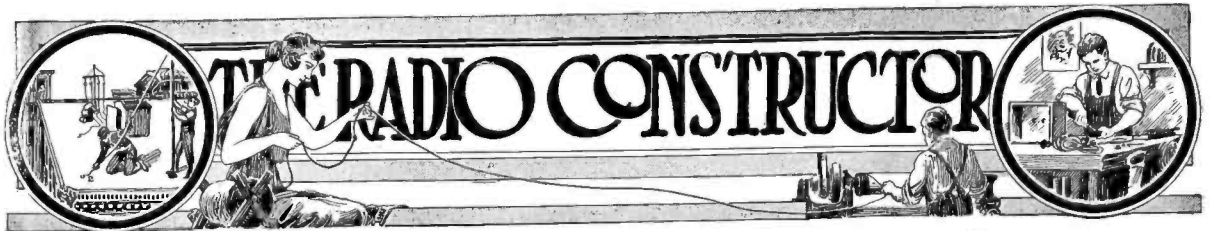

Fig. 13

For Longer Wavelengths it is Necessary to Place a Condenser Across the Phones.

know, there will be a certain, steady Direct Current flowing in the plate circuit, the amount depending on the characteristic curve as already explained. A steady current in the plate circuit will plainly cause a steady magneto field around the coil L_p . Let us now turn L_p so that it is inductively coupled to the coil L . As the field of L_p cuts thru the turns of L , it induces a current in L . This current lasts only momen-

(Continued on page 204)



Short Wave Receiving Transformer of Novel Design

By RAYMOND EVANS

THE type of coupler about to be described will be found very efficient for the following reasons:
The maximum wavelength it will be possible to tune to with an ordinary sized aerial will be 600 metres, thereby

nected up as per hookup shown in Fig. 7. in conjunction with a longwave receiver, so that long or short waves could be efficiently received as desired by the mere throwing of a switch.

Referring to the drawing, it will be seen that the primary turns are varied by means of the center switch over the six contact studs, while the secondary variation is effected by plugging in at either of the four plug sockets, which, by the way, can be calibrated, if desired, exactly in wavelengths, by means of a wavemeter. Changes in coupling are obtained by moving the small knob, the relative positions of the coils for close and loose coupling being shown in Fig. 3.

The primary terminals are placed on a hard rubber block on the left side of the base, while the secondary are on the right. See Fig. 4.

Regarding the construction, the experimenter had best start with the base.

This can be made of oak, mahogany, maple or any close-grained wood, cut to the dimensions shown in Fig. 1, care being taken to see that it is perfectly square.

of panel. For the contact studs, mark off on this curve $3/16''$ on each side of the center line by means of the dividers, then reset them to $3/8''$ and mark off the remaining four holes.

It would be advisable now to run over these marks again with the dividers in order to check them and see that they are uniformly spaced. Next make a neat

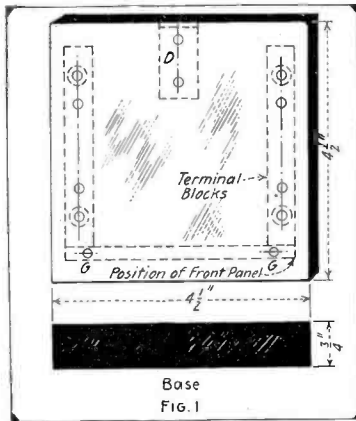

The Base of This Efficient Short-Wave Receiver is Shown Here With All the Necessary Dimensions for Drilling.

reducing the losses due to the capacity effect of the unused turns (which, with an ordinary tuner covering wavelengths say to 2,500 metres) are fairly large.

Now, a tuner built to tune to wavelengths ranging from 150 to 600 metres only, will certainly be more efficient for short waves, other things being equal, and amateurs who would care to follow the instructions carefully will find that not only will they get stronger signals, but greater selectivity will at all times be obtained with a tuner built on the following lines:

The writer would suggest that a short wave tuner, as described, could be con-

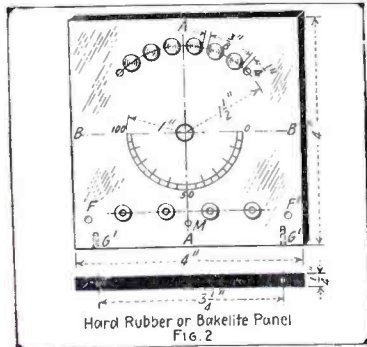

Method of Scribing the Curve on the Front as Shown Here and Described Fully in the Text.

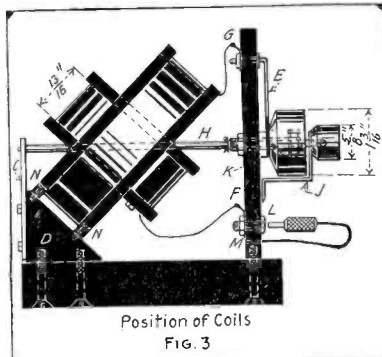

The Complete Instruments Clearly Showing its Newness of Design.

The position of the holes must be carefully measured with a pair of dividers and countersunk from underneath. It can then be well sand papered, given a coat of some good filling and finally polished to conform with the rest of the apparatus on the radio table.

The front panel, shown in Fig. 2, can be made of either $1/4''$ sheet hard rubber or "bakelite," the latter of course is to be preferred, being a better insulator for our purpose. It must be cut to size and accurately squared before marking holes and drilling. To properly locate the holes, start by scribing lightly the two center lines AA and BB and at the intersection of these lines mark, by lightly centerpunching.

Now, set your dividers to $1 1/2''$ and, using the punchmark as center, lightly scribe a curve as shown in Fig. 2 on the top half

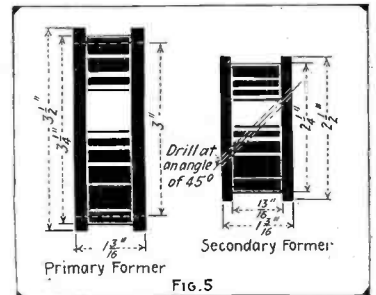

Dimensions of the Wood Forms Are Given Here.

punch mark in the position of each of the six contact studs. These are for the primary tappings.

The drawing shows a pair of stop pins at each side of the primary contacts to prevent the switch blade from slipping off the first and last studs.

Mark off the position for these, say at about $1/4''$ outside the first and last studs as shown in Fig. 2.

The next operation is the marking off of the positions of the secondary plug pockets. These are spaced $5/8''$ from bottom of panel and $3/4''$ apart.

The four holes, F¹, F², G¹, G², must then be marked off according to the drawing.

An easy, though effective, method of making the coupling scale is to scribe it with a pair of dividers, one point of which has been given a graver edge by means of an oil stone.

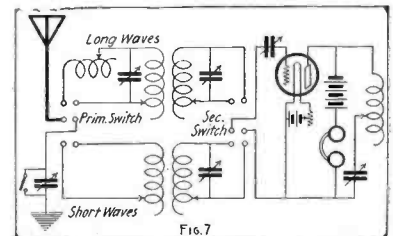

Connections Employed With This Short-Wave Receiver and a Long Wave One, Permitting the Operator to Change from One to the Other.

Set the dividers to the dimensions shown for the scale in Fig. 2 and carefully scribe the two semi-circular lines, cutting in fairly

deeply. Now divide them into twenty equal parts, as shown, and scribe the straight lines by means of a steel rule and a graver. This may require a little practice, and the writer would recommend that a few trial scales be made on scrap material before attempting it upon our panel.

The holes must now be drilled to the sizes on the drawing and the holes F' F' counter-sunk. Place your panel on something firm for this, preferably a wooden block, and make sure that your drill is at right angles to the panel and that the holes do not "run out."

Drill the two holes G' G' by placing the panel in a vise, after which, drilling will be complete. The panel should now look like Fig. 2.

Finish the panel by either polishing with pumice powder or rottenstone, or better still, give it a fine "straight grain" by means of some fine emery cloth and a little olive oil. To make a neat job, secure the panel flat on the bench between two narrow strips of wood and clean off with emery cloth (say No. 1) on a small block of wood—only rub in one direction and be careful to keep the grain parallel to the edge and not to round off the corners. Finish with a finer grade emery and a cloth moistened with olive or any other vegetable oil. Don't use mineral or animal oil, as some grades of hard rubber turn brown under their influence.

Now fill in the scale with a thin paste made by mixing a little zinc oxide with a few drops of copal varnish on a piece of glass. Use a flattened stick or spatula for the purpose and clean off the surplus white with a clean cloth. Use a fine camel's hair

brush for the figuring of the panel. The writer has used this method of engraving and filling in scales for some years

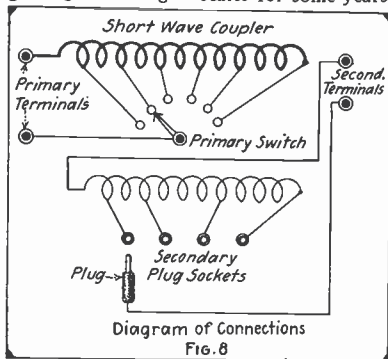

Method of Connecting the Short Wave Coupler When Completed.

and considers that it compares favorably with the machine engraved ones and is certainly quite suitable for amateur experi-

mental gear as well as commercial purposes. Two pieces of hard rubber can now be cut to Fig. 4 and drilled as shown. These are for the terminal blocks. They should be finished the same as the panel.

The two hard rubber knobs can be bought ready made or, if the reader has access to a lathe, they can be turned.

Next in order come the primary and secondary formers.

In the coupler actually built, these were turned from hard rubber to the dimensions shown in the drawing, but of course this is not essential.

As an alternative, the primary tube could be made up by winding about the layers of presspahn around a wooden drum of suitable dimensions and well shellingac, while the secondary can be cut from a plain cylinder of wood.

Shellac these both again before winding. Carefully mark off and drill the secondary drum as shown in Fig. 5.

This is very important, as faulty workmanship will not give a pleasing movement to your coupling adjustment.

For the contact studs, procure six brass machine screws 1/2" long with cheese heads and turn or file away the slotted portion, leaving a smooth surface of even height, and finish with fine emery cloth and lacquer.

The plug sockets are made by drilling (in the lathe) four 1/4" brass cheese head screws 3/8" long, as shown in Fig. 3 and rounding off the edges as shown at L.

The plug itself is made from an ordinary machine screw, which has not been threaded the full length, filed to fit the plug sockets and fitted into a small hard rubber knob (Cont. on page 200)

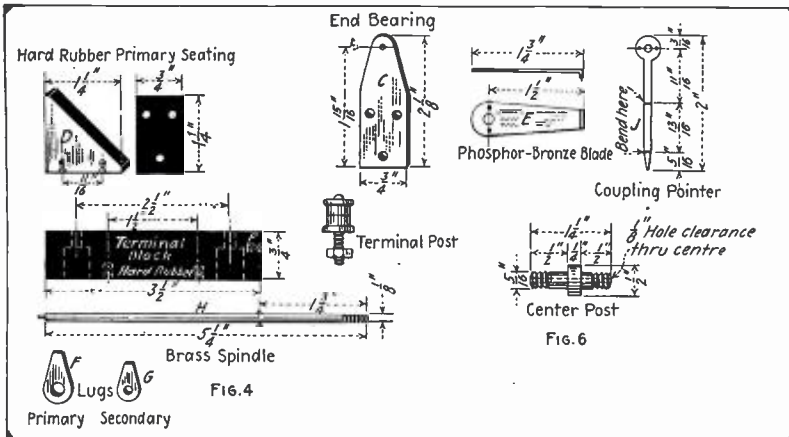

Various Parts of the Instrument, Giving the Dimensions of Each.

"Long Wave Receiving"

By H. L. BEEDENBENDER

Eastern Radio Laboratory

AS the general opinion today is that a radio amateur or experimenter isn't "in it" unless his receiving apparatus is good for a couple of thousand miles, and the reception of messages from Europe seems to be the latest fad, the writer thought it would not be amiss to take up the methods of receiving the "elusive undamp't wave." Of course, a VT is necessary as a detector, and the experimenter who is fortunate in having a two or three stage amplifier is in luck. Signals can be copied and are copied at the writer's station with a signal tube. They will come in much louder, of course, if amplified.

Before the war we were in the habit of seeing the long "stove pipe" inductance coils as a part of long wave receiving apparatus. Times have changed. "The old order changeth giving place to the new." The days of the long coil are passed. The multi-layered or concentrated inductance type has taken its place. The capacity and resistance of these coils is comparatively low, and when used with the ordinary variable receiving condensers a broad range of wave lengths can be obtained. They therefore make an ideal tuning arrangement. Figure 1 shows one of the methods of connecting

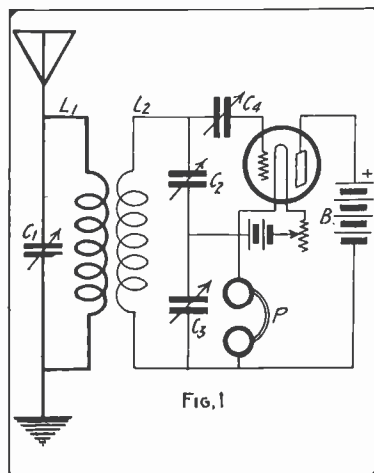

Circuit Showing the Capacity Feedback Regenerative Audion Connection—Once You Get Acquainted With This Circuit Stations Will Come In by the Dozens.

the apparatus. This is known as the "capacity feedback." L₁ and L₂ are two of these multi-layered coils. C₁ and C₂ are variable condensers of .001 capacity. C₂ is .003 mfd and C₁ is the usual type of small grid condenser. It may be made of two sheets of copper or tinfoil separated by mica. With the new type of audion it is necessary to use a grid leak connected from the grid to the common side of the filament. Several pencil lines on a piece of cardboard makes a good grid leak of several thousand ohms. Of course, the resistance may be changed to suit the particular VT by making the lines thicker or thinner. The correct value has to be found by experiment. It might be well to mention that the juggling of the apparatus in long wave work is an important factor. Experience teaches. Things may not seem to be going right at first, but when the operator gets "acquainted" with his apparatus stations will come in by the dozen.

Figure 2 is the diagram of the connection for the "inductive feedback." There are many ways of connecting the apparatus, and the amateur must not think that there is a set rule for doing it. Either of these connections will give good results. (Continued on page 198)

Selector Switch for the "Rogers" Underground System

By J. STANLEY BROWN

TO the present-day amateur the ground wire presents an almost unlimited field of experimentation. Countless points of interest will come to light during its perfection, so it is only proper that the amateur equip himself with the necessary instruments before he does any work.

Due to the very directional tendencies of the ground wire it is necessary that at least four or five wires which run in different directions be installed so as to allow reception or transmission in any direction. If the experimenter wishes to work on undamp waves as well as the ordinary range of damp waves, two distinct sets of wires should be used. Audibility comparisons with an elevated aerial are desirable, so it is advisable to have a short and long wave aerial at hand. To avoid much trouble in changing adjustments and the loss of signals a selector switch should be constructed. In the following columns the writer will endeavor to make clear the construction of such a switch.

The general assembly of the switch is shown in Figure 1. This switch is designed for use with either receiving or low voltage transmitting sets. It is not advisable to allow it to handle voltages over five or six thousand. Contacts, as the reader will see, are provided for both spark and arc work and allow for wires to the north, east, south and west as well as a terminal each for antenna and ground. Additional contacts may be added, but it is seldom that a use will be found for them.

The panel which is shown in detail in Figure 2 is of black "Formica" or "Bakelite," and is to be given a dull grain finish with fine sandpaper and oil. As yet no mechanical process has been found satisfactory in applying the finish just mentioned, and even the manufacturers of commercial apparatus use the hand method. If the builder wishes to stamp letters into the panel or the flush mounting he can make a fine job of it by first heating them in boiling water. "Formica" is not hard on drills if the work is not rushed and they are kept well sharpened.

In order that the switch might be used for transmitting it is necessary that the contacts be well spaced. It's plain to the experimenter that smooth switch action could no longer be expected unless all the contacts were made flush with some surface. The necessary surface is provided by the flush mounting shown in detail in Figure 3. The mounting is of "Formica," and if but a single one is being made, is best turned out in the form of a ring and cut to size with a hack-saw. The holes for the contacts are drilled with a $\frac{1}{4}$ " drill and reamed.

The amateur should make the contacts on a screw machine if possible, as they should be of

the same height. $\frac{1}{4}$ " brass rod is used to turn them from. The contact details are shown in Figure 4. After fastening the flush mounting on the panel with six No. 6-32 x $\frac{3}{8}$ " oval head machine screws the contacts are pushed into place.

Over the shank at the rear of each contact on the smaller diameter a copper tubing lug is placed and held on by a No. 8-32 x $\frac{1}{8}$ " thick $\frac{1}{4}$ " hexagon brass nut. One

the punching would be repunched to $\frac{1}{2}$ ". Figure 5 also shows how the punchings should be bent away from the large knob in order to assure positive tension and contact.

The switches are held onto the knobs by No. 2-56 x $\frac{1}{4}$ " round headed iron machine screws, and in the case of the small switch by the shaft and drive fit separator, Figures 6 and 7.

The shaft is made of $\frac{3}{16}$ " brass rod and is threaded for $\frac{1}{4}$ " with a No. 10-32 die.

The separator is turned out of $\frac{1}{2}$ " brass rod and drilled with a No. 13 drill. The knob, switch blades and separator are now driven onto the shaft as shown in Figure 1.

Figure 8 gives the details of the brass bushing and nut. The bushing is turned out of $\frac{3}{4}$ " brass rod and the nut is made from $\frac{3}{4}$ " hex. brass rod. If a $\frac{1}{2}$ "-32 tap and die are not to be had the nut may be made blank and a drive fit to the bushing. In a case like this it would be necessary to solder them together.

The bushing shown in the assembly view as next to the switch shaft must be made of a good insulator to avoid any possible breakdown. Also it must be a suitable substance for a bearing to the brass shaft. The Bureau of Standards specifies "Bakelite" as a good bearing material in such a case and, of course, its insulating qualities are well known. If drilled out with a No. 12 drill an almost exact running fit will be secured and no reaming will be necessary. Be sure that the body of the bushing "mics" to .376", as it is to be an internal drive fit to the brass outer bushing. Before driving it on, however, be sure that the large knob is in place. Details are shown in Figure 9.

The connection strip and ten-spring combined, Figure 10, is cut from No. 22 B. & S. spring brass. It is held in place by one of the No. 8-32 iron machine screws that hold the binding posts on. After fastening on the panel it is bent away from it to give necessary tension. The switch shaft is now slipped into place and held there with a No. 10-32 x $\frac{1}{8}$ " thick $\frac{5}{16}$ " hex. brass nut and soldered. The connection to the other binding post is a piece of heavy copper strip well soldered to the bushing nut.

Binding posts may be of any standard variety and with No. 8-32 threads in the base.

The base is a form of false bottom and is screwed to the bottom edge of the panel with 3 No. 3-32 x $\frac{5}{8}$ " round headed iron machine screws and washers. Further stiffening is provided by gluing a three-cornered strip of wood in the angle formed by the bottom and the base. The base measures $\frac{1}{2}$ " x $2\frac{1}{2}$ " x 6" and is of birch or any suitable hard wood. Eleven $\frac{5}{16}$ " holes are staggered in the bottom to provide exits for the leads.

A case must be

This is an article intended for the amateur constructor desirous of delving into the Rogers underground system. Mr. Brown has recently emerged from the service where he had considerable experience in the Radio Branch; therefore he speaks with authority.—Editor.

of the same nuts is also used to fasten the outer contact in place. Solder is then run down in between the two of them, thereby making a permanent job. After the contacts are put into place and made fast the surface of the flush mounting and the tops of the contacts are gone over with fine sandpaper and oil.

The knobs for the switches are best made of hard rubber and polished. The large knob is $1\frac{3}{4}$ " in diameter and $\frac{3}{8}$ " thick. The center hole is made with a $\frac{1}{2}$ " drill and reamed. The small knob is $1\frac{1}{2}$ " in diameter and $\frac{3}{8}$ " thick. The center hole is made with a No. 13 drill to allow a drive fit to a $\frac{3}{16}$ " shaft. Both knobs should be knurled on the edges.

The switchblades are built up 4 ply out of some standard switch punching of 22 gauge spring brass. Figure 5 shows a punching which is almost universal in its applications. The writer has specified this switch for thousands of instruments and it has proved adaptable to almost any job. When used on a job similar to that called for in connection with the largest knob

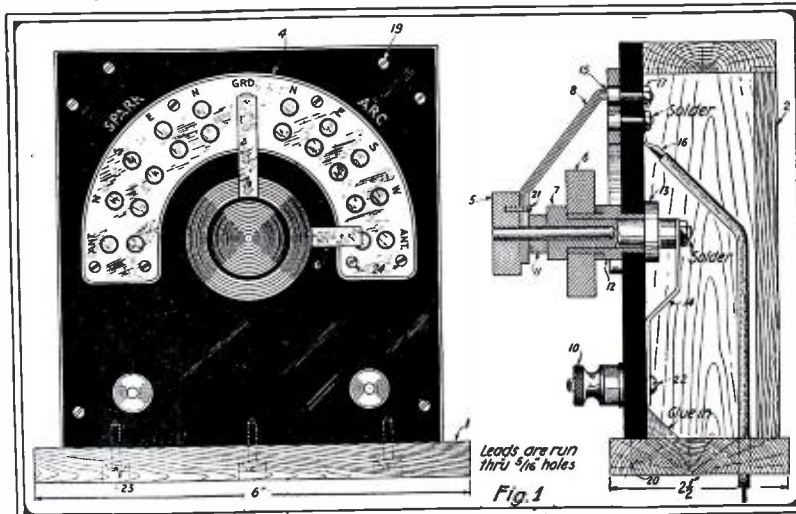

Front and Side View of the Rogers Underground Antenna Switch.

made of the same material as the bottom. It should be $5\frac{1}{4}$ " square and $1\frac{7}{8}$ " wide. It is held to the panel with six No. 6-32 x $\frac{3}{8}$ " oval headed brass wood screws.

Its fastenings allow its removal, so it is an easy matter to get at the connections of the switch.

All wood work looks fine if made of

birch and given a good mahogany finish.

The visible metal parts of this instrument should be polished and nickel plated, with the exception of the contacts.

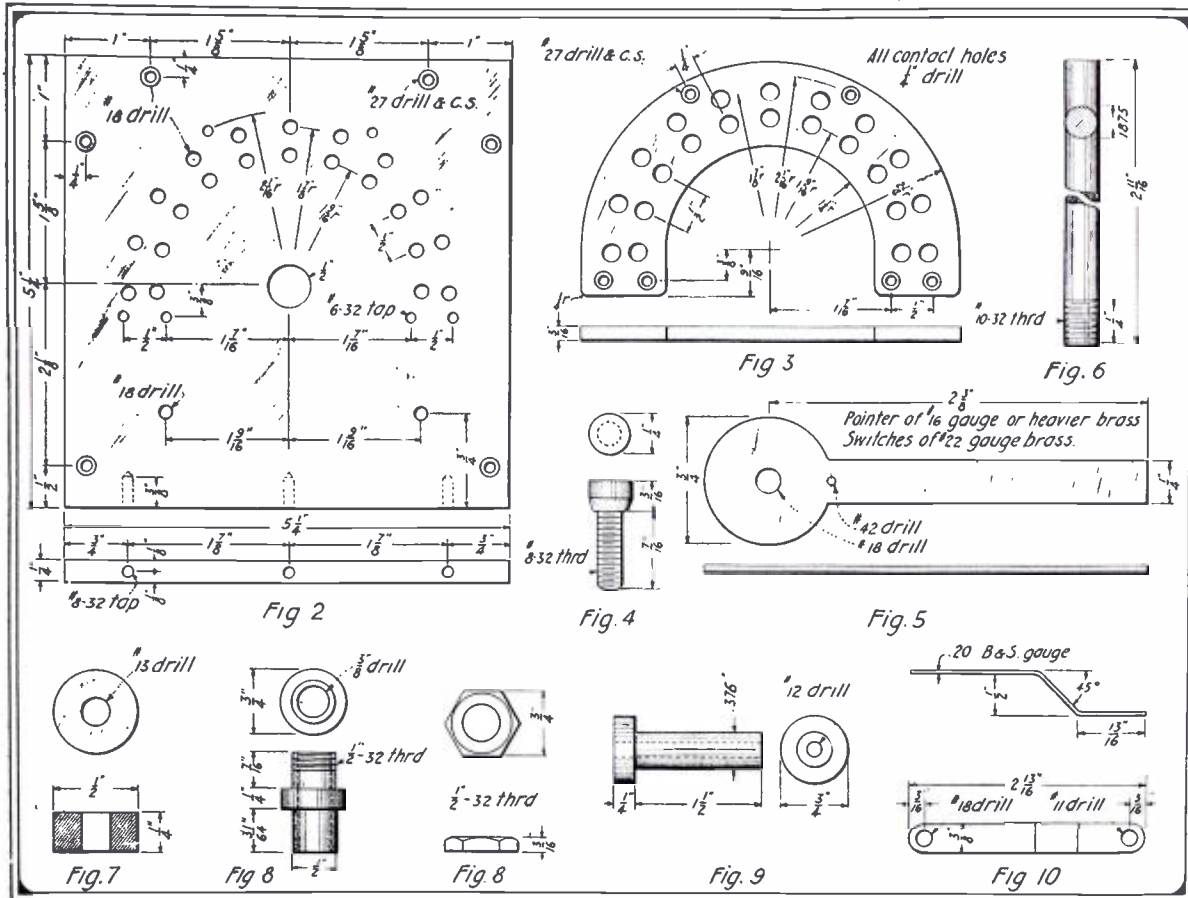

Constructional Details of the Rogers Antenna Control Switch. 2—Panel. 3—Flush Mounting. 4—Contact Points. 5—Switch Blades. 6-7—Bolt Which Holds Blades to Knob. 8—Brass Bushing and Nut. 9—Bushings. 10—Spring to Contact Strip.

Audion Protective Device

By E. T. JONES

Associate Editor

THE average amateur can afford audion bulbs which in return deliver more than value received, but it is very unlikely that the average experimenter can afford to use these valuable assets to his receiving station or laboratory without the use of some form of circuit-breaker or overload release, as is the practice in commercial types of audion control panels.

With the protection of the needy in view, it is the object of this article to show clearly the construction of such a device for the small sum of approximately fifty cents.

It cannot be disputed that many of the audion bulbs used for amateur work prior to the war were burnt out before their life was spent, due to the lack of adequate protection; by means of a device described herein. The necessity of keeping the filament at practically a white heat, while giving maximum results, was very hazardous, and necessary for the proper operation of the audions as sold for such purposes. The commercial audion will give good response when the filament can hardly be detected as lit. This is a very valuable feature, which to my understanding has not been applied to the manufacture of amateur tubes.

A description and drawings of this valuable asset to the popular audion circuits of today are given on the attached page.

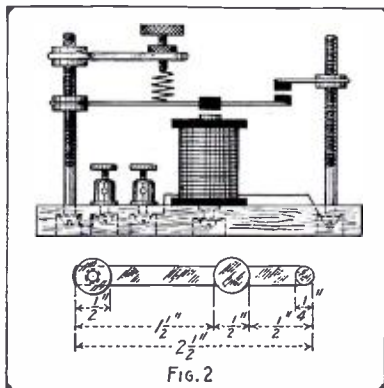

An Instrument Which Will Save Many an Audion Filament. It Cuts Off the Current When the Danger Point is Reached, and the Current Has to Be Brought to Zero Before the Filament Can Be Lit Again.

Many an audion will be saved by its use.

This instrument consists mainly of a magnet, which actuates a contact member, releasing the current in the vacuum tube filament, while the shunt resistance to the contact members keeps the contacts open until the filament-rheostat is brought to zero position, for otherwise the instrument would vibrate much the same as an ordinary buzzer. The current permitted to pass thru the magnet by the shunt resistance across the contacts (which are open) is sufficient to hold the armature down.

The Magnet.

Figure 1 gives the dimensions of the magnet core. It consists of a soft piece of iron $\frac{1}{2}$ inch in diameter by one inch long. Over an insulation of empire cloth is wound four layers of No. 24 SCC magnet wire. The winding covers but $\frac{3}{4}$ of the core—the remaining quarter inch is employed for holding same in the base, which has a hole bored slightly smaller than the diameter of the core.

The Armature.

A piece of $1/32$ " spring brass, shown in Figure 2, measuring $2\frac{1}{2}$ inches long— $1/2$ " (Continued on page 203)

Cascade Amplification at Radio Frequencies

By THOMAS W. BENSON

NO doubt more amateurs would make use of cascade amplification in connection with regenerative circuits were it not for the prevailing belief that an expensive audio frequency transformer is required to couple the circuits. As a matter of fact the majority of transformers used for the purpose are but a compromise, the proper

capacity of the grid condenser being such that at the end of the oscillations of each set of waves forming one beat of the group frequency the charge on the grid has reduced the electronic stream between the filament and plate to its lowest value. The decrease of current in the plate circuit acts thru the iron core transformer to induce a current in the grid circuit of the second tube where it is further amplified and detected by the 'phones.

has a grid condenser that serves to hold a negative charge on the grid and interrupt the plate current of the second tube at audio frequency. In this manner an audible note is heard in the 'phone.

The same scheme could be employed in a

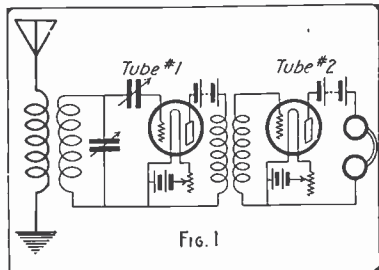

FIG. 1
Circuit for One Step Radio Frequency Amplifier.

inductance varying to a certain extent with each tube employed. That such transformers are necessary is not the case, for it is possible to use the easier constructed radio frequency transformers or loose coupled tuning inductances for the same purpose.

Let us consider the action taking place in the usual cascade system where amplification takes place at audio frequency. The current from the incoming wave is rectified by the unidirectional conduction of the electronic stream from the filament and the grid is charged negatively. The

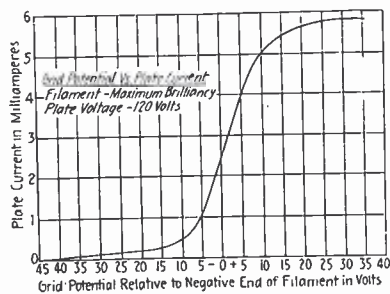

FIG. 2

Note, however, that the current variations in the plate circuit take place at audio frequency, hence no condenser is required for the grid of the second tube, the charges on the grid occur at audio frequency, it not being necessary to rectify several oscillations of the radio frequency currents.

Consider now the curve shown in Figure 2, which gives the grid potential VS plate current characteristics of the average three electrode vacuum tube. It will be seen that should the grid potential be at zero when the tube is connected in a circuit, as shown in Figure 3, and a negative charge be impressed on the grid the plate current will drop sharply. Conversely, were a positive charge placed on the grid the plate current would jump in value. Consequently, when the secondary circuit of Figure 3 is put in oscillation by an incoming wave the grid is alternately negatively and positively charged, each variation of the grid potential affecting the plate current. In this manner a current at radio frequency will flow in the plate circuit.

In view of the above what is simpler than to use a loose coupler or similar device to couple the grid of the second tube to the plate circuit of the first. This instrument may take the form of two coils wound on tubes 4 and 4½ inches in diameter, about 8 inches long, each tube having 200 turns of No. 22 S.C.C. wire tapped every twenty turns. The tubes are placed one inside the other and can be mounted in a box, on the front of which are the switches to tune the circuits.

A circuit employing this arrangement is shown in Figure 4. The first tube has no grid condenser, but has a biasing battery of 10 volts controlled by a potentiometer connected across a small fixed condenser. This battery is used to bring the grid potential to the proper value for the production of radio frequency currents in the plate circuit. The second tube, however,

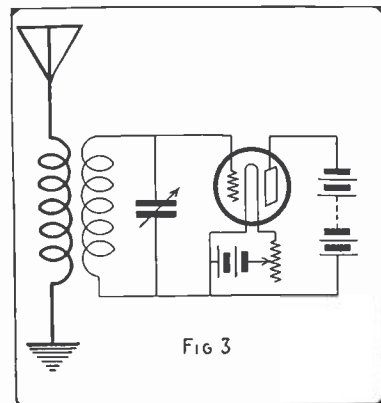

FIG. 3
The Incoming Waves Alternately Charge the Grid (Positive and Negative) and Each Variation of the Grid Potential Affects the Plate Current.

two-step amplifier if a biasing battery were used on the second tube and the grid condenser put in the grid circuit of the last tube. Or regenerative coupling may be employed between the plate and grid circuits of the last tube to obtain still greater amplification.

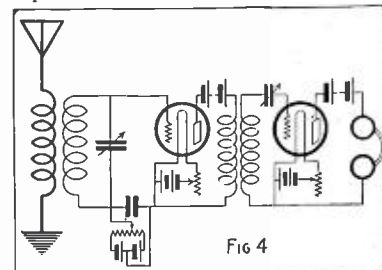
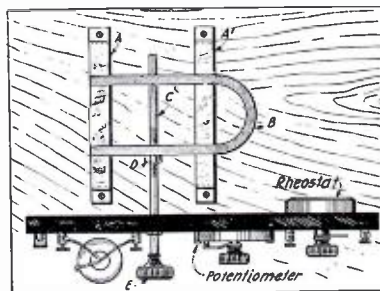

FIG. 4
With Two Coils Very Much Similar to a Loose Coupler Amplification at Radio Frequencies is Made Possible.

Magnet Control for Vacuum Tubes

By HERBERT WEBB

A great many wireless experimenters do not know that a magnet placed near a vacuum tube will improve it. I found out the fact from a friend of mine, and proceeded to try it. Before I used it I could barely hear Arlington 5 feet from the phones, and I now get them 60 feet away easily, even in this hot weather. A magnet from an old magneto is the best, because they are usually very strong and can thus be placed farther away from the bulb. Then when I noticed that it worked most efficiently when about an inch and a half away, I thought of placing the magnet in the rear of the panel. The magnet must have some way of being moved backward and forward through a distance of about a half an inch. This was accomplished in the way shown by the diagram. A and A¹ are the two pieces that the magnet slides on. B is the magnet, C is the rod, which



A Clever Method of Regulating the Distance of a Magnet from the Vacuum Tube, Mounted on the Panel.

is threaded for about an inch, D is a nut which is soldered to the magnet, and E is the knob which turns the rod. As is evident, there are two holes in the magnet thru which the rod will easily slide. If the magnet is taken from a magneto there are already two holes drilled which are in the right position usually.

There are some tubes which are not appreciably improved by the use of a magnet, such as some types of the Marconi V. T., but the audio-tron vacuum tubes are almost invariably improved. The panel in the diagram is just a plain audio-tron set, but I have put my knob on my set in such a position that if I change it into a cabinet set I can still use the same system without boring any more holes.

It should also be mentioned that a fairly critical adjustment of the filament current is necessary.

Design of the Loading Coil

By RALPH H. LANGLEY

Of all the various parts of a radio transmitting set, there is probably no one of them that is responsible for more avoidable losses than the loading coil. Even in the small amateur set, working on low wave-lengths, the loading coil may eat up as much as all of the energy that would otherwise be supplied to the aerial. In the larger sets, and in using higher wave-lengths, the design of the loading coil becomes increasingly important.

Loading coils have been made in all sorts of shapes, and with all sorts of material. They have been wound as helices on square forms, and octagonal forms, and round forms. They have been made of litzendraht (stranded wire with each strand insulated from the others), they have been made of solid wire, and of tubing and of copper strip. It is obvious that there must be some best form, and some best conductor to use.

Litzendraht would undoubtedly be the best kind of wire to use, if it were not for the fact that it does not permit of making easy adjustments. The amount of inductance in the loading coil must be carefully adjusted, not only when the set is first tuned up, but at frequent intervals afterward, due to changes in the capacity of the aerial, or changes in the wave-lengths of the primary circuit. A coil made of litzendraht cannot have any sliding contacts, and making taps on such a coil is a matter of considerable difficulty.

In making the choice between the solid wire, the tubing and the strip, we have only one thing to consider. High-frequency currents travel in the surface of the wire. This eliminates the solid wire, because it has less surface for a given amount of copper than any other form. The next point is that the inductance, and also the resistance and the losses, of a coil depend on how many turns we can put in a given space. This shows us that the strip will be better than the tubing. As a matter of fact, any tubing which could be used would have less surface than a thin copper strip made with the same amount of copper. So we see that the strip is better for two reasons.

There will be less copper for a given inductance in a round coil than there will be in a square one or an octagonal one. There are two ways to make a round coil, however. We can wind it in a helix (as when it is wound on a tube) or we can wind it in a spiral (like the hair-spring in a watch). Since we have decided on the copper strip, we will chose the spiral form of coil, because it is very much easier to wind the strip in this form.

There is a very simple formula for the inductance of a flat spiral coil, which anyone can use. If we let

L = the inductance of the coil in centimeters,
 n = the total number of turns,
 a = the mean radius of the coil (the inside radius plus the outside radius, divided by 2) in inches,
 b = the width of the copper strip in inches,
 c = the radial depth of the coil (the difference between the inside radius and the outside radius) in inches,
 then we have

$$L = \frac{32 \times n^2 \times a^2}{0.23a \quad 0.44b \quad 0.39c}$$

This formula is very accurate, and can be used to find the number of turns required for a given inductance as well as to find what inductance a given coil will have.

Building coils of this kind is quite simple. Any hard wood will do for the frame, provided it is boiled in paraffin. It is then only necessary to build a wheel having four or six spokes, and to put saw slots in the spokes to set the copper strip into. If four spokes are used, the frame for the coil can be a square of wood. The spokes can run all the way across, being jointed together at the center. If six spokes are used, a hub can be made to hold them, and no outside frame will be needed. Such a coil as this can easily be fastened to the wall, and connections made by means of little copper clips made of the same copper strip.

For the usual amateur set, the strip should be $\frac{1}{4}'' \times 1/32''$. It should have rounded edges if possible, so as to cut down the possibility of sparking. Strips of this kind can be purchased from any of the large metal dealers.

A sliding contact can be arranged on this kind of a coil without much difficulty. If the coil is made with a hub, a rotating arm can be mounted on a bearing at the center of the hub, and arranged with an insulating handle. The little contact clip must then be made so that it can slide along the copper strip of the coil, and also slide in and out on the rotating arm. With this arrangement, tuning can be done with power on, and will be very much quicker and more accurate than when the power has to be shut off each time, and the clip has to be moved a whole turn.

Coils of this kind are equally suitable for the primary. If two of them are used, one for the primary and one for the secondary, they can be hinged together to give the coupling variation. In this case, one coil will be fastened to the wall or table, and the other will swing on the hinges. One spoke in the swinging coil should be made longer so as to act as a handle to use in getting the proper coupling. An oscillation transformer of just this kind has been used

in Army Pack Sets for years, and is highly efficient and very satisfactory in operation.

In making connections to a coil of this kind, it is better to make the permanent connection at the outside end of the coil, and to increase the inductance by moving the adjustable contact in toward the center. The outside turns of the coil have greater inductance than the inside turns. This means that the amount of copper in circuit (and consequently the losses) will be less for any particular inductance if the outside turns of the coil are used.

Two coils made in this way may be used to make a transmitting variometer. For this purpose they should be hinged together in the same way as for an oscillation transformer, but the method of connection will be different, and one coil is to be placed upside down with reference to the other. This is in order that when the two coils are closed together they will oppose, and thus give minimum inductance. When one coil is swung around so as to come in line with the other, they will give maximum. This maximum will be about 40 per cent greater than the sum of the separate inductances of the coils, due to the mutual between them. The two outside ends should be connected together by a flexible connector, and the circuit brought to the middle of one coil and taken from the middle of the other.

In building coils of this type, it is not profitable to make the inside radius much less than $1\frac{1}{2}''$, as the turns at this radius and less have very small inductance. For the $\frac{1}{4}'' \times 1/32''$ copper strip, the spacing of the turns cannot be much less than $\frac{1}{8}''$. It will usually be best to make it about $3/16''$ in order to be sure that there will be no sparking between turns along the supporting spokes, and in order that the little pieces between slots may not break out. A small "fret-work" saw should be used to make the slots.

If we build the coil as explained in the preceding paragraph, and then figure its inductance by our formula, we shall find that for five turns it will have 3,350 centimeters, for ten turns it will have 15,700 centimeters, and for fifteen turns it will have 32,500 centimeters. Now, for a wave-length of 200 meters and an aerial whose capacity is 0.0004 microfarads, we will need a total of 28,200 centimeters. The 15-turn coil would therefore be suitable for the secondary of the oscillation transformer. A similar coil, calculated to give the proper inductance for 200 meters when used with the primary capacity, can be built for the primary of the oscillation transformer.

Concerning the efficiency of coils of this type, it is only necessary for us to notice that they are standard in the Army and Navy, and also with the large commercial radio companies.

Copying Thru Static

The art of copying thru strays (static or X's as they are generally termed) is quite an accomplishment, and a few hints as to how this is done are herewith explained for the benefit of those who are learning Radio and will in the near future have to combat this aggravating source of annoyance.

The main principle lies in the fact that while endeavoring to copy thru static, one should concentrate his undivided attention upon the incoming signal, and furthermore, by all means endeavor to overcome the added disadvantages of such disturbances by not allowing himself to get rattled or angry over the fact that it is not easy

"pickings," for this is one of the worst conditions which presents itself in the case of the beginner and some of the advanced operators. When this happens, your concentrative powers disappear and it takes considerable time to get back to the normal state again; during this period the transmitting operator has been sending all for naught. It is much easier to get what you can, taking it for granted that the sending operator did not send any but the letters you received, relying upon the repetition in order to complete the word or words, rather than fly up excitedly and miss all of it.

You will note that the longer (of course

there is a limit) you copy conditions seem to gradually improve, but when he stops sending in order to get your "O.K." or request for repetition, you will find that upon resuming reception that it takes quite a little time to get back to a concentrated state. Therefore, it is easy to recognize the importance of having as few breaks as possible under the circumstances. To accomplish this have the sending operator send three or four messages at a time, repeating as usual, then stop to get your "O.K.," this will lessen the number of actual breaks.

A little word in regard to cutting out or
(Continued on page 201)

A Wireless Telegraph Receiver

By RAY T. FOSTER

The articles needed to construct this receiver are as follows: One phonograph reproducer (cylinder type preferred), one piece of steel wire about No. 28 B. & S. one old bi-polar receiver, one brass strip about 3/8 inches wide and 2 inches long, one iron strip 1/2 inch wide, 3 inches long and 1/16 inch thick, two large binding posts that will pass No. 14 B. & S. wire, two small binding posts for terminals, one

shape of "L." The upright to be three inches long and the bottom part one-half inch. Now drill two small holes in the upright, depending on size of thumb screw and small bolt used. Next a small hole in the bottom part to hold upright in place. The hole, O, in the iron piece is to be threaded. Fig. 2, article "J."

Take the small brass strip and bend to shape as shown in Figs. Nos. 1 and 3, the

uprights for holding the steel wire "C" in place.

Figure 2 (A) small horn 3x2 inches which can be dispensed with, as it merely increased the volume of the sound emitted by the reproducer. (B) Phonograph reproducer mounted in wire loop (D) which is attached to two binding posts (E). (F) Coil (preferably wound with No. 40 B. & S. enameled wire) This small coil is wired to the two small binding posts on the back of the board. (G) Small horseshoe magnet taken from A, Bi-Polar receiver. (H, I, J.) Upright arrangement made from iron strips (No. 2 in Fig. 1) and brass strip (No. 3 in Fig. 1) and A, thumb screw for pulling "H" toward "J" to adjust steel wire "C."

The small piano steel wire "C" is fastened to the center of the diaphragm of the reproducer and is stretched by thumb screw "I" over the magnet "F." The wire C is soldered to H, which will be found the best way. Under no condition must the wire C be twisted.

It will take experiments to find the distance above magnet F to place wire C and how many turns must be given the thumb screw I so as to get the proper sound when the wire C is made to vibrate by the incoming signals.

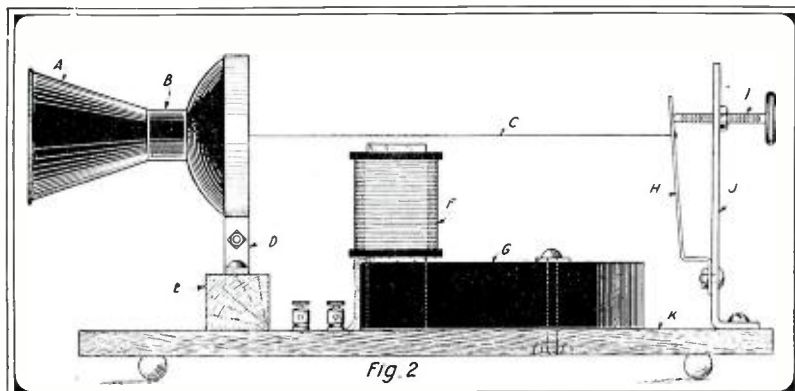

With an Old Phonograph Reproducer a Steel Wire and the Magnets Form a Bi-Polar Receiver. A Very Good Experimental Receiver Can Be Constructed as Shown Above.

1-inch brass screw with brass washer about 1/2 inch in diameter, one 1/4-inch brass wood screw, one small brass bolt, one brass thumb screw with hard rubber handle, one piece sheet brass about 5 inches square, one piece brass or copper wire No. 14 B. & S. about 8 inches long, one base board of wood or hard rubber about 4 x 7 inches.

Take the old bi-polar receiver apart and if the winding on one of the coils is not good take the wire off and rewind with No. 40 enameled copper wire; wind very carefully so as to enable the coil to operate good. Now take the horseshoe magnet that was in the receiver and put the coil between the poles and use the same brass bolt that was in the magnet at first to hold the coil in place; use some thin sheets of brass to bush the coil so that it is half way between the positive and negative pole. Figure 2, articles F and G.

Now take the iron strip and bend to

longer part to be one and five-eighths inch long and the bottom, "L," being one-half by one-half inch. Drill a hole as shown to take the small bolt used to fasten same to the iron upright described above. Fig. 2, article "H."

Take the phonograph reproducer and remove the weight and the point which will give you access to the small loop fastened to the center of the diaphragm. You are now ready to mount the reproducer in the brass strip, "D," Fig. 2.

It will be understood that this outfit is to take place of the "phones" which are used in the receipt of all wireless messages. This outfit if adjusted properly and constructed carefully will prove very useful, as it is not necessary to have the phones fastened over your head.

Key to Diagrams.

Figure 1 shows the way in which the loop for holding the reproducer and the

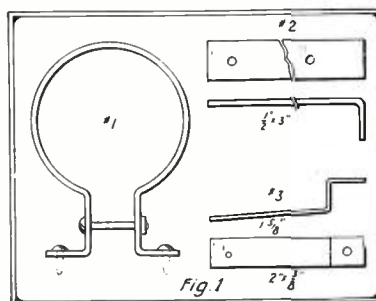

Various Parts Employed in the Construction of the Receiver.

Figure 3 gives the layout of the base board.

It will be understood that if smaller wire than No. 40 B. & S. is used the efficiency of this outfit is increased to an appreciable extent.

Construction of Mica Receiving Condensers

By L. R. JEWETT

Mica, when used as a dielectric, has proven ideal for receiving condensers. Its losses are very low and it takes up very little space.

There are many grades of mica on the market and only the best should be used, namely, India ruby mica. It is perfectly clear and transparent, but sometimes contains a very slight pink tint. A little experience is required in order to recognize this grade.

A very unsuitable grade of mica for use as a dielectric is utilized on armature construction, telephone work, etc. It usually contains black or brown streaks and spots. Built-up mica, which is composed of small pieces held together by a binder, sometimes shellac, should not be used. These grades of mica are much more inferior to paper.

Several manufacturers of condensers are using India ruby mica and no doubt the amateurs could obtain enough for their

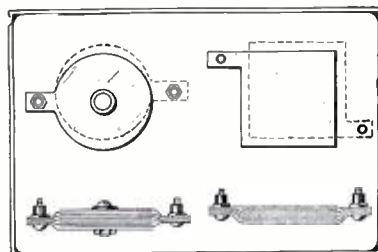

The Condensers Can Be of the Circular or Square Type. This Shows How They Are Held Together.

needs for a few cents. Ordinary leadfoil or tinfoil is very satisfactory for the conducting surfaces.

The accompanying table gives the correct amount of active dielectric surface area for several thicknesses of India ruby mica. The capacities were not calculated but were actually measured on a Weston direct reading capacity meter at 500 cycles. Thus, the amateur can easily design an efficient mica condenser after having obtained the necessary data outlined in the table.

Thickness.	Capacity in mfd. per sq. in.	Sq. in. per .0001 mfd.
.0010	.00094	.1064
.0015	.00081	.1230
.0020	.00070	.1430
.0025	.00059	.1700
.0030	.00048	.2080

(Continued on page 201)

How to Make a Good Variable Condenser

By A. WARR

This type of condenser is fine for amateur construction, as it combines simplicity with stability and cheapness of materials required, no dimensions are given as different amateurs will have different sizes of material to hand.

Begin by making a suitable base for the instrument; this may be made from wood,

such as mahogany, altho, if it can be made of hard rubber, so much the better.

The supports (a) and (d) must be made of some good insulating material, such as hard rubber, bakelite, etc., as it is essential that the tubes be thoroly insulated to prevent losses, the support (d) is drilled as shown in Fig. 3, the hole being slightly smaller than the tube (c), this tube can

be made of fiber taken from an old cartridge fuse of the right size, it should be a little larger than the sliding tube (e), this short tube acts as a bearing for the sliding tube.

The tube (b) can be made of brass or aluminum (mine was made from an old brass bicycle pump), and should be the same diameter as the small fiber tube (c), the length depends on the size of the condenser, thus tube is mounted securely on the support (a) as shown in Fig. 1. A binding post screw run thru the tube and support will serve also to make connection.

The tube (e) is made of the same material as the tube (b) and should be a good sliding fit in (b); this tube is to be covered with dielectric; the best way to do this is as follows: cut a piece of wax paper so that it can be wrapped around the tube twice, making it about half an inch longer than the tube, next cover the tube with a coat of shellac and then wrap the wax paper around it, turning the end into the tube as shown in Fig. (4), then give the wax paper two coats of shellac. With this dielectric there is no fear of a short circuited condenser, connection is made to the sliding tube by means of a flexible conductor soldered to it as shown in Fig. (1). If this condenser is properly made it will give just as good service as a rotary variable and the cost will not be anywhere near as much.

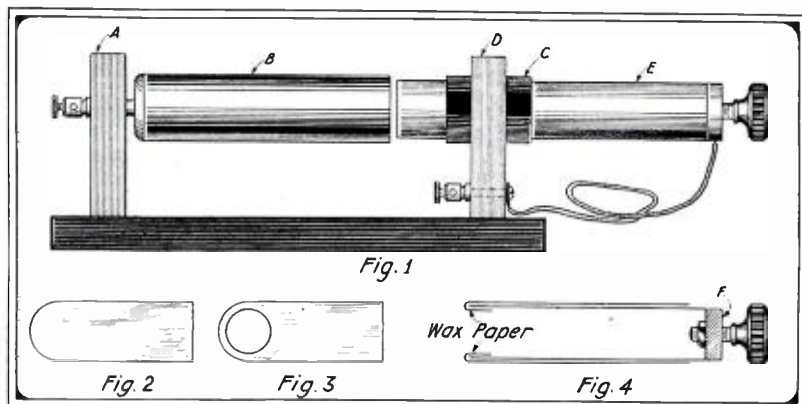

A Simple Method of Constructing a Variable Condenser Suitable for Vacuum Tube Work.

A Radio Goniometer

By EDGAR TERRAIN JOHNSTONE

This little instrument when completed will afford the experimenter many ways of testing various circuits, with various antennae, etc.

The construction is very simple and cheap and is recommended for those who desire to test arrangements mentioned above.

At a 5c and 10c store I procured three knitting hoops, Figure 1, measuring 8", 7" and 6" in diameter. The largest and smallest were made stationary and the medium size coil (7") was chosen as the revolving unit for the following reasons: that it would have the same maximum relation between each of the two stationary coils while, if the small coil is made to revolve, there will be quite an amount of coupling even at maximum position, between the largest and the small coil.

The small coil was made stationary by means of a T piece, Fig. 2, which clamped the coil and held same in that position. The medium coil was caused to rotate on its axis under the largest and over the smallest coil.

On the front of the instrument I put a scale which was marked off as shown in Figure 3. The center, which shows zero position, is really half-way between the two coils or a position shown at 3 a.

All the forms which are 1/2" in width are wound with 20 turns of No. 28 S.S.C. wire. They are then coated with shellac and just before they are entirely dry the wires are pushed aside, as shown at 3-b, so that a hole may be drilled to take an 8/32 screw which clamps one end of the revolving coil. A smaller hole is made at the farther end (marked X) and a small cigar box nail is passed thru both frames and bent on the outer side.

Connections are made to the movable coil by taking a piece of old telephone cord

(which is of course flexible), the ends of which are connected to the free ends of the coil and the cord is bound to the frame until it approaches near the handle and scale, where it drops to the base and is made fast. This is done in order to permit the smallest amount of spare cord necessary to allow the coil to move thru its two positions. When suitably connected two variometers can be used by the same instrument. Figure 4 shows the completed instrument.

Now take into consideration the uses this valuable little instrument can be put to. For instance, any one interested in the underground system can make very efficient comparisons between his overhead antenna and the underground system. It only being necessary to connect the overhead antenna and ground in series with one of the stationary coils and the underground sys-

tem in series with the remaining stationary coil. The receiving apparatus, of course, is connected to the revolving coil, which can be brought into inductive relation with whichever coil it is desired to receive energy from.

Another interesting experiment can be carried on with two elevated antennae, and the difference in signals strength between the two readily noted. From these experiments much data can be collected which may prove of extreme value in studying the propagation of waves and the detection of same. Besides, the relation existing between various shapes and types of antennae can readily be ascertained. This is the first time that an instrument of this nature has been described, and it is hoped that anyone constructing such a valuable instrument will send in for the benefit of other readers experiments of interest which they carried out

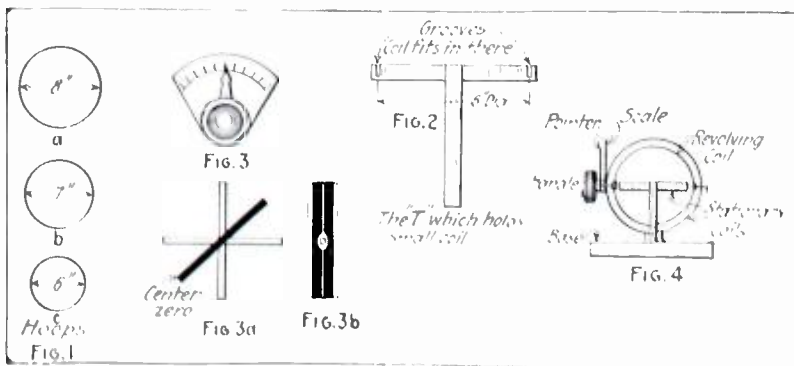

Constructional Details of the Radio Goniometer Showing Each Part and the Completed Instrument.

Improving the Rotary Gap

By C. H. BIRON

AS an extravagant waster of valuable energy a poorly designed spark gap is the most common and generally the worst offender in the circuit of the average amateur's transmitter. Nor are its vices confined to the immediate circuit in which it functions, for its condemning features are invariably an imposition upon the good nature of all operators within its range.

A good gap is no more costly than a poor one and record-breaking apparatus often attributes its success to design that does not overlook the few conditions necessary for success.

The arcing tendency in spark discharges is the most formidable problem to contend with; especially where this is augmented by the use of transformers having a low value of magnetic leakage. This fault is partially overcome by the use of rotors which, due to the shape of their teeth, set up a maximum rush of air between the sparking points without recouring to excessive speeds.

In the question of choice in motors the prospective buyer will do well to favor a type that is variable as to speed control as against the straight induction type, for the reason that it is easier to adapt a motor's speed to a given condenser than vice versa. Yet for precise tuning and the correct discharge rate of the condenser, one or the other procedure is absolutely necessary.

Another consideration faced is the distracting noise attending even the operation of the comparatively low-powered sets. For this reason it is not uncommon to see gaps muffled in boxes built as nearly sound-

to the motor by the removal of a few wood screws.

Figure 2 shows the disposition of the motor leads and the method of mounting hard rubber or fibre pieces for the stationary electrodes.

When filling with gas the cap on the outlet tube should be removed and a lighted match held over the opening until the gas leaves in sufficient quantity to be ignited. The length of this tube will prevent back-firing into the box. After the chamber is full of gas the pinch cock is closed and the outlet cap replaced. This eliminates the necessity for a continuous flow.

While coal gas is not inflammable unless mixed with a critical amount of air, good engineering practice should provide a substantial factor of safety. This would call for some sort of explosion relief which may be a number of holes in the back of the box, fitted not too tightly with large corks.

Here the true economist will see a means of conserving the cork supply by advising the operator that he be certain of the gas density before starting the motor and pressing the key. . . . Also it should be borne in mind popping corks have a report peculiar to themselves and one can not be too careful, etc., etc.

A few refinements may suggest themselves, such as that shown in Figure 3, where the pinch cock is shown as mounted conveniently on the edge of the lid.

Where gas is not available the reader will find that even without this feature the box will impart good quenching qualities to the discharger comparing favorably to the best home-made types found.

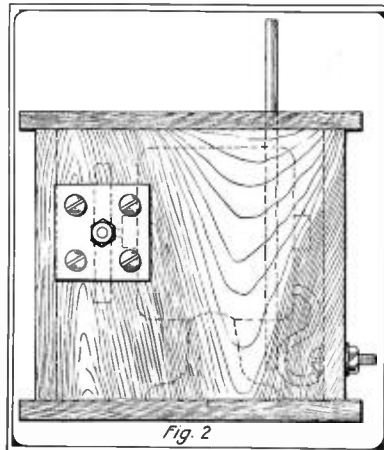

Side View Showing How the Stationary Electrodes are Mounted.

proof as possible. The amateur who has progressed this far may well go a step further and introduce a quenching medium within the box and thus heighten his present efficiency a great deal.

Fortunately, a first-class medium is found in common coal gas, which functions well owing to its high density. Obviously a box for this purpose involves some careful fitting of joints, but beyond this there should be little trouble experienced in reaching the desired ends.

The accompanying illustrations show clearly a few of the features necessary for the construction and convenient operation of such a device.

Figure 1 shows a complete gap and housing with the front removed for clearness, and one side shown in section through the stationary electrode. With this arrangement it is possible to build the box and assemble the component parts of the gap proper, placing the lid, with blotting paper gasket, last. This will permit ready access

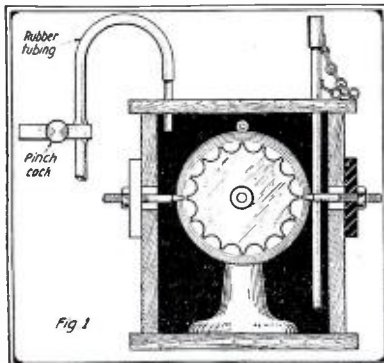

The Gap Enclosed in an Airtight Compartment Filled With Gas Will Increase Your Gap Efficiency.

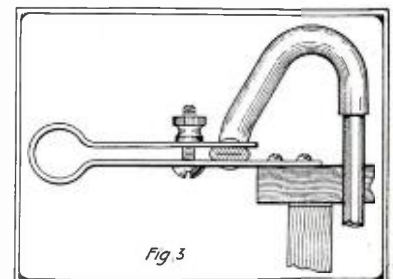

The Rubber Hose and Clamp for Stopping the Flow of Gas.

A Variable Grid Leak

Resistance on the order of 2 megohms are required for numerous purposes in audion receiving sets, such as grid leaks, resistance coupling of amplifiers, etc., and it is best to use variable resistances for this purpose. Pencil marks are commonly used, but their limitations are apparent. Here is a resistance that is easily variable, and yet more permanent than a pencil mark.

On a piece of bakelite or hard rubber 2 inches square draw a semicircle with a 3/4-inch radius, using a drawing compass pen and India ink. The pen should be set for making a 1/32-inch line, and the circle should be ruled over about three times, first allowing the ink to dry each time. Drill a hole at the exact point where the compass was set (the exact center of the bakelite square) for an 8-32 screw for the switch shaft. The switch arm is made of

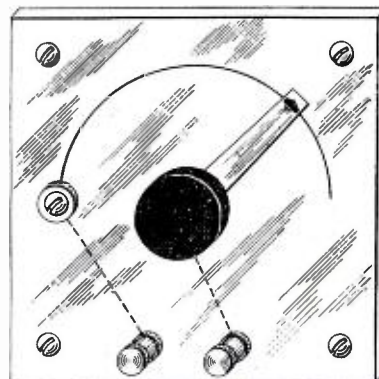

A Clever Method of Constructing a Grid Leak.

very thin spring brass, slightly convex downward at the point where it touches the inked line. But little tension is required in this arm, or it will wear the line away unduly. A small 1/4-inch knob is used to complete the switch.

At the left end of the inked line a hole is drilled to receive a small machine screw and washer for making connection to the line. Holes for mounting are also drilled in each corner of the bakelite. Connections are brot from the switch arm and from the machine screw just mentioned. When used as a grid leak the device is connected between the grid and the negative pole of the filament. The drawing shows the finished instrument, which is far superior to the usual form, as it is variable at a uniform rate, and not by jerks, as is the case with pencil marks.

Contributed by ARNO A. KLUGE.

New Vacuum Tube

The vacuum tube shown in the photo is a German (Telefunken) tube which was picked up on the battle-field of France during the great German retreat. From all appearances, the construction details appear to be identical with those of the French tube; and was evidently copied from tubes captured during their advance thru the allied lines previously.

The tube is of very rugged construction and evidently designed for field sets where rigidity was the main essential.

Owing to the shortage of metal and adequate insulating material, they were compelled to provide a substitute for this much-used material. From all appearances, peat has been used in the construction of the base. Four brass connectors emerge from the bottom of the base, three of which are in the form of plugs; the fourth, which constitutes the plate connection, differs from the rest in that it forms a receptacle for a plug evidently furnished on the panel of the receiver or transmitter. This also insures against connecting the bulb in the wrong position, since it can only be put in place one way.

Another great improvement has been brought about by a certain process which does away with the tip of the bulb, thereby protecting its life further. This strikes us as a very valuable feature which should be adopted here in the construction of our own tubes, since the protruding tip is generally the cause of breakage.

Other points worthy of consideration are the following: The leads from the grid

and plate, respectively, are caused to pass thru very small glass tubing to the base, which provides a means of absolute insulation between the filament circuits and the grid-plate leads. Since the supports holding the cylindrical plate and filament are subject to vibration in other tubes of this design, small glass beads were placed on the two supporting members at a point midway between the main support and the plate and grid.

A sample of one of these tubes brought over by a returning hero was tested, and comparisons proved that this tube is far superior to our present standard V.T.I. This assertion is based on this one particular tube and does not infer that the same holds true with other tubes. Due to the fact that no characteristic curves were taken, nothing definite in regard to the operating characteristics can be given, but the strength of signals received with this valve in an ordinary circuit were from five to ten times the audibility of those received when a V.T.I. was substituted in the same circuit.

A Telefunken tube picked up on the battle-fields of Europe, forgotten by the fleeing Huns. It has demonstrated exceptional merits as an oscillator, amplifier and detector. Note the rugged design and the individual points of construction—such as the connectors, peat-base, glass beads to support leads to plate and grid and elimination of the glass tip.



Efficient Amateur Radio Transmitter

A CHICAGO concern, manufacturing highly efficient Radio apparatus, has placed on the market a new complete transmitting unit, which is shown in our photograph.

Transformer

Beginning at the left a 1 K.V.A. transformer especially designed for wireless work is shown. It is rated at 25,000 volts secondary output and is air cooled.

It embodies the principle of the closed core double magnetic circuit. One magnetic circuit being variable to give great regula-

tion of voltage, capacity and reactance.

The core is of high silicon steel .008 (8 Mills) thick laminated.

Magnetically, mechanically, and electrically extremely efficient. It operates at the remarkable efficiency of 92% and has a high factor of safety.

Brass, steel and aluminum have been judiciously utilized, not only with the idea of making this design highly efficient, but handsome as well. Too often the transformer part of the wireless equipment is crude and unsightly. They have made this type in keeping with the rest of the appa-

ratus, a device to which the operator can point with pride.

The essential feature of this Wireless Transformer has always been its magnetic shunt control. This feature protects the transformer from all undue current surges, such as are present in operation.

These transformers are designed to be connected direct to source of alternating current. No impedance or chock coil is necessary.

Transmitting Condenser

Next, towards the right, is shown the special condenser for this equipment, the dielectric of which is phenol fiber, which has withstood potential tests at 48,000 volts before breaking down. It thus permits of an overload of nearly 100% when used with the 25,000-volt transformer. The edges of the sheet brass are rolled and the corners rounded, thereby preventing a loss of energy by corona or brush discharge. Be-

The latest thing in transmitting apparatus. With its short connections a set of this type will prove exceptionally efficient on amateur short wavelengths.

tween each two sheets of brass on each terminal of the condenser is inserted a third sheet which is corrugated. This arrangement permits the oil to penetrate and circulate, and at the same time prevents heating. There is practically no loss of energy due to heating, corona, or brush discharge, and therefore extremely high efficiency is attained. After assembling, the condenser is immersed in a container of oil, as it is a well-known fact that the greater

(Continued on page 190)

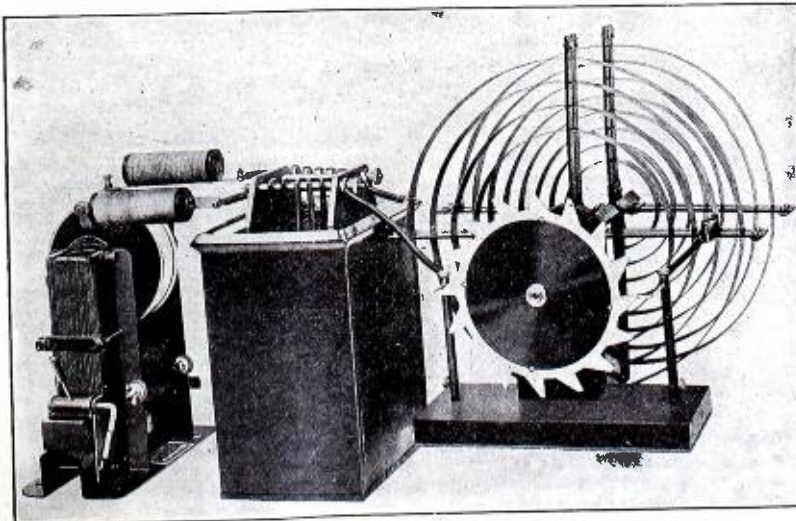



NEW ORLEANS SCIENTIFIC RESEARCH SOCIETY.

Editor RADIO AMATEUR NEWS:

I am at present writing you in regard to the Scientific Research Society. The members comprise boys and young men interested in any branch of science. Our motto, "Make science serve humanity, not humanity slave for science."

We intend studying the practical side of all the arts and sciences, including wireless, chemistry, electricity, geology, bacteriology, astronomy, engineering, etc. The present headquarters are at 915 Jackson Ave., New Orleans, La. We intend establishing local chapters in all cities and towns, and anyone wishing to learn more should correspond with the president, 730 Delachaise, or the secretary, J. C. Cahill, 915 Jackson Ave.

New members are solicited. We intend securing all the present scientists as honorary members. We have so far secured Hon. H. Gernsback as an honorary member.

We have a modern wireless set and complete technical as well as practical chemical laboratory and a library in which any of the books in the known category can be pursued.

Beautiful certificates and buttons have been made, and any one enrolling inclosing 25c to help cover mailing cost can secure one free of charge.

730 Delachaise, New Orleans, La.
J. A. WEICK,

HOW THE PITTSBURGH RADIO ENGINEERING SOCIETY COMBATS GOVERNMENT RADIO CONTROL.

(Letter sent to Senators and Congressmen at Washington by members of the Pittsburgh Radio Club.)

Honorable Sir:

The undersigned is a radio amateur who has spent considerable time and money in the pursuit of this fascinating study, with the hope that he might be able to add something for the benefit of radio communication, believing that there is still an unlimited field for research work in that direction. It is also his belief that a great deal of good will be accomplished in the future, as has undoubtedly been in the past, by the efforts of radio amateurs and commercial wireless companies in the development and perfection of radio communication and that the control of this public utility is not primarily the concern of the Federal Government.

He further believes that navy control of wireless would spell "death" to both amateur and business use of this method of communication and respectfully urges that you use your good efforts to prevent the passage of the legislation now being proposed by the Navy Department to authorize a government monopoly of same under their control.

The fact that many thousands of radio amateurs assisted materially in winning the world war should, in itself, be sufficient cause for your serious consideration of this request.

In closing, I also appeal to you to have the ban on wireless transmission removed. This was purely a wartime measure and should now be repealed.

NYCSSA RADIO CLUB.

Editor Club Gossip:

DEAR SIR:—The Nycssa Radio Club was organized this summer at Camp Nycssa, where it built a station and successfully operated it. The club will resume activities this winter under Mr. Tilden at the West End Presbyterian Church, where we will install a station. The club has fifteen active members and expects to double that number before long. The Nycssa Radio Club would be pleased to hear from other clubs concerning their activities. All communications should be addressed to C. Stanley Johnson, Jr., secretary, 160 Wadsworth ave., New York city.

CLUBS. PLEASE NOTE.

We want the latest gossip from all clubs and associations. We will be only too glad to give them the widest publicity. We ask the secretary of each club or association to send us a monthly report of the doings of his club. Such notices will be published free of charge. All amateurs, no matter where they live, should know what our clubs are doing, and what is being done to further their members' welfare and interest. RADIO AMATEUR NEWS will be an exchange place for ideas of this kind.

What we want particularly is: A good photo of your club-room and of the members; a copy of your by-laws or constitution, rules, etc.; if a weekly or monthly paper is read, send us a copy for publication.

Address all correspondence to Editor, Club Gossip.

EVERGREEN RADIO CLUB.

The Evergreen Radio Association of Long Island was organized August 16, 1919. This insertion is for the benefit of those who desire to become members of this club, which was organized primarily to promote good fellowship among all amateurs and to increase the efficiency of its members so as to reduce A.R.M. to a minimum. Those interested will kindly communicate with our secretary, Geo. H. Roy, 681 Grandview Avenue, Evergreen, L. I.

WIRELESS "BUGS"—

RADIO AMATEURS

ALL radio amateurs, formerly licensed or unlicensed, within the 3d radio district, who are interested in organizing an association of amateurs of said district, will kindly communicate with Box 300-C, Star office, Washington, D. C. The advertiser, a radio amateur, desires to, with assistance of other amateurs, organize a self-governing and self-supporting organization for amateurs exclusively.

The above shows the novel method of some Washington, D. C., Radio Amateurs who, by inserting an "ad" in their local paper, attracted many radio bugs to their club. Good idea, we say!

CONNECT WIRELESS PHONES WITH DESK SETS.

A new radio telephone system which will permit San Franciscans talking to ships of the Pacific fleet in the harbor through their

ordinary desk or wall telephones, is being set up by the Navy Department at the Goat Island radio station here. To get the connection it will only be necessary to call up the radio station and then ask for the ship and person desired. This connection will be made by the station.

LEGION FORMS RADIO POST.

Guynemer Post, American Legion, has been formed in this city by radio men of the Signal Corps, Marine Corp, and Navy. The post is named for the famous French ace, who was downed after he had brought down seventy German planes.

The new post will be the "radio post" of the Legion. Among its charter members are: Edgar H. Felix, Will T. Weatherbee, J. E. Howay, Donald D. Way, Harry A. Burgess, Johannes E. Howay, Julian E. Howay, William A. Weber, Philip Jean d'Iounors, Jr., Joseph Stanley, Vincent James Lepore, Quested Latus Elgar, Albert B. Bingham, Harry A. Burgess, David S. Brown, Theodore J. Hartung, Jr., and Arthur Dickson.

Edgar H. Felix of 228 Bragaw Street, Long Island City, is secretary.

RADIO TRAFFIC ASSOCIATION.

The prevalence of inefficient operating was responsible for the organization of the Radio Traffic Association of Brooklyn, N. Y., in January, 1917. It is again preparing to carry out its main objects, which are to minimize unnecessary interference and reduce inefficient operating by the dissemination of practical ideas. It also purposes to promote good fellowship and establish an efficient relay system among the amateurs of Brooklyn.

At present the officers are: Ferd C. W. Thiede, chairman; Albert R. Heydon, secretary; Ernest K. Seyd, financial secretary, and Clifford J. Goette, treasurer.

All amateurs above the age of 18 who are desirous of connecting with an organization offering obvious advantages, are cordially invited to communicate with the Chairman at 486 Decatur Street, Brooklyn, N. Y.

Very truly yours,

RADIO TRAFFIC ASSOCIATION.
FERD C. W. THIEDE, Chairman,
486 Decatur St., Brooklyn, N. Y.

BALTIMORE RADIO AMATEURS.

All radio amateurs in the city of Baltimore that own either sending or receiving outfits, or both, and that are interested in forming a radio club, are requested to communicate in writing with Robert L. Crowther, Jr., 1130 W. Lafayette Avenue, Baltimore, Md.

As most amateurs know all restrictions on amateur receiving outfits were removed on April 15, and the restrictions on sending will be removed as soon as the peace treaty is ratified by Congress.

The purpose of forming such a club is as follows:

1. Further development of wireless telegraphy and telephony in the city.
2. Regulation of amateur communications so as to reduce QRM to a minimum.
3. To assist the Radio Inspector in locating all wilful violators of the Wireless Law.

Radio Digest

VALUE OF AMATEUR RADIO APPARATUS SOLD IN THE UNITED STATES IN ONE YEAR.

In the year 1914, before governmental restrictions were placed upon Amateur radio operations and experimentation, the value of the apparatus sold to amateurs in the United States amounted to \$672,000.—*Telegraph & Telephone Age.*

SHORT WAVE RECEPTION AND TRANSMISSION ON GROUND WIRES.

Lieut. Comdr. A. Hoyt Taylor: After an historical review of the work of the United States Navy with underground and underwater receiving systems, the author gives data demonstrating the possibility of effective reception on such systems, particularly when using amplifiers.

These systems are found to be directional toward waves traveling parallel to the length of the wire pair. This directional selectivity, which is marked, is applied in control stations for duplex working.

For such underground systems, an optimum wire length for best reception is found to be roughly proportional to the wave length (for short waves) and independent of the direction of the approach of the signal. The existence of this optimum length gives further utilizable selectivity. This length is independent of the nature of the surrounding medium and varies inversely as the capacity per unit length of the wire. The wire in question must be well insulated.

Reception thru violent storms, and suppression of summer strays (particularly at short wave lengths) are found.

It is found that lowering such wire systems from above ground into wet soil or into water greatly increases the signal strength and diminishes strays.

Transmission at short wave lengths, over considerable distances, using such systems has been found possible with low power sustained wave transmitters.—(*Abstracted Proc. I. R. E.*)

INSTITUTE FOR WEAK-CURRENT TECHNOLOGY AT DRESDEN.

By H. BARKHUSEN.

An institute for weak-current technology (in distinction to heavy-current technology), with a professorial chair, has been formed in connection with the Dresden Polytechnik. The study of this branch of electrical engineering, which is concerned with methods of signaling, has not received the attention that it deserves. The curriculum will include telegraphy, telephony, wireless telegraphy and the theory of instruments, measurements and transmission lines.—*Technical Supplement to Review of Foreign Press.*

TELEPHONING ELECTROSTATICALLY A NEW RADIO SYSTEM.

Earl C. Hanson, of Washington, D. C., is claimed to have perfected a new method of transmitting the voice as well as music by an electrostatic process. From the diagram furnished he makes use of a step-up transformer with a ratio of approximately 34 to 1, the primary is divided into three sections, which are in turn connected to three transmitters of the carbon granular type in series with a 6-volt battery supply. The primary consists of 480 turns of No. 16 DCC wire for each coil, and a total of 1,440 turns. The secondary winding, which is connected directly in the antenna-ground circuit, consists of 50,000 turns of No. 40 enamel copper wire.—*Abstracted September Popular Science.*

VACUUM TUBES AS COMMUTATOR.

The following, which was read before the Physical Society of London, is due to W. H. Eccles, D. Sc. and F. W. Jordan, B. Sc.

In physical laboratories, especially those in which electric waves and oscillations are studied, circumstances sometimes arise in which a wheel or disc has to be spun rapidly under light load and with absolute freedom from the sparking that occurs in the best ordinary direct-current motor. In such cases a motor employing a rotating magnetic field can be used if alternating current is available, but often alternating current is not at hand. We therefore describe in this paper a small perfectly sparkless motor that can be run from a direct-current supply, such as that used for lighting. Apart from the applications alluded to, this new motor might be used for maintaining gyrostats in rotation, for driving stroboscopes, and so on.

The motor is an application of the three-electrode ionic relay now so well known. In such relays there is a glowing filament F functioning as cathode, a plate or cylin-

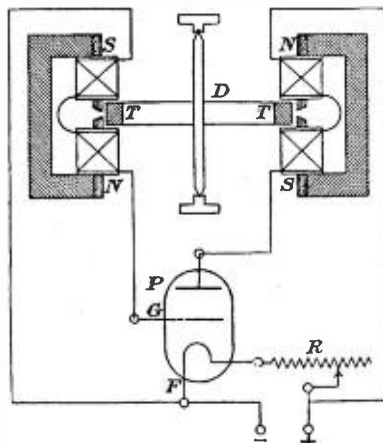

A New Use for Vacuum Tubes. The Tube is Substituted for the Commutator.

der P as anode, and an intervening grid G as control electrode. A constant E.M.F. is applied between filament F and anode P and causes a steady stream of electrons to pass from filament to anode across the vacuum.—*Wireless World.*

WAVEMETER.

M. B. Sleeper by employing the De Forest coils as well as the condenser manufactured by the same concern, a wavemeter that meets the requirements of every radio experimenter can be had at an extremely small cost. The condenser type C. V. 1,000, when employed with the following coils, will give a range from 100 to 24,500 meters:

Milhenries	λ Min.	λ Min.
0.04	100	400
0.15	250	750
0.60	450	1,550
2.3	900	3,000
11.0	2,000	6,600
40.0	4,000	12,500
175.0	8,000	24,500

(*Abstracted September Everyday Engineering.*)

WIRELESS IN THE A. E. F.

Lieut. Col. L. R. Krumm and Capt. Willis H. Taylor, Jr., point out that in mobile warfare ground telegraphy proved to be practically worthless, and in future wars this system will be displaced by small loop antenna wireless sets. In providing sets for the tanks many difficulties had to be rectified and a set was finally developed which made possible communication with the post of command and co-operating airplanes. The main key to the enemy's projected operations was furnished the intelligence department by listening stations which were installed in dugouts several hundred feet behind the front line trenches, and the experiences of the men detailed to such duty were among the most heroic of the war. The debt the United States owes to the AMATEUR operator is clearly defined. They were the first to respond as volunteers, and their excellent work in the field under the most discouraging circumstances earned them a place in history.—*Abstracted September Wireless Age.*

LOWENSTEIN'S QUENCHED GAP.

Gaps of this type which we have been familiar with in the past have but one disadvantage. If the gap has to be removed or repaired it interferes with the other gaps in the circuit. Besides, it requires expert work, which may not be convenient at all times. Mr. F. Lowenstein has perfected a gap which obviates this and other defects inherent in quenched gaps. In this gap the component elements which are of the tubular are so assembled and mounted that any spark gap element or unit is individually removable and replaceable in an instant without interfering with any other units of the gap and without the aid of special skill on the part of the operator.—*Abstracted September Wireless Age.*

WIRELESS DEVELOPMENTS IN GERMANY DURING THE WAR.

A. Meissner.

Great improvements have been made in wireless communication during the war. It was found possible to keep up communication in both directions between Germany and the colonies for at least six hours in the day, the best times being 6 to 11 a.m. and the best wave length 5,500 m. With 100 kw. it was at times possible to reach Windhuk. The Goldschmidt machine at Eilvese gave much trouble and failed for long periods; nevertheless toward the end of the war, as the result of certain improvements, it became much more reliable. Its capacity was increased to 800 kw. The Nauen station, also with 800 kw. capacity, was most satisfactory in its operation. Methods of double sendings by two senders acting on one antenna tuned simultaneously to two wave lengths have the advantage of attaining a greater degree of selectivity by the combination of the wave lengths. New types of cathode tube amplifiers rendered communication possible between fringing trenches with very light apparatus. Blocking stations were used to interrupt the wireless communications of enemy aircraft. Directive stations were very successful in aiding Zeppelins over Paris through a thick fog. Various improvements are referred to in arc transmitters, tube transmitters, high-frequency coils, receivers, relays and antennas.—*Technical Supplement to Review of Foreign Press, May 27, 1919. (Abstracted from Elektrische Zeitschrift, March 13, 1919.)*



THIS Department is open to all readers. It matters not whether subscribers or not. All photos are judged for best arrangement and efficiency of the apparatus, neatness of connections and general appearance. In order to increase the interest in this department, we make it a rule not to publish photographs of stations unaccompanied by a picture of the owner. We prefer dark photos to light ones. The prize winning pictures must be on prints not smaller than 5 x 7". We cannot reproduce pictures smaller than 3 1/4 x 3 1/4". All pictures must bear name and address written in ink on the back. A letter of not less than 100 words giving full description of the station, aerial equipment, etc., must accompany the pictures.

PRIZES: One first monthly prize of \$5.00. All other pictures published will be paid for at the rate of \$2.00.

Paul Lifschiz Station

FIRST PRIZE \$5.00

This set was designed and constructed by myself. I have arranged for crystal detector or vacuum valves, and for damp and undamp reception. Everything ex-

cept the "A" battery and the detector is contained in the set, connections being made by binding posts on the side. The set consists of a receiving transformer,

stopping condenser, a large variable condenser and a small one, a filament rheostat, buzzer, "B" battery and a test coil for tuning the set and adjusting the detector.

Everything is controlled from the front panel. The stopping condenser was obtained from telephone condenser. The secondary coupling is varied by pulley and the cords, the secondary being mounted on a square rod in the center. The dimensions of the set are 15 inches long, 12 inches high, and 6 inches deep.

An explanation of the switchboard follows: Beginning at the upper left-hand corner are the primary switches, one turn per tap and twenty turns per tap; directly below is the arc and spark switch, one point between being dead. Below that is a variable condenser. In the center on top is the vacuum tube, below that the secondary coupling control and below that the filament rheostat. A telephone jack for crystal or vacuum valve is between the tube and the secondary control, and a telephone plug is used for the phones. On the right next to the tube is the secondary turns control switch, and next to that the "B" battery control. Below is buzzer test switch and variable condenser.

I have had very good results with this set, copying Alaska on a 60-foot aerial anywhere in the room.

PAUL LIFSCHIZ,
15 Canyon Road, Berkeley, Cal.

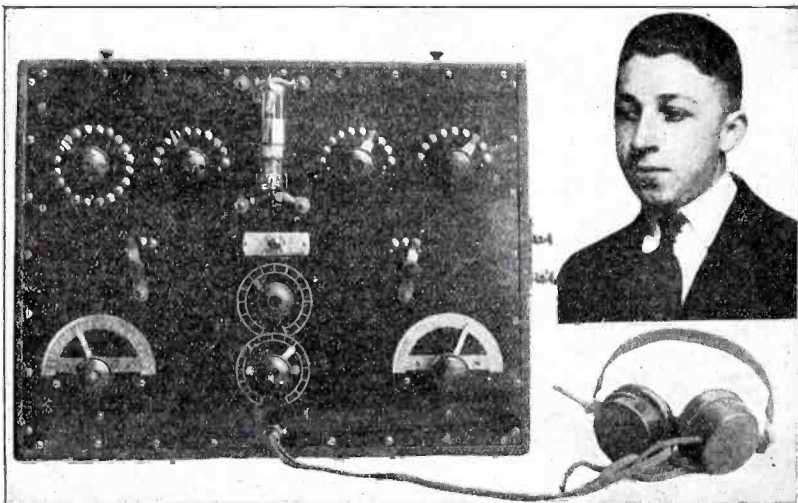

Here is a Very Good Design of Receiver and Its Proud Designer and Constructor. Note the Advanced Type of Phones Employed. He is Up-to-Date in Every Respect.

Harold Schultz Station

Yours for R. A. N.,
HAROLD B. SCHULTZ,
360 Hart Ave., Detroit, Mich.

Here are three photos. At present my station is not complete, as I was but lately discharged from the signal battalion, radio section, U. S. M. C. For two years of the war I worked ship radio stations, New York to France. The inclosed photo of myself was taken just after my last trip of four months, hence the joyful expression. Just now my station is equipt with but an inch coil transmitter and crystal detector. As all advanced amateurs know, efficiency counts for more than power in transmitting, hence I find I can do more with an inch coil than some less experienced with a half kw. Thirty miles is about my record. The short leads can be seen plainly in the close-up of the transmitter. My aerial is a 300-foot two-strand aluminum L type. All receiving apparatus except phone and audion are home-made. Beneath the table you can see a small 80-watt generator I am building, and other parts of apparatus. The drawer desk on the right contains my materials and library. My bag and storage battery are not shown, as I was making improvements in them at time. I am a photographer and experimenter in chemistry in addition to being a radio man, but could not get a photo of my chemical lab, due to lack of room. I have a very complete microscopic equipment. Now I will "pipe down" and give some one else a chance.



Here is a Station with a Long Distance Record. Note the Smile of Its Proud Owner. Well, You Fellows Know Just How You Do It After Getting Back from a Four Months' Voyage, so I Won't Explain.

An Amateur's Retrospect

By SCOTT E. VANCE

KNOWING that every radio amateur worthy of the name has had at some time or other in his experimental days experiences similar to the following, I am narrating this with the hope that it will take our readers back to the old experimental days when every one thought he had a very efficient and complete outfit if he was the proud possessor of a one-inch spark coil, old telegraph key, and an old 4 x 5 condenser, made from cracked photograph plates. At least that was the opinion my chum and I held in regard to our first set!

My first plunge into the wireless world dates back to about 1908, when this chum and myself decided that we would construct a wireless set which would be a marvel of perfection in workmanship and operation. Our first step was the purchasing of a beautiful one-inch spark coil, which must have been made to look at, for that was about all it was good for.

While waiting for this coil to arrive we constructed our spark gap and condenser. The condenser was made from old photo plates, some of which, I am sorry to say, were not in the best of condition physically, which added greatly to our troubles later. Our gap consisted of two zinc battery pencils, secured to wood and pieces, the latter being direct descendants from an old soap box, as were also the tuning coil ends, which will be mentioned later.

We also decided that if we were going to do any long distance sending (such is the vanity of youth!), we would require a helix, which we immediately proceeded to construct, using as uprights for the wire two of mother's best curtain rods, which, altho serving the cause of science in a much more becoming manner than they did when supporting the curtains in the front room, were, nevertheless, the direct cause of much distress and worry on the part of certain persons, because certain "others" did not look at the matter in the same light that we did, much to our sorrow. Having completed these instruments of future torture, we laid them away and waited for our coil to arrive—and—waited some more. By the way, in regard to this particular point, time hasn't changed things in the least! Well, after waiting so long a time the coil arrived, and then we felt the need of a key, and as our combined inventive facilities were at this time rather foggy as to the construction of a key which would be worthy of a place with the balance of the apparatus, we decided to

lack a few little immaterial attachments which are usually found on telegraph keys, such as the knob, spring and one binding post. However, as the junk man was careful to impress upon our youthful minds—when we parted company with the fifty cents—the key had platinum contacts, and that seemed all that was necessary for a key, so we were satisfied. We were able to find the missing parts in our box of odds and ends, which required the best part of our young life to protect and preserve from the hands of "Ma" during house-cleaning time.

We next turned our mental facilities toward the receiving set, which we constructed as follows: The first requisite was some sort of a receiver, so we invested what was left of our financial resources in a 75-ohm watch case receiver, the solitary and half starved looking magnet of which was wound with enameled copper (?) wire. *The diaphragm was a most wonderful specimen of diaphragm workmanship, resembling as it did one of the lids on the baby's toy stove, with the exception that the stove lids were more easily broken, for they were thinner.* Our next brain child was a tuning coil. This was made from a piece of home-made cardboard tubing wound with green cotton-covered wire, and the whole thing placed between two wooden ends—brothers of the spark gap ends. The sliders were also home-made affairs, and when in operation the sound made by them was similar to that caused by drawing a stick across the corrugations of a washboard. Where the insulation was removed to furnish connections for the sliders it reminded one of newly plowed furrows in a meadow.

Then came the detector, which had a base some five or six inches square, and consisted of a small piece of spring brass fastened to one corner of the base by two brass-headed tacks, and under which we placed a huge piece of galena, or at least it was called galena, but I always believed that it was something else, for never have I seen galena that looked like that substance did! On the other end of the base we mounted a double binding post of pleasing design, in the upper hole of which we inserted a piece of spring wire, bent to resemble the old-fashioned loop-the-loops which we used to see at country fairs.

Having thus finished the apparatus, both sending and receiving, we turned our attention to the aerials, of which we constructed two, one for our receiving set and one for the sending set. These antennae were extraordinary examples of scientific antenna construction, and would have put the NAA antenna to shame. That was our opinion, of course. To one of these aerials we connected the receiving set and to the other the sending set. A spike nail driven into the ground under each aerial furnished a very good ground connection. The aerials were about twenty feet long, and seven feet above ground, located some fifty feet apart. The fact that the aerials were of exactly the same length, shows the absolute necessity of the tuning coil and helix! (Ignorance is bliss!) Having everything fixed up to our satisfaction, we proceeded to business. As we did not have a head band I, of course, had to use my one hand as a clamp to hold the receiver against my ear and with the other hand adjust the detector, which had a tendency to move all over the table every time you tried to adjust it. At last I had it adjusted, or thought I did, but, sad to

relate, the harder I listened in one that set the less I heard! Of course, all the fault was with the other fellow, so I decided the sending set needed my worthy attention, but the real cause of my leaving the receiving set was to give my ear a rest. Arriving at the sending end, I found my efficient assistant profusely perspiring over the spark coil, which had broken down or something. No doubt it would render the future happenings in the story more easily understood if I state that we were experimenting out of doors, and were both standing on the ground! I proceeded to give the sending set a thoro examination in that dignified manner which I thought was in keeping with the position of radio amateurs and experimenters of my ability! I soon discovered that we had forgotten to connect all the cells of our batteries together. After remedying this slight evidence of absent-mindedness, I drew myself up in a very important manner with the intention of giving my assistant a lecture upon the futility of trying to operate the coil when his batteries were disconnected, when suddenly I was startled out of half a year's growth—not to mention the important manner—by a blood-curdling howl from my partner in crime. Looking around with a promptness which was not altogether born of curiosity, but perhaps somewhat of terror, I discovered my youthful associate in the act of falling earthward with one of the aerial wires grasped firmly in his hand and a terrified look upon his face. The cause of this sudden desire to become more closely associated with old mother earth was easily explained. When I was adjusting the batteries, my chum decided that a certain joint in the antenna needed his attention, which he immediately gave it, standing on the ground as he was, and having closed the lever on the old Morse closed-circuit key—is it all plain, bugs? However, in his earthward descent, probably desiring that I should share in his shocking experience, or perhaps thinking to say good-bye to me, he made a convulsive grasp at my bare arm and succeeded in gaining thereon a death-like grip with his unoccupied hand, all the while holding the aerial with the other, the natural and probable cause thereof being that I accompanied him in his rapid earthward journey, much to my disgust.

Of course as soon as the broken down aerial touched the ground all was well, but I am sorry to say that there were other troubles also.

(Continued on page 199)



I Left the Receiving Set to Give My Worthy Attention to the Transmitter—the Real Cause was to Give My Ears a Rest.

make a visit to that wonderful institution which is so dear to the heart of every experimenter—the junk shop.

Here we picked up a very good Morse key—for fifty cents, of course—but it



In His Earthward Descent, Probably to Say Good Bye to Me, He Made a Convulsive Grasp at My Bare Arm. I Accompanied Him in His Rapid Earthward Journey, and the Table and Apparatus Fell on Top of Us. Adding insult to injury.

The Nauen High-Power Wireless Station

By E. QUACK

To Right—One of the Smaller Towers at Nauen Employed to Support the Lead-in Wires of the Large Antenna.
To Left—One of the Main Towers, Which Support the Large Antenna. This Tower is Said to Be Six Hundred Feet High.

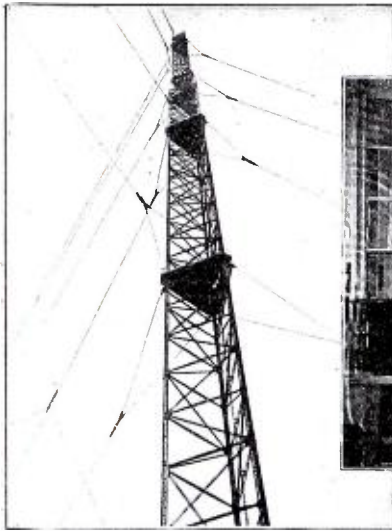

The Receiving Room of the Nauen Station.

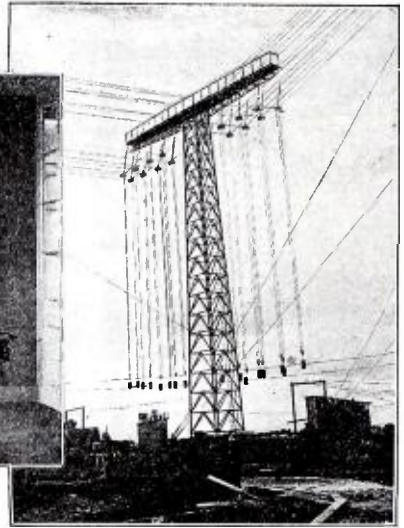

The author gives an account of the changes undergone by the Nauen station as a result of the necessity of providing increased power, etc., on account of war requirements after Germany found herself cut off from cable communication with the outer world. At the beginning of 1914 the station made use of 100 kw. in the antenna, with a musical quenched spark obtained from a high-frequency alternator employing the frequency-doubling method with static transformers. The difficulty of the radiographically unfavorable months rendered it necessary to increase the power of the Nauen station. The new installation at Nauen consists of an extensive antenna system, with a large building for the plant and apparatus. A certain number of details are given of the plant and arrangements, but a full description is kept back for military reasons. The antenna energy has been raised to 400 kw.

and two antenna systems are provided. The larger system is a T-antenna and can be supplied with 600 kw. The smaller system has the shape of a horizontal triangle, the energy (up to 200 kw.) being supplied to the apex. Its mid line is arranged so as to be at right angles to the large antenna, and in this way, owing to the coupling between the two systems being a minimum, simultaneous transmission with two different waves is possible, while the provision of two independent antenna systems assures the continuity of the service in case of a breakdown of one system. The two masts, of lattice construction, are 200 m. high and are bedded on an insulating ball at the base, there being another insulating link at 150 m. from the ground. The special insulators placed in the guy ropes are capable of withstanding a pull of 650 tons are described. The alternator is single-phase of 800 hp. and has a fre-

quency sufficiently high for it to yield, after several stages of frequency doubling, 24,000 cycles per second, corresponding to a wave length of 12,500 m. The transmitting key is arranged for operation at 200 letters per minute. The efficiency of the installation, from energy input at driving motor to antenna energy is stated to be about 65 per cent at 12,000 m. wave length. The following comparative figures are given:

WIRELESS OPERATORS SCARCE, NOVICES GETTING CHANCE.

An opportunity for amateur wireless operators to complete their training and receive a salary while doing so is offered by Radio Inspector Charles C. Kolster at the Custom House, New Orleans, La. The only requirement of applicants is that they shall be able to pass the code tests and send and receive twenty words a minute. Successful novices will receive pay at the rate of \$125 a month, Inspector Kolster announces.

These student operators will be sent to sea on ships now operatorless since the government withdrew its own men from the Merchant Marine. Allowances for board and room in addition to \$3 in cash is provided while the ships are in port.

	1908	1918
Masts	One of 100 m.	Small Antenna Two of 150 m.
Antenna area	31,000 sq. m.	One of 135 m.
Primary output	50 kw.	175 kw.
Antenna energy	112 kw.	100 kw.
System, slow sparking		Quenched spark
Range, 3600 km.		800 km.
		Large Antenna Two of 260 m. Four of 120 m. 155,500 sq. m. 600 kw. 400 kw. H.f. alternator 20,000 km.

Science Abstracts, Section B, April 30, 1919. (Abstracted from Jahrb. d. Drahtl. Tele. 13, 1919.)

Function of Each Piece of Radio Apparatus

TRANSMITTING SET

By EDGAR TERRAIN JOHNSTONE

Starting Rheostat: To insure against the blowing of fuses and the probable burning out of the armature coils.

Motor: By virtue of its mechanical strength to turn the armature coils of the generator so as to cut the magnetic lines of force, thereby generating electrical current.

Generator: To furnish alternating current at the required frequency to the primary terminals of the step-up transformer.

Protective Devices: To protect the low voltage lines from the high voltage surges (high frequency). The resistance rods are of too high a value to permit the passage

of low frequency, low voltage currents; but should the high frequency, high voltage surges from the secondary of the transformer pass back toward the generator, they will leak across the resistance rods to the ground connection, thus protecting the generator.

Step-up Transformer: To convert the low voltage current into high voltage current.

Condenser: To store the energy in the form of an electrostatic capacity charge furnished to it by the secondary of the step-up transformer and discharge the same when at a maximum charge, across the spark gap, in the form of decadent elec-

trical oscillations.

Spark Gap: To act as a valve, holding the circuit open until the condenser reaches its maximum charge, then offering little or no resistance to its passage for that fraction of a second.

Oscillation Transformer: To transfer the high-frequency electrical oscillations from the closed to the open radiating circuit.

Loading Coil (Inductance): To increase the wave length to a value beyond the capacity of the aerial and oscillation transformer secondary.

Series Ground Condenser: To decrease
(Continued on page 194)

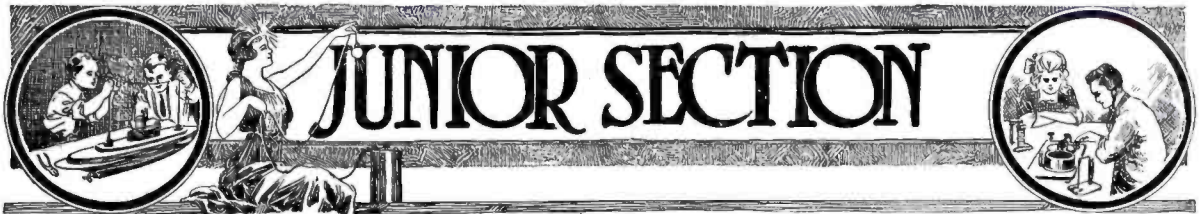

Junior Radio Course

By E. T. JONES, Associate Editor

Lesson Two

GENERATION OF WIRELESS WAVES.

IN the first lesson we were made to understand that communication was effected by employing a means of creating a disturbance and another means of detecting this disturbance at some distant point, recording the disturbance or waves as they passed by. This lesson will treat with the production or generation of wireless waves. We remember that by moving an oar back and forth in a pond of water, waves were created, and the same result can be had by dropping a pebble into the water. As figure 3 shows, this creates

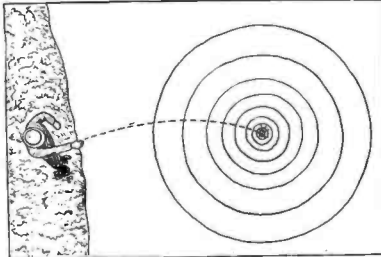

By Throwing a Pebble into a Pond of Water, Water Waves Are Created. The Larger the Stone the Greater the Distance the Waves Will Expand from the Common Center.

waves in circles moving away from the common center. Now a larger pebble would create larger waves, and the distance which one could effectively communicate with the party desired would also be greatly increased.

Bearing this in mind, it shall be pointed out in what follows that the larger the electrical power of the radio transmitting station, the more powerful the waves produced in the ether, and, therefore, the further we can send messages from the transmitter or sending station.

Generation

The reader may be more or less familiar with the electricity or current which he employs to light his residence and cause his fans to run, etc.; however, there are two kinds of current or electricity used in various locations of each city, one known as direct current and the other alternating current. Now the former is practically never employed, for reasons given below in what follows:

In order that we may successfully radiate or propagate wireless waves, we

This course, which will continue in the issues to come, began with the September issue, and everyone desirous of learning something of real value of this fascinating art should procure the previous edition, which contained the first lesson. This course is intended for the beginner and everything presented will be in plain English, and no layman will find any trouble in understanding and assimilating the knowledge contained therein.

The second lesson shall explain in detail the generation of wireless waves; and from this the reader will be placed on a sound basis for the general discussion which is to follow on the various pieces of apparatus and circuits of connections employed to generate and propagate these waves, which are the means of communicating without wires from one fixed point to another, and from a fixed point to a continuously moving one—such as a ship at sea.

must have a great amount of electric pressure exercised on the aerial wires, and this pressure corresponds to the stone dropt into the pond and depicted or clearly shown in Figure 3. Now, in order to generate (or manufacture) this great pressure, we have to transform our house current, which generally measures something like 110 volts, into about 40,000 volts. While the term transform is fresh in our minds let us also remember that the apparatus employed to accomplish these results is termed a transformer. A transformer of efficient design is shown in the illustration and is employed in Amateur installations where great distances such as are necessary for commercial operation are not necessary, and are not permitted.

The Transformer

Before describing just what a transform-

er is, it will be well to refer to figure 4, where a hydraulic pressure analogy is given. Here it is seen that if we have but one container which has one of its ends considerably smaller than the other, a pressure representing that of 10 pounds at the smaller end will cause 100 pounds pressure to be evident at the other. Here we have transformed a 10-pound working pressure into 100 pounds working pressure. Opposite this illustration is given the circuits of a transformer, and, as shown, ten volts

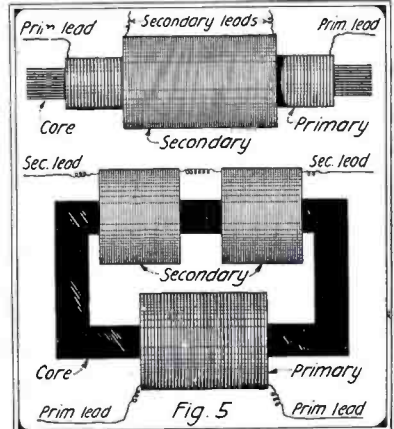

Here Are Two Types of Transformers: Above, Open Core; Below, Closed Core.

(pressure) is passed thru the primary (or smaller number of turns) and the result is that at the secondary terminals we have a noticeable pressure of 100 volts. This instrument (a transformer) is constructed of an iron core, sometimes open core—and again, closed core. The difference existing

between the two are shown in Figure 5 and the closed-core type is being adopted universally for wireless purposes for many reasons which will be discussed later on.

In order to understand what takes place in the transformation of the voltage as mentioned previously, we can well remember that this piece of apparatus comprises three essential parts: first, the iron core; second, the primary winding, and third, the secondary winding. The primary winding and the core

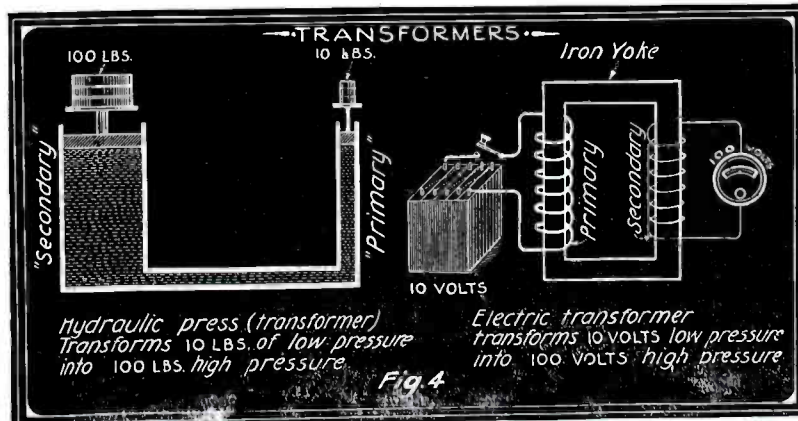

This Explains Diagrammatically How the Voltage Is Stopt up at a Ratio of 10 to 1.

alone would constitute a large magnet capable of lifting several pounds of steel or iron. The secondary consists of several thousand feet of very small insulated copper wire, which is placed directly over the primary and insulated from it by empire cloth or hard rubber tubing. The secondary has no wire connection whatsoever with the primary windings. A cross-section of a transformer is given in Figure 6, so that the reader may realize fully the component parts of such an instrument. Now, the amount of voltage which emerges or can be taken from the secondary depends upon the amount of current connected to (or put thru) the primary; and the number of turns on the primary in relation to those of the secondary. In other words, if 110 volts were connected to the primary windings, and the ratio between the windings was 10 to 1 (ten turns of secondary to every turn of primary winding), then the voltage derived by the transformation would be approximately 1,100 volts. And since in this particular work we require something like 40,000 volts, one can imagine the number of turns of wire necessary

and direct current. In the first it is seen that by pushing the piston into the tube containing the water, it will be forced out gradually, but in one direction only. This is the case in an electrical circuit—shown opposite where direct current flowing. It is shown more clearly by the arrows, which are all pointing in one direction, showing

above reasons, it is necessary aboard ship to install a motor-generator system for the wireless installation, due to the fact that all ships have direct current installations, and a direct current motor is necessary to turn an alternating current generator, the latter supply being brought directly to the transformer in series with the hand-operated key, so that the supply into the transformer can be controlled at the operator's will and intelligent signals produced.

By closing the key the alternating current supply is permitted to flow thru the primary windings of the transformer (see Figure 8) and the rise and fall of the magnetic strength of the primary magnet (windings and core) induces into the secondary windings currents of extremely high voltages, capable of producing a spark between two electrodes spaced several inches apart. It is this spark that produces the waves which finally leave the aerial wires; however, they must go thru some further transformation before leaving for their destination and convey the message intended. If we were to permit the waves created by this crude arrangement to leave the antenna or aerial wires they would not be

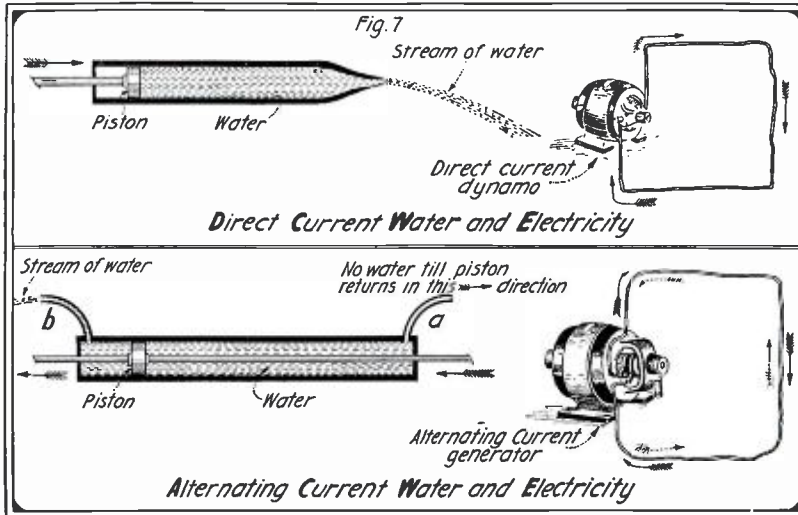

Difference Existing Between Direct and Alternating Current Is Demonstrated Very Clearly Here.

the course of the current in its path thru the circuit. However, if we refer to the lower sketch, where we have a pump with the piston in the center of same, when the piston rod is pulled to the right, water will be forced from the nozzle, a. Upon its returning stroke to the left, water is forced from the outlet, b—this corresponds to the flow of alternating current and is also shown in the sketch alongside it. Here it is seen from the arrow marks that the current first flows in one direction and then the other, this continuing as long as the pump is pulled back and forth—or, in other words, as long as the generator is being turned by some form of engine, whether steam, gasoline, etc.

however, they must go thru some further transformation before leaving for their destination and convey the message intended. If we were to permit the waves created by this crude arrangement to leave the antenna or aerial wires they would not be

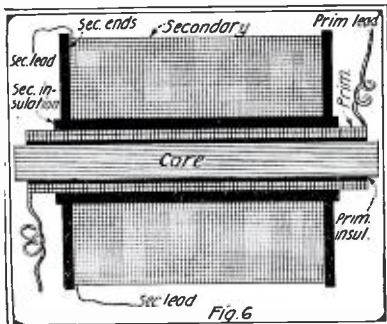

Cross Section of a Transformer. Note That Its Secondary Windings Are Not Connected to Those of the Primary.

on the secondary in relation to those of the primary.

Direct vs. Alternating Current

In order to explain the difference existing between alternating and direct current the reader is referred to Figure 7, where a water analogy is given for both alternating

Now that we understand just what a transformer is and the nature of its duty in the circuits (stepping up the energy) we must consider the source of current supplied to its primary terminals. Direct current cannot be employed in connection with a transformer alone, as it is absolutely necessary that the current be broken up or caused to rise from maximum to zero at a rapid rate. For this reason vibrators or mechanical interrupters for breaking up the direct current of an automobile (transformer) or spark coil, as it is known to the layman, are provided and are necessary; however, alternating current possesses this feature inherently, as the current supplied from an alternating current generator rises and falls at a very rapid rate. For the

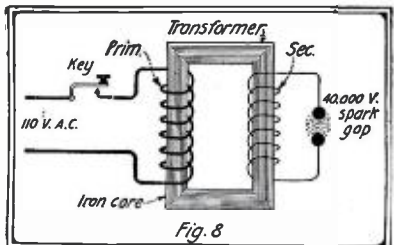

When the Key Is Closed, Current Is Permitted to Flow Thru the Primary Windings. This Induces Extremely High Voltages in the Secondary, and at This Point a Spark Is Forced Across the Gap. It Is This Spark Which Produces the Waves.

powerful enough to travel the distance desired, because they would leak off the aerial before a maximum of energy was reached, and, therefore, be very feeble.

(To be continued)

The third lesson will appear in the November issue.

Important Announcement

The Audio Frequency Wireless Telephone

(From a special interview with the inventor)

Beginning with the November issue of RADIO AMATEUR NEWS.

The late war invention employed to tap the enemy's lines, known as the T. P. S. System in Europe. Mr. Earl C. Hanson, Audio Frequency Expert, is the inventor.

In the December issue the construction and operation of this system will be discussed in detail. A new field for experimentation has been created by Mr. Hanson's ingenious gift to the art. A system which will lend a helping hand to the amateur as it does not interfere with Radio

stations. There are therefore no regulations governing its operation, and the amateur has a much broader field to experiment in than the present-day Radio game, with its 200 meter restrictions. Don't miss this.—EDITOR.

A HIGH NOTE BUZZER.

The following is a description of a cheap and easily made high pitched buzzer made

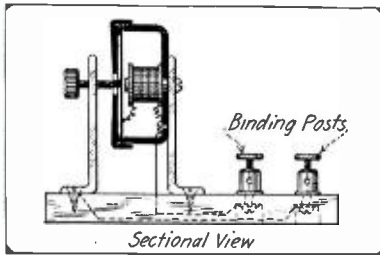

By Taking an Old Watch Case Receiver and Rewinding the Magnet a Very Good High Note Buzzer Can Be Constructed

from an old head-phone and various odds and ends found around nearly every radio amateur's workshop.

First take the magnet out and unwind it. Then rewind it with No. 24 or 26 insulated copper wire and replace it in the phone. Connect one of the wires from the coil just wound to one of the screw heads inside the phone and solder the other one to the inside of the diaphragm, which must be of tin. The next step is to secure the contact point from the armature of an electric bell and solder it in the center of the upper side of the diaphragm. The regulating screw of the bell is also taken and fitted into a piece of iron bent in the shape shown in the illustration. This piece of iron has two counter sunk holes in the bottom of it and a threaded hole to receive the regulating screw. Another piece is bent in a similar manner with a threaded hole for a small machine screw, which goes into the back of the phone. Now bring the wire from the phone to a binding post on the board and a wire from the regulating screw to another, completing the buzzer.

Contributed by PAUL HASTINGS.

A NOVEL FIXT CONDENSER.

Here is a condenser which will suit the

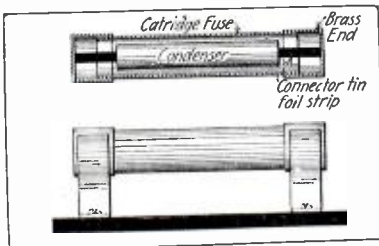

An Old Cartridge Fuse Makes a Very Good Case for a Fixt Condenser.

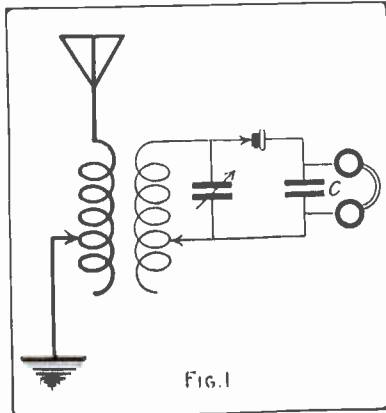

The Condenser when Completed is Connected as Shown in The Diagram at C.

needs of every amateur. It is employed as a shunt telephone condenser, and is connected as shown in figure 1 at C. Take an old 60-ampere cartridge fuse and with a round file, after the brass ends have been removed, clean the insides well. Take two sheets of tinfoil 1 inch wide by 8 inches long and after separating them by strips of paraffin paper roll the condenser up tightly. Connector strips are allowed to protrude at each end, and are connected to both brass ends, which are finally forced over the fiber cartridge into place.

Contributed by JOHN GROSSKOPF.

SAVE YOUR OLD COUPLER.

By M. B. Lowe.

The hook-up given will enable any amateur to copy signals from all the high-wave, undamp't transmitting stations without the large, bulky and expensive loading coils. To receive undamp't signals it will be found necessary to use all of the primary of the coupler, and about seven-eighths of the secondary winding. Get the audion to oscillating. Set condenser C₂ about 120 degrees. The remainder of the tuning is done alone with condensers C₃ and C₄. Spark signals may be received by merely setting condenser C₄ at zero.

Using this hook-up signals have been

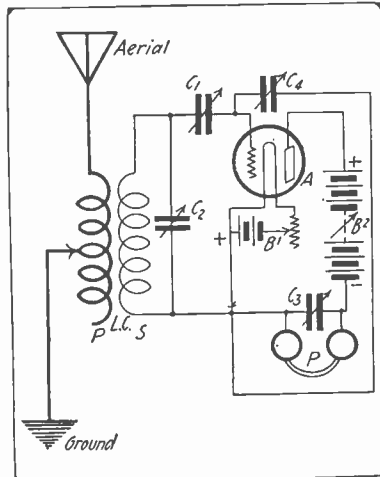

This Connection Revives Your Old Coupler Get Long Waves Without Extra Long Inductance.

copied from "Y.N." "IDO." "POZ." and nearly all the large undamp't stations in this country. No loading coils are required. An average amateur aerial is quite large enough to use with this hook-up. Using a one-step amplifier, "Y.N." Lyons, France, has been copied using an indoor aerial 35 feet high and 60 feet long composed of only four wires.

Remember to save; so hunt up that old loose coupler that has long been discarded for the small regenerative 200 meter set and get long wave stations until the Government allows us to open up our transmitting sets again. Plenty of time then to listen on low waves, but now every one should copy all the general news sent out by undamp't stations all over the world.

TREE WIRELESS CODE PRACTICE.

While I was trying out the tree wireless stunt I noticed that there was an incessant humming in the phones when they were in the circuit alone; that is, when one phone terminal was in connection with a tree and the other grounded.

This hum, due to an induced current

from power, and electric light lines, is not unknown to those wireless "hams" who have their aerials near such lines. It re-

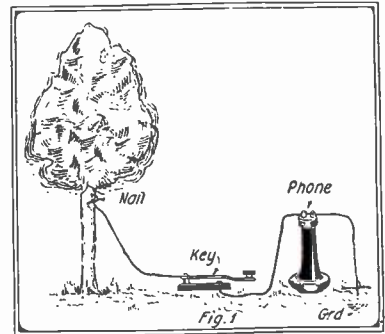

The Latest! Code Practicing with Tree Antenna.

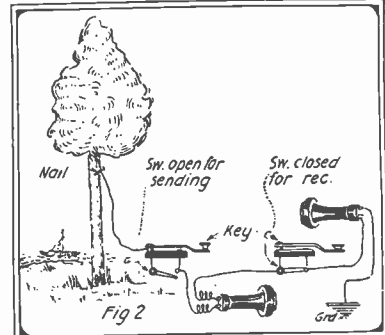

The Two-Way Tree-Code Practice Set.

sembles an intense, rather low-pitched note of a wireless signal, and, when a key is used to break the circuit, as in Fig. 1, it can be used for code practice, instead of the usual buzzer.

The best code practice may be gained by using the hook-up shown in Fig. II, where two "play the game." As you see, this hookup is similar to the one-wire two-station telegraph line.

Contributed by W. J. SOSNOSKI.

THE "PUZZERALA."

Referring to the diagram, it is seen that both buzzers—that is, their armatures—vibrate when one station sends. If you do not understand press your key and the other fellow noticing that his buzzer vibrates after he has released his key will repeat what he has said. The buzzer in the receiving station acts as receiver.

Contributed by THEODORE PECK, Jr.

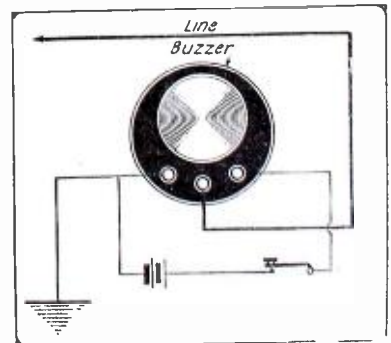

A Buzzer Circuit Which Permits One to Break in When a Mistake is Made by the Sender.

Comment on Government Radio Control

Amateurs Oppose Daniels' Plan

(From the New York Globe)

On the grounds that further government regulation of wireless communication is unnecessary and harmful, more than 300,000 amateur and professional radio enthusiasts throughout the country are united in opposing Secretary Daniels' recommendation that Government control be extended. H. Gernsback, manager of the Radio League of America and editor of RADIO AMATEUR NEWS said today:

"The ultimate effect of complete Government control would be to kill interest in the development of radio methods, and, by eliminating private competition, stop further invention in the fruitful and rapidly expanding field of wireless telegraphy. The attempt of Secretary Daniels is being fought by those interested in the science thru their congressional representatives on the ground that the laws of 1912 are amply sufficient to cover all contingencies which might arise.

"No single situation before or during the war has arisen which has not been adequately covered by the existing laws," declared Mr. Gernsback, "and the control of the entire radio situation in the United States by the proposed department was done without legislative enactment."

Connected with Mr. Gernsback in the Radio League of America are Nikola Tesla, Prof. Reginald Fessenden, Dr. Lee de Forest and Captain W. H. G. Bullard, U. S. N.

What One Amateur Wrote His Senator.

As an indication of the wonderful forward strides in connection with the use of wireless communication the information contained in a letter from J. B. Manderville, chief engineer of the T. W. Phillips Gas & Oil Company of Butler, printed below, is interesting. Mr. Manderville has kindly allowed the use of this letter with hope that it might prove an incentive to local radio amateurs to write to their Congressmen along the same line for the protection of their interests. This is in view of proposed wireless legislation urged at Washington by Secretary of the Navy Daniels, comments of which were contained in this department August 3.

The letter points out the utility of wireless communication in everyday business life and that corporations of the country are applying to their business needs. The letter follows:

"Butler, Pa., Aug. 16, 1919.

"Boies Penrose, U. S. Senate,
Washington, D. C.

"Dear Senator:—The writer wishes to appeal to you to prevent, if possible, the control of all wireless telegraphic communication being placed in the hands of the Navy Department. He asks this in a dual capacity; first, as a private citizen who is a wireless amateur and vitally interested in wireless telegraphy, both as an electrical engineer and as an experimenter, and, second, as chief engineer of the T. W. Phillips Gas & Oil Company, a public service corporation engaged in supplying gas to 20,000 consumers in Western Pennsylvania.

"As a corporation we have planned to install wireless communication thruout our gas fields to better serve our consumers. In many cases wireless communication is about the only reliable way we can control our gas service without almost prohibitive cost. It always means reliable service when stress of weather conditions preclude other methods of communication. This point of being

reliable is of much more importance than any other feature.

"Navy control of wireless telegraphy spells death to both amateur and business use of this method of communication. Another point is that all wireless installations now are thoroly under government control in the hands of efficient officers of the Department of Commerce and there is no good reason for any change.

"I also appeal to you to have the ban on the use of wireless transmission removed. This was a war-time measure and should now be repealed.

"In closing I wish to point out that all the great advances in the use of wireless telegraphy and telephony have been made by amateurs or commercial companies.

"Trusting you will do what you can to prevent a military or naval control of wireless telegraphy, I am,

"Very respectfully yours,

"J. B. MANDERVILLE,

"Chief Engineer, T. W. Phillips Gas & Oil Company."

Radio Control.

(From the Seattle Post-Intelligencer)

Except as an emergency makeshift policy, there is no reason why the radio business of the country should be confided to the navy. The naval department has been doing the commercial business of the country during the war, but the business, owing to war circumstances, was not large and was rigidly circumscribed by the censorship on all communications to foreign countries and the restrictions on foreign business. Under these circumstances the business was done by the naval department with a minimum of dissatisfaction. But the latent idea of extending this duty to the navy permanently should not be entertained.

Owing to the nature of wireless communication used internationally, we are not prepared to say that it should not be under government censorship. That it will be done as satisfactorily, as efficiently and as economically under government ownership we do not believe, but there are other factors which may well outweigh the advantages of private ownership in this particular case. For one point in support of our supposition we might cite the possibility of foreign ownership of our stations in time of war, which, owing to the ease of their destruction, might easily leave us wanting an imperatively needed service. We have no control of oceanic cables after they leave our own shores, and whoever controls the sea can cut them at any time. But we can control our wireless stations, and the most secure control would be to have them under government operation.

This argument doesn't dispose of the possibility of having privately operated systems, so long as we have an adequate national system, except in so far as there might be needless duplication of effort.

It would hardly be advisable, however, to make our wireless system primarily a military affair. There is no fundamental reason why the navy should be in charge of a wireless system, any more than the army should be in charge of the land telegraph system. Conceding the unlikelihood of another Burleson, the postal department might properly be put in charge of this means of communication, and of the nationally owned cables, for the public cannot deal comfortably with either the army or the navy. The faults and red tape of bureaucracy find their highest exposition in the business of the army and the navy, and commerce always frets under their control. The army and navy, dear as they are to us and as proud of them as we

are, are institutions apart from the life of the people, properly aloof and, under our flag, cosmopolitan. They have no local interests and are not necessarily amenable to the public's will. Consequently they are not fitted, except in individual instances, to render commercial service as other departments of a more flexible character.

Radio Control Looked on as Doubtful Policy.

(From the New York Wall Street Journal)

Washington.—The appeal of Secretary of the Navy Daniels for Government control of radio communications is regarded in many quarters as a revival in a new form of Government ownership at a time when the movement is undergoing a decline in other directions.

Coming as it does almost coincidentally with the return of the telegraphs and telephones to private control, the question is raised whether the arguments advanced for the proposed control of radio communications by the Government are conclusive. The opinion is freely advanced that Daniels is endeavoring to array himself in the mantle which has just been stripped from Burleson's shoulders, and with even less excuse than the latter had for donning the garment in the first place.

Those who are best acquainted with the intricacies of radio communication contend that the points raised by the Secretary of the Navy about wave lengths and interference can easily be met by intelligent legislation, which will fully protect the needs of the Government and yet leave open this vast field of enterprise to private initiative and private capital. In so far as secrecy of transmission is concerned, either the radio will be open to objections against its use for important official communications under any sort of control, or else means will be devised which will protect the messages from falling into enemy hands, in which event Government ownership will be no more necessary than with the cables. Those who are opposed to Government ownership on general principles are of the opinion that Mr. Daniels' contentions merely represent the cropping out of that particular gospel in a new phase, somewhat camouflaged by public ignorance of the subject.

Oppose U. S. Radio Ownership.

(From the New York Sun)

Washington, Sept. 4.—Governmental control of radio communication will result in the long run in lower standards of service, higher rates and an added burden to the taxpayers, the Senate naval subcommittee was told to-day by John L. Merrill, of New York, president of the Central and South American Cable Company.

"Any permanent benefits claimed for Government ownership can be better secured by regulation," said Mr. Merrill. "If the Government once enters the field of commercial radio telegraph under peace conditions, developments of the industry will stop.

"There is every reason to believe that American enterprise can succeed in establishing a system of American owned and operated radio communication throughout South America, if the Government does not enter the radio field.

The committee held an executive session to hear Walter S. Rogers, of New York, adviser on telegraph, cables and radio to the American Peace Commission, who discussed control of international radio communication.

Efficient Amateur Radio Transmitter

(Continued from page 181)

number of long-distance amateurs use an oil-immersed condenser.

The outstanding feature of this condenser is the arrangement of the 10 terminals. The capacity can be increased from a minimum of 0.0018 mf. to a maximum of 0.009 mf. in single steps of 0.0009 mf. each. This permits very fine adjustment in the closed secondary circuit, and the number of turns on the primary of the oscillation transformer can be increased or decreased by merely decreasing or increasing the capacity of the condenser.

Oscillation Transformer

At the right is shown the Oscillation Transformer. The primary of this Oscilla-

tion Transformer consists of 3¼ turns of 1 inch heavy copper ribbon supported in fibre strips. The secondary consists of 7¼ turns mounted same as primary. Primary inductance is approximately 4.5 microhenries. When maximum turns on the primary are used with condenser having a capacity of .009 microfarads, the wave meter shows a reading of 385 meters. Using one complete outside turn or an inductance of about 1.2 microhenries and a condenser capacity of .009 microfarads, the wave meter shows a reading of 205 meters. Secondary inductance is approximately 10.9 microhenries. When using a condenser capacity of .004 microfarads to .009 microfarads, a very select range of short wave lengths can be attained.

Rotary Spark Gap

Last, but not least, and just in front of the Oscillation Transformer, is shown the Rotary Spark Gap.

The Rotor of electrodes is of ¼ inch hard aluminum, 8 inches in diameter. The center disc is phenol fibre. Actual test with the Rotor of 16 teeth on a motor driven at 1,000 R.P.M. to 1,500 R.P.M. produces a low note with carrying quality. The same tone was produced with the Rotor of 8 teeth and motor driven at 2,000 R.P.M. to 3,000 R.P.M. The tone can be varied by regulating the speed of the motor, but it is the low note that makes amateurs heard at long distance.

(Photo, Courtesy Thordarson Elec. Mfg. Co.)



THIS Department is conducted for the benefit of our Radio Experimenters. We shall be glad to answer here questions for the benefit of all, but we can only publish such matter of sufficient interest to all.

1. This Department cannot answer more than three questions for each correspondent.
2. Only one side of the sheet should be written upon; all matter should be typewritten or else written in ink. No attention paid to penciled matter.
3. Sketches, diagrams, etc., must be on separate sheets. This Department does not answer questions by mail free of charge.
4. Our Editors will be glad to answer any letter at the rate of 25c for each question. If, however, questions entail considerable research work, intricate calculations, patent research, etc., a special charge will be made. Before we answer such questions, correspondents will be informed as to the price charge.

You will do the Editors a personal favor if you make your letter as brief as possible.

TUNING COIL TROUBLE.

(56) C. P. Bernharde, Edgemere, L. I., wants to know why his receiver won't work unless connected a certain way.

Q. 1. I have built a loose coupler, primary; diameter is 4½ inches and length 6 inches, wound with 200 turns No. 22SCC wire, turns controlled by tens and unit switches, approximate inductance is 2,177,415 cms. Secondary diameter is 3½ inches, length 7 inches, 400 turns No. 28SCC wire. Winding taken to 15 switch points. Approximate inductance is 5,334,200 cms. I have found it impossible to hear signals

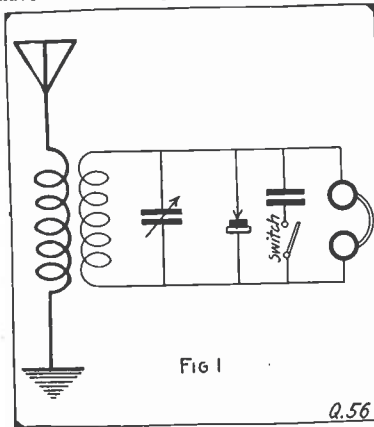

Here the Detector is Shorted by the Secondary Inductance.

with the usual connections shown in Fig. 1, and have been obliged to use the connections shown in Fig. 2. Primary and secondary windings do not oppose each other, and I am at a loss to understand this action of coupler. Will you kindly inform me if there is anything wrong with the design of coupler?

A. 1. There is nothing wrong with your coupler. You will, however, notice that in Fig. 1 your detector is short circuited by the secondary inductance, naturally when you inserted the condenser in the circuit as you show in Fig. 2. If you will make use of the circuit shown in 3 your troubles will disappear.

Q. 2. What is the maximum wave length range of this coupler, with an aerial having a fundamental wave length of 200 meters?

A. 2. Approximately 4000 meters.

Q. 3. What wave length would coils having inductances of 700,000 cms, 1,000,000 cms, 2,500,000, be capable of tuning to without variable condensers shunting them?

A. 3. With a condenser of .001 mf., 1,600, 1,900, and 2,800 meters, respectively.

LOOP ANTENNAE.

(57) Lorraine F. Jones, Kirkwood, Mo., asks for information.

My set comprises the following: Loop aerial, comprising 700 feet of wire; loose coupler, will tune to 1,500 meters; variable condenser, 3,000 ohms phones, audion bulb, B battery for bulb.

Q. 1. How shall I connect the above instruments?

Q. 2. How far may I receive with these instruments?

A. 1. A diagram of connections for the apparatus mentioned is given below.

A. 2. While you do not state the size of the loop and No. turns, we cannot answer this question correctly, but would refer you to the August issue of this publication, where you will obtain complete data on loop antennae.

WAVE LENGTHS OF ANTENNA AND COILS.

(58) L. A. Wankel, Woodhaven, N. Y., requests data:

Q. 1. What is the wave length of a coil 32 inches high, 4½ inches diameter, wound with No. 24 D.C.C. wire?

A. 1. Approximately 4,000 meters.

Q. 2. What is the natural wave length of an aerial composed of six wires spaced 1 foot apart, 80 feet long, 50 feet high and a 20-foot lead in "L" type?

A. 2. Two hundred and twenty-five meters.

Q. 3. What is the wave length of a loose-coupler, primary 7½ inches long, 4½ inches diameter, wound with No. 24 D.C.C. wire. Secondary 7½ inches long, 3½ inches diameter, wound with No. 32 S.C.C.

A. 3. Two thousand five hundred meters.

A. 1. It will only be necessary to shunt an inductance and capacity (in series) across the phone and "B" battery supply. Lack of space makes it impossible to re-print your diagram.

Q. 2. How far should I be able to receive using four-wire aerial 130 feet long, 35 feet high and 20 feet lead-in, 3,000 M. loose coupler, audion panel, 43 plate Var. Cond. and 2,000 ohm phones?

A. 2. Several thousand miles.

Q. 3. Could I receive the European

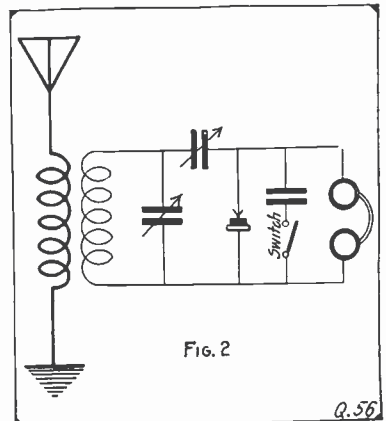

With a Condenser in Series With the Detector and Secondary Signals Could Be Heard.

stations provided I had proper tuning instruments?

A. 3. With several long-wave loading inductances we see no reason why you could not successfully receive foreign high-powered stations.

OPEN CORE TRANSFORMER.

(60) Morris Hughes, Cambridge, Mass., requests:

Q. 1. The diagram of a good short-wave regenerative receiver, using one audion bulb. Will this hook-up work as high as 600 meters, and what should be the range of this set with an aerial 100 feet long by 60 feet high?

A. 1. In the construction department of this issue you will find the data you desire.

Q. 2. Is there any way of working an

E. 1. Co. open core transformer straight off 60 cycles alternating current without any form of interrupter, either mechanical or chemical?

A. 2. By inserting a reactance of suitable size.

Q. 3. How many sections of Murdoch condenser should be used with an E. 1. Co. open core transformer when used in connection with a 5,000-r.p.m. rotary gap, having eight stationary and two rotary points?

A. 3. Two sections.

Radio Articles in October Issue Electrical Experimenter

- The Submarine's Under-Water Radio, by H. Winfield Secor.*
- The Wireless Ukulele, by Emerson Eastberg.*
- Unique Radiophone Helmet.*
- How Radio in the Clouds Foiled the Germans.*
- Government Radio Control—Once More, by H. Gernsback.*
- Pieces of Navy Department on Radio Communication.*
- Latest Amateur Radio Receiving Apparatus by Charles H. Noller.*
- Radio Problems in Aviation, by Edward Rice Doyle.*
- An Efficient Radio Crystal Detector, by Robert F. Gowen.*

RECEIVING RANGE.

(59) Theodor Schreyer, Staten Island, N. Y., asks the following:

Q. 1. With this hook up am I able to receive damped and undamped waves? If not, give me one that will.

WIRING-UP INSTRUMENTS.

(61) J. E. C. Nashville, Tenn.:
 Q. 1. What is the proper size wire to use in wiring from the instruments to the gas pipe on the inside of the building? Should it be bare or insulated wire? Should it be insulated from the wall by porcelain insulators?
 A. 1. No. 4 bare copper wire. Since it is the ground lead it need not be insulated.
 Q. 2. Would it be all right if I insu-

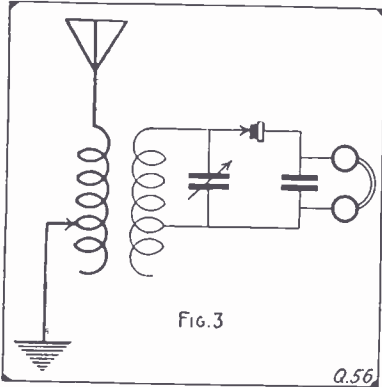

This Shows the Correct Method of Connecting the Detector and Associated Circuits.

lated the lead in wire from the window sash by a small porcelain insulator?
 A. 2. Yes.
 Q. 2. What is the wave lengths of a single-wire aerial 75 feet long and 75 feet high, lead-in about 20 feet? What size wire should be used for lead-in?
 A. 3. One hundred and fifteen meters approximately.

RADIO DYNAMIC CONTROL

(62) Robt. Sandlier, Richmond, Ky., desires to know:
 Q. 1. If waves transmitted by a wireless outfit would operate a relay at a distance of 20 feet with any effect; also would this relay close a circuit for light operated by flashlight batteries?
 A. 1. Yes; provided you have a sensitive coherer.
 Q. 2. Would a selenium cell close the above-named circuit with good effect?
 A. 2. Yes; according to what part of the circuit you place this cell. You are referred to an article in this issue by Lieut. W. R. Coventry on Radio Dynamic Control.

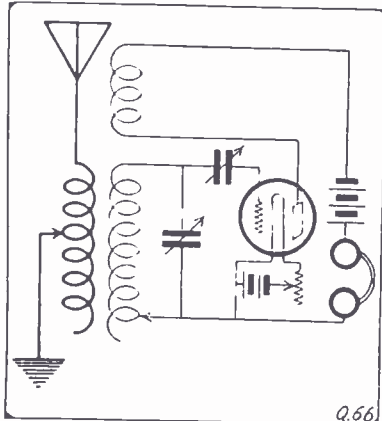

The Regenerative Circuit Employing the Tickler Coil to Couple the Grid and Plate Circuits.

CONDENSER FOR 150-WATT COIL.

(63) Raymond Synnestveit, Bryn Athyn, Pa., asks:
 Q. 1. What is the input in watts of a

2-inch spark coil, using 110-volt, 10-ampere, 60-cycle alternating current stepped down to 15 volts?

A. 1. You state you are drawing 10 amperes at a voltage of 15, then the watts consumed is equal to $V \times A$, or 150 watts.
 Q. 2. What is the proper condenser capacity to be used in sending with this coil?
 A. 2. A condenser employing 10 photo plates, 6 inches x 10 inches, with tinfoil inter-vening, cut 1 inch smaller all around.
 Q. 3. The ground wire to my instruments is about 35 feet long. Should this be taken into consideration when computing the wave length of the open circuit?
 A. 3. Yes; and you should endeavor to shorten this lead.

INDOOR ANTENNA.

(64) Chas. Kress, Rochester, N.Y., writes:
 Q. 1. With a fixed condenser, a silicon detector, two-slide tuning coil and a 75-ohm receiver, how can I make an indoor aerial in a room 10 x 20 feet and connect it to receive within a radius of 100 miles?
 A. 1. By constructing what is known as a loop or concentrated antenna. See August issue of this publication, page 60.

LOADING COIL DATA.

(65) Harry Missimer, Brooklyn, N. Y., asks the following:
 Q. 1. Could I use a variometer as a loading coil for my loose coupler? If so, what size and kind of wire should be used?
 A. 1. Yes. No. 22 S.C.C. magnet wire.
 Q. 2. Could I make a loading coil for the primary of the loose coupler out of larger size wire than the primary windings?
 A. 2. Certainly; but never smaller.

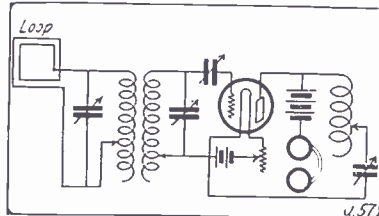

Employing a Loop Antenna in Conjunction With a Loose Coupler.

CONNECTING VACUUM TUBE.

(66) L. H. B., New Orleans, La., asks:
 Q. 1. Please show me how to connect a vacuum tube detector in a regenerative circuit.
 A. 1. A suitable circuit for vacuum tubes is given herewith.
 Q. 2. Where can I obtain a suitable panel to use with it?
 A. 2. You can secure a panel from the Electro Importing Co., 231 Fulton Street, New York.

LOOP ANTENNAE.

(67) Howard Chinn, New York City, wants to know:
 Q. 1. What size wire is used to make the loop antennae in the article "Loop Antennae and Direction Finders for Amateur Use" by David S. Brown?
 A. 1. No. 18 annunciator wire.
 Q. 2. Wave length of aerials 40 feet long, four wires, 2 feet apart, and 50 feet high?
 A. 2. One hundred and sixty meters.

RECTIFIER VACUUM TUBES.

(68) Irving R. Groves, Bailey Island, Me., requests data:
 Q. 1. Please tell me if a 6-volt automobile lamp and an outside plate would do for a rectifier for using A.C. on an audion, as described in the July issue of the *Electric Experimenter*?
 A. 1. Rectifier bulbs are especially built for the purpose intended, and we believe

you will have very poor results, if any, with such an arrangement.

Q. 2. Where the rectifier bulbs can be bought and the price?
 A. 2. Probably from the Marconi Company, or probably the Western Electric Co. Would advise you to get in touch with them.

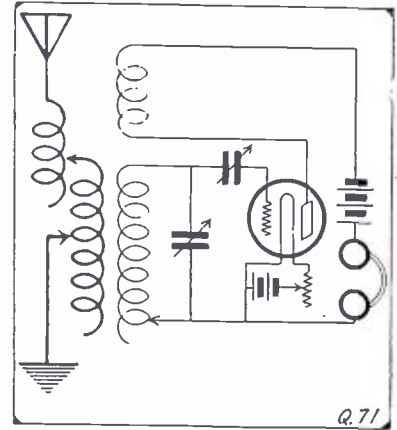

Here is the Best Hookup for Your Apparatus, Showing the Load Coil in the Primary Circuit.

CONDENSER COIL.

(69) B. W. Casselberry, Jr., Gibbsboro, N. J., asks:
 Q. 1. What kind of oil should be used to put in a variable condenser, and where can it be obtained?
 A. 1. Castor oil is generally employed.
 Q. 2. What is the range of my station, which is made up of the following apparatus: 65-foot aerial, 30 feet high; 3,000-meter loose coupler; 3,000-ohm head set; 43 and 23 plate variables; silicon detector; fixed condenser?
 A. 2. Approximately 1,000 miles.

DIMENSIONS OF COIL.

(70) Otto Hartwig, Chicago, Ill., desires to know:
 Q. 1. How much wire is required to wind a cardboard tube 11 inches long by 3 inches in diameter?
 A. 1. Two thousand six hundred and twelve feet No. 20 S.C.C.
 Q. 2. What kind of wire and what size is best to use?
 A. 2. No. 20 single cotton-covered magnet wire.
 Q. 3. Where can I procure such wire?
 A. 3. From any electrical supply store.

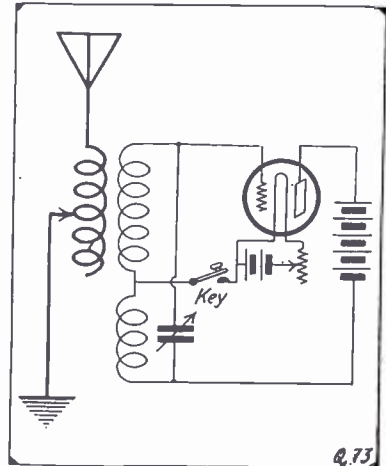

I Want to Know

WAVE LENGTH OF ANTENNA.

- (71) Chas. L. Pierce, Atlanta, Ga.
 Q. 1. What is the wave length of an aerial, six-wire, 70 feet long, 47 feet high, with a 40-foot lead-in?
 A. 1. One hundred and ninety meters.
 Q. 2. What is the wave length of a loose-coupler primary, 25 B. & S., 6 inches diameter, 10 inches long; secondary 29 B. & S. 5 inches diameter, 10 inches long?
 A. 2. Four thousand five hundred meters.
 Q. 3. Give hook-up using one audiotron, the above loose coupler, loading coil, 3,000-ohm phones and variable condensers to receive undamp stations using the above aerial.
 A. 3. Hook-up is given herewith.

TREE ANTENNA.

- (72) Everett H. Wing, Springfield, Mass., asks:
 Q. 1. Will you please tell me in your "I Want to Know" page if it is possible to use a "tree antenna" to good advantage with a mineral detector?
 A. 1. Yes, but you will get much better results by the substitution of a vacuum tube.

VACUUM TUBE TRANSMITTER.

- (73) F. Nicol, Philadelphia, Pa., requests data:
 Q. 1. Please give hook-up for sending with a vacuum or audion bulb (not wireless telephone, but with a key)?
 A. 1. The circuit you want is given herewith.
 Q. 2. Can you tell me the reason why every time I reach the second and sixth tap on my coupler it makes a buzz or ring in my phones?
 A. 2. This is probably due to an open circuit in the windings, but may be due to many other causes too lengthy for the space of these columns.
 Q. 3. Is it necessary for the audion tube to be oscillating in order to hear arc stations, or is it just below the point of oscillation that they are heard?
 A. 3. Yes, it is necessary to have the bulb oscillating.

N. A. A. TIME SIGNALS.

- (74) W. K. of Collingswood, N. J., asks the following:
 Q. 1. On what wave length are the time signals sent out from Washington, D. C.?
 A. 1. Two thousand five hundred meters.
 Q. 2. Can the time signals be received with a crystal detector and a 6-foot square solenoid loop antenna as described in August issue?
 A. 2. Yes, by proper tuning and handling of the loop, altho you should employ an audion with loop antenna for any considerable distance.
 Q. 3. About what size variable condenser would be necessary and about how many turns would it require on a 6-foot square loop?
 A. 3. About twenty turns No. 18 annunciator wire. Variable condenser of .001 mf.

NEW PERUVIAN WIRELESS STATION.

The Minister of Public Works of Peru has informed the public that the new wireless station at the port of Eten has been opened for business. This station is now in communication with the large wireless station at Lima (San Cristobal) and at Iquitos, a town situated in the headwaters of the Amazon River. The Eten station is open night and day.

AN OPEN LETTER TO ALL RADIO MEN

WM. J. MURDOCK CO.
 MANUFACTURERS OF
WIRELESS APPARATUS
 CHELSEA, MASS.

October 1, 1919

Gentlemen:

The first MURDOCK receivers for radio use were produced in 1904, their introduction being coincident with the first signs of interest in experimental radio telegraphy. In reviewing a record of fifteen years of production, beginning with a few sets virtually built to order, and growing to the present output of thousands, there is a real satisfaction in the knowledge that these receivers have come to be universally recognized as desirable additions to the experimenter's outfit. No volumes of persuasive advertising, nor no piling up of boastful claims could achieve such a permanent success as this. The real cause of the success depended upon the receivers themselves. These fifteen years of steady growth in the esteem of the leading radio experimenters of the United States is the best assurance of the value of MURDOCK receivers, and is, moreover, a true pledge, for the future, of the satisfaction of those who have not as yet become acquainted with their worth.

Sincerely,



**THE QUALITY IS UNUSUALLY HIGH
 THE PRICES ARE REMARKABLY LOW**



**2000 OHM
 Double Set
 \$4.50**

**3000 OHM
 Double Set
 \$5.50**

Sold with the usual "MONEY BACK" guarantee. To be sure of getting your set, ORDER NOW.

BULLETIN 19B showing the complete MURDOCK line of really good radio apparatus, sent free on request.

WM. J. MURDOCK CO.
 50 Carter Street
 CHELSEA, MASS.

509 Mission St.,

San Francisco, Cal.

The BEST THING IN LIFE and the first thing to strive for IS ROBUST HEALTH

Without health, you cannot be successful, neither can you enjoy the privilege of living. You will find that health comes before Love, Money or anything else. What good are you if you are sickly, run down, discouraged, a wreck from past errors, or a sufferer from dyspepsia, indigestion, kidney trouble, or any other like ailment? If you do not feel energetic ALWAYS—if you don't feel like running or jumping so to speak, all the time, or if your day's work tires you out, you are not what you SHOULD be and CAN be. You do not know what life means unless you have a good physique, with unlimited strength and energy to back it up.



EARLE LIEDERMAN
The Acme of Physical Perfection

Why not let me take hold of you and make a real Man of YOU. I can do it for YOU, for I am doing it every day to hundreds of others and I have done it for thousands of others in the past. My system never fails. I can give you broad shoulders, thick muscular arms, a broad and deep chest and a commanding appearance that will positively bring you success, both in social life and in business. You are judged by your appearance, so why not have a pleasing one so everyone will like you?

If you will SEND for MY NEW BOOK "Muscular Development"

you will not only be greatly interested in its contents and 20 full page photographs of myself and of some of the Men and Boys I have trained, but it may be the turning point in your whole life. You will miss the day you sent for my book after you have read it.

DO THIS NOW—Simply tear off coupon and mail to me with 10c in stamps or coin, to cover wrapping and mailing, and you will receive your copy promptly.

EARLE E. LIEDERMAN
Dept. 903, 203 Broadway, New York

Earle E. Liederman
Dept. 903, 203 B'way, N. Y. C.

Enclosed find the for which you are to send me at once your new, illustrated book, "Muscular Development."

Name.....

Address.....

City..... R.A.N. OCT. 1919

Arc Undampmt Transmission

(Continued from page 160)

of power being used during both tests on various wave lengths between 6,000 and 14,000 meters. This test conclusively proved the Poulsen arc at Cavitte to be more efficient than Nauen's alternator.

1. Greater distances may be covered by the arc.
 2. Sharper tuning necessary in arc reception, therefore interference is minimized.
 3. The high-frequency waves of the arc being continuous, it is not necessary that their amplitude peak be as high as in the case of the dampmt spark, therefore condenser and antenna voltage considerably lower and less insulation required.
 4. Unlike dampmt spark reception, the receiving operator may control at will the tone of signals to suit the sensitiveness of his hearing.
 5. The arc used extensively in long distance radiotelephone work.
- In conclusion, it may be said that the day is approaching when spark transmission will be a thing of the past, and there is no doubt that the arc as well as other systems of undampmt transmission will be employed exclusively in order to meet the constantly increasing problem of radio interference.

W. C. G.

(Continued from page 167)

was brought out many years ago when the company was the National Electric Signaling Company.

The motor-generator, with the rotary on its shaft, is mounted on the substantial concrete foundation for security. The gap, as shown, is entirely enclosed, and consists of a number of special alloy studs of triangular shape mounted on the periphery of the rotor. The two stationary electrodes are similar to the ones on the rotor, and are fully adjustable by the operation of a single control knob which admits of very precise adjustment of the space between sparking electrodes.

The transformer, shown at the right bulk-head is one of the wonderful things that have resulted from the careful researches of the Fessenden engineers. So well designed are these transformers, that the losses have, as far as is humanly possible, been eliminated. In fact, these transformers have been operated steadily for hour upon hour without showing the least trace of heating. It's the kind of transformer it is a pleasure to work with.

And the panel! Oh boy, she's a beauty! It is indeed true that the designers were possessed of a sense of the fitness of things. It is, unquestionably, the finest transmitting panel a fellow can have the luck to meet. Working the controls on the board is almost like shaking hands with a human being, and the meters mounted on the top seem to smile at one. If you should see the pointer on the Radiation Ammeter, you, too, would smile. To put it differently, the controls are so placed on the panel that they are readily within reach of the operator.

The 2 K.W. Set is but a smaller edition of its big brother. It is practically the same in details as the larger set, and its efficiency is equally as high. The writer had the pleasure of operating the 2 K.W. equipment on board the S.S. *Zealandia*, and when lying at Progreso, Yucatan, he continually relayed traffic from ships throughout the Gulf to the States. Even land-line stuff was given to us to send to the U. S. The terrific atmospherics had practically paralyzed Radio work, but the *Zealandia* with her set was able to carry on.

Function of Each Piece of Radio Apparatus

(Continued from page 186)

the natural period of the antenna to a value lower than is possible to be had with the plain aerial.

Aerial: To act as a displacement or radiating agent for the high-frequency oscillations which traverse the aerial-ground circuit.

RECEIVING SET.

Receiving Transformer: Primary—To furnish a means for placing the antenna ground circuits in resonance with the incoming oscillations. **Secondary**—To provide a variable means of adjusting the incoming signals to their maximum strength.

Detector: To rectify the incoming oscillations by virtue of its peculiar property; that is, it allows a greater amount of current to flow in one direction than in the other.

First Condenser: To store up the current and discharge the same into the 'phones and in some circuits to act as a by-path for the high-frequency oscillations.

Potentiometer: To furnish a variable element to control the supply of battery current which seems to aid some types of crystal detectors.

Telephone Receivers: To provide some means of recording the feeble currents encountered in radio receiving circuits.

Loading Coils: Same as above; to increase the wave length beyond the value of the antenna and primary of the oscillation transformer.

LOOSEN UP.

Secretary of the Navy Daniels wants the government to have a monopoly of the wireless telegraph. People who have seen the results of government monopoly of railroad management, government monopoly of telegraph and telephone operation, and government hoarding of food—to say nothing of government squandering of war funds—will hope that hereafter the government will have as little monopoly as possible.—*Burlington Enterprise*.

LIGHTVESSEL TO GET RADIO.

Lightvessel No. 88, stationed off the mouth of the Columbia River, has been relieved, August 10, to proceed to the Bremerton navy yard for the installation of wireless apparatus, and she will be the first of the floating sentinels of the deep in northwest waters to be equipped with radio gear.

Wireless Telegraphy Pays BIG MONEY We Teach You in 2 to 3 Months

There is a great shortage of wireless telegraphers, due to enormously increased demand. Ships cannot or will not leave port without wireless operators; the pay is high; advancement rapid; the hours are short—it's worth while. Write for catalogue—learn how quickly and easily you can qualify for positions paying **\$110.00 to \$125.00 Per Month Including Food and Quarters**

Our scientific system of teaching wireless telegraphy perfected by a corps of practical experts, makes you fully competent in two to three months. Wireless is easy to learn—the cost is low and the result is certain. Hundreds of our graduates are profitably employed and are doing duty and seeing the sights in every port of the world. This is your opportunity. We put you in touch with the position you want. Write today for catalogue. It explains all fully. Our course is recognized and endorsed by United States Government Officials. Our course in railroad, commercial and brokerage telegraphy may interest you. Taught in two to four months, by photographic system in your own home in spare time. Big pay—big demand—Write today.

CHICAGO TELEGRAPH INSTITUTE
America's Finest School
3404 Michigan Ave. Chicago

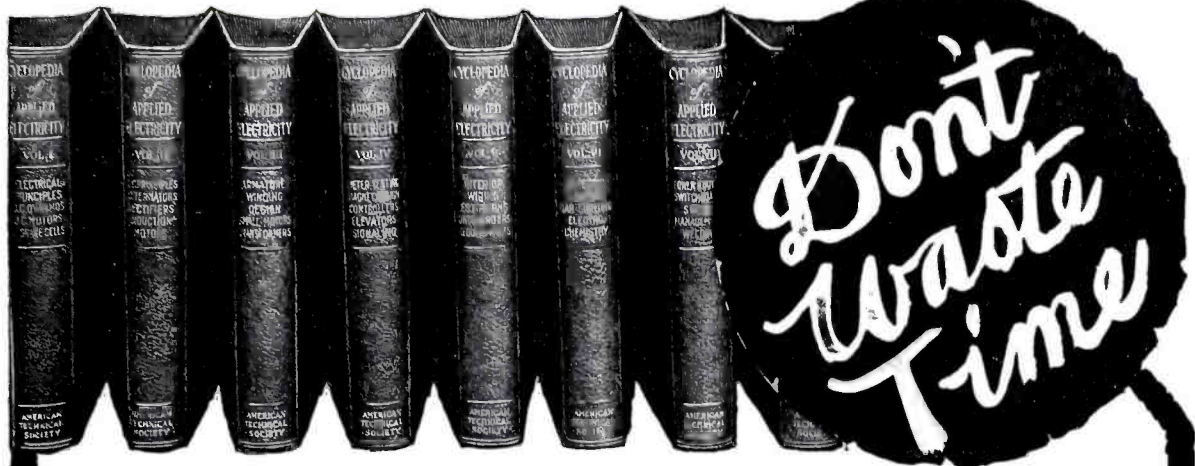

Learn Electricity —the New Way

IT'S no longer necessary to go to school or serve an apprenticeship to learn electricity. With this new library of APPLIED PRACTICAL ELECTRICITY you learn right at home—in your spare time without interfering with your present work. Any big job that you want in the electrical field is yours if you will train yourself to fill it. It only takes an hour or two a day with these books.

This is the 1920 edition—new from cover to cover—chuck full of the latest methods and most recent discoveries in this fascinating field. Everything is written in plain, good old U. S. language by 27 of the greatest experts in the business. The eight volumes with 3800 pages make up a complete course in electrical engineering. It's a home study course for the beginner and a handy reference guide for the expert combined.

Big Pay for Trained Men Jobs paying \$1500.00 to \$5000.00 a year are waiting for men who can qualify as Electrical Engineers—Substation Operators—Troublemakers—Switchboard Operators—DynamoTenders—Electricians. Electricity is the greatest force in the world and it is growing bigger and bigger every day. More and more men are needed all the time. Why don't you get into this big paying field now?

Good Jobs Are Waiting If you are trained in some branch of electricity you will never have to look for a job. The job and the big pay will be looking for you. You can't dodge a good job if you have the "know how" under your hat. Let these 27 great engineers help you to the best kind of job with their books. Send the coupon below and get them for FREE examination. See our free offer below.

What the Books Teach Elements of Electricity—Electrical Measurements—Electric Wiring—Underwriter's Electrical Requirements—Theory, Calculation, Design and Construction of Direct Current Generators and Motors—Types of Generators and Motors—Management of Electrical Machinery—Electric Lighting—Alternating Current Machinery—Power Transmission—Electric Railways—Self-Propelled Railway Cars—Trackless Trolley—Power Stations—Switchboards and Switching—Storage Batteries—Applied Electro-chemistry—Electric Elevators—Electric Welding and Heating—Wireless Telegraphy and Telephony—Land and Submarine Telegraphy.

Free Service With every set of these great electrical books we give a one year membership in this society. This entitles you to consult our engineers and experts on any electrical problem. Write as often as you like. Ask as many questions as you like for one year.

The World's Greatest Electrical Books LOANED to YOU FREE

We will lend you this wonderful library to use in your own home or shop a whole week FREE. It won't cost you one cent. DON'T SEND ANY MONEY. Just fill out and mail the coupon today and the set of eight volumes will come to you by express collect. You be the judge and find out for yourself what the books will do for you. Use them as you please. Show them to your friends and get their opinion. Then if you have any doubt as to their value send them back at our expense and you won't owe us anything.

Only 7 Cents a Day

If you like the books after a week's examination you pay us only \$2.00 and the same amount each month until \$24.80 is paid. This is only 50 cents a week—7 cents a day. You can't afford to pass up a better job on these easy terms. MAIL THE COUPON NOW.

American Technical Society
Dept. E-927, CHICAGO

Coupon is All You Need— Send it Now

American Technical Society
Dept. E-927
Chicago, U. S. A.

Please send me the 8-volume set of Electrical Engineering for 7 days' examination, shipping charges collect. If I decide to buy I will send \$2.00 within 7 days and balance at the rate of \$2.00 a month until \$24.80 has been paid. Then you will send me a receipt showing that the set of books and the Consulting Membership are mine and fully paid for. If I want to get along without the books, I will return them, after 7 days, at your expense.

Name.....

Address.....

Reference.....

You benefit by mentioning the "Radio Amateur News" when writing to advertisers.



The Electric Safety razor makes shaving a pleasure. Blade vibrating 7,200 times a minute cuts the beard smoothly and without slightest pull or irritation—feels like a gentle massage. Can be used with or without electric current.

All users of the Lek-Tro Shav speak well of it.

A barber says—"I have shaved for years and have never used any shaving device near its equal."

A home user says—"The most pleasing shave I've ever had in my life. Shaves my face closer than I used to shave, but there is no after irritation or ill effects as I usually get from another razor."

No. 1 Made for use from Light Socket.
No. 2 Made for use from Dry Battery.
Write for illustrated circular describing Lek-Tro Shav Safety Razor fully.

VIBRATING ELECTRIC RAZOR CO.
Dept. 145, Omaha, Nebr.

Genuine Original Photographs



If you are a lover of the beautiful in art, here is just what you have long wanted for your den or bedroom. For a short time we will make a special introductory offer, as follows:



SEND 25c AND WE WILL SEND YOU THREE GENUINE ORIGINAL PHOTOGRAPHS AS SHOWN

IN THIS AD, SIZE 4x6 INCHES, ALL READY FOR MOUNTING AND FRAMING and our beautiful illustrated catalogue.



After seeing the samples you will want more. We guarantee all our photographs are original and are made in our own studio and cannot be purchased elsewhere.

PARIS NOVELTY COMPANY
Dept. P217, 24 E. Adams St., Chicago, Ill.

ACROMATIC TELESCOPE



Made upon new scientific principles, nicely brass bound with powerful lenses, scientifically ground. Travelers, hunters, farmers, boy scouts and everyone needs a telescope. Have you ever enjoyed the marvels of a telescope? Each telescope guaranteed just as represented, or money promptly refunded. Send 99 cents to-day. EASTERN NOVELTY CO., Dept. 69 177 E. 43rd St., New York



Being 4 in., 11 in. between centers, 17 in. total length. Shipping weight 13 lbs. Body of lath is machined. Workmanship first-class. Fitted with wood turning chuck. Can be fitted with 3 in. face plate and drill chuck as special equipment. Order one today. Price \$5.00 cash with order. SIPHER MFG. CO., DEPT. E TOLEDO, OHIO

POPULARITY FOLLOWS THE UKULELE

If you play quaint, dreamy Hawaiian music or latest songs on the Ukulele you write wanted everywhere. We teach by mail 20 simple lessons, give you free a genuine Hawaiian Ukulele, music, everything in patina. Ask us to send the story of Hawaiian music. You will love it. No obligation absolutely free.

The Hawaiian Institute of Music
140 Broadway, Dept. 123, New York

You can be quickly cured, if you STAMMER

Send 10 cents coin or stamps for 70-page book on Stammering and Stuttering, "Its Cause and Cure." It tells how I cured myself after stammering for 20 years. Benjamin N. Bogue, 851 Bogue Building, Indianapolis

An Undamp Transmitter of the De Forest Type

(Continued from page 163)

Referring to Figure 1, switch C is of particular interest. It is to be noted that when the six hundred volts are applied to the arc, nothing will happen because the space between the electrodes makes a break in the circuit. It is manifestly unpractical to bring the electrodes together and then quickly separate them; and this condition is responsible for the necessity of starting the arc with the switch shown. This is thrown in the "in" position and then quickly opened again. When the switch is opened there will be a big splash of light at the contacts, which when the switch is wide open will cause the current to seek a shorter path for its flow, and as the arc gap offers that short jump, it will immediately jump the gap and so start the arc. One of the humorous incidents in the operation of this transmitter was that at times the arc across the switch would not extinguish itself and it was necessary for the operator to blow it out himself. This offered quite a bit of lung exercise for a while.

As illustrated in Figure 1, there are two switches on the upper section of the switch board which are provided for change of wavelengths. It is, of course, understood that these are not absolutely essential to the transmitter, and if it is desired to transmit only on one wavelength the two switches may be dispensed with altogether, thus simplifying the instrument appreciably.

Now, it may be desired to transmit on damp waves so that the general receiving station will be enabled to communicate with the transmitter. It might not be a bad idea to call the fellow you wish to speak to on the damp wave and tell him to hook in his oscillating valve so that he may receive your undamp signals. For this purpose a motor similar to the one used for cooling the arc may be mounted on a base. The shaft of the motor is lengthened to take a fairly good-sized commutator from an old motor. Two brushes of brass spring are provided side by side, so that they both rest on one segment of the commutator. However, when the commutator is re-versed, contact will be rapidly made and broken. This "chopper" is placed in the ground lead, and it will be evident that the frequency of the emitted signal may be varied at will by the operator by simply lowering or heightening the speed of the motor within its speed limits. It will be a good thing to have spare brushes for the chopper on hand, as they are used up very quickly because of the sparking. The efficiency when transmitting with the chopper is a bit lower than without.

Sometimes the arc will refuse to form in spite of the starting switch. In that case a short circuit with a screwdriver will promptly start it. But one must make sure that the handle of the screwdriver is properly insulated.

The fan motor may be mounted on the panel by means of a swivel so that when not in use to cool the arc it may cool the operator. This was actually done on the commercial equipment of this type which was provided for ships.

RADIO FORCE DEARTH CUTS WEATHER REPORT.

The Navy Department announced recently that due to the shortage of wireless operators no more weather reports would be received from the Farallon Islands.

The handling of commercial messages by the government between here and the Orient has caused the department to utilize the men formerly operating the weather stations in handling commercial business.

H-O-W



could your den be complete without such a glistening hanging in it? It will make your station look big and command respect. It is the neatest sign made. Printed in bright red with big bold letters on stiff card-board. Price only 20c, 3 for 50c, postpaid everywhere. 7 1/4" x 11 1/4".

LEONARD BECK
102 Beach 65 Street, A1 verne, New York

ATLANTIC RADIO CO.

Our line of new apparatus comprises the latest post-war equipment.

Prepare your station for the new era in the amateur radio world by equipping with our standard, high grade apparatus, parts and supplies.

34 Batterymarch Street BOSTON MASS.

CONSOLIDATED

Consolidated Radio Call Book

The Telephone Directory of the Sea
No Radio Station Can properly operate without a Call Book. The Consolidated Radio Call Book is the only complete book of its kind on the market today. Price ONE DOLLAR postpaid.

Consolidated Radio Call Book Co., Inc.
Dept. "A", 41 Park Row, New York, N. Y.
Only 300 copies left so ACT NOW

"B" (Storage) BATTERIES

Inexpensive—Durable—Efficient
These batteries are a modification of the well known "Marcuson" Potential Batteries which have been the standard for over 10 years.

E. MARCUSON
70 Cortlandt Street New York



B-Batteries

Standard Signal Corps, U. S. Army for Vacuum Tubes Type BA-2 at 90c Postpaid.

Also Wireless Receiving & Sending Instruments at reasonable prices. State wants.

THE H. S. WIRELESS CO., 164 Ross St., Brooklyn, N. Y.

The Universal Instrument For Radio Service

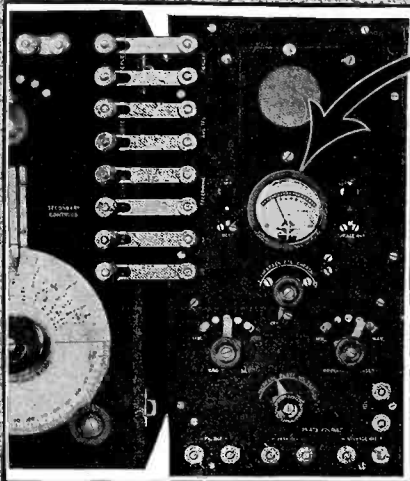

Radio Control Box Showing Type BX Instrument for Measuring Filament Current.

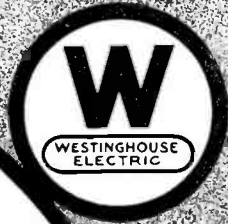

Radio Equipments require the highest grade of instruments consistent with reliable service and the available space.

The Type BX

was especially developed for Radio application. Operating on the D'Arsonval principle, it will measure vacuum-tube filament currents and other direct currents used in wireless work, while for radio frequency currents it is provided with a self-contained heater and thermo-couple.

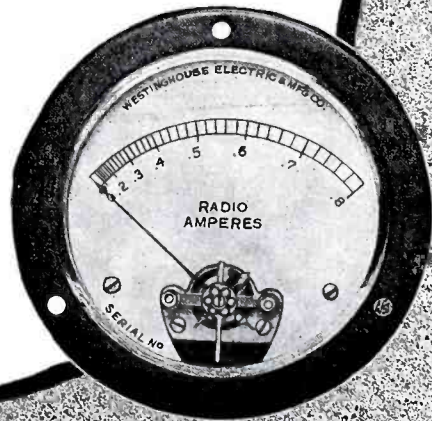

For further information address our nearest office.

Full Size Two-inch Body

Westinghouse Electric & Manufacturing Company

East Pittsburgh, Pa.

Atlanta, Ga.
Baltimore, Md.
Birmingham, Ala.
Bluefield, W. Va.
Boston, Mass.
Buffalo, N. Y.
Butte, Mont.

Charleston, W. Va.
Charlotte, N. C.
Chattanooga, Tenn.
Chicago, Ill.
Cincinnati, Ohio.
Cleveland, Ohio.
Columbus, Ohio.

Dallas, Texas.
Dayton, Ohio.
Denver, Colo.
Des Moines, Ia.
Detroit, Mich.
Duluth, Minn.
El Paso, Texas.

Houston, Texas.
Indianapolis, Ind.
Joplin, Mo.
Kansas City, Mo.
Louisville, Ky.
Los Angeles, Calif.
Memphis, Tenn.

Milwaukee, Wis.
Minneapolis, Minn.
New Orleans, La.
New York, N. Y.
Philadelphia, Pa.
Pittsburgh, Pa.
Portland, Ore.
Rochester, N. Y.

St. Louis, Mo.
Salt Lake City, Utah
San Francisco, Cal.
Seattle, Wash.
Syracuse, N. Y.
Toledo, Ohio.
Washington, D. C.
Wilkes-Barre, Pa.

Westinghouse

You benefit by mentioning the "Radio Amateur News" when writing to advertisers.

**YOU HAVE A BEAUTIFUL FACE
BUT YOUR NOSE?**

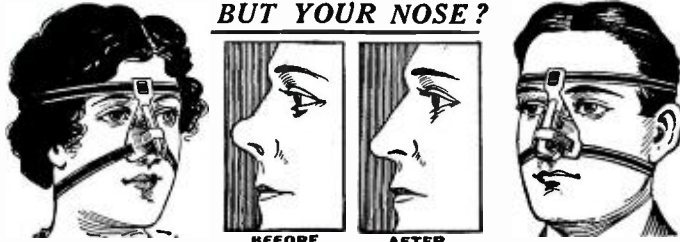

BEFORE
IN THIS DAY AND AGE attention to your appearance is an absolute necessity if you expect to make the most out of life. Not only should you wish to appear as attractive as possible, for your own self-satisfaction, which is alone well worth your efforts, but you will find the world in general judging you greatly, if not wholly, by your "looks," therefore it pays to "look your best" at all times.

AFTER
Permit no one to see you looking otherwise; it will injure your welfare! Upon the impression you constantly make rests the future or success of your life. Which is to be your ultimate destiny? My new Nose-Sheper, "TRANSO" (Model 24) corrects now ill-shaped noses without operation, quickly, safely and permanently. Is pleasant and does not interfere with one's daily occupation, being worn at night.

Write today for free booklet, which tells you how to correct ill-shaped noses without cost if not satisfactory

M. TRILETY, Face Specialist

1270 Ackerman Bldg., Binghamton, N. Y.

**SPECIAL
SALE!**

We have on hand 2,000 Carbon Grain Transmitters as per photograph. They are first-



Reduced Photograph of Transmitter showing nickel plated case and Hard Rubber Mouthpiece

**\$1.00
ONLY**

Postage extra.

Ship. Weight, 2 lbs.

Diameter, 3 3/4 ins.

class instruments and may be used for all kind of experiments, especially for wireless telephone sets, where a heavy current is to be passed through. Slightly used, but in perfect working order. Money refunded if not satisfied. A real bargain. Order one or more today.

THE ELECTRO IMPORTING CO., 231 Fulton St., NEW YORK



**EASTERN
RADIO
INSTITUTE
RADIO**

899 Boylston St.
Boston, - Mass.

TEL.
BACK BAY
5 9 6 4

Tremendous demand for Wireless Operators! Splendid opportunities now in the Merchant Marine. Big salaries! Junior operators, \$100 per month, Chief operators, \$125, food and quarters included. Our Graduates in all parts of the world as operators, instructors, inspectors, engineers, etc., etc. Let the Eastern Radio Institute train you because we have never yet failed to secure a graduate a position. **DAY AND**

EVENING CLASSES. START ANY MONDAY. Send for prospectus.

You Need These Remarkable Books

Three up-to-date radio books, chock full of the information you have been looking for.

No. 6 Experimental Wireless Construction

88 pages and 93 illustrations explaining in full detail with working dimensions, the construction of modern amateur radio apparatus, the erection of aerials, installation, operation, etc.

No. 5 Wireless Construction and Installation for Beginners

Describes in detail with working drawings how any handy man can make his own apparatus at lowest possible cost. Describes simpler and less expensive apparatus than No. 6. 73 pages—67 illustrations.

No. 3 Lesson in Wireless Telegraphy

An extremely valuable book which should be in the possession of every radio experimenter. Explains in complete detail the theory and operation of all types of radio apparatus. Explains the Audion, amplifier, tickler, end losses, distributed capacity, etc.

Any one of the wonderful books will be sent to you postpaid for 30 cents.

Cole & Morgan, Inc. Publishers 19 Park Place, New York



LEARN TELEGRAPHY
at home in shortest possible time. Morse or Wireless. **OMNIGRAPH AUTOMATIC TRANSMITTER**, connected with Sounder or Buzzer, sends you messages at any speed, just as expert operator would. Adopted by U. S. Govt. 6 styles. Catalog free.
OMNIGRAPH MFG. COMPANY.
39-F Cortlandt Street, New York

SEND TO-DAY
For Catalog for Complete Line of
Receiving Apparatus
REMLER RADIO MFG. CO.
163 Sutter St. San Francisco, Calif.

Long Wave Receiving

(Continued from page 173)

It all depends upon the operator and the handling of the apparatus. L_1 , L_2 and L_3 are multi-layered coils placed in coupling relationship to each other. They may be moved about on the table or they may be mounted on a panel and controlled by knobs. The variable condensers are the usual type of receiving condensers.

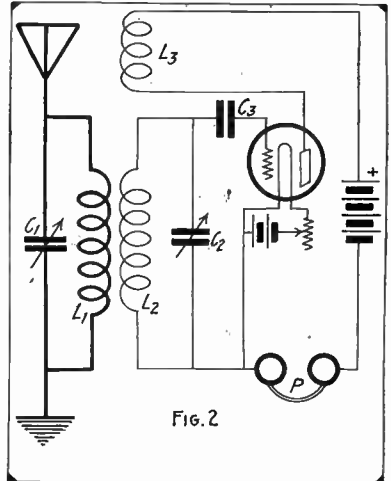

Here is Shown the "Famous Tickler" Regenerative Hook-up.

No doubt many of the experimenters would like to make a few of these new coils to experiment with. For the experimenter who has the tools and the equipment Figure 3 will prove interesting. The coil is wound on a frame constructed according to the diagram. The frame is made in the form of a spool. The core is made up of eight round dowel sticks (B). (A) (A) are binding posts for connections. The layers are air spaced by placing paper or cardboard strips 1 inch by 1/4 inch at regular intervals after each layer is wound on. The data for the coil is as follows:

- Wave lengths when used with variable condenser .001 mfd, 15,000 meters.
- Inside diameter of spool, 3 1/2 inches.
- Axial length, 1 inch.
- Ten layers of No. 30 S.C.C. or S.S.C. wire.

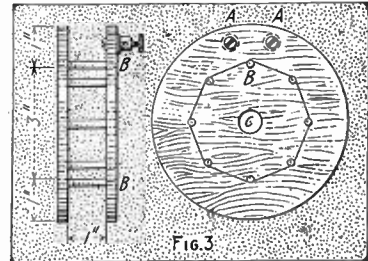

Details of the Coil and Frame for Winding the Wire On.

If the inductive feedback connection is used a coil with an axial length of 1/2 inch and wound with ten layers should be made for the plate circuit. In Figure 2 L_3 is the plate coil. It is sometimes called the "tickler coil."
Figure 4 shows another type of multi-layered coil which is somewhat simpler to construct. The windings in this coil are separated by paraffined paper. They are wound on a cardboard or bakelite tube 1 1/2 inches in diameter and 1/2 inch long. Be-

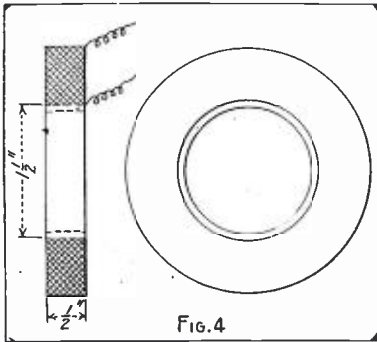

FIG. 4

Here is Shown Another Type of Multilayer Coil.

low is the data for the same:
 Wave length, 12,000 meters.
 Inside diameter, 1 1/2 inches.
 Axial length, 1 1/2 inches.
 One thousand two hundred turns of No. 30 S.S.C. wire.

Paper between layers, 6 to 10 mils thick.
 A tickler coil should be wound with 500 turns No. 30 S.S.C.

Of course, all of the given dimensions, etc., are only suggestive, and they may be changed to suit particular instances. Whenever it is possible it is better to employ inductance for tuning than capacity. Use as much inductance as possible and just enough capacity to get the desired wave length.

AN AUTO WITH A MARVELOUS WIRELESS EQUIPMENT.

An automobile with a marvelous wireless equipment is being built for Glen Martin, who is probably the leading designer and manufacturer of American airplanes, particularly the Martin Bomber. "It's going to have practically everything that an airplane has on it, including a combination wireless telephone and telegraph outfit," Mr. Martin says. "My work is divided between the flying fields and the factory, so that it is of extreme importance to me to be in touch with both places at all times, and it will be a marked convenience as well to be in communication with the aviators in their testing work in the air. At present these wireless outfits cost \$2,200, but I can foresee the time when they will not cost more than \$500 and will be installed as optional equipment on many high-grade cars. They have a telephonic range of thirty miles, and the simple turning of a switch converts them into a wireless telegraph outfit with a range of 300 miles. A red light will flash on the dash of my car when someone wants to get in communication with me, and it will only be necessary to put the receiver to my ear to get the message, if I am within thirty miles of the man who wants to talk to me."

An Amateur's Retrospect
 (Continued from page 185)

In the mix-up some one kicked the table over, and spark coil, batteries, condenser and everything, including friend helix, with the idea no doubt of adding insult to injury, proceeded to descend with great rapidity upon our prostrate forms, striking us in a part of our anatomy which, when speaking of ships, would be termed "amid-ships" which fact, while prolonging the longevity of the instruments, caused us much dissatisfaction and many hard feelings toward the guy who invented wireless. While these good old days of experimentation have long since passed, their memory will forever remain in my mind, and I suspect that many of my amateur friends have had the same harrowing experiences, which, after all, is what makes life worth living.

Learn Electricity

**In the Great Shops of
 COYNE
 IN 3 1/2 MONTHS**

Thousands of Electrical experts are needed now. Come to the great shops of Coyne and let us train you quickly by our sure practical way backed by 20 years of success.

Earn \$125 to \$300 a Month

Come to Coyne where experts train you on the actual apparatus. You work on everything from the simple bell to the mighty Generators, Electrical Locomotives and Power Plants. Everything to make you a Master Electrician. Look at the picture taken from life in our shops.

Become an Expert in 3 1/2 Months

No need of taking 1 to 4 years to become an expert. We have proved this in thousands of cases. We are the only school teaching by the original Coyne methods, which means no books, no classes—all practical training.

Earn Your Way. Our employment department will help every ambitious man to earn a part or all his expenses—without charge.

Bennett W. Cooke, Director
COYNE TRADE AND ENGINEERING SCHOOLS
 Dept. 110, 39-51 E. Illinois Street
 CHICAGO, ILL.

LEARN DRAFTING

The country needs hundreds of skilled Draftsmen in all lines at big salaries.

Coyne is the only school in the country that gives you the advantages of big shops full of construction and machinery. This makes our drafting courses practical, just like the job you'll have when you graduate. You can't get this in any other school.

WE TEACH ELECTRICITY, DRAFTING, MOTION PICTURE OPERATING AND PLUMBING

We teach all these professions in such a thorough, practical way that when you finish you can step right into a position of responsibility and big pay.

Fill out the coupon now and send it for our big free book of information. It tells what others are doing and have done, what you can do.

Be sure and check the trade that interests you. Do it now

COYNE SCHOOLS
 Dept. 110, 39-51 E. Illinois St.
 CHICAGO, ILL.

Please send me that big free book. I'm interested in:

- Electricity Drafting Plumbing
- Motion Picture Operating.

Name

Address

ARE YOU GETTING THE MOST OUT OF YOUR RECEIVER ?



The ether is full of signals these days, some easy to hear and some inaudible. Inaudible because the proper apparatus is not being used.

It is to make those inaudible signals audible that the Grebe RORB two-stage audio-frequency amplifier has been designed. Here is a properly balanced two-stage amplifier, which gets the most out of available vacuum tubes without distortion. A telephone cam switch with auxiliary contactors accomplishes the change from the "off" position to either one or two stages without necessitating any other manipulations. The filaments, as well as the stage circuits, are controlled by this cam switch. This is a feature not found in other amplifiers available at present. Send for bulletin R-108.

TYPE RORB, TWO STAGE AMPLIFIER, PRICE, \$45.00

RICHMOND HILL A. H. GREBE & CO. NEW YORK

AMATEURS

Why not make your own instruments? The Amateur Wireless Equipment Company of 1380 Prospect Ave., Bronx, N. Y., will make the parts or complete sets for you after September 1st, 1919. We will also carry a complete line of standard apparatus. Send us your sketches.

Phone Intervale 6966.



Remarkable Price On Aerial Wire
 Pure copper, B. & S. Gage No. 12 aerial wire priced at 40c per pound. Immediate shipment. When ordering, do not forget to add enough to cover postage. A five cent stamp will procure our illustrated catalogue showing many bargains in apparatus for electrical experimenters.
ELECTRICAL SPECIALTY COMPANY
 Dept. R-18-50 South Front Street
 Columbus, Ohio
 Dept. R-123 So. Eleventh Street
 Philadelphia, Pa.

A Short Wave Receiver of Novel Design

(Continued from page 173)

studs, plug sockets and terminal posts. The connections will be soldered to these after assembling has been completed. All brass and phosphor bronze parts should be lacquered. A good lacquer can be made as follows: dissolve 1 oz. shellac, 1 oz. seedlac, and 1/8 oz. gamboge in 1 pint of methylated spirit, or better still, rectified spirit. Let settle for several days, then pour off the clear lacquer. After this, add a few drops of picric acid to suit color required. It is now ready for use. Before applying, the parts must be warmed slightly over a bunsen flame.

Use a small flat-edged camel's-hair brush and be careful not to go over the same part twice with the lacquer. Do not "paint" lacquer, but apply with as few strokes as possible. After warming again the parts can be given another coat in the same manner until the desired color is reached.

All parts being now complete, we can now begin to assemble.

Start by mounting the switch-gear, studs and plug sockets all on the front panel. Place one of the small copper lugs at the back of each stud under the nut, and one of the large ones under the nuts on each of the four plug sockets.

Secure your panel to the wooden base by means of the two 4/32" screws at G' and after fitting the terminals in the terminal blocks these also can be secured to the base.

One of the large size copper lugs must be placed under the base of each terminal before screwing down. Fasten the front panel to the terminal blocks at F' & F'.

The center spindle and secondary coil come next. The correct position of the coil on this spindle will be found by trial.

After placing the spindle through the center post of primary switch, the small knob and coupling pointer can be screwed onto the end of the spindle tightly, and is left in such a position that when both coils are in the same plane the coupling pointer is at 100, and when both coils are at right angles the pointer is at zero.

The secondary windings can now be neatly soldered to the lugs on the plug sockets, etc., as will be seen in the circuit diagram shown in Fig. 8.

One end of the coil is connected by light flexible conductor to one of the secondary terminals. The other terminal is connected by a short length through the hole in panel to the plug. Next secure the primary tube to the hard rubber block D and set in position by means of two small screws M.

RADIO APPARATUS

Distributors of All Prominent Makes:—

De Forest, Wireless Specialty, Murdock, Grebe, General Radio, Clapp-Eastham, Brandes, etc., etc. Largest and Best Stock of any House in New England.

For real prompt delivery send us your orders. For Honey-Comb Coils, Unit Panels, Vacuum Tubes, Baldwin Telephones, Murdock 55's, Grebe Developments, etc., etc.

F. D. PITTS CO.

Dept. C.

12 PARK SQUARE BOSTON, MASS.

TYPE RS-100 JEWELERS TIME RECEIVER

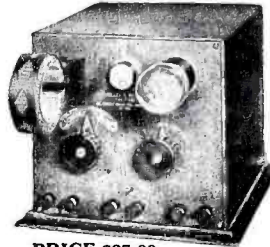

PRICE \$25.00

WILCOX PANEL SWITCH

1 1/2 In. Radius "The Best" Postpaid Price
 Complete Switch, polished brass finish 50c
 Complete switch, nickel plated finish 60c
 Knob, turned and polished 25c
 Switch points, brass finish 2c
 Switch points, nickel plated finish 4c

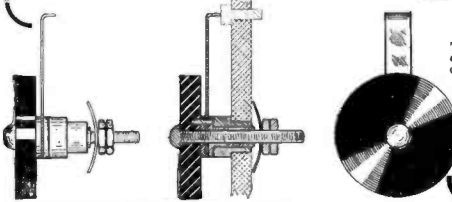

VARIOMETER PARTS

Turned from hardwood. Set as shown consisting of stator (two parts), rotor and form for winding coils Postpaid \$2.50
 Size of stator 5 1/4" sq.
 Other sizes made to order.

SET NO. TWO contains all parts for the variometer including the above and knob, scale, pointer, shaft, binding posts, wire and instructions for assembly Postpaid \$5.00

The Wilcox Laboratories
 Lansing Dept. C Michigan

CANADIAN AMATEURS!

We carry in stock the well-known high-class lines of

Clapp-Eastham Apparatus

also materials for constructing sets at home.

RADIO & ELECTRICAL SUPPLY CO.

43 McGill College Ave. Phone Uptown 1522 Montreal, Que.

AUDION VALVES, BOYS! WE HAVE 'EM!

THE NEW YORK ELECTRICAL SCHOOL

THE N. Y. ELECTRICAL SCHOOL is the pioneer and premier school of the "Learn by Doing" method. When you have completed this Course you shall be fully qualified to handle ALL branches of Electrical Industry. The equipment of this School is unequalled and up-to-the-minute. No preparation needed to become a "learner" in this school. You can start to learn on any day of any week throughout the whole year. Send for catalogue. **OPEN ALL SUMMER**
NEW YORK ELECTRICAL SCHOOL
 29-31 West 17th St. New York City

You benefit by mentioning the "Radio Amateur News" when writing to advertisers.

Screw the brass bearing piece to the block D and connect tappings to primary studs as in Fig. 8.

After carefully soldering the leads the coupler is complete.

In conclusion, the writer desires to point out the small amount of space taken up by a tuner of this type, which is certainly a consideration in these days of regenerative circuits and cascade amplifiers. Then again the ease in operation should appeal to many.

Construction of Mica Receiving Condensers

(Continued from page 178)

In assembling the condenser, the mica and foil should be dipped in hot paraffin, removed while hot and clamped immediately between suitable plates. Each plate should consist of sheet bakelite and brass, the bakelite being next to the condenser. These plates should not be connected electrically by either terminal, since the capacity of the condenser would be increased in some cases. It is compulsory that all joints be soldered.

Several forms of condenser are possible, but those mentioned are commonly in use and give very satisfactory service.

Copying Thru Static

(Continued from page 177)

rather cutting down the static may be of value. It is now recognized that the static which is so troublesome is very much greater in voltage but shorter in duration than the musical note signals, that is the instantaneous current value of static is very much greater than that of the signals, but the total energy is not so very much more. To increase efficiency, it is necessary, then, to have a receiver which has a low efficiency for high-current values and a high efficiency for the particular current values given by the signals. There are numerous ways by which the static can be reduced, but there are none of them that entirely eliminate it. Those points of interest in regard to copying thru static were obtained thru my personal experiences in connection with the receiving apparatus and its manipulation.

Contributed by E. T. JOHNSTONE.

PREDICTS WIRELESS TO DISTANT PLANETS.

Sir Oliver Lodge, the noted English scientist, states his belief that the earth will soon be in communication with other planets by wireless. Projection of a stream of electrons across the spaces of infinity thru employing the vacuum relay, and utilizing ultra-violet, or the X-ray, are suggestions which he makes.

NEW RADIO STATION AT POINT HUENEME.

Orders have been issued by the United States Navy Department for the construction of a powerful wireless station at Point Huene me, which will be situated near the lighthouse there.

Point Huene me is regarded by the Navy Department as one of the four most important points on the Pacific. The station here will be one of a chain of such stations established at various points where there are lighthouses on the western coast from the Mexican border to the northern boundary of Alaska. They will be of the compass radio type and are intended for the protection of boats plying along the coast.

UNIVERSAL RADIO APPARATUS

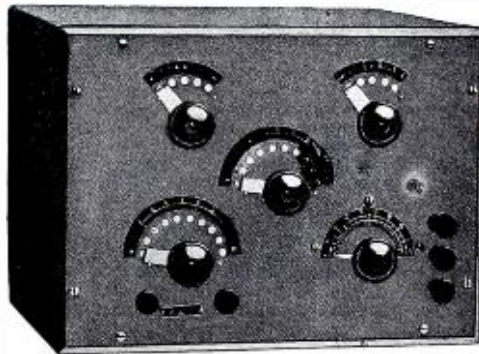

Type UL-5 Receiver

It is the policy of this company never to consider a sale completed until the customer is thoroughly satisfied. Incidentally our instruments seldom fail to satisfy, because they are scientifically designed and built on honor. If you are interested in radio apparatus of the highest grade at fair prices, enclose a 2-cent stamp for our catalogue.

Type UL-5 Receiver.

This is a complete receiver for undamped waves up to 17,000 meters. No external coils, couplers or condensers are needed, since it is entirely self-contained. Sizes 8" x 12" x 7" approximately.

We control the patent rights for the Mignon System and can supply these instruments.

UNIVERSAL RADIO MANUFACTURING CORP.

Dept. W Elmira, N. Y.



DUCK'S New Big 264-Page Wireless and Electrical Catalog Just Out—Now Ready

It is mailed for 12c in stamps or coin which may be deducted on first order of \$1.00. Catalog not sent otherwise.

We regard this catalog as our greatest effort. It embraces everything in wireless worth while. 172 pages with no waste space devoted exclusively to wireless instruments. Your amateur friend will tell you that there never has been any wireless catalog

to take the place of catalog of this company and above all that you can absolutely depend on our goods. There is no need for any other catalog when you have this big catalog.

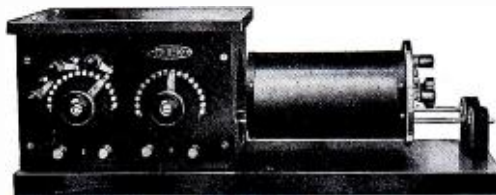

NEW MODEL 5BB. NAVY TYPE RECEIVING TRANSFORMER

A big improvement over our former model. Primary divided into two sections, with three dead end switches, greatly improving selectivity.

Secondary divided into three sections, with two dead end switches, eliminating harmonics. By changing the construction of the end piece, there is also greater loose coupling. It is a wonderful improvement over our old model both in performance and appearance. Only \$23.50.



OUR IMPROVED, ARLINGTON RECEIVING TRANSFORMER

The secondary on our new type Arlington is divided into three sections with two dead end switches, eliminating dead end effect and harmonic and giving greater selectivity. The end support similar to that on our Navy type permitting of greater loose coupling. It is a beautifully finished instrument and will be sold by us at the same price as the old model. \$9.00.

THE WILLIAM B. DUCK CO., 240-242 Superior St., Toledo, Ohio

FREE TO YOU!

Read this Remarkable Offer!



OFFER No. 1
Wireless Course
 The most comprehensive Wireless Course ever printed. Contains 160 pages, 350 illustrations. Size of book 6 3/4"x10". Very fine flexible cloth cover.
FREE with a year's subscription.
 Add 5c for postage

OFFER No. 2
Experimental Electricity Course
 This masterpiece contains 160 pages, 400 illustrations. Size of book 5"x9". Printed on extra thin paper, so book can be slipped into pocket. Handsome flexible cloth cover.
FREE with a year's subscription. Add 5c postage

OFFER No. 3
How to Make Wireless Sending Apparatus
 By 20 Radio Experts
How to Make Wireless Receiving Apparatus
 By 20 Radio Constructors
 These books are by far the most successful wireless books on the market. Size of each book 5"x7", well bound on good book paper. Covers in two colors. We really cannot praise these books too highly. Each book contains 100 pages and from 88 to 90 illustrations. **BOTH** books **FREE** with a year's subscription. Add 5c for postage

This is a very limited offer. It may be withdrawn at any time, due to the tremendous cost of paper, which IS JUST DOUBLE WHAT IT WAS ONE YEAR AGO. We have only a limited supply of these fine books on hand; after they are gone we cannot reprint the books until conditions become normal again. **Now is your chance.**

The publishers of this journal have earned an enviable reputation of giving more than 100 cents' worth of each dollar spent with them. Profit by this liberal opportunity NOW; It may never be made again.

HERE'S THE OFFER

Subscribe to RADIO AMATEUR NEWS for one year, at the regular subscription price of \$1.50 per year (Canada, foreign and New York City \$2.00) and we will send you either books shown in one of the above offers. If you subscribe for two years, two offers will be given, etc.

If you are a subscriber at present take advantage of this wonderful opportunity anyway. If you do, we will extend your present subscription.

This Offer Limited.

Act Now.

EXPERIMENTER PUBLISHING COMPANY
 233 FULTON STREET
 NEW YORK CITY

FILL IN - TEAR OUT - AND MAIL

10-19
 R. A. N.
 Gentlemen:
 Please enter my subscription to the RADIO AMATEUR NEWS for the term of year.. for which I enclose herewith \$.....
 You will also send me at once **FREE** as per offer No. your book
 Name.....
 Address.....

You benefit by mentioning the "Radio Amateur News" when writing to advertisers.

Audion Protective Device

(Continued from page 175)

inch tapering to $\frac{1}{4}$ inch wide. A suitable contact is soldered on the $\frac{1}{4}$ " end, preferably a contact used on the regular telegraph key. For adjustment of the armature for various loads another piece of brass strip $\frac{1}{8}$ " thick by $1\frac{1}{2}$ " long. An 8/32 nut is soldered as shown and the screw with a suitable knob is used to vary the tension of the very fine hair spring which is connected to the lower member. The entire arrangement is made fast to an 8/32 screw post of sufficient length. The small iron piece shown in Figure 3 placed on the armature is cut from the same piece that the magnet core was taken from. This is done in the following manner: the half-

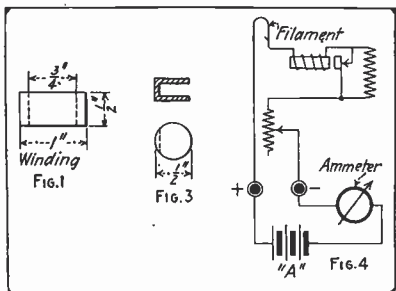
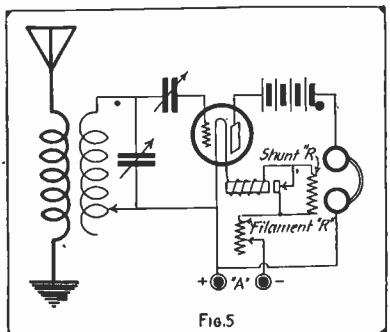

Figure One Shows the Iron Core, Three, the Armature Lug and, Four, the Circuit Used When Calibrating the Instrument.

inch iron rod is clamped in the vise and as close as possible to the end ($\frac{1}{8}$ " a slit is cut with a hacksaw which nearly severs it from the bar, then the piece is cut off $\frac{1}{8}$ " further down, the finished article resembling that shown below; the spring brass armature fits in the wedge and same is then forced tightly closed by a few strokes of the hammer.

The resistance unit which shunts the contacts was made of about twenty feet of No. 28 German resistance wire, altho this can be done by test after the instrument is completed and it is then only necessary to connect same across the contact points.



The Instrument Connected in the Receiving Circuit.

Calibration of the Instrument.

This is done in the following manner: If it is not possible to get it calibrated at a commercial or naval station, which stations employ the audion control panel, take an ordinary battery measuring ammeter and connect this instrument in series with the known value meter, as shown in Figure 4. The current can then be regulated to the approaching danger point and the instrument set or regulated to respond to this value when reached upon trying after each setting—by bringing the current to a zero

(Continued on page 207)



WIRELESS PARTS SUPPLIES

BAKELITE-DILECTO PANELS

All Panels are Black XX Grade, the Best Insulating Material. Include Postage on 3 lbs. on all Size Panels.

$9\frac{1}{2} \times 19 \times \frac{1}{4}$.. \$4.00
$19 \times 19 \times \frac{1}{4}$.. 8.00
$9\frac{1}{2} \times 19 \times 3/16$.. 3.00
$19 \times 19 \times 3/16$.. 6.00

Knob and Switch Lever Brass Mounted. Spring Brass Lever Securely Fixed to Black Knob. Cut shows full size.

Each 40 cents, postage 5 cents.

Knob only with hole for mounting $1\frac{1}{4} \times \frac{3}{4}$, each 20c postpaid.

CONTACT POINTS, brass 7/32 x 7/32, with screw for mounting, like cut. Postpaid 25 cents. Cut shows full size.



Contact Point No. CP-4, with nut for mounting.

Top is 7/32 x 7/32 per dozen, 35 cents; postage, 2 cents. Price includes one nut. Extra nuts, 8 cents per dozen, postpaid.



"Electrose" Ball Insulators for Aerials, each 30c; postage on 1 lb. 10, \$2.70 postage on 8 lbs.

Consolidated Radio Call Book, postpaid \$1.00

Send 5 cents for Catalog and get on our Mailing List for future Bulletins

A. H. CORWIN & CO.

924 KINNEY BUILDING

NEWARK, N. J.

CONTACT POINTS

Several styles—ANY QUANTITY—GOOD DELIVERY.

DEALERS and MANUFACTURERS should get our prices in all quantities before ordering your Fall Supply. Samples and price list 2 cents.

A. H. CORWIN & CO. NEWARK, N. J.

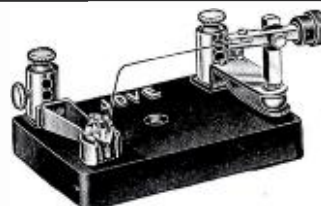

Jove Detector (Patented)

Bunnell Instruments Always Satisfy--

Our Jove Detectors Simplest and Best-- Sample by Mail, \$1.44.

Tested Galena Crystals, 25c per box.

Our Condensers, Transformers, etc., are High Grade, but inexpensive.

Send stamp for our New Catalog 40 R.N.

J. H. BUNNELL & CO.

32 Park Place, New York

(Marconi Licensee)

THE BARR Mercury-Cup Wireless Detector



The most efficient Detector on the market. Tested by the United States Government and Marconi Wireless Telegraph Co.

Increases the efficiency of every wireless receiving set by making the signals clear, sharp and distinct.

Instantly adjustable at a constant pressure.

For full information and price—write

The Barr Mercury-Cup Detector, Dept. B. The Wyoming, Washington, D. C.

LEARN WIRELESS TELEGRAPHY

Fascinating and Educational Work—Big Salaries—Prepare Now

The United States Shipping Board is making heavy demands upon us for Dodge-trained wireless operators. Travel all over the world, secure, free, unsurpassed living accommodations and earn a big salary.

We Also Teach Morse (Wire) Telegraphy and Railway Accounting School established 45 years. Endorsed by wireless, railway and telegraph officials. Low rates. Students can earn living expenses while attending school. Catalog Free. Write Today, Dodge's Telegraph and Wireless Institute 26th St., Valparaiso, Indiana

MASSACHUSETTS RADIO AND TELEGRAPH SCHOOL

Instruction in RADIO AND TELEGRAPHY Day and Evening Classes 18 Boylston Street Boston, Mass.

You benefit by mentioning the "Radio Amateur News" when writing to advertisers.

Mesco Radio Buzzer

With Shunt Resistance—
U. S. Navy and U. S. Army
Standard.



The Radio Officers of the NC planes, after testing all other buzzers, decided to use the "Mesco" on their radio equipment. The R-34 was equipped with two of them.

Why? Because of its reliability and constancy in operation; greater output efficiency; ease of adjustment; unaffected by extreme variations in weather conditions; exposed wire eliminated.

Sparking is almost entirely eliminated, so that the energy lost in light and heat in the operation of other buzzers is here conserved and radiated in the form of oscillating energy.

This buzzer maintains a constant note and is recommended as an exciter for checking wavemeters where pure note and ample energy are required.

List No. 55. Mesco Radio Buzzer. Price...\$2.05

We carry a very large and complete line of standard wireless apparatus and solicit your inquiries. Wireless experts in all of our stores.

Send for the New Edition of Our Catalog M 29

It is pocket size, contains 264 pages, with over 1,000 illustrations, and describes in plain, clear language all about Bells, Push Buttons, Batteries, Telephone and Telegraph Material, Electric Toys, Burglar and Fire Alarm Contrivances, Electric Call Bells, Medical Batteries, Electrically Heated Apparatus, Battery Connectors, Switches, Battery Gauges, Wireless Telegraph Instruments, Ignition Supplies, etc.

IT MEANS MONEY SAVED TO YOU to have our Catalog when you want to buy.

Manhattan Electrical Supply Co., Inc.

New York: Chicago: St. Louis: 17 Park Place 114 S. Wells St. 1106 P'ino St. San Francisco Office: 604 Mason St.

READ THE CLASSIFIED ADS. ON PAGES 206 and 207

Fundamental Operation of Vacuum Tubes

(Continued from page 171)

arily but, of course, long enough to affect the voltage of the grid. Now, a change in the grid voltage causes a change in plate current. And a change in plate current causes a change in the magnetic field of L. This change of field intensity again causes a momentary current in L which again changes the voltage of the grid. Thus we find the varying plate current, by induction, to be continually varying the grid voltage, and this varying grid voltage to be automatically varying the plate current. So, when once started, this system settles down to a steady generation of oscillations, the plate battery furnishing the power and the grid automatically varying it into the form of undamped oscillations.

It will be plainly seen that for a maximum strength of oscillation, the greatest possible variation in the plate current must be obtained. This occurs when, as explained for amplifiers the tube is operated on the steep part of the curve. The system of producing oscillation as just described is fundamentally that used for both transmission and reception.

The oscillations generated as explained above are, of course, at a radio frequency. The exact frequency depends upon the values of inductance and capacity in the circuit. Suppose we tune the circuit to a wavelength slightly below 600 meters, so that the frequency is 1001000. Now some undamped transmitter on 600 meters is tuned in on the aerial. The incoming oscillations of a frequency of 1000000 per second will be impressed upon the circuit LC. There are now two separate and distinct series of oscillations in the same circuit; and the result is the production of beats. In this case there would be 1001000 minus 1000000 or 1000 beats per second. These beats are amplified by the audion in the usual way and cause the telephone to vibrate 1000 times per second, producing thereby the 500 cycle note. The number of beats and, consequently, the note in the telephone, depends upon the difference in frequencies of the incoming oscillations and the local oscillations. As the frequency of the local oscillations may be changed at will, the note received may, therefore,

be made anything the operator wishes. Such an oscillating audion system is called a "self heterodyne" or "autodyne." There are very many circuits which give the same effect as that of Fig. 10. Sometimes two local frequencies are generated which produce local beats. These result in either a pleasant musical note in the telephones or an unpleasant howl. The operator can easily stop this by loosening his coupling or changing the frequency of the oscillating circuit. It is sometimes caused by too small capacity in the grid condenser or by too low filament current.

The plate feed-back coil "L_p" is generally called the "tickler coil." When it is loosely coupled to the grid inductance L, no oscillations are produced. As it is brought close to L and just as the oscillations start, a sharp click will be heard in the telephones.

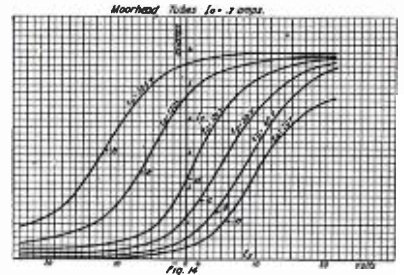

Characteristic Curves of the Marconi Moorhead Tubes.

That point just beyond where the click occurs is the most sensitive point of operation and the maximum amplification generally.

The tickler coil may be made in any form. One very convenient system uses a "variometer" inductance. One coil is considered merely as a continuation of the grid inductance, while the other coil is the tickler. Two typical circuits are shown in Fig. 11 a and b. Here M is the variometer. It is used precisely as described in the preceding paragraph.

A somewhat different circuit for undamped waves is that of Fig. 12 a and b. The grid circuit is tuned to the incoming signal and the plate circuit is then tuned until maximum signals are heard. The plate tuning is usually accomplished at short wavelengths by a variometer and at long wavelengths with both inductance and capacity.

The third system of oscillating audion consists of a capacity feed-back and has no



Curves for the V T II.

tickler coil. This is frequently called the "ultra-audion." It is particularly satisfactory for short wavelengths. For longer wavelengths it is necessary to put a condenser across the telephones. A description of the operation of this circuit was given by the writer in the August issue of RADIO AMATEUR NEWS in the article on "Loop Antennae." The simple circuit is shown in Fig. 13.

Fig. 14 shows the characteristic curves for the Marconi-Moorhead tubes. It is identical with Fig. 3 in the last issue with (Continued on page 207)

IMMEDIATE SHIPMENT

We are prepared to ship from stock same day order is received, any of the following switch points and knobs. Postage extra:

	SWITCH POINTS	Doz.	50	100
No. 626—	1/4" dia. x 3/8" high tapped 6-32	\$.30	\$1.00	\$1.75
No. 627—	1/4" dia. x 1/2" head 3/8" shank 6-32	.36	1.25	2.00
No. 628—	1/4" dia. x 1/2" high tapped 6-32	.30	.90	1.50

Above plain brass finish—Nickel 50 per cent. advance.

KNOBS



	Each	Doz.	
No. 601—	1/2" dia. 8-32 bushing	\$.05	\$1.00
No. 602—	1" dia. 8-32 bushing	.10	1.00
No. 606—	1 1/4" dia. 13/16" high	.20	2.00
No. 608—	1 1/16" dia. 15/32" high, 10-32 bush.	.06	.60

SEND TODAY FOR YOUR COPY OF OUR NEW CIRCULAR G SHOWING COMPLETE LINE.

SHOTTON RADIO MANUFACTURING CO.

Successors to Maguire & Shotton, Albany, N. Y.

P. O. Box 3

SCRANTON, PENNA.

\$5.

The Boy's Electric Toys



EXPERIMENTERS!

A Sample of What You Can Do With This Outfit

This illustration, made from an actual photograph, shows only a very few instruments that can be made with the Boy's Electric Toys: Electric Pendulum, Electric Telegraph, Current Generator, Electric Dancing Spiral, Galvanometer. Space does not permit us to show the hundreds of experiments that can be performed with this wonderful outfit.

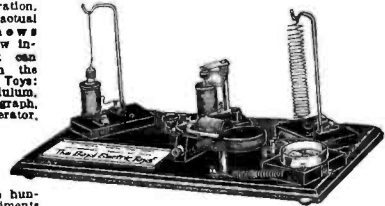

No. EX2002

"THE BOY'S ELECTRIC TOYS" contains enough material to make AND COMPLETE OVER TWENTY-FIVE DIFFERENT ELECTRICAL APPARATUS without any other tools, except a screw-driver furnished with the outfit. The box contains the following complete instruments and apparatus which are already assembled:

Student's chromic plunze battery, compass-galvanometer, solenoid, telephone receiver, electric lamp. Enough various parts, wire, etc., are furnished to make the following apparatus:

Electromagnet, electric cannon, magnetic pictures, dancing spiral, electric hammer, galvanometer, voltmeter, hook for telephone receiver, condenser, sensitive microphone, short distance wireless telephone, test storage battery, shocking coil, complete telegraph set, electric riveting machine, electric buzzer, dancing fishes, singing telephone, mysterious dancing man, electric jumping jack, magnetic geometric figures, rheostat, erratic pendulum, electric but-terly, thermo electric motor, visual telegraph, etc., etc.

This does not by any means exhaust the list, but a great many more apparatus can be built actually and effectually.

With the instruction book which we furnish, one hundred experiments that can be made with this outfit are listed, nearly all of these being illustrated with superb illustrations. No other materials, goods or supplies are necessary to perform any of the one hundred experiments or to make any of the 25 apparatus. Everything can be constructed and accomplished by means of this outfit, two hands, and a screw-driver.

The outfit contains 114 separate pieces of material and 24 pieces of finished articles ready to use at once.

Among the finished material the following parts are included: Chromic salts for battery, lamp socket, bottle of mercury, core wire (two different lengths), a bottle of iron filings, three spools of wire, carbons, a quantity of machine screws, flexible cord, two wood bases, glass plate, paraffin paper, binding posts, screw-driver, etc., etc. The instruction book is so clear that anyone can make the apparatus without trouble, and besides a section of the instruction book is taken up with the fundamentals of electricity to acquaint the layman with all important facts in electricity in a simple manner.

We guarantee satisfaction.

The size over all of the outfit is 14 x 9 x 2 1/4". Shipping weight, 8 lbs. \$5.00 No. EX2002 "The Boy's Electric Toys" outfit as described. \$5.00
IMMEDIATE SHIPMENTS

ELECTRO IMPORTING CO., 231-A Fulton St. NEW YORK

The "Electro" Radiotone

HIGH FREQUENCY SILENT TEST BUZZER

This instrument gives a wonderful high pitched MUSICAL NOTE in the receivers, impossible to obtain with the ordinary test buzzer. The **RADIOTONE** is built along entirely new lines; it is NOT an ordinary buzzer, reconstructed in some manner. The **RADIOTONE** has a single fine steel reed vibrating at a remarkably high speed, adjusted to its most efficient frequency at the factory. Hard silver contacts are used to make the instrument last practically forever.

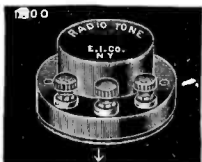

The "Electro" Telegraph

Yes, the **RADIOTONE** is SILENT. In fact, it is so silent that you must place your ear on top of it to hear its beautiful musical note.

You will be astounded at the wonderfully clear, 500 cycle note, sounding sharply in your receivers. To learn the codes, there is absolutely nothing like it. With the radiotone, a key and one dry cell and ANY telephone, a fine learner's set is had. Two or more such sets in series will afford no end of pleasure for intercommunication work. Shipping Weight 1 lb.

Radiotone as described. each \$1.90
IMMEDIATE SHIPMENTS

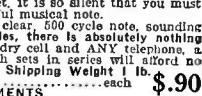

Is not a toy, but a practical, honestly built telegraph outfit, which not only sounds but works like the big commercial instruments. By studying the code for 30 days you can become a first-class telegraph operator. Such operators are in big demand now. Outfit consists of TWO complete telegraph instruments each measuring 3 1/4 x 2 1/4 x 2 1/4". All metal parts are highly nickel plated, including key lever. Note hard rubber knob. Telegraph Code Chart, telegraph blanks and connecting wire comes with set, but no batteries. Outfit works on 2 dry cells (one cell for each instrument). The "Electro" is the ONLY outfit that works both ways, each station can call; no switches, no extras. Nothing to get out of order. Guaranteed to please you or money back. Price Complete as illustrated (TWO INSTRUMENTS), . . . \$1.25
Shipping Weight, 2 lbs.
IMMEDIATE SHIPMENTS

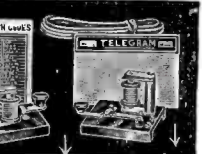

The "Electro" Codophone (Patents Pending)

What this remarkable instrument is and does.

The "Electro" Codophone is positively the only instrument made that will imitate a 500 cycle note exactly as heard in a wireless receiver. The loud-talking receiver equipped with a horn, talks so loud that you can hear the sound all over the room, even if there is a lot of other noise.

THAT'S NOT ALL. By lessening or tightening the receiver cap, a tone from the lowest, up to the loudest and highest screaming sound can be had in a few seconds.

FOR INTERCOMMUNICATION. Using two dry cells for each instrument, two Codophones can be connected with one wire and return ground. Can be used for intercommunication between two houses one-half mile apart.

One outfit alone replaces the old-fashioned learner's telegraph set, consisting of key and sounder.

The "Electro" Codophone is a handsome, well made instrument, fool proof, and built for hard work. Contacts are of hard silver 1/8 inch in diameter, that will outlast the instrument.

There is also a neat code chart and full directions enabling any intelligent young man or girl to learn the codes within 30 days. Practising one-half hour a day.

Size: 6 1/2 x 3 x 2 1/4". Shipping weight, 2 lbs.
The "Electro" Codophone as described, complete. \$1.50



"The Livest Catalog in America"

Our big, new electric encyclopedia No. 20 is waiting for you. Positively the most complete Wireless and electrical catalog in print today. 255 Big Pages, 600 illustrations, 500 instruments and apparatus, etc. Big "Treatise on Wireless Telegraphy," 30 FREE coupons for our 160-page FREE Wireless Course in 20 lessons. FREE Encyclopedia No. 20 measures 7 1/2 x 7 1/2. Weight 1/2 lb. Beautiful stiff covers.



ELECTRO IMPORTING COMPANY
231A Fulton St., New York City

I enclose herewith 6 cents in stamps or coin for which please send me your latest Encyclopedia Catalog No. 20 as described.

NAME

ADDRESS

STATE

You benefit by mentioning the "Radio Amateur News" when writing to advertisers.

OPPORTUNITY AD-LETS

Follow these advertisements every month. Reliable advertisers from all over the country offer you their most attractive specials in these columns.

Classified advertising rate two cents a word for each insertion. Ten per cent discount for 6 issues, 20 per cent discount for 12 issues. No advertisement for less than 20c accepted. Name and address must be included at the above rate. Cash should accompany all classified advertisements unless placed by an accredited advertising agency.

Objectionable or misleading advertisements not accepted. Advertisements for the November issue must reach us not later than October 15.

EXPERIMENTER PUBLISHING CO., INC., 233 Fulton Street, New York, N. Y.

Auto Accessories

Lock your car against theft. Price 25c. R. Wallner Frontenac, Kansas.

Books

Midget Bible. Smallest in the world. Size of postage stamp. 250 pages of New Testament, illustrated, 12c postpaid. Charles Dynes, Winchester, Indiana.

Concordia contains essays, formulas, plans. Year's subscription soc. trial 20c. Concordia Magazine, 9 Water, York, Pa.

Laws of Nature every married and engaged person should know, 50c (no stamps). Central Company, 599 Ninth Ave., New York.

Books describing Hun atrocities and their attacks on women and girls in Belgium, 25c. Belgian Specialty House, 2806 Union Ave., Dept. 3, Chicago.

Books, Practical, Mechanical, Auto, Aviation, Home Study Books. Easy payments. Send dime "tonight" for catalogs. Amsco, Dept. G-1, Aurora, Illinois.

Books Worth While. Circulars for stamp. Joel Tillberg, Proctor, Vermont.

Business Opportunities

\$30 per 100 paid for names and addresses. Particulars Free. Victor-King Co., 36 Bromfield St., Boston, Mass.

Build up an Income in Oil—Others are doing it. Why not you? Today is the opportunity. Join our easy monthly payment plan now—it may mean hundreds in profits. Write for information. National Oil Drilling Co., Dept. M, Houston, Texas.

\$30.00 a week evenings. I made it with a small mail order business; continued my regular job daytime. Free Booklet tells how; 2 cents postage. Albert W. Scott, Cohoes, N. Y.

Stamp names on key checks spare time make as high as \$19 a hundred. Send 25c for sample and instructions; returned if required. Elct Keytag Co., Cohoes, N. Y.

Boys, make big money Tattooing. Complete treatise on art tells all about both Ancient and Modern Tattooing, 50c. Electric Tattooing machines, designs, etc., for sale. Robt. C. Knox, "Tattooist," Rogers, Arkansas.

Detectives make big money. Travel, be your own boss. Either sex. We instruct, small cost. Write Johnson's Detective School, 232 Sheldon Ave., Grand Rapids, Michigan, Dept. A.

Just one moment, please! Are you artistically inclined? Would you like to be one of the many well paid Showcard Writers or Designers? Turn your idle moments into dollars. We will teach you thoroughly Showcard Writing Lettering, and Designing by our Special method of personal correspondence. Why not make \$35 to \$75 a week! if you have talent. Write for Free Details Now! Commercial School of Lettering, Wausau, Wisconsin.

\$10.00 a Day for Amateur Photographers. Ten cents brings the plan which has been successfully operated. J. W. Blodau, Lyndonville, Vt., Dept. 09.

Abraham Bros., Shanghai, China, Importers and Exporters, desire connections.

Help Wanted

Secret Service operatives and Detectives are in demand. Earn big money. Travel everywhere. Fascinating work. Learn this profession by home study. Particulars free. American School of Criminology, Dept. R, Detroit, Michigan.

Miscellaneous

Shoes for All the Family, reasonable prices. Educational, business books, etc. Send for descriptive circulars. Retail only. Central Sales Co., 599 Ninth Ave., New York.

Send stamp for catalog. Chicago Aero Works, 28 River Street.

"Uncle Sam to the Front," brilliant march, piano jec; "Town Talk," latest rag hit, piano 15c. Catalogues free. Quincke, Box 48, Station C, Los Angeles, Cal.

Instruction

Cornetists—Trombonists: Send for "Free Pointers." Weak Lips—High Tones. Virtuoso Cornet School, Buffalo, New York.

Progressive Shorthand, Home Study Course complete in 5 lessons for \$5.00. System based on long hand; easy to learn, easy to read, simple yet perfectly adapted to English or any Latin language. Progressive Shorthand School (E), 1910 East Fir, Seattle, Washington.

Gregg Shorthand. Business correspondence and punctuation taught by mail. Low rates. Providence Correspondence School, 44 Franklin St., Providence, R. I.

For Men

Dredge's Necktie Valet removes wrinkles (without ironing) from neckties. Sample, 25c. Get one to-day. Dredge, 190 Pilgrim Avenue, Highland Park, Mich.

Shavine Powder—enough for five razorless shaves, 25c. Durso, Dept. 50, 25 Mulberry, N. Y. City.

Health

Pyorrhea (Rigg's Disease—Bleeding or Swollen Gums). H. E. Kely, D.D.S., M.D., pyorrhea specialist for 15 years, has developed a successful home treatment for pyorrhea Purifying, healing, preventative. Full month's treatment, \$5 postpaid. Or write for free booklet. Pyorem Mfg. Co., 439 Seventh Street, Brooklyn, N. Y.

Tobacco or Snuff Habit Cured or no pay; \$1 if cured. Remedy sent on trial. Superba Co., SB, Baltimore, Md.

Office Devices

Addressographs, Multigraphs, Duplicators, Multicolors, Folders, Typewriters, Dictaphones, Check Writers, Sealers. Office Device Company, 222-Y North Wabash, Chicago.

Old Coins Wanted

Never Sell Old Coins until you see our Copy-righted 6x9 illustrated Coin Value Book (New Edition), showing high prices we pay, \$100.00 paid for 1894 dime, S. Mint. \$5.00 for 1856 Eagle Cent. Send 10c for your copy today. You may have valuable coins. International Coin Co., Box 151-S, Philadelphia, Pa.

Phonographs

Build Your Own Phonograph. We furnish complete material and full instructions. Big profits building and selling. Write for catalogue and free blueprint offer. Choralphonograph Co., 3410 Choraleon Bldg., Elkhart, Ind.

Personal

The Salesman Wins. Thousands of positions open. We teach traveling salesmanship by mail, and guarantee offer of position or refund tuition. For interesting particulars address Kansas Vocational Bureau, Miltonvale, Kansas.

Patent Attorneys

M. H. Loughridge, Patent Attorney, Consulting Engineer—the high class service of the large manufacturer at modest cost. Designs and manufacturing specifications prepared. Room 903, 1457 Broadway, New York City.

Telegraphy

Telegraphy (both Morse and Wireless) and Railway Accounting taught thoroughly and quickly. Big salaries now paid. Great opportunities. Oldest and largest school; Est. 45 years; catalog free. Dodges Institute, 25th St., Valparaiso, Ind.

Chemical

Experimenters. Get a complete Chemical Set for 25c. M. & R. Laboratories, 531 N. 4th, Saginaw, Michigan.

Exchange

Buy, Sell, Exchange. Wireless and electrical goods. Murdock, Clapp-Eastham, Thordarson, Brandes, etc. Send 10c stamps for our circulars listing new standard apparatus at less than manufacturers' prices. We have to exchange: Wireless, Electrical, Optical, Cameras, Printing Presses, Typewriters. Large list free. LaRoy Zehrbach, 10 College Ave., Hiram, Ohio.

For Sale 4 Telefunken amplifier bulbs, 2 bases for bulbs, 2 low frequency transformers for use with bulbs, 1 navy type amplifier bulb, 1 pair Murdock phones. All in perfect condition. C. B. Wright, 822 Michigan St., Petoskey, Michigan.

Bargain—Short Wave regenerative receiver cabinet, \$20.00; hard rubber panel, receives amateur sending stations from North Dakota. Enclose Stamp, must sell at once, First money order \$18.00 takes set. George Sprouls, 5624 Patehoye St., Philadelphia, Pa.

For Sale: 5x7 Conley camera, reversible back, long focus, F.8 lens, 2 plate holders, case and tripod. Good as new—price \$18.00. Also 4x5 Conley box camera and complete outfit, price \$3.50. Harry E. Stromquist, R No. 2, Oakland, Nebraska.

For Sale. Three International Chicken Hovers. Used little. J. R. Simpson, Piermont, New Hampshire.

Sell Cyclopeda Applied Electricity, \$12.00. Steven's "Favorite" 22 rifle, \$4.00. Electro Chemical Laboratory, \$2.00. Schreyer, 72 Ridgewood Pl., Staten Island.

Salé or Exchange—Vacuum tube detectors, panel set, couplers, buzzer-blinker set, line protector, other radio apparatus, rifle, stamp collection, and photo supplies. Want omnigraph, 6 V. storage battery, or what have you? Send for list. H. E. Ryman, Hastings, Fla.

Have for sale or exchange Receiving and Transmitting Apparatus at very reasonable prices. Let me know what you want, also what you have. Also have a few old style De Forest Amplifying Audions, Switch Points, Knobs, and Binding Posts; Address, O. M. Radio, P. O. Box No. 149, Jersey City, New Jersey.

Bargain—34" spark coil, \$2.50. Emanuel Nymann, 525 W. 100 St., New York City.

For Sale. Murdock kick-back preventer, \$4; heavy duty key, \$2.50. Crawford, 13 Ten Broeck St., Albany, N. Y.

For Sale. Cabinet style receiving set, cheap. Winkler, 1332 First Ave., N. Y. C.

Wanted Guns. Please enclose stamp. Natalish, Stockbridge, Mass.

For Sale Receiving Set, \$5.00; Tuning Coil \$1.50; Large Spark Gap, \$2.50; Brownie Camera with case, \$2.25; Bench lathe, \$3.50. Want half kilowatt transformer. A Hengelbros, 922 Washington, Newport, Ky.

For Sale 1 Marconi V. T., \$7.00. 1 Electro "Intercity" sending outfit, \$7.50. 450 feet No. 12 R. C. Copper wire \$10.00. 1 De Forest Vacuum Tube, new type broken filament, \$1.50. 600 feet Antennium aerial wire, \$2.70. L. B. Cheney, Southbridge, Mass.

Modern Radio instruments for sale. Please enclose stamp. What do you want? Natalish, 145 West 55th St., New York City.

For Advertisers

Money Makes Money. So does Good Advertising. You need look no further for your opportunity. Connect with Jacobus Service and sales will come. Letters, \$2. Booklets, \$10 up. Write now and be convinced. Jacobus Advertising Service, 103 R Sanford Ave., Irvington, New Jersey.

For the Photographer

Correct Distance at a Glance. MacMillan's Distograph, when adjusted for user's height, will accurately measure the distance at a glance. Sharp pictures assured. A war time invention. Fits in vest pocket. Nickel silver with etched scales. At your dealers or postpaid, \$1.25. A. W. MacMillan, Ellis Ave. and 43rd St., Chicago, Illinois.

(Continued on page 207)

NEW WIRELESS TO HAVE 12,000-MILE RADIUS.

Paris.—The new wireless station to be erected at Croix-d'Hins, near Bordeaux, will have a sending radius of 12,000 miles.

It will be one of the most powerful wireless stations in the world, with five times the strength of the Eiffel Tower, three times that of Lyons and twice that of Nauzen.

OPPORTUNITY AD-LETS

(Continued from page 206)

Formulas

Invisible Inks. 30 formulas, 15c. Horton P. Jones, Perry, Ia.

Postcards

Join a postcard club. Have friends everywhere. Membership, 10c. John Miller, 1430 11. Street, Sacramento, California.

Five Prettiest Women Cards, hand colored, 25c. Chas. Durso, Dept. 50, 25 Mulberry St., New York City.

Song Writers

Song Writers: You cannot afford to miss our proposition. Reference any bank or first-class sheet music house. Warner C. Williams & Co., Dept. R, Indianapolis, Ind.

Song-Writers Manual & Guide Sent Free! Contains valuable instructions and advice. Submit song-poems for examination. We will furnish music, copyright and facilitate publication or sale. Knickerbocker Studios, 311 Gaiety Bldg., New York.

Stamps and Coins

Six old American and foreign coins, 25c. Durso, Dept. 50, 25 Mulberry, New York City.

Stamps Free—large packet including Brazil, Canada, New York State revenues, etc., for names two collectors. Stampercraft, Box 252, Hanford, California.

100 Different Stamps, 12c; 200, 27c. Michaels, 5600 Prairie, Chicago.

Best one cent approvals in America. F. P. Hand, 1117 So. 60th St., Philadelphia, Pa.

Scenery for Hire

Collapsible Scenery for All Plays. Amelia Grain, Philadelphia, Penn.

Stammering

St-Stu-t-t-tering and Stammering cured at home. Instructive booklet free. Walter McDonnell, 121 Potomac Bank Bldg., Washington, D. C.

Tricks, Puzzles and Games

Boys—Send 10c for the Greatest Magic Trick Book ever published—Free trick. Lindhorst Magic Shop, St. Louis, Mo.

Wireless

Have your wireless instrument parts made in an up-to-date shop ready to assemble. Send us your sketches or description and get prices, all kinds of machine work done, parts and material supplied. Stevens, 29 N. Seventh St., Philadelphia.

New Price List nearly ready. Order yours immediately. List covers Electrical and Wireless goods, including Brandes receivers. Thordarson Transformers, Audel's Educational Books, Omnigraphs, etc. Stratton Electric Company, Federal St., Greenfield, Mass.

Wireless Bugs want prompt delivery—we do so sure. Standard 1/4" wireless switch knob-lever complete, 35c. Regular 1" switch knob-lever, 25c; brass switch points with screws, dozen, 25c. State panel thickness. All postpaid. Tell us your wants in brass, copper, zinc, wood, fibre, bakelite, etc. Electric Novelty Shop, 2000 Fifth Ave., Charlotte, N. C.

Complete receiving sets \$7.00 and up. With 1000 ohm receiver, tested mineral; guaranteed. Bulletin for stamp. Jenkins, 923 Purchase St., New Bedford, Mass.

Look: 2 1/2 Volt—75 Cells B-Batteries: Standard Signal Corps, U. S. Army, for Vacuum Tubes Type BA-2 at 15c postpaid. Also receiving and sending instruments at reasonable prices. State wants. The H.S. Wireless Co., 164 Ross St., Brooklyn, New York.

Look! Complete plans and diagrams of an efficient receiving set, panel type, knob adjustments. Complete 25c. Write, Meyer Bros., 110 Park Row, New Orleans, La.

Fundamental Operation of Vacuum Tubes

(Continued from page 204)

the addition of the reference letters which were accidentally omitted. By the aid of such a family of curves it should be possible to determine the correct grid voltage at which to work the tube for the desired results. The only thing to be remembered is that for amplification, detection (with grid condenser) or oscillation the tube must be operated on the straight part of the curve, while for detection without grid condenser the tube must be operated on the lower bend. Fig. 15 shows the curves for the VT2. This tube is usually used as a transmitter but works also as either detector or amplifier.

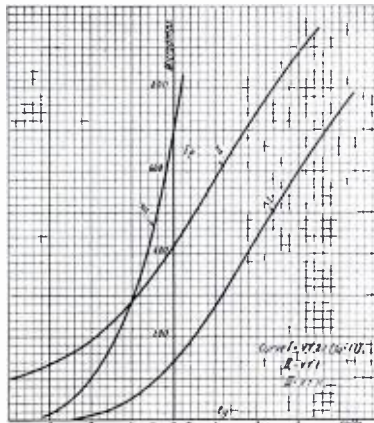

This Shows the Lower Working Portions of the Common Vacuum Tubes, VT 1, VT 11, and VT 21.

Fig. 16 shows enlarged the lower working portions of the curves of the common tubes, namely VT 1, VT 11, VT 21. They all operate on 1.1 amperes filament current and usually 20 volts plate. The VT 11 and 21 are steep on zero grid volts while it is necessary to make the VT1 slightly positive for best results. On the other hand, for detection without grid condenser all three should be somewhat negative on the grid.

As previously mentioned, the internal impedance of the VT 1 is about 20,000 ohms, while that of the VT 21 is around 60,000 ohms. For amplification the VT1 has a constant of 8 while the VT 21 is between 10 and 12. These data would indicate that the VT 21 is a better amplifier than the VT1; and, of course, because of the different internal impedance, the two tubes are not to be operated efficiently in the same circuit with the same impedance phones or transformer.

In the last issue Fig. 4 (a) indicated a plate voltage of 120. In order to agree with the text, it should have read 40 volts. Likewise in the third paragraph it should have read "I_p" means current flowing in the plate circuit. "E_g" means voltage of the grid." The reference letters were omitted from Fig. 3 but have been correctly placed in Fig. 14.

Audion Protective Device

(Continued from page 203)

value. The diagram below shows the connections.

This instrument should prove of value to all owners of audion circuits, and will save many a bulb which would have been burnt out by mistake or reckless handling.

You benefit by mentioning the "Radio Amateur News" when writing to advertisers.



Type L-1 Inductance Units

Pancake wound in Oak Cabinet with Bakelite front. Can be used as a Primary and a second as a Secondary constituting an excellent long wave-tuner, the range depending upon the size units employed. To vary the coupling it is only necessary to change the relative positions of the units. Also can be used with great success as Ticker Coils for Regenerative Reception. Furnished in three sizes. Maximum wavelength obtainable, 5,000 meters \$10.00. Maximum wavelength obtainable, 10,000 meters 11.00. Maximum wavelength obtainable, 15,000 meters 12.00.

Shipping Weight 4 pounds. Send stamps for complete catalog of high grade apparatus

WESTERN RADIO LABORATORIES
156 Second Street
San Francisco, California.



FLIES 500 FEET

Lightning Racer Experimental Model. This is not a toy. It is a practical, scientific flying model, guaranteed to fly hundreds of feet; designed and built from the finest selected materials, by Model Experts. This machine and our famous "Montauk Flyer" are the only Complete Model Aeroplanes guaranteed to fly 500 ft. selling for less than \$5.00. This model, shipped with monoplane detached, ready and guaranteed to fly \$2.75 prepaid. Send stamps for circular describing this wonderful model. Blueprints of the following models 1-2 actual size 60 cents per set paid in U. S. Blarlet Racer, flies 600 ft. Montauk Racer, flies 2000 ft. Montauk Flyer, flies 500 ft. 3 ft. Curtiss or De Havilland Biplane, 75 cents each, postpaid. REC Flying Boat guaranteed to rise from the water and fly 500 ft. Two sheets blueprint \$1.00 postpaid U. S. HEO AEROPLANE CO., 300 E. 49th St., N. Y. C.



VACUUM TUBE CONTROL PANEL

Most efficient and neatest panel manufactured.

Bakelite panel, graduated dials, mounted in oak cabinet. Variable grid condenser, rheostat, and tube receptacle mounted back of panel.

May be used in any circuit. PRICE—less Bulb (with V. T. Base)—\$13.25 (with Audiotron mounting)—\$12.00 For full information write

DAYNOR RADIO ELECTRIC COMPANY
Box 105 Wilkesburg, Pa.



SUPERLATIVE RADIO EQUIPMENT THE BEST KEY IN THE COUNTRY

10 Amp. \$7.75—20 Amp. \$8.25 A three cent stamp will bring bulletins of this and other higher grade apparatus.

THE RADIO ENGINEERING COMPANY,
22 St. Paul St., Baltimore, Md.

GOOD PRINTING BOOSTS SALES

We do it right and at reasonable prices. Write for quotation and samples. Parcel Post Printer. Dept. B, Kinmundy, Ill.

Baldwin Mica Diaphragm Amplifying Telephones

In order to enable every wireless operator to use the well-known Baldwin phones, we have reduced the prices as follows:

- NAVY TYPE "C".....\$15.50 each, F. O. B. New York
- SMALLER TYPE "D"..... 16.50 each, " " "
- NEWEST TYPE "E"..... 17.50 each, " " "

(more rugged and just as sensitive.)

Prices subject to change without notice

Apply to your nearest local distributors. If unable to obtain same, forward your order with money order direct to us. If any operator desires a lower cost but high class phone other than the "Baldwin" we can recommend the "Brownlie" adjustable type—Price \$11.00, F.O.B. New York.

We are also sole distributors of Kolster Decremeters and Wavemeters for un-damped waves.

Navy Standard Lyden Jars with silver and copper deposit.

JOHN FIRTH & COMPANY, Inc.

81 New Street

New York City

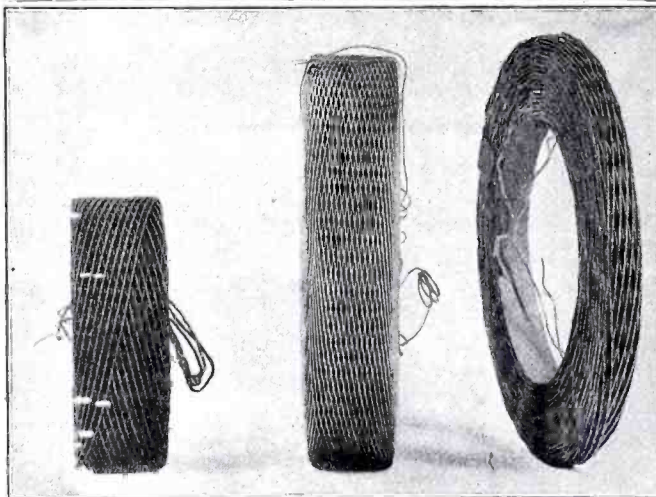

"Not Sold"

—This was the answer you received when you attempted to purchase these coils unmounted.

*Radisco High Frequency Inductances
(Universal Spaced Winding)*

The above coils are only one of the many articles which the RADISCO agencies carry in stock.

Within a short time there will be a RADISCO agency in every part of the United States.

You will profit by becoming acquainted with the RADISCO agency in your vicinity.

Drop them a post card with your name and address, and on this post card tell them what kind of receiving or transmitting apparatus you now have.

If there is no agency in your vicinity, communicate direct with—

THE RADIO DISTRIBUTING COMPANY, 312 FLATBUSH AVE., BROOKLYN, N. Y.

RADISCO AGENCIES:

- BIENVILLE, QUE., CAN.....Canadian Radio Mfg. Co.
- BOSTON, MASS.....Atlantic Radio Co., 34 Batterymarch St.
- BROOKLYN, N. Y.....Kelly & Phillips Elec. Co., Flatbush Ave., bet. 7th & 8th.
- NEWARK N. J.....A. H. Corwin Co., 924 Kinney Bldg.
- NEW ORLEANS, LA.....L. A. Rose, 4323 Magnolia St.
- PROVIDENCE, R. I.....Rhode Island Elec. Equip. Co., 45 Washington St.

You benefit by mentioning the "Radio Amateur News" when writing to advertisers.



Every Electrical Man Wants These Books and we ship them for your inspection **FREE**

Flexible
Covers
—
Handy
Pocket-
Size
Volumes

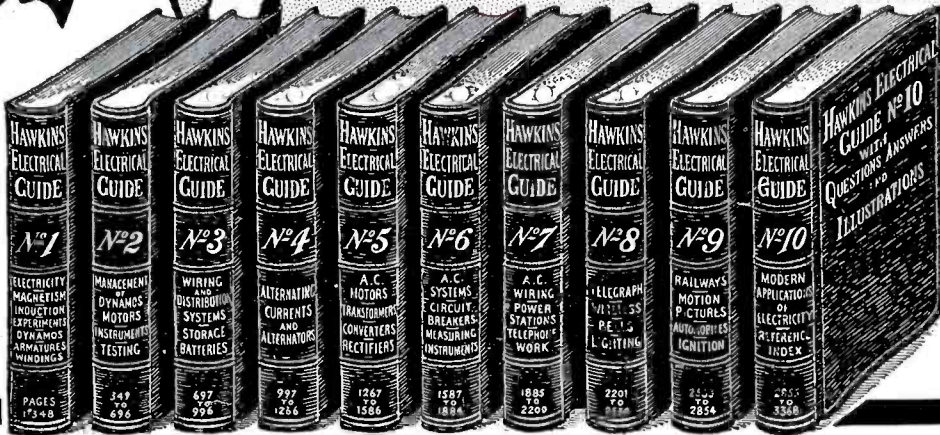

10
Volumes
3500
Pages
4700
Pictures
\$1 Per
Volume
\$1 Per
Month

Just what you need to know to succeed in ELECTRICITY

EVERY electrician, every engineer, every mechanic should know about these wonderfully helpful instructive books, which give in plain words a complete working knowledge of electrical engineering in all its phases.

You run into some new electrical problem almost every day. The information you need to help you in your every day work is in

HAWKINS ELECTRICAL GUIDES

These books place electricity at your finger ends. They cover every imaginable subject, principle, theory, problem, trouble, and way of doing things electrically. Every subject is indexed so that you can turn right to it. They are a study course and a reference guide in one, written in plain every day language—no wasted words—only what you need to know—chock full of up-to-the-minute electrical knowledge. The guides are a complete course in electrical engineering. They will help you in every detail of the day's electrical work. You can't ask an electrical question that Hawkins Guides can't answer.

Pocket-Size Flexible Covers

The books are small enough to slip into your coat pocket—handsomely bound in flexible black covers. You can carry each volume with you until you have mastered its contents. 3,500 pages of actual information and 4,700 illustrations. Once you see these books and put them into actual use you will never again want to be without them. Try it at our expense.

SEND NO MONEY

It will cost you nothing to receive these books—to look them over—ask them all the questions you can think of—use them in your work—study them—pick up some information that will increase your earning ability. We will ship you the entire set of 10 volumes entirely FREE. This is a sign of our confidence in the guides. Pure gold does not object to being tested. Keep them for seven days and if you do not decide that you can't get along without them, return them to us and owe us nothing.

When you decide to keep them you only have to pay \$1.00 down and remit the balance of \$9.00 on the easy payment of \$1.00 a month till paid for.

Theo. Au-del & Co. will pay you many times over.

THEO. AUDEL & CO.
72 Fifth Ave. New York, N. Y.



READ THIS PARTIAL LIST OF CONTENTS

- No. 1** Contains 348 pages, 388 illustrations. Electrical signs and symbols—static and current electricity—primary cells—conductors and insulators—resistance and conductivity—magnetism—induction coils—dynamic principles—classes of dynamos—armatures—windings—commutation—brushes, etc.
- No. 2** Contains 348 pages, 394 illustrations. Motor principles—armature reaction—motor starting—calculations—brake horsepower—selection and installation of dynamo and motors—galvanometers—standard cells—current measurement—resistance measurement—volumeters—wattmeters—watt hour meters—operation of dynamos—operation of motors, etc.
- No. 3** Contains 300 pages, 423 illustrations. Distribution systems—wires and wire calculations—inside, outside and underground wiring—sign flashers—lightning protection—rectifiers—storage battery systems, etc.
- No. 4** Contains 270 pages, 379 illustrations. Alternating current principles—alternating current diagrams—the power factor—alternator principles—alternator construction—windings, etc.
- No. 5** Contains 320 pages, 614 illustrations. A. C. Motors—synchronous and induction motor principles—A. C. commutator motors—induction motors; transformers; losses, construction, connections, tests—converters—rectifiers, etc.
- No. 6** Contains 298 pages, 472 illustrations. Alternating current systems—switching devices—circuit breakers—relays—lighting protector apparatus—regulating devices—synchronous condensers—indicating devices—meters—power factor indicators—wave form measurement—switch boards, etc.
- No. 7** Contains 318 pages, 379 illustrations. Alternating current, wiring power stations—turbines; management, selection, location, erection, testing, running, care and repair—telephones, etc.
- No. 8** Contains 332 pages, 436 illustrations. Telegraph—simultaneous telegraphy and telephony—wireless—electric bells—electric lighting—photometry, etc.
- No. 9** Contains 322 pages, 627 illustrations. Electric railways—electric locomotives—car lighting—rolley car operation—miscellaneous applications—motion pictures—gas engine location—automobile self-starters and lighting systems. electric vehicles, etc.
- No. 10** Contains 513 pages, 599 illustrations. Elevators—cranes—pumps—air compressors—electric heating—electric welding—soldering and brazing—industrial electro-lysis—electro plating—electro-therapeutic—X-rays, etc.

Also a complete 126-page ready reference index of the complete library. This index has been planned to render easily accessible all the vast information contained in the 10 electrical guides. There are over 13,500 cross references. You find what you want to know instantly.

THEO. AUDEL & CO.
72 Fifth Ave.
New York, N. Y.

Please submit me for examination Hawkins Electrical Guides (price \$1 each). Ship at once, pre-paid, the 10 numbers. If satisfactory I agree to send you \$1 within seven days and to further mail you \$1 each month until paid.

Signature _____
Occupation _____
Employed by _____
Residence _____
Reference _____

What Electrical Men Say

- Helped Him Make Good**
"It is only right for me to recommend highly the Hawkins Guides, for they have been of the greatest assistance to me in placing me in my present position as Superintendent of Construction Department of one of Ohio's largest Electrical Companies. I would like to see every man have a set of Hawkins Guides."
Geo. Knecht, Columbus, Ohio.
- In the Naval Electrical Dept.**
"The Hawkins Guides are great help to me in the Naval Electrical Department, which they cover very thoroughly."
C. J. Cornell, U. S. Receiving Ship, Brooklyn, N. Y.
- Superintendent**
"I am now superintendent of the Dunville Hydro-Electric Systems, and Hawkins Guides were a great help to me in holding down a responsible position."
W. E. Swartz, Dunville, Ontario.
- Wireless Operators**
"I have worked wireless for ten years—but I wish I had these books years ago, as they have saved me a great deal of trouble."
E. Marshall, Brouwer, M & B No. 2, Walkerville, Ont.

You benefit by mentioning the "Radio Amateur News" when writing to advertisers.



BE A CERTIFICATED ELECTRICIAN

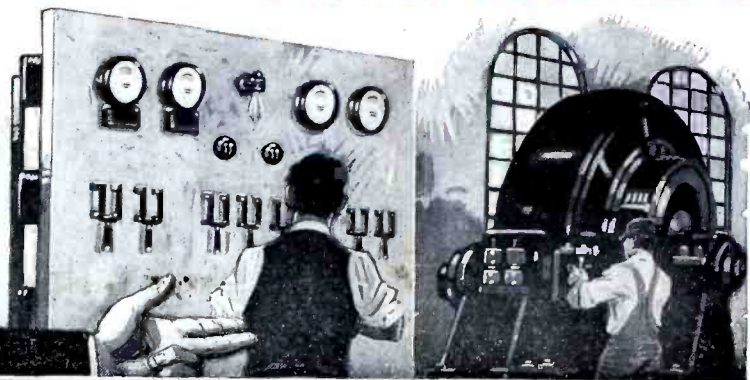

I WILL TRAIN YOU AT HOME

A REAL POSITION LIKE THIS—FOR YOU

The country needs thousands of trained, Certificated Electricians to fill good positions—and at big pay. It's all a matter of knowing how, and I will teach you by up-to-date, modern instruction. You can learn at home, without interfering with your regular work, by my highly successful method of *Home Instruction in Practical Electricity*.

Prepare NOW and be ready in a few months to earn your \$46 to \$100 A WEEK

Send for this Book

My book, "HOW TO BECOME AN EXPERT ELECTRICIAN," has started thousands of young men on the way to splendid success. A new edition of this has just been printed. I want every young man interested in Electricity to have a copy, and will send you one, ABSOLUTELY FREE AND PREPAID. Write me today.

How I Train My Students

As Chief Engineer of the Chicago Engineering Works I know exactly the kind of training a man needs to enable him to get and hold good positions, and to earn big pay. I have trained hundreds of men who are holding splendid electrical jobs.

I give each of my students personal attention and a complete and

thorough training. I give him a **SPLENDID ELECTRICAL OUTFIT FREE**, and much of the training is done by actual work. When my students graduate and receive their Certificate, they are ready for a real position. But *still more*, at any time you wish you can come to our splendidly equipped Electrical Shops for special training. No other school can give you this.

A Real Opportunity for YOU

Wishing is never going to make your dreams come true. You've got to *study—to learn*. A man is worth possibly \$2 or \$3 a day from his neck down—and no more; but there is *no limit* to what he can be worth from his neck up.

A *trained mind* is what gets the big pay. It is this training that you need, and I can train you in a few months. Are you ambitious to make a real success—then send me the coupon—today.

Electrical Outfit FREE

To every student who answers this ad I am giving a Splendid Electrical Outfit of standard size Electrical Tools, Instruments, Materials, etc., *absolutely free*. Furthermore, to every Electrical Student I give a truly *valuable* surprise that I cannot explain here.

Free Employment Service

I am continually receiving requests from employers to send them trained Electrical men. I assist my students to secure good positions. I keep in touch with them for years, helping and advising them in every possible way.

Write Now—Don't Delay

Delay never got you anything. Action is what counts. Get started—and get started now. Write me, or send me the coupon, right NOW.

L. L. COOKE, Chief Engineer
CHICAGO ENGINEERING WORKS
441 CASS ST. Dept. 410 CHICAGO

USE THIS "FREE OUTFIT" COUPON
CHIEF ENG. COOKE, Chicago, Ill.
Dept. 410 441 Cass St., Chicago, Ill.
Sir: Send at once—fully prepaid and outfit free—complete particulars of your great offer for this month.
Name.....
Address.....
City.....
State.....

YOU CAN DO IT