

# RADIO AND

SEPTEMBER 1949 25c



# DISTRIBUTION AND MAINTENANCE

DEVOTED TO SALES AND SERVICE OF RADIO - VIDEO - AUDIO

*An RCA Merchandising First...*



**You GIVE AWAY this toy truck  
with every RCA-VS022T Farm Pack**

Each standard-size RCA Farm Pack is now shipped in a container that any child can easily assemble into a handsome and serviceable toy truck. Order a

generous supply of RCA-VS022T's from your RCA Battery Distributor. The RCA Toy Truck is a sales opportunity you can't afford to pass up!

ALWAYS KEEP IN TOUCH WITH YOUR RCA DISTRIBUTOR



**RADIO CORPORATION of AMERICA**

HARRISON, N. J.



*Setting the Pace...*

**in the seven-inch field  
Webster-Chicago Model 77**

**... Plays Eight 7-Inch Records Automatically — Either 33 $\frac{1}{3}$  or 45 RPM**

Typical of Webster-Chicago quality engineering, the Model 77 Record Changer incorporates all of the finest features of automatic record changer design. It provides quick, fool-proof operation and quality reproduction with a minimum of delicate record groove wear.

There's plenty of "eye appeal," too, in this smartly styled unit. It's compact in size—an ideal installation or replacement unit for any radio or amplifier.

Just look at all these features.

- Plays up to eight 33 $\frac{1}{3}$  or 45 rpm records automatically.
- 3 second change "cycle"—"from music to music"... fastest on the market

- Velocity-Trip—no lateral pressure on delicate record grooves, assures quick fool-proof record change—low record wear.
- Single Tone Arm—smooth controlled tone arm performance properly balanced for either record.
- Needle matched to cartridge for superb tracking and better reproduction—5 to 7 gram needle pressure.
- Fool-proof spindle record release with ingenious rubber record retaining shoulder that will not damage the records.
- Positive, easily selected speed control.
- Reject mechanism features "Memory Delay"—positive acting, never fails.

*DIMENSIONS: Base Plate: 10 $\frac{1}{4}$ " x 7 $\frac{1}{8}$ ", Height above base plate 3 $\frac{1}{2}$ ", Depth below base plate 3 $\frac{1}{8}$ ".*

*...here's a formula that really adds up...*

**THE FAMOUS  
WEBSTER-CHICAGO NAME**

The name Webster-Chicago has long been identified with quality products in the public's mind.

**DEPENDABLE WEBSTER-  
CHICAGO QUALITY**

Every WEBSTER-CHICAGO product stresses quality materials and manufacture.

**CONSISTENT WEBSTER-  
CHICAGO PROMOTION**

Backed by effective literature, display material and a liberal cooperative advertising policy.

**It all adds up — MORE SALES AND PROFITS — for You**



**WEBSTER-CHICAGO**

CHICAGO 39, ILLINOIS

# NOW...

**ONE MAN  
ALONE  
CAN ORIENT  
A TV ANTENNA  
QUICKER AND  
BETTER!**

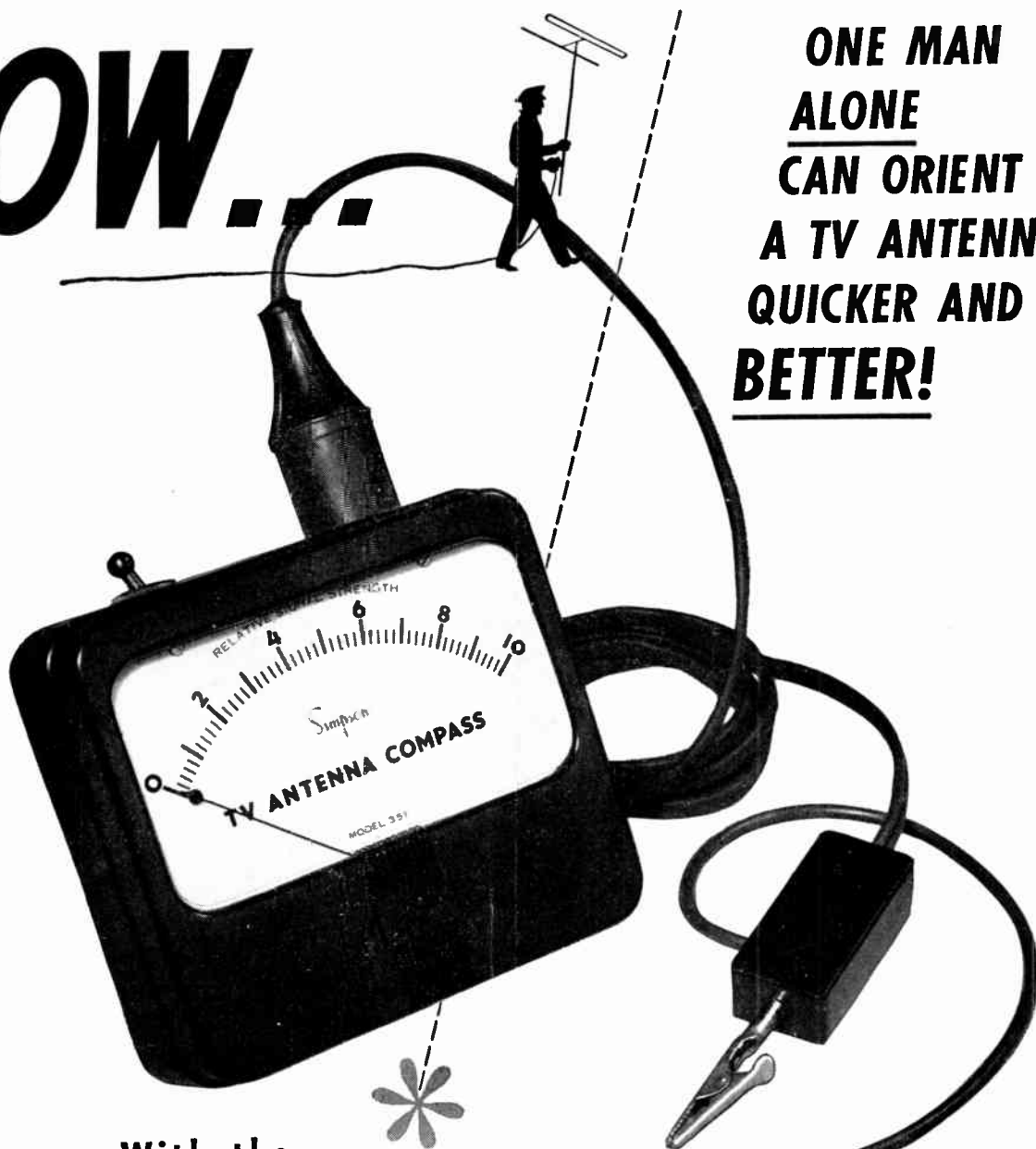

With the  
New  
SIMPSON

**TV**  
*Antenna Compass*

Simpson Model 351 is a ruggedly built pocket size meter which connects to the video input of the cathode ray tube in a television receiver. By an extension cord it is carried to the antenna site. With a test pattern tuned in on the area's weakest station, the antenna is simply rotated for maximum deflection of the TV Antenna Compass! Identifies ghosts, too. Much more accurate than the old-fashioned method — and *one man does it in one-third the time two men used to take!* Dealer's net price only \$16.35. Your Parts Jobber has them NOW.

**Simpson**  
INSTRUMENTS THAT STAY ACCURATE

SIMPSON ELECTRIC COMPANY 5200-18 WEST KINZIE STREET CHICAGO 44, ILLINOIS

In Canada: Bach-Simpson Ltd., London, Ontario



**IT'S  
SYLVANIA  
AGAIN!**

**ION TRAP IN SYLVANIA  
TELEVISION TUBES  
ASSURES HUNDREDS  
OF HOURS FREE FROM  
SCREEN BURNS**



**HERE'S HOW IT WORKS ...**

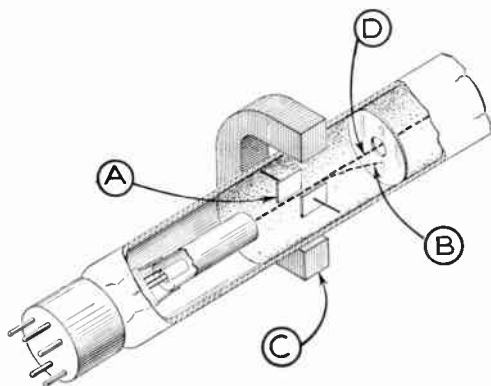

- A.** Electrostatic field
- B.** Ions are bent away from normal axis of tube by electrostatic field
- C.** External magnet neutralizes the effect of the electrostatic field on the electrons
- D.** Electrons follow a straight line

*Heavy ions are thus trapped in the electron gun while the electrons pass through to strike the fluorescent screen.*

Owners of television sets equipped with Sylvania Television Picture Tubes report their screens still bright and unblemished after more than 1000 hours' use. Much credit for this top quality performance belongs to Sylvania scientists who hold the basic patents on the magic "ion trap." With this device these scientists prevented destruction of the fluorescent screen by heavy ion bombardment. So successful is this ion trap that now many other major TV tube makers are using it under agreements with Sylvania.

These same Sylvania Television Tube scientists are now developing shorter large-screen picture tubes and special tubes for uhf television. Their continued research makes the Sylvania label your guarantee of the newest and finest in television picture tubes. Sylvania has a complete line of all-glass and glass-metal types for television and general purpose cathode ray applications. They are available now from your Sylvania Distributor.

Write for free characteristics and TV set complement chart. Advertising Department, Box R-2009, Emporium, Pa.

**SYLVANIA  
ELECTRIC**

RADIO TUBES; CATHODE RAY TUBES; ELECTRONIC DEVICES; FLUORESCENT LAMPS, FIXTURES, WIRING DEVICES, SIGN TUBING; LIGHT BULBS; PHOTOLAMPS

SEPTEMBER 1949 • RADIO DISTRIBUTION AND MAINTENANCE

# RADIO AND

# DISTRIBUTION MAINTENANCE

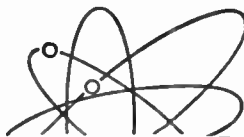

**WILLIAM F. BOYCE**  
Publisher

**JOSEPH J. ROCHE**  
Editor

**ISIDOR I. GROSS**  
Assistant Editor

**VICTOR M. TURNER**  
Art and Sales

**MORTON SCHERAGA**  
Contributing Editor

**FRANK VAN SEETERS**  
Circulation Manager

Volume 5

September 1949

Number 9

## CONTENTS

Comments .....	6
Radio Industry Newsletter .....	9
Do You Know Your Test Equipment? .....	12
The first article in a new series devoted to f-m and television test instruments	
How to Service Video Amplifiers .....	14
Going into the numerous problems which the technician will encounter when servicing teletests	
It's Time to Review Installation Policy .....	17
A timely discussion of a problem that is rapidly coming to a head	
It's PA for Big Profits .....	18
Showing that the field of public address work bears looking into	
Electronically Speaking .....	20
Over the Bench .....	22
Trade Literature .....	24
Industry Presents .....	26

### ADVERTISING REPRESENTATIVES

**Eastern**  
Herbert J. Olsov  
480 Lexington Ave.  
New York 17, N. Y.  
Plaza 9-0861

**Midwestern**  
Stuart J. Osten  
333 No. Michigan Ave.  
Chicago 1, Ill.  
Dearborn 2-3507

Copyright 1949, Boland & Boyce, Inc.

Radio Distribution and Maintenance is published monthly by Boland & Boyce, Inc., at 34 No. Crystal St., East Stroudsburg, Pa., U.S.A.; Executive and Editorial Office, 460 Bloomfield Ave., Montclair, N. J. Subscription Rates: In U. S., Mexico, South and Central America, and U. S. possessions, \$3.00 for 1 year, \$5.00 for two years, single copies 25 cents; in Canada, \$3.50 for 1 year, \$6.00 for 2 years, single copies 30 cents; in British Empire, \$4.00 for 1 year, \$7.00 for 2 years, single copies 45 cents; all other foreign countries, \$5.00 for 1 year.

Entered as second class matter June 15, 1949, at Post Office, East Stroudsburg, Pa., under the Act of March 3, 1879.

Change of address: Four weeks' notice required for change of address. When ordering a change, furnish an address stencil impression from a recent issue if you can. Address changes cannot be made without the old stencil as well as the new one.

*Play Safe!*  
Use Reliable  
**TELEVISION  
REPLACEMENTS**

Television requires the most durable, heat-and-moisture-resistant components you can get. In capacitors, that means Sprague. You'll have no profitless call-backs with extra-dependable Sprague TV capacitors.

**SPRAGUE  
TELECAP\*  
MOLDED TUBULARS**



Only Telecaps are molded in heat-resistant Bakelite phenolic, oil-impregnated, and then solder-sealed—just like metal-encased oil-paper capacitors. No other manufacturer can make this claim! Ratings from 600 to 10,000 volts.

**SPRAGUE  
ATOM® and  
TWIST-LOK\*  
DRY ELECTROLYTICS**



The most complete line of television electrolytics. Engineered especially for tough TV replacement applications, Sprague's new Type TVA Atom and Type TVL Twist-Lok electrolytics stand up under the extremely high temperatures, high ripple currents and high surge voltages encountered in TV receivers.

Write for Sprague Bulletin M-429

**SPRAGUE PRODUCTS CO.**  
(Distributors' Division of the Sprague Electric Co.)  
NORTH ADAMS, MASS.

\*Trademark

**Representatives for Boland & Boyce Publications: Radio Distribution and Maintenance, Radio Data Book, Video Handbook, Radio & Television Library Set, Technical Manuals.**

**THOMAS A. BYRNES**

Director of Field Services  
460 Bloomfield Ave., Montclair, N. J.

**CHARLES H. BROOKSBANK**

Manager, Book Sales  
460 Bloomfield Ave., Montclair, N. J.

**VICTOR M. TURNER**

Manager Circulation Sales  
460 Bloomfield Ave., Montclair, N. J.

**ROBERT STANG**

79 Storer Ave., Pelham 65, N. Y.  
Area 1 & 5: N. Y., N. J., E. Pa., Md.,  
Del., D.C.

**ROY M. HOWARD**

Midwest Sales Co. Mfgs. Agents  
Hanna Bldg., Cleveland 15, Ohio  
Tel: Main 9392  
Area 2: W. Pa., W. Va., Ky., Ohio,  
Ind., Mich.

**NORMAN R. MACINNIS**

53 Youle St., Melrose 76, Mass.  
Tel: Melrose 4-0879  
Area 4: New England

**FLOYD FAUSETT & SON**

1347 Beecher Street S. W., Atlanta, Ga.  
Tel: Cypress 4646  
Area 6: E. Tenn., S. C., N. C., Va.,  
Ala., Fla., Ga.

**MICHAEL ALFEND**

3100-06 Chouteau Ave., St. Louis 3, Mo.  
Tel: Sidney 7616  
Area 7: E. Nebr., W. Iowa, Kansas, Mo.,  
S. Ill., N. Ark.

**AL J. RISSI**

1169 S. Bway., Los Angeles 15, Calif.  
Tel: Prospect 2105  
Area 10: California

**FRANK WEDEL CO.**

Seattle 5, Wash.  
Area 11: Wash., Ore., Idaho, Mont.

**GEORGE H. PIERCE**

715 Camp St., New Orleans 12, La.  
Tel: Raymond 9009, Magnolia 2643  
Area 12: S. Ark., La., W. Tenn., Miss.

**FRANKLIN Y. GATES**

Gates Co.  
200 South Main, Salt Lake City 1, Utah  
Tel: 9-1101  
Area 14: Wyo., Utah., Colo., Nev.,  
N. M., W. Nebr.

# Comments

## Service Policies

Recent developments point to a trend away from yearly service policies for TV receivers. A great deal has been said for and against the yearly service agreement, and there is no doubt that it has both good and bad points.

While we don't think that the yearly policy is headed for extinction, we feel certain that most service work will not be performed on this basis in the future. Since the customer pays in advance at the time he purchases his receiver, the cost of the policy is mentally added to the price of the teletset. The events of the past few months have made it clear that price is now a primary factor in selling TV receivers.

Several other industries have experimented unsuccessfully with yearly service agreements. Such agreements have generally failed when used at the consumer level, even though they have proved successful when sold to business concerns.

The recent finding of New York's Attorney General to the effect that service agreements are a form of insurance will be a factor in the decline in the use of yearly agreements in that state.

## Level Ground

The price readjustment in television receivers which has been in full swing for the last few months seems to be coming to an end. Most of the large manufacturers have announced, or are about to announce, new receiver lines with prices considerably below the last crop. Many manufacturers are guaranteeing their dealers against losses incurred should further reduction in prices become necessary. This of course places a severe restriction on future price cuts by the manufacturer. He will be doubly reluctant to cut his prices if it means paying a considerable sum to dealers.

At the moment, the most painful part of the readjustment is in progress. Dealers are disposing of their stock of older models at sale prices. When current inventory has been moved out of the stores, prices should stabilize.

The advent of cooler weather and the return of the top television shows in September, will be a considerable stimulus for sales. With good television receivers available for less than \$200, 1949 should continue to be television's year.

## The Color of Things

A few months ago we mentioned here that an FCC announcement regarding color television would probably bring about a renewal of the controversy which took place several years ago.

FCC set the time for the bout when it announced that it would consider color during the September allocation hearings. The contestants are presently in training, readying their big guns for that time.

CBS has let it be known that it has devised an inexpensive converter which can be used with present receivers, after modification.

Several teletset manufacturers have expressed fear that color may prove a blow to their receiver sales button, and stagger the still groggy marketing situation. It's still too early to predict the outcome of the contest, but September should tell the tale.

JJR

*announcing*

The Greatest Advent in Speaker Development!

*The New*  
**PERMOFLUX**  
**High-Fidelity**  
**SPEAKERS**

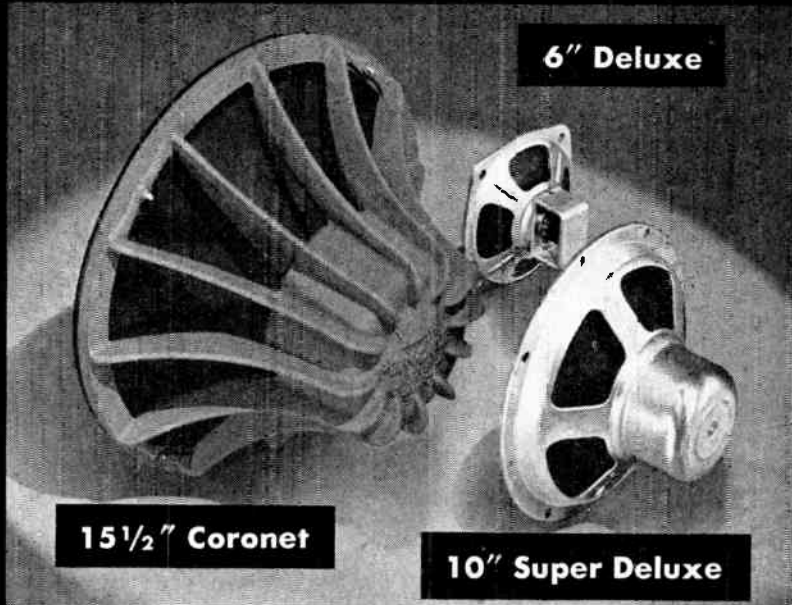

A Special Treatment in Design that Eliminates Distortion!

These outstanding, new, deluxe high-fidelity speakers make PERMOFLUX, the most complete speaker line in the world!

**SERVICEMEN — DEALERS**

- Insist on the best!
- Buy PERMOFLUX Speakers!
- See your jobber today!

PERMOFLUX speakers will outperform, model for model, any speaker on the market.

PERMOFLUX HIGH-FIDELITY SPEAKERS					
Deluxe High Fidelity Models—Heavy Magnets—No Pot Covers					
SIZE	MODEL NO. OR CODE	MAGNET DATA FLUX GAUSS	VOICE COIL DIA-METER	DATA IMPE-DANCE	WATTS
6"	6L-1	10000	3/4"	3.2	5
8"	8T-8-1	10000	1"	8.0	8
10"	10T-8-1	10000	1"	8.0	9
12"	12T-8-1	10000	1"	8.0	10
Super Deluxe High Fidelity Models — Extra Heavy Magnets — With Pot Covers					
8"	8WP-8-1	10000	1 1/4"	8.0	10
10"	10WP-8-1	10000	1 1/4"	8.0	11
12"	12WP-8-1	10000	1 1/4"	8.0	12
15"	15WP-8-1	10000	1 1/4"	8.0	15
"Coronet" Supreme High Fidelity					
12 1/2"	125Z-16	15000	2"	16 ohms	20
15 1/2"	155Z-16	15000	2"	16 ohms	35

NEW catalog available upon request. Write for your FREE copy!

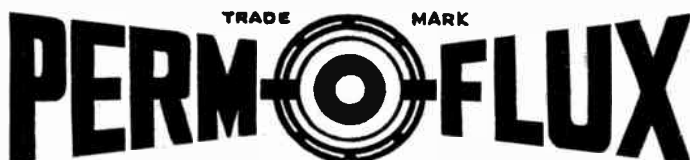

**PERMOFLUX CORPORATION**

Two Factories to Serve You  
 Chicago 39, Illinois 4900 West Grand Avenue  
 Glendale 5, California 236 South Verdugo Road

# BUY THE BEST • THE V.O.M.A. THAT DOES MORE

**MORE FOR YOUR MONEY**



**Triplet Model 630**

**\$37.50**  
Dealer Net

In the relatively short time since Model 630 was introduced to the trade it has steadily risen to the top in sales. The reason is obvious. Here is a Volt-Ohm-Mil-Ammeter that does more . . . has proven components . . . and will give a lifetime of satisfaction. All the engineering skill and facilities of the industries' largest manufacturer of Volt-Ohm-Mil-Ammeters joined forces to make it outstanding in every way. Look over all the features and you too will buy Model 630.

## NOTE THESE SENSATIONAL IMPROVEMENTS:

- ★ Individual Scales with separated spacing are easy to read.
- ★ Large 5½ Inch Meter In Special Molded Case Under Panel.
- ★ Resistance Scale Markings from .2 Ohms to 100 Megohms—Zero Ohms Control Flush With Panel.
- ★ Only One Switch—Has Extra Large Knob 2½" Long—Easy To Turn—Flush With Panel Surface.
- ★ Enclosed New Molded Selector Switch and insulated resistor housing in unit construction.
- ★ All Resistors Are Precision Film or Wire Wound Types For Permanent Accuracy.
- ★ Batteries Easily Replaced—Balanced Double-Contact Grip. Spiral Spring—Battery for Ohms test due to low drain insures shelf-life usage.

### TECH DATA

D.C. VOLTS: 0.3-12-60-300-1200-6000 at 20,000 Ohms/Volt  
 A.C. VOLTS: 0.3-12-60-300-1200-6000 at 5,000 Ohms/Volt  
 D.C. MICROAMPERES 0-60 at 250 Millivolts  
 D.C. AMPERES 0-12 at 250 Millivolts  
 D.C. MILLIAMPERES 0-1.2-12-120, at 250 Millivolts  
 OHMS: 0-1000-10,000; (3.4 Ohms and 41 Ohms center scale)  
 MEGOHMS: 0-1-100 (4400-440,000 at center scale)  
 DECIBELS: -30 to +4, +16, +30, +44, +56, +70  
 OUTPUT: Condenser in series with A.C. Volt ranges  
 High voltage Probes available, extra; also plug-in shunts for other current measurements to suit special needs.

**Laboratory Standard Model 630-A**—All scales on this model are hand drawn and hand stepped, used with mirror for extreme accuracies, beyond the average servicing needs of the model 630.

**Triplet Model 630-A Dealer Net \$47.50**

## VOMA JR.—A NEW VOLT-OHM-MIL-AMMETER

**Handy "POCKET-SIZE LABORATORY"  
By Triplet**

VOMA Jr. MODEL 666-R has many of the design features of the popular Model 630:

1. Switch and controls flush with panel.
2. Enclosed molded selector switch.
3. Exclusive Unit construction-resistor housing integral with switch.
4. Resistors Precision wire wound and permanent film type.
5. Resistance Measurements to 3 Megohms.
6. Batteries with spiral spring contacts, easily replaced.

**VOMA Jr. MODEL 666-R . . . \$24.50**

*U.S.A. Dealer Net Price*

**Note:** Model 666-HH The Original Pocket-Size Lab—still a favorite with many. U.S.A. Dealer Net \$22.00.

**TRIPLET ELECTRICAL INSTRUMENT COMPANY • BLUFFTON, OHIO, U.S.A.**

*In Canada: Triplet Instruments of Canada, Georgetown, Ontario*



### TECH DATA

D.C. VOLTS: 0-10-50-250-1000-5000, at 1000 Ohms/Volt  
 A.C. VOLTS: 0-10-50-250-1000-5000, at 1000 Ohms/Volt  
 D.C. MILLIAMPERES: 0-10-100, at 250 Millivolts  
 D.C. AMPERES: 0-1, at 250 Millivolts  
 OHMS: 0-3000-300,000 . . . (20-2000 at center scale)  
 MEGOHMS: 0-3 . . . (20,000 ohm center scale)

*Precision first . . . to Last*

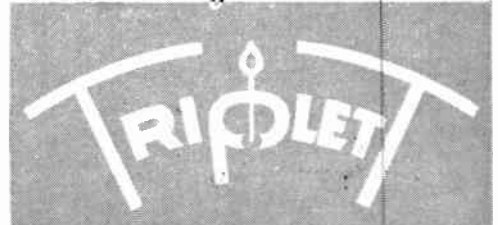



# RADIO INDUSTRY

# Newsletter

edited by Joseph J. Roche

September 1, 1949

The FCC made several anxiously awaited announcements during the month. The Commission released its proposed revision of TV channel assignments. The proposal would add 42 new channels. With the present twelve, that means there would be a total of 54 TV channels available.

32 of the additional channels are for metropolitan stations, the remaining for community stations.

To be numbered 14 through 55, the new channels would start at either 470 Mc or 500 Mc, depending upon what action the commission takes with regards to a Bell Telephone request for space for a mobile communications system.

The Commission stated that it had attempted to maintain 200-mile co-channel and 110-mile adjacent channel station separation in the present band, with 140-mile co-channel and 60-mile adjacent channel station separation in the u-h-f band.

The upper portion of the u-h-f television band would still remain available for experimental TV.

Under the new plan, more than 2,000 station assignments would be available.

Question being asked . . . who is going to build all the stations and when?

How the new proposal will affect you depends upon your location.  
Samples . . .

In New York, Boston, or Chicago the change will be slight since present channel assignments will remain the same and no u-h-f assignments have been added. Only difference . . . You may or may not be able to receive near-by community stations operating in u-h-f band.

In Philadelphia, Baltimore, or Washington, present channel assignments will remain. In addition, one or more u-h-f channels will be available . . . If you live in any one of several hundred small communities, you will have a local television station . . . that is, if someone decides to build and operate one.

Reaction . . . some thought that the public should not have been let in on this proposal for the use of their (the public's) airwaves . . . Others wanted to know why New York with a population in the millions would have only seven channels, while a community populated by a mere 7,000 would have six channels.

September 26 has been set for the beginning of hearings on the allocation proposal.

Color Television will be given consideration during the hearings. The

Commission requested that interested parties submit comments and evidence.

Also to be considered . . . will be Stratovision, and non-commercial educational TV broadcasting.

\* \* \* \* \*

Everyone is getting into the act . . . the National Bureau of Standards got in by appointing its own Color Television Committee. The committee will study bandwidth requirements, equipment development, propagation, and adaptability of present receivers.

The NBS Committee will report to Senator Johnson's Senate Committee on Interstate and Foreign Commerce, which is concerned with policy in the radio communications field.

\* \* \* \* \*

The RMA called a meeting at the Roosevelt Hotel in New York to draft its recommendations on the TV allocation proposals.

At the meeting . . . a report was received from RMA's newly appointed Color Television Committee.

\* \* \* \* \*

Another FCC announcement is causing considerable reaction.

In June, FCC ruled that TV stations could not broadcast test patterns accompanied by music or news broadcasts.

Said the Commission . . . "television channels shall be used only for simultaneous visual and aural television programming . . . and not for separate aural broadcasts.

The National Association of Broadcasters asked for a delay in enforcement . . . so that it could gather comments from its members.

The FM Association informed the Commission that it was in agreement with the new ruling.

The Television Broadcasters Association felt that TV stations should be permitted to broadcast music with test patterns because it is easier to tune teletests with music.

\* \* \* \* \*

Diathermy interference has been a major cause of complaint by viewers. The FCC has announced its proposal to modify the rules concerning diathermy in an effort to minimize interference from this source . . . Users of diathermy apparatus, now responsible for interference resulting from harmonic and spurious radiation, will probably also be responsible for fundamental frequency interference.

\* \* \* \* \*

The trend toward lower teletest prices continues.

Most notable development during month has been the announcement of a new lower priced line by RCA, which unveiled eight new models. Typical prices . . .

A 16-inch table model for \$392, a hundred dollars lower than the previous equivalent model . . . a 16-inch console priced at \$429.50 . . . and a 10-inch table model for \$199.95, about 70 dollars below the last such model. RCA also announced its first 12 1/2" set.

\* \* \* \* \*

Dealer price protection policies are being adopted by many teletest manufacturers.

Westinghouse now protects dealers from loss on any set purchased within 60 days prior to a price reduction.

Emerson has announced a similar plan.

\* \* \* \* \*

Sylvania announced its net income for the second quarter of '49 . . . \$378,-252 as compared to \$948,565 for the same period of '48. Sales for both periods were roughly the same. Reason for lower income . . . reduced demand for radio tubes which necessitated closing one of company's five tube plants, sharp price reductions in cathode ray tubes, severe decline in the fluorescent fixture business.

Motorola announced net earnings of \$1,908,255 for the first half of '49; up from first half of '48 when earnings were \$1,650,039.

\* \* \* \* \*

Most experts still believe that teletest sales for the balance of this year will exceed 1 1/2 million, despite present difficulties.

DuMont filed a court motion for a temporary injunction restraining New York's R. H. Macy from advertising and selling DuMont teletests at cut prices.

More than a million teletests . . . have been manufactured this year, according to an RMA estimate. That's more than were produced in the whole of 1948.

Production of FM receivers was approximately a half million, down considerably from last year.

AM home receiver production was a mere shadow of its former self. Only 1,220,098 sets were manufactured.

\* \* \* \* \*

Sylvania engineers Ralph R. Shields and Clarence G. Simpson are scheduling a nation-wide series of television service meetings. Meetings will be sponsored by Sylvania distributors.

\* \* \* \* \*

Teaching by television . . . is the subject of a Navy research experiment. NBC, in cooperation, is giving air time over its New York, Philadelphia, and Washington stations, Saturdays and Sundays, from July 30.

\* \* \* \* \*

The Television Technicians Lecture Bureau will sponsor a nation-wide program of technical lectures for service technicians.

\* \* \* \* \*

In Chicago . . . Mayor Martin Kennelly proclaimed October 1 through 9 National Electric Living Week; the show of the same name will be held there at that time.

\* \* \* \* \*

As of July 1, FCC had authorized . . . 2,187 a-m stations, 868 f-m stations, and 120 television stations, a grand total of 3,175 broadcast stations.

Sylvania's new teletests went into production August 15.

Motorola completed a 40% expansion of its teletest production facilities, can now produce 500 sets daily.

\* \* \* \* \*

Philco held a two-day convention attended by 250 wholesale distributor service managers.

DuMont announced that it had developed a new 19-inch screen metal picture tube. The tube is two inches shorter than the present 15-inch tube and weighs only 16 pounds.

Zenith disclosed that it had developed a new screen coating which will greatly increase the contrast of television pictures. It will produce pictures with contrast equal to that of photographs.

Pittsburgh Plate Glass Co. has developed a new type glass for use in picture tubes. The glass is said to greatly decrease glare and eyestrain.

Joseph J. Roche  
Editor

## ***f-m and tv test equipment***



Courtesy Allen B. DuMont Labs.

# do you know your TEST

***Starting a new series on test equipment, how it works, how to choose it***

**W**ITH the growth of f-m and television sales and service business, most service organizations are finding it necessary to invest in new test equipment. In the past, a tube checker, multimeter, and signal generator were considered adequate for servicing radio receivers. These three basic instruments however are not sufficient for the profitable servicing of f-m and television sets.

Many new instruments have become available for troubleshooting, adjusting, and aligning f-m and television receivers. Unfortunately, many of them are expensive, and very often the service organization cannot invest in all the instruments at once. For this reason, it is desirable to divide the types of new test equipment into two groups: (1) those instruments which are essential and (2) those which, although not essential, will simplify maintenance procedures and save time.

The following instruments are generally considered essential; they are

### ***y Morton G. Scheraga***

Allen B. DuMont Laboratories  
Co-author, *Video Handbook*

listed in the suggested order of their purchase, if all of them cannot be bought together.

1. Cathode-ray oscillograph.
2. Vacuum tube voltmeter and probe.
3. Sweep frequency generator.
4. R-F frequency signal generator.
5. Audio frequency signal generator.
6. Kilovoltmeter.
7. Multimeter.

The useful instruments in the second group are also listed in the order of their importance for f-m and television service work:

1. R-F probe for oscillograph.
2. Oscillograph voltage calibrator.
3. Square wave generator.
4. Field strength meter.
5. R-C bridge.

6. Grid dip meter.
7. Q-meter.
8. Linearity bar signal generator.

Before selecting and purchasing a piece of test equipment, the specifications should be examined carefully to make certain that the instrument is adequate for the intended job. It is equally important that test equipment which is selected does not overlap the functions of another instrument already in the possession of the purchaser. For example, there is no need for a voltage calibrator if one is built into the oscillograph. Or, if the sweep frequency generator has a certain range of built-in markers, the requirements for the r-f signal generator may be relaxed and its cost thereby reduced.

Other things which should be taken into account are the construction, accuracy, versatility, and freedom from obsolescence of the equipment.

Specifications for test equipment are often misleading, and unless the technician understands the operation

and reasons for certain types of test equipment designs, he may invest unwisely. In this series of articles, the requirements for f-m and television servicing will be presented, with descriptions of the various types of test equipment, how they are designed, operated, and applied to service work.

### The Cathode-ray Oscillograph

The most versatile and useful instrument for servicing all sections of f-m and television receivers is the cathode-ray oscillograph, or, as it is often called, the 'scope or CRO. Although the oscillograph can be applied to radio service work, it is rarely employed for this purpose. Signal tracing and alignment of radios can be done efficiently with a signal generator and vacuum tube voltmeter. The nature of f-m and television circuits does not permit this simple technique. Wideband audio and video amplifiers are most easily aligned by observing the response curve on the oscillograph. Signal tracing the sync

and deflection circuits can be done only by observing the complex voltage waveforms on the oscillograph.

The extreme versatility of the oscillograph can be appreciated by noting the important functions it can perform by itself or in conjunction with other test instruments.

By itself the scope is used for troubleshooting the vertical and horizontal sawtooth generator and deflection circuits, and the sync circuits. In the video amplifier stages, the oscillograph can be used to show up such faults as clipping due to improper bias, or loss of amplification due to faulty components. Excessive hum from power supplies is quickly identified on the oscillograph, both as to amplitude and frequency.

The oscillograph is required as an indicator unit for use with other test equipment. Wideband r-f amplifiers, video i-f amplifiers, audio i-f amplifiers, discriminators, and ratio detector circuits are aligned with a sweep frequency generator and CRO

The sweep generator furnishes the source of signal while the response of the amplifier is plotted on the oscillograph.

The response of video amplifier stages is best checked with a square wave generator and an oscillograph. This is done by feeding various frequency square wave signals into the video amplifier and noting the shape of the square waves on the CRO, as they appear at the output of the amplifier.

During the alignment of the video i-f amplifiers, the sound traps must be adjusted so that no sound signals get into the picture channel. Precise setting of the ground traps is accomplished by injecting a fixed frequency from a signal generator into the video i-f amplifier stages and noting the effect on the shape of the response curve as it appears on the oscillograph.

When used with a voltage calibrator, the oscillograph can measure the peak-to-peak amplitude of complex waveforms. This is often advantageous in troubleshooting the sync and sweep circuits. A comparison check on the oscillograph of a voltage at a particular point in the circuit with the value specified by the manufacturer for a normally operating receiver generally helps to isolate a fault.

It can thus be seen that the oscillograph can perform many functions by itself and also serves to make other test equipment more useful. In order to be able to perform these many functions, the oscillograph must be flexibly designed and meet certain requirements. Today there are many oscillographs on the market. They are suitable for f-m and television servicing to various degrees, depending upon their cost and design. No one commercial oscillograph that is presently available can meet all the exacting requirements. However, certain compromises on the performance of the instrument can be made by the technician if he understands its limitations and how they affect his measurements. This understanding can be achieved through a knowledge of the circuit design of oscillographs and their application to specific f-m and television service problems. With this understanding, the technician can select an oscillograph which best suits his needs and budget.

# EQUIPMENT?

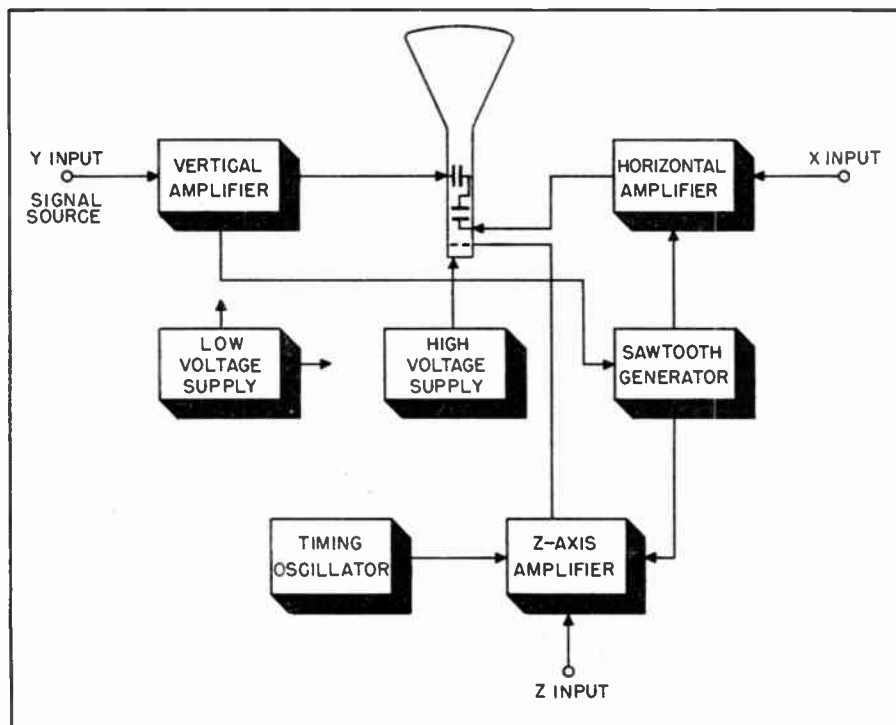
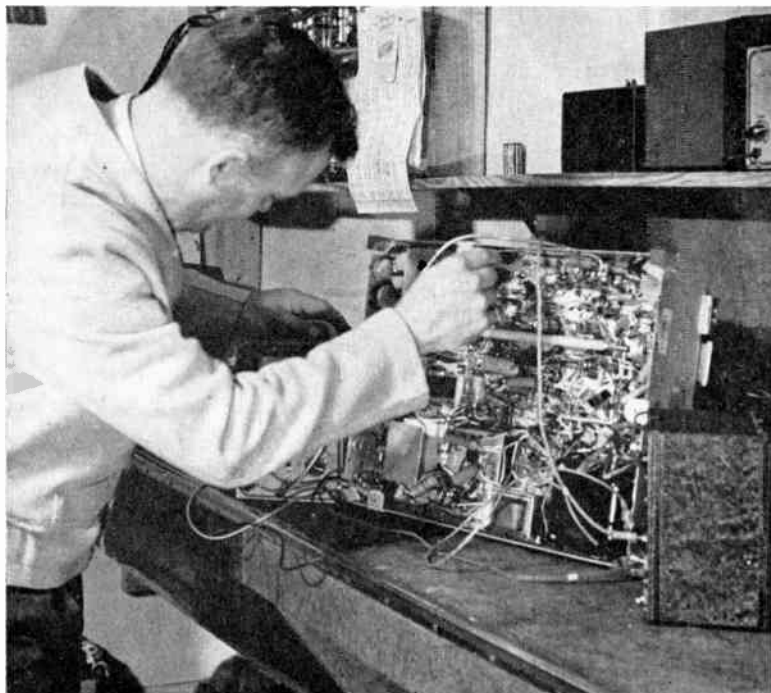

Fig. 1 Shown above is a block diagram of a general purpose cathode-ray oscillograph

→ to page 36



## HOW TO SERVICE

# Video Amplifiers

by Matthew Mandl

**What are the problems which the technician will encounter when servicing video amplifiers? How can he solve them? Read the answers here**

**V**IDEO amplifiers in television receivers may be compared to resistance coupled amplifiers in a-m receivers. In a-m sets they are necessary to amplify the signal after detection in order to bring it to the proper level for the loudspeaker. In video amplifiers, the goal is essentially the same. After the picture signal has been detected, it is necessary to give it greater amplification before applying it to the grid of the picture tube. In audio amplification, however, the frequency range rarely extends beyond 15,000 cycles—even in high-fidelity amplifiers, while in video amplification we must have a substantially flat response from 30 cps to 4 megacycles. Such an enormous range of frequencies means, of course, that the ordinary audio type of amplifier is no longer useful, and that it will have to be modified.

The more clearly we understand the purpose and function of the various components of a video amplifier, the more easily and quickly will we be able to localize troubles. For this reason, let us analyze briefly a typical video amplifier before we go into a discussion of common troubles and servicing procedures.

### Circuit Design

At first glance, the video amplifier in Fig. 1 closely resembles a resistance-coupled audio amplifier. The only apparent difference is in the coils  $P$  with their associated resistors. These inductances are the peaking coils which help extend the range of frequencies. Actually, however, additional means must be employed before the video amplifier will give a flat response over the desired range.

The video detector shown in Fig. 1 is a conventional diode, which demodulates the picture signal by half-wave rectification.  $R_2$  and  $C_1$  comprise the load resistor and the filter capacitor. In audio amplification, the detector load resistor would be several megohms, but in video detection it is necessary to use a load resistor of very low value (from 2000 to 4000 ohms).

The reason for this lies in the fact that diode detectors are prone to give a stronger signal at medium frequencies than at the highs because of the shunting effect of the inter-electrode capacitance of the tube. By making the load resistor small, the shunt capacity has less effect on the reproduction of the higher frequencies. In

audio, with its comparatively smaller frequency requirements, the shunt capacity effect and, in consequence, the load resistor is made larger so that more over-all output is secured from the detector. In television, the reduced amplitude of the signal derived from the detector necessitates more video i-f amplification preceding the detector.

The peaking coil P1 and resistor R1 constitute a series peaking circuit, while P2 provides shunt peaking. Most video amplifiers use either series or shunt peaking, or a combination of both. The shunt-peaking inductance P2 helps extend the high frequency range by acting in conjunction with the distributed capacitance associated with the circuit. Distributed capacitance consists of the input and output capacitances of the tubes, capacitance between circuit wiring and between circuit wiring and ground. All these capacitances have a serious effect on high frequency response because they act as a shunt for the higher frequencies. The shunt peaking inductance, in combination with the distributed capacitances, becomes a resonant circuit for the higher frequency range of the video signals. This parallel resonant circuit has a high impedance, thus increasing amplification at the upper frequencies.

The series-peaking inductance P1 acts to isolate the shunt capacitances of the tubes ahead of and following it. By decreasing the shunting effect of the distributed capacitance, the

load resistor can be increased with the resultant increase in output and a decrease in degeneration at the higher frequencies because of capacitance shunting effects. The combination of series and shunt peaking, in conjunction with low loss tubes and careful wiring, permits video amplifiers to handle signals up to the required 4 Mc.

#### Degeneration Problems

The coupling capacitor C2 has a low reactance for high frequencies and thus does not present a problem for them. It does, however, have an effect on low-frequency response, because the lower the frequency to be passed, the higher the reactance of this capacitor. In video amplifiers, therefore, both the coupling capacitors and grid leak resistors are made as large as possible. The only limiting factors are the tube characteristics. Too large a coupling capacitor means greater d-c leakage from the plus B of the preceding plate circuit. Besides this, if the physical size of the coupling capacitor becomes too large, it will have capacitance to nearby wiring or the chassis, which again affects the high frequencies in terms of shunting effects. The grid leak, too, must not be made too large in value, or motorboating will result due to a virtual floating grid. In addition, gas currents become a factor with too large a value of grid resistance.

Another source of degeneration for low frequencies is, C6, the ca-

pacitor associated with the cathode resistor R8. C6 must be made very large in capacitance so that amplification of low frequencies is not reduced. For this reason, it is important, when servicing, to replace a defective cathode capacitor with one of the same value or larger. Some manufacturers ground the cathode and apply bias directly to the bottom of the grid leak, as at V2. In this manner, the degeneration associated with the cathode capacitor is virtually eliminated.

Another method for increasing low frequency response is the use of the network R6 and C4 in Fig. 1. This is commonly called a decoupler circuit because it serves to isolate the common coupling which would be present due to the common B voltage terminal at the power supply. This decoupler circuit minimizes regeneration effects which would cause the amplifier to go into oscillation. It will, however, also aid materially in increasing low frequency response, for the circuit automatically increases the total load resistance whenever low frequencies appear in it.

The manner in which this is accomplished is as follows: At high frequencies, R5 is the load resistor, with C4 acting to place the bottom of the load resistor at virtual ground for the signal voltage (low capacitive reactance for high frequencies). At low frequencies, however, C4 presents a high reactance and becomes, for practical purposes an

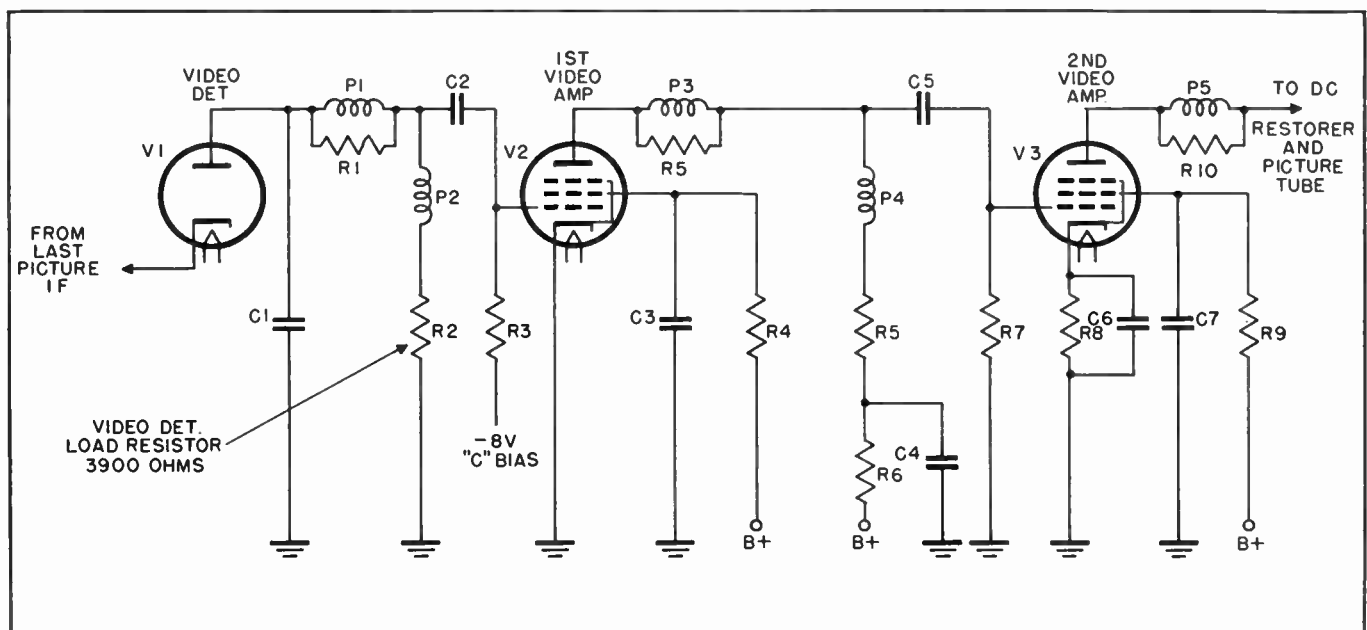

Fig. 1 Schematic diagram of typical video amplifier stages, looking very much like resistance-coupled audio amplifier. Peaking

coils P help extend frequency range. Detector load resistor R2 has low ohmic value, for reasons discussed fully in the article

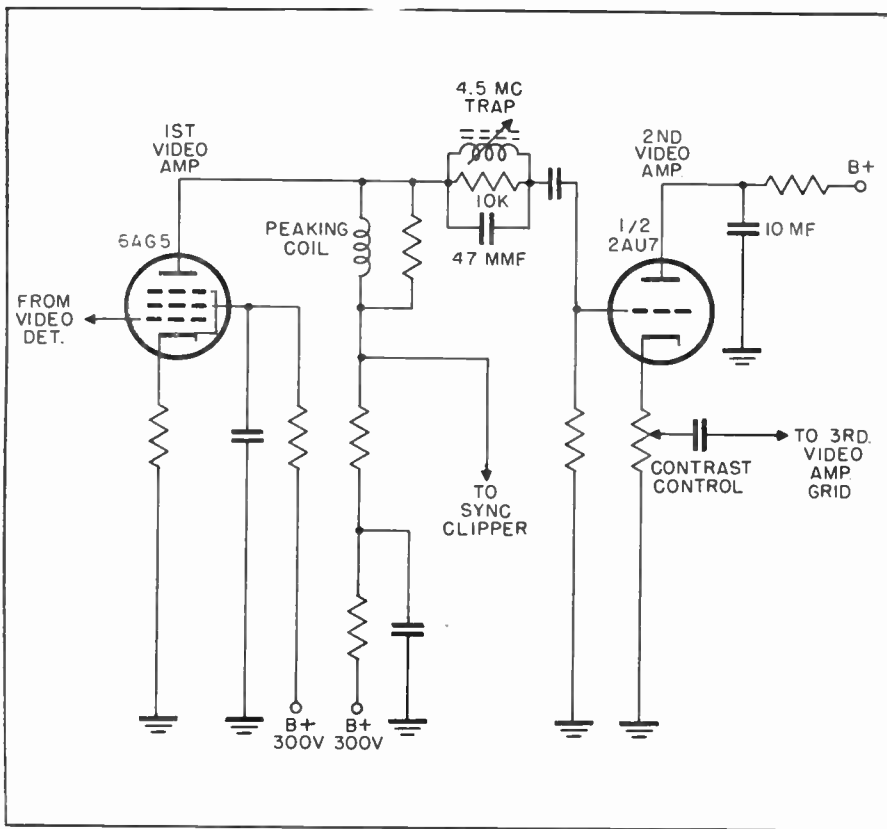

Fig. 2 Simplified schematic diagram showing the 4.5 Mc wavetrap which has been incorporated in the interstage circuit of the video amplifiers in the DuMont Model RA-105

open circuit. This means that for low frequencies, the total load resistance is now a combination of R5 plus R6. The increase in load resistance for low frequencies will, of course, increase amplification. Therefore, while servicing, it again becomes important to watch values during replacement so that the manufacturer's design factors will not be distributed to the detriment of picture quality.

#### Commercial Types

The technician will encounter differences in circuit design for various telesets, but the underlying principles will be the same. The number of stages will vary, and some manufacturers will use dual purpose tubes which combine stages. Some sets, like the Emerson 571, use a 6SN7 tube to provide two stages of video amplification. The DuMont RA-105 uses three stages of video amplification. The Admiral 19A11S, in common with other 7-inch sets, uses only one video amplifier stage.

Occasionally a 4.5 Mc trap may be included in the interstage circuits of video amplifiers, as shown in Fig. 2. In servicing, it is important to distinguish between such a trap and the regular peaking coils, for their pur-

poses and functions differ. The trap is inserted to prevent this frequency from getting to the picture tube grid. The presence of 4.5 Mc is derived from a beat note resulting from heterodyning of the picture and sound i-f frequencies. If, for instance, the video i-f frequency is 25.75 Mc, and the sound i-f is 21.25 Mc, the mixing of these two at the second detector would result in a beat note of 4.5 Mc. The trap presents a high impedance against this frequency, since it is a parallel resonant circuit in series with the signal.

Sets incorporating a.g.c. usually have the contrast control in the video amplifier section, as shown in Fig. 2. In this particular case the signal for the next stage grid is taken off the center arm of the contrast control. This is a cathode follower circuit, and is characterized by linear response. Signal energy is kept out of the plate circuit by the large capacitance (10 mf) to ground. The gain of this 2nd video amplifier, as of all cathode followers, is less than unity, which means that this stage does not amplify, but gives the advantages of cathode-follower coupling to the next stage.

#### Trouble Shooting

As with all trouble shooting procedures, when servicing video amplifiers, the tubes should be checked first. This is good insurance against hours of vain searching for a defective resistor or capacitor. Once we know the tubes are good, we can then proceed with voltage measurements or signal tracing with a signal generator and a scope. Voltage measurements would, of course, include plate and screen voltage and bias voltages as indicated by measurement across grid cathode. Any indication of zero or positive voltage between grid and cathode should bear further investigation. A defective coupling capacitor will allow d-c leakage to the grid of the tube and cause severe distortion. A shorted capacitor across the cathode resistor will also affect bias. A decrease in bias will cause excessive currents through and will in time damage the tube.

Lack of plate voltage could indicate an open load resistor or an open shunt peaking coil. In either case, the picture would disappear from the screen, though the raster would still be present if the rest of the receiver is operating properly. Lack of screen grid voltage would indicate either an open screen dropping resistor or a shorted screen by-pass capacitor. A shorted screen capacitor would cause excessive currents to flow through the dropping resistor, with the result that this unit usually burns out. Before a burned out resistor is replaced, always check for a shorted capacitor associated with the resistor.

The presence of a dead stage can be found by the signal tracing method. A 400-cps audio output from a signal generator can be applied to the grid of V3, in Fig. 1, for instance. The presence of sound bars on the picture screen indicates this stage is working. Of course, this procedure would not indicate slightly defective components which may give poor picture quality, but the method is satisfactory for finding a dead stage. The character of the signal is not as important here as its presence. Once the presence or the absence of the signal has been established, we have secured the desired information for localizing the defective stage. The characteristics of the signal can be ascertained later by a study of its actual appearance on the face of the tube.

If the last stage passes the signal,

→ to page 30



# IT'S TIME TO REVIEW

## Installation Policy

**because we have  
learned from experience  
that some of our ideas  
have to be revised**

**by William L. Bowne**

**A** SATISFIED customer is a constant customer. An installation which operates properly makes for increased sales and service volume.

For the television sales and service organization, the problem of customer satisfaction is twofold. First, the technical work must be reliable, whether it is installation or maintenance. Second, the multitude of factors which affect the business relations between customer and technician must be understood and controlled by the technician so as to keep the customer happy and himself in business. For the purpose of this article, we shall concern ourselves with some of these public relations factors.

If the problem were merely one of keeping the customer satisfied, the difficulties could quickly be solved by giving him everything he asks for. Unfortunately, as we all know, some of his wishes are of such a nature as to put us quickly out of business. The solution then, must be a compromise which will satisfy the customer and allow us to make a profit.

This program is particularly important today when sales and service are becoming increasingly tied together and when the question of whether or not to write contracts and what type contract to write presents itself daily to the television technician. In areas where television has been fairly advanced for the few years, technicians have had various experiences with a number of instal-

lation policies. Their experiences have pointed up the various pros and cons concerning different types of installation policies. They have also shown that in order to operate a television business successfully, the technician must be aware of the implications of all of these agreements.

Present practices fall roughly into three general groups: the "free" installation, the "Installation and Service Policy" for an additional fixed fee over the sales price of the set, and a compromise approach which generally omits servicing, and on which the charges may be estimated independently for each job.

### Free Installation

The so-called free installation is usually made by untrained delivery men who plug the set into the nearest electrical outlet, toss up an inside dipole, which may or may not be suitable, and orient the antenna so that some kind of picture results.

This procedure is generally unsatisfactory. In most cases the inside dipole is used as a sales inducement, since its use cuts the total cost of the receiver purchase. However, experience has shown that owners who bought such sets soon come to the conclusion that it is not operating as well as they would like it to. And as a result they make dissatisfied customers—lost customers.

### Installation Plus Service

Yearly service and installation agreements are preferable to such

free installations. They are, however, not altogether satisfactory. Although they have a number of advantages, they also involve some serious drawbacks.

As advantages we might list the following:

1) The customer buys his receiver with the assurance that he will get necessary service when the need arises.

2) He buys the receiver without having to worry about unexpected maintenance costs which would arise during the course of the year.

3) Some service technicians find that the advantages to the customer of such a policy constitute a strong advertising point and increase sales volume.

4) The contract provides an opportunity for the service technician to maintain year-round contact with his customer. The advantages of continuous contact are obvious.

As to the disadvantages of a yearly installation and service policy, they might be summarized briefly as follows:

1) The high flat-rate nature of the charges has a discouraging effect on a customer who must contemplate an additional fee equal to from 60 to 200 dollars over his initial investment to get the unit put into his home. That the prospect of charges above the actual selling price is a deterrent to sales has been borne out by the

# .. it's PA for BIG profits



Cliff Herring of Ft. Worth, Texas adjusting the installation he designed and built for Texas Christian University Bowl

by Robert Stang

**How big is the p-a field? How can you become a success in it? Read this eye opener for the answer**

**I**T IS axiomatic that successful selling requires maximum exploitation of the potential market. This is especially true for the radio dealer who, in most cases, has both technical service and equipment to sell. Virtually all sales and service organizations are active to some degree in allied fields such as electrical appliances, wire recorders, automobile radios and similar devices. A very small minority actively sell and service marine equipment, police radio and the like, usually as a result of their pre-dealer days experience or some unusual connection. Most dealers handle "ham" equipment to some degree or other, being limited by their display facilities and the technical know-how of their sales force, since the "ham" requires special handling.

It is amazing, however, how many dealers do not handle public address and other sound equipment. This is one of the most lucrative branches of the electronics field and, with the exception of TV, probably the one for which there is the largest potential market. Unlike most electronic

devices, public address equipment is not a luxury. It is functional and becomes an integral working part of organizations who purchase it. Experience has indicated that most organizations who purchase any sound equipment, sell themselves on expansion of its applications, so that the sale of an intercommunication system to a factory usually leads to the sale of a paging system to the same factory, etc.

#### **How Big is the Market,**

It is not generally realized to what extent sound equipment is now being accepted as essential equipment. For example, 36% or about 22,000 schools in the U. S. have some form of public address or school system. However, that means there are at least 40,000 additional schools still to be sold, and these figures do not take into account schools with less than 12 rooms, nor do they consider the replacement market. Nineteen thousand churches use sound equipment for church-music reproduction, public address, or other purposes. This represents only about 10% of the

country's churches, leaving a huge majority as a potential market. Similarly, hospitals, hotels, airports, factories, restaurants and all other centers of large-scale human activity are potential markets for this type of equipment. Consider the many untapped fields. Think what a paging system would do for a super market or a large parking lot or a warehouse, and you begin to see the potentialities which present themselves.

Lest the reader obtain the impression that this is a virgin field, let me point out that there are a fair number of dealer organizations who are fully aware of the market described above. Investigation will prove that these are generally the more experienced and older dealers. A survey on the subject made by John L. Rider (who is also responsible for the percentages above) in 1947 revealed that of those dealer organizations active in sound merchandising, 47.6% were in business twenty years or more whereas only 22.1% had been in business five years or less. Approximately the same percentage proportion applies with regard to the "pack-

age" sales of amplifiers and accessories as well as to the rental of sound equipment.

The question naturally arises as to why a dealer has to be in business a number of years before he becomes aware of the sound equipment market. Several answers are involved here. In some cases, limited capital is the reason. After all, a stock of sound equipment is not essential to the maintenance of a dealer establishment even though it does mean some lost sales. More important, I think, is the lack of know-how on the part of the dealer who has had no sound sales experience. As in all matters where the unknown is involved, bugaboos arise and complications which are unreal manifest themselves. Actually, the sale and installation of sound equipment is as naturally a function of the radio dealer as it is possible to imagine.

Although it is true that at one time planning a sound installation was essentially an engineering job, today this is no longer true. Manufacturers have been acutely aware of the technical limitations of their dealer outlets with the result that at present amplifiers, microphones and speakers are highly standardized and installation correspondingly simplified. In

addition, the Radio Manufacturers Association is to be highly commended for the work it has done to establish standard power levels, impedances, etc. Circuit development has led to much more stable amplifiers so that leading resistors and other complications are eliminated. The use of Constant Voltage reduces the speaker matching problem to a simple computation and, in most cases, eliminates the need for L pads. Similarly there is hardly ever a need for the dealer to modify standard equipment for specialized applications.

There is available to the dealer a wide variety of "system" equipment designed for specific applications. These include school systems, church systems, sound broadcasters for industrial plants, auditorium amplifiers, intercommunication systems of a variety of types, etc. Each type, since it is designed for a specific application, lends itself ideally to such application resulting in an easy installation and optimum satisfaction for the purchaser. For the occasional case where nothing in the line seems proper for the job at hand, some sound manufacturers maintain a "Custom Division" in which competent engineers design installations for their dealers, either using modi-

fied production equipment or units designed for the specific job at hand.

#### How Do You Get Started?

How is a dealer to go about merchandising sound? To begin with there are two basically different types of sale, one emphasizing the equipment and the other the "system," or functional operation of the installation. In the first category are high fidelity amplifiers and components, transcription players, tuners, guitar amplifiers and all other equipment used exclusively for sound reinforcement or musical reproduction. To be sold successfully, this type of equipment must be demonstrated and the sale tailored to meet the customer's listening taste and purse. Many dealers have a department exclusively devoted to such demonstration with the equipment so arranged that any combination of tuner, microphone or changer can be switched into any amplifier and speaker combination. As might be expected, such a sales technique results in considerably built-up sales, since the superiorities of more expensive equipment becomes apparent on demonstration.

Although many dealers have an

→ to page 31



Schools need p.a. Wisconsin Dells public school principal P. M. Loofsboro, shown here using the Bogen school system

**RADIO DISTRIBUTION AND MAINTENANCE • SEPTEMBER 1949**

# ELECTRONICALLY SPEAKING



by Isidor I. Gross

**Not in the Groove.** For a while last month it looked as if peace was not far away from the record industry. Rumors were flying fast, hinted that Columbia, RCA, and Decca were meeting to put the house they built in order. But these peace rumors were premature. At the National Association of Music Merchants Convention held in New York, RCA and Columbia made it clear that they had no intentions or plans for compromise, stated that they would go along at their respective speeds. To sweltering delegates at the convention, the situation in the disc business read like the end of a weather forecast: No relief in sight.

**In this Corner: Music.** Prior to the convention, RCA had scooped the field with the announcement that its 45-rpm model 9EY3 was being installed as standard equipment in each of the 310 New Jersey garden apartments erected by Milton Ehrlich. For the first time in the history of the building and record trade, a built-in phonograph would be included with each apartment rented. Gussed builder Ehrlich that the record market would be expanded to new and important proportions. Let's hope so.

**Strategems.** Television merchandising idea men came up with a few new ones last month. RCA, having discovered the built-in phonograph possibilities, wondered why the same couldn't be done with TV, got together with Wheatley Acres Inc. Result: Fireplaces with built-in television are featured at the Whitley Acres project near Manhasset, L. I.

Crosley, recalling earlier days, introduced the Visimeter, a coin-oper-

ated TV receiver. The owner drops a quarter in the slot, gets one hour's worth of video. Then the man comes around and collects all the quarters till the set is paid for. So you invite a party of friends over on Milton Berle night . . . and there's no quarter in the house. Ah, there's the rub.

New York's license commissioner Murtagh found that people had paid as much as 60 dollars to get two tickets for the musical South Pacific. Last month you could get them free at Macy's. Of course, you had to buy one of their brandless telesets.

Philco developed built-in-antenna television for its 1950 line, was hoping to increase video sales by door-to-door selling. Said Sales Promotion Manager George: "Due to the fact that the new Philco video sets have electronic built-in-aerial systems, it will now be possible for a salesman to give a demonstration by merely using a wall socket. From that point he can easily suggest that the set be kept overnight to test the evening reception." In addition, Philco came up with a down-pay-

---

On July 23, Murray Mentzer, president of co-founder of Precision Apparatus Co., Inc. passed away. He is survived by his wife and son. Mr. Mentzer entered the radio field in 1933 when he founded, together with Mr. S. Weingast, Precision Apparatus Co. Finding test equipment of that day deficient in many respects, he began by modifying existing instruments, and finally entered the field with his own design. His passing is mourned by the entire trade.

---

ment saver: a piggy bank which looks like a Philco receiver, shows illuminated 35-mm stills, and is there to be filled with change till the real thing can be bought.

**Say Ah.** Our medicine men took a look at television, came up with some answers about video and health in the Journal of the American Medical Association. They found that TV is not responsible for eye strain, that larger screens are better than small ones, that a viewing distance of at least 10 feet is best, that you can look at the screen as long as you please without ill effect, provided you don't get fatigued, that daylight screens are preferable, and that it is best to view the screen perpendicularly.

**Laying down the Law.** The law also had a few things to say about television last month, not altogether kind. In Kings County Supreme Court, Justice William T. Powers ruled that erecting a video antenna on the roof without the written consent of the landlord is considered a trespass. Thousands of persons without such a permit were scurrying to the landlords to get it in writing.

In New York State, Attorney General Goldstein declared that service contracts written by independent service dealers constitute an insurance contract and fall under the provisions of the insurance law. As handled by the majority of service technicians, installation and service policies are therefore illegal. The only organizations writing such contracts who are within the law at present are the manufacturer and his authorized dealers. Looks like there are going to be some changes made. The RMA had brought these facts to the attention of the trade months ago. Now the Television Manufacturers Association (TMA) has gone to work on the problem to take the insurance angle out of service agreements. They hope to be coming up with something concrete shortly.

**Congratulations.** TV scored at both the manufacturing and selling end when Dr. Allen DuMont (manufacturer) and Earl W. (Madman) Muntz (seller) were among the five business leaders selected by a nationwide poll of U. S. schools and colleges to receive the Horatio Alger Award. Nice going there.

# "What a Stethoscope is to a Doctor, Rider Manuals are to me!"

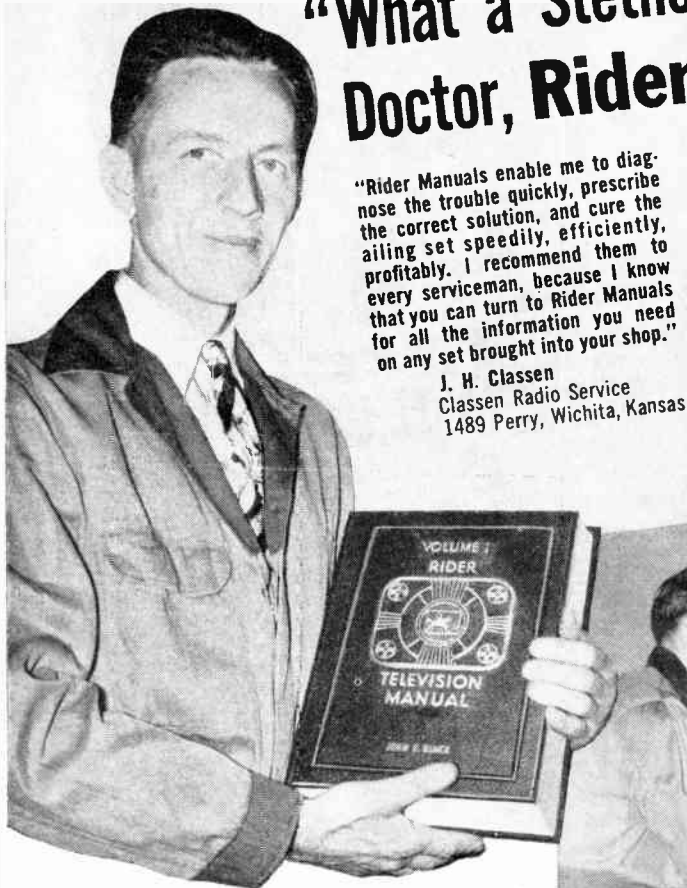

"Rider Manuals enable me to diagnose the trouble quickly, prescribe the correct solution, and cure the ailing set speedily, efficiently, profitably. I recommend them to every serviceman, because I know that you can turn to Rider Manuals for all the information you need on any set brought into your shop."

J. H. Classen  
Classen Radio Service  
1489 Perry, Wichita, Kansas

From Kansas to Kentucky, New York to Mexico, stretching all over the United States, the family of Rider-equipped servicemen is building a strong, faithful and profitable following. You, too, should join this ever-growing family. All material contained in Rider Manuals is factory-authorized. It originates at the manufacturer, and is compiled by Rider in easy, quick-to-grasp form. You and your men can locate the trouble faster and solve the problem better. You'll satisfy customers and get the price you ask for a job well done. Moreover, you are free to call upon the Rider staff of technicians at any time for any sort of help pertaining to your business. Rider and Rider alone offers such an authoritative, reliable and comprehensive service for the radio and television servicing industry. Join the Rider family today... and watch the difference it makes in your business.

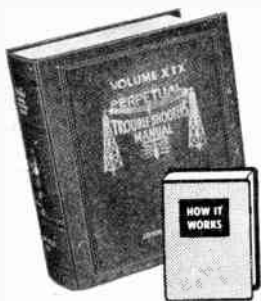
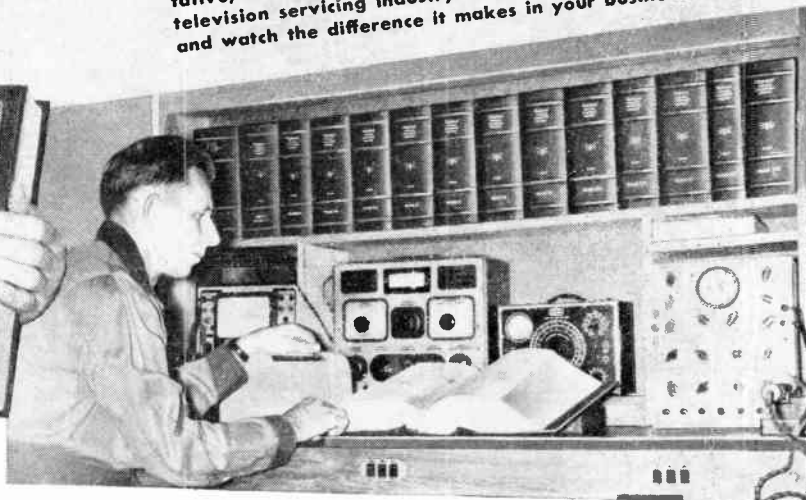

## The Biggest and Best Yet! RIDER MANUAL vol. XIX

Newest, most comprehensive, factory-authorized servicing data from over 100 manufacturers. 2122 pages. Including AM-FM, amateur receivers, auto receivers and record changers. PLUS Cumulative Index Volumes XVI, XVII, XVIII, XIX. PLUS the famous Rider "HOW IT WORKS" Book.

ALL FOR ONLY **\$19.80**

## RIDER MANUALS

Television Manual, Vol. 2 .....	\$18.00	Volume XIV to VII (each vol.) .....	\$16.50
(plus "How It Works" and Index)		Volume VI .....	12.50
Television Manual, Vol. 1 .....	18.00	Abridged Manuals I to V (one volume) .....	19.80
(plus "How It Works" and Index)		Record Changers and Recorders .....	9.00
Volume XIX .....	19.80	Master Index, Covering Manuals, Vols. I to XV .....	1.50
Volume XVIII .....	19.80	PA Equipment Manual, Vol. I .....	18.00
Volume XVII .....	16.50		
Volume XVI .....	8.40		
Volume XV .....	19.80		



## You Can't Do Without It! RIDER TV MANUAL vol. 2

No man in a TV area can afford to be without Rider TV Manuals. Equivalent of 2300 pages, PLUS Cumulative Index covering TV Volumes 1 and 2...and "HOW IT WORKS" Book. Data on receivers, tuners, kits, boosters from 67 manufacturers.

COMPLETE ONLY **\$18.00**

## Another Rider First!

## RIDER PA MANUAL

The first industry-wide Public Address Equipment Manual, covering amplifier production of 147 manufacturers from 1938 to 1948. 2024 Pages PLUS "HOW IT WORKS" Book.

COMPLETE ONLY **\$18.00**

**JOHN F. RIDER PUBLISHER, Inc.,**

480 Canal Street, New York 13, N. Y.  
Export Agent: Rocke International Corp., 13 E. 40th St., N.Y.C.  
Cables, ARLAB.

RIDER MANUALS mean SUCCESSFUL SERVICING

**NOTE:** Are you receiving your copy of "Successful Servicing?" It's Rider's own publication of interest to every Serviceman. Write for it... it's FREE!

NOTE: The Mallory Radio Service Encyclopedia, 6th edition makes reference to only one source of radio receiver schematics — Rider Manuals.

ANOTHER NOTE: The C-D Capacitor Manual for Radio Servicing, 1948 edition No. 4, makes reference to only one source of receiver schematics — Rider Manuals.

# over the bench

by John T. Frye



**T**RY putting yourself in the customer's place" is a bit of advice that we all hear over and over, but I'll be darned if I could ever do it—at least until very recently. I simply could not imagine myself taking an AC-DC set into a shop and saying, "I'm sure there is not much the matter with this. It was playing perfectly OK until it quit. I know it can't be the condenser, for I just had one put in three years ago. Must be a loose connection or something. I don't want to put much into it."

No; I could not imagine myself doing that.

But very recently I bought a new car; and, strangely enough, out of this experience has come a new sympathy for and understanding of my radio customers. Let me tell you how this came about:

The car has an automatic transmission, which was all completely new to me. When I asked a couple of hesitant questions about this feature, Charlie, the chief mechanic of the garage where I bought the car, said that he thought I could use the car more intelligently if I knew what was going on; so he took the time to explain and diagram for me exactly what took place under the floorboards when I pushed down on the accelerator.

In the rush of appreciation I felt for this courtesy, I resolved never again to give a short answer or to brush off a customer when he wants to know why his radio fades at night but not in daytime, or why he cannot get as good TV reception in his fringe area as his uncle in Chicago

does when both have identical receivers and antennas. Those customers are just as ignorant about radio as I am about automatic transmissions, and they will probably feel just as grateful as I did when a little light is cast upon their ignorance.

While examining the undercoating job, I called the mechanic's attention to a slight leak in the "transmission." He politely informed me that what I was pointing at was called the "differential." I shall remember that with a slightly red face the next time I tend to feel a condescending contempt for a poor woman who gravely tells me that she suspects something is wrong with the "vibrator-tube" of her AC-DC receiver. I hope that I can be as considerately courteous as was the mechanic in explaining to her that she is a little confused in her terms.

The second day I had the car I was out in a driving rainstorm, and you can imagine my consternation when I saw a regular little rivulet of water running in beneath the windshield and down across the dash. My feelings at that moment will still be clearly in mind the next time I listen to a customer complaining that the needle does not set down exactly where he thinks it should on his brand-new record player or that one of the push-buttons sticks on the receiver he has just bought. He has paid out his good money, and he feels precisely as I did: he cannot bear the idea that his purchase is imperfect in any detail, no matter how small.

I shall remember, too, how feverishly insistent I was that the leak

should be fixed without delay, and I shall try to be as prompt in restoring the satisfaction of my customer with his purchase as the car-dealer was in taking care of my complaint.

When the car was returned to me after the leak was sealed, I discovered that the chrome license plate holder on the front bumper had been dented. The sharp annoyance I felt at the carelessness causing this minor marring should serve as a lesson to me when I am working on a receiver. I am confident it will make me handle the cabinet and the chassis of any radio on my bench as gently and considerately as I like to see the mechanics show in handling my car.

The hood-latch release was very hard to pull, but when the car was taken in to have the break-in oil removed at five hundred miles this annoying feature was corrected without my even mentioning it. The pleasure I felt at this little something "extra" will make me go over the sets I service very thoroughly in an effort to find some little item about which the customer has not complained but the repair of which will add to his pleasure in its use. I am confident that my thoughtfulness will be appreciated as much as was the mechanic's who took time to ease the working of that latch.

I could go on giving further examples, but I do not think it is necessary. The point is, that while I could never imagine myself as a radio-service customer, I could see, as an automobile-service customer, exactly how much my clients feel. You can do the same thing. The next time you take your car to the garage or your watch to the jeweler, make a note of your impressions of the fellow behind the counter. Ask yourself, as you go out of his door, if you feel that you have left your property in honest and expert hands. Why so or why not?

If you make a habit of this, you will be surprised at how many tips you will pick up that will aid you in running your own business. It will amaze you, too, to find out what an astonishing similarity there is between your own legitimate and reasonable complaints and the narrow-minded, chiseling, something-for-nothing griping of your customers. It is uncanny how two things so utterly different could sound so much alike!

→ to page 24

**This is it!**  
**"LITTLE GIANT"**



**RADIART**

# TELE-ROTOR

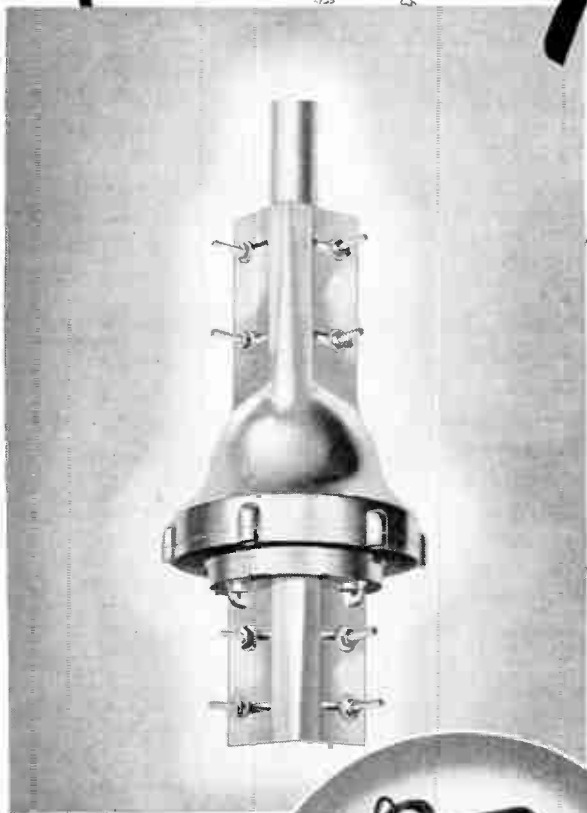
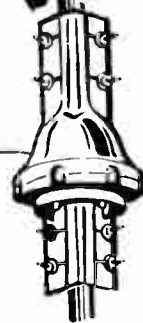
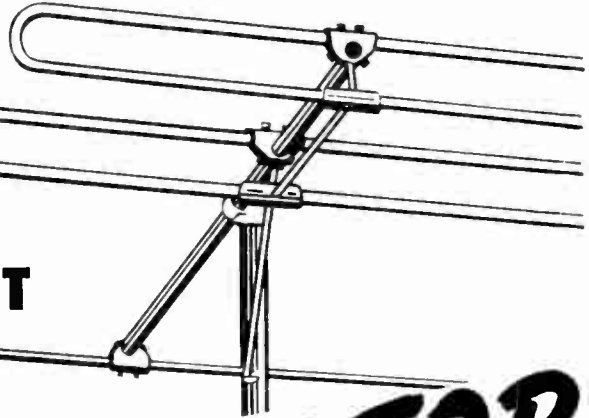

At last . . . the ultimate in rotators . . . a triumph in engineering skill. Months and months of patient research and development . . . now . . . we are proud to announce our latest triumph . . . the Radiart "Little Giant" TELE-ROTOR! Not a single factor has been overlooked to bring you the best . . . true to Radiart tradition that makes Radiart products . . . THE STANDARD OF COMPARISON! To you who have wanted a superior rotator that out-performs all others . . . **THIS IS IT!**

**Better Because:**

- Handles Heavier Loads . . . With Ease
- Remarkably Durable, Sturdy Design and Construction
- Absolutely Trouble-Free and Fool-Proof
- Available with "Compass Control" Directional Indicator

**Check These Features:**

- Heavily Reinforced Die-cast Housing
- Two 6½" Ball-Bearing Races
- Heavy-duty Precision Gears
- Positive Stop at End of Rotation
- Takes ¾" to 2" Upper and Lower Masts
- Motor Instantly Reversible
- Mast or Platform Mounting
- Three Heavy-duty Guy-Wire Lugs
- Completely Weather-Sealed
- Factory Lubricated for Life

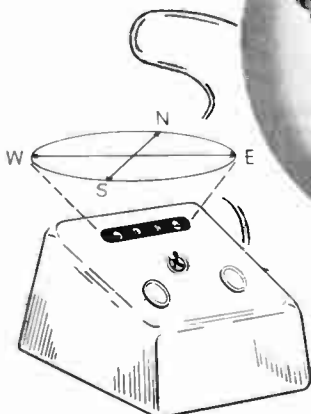

IT'S RIGHT WHEN IT'S RADIART!



**THE RADIART CORPORATION**  
 CLEVELAND 2, OHIO



**Manufacturers of the Famous Red Seal Vibrators**

# trade LITERATURE

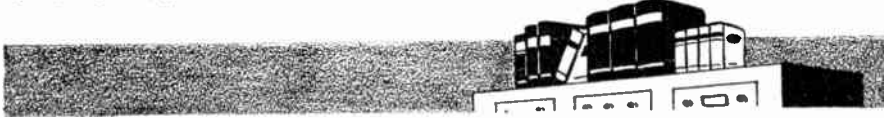

**Television Antennas**, by DONALD A. NELSON, (*Howard W. Sams & Co. Inc.*, 166 pages, \$1.25)

A bewildering number of television antennas have been introduced to the market over the last few years and their number is swelling daily. Now Donald Nelson has taken a plunge into this mass of antennas and their various claims, and has come up with a nicely organized book about them, designed particularly for the television technician.

His work covers all types of antennas, from the simple straight dipole to complex arrays. Realizing that commercial antennas may not always be available when needed, the author has included some very worthwhile tables on the construction of several antennas. Another feature of the book that we liked particularly was the listing of over 50 antenna manufacturers and their products. This list will come in very handy in installation work. The book also goes into considerable detail on the subject of the actual installation work, discussing the important subject of impedance matching, mounts, tools, and the like; and it concludes with a section on troubleshooting faults attributable to the antenna.

The book is nicely written and well illustrated, and will be a worthwhile addition to your service library.

## Catalogs and Pamphlets

**TV Servicing Aid.** A rather interesting handbook has been put out by RCA. Called the Pict-O-Guide, it is a loose-leaf album of photographs (and text), showing test patterns for various conditions of fault in the receiver. Comparing the actual picture on the screen of a faulty receiver with the corresponding picture in the book is meant to help identify the source of trouble. The book contains 100 pages of text and photographs. The latter were made from actual signals received on RCA's Television Dynamic Demonstrator. It is being distributed to users of RCA electron tubes through their distributors.

**For Your Customers.** Here's a 16-page booklet designed for the local technician to pass out to his customers. Its purpose is to give set owners a proper appreciation of modern service facilities and to prove that good service is worth good money. It's also a pretty good plug for the service technician. A postcard will bring you a copy of this nice item, as well as instructions on how to get a supply for local distribution. Write to Sprague Products Co., North Adams, Mass. Incidentally, the booklet contains space for the technician's imprint.

**Electric Instruments Catalog.** Simpson has published its catalog No. 16, and it's a very handsome catalog indeed. This 50-page booklet is a little unusual as catalogs go, in that it has an illustrated section, describing the production methods used at the factory. It lists of course all measuring devices produced by Simpson. May be obtained by writing to Simpson Electric Co., 5200-18 West Kinzine St., Chicago 44, Ill.

**Miniature Selenium Rectifier Handbook.** A 48-page booklet giving many new circuits for application in television, home receivers, electrical appliances, industrial and other equipment, as well as complete engineering information on miniature selenium rectifiers. Contains basic theory of the use of selenium rectifiers and lists many circuits in which they are applied. The last half of the book is devoted to application. 25 cents at Federal Telephone and Radio Corp., 900 Passaic Ave., E. Newark, N. J., or at your jobbers.

**Decoder Chart.** Simply match colors and read exact values. That's what the Duranite Decoder Chart is said to do. The chart shows the RMA color band coding for molded tubular paper capacitors, with corresponding numerical values for capacitance, tolerance and voltage. The user compares the color band tubulars with the units on the chart until the color bands match, whereupon

## Over the Bench

→ from page 22

Not many of us are able "to see ourselves as others see us"—and probably for our peace of mind it is just as well—but watching other servicemen in various lines of work and observing your reactions to their behavior is the next best thing. Out of my experience with the car dealer, I have resolved:

To answer all questions of my customers as fully and as patiently as I know how.

To take care of all complaints promptly.

To treat all receivers, regardless of their age, as gently as possible.

To try and give some little "extra" with every service job.

To do my best to see that my customers are fully instructed as to how to obtain the most from their sets.

To make my customers feel welcome to visit my shop at any time, and to let them know I appreciate their patronage.

To impress upon each customer that I do not lose interest in his set as soon as I have been paid.

To try and convince him that the advice I give in regard to service or repairs is concerned as much with his interest as with my own.

To be just as hearty in my welcome of the customer who brings in all of his tubes in a paper sack every three months to have them tested as I am in greeting the fellow who says that the power transformer of his twelve-tube console has been smooking!

Being human and knowing all too well my own weakness, I am not too optimistic that my keeping of these resolutions will be one hundred per cent; but I know that I shall be a better serviceman for having tried. " " "

the values are read off the chart. Available from Aerovox jobbers.

**Tube Complement Chart.** This 3-page chart, for handy reference by radio and television technicians, lists total tube complement, viewing tube type, and number of tubes by type in 110 telesets of 44 manufacturers. Punched for insertion in 8½ x 11 three ring binder. Copies obtainable on request to Advertising Department, Sylvania Electric Products, Emporium, Pa.



# A COMPACT AND COMPLETE LIBRARY!

The BIGGEST Book Value in the Industry!

## THE RADIO & TELEVISION LIBRARY

CONSISTING OF

### THE VIDEO HAND BOOK

The complete television manual... over 900 pages... over 860 illustrations... in 14 big sections.

Now in this great one volume book—all the essential knowledge of television! Inside the covers of the VIDEO HANDBOOK is presented complete up-to-the-minute information on television arranged for quick reference—in easy to read, non-mathematical style.

The VIDEO HANDBOOK is designed to give you the practical... answers to all your questions on television—the complete, detailed procedures on all phases of television work—step-by-step explanations for everyday problems. This book provides the ready information to make your television education complete.

The VIDEO HANDBOOK will save you time—improve your efficiency and make your work easier. It provides the knowledge that means more profit for you. Every page adds to your background for greater prestige and income. Here is the means for everyone in television—employed and executive—to increase his value to his firm.

This book is more than a source of information and interesting reading—it is an investment in your future in television.

### THE RADIO DATA BOOK

the only radio handbook of its kind... over 900 pages... 12 sections, each covering a radio subject more completely than any other book!

Used by Engineers, Servicemen, Designers, Laboratory Technicians, Draftsmen, Operators, Inspectors, Amateurs, Experimenters, Research Development, Consultants, Broadcast Technicians, Planners, Installation Men, Military, Marine, Police, Fire, Forestry and Railroad Communications.

ANYONE and everyone in radio and electronics can use this book!

Plan every operation in radio and electronics with the Radio Data Book. This new radio bible will be your lifelong tool... you will use it every day, on the board, at the bench, in the field! Use it for engineering, construction, troubleshooting and testing. The RADIO DATA BOOK will be your invaluable aid in design, experiment and in layout. It will help make your production better, faster and easier. In any and every operation in radio and electronics, you will use the RADIO DATA BOOK!

#### CONTENTS:

- Section 1. THE 150 BASIC CIRCUITS IN RADIO
- Section 2. COMPLETE TEST EQUIPMENT DATA
- Section 3. TESTING, MEASURING AND ALIGNMENT
- Section 4. ALL ABOUT ANTENNAS
- Section 5. SOUND SYSTEMS
- Section 6. RECORDING
- Section 7. COMPLETE TUBE MANUAL
- Section 8. CHARTS, GRAPHS AND CURVES
- Section 9. CODES, SYMBOLS AND STANDARDS
- Section 10. 50 TESTED CIRCUITS DESIGNED FOR OPTIMUM PERFORMANCE
- Section 11. DICTIONARY OF RADIO AND ELECTRONIC TERMS

### THE VIDEO HANDBOOK

#### CONTENTS:

- Section 1. Television: Past, Present & Future
- Section 2. Fundamentals of electronic Television
- Section 3. The Television Station
- Section 4. The Television Receiver
- Section 5. Television Antenna Systems
- Section 6. Creating a Television Show
- Section 7. Descriptions of Modern Television Receivers
- Section 8. Installing Television Receivers
- Section 9. Servicing Television Receivers
- Section 10. Television Test Equipment
- Section 11. Building a Television Receiver
- Section 12. Data Section
- Section 13. Television Terms
- Section 14. Bibliography

THE RADIO & TELEVISION LIBRARY IN ATTRACTIVE SLIP CASE \$9.00 AT YOUR LOCAL RADIO JOBBER

A PRODUCT OF

**BOLAND & BOYCE INC., PUBLISHERS**

MONTCLAIR, N. J.

# American Beauty

## ELECTRIC SOLDERING IRONS

are sturdily built for the hard usage of industrial service. Have plug type tips and are constructed on the unit system with each vital part, such as heating element, easily removable and replaceable. In 5 sizes, from 50 watts to 550 watts.

## TEMPERATURE REGULATING STAND

This is a thermostatically controlled device for the regulation of the temperature of an electric soldering iron. When placed on and connected to this stand, iron may be maintained at working temperature or through adjustment on bottom of stand at low or warm temperatures.



For descriptive literature write

110-2

**AMERICAN ELECTRICAL  
HEATER COMPANY**  
DETROIT 2, MICH., U. S. A.

# the INDUSTRY Presents

## TEST EQUIPMENT

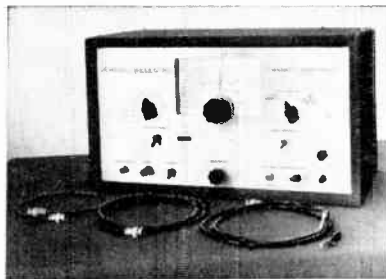

### MARKER GENERATOR

A new marker generator has been put on the market by General Electric. The unit is designed for work requiring an accurate source of markers for specific frequency locations on a tuned circuit response curve as presented on an oscillograph. A separate crystal for each TV channel is selectable by a

rotary switch. Picture and audio carrier markers are available simultaneously, and from one to five markers may be used at the same time. Since the markers are not passed through the circuits under test, there is no radio frequency output.

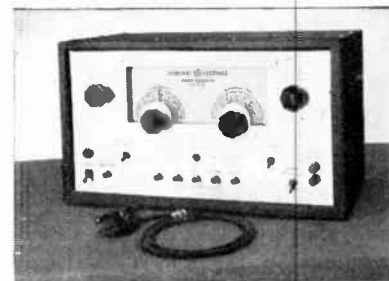

### SWEEP GENERATOR

In addition to the marker generator, G-E has also added a new sweep gen-

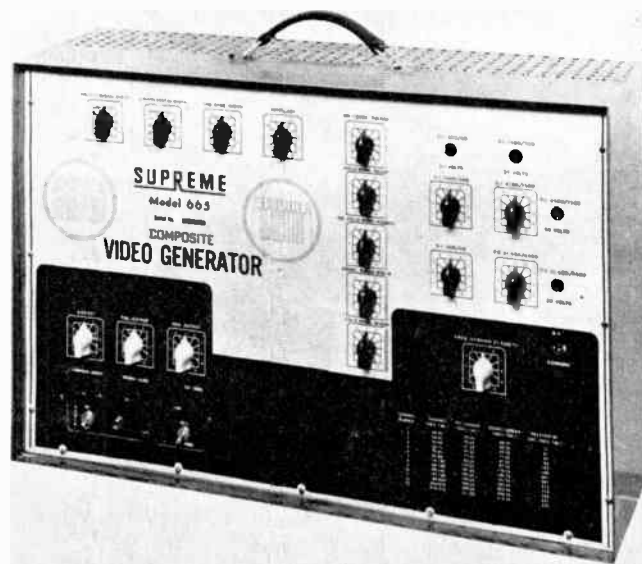

Supreme's new Composite Video Generator is a welcome addition to the ranks of television test instruments. This generator provides the technician with a complete video signal and makes his work independent of the transmission of test patterns from television stations.

The output signal of the instrument is in accordance with FCC video standards. It provides horizontal and vertical blanking pulses, horizontal and vertical synchronizing pulses, equalizing pulses, and a pulse video modulating signal. Television receivers can thus be tested for horizontal and vertical synchronization, horizontal and

vertical size, and positioning of the raster. Correct placement may be made of electrostatically scanned picture tubes, deflection yokes, focus coils, and ion traps of magnetically scanned tubes. The pulse video modulating signal produces a grating pattern on the television raster. And this is used to adjust either or both of the horizontal and vertical linearity controls, as well as the focus control.

The idea of such an instrument is of course not new. But this is the first complete video generator in the "lightweight" class. Earlier models of similar generators have been rather bulky and cumbersome.

erator to its line of test equipment. This instrument is of advanced design. It uses a permeability type sweep and has no moving components, thereby overcoming the disadvantages of an electro-mechanical system of sweep generation. The frequency of the instrument is continuously variable from 4 to 110 Mc and from 170 to 220 Mc, with a linear sweep from 500 kc to over 15 Mc. This frequency range meets the requirements for a satisfactory instrument.

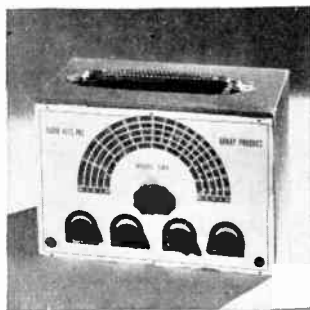

### SWEEP GENERATOR KIT

For those who like to build their own instruments, the sweep generator kit offered by Radio Kits Co. may be of interest. The instrument covers a range from 2 Mc to 226 Mc, which is adequate for f-m and television work; and it has variable phase control, variable sweep width, and sweep out for 'scope. The kit comes complete with prewound coils, miniature high-frequency tubes, and calibrated dial. Needless to say, assembling instructions come with it too. 120 Cedar St., New York 6, N. Y.

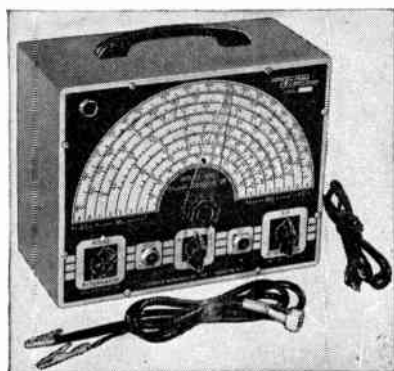

### SIGNAL GENERATOR KIT

Another test instrument offered in kit form this month is Eico's Model 320 Signal Generator. With a frequency range from 150 kc to 100 Mc, the instrument is useful for a-m and f-m work (for television work a frequency range from 8 Mc to 240 Mc is required). The signal in the instrument is generated by a Hartley oscillator, while a Colpitts type audio oscillator supplies pure 400-cycle sine wave volt-

# use *Telrex* "V" BEAM CONICAL ANTENNAS

...for better reception on all TV and FM channels

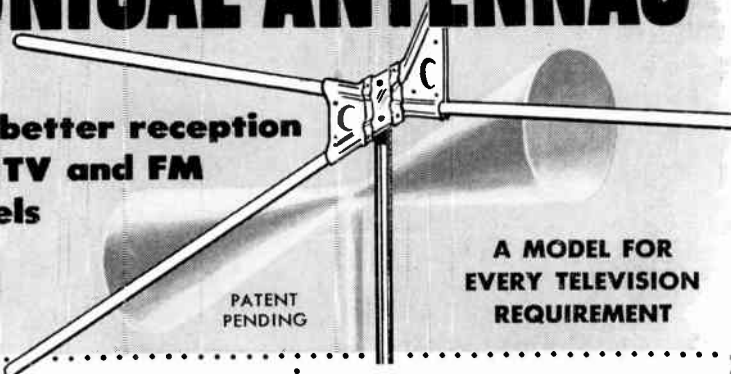

A MODEL FOR EVERY TELEVISION REQUIREMENT

### TELREX MODEL 1X-BD

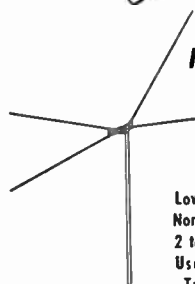

Bi-Directional Hi-Gain Conical "V" Beam  
Broad Band Full Audio and Video Band Pass  
Low Vertical Angle  
Non-Varying Center Impedance 2 to 1 Front to Back Ratio  
Uses 72, 150 or 300 Ohm Transmission Lines  
Universal Mounting Clamp

### TELREX MODEL 8X-TV



4 Bay Conical "V" Beam  
Broad Band Full Audio and Video Band Pass  
Low Vertical Angle, Minimum Reflections  
Maximum Signal to Noise Ratio 12 DB Front to Back Ratio, all Frequencies  
150 Ohm Constant Center Impedance  
Uses 72, 150 or 300 Ohm Transmission Lines  
Universal Mounting Clamp

OVER 12 DB FRONT TO BACK RATIO—ALL FREQUENCIES  
—NO HIGH FREQUENCY HEAD NEEDED WITH TELREX

### TELREX MODEL 2X-BD



Bi-Directional Stacked Conical "V" Beam  
Low Vertical Angle  
Extremely High Signal to Noise Ratio  
Constant Center Impedance  
Uses 72, 150 or 300 Ohm Transmission Lines  
Universal Mounting Clamp  
FOR THE ULTIMATE IN BI-DIRECTIONAL GAIN. USE TELREX MODEL 4X BD.

### TELREX MODEL 2X-TV

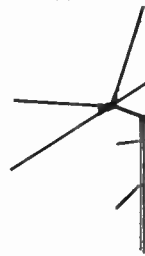

Uni-Directional Conical "V" Beam  
Broad Band—Full Audio and Video Band Pass  
Low Vertical Angle, Minimum Reflections  
Maximum Signal to Noise Ratio 4 to 1 Front to Back Ratio all Frequencies  
Universal Mounting Clamps

BEFORE YOU LABEL ANY AREA IN YOUR LOCALITY REMOTE FOR TV—CHECK WITH TELREX!



### ALL TELREX ELEMENTS ARE MADE OF LASTING DURAL

For best results in any TV area, use Telrex—the highest gain antenna with constant center impedance on all channels. Signals received at the antenna are carried to the set with negligible loss and no reflections or ghosts. Actual case records show Telrex antennas receiving satisfactorily 200 miles over land, 300 miles over all-water TV paths. Before you say "too remote", check with Telrex.

We'll give you an impartial, based-on-experience opinion—without obligation.

COPYRIGHTED 1949

# Telrex·INC

ASBURY PARK 9, NEW JERSEY

AMERICA'S OUTSTANDING TELEVISION BEAM

## MIDSUMMER SPECIALS

FROM

## MORT'S RADIO SHACK

### MICRO-VOX . . . The Wireless 'Mike!'

Broadcasts Over Any Radio  
Within 75 Feet!



Here's a fascinating, complete miniature transmitting system that will delight everyone! Round table discussions . . . Baby listeners . . . Practical jokes and dozens of other uses that will astonish one and all! Complete with tube, batteries, tuner and built-in high-fidelity microphone. Clear Life-like Tone. EASY TO OPERATE!

COMPLETE  
\$4.64



### EICO 5" SCOPE KIT Model 100-K

Precision scope for FM, AM & TV servicing. Linear sweep with 884 gas triode. Horizontal sweep circuit. 15 to 30,000 cycles. Frequency response of horizontal and vertical amps is from 50 to 50,000 cycles. Complete with 2-6S37's, 2-5Y3's, 884 and 5841 CR tube. Graph screen for measuring peak to peak voltages. Provision for external synchronization, test voltage and intensity modulation. All controls on front panel. Operates on 110 to 130 volts AC, 50-60 cycles. Size: 8 1/2" x 17" x 13". Shipping weight 40 lbs. Detailed instructions and pictorial diagrams. . . . .

\$39.95

### NEW! MODEL 320-K SIGNAL GENERATOR

\$19.95

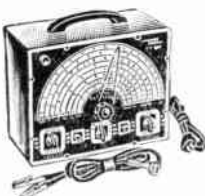

An excellent instrument for service, lab. and school use. Can be used for FM-AM alignment and to provide TV marker frequencies. Highly stable Hartley oscillator has range of 150 kc to 102 mc with fundamentals to 33 mc. Colpitts audio oscillator supplies pure 400 cycle sine wave voltage for modulation. Audio oscillator voltage can be used for testing distortion in audio equipment, bridge measurements, etc. Handsome etched panel with easy-to-read calibrations. Easily assembled and aligned. Complete with tubes.

FACTORY WIRED AND ALIGNED Model 320. Ready to use. . . . .

\$29.95

### TWIN LINE SLICER

Made of polystyrene with two set screws for holding spliced ends of 300 ohm line. Makes positive electrical contact. No solder needed. Waterproof by using cement.

CAT. No. N-111 SPECIAL 17c each 10 for \$1.49

70 MIL POWER TRANSFORMER— 300 v—  
70 MA. 6.3 v at 3 Amps, 5 v at 2 Amps Upright & fully shielded. . . . .

\$1.95

SINGLE POST-RECORD CHANGER— Nation-  
ally known make. . . . .

\$9.95

Guy Wire 1000 ft. . . . .

\$3.95

300 Ohm Lts 1000 ft. . . . .

\$12.75

25% with order, balance C.O.D.

WRITE FOR BARGAIN LIST

**MORT'S RADIO SHACK** INC. OF CHICAGO

630 W Randolph St. Chicago 6, Ill. Dept. Rm. 8

age for modulation. The instrument also allows obtaining the audio voltage externally for testing audio equipment. The kit contains all component parts and assembly instructions. The r-f section may be aligned by using any standard broadcast receiver. The instrument is also available factory wired and tested. **Electronics Instrument Co., Inc., Newport St., Brooklyn 12, N. Y.**

### SIGNAL GENERATOR

The primary use of Hickok's new microvolt signal generator Model 292X is in the coverage of mobile band frequencies for taxicabs, police departments, railways, ships, and the like. No expanded scale instrument with an accuracy of 0.05% has previously been available for this work. However, this generator also covers all a-m, f-m, and television bands. The instrument measures both input and output for units under test and provides modulated and unmodulated output from 1 to 100,000 microvolts. It may be externally modulated from 15 to 10,000 cps.

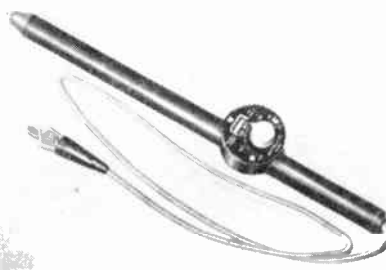

### HIGH VOLTAGE VOLTMETER

Here's a little novelty in high voltage voltmeters. It's an instrument utilizing a neon-lamp indicator in place of the usual delicate meter movement. During operation, the knob on the meter is turned until the neon lamp extinguishes, and the voltage is then read directly off scale where pointer rests. Insulation of the instrument is heavy, and a multimegohm multiplier is used. The test prod is seven inches long. **Industrial Devices, Inc., Edgewater, N. J.**

### VOLOMETER

Electronic Measurements Corp. has written in about their new pocket "Voltmeter". They say it's a lightweight, 1000 ohms-per-volt meter, housed in a round cornered bakelite molded case, and includes 5 a-c and 5 d-c voltage ranges, 4 d-c and 3 a-c current ranges, and 2 resistance ranges. Exact specifications for this Model 102 are available from the manufacturer, **423 Broome Street, New York 13, N. Y.**

## Accessories

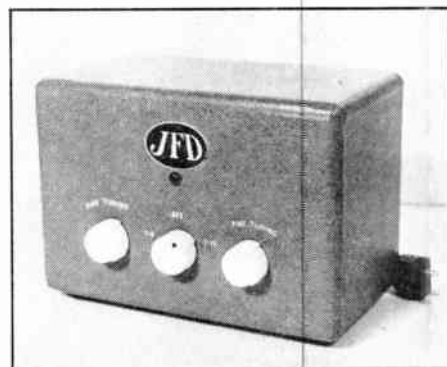

### BOOSTER

A booster amplifier meeting the requirements with respect to wide response characteristics as well as to matching transmission line and receiver, has been introduced by JFD, and will prove useful in fringe and remote areas. As with other boosters, Model TV10 will prove particularly effective with receivers having r-f amplifiers of compromise design, or no r-f amplifiers at all. If you want to check further into this, ask for bulletin TV10. **JFD Mfg. Co., 6101 16th Ave., Brooklyn, N. Y.**

### POWER SUPPLY

An item of interest to those technicians doing a lot of auto radio work is an efficient power supply, delivering 3 to 9 volts, rated at 6 volts at 20 amperes continuous, and 35 amperes instantaneous, from a 50 to 60-cycle, 115-volt power source. These ratings are sufficient to operate any one receiver, or two receivers with push button control. The supply has less than 3% a-c ripple and performs effectively as a storage battery. **Electro Products Labs, 549 Randolph St., Chicago 6, Ill.**

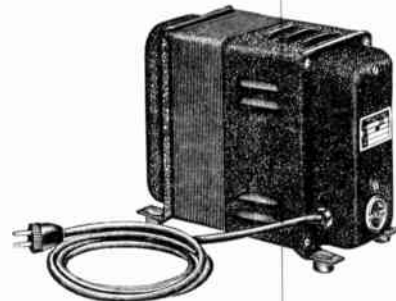

### CONSTANT VOLTAGE

As is well known, line voltage variations are responsible for some instances of unsatisfactory television reception. Most of the flicker is due to small line voltage changes, and width and horizontal control also varies with voltage changes. Sola has now introduced a constant voltage transformer

designed to eliminate this one source of receiver trouble. The transformer is of the plug-in type, and is turned on and off automatically as the receiver is turned on and off. It may be operated over a range of 175 VA to 300 VA, which will perform properly on practically all 10", 12" and 15" teletests. Sola Electric Co., 4633 W. 16th St., Chicago 50, Ill.

### ANTENNA ORIENTER

Television installation men have been offered another aid in the form of the Antenna Orienter. Known as EMC Model TVAO, the device will identify ghosts and also the direction whence they originate. It works in conjunction with any voltmeter having a sensitivity of 1000 ohms-per-volt or higher, and can be used for peaking r-f and oscillator sections of the receiver. It needs no soldering connection. Not superseding the more complex instruments used in installation work, it is nevertheless a handy aid to have. Electronics Measurements Corp., 423 Broome St., New York 13, N. Y.

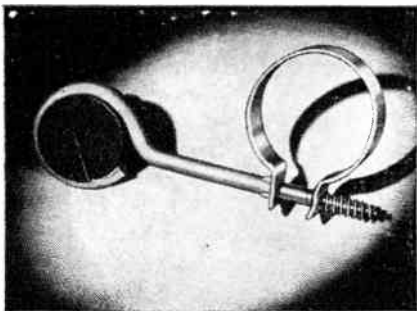

### CLAMP

This little item might be quite helpful in speeding up your TV installation work. It's a clamp that does away with the need for small nuts. A special thread on the standoff, requiring no nuts and no aligning time to start it, has been utilized. It will grip masts or pipes from 1" to 1-15/16" diameter. The clamp may also be used as wall standoff by unscrewing the clamping band, and using the standoff alone. Technical Appliance Corp., Sherburne, N. Y.

### CONVERTER

Technicians in areas with only d-c power will be interested in Radiart's new line of vibrator powered d-c to a-c converters. These converters are now available to furnish 110-volt 60-cycle, a-c current from 6, 12, 32, or 110-volt direct current sources. The various models will handle power requirements ranging from 50 to 350 watts. Radiart Corporation, Cleveland, Ohio.

# Kester Solder 1<sup>st</sup> choice of service men everywhere...



*Standard for the Trade since 1921*

Kester products have been in constant demand by service men since the early days of radio.

**LABORATORY  
CONTROLLED**

**POSITIVE  
FLUX  
UNIFORMITY**

In TV and radio repairs, use the same high quality solder that the manufacturer of the original equipment considers the standard in his field. Kester Plastic Rosin-Core Solder will do that repair job faster and more efficiently. Insist upon it from your jobber.

### A New Kester Flux-Core Solder

Watch for the announcement of Kester's newest product, soon to be available to the service man, "Resin-Five" Core Solder.



### KESTER SOLDER COMPANY

4201 Wrightwood Avenue, Chicago 39, Illinois

Factories Also at

Newark, New Jersey • Brantford, Canada

**KESTER  
SOLDER**

FOR  
DEMONSTRATING  
& TESTING AUTO RADIOS  
from AC LINES

**ATR**

## "A" BATTERY ELIMINATORS



### for DEMONSTRATING AND TESTING AUTO RADIOS

New Models . . . Designed for testing D. C. Electrical Apparatus on Regular A. C. Lines. Equipped with Full-Wave Dry Disc Type Rectifier, Assuring Noiseless, Interference-Free Operation and Extreme Long Life and Reliability.



### AUTO RADIO VIBRATORS

A Complete Line of Vibrators . . . Designed for Use in Standard Vibrator-Operated Auto Radio Receivers. Built with Precision Construction, featuring Ceramic Stack Spacers for Longer Lasting Life.

NEW MODELS ✓ NEW DESIGNS  
NEW LITERATURE ✓

ATR "A" Battery Eliminator, DC-AC Inverters, Auto Radio Vibrators

See your jobber or write factory

**AMERICAN TELEVISION & RADIO Co.**  
Quality Products Since 1931  
SAINT PAUL 1, MINNESOTA-U. S. A.

## Video Amplifiers

→ from page 16

then the generator output should be injected into the next preceding stage, again checking for sound bars on the picture tube. This can be done with a number of stages, working backwards from the picture tube to the detector, until the dead stage has been found.

If a station is on the air, it can be used for signal tracing purposes. Since both 60-cps and 15,750-cps pulses appear in the video signal, the scope will show their presence from the detector right to the picture tube grid. 60 and 15,750 cycle pulses cannot both be seen at the same time because of the difference in frequency. The coarse frequency of the 'scope must be set to pick up either the low or high frequency pulses. Apply the vertical input to the scope across the video amplifier input and output circuits, stage by stage. Fig. 3 shows the type of signal secured.

### Frequency Loss

Loss of low frequencies in video amplifiers shows up on the picture screen by affecting the appearance of large objects and the background shading. Trailing smears will also be visible as shown in Fig. 4. When this occurs, check for defective coupling capacitors, decoupler networks, capacitors across cathode resistors and tubes. A change in capacity, or a leakage in a capacitor, can seriously affect low-frequency response. While high frequency losses can originate in i-f amplifiers because of poor alignment, low-frequency losses are usually the result of a defect in the video amplifiers.

When the fine detail in a picture is lacking, the trouble usually is due

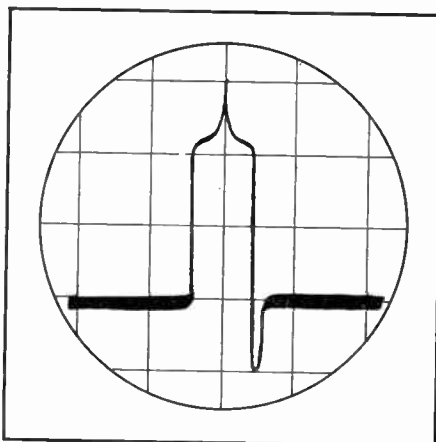

Fig. 3 This is the approximate scope pattern as it appears in video amplifiers when the receiver is tuned to a tv station

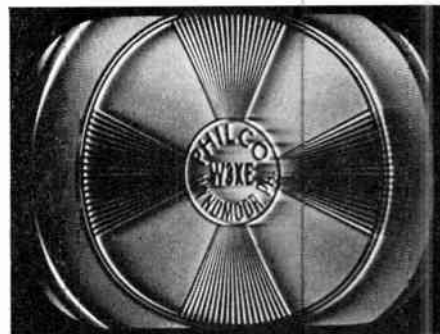

Fig. 4 Trailing smears, apparent in this test pattern, are an indication of loss of low frequencies in video amplifiers

to high frequency losses. Fuzzy pictures, however, may also be due to an improperly adjusted focus control, poor band-pass in the video i-f's, or a defective picture tube. For good high-frequency response, the vertical wedges in Fig. 4 should be clearly defined and sharp down to the inner circle.

Defective peaking coils are the major cause for loss of high frequency response. Peaking coils range from 30 to 300 mh, and have such a low d-c resistance that an ohmmeter does not give a satisfactory check. Short out a defective or suspected coil and note any change in the picture. The absence of change would indicate a bad peaking coil. Direct substitution is perhaps the best method. Most peaking coils are mounted directly on the resistors associated with them. Always replace a defective peaking coil with one of the same value.

In replacing peaking coils, make sure to dress them up and away from chassis and other wiring. Their permeability (and therefore the inductance) of peaking coil can be altered when their fields are brought too close to other wiring or chassis. Altering their characteristics will affect their functioning in the circuit.

In replacing capacitors try to get the exact replacement so that the physical size will be the same. Keep leads short to minimize losses. Check final results by observation of a pattern on the screen of the tube. If high frequency detail is still lacking after servicing video amplifiers, then the i-f response must be checked by a sweep generator and scope. Also check for a defective focus control and focus coil. Such components, or their misadjustment, often simulate loss of fine detail when actually the trouble is a matter of improper focus. ✓ ✓ ✓

## P-A for BIG Profits

→ from page 19

elaborate set-up for this type of demonstration, an effective arrangement can be made quite simply through the use of a small patch-cord panel which connects the input and output of any amplifier on display to selected input devices and speakers. Many small dealers combine their sound demonstration room with "ham" equipment and television which enables the same specialized salesman to handle all three types of equipment.

With the advent of LP records and the present acceptance of f.m. there is a large market for the sale of high fidelity amplifiers, f-m tuners, three-speed changers and similar equipment, and the sound demonstration room is the only efficient way to sell to this market.

The second category is the systems market. Here the potential rewards are much greater but so are the demands. To begin with the salesman must be familiar with the equipment he is selling to an extent where he knows what it can do and what its functional limitations are. Secondly these customers do not come to you—you must go to them. In this group fall school system, church systems, paging and intercom systems of all types, various types of factory systems, including music distribution and paging and all the numerous variations of the above, depending only on the nature of the organization being outfitted. In most cases standard equipment is available so that after the proper components have been chosen, the installation can be turned over to an electrical contractor. The proper choice of equipment has been largely simplified by manufacturers who are active in publishing literature advising dealers in how to properly select equipment for given applications.

Virtually any commercial organization can easily be shown how it can benefit from the installation of sound equipment. The technique will vary among salesmen but primarily must emphasize time saving, step saving, morale building and prestige. The field is enormous and a detailed merchandising discussion, even on only one specific type of system such as church or school systems, is beyond the scope of this article and will be discussed in future articles to which this is an introduction. ✓✓✓



### THE

*Master*

## VOLTOHMYST\*

... has no equal for fast, accurate servicing

**MEASURES . . .**  
 ✓ DC Voltage  
 ✓ Capacitance  
 ✓ DC Current  
 ✓ AC Voltage  
 ✓ Resistance

Truly the "master" electronic multimeter, the RCA WV-95A combines in one instrument virtually every measuring facility required in the service shop. It measures ac and dc voltages to 1000 volts, dc current from 1 microampere to 10 amperes, resistance from 0.1 ohm to 1000 megohms, and capacitance from 4 mmf to 1000 mf. A polarizing voltage is included for the measurement of electrolytics. The carefully balanced meter is virtually burnout-proof; and has a full scale accuracy of  $\pm 2\%$ . Zero-center indication is provided for discriminator alignment.

The entire electrical system of the WV-95A is insulated from the metal case which may be grounded separately.

When used with the RCA WG-275 accessory diode probe, the WV-95A will measure rf voltages in communication equipment and coaxial lines, and peak-to-peak voltages of recurrent pulses in sync signal generators, television receivers,

\*Trade Mark, Reg., U. S. Pat. Off.

etc. The WV-95A can also be used with the RCA WG-284 accessory high-voltage probe to measure up to 30,000 dc volts.

For full details, ask your RCA Test Equipment Distributor for Bulletin 2F721—or write RCA, Commercial Engineering, Section 511X, Harrison, N. J.

#### SPECIFICATIONS

**DC VOLTMETER**  
 Six Ranges.....0 to 5, 10, 100, 500, 1000 dc volts  
 Input Resistance, all ranges.....11 megohms

**DC AMMETER**  
 Seven Ranges:  
 Through DC Amplifier  
 0 to 10, 100 microamps; 0 to 1, 10, 100 ma.  
 Direct to Meter Movement.....0 to 1, 10 amperes

**OHMMETER**  
 Six Ranges.....0.1 ohm to 1000 megohms  
 Center-scale Indications  
 10, 100, 1000, 10000 ohms; 0.1, 10 megohms

**AC VOLTMETER**  
 Seven Ranges  
 0 to 1, 5, 10, 50, 100, 500, 1000 RMS Volts  
 Input Resistance and Capacitance  
 0.5 megohm shunted by 125 mmf.  
 Frequency Response.....30 to 20,000 cps

**CAPACITANCE METER**  
 Six Ranges.....4 mmf. to 1000 mf.  
 Center-scale Indications  
 100, 1000 mmf.; 0.01, 0.1, 1, 10 mf.

**RF VOLTMETER**  
 Ranges: (Requires WG-275 accessory probe)  
 From 30 cps to 17.5 Mc.  
 0 to 5, 10, 50, 100 RMS Volts  
 To 75 Mc.....0 to 5, 10, 30 RMS Volts  
 To 250 Mc.....0 to 5, 10 RMS Volts  
 Dimensions.....10" high, 13 1/2" wide, 7 1/2" deep

For Test Equipment you can trust . . . see your RCA Distributor



**RADIO CORPORATION of AMERICA**  
 TEST AND MEASURING EQUIPMENT  
 HARRISON, N. J.

**Build YOUR OWN Heathkit TEST EQUIPMENT**

**Heathkit AUDIO GEN KIT \$34.50**

**Heathkit TUBE CHECKER KIT \$29.50**

**Heathkit TELEVISION GENERATOR KIT \$39.50**

**Heathkit SIGNAL TRACER KIT \$19.50**

**Heathkit CONDENSER CHECKER KIT \$19.50**

**NEW Heathkit IMPEDANCE BRIDGE SET \$69.50**

**Heathkit R.F. SIGNAL GEN. KIT \$19.50**

**Heathkit 5" OSCILLOSCOPE KIT \$39.50**

**Heathkit BATTERY ELIMINATOR KIT \$22.50**

**Heathkit ELECTRONIC SWITCH KIT \$34.50**

**Heathkit VACUUM TUBE VOLTMETER KIT \$24.50**

**NEW Heathkit HANDTESTER KIT \$13.50**

Heathkits are beautiful factory engineered quality service instruments supplied un assembled. The builder not only saves the assembly labor cost but learns a great deal about the construction and features of the instrument. This knowledge aids materially in the use and maintenance of the equipment. Heathkits are ideal for and used by leading universities and schools throughout the United States. Each kit is complete with cabinet, 110V 60 cycle transformer (except Hand Tester), all tubes, coils assembled and calibrated, panel already printed, chassis all punched, formed and plated, every part supplied. Each kit is provided with detailed instruction manual for assembly and use. Heathkits provide the perfect solution to the problem of affording complete service equipment on a limited budget. The basic three instruments — an Oscilloscope, Vacuum Tube Voltmeter and Signal Generator — can be purchased in Heathkits for \$83.50, about the cost of a factory built VTVM alone. Write for complete catalog.

**HEATH COMPANY**  
BENTON HARBOR, 10 MICHIGAN

EXPORT DEPARTMENT  
13 EAST 40th STREET  
NEW YORK 16, N. Y.  
CABLE — ARLAB — N. Y.

## Review Installation Policy

→ from page 17

experience of many dealers. It has often resulted in last minute cancellations of orders.

2) The installation-service contract is also often unsatisfactory to the technician who must undertake the initial work and then obligate himself to be at the customer's beck and call for a year more at a price frequently too low for efficient service. This is especially true for contracts which place no limit on the number of calls per year. The fact that the customer feels that he has paid good money for this service is no inducement for him to limit his calls to real service needs.

One technician reports that every time a major event is scheduled, certain customers plan television parties and make it a policy of insisting that a man be sent out to check the operation of their sets just before the crowd arrives. Any attempt to pre-establish the nature of the "trouble" by questioning the owner about the symptoms usually results in a fantastic series of contradictory complaints.

However, experience has shown that no hard and fast rules can be laid down as to which part of the contract is advantageous and which isn't. Some technicians have reported that they increased their sales by offering an installation and service policy, while others found their sales drop as a result of that practice. It also seems clear that the volume of unnecessary service calls depends to a large degree on the customer and the reputation of the service man. Where the customer-technician relation is one of mutual trust and confidence, non-legitimate callbacks have been found to be rare.

Nevertheless, many technician today are inclined not to work exclusively on the basis of installation and service agreements. They treat each job individually and decide on writing or renewing a one year policy on the basis of the receiver involved and the type of customer buying it.

### Installation without Service

Another approach to the installation problem eliminates the installation and service policy and cuts servicing to a bare minimum as far as the

→ to page 34

# CHECK!

- ★ Cold inorganic-cement coated
- ★ Won't blister, peel, flake, crack
- ★ Stands up under severe overloads
- ★ Fixed and adjustable. 5 to 200 watts
- ★ Wide selection of resistance values

**YES INDEED, GREENOHMS ARE TOUGHER!**

★ Those green power resistors you find in better-grade TV sets, oscillographs, test instruments, transmitters and industrial equipment, are GREENOHMS. Take a tip! For your "stay-put" jobs — where you can't take a chance with component breakdowns — when you don't want to lose your profit by going back again — use GREENOHMS. They'll never let you down! And they cost less!

Ask our jobber for Greenohms.  
Try them once!  
Latest catalog on request.

**CLAROSTAT**

Controls and Resistors

CLAROSTAT MFG. CO., INC. • DOVER, NEW HAMPSHIRE • In Canada: CANADIAN MARCONI CO., LTD. Montreal, P. Q., and branches



# BACK NUMBERS . . .

. . . get them while they last

February 1948

LET'S WORK TOGETHER  
HOW TO USE SWEEP GENERATORS  
VOLTAGE REGULATORS

March 1948

HOW TO ELIMINATE HUM  
TELEVISION INTERCARRIER SYSTEM  
SWEEP GENERATORS OR FM ALIGNMENT PART II

April 1948

NEW FM SIGNAL GENERATOR  
DB CALCULATORS MADE EASY  
GET THE MOST FROM YOUR VTVM  
AFC IN FM

May 1948

TROUBLESHOOTING RECEIVER DISTORTION  
INTERFERENCE  
A POCKET FM SIGNAL GENERATOR  
A SWEEP GENERATOR FOR F.M. & T.V.

June 1948

INTERFERENCE PART II  
HEATER-CATHODE HUM  
SUPER SERVICE  
F. M. AND YOU

July 1948

OHM'S LAW IN RADIO SERVICING  
INTERFERENCE PART III  
HOME SERVICE CALLS . . . DO THEY PAY?  
SERVICING RC FILTERS

August 1948

ADVERTISING WILL BUILD YOUR BUSINESS  
INSTALLATION OF F.M. ANTENNAS  
CUSTOM BUILDING  
YGS-3 SIGNAL GENERATOR

September 1948

SERVICING WITH VTVM  
TRANSMISSION LINE PROBLEMS  
RADIO PHOTOGRAPHS  
RECEPTION UNLIMITED

November 1948

RECORD CHANGER REPAIRS  
SIGNAL TRACING TV  
NEW TV INSTRUMENTS  
F.M. DETECTORS

**RADIO MAINTENANCE MAGAZINE**  
460 BLOOMFIELD AVE.,  
MONTCLAIR, N. J.

Please send me the back numbers checked here . . .

I am enclosing 35c for each copy, or \$2 for any 8 copies.

- February 1948  
 March 1948  
 April 1948  
 May 1948

- June 1948  
 July 1948  
 August 1948  
 September 1948  
 November 1948

NAME .....  
ADDRESS .....  
CITY .....  
ZONE ..... STATE .....

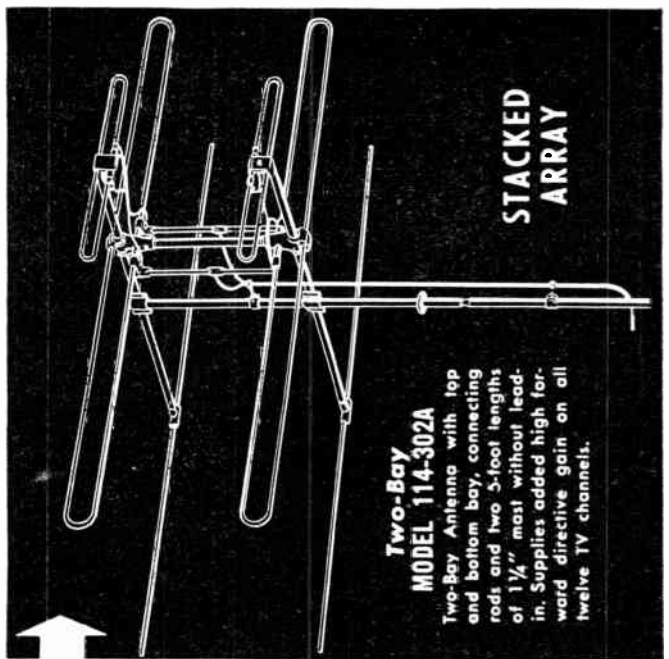

**STACKED  
ARRAY**

**Two-Bay  
MODEL 114-302A**

Two-Bay Antenna with top and bottom bay, connecting rods and two 3-foot lengths of 1/4" mast without lead-in. Supplies added high forward directive gain on all twelve TV channels.

**→ INLINE TV ANTENNAS ←**

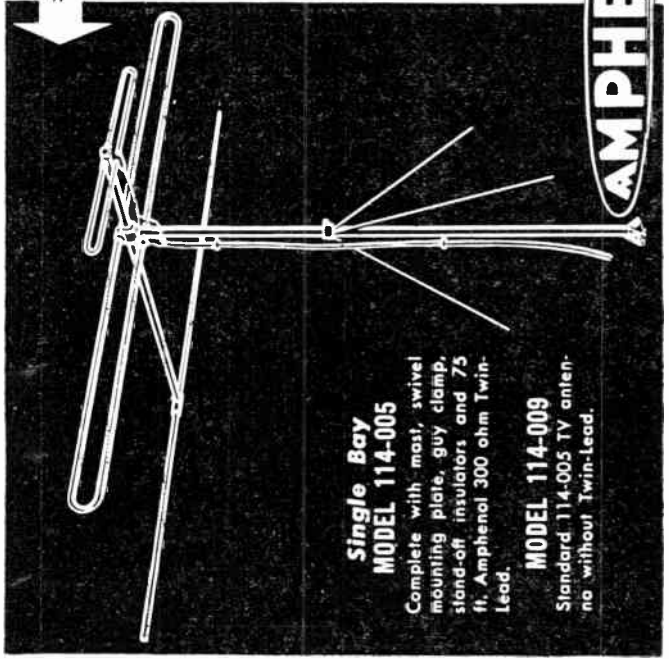

**Single Bay  
MODEL 114-005**

Complete with mast, swivel mounting plate, guy clamp, stand-off insulators and 75 ft. Amphenol 300 ohm Twin-Lead.

**MODEL 114-009**

Standard 114-005 TV antenna without Twin-Lead.

The best reception of picture and sound on ALL TV CHANNELS is directly dependent upon the mechanical and electrical construction of the antenna.

Amphenol has designed the Model 114-005 INLINE TV ANTENNA after years of study and research to meet the strict demands for optimum antenna performance . . . this antenna provides the best in high, uniform gain with clear, brilliant reception on all channels. The Model 114-302A TWO-BAY INLINE TV ANTENNA provides added high forward gain for TV sets in fringe areas.

Costly service calls due to antenna maintenance problems are eliminated with an Amphenol installation. The faithful, steady performance of Amphenol antennas is the solution for excellent picture reception through many years.

Amphenol Inline Antennas are manufactured under Patent No. 2,474,480.

**AMERICAN PHENOLIC CORPORATION**  
1830 SO. 54TH AVENUE  
CHICAGO 50, ILLINOIS





## NEW PRICE

Announced by Allen B. Du Mont Laboratories on the well-known Type 274-A Cathode-Ray Oscillograph.

NOW ONLY \$124.50

Allen B. DuMont Labs., Inc.  
1000 Main Ave., Clifton, N. J.

## TELEVISION MARKER

MODEL  
TV 50

Net Price  
\$49.95

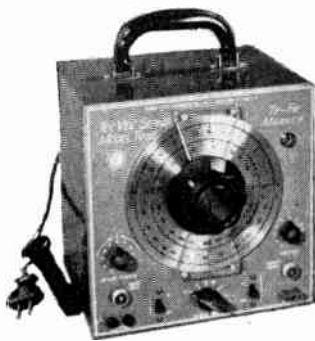

Designed for use in marking television sweep generators. The large planetary driven dial is calibrated to an accuracy of 1%. Uses 4 frequency bands covering frequency of 5 to 130 mc and 96 mc to 260 mc. A self contained crystal oscillator circuit is available for simultaneous marking or may be used alone with the variable frequency marker turned off. Due to the type of oscillator any crystal from 100 KC up, may be used in the crystal socket. An internal mixing arrangement is provided so that the output of a sweep generator may be connected to the TV 50 and the output lead will carry both the sweep frequency and the marker frequency. Buy it from your jobber.

**RADIO CITY PRODUCTS CO., INC.**  
152 West 25th St.  New York 1, N. Y.

## Review Installation Policy

→ from page 32

initial agreement is concerned. Since most manufacturers place a ninety day guaranty on the workmanship and materials which go into their products, many customers today actually prefer to do without the one-year service policy when they discover that they will be assured a guaranteed installation plus the maker's warrant, at less money than a comparable Installation and Service policy would cost.

Under this arrangement, the technician acts as the manufacturers' agent for the duration of the guaranty period, just as an automobile dealer must provide certain services on a new car during the break-in time. It has the advantage of eliminating the one-year period during which the technician's income is subject to the whims of the buyer, and enables him to give more for each installation dollar spent by the customer. At the same time, the lower fee tends to alleviate the deterrent effect on the decision to buy.

### What about the Manufacturer?

The question has been asked what to do if the manufacturer's specifications demand that the set be installed under an installation and service agreement determined by him. If such a contract does not define what constitutes a legitimate service call, or if it does not limit the number of calls allowable under it, then the technician will find himself spending a considerable amount of time on work from which he derives no income. Many a technician has found himself on the brink of bankruptcy because of entering upon such loosely written agreements.

There is a further drawback to this arrangement. Even if the contract specifies what constitutes a legitimate call, the buyer will discover that many times when he wants service his complaint is not chargeable to the policy. As a result, a policy such as that at times results in customer dissatisfaction and loss of future sales.

Manufacturers have taken divided views on this question in the past. Some preferred to keep all installation and service work in their own hands or insist that their licensed dealers write specified one-year policies. Others took a more flexible at-

titude. But recent experiences of service technicians have shown that this practice is generally falling into disuse. Many technicians have found such policies both uneconomical and too rigid for the proper operation of their business. With the advent of a buyers' market in the television field, one-year service policies prescribed by manufacturers are no longer generally accepted.

Under no circumstances, however, should the technician feel free to ignore any clause in an existing contract with a manufacturer until that contract is amended or expires. The fact that some dealers are free of such restrictions indicates that little difficulty need be expected to obtain suitable terms.

### An Alternative Method

There is still another approach to the problem, which has been adopted by two enterprising engineers who have recently entered the installation field as a sideline.

At the time of installation, or on the first call to an old installation, they offer a periodic inspection service at a nominal fee. At regular intervals then, and on appointment, they will call to check visually for any new sources of reflection or interference, and possible damage to the exterior parts of the installation. Aware of any new stations which have been put on the air, they will be able to provide for simple reorienta-

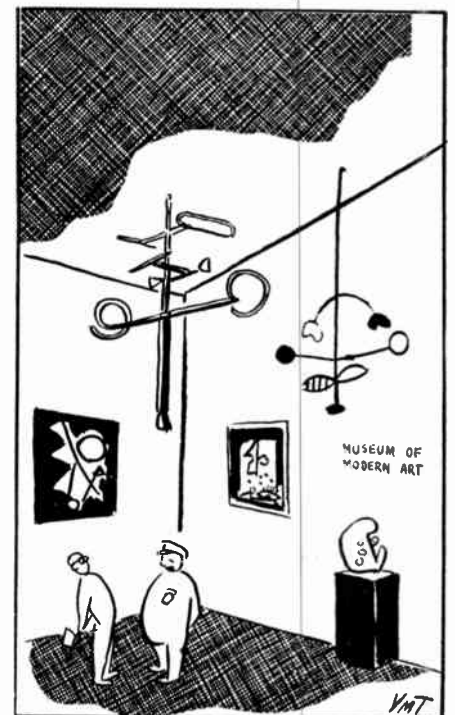

"That? That's a TV antenna by Teknikraft of Brooklyn."

tion adjustments. In cleaning out the accumulation of dust from the interior of the equipment, they save both the housewife and the equipment from danger which might result from careless cleaning, and are able to examine the receiver to anticipate troubles. If imminent trouble is apparent, they can point this out to the owner with a possible saving to both the customer and themselves by effecting repairs before major damage develops.

Aside from all other advantages inherent in this system, it enables the technicians to keep in touch with his customer and thus retain his good will.

#### An Old Installation

It goes without saying that customer satisfaction is not necessarily achieved by any one of these arrangements. The ultimate test, and the basis on which the customer judges his degree of satisfaction, is the trouble-free, consistently good output of his set. But given satisfactory performance, it is the business relation between the customer and dealer-technician which will determine whether the former's patronage will be a one-time affair or whether it will be repeated with invaluable word of mouth advertising.

A special case in the customer-technician relation, and one which needs special emphasis, is the situation in which the technician inherits a job which was installed some time previously by someone else. Customer satisfaction in such cases is more difficult to achieve than in the case of an original client. Actually, the very fact that a new technician was called means that the customer is already dissatisfied. The second technician is likely to be called at a time when the customer finds himself disgusted with the first technician's inability to "keep the set repaired." It takes considerable business enterprise and tact to overcome this dissatisfaction.

The first thing which should be done in such cases is to perform a complete check of the receiver and restore it to its original condition. With this factor eliminated, the rest of the installation must be checked thoroughly. The customer may question the need for this—he won't want to pay for work which he believes was done before—but he can easily

→ to following page

## DEPEND ON IRC

### FOR TELEVISION SERVICING

Television servicing requires replacements of *absolute* dependability. Otherwise, you risk expensive call-backs. Be positive of that dependability in resistors and controls... always buy "IRC"! Produced by the largest resistor manufacturer in the world, IRC parts are standard equipment in the finest television sets.

New, Advanced Type BT Resistors are IRC engineered to meet the rigorous requirements of television. They surpass Army-Navy Specification Jan-R-11. Small, fully insulated, and cool operating, Advanced BT's are supplied in 1/2, 1 and 2 watt sizes.

Every requirement of television servicing has been considered in the design of IRC's new, compact 15/16" volume controls. Revolutionary Interchangeable Fixed Shaft feature means faster and better servicing... resilient retaining ring cushions the turn; your customers can feel the difference.

New IRC PRECISTORS are ideal as low cost replacements for wire wound precisions and strings of insulated resistors. These deposited carbon units combine accuracy, stability and economy. Guaranteed accuracy 1%, in 2 sizes and a wide range of values.

For vertical or horizontal centering, IRC Type W Wire Wound Controls are furnished with a center tap. Tight, uniform windings insure accurate focusing.

International Resistance Co., 401 N. Broad St., Phila. 8, Pa. In Canada: International Resistance Co., Ltd., Toronto, Licensee.

## INTERNATIONAL RESISTANCE CO.

Wherever the Circuit Says 



**ADVANCED TYPE BT's**  
BT means Better Television!  
Tiny 1/2, 1 and 2 watt resistors are JAN approved.



**NEW INTERCHANGEABLE  
FIXED SHAFT CONTROLS**  
quiet operating, compact  
15/16" design.



**CLOSE TOLERANCE PRECISTORS**  
guaranteed accuracy 1%.



**CENTERING CONTROLS**  
for accurate horizontal or  
vertical focusing IRC Type  
W Control

MODEL 209A



**HICKOK**  
Volt-Ohm-Capacity  
**MILLIAMMETER**  
NEW PEAK TO PEAK VOLTMETER

World Famous

THE HICKOK ELECTRICAL INSTRUMENT CO.  
10634 DUPONT AVE. • CLEVELAND 8, OHIO

SEE YOUR JOBBER OR WRITE FOR COMPLETE INFORMATION TODAY

*It's For You...*

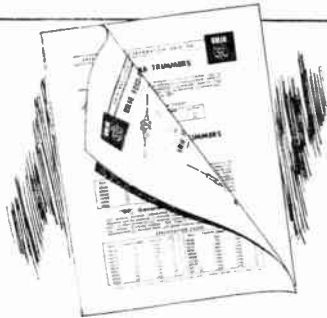

## ERIE RESISTOR'S New Catalog

You can rely on the performance of Erie Resistor components when repairs call for replacement. If your distributor cannot supply you, write us for information, and ask for the new catalog.

*Electronics Division*  
**ERIE RESISTOR CORP., ERIE, PA.**  
LONDON, ENGLAND      TORONTO, CANADA

**FREE! Send for it NOW!**

## ALLIED'S NEW 1950 CATALOG!

**196 PAGES—  
Everything in  
Radio and  
Electronics**



### GET RADIO'S LEADING BUYING GUIDE

Service Technicians and Engineers: ALLIED'S 1950 Buying Guide brings you all the new releases and money-saving values—from the world's largest stocks of test instruments, amplifiers, P.A. systems and equipment, tubes, parts, tools, books and accessories—ready for instant expert shipment. Send today for your FREE new 196-page ALLIED Catalog.

ALLIED RADIO CORP., DEPT. 27-J-9  
833 W. Jackson Blvd., Chicago 7, Ill.

Send FREE New ALLIED Catalog.

**FREE**

Name.....  
Address.....

**ALLIED RADIO**

## Review Installation Policy

→ from preceding page

be satisfied by pointing out to him that something may have gone wrong which the earlier people overlooked.

The heavy physical work of installation work will largely be eliminated, even if adjustments are needed, but a complete check and removal of trouble is still essential. New transmitters may have been put into operation, or new sources of interference may have appeared, and reorientation will be necessary to overcome these difficulties. Even if the original work was done by the same technician, this factor should be checked occasionally. Failure to note such changes will act detrimentally to the reputation of the technician.

Finally, the technician must be sure that the customer knows how to use the set. Controls which are obvious and elementary to the technician may be a mass of complicated operations to the set owner. Explaining how they work will take a little more diplomacy in an old installation than at the time of the original work. However, a few simple questions will quickly reveal the need and give the opportunity to make such "suggestions" for "more satisfactory" performance. At the time when controls are explained, a few words as to the proper level of illumination might be added, followed by a demonstration of the proper amount of ambient light advisable when viewing the receiver screen.

The peculiar problems faced by a technician on a visit such as this will be a justifiable temptation to charge heavily for the work. Great care must be taken to avoid driving away future business by this attitude. If the work has been good and the customer satisfied, he will pay willingly for that satisfaction—provided he does not feel that he is paying for work which was done and paid for under a previous agreement. Charges, therefore, must be split between actual work on the receiver, major changes in the installation which were authorized by the owner, and that intangible account which all shops must consider—advertising and good will. It is probably best to expect the first trip on such a job to be without profit. More can be gained in the long run by getting a good regular customer. ▶▶▶

## Know Your Test Equipment

→ from page 13

### Classification of Oscillographs

We can begin the process of whittling down the numerous types of oscillographs used by service organizations by first classifying existing types according to price range and performance. This classification can be understood best by referring to a block diagram of a general purpose oscillograph which appears in Figure 1. The operation of the oscillograph is briefly as follows:

1. The signal to be examined is fed to the vertical amplifier of the oscillograph and then to the vertical deflection plates of the cathode-ray tube. An amplifier is required because the amplitude of the signal is generally not sufficient to deflect the electron beam across the entire face of the cathode-ray tube.

2. At the same time that the signal is applied to the vertical axis, a built-in sweep oscillator generates a sawtooth voltage which is applied to the horizontal deflection plates through a horizontal amplifier.

3. With both signals applied simultaneously to the cathode-ray tube, the signal voltage under study appears spread out across the screen.

4. Some of the incoming signal to the oscillograph is fed to the sawtooth generator to lock it into synchronism. As a result the signal appears to stand still on the screen and can be easily studied.

5. Power for the deflection circuits, amplifiers, and the cathode-ray tube is provided by a low and high voltage power supply.

6. In some oscillographs provision is made to intensity-modulate the beam, just as the video signal modulates the grid of the picture tube in a television receiver, in order to produce variations in intensity of the scanning beam. Modulation of the beam in an oscillograph is often useful for the purpose of injecting timing markers onto the trace and thus be able to measure the frequency of the signal. These timing markers are generated by a built-in oscillator in some oscillographs, or are fed from an external oscillator to the grid of the cathode-ray tube through the Z-axis amplifier.

The most important section of the oscillograph which puts the instru-

ment into a particular classification is the vertical amplifier. In the low-cost oscillographs, the vertical amplifier is a single stage, having a frequency response of about 20 cycles to 100 kc. These instruments fall into the price range of about \$60-125. The gain of the vertical amplifier is such as to provide about one inch of deflection on the screen for 0.3 volt peak to peak input signal. The frequency response and gain of these instruments limit their utility to examination of relatively low frequency, high level signals. For example, it is impossible to do a stage by stage alignment of the video i-f amplifiers where the signal level is low. Also, horizontal sync pulses, which contain high frequency sub-harmonics, will be distorted by the vertical amplifier in these oscillographs.

Low-priced instruments in this group have a sweep generator which operates in the range of about 10 cycles to 30 Kc. This range is adequate for the examination of television signals. Z-axis amplifiers and built-in timing oscillators are not found in these instruments.

#### Higher Gain, Wider Bandwidth

The distinguishing feature of the next classification of oscillographs is the higher gain and wider bandwidth of the vertical amplifier. These instruments may be classified as high gain, medium bandwidth oscillographs. Sensitivities as good as 10 millivolts rms per inch of deflection are encountered in this group, which is in the price range of \$200-300. The low and high frequency response is extended from about two cycles to 300 Kc., a considerable improvement over the very low-cost instruments. The higher gain and better low frequency response of the second group permits the alignment of single r-f and i-f amplifier stages and the examination, without distortion, of low frequency signals. Most other general-purpose trouble-shooting can be done with these instruments.

In a little higher price range than the high gain, medium bandwidth oscillographs are the low gain, wide bandwidth instruments. These have a frequency response as high as four or five megacycles and a sensitivity of about 0.1 volts rms per inch. Oscillographs with such wideband response are suited for the study of the high frequency horizontal sync and deflection signals and for square wave

## For TELEVISION, F.M. and A.M.

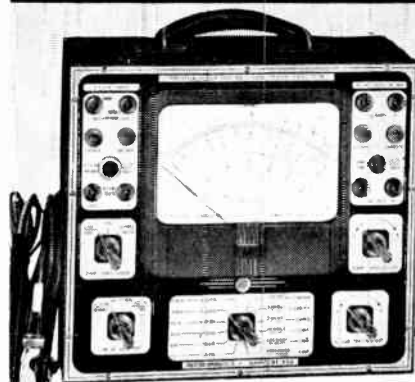

demand a  
**MODERN**  
VTVM—Megohmmeter  
**PRECISION**  
SERIES EV-10

Zero Center  
on ALL  
VTVM ranges  
Large 7" meter

Self-contained to 6000 volts  
-2000 Megs. - 12 Amps - +70DB.  
D.C. Voltage ranges to 60,000 V.  
when used with Series TV Super  
High Voltage Television Test Probe.

PLUS complete  
standard sensitivity  
1000 ohms per volt  
functions

EV-10 is a WIDE-RANGE ZERO-CENTER ELECTRONIC INSTRUMENT, stressing the utmost in performance and ease of manipulation. Application Engineered for rapid check of modern A.M., F.M., and TV networks.

#### IMPORTANT FEATURES

- ★ VOLTAGE REGULATED—BRIDGE TYPE CIRCUIT
- ★ ZERO-CENTER VTVM—no polarity switching or reversal of test prods
- ★ SHIELDED COAXIAL TEST PROBES.
- ★ 1% wire and metallized resistors.
- ★ MOISTURE RESISTANT, plastic insulated wiring assures performance under adverse conditions.
- ★ DUO-BALANCED ELECTRONIC-BRIDGE OHMMETER
- ★ 7" RECTANGULAR METER

#### RANGE SPECIFICATIONS

- ★ Eight Zero-Center VTVM Ranges, from  $\pm 3$  to  $\pm 6000$  V.D.C.
- ★ Input Resistance—  
13 $\frac{1}{2}$  meg. constant to 600 volts.  
133 $\frac{1}{2}$  meg. at 6000 volts.
- ★ Seven D.C. Current Ranges:  
from 0-600 microamperes to 12 amps.
- ★ Six Ohmmeter-Megohmmeter Ranges:  
self-contained to 2000 megohms.
- ★ Eight A.C.-D.C. and Output Voltage Ranges at 1000 ohms per volt:  
from 0-3 to 6000 volts.
- ★ Six Circuit Probing, Zero-Center, VTVM Ranges:  
from  $\pm 3$  to  $\pm 600$  volts D.C.
- ★ Eight DB Ranges. — 26 to + 70 DB.
- ★ VTVM Ranges to 60,000 volts available via use of Series TV Test Probe.

ASK TO SEE Series E-400 Wide Range Sweep Signal Generator • Series ES-500 High Sensitivity 5" Oscilloscope.  
WRITE for the new 1949 catalog (JUST OFF THE PRESS) describing the complete "Precision" line of quality test instruments for all phases of AM-FM-TV service and test.

#### SERIES RF-10 HIGH FREQUENCY PROBE

An accessory item to Series EV-10, the RF-10 Probe provides direct voltage test facility to approx. 200 MC. Connects directly to EV-10 panel. Employs type 9002 tube. Net Price: \$14.40

EV-10 MCP (illustrated) In open face portable steel case. Complete with tubes, battery, and test probes ..... \$89.95  
EV-10-P In closed portable case ..... \$92.70  
EV-10-PM For standard rack mount ..... \$92.70



**PRECISION APPARATUS CO., INC.**

92-27 Horace Harding Boulevard, Elmhurst 5, New York  
Export Division: 458 Broadway, New York, U.S.A. • Cables—Morhanex

testing the upper frequency limits of video amplifiers.

The last category of oscillographs is the laboratory type, and includes a multitude of relatively expensive, special purpose instruments which go beyond the requirements of the service shop. Some of the features of these instruments are 10-15 Mc. vertical amplifiers, crystal-controlled timing oscillators, complex sweep circuits for examination of very high calibrators, and cathode-ray tubes which operate as high as 30,000 volts in order to provide sufficient light output from extremely short duration

signals. The technician may encounter these instruments in the design laboratory, on receiver production lines, and in broadcast stations.

Mr. Roche's article on saw-tooth generator circuits in oscillographs, originally scheduled for publication in September, will appear in the next issue.

# THE LEADER IN VIDEO PUBLICATIONS!

## THE COMPLETE TELEVISION MANUAL

## THE VIDEO HANDBOOK

Morton Scheraga and Joseph J. Roche

- How Television Works,  
Basic . . . through advanced.
- How to Design and Engineer Television.
- How to Troubleshoot and Repair Television, Safety procedures.
- How to Select and Install a Television Antenna.
- How to Create a Television Show.
- How to Build an Operating Television Receiver, Complete instructions.
- How to Select a Television Receiver.

Now in this great one volume book—all the essential knowledge of television! Inside the covers of the VIDEO HANDBOOK is presented complete up-to-the-minute information on television arranged for quick reference—in easy to read, non-mathematical style.

The VIDEO HANDBOOK is designed to give you the practical . . . answers to all your questions on television—the complete, detailed procedures on all phases of television work—step-by-step explanations for everyday problems. This book provides the ready information to make your television education complete.

The VIDEO HANDBOOK will save you time—improve your efficiency and make your work easier. It provides the knowledge that means more profit for you. Every page adds to your background for greater prestige and income. Here is the means for everyone in television—employed and executive—to increase his value to his firm.

This book is more than a source of information and interesting reading—it is an investment in your future in television.

### READ BY:

Engineers, Designers, Servicemen, Experimenters, Production men, Laboratory technicians, Maintenance men, Program directors, Studio personnel, Broadcast technicians, Manufacturers, Laymen.

The vast amount of information contained in this book can only be briefly outlined here. The VIDEO HANDBOOK contains 900 pages—over 800 illustrations—thousands of vital facts—covering everything you need for working in Television. All this information is designed for easy reading, quick reference—all in non-mathematical language, every point of discussion pictured in diagrams or photographs. The VIDEO HANDBOOK is divided into 14 sections—each a complete, authoritative coverage on its subject—arranged in a practical, easy-to-follow handbook of solutions to every television problem.

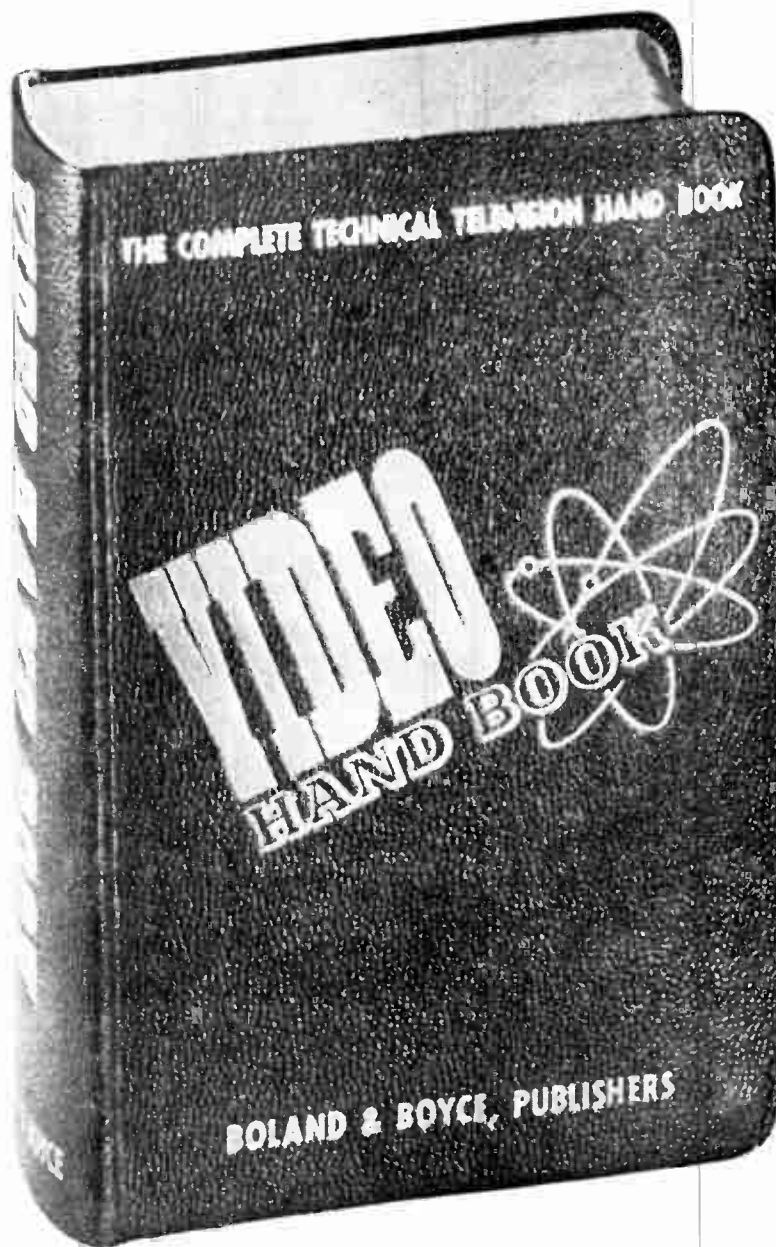

Handsomely bound in DuPont Fabrikoid . . . over 900 pages . . . 14 sections . . . over 800 illustrations — photographs, charts, diagrams, schematics.

- |   |   |
|---|---|
| Section 1. Television: Past, Present & Future.    | Section 7. Descriptions of Modern Television Receivers. |
| Section 2. Fundamentals of electronic Television. | Section 8. Installing Television Receivers.             |
| Section 3. The Television Station.                | Section 9. Servicing Television Receivers.              |
| Section 4. The Television Receiver.               | Section 10. Television Test Equipment.                  |
| Section 5. Television Antenna Systems.            | Section 11. Building a Television Receiver.             |
| Section 6. Creating a Television Show.            | Section 12. Data Section.                               |
|   | Section 13. Television Terms.                           |
|   | Section 14. Bibliography.                               |

**\$5.00 • AT YOUR LOCAL RADIO JOBBER**

A PRODUCT OF

**BOLAND & BOYCE INC., PUBLISHERS**

MONTCLAIR, N. J.

IN RADIO AND TELEVISION TUBE SALES

# 1949 IS A G-E YEAR

Now . . . help toward streamlining your service calls! The brand-new **POCKET OFFICE** (a General Electric "first" for more sales and profits) organizes your cards, prices, order blanks, job records in a handy 5" by 8" wallet.

**Y**ou have only so many working hours. And an hour lasts but sixty minutes. How can you make your time more productive?

One answer is the new G-E Pocket Office. All the papers you need on the job, are tucked away neatly in this flat binder that slips conveniently into your coat pocket. When you want a business card, a tube price, a job ticket, it's *there* . . . no searching for a form left back at your headquarters, no calling on your memory to record data best jotted down in pencil.

Handsome in rich brown simulated leather with gold lettering . . . strongly made, durable . . . the G-E Pocket Office is an accessory you'll be proud to own. It holds:

- Your business cards.
- New, cleverly designed "out" cards.
- Tube price list, beneath a clear acetate protective cover.
- Resistor-condenser color code card.
- Job tickets, repair stickers, tube-test stickers.
- Large memo pad.

Ask your General Electric tube distributor to show you the Pocket Office, and give you the details on how to secure this up-to-date aid to efficiency. Then use it to convert every minute of your working time into profits! *Electronics Department, General Electric Company, Schenectady 5, New York.*

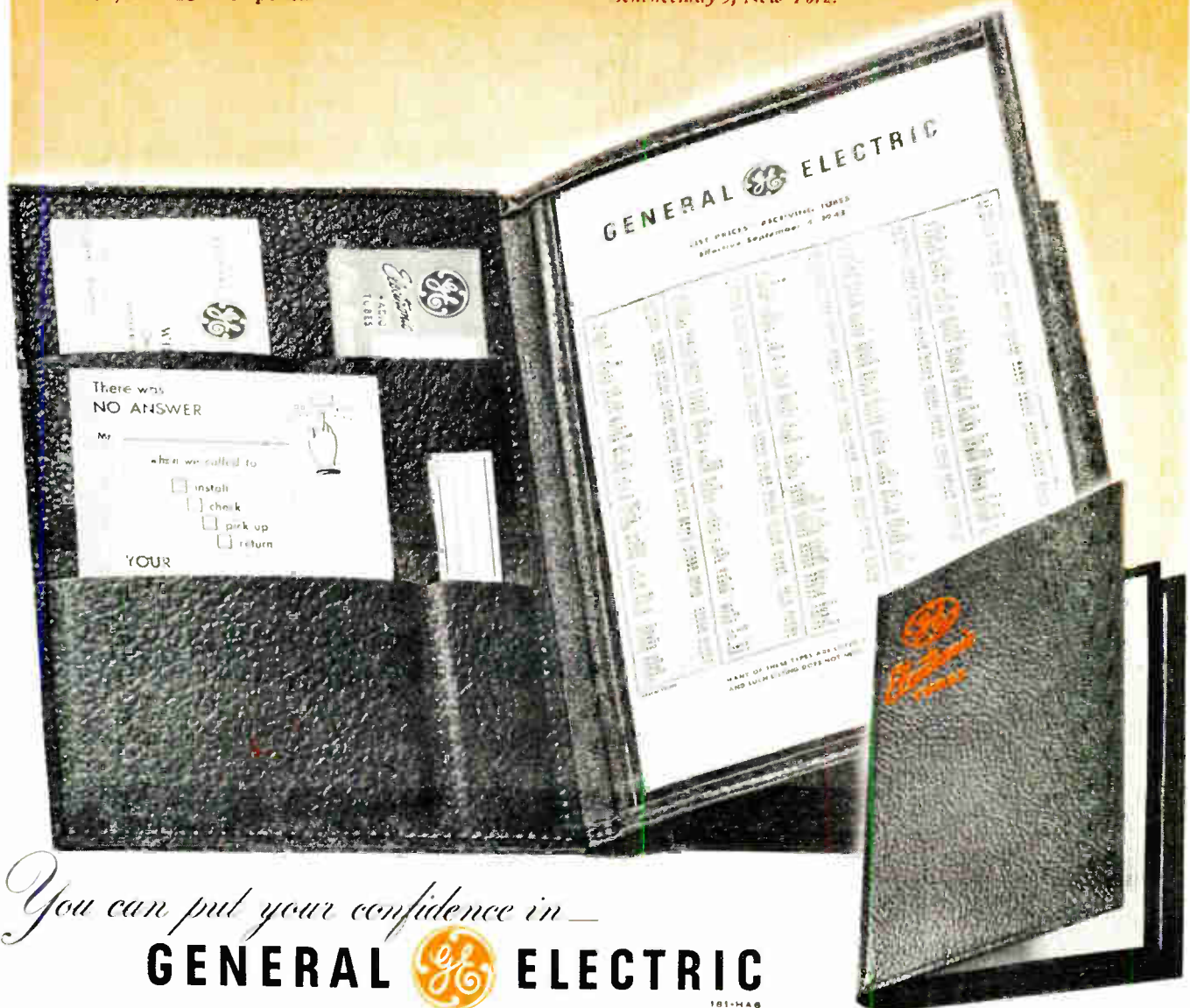

*You can put your confidence in—*  
**GENERAL  ELECTRIC**  
181-HA-6

Can I trust him to do a good repair job on my radio at a fair price?

How can I convince him that we do good work at reasonable cost?



Only **RAYTHEON**® gives both You and your Customers the right answer and here it is—

## The Raytheon Bonded Electronic Technician Program...

It's a 90-day BONDED guarantee on your radio set repair work and replacement parts, backed by *American Mutual Liability Insurance Co.*'s assets of close to a hundred million dollars!

**RAYTHEON pays for it**—The Raytheon Tube Distributor has this Bond for you — if you qualify. It doesn't cost you a cent. Here's honest-to-goodness *customer insurance* — the one and only answer that clears away mistrust — the biggest barrier to volume and profit.

Get in touch with your Raytheon Distributor, now. Ask him how to become a **BONDED ELECTRONIC TECHNICIAN.**

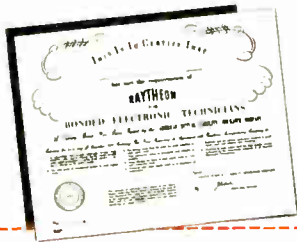

## Why RAYTHEON Tubes are Easier to Sell

**Universally Recognized Quality**—Raytheon's reputation for excellence in electronics is unsurpassed. Your customers and prospects know the name, RAYTHEON, and know it stands for quality all along the line, from tiny hearing aid tubes to huge Magnetrons.

### Don't take our word for it, alone

*R. W. Roller, Electronics Service, Inc., Denver, Colorado, writes:* "The framed Bonded Electronic Technicians Certificate hangs in a prominent place on our show room wall. There is no doubt that it inspires confidence in our place of business."

*R. S. Bryant, Lubbock Radio, Lubbock, Texas, writes:* "To my knowledge, your Bonded Dealer Program is the best thing for the Service business."



**Efficient Merchandising** — Your Raytheon distributor is one of the best parts sources in town — a good one to deal with. He *has* to be as sponsor of the Raytheon Bonded Dealer Program.

Raytheon national advertising and point-of-sale display material constantly reminds your customers of the value of the Raytheon name on every tube.

**RAYTHEON**  
MANUFACTURING COMPANY  
RADIO RECEIVING TUBE DIVISION

NEWTON, MASSACHUSETTS • CHICAGO, ILLINOIS • LOS ANGELES, CAL.

RADIO RECEIVING TUBES • SUB-MINIATURE TUBES • SPECIAL PURPOSE TUBES • MICROWAVE TUBES