

NOVEMBER 1948

40 CENTS

**EVERYTHING IN TELEVISION · RADIO · ELECTRONICS
FOR THE RADIO SERVICE - TECHNICIAN**

RADIO

MAINTENANCE

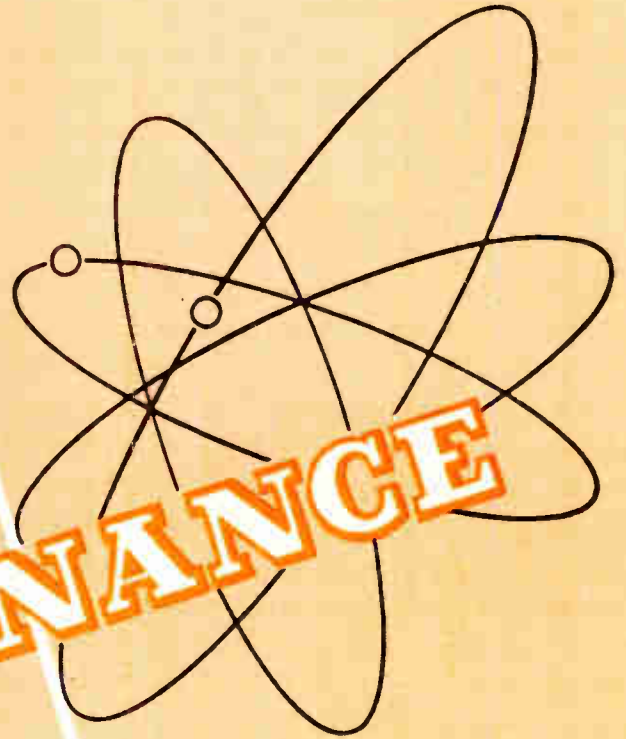

**RECORD CHANGER
REPAIR**

SIGNAL TRACING TV

NEW TV INSTRUMENTS

FM DETECTORS

YEARLY SUBSCRIPTION \$3.00

BOLAND & BOYCE INC., PUBLISHERS MONTCLAIR, N. J.



Have You Met the Little Fellow with the **BIG** Advantages?

The All New Mallory Midgetrol

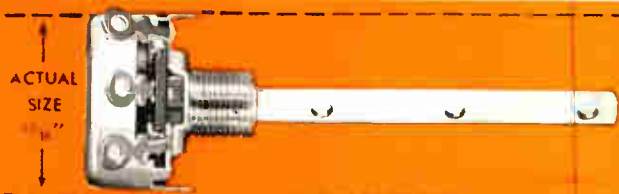

Offers These BIG Advantages...

BIGGER MARKET

The small size of the Mallory Midgetrol lets you service portables, auto radios and small AC-DC receivers which require $15/16''$ controls.

SIMPLER INSTALLATION

The unique shaft design of the Mallory Midgetrol saves installation time with *all* types of knobs.

SIMPLER STOCKING

Electrical characteristics let you use the Mallory Midgetrol to replace $1/8''$ as well as $15/16''$ controls. Stocks are further reduced because no special shafts are needed.

The Mallory Midgetrol is unusually quiet, both mechanically and electrically —and tests prove it *stays* quiet. In addition, the Mallory Midgetrol has nine *all new* features.

- NEW SIZE
- NEW DESIGN
- NEW SHAFT
- NEW EXTENSION
- NEW SWITCH
- NEW ELEMENT
- NEW CONTACT
- NEW TERMINAL
- NEW TWO-POINT SUSPENSION

It's the NEW Standard in Carbon Controls. See your Mallory distributor.

P. R. MALLORY & CO. Inc.
MALLORY

CAPACITORS... CONTROLS... VIBRATORS...
SWITCHES... RESISTORS... RECTIFIERS...
VIBRAPACK® POWER SUPPLIES... FILTERS
*Reg. U. S. Pat. Off.

APPROVED PRECISION PRODUCTS

P. R. MALLORY & CO., Inc., INDIANAPOLIS 6, INDIANA

It's here!

The NEW General Electric Variable Reluctance Cartridge for Long Playing Records

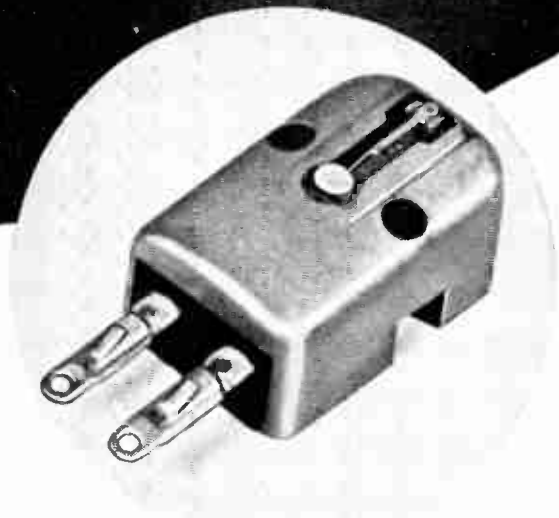

- Specifically designed for the new long playing records...high compliance...low mass stylus assembly
- Equipped with 1 mil tip radius sapphire stylus
- Can be used with standard G-E preamplifiers

Place your order today!

*General Electric Company, Electronics Park,
Syracuse, New York*

You can put your confidence in—

GENERAL  **ELECTRIC**

188-G1W

TV and HYTRON go together!

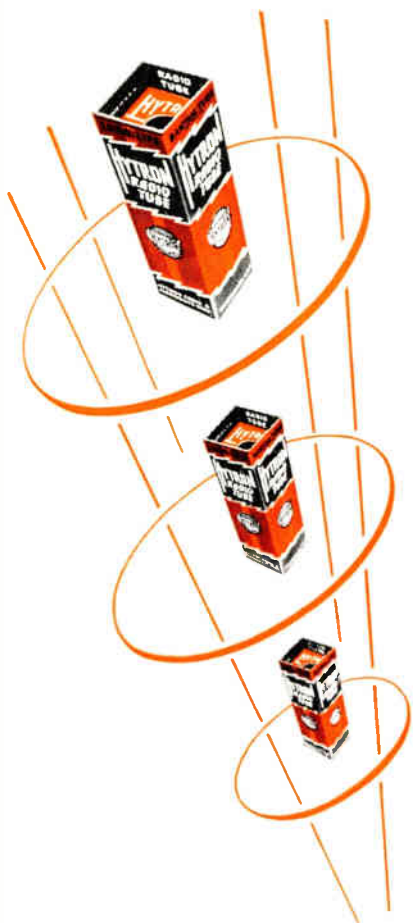

GOING...GOING...GONE!



Last prizes in your Hytron service-man's contest going-gone-gone. Grand prize winner soon to be announced. Contest over. *BUT* the

results are just beginning. We are now up to our necks in "hot" ideas. Two swell new shop tools are already scheduled for production. Many more coming. Don't miss a single one. And thanks a million for your cooperation in the contest. We are doing our darndest to make your efforts pay off for you.

TV and tubes go together. A heck of a lot of tubes. Lots of kinds of tubes. Miniature, GT, G, metal, and lock-in. In TV you find all varieties of receiving tubes.

To replace them, you need dependable tubes and a wide range of types. Dependable—because the complex TV tube chain is no stronger than its weakest link. A wide choice of types—to match the ingenuity of TV set designers.

Hytron gives you both. All kinds of tubes—and the same dependable Hytron tubes which keep company with the best of TV set makers. Service your TV sets with Hytron tubes; you'll find that TV and Hytron go well together.

SPECIALISTS IN RADIO RECEIVING TUBES SINCE 1921

HYTRON

RADIO AND ELECTRONICS CORP.

MAIN OFFICE: SALEM, MASSACHUSETTS



RADIO

MAINTENANCE

INCLUDING
ELECTRONIC
MAINTENANCE

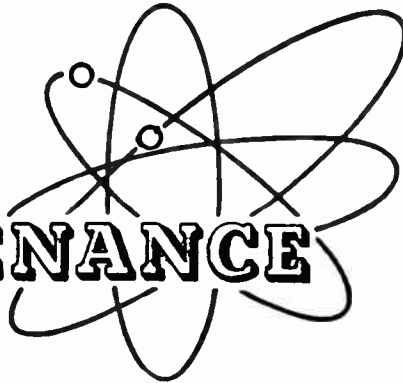

Volume 4

NOVEMBER 1948

Number 11

CONTENTS

Specializing in Record Changer Repair	Alden Capen	14
<i>Another portable sideline for the radio service outfit</i>		
New Television Test Equipment	Marvin H. Albert	16
<i>RCA issues new TV instruments and equipment rack</i>		
FM Detectors—Part I	J. Richard Johnson	18
<i>The discriminator and ratio types of FM detectors</i>		
Custom Building with Stock Components	Walter I. Fischman	20
<i>The final article in our series</i>		
How to Signal Trace TV Receivers	M. Mandl	22
<i>Applying this trouble shooting technique to TV</i>		
The Industry Presents		26
Over the Bench	John T. Frye	28
Electronically Speaking		30
Review of Trade Literature		32

WILLIAM F. BOYCE
Publisher

JOSEPH J. ROCHE
Editor

VICTOR M. TURNER
Art Director

ROY HOWARD
Advertising Sales, Cleveland

MARVIN H. ALBERT
Associate Editor

THOMAS A. BYRNES
Director of Field Services
and Quality Control

MORTON SCHERAGA
Contributing Editor

Stuart J. Osten
Advertising Sales Manager,
Midwestern Division

AL JOHNSTON
Circulation Manager

Eastern Office
460 Bloomfield Avenue
Montclair, N. J.
Montclair 2-7101

Midwestern Office
228 No. La Salle St.
Chicago 1, Ill.
Dearborn 2-3507

West Coast
Swain Associates
639 So. Wilton Place
Los Angeles 5, Calif.
Dunkirk 8-2248

Copyright 1948, Boland & Boyce, Inc.

Radio Maintenance is published monthly by Boland & Boyce, Inc., at 34 No. Crystal St., East Stroudsburg, Pa., U.S.A.; Executive and Editorial Office, 460 Bloomfield Ave., Montclair, N. J. Subscription Rates: In U. S., Mexico, South and Central America, and U. S. possessions, \$3.00 for 1 year, \$5.00 for two years, single copies 40 cents; in Canada, \$3.50 for 1 year, \$6.00 for 2 years, single copies 45 cents; in British Empire, \$4.00 for 1 year, \$7.00 for 2 years, single copies 60 cents; all other foreign countries, \$5.00 for 1 year.

Entered as second class matter July 13, 1946, at Post Office, East Stroudsburg, Pa., under the Act of March 3, 1879.

Change of address: Four weeks' notice required for change of address. When ordering a change, please furnish an address stencil impression from a recent issue if you can. Address changes cannot be made without the old stencil as well as the new one.

First again



with radio men!

This year again more radio men will buy more Sealdtite★ Capacitors than any other molded paper tubulars.

This year-after-year preference for Sealdtite Capacitors over all other molded paper tubulars is positive proof of Sealdtite superiority. And there are reasons! Solar's exclusive all-purpose molded Hi-Temp construction resists atmospheric moisture, and heat up to 100°C—no cardboard tubes to grow soggy—no dripping wax. These all add up to definite assurance of long trouble-free life. Write right now for catalog.

SOLAR CAPACITOR SALES CORP.
NORTH BERGEN, NEW JERSEY

SEALDTITE MEANS LONGER LIFE

★Trade Mark



Build YOUR OWN TEST EQUIPMENT

Heathkit ELECTRONIC SWITCH KIT DOUBLES THE UTILITY OF ANY SCOPE



\$34.50

Two separately controllable traces on individual inputs on any scope. See both the input and output traces, locate distortion, phase shift, etc., immediately. Individual gain controls and positioning control. Coarse and fine sweeping rate controls. Complete Heathkit matches others, with 5 tubes. All metal parts are punched, formed and cadmium plated. Complete with tubes, all parts, detailed blueprints and instructions. Shipping Wt. 13 lbs.

Nothing ELSE TO BUY

HEATHKIT CONDENSER CHECKER KIT

\$19.50

Nothing ELSE TO BUY

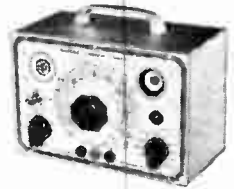

A condenser checker anyone can afford to own. Measures capacity and leakage from .00001 to 1000 MFD on calibrated scales with test voltage up to 500 volts. No need for tables or multipliers. Reads resistance 500 ohms to 2 megohms. 110V 60 cycle transformer operated complete with rectifier and magic eye indicator tubes. Easy quick assembly with clear detailed blueprints and instructions. Small convenient size 9" x 6" x 4 3/4". Wt. 4 lbs.

HEATHKIT SIGNAL GENERATOR KIT

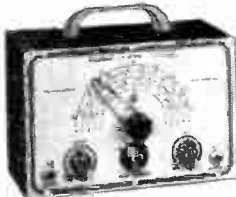

\$19.50

NOTHING ELSE TO BUY

Every shop needs a good signal generator. The Heathkit fulfills every servicing need, fundamentals from 150 Kc. to 30 megacycles with strong harmonics over 100 megacycles covering the new television and FM bands. 110V 60 cycle transformer operated power supply.

400 cycle audio available for 30% modulation or audio testing. Uses 6SN7 as RF oscillator and audio amplifier. Complete kit has every part necessary and detailed blueprints and instructions enable the builder to assemble it in a few hours. Large easy to read calibration. Convenient size 9" x 6" x 4 3/4". Wt. 4 1/2 lbs.

HEATHKIT SIGNAL TRACER KIT

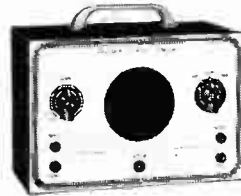

\$19.50

Nothing ELSE TO BUY

Reduces service time and greatly increases profits of any service shop. Uses crystal diode to follow signal from antenna to speaker. Locates faults immediately. Internal amplifier available for speaker testing and internal speaker available for amplifier testing. Connection for VTVM on panel allows visual tracing and gain measurements. Also tests phonograph pickups, microphones, PA systems, etc. Frequency range to 200 Mc. Complete ready to assemble. 110V 60 cycle transformer operated. Supplied with 3 tubes, diode probe, 2 color panel, all other parts. Easy to assemble, detailed blueprints and instructions.

Small portable 9" x 6" x 4 3/4". Wt. 6 pounds. Ideal for taking on service calls. Complete your service shop with this instrument.

HEATHKIT SINE AND SQUARE WAVE AUDIO GENERATOR KIT

The ideal instrument for checking audio amplifiers, television response, distortion, etc. Supplies excellent sine wave 20 cycles to 20,000 cycles and in addition supplies square wave over same range. Extremely low distortion, less than 1%, large calibrated dial, beautiful 2 color panel, 1% precision calibrating resistors, 110 V 60 cycle power transformer, 5 tubes, detailed blueprints and instructions. R.C. type circuit with excellent stability. Shipping weight 15 pounds.



\$34.50

Nothing ELSE TO BUY

THE NEW HEATHKIT VACUUM TUBE VOLTMETER KIT

The most essential tool a radio man can have, now within the reach of his pocketbook. The Heathkit VTVM is equal in quality to instruments selling for \$75.00 or more. Features 500 microamp meter, transformer power supply, 1% glass enclosed divider resistors, ceramic selector switches, 11 megohms input resistance, linear AC and DC scale, electronic AC reading RMS. Circuit uses 6SN7 in balanced bridge circuit, a 6H6 as AC rectifier and 6 x 5 os transformer power supply rectifier. Included is means of calibrating without standards. Average assembly time less than four pleasant hours and you have the most useful test instrument you will ever own. Ranges 0-3, 30, 100, 300, 1000 volts AC and DC. Ohmmeter has ranges of scale times 1, 100, 1000, 10M and 1 megohm, giving range .1 ohm to 1000 megohms. Complete with detailed instructions. Add postage for 8 lbs.

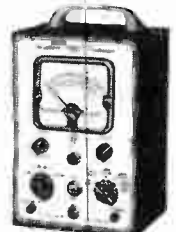

\$24.50

Nothing ELSE TO BUY

HEATHKIT FM AND TELEVISION SWEEP GENERATOR KIT



\$24.50

NOTHING ELSE TO BUY

THE BASIC FM AND TELEVISION SERVICE INSTRUMENT

At the lowest cost possible, anyone can now service FM and television receivers. The Heathkit sweep generator kit operates with oscilloscope and covers all necessary frequencies. A few pleasant hours assembling this kit puts any organization in position to share the profits of the FM and TV boom.

Every part supplied — grey crockle cabinet, two color calibrated panel, all metal parts punched, formed and plated. 5 tubes, complete detailed instructions for assembly and use. Shipping weight 6 lbs.

The NEW 1948 HEATHKIT 5 INCH OSCILLOSCOPE KIT

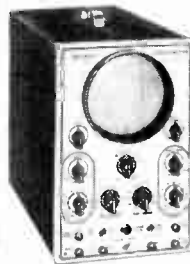

\$39.50

NOTHING ELSE TO BUY

New improved model of the famous Heathkit Oscilloscope. Building on oscilloscope is the finest training for television and newer servicing technique and you save two-thirds the cost. All the features and quality of instruments selling for \$100.00 or more. Supplied complete with cabinet, two color panel, 5B1P tube, 2 5Y3 tubes, 2 6S17 tubes and 884 sweep generator tube. Power transformer supplies 1000V negative and 350 volt positive. Sweep generator 15 cycles to 30 M. cycles. Has vertical and horizontal amplifiers. Oil filled filter condensers for long life. Complete blueprints and instructions included.



The **HEATH COMPANY**

... BENTON HARBOR 10, MICHIGAN

In Radio "B" Batteries...as in Tire Chains...



INTERLOCKED Means Strength!

STRONG!

The chains with each link interlocked with its neighbor are strong.

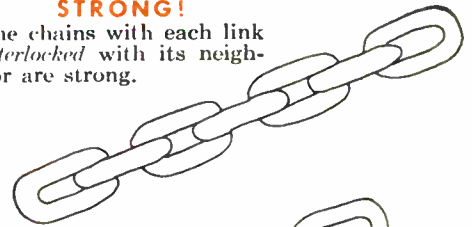

WEAK!

Links which are taped or tied together are useless as tire chains.

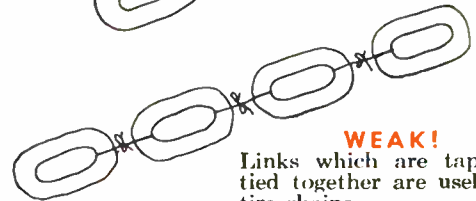

INTERLOCKED...means strength... That's why it is important to know that *only* the New OLIN radio "B" batteries have INTERLOCKED flat cells. Other brands of radio flat cell "B" batteries are bound or linked together with paper tapes or other type wrappings.

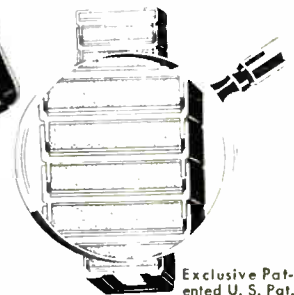

Exclusive Patented U. S. Pat. No. 2416576

FLAT CELL "B" BATTERIES ...with Activated Chemicals

There's Nothing Like Them ...They're the **ONLY** Radio "B" Batteries in Which Each Cell Interlocks with Its Neighbor

THEY ARE BETTER IN 6 DISTINCT WAYS

- 1 Only OLIN INTERLOCKED flat cells are Triple Sealed under FIXED PRESSURE ... (a) insuring against power leakage ... (b) gives each battery dimensional stability not found in other brands—this feature is vital.
- 2 Each Cell Holds More Power-Producing Chemicals.
- 3 No Waste Space.
- 4 91% Less Soldered Connections ... Really Reduces Battery Failure.
- 5 Result of WAR-TIME Electronic Research.
- 6 Tested and Approved by Leading Radio Manufacturers.

Available only in the

WINCHESTER and **BOND** Lines
TRADE-MARK

of OLIN INDUSTRIES, INC., Electrical Division, New Haven, Conn.

FREE! TWO AUTOMATIC SALESMEN

Use the coupon for yours ... 1 to work on your counter, the other on your window. Brilliant 3-color display salesmen. They've sold thousands upon thousands of OLIN INTERLOCKED flat cell "B" batteries.

Olin Industries, Inc.
Electrical Division
New Haven, Conn.
Dept. G-1

Mail me at once—no charge—Counter Display and Window streamer. BOND-OLIN or WINCHESTER-OLIN. (Check brand desired.)

Name.....
Street & Number.....
City.....Zone....State.....

RIGHT . . . FOR SERVICING HOME RECEIVERS

Now, A Replacement Line of Chicago Transformers & Reactors

Now available in principal cities, this new replacement transformer line fits a wide range of the service man's most frequent power and audio requirements and fills, as well, the needs of the amateur and experimenter for efficient, standard-type ratings at low cost.

Here's transformer design and construction you can rely upon to give accurate, dependable performance. Every unit is backed by Chicago Transformer's reputation for quality . . . established in over 20 years of designing and producing original equipment transformers for the nation's leading set manufacturers.

RMA color-coded leads, tinned lead ends, and compact, standard-dimension mountings make for easy installation at the service bench. Included in the line are power transformers and chokes, filament, driver, speaker matching, interstage, and output transformers in a range of carefully chosen, practical ratings.

Ask for *Chicago Replacement Transformers* the next time you call or visit our parts jobber. *In the meantime . . .*

WRITE FOR CATALOG

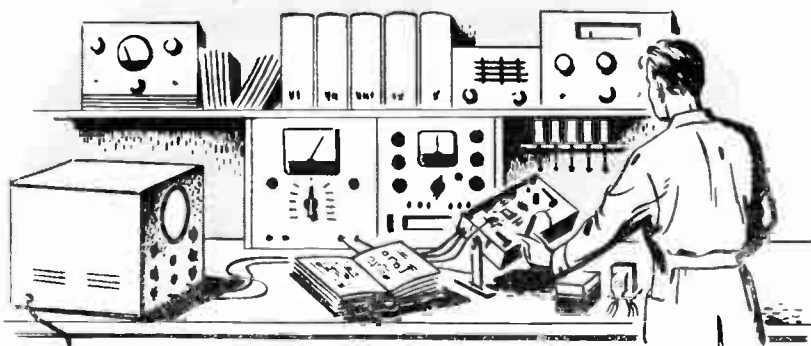

CHICAGO TRANSFORMER

DIVISION OF ESSEX WIRE CORPORATION

3501 ADDISON STREET • CHICAGO 18, ILLINOIS

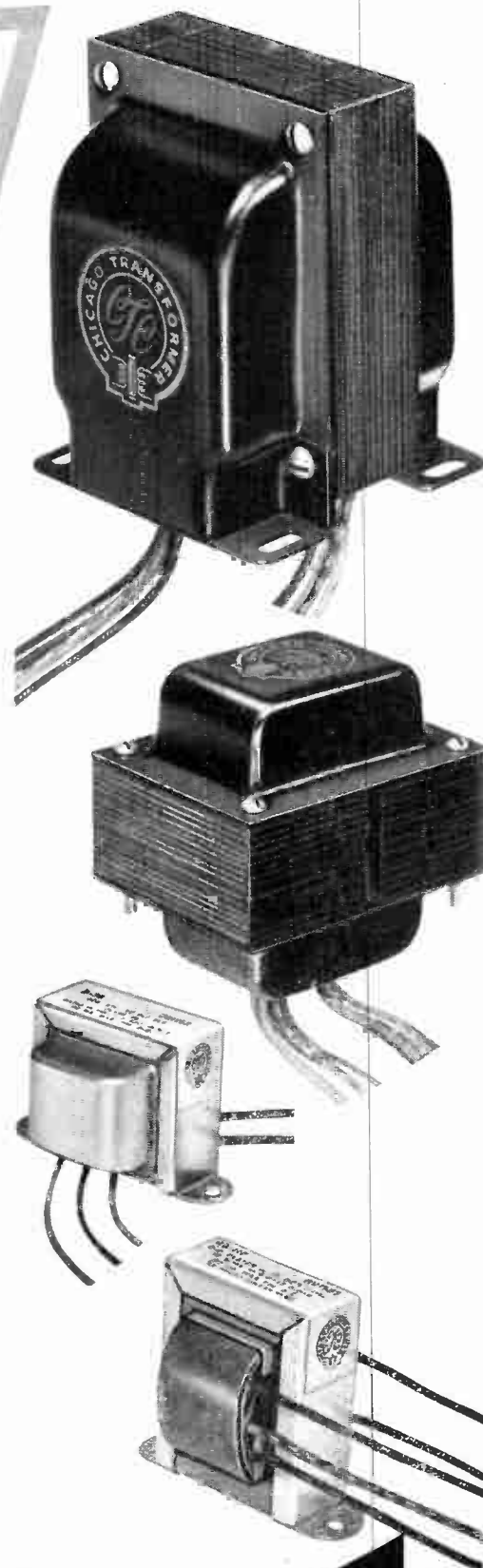

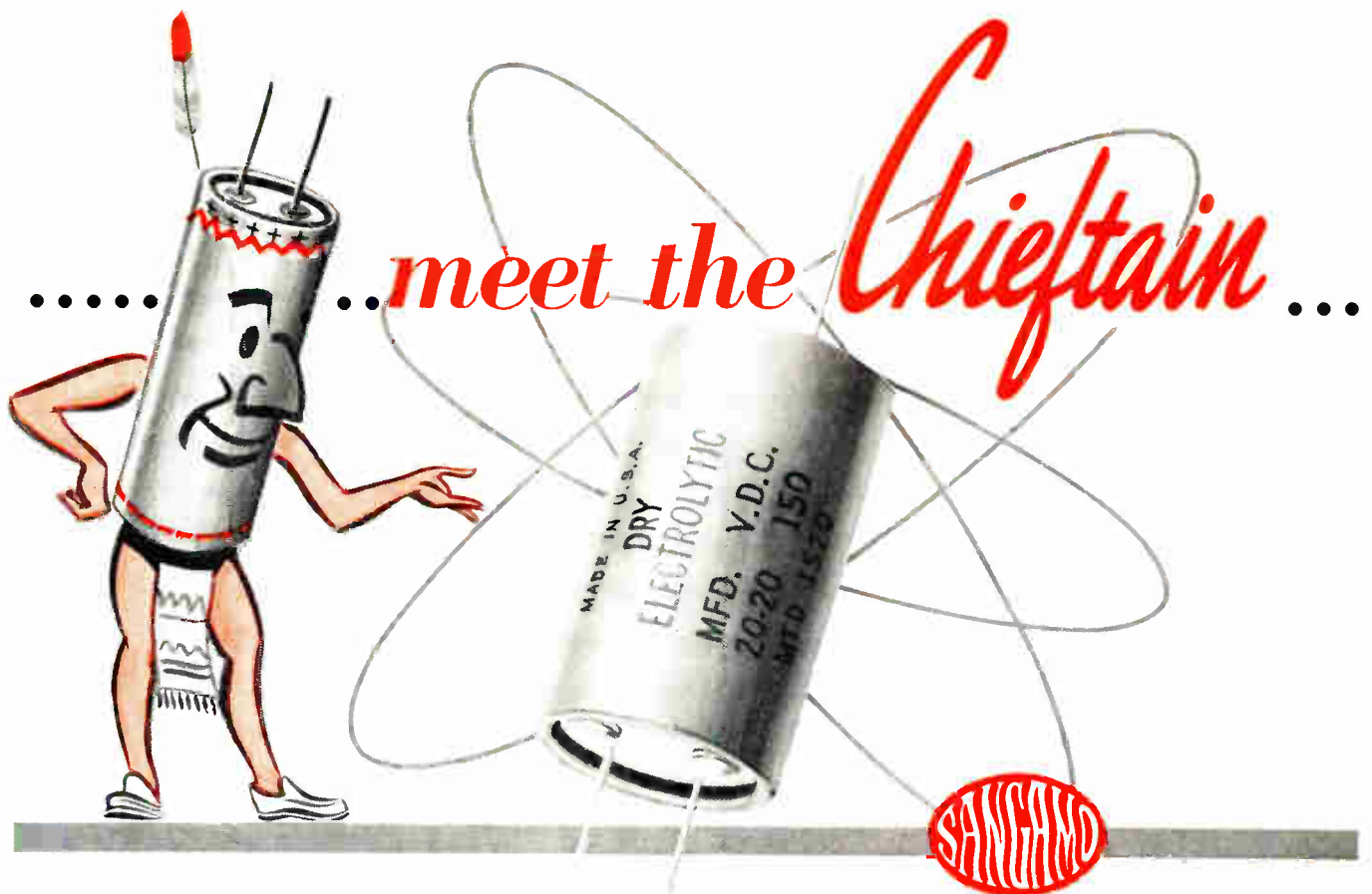

dry tubular electrolytic capacitor

Type MT and MTD electrolytic capacitors. "Chieftains" of the Sangamo line, are built to provide longer life, greater dependability, and better electrical characteristics. Ideal for replacements, they fit anywhere! Their small physical size makes them a "natural" for application in tight spots beneath a chassis, and the bare tinned-copper wire leads make them easy to mount.

Sangamo "Chieftains" are contained in hermetically-sealed round aluminum cans and are tightly encased in heavy cardboard sleeves on which polarity is clearly indicated. Double, pure paper spacers assure adequate

breakdown characteristics and all sections are tightly held in place within the container. Multiple staking connects the terminal tabs to the electrodes, providing permanent low resistance contact throughout the life of the capacitor. The low voltage units are supplied with etched cathodes to maintain uniform capacity when the capacitor is subjected to heat and high ripple currents.

"Chieftains" are manufactured under controlled conditions of almost surgical cleanliness, utilizing the very finest materials and production procedures available in the industry, for your assurance of quality in every respect.



Tomahawk



Warrior



Apache



Mohican

Your own trial-use will convince you that new standards of dependability and longevity have been built into Sangamo Electrolytics. Order from the new Sangamo Electrolytic Capacitor Catalog No. 825B, which is yours for the asking, and without obligation.

SC 4810



SANGAMO ELECTRIC COMPANY
SPRINGFIELD • ILLINOIS



Tests any tube—

... regardless of base connections
or internal connections of its elements

This is today's outstanding tube tester in simplicity of operation. It is engineered to test all tubes for present radio receivers and any that may come to market within the foreseeable future.

Using the basic RMA recommended circuit, it is possible to test any tube regardless of its base connections or the internal connections of its elements through the use of the new exclusive Simpson three-position lever-operated toggle switches. These new Simpson toggle switches use a molded rotor carrying silver plated contacts which are self-cleaning through their wiping action.

Sockets are provided for all receiving tubes, including the latest nine pin miniature tubes, and the sub-miniatures. Flexible individual element switching arrangement takes care of any future tube developments. Special Simpson acorn tube socket with floating contacts assures positive contact with insurance against damage to the delicate prong construction. Tests can also be made on gaseous rectifiers, pilot lamps and continuity of ballast tubes.

No adapters or special sockets are required. Model 555 is properly fused and provides for line adjustment from 100 to 230 volts with smooth vernier control.

SIZE: 16¾" WIDE x 12½" HIGH x 6" DEEP

Dealer's Net Price, complete with test leads
and Operator's Manual \$69.85

★ Handsome styling for
quick, accurate operation

- Panel—Beautiful modern styling in the shining silver and black of highly polished, enduring anodized aluminum.
- Meter—Large, in modern design, facilitates quick observation in tube testing operations. One of the special features is the jewel-like molded Lucite block above the dial opening. This block houses the Neon bulb which glows to indicate shorts and inter-element leakages. Another feature is the projection of the line adjustment control through the meter cover just below the dial opening for ease in observation and adjustment of the line voltage.
- Case—Sturdy plywood with heavy fabricoid covering, slip type hinges and compartment for accommodating line cord and grid cap lead.

With Simpson *No-Backlash* Roll Chart

Ask your jobber, or write for descriptive literature

SIMPSON ELECTRIC COMPANY
5200-5218 W. Kinzie St., Chicago 44, Ill.
In Canada: Bach-Simpson Ltd., London, Ont.

Simpson
INSTRUMENTS THAT STAY ACCURATE



Guiding Light..

The beacon light that lends a guiding hand to ships at sea is the sailors best friend. And so it has been true over the years of the RADIART VIBRATOR catalog! Carefully edited . . . skillfully planned . . . this catalog manual has been of infinite help to servicemen everywhere! For the invaluable technical data . . . the carefully cataloged listings . . . these have been the source of information that radio men depend upon. We are proud to help the trade in this manner, and will continue to print a catalog that will be regarded as "the bible of the industry".

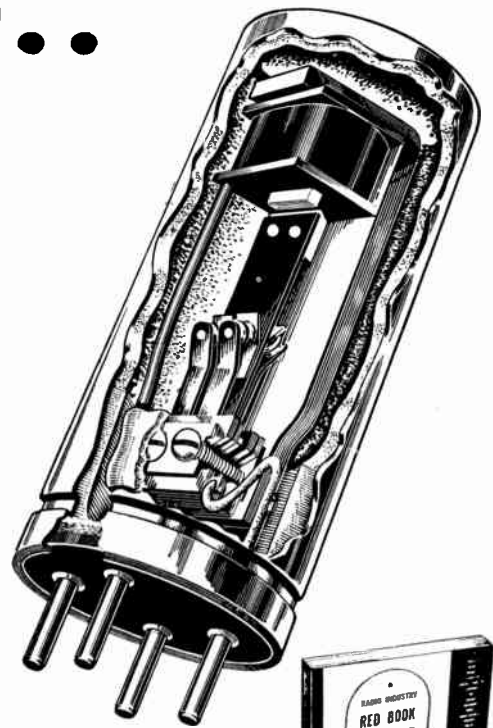

THE ONLY VIBRATOR LINE
LISTED IN SAM'S RED BOOK



The Radiart Corp.

CLEVELAND 2, OHIO

Export—Scheel international 4237 N. Lincoln Ave., Chicago 18, Ill.

NEW!



OHMITE
Little Devil

RESISTOR ASSORTMENT

IN RUGGED *All-Plastic* CABINET

REGULAR PRICE FOR RESISTORS
\$10.00
NO CHARGE FOR CABINET

Servicemen's Assortment Contains 125 Selected 1/2-Watt Little Devil Composition Resistors in 40 Separate Compartments

Here's a handsome, sturdy, all-plastic resistor cabinet you'll be proud to have in your shop—and one that will save you hours of valuable time. The new cabinet is molded of solid plastic and has five drawers with eight compartments in each drawer. It is extremely compact—only 9" long, 4-3/4" high, and 5-1/4" deep. Factory-packed in the cabinet is a serviceman's assortment of 125 carefully selected Ohmite "Little Devil," 1/2-watt, individually marked, insulated composition resistors, in the 40 values (10 ohms to 10 megohms) most fre-

quently used by servicemen. The assortment is offered at the price of the resistors alone—the cabinet is furnished without extra cost!

You'll need one or several of these handy cabinets in your shop to protect your resistors and to help you find resistance values quickly. What's more, they provide visual stock control so you can avoid duplicate inventories or unnecessary trips to your distributor. Order your assortment and cabinet from your jobber, today!

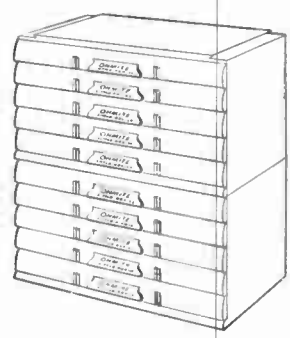

CAN BE STACKED ON EACH OTHER

A dovetail joint is provided on top and bottom of each cabinet so they can be stacked one on top of another.

QUANTITIES AND RESISTANCE VALUES IN THE SERVICEMAN'S ASSORTMENT

Quantity	OHMS	Quantity	OHMS	Quantity	OHMS	Quantity	OHMS
1	10	3	1000	1	33000	10	0.47 meg.
1	15	1	1500	5	39000	1	0.68 meg.
1	27	1	2200	10	47000	10	1.0 meg.
1	47	3	2700	1	68000	1	1.5 meg.
1	100	5	4700	1	82000	1	2.2 meg.
1	150	1	6800	10	0.1 meg.	1	2.7 meg.
1	270	10	10000	5	0.15 meg.	1	3.9 meg.
1	330	3	15000	1	0.22 meg.	1	4.7 meg.
1	470	5	22000	10	0.27 meg.	1	6.8 meg.
1	680	10	27000	1	0.33 meg.	1	10 meg.

Stocked by Leading Distributors

OHMITE MANUFACTURING CO., 4912 FLOURNOY ST., CHICAGO 44

Be Right with **OHMITE**

RHEOSTATS • RESISTORS • TAP SWITCHES

Tube Testers for Today and Tomorrow...

SPECIFY

TRIPLETT

**UP
and
DOWN**

Lever Switching Connects Each Tube Pin to Proper Circuit

1. **ALL ELEMENT CHECK** — Thorough conclusive test of tube elements, shields and taps. The only commercial tester to get at each tube pin and make an open and short check.
2. **NO HUNTING FOR SOCKETS** — No plugging into wrong socket. Circuit flexibility requires only one socket for each type of tube base.
3. **CIRCUIT CLARITY** — Lever switch numbering corresponds to RMA tube pin numbers, connected to bring out each active tube element. A simple up or down motion of the lever instantly makes the connection.
4. **OPERATION SIMPLICITY** — Minimum of control settings plus straightforward arrangement of this outstanding emission circuit. Generally not more than five of the 10 lever switches need be set.
5. **"PICTURE" YOUR CIRCUIT** — Assures confidence in tests and enables special tube checks for balanced circuits, special loads, etc. "Trick" switching circuits make it more difficult for the serviceman to "picture" his test circuit.
6. **SET UP YOUR OWN TEST FOR NEW TUBES** — The "pictured" circuit and straightforward test procedures enable the user to set up data for new tubes. A feature rarely found in commercial type tube testers.
7. **INDIVIDUAL CONTROL FOR EACH TUBE ELEMENT** — Takes care of roaming elements, dual cathode structures, multi-purpose tubes, etc., in addition to standard value tests.

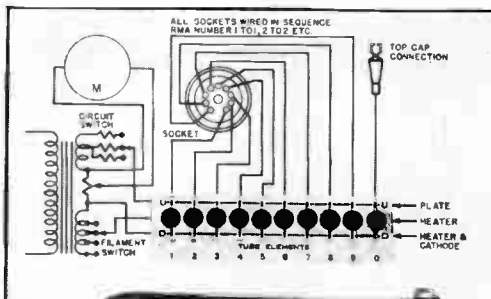

TUBE TESTER MODEL 3413

Triplett lever switching circuit arrangement has 7 distinct advantages contributing to maximum flexibility, simplicity of operation and anti-obsolence.

**NET DEALER \$66⁷⁵
PRICE**



... Combination

Volt-Ohm-Mil-Ammeter Model 3480

This tester combines the Tube Tester Model 3413 with complete facilities for voltage current and resistance analyses . . . a real economy for those shops requiring a combination tube tester and volt-ohm-mil-ammeter . . . Attractive two tone metal case with detachable hinged cover . . .

TECH DATA

- D. C. Volts: 0-3-12-60-300-1200, at 10,000 Ohms/Volt.
- A. C. Volts: 0-3-12-60-300-1200, at 2,000 Ohms/Volt.
- D. C. Amps: 0-12, at 250 Millivolts.
- D. C. Milliamps: 0-1-2-12-120, at 250 Millivolts.
- Ohms: 0-1000-10,000 (10-100 at center scale).
- Megohms: 0-1-50 (10,000-500,000 Ohms center scale).
- Output Output Jacks, Condenser in series with A. C. Volt ranges.
- Scale: 5.6" long on top scale arc. 0-1000 Ohms and 0-50 Megohms on top arc.
- 0-12-60-300 A. C. and D. C. Volt figures are on four separate arcs. Scale markings are black on white except A. C. are red on white; 0-1K Ohms scale is green on white.



MODEL 3480 \$98⁷⁵ . . . U.S.A. Dealer Net

SEE AT YOUR RADIO PARTS DISTRIBUTOR OR FOR MORE INFORMATION . . . WRITE

TRIPLETT ELECTRICAL INSTRUMENT COMPANY • BLUFFTON, OHIO, U.S.A.

In Canada: Triplett Instruments of Canada, Georgetown, Ontario

Precision first... to Last



Why play "PENNY-ANTE" . . . when your business is at stake?

A good reputation, like good-will, is built by many deeds, but may be destroyed by a single dissatisfied customer. Your reputation is too valuable to risk for the few pennies "saved"

by buying inferior or unknown "bargains." That's why we keep repeating "Your Reputation and your customers deserve the best!" And the best means Sprague.

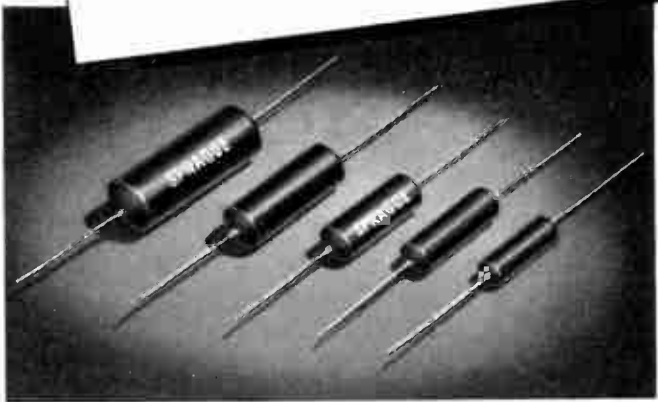
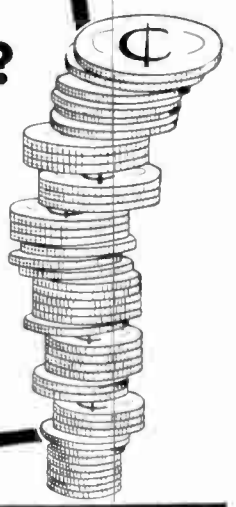

SPRAGUE TM TUBULARS—The first truly practical MOLDED Paper Tubular Capacitors!

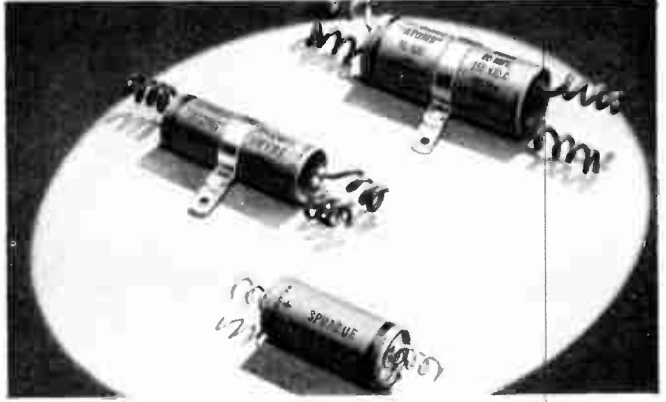

SPRAGUE ATOMS—Universal Midget Dry Electrolytics!



SPRAGUE LM—Universal Mounting Replacements!

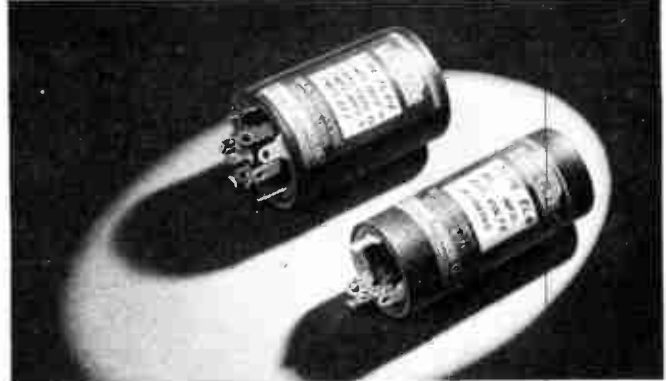

SPRAGUE EL—Self-Mounting Midget Can Type!

Reach for a **SPRAGUE**
and Know you're Right!

THESE SPRAGUE PRODUCTS ARE UNCONDITIONALLY GUARANTEED!

When used at their capacitance and voltage ratings, these Sprague Products are unconditionally guaranteed to render satisfactory performance.

*KOOLOHM
RESISTORS

CAPACITORS

SPRAGUE

*T.M. Reg.
U.S. Pat. Off.

SPRAGUE PRODUCTS COMPANY, North Adams, Mass.

(JOBGING AND DISTRIBUTING ORGANIZATION FOR THE PRODUCTS OF THE SPRAGUE ELECTRIC COMPANY)

WANTED
**Economical, Positive,
 Tube and Battery Tester**
 combined with
**complete 20,000 ohms per volt
 circuit testing facilities.**

Must handle all modern tubes with
 full anti-obsolescence features.
 Must test all up-to-date A.M.-F.M.
 and TV. circuits.

Now Available!

THE NEW PRECISION SERIES 654

COMBINATION

Cathode Conductance Tube Tester
 Dynamic (Under-Load) Battery Tester
 High Sensitivity A. C. and D. C. Circuit Tester
 (20,000 ohms per volt D.C.)

Ranges to 6000 Volts*, 120 Microamperes,
 12 amperes, 60 Megohms, + 70 DB

*(30,000 Volts with Series TV-2 Super
 High Voltage Television Test Probe.)

Series 654 is a rugged, complete, compact, high sensitivity Service Laboratory designed to meet the specific needs of the modern electronics service-maintenance technician, with utmost practical economy — conforming fully to the "Precision" high standards of quality, workmanship and performance!

TUBE AND BATTERY TESTING FEATURES

- Tests all modern tube types including Noval 9 pin, dual capped H.F. tubes, and TV amplifiers, via time-proven RMA-recommended, emission test parameters.
- Filament voltages — 3/4 to 117 V.
- Absolute Free-Point 10 element lever selection for both short and merit tests.
- Dual short-check sensitivity.
- Individual Tests of Multi-Section Tubes.
- Ballast Unit Tests.
- Micro-Line adjustment.
- Pilot and signal light tests.
- Noise and Condenser test jacks.
- Dynamic "under-load" test for all popular radio A, B, and C dry batteries.
- Built-in, brass geared roll chart.
- Anodized, etched, easy reading, heavy gauge aluminum panel.
- Fuse Extractor Post.
- Telephone type cabled wiring using plastic-insulated, moisture resistant hook-up wire.

CIRCUIT TESTING FEATURES

- 5 D.C. Voltage Ranges: — 20,000 ohms per volt.
- 5 A.C. and Output Voltage Ranges: — 1000 ohms per volt
 0-12-60-300-1200-6000 volts
 also 0-30,000 volts via optional TV-2 Television Test Probe.
- 6 D.C. Current Ranges: — 0-120 microamperes.
 0-1.2-12-120 MA
 0-1.2-12 Amperes
- 3 Wide Resistance Ranges: — 0-6000-600,000 ohms. 0-60 megohms.
 (No A.C. power required)
- 5 Decibel Ranges from —12 to +70 DB.

- ★ Fully Rotary Selective Ranges and Functions.
- ★ Only 2 pin jacks for all standard ranges.
- ★ 50 microampere, 4 7/8" Wide-Angle meter.
- ★ 1% Wirewound and film-type resistors.
- ★ All circuits isolated from power line.

SEE this new "Precision" Test Instrument on display at leading radio parts and equipment distributors. Write directly for the latest Precision catalog describing the full Precision line of quality Electronic Test Instruments for all phases of A.M., F.M. and TV.

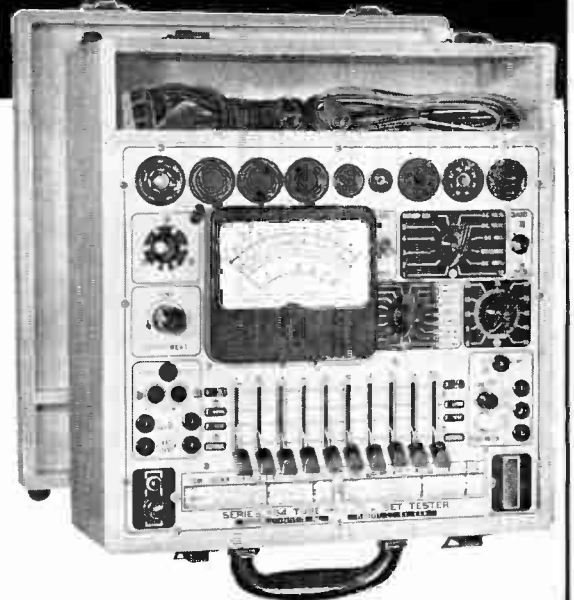

Series 654 is available in 4 distinctive models to suit individual application requirements.

★ 654-P . . . PORTABLE . . . In hardwood portable case, with tool compartment and hinged removable cover. Size 12 x 13 x 6".
 Complete: — \$106.40

★ 654-MCP . . . LAB. PORTABLE . . . Open style Metal Case Portable. Fine dull black ripple finish on heavy gauge steel. Size 10 1/2 x 12 x 6".
 Complete: — \$103.55

★ 654-PM . . . PANEL MOUNT . . . In standard size panel mount, size 12 1/4 x 13", with dust cover. For rack, cabinet or wall mount
 Complete: — \$106.40

★ 654-C . . . COUNTER . . . In modern, chrome-trimmed counter cabinet. Fine black ripple finish on heavy gauge steel. Size 16 x 13 1/2 x 7" slopes to 3" at front. Complete: — \$108.90

Coming Soon—Watch for
 Official Announcement
 —Worth Waiting For:
 The New Series E-400
 WIDE RANGE SWEEP GENERATOR
 The New Series ES-500
 MULTI-PURPOSE 5" OSCILLOSCOPE



PRECISION APPARATUS CO., INC.

92-27 HORACE HARDING BOULEVARD • ELMHURST 5, NEW YORK

Export Division: 458 BROADWAY, NEW YORK CITY, U. S. A. • Cables: MORHANEX

SPECIALIZING IN RECORD CHANGER REPAIR

by Alden Capen

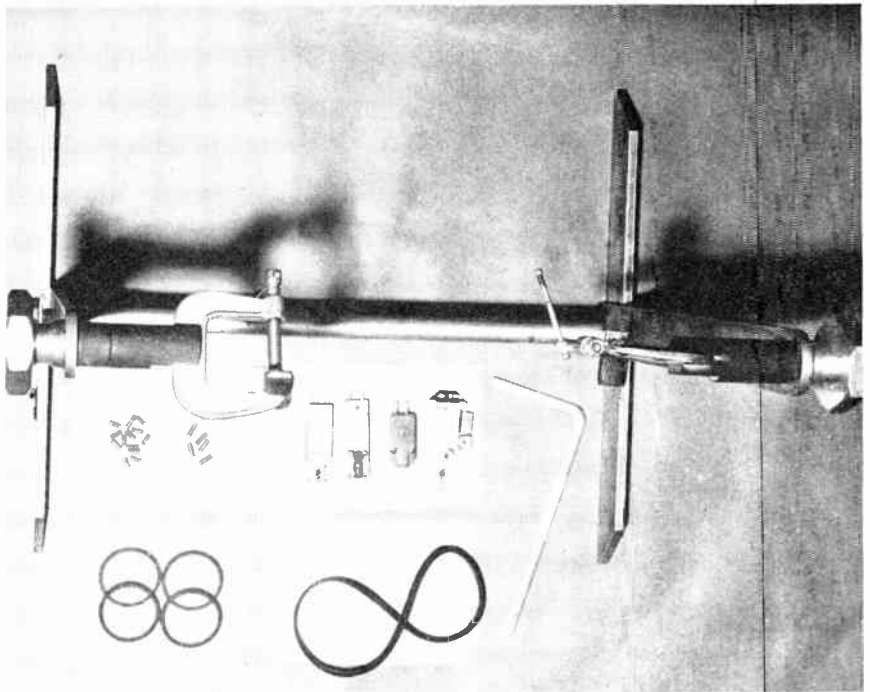

These are the basic parts necessary to begin record changer repair work. In addition to assorted hardware (not shown) they include a record changer rack, replacement crystals, bending tools, assorted springs and phono drives. Other parts fit only one specific changer and, unless the business volume builds up to large proportions, should be ordered only as needed.

Here is a profitable sideline for the radio service technician equipped with the tools and the know-how to handle the business.

THE radio serviceman sat at his bench and scowled at the record changer. Five times it went through its cycle and five times the tone arm missed the record. Finally, the serviceman threw his screw driver across the room and shouted in disgust: "FM discriminator circuits are a cinch for me, but this fool changer has me stumped."

Watching the serviceman was Herman Friend. Record changers had always been a pet interest of his. He constantly marveled at the number of radio servicemen who were able to handle intricate electronic problems but found themselves completely helpless in the face of simple mechanical equipment. "Perhaps," he reasoned, "a repair service exclusively for record changers would be welcomed."

Later, in 1945, he opened the doors of "Friend's Record Changer Service." There had never been an agency in Philadelphia specializing only in changer repairs, and it took a while before customers and local repairmen learned of the service. Newspaper advertisements and the distribution of cards helped, but it was

several months before the business was holding its own.

Friend took in a partner, William Felsher, about a year later, and they decided to supply also record changer parts to the trade. Generally, when a radio serviceman wanted to repair a changer and needed a part, he had to write to each individual factory. It took anywhere from two to six months before he received the part, and by that time, the customer had lost his patience. During the waiting period, the changer was occupying space and subject to damage. The partners decided to stock the parts of all changers and have them on hand for prompt delivery. This turned out to be such a profitable venture, that it is now a valuable addition to the service work.

Friends has been careful to build up the confidence of the servicemen who come in to buy parts. Many times, repairmen will want specific information on some problem; and either Friend or Felsher will take time out to find the probable source of trouble in the balky changer and give repair tips.

When they first began repairing

changers, the two partners found models coming into the shop they'd never seen before. However, they knew all changers operate on approximately the same basic principles. It was a matter of watching the cycle over and over again until the defect could be spotted.

Repair work, the mainstay of the business, totals up to an average of 40 to 50 changers a week. That's enough to keep two men busy all week. The firm finds that pre-war changers constitute 80% of the sets that come in for repair. These present a special problem.

Castings

Before the war, most changers were made with castings. Over a period of years the castings have become brittle. When the changer was new it could take a lot of abuse, but as the castings aged they became more fragile. Finally, one day, a tug on the tone arm that never did any harm before would suddenly cause it to snap and part, and the set land at Friends for repair.

With changers of this nature, Friends are always careful to point

out one factor to the customer before he leaves the set. They turn the changer over and show him the castings on the bottom. They explain about the brittleness that comes with age and add that as a result, some of the parts that look alright now, may be impossible to repair and will have to be replaced, necessitating a larger bill. From past experience, Friends has learned that a little pressure from a screw driver is often sufficient to snap a brittle casting. By informing the customer in advance, they are not left in the position of having to replace parts that are not sturdy enough to be repaired, thus losing money because of a low estimate.

In addition to breaking, many cast parts are subject to metal fatigue. The parts of the changer will gradually sag until the gears are so out of line that they cannot mesh properly. Most of the time, the condition is within the limits of the compensating adjustments, but occasionally the cast part of a changer will be so warped that a new one will have to be substituted.

Worn Parts

Wear on cam gears and worms account for a good deal of the breakdown of sets. The gears wear a little and there is a bit of play in them. The play greatly accelerates the wear so that the gears soon either refuse to mesh or else are so erratic in action as to make the changer worthless.

The blade type changers are subject to a malady known as jam-up. The blades that slice the records to separate one from the stack gradually wear and no longer allow for thickness. Then, instead of sliding in between the records, they catch on the edge of a record and either crunch it into bits or else the record resists breakage and jams the mechanism. Sometimes the record can be freed by the customer without damage to the changer, but sets are often brought in with the offending record still clutched tightly in the grasp of the changer.

In cases like these, either new blades or adjustment of the old ones are in order. Releasing the jammed record only makes way for another victim later.

Although Friends is an authorized factory service agent for Webster, Oak and Garrard changers, such

work only accounts for a small percentage of their business. They attribute this to the fact that post-war changers are made with fewer parts and the cycles are much simpler mechanically. In addition to this, almost all post-war changers use stamped parts that almost eliminate the element of metal brittleness and fatigue and the consequent upsetting

of adjustments.

A thorough test procedure checks changers before they go back to the customer. After a changer has been repaired, it is loaded with a stack of 10" records and then a stack of 12" records; or, in the case of some changers, with an intermixed stack. Close attention is given to the cycle,

→ to page 34



On the test bench at Friends, a balky changer gets a going over by the two partners, Herman Friend (left) and William Felsher.



William Felsher (left) and Herman Friend (background) assemble parts to fill a customer's order. Their stock includes every part for every post-war changer, and many pre-war ones.

NEW TELEVISION TEST EQUIPMENT

BY MARVIN H. ALBERT

RCA has issued six new pieces of television test equipment. These, together with RCA's new test equipment rack, cover the needs of the radio service technician handling a great deal of video servicing.

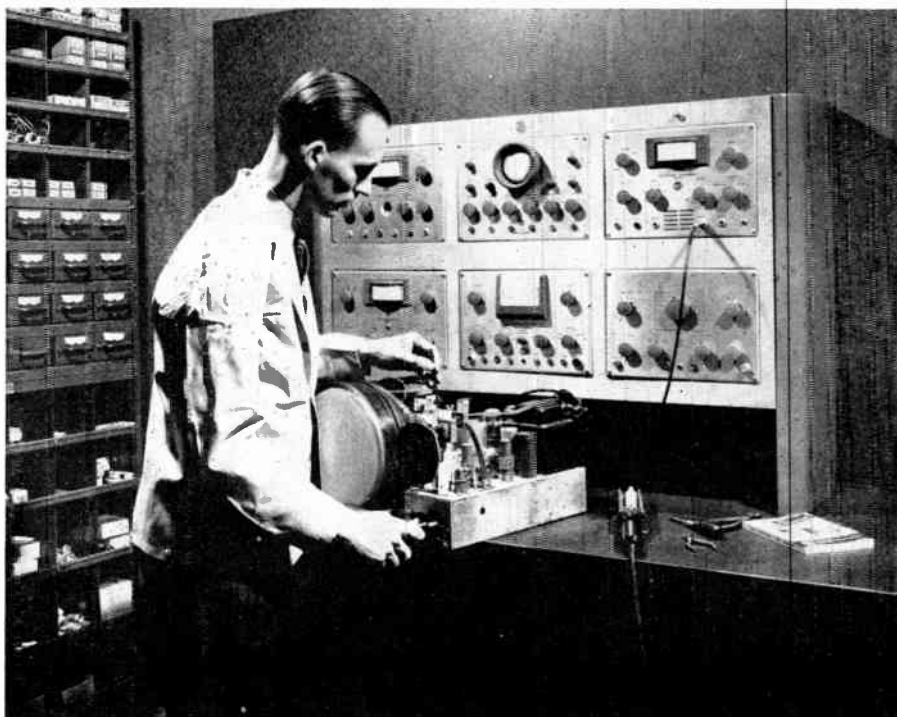

THE radio service technician, faced by increasing calls from television set owners, must add video servicing equipment to his shop. Television servicing, being more complex than AM or FM work, presents a troublesome problem to the man who has had relatively little experience with this branch of radio. He will be helped a great deal if he has equipment that was specifically designed to do this type of work.

RCA has recently put on the market four instruments which, used together, will speed the alignment and general servicing of television receivers. These are: a Television Sweep Generator, Television Calibrator, Cathode Ray Oscilloscope, and VTVM. They are shown in a typical setup for TV alignment in the sketch at the bottom of the opposite page. RCA has also issued an Audio Oscillator and a Test Oscillator, which can be used together with the other four instruments in video service work.

In conjunction with this new equipment, RCA has put out the rack shown above. This rack will hold any six of RCA's matched instruments, and is especially suited for the six described in this article.

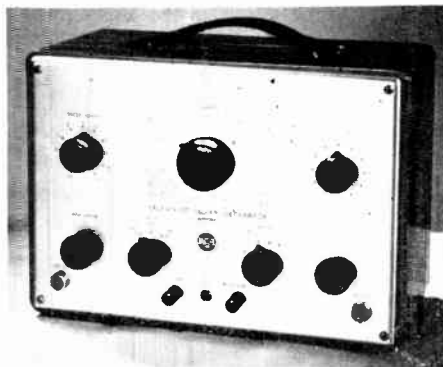

TELEVISION SWEEP GENERATOR

The WR-59A Television Sweep Generator is designed for the alignment and general servicing of TV and FM receivers. Used in conjunction with an oscilloscope, the response curve of a circuit under test can be obtained and observed. The WR-59A furnishes a frequency-modulated signal to cover all the thirteen standard TV channels, the picture and sound i-f channels, and a video sweep frequency for checking video amplifiers. It also covers the pre-war picture i-f channel, the i-f FM channel, and an extra channel covering the 25-40 Mc. range.

The WR-59A is excellent for aligning television receivers, when used with the other instruments.

This same equipment setup is used for aligning the picture i-f stages. The VTVM will be needed for setting traps, and for aligning sets that use the stagger-tuned i-f system.

The sweep generator is used in the adjustment of trap circuits. Using it, the sound i-f stages and discriminator circuit is generally aligned in the same manner as the conventional FM receiver. With the WR-59A, the discriminator circuit can be adjusted by the visual method, using an oscilloscope as an output indicator.

The video amplifier circuits in the television receiver are normally not capable of adjustment. The response characteristic may be studied, however, as an aid to locating faulty components.

The Television Sweep Generator can also be used for the alignment of FM receivers by setting the CHANNEL switch on "A-FM-IF." The center frequency of this band is set approximately to 10.7 Mc, the RMS standard intermediate frequency. This center frequency may be set to any point between 8 and 12 Mc by adjusting the "A" band tuning slug. Alignment procedure is the same as for aligning the sound channel in TV receivers.



TELEVISION CALIBRATOR

The Television Calibrator, type WR-39A, is designed primarily to be used with the RCA Television Sweep Generator and a suitable oscilloscope to align television receivers. It is a generator of crystal-calibrated marker frequencies, and combines the precision of crystal oscillators with the versatility of the variable-frequency oscillator. It contains all the elements of a complete frequency measuring system: a variable-frequency oscillator, two crystal oscillators, a heterodyne detector, and an audio amplifier.

In addition to its primary function as a marker generator, the Calibrator can also be used to identify unknown frequencies falling within its frequency range. A phone jack is provided on the front panel to enable the technician to identify the frequencies of very weak signals. Another jack allows the introduction of an external modulating voltage of any frequency when modulation of the marker output is desired.

The main application of the WR-39A is in visually aligning television receivers. It is also intended to be used in aligning picture i-f amplifiers, sound i-f amplifiers, r-f stages, and adjusting trap circuits.

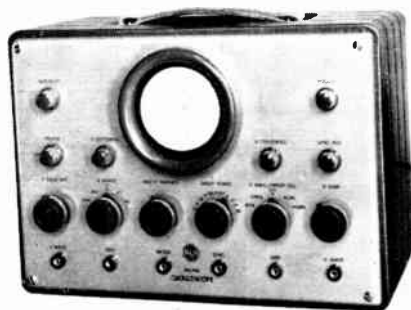

OSCILLOSCOPE

The type WO-55A Cathode-Ray Oscilloscope is portable and compact. It uses an extremely short cathode-ray tube and miniature tubes which makes possible its small size. Provision for calibration of the vertical amplifier is incorporated into this instrument, so that it can be used practically as a visual voltmeter. Generous overlap is allowed by the three-to-one ranges of the vertical attenuator, rather than the usual five- or ten-to-one ranges of most oscilloscopes. One feature of the WO-55A is the use of low-tolerance resistors in the range control unit to insure accuracy of measurement.

This oscilloscope has a retractable light shield, which increases the contrast obtainable by reducing the amount of incident light on the

cathode-ray tube screen. A removable, transparent screen, mounted in front of the cathode-ray tube, has "graph paper" ruling to facilitate voltage measurement and calibration of the vertical amplifier. The screen is removed for more detailed study of waveforms.

The sweep oscillator is a Potter type with a high-vacuum tube. It is easily synchronized with the phenomena to be observed and the waveform is exceptionally linear.



VACUUM TUBE VOLTMETER

The Master VoltOhmyst, Type WV-95A, is an electronic meter designed to measure resistance, capacitance, direct current, d-c voltage, and a-c voltage (both audio and radio frequency) over very wide ranges. Outstanding features of the instrument are: isolated measuring circuit for reading up to 1000 volts d.c. or 230 volts r.m.s. (a.c.) above ground; high input resistance; automatic protection of the indicating meter against

→ to page 38

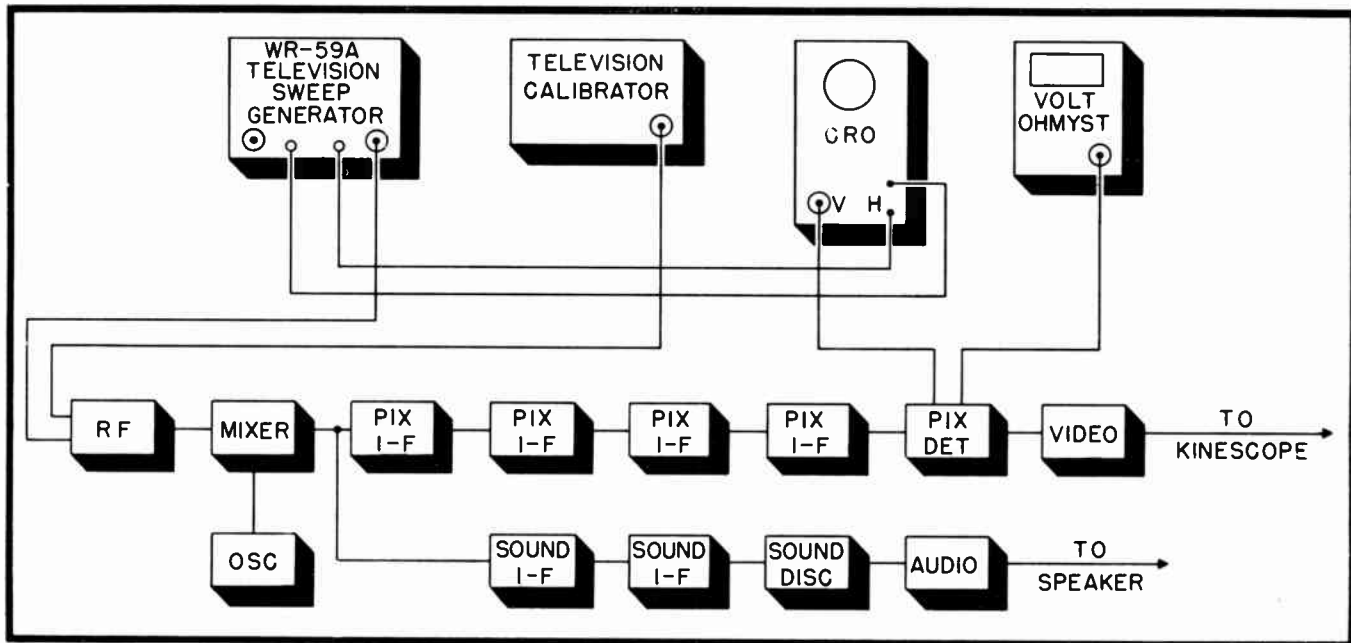

AN EXAMINATION OF DISCRIMINATOR AND RATIO TYPES OF FM DETECTORS

IN no other section is the FM receiver as different, electrically, from the AM receiver as in the detector circuit. Several types of circuits are now in use for demodulation of FM waves. Each one is quite different from corresponding detector circuits in AM receivers, and requires a different alignment and servicing approach.

The serviceman's success in dealing efficiently and profitably with FM receivers is largely dependent upon his basic knowledge of the operation of FM detectors. This article, and the one which follows, will devote themselves to those detector funda-

mentals which are applicable to successful service work.

Relation between Detector and I.F.

FM detectors, especially discriminators and ratio detectors, are critical with respect to the intermediate center frequency adjustment. If the center frequency of the i-f signal is detuned from the balance frequency of the discriminator by as much as a few kilocycles, linearity is lost and distortion results, at least on high levels of modulation. In this respect the FM detector is quite different from the AM detector. The latter

type, usually a diode, simply rectifies the signal and does not depend on a balanced condition for its operation. The diode demodulates all i-f carrier signals equally well, provided the tuning is such that sufficient signal voltage is present.

In an AM receiver, the i-f section may be detuned, the oscillator adjusted to compensate (by using the wrong dial setting), and undistorted output obtained. In fact, this is what the "practical" serviceman does when he tunes *approximately* to a station and trims up the i-f trimmers. The final i-f response may peak at 475 kc. or 425 kc., but the receiver goes

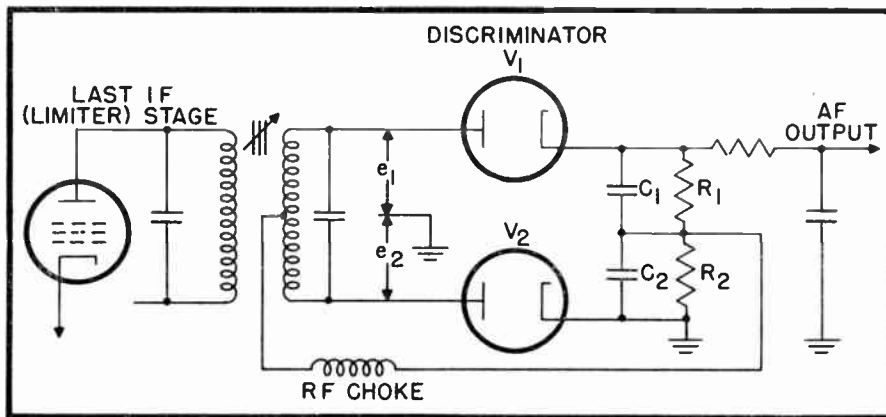

Fig. 1. Conventional basic Foster Seeley discriminator circuit.

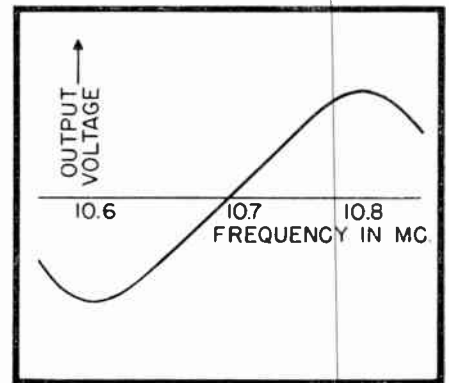

Fig. 2. The r-f frequency response of a well designed discriminator. The linear portion can be made longer, at a sacrifice of the sensitivity, which depends on the slope.

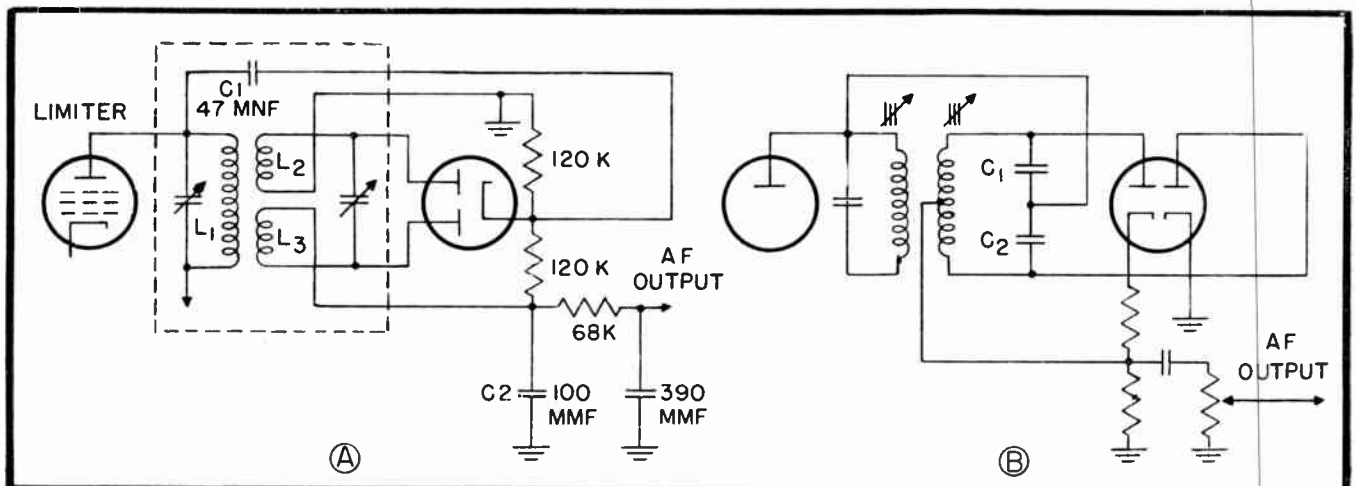

Fig. 3. Two variations of the basic discriminator circuit. (A) is an ingenious method used to make it possible to employ a tube with only one cathode. (B) applies the primary voltage to the secondary through a capacitive voltage divider.

merrily on, with only a slight displacement of the stations on the dial and perhaps a station or two lost on one end or the other.

This is a questionable practice with AM receivers; it is *very bad* practice with FM receivers. FM detectors are carefully balanced, or otherwise adjusted, to produce undistorted output only with signals having the intermediate center frequency and the standard deviation. No matter how strong is the signal applied to the FM detector, its a-f output contains distortions at high level modulation peaks if the applied center frequency is not correct.

It must always be borne in mind that the adjustment of other sections of the receiver to produce a different i.f. will cause distortion in the a-f output signal.

Discriminator

Once the only type of FM detector available, the discriminator is still one of the most common types, in spite of heavy competition from newer designs. Fig. 1 is a schematic diagram of the Foster Seeley type, most frequently used of the discriminators. Two diodes, usually in the same envelope as in the 6H16, 6AL5, etc., are used. The diodes must have separate cathodes for use in this circuit. This precludes the use of ordinary dual-diode-triode tubes like the 6SQ7. However, new types like the 7K7, 7X7 and the 6AQ7 have separate cathodes and make it possible to combine the detector and first a-f stage as in AM receivers.

The operation of the Foster Seeley circuit depends on the voltage unbalance in the two halves of the discriminator transformer secondary winding when the i-f signal deviates. The secondary circuit is tuned to

→ to page 44

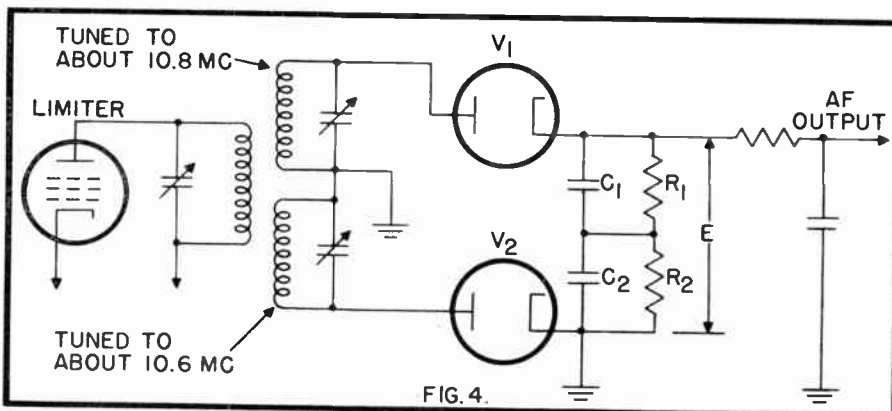

FIG. 4.

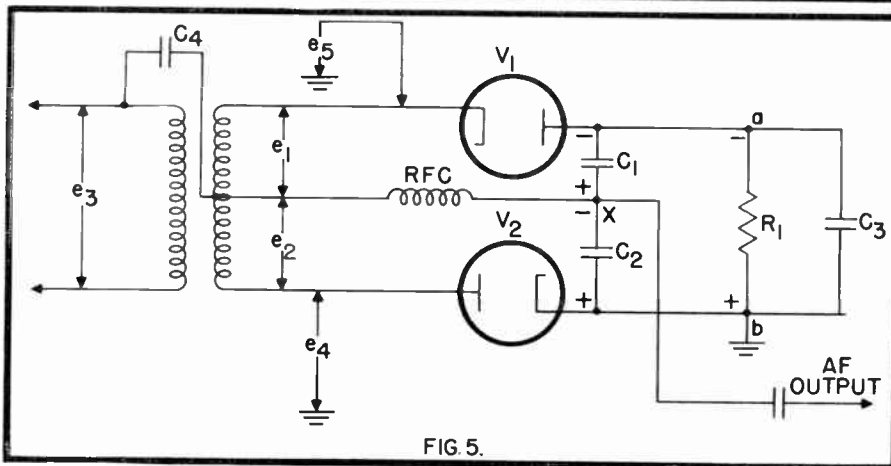

FIG. 5.

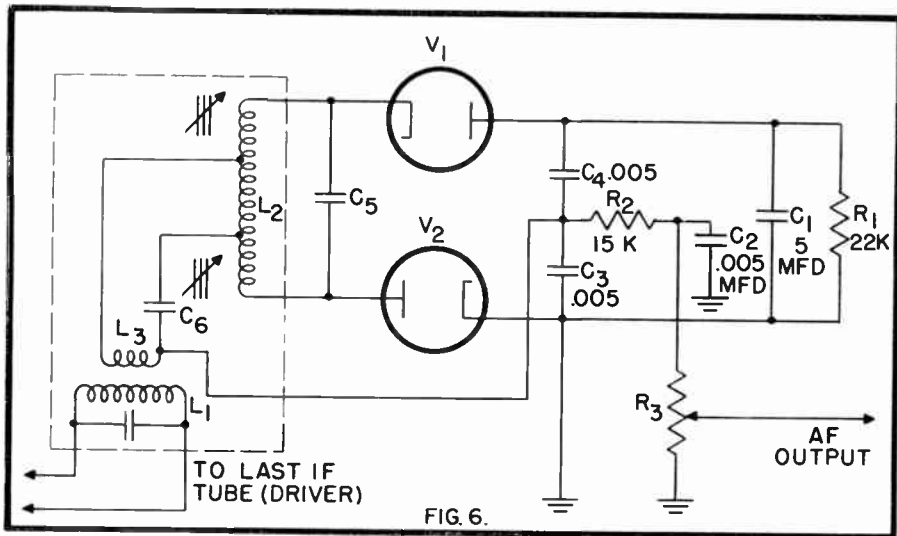

FIG. 6.

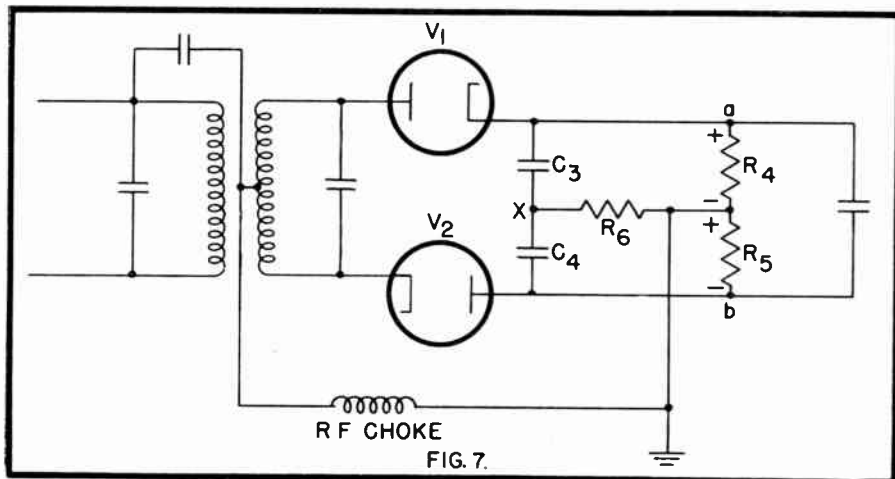

FIG. 7.

Fig. 4. Circuit of the "off-tune" discriminator. No connection between the primary and secondary windings is necessary, but an extra resonant circuit must be used.

Fig. 5. Basic circuit of the ratio detector. C-4 charges to a d-c voltage proportional to the carrier strength of the received signal. This keeps the sum of the C-2 and C-3 voltages constant, suppressing the effect of amplitude modulation signals.

Fig. 6. A variation of the ratio detector circuit used in RCA receivers.

Fig. 7. The "balanced" ratio detector circuit.

CUSTOM BUILDING WITH STOCK COMPONENTS

by Walter I. Fischman

The final article in this series deals with the type of custom building most radio service technicians will encounter: Assembling of stock components. For the average outfit that wants to do custom building as a sideline, this is the best and most profitable method.

AN EXCELLENT method of achieving many of the characteristics of top quality radio and phonograph reproduction is the careful assembling and balancing of ready-built components. In this way, using standard amplifiers, tuners, etc., costs are cut by eliminating "from scratch" construction, while good results are obtained by careful attention to the selection and matching of parts.

Requirements of Components

Both Danby Radio Corp. and Ver-tech Radio of Philadelphia have evolved minimum specifications for components to give the required performance. It was a question of weighing one operating feature against another and weeding out the weaker ones so that the selected component would be tops from a price as well as a performance standpoint.



According to these two firms that specialize in special order radio-phonographs, in order to insure good quality and trouble free operation, as well as ease in matching, components should meet with minimum requirements as follows:

Changer—Silent and foolproof operation is the top consideration for a changer. Gadgets, such as a pause cycle, only add to maintenance problems and are demanded by very few customers. The important factor is that changers be capable of operating year after year without erratic behavior or breakdown.

When Ver-tech decided to standardize on one changer, they made the rounds of all restaurants, tap-rooms and other places that provide continuous music for customers. They checked to see what changer was used most, and how well it held up under severe use.

One problem with some changers is that the new types of magnetic cartridges either won't fit at all, or can be fitted only with difficulty into the arm. It is a good idea to make

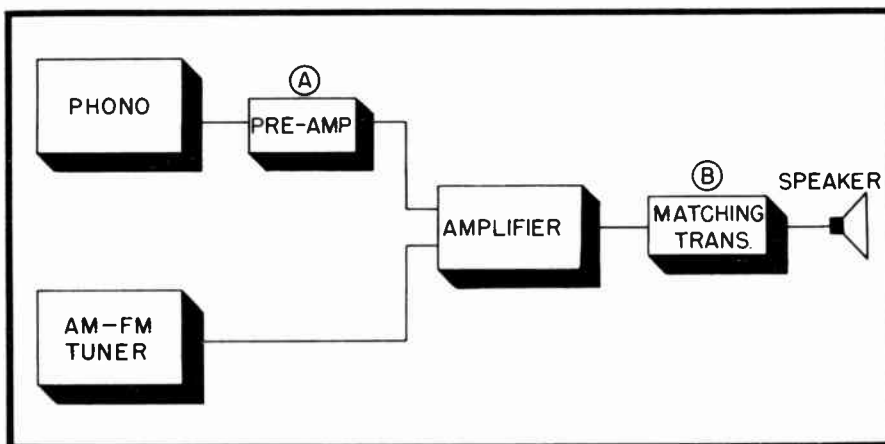

Block diagram of hook-up. A and B are points where matching equalization is most often needed.

certain the arm will accept all types before buying.

In general, reliability and lack of noise should have precedence over speed in change cycle. One or two seconds more, usually make little difference in between records if the changer is quiet. The exception is perhaps one "flipper" changer on the market whose cycle takes about twenty seconds.

When buying a changer, Danby advises that the radio man check the underside of the plate and see that no castings are used. In time these become brittle and after several years are an almost constant source of trouble. Then, too, castings have a tendency to fatigue and throw the gears out of alignment. Stamped parts are best.

If at all possible, try the changer before buying. They are put out on assembly lines and are subject to unavoidable variations. Next to a perfect changer may be a "lemon." Learn to make small adjustments yourself so that the changer may be in perfect condition when mounted in the completed set and delivered to the customer.

Amplifier—Perhaps the most indicative single sign of quality in a ready built amplifier is the output transformer. It should be big. It should be of such size and capacity that under steady use it be only moderately warm to the touch. If it runs too hot, it is undersized for the set. The same applies to the power transformer. It should be heavy enough to run cool.

An output transformer of sufficient capacity will permit a high volume level, while a cheap one will be subject to core saturation. This will result in a poor bass response and distortion.

Several manufacturers are taking advantage of the large number of surplus oil condensers on the market; and this is to the advantage of the radioman who buys such a set. Their greater electronic efficiency, extended life and ruggedness all count in their favor.

Another indication of quality, according to Vertech, is wire wound resistors that run reasonably cool. They must get warm, but they should not heat up too much.

The chassis should be rugged enough to support the weight of

transformers. They should be without structural weakness. Turn the amplifier over, says Vertech, and look for the marks of good construction. These are good, clean solder joints, parts laid out well and wiring reasonably symmetrical. Good hardware should be used on the input and output plugs that are subject to hard usage. Check to see that there is no transformer vibration.

In beam output stages, Danby recommends that the amplifier have 10 or 12 db of negative feedback over 2 or 3 stages. If it is intelligently used, it will extend the range of the equipment and minimize possible hum and distortion.

Tuner—The same requirements concerning general construction as noted

above with respect to amplifiers, also apply to tuners. Good parts, rugged construction and sensible layout are all factors to be considered. Check the FM section for excessive drift. After the set has warmed up, it should be comparatively stable. For appearance, the set should possess a good looking and easy to read dial, sufficiently geared down to make for easy tuning. Often, Vertech will tap into the audio of a modern table radio. For this, a set with a power transformer is a necessity.

Pickup—On all hi-fi sets, Vertech uses one of the new variable reluctance pickups on the market. Danby follows the same pattern, except that they also at times use one of the

→ to page 36



The completely assembled rig of amplifier, tuner, speaker and changer, plus pre-amp and matching transformer if necessary, should be thoroughly checked before mounting in cabinet. Here, a set of components is put on the test bench at Danby Radio Corp.

HOW TO SIGNAL TRACE TV RECEIVERS

by M. Mandl

This proven trouble shooting method can be applied very successfully to television work.

ONE of the quickest methods of localizing trouble is signal tracing. By this procedure we can check for the absence, presence or modification of any signal, whether audio, video, RF or other, and thus save considerable trouble-shooting time. This servicing method has long been the favorite of the busy radio serviceman, and can be adapted to television trouble shooting very easily with the same time saving advantages.

A variety of equipment can be used for television signal tracing, including sweep generators and oscilloscopes. These are more flexible and will yield greater information, though basic signal tracing can be accomplished without them. In television, however, the variety and number of circuits involved requires finer analysis with better equipment.

As with ordinary signal tracing, we should have a signal source so that we can inject a signal when desired, because a circuit failure may prevent a signal pick-up from a transmitting station. The second device necessary is something that will give us either an audible or a visible

indication of the signal's presence. We can secure an audible indication with a pair of earphones or a loudspeaker, while the visible indication can be a meter, an oscilloscope or, as with television, an indication on the face of the picture tube itself.

Video Amplifiers

In the video amplifier circuits we can use the picture tube itself as our indicating device. An ordinary signal generator may be used, as long as it is capable of the usual 400 c modulation of the RF. The output from the signal generator is injected into the grid of each video amplifier and visible sound bars will appear on the screen if the signal gets through the circuit. If the 400 cycles per second audio note is available alone, it can be injected into the grid without the RF. If the 400 c not is only for internal AM modulation of the RF output, we can use such amplitude modulated RF up to several megacycles. Figure 1 illustrates this procedure.

Theoretically we should be able to inject RF up to 4 megacycles, since the video response of sets using 10" tubes should be from 30 cycles to 4

megacycles. However, since the video response to higher frequencies may be down, it is best to use the lowest RF range on the meter for tracing through the video amplifier stages.

Sixty cycle current from the filament winding of a transformer (or from the filaments of the set itself) can be used by attaching test prods. Use an isolating condenser of .01 as indicated in Figure 2.

As with all signal tracing using these procedures, start with the last stage and work back as each stage is proved to be in good working order. The above procedure can be followed by working back to, and including, the 2nd video detector. From then on the procedure changes somewhat.

Video IF Stages

The signal which we inject into the video IF stages for tracing purposes must be of the same frequency to which the IF stages are tuned. Thus, if the video IF frequency is 25.75 megacycles, we should adjust our signal generator to give us such a frequency. Internal modulation of the generator will again produce vis-

→ to page 24

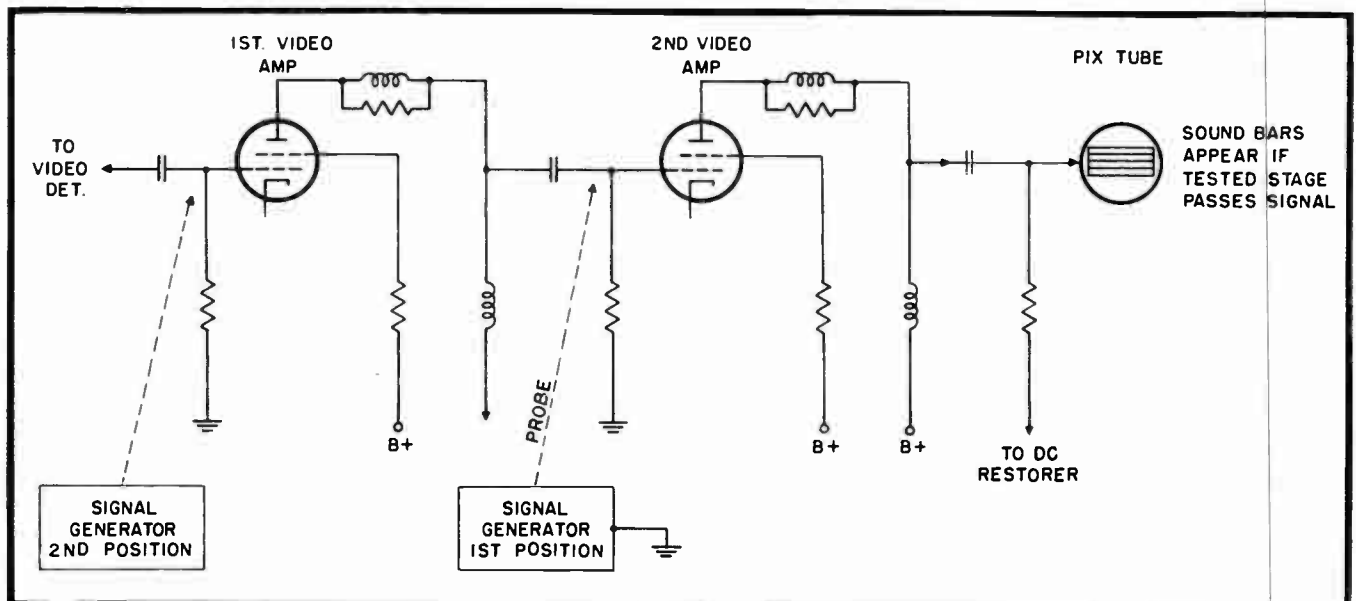
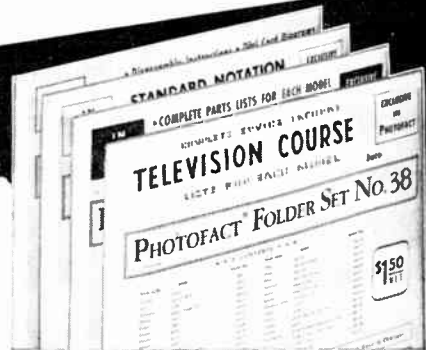

Fig. 1—Any frequency from 100 to 3,000 kc may be used to produce sound bars. Higher frequencies should be sound modulated.

Switch to PHOTOFACT— the Best Service Data Buy You'll Ever Make!

Thousands of Radio Service Technicians are *right!* They've found the way to quicker, easier, more profitable servicing. Join these thousands of successful money-making Servicemen who have switched to PHOTOFACT Service Data. Learn for yourself how this accurate, easy-to-use, practical data saves you time, makes your work easier, helps you earn more. PHOTOFACT gives you 100% useful service data—every photograph, every diagram, every bit of information helps you do a *complete job*. You owe it to yourself to switch to PHOTOFACT. There'll be a big difference in the time you save and the bigger profits you'll earn every single working day.



Subscribe Regularly to PHOTOFACT Folder Sets

Here's the most accurate and complete Radio Data ever compiled—issued regularly two sets per month. Keeps you right up-to-the-minute on all current receiver production. Your best buy in Service data—practical, useful information that makes money for you every day by saving you time on service jobs. Shows you everything you need to know about the sets you service—in clear, accurate, uniform style. Packed with extra help—full PHOTOFACT data on Automatic Record Changers—communications receivers—amplifiers—*plus* new PHOTOFACT Television Folders—exclusive, uniform coverage of popular Television Models, data proved best by actual service clinic experience. Subscribe at your Jobber today, for regular monthly issues. **\$1.50 PER SET ONLY**.....

FREE Photofact Cumulative Index

Send for the FREE Cumulative Index to PHOTOFACT Folders covering all postwar receivers up to the present. You'll want this valuable reference guide to the Radio Service Data preferred and used by thousands. Helps you find the Folders you want quickly. Get this Index at your Jobber or write for it today.



PHOTOFACT VOLUMES The Preferred Service Data



Your Price
Each Volume,
In Deluxe Binder **\$18.39**

Bring your file of post-war receiver Service Data right up to July, 1948! Here's the most accurate and complete radio data ever compiled—preferred and used daily by thousands of Radio Service Technicians. Includes: Exclusive Standard Notation Schematics; photo views keyed to parts lists and alignment data; complete parts listings and proper replacements; alignment, stage gain, circuit voltage and resistance analysis; coil resistances; record changer service data, etc. Order Volume 4 today—keep your Photofact library up-to-date—it's the *only* Radio Service Data that meets your *actual* needs!

- Vol. 4.** Covers models from Jan. 1, 1948 to July 1, 1948
- Vol. 3.** Covers models from July 1, 1947 to Jan. 1, 1948
- Vol. 2.** Covers models from Jan. 1, 1947 to July 1, 1947
- Vol. 1.** Covers all post-war models up to Jan. 1, 1947



1947 Record Changer Manual

Nothing like it! Complete, accurate data on over 40 post-war models. Exclusive exploded views, photos from all angles. Gives full change cycle data, information on adjustments, service hints and kinks, complete parts lists. **PLUS**—for the first time—complete data on leading Wire, Ribbon, Tape and Paper Disc Recorders! 400 pages; hard cover; opens flat. Order now! **\$4.95 ONLY**.....



Receiver Tube Placement Guide

Shows you exactly where to replace each tube in 5500 radio models, covering 1938 to 1947 receivers. Each tube layout is illustrated by a clear, accurate diagram. Saves time—eliminates risky hit-and-miss methods. 192 pages, completely indexed. **\$1.25 ONLY**.....



Dial Cord Stringing Guide

The book that shows you the *one right* way to string a dial cord. Here, in one handy pocket-sized book, are all available dial cord diagrams covering over 2300 receivers, 1938 through 1946. Makes dial cord restringing jobs quick and simple. **\$1.00 ONLY**.....



Radio Industry RED BOOK

The RED BOOK tells you in *one volume* all you need to know about replacement parts for approximately 17,000 sets made from 1938 to 1948. Includes complete, accurate listings of all 9 major replacement components—not just one. Lists correct replacement parts made by 17 leading manufacturers—not just one. Covers original parts numbers, proper replacement numbers and valuable installation notes on: Capacitors, Transformers, Controls, IF's, Speakers, Vibrators, Phono-Cartridges. **Plus**—Tube and Dial Light data, and Battery replacement data. 440 pages, 8½ x 11; sewed binding. **\$3.95 ONLY**.....

BOOST YOUR EARNING POWER!

Mail This Order Form
to HOWARD W. SAMS & CO., INC.
2924 E. Washington St., Indianapolis 7, Indiana

My (check) (money order) for \$.....enclosed.

- Send the RED BOOK. \$3.95 per copy.
- Send PHOTOFACT Volumes in DeLuxe Binder:
 - Vol 4. Vol. 3. Vol. 2. Vol. 1 (\$18.39 each).
- Automatic Record Changer Manual, \$4.95.
- Tube Placement Guide, \$1.25.
- Dial Cord Stringing Guide, \$1.00.
- Send FREE Photofact Cumulative Index.

Name.....

Address.....

City.....State.....

HOWARD W. SAMS & CO., INC.
INDIANAPOLIS 7, INDIANA

Signal Tracing TV

→ from page 22

ible sound bars on the picture tube screen if the injected signal gets through the stage under test.

Since the first procedure should be signal tracing through the video amplifier stages, we can localize a defective circuit as being a video IF stage if the signal does not get to the pix tube. The modulated RF signal makes an ideal check because it simulates the amplitude modulated picture RF and IF carrier.

In signal tracing through the IF stages we can add another means of visual indication by attaching an oscilloscope across the load resistor of the 2nd video detector as shown in Fig. 3. The scope can be adjusted for a stationary pattern of the modulated signal generator frequency (usually 400 c) and the sine wave appearing on the face of the scope screen will indicate the signal getting through. Inject the signal into the last video IF grid again and work backwards toward the mixer tube.

At the mixer, we inject a signal into the grid, but now change the generator dial to correspond to the frequency of the channel to which the set is tuned. Thus, if we set the channel selector on No. 3 channel, the signal generator should be set to 61.25 megacycles, which is the video carrier. This frequency should ride through the video IF, detector and amplifier stages and produce sound bars on the screen of the pix tube.

If we know that the sound IF and audio sections of the television re-

ceiver are working properly, we could check mixer performance by injecting the sound carrier frequency into the mixer grid, which in the case of Channel 3 would be 85.75 megacycles. Failure of the signal getting through from the mixer to either the video or audio IF stages when using the above two methods may be an indication of oscillator trouble as well as mixer stage trouble, since the local oscillator heterodynes its single signal with both video and sound carriers.

Many older signal generators were not designed to go as high as these television carrier frequencies, but may still have sufficient output on their harmonics for satisfactory signal injection. An initial trial on a set in good operating condition will establish this fact.

FM and Audio Stages

The injection of a 400 cycle audio note into the grid of each audio stage, and listening for the sound output in the speaker is the conventional method used in the audio amplifiers of the TV set as well as the home radio. For best results in the IF stages of the FM sound section, however, a sweep generator set to the sound IF frequency is preferable. The modulation note appearing in the speaker indicates that the signal is getting through. A VTVM or a 'scope can also be connected across one-half of the discriminator load as an additional check. If a ratio detector is used, the indicating device should be placed across the total output of the detector, though for sig-

nal tracing purposes the sound appearing in the speaker will suffice.

In the absence of a sweep generator, a conventional generator can be used, again employing internal AM modulation. The modulation pattern will be visible on the 'scope as successive stages are traced back to the mixer.

Sweep Circuits

Since both vertical and horizontal oscillators are free running even though no TV signal is tuned in, we can signal trace for the product of the oscillators themselves, viz. the saw-tooth wave forms. The best method, of course, is by use of an oscilloscope, for this device will show the actual saw tooth wave shapes, and their absence is an immediate indication of a faulty stage. In a similar manner we can check our sync separator stages, though here we would have no signal present unless our video stages were functioning properly and we had a station tuned in. A 'scope will again give us a visual indication of the presence of the sync pulses. In the absence of a station on the air, we can inject a 400 c note from our signal generator, or 60 cycles from the filament supply. A scope pattern will then result.

Earphones can be used to pick up the sound of the sync pulses or the vertical and horizontal sweep sound. The phones should be isolated with a paper condenser, in which case they can be placed across the plate load as against ground for an audible check. ✓ ✓ ✓

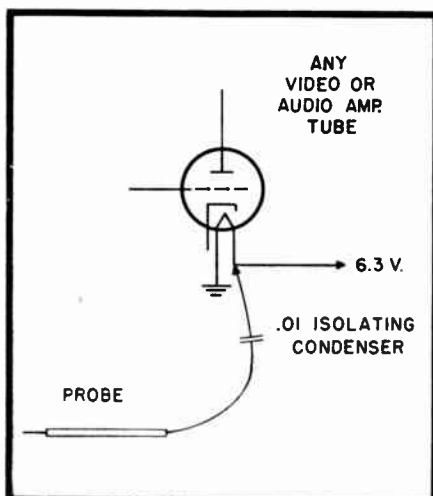

Fig. 2—Signal injection, utilizing 60 cps of filament voltage.

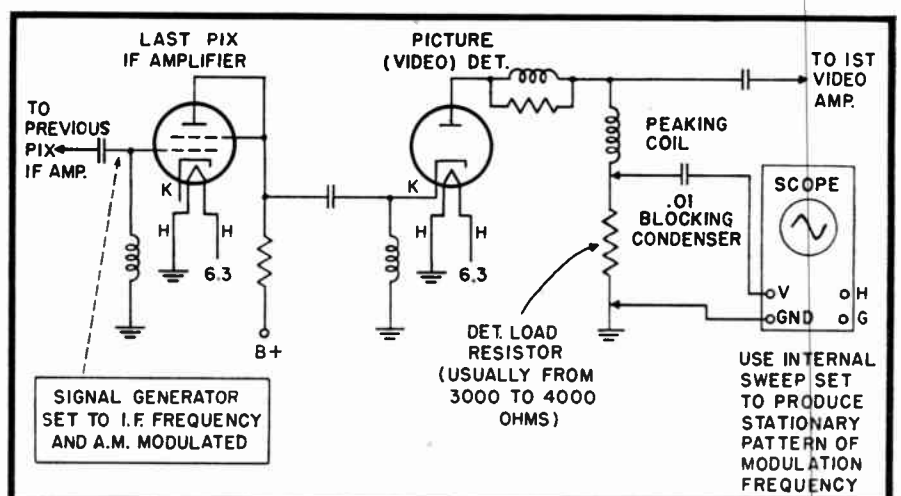

Fig. 3—Oscilloscope is connected across the load resistor to signal trace through the I.F. stages.

TWO GREAT BOOKS...COVERING EVERYTHING IN RADIO & TELEVISION

EVERYTHING IN RADIO AND ELECTRONICS IN ONE BOOK!

THE RADIO DATA BOOK

the only radio handbook of its kind . . . 1148 pages . . . 12 sections, each covering a radio subject more completely than any other book!

Used by Engineers, Servicemen, Designers, Laboratory Technicians, Draftsmen, Operators, Inspectors, Amateurs, Experimenters, Research Development, Consultants, Broadcast Technicians, Planners, Installation Men, Military, Marine, Police, Fire, Forestry and Railroad Communications.

Anyone and everyone in radio and electronics can use this book!

SECTION 1. 150 BASIC CIRCUITS

Each circuit properly classified and clearly labeled for instant reference! Every basic operating unit in the entire field of electronics for the convenience of everyone in radio—150 circuits—completely illustrated—ALL in this one section!

SECTION 2. TEST EQUIPMENT

All types of volt, current and ohmmeters, tube checkers, condenser meters, inductance meters, bridge measuring devices, RF signal generators, AF signal generators, signal tracers, distortion analyzers, test speakers, oscilloscopes, square-wave generators, frequency meters, field strength and tuning meters are explained and illustrated.

SECTION 3. TESTING AND MEASURING

How to use test equipment and make every kind of measurement in radio. This section alone is worth the price of the entire book.

SECTION 4. ANTENNAS

This section presents complete information on all antennas, transmitting and receiving. Completely illustrated, showing various types of antennas, their construction and wave patterns.

SECTION 5. SOUND SYSTEMS

The planning, selection of equipment and the assembling and combining of various components in complete PA installations. Every type of unit used is described and analyzed in detail.

SECTION 6. RECORDING

This section is the only complete description of disc recording found in any radio manual on the market. Here all phases of recording are covered—both home and commercial.

SECTION 7. TUBE MANUAL

The only uncommercial tube manual giving complete listing of all transmitting and receiving tubes with each tube base illustrated alongside the description.

SECTION 8 & 9. CHARTS, FORMULAS, CODES, GRAPHS, SYMBOLS

Here in these two sections are found all data and information useful to anyone in radio and electronics.

SECTION 10. TESTED CIRCUITS

98% of all equipment built in radio & electronics is covered here in a section presenting the typical circuit with parts lists and descriptions of each type. This is by far the most useful collection of circuits ever presented.

SECTION 11. DICTIONARY OF ELECTRONIC TERMS

This dictionary will explain every radio term—any word used in radio.

SECTION 12. BIBLIOGRAPHY

Here is a unique and valuable list of books for anyone desiring further details on any subject in Radio.

12 complete books in one only
Less than 42c per book!

\$5.00!

THE MOST COMPLETE TELEVISION MANUAL

THE VIDEO HANDBOOK

768 pages . . . 14 sections, covering every phase in television . . . over 800 illustrations . . . handsomely bound in Du Pont Fabrikoid with red and silver letters.

How Television Works, Basic . . . through advanced.
How to Design and Engineer Television.
How to Troubleshoot and Repair Television. Safety procedures.
How to Select and Install a Television Antenna.
How to Create a Television Show.
How to Build an Operating Television Receiver Complete Instructions.
How to Select a Television Receiver.

SECTION 1. TELEVISION, PAST, PRESENT AND FUTURE

Here you will find an account of the inventions, discoveries and developments that led to the present system of television.

SECTION 2. FUNDAMENTALS OF ELECTRONIC TELEVISION

In this chapter, a simplified explanation of the complete electronic television system is given.

SECTION 3. THE TELEVISION STATION—PICK-UP—CONTROL—TRANSMISSION

Each operation and piece of equipment is taken in a step-by-step presentation, illustrated with photographs, schematics, white on black scope patterns and graphs, and simplified line drawings.

SECTION 4. THE TELEVISION RECEIVER

Programming and Production

Each stage is individually studied and its function completely described as a unit and in relation to all the other stages.

SECTION 5. TELEVISION ANTENNA SYSTEMS

Circuit Variations—Design—Mechanical Features

The proper antenna for the various receivers and locales are explained.

SECTION 6. CREATING A TELEVISION SHOW

In television programming is tightly interwoven with technical operation—the man who knows this and studies both will profit greatly.

SECTION 7. DESCRIPTIONS OF MODERN TELEVISION RECEIVERS

Troubleshooting—Interpreting Test Patterns—Alignment—Repair

This section includes a circuit diagram of every type of receiver on the market today.

SECTION 8. INSTALLING TELEVISION RECEIVERS

Every step is covered . . . pre-installation surveys, equipment required, locating and erecting the antenna, laying transmission lines, locating the receiver in the building.

SECTION 9. SERVICING TELEVISION RECEIVERS

This is another section devoted to detailed, how-to-do-it procedure, this time on servicing the receiver.

SECTION 10. TELEVISION TEST EQUIPMENT. HOW TO USE IT—HOW TO BUY IT

Section 10 of the VIDEO HANDBOOK was expressly designed to give you this information—it can save you as much as \$1000.00 in purchasing test equipment.

SECTION 11. BUILDING A TELEVISION RECEIVER

Included here are complete plans, diagrams, photographs of components needed and step-by-step assembly instructions.

SECTION 12. DATA SECTION

Here are compiled all the graphs, charts, curves, nomographs, symbols, formulas and rules used in television.

SECTION 13. TELEVISION TERMS

A complete dictionary of words, terms, phrases and titles used in television.

SECTION 14. BIBLIOGRAPHY

This is the most complete list of literature on television issued to date.

**ADVANCE SALE
ORDER NOW!**

\$5.00

These books are best sellers in the radio and television field. Make sure you get your copies . . . order now! Use this coupon to order either one or both books—get them both, you'll profit by the valuable information they contain!

Mail This Coupon to Your Jobber Today — or Direct to: **RM-10**
BOLAND & BOYCE, 460 Bloomfield Ave., Montclair, N. J.

Send me 1 RADIO DATA BOOK

I enclose \$5.00 (\$5.50 Foreign)
 I enclose \$1.00 and will pay postman \$4.00 on delivery (in U. S. only)

Send me 1 VIDEO HANDBOOK

I enclose \$5.00 (\$5.50 Foreign)
 I enclose \$1.00 and will pay postman \$4.00 on delivery (in U. S. only)

NAME
ADDRESS
CITY ZONE
STATE

BOLAND & BOYCE INC., PUBLISHERS

American Beauty

ELECTRIC SOLDERING IRONS

are sturdily built for the hard usage of industrial service. Have plug type tips and are constructed on the unit system with each vital part, such as heating element, easily removable and replaceable. In 5 sizes, from 50 watts to 550 watts.

TEMPERATURE REGULATING STAND

This is a thermostatically controlled device for the regulation of the temperature of an electric soldering iron. When placed on and connected to this stand, iron may be maintained at working temperature or through adjustment on bottom of stand at low or warm temperatures.

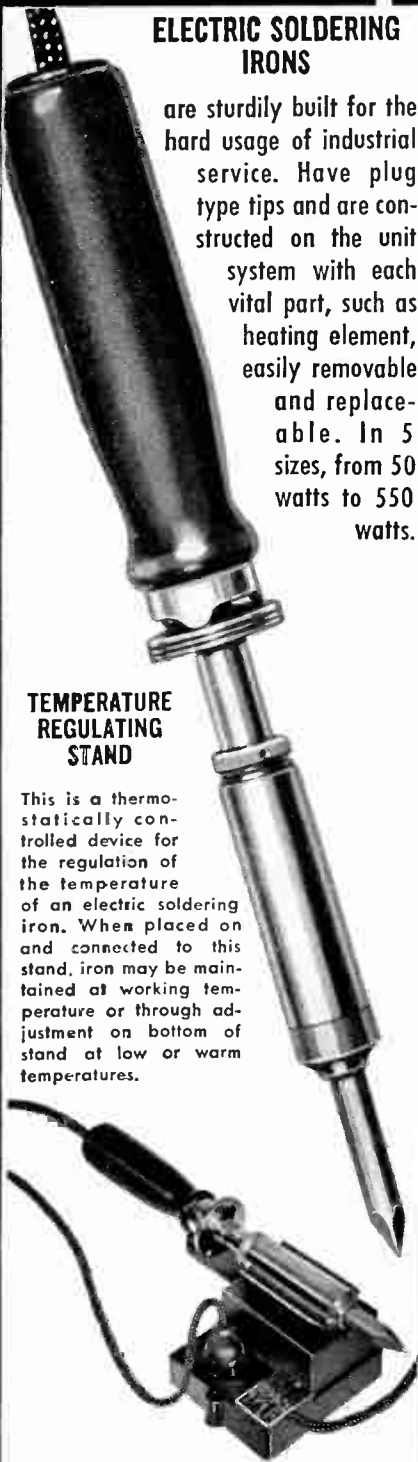

For descriptive literature write

110-1

**AMERICAN ELECTRICAL
HEATER COMPANY
DETROIT 2, MICH., U. S. A.**

THE INDUSTRY PRESENTS



HIGH VOLTAGE TV TEST PROBES

Safety, simplicity and economy, three highly significant words in the radio technician's dictionary, particularly where television servicing is concerned, have been assembled into one neat little package by Precision Apparatus Co., Inc., with their new Series TV High Voltage Safety Test Probes. These probes are the positive and economical solution to the serious service problem created by high voltage television circuit testing. The new Series TV Test Probes afford direct measurement facilities up to 30,000 volts d.c., with complete safety to the operator, with utmost simplicity, speed and accuracy. These probes provide direct kilovoltmeter facilities with present high sensitivity test sets and vacuum tube voltmeters. They can be used with most popular high sensitivity test sets due to the availability of stock value and special value multiplier cartridges. Convenient, tool-less interchange of the special tubular multiplier permits a single Precision TV Probe to be used with various test sets, provided the proper cartridge has been purchased.

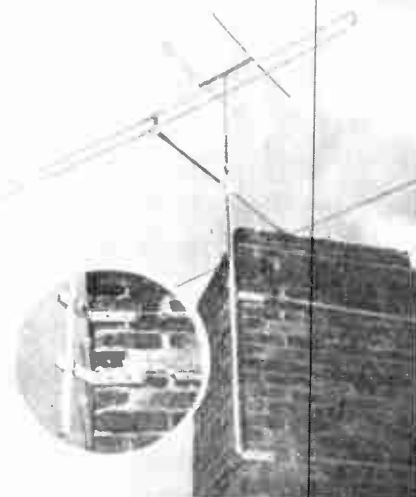

ANTENNA MOUNT ADJUSTABLE CHIMNEY

The JFD Manufacturing Co., Inc., announces the availability of its new *adjustable* Chimney Antenna Mount. This ruggedly designed mount can be erected in 5 minutes. Only a pair of pliers and a screw driver are required. There are no holes to drill. **Result:** Sharply cut installation time and cost. The JFD unit mounts on any chimney, pipe or other rectangular-shaped extension and is securely held with two 12 foot lengths of heavy duty galvanized steel bands, long enough to girdle the largest size chimney or pole. Constructed in two separate sections, the mount permits unlimited spacing between brackets. This achieves maximum support of antenna masts though they be over 6 feet in height. This outstanding advantage obviates the need for secondary mounts, guy wires or additional supports when installing unusually high antenna masts. Moreover, more than one mount can be bound to the same chimney. The brackets firmly hold any size mast from 1/2" to 1 1/2" OD and do not require any spacers or shims. All parts are made from galvanized steel and are completely corrosion-proof. If desired, the JFD engineered mount can also be screwed to any corner of a building or similarly shaped extension.

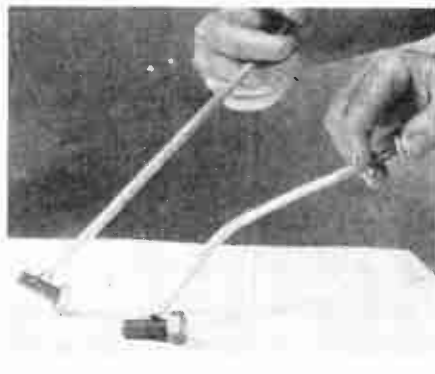

FLEX-O-PIC

This is a specialty tool for hard-to-reach parts and places, now being introduced by Emco Enterprises, Chicago, Ill. It is a recent development in specialty tools and an initial market investigation proved that there is a definite need and variety of uses for it. Flex-O-Pic can be ordered in any length.

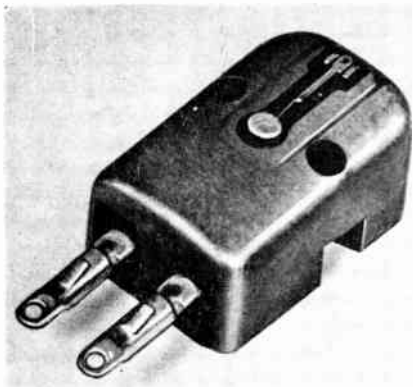

CARTRIDGE FOR LONG-PLAYING RECORDS

A new variable reluctance cartridge, designed especially for the new long-playing records, has been announced by the Receiver Division of General Electric's Electronics Department at Electronics Park, Syracuse, N. Y. The new cartridge, which features a low mass stylus assembly and high compliance for more faithful tracking, is one-third smaller than previous models, according to R. S. Fenton, sales manager for the division's component parts section. The new, improved shape of the cartridge makes it more universally adaptable to various tone arms. It also affords greater clearance for record changers. The stylus of the new cartridge is a sapphire, measuring one mil in diameter, as required by the new microgroove recordings.



ISOLATION TRANSFORMER

A new tool for the radio serviceman which permits speedier servicing of ac-dc receivers, provides greater on-the-job safety, and offers a number of other advantages to the radio shop, is a new RCA "Isopat" Variable-Voltage Isolation Transformer (WP-24A) introduced by the RCA Tube Department. Exclusive feature of the new instrument is an adjustable voltage-tapped primary and secondary. With this tap arrangement, the primary can be set to the prevailing power-line voltage, and the secondary receptacles in the instrument will then provide a choice of a 117-volt normal supply, a 105-volt low supply, or a 130-volt high supply, under medium-load conditions. Speedier servicing and quicker detection of faulty components is made possible by this choice of test voltages. The 117-volt normal supply permits the serviceman to check receivers at the voltages for which they were designed to operate. Tests at high and low voltages prevent kickbacks

→ to page 33

Tailor-made for WIRE RECORDER- RADIO combinations



MODEL
78

with push-button
control

Webster-Chicago WIRE RECORDER

is a top quality, precision unit designed for installation in radio console or for use in semi-portable applications with radio or high fidelity amplifier. Model 78 provides all combinations... recording from radio or microphone; playback through headphones, radio or external amplifier, with simple push-button control of electrical circuits. A sensitive meter provides accurate recording level indication and the wire transport mechanism is positive acting and foolproof.

Easy to install... Model 78 is easy to install, and makes an ideal combination. Contained in an attractive metal case which mounts as a complete unit, Model 78 is furnished complete with microphone, one spool of wire and all necessary plugs, cords and instructions for neat installation.

■ The radio-listening public is demanding auxiliary equipment for more complete enjoyment of their radio programs, record music and home entertainment.

■ DEMONSTRATE and install Webster-Chicago Model 78 Wire Recorder.

■ Ask your Webster-Chicago Distributor



WEBSTER-CHICAGO

famous, too, for Webster-Chicago Record Changers and
Magic Nylon Phonograph Needles
5610 W. BLOOMINGDALE AVE. • CHICAGO 39, ILL.

JUST PUBLISHED!
2 NEW BOOKS
 to help you cash in
 on the industry's
**GREATEST SERVICING
 OPPORTUNITIES**

**PRACTICAL TELEVISION
 SERVICING**



By J. R. Johnson and J. H. Newitt. 375 pages, 6x9, over 230 illus., \$4.00.

**NEW! DIFFERENT!
 DOWN-TO-EARTH**

At last you can get a book that really gives the lowdown on television servicing—one that tells you just what to do and guides you on precautions to take and mistakes to avoid. **PRACTICAL TELEVISION SERVICING** isn't a book of theory or mathematics. The authors—one a radio editor, the other a well-known engineer—actually operated a television service shop to get the how-to-do-it data they now pass along to you in easily understood form. Television components, construction and operation and how they differ from radio are clearly explained. Also, they show step by step how to handle television trouble diagnosing and servicing. Read it 10 days at our risk!

- Practical Help On:**
- R-f, I-f, detector sections
 - video amplifiers
 - synchronizing and sw sweep circuits
 - power supplies
 - antennas; wave propagation
 - installation
 - test equipment; alignment
 - wiring; repair techniques
 - receiver troubles
 - troubleshooting
 - service hints; case histories etc.

**FREQUENCY
 MODULATION**

**Fundamentals—Apparatus
 Servicing**

By Nathan Marchand. 448 pages, 6x9, over 300 illustrations, \$5.00



**SIMPLIFIES
 SERVICE
 PROBLEMS!**

It takes more than ordinary radio knowledge to handle modern FM servicing. This book—replete with illustrations, schematic and on-the-job examples—quickly helps you understand each step of the work.

**10
 DAYS'
 TRIAL**

Dept. RM-118, Murray Hill Books, Inc.,
 232 Madison Ave., New York, 16, N. Y.

Send me the books checked below for 10 days' examination on approval. In 10 days I will pay for the books plus a few cents postage or return them postpaid. (Postage paid on cash orders; same return privilege. Books sent on approval in U. S. only.)

- Johnson & Newitt—**PRACTICAL TELEVISION SERVICING**, \$4.00.
- Marchand—**FREQUENCY MODULATION**, \$5.00.

Name
 Address
 City Zone
 State



by John T. Frye

THE other day I was visiting the shop of a serviceman for whom I have a great deal of respect. Not only has he been fixing radios for a score of years, but he does a lot of reading and has a very sound knowledge of radio theory.

I noticed that he was still using his multimeter for all of his testing, and the thin layer of dust on the new vacuum-tube voltmeter that he had bought about six months ago strongly indicated a lack of use.

"What's the matter with the vacuum-tube voltmeter?" I inquired.

"Nothing's the matter with it," he replied, "but I guess I'm just too old a dog to learn new tricks. I can't get used to the thing. The voltage pattern of a radio looks altogether different when you use it from what it does when you test with Old Betsy here. The plate voltage on a first audio stage will read fifty or seventy-five volts higher with the VTVM than it will when you check with the ordinary meter. An a.v.c. voltage that will just make the meter of the multitester twitch, will pin the needle on the VTVM on a low-range scale. Old Betsy has been lying to me so long, and I have become so accustomed to allowing for that, that I just can't get used to having that new gadget tell me the truth."

He was half joking, but the fact remained that he was not taking advantage of the fine features of the new instrument simply because he had not become sufficiently familiar with it to have confidence in its readings. It was extremely easy for me to understand his feelings in the matter, for I had been guilty of the same thing.

In forcing myself to learn to use new instruments and new techniques, I believe I have found the most practical way of accomplishing this end.

The system I use is a combination of "playing" with the instruments and of comparing the findings of the new instrument with that of a familiar piece of test equipment.

Let's take the 'scope, for example. When I first bought mine, I tried everything I could think of on it. I did not take the manufacturer's word for the sensitivity. I placed various a-c voltages on the deflection plates, both with and without the amplifiers, and measured the amount of spot deflection. I looked at the 60 cycle sine wave and at the sine wave output of my audio oscillator. A simple phase splitter was built up so that the pattern obtained with a phase angle of anywhere from 0 to nearly 180 degrees could be seen.

The modulated r-f voltage was put into a receiver, and this r.f. was picked off of the last i-f plate and put on the vertical plate of the 'scope without the amplifier. This permitted me to use the familiar "modulated envelope" method of checking the percentage of modulation of the signal generator. With the same setup, the detected sine wave was inspected at every point in the audio systems of various receivers. The cathode circuit of an audio stage was opened and a variable resistor inserted in place of the usual fixed one. Varying this while watching the sine wave on the 'scope screen quickly taught me what happened when a tube had either too much or too little bias.

When I ran across a set with a leaky coupling condenser I took a look at the sine wave output before I replaced the condenser, and then I took another look and noticed the difference. The same thing was done with a radio in which the plate resistor of one of the tubes in the phase-inverting system had changed value considerably and had thrown

the network out of balance. In short, every time I ran across a receiver defect which I thought could be indicated by the 'scope, I made it a point to examine the output of the set with the oscilloscope, making careful notes and sketches of the pattern *before* and *after* the trouble was corrected.

The same thing was done with the VTVM. A few extra minutes were taken to go over nearly every set just before it was taken off the bench after it had been put into correct operating condition. From this practice was gleaned a practical working knowledge of what constituted normal voltages in every type of set as measured with the VTVM. Next, radios were first serviced with the usual methods, and then I tried to think of a way in which the new instrument could have been used to spot the trouble quicker and more easily. If I could think of one, I checked the theory by actual measurements before the set was returned to normal operation.

It did not take many weeks of this sort of experimenting and comparing before I found myself reaching for the VTVM or the 'scope probes first when I encountered a tough problem. Without realizing it, I had built up confidence in the new instruments and had learned to recognize deviations from normal receiver performance in terms of VTVM readings or oscilloscope traces.

Perhaps there are some of you who say, "You can learn how to use a vacuum-tube voltmeter or an oscilloscope by reading books and magazine articles. Why should I go through all of that comparing and experimenting just to prove to myself that what the books say is so?"

Well, my friend, I am one of those persons who need to try out a new bit of information to make it really stick. It is not so much that I doubt what I read. Rather it is a case in which a demonstrated bit of new knowledge seems to sink much deeper into my mind and to take on much greater significance. I often forget what I read, but I never forget an experiment that I have carried out. Take the case of service notes, for example. I have to have a filing system for those that I clip from magazines, but I need no such system for those I have discovered my-

→ to page 38

NEW

SHURE "900MG"

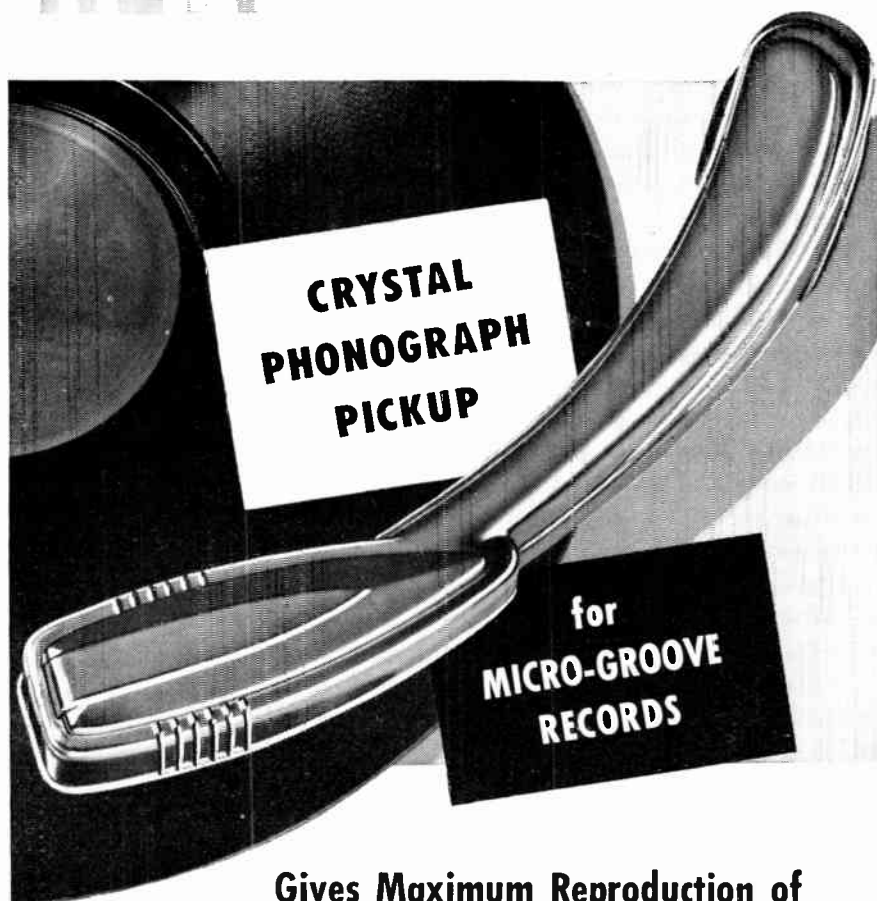

Gives Maximum Reproduction of Micro-Groove Record Fidelity

The Shure "900MG" Pickup is an ideal instrument for tracking on the new micro-groove records. It tracks at 6 grams . . . uses a special offset osmium-tipped needle with a point radius of only .001" . . . and has an output of 1 volt! The Shure lever system has been adapted in the development of this new pickup—providing a high needle compliance. Listen to it—you will be thrilled with the results!

Model "900MG"

Code: RUZUZ

Shure Patents Issued and Pending. Licensed under the Patents of the Brush Development Co.



SHURE BROTHERS, Inc.

Microphones and Acoustic Devices

225 W. HURON ST., CHICAGO 10, ILL. • CABLE ADDRESS: SHUREMICRO



BIG NEWS OF THE YEAR!

Introducing—
**The 1st All Service Course
in CREI History**

**"Television and
FM Servicing"**

This basic CREI Servicing Course paves the way to greater earnings for you. Since 1927 thousands of professional radiomen have enrolled for our home study courses in Practical Radio Engineering. Now, for the first time, we introduce a Practical Servicing Course. You do not have to be, or want to be, an engineer to benefit from this course. It is written for you—the average good servicemen! It's not too elementary for the experienced. It's not "over the head" of those who have limited experience—if they have real ambition and natural ability.

CREI developed this course at the request of several large industrial organizations. The urgent need of capable, trained servicemen is one of the big problems of the industry. Hundreds of thousands of Television Receivers will be marketed in 1948. In years to come millions more will flow into American homes. With Television comes FM receivers and circuits. This new field demands a tremendous increase in the number of properly trained television and FM technicians to install and service this equipment.

This can be your big year! Don't waste another day. CREI has the answer to your future security in this new servicing course. Write today for complete information. The cost is popular. The terms are easy, the information is free. Write today.

MAIL COUPON TODAY

CAPITOL RADIO ENGINEERING INSTITUTE
16th & Park Road, N. W., Dept. RM
Washington 10, D. C.

Gentlemen:

Please send me complete details of your new home study course in Television and FM Servicing. I am attaching a brief resume of my experience, education and present position.

NAME

STREET

CITY ZONE.....STATE

I am entitled to training under G.I. Bill.

**ELECTRONICALLY
SPEAKING**



Current expansion of television viewing tube production by Sylvania Electric Products, Inc., will include a new plant at Ottawa, Ohio, according to J. C. Farley, general manager, Radio Division. He said that operation of the new plant will begin within a few weeks and that it will double Sylvania's present rate of tube output for the increasing demand of television set makers. "Initial pro-

duction facilities at Ottawa," he continued, "will be increased, supplementing the capacity of two plants at Emporium. Decision to establish a new television tube plant in Ohio is consistent with Sylvania's decentralization pattern. The location, close to supplies of vital glass and strategically located for distribution to television set manufacturers in the Chicago area, should help expedite

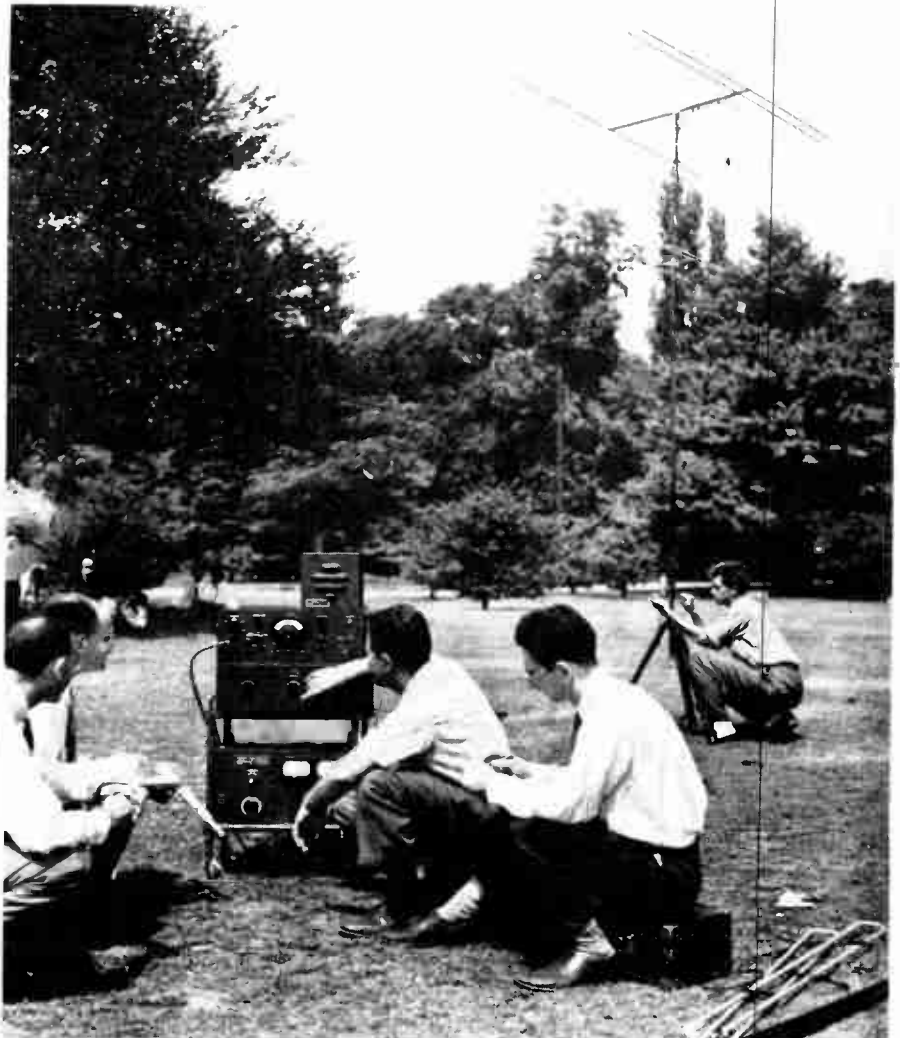

J. Fine, Research, Jim Finneburg, Chief Engineer, Milt Friedburg, Assistant Chief Engineer, Bob Weiss, Test Engineer, and Ray Jaracz, of the Ward Products Corporation, submitting the new Ward TVH-9 television antenna to field tests.

shipments by reducing transportation time required for both raw materials and finished products."

Widespread cooperation of retail and wholesale trade organizations, as well as other groups associated with the broadcasting industry, in the promotion and observance of National Radio Week, Nov. 14-20, is indicated in the initial responses to letters of invitation from the RMA-NAB National Radio Week Committee, Chairman W. B. McGill, of Westinghouse Radio Stations, Inc., said recently. More than a dozen trade groups have pledged their aid in making the 28th anniversary of radio broadcasting the industry's greatest joint celebration, Mr. McGill said, and others are being heard from almost daily.

A gala radio industry celebration is planned in Chicago during the week of May 15, 1949, combining the 25th RMA "Silver Anniversary" convention and the annual Radio Parts Industry Trade Show. The Stevens Hotel will be largely taken over for the joint industry program marking the founding of RMA in 1924 and the annual Parts Trade Show. An elaborate "Silver Anniversary" industry banquet will climax the celebration on Thursday evening, May 19, in the Stevens Hotel Grand Ballroom. The decision to combine the two big industry events was made recently by the RMA Board of Directors and concurred in by the directors of the Radio Parts and Electronic Equipment Shows, Inc., which operates the Parts Show.

A tentative program for the Rochester fall meeting of members of the Institute of Radio Engineers and RMA Engineering Department has been sent out. The meeting will take place in the Sheraton Hotel, Rochester, New York, on November 8, 9, 10, 1948.

With U. S. government purchases accounting for 71 percent of the total, sales of radio and television transmitting and communications equipment by RMA member-companies aggregated \$50,318,006 during the second quarter of 1948 and brought sales of this type to \$80,346,321 for the first six months of this year, the Radio Manufacturers

→ to page 43

Flexibility makes

"the Service Man's Line"

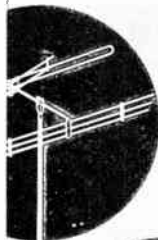
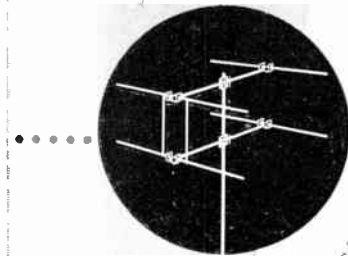

Brach antennas . . . long known for dependability . . . maximum reception . . . trouble-free operation . . . durability and ease of installation . . . now feature an added extra . . . Flexibility. Unique construction features aid the service man in making a more rapid installation to which future additions or modifications can be easily made.

1. FLEXIBILITY A complete line designed with basic antenna parts which are convertible to more complex arrays as required by location and reception problems.

2. COMPLETE KITS Each antenna model is independently designed and furnished in a completely packaged kit containing all necessary hardware, download (when desired) and the Universal Base Mount . . . ready for installation.

3. PRE-ASSEMBLY Each antenna is factory pre-assembled as far as possible, ready to erect. Complete and simple installation instructions. Saves valuable man-hours on the roof.

4. MECHANICAL STRENGTH Weather - tested for durability, Brach Antennas feature a husky steel mast, rigid connections, sturdy base mount, neat appearance. All parts corrosion resistant.

5. SUPERIOR RECEPTION Designed with engineering "know-how". All Brach antennas are factory pre-tuned, matched for 300 ohm transmission line with large diameter aluminum elements for better signal pick-up. Directivity patterns and standing wave ratios available upon request.

New! Tops in TV! HI-LO ROTATABLE Antenna

Here it is! A rotatable antenna to provide peak performance with any station at any time. Brach introduces the new "Superview" Rotatable, covering both high (174 MC to 216 MC) and low (88 MC to 108 MC) TV bands. High band extension available for easy addition to standard dipole array for separate orientation. No more multiple images. No more "weak" stations. Brach's Superview HI-LO assures television reception that's tops. Make sure and investigate the new Superview line today.

Write for Free Brach catalog showing complete line of TV and FM antennas and accessories.

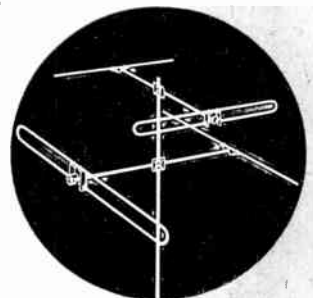

L. S. BRACH MFG. CORP.

200 CENTRAL AVENUE, NEWARK, N. J.

WORLD'S OLDEST AND LARGEST MANUFACTURERS OF RADIO ANTENNAS AND ACCESSORIES

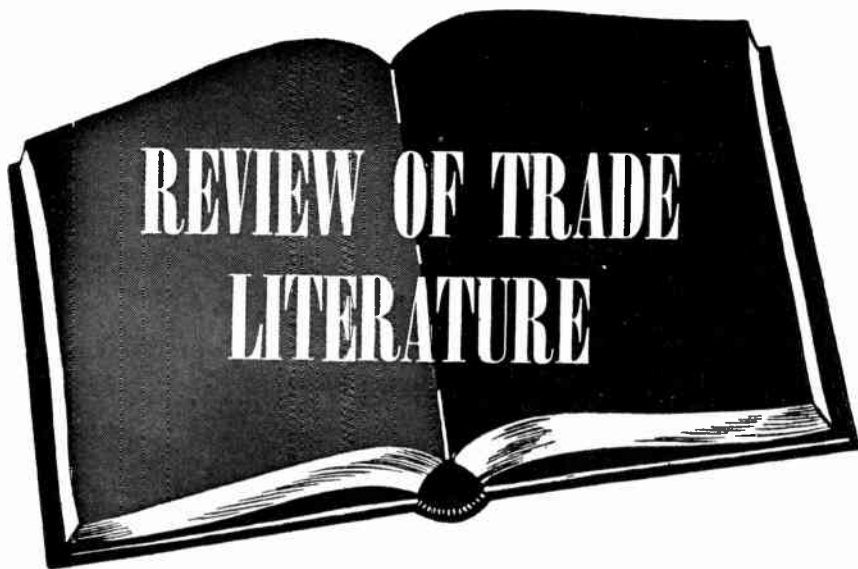

To avoid delay when writing to the manufacturer give issue and page number

RCA Sound Catalog—A new 84-page illustrated Sound Products Catalog, listing the company's complete line of sound equipment, has just been released by the RCA Engineering Products Department. The attractive new booklet is divided into sections dealing with such sound

products as microphones, amplifiers, speakers, program control and distribution facilities, and specialty products. Each section in turn presents a comprehensive list of products designed to meet needs ranging from those of portable systems to those of giant sound installations.

Concise descriptions of each model include such information as special features, uses, and specifications, as well as photographs and diagrams. Many new items, such as the RCA Wire Recorder, the Model SP-15A Portable Sound System, the RCA Intercom System, the 250-watt Amplifier, and the Bantam Velocity Microphone (MI-12002), are fully described.

Copies of the new catalog may be obtained by making written request to the Sound Products Section, Engineering Products Department, Radio Corporation of America, Camden, N. J., specifying "Sound Products Catalogue #218-P."

Allied Radio's 1949 Catalog—Allied Radio Corporation, Chicago, announces the publication of its new 1949, 180-page catalog, covering "Everything in Radio and Electronics." Special emphasis has been placed on equipment for industrial maintenance, research, and production requirements, as well as for the needs of government agencies. There are detailed listings of electronic tubes, test instruments, transformers, resistors, condensers, rheostats, relays, switches, rectifiers, tools, wire and cable, batteries, sockets, generators, power supplies, and other types of equipment in the industrial field.

All equipment is presented in organized sections with items indexed for easy reference. A handsome rotogravure section lists public address and intercommunication units for every indoor and outdoor requirement, including ready-to-install systems for a variety of industrial applications. The electronic sound equipment section features high-fidelity amplifiers by Knight, Altec-Lansing, Brook, and Goodell, and high-fidelity speakers by Jensen and Stephens. This section also includes comprehensive listing of microphones, speakers, and other accessories.

This new 1949 buying guide may be obtained without charge from Allied Radio Corporation, 833 West Jackson Blvd., Chicago 7, Ill. ✓ ✓ ✓

Lafayette-Concord Radio 1949 Catalog—The new catalog of this company (No. 89) has 178 pages full of descriptions and prices of available

RUGGED! DURABLE!
A POWER SUPPLY
THAT CAN REALLY "TAKE IT"

ELECTRO
 ELECTRICAL AND RADIO EQUIPMENT

MODEL "A"

6V or 12V DC filtered from
 110/115 V 60 cycle power line

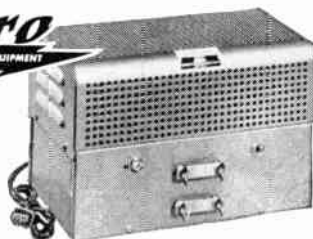

This model has proper rectifier, choke coil, condenser and transformer to provide heavy instantaneous output and still maintain rated output under unusual load and heat conditions.

Ideal long life power supply for testing auto radios with solenoid tuning and tone controls; 12 volt marine and aircraft radios; telephone circuits, laboratory apparatus, etc.

Write for complete information

ELECTRO PRODUCTS LABORATORIES

Pioneer Manufacturers of Battery Eliminators

549 W. Randolph St.

Chicago 6, Ill.

→ to page 40

Industry Presents

→ from page 27

due to different line voltages between customer homes and the service shop. The 105-volt low supply permits a quick check for oscillator stability, and the 130-volt high supply makes possible a breakdown test to expose parts on the verge of failure. Intermittents may also be revealed by the high-voltage testing technique, since receivers which operate satisfactorily at 117 volts occasionally develop intermittents at 130 volts due to expansion caused by increased heat. The new RCA Isotap provides protection against shocks from ac-dc chassis to ground, and prevents damage to test equipment. By placing the instrument between the power supply and the radio receiver being tested or the test equipment being used, shorts are eliminated between chassis and ground, and between two separate chassis. Line noise, which may interfere with radio servicing, is also reduced by the Isotap, which has its secondary conductively isolated from the primary. In areas having high or low line voltage, or noisy power lines, the Isotap can be permanently installed to provide improved radio reception in customers' homes. Various useful in other ways around the radio shop, the new RCA Isotap can be used to speed up the heating of a soldering iron, or to overheat it temporarily for soldering large joints, by plugging into the 130-volt tap. The 105-volt tap can be used as a keep-alive connection for the iron.

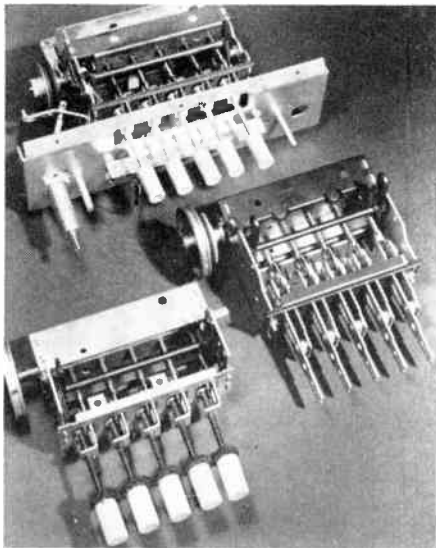

PRECISION TUNERS

Precision tuning assemblies calling for very close tolerances required for dependable settings with a minimum of frequency shift at any point within the a-m broadcast band in automobile radio receivers are now available from the Parts Department of Sylvania Electric Products Inc., Emporium, Pa. Service provided includes tooling for production, metal stamping, plating, fabrication and overall assembly of component products built to customer specification.

→ to page 37

NOW! UTAH TRANSFORMERS



Tested

PERFORMANCE

UTAH announces a new group of replacement transformers designed especially for use with Utah Speakers. They're engineered and built for peak performance under severe climatic conditions . . . each transformer must pass moisture and operational tests. Utah construction assures complete vacuum impregnation, the use of cellulose acetate insulation, and other fine materials. Three types . . . Universal Output, Universal Line, and Single Output . . . in eight sizes, are available for immediate delivery.



UTAH RADIO PRODUCTS

HUNTINGTON, INDIANA
DIVISION OF INTERNATIONAL DETROIT CORPORATION
EXPORT DIVISION: MORHAN EXPORTING CORP., N.Y.C.

UTAH QUALITY RADIO PRODUCTS

Ask For Model 209



THE

HICKOK

World Famous

Electronic

VOLT—OHM—CAPACITY
MILLIAMMETER

Large laboratory size with giant 9-inch meter. Measures resistance (.1 ohm to 10,000 megohms), capacitance, inductance, current, voltage, both AC (30 cycles to 300 megacycles) and DC. A universal test instrument for all radio and electronic service work.

See Your Jobber Today or Write for Literature
THE HICKOK ELECTRICAL INSTRUMENT CO.
10634 Dupont Avenue • Cleveland 8, Ohio

TRANSVISION

NEW Television Kits, and Equipment

Important Advances in TV Reception and Servicing!

Transvision makes television more enjoyable, more profitable

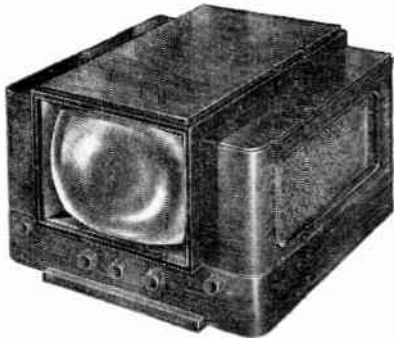

MODEL 10 BL TV FM KIT

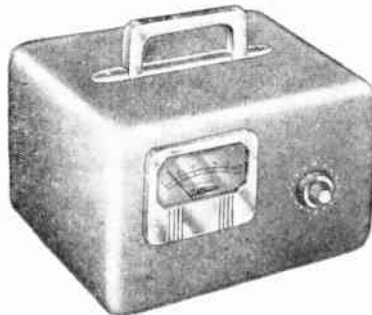

NEW . . . FIELD STRENGTH METER

TRANSVISION manufactures the most extensive line of high quality *Television Kits, Cabinets, Components, and Special Equipment.* Illustrated and listed here are only a representative few of Transvision's leading values. *See your distributor.*

MODEL 10BL TV/FM Kit, gives 115 sq. in. picture; complete FM Radio; receives all channels; streamlined cabinetNET \$269.00
 Roto-Table for Model 10BL, gives full 180° visibilityNET \$23.50
 MODEL 7CL TV kit, gives 60 sq. in. picture; console cabinet with Roto-Table; streamlined design. Receives all 12 channels; continuous tuningNET \$199.00
 MODEL 7BL, same as 7CL except that it is a table modelNET \$189.00
 All prices include cabinets, tubes, all-channel double folded di-pole antenna, and 60 ft. of lead-in wire.

NEW . . . TRANSVISION FIELD STRENGTH METER . . .

Improves Installation! Saves 1/2 the Work! Has numerous features and advantages, including—(1) Measures actual picture signal strength . . . (2) Permits actual picture signal measurements without the use of a complete television set . . . (3) Antenna orientation can be done exactly . . . (4) Measures losses or gain of various antenna and lead-in combinations . . . (5) Useful for checking receiver radiation (local oscillator) . . . (6) 13 CHANNEL SELECTOR . . . (7) Amplitudes of interfering signals can be checked . . . (8) Weighs only 5 lbs. . . (9) Individually calibrated. . . (10) Housed in attractive metal carrying case . . . (11) Initial cost of this unit* is covered after only 3 or 4 installations . . . (12) Operates from 120 volts, 60 cycles.
 Transvision Field Strength Meter. MODEL FSM-1, complete with tubesNET \$99.50



NEW ALL-CHANNEL BOOSTER

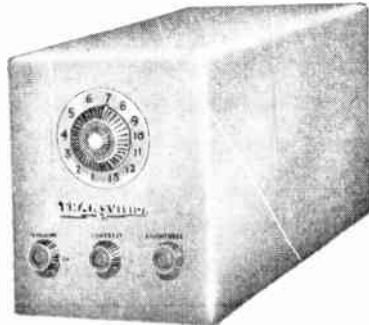

NEW REMOTE CONTROL UNIT KIT

TRANSVISION ALL-CHANNEL TELEVISION BOOSTER . . .
 To assure television reception in weak signal areas, or areas which are out of range of certain broadcast stations, Transvision engineers have designed this new booster. It increases signal strength on all 13 television channels. Tunes all 13 television channels continuously. Can be used with any type of television receiver. Unusually high gain in upper television channels. LIST \$39.95
 Model B-1

TRANSVISION REMOTE CONTROL UNIT KIT . . . Will operate any TV receiver from a distance. Turns set on, tunes in stations, controls contrast and brightness, turns set off. Ideal for installations where the television receiver is inaccessible. Tuner unit is a high gain, all-channel unit with about 50 micro-volt sensitivity. Easy to assemble in about an hour.
 Model TRCU, with 25 feet of cableLIST \$49.00
 Without cabinet \$47.00

NEW 8-PAGE CATALOG showing complete Transvision line now available at your distributor, or write to:

TRANSVISION, Inc. Dept. RM New Rochelle, N. Y.
 In Calif.: Transvision of California
 8572 Santa Monica Blvd., Hollywood 46

All prices 5% higher west of Mississippi; all prices fair traded.
 All Prices Subject to Change Without Notice

Radiomen . . . you can

GET INTO THE
**TELEVISION
 BUSINESS**

In a BIG WAY with the

**TRANSVISION
 DEALER PLAN**

Write for details now!

Record-Changer Repair

→ from page 15

tone arm landings and record kick-off. If the mechanism appears to be operating correctly, it is loaded with records and set playing while the serviceman goes to work on the next set. The changer is checked with several stacks of records in this manner. If no faults become apparent, it is given one more test stack under close surveillance. The changer then goes back to the customer.

Since they began this test procedure, the number of returned sets has dropped to negligible proportions.

Parts Sales

At first, the stock problem was simple. They just kept on hand a small supply of the parts, such as gears, motors, springs, etc., that were commonly used. Expensive, seldom used parts, were ordered from the factory as needed. Now that the firm carries a large and complete stock, it is more complex. As the partners express it: "It is enough to drive you crazy. We've got every nut, bolt, gear, spring, wire and part for every changer now being made, and some that haven't been made in years."

To simplify matters for repairmen who want to order, both catalog and service manual numbers are used for parts. In this manner, a repairman who has a service manual but doesn't have a factory catalog, can still get replacement parts. Even with the dual number system, the shop still gets orders for "the little gadget that pushes up the bar under the rubber wheel for the turntable." Eventually, they usually get the order straightened out, but it often means extra correspondence back and forth. Orders like this break into the one to ten day delivery service of which Friends is so proud. Some repair shops get around the order number problem by just sending along the broken part and requesting another just like it.

Both men have electronic backgrounds. Herman Friend was with a large Philadelphia radio distributor for 16 years, first in the capacity of radio technician and then as service manager. He served in the radio

section of the OSS during the war.

William Felsher was with the same company in the capacity of radio technician for three years before transferring over to the radio engineering section. During the war, he was in the Signal Corps, making radar installations.

Changer Rack

Besides distributing parts, Friends has also started to manufacture certain parts and some equipment. In the same manner in which they formulated their own service information on certain changer models before manuals became available, they also designed special tools to make their work easier.

Biggest headache was a method of holding a changer so that it could be worked on. At times it had to be held upside down so that work could be done on the under side, but most of the time it had to be propped in upright position in such a manner that the cycle could run through. They tried every commercial rack on the market and found them either clumsy to operate or else not sturdy enough. The result was that one night they stayed late at the shop and assembled a trial model of their own rack. Servicemen coming into the shop for parts would spot the rack and want one. It's now a standard item in their stock.

The same applied to rubber phono drives. Good ones that didn't require dressing when mounted on motors were almost impossible to obtain, so they started to manufacture their own. It was foolish to turn out just a few of them for their own use, so now Friends supplies phono drives to the trade.

Bending Levers

One problem of changer servicing was straightening or bending levers. Previously they had to be taken out of the changer, straightened or bent at the correct angle and then put back in the changer. The actual work on the lever itself just took a few seconds, but the time consumed to get the part out of the mechanism and then put it back later, was considerable. The two partners devised a simple slotted bending tool that would do the work while the part was in the changer mechanism, thus eliminating the need for time consuming knock-down and assembly.

As more and more radio-phono-

graph combinations are manufactured and sold, and as public acceptance increases the number of record changers in use, the radio serviceman is discovering that a growing proportion of his business is becoming the repair of record changers. When a combination is brought in, he can't very well repair the radio and turn down the changer, as so many shops would like to do.

According to Friends, there is really no reason for the fear in the minds of servicemen about servicing changers. They are not an especially complex mechanism and are certainly a good deal simpler than any radio. Although ability in electronic lines doesn't automatically mean mechanical capabilities, the average radioman should, with the aid of a service manual and a source of supply for parts, be able to handle any service job on any make of post-war changer.

Equipment

Little equipment is needed to start in record changer servicing. Outside of the standard tools used for radio repair, a rack to hold the changer and a bare minimum inventory of parts are a must. This includes a supply of springs, rivets, phono drives, hardware and a bottle of cleaning fluid. Replacement crystals should also be stocked in the most commonly used types and values, and a bending tool will prove helpful. The entire stock, tools and equipment, will probably be less than \$25.00.

If possible, a separate section of the bench should be set aside for changer repair so that tools and parts can have a regular place. Then too, the underside of changers in use for a considerable time is often dusty and grimy and might gum up cabinets of radios left for repair. As technical reference, a good standard service manual covering changers is invaluable.

Many shops, once they find that changer repairs are forming a sizable enough portion of their work, hire a man simply to take care of that phase of the business. They are careful to pick a man with decided mechanical ability, because he is capable of a great output.

Here's how the financial picture looks for the average radio serviceman in the Philadelphia area who

→ to page 39

MEASUREMENTS CORPORATION Model 59



2.2 mc.
to
400 mc.

MEGACYCLE METER

Radio's newest, multi-purpose instrument consisting of a grid-dip oscillator connected to its power supply by a flexible cord.

Check these applications:

- For determining the resonant frequency of tuned circuits, antennas, transmission lines, by-pass condensers, chokes, coils.
- For measuring capacitance, inductance, Q, mutual inductance.
- For preliminary tracking and alignment of receivers.
- As an auxiliary signal generator; modulated or unmodulated.
- For antenna tuning and transmitter neutralizing, power off.
- For locating parasitic circuits and spurious resonances.
- As a low sensitivity receiver for signal tracing.

MANUFACTURERS OF
Standard Signal Generators
Pulse Generators
FM Signal Generators
Square Wave Generators
Vacuum Tube Voltmeters
UHF Radio Noise & Field Strength Meters
Capacity Bridges
Megohm Meters
Phase Sequence Indicators
Television and FM Test Equipment

SPECIFICATIONS:
Power Unit: 5 1/8" wide; 6 1/8" high; 7 1/2" deep.
Oscillator Unit: 3 3/4" diameter; 2" deep.

FREQUENCY:
2.2 mc. to 400 mc.; seven plug-in coils.

MODULATION:
CW or 120 cycles; or external.

POWER SUPPLY:
110-120 volts, 50-60 cycles; 20 watts.

MEASUREMENTS CORPORATION
BOONTON NEW JERSEY

3 BASIC TYPES REPLACE OVER 150 STANDARD MODELS

**Revolutionary Discovery
Simplifies Replacement—
Greatly Improves
Record Playing**



REPLACEMENT FOR						
ELECTRO-VOICE	ASTATIC		SHURE		WEBSTER	RCA
MODEL M12 Medium Voltage (Red)	L-22A	L-76S	P30	P93C	E4 N4	31050*
	L-25A	L-76AS	P30B	P93D	E4-1 N6	31156*
	L-26A	LT-M	P30C	P93E	E-9 N6P	32632*
	L-27A	LT-MA	P30D	P93S	F1 N6P-4	33122*
	L-32A	LT1-M	P30E	P94	F1P N8	33217*
	L-70	LT1-MA	P30S	P94B	F2 N8P	33905*
	L-70A	LT2-M	P87	P94E	F2P N9	34225*
	L-70S	LT2-MA	P87B	W42A	F3P N11	34307*
	L-70AS	LT3-M	P87S	W57A	F4P N11P	34710*
	L-71	1-J	P90B	W57AN	F5	35171*
	L-71A	1-M	P90D	W58A	F5P	37158*
	L-71S	401-A	P90S	W60A	F6	39686*
	L-76		P93	W60B	F6P	
L-76A		P93B	W60HS	N2		
			W61B	N3		
					AMERICAN	
					S-1	
ELECTRO-VOICE	ASTATIC		SHURE		WEBSTER	AMERICAN
MODEL H12 High Voltage (Blue)	L-24A	L-72S	P88	W56A	C-21	CR1A
	L-36A	L-72AS	P88S	W59A	C-31	CR2A
	L-46A	L-82	P89	99-180	C-6†	S2
	L-50A	L-82A	P89S	99-181	N-10	
	L-72	L-82V	W40A		N-10P	
	L-72A	M-23	W41A		N-10P-1	
ELECTRO-VOICE	ASTATIC				WEBSTER	RCA
MODEL L12 Low Voltage (Yellow)	L-40A	LP-6	QC	QT-3JA	C5†	71173
	L-41A	LP-21	QT-J	QT-3M	F3	70339
	L-75	LP-23	QT-M	QT-3MA	F7P	70338
	L-75A	MLP-1	QT-2J		N3	
	L-75S	MLP-1J	QT-2M		N5	
L-75AS	MLP-2	QT-3J		N7		

Use "A" mounting plate furnished with cartridges (1/2" hole centers) for all replacements except those marked with an * or †. *Use "B" mounting plate furnished (3/8" to 1 1/4" hole centers). †Use "C" mounting plate furnished (Webster Side Flange). All Model 12 Cartridges equivalent to ASTATIC "A" type except Tone Arm Rest Button is not supplied. It is recommended that the lower voltage cartridge consistent with volume level be installed. NOTE: Models M12, H12 and L12 have Osmium-tip Needles. For Cartridge with Sapphire-tip Needle, specify Model M12-S, H12-S, or L12-S.

E.V. Pat. Pend. Licensed under Brush Patents

ELECTRO VOICE, INC.
BUCHANAN, MICH.
Export: 13 East 40th St., New York 16,
U.S.A. Cables: Arlab

IT PAYS TO REPLACE WITH

Electro-Voice

Custom Building

→ from page 21

newer crystal pickups of the type that have low needle point impedance and better high response.

Speaker—General overall quality of construction is important in a speaker, according to Danby. High powered magnets and a small gap make for greater efficiency. Vertech specifies that the h-f section on the horn have metal or phenolic cone, because it is superior to paper in lack of peaks. All speakers should be checked for cone centering before purchasing. This is done by the old reliable method of pressing gently with the fingers at points 90 degrees around the circumference and listening for any sign of scrape.

Extra Features

When a piece of equipment has extras or gadgets, the possibility of trouble is considerably greater. If the extra feature is of good quality and design, then it is alright. But if the extra rates only fair in this respect, then it is a likely source of trouble.

For example, a volume expander is rated by many music lovers a necessary addition to a record collection. However, if the volume expander in a set is poorly designed, the entire instrument may be disqualified electronically. If a tube is bad, the set may still sound right, but when the volume expander is off, the entire set becomes inferior.

In general, both firms advise against the use of extras, such as volume expanders and scratch suppressors, unless the customer specifically demands it.

The quality of extra features can be judged best by simply listening to the reproduction. For a volume expander, play a record of some percussion instrument or of a harp string suddenly muted with the hand. Play the record at a loud volume and listen. The music and the expansion should be reasonably clean and sharp. There should be no obvious hangover. The equipment should be capable of handling the volume without overload and should introduce no distortion of itself. In other words, the listening quality of the

**New Torque Drive
Crystal Pickup Cartridge achieves clean,
clear tone definition
and fidelity that are
truly amazing! You
can hear the difference!
Give new life
to every record
library.**

**AUTHORIZED
DISTRIBUTORS
EVERYWHERE**

**Write for Re-
placement Chart
Bulletin No. 146**

**New Model L-14
Microgroove
Crystal Cartridge, and New
Model 20 Magnetic Cartridge
for Regular or
Microgroove
records also
available.**

music should be improved but the final sound should not hint at the means.

Picking Components

High fidelity components are available in many price ranges, varying from the moderate to the astronomical. Quality does not absolutely follow with an increased price tag. There are top quality expensive sets, but similar performance is also a characteristic of many moderate cost speakers, amplifiers, etc. For each serviceman going into high fidelity building, there will have to be a certain amount of experimenting until he determines for himself just which components are best.

In general allotment of money for components should follow a certain ratio, with a large proportion allowed for the electronically more important or more critical sections of the circuit. First consideration, according to the Vertech, is the speaker. A speaker must be good to begin with, because no adjustments are possible on it. A speaker that distorts or cannot carry sufficient load, can't be "jacked-up" in any manner.

Next in importance for consideration is the phono pickup. Here again, if the arm does not pick up the tones, they can't be introduced later. With most commercial sets, the pickup and the speaker compliment are usually the weak links. The amplifying section often far outstrips the ability of the tone arm to send in signals, or the speaker to send forth the vibrations.

The third most important component of the set is the amplifying section. There are amplifiers on the market at moderate cost that can, except at very high levels, meet the requirements of much better than average speakers. Thus, while the price range of the various parts may vary, they should be equal in respect to quality of reproduction.

When buying stock components, it is a good idea to stick pretty close to name brands. When you buy big names, it is a safe bet that the guarantee will be good and that replacement parts will be available for years to come. There is nothing more exasperating than trying to fine a tone choke for a little known set no longer made. If possible, even when buying reputable makes, always try the set before buying. It's the same production line story all over again.

Right next to the perfect unit may be a lemon.

It would be almost impossible to list specific brands and say "Here are the components to use." So much of this is a matter of opinion. Both Vertech and Danby tried units of many makes before they evolved their own standard set of components for each price range. The selections they made are based on individual preferences, narrowing the field to one part will have to be tried by the individual serviceman. The factors suggested above are good minimum standards. Beyond that, it's largely personal preference.

Components are manufactured by many leading companies. They can be obtained through dealers, supply houses and mail order firms. There are plenty to choose from.

Matching Components

It is comparatively easy to match the various components. Just follow the manufacturer's specifications. Each part has a value, and it is just a matter of equalizing down the line. If the pickup has a low output, then it needs a pre-amplifier. If the amplifier output and the speaker input don't match, then a matching transformer is in order.

The manufacturer will often—as in the case of speakers—recommend certain transformers, if it is necessary to match the speaker to various amplifier outputs. These, based on careful calculations and tests, have been found to be accurate. In general, it is good practice to follow such recommendations.

Results That May Be Expected

A wise, carefully chosen and matched expenditure of \$250.00, can produce a set that is equal or superior to most commercial radio-phonographs on the market, selling around \$750.00. It isn't necessary to spend as much as \$250.00. A smaller investment will give results in this same proportion. In every case, the specially built set will be superior to the commercial one.

Most elite commercial sets have good tuners, excellent amplifiers, but an insufficient speaker compliment to handle the output. It's like mounting a Rolls Royce engine on a scooter. The serviceman, by picking his components more evenly matched in



THE TILT-O-MATIC TONE ARM

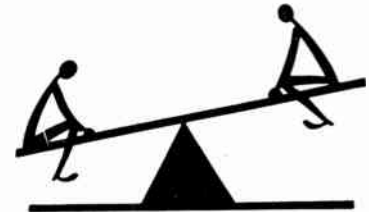

See Page 47
for the important full
page advertisement



WEBSTER-CHICAGO

quality, can obtain far more consistent results.

Let's say that the amplifier in a commercial set has an output of 20 watts. The set you build has an output of 12 watts. The same speaker that you both use will pass, undistorted, 10 watts. It comes out even in the end, except that the cost column for your set is a lot less.

In selling a specially built set of this type, the best method is to give the customer a listening test. Show him the speaker used in a large commercial set and then show him that you are using the same one in a set at a much lower price. ✓ ✓ ✓

Industry Presents

→ from page 33

INTERFERENCE FILTER

What interference filter to use and how to connect it is readily and positively determined by the Aerovox Interference Filter, offered by Aerovox Corporation of New Bedford, Mass. In a sturdy metal cabinet with rigid side handle and with hinged cover compartment holding the assortment of connecting cords, plugs, receptacles and clips, the Selector goes out on the job. There it is readily connected in various ways with the noise producing appliance or equipment. The knob is then turned through the series of different settings, each bringing into circuit the same circuit elements as found in

→ to page 41

TV Equipment

→ from page 17

burnout; simplicity of meter scales; "Zero Adjust" that does not have to be reset when ranges are changed; a zero-center scale for use in aligning FM and a-f-c discriminator circuits; and provision for the use of the RCA Diode Probe or the RCA Crystal Probe to measure r-f voltages up to 250 megacycles.



TEST OSCILLATOR

The WR-67A Test Oscillator was designed to provide a dependable instrument for use in the analysis of receiver performance. It is adapted to the alignment of radio receivers, i-f alignment, r-f alignment, receiver fidelity measurements, CW tests, audio tests, and calibration. It is particularly useful on the service bench as an instrument for determining the source of trouble in a receiver by the signal-injection method.

The WR-67A has excellent oscillator stability, iron-core inductances in the audio-oscillator circuit, a variable-level constant-impedance output circuit for each setting of the Step Attenuator, and three constant-fre-

quency channels for use in aligning the r-f and i-f stages of standard-broadcast receivers. To facilitate alignment operations, a source of amplitude modulation at approximately 400 cycles is provided internally. This audio signal may be used independently if desired, up to 25 volts appearing across 100,000 ohms impedance at no extra load. For measurements such as overall fidelity, modulation from an external a-f source may be applied.



AUDIO OSCILLATOR

The type WA-54A Audio Oscillator is an a-c operated instrument for generating sinusoidal voltages within the frequency range of 20 to 17,000 cycles per second. A tapped output transformer makes it possible to match the oscillator output to load impedances most frequently encountered. An electronic eye indicator serves as calibration indicator, output level indicator, and pilot lamp.

It finds application in locating speaker and cabinet rattles, signal tracing in public address systems, measuring radio receiver fidelity, fidelity signal tracing audio amplifier frequency response, frequency measurement, audio amplifier overload

characteristics, small transmitter modulation characteristics, r-f signal tracing, checking tone controls, and precision measurements of various kinds.

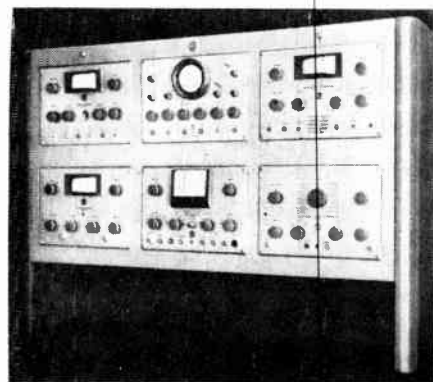

EQUIPMENT RACK

The RCA Test Equipment Rack (WS-16A) is designed as an efficient, ultra-modern cabinet for any six of RCA's matched units of test and measuring equipment. Combining eye-appeal with utility, the new rack serves both as a smart showcase for the display of such units as the six discussed in this article, and as an efficient service rack.

Built for mounting on top of a workbench, the new rack accommodates the six pieces of equipment in two rows with a flush fitting front panel which exposes only the faces of the equipment, providing the effect of custom-built laboratory test equipment. ✓ ✓ ✓

Over the Bench

→ from page 29

self. As soon as I put a receiver on the bench, all of my former experiences with this particular model are instantly available in my memory. Most other servicemen tell me that their minds work in the same way.

The important thing is, though, that this system makes you thoroughly familiar with your tools, with exactly what can and cannot be done with each, so that you reach almost instinctively for the best pair of probes when you are confronted with a particular problem. In your case, familiarity will have bred confidence so that you can focus all of the powers of your mind upon the problem to be solved instead of diverting part of those powers to the questioning and interpreting of the indications of an unfamiliar test instrument. ✓ ✓ ✓

SPEAKER SPECIALIST

Build yourself a reputation for improved tone of every speaker job you handle. A.G. will back you with the finest reconing service.

- Cones and fields in stock for any speaker
- Full range frequency test
- Audio test at full power rating
- Professional workmanship

Send a trial speaker, parcel post, for quick reconing and return in perfect condition . . . 5"—\$1.50 . . . 12"—\$3.00 . . . others low too!

A. G. RADIO PARTS CO.

3515 N. 17th St.

Philadelphia 40, Pa.

GREYLOCK

A Dependable Name in

RADIO TUBES

GT, Glass & Miniature Types
All Tubes in Individual Cartons

6A8GT 12AT6 1R5
6AT6 12BA6 1T4
6BA6 12BE6 1U4
6BE6 12K7GT 1S5
6K7GT 12Q7GT 3S4
6D7GT 12S47 3Q4
6SA7GT 12SK7 3V4
6SK7GT 12SQ7 12AU6
6SQ7GT 25L6GT 12BF6
6V6GT 25Z6GT 35B5
6X4 50B5 35L6GT
12A8GT 50L6 35Z5GT

39c
each

SPECIAL OFFER!

All 39c Tubes may be purchased in lots of 100 assorted, at \$35.00 per 100.

6A7 6A6 6G6G
6AC5 6BH6 6SN7GT
6AK5 6BJ6 12AU7
6AQ5 6C6 25Z5
6AQ6 6D6 75
6AJ5 6SL7GT 117Z3

49c
each

1H5GT 19T8 117L7
1N5GT 70L7 6L6GA
32L7 84 53

59c
each

SPECIAL! 6BG6G 89c
Standard Replacement VOLUME CONTROLS,
All sizes, 1 1/2" shaft, less switch, each... \$.24
With S/PST switch, each... \$.34
With DPST Switch, each... \$.39

PM SPEAKERS

Less Trans.

4" with Alnico V Magnet... \$1.14
5" with Alnico V Magnet... 1.14
6" with Alnico V Magnet... 1.49
3" PM with plastic cone, and 8-oz. Alnico V Magnet... 1.35
6"x1 1/2" PM with Alnico V Magnet... 1.19
WEBSTER A-1 Pickup, plastic arm... 1.49

SELENIUM RECTIFIERS

100 Ma. \$.59
75 Ma.49

TERMS: Net C.O.D., F.O.B. N.Y.C. 35c Handling Charge on all orders under \$5.00.
Write for Bargain Catalog M-11

Greylock Electronic Supply Co.

30 Church Street New York 7, N. Y.

Record-Changer Repair

→ from page 35

takes in changer repair work. The basic rate in this section of the country runs at approximately \$3.00 an hour. Most jobs take about an hour, although some of them, such as bending a lever or tightening a screw, may take just a minute or two. Let's figure an hour job, though. Correcting speed variation in a changer usually takes about that time. Most frequently it comes from a gummed motor, bad tire or bad bearings. The parts must be cleaned and perhaps replaced. The cost of parts will most likely range from about 50 cents to perhaps five dollars for a new motor. The serviceman gets parts at the standard discount. The final total of time plus parts adds up to a profitable addition to any radio service business. Considering the small initial outlay, most shops that decide to take in changer work, consider it a valuable source of extra income to tide them over lulls in regular radio trade.

Return complaints on changers that have been repaired are considerably fewer in proportion to radio service jobs. Almost all the working parts of a changer can be inspected at the same time, and rather quickly.

The two partners of Friends consider the following points most important when starting in record changer service:

First of all, an adequate advertising program is a must. This may consist of distributing or mailing cards announcing the service, or it may be coupled with newspaper or magazine advertisements.

Proper facilities for the work are necessary along with mechanically inclined personnel and a sufficient stock of basic parts.

As in radio work, an accurate cost accounting system will insure the repairman of a fair profit on his labor and a return on the parts.

Also important is a factor that is often underestimated and that applies to radio service as well as changer work. Always give the changer a good cleaning before it goes back to the customer. Be certain the changer goes back looking shiny, besides being in top mechanical shape. ▶ ▶ ▶



Servicemen's choice!
in...

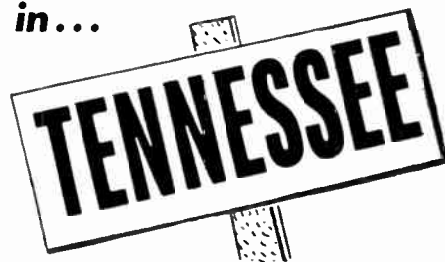

● Throughout Tennessee—experienced servicemen are casting their votes for Cunningham . . . the tube that's *built for service*. You can count on more customers if you make top-quality Cunninghams *your* choice whenever new tubes are called for.

See your
CUNNINGHAM DISTRIBUTOR

Bomar Appliance Co., Inc., Knoxville
Curl Radio Supply & Sound Service
Chattanooga
Randolph & Cole, Inc., Nashville



FREE ALLIED'S NEW 1949 RADIO CATALOG

Everything for the Radio Service Technician . . .

SEND FOR THIS 180-PAGE BUYING GUIDE NOW

Radiomen! Here's the new 1949 ALLIED Buying Guide that brings you everything you need in radio and electronic equipment. Get everything that's newest and finest from the world's largest stocks—test instruments, sound systems and P.A. equipment, thousands of parts, tubes, tools, books—all at lowest money-saving prices, ready for instant expert shipment. Send for your FREE copy of the new 180-page ALLIED Catalog—today!

ALLIED RADIO

ALLIED RADIO CORP., DEPT 27-L-8
833 W. Jackson Blvd., Chicago 7, Ill.

Send FREE New ALLIED Catalog.

Name.....

Address.....

FREE! send for our
RADIO BUYING GUIDE
 a complete and diversified line-up of:

- electronic equipment
- sound systems
- recording equipment
- amateur gear
- television components and kits
- replacement parts
- laboratory and service test equipment

Save time and money—buy direct from distributor! Consult the NEWARK radio buying guide, featuring all standard makes... a value-packed listing of 20,000 essentials for expert servicemen, engineers, soundmen, experimenters, teachers, hobbyists, amateurs!

24 HOUR SERVICE ON ALL ORDERS
 Free technical advisory service!

JUST MAIL THIS COUPON TO GET YOUR CATALOGUE
Newark Electric Co., Inc., Dept. 13
242 West 55th St., New York 19

Please send me the FREE Newark Buying Guide of fine radio equipment.

Name _____
 Address _____
 City _____ State _____

NEWARK
 RADIO & TELEVISION

3 GREAT STORES
 115 W. 45th St. & 212 Fulton St., NEW YORK
 and 323 West Madison Street in CHICAGO

MAIL ORDER DIVISIONS
 242 West 55th Street, NEW YORK 19, N. Y.
 323 West Madison Street, CHICAGO 6, ILL.

Trade Literature

→ from page 32

equipment. Most of the items listed are shown in accompanying sketches and photographs. A special, yellow-page section, lists special-value bargain items. This book covers every sort of radio and electronic parts, radios, custom chassis and cabinets, test equipment, appliances, wire recorders, sound systems, and many other items. The catalog may be obtained from Lafayette-Concord.

PHOTOFACT FOLDER

The new Photofact Folder, covering Emerson Models 571, 606 (CH. 120066) is now ready. This is folder No. 25 of Set No. 46. These folders are published by Howard W. Sams & Co., Inc., 2924 East Washington Street, Indianapolis 7, Indiana.

GENERAL CEMENT'S NEW CATALOG

General Cement Manufacturing Company, Rockford, Illinois, manu-

facturers of radio and electronic products, including chemicals, tools, kits, hardware, insulation, etc., announces the publication of a new sixty-four page beautifully illustrated catalog. The catalog includes complete information on cements, chemicals, paints, finishes, cabinet repair kits, grille cloth, dial cords, dial belts, radio knobs, phono needles, switches, plugs, jacks, wire strippers, neolites, aerials, alignment tools, miscellaneous tools, hardware, radio parts, etc., for the radio, electrical electronic, hardware, and other fields. The catalogue is very complete. In addition to illustrations of the various items, complete descriptions of each item are given part numbers are listed, list price is given as well as package information. The catalog also includes General Cement's displays for cements and chemicals, radio parts and hardware tools and parts. A variety of different size and type displays are illustrated, such as large chemical displays, revolving hardware displays, "wall-view" displays, etc. ✓ ✓ ✓

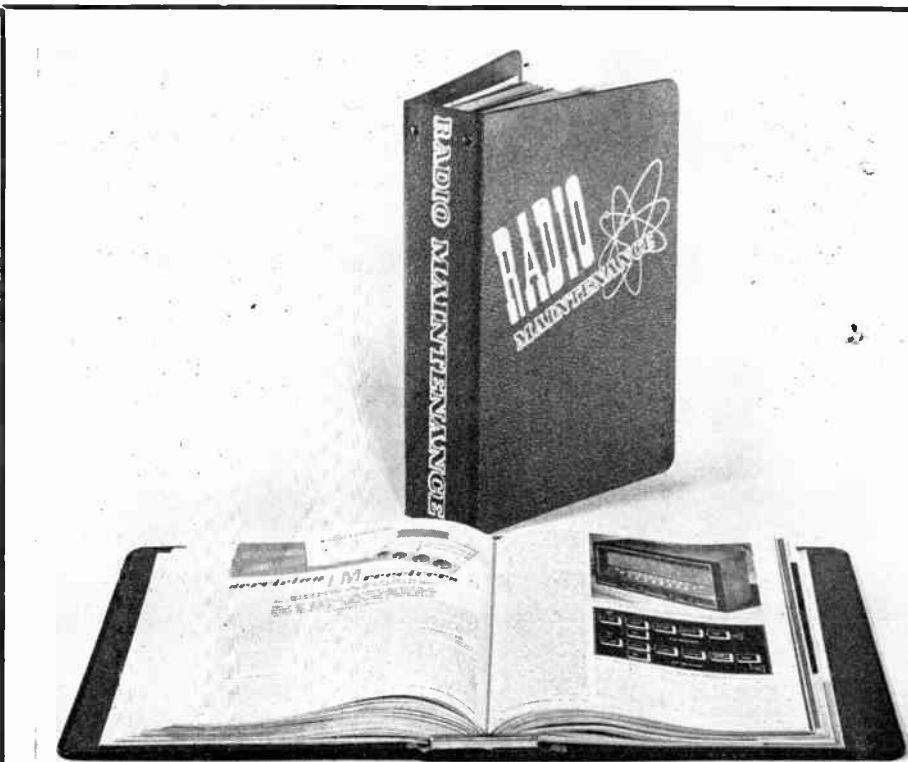

Keep your back numbers of RADIO MAINTENANCE in these handsome green and gold binders. Each binder will hold up to 18 copies of the magazines without puncturing holes or mutilating them in any way. They are held securely but are easily removed if desired. With the index printed at the end of each year, your magazines will be a constant reference for . . . a valuable service library. Send for your binders now!

BINDERS

TO PRESERVE YOUR RADIO MAINTENANCE MAGAZINES

RADIO MAINTENANCE
 460 Bloomfield Avenue
 Montclair, N. J.

Please send me . . . binders at \$3.00 each. (2 for \$5.00)
 Total amount enclosed . . .
 Name
 Address
 City Zone
 State

Industry Presents

→ from page 37

Aerovox Inference Filters of corresponding type numbers. Thus the type filter to use, as well as the best connections, are immediately known, and the permanent installation made accordingly.



HIGH Q CHOKES

Two efficient, especially compact High Q Chokes are now being marketed by Chicago Transformer, 3501 W. Addison Blvd., Chicago, Ill., a Division of the Essex Wire Corporation. While designed specifically for use in Dynamic Noise Suppressor circuits, Chi-

cago Transformer's NSI-1 and NSI-2 reactors can be used in any tuned circuit requiring the given inductances. Inductance values 2.4 and .8 henrys respectively, are accurate within plus or minus 5% with up to 15 milliamperes of direct current. Units have a minimum Q of 20.



TV BOOSTER

The introduction of two new Bowers Television Signal Booster models has been announced by the Bowers Battery & Spark Plug Co., Reading, Pa. Both models are in production after having been thoroughly tested under the most adverse operating conditions. The high gain of these units is reported to provide clear, steady pictures in weak signal areas and to make possible the reception of additional stations. Model TB-26 preamplifies channels 2 to 6. Model TB-213 covers the complete range of channels from 2 to 13. The rich, deep-brown wrinkle finish case is said to harmonize perfectly with the television receiver and room appointment.



THE TANDEM-TIP NYLON NEEDLE

makes

Record Changer News!



Don't miss the full page advertisement on page 47 of this issue



WEBSTER-CHICAGO

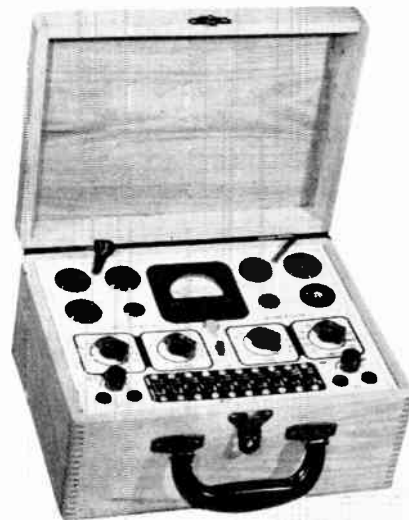

TUBE AND SET TESTER

A complete laboratory, all-purpose instrument, the new Model TC-50, manufactured by Test Craft Instrument Co., 42 Warren Street, New York 7, N. Y., will accurately test all up-to-date designed tubes. The multi-meter section affords many necessary measurements for everyday service work. The new Model TC-50 Tube and Set Tester combines seven instruments, d.c.v., a.c.v., d.c.m.a., ohms, output meter, decibel meter and tube tester. It has full scale accuracy to 2%.

→ to page 42

Built for Service



Servicemen's choice!

in...



• Cunningham tubes continue to carry Washington because of their long-standing record of reliability. That's why—when you sell Cunningham tubes—more customers will come your way. Elect to use Cunninghams in *your* work.

See your
CUNNINGHAM DISTRIBUTOR

HERB E. ZOBRIST CO. . . . Seattle
HERB E. ZOBRIST CO. . . . Spokane

Cunningham Tubes

A product of
RADIO CORPORATION OF AMERICA
Harrison, N. J.

Industry Presents

→ from page 41

and English Reading GOOD and BAD scale for testing tubes. Obsolescence is reduced to an absolute minimum. Simple and quick reading charts for tube testing are provided.



MULTITESTERS

The new Model 450 series of HI-MEG

multitesters comprising many new advanced features in accurate multimeters is announced by Radio City Products, 152 West 25th Street, New York City. An outstanding feature is the HI-MEG scale for making resistance measurements as high as 50 megohms to 1,000 megohms without the use of tubes or batteries. Low ohm ranges use a single cell battery which is supplied with the instrument. These Multitesters are available in 3 meter sensitivities—1,000—5,000—20,000 ohms per volt designated by letters A-B-C respectively.

AC voltage measurements are free from the usual frequency and temperature errors that exist with the conventional multimeters. Model 450 series use germanium crystal rectifiers for the meter and eliminate such errors. High degree of accuracy is maintained by individually calibrating shunts and multipliers within 1%. Meters are 4 5/8 inches and are maintained accurate within 2%.



WIRE RECORDER

"Electro-Wire" High fidelity wire recorder, record player and radio combination for universal use is announced by Electronic Products, 443 Greenwich Street, New York 13, N. Y. The manufacturer states that this new versatile recorder has construction and performance features of unique interest to many fields, including music, business, education, as well as the home. The "Electro-Wire" recorder includes radio, sensitive crystal microphone with desk stand and cable, record player, and two 1/2 hour spools of recording wire.

"ELECTRONIC MEMORY" DEPARTMENT

As an aid to helping its retail outlets increase their sales of wire recorders, record players and amplifiers, the Webster-Chicago Corporation, manufacturer of the "Electronic Memory" wire recorder, record changers, phonographs and nylon "knee action" needles, is offering dealers an exclusive "Electronic Memory" department for radio and

→ to page 43

Television 'HOW IT WORKS'

Just out. Here is practical theory on the biggest development since the introduction of radio. Deals with transmission and reception of television signals, giving clear over-all picture. Goes into frequency standards, antennas, and describes the various portions of a television receiver. Covers alignment and servicing. This book is part of Vol. 1 Rider Television Manual. If of Vol. 1 Rider Television Manual, you automatically get this book.

Even if television is not yet in your area it will be soon. You need to know about it now.

• Manufacturers: Here is the textbook you can use in training your servicemen.

Over 200 pages
Illustrated ... \$2.70

UNDERSTANDING VECTORS AND PHASE

Provides easy understanding of vectorial presentations so you will get more benefit from radio articles and books.

160 Pages Cloth bound ... \$1.89
Paper bound ... 99c

BROADCAST OPERATORS' HANDBOOK

by H. E. Enns, Station Engineer, WIRE
Tells how to operate a radio station and keep it in operation. Covers transmitter operation and maintenance, what to do and how to operate control room, master and remote controls.

288 Pgs.—Profusely illus.—\$3.30

JOHN F. RIDER Publisher, Inc.

404 FOURTH AVENUE, NEW YORK 16, N. Y.

Export: Rocke-International Corp.

13 E. 40th Street, New York 16, N. Y.

LEARN RIGHT WITH RIDER!

FM TRANSMISSION & RECEPTION

by John F. Rider and Seymour D. Uslan

Included among the "100 Best Technical Books of 1947 and early 1948" by the "Library Journal" this book has been adopted with equal enthusiasm by schools, colleges, engineers and radio servicemen.

Latest in theory, method of operation, high and low power, antennas, methods of alignment, solutions of servicing problems—everything needed
416 Cloth Cover, \$3.60
Pages

OTHER RIDER BOOKS

Inside Vacuum Tube 424 Pgs. \$4.50

Servicing by Signal Tracing 360 Pgs. 4.00

Cathode Ray Tube at Work 338 Pgs. 4.00

Send for Complete Catalog of titles

BY THE PUBLISHER OF RIDER MANUALS

Order From Your Jobber or write direct to us.

Notice to Service Organizations

RADIO MAINTENANCE Magazine
Special Group Plan

Radio Servicemen enrolled in service trade organizations may subscribe to RADIO MAINTENANCE at a special Group Plan price. WRITE US FOR PRICES. Here's how it's done:

1. Offer open to members of Radio Servicemen's Association, societies or organizations.
2. Applies to all orders from these organizations containing five or more names.
3. Orders must be on the organization letterhead and must give the name and address of each subscriber. State subscriber's service status (is he a shop owner, employee of service department, service manager, etc?) Magazines will be delivered to subscriber's address.
4. Payment must accompany each order.
5. If a serviceman already has a subscription he may renew it through this group plan, but be sure to mark plainly "RENEWAL" in these cases.
6. Address all orders to:

RADIO MAINTENANCE Magazine.
460 Bloomfield Ave., Montclair, N. J.

department stores. The display counter, which requires relatively small floor space, builds upwards instead of outwards. It has built-in provisions for easy hook-up of all units for convenient demonstration. The Webster-Chicago Corporation's "Electronic Memory" department stands 53 inches wide and 30½ inches deep but pyramids to a height of 76 inches. It weighs 70 pounds and has shelves at three levels. Outlets are provided for easy interconnection of units. Norm C. Owen, sales manager of the distributor division, said that dealers may obtain this "W/C display" from their authorized Webster-Chicago distributor under any of four merchandising plans.



MODEL 300

The E.M.C. Model 300 has just been announced by the Electronic Measurement Corporation, 423 Broome Street, New York, N. Y. A vacuum tube volt-ohm-capacity meter, the new Model 300 features a 4½-inch meter for quick and accurate legibility, a sturdy oak case, clear easy-to-read panel, and high quality construction throughout. The new Model 300 has been carefully engineered and constructed to meet the most exacting needs of radio servicemen and advanced amateurs.



RESISTOR ASSORTMENT

To provide radio servicemen and experimenters with a neat and convenient method of storing composition resistors, Ohmite Manufacturing Co., Chicago, is offering a new

→ to page 46

Electronically Speaking

→ from page 31

Association reports. Federal purchases represented 6% of the six months' total.

A nation-wide attempt to re-educate an entire industry was launched in New York on September 27, at the Town Meeting of Radio Technicians in the Astor Hotel. The Town Meeting, in session for three nights and one afternoon, was the first of five in the next eight months which will spearhead a drive by the entire radio manufacturing and distributing industry to convert the radio service industry to the demands of television installation and maintenance.

Harry A. Ehle, chairman of the Town Meeting sub-committee of the Radio Parts Industry Coordinating Committee, pointed out: "In terms of requirements for technical proficiency on the part of the serviceman, the demands of television are far greater than the demands of radio. For one thing, television is much more complicated than AM radio. For another, the eye is vastly more discriminating than the ear, and the set owner consequently—and properly—insists on perfect workmanship.

"The radio manufacturing industry feels that it has an obligation to the 30,000 or 40,000 radio repairmen who have devoted years of their lives to servicing the AM sets we made. As a consequence, we are undertaking a national educational program, at no cost whatsoever to the radio technician, to present him with two types of information:

"First, the most advanced information on television, based on actual servicing experience, which the top-flight technical brains of the country can prepare to enable him the better to serve television set owners;

"Second, the most practical, down-to-earth information on management and merchandising of his own business to enable him to become a stable and expanding businessman. This is necessary if he is to grow and advance with the growth and advance of television." ✓ ✓ ✓



Servicemen's choice!
in...



● Cunningham tubes get more votes of confidence and receive more southern hospitality in Virginia... because Cunningham tubes have demonstrated their long life and top performance over a period of 32 years. That's why Cunninghams get more customers when renewal tubes are needed... and that's why *you* should make Cunningham tubes your leading brand.

See your
CUNNINGHAM DISTRIBUTOR
JOHNSTON-GASSER CO.
Richmond





Even The records like

VELOCITY-TRIP RECORD CHANGE

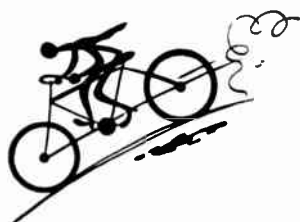

See page 47
for full details



WEBSTER-CHICAGO



Free illustrated booklet tells the "Inside Story" of an amazing new servicing method. It also contains valuable "hints and kinks" for every radio man. Just send your name, address, and the words—"Inside Story"—on a post card and we will mail your copy at once, without cost or obligation. Do it now before you forget!

FEILER

FEILER ENGINEERING CO.
Dept. 11M 8, 945 George St.
Chicago 14, Ill.

FM Detectors—I

→ from page 19

resonance at the center i-f value, so there is no reactance present at the center frequency.

When deviation (variation away from the center frequency) takes place, the phase relations of e_1 and e_2 vary. This makes e_1 larger than e_2 for signals of frequency higher than the i.f.; e_2 becomes larger than e_1 for signals of frequency lower than the i.f. Resistors R-1 and R-2 are diode load resistors for the respective diodes. The d-c voltage across each is, therefore, proportional to the respective signal voltages e_1 and e_2 . Being in series, the d-c voltages across R-1 and R-2 combine at point "a" (with respect to ground) and produce a characteristic with frequency like that shown in Fig. 2. A complete, detailed description of the operation of a Foster Seeley discriminator was given in a previous article in this magazine.

Amplitude variations in the signal have an unbalanced effect on the voltages on the two diode plates, producing greater effects on the higher of the two voltages. AM as well as FM signals are thus demodulated by the discriminator. Thus, to obtain full noise suppression qualities of FM reception, a limiter stage must be used ahead of the discriminator to remove AM fluctuations. The function of the limiter stage was described in our previous FM article.

Although the basic discriminator circuit is as shown in Fig. 1, several important variations have come into use in commercial receivers. Two of these variations are illustrated in Fig. 3. In the circuit at "A", the primary voltage is placed in series with the cathode instead of in series with the center tap of the secondary winding. This circuit requires a dual winding secondary, but is designed to allow operation without the necessity of separate cathodes in the sections of the detector tube.

Another variation, Fig. 3, "B", includes two condensers connected in series across the secondary winding. The primary signal voltage is applied at the common center connection of these condensers.

Still another type of discriminator is the "off-tune" arrangement shown

in Fig. 4. The circuit uses two secondary windings. Each secondary winding is tuned by a condenser and sometimes also by an iron dust slug. The resonant frequency of one secondary circuit is tuned to a little above the i.f.; the resonant frequency of the other secondary circuit is tuned to a little below the i.f. Positive deviation increases the d-c voltage across R-1, decreases the voltage across R-2.

With negative deviation, the d.c. across R-2 is larger. The effect on the total voltage (E) is the same as with the Foster Seeley discriminator. This circuit has good linearity over a wide deviation range, but is not as popular as the Foster Seeley type because the extra resonant circuit makes it more expensive.

In any discriminator design, the circuit is sensitive to amplitude modulation as well as to frequency modulation. For this reason a limiter stage must be used for proper noise suppression.

Ratio Detector

As can be seen by reference to Fig. 5, the ratio detector is quite similar to the Foster Seeley discriminator in many respects. The main differences are:

1. The polarity of one diode is reversed (cathode and plate connections interchanged).
2. The load is one complete resistor in parallel with a rather large capacitance.
3. The output voltage is obtained from the common terminal of two extra condensers connected in series across the load (point a).

In this detector, the diodes both rectify in the same direction, causing a d-c voltage, proportional to the strength of the received carrier, to appear across the load resistor R-1. Only very slow amplitude fluctuations of the carrier can affect this d-c voltage because of the large time constant of R-1 — C-3.

The voltages e_1 and e_2 of the transformer secondary winding vary in the same way as in the Foster Seeley discriminator. Instantaneous voltages, proportional to e_1 and e_2 , appear across C-1 and C-2. These voltages are in series and their sum is the voltage at point a. But this voltage is kept constant regardless of modulation, as described above. Thus, the center point (x) voltage varies according to the instantaneous value of

the modulation signal. This voltage, which is the detector output signal, is then coupled into the first a-f amplifier stage.

Because of the self-limiting property of the ratio detector, it has found wide use in FM receivers. A variation of the circuit is shown in Fig. 6.

This variation is used in RCA FM receivers. The transformer which couples the signal from the i-f section has a tertiary (third) winding, L-3. The coupling between L-1 and L-2 is mainly obtained by means of this tertiary winding. L-3 is inductively coupled to L-1. The two leads are then tapped into L-2, condenser C-6 being connected in series with one of the leads. The signal voltage across L-3 has the same phase as the primary voltage and substitutes for the condenser and r-f choke combination in the standard ratio detector circuit of Fig. 5.

Two tuning slugs are provided for the transformer secondary. The circuit is tuned to the proper center frequency with one slug and adjusted for balance with the other.

Another variation of the ratio detector is the one shown in Fig. 7. It will be noted that the only difference here is that separate load resistors are used, as in the Foster Seeley discriminator, and their center point joined through a resistor to the center point of the series capacitors C-3 and C-4. However, because of the large residual condenser C-1, no signal voltage can appear across these resistors R-4 and R-5. The output signal of the detector still appears at point *x*, and now also across R-6.

The circuit of Fig. 7 is often referred to as the "balanced" ratio detector, because the center of the load resistor is grounded and the ends of this resistor have equal and opposite d-c voltages with respect to ground.

The ratio detector circuit lends itself very well to the use of automatic volume control. It might at first seem that a.v.c. is out of place in an FM receiver, which purposely is made to overload in the limiter stage and whose output volume depends on the deviation of the signal, rather than on its amplitude. In spite of these factors, however, a.v.c. can serve an important function in an FM receiver. A.V.C. prevents overload on strong signals in the i-f stages preceding the limiter. The effect of an overload in

these stages is to lower the input resistances of the tubes and lower the Q of the circuits. The lower Q broadens the response curve, and the selectivity becomes poor. Proper use of a.v.c. prevents this broadening effect.

The a.v.c. lead can be connected to point *a* in Fig. 5 or Fig. 7. These points develop negative d-c voltages proportional to the carrier strength of the signal being received. Applied to the grids of the i-f and converter sections or r-f stages, these negative voltages control the gain as in AM broadcast receivers.

An additional feature of the circuit of Fig. 7 is that a positive voltage, proportional to the strength of the carrier, is available at point *a*. This positive voltage can be used to operate a squelch (muting) system. This system disables the audio or other section of the receiver when no stations above a certain minimum signal strength are being received. When a satisfactory signal is applied to the detector, the bias on the controlled tube is lowered sufficiently to allow the receiver to operate.

With the output of the receiver shut off in the absence of a signal, the background random and other noise, which would otherwise be heard, is eliminated. Squelch systems are found in a number of FM receivers because the normal random receiver noise is much greater, but some AM broadcast receivers also include squelch circuits.

In this first part of our discussion of FM detectors, we have considered discriminators and ratio detectors. In the next part we proceed to the new locked oscillator stage (Philco) and the supergenerative (Fremodyne) types, and pre-emphasis and de-emphasis. ✓ ✓ ✓

Beginning
Soon . . .
A new, complete
series on
Television
for the Radio Service
Technician.



Servicemen's choice!
... for the last word
in TV service data



● Now you can get the *practical* information you want on the servicing of television receivers! John R. Meagher, with his wealth of experience as Television Specialist for the RCA Tube Department, has prepared a series of articles exclusively for RCA SERVICE NEWS on the servicing of TV receivers. Here's valuable, authentic data you can't get elsewhere . . . so check with your Cunningham Distributor to make sure you get the entire series. The first article appeared in the May-June issue.



Introducing... another Famous FERRET instrument

F.M. - TELEVISION SWEEP GENERATOR



MODEL 720

Electronic Sweep on All Bands
50 K.C. to 20 M.C.

No Vibrators or Speakers Used
Range 0 - 260 M.C.—All Fundamentals
Built-In Market Oscillator
19 M.C. to 40 M.C.—On Fundamentals
Absorption or Pipper Type Marker

This Ferret Sweep Generator is a revolutionary designed instrument for aligning any modern F.M. or television receiver. Push-button control permits simultaneous use of Crystal Oscillator, Fixed Audio Oscillator, R.F. Oscillator or Sweep Generator. This combination not possible with any other generator.

Check these Features!

- Sweep width adaptable to F.M. and Television
- Pipper or absorption type marker—fully attenuated
- Crystal oscillator standard from 250 K.C. to 10 M.C. or any multiple
- Phasing control on front panel
- Master Oscillator can be externally modulated up to 20 K.C.
- Output impedance approximately 75 ohms
- R.F. output 1 volt
- Accuracy 1/2 to 1 per cent
- 9" Glass enclosed dial with 5 to 1 vernier drive

\$164.95*

Dealer Price

SEE YOUR JOBBER OR WRITE FOR DESCRIPTIVE LITERATURE

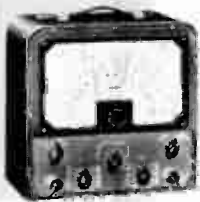

SIGNAL GENERATOR
Wide Range
FM-AM Television
Model 701
\$74.95 Net*

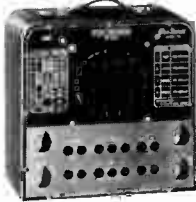

DELUXE TEST SPEAKER
& Universal Substitutor
Model 721
\$29.95 Net*

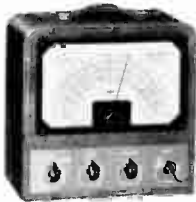

AUDIO OSCILLATOR
Sine Wave—
Square Wave
Model 710
\$89.95 Net*



COMBINATION SIG-
NAL TRACER & ELEC-
TRONIC VOLT OHM
METER
Model 730
\$99.95 Net*

*All Prices Slightly Higher in Eastern States

Coastwise ELECTRONICS CO., INC.

Designers and Manufacturers of Electronic Equipment

130 North Beaudry Ave., Los Angeles 12, Calif.
New York Office & Warehouse, 315 Broadway, New York 7, N. Y.



Permoflux SPEAKERS

YOUR JOBBER CAN SUPPLY YOU!

Permoflux quality and dependability—the same as supplied to the major set manufacturers—is your assurance of complete customer satisfaction. You'll find Permoflux Speakers easy to install and readily available in both PM and Electrodynamic types. You'll find too, that it pays to give your customers "tops in tone" with a Permoflux Replacement Speaker.

TWO COMPLETE
FACTORIES TO SERVE YOU

PERMO-FLUX

WRITE FOR
FREE BULLETIN

PIONEER MANUFACTURERS OF PERMANENT MAGNET DYNAMIC TRANSDUCERS

PERMOFLUX CORPORATION

4900 WEST GRAND AVE., CHICAGO 39, ILLINOIS
236 SOUTH VERDUGO ROAD, GLENDALE 5, CALIFORNIA

Industry Presents

→ from page 43

servicemen's resistor assortment in a modern, attractive plastic cabinet. The assortment consists of 125 carefully selected Ohmite "Little Devil" individually marked insulated composition resistors of the 1/2-watt size. These resistors are furnished in 40 resistance values from 10 ohms to 10 megohms, and represent the types most frequently used by the radio serviceman in his day-to-day work. The resistors are factory-packed in a compact, handsome, all-plastic cabinet having five drawers with eight compartments in each drawer. Resistance values are clearly printed in front of each compartment so the desired resistor can be located instantly.

The cabinet itself is molded for durable plastic and measures 9" long, 4 3/4" high, and 5 1/4" deep. If a larger assortment is desired, any number of cabinets can be conveniently stacked one on top of the other, rigidly locked in place.

MAGNETAPE RECORDER

Four continuous hours of recording and playback, at the standard RMA tape speed of 7 1/2 inches per second, is featured by Model 910-B Twin-Trax Tape Recorder now being produced by the Amplifier Corpora-



tion of America, New York City. Through the newly developed principle of two-way dual-channel operation, whereby one sound track of the tape records in the forward direction, and a completely isolated second track records during reverse travel, the 4,900 ft. (13 1/2 inch diameter) reels of tape accommodated by the recorder, which would ordinarily give two hours of operation, actually provide doubled playing time. An automatic switch and solenoid instantly reverses the direction of tape travel at the end of the reel, thereby also eliminating the necessity for rewinding. Through a new space-saving design and coupling principle, the full reel and the take-up reel are fastened paral-

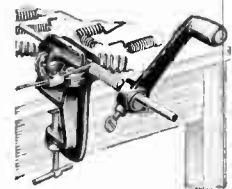

lel to the sides of the recorder cabinet, and are coupled to the main drive in a 2-way drive system which also permits the use of standard 7" reels on top of the chassis for one hour recordings.

1.

TILT-O-MATIC TONE ARM

... a perfectly balanced tone arm for either standard or Microgroove records. A flip of the lever distributes the weight properly for the type of record to be played.



Will fit any radio console ... ideal for replacement service business.

Model 246

Only **WEBSTER-CHICAGO**

Dual-Speed Record Changers

have these

3 Features

2.



TANDEM-TIP NYLON NEEDLE

... two needles in one! A micro-ground tip for Microgroove records and a standard-ground tip for standard records. The Tilt-O-Matic Tone Arm lever automatically selects the right tip.



Model 256

Deluxe record changer for custom installation or replacement.

3.

VELOCITY-TRIP RECORD CHANGE

... no "lead-in" springs. Record Change operates on normal lateral motion of the tone arm which travels freely in either direction ... tracks "comfortably" in either Microgroove or standard record grooves with minimum wear.



These models and others available now.

Call Your Webster-Chicago Distributor today!

Plays 10 twelve-inch or 12 ten-inch records automatically in one loading of either standard or Microgroove records.

Record drop is gentle and quiet ... cushioned spindle and heavy flock turntable preserve records.

Motor is four pole, shaded pole, two-speed type with ample power for "wowless" performance at either speed.

Tone Arm comes to rest at the side after last record has been played. Turntable revolves until shut off.



WEBSTER-CHICAGO

5610 W. Bloomingdale Ave. ♦ Chicago 39, Illinois

ADVERTISERS

A-G Radio Parts Co.	38
Allied Radio Corporation	39
Agency: George Brodsky Advertising	
American Electrical Heater Co. 26	
Agency: Dudgeon, Taylor & Bruske, Inc.	
L. S. Brach Mfg. Co.	31
Agency: A. W. Lewin Co.	
Capitol Radio Engineering Institute	30
Agency: Henry J. Kaufman	
Chicago Transformer Co.	6
Agency: Burton Browne	
Coastwise Electronics Co., Inc.	46
Electro-Products Laboratories	32
Agency: Merrill Symonds	
Feiler Engineering Co.	44
Agency: Sander Rodkin, Adv.	
General Electric Co. I, 3rd Cover	
Agency: Maxon, Inc.	
Greylock Electronics Supply Co. 39	
Agency: Bergman-Jarrett	
Heath Co.	4
Agency: Paxon Adv.	
Hickok Electrical Instrument Co. 33	
Agency: White Advertising Co.	
Hytron Radio & Electronics Corp. 2	
Agency: Henry A. Loudon Adv.	
P. R. Mallory Co., Inc. 2nd Cover	
Agency: The Aitkin-Kynett Co.	
Murray-Hill Books	28
Agency: Harry P. Bridge Co.	
Measurements Corp.	35
Agency: Frederick Smith	
Newark Electric Co.	46
Agency: Chernow Co. Inc.	
Ohmite Mfg. Co.	10
Agency: Fensholt Co.	
Olin Industries, Inc.	5
Agency: D'Arcy Adv. Co.	
Permoflux Corporation	46
Agency: Turner Adv. Agency	
Precision Apparatus Co.	13
Agency: Shappe-Wilkes, Inc.	
Radiart Co.	9
Agency: Ohio Adv. Agency	
Radio Corporation of America	39, 41, 43, 45
Agency: J. Walter Thompson Co.	
John F. Rider, Publisher	42
Agency: Lansford F. King	
Howard W. Sams & Co.	23
Agency: George Brodsky, Adv.	
Sangamo Electrical Co.	10
Agency: Arthur R. Mogge, Inc.	
Shure Brothers	29
Agency: Casler, Hempstead & Handford, Inc.	
Simpson	8
Solar Manufacturing Corporation	3
Agency: O. S. Tyson, Inc.	
Sprague Products Co.	12
Agency: The Harry P. Bridge Co.	
Transvision, Inc.	34
Agency: H. J. Gold Co.	
Triplett Electrical Instrument Co. 11	
Agency: Western Adv. Agency	
Utah Radio Products Co.	33
Agency: Bonsib Adv.	
Webster-Chicago Corporation	27, 37, 41, 44, 47
Agency: Fuller, Smith & Ross, Inc.	

BACK NUMBERS

Get Them While They Last

JANUARY 1946

THE PROBLEMS OF ORGANIZATION
TELEVISION RECEIVER INSTALLATION
RADIO MAINTENANCE IN AVIATION
USING THE OSCILLOGRAPH FOR
DISTORTION MEASUREMENTS

APRIL 1946

A MIDGET AUDIO FREQUENCY
OSCILLATOR
IF I WERE A SERVICEMAN
AN EQUALIZED AMPLIFIER FOR
MAGNETIC PICKUPS

MAY 1946

PA SYSTEMS
TEST PANEL FOR THE MODERN BENCH
RINGING THE BELL

JUNE-JULY 1946

FUNDAMENTALS OF TELEVISION
VOLUME CONTROL TAPERS
THE ELECTRONIC OHMMETER
VECTOR ANALYSIS

AUGUST 1946

AVC CIRCUITS
FM TROUBLESHOOTING
TELEVISION RECEIVER FUNDAMENTALS
RECORD CHANGERS

DECEMBER 1946

TELEVISION RECEIVERS ...
THE RF SECTION
TUNING THE INDICATORS
PART II—THE OSCILLOGRAPH ...
HOW TO USE IT
REPLACING AUTO CABLES

JANUARY 1947

SERVICING BY EAR
TELEVISION RECEIVERS ... VIDEO
CHANNEL
PART III—THE OSCILLOGRAPH ...
HOW TO USE IT
MINIATURE TUBE CHART

FEBRUARY 1947

THE OSCILLOGRAPH ... HOW TO USE
IT PART IV
TELEVISION RECEIVERS ... THE SOUND
CHANNEL
THE AUDIO OSCILLATOR
SELENIUM RECTIFIERS

MARCH 1947

ANTENNAS ... FM AND TELEVISION
PART I
SERVICING AUTOMATIC RECORD
CHANGERS
OSCILLATORS AND CONVERTERS
TELEVISION RECEIVERS ... THE VERTICAL
SWEEP

APRIL 1947

ANTENNAS ... FM AND TELEVISION,
PART II
PHASE INVERTER CIRCUITS
A UNIVERSAL SPEAKER
TELEVISION RECEIVERS ...
THE HORIZONTAL SWEEP

MAY 1947

THE OPEN AND CLOSE CASES
VOLTAGE DOUBLERS
SIGNAL TRACER
TELEVISION RECEIVERS ... THE
CATHODE RAY TUBE

JUNE 1947

WHEN THE CUSTOMER ISN'T RIGHT
TEST EQUIPMENT MAINTENANCE
CRYSTAL CONTROLLED SIGNAL
GENERATOR
TELEVISION RECEIVERS ... THE
POWER SUPPLY

JULY 1947

SERVICING FM RECEIVERS
TEST EQUIPMENT MAINTENANCE, PART II
TELEVISION RECEIVERS ...
FLYWHEEL SYNC

AUGUST 1947

SPEAKER MATCHING
TEST EQUIPMENT MAINTENANCE, PART III
SERVICING FM RECEIVERS
TELEVISION ... HF POWER SUPPLIES

RADIO MAINTENANCE MAGAZINE

460 BLOOMFIELD AVE., MONTCLAIR, N. J.

Please send me the back numbers checked here . . .
I am enclosing 35c for each copy, or \$2 for any 8 copies, or \$3.25 for all 14.

- January 1946
 April 1946
 May 1946
 June-July 1946
 August 1946

- December 1946
 January 1947
 February 1947
 March 1947
 April 1947

- May 1947
 June 1947
 July 1947
 August 1947

Have selected 8 copies . . . enclosing \$2.00

Send me all 14 . . . enclosing \$3.25

NAME

ADDRESS

CITY

ZONE

STATE

30,000

SERVICE TECHNICIANS

Read

RADIO MAINTENANCE

Every Month

Every day is

RADIO MAINTENANCE

day in your shop!

RADIO MAINTENANCE

460 Bloomfield Ave.,
Montclair 1, N. J.

Please send me RADIO MAINTENANCE for:

- 2 years at \$5.00
 1 year at \$3.00
 Check enclosed
 Bill me later

Name

Occupation

Address

City

Zone

State

SERVES AND PLEASES MILLIONS!



GENERAL  ELECTRIC

176-GA7-0050

FIRST AND GREATEST NAME IN ELECTRONICS

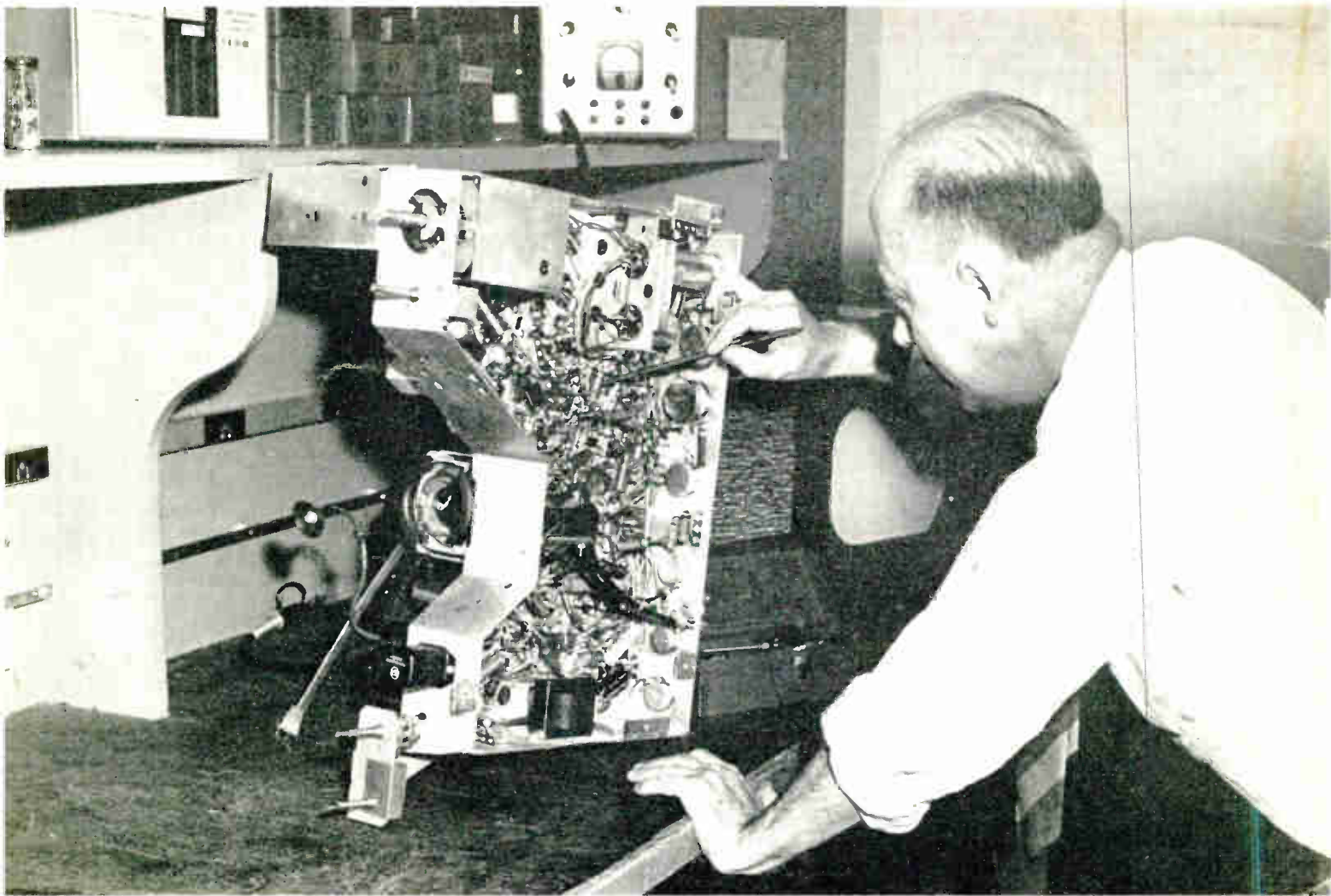

**How to make
more money
in the servicing
business!**

Your local jobber believes in helping you—his best customer—to make more money, because then you will become a bigger customer and everyone will be happy!

In line with this policy, he pledges his high standard of service and better buys for radio servicemen . . . **AND** he will present ideas to help you expand your business. In the months to come he will feature a different subject each month on this back cover of **RADIO MAINTENANCE**. This may be in the nature of new moneymaking ideas, or announcements of special sales in his store, or suggestions on the proper equipment for your work. In all cases, the idea will be to help you—the radio serviceman—make more profit.

Of course his staff of experienced clerks are ready to serve you every day. Drop in his store today—browse around. He has all kinds of good buys you may want to look over. Just mention **RADIO MAINTENANCE**—and watch this back cover for extra profit for you!

RADIO MAINTENANCE

460 Bloomfield Ave.

Montclair, N. J.