

MARCH 1948

35 CENTS

**EVERYTHING IN TELEVISION · RADIO · ELECTRONICS
FOR THE RADIO SERVICE · TECHNICIAN**

RADIO

MAINTENANCE

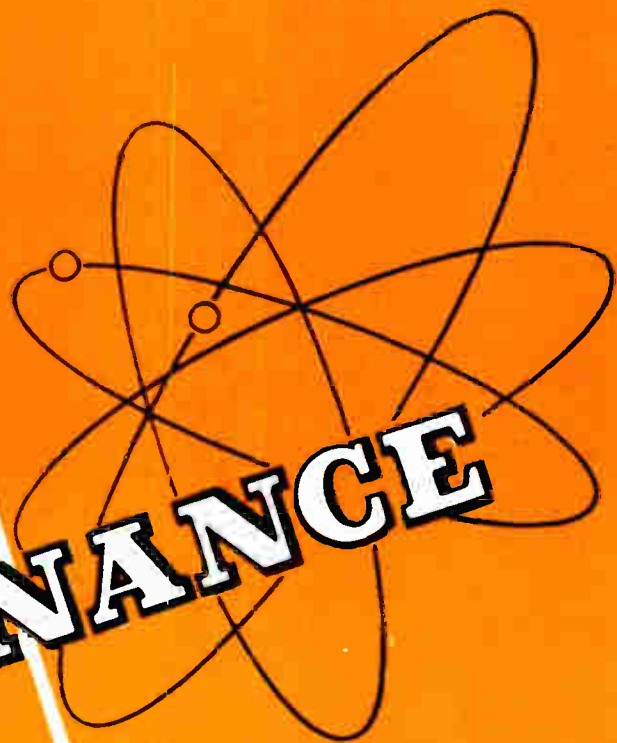

**HOW TO ELIMINATE HUM
TELEVISION INTERCARRIER
SYSTEM**

**SWEEP GENERATORS
FOR FM ALIGNMENT
PART II**

YEARLY SUBSCRIPTION \$3.00

BOLAND & BOYCE INC., PUBLISHERS

MONTCLAIR, N. J.

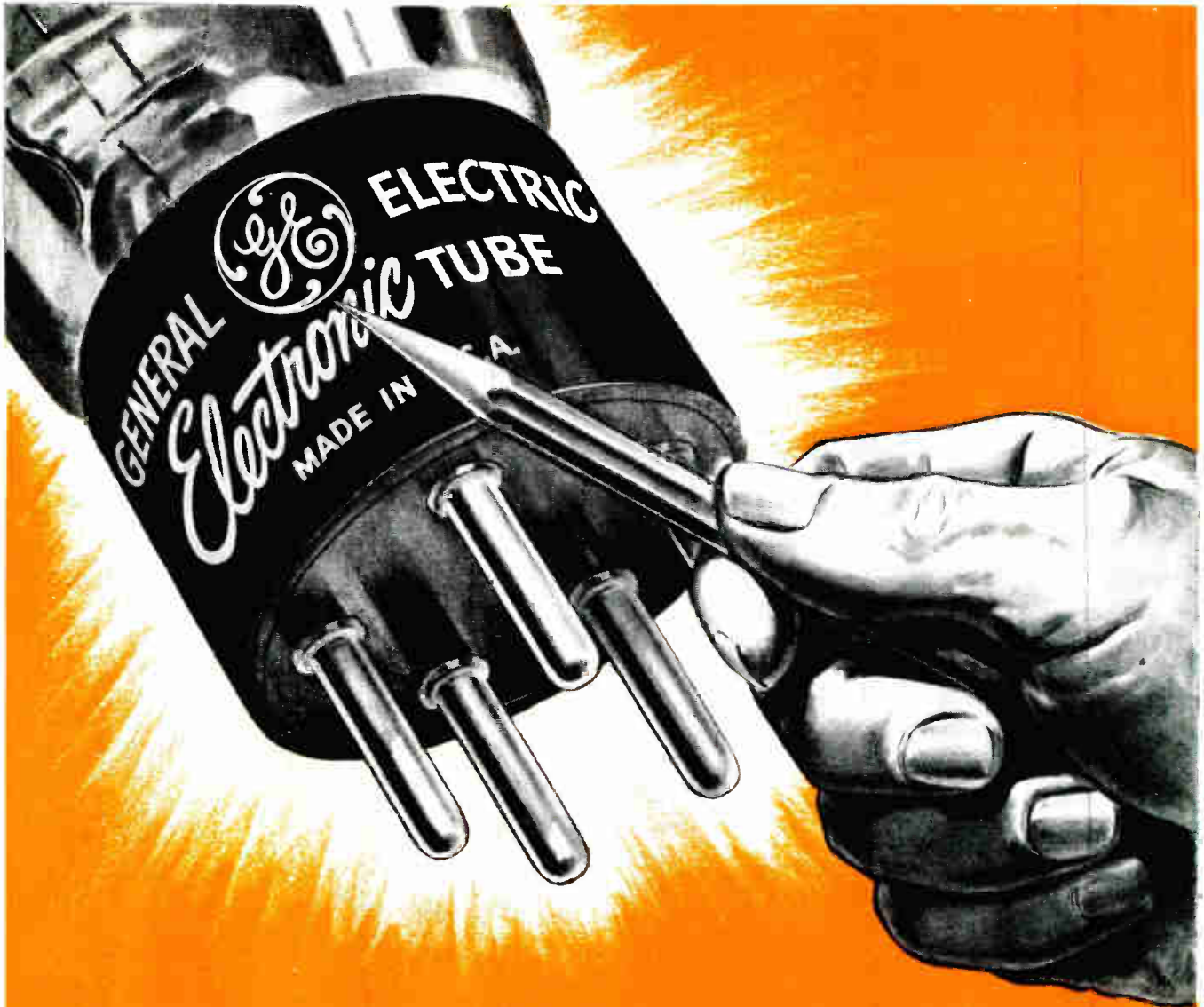

No other name means so much!



GENERAL  ELECTRIC

174-GA3-6880

FIRST AND GREATEST NAME IN ELECTRONICS

FROM A LEADING RECORD MANUFACTURER

"The pickups are proving quite the thing with the engineers here. If you ever get to New York, I'd like very much to let you hear how fine they sound."

"Recently I purchased one of the Variable Reluctance Pickups manufactured by your company. I have installed it in a . . . in conjunction with your MSC phono preamplifier and a high fidelity amplifier. The results of this installation to date have been excellent and I would like to congratulate you on this development."

FROM A LEADING UTILITY LABORATORY

"I have been using for the last several months a pair of your variable reluctance pickups in connection with a high fidelity play-back system with eminent satisfaction. I would in fact go so far as to say that the results when first put to use were astonishing."

"I have installed one of your DL IRM 6C Variable Reluctance type pickup cartridges in my record changer and am feeding it through a preamplifier made by you, the diagram of which is given in figure 2 of the descriptive sheet belonging to the above mentioned pickup. I find that the results I have obtained from this pickup are better than anything I have heard before."

FROM A LEADING SET MANUFACTURER
 "We are rapidly approaching the day on which the G.E. Variable Reluctance Pickup will be a standard component in our instruments. May I say that I continue to enjoy immensely the results from the sample pick-ups you were kind enough to send some weeks ago. I have yet to hear their superior even at considerably higher price levels."

"I have been using a General Electric Reluctance Phonograph Pickup for the past few weeks, and am greatly impressed by the cleanness of its reproduction."

"I recently heard a demonstration of the G.E. Variable Reluctance Reproducer Model DL IRM 6C, which was very impressive."

RESEARCH AND DEVELOPMENT COMPANY
 "The combination of . . . G.E. cartridge, and . . . is being adopted with enthusiasm by radio stations throughout the country. National radio networks . . . are placing them on all of their transcription tables."

They're all talking about the

VARIABLE RELUCTANCE PICKUP



Have you sent in your order?

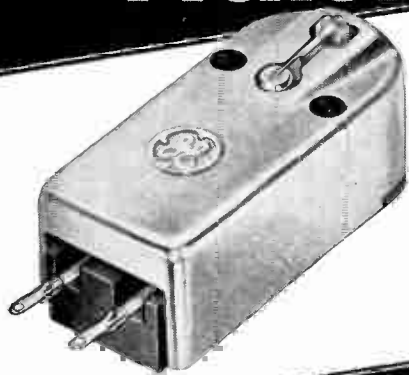

General Electric Company, Electronics Department, Electronics Park, Syracuse, New York.

GENERAL ELECTRIC

"Not so long ago I bought one of your DL IRM 6C variable reluctance pickups. I am completely satisfied with it. It has more than lived up to my expectations."

FROM A LEADING STATION
 "Retel Nov. 27 ordered 30 G-E pickups because tests indicated that they were superior . . . and station is going to include G-E pickups in all transcription equipment."

"The release for public sale of your Variable Reluctance pickup Cartridge has made a large number of people in this neighborhood happy. Listening comparisons with other types of cartridges lead only to the conclusion that the G-E is perhaps the biggest improvement in record reproduction for the poor man in the last ten years."

McMurdo
SILVER

NEW!

MAKES YOU MASTER OF FM & TELEVISION SERVICE



Here's what you and thousands of research and service technicians have demanded . . . a frequency-modulated FM and TV *sweep* signal generator. With this new McMurdo Silver MODEL 909 and your oscilloscope you can visually align FM and TV receivers . . . quickly and perfectly . . . for it comes with simple but complete instructions to *put you at the head of the parade* in FM and TV service.

Quality and completeness are as high as price is low . . . the regular "trademark" of Silver LCETI . . . Laboratory Caliber Electronic Test Instruments at prices you can afford.

CENTER-FREQUENCY RANGE 2/226 mc. — 5" vernier-driven calibrated dial. A new Silver development covers 2/77, 70/154 and 151/226 mc. in 3 bands without band-switching!

STABILITY is extraordinary. New u.h.f. tubes give stability such that FM and TV 'scope pictures once set up will "stay put" for hours on end.

SIZE AND STYLE match "VOMAX" and all Silver LCETI. Power required is 105/125V., 50/60 a.c. at 35 watts. Size 12 $\frac{3}{4}$ " x 7 $\frac{3}{4}$ " x 6" overall.

CO-AXIAL OUTPUT CABLES. 3 ft., d.c. isolated, 5/125 Ω impedance for r.f.; separate horizontal synchronizing cable. Both with clips for direct connection to receiver circuits.

SWEEP FREQUENCY is panel-knob variable 0/9 mc. . . . to set correct sweep for FM and TV i.f. and r.f. alignment. True electronic, not distorting and troublesome mechanical sweep.

SYNCHRONIZATION is either power line sine wave, or saw-tooth to 'scope from 909. R.F. OUTPUT is panel-knob controllable 0/500,000 microvolts maximum. More than ample for all visual alignment with any good oscilloscope.

MODEL 909 FM & TV SWEEP SIGNAL GENERATOR makes you master, not victim, of today's most profitable service fields . . . at a price which is already the amazement of the industry!

Model 909 Only \$48.50 Net

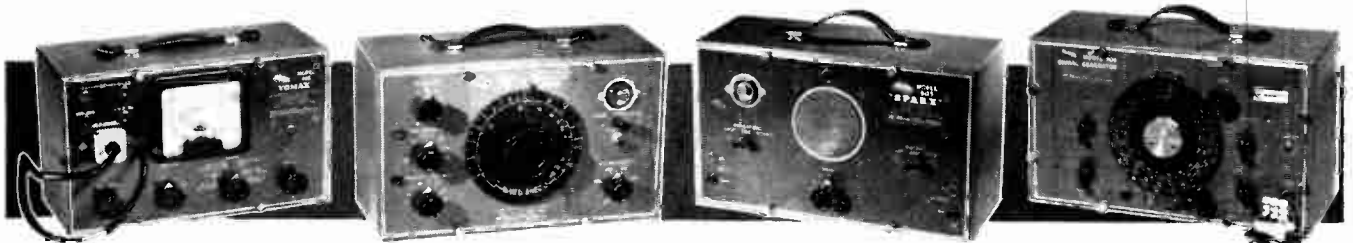

900 "VOMAX" 51 ranges; d.c., a.c., a.f., i.f., r.f., 20 ν /500 mc. 0/3000 V. d.c.; 0/1200 V. a.c., current 0/12 A. ; resistance 0/2000 meg Ω ; db.—10/ \pm 50.

The overwhelming choice of wise research and service technicians.

Only \$59.85 Net

904 CONDENSER/RESISTOR TESTER. $\frac{1}{4}$ mmfd./1000 mfd.; $\frac{1}{4}$ Ω /1000 meg Ω ; variable d.c. polarizing voltage leakage current; 0/50% power factor. Laboratory accuracy of \pm 3%.

Measures all condensers with 0/500 V. rated d.c. volts applied. Only \$49.90 Net

905 "SPARX" DYNAMIC SIGNAL TRACER/TEST SPEAKER.

Traces a.f., i.f., r.f. signals thru any receiver, tests pick ups, mikes, PA amplifiers. 20 ν /200 mc. Saves time in receiver repairs as does no other single instrument. Only \$39.90 Net

906 FM/AM SIGNAL GENERATOR. 8 ranges, \pm 1% accurate, 90 kc./210 mc. 0/100% AM, 0/1000 kc. FM modulation. Less than 1 microvolt to over 1 volt metered output. The outstanding signal generator buy.

Only \$99.50 Net

SEND FOR COMPLETE CATALOG. See these and Silver communication transmitters, receivers, "Micromatch", Xtal-controlled VFO, pretuned freq. multiplier at your jobber.

OVER 36 YEARS OF RADIO ENGINEERING ACHIEVEMENT

McMurdo Silver Co., Inc.

EXECUTIVE OFFICES: 1240 MAIN ST., HARTFORD 3, CONN.
FACTORY OFFICE: 1249 MAIN ST. HARTFORD 3, CONN.

RADIO

MAINTENANCE

INCLUDING
ELECTRONIC
MAINTENANCE

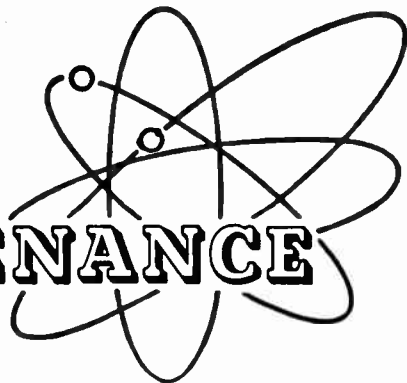

Volume 4

MARCH 1948

Number 3

CONTENTS

How to Eliminate Hum	K. E. Stewart	6
A complete procedure for removing hum		
Using Sweep Generators for FM Alignment	McMurdo Silver	8
Visual Alignment, Part II		
Low-cost Television with the Intercarrier System	Morton Scheraga	11
A new type of television receiver		
An FM Signal Source	Stanley Curtis	12
An FM record player for test purposes		
Over the Bench	John T. Frye	20
A Serviceman's Opinion		
The Organizations		33
News about servicemen's groups		
Review of Trade Literature		34
Catalogs, books, etc.		
The Industry Presents		37
New products		
The Notebook		39
Practical suggestions from readers		

WILLIAM F. BOYCE
Publisher

JOSEPH J. ROCHE
Editor

VICTOR M. TURNER
Art Director

FRANK SCHMITT
Eastern Advertising

J. RICHARD JOHNSON
Managing Editor

THOMAS A. BYRNES
Director of Field Services
and Quality Control

STUART J. OSTEN
Midwestern Advertising
Eastern Office
460 Bloomfield Avenue
Montclair, N. J.
Montclair 2-7101

MORTON SCHERAGA
Contributing Editor
Midwestern Office
228 No. La Salle St.
Chicago 1, Ill.
Dearborn 3507

AL JOHNSTON
Circulation Manager
West Coast
Swain Associates
Wilshire-Wilton Bldg.
639 So. Wilton Place
Los Angeles 5, Calif.
Fitzroy 6146

Copyright 1947, Boland & Boyce, Inc.

Radio Maintenance is published monthly by Boland & Boyce, Inc., at 34 No. Crystal St., East Stroudsburg, Pa., U.S.A.; Executive and Editorial Office, 460 Bloomfield Ave., Montclair, N. J. Subscription Rates: In U. S., Mexico, South and Central America, and U. S. possessions, \$3.00 for 1 year, \$5.00 for two years, single copies 35 cents; in Canada, \$3.50 for 1 year, \$6.00 for 2 years, single copies 40 cents; in British Empire, \$4.00 for 1 year, \$7.00 for 2 years, single copies 50 cents; all other foreign countries, \$5.00 for 1 year.

Change of address: Four weeks' notice required for change of address. When ordering a change, please furnish an address stencil impression from a recent issue if you can. Address changes cannot be made without the old stencil as well as the new one.

HIGH-VOLTAGE

PAPER

TUBULARS

for TELEVISION,

OSCILLOGRAPHS, etc.



• Interested in higher-voltage, dependable yet inexpensive paper capacitors? Here's the Aerovox answer:

The popular Aerovox Type "84" paper tubulars are now available in extended-voltage ratings — 2500, 3500, 5000, 7500 and 10,000 volts D. C. W. Capacitances of .0001 to .05 mfd. Compact dimensions—from 1/8" dia. by 1-1/2" long for smallest, to 1-3/8" dia. to 3" long for largest. Oil-impregnated wax-filled. Sturdy insulating tube. Sealed ends. Bare pigtail leads that won't work loose. Bright yellow-red-black label jacket. And tough!

• See Our Jobber . . .

These extended-voltage paper tubulars are now available. Order your needs from our jobber. Ask for latest catalog.



FOR RADIO-ELECTRONIC AND INDUSTRIAL APPLICATIONS

AEROVOX CORP., NEW BEDFORD, MASS., U.S.A.
Export: 13 E. 40th St., New York 16, N.Y. • Cable: 'ARLAB'
In Canada: AEROVOX CANADA LTD., Hamilton, Ont.

RIDER MANUALS

Mean

SUCCESSFUL
SERVICING

McNEIL HAS ALL 16

(AND VOL. XVII ON ORDER)



MCNEILL
RADIO

NOWHERE
nowhere but in Rider Manuals
will you find:

- so many single band receivers • so many multi band receivers • so many manufacturers • so many models • wire recorders and record players when part of a set • "How It Works" book explaining the theory of complexities in new receivers • "clarified - schematics" with their time-saving breakdowns of multi-band jobs—all the data you need for fast diagnosis of troubles

RIDER MANUALS OFFER
**OFFICIAL, AUTHORIZED
SERVICING DATA**
Direct from the service departments of the set manufacturers come the makers' own recommendations for **PROPER SERVICING PROCEDURES**

"can't operate efficiently without them."

"It's true with those radio servicing shops with which I am familiar — those that have all volumes of Rider Manuals are successful shops. I don't see how anyone can operate efficiently without them," says Howard H. McNeill of McNeill Radio, Long Beach, Calif.

find all sixteen volumes of Rider Manuals. These complete sets are there for a reason. The most fundamental reason. They enable the technician to work more productively, make more money.

If that is what you want, then benefit from the findings of experienced, successful men in the servicing industry. Keep a complete set of all 17 Rider Manuals at your fingertips. Give your shop the Sign of Successful Servicing.

So it is with successful servicemen in towns from coast to coast, over whose servicing benches you will

You NEED ALL 17—ORDER TODAY

VOLUME XVII.....	\$15.00	Record Changers and Recorders .	9.00
Volume XVI	8.40	Master Index, (covering Manuals,	
Volume XV	18.00	Vols. I to XV)	1.50
Volumes XIV to VII (ea. vol.) .	15.00		
Volume VI	11.00		
Abridged Manuals I to V (one vol.)	17.50		

NOTE: Individual Volumes VI, VII and VIII will be replaced after this year by a single Abridged Manual Vol. VI to VIII.

24 HOUR DATA SERVICE. For 10c you receive schematic, voltage data parts list (everything that will fit on two 8 x 11 inch sheets) on any new or old receivers. Additional material 5c a sheet. Send 20c with order.

JOHN F. RIDER PUBLISHER, Inc., 404 Fourth Avenue, N. Y. 16
Export Agent: Rocke International Corp., 13 E. 40th St., N.Y.C. Cable ARLAB

**Give Your Shop The Sign
of Successful Servicing
RIDER MANUALS**

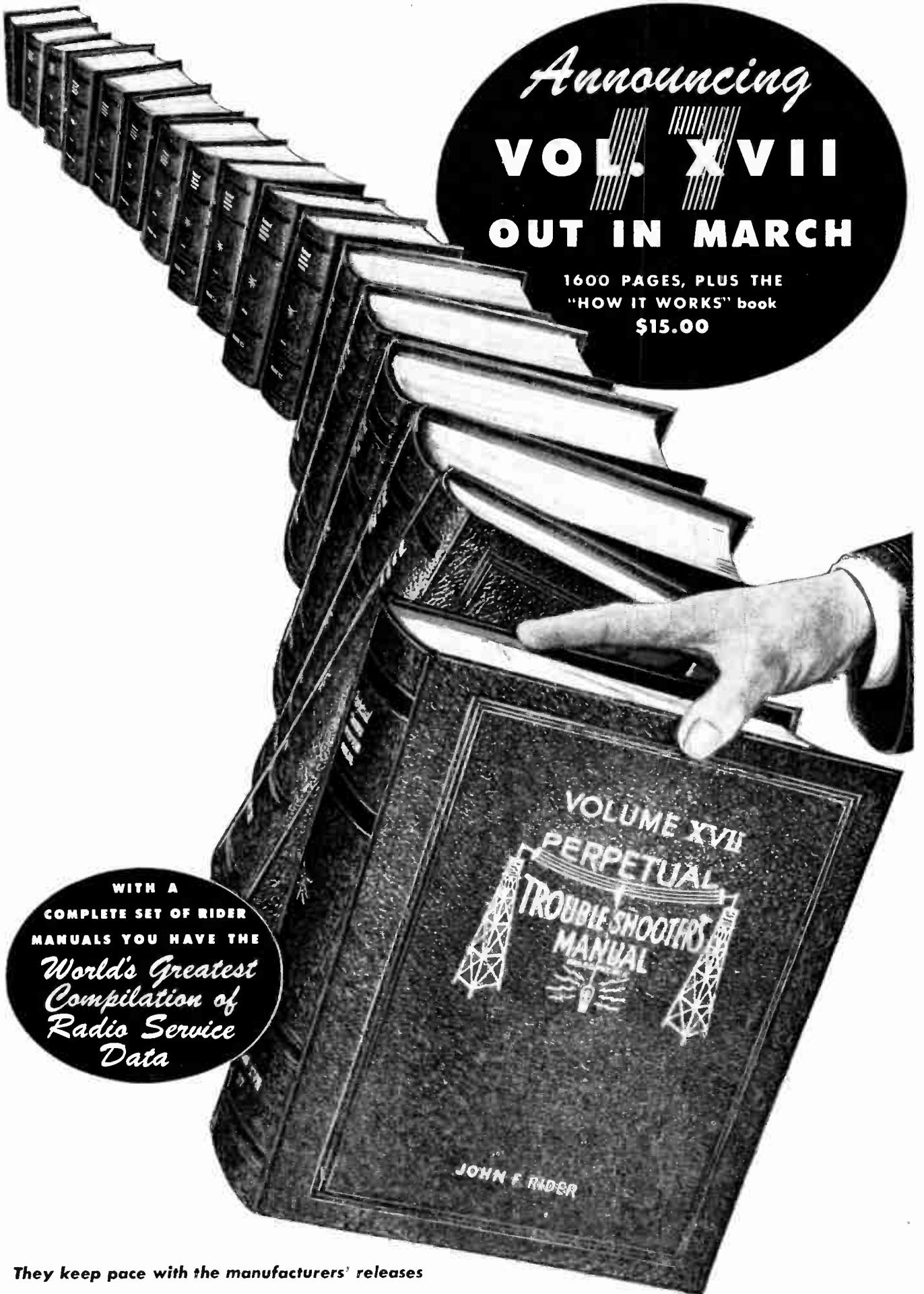

Announcing

**VOL. XVII
OUT IN MARCH**

1600 PAGES, PLUS THE
"HOW IT WORKS" book
\$15.00

WITH A
COMPLETE SET OF RIDER
MANUALS YOU HAVE THE

*World's Greatest
Compilation of
Radio Service
Data*

VOLUME XVII
PERPETUAL
TROUBLE SHOOTER'S
MANUAL

JOHN F. RIDER

They keep pace with the manufacturers' releases

How to Eliminate Hum

K. E. Stewart

You can send the receivers right back—it's better to eliminate all the hum first and add more customers to your list.

EVER since AC sets replaced the old battery jobs, hum has been an important source of trouble to the serviceman. Usually it can be traced in a matter of time. But time means money and the best way to save it is to review the latest information and methods of attack. Important sources of hum in receivers and how to combat them are considered in the following article.

Filter Condensers

When there is undue hum present in a receiver, it is the usual procedure first to check the filter condensers in the power supply. These can usually be tested for low capacitance by temporarily connecting another condenser of low capacitance (8 mfd. is a good size to use) across each condenser respectively. (See Fig. 1.) In some cases, however, the added capacitance of the test condenser will reduce the hum, although the condenser under test is in perfect condition. In such a case the serviceman may be tempted to install a larger filter condenser in order to eliminate, or reduce, the hum. This is bad policy, and is not to be recommended for the conscientious repairman. If it has been determined that the filter condensers are OK, then the correct procedure would be to determine what condition exists that is responsible for the undue hum: The receiver was designed to operate with

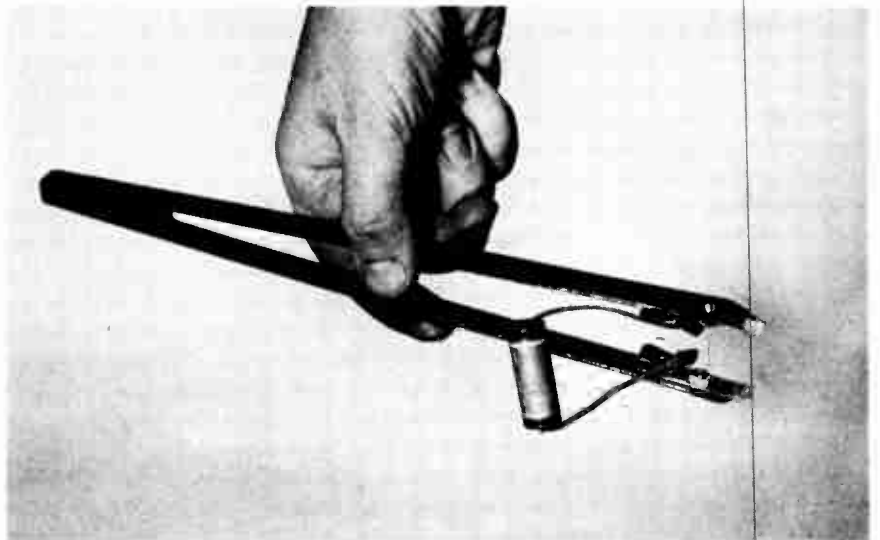

Fig. 1 Condensers can be checked for low capacity by bridging with one known to be good.

the condenser values that were installed at the factory. The chances are good that the hum level is not too high with these values when everything else is OK. There are some AC-DC sets appearing on the market today, however, which have a considerable amount of AC hum. Very often a simple alteration or two in the circuit will help matters a great deal.

AC-DC Sets

Most of these AC-DC hummers feature a P-M type speaker and a simple RC filter in the power supply. Either condenser may range

from fifteen to fifty mfd., with the resistor (there is usually only one in the filter circuit) ranging from 500 to 3000 ohms. This is usually a condenser input pi type of filter; see Fig. (2). By adding another resistor and condenser (Fig. (3)) and converting this into a double pi filter, a material improvement can often be effected. We must bear in mind the fact that by adding resistance in the circuit we will reduce the DC voltage output of the power supply. Therefore it may become necessary in some cases to replace the resistor already in the circuit with one of lower value when add-

ing another RC section to the filter. In a particularly stubborn case, one can sometimes help matters considerably (when space permits) by substituting a filter choke for the resistor in the filter circuit. This will also increase the voltage output of the lower resistance offered by the choke. The result is increased volume from the set. The writer's experience with these hummers has proved that only a few have any cathode by-pass condenser in the output stage. The output cathode condenser may be removed from any AC-DC set using one, resulting in a material reduction of hum; but there will also be a material reduction of bass response and volume available from the set when this is done. The serviceman must decide which, in the particular case, is the lesser of the two evils. A condition which sometimes exists is that of a long unshielded grid lead, in the AF amplifier circuit, with one end connected to the volume control. Any stray hum voltage which is induced in this lead will, of course, be amplified by the audio stages and reproduced by the speaker. Such a condition can be remedied by dressing the grid lead away from adjoining leads or parts. In one portable model, the writer corrected the trouble by taking this lead around over the top side of the chassis. In most cases, however, the lead will have to be shielded. It often pays to replace the original lead with a shielded mike cable, grounding the shielding at one point.

Some AC-DC sets use a voltage doubler system in the power supply. Two of the electrolytic condensers in these power supplies are connected with the negative end of one connected to the positive end of the other, see Fig. (5). It is essential that these two condensers be of the same capacity. If there is any material difference between these two capacitances, the DC voltage output will not be the same for the two halves of the AC cycle of the line voltage. This causes a ripple, or hum voltage to be generated. If one of these condensers is found to be defective, it is advisable to replace them both, unless the receiver is new. By the way, should either of these two condensers become open, there will be no DC voltage output

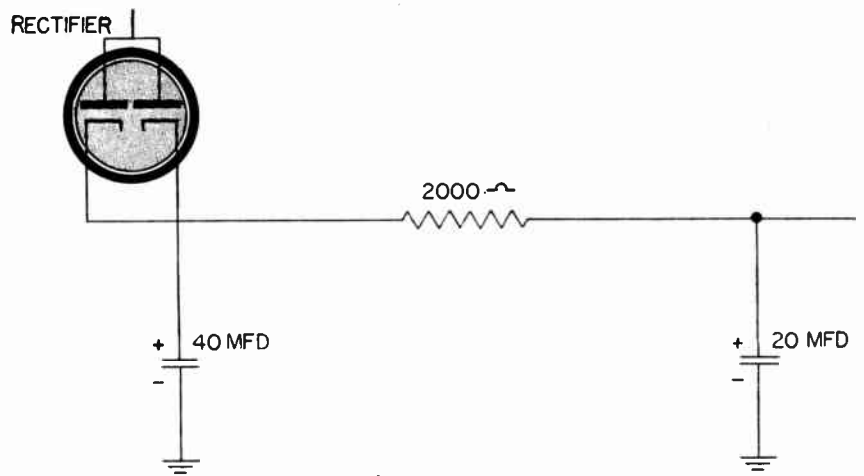

Fig. 2 RC filter of the simple pi type.

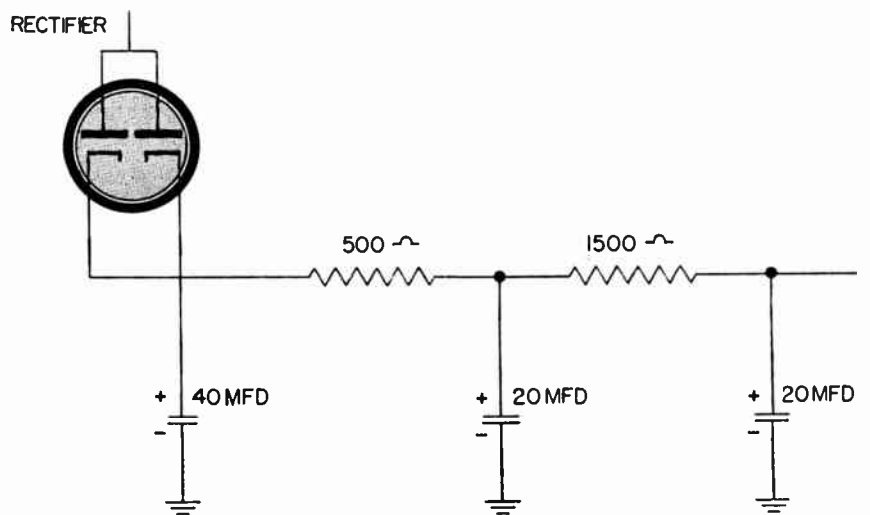

Fig. 3 Double pi type of RC filter. RC filters are often found in the less expensive AC-DC receivers.

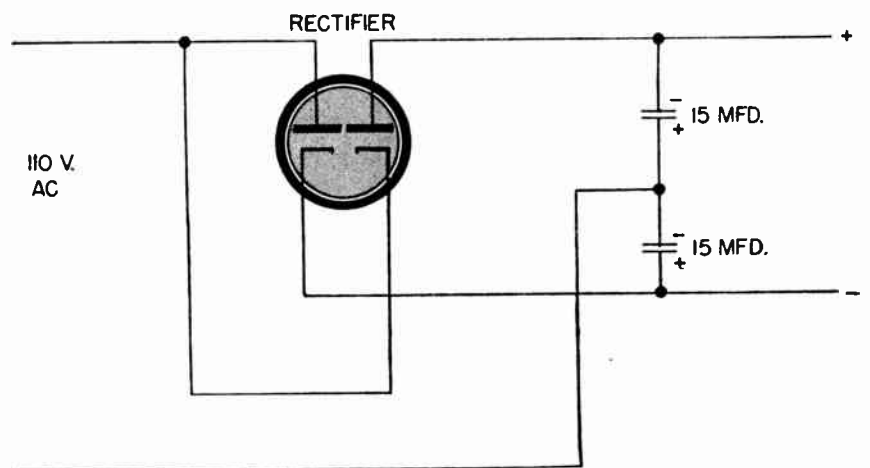

Fig. 5 Typical voltage doubler circuit.

from the power supply.

Hum Bucking Coil

Many present day receivers don't use a hum bucking coil in the

speaker, as there is wide use of P-M (permanent magnet) speakers. Nevertheless there are a great many that have electrodynamic type speakers

→ To Page 16

USING

SWEEP GENERATORS

FOR

FM ALIGNMENT

PART II

By McMurdo Silver

IN PART I of this series we discussed the theory of FM alignment and the characteristics of the signal generators used. Next we logically proceed to the actual operations involved in the alignment procedure.

To align an FM IF amplifier, connect a good, high-resistance VTVM such as "VOMAX," ground to the grounded end of first limiter grid resistor, "Plus" to the joint between this resistor and last IF transformer secondary. Set meter FUNCTION switch to DC—, RANGE to 12 volts. Connect signal generator output terminals, ground to receiver B— (ground in all but AC/DC receivers), "high" terminal to receiver's mixer tube grid. Mute the receiver oscillator by temporarily shortcircuiting the oscillator tuning condenser. If AVC is present, temporarily short main AVC load resistor to ground. Using an unmodulated AM signal from the generator at specified center-frequency for the IF amplifier being aligned, adjust all IF transformer trimmers for maximum output meter reading. Don't touch discriminator trans-

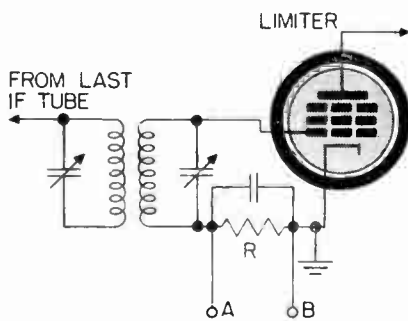

Fig. 1 Schematic of a typical limiter stage. The VTVM is connected to points A and B (across grid resistor R) during alignment.

Part II of a complete description of visual alignment procedure by an authority in the field

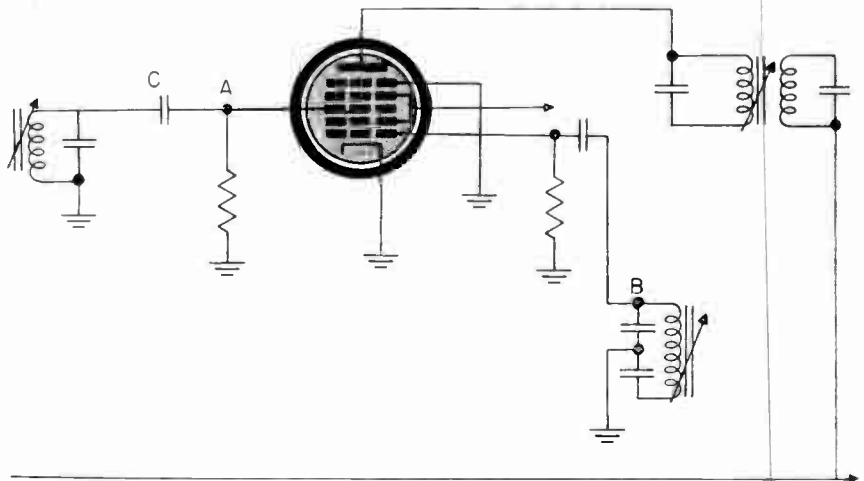

Fig. 2 Diagram of a converter circuit using 6SB7-Y tube. The signal generator is applied between point A and ground as described in the text. In this case condenser C prevents too much shunting through the coil. A short from point B to ground or across the coil disables the oscillator. It is also desirable to short the AVC lead to ground during alignment.

former trimmers. Adjust signal generator output controls as may be necessary to yield about 10 volts reading on VTVM when all IF trimmers are aligned for greatest output. (It may be necessary temporarily to open the receiver's mixer grid circuit so the RF transformer secondary connected between grid and ground will not "short" the generator test signal.)

Restore the receiver oscillator to operation by removing the "short" across its tuning condenser section used for IF alignment, restore the mixer grid circuit to original connections, shift the signal generator output over to receiver antenna binding posts. Adjust RF, mixer and oscillator trimmers in accordance with the manufacturer's test instructions to yield about 10 volts on the VTVM at specified radio frequencies by returning signal generator output as the RF circuits are

aligned. Keep limiter output at about 10 volts.

Receiver sensitivity may now be determined as the unmodulated signal generator output in microvolts required to bring the output meter reading just up to a value which does not appreciably increase with increase in signal generator output. This is the number of microvolts of signal required for full limiting, and should substantially agree with the set manufacturer's specification thereof.

Had the receiver being aligned employed a ratio detector and no limiter, then the VTVM would have been connected across the single ratio detector load resistor if one were used (between ground and the ungrounded ratio detector diode cathode). It would usually be necessary to disconnect temporarily the large-capacity condenser (if of more than a few thousand mmfd.) from across the ratio detector load

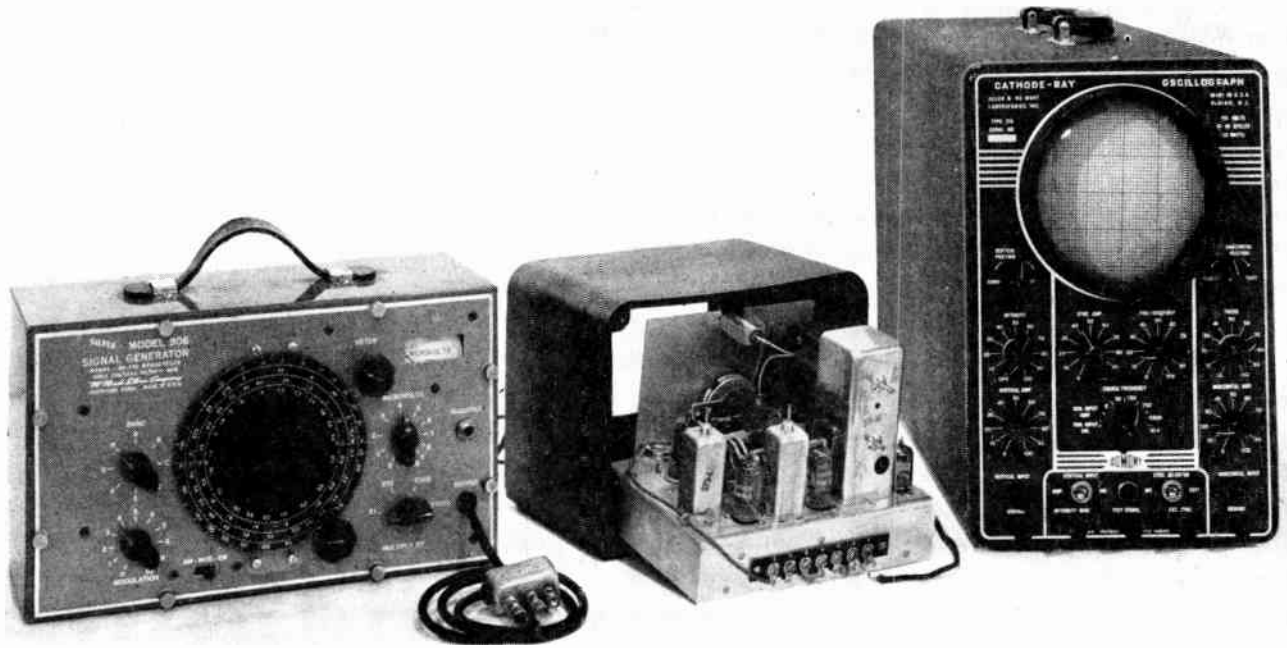

Fig. 4 A typical FM alignment setup. The Silver 906 generator and a Dumont oscilloscope are shown prepared to align a "Pilotuner."

resistor. In RF alignment of the ratio detector, sensitivity of the receiver would be determined by microvolts input required to yield one or two volts of rectified signal voltage on the VTVM shunting the ratio detector load resistor. Alignment would have involved adjustment of the ratio detector primary trimmer as well as of the IF transformer trimmers—but *not* of detector transformer secondary trimmer.

Visual Alignment of IF

If the VTVM now be disconnected from the limiter grid resistor, and the oscilloscope vertical amplifier be connected thereto instead (by a shielded cable), ground to ground, oscilloscope "high" to the joint of the limiter grid resistor and last IF transformer secondary (or scope across ratio detector load resistor, as above), visual alignment may be effected. For IF alignment, reconnect the signal generator between the mixer grid circuit (temporarily opened in receiver, as above) and B—. Set generator to FM output, and set dial to frequency which, beat against the known frequency (40 mc for the Silver 906) of the generator's fixed-frequency oscillator, yields the desired output frequency. Set generator "sweep" or modulation control to yield about 500 kc sweep. Set the oscilloscope frequency controls to one third of the power line frequency, and very

slightly adjust signal generator about the desired output frequency setting until three selectivity curves (as in Fig. 5) appear on the oscilloscope screen. "Stop" the picture on the oscilloscope screen by adjustment of the "fine frequency" control, having first set the 'scope "coarse" frequency control to the range including the power frequency. Readjust signal generator frequency until the length of the two horizontal lines connecting the three "upside-down" selectivity curves of Fig. 5 are of equal length. *Don't change signal generator frequency from this setting until the IF and discriminator (or ratio detector secondary) alignment is completed.*

Now the IF trimmers may be adjusted for maximum depth (amplitude) of the curves and maximum symmetry thereof. It is better, however, to set the oscilloscope frequency control to double power line

frequency, which will yield the picture of Fig. 6. Here two traces only of the selectivity curve are superimposed on each other, one reversed from the other. Adjust signal generator frequency to bring them as closely, one over the other, as possible. Then touch up IF trimmers (and the primary of the ratio detector transformer only, if present) for exact similarity of curve noses. Skirts may separate slightly as they ascend to the base line on the oscilloscope screen, but noses must be identical and symmetrical, side by side. "Pips," or extreme dissymmetry in curve shapes can be caused by misalignment or by regeneration. Short, shielded leads from generator and oscilloscope to receiver will minimize regeneration. If present, it must be "shot" by conventional means.

Detector Visual Alignment

Circuit-wise, the discriminator

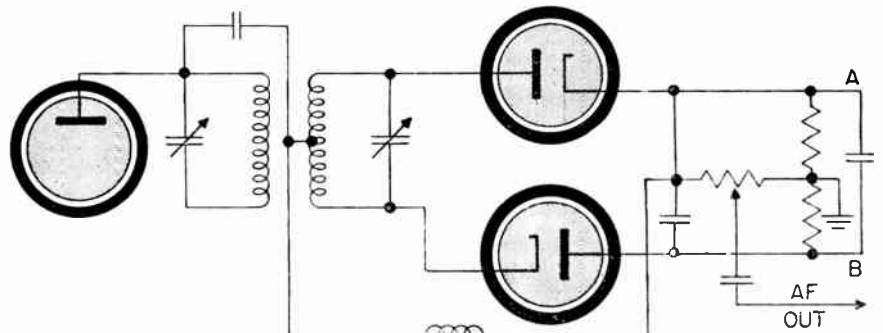

Fig. 3 Schematic diagram of a ratio detector. The VTVM is connected to points A and B.



Fig. 5 Oscilloscope pattern obtained when the ratio of the oscilloscope sweep frequency to the sweep frequency of the generator is 2/3.

and the ratio detector look quite similar. The similarity ends here, however. Both operate to convert changes in frequency caused by transmitter modulation back to amplitude variations in voltage. The discriminator does only this, while the ratio detector also simultaneously erases any amplitude modulation such as noise accompanying the signal. Thus in one dual diode the ratio detector does the job of a pentode limiter tube and a dual diode discriminator.

Alignment of either type of FM detector for proper symmetry is almost impossible in practical servicing except via the visual route.

With signal generator and oscilloscope connected as we left them above while performing the visual IF alignment check and touch-up, the oscilloscope only has its connections shifted from across the limiter grid resistor to across the discriminator load resistors. Without touching the signal generator frequency setting, set the oscillo-



Fig. 6 Left: IF trace obtained by setting the oscilloscope to twice the power line frequency. Right: discriminator curves, 'scope at power frequency.

scope fine frequency control to power line frequency to "stop" the two S-curves of Fig. 6 (right) upon the screen. After looking at what two traces, reversed one from the other, of a discriminator S-curve look like, shift oscilloscope fine frequency control to twice power line frequency to stop the same two curves, but now laid one over the other upon the screen as in Fig. 7. Adjust the discriminator primary trimmer for maximum height and depth of the total of four curve peaks above and below the horizontal base-line. Adjust the discriminator secondary trimmer so that the cross-over of the two diagonal lines at the center of the curve is exactly on line with the horizontal base-line at each side of it. (Adjust secondary trimmer for maximum symmetry of the picture of Fig. 7, in other words.)

To establish correct S-curve and symmetry thereof for a ratio detector involves adjustment of the ratio detector secondary trimmer only—since we adjusted its primary trimmer in IF alignment. Two types of ratio detector circuits are in use. In one type a single diode load resistor is found having one end grounded. In the second type there are two diode load resistors connected in series, with their center-tap grounded. For either receiver connect oscilloscope vertical amplifier from ground to "audio take-off point" (to joint of "low" terminal of ratio detector transformer tertiary winding where it is by-passed to ground). If a VTVM is used with a single resistor circuit, temporarily bridge this load resistor with two equal fixed resistors whose sum is five to ten times



the resistance of the receiver load resistor.

Before doing this, however, and with signal generator set for center-frequency unmodulated output, note upon the VTVM connected across the ratio detector load resistor the exact rectified signal voltage measured there. Adjust signal generator output to make this about 1½ volts. Having done so, connect a 1½ volt dry battery across the ratio detector load resistor (minus to ground or diode plate, plus to ungrounded diode cathode) to stabilize the rectified signal voltage during S-curve adjustment. Now set up signal generator and oscilloscope as instructed for discriminator alignment and simply adjust ratio detector transformer secondary trimmer for a symmetrical, "mirror-image" superimposed S-curve as in Fig. 7.

It has been found with certain ratio detectors that visual IF alignment may be effected with the os-

→ To Page 24

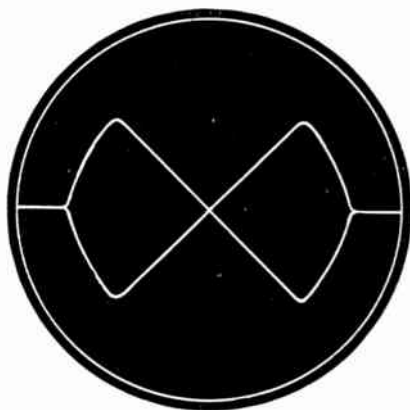

Fig. 7 When the oscilloscope fine frequency control is set for twice the power line frequency the pattern contains two discriminator curves with one laid over the other as shown

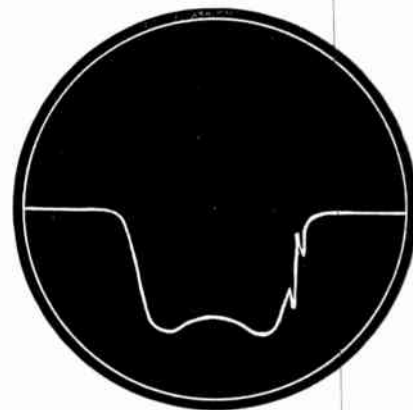
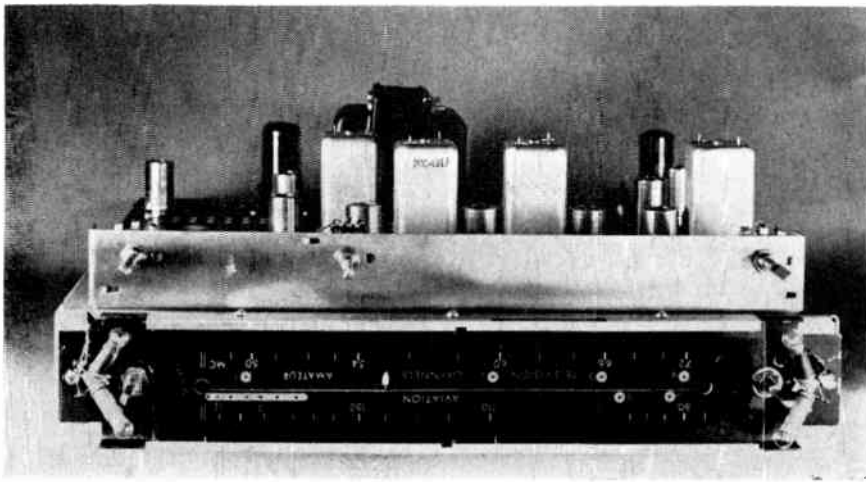
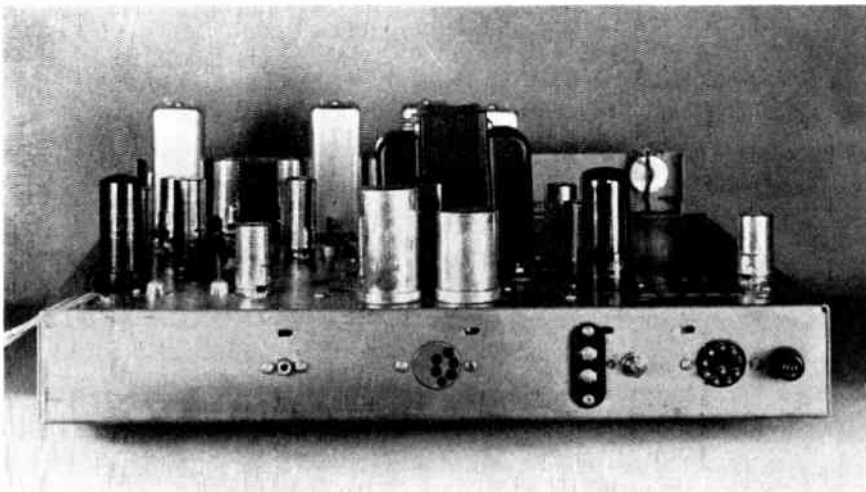

Fig. 8 How a marker shows up as a "pip" on the oscilloscope screen. The marker pip of a frequency 75 kc off the intermediate frequency should not appear further than half way up the side of the curve as shown here.



LOW-COST TELEVISION WITH THE INTERCARRIER SYSTEM

by Morton Scheraga
Allen B. Dumont Labs.



You may be seeing this system in many television receivers soon.

Television receiver manufacturers are constantly striving to make their equipment simpler and less expensive. As more and more people are able to buy television receivers, the importance of television to the serviceman increases. More sets mean more potential repair and maintenance jobs. An interesting development is now proposed which may bring television into many more homes in the future. Although it is not yet being used, it may point a way to greater production of less expensive television receivers. This method is known as the "inter-carrier" system. Fig. 1 compares the conventional and "intercarrier" systems. The conventional system splits the IF into sound and video sections right after the mixer circuit. The IF carriers are then detected and amplified separately.

The bottom diagram of Fig. 10 illustrates the intercarrier system. The actions in this system are as follows:

1. Incoming television signal is heterodyned as usual, producing sound and video IF carriers.
2. Combination of sound and video IF carriers is amplified as a unit in the IF amplifier.
3. Video signal is detected and amplified as usual. It is then fed to the CR tube.
4. The video IF carrier and the sound IF carrier *mix* at the second detector and produce a 4.5 mc beat carrier. This beat carrier has the 25 kc FM deviation of the sound signal.
5. This 4.5 mc FM beat is amplified in the video amplifier. It is

→ To Page 22

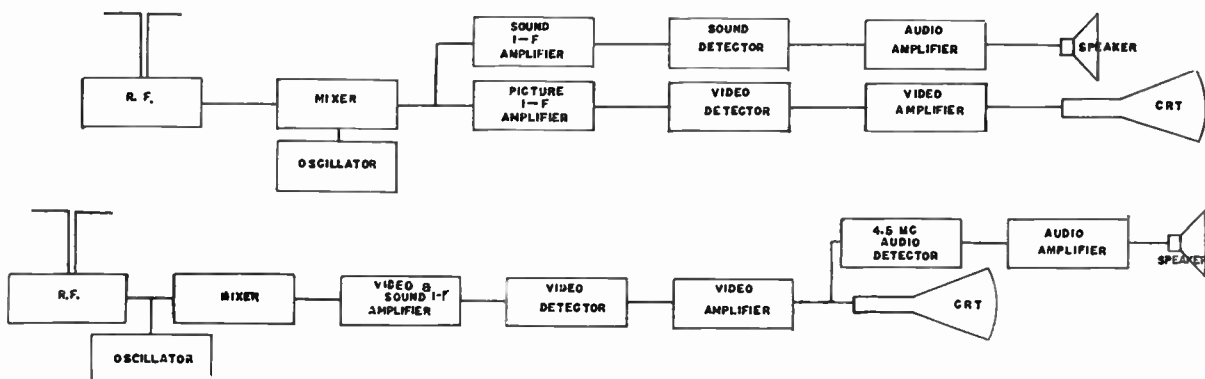

Fig. 1 Block diagrams showing difference between the conventional arrangement and the "intercarrier" system. Above: conventional television receiver. Below: intercarrier receiver.

AN FM SIGNAL SOURCE

by Stanley Curtis

If you have only one FM station in your area and its on only part of the day, this frequency modulation record player will prove helpful for test and demonstration purposes.

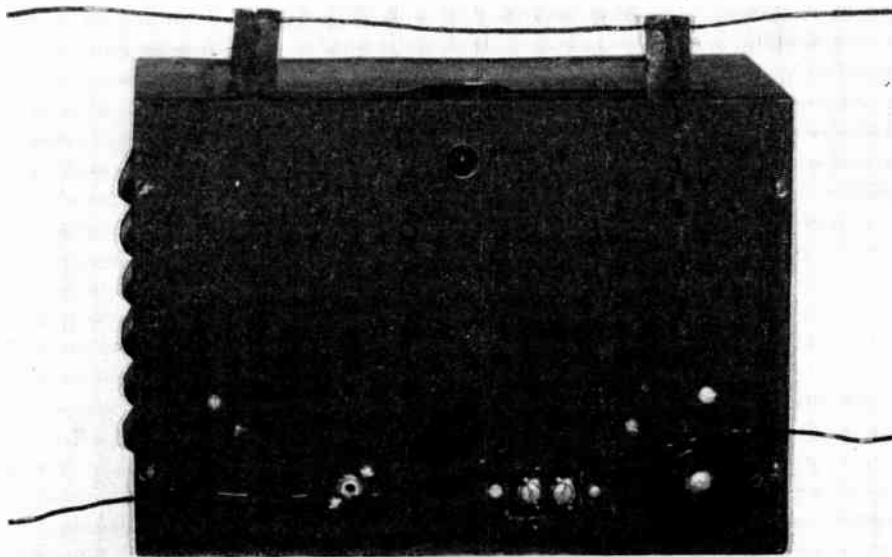

Fig. 1 External view of the frequency modulated record player. Part of the radiating loop is seen connected to the binding posts.

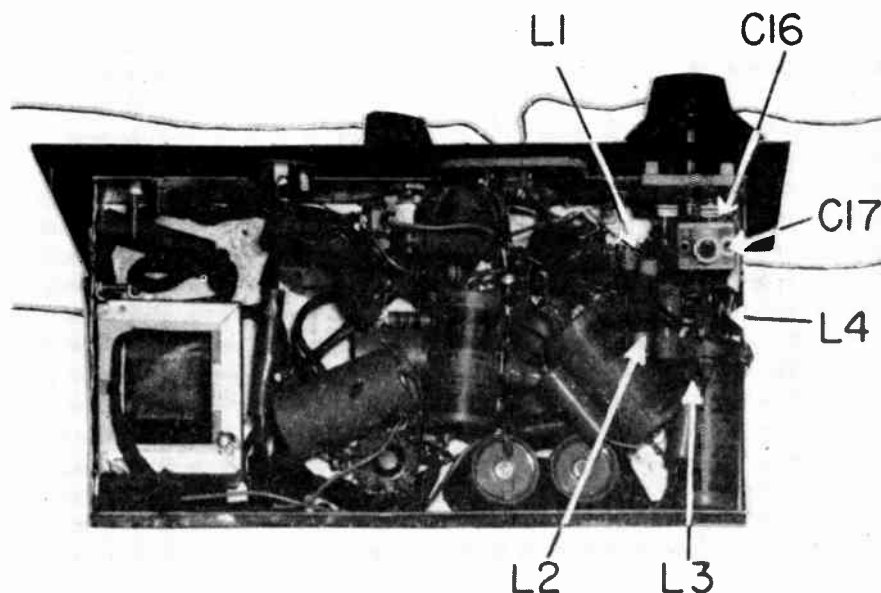

Fig. 2 Bottom view, showing the locations of the components.

WE'VE all had the same annoying experience. An FM receiver to be tested, a customer in the store wanting a demonstration of FM and the FM station not on the air.

Since FM stations have yet in most communities to prove themselves self supporting, they operate for the minimum time allowable to keep their FM licenses. This amounts to six hours a day. In the writer's home city of Utica, this happens to be from 3 P.M. to 9 P.M. daily.

When demonstrating repaired radios on the FM band or servicing FM receivers, the problem of what to do when there are no stations on the air is a serious one. Of course you can always tell the customer to come back later or wait for the hour when the FM station is on the air. It is unsatisfactory, to say the least.

An FM record player which covers the range of 88 to 108 megacycles with a fair deviation gives an adequate signal for test purposes and provides a source of FM signal for demonstrating the FM receivers.

Remember always that for demonstrating radios, the important point to be stressed to the customer is the noise reduction accomplished by the use of frequency modulation. The wide frequency range possible with FM is limited by the range of the crystal pickup used in conjunction with the FM record player and the limited range in which most recordings are made. The quality of signal possessed by the signal generator hereafter described is entirely acceptable and can be picked up by any FM receiver in your shop.

Tubes Used

A 6J5 was decided on as an oscillator because of its stability and self shielding. A 6SA7 is used as

— To Page 14

HOWARD W. SAMS WINS "OSCAR" FOR AID TO RADIO SERVICE INDUSTRY!



The handsome plaque awarded to Howard W. Sams carries the inscription: "The Federation of Radio Servicemen's Associations of Pennsylvania Award to Howard W. Sams in Recognition of His Outstanding Efforts in Behalf of the Radio Service Industry, 1947." The award is a tribute to the practical usefulness of PHOTOFACT Publications—the world's finest radio service data—in- dispensable to the Radio Serviceman.

PHOTOFACT Publications Cited as Outstanding Effort in Behalf of Servicemen

"For Outstanding Efforts in Behalf of the Radio Service Industry"—reads the citation of the first annual award bestowed on Howard W. Sams by the Federation of Radio Servicemen's Associations of Pennsylvania. The "Oscar" was presented before a group of over 600 persons, including many radio industry leaders, at a banquet held on January 12, 1948, at Philadelphia's Bellevue-Stratford Hotel. The surprise ceremony was arranged as a demonstration of appreciation for the significant, practical aid made available to Radio Servicemen in PHOTOFACT Publications, and for the efforts of the SAMS' organization in behalf of the Radio Service Industry. This spontaneous demonstration marks a milestone in the Radio Service field. It is a healthy sign of growing recognition of the Serviceman's importance to the Radio Industry.



These Are the Award-Winning Service Aids that Earn More Money for You!

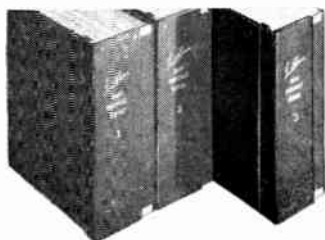

Own PHOTOFACT Volumes 1, 2 and 3—world's most complete, accurate, practical radio service data manuals. Here is everything you need for faster, easier, more profitable servicing—bound in easy-to-use volumes. Exclusive Standard Notation Schematics: photo views keyed to complete replacement parts lists; exhaustive electrical and mechanical analysis of every set covered. Brings you right up to January 1948! Have the exclusive advantages that are now earning bigger profits for thousands of servicemen!

Vol. 1. All post-war models up to Jan. 1, 1947.
Vol. 2. Models from Jan. 1, 1947 to July 1, 1947.
Vol. 3. Models from July 1, 1947 to Jan. 1, 1948.

YOUR PRICE, EACH VOLUME, IN EASY-TO-USE DELUXE BINDER . . . **\$18.39**



Radio Receiver Tube Placement Guide

Shows you exactly where to replace each tube in 5500 radio models, covering 1938 to 1947 receivers. Each tube layout is illustrated by a clear, accurate diagram. Saves time—eliminates risky hit-and-miss methods. You'll use this handy

pocket-sized book every single day. 192 pages, completely indexed. Order several copies now. **ONLY \$1.25**



Dial Cord Stringing Guide

The book that shows you the *one right way* to string a dial cord. Here, for the first time, in one handy pocket-sized book, are all available dial cord diagrams covering over 2300 receivers, 1938 through 1946. Makes dial cord restringing jobs quick and simple. A "must" for every service bench and tool kit.

Order your copies now. **ONLY .75c**

1947 Automatic Record Changer Manual

Nothing like it! Complete, accurate data on over 40 post-war models. Exclusive exploded views, photos from all angles. Gives full change cycle data, information on adjustments, service hints and kinks, complete parts lists. PLUS—for the first time—complete data on leading WIRE, RIBBON, TAPE and PAPER DISC RECORDERS! 400 pages; hard cover; opens flat. Order now! **ONLY \$4.95**



BOOST YOUR EARNING POWER!

Mail This Order Form

to HOWARD W. SAMS & CO., INC.
2924 E. Washington St., Indianapolis 6, Indiana.

My (check) (money order) for \$.....enclosed.

- Send.....SAMS' TUBE PLACEMENT GUIDE(S) at \$1.25 per copy.
- Send PHOTOFACT Volume 3 (including Sets Nos. 21 through 30) in DeLuxe Binder, \$18.39.
- Send Volume 2. Send Volume 1 (\$18.39 each).
- Send.....SAMS' 1947 AUTOMATIC RECORD CHANGER MANUAL(S) at \$4.95 each.
- Send.....SAMS' DIAL CORD STRINGING GUIDE(S) at \$0.75 per copy.

Name.....

Address.....

City.....State.....

HOWARD W. SAMS & CO., INC.
INDIANAPOLIS 6, INDIANA

Export—Ad. Auriema—89 Broad St., New York 4, N. Y.—U. S. of America
Canada—A. C. Simmonds & Sons, 301 King St., East—Toronto, Ontario

PHOTOFACT SERVICE

"The Service that pays for itself over and over again"

a reactance modulator. A 6J5 is used as a straight audio amplifier to boost the output of the crystal and drive the reactance modulator. A 5Z4 is used as the rectifier. A Bud 903 metal cabinet is used to house the signal source. An AC-DC chassis provided our sub-panel. The overall dimensions then turned out to be 7 × 10 × 6 inches. Fig. 1 shows an external view.

Coils

The oscillator tank coil consists of 4 turns of No. 18 enamel wire wound with a ½ inch diameter spaced as to be ⅜ inches long. This is tapped approximately 1 turn from the bottom of the coil, or the side opposite from the antenna coil. The coil is self-supporting. It is indicated on the schematic of Fig. 3 as L4.

L5 is the antenna coil which con-

sists of 2 turns of No. 18 enamel wire ½ inch diameter closely coupled to L4. This coil is also self-supporting.

L6 is the radiator, quarter wave, 58 inch loop, self-supporting of No. 14 enamel wire.

The three radio frequency chokes, L1, L2, and L3 are wound on ¼ inch dowels. They are respectively 22, 23 and 25 turns to avoid possible resonance or parasitic oscillation.

Other Components

C16 is a 15mmfd variable. This is your main oscillator tuning condenser. C17 is a 3-30mmfd trimmer condenser. This is set only once to give the desired frequency range of 88-108mc.

The main thing to be careful of when assembling the unit is to be sure that all the filament wires are twist-

ed to minimize hum and that all components to be grounded are grounded at the associated tube sockets. The under-chassis arrangement of parts is shown in Fig. 2.

The power supply presents no deviation from the conventional type. Adequate filtering is used in each plate and screen circuit. Don't try to eliminate any of the by-pass condensers. At the frequencies used, they are all vital.

A jeweled pilot light is incorporated to keep us from forgetting to turn the generator off. It is easy to forget when you're not testing an FM receiver.

In this unit we incorporated the switch on the deviation control for convenience. Turn on an FM receiver and slowly tune the band to determine where you hear the carrier "pop." If there is a "tuning

→ Turn to Page 28

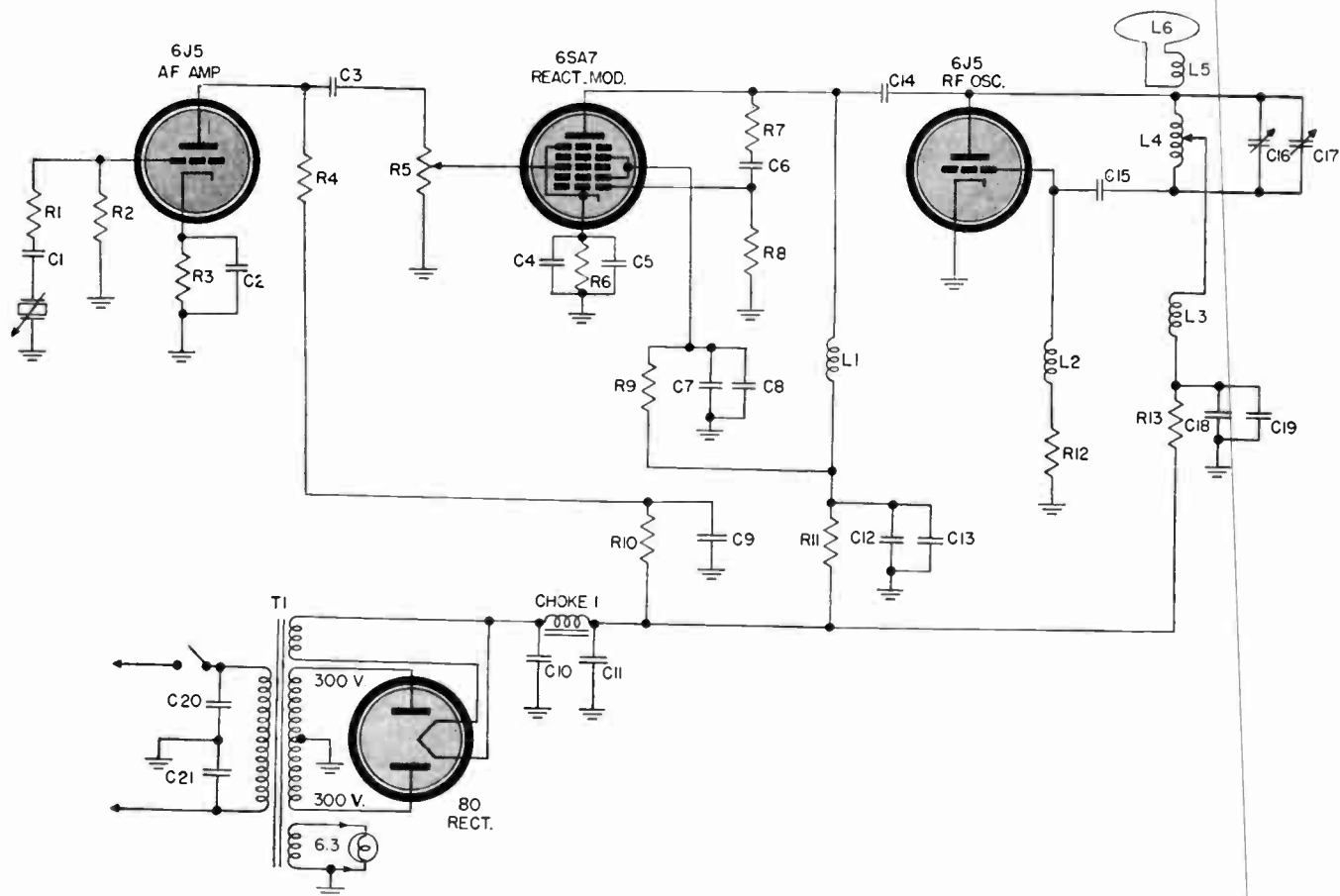

Fig. 3 Schematic diagram of the unit.

- C1, C3, C20, C21—.05 mfd tubular 600 V. condenser.
- C2, C4—20 mfd 25 V. electrolytic condenser.
- C5, C13—.005 mfd tubular 600 V.
- C6—.0002 mfd mica 600 V. condenser.
- C7, C9, C10, C11, C12—12 mfd 450 V. electrolytic.
- C8—.005 mfd tubular 600 V. condenser.
- C14—.00025 mfd. mica 6000 V.
- C15—.00005 mfd mica or ceramic condenser.
- C16—15 mmfd variable.
- C17—3-30 mmfd trimmer.
- C18—8 mfd 450 V. electrolytic condenser.
- C19—.01 mfd tubular 600 V. condenser.

- L1—RFC 22 turns No. 22 en. ¼ inch dowel.
- L2—RFC 23 turns No. 22 en. ¼ inch dowel.
- L3—RFC 25 turns No. 22 en. ¼ inch dowel.
- L4—Tank Coil. 4 turns No. 18 enamel, ½ inch spaced to ⅜ inch tapped approximately 1 turn from bottom of coil, opposite side from antenna coil.
- L5—Antenna coil, 2 turns No. 18 en. ½ inch closely coupled to L4.
- L6—Radiator ½ wave. 58 inch loop, self-supporting No. 14 enamel.
- R1, R2—500,000 ohm ½ W.
- R3—3000 ohm 1 W.

- R4—100,000 ohm 1 W.
- R5—500,000 ohm Potentiometer
- R6—1000 ohm 1 W
- R7, R10—50,000 ohm ½ W.
- R8—250,000 ohm ½ WW.
- R9, R12—5000 ohm 5 W.
- R11—20,000 ohm 5 W.
- o aR13—10,000 ohm 5 Wt.
- V1—6J5 audio amplifier.
- V2—6SA7 reactance modulator.
- V3—6J5 oscillator.
- T1—300-300 V. 50 MA 6.3V Trans.
- Ch1—10 H. 30 MA choke.



The New **PRECISION "612"** is your answer

to **Economical, Positive, Tube and Battery Testing**



- ★ Positive Free-Point Tube Testing
- PLUS ★ Highest Practical Obsolescence Insurance
- PLUS ★ Utmost Simplicity of Operation
- PLUS ★ "Precision" Quality and Workmanship
- PLUS ★ Moderate Cost . . . Impressive Design

The new Series 612 is a modern, **free-point, lever-operated Cathode Conductance Tube Tester** representing the culmination of extended and intensive development in the field of modern tube checking requirements. It answers the ever-present need for **positive tube testing results at moderate cost**, with full conformity to "Precision's" high standards of workmanship, performance and quality components.

The new "600" line affords tube testing parameters based upon the time-proven emission testing principles as recommended by both tube manufacturers and R.M.A.; plus innumerable circuit features which render it incomparable amongst instruments in its category.

612-C (illustrated). In modern chrome-trimmed, Counter type cabinet. Dull black ripple finish on heavy gauge steel. 16 x 13 1/2 x 7", sloping to 3" at front.
Complete: - \$63.95

612-P-In hardwood, Portable case with tool compartment. Size 12 x 13 x 6" Complete: - \$61.95

612-MCP-Open style Metal Case Portable, fine dull black ripple finish on heavy gauge steel. Size 10 1/2 x 12 x 6" Complete: - \$59.95

612-PM-In standard size Panel Mount 12 1/4 x 19" with dust cover. For rack cabinet or wall mounting. Complete: - \$61.95

TUBE AND BATTERY TESTING FEATURES

- ★ Tests all modern tube types including 7 pin Acorns, button 7 and Noval 9 pin types, dual-capped H.F. tubes, FM and TV amplifiers, etc.
- ★ Filament voltages from 3/4 to 117 volts.
- ★ Absolute Free-Point 10 element lever selection for both short and merit tests.
- ★ 4 1/2" wide vision meter. 2% Accuracy.
- ★ Dual HI-LO short-check sensitivity.
- ★ Individual Tests of Multi-Section Tubes including tuning indicators, gas rectifiers, oscillator-converters, etc.
- ★ Ballast Unit Tests.
- ★ Micro-Line adjustment -- continuously variable.
- ★ Pilot and signal light tests.
- ★ Noise and Condenser test pin jacks.
- ★ Dynamic "under-load" test for all popular radio A, B, and C dry batteries.
- ★ Built-in, brass geared roll chart.
- ★ Anodized, deep-etched, heavy gauge aluminum panel.
- ★ Panel-mounted Fuse extractor Post.
- ★ Telephone type cabled wiring using plastic-insulated moisture resistant hook-up wire.

SERIES 620 TUBE, BATTERY AND SET TESTER
RANGES TO 3000 VOLTS, 12 AMPERES, + 64DB, 10 MEGOHMS

A COMPLETE, PORTABLE, SERVICE LABORATORY providing every essential feature for general purpose test and check of modern radio and electronic equipment.

Incorporates the identical tube test circuit and battery testing features of the Series 612. (described above) PLUS a complete A.C.-D.C. Multi-Range Circuit Tester of 1000 ohms per volt sensitivity.

The Series 620 is available in the same four model types as described for the series 612 (above)

620-C - Counter Cabinet..... Net Price \$84.30
 620-P - Portable Case..... Net Price \$82.30
 620-MCP - Metal Case Port. Net Price \$80.30
 620-PM - Panel Mount..... Net Price \$82.30

CIRCUIT TESTING FEATURES

- ★ 5 A.C.-D.C.-Output Voltage Ranges: to 3000 volts.
- ★ 5 D.C. Current Ranges: to 12 Amperes
- ★ 3 Resistance Ranges: self-contained: to 10 Megohms.
- ★ 5 Decibel Ranges from -12 to +64 DB.
- ★ Full rotary Range and Function Selection.
- ★ 2 pin jacks serve all standard ranges.
- ★ 1% Wire-wound and Metallized Resistors.
- ★ 400 microampere 4 1/4" Meter. 2% accuracy.
- ★ All Circuits Insulated from power line.

SEE these new "Precision" Test Instruments now on display at all leading radio parts and equipment distributors, or write directly for the Precision 1948 catalog describing the full Precision line of quality Electronic Test Instruments.

PRECISION
TEST EQUIPMENT

Standard of Accuracy

PRECISION

APPARATUS COMPANY INC.

92-27 HORACE HARDING BOULEVARD
ELMHURST 5, NEW YORK

Export Division: 458 BROADWAY, NEW YORK CITY, U. S. A. • Cables: MORHANEX

American Beauty

ELECTRIC SOLDERING IRONS

are sturdily built for the hard usage of industrial service. Have plug type tips and are constructed on the unit system with each vital part, such as heating element, easily removable and replaceable. In 5 sizes, from 50 watts to 550 watts.

TEMPERATURE REGULATING STAND

This is a thermostatically controlled device for the regulation of the temperature of an electric soldering iron. When placed on and connected to this stand, iron may be maintained at working temperature or through adjustment on bottom of stand at low or warm temperatures.

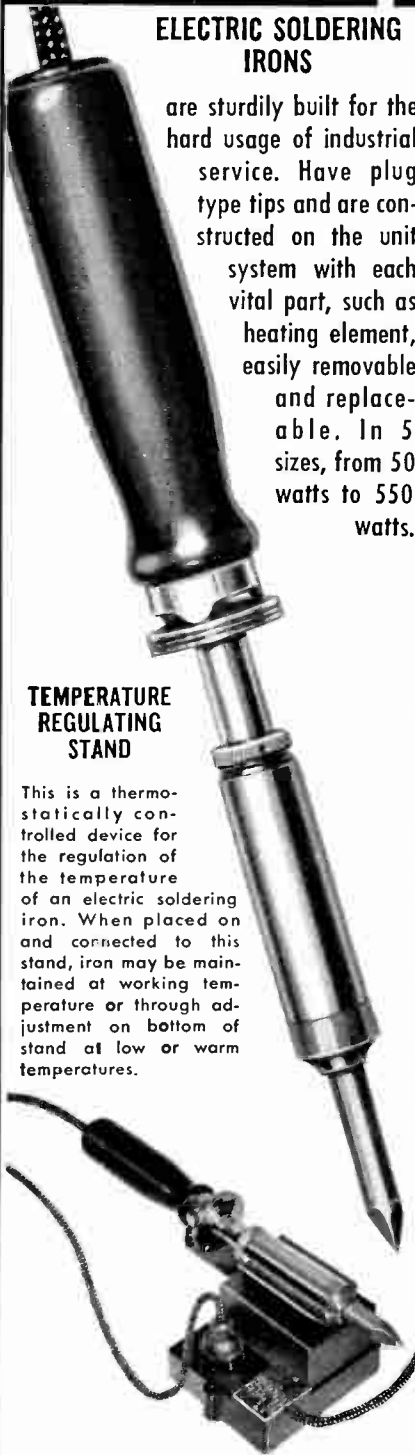

For descriptive literature write

110-1

AMERICAN ELECTRICAL HEATER COMPANY
DETROIT 2, MICH., U. S. A.

How to Eliminate Hum

→ From Page 7

with hum bucking. The bucking coil is wound next to one end of the field coil and connected in series with the voice coil circuit. A typical arrangement is shown in Fig. 6. The bucking coil introduces a counter hum voltage into the voice coil circuit which is out of phase with the hum voltage being introduced via the output transformer. Occasionally the hum bucking coil connections are reversed. In such a case the hum will be aided, rather than attenuated. It is not necessary to disconnect these leads to test for this condition. Just temporarily short circuit the bucking coil (this can usually be accomplished with a screw driver) and listen to the hum. If the connections are reversed, short-

ing will reduce the hum. On the other hand, if the coil is wired correctly, the hum will become louder when the coil connections are shorted.

Tunable Hum

In some cases an annoying hum appears when a receiver is tuned to a station carrier, then disappears when the dial is turned away from the carrier. Tunable hum may happen with either an AC-DC or a straight AC receiver. It is usually eliminated by connecting a condenser having a capacitance of from .01 to .05 mfd. across the A-C line entering the receiver power supply. It is advisable to connect one end of the condenser to the set side of the on-off switch so that the line voltage will not be applied to the condenser when the set is not in operation. A more reliable method is to use two condensers connected in series with

→ To Page 18

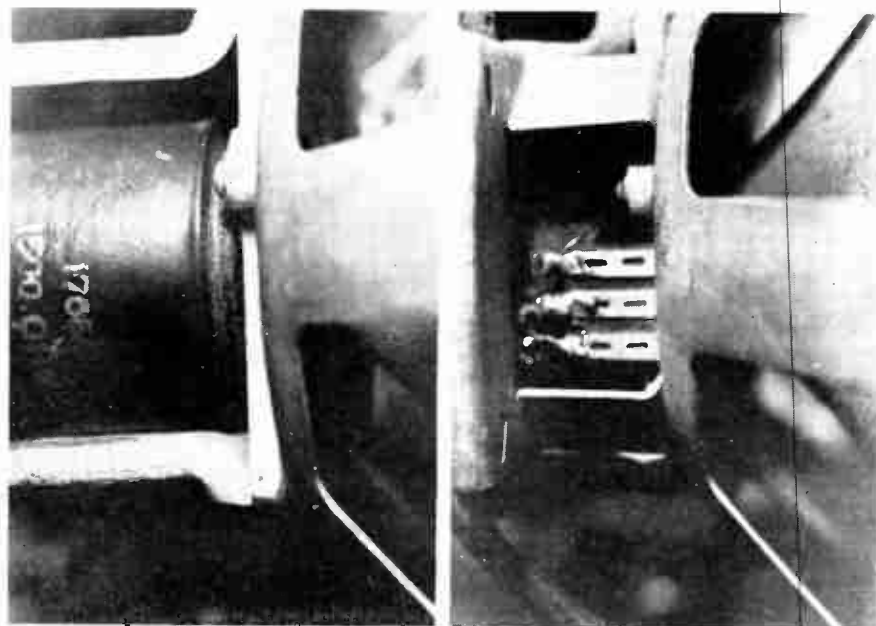

Fig. 6—Left, hum bucking coil winding on the field coil of a speaker. Right, terminals provided on the same speaker for voice coil and hum bucking coil connections. The wire on the top terminal comes from the hum bucking coil.

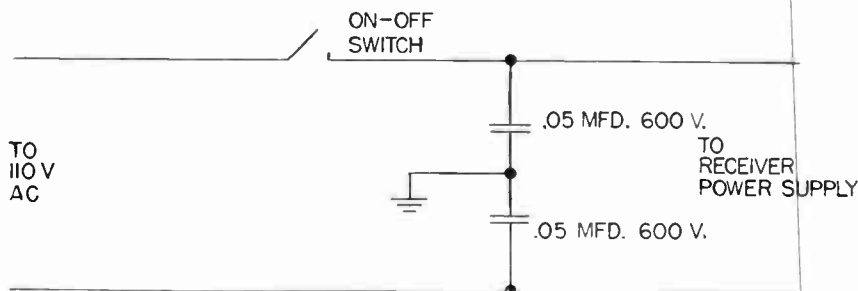

Fig. 7 How condensers may be connected across the line to reduce tunable hum.

Uniform Resistance

Mallory carbon controls are accurate in overall resistance value



You will find no variation in the resistance values of Mallory carbon controls. Frequent, critical inspections reject the imperfect, and pass only those carbon elements of the resistance values specified on the labels.

Recently dozens of controls from leading manufacturers were tested competitively for overall resistance value. Mallory controls averaged within 2% of specified resistance, the closest tolerance of any group in the test.



Every carbon element that goes into Mallory controls is individually inspected to be sure that its resistance value is the same as specified on the labels.

In volume controls you look for uniform

resistance, accurate tapers, silent operation and long life. Mallory gives you all four, and more, too. The Mallory trade mark is your assurance that the volume control, vibrator or capacitor you buy is the finest that can be made.

The Mallory 1485 Control Deal

This attractive metal cabinet contains the 15 Controls and 9 Switches that will take care of 90% of your service calls. Its arrangement makes inventory control almost automatic — saves you frequent trips to the distributor's counter. It contains a rack for your Radio Service Encyclopedia. You pay only for the Volume Controls and Switches; the cabinet is included in the deal at no extra cost to you. Check your Mallory distributor on this special offer.



Visit us at
Booths 84, 85, 86
I. R. E. Show
Grand Central
Palace
New York
March 22-25

P. R. MALLORY & CO. Inc.
MALLORY

CAPACITORS . . . CONTROLS . . . VIBRATORS . . .
SWITCHES . . . RESISTORS . . . RECTIFIERS . . .
VIBRAPACK® POWER SUPPLIES . . . FILTERS

*Reg. U. S. Pat. Off.

APPROVED PRECISION PRODUCTS

P. R. MALLORY & CO., Inc., INDIANAPOLIS 6, INDIANA

ESPEY

The Custom Built Chassis



**Notice those
lines!
That compact—
well-proportioned
—design!
Really a beaut!**

Yessir! In producing the **ESPEY** line of custom-built chassis we have kept in mind the physical dimensions necessary for chassis units which could be easily adapted to custom-built work, or as replacements for existing inferior units. Carefully engineered and manufactured to give absolute satisfaction in any type of installation. The **Model 7-B** can serve as an ideal replacement for AM sets housed in highly thought-of cabinets.

The **ESPEY Model 7-B** is an AM/FM superheterodyne receiver with 10 tubes plus a rectifier tube, operating on 105/125 volts AC, 50/60 cycle. Wired for phono operation, this superbly engineered receiver is supplied, ready to operate, with 10" speaker with Alnico #5 magnet, antennas, and all necessary hardware.

For further details about this—and the rest of the **ESPEY** line—write to Department F today.

ESPEY MANUFACTURING COMPANY, INC.
528 EAST 72ND STREET—NEW YORK 21, N.Y.

→ From Page 16

each other, with the center connections grounded to the receiver chassis and the two outside ends connected across the line. See Fig. 7. Tunable hum can also be caused by a defective tube or a defective filter condenser.

Mutual Inductance

Once in a while a receiver using an interstage audio transformer will have hum due to stray mutual inductance between the audio transformer and the power transformer, with the chassis acting as a common core. A simple remedy is to remount the audio transformer, using brass screws and brass, or aluminum, bushings. (See Fig. 8) Where the two transformers are located extremely close together, it becomes necessary to reposition the audio transformer so as to change the relative angle between its core and that of the power transformer, or possibly to relocate it entirely. In a few cases it is found that an audio transformer is located extremely close to the speaker field coil, resulting in hum due to the mutual inductance of the two. In such a case it is better to relocate the transformer, if possible.

Miscellaneous Remedies

The filament leads should be inspected and dressed away from other leads; especially the grid leads of the audio stages. Very often a bad case of hum can be corrected in this way. Hum may also be caused by a shorted cathode by-pass condenser. In such a case, there is usually considerable distortion present, but this is not always readily detected. If there is any doubt about the condition of this condenser, one end should be disconnected so that it can be more accurately tested. A stubborn hum may sometimes be remedied by grounding the cathode condenser, the cathode resistor, and the grid resistor of each audio stage to a common point on the chassis. In many cases a leaky audio coupling condenser will be found to be the cause of excessive hum. In these cases the hum will be accompanied by distortion and loss of volume; but not always obvious enough to be readily detected by a serviceman not acquainted with the particular model in which the trouble occurs. Since

→ Turn to Page 22

Permoflux SPEAKERS

YOUR JOBBER CAN SUPPLY YOU!

Permoflux quality and dependability—the same as supplied to the major set manufacturers—is your assurance of complete customer satisfaction. You'll find Permoflux Speakers easy to install and readily available in both PM and Electrodynamic types. You'll find too, that it pays to give your customers "tops in tone" with a Permoflux Replacement Speaker.

TWO COMPLETE
FACORIES TO SERVE YOU

PERMO-FLUX

WRITE FOR
FREE BULLETIN

PIONEER MANUFACTURERS OF PERMANENT MAGNET DYNAMIC TRANSDUCERS

PERMOFLUX CORPORATION

4900 WEST GRAND AVE., CHICAGO 39, ILLINOIS
236 SOUTH VERDUGO ROAD, GLENDALE 5, CALIFORNIA

SIMPSON ELECTRICAL LABORATORY MODEL 1005

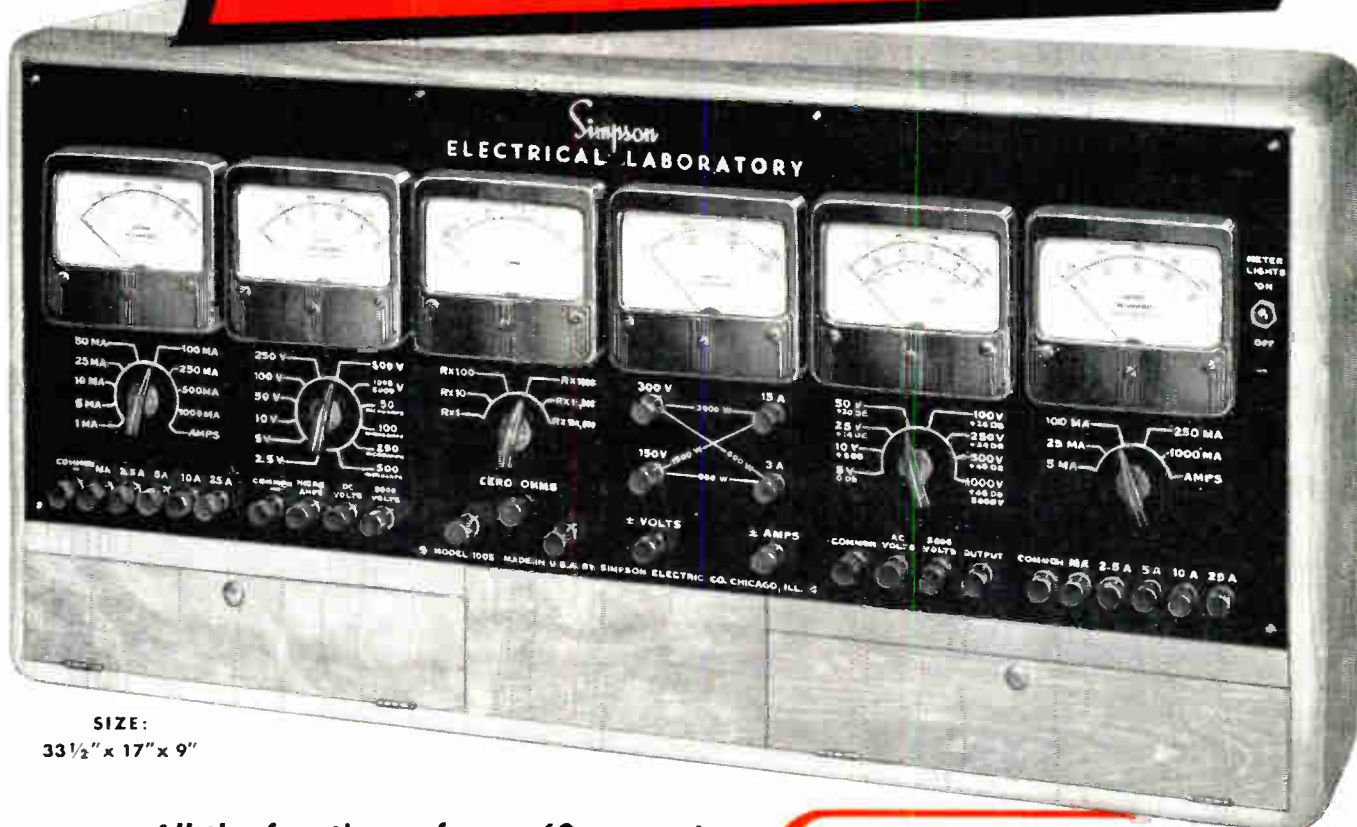

SIZE:
33½" x 17" x 9"

All the functions of over 60 separate instruments combined in one unit!

Here is a complete test unit for use by radio, electronic, and electrical technicians in laboratories, shops, or service departments. It is adaptable to the testing of all electrical appliances, small motors, circuits, radio sets, etc. It consists of six individual 4½" rectangular instruments, indirectly illuminated, each with a complete set of ranges.

In addition to the wide variety of A.C. and D.C. voltage and current ranges, a multi-range ohmmeter and a single phase wattmeter have been incorporated. Also, to meet the need for extreme sensitivity required in testing circuits where only a small amount of current is available, an instrument is provided with a sensitivity of 50 microamperes, providing 20,000 ohms per volt on all D.C. voltage ranges. The Electrical Laboratory incorporates a rectifier type instrument for measuring A.C. voltage with a resistance of 1,000 ohms per volt on all ranges. This latter instrument also has in combination a complete coverage of DB ranges, from minus 10 to plus 54 for volume indications.

This beautiful instrument is Simpson-engineered and Simpson-built throughout for lifetime service.

Dealer's Net Price, complete with Leads and Break-in Plug, \$218.00

SIMPSON ELECTRIC COMPANY

5200-5218 West Kinzie Street, Chicago 44, Illinois
In Canada, Bach-Simpson Ltd., London, Ont.

Simpson

Ask your jobber

RANGES OF MODEL 1005

Meter No. 1 (D.C. Milliammeter and Ammeter)

0-1 MA. D.C.
0-5 MA. D.C.
0-10 MA. D.C.
0-25 MA. D.C.
0-50 MA. D.C.
0-100 MA. D.C.
0-250 MA. D.C.
0-500 MA. D.C.
0-1000 MA. D.C.
0-2.5 Amps. D.C.
0-5 Amps. D.C.
0-10 Amps. D.C.
0-25 Amps. D.C.

Meter No. 2 (D.C. Microammeter and Voltmeter)

0-2.5 Volts D.C.
0-5 Volts D.C.
0-10 Volts D.C.
0-50 Volts D.C.
0-100 Volts D.C.
0-250 Volts D.C.
0-500 Volts D.C.
0-1000 Volts D.C.
0-5000 Volts D.C.
20,000 ohms per volt
0-50 Microamps
0-100 Microamps
0-250 Microamps
0-500 Microamps

Meter No. 3 (Ohmmeter)

0-500 Ohms (5 ohms center)
0-5000 Ohms (50 ohms center)
0-50,000 Ohms (500 ohms center)
0-500,000 Ohms (5,000 ohms center)
0-5 Megohms (50,000 ohms center)
0-50 Megohms (500,000 ohms center)

Meter No. 4 (Wattmeter)

0-300 Watts A.C.
0-600 Watts A.C.
0-1500 Watts A.C.
0-3000 Watts A.C.

Meter No. 5 (A.C. Voltmeter, Output and DB meter)

0-5 Volts A.C.
0-10 Volts A.C.
0-25 Volts A.C.
0-50 Volts A.C.
0-100 Volts A.C.
0-250 Volts A.C.
0-500 Volts A.C.
0-1000 Volts A.C.
0-5000 Volts A.C.
Rectifier type
1000 Ohms per volt
DB Ranges
-10 to +54
Output Ranges
same as volts
except 5000
Volt Range

Meter No. 6 (A.C. Milliammeter and Ammeter)

0-5 MA. A.C.
0-25 MA. A.C.
0-100 MA. A.C.
0-250 MA. A.C.
0-1000 MA. A.C.
0-2.5 Amps. A.C.
0-5 Amps. A.C.
0-10 Amps. A.C.
0-25 Amps. A.C.



'nuff said . . . we're all nuts, but that shouldn't bother you. Everything begins new and fresh in '48. You'll find terrific buys below . . . and at these prices bring you're own truck. We're cleaning the slate for '48.

SUPER OUTPUT TRANSFORMERS. We're nuts, but they are for 5GL6, 25L6 . . . you can't use them, even though they're for standard 4, 5, and 6 inch speakers. Don't even look at 'em for 79c ea. How about 54c ea. . . . oh well! 10 for \$4.90 or we throw 'em away.

NOW HEAR THIS . . . the newest, the latest super-duper, Superhet Radio with Five Jumps, Jiving tubes, AC, DC. Terrific cabinet can be used for a foot rest . . . a gift at \$16.95 Ea. A triple gift at 3 for \$47.50.

CAN CONDENSERS THE SCREW TYPE WAY . . . if you can use some more junk, these are 35x35x35 mfd. at 150V. . . . sweeping them out the door for 89c ea. . . . or 10 for \$7.90.

WE'RE PRACTICALLY GIVING AWAY these Resistor Kits. Unlucky purchase by some dumb schmoe means 100 asst. Resistors 1/4, 1/2 and 1 watt at 10% Resistors for next to nothing. Super deal at \$1.49 per kit.

THAT BOSS OF OURS expects us to sell these brand new Volume Controls with Switch Half Meg 2 1/2 inch shafts . . . now you know we can't expect you to buy them at 49c ea. . . . or 10 for \$4.40.

MORT BOUGHT 'EM AND WE'RE STUCK . . . sneaked these Standard 5" PM Speakers . . . Alnico V. Magnet, out the back way . . . take 'em out under your coat for \$1.45 Ea.

WE'RE SURE NOT PROUD OF THESE Metal Speaker Cabinets . . . don't know what you can do with 'em, but they will house a 6" Speaker and small Amplifier. Not worth \$3.75 Ea. . . . but you can't go wrong at \$1.25 Ea.

NOT JESS WILLARD THE FIGHTER . . . but Willard 2-volt Storage Battery . . . a fighter nevertheless. Comes in a snazzy plastic case. Shipped dry . . . spill proof. 5 1/2" high. 3 1/2" x 2 7/8" . . . was \$6.00. The Winnah at \$1.95.

SHOCKING! Bare necked Copper Stranded Antenna Wire in 50 or 100' rolls . . . 50' for 28c . . . 100' for 34c.

WATCH YOUR WIFE? BABIES? GIRL-FRIEND . . . put "Ultra Mike" on guard. No wires, connects to blab box with a terrific steal with batteries, tubes, and what have you. Super special . . . \$6.63 ea. Retail \$18.00. F.O.B. Chicago.

THE BOSS SURE GOT TAKEN when he bought these Three Tube Amplifiers at \$15.50. . . . they're 110 volt, AC, 6U Cy . . . complete, less tubes. We're giving 'em away at \$10.95.

WEBSTER MODEL 79 WIRE RECORDER foundation unit. Formerly retailed at \$90. This is the first time that this quality product has ever been offered to the trade at less than \$52.92 . . . new low price of \$44.10.

NO ONE WANTS 'EM at 32c each, so we're condensing a bunch of 20 mfd. 150V Condensers into 10 for \$1.49.

HOLD ON TO YOUR UPPERS . . . we lost our eye-teeth when we bought these Antennas at \$2.75 . . . but because they're brass with chrome plating . . . in 3 sections, and rust-proof, with side cowl mounting, you can take advantage of our stupidity for \$1.75 ea.

CHECK YOUR INLAYS AND RELAYS . . . we're crazy and you will be too if you buy 10 of these assorted relays for \$25 when Mort's giving them away at \$2.49.

Write for our new, **FREE 1948 Catalog.** Terms: 25% Deposit with order . . . Balance C.O.D.

MORT'S RADIO SHACK
630 W. Randolph St. Chicago, Ill.



OVER THE BENCH

by John T. Frye

PROBABLY all of you fellows have heard a recording of your voice, either on wax or wire. How did it sound to you? Unless yours is indeed an unusual case, the voice seemed like nothing you ever heard before; and, in spite of the insistence of your friends that "it sounds exactly like you," you could not bring yourself to admit that there was any resemblance between your own voice and that odd-sounding recording.

Since you do not recognize your own voice when you hear it, did you ever stop to wonder what kind of an impression your customers get of you when they call on the telephone? Undoubtedly a large percentage of your customer-relations are carried on by means of Mr. Bell's handy little invention. Many of your first contacts with your customers are established over the telephone. The first impression they get of you, your ability, and your business are based upon how you sound over the wire, and these first impressions are important—and lasting.

It is easy to overlook or to minimize the importance of this fact. There is something about talking over the telephone that gives a deceptive sense of anonymity, of not having to display the same courtesy and patience you would use as a matter of course in dealing with people face to face.

This is definitely a mistake. If anything, you should make an effort to be even more courteous and more patient over the telephone than you are in the presence of the customer. Then he can see you; a smile or a gesture can give an altogether different meaning to a spoken word; but when you talk to him over the telephone, he has nothing to go on except what you say and how you say it. I do not mean to imply that you are to take voice-culture lessons or attempt to be the "Voice

of Charm." I simply mean that your telephone-technique should receive the same careful consideration that you give to any other facet of your business that can make either a good or bad impression on your customers.

One of the first considerations, of course, is to be understood. That is accomplished by speaking clearly and distinctly with the lips two or three inches from the mouthpiece. Do not turn your head away from the microphone while you peer out of the window or put an extra flourish on an artistic bit of doodling. Speak in an ordinary conversational tone. Neither yell nor whisper. The telephone has been carefully designed for the quiet, conversational voice, and it responds best to that manner of speaking. Do not interrupt the party on the other end of the line any more than you would if you were talking to him face to face. Listen carefully to what he says; try to grasp what he wants; and let your own conversation show that you have done both of these things.

Remember, too, that you can offend without the slightest intention of being discourteous. Quick speech often gives the impression of impatience. Monosyllabic responses sound short and discourteous to many people. I had this brought home to me when I asked some Mexicans who were teaching me Spanish why they never answered a question simply "Si" or "No." "It does not sound polite," they told me gently. "Yes" was always "Si, cómo no?" (Yes, why not?); and "No" with them, was softened into "Creo que no" (I believe not). Keeping this in mind I have tried to train myself to avoid giving single-syllable answers to questions. "I am very sorry I cannot," or, "I'm afraid that is impossible," will leave a much better impression than a flat "No," even

→ To Page 30

SAVE TIME — SAVE MONEY SAVE TUBES....

With the New HYTRON Miniature Pin STRAIGHTENER

Ever cursed the pins of miniatures when they broke as you fussed to straighten them with your fingers or with long-nose pliers? Unfortunately the pins have to be pliable to avoid cracked buttons. But you can make pin straightening easy and safe.

For only 49c — less than cost — a fraction of normal price, you can own a new Hytron Miniature Pin Straightener. You then merely press a 7-pin miniature gently into the Straightener until the button base seats squarely. Presto, the pins are straight again! Best of all, avoiding just one broken tube can pay for the Straightener twice over.

Features: precision die of wear and rust resistant steel for long life and close tolerances, production-tested, easy clean-out, adapted to hand or bench use. It's faster, cheaper, safer to use the Straightener *always* before plugging in miniatures. You need three Pin Straighteners — for bench — for field tool kit — for counter. Available only from Hytron jobbers. Order yours today.

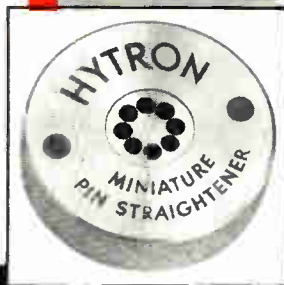

ONLY 49c
AT YOUR HYTRON JOBBER'S

A PREVIEW

The Hytron Miniature Tube Pin Straightener and Handy Tube Tapper are just the beginning. Watch for more lower-than-cost Hytron tube tools designed especially for you. They will save you time — help you make more money. Follow the Hytron ads for announcements. Order the tools from your Hytron jobber.



Hytron Handy Tube Tapper — novel and useful tool locates elusive intermittent "shorts" and "opens". Pencil, eraser, and tube tapper. Fits breast pocket. Compact and nonmetallic. Rugged and effective. Only 5c at your Hytron jobber's.



TUBES ARE KNOWN BY THE COMPANY THEY KEEP

Bendix MRT-3A, 152-162 mc f-m taxicab transmitter uses Hytron tubes generously.

Companies with top names like Bendix pick top quality components. You, too, choose the best when you ask for Hytron. Join the leaders. Specify Hytron tubes.

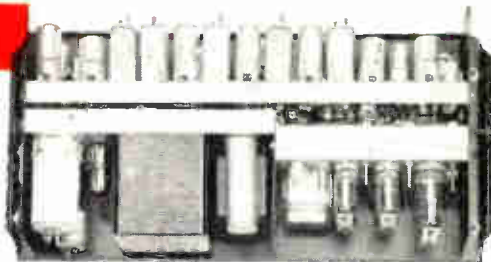

SPECIALISTS IN RADIO RECEIVING TUBES SINCE 1921

These service tools made available to you on a non-profit basis by both Hytron and its jobbers.

HYTRON

RADIO AND ELECTRONICS CORP.



MAIN OFFICE: SALEM, MASSACHUSETTS

How to Eliminate Hum

→ From Page 18

this is usually a very high resistance leak, in the neighborhood of several megohms, the best way to be sure about the coupler is to disconnect one end of it and substitute in its place a condenser known to be OK. If everything else fails the hum can sometimes be effectively reduced by substituting condensers of considerably lower capacity in place of the original coupling condensers. This should be a last resort, however, since it will mean sacrificing the lower bass notes as well as some volume. The optimum value of capacitances to use will have to be determined by experiment in each case. A hum remedy is sometimes effected by installing RC isolating networks in the B plus line of one or more stages, where such networks are not always incorporated in the circuit. ✓✓✓

Television Intercarrier System

→ From Page 11

then detected in a discriminator and passed through the AF amplifier to the speaker. These operations are illustrated in Fig. 2.

The intercarrier system thus eliminates the need for a sound IF channel. A simple circuit for separating the sound carrier from the video pass band is shown in Fig. 3. It will be remembered that the audio carrier is always fixed at 4.5 mc from the picture carrier. Thus a 4.5 mc trap, placed in the plate circuit of the video amplifier, allows separation of the sound signal from the picture signal.

The intercarrier sound receiver is less affected by oscillator drift since the sound frequencies will not normally move out of the wide video pass band. The system also makes possible lower cost television receivers at only a slight sacrifice of resolution and adjacent channel rejection. It may therefore eventually be adopted for all cheaper television sets. However, before this system can be fully employed commercially, it will be necessary to amend the standards for television transmission to insure that the video

→ To Page 36

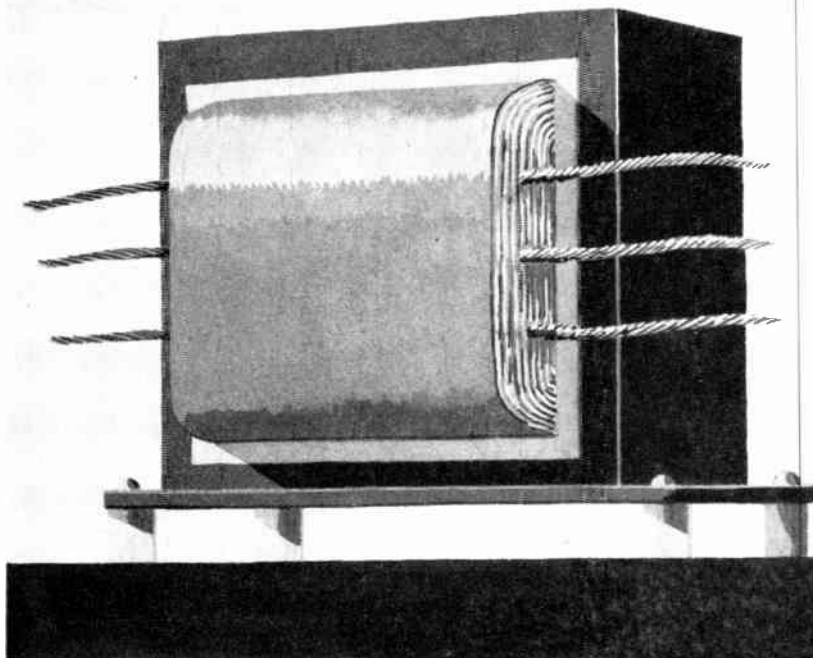

Fig. 8 Hum is sometimes caused by formation of a "common core" between audio and power transformers. This trouble can be remedied by mounting the audio transformer on brass standoffs.

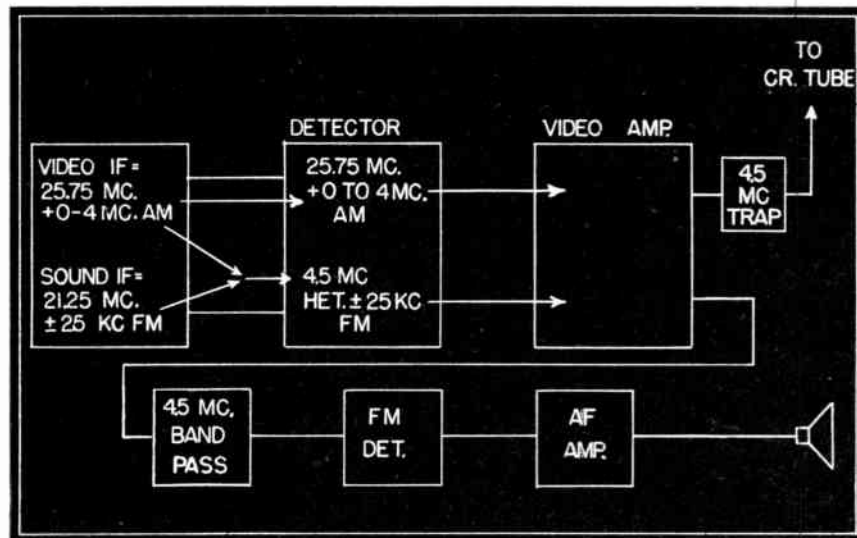

Fig. 2 Operation of the "intercarrier" television system. This system may soon allow production of low cost home receivers.

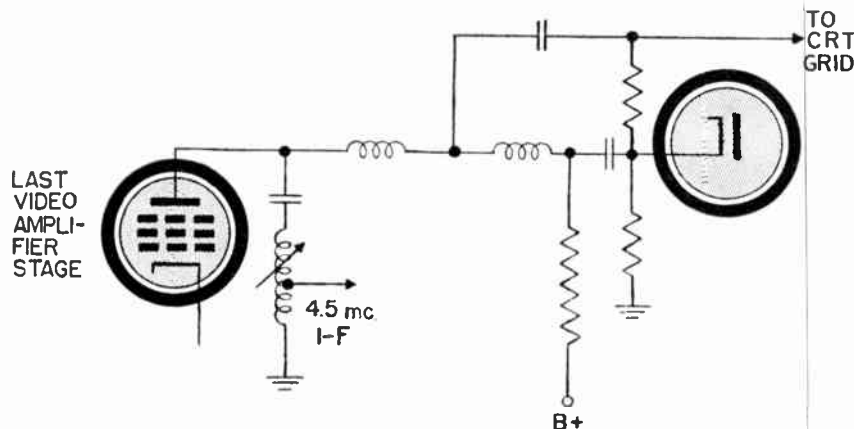
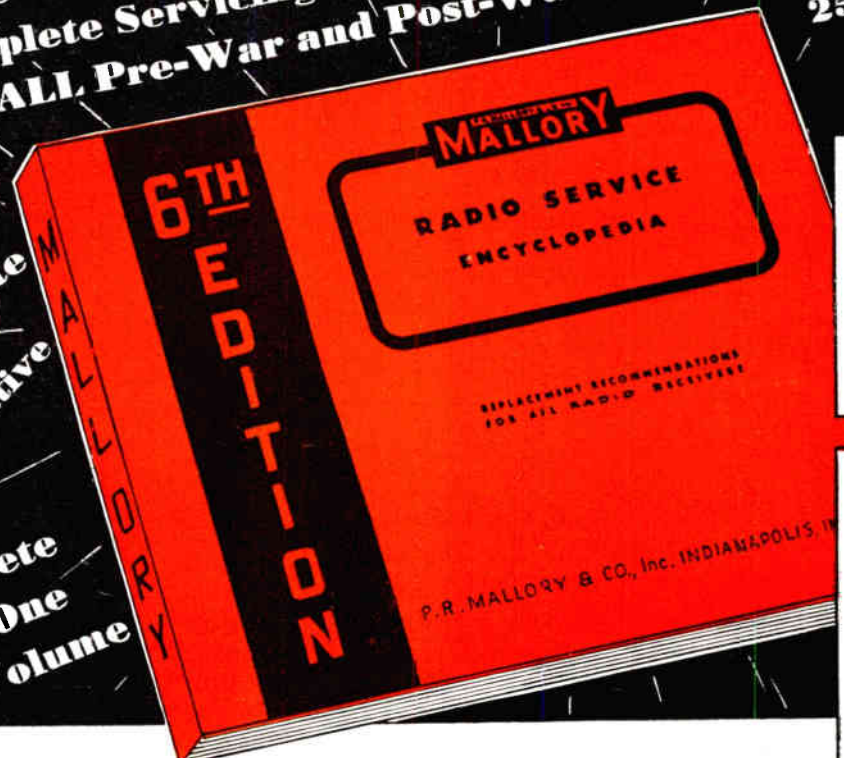

Fig. 3 Combination 4.5 mc trap and sound take-off point in intercarrier receiver.

The **ONLY**
Complete Servicing Reference
on ALL Pre-War and Post-War Receivers

25% More Listings
Than the
5th Edition

Accurate
Authoritative
Complete
in One
Volume



SALES of previous editions offer the best evidence of its worth.

Edition	Year	Copies sold
1st	1937	51,000
2nd	1938	25,000
3rd	1939	55,000
4th	1941	60,000
5th	1946	75,000

Here's what you get:

- Data on correct replacement parts
 - Circuit information
 - Servicing hints
 - Installation notes
 - IF peaks
 - Tube complements and number of tubes
 - References to Rider, giving volume and page number
- RESERVE YOUR COPY NOW**

Ready April 1st— The 6th Edition Mallory Radio Service Encyclopedia

Here it is—up to date—the only accurate, authoritative radio service engineers guide, complete in one volume—the Mallory Radio Service Encyclopedia, 6th Edition.

Made up in the same easy-to-use form that proved so popular in the 5th Edition, it gives you the complete facts on servicing all pre-war and post-war sets . . . volume and tone controls, capacitors, and vibrators . . . circuit information, servicing hints, installation notes, IF peaks, tube complements and

number of tubes . . . and in addition, cross-index to Rider by volume and page number for easy reference. **NO OTHER BOOK GIVES YOU ALL THIS INFORMATION**—that's why it's a **MUST** for every radio service engineer.

25% more listings than the 5th Edition. Our ability to supply these books is taxed to the limit. The only way of being sure that you will get *your copy quickly* is to order a copy today. Your Mallory Distributor will reserve one for you. The cost to you is \$2.00 net. It's the buy of the year.

THE MALLORY RADIO SERVICE ENCYCLOPEDIA
Complete—Authoritative—All in One Volume

P. R. MALLORY & CO. Inc.

MALLORY

CAPACITORS . . . CONTROLS . . . VIBRATORS . . .
SWITCHES . . . RESISTORS . . . RECTIFIERS . . .
VIBRAPACK* POWER SUPPLIES . . . FILTERS

*Reg. U. S. Pat. Off.

APPROVED PRECISION PRODUCTS

P. R. MALLORY & CO., Inc., INDIANAPOLIS 6, INDIANA

MAKE THE MOST OF THE

NEW

SHURE

Monoplex

MODEL "737A"

Available Now!

THE Only SUPER-CARDIOID CRYSTAL MICROPHONE



HIGH OUTPUT (-53 db)

Here indeed is the crystal microphone of all time—a high-output, unidirectional microphone that ranks far, far above ordinary crystal microphones. Why? Because it is a SUPER-CARDIOID microphone. What does this mean? It means that the "Monoplex" is twice as unidirectional as the Cardioid. It has wide angle pickup across the front of the microphone but it reduces sound pickup from the rear by 15 db—over a broad range of frequencies, and reduces pickup of random sound by 73%! The "Monoplex" employs the same type of acoustic phase-shifting network used in the highest-cost Shure Broadcast microphones. New "Metal-Seal" crystal. The case is pivoted at the rear and can be pointed toward desired sound or upwards for horizontal plane pickup. The "Monoplex" is excellent for high-quality public-address, communications, recording and similar applications. It will operate under adverse conditions of background noise and reverberation where a conventional microphone would be practically useless. Make the most of the "Monoplex"—it is destined for a performance record unique in crystal microphone history!

Manufactured under Shure patents issued and pending. Licensed under patents of Brush Development Co.

SHURE

Model "737A" CODE: RUMON List Price: \$35.50

SHURE BROTHERS, INC.

Microphones & Acoustic Devices

225 W. HURON ST., CHICAGO 10, ILL. • CABLE ADDRESS: SHUREMICRO

Sweep Generators for FM Alignment

→ From Page 10

illoscope connected with the "audio take off" point to ground and the large bypass capacitor across the load resistor disconnected, IF coil secondary alignment for best S-curve performed immediately thereafter. A 1½ volt dry cell must be connected across the load resistor as described above.

There only needs to be added one point—the answer to the question "How do I know my curves are wide enough, but not too wide, now I've aligned circuits for symmetry?" Unless grossly improper IF and S-curves have been set up in alignment, proper pass band width may be presumed operative in any properly designed receiver. However band width can also be checked with an extra AM signal generator, of known accurate frequency calibration. Connect it in shunt with the FM generator, and adjust its output so as it is tuned a little "pip" traces across the curves seen on the oscilloscope screen. For dis-

→ To Page 26

FREE! Send for it NOW!

ALLIED'S NEW CATALOG

Everything in Radio for Everyone in Radio



Radiomen! Here's the new 172-page ALLIED Buying Guide that brings you everything you need in radio and electronic equipment! Here's the newest and best in test instruments, sound systems and P. A. equipment, thousands of parts, tubes, tools, books—the world's largest stocks, at lowest money-saving prices, ready for instant, expert shipment. Send for your FREE copy of the new ALLIED Catalog—today!

ALLIED RADIO CORP., Dept. 71-C-8 833 W. Jackson Blvd., Chicago 7, Ill. Send FREE New ALLIED Catalog

Name Address

ALLIED RADIO

Are the New SPRAGUE TM's REALLY BETTER?

you be the judge—TRY THEM IN YOUR TOUGHEST JOBS

We think the new Sprague type TM *molded* paper tubular capacitors are so far ahead of any other capacitors that there just isn't any comparison.

Quite naturally, we should! Not only do we make them . . . we know *how* they are made and *why* they are better.

But don't take our word for it. If you haven't already seen and used these new units, by all means get at least a few today. Try them in your toughest jobs—auto radios that get hot and are subjected to severe mechanical shocks. Use them in

portable sets and in some of those small ac-dc radios that operate at temperatures at which you normally fry eggs. Give them the kind of jobs to do that are tough on paper tubulars. Then check for performance and long life.

All we ask is that you *try* them. If you don't decide the new Sprague Molded TM's are better than any other paper tubular capacitor you have ever used, we don't want to try to convince you! We feel confident of the result because we know that *your reputation* and *your customers deserve the best!*

"PROOF POSITIVE!" by Prof. Squeegee



Professor Oswald Z. Squeegee, the man who first successfully smashed the Atom in Sprague advertising back in 1938, took time out from his secret studies to wire:

HAVE JUST COMPLETED SEVERE LABORATORY TEST OF NEW SPRAGUE TM. SOAKED IT ONE WEEK IN SALINE SOLUTION (FISH BOWL, TO BE SPECIFIC). MIXED CONTENTS INCLUDING FISH AND SPRAGUE TM WITH ONE CAN DOG FOOD. HEATED TO 85° C. FOR THREE HOURS. DOGS ATE EVERYTHING BUT MOLDED CAPACITOR, WHICH WAS TOO HARD FOR CANINE TEETH. HATS OFF TO SPRAGUE! MUST HURRY BACK TO HISTORY-SHAKING EXPERIMENTS.

PROF. SQUEEGEE



CAPACITORS

SPRAGUE

*KOOLOHM
RESISTORS

*T.M. Reg.
U.S. Pat. Off.

SPRAGUE PRODUCTS COMPANY, North Adams, Mass.

JOBBING DISTRIBUTING ORGANIZATION FOR PRODUCTS OF SPRAGUE ELECTRIC CO.

*Reach for a SPRAGUE
and Know You're Right!*

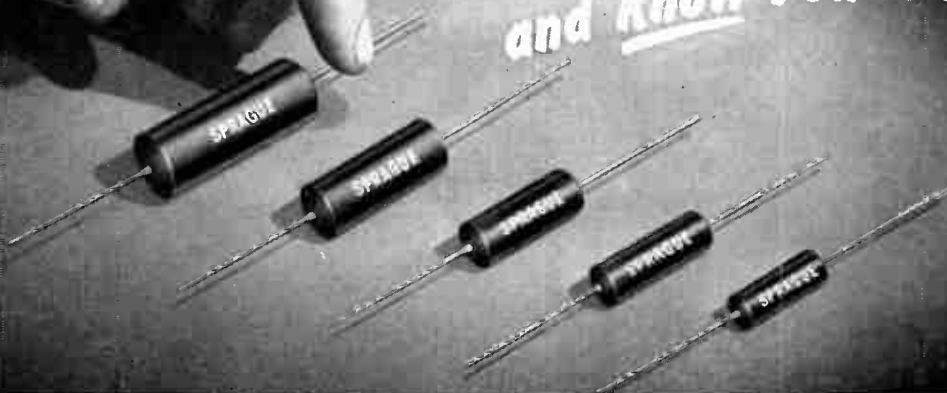

SENSATIONAL NEW TRADE-IN OFFER On Your Used Test Equipment

Here's the way to get that new Test Equipment you've been wanting and at an amazing saving! Simply tell us what factory-built Test Equipment you have to trade. We'll come right back with a "bigger-than-ever" allowance that will save you real money. Get your trade-in deal working today. Wire, phone or use the handy coupon below.

ALSO... SMASH VALUES IN USED,
GOOD-AS-NEW TEST EQUIPMENT

"Surprise" Trade-In Allowances
by Walter Ashe on the make or
model of your choice

NEW "PRECISION" TEST INSTRUMENTS

TUBE TESTERS

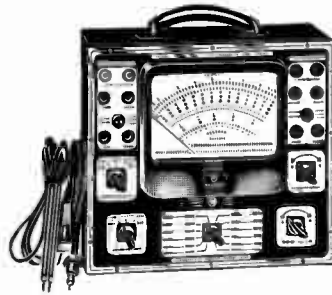

Model EV-10P
Multi-Range Vacuum Tube Tester.
Range to 6000 volts AC and DC and
up to 2000 megohms.

NET **8146**

Model RF-10
RF probe for use with
above.

NET **1305**

TIME PAYMENTS AVAILABLE
ALL PRICES F.O.B. ST. LOUIS

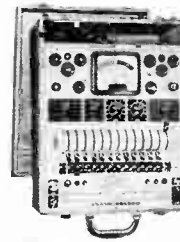

Model 10-12P
Utilizes exclusive ELEC-
TRONAMIC checking cir-
cuit. Handles all type tubes.
Hardwood carrying case.

NET **8443**

Model 10-20P
Same tube checker as
above, but has built-in
VOM with 34 AC and DC
ranges.

NET **10692**

Model 10-54P
Same as 10-20P listed
above, but has 20,000 per
volt DC voltage range.

NET **12093**

PRECISION SIGNAL GENERATOR



Model E-200C
Range 88 KC. to 120 MC. 400 Cy
modulated. Individually hand
calibrated

NET **6287**

Send for your FREE COPY
of the 1948
Walter Ashe Catalog

MAIL COUPON TODAY!

Use this coupon to get Walter Ashe's "Surprise Trade-In Allowance on your used factory-built test equipment." RM 3

WALTER ASHE RADIO CO.
1125 Pine St., St. Louis 1, Missouri

Am interested in the following top condition, slightly used Test Equipment..... (list preference)

I want to trade..... (describe used equipment)

for..... (show make, model of new Test Instrument desired)

Rush my FREE COPY of the big, New 1948 Walter Ashe Catalog.

NAME.....

ADDRESS.....

CITY..... ZONE..... STATE.....

Other New Test Equipment

(in stock ready for immediate delivery)

McMURDO SILVER • WATERMAN • PRECISION
SPECIAL PRODUCTS CO. • TRIPLETT • BILEY
INDUSTRIAL EQUIPMENT • CORNELL-DUBILIER
COASTWISE ELECTRONIC • SUPERIOR • WESTON
JACKSON • HICKOK • DUMONT • FEILER • RCA
SUPREME • SIMPSON • MEISSNER • SPRAGUE

Walter Ashe
RADIO CO.
"Test Equipment Headquarters"
1125 PINE ST. ST. LOUIS 1, MO.
PHONE Chestnut 1125

JUST OUT!

FM TRANSMISSION and RECEPTION

by John F. Rider and Seymour D. Uslan

New BROADCAST OPERATOR'S HANDBOOK
by HAROLD E. ENNES,
Engineer, Station WIRE
Here are coordinated facts,
standards of good operating
practice written by an opera-
tor in operators' language.
288 Pages..... \$3.30

NEW RIDER 99'r
over 130 pages
only... 99c

JUST OUT!

UNDERSTANDING VECTORS AND PHASE — Vector presentations are widely used in conveying latest radio technical information. This book is a must for students.

BY THE PUBLISHER OF
RIDER MANUALS

JOHN F. RIDER PUBLISHER, INC.
404 FOURTH AVENUE, NEW YORK 16, N.Y.

For radio servicemen, who can look to FM as a big part of their future profits—for the "ham" who is considering narrow band FM—for the student who is grooming himself for activity in the electronic field—this new book explains both the theory and servicing of f-m receivers. Its text is equally valuable to every person interested in this phase of electronics and will serve as a valuable handbook for engineers.

The unique publication principle employed in the production of this new book is as practical as its contents. It is offered in two editions identical in contents, printing quality and paper—differing only in covers.

OVER 300 FACT-PACKED PAGES
(substantial paper cover) **\$180**
Hard back cloth cover, \$2.70

Sweep Generators

→ From Page 24

criminator with "pip" at horizontal cross-over point in Fig. 5 the signal generator shows the exact frequency of center of pass-band. The difference in signal generator frequency as it traces up to one curve peak, down to the other, shows the separation of these peaks from center frequency. This separation should be 150 to 200 kc between peaks—half this between either peak and center-frequency cross-over. If with a particular receiver, "pips" are not visible upon the discriminator S-curve, use a VTVM in place of the oscilloscope across discriminator and load resistors. Vary the unmodulated signal generator frequency and align discriminator transformer secondary to yield zero voltage at center-frequency, equal, maximum and opposite polarity voltage at points 150 to 200 kc above and below center-frequency. The same "pip" technique checks IF pass-band width. On the IF curve, points 75 kc off center-frequency should not be closer to the base-line than halfway down from curve peak. (See Fig. 8.)

It hardly seems necessary to add that with oscilloscope, and frequency-modulated signal generator connected to receiver input, it is possible to see the overall RF-IF selectivity curve of any FM receiver—to align visually RF, mixer and oscillator circuits just as one would the IF amplifier alone.

Always read and study test equipment manufacturer's instruction books. They're written to help you—*must be read and understood if satisfactory results are to be obtained.* ✓✓✓



Long Life

As the sphinx and pyramid have withstood the ravages of time over the centuries gaining their reputation for longevity, the mighty Radiart VIBRATOR has proven itself to be long lasting even beyond its normal expected effectiveness. This quality of long life helps to make Radiart VIBRATORS outstanding and cuts to a minimum expensive duplicate installation costs. This is one of the factors that brings customers back to servicemen, satisfied and asking for Radiart by name and number. Dealers everywhere know when they sell Radiart, they sell quality. On this concept, your success and ours is assured.

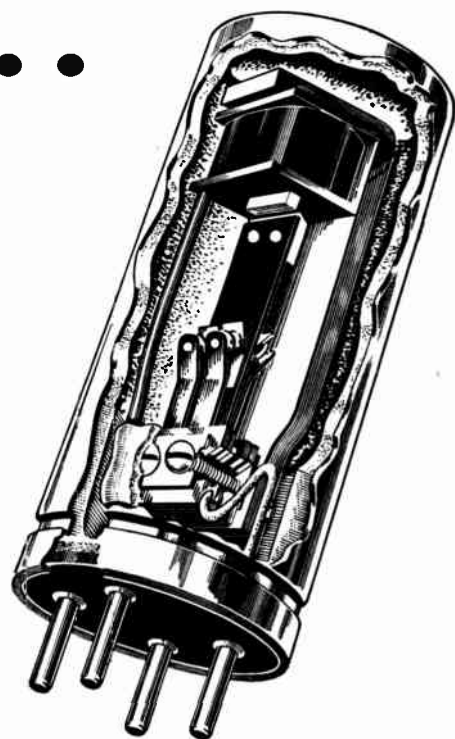

The Radiart Corp.

CLEVELAND 2, OHIO

New! Permanent PANEL SWITCH

Mounts on console panel—
Eliminates groping behind
radio to turn on and off.



BATTERY ELIMINATORS

A COMPLETE LINE FOR EVERY REQUIREMENT

NEW MODEL "S" WITH SELENIUM RECTIFIERS—operates any 1.4 volt, 4, 5 or 6 tube radio from 115 volt, 60 cycle source.

MODEL "P"—Same as MODEL "S" except with tube rectifiers at lower cost.

MODEL "Q"—Operates any 1.4 volt 4, 5, or 6 tube radio from 6 volt storage or dry battery, or Wincharger. Ideal for farms, camps, autos, boats, etc.

MODEL "A"—Operates 2 volt 4, 5, 6 or 7 tube radio from 6 volt storage or dry battery, or Wincharger. (0.5 amp. filament max.)

Models to convert dry battery radio to AC receivers—other models for use with 6 volt storage battery. Costs but a few cents per hundred hours of operation. Completely filtered, hum free, silent and efficient. Sturdy construction with Harmerloid finish. No liquids or moving parts. Operate in any position.

CANADIAN REPRESENTATIVE: ATLAS RADIO CORP., TORONTO, CAN.

ELECTRO PRODUCTS LABORATORIES

Pioneer Manufacturers of Battery Eliminators

549 West Randolph Street

Chicago 6, Illinois

FM Sig Source

→ From Page 14

eye" on the receiver, it will close when in tune with your FM carrier. If no carrier is heard, adjust C17, the 3-30mmfd trimmer paralleled with the main tuning condenser. This will bring the tuning into the band. It is then only necessary to make a finer adjustment on this trimmer to put the tuning range into the 88-108mc band.

Should any difficulty be encountered in getting the oscillator functioning, it may be necessary to shift the setting of the plate tap on L4 slightly. When we say slightly, take it literally.

Operation

Now, plug any record player of high impedance to the input jack and you will modulate the carrier with frequency modulation. R-5 is your deviation control, the 500,000 ohm potentiometer. Keep the deviation as low as possible to obtain an adequate signal.

You'll find this a useful tool to take along to a customer's house when there is a complaint of no FM reception. It can then be easily determined whether the fault lies in the antenna system. It frequently happens that folded dipoles incorporated in consoles give too weak a signal. The signal generator anywhere in the house will give adequate pickup to show if the receiver is functioning. If so, it will show the necessity of an outdoor dipole installation to bring the signal up to proper strength. ✓✓✓

PHOTOGRAPH CREDITS

Page 11 (2)

Allen B. Dumont Labs.

Throw Away Your Old Instruments Remarkable New STETHOSCOPE Method Guaranteed to Lick Toughest Jobs

Why let old-fashioned methods and equipment hamper your servicing ability? Thousands of radio men—many with little experience—are already fixing radios this remarkable "automatid" way. It's as simple as A.B.C., because Stethoscope Servicing is the newest, most basic method yet devised to simplify all repairs. Right at this very moment, you probably have on your bench one of those familiar "stumpers" for repair. But now you can fix these "headaches" in a jiffy—the Stethoscope way. **STETHOSCOPE SERVICING** is guaranteed to speed up and improve your servicing ability, or your money will be refunded. You owe it to yourself to find out how you, too, can begin cashing in. Don't delay! Send for 24 page illustrated booklet, "The Inside Story." It's FREE!

Feiler Engineering Co.,

945 George St., Chicago 14, Illinois Dept. 3M8

New! Complete!

Concord Radio Catalog

LOWEST PRICES
on Everything in...

RADIO·TELEVISION·RADAR
ELECTRONIC EQUIPMENT

- Thousands of items for every Radio and Electronic need.
- Special Bargains—money-saving values in top quality Radio Parts.
- Immediate delivery from huge stocks at Chicago and Atlanta.

MAIL COUPON FOR FREE COPY

Concord Radio Corporation, Dept. RM-38
901 W. Jackson Blvd., Chicago 7, Ill.

Yes, rush FREE COPY of the comprehensive new Concord Radio Catalog.

Name.....

Address.....

City.....State.....



STANDARD BRAND LINES

RCA · AMPERITE · SIMPSON-JENSEN
STANCOR · OHMITE · SHURE · BLILEY
DUMONT · IRC · TRIPLETT · SPRAGUE
and hundreds of other well-known brands
COMPLETE STOCKS

CONCORD RADIO CORPORATION

CHICAGO 7 ATLANTA 3
901 W. Jackson Blvd. 265 Peachtree St.
Downtown Chicago Branch - 229 West Madison St.
LAFAYETTE RADIO CORP.

FIRST *in Quality,* FIRST *in Performance*

**You be the Judge! See why Centralab's
Ceramic BC "Hi-Kap" Capacitors are your best buy!**

"HI-KAP" FEATURES	DESCRIPTION	ADVANTAGES
1. Impervious to moisture	Ceramic-X is non-hygroscopic. Moisture absorption is .007% or less.	No deterioration, no shorting. Longer life even under the most adverse conditions.
2. Low mass weight	Av. Wt. .029 oz.	For unit size and weight, Centralab BC "Hi-Kaps", made with Ceramic-X, are the only capacitors on the market which provide these voltage ratings.
3. Small size	Dimensions L—.540" D—.315"	
4. High capacity	Values .00005—.00025 mfd.	
	L—.830" D—.315"	
	.044 oz.	.0005 mfd.
	.050 oz.	L—1" D—.340"
	.082 oz.	L—1.305" D—.400"
	Rating: 600 WVDC — 1000 VDC flash test.	.01 mfd.
5. Special insulation	Wax impregnated, lacquered, dipped in special phenolic resin, cured and wax impregnated.	Prevents any possibility of shorting to adjacent leads, chassis or components.
6. Convenient side leads	Heavy #22 gauge tinned copper.	Permit rapid, close-coupled connections. No tricky bending or fitting required.
7. Low power factor	Initial — .6%. After 100 hours, 95% humidity test — 3.0%.	More efficient circuit operation, fewer failures.
8. High leakage resistance	Initial — 5000 megohms. After humidity — 500 megohms.	Long life, more efficient performance.
9. Maximum dependability	One-piece construction. Leads soldered directly to electrodes.	Will not short or become intermittent.
10. Factory tested	For your protection, all units 100% factory tested before packaging and shipping.	Your guarantee to your customers of reliable service and performance.

PART NUMBER	VALUE (MFD).	LIST PRICE*
D6-500	.000050	\$1.25*
D6-101	.000100	1.25*
D6-151	.000150	1.25*
D6-251	.000250	1.25*
D6-501	.000500	1.25*
D6-751	.000750	1.25*
D6-102	.001000	1.25*
D6-202	.002000	1.25*
D6-502	.005000	1.50*
D6-103	.010000	1.50*

*PER ENVELOPE OF 5

Rating: 600 WVDC — 1000 V. flash tested. Individually color coded, inspected and insulated.

All Capacitors Are Not Alike!

THAT'S why more and more Radio Service Dealers are turning to Centralab's *ceramic* by-pass and coupling capacitors for new dependability, permanence and convenient size. Compare the amazing low price at which Centralab is offering these *ceramic* capacitors, and you'll agree now's the time to give yourself and your service customers the newest and finest in capacitor components!

Note the wide range of *Hi-Kap* values available at left, and order a supply of these top quality capacitors from your Centralab Distributor today. For complete information, see your Centralab Distributor or write to *Centralab, Division of Globe-Union, Milwaukee, Wis.*

LOOK TO **Centralab** IN 1948!

First in component research that means lower costs for the electronic industry.

→ From Page 20



- High Permeability nickel-iron cores
- Flat from 20 to 20,000 cycles ± 1 db
- Quadruple alloy-shielded
- Vacuum sealed for 100% Protection

Item Number	Application	Primary Impedance	Secondary Impedance	± 1 db from
Y-1	Interstage—Single Plate to P.P. Grid	8,000 to 15,000	60,000 C.T.	20 to 20,000
Y-2	Low level Output to Line	8,000 to 15,000 in Two Sections	50-125-200-250-333-500	20 to 20,000
Y-3	Low Level Input	500-333-250-200-125-50	50,000 in Two Sections	20 to 20,000
Y-4	Bridging Trons.	20,000	50,000	20 to 20,000
Y-5	Repeat Coil	500/600	500/600	20 to 20,000



Typical frequency response curve for above units

HIGH LEVEL OUTPUT TRANSFORMERS

Part No.	Primary Impedance	Secondary Impedance	Max. Watts	± 2 db From	Height	Width	Depth
Y-20	8500	500	15	20-20000	3 1/8"	2 3/8"	2 5/8"
Y-21	5400	4-8-15-125-250-500	35	20-20000	4 3/4"	3 1/2"	4 1/8"
Y-22	3800	4-8-15-125-250-500	50	20-20000	4 1/2"	3 3/8"	4 3/8"

These new Halldorson Transformers offer broadcasting stations, laboratories, and service engineers an opportunity to install high fidelity equipment with moderate transformer

cost. While these transformers give laboratory standards of performance, they are small in size and are equipped with convenient clamps. Try them. Ask your Radio Parts-Distributor.

For more technical information and new catalog, write The Halldorson Co., 4500 Ravenswood Ave., Chicago 40, Ill.



though the meaning is exactly the same.

You will notice that there is a great difference in the telephone techniques of different customers. Some will come directly to the point of the call with almost startling abruptness; others will beat all around the bush before stating what they want. You must be able to adapt your own way of speaking, to a degree, to that of the person with whom you are talking. With the to-the-point man, you should be able to be brisk and business-like without seeming short or discourteous. With the beater-around-the-bush, you should gently but firmly steer the conversation into the reason for the call without leaving the impression that your mind is on your soldering-iron.

Make sure that you get all necessary information before hanging up.

→ To Page 32



BINDERS!

PRESERVE YOUR RADIO MAINTENANCE MAGAZINES IN THEM

RADIO MAINTENANCE
460 Bloomfield Avenue
Montclair, N. J.
Please send me . . . binders at \$3.00 each.

Total amount enclosed

Name

Address

City Zone

State

LET'S REVIEW THE FACTS



on Plastic Molded Tubular Paper Capacitors

Pioneered by Sangamo

The first tubular paper capacitor to be molded in a thermo-setting plastic was introduced by Sangamo in 1946. It offered many of the same advantages available in molded mica capacitors which were also pioneered by Sangamo twenty-five years ago: better characteristics, longer life, and more dependable performance.

Universal Acceptance

The many advantages of Sangamo Type 30 Capacitors assure that molded tubular paper capacitors will soon be universally used in place of ordinary wax-filled paper capacitors: capacity values are permanently sealed in; no wax ends to melt out at high

temperatures; and their mechanical stability has been improved so that it does away with the necessity for delicate handling. They can be used wherever ordinary paper capacitors are now used. Heat from a soldering iron will not cause wax to run . . . nothing can burn! This means greater ease of installation—fewer damaged assemblies—and more jobs finished in less time. The new Sangamo Type 30 Capacitor is definitely superior.

Send for Catalog

Write for the Sangamo Capacitor Catalog Number 23B. It gives you technical capacitor information and covers the complete range of Sangamo Mica, Paper, and Silver Button Capacitors.



SANGAMO
ELECTRIC COMPANY
SPRINGFIELD • ILLINOIS

SC 482

WELLER

SOLDERING GUN

Time Saving-Money Making Features

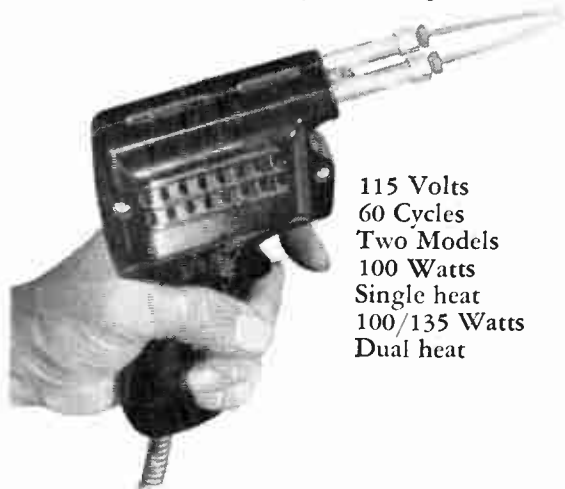

115 Volts
60 Cycles
Two Models
100 Watts
Single heat
100/135 Watts
Dual heat

See your radio parts distributor or electrical wholesaler. Or write direct for bulletin.

WELLER Mfg. Co.
812 Packer St. • Easton, Pa.

5 SECOND HEATING

ADJUSTABLE TIP

BUILT-IN SPOTLIGHT

LONG REACH

DUAL HEAT

→ From Page 30

A call-back is like a P.S. on a letter: it shows poor organization. Incidentally, hanging up has a right and a wrong way. Do not toss the hand-set back on the cradle. That causes an ear-splitting thump at the other end of the line. Develop the habit of striking the disconnecting plunger with your thumb so that the line is disconnected before the hand-set is dropped into the cradle.

I must admit that it is not easy always to be polite over the telephone. There are times when that little black box seems possessed of a devil. For example, it will ring right when you are at the most critical point of hooking the spring on a yard-long dial cable. When you think sourly about having to restring all of those pulleys, it is pretty hard to pick up the receiver and sound as pleasant as a date-minded teen-ager answering the phone.

Just remember, though, that you would be a lot unhappier if that telephone did not ring at all, and that will help you to inject just the right note of interest into your voice. Never forget that the customer's ra-

→ To Page 36

"Cash in"
on your Practical Experience...

BE AN FCC LICENSED RADIO TECHNICIAN AND GET IN ON THE "GROUND FLOOR" OF THESE GROWING, PROFITABLE NEW FIELDS

FCC COMMERCIAL LICENSE

THESE EMPLOYERS NEED FCC LICENSED RADIO TECHNICIANS NOW!

TAXICAB FLEETS—BUS AND TRUCK FLEETS—POLICE AND FIRE DEPTS.—RAILROADS—GAS AND ELECTRIC COS.—HIGHWAY PATROLS—AIR LINES—TELEPHONE COS—FORESTRY DEPARTMENTS—GAS AND OIL PIPE LINES.

Be an **FCC LICENSED** radio technician and get in on the "ground floor" of these growing, profitable new fields in mobile radio communication.

Thousands of new jobs are opening up—FM Broadcasting, Mobile Communication Systems, Television. These are only a few of the new radio fields which require FCC licensed technicians.

These new fields offer to radio servicemen exceptional opportunities to become specialists, to obtain dignified, high-paying employment, to get out of the rut of "fixing radios," to rise above run-of-the-mill, commonplace, radio servicing.

YOUR FCC "TICKET" IS RECOGNIZED IN ALL RADIO FIELDS AS PROOF OF YOUR TECHNICAL ABILITY!

More than ever before an FCC Commercial license is a sure passport to many of the better paying jobs in this New World of Electronics. Get your license without delay. Let Cleveland In-

stitute prepare you to pass the FCC license examinations, AND TO HOLD THE JOBS WHICH A LICENSE ENTITLES YOU TO, using CIRE streamlined post-war methods of coaching and training.

OTHER CLEVELAND INSTITUTE HOME STUDY COURSES OFFER COMPLETE TECHNICAL RADIO TRAINING FROM LOW-LEVEL TO COLLEGE-LEVEL, FOR THE RADIOMAN WITH PRACTICAL EXPERIENCE!

CLEVELAND INSTITUTE OF RADIO ELECTRONICS RM-3 TERMINAL TOWER CLEVELAND 13, OHIO

CLEVELAND INSTITUTE OF RADIO ELECTRONICS □ Check here for Veteran's Information.
RM-3 TERMINAL TOWER, CLEVELAND 13, OHIO

Gentlemen: □ Please send me your Booklet B, "HOW TO PASS FCC LICENSE EXAMINATIONS." (Does not cover Amateur License Exams.)
□ Please send Catalog A describing all courses.

NAME

ADDRESS

CITY STATE

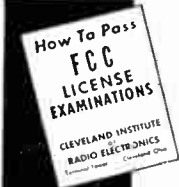

Don't Delay—Write Today!
Approved for Training under "G-I Bill of Rights."

DO YOU HAVE IHT?

ILLINI-HYCAPS . . .

Type IHT—tubular electrolytics are always ready to fill your need for capacitors of superior quality and ability. A complete line of these tubular electrolytic capacitors are now available.

Included in the list of old standbys are NEW types especially designed for use in voltage doubling circuits. With either tube or selenium rectifiers these units are superior because of their ability to stand up under higher temperatures, handle larger voltage and current surges, last longer because of their new and special engineering design.

NOTE: A new supplement, listing these new condensers, along with other high voltage, high capacity types, has been added to our catalogue. Write today for your copy.

ILLINOIS CONDENSER CO.
1816 NORTH THROOP STREET - CHICAGO 22, ILL.

The Organizations

Reports from all over United States and Canada are making it clear that the Radio Service Technician is finding membership in an organization of great benefit. Radio Maintenance has kept you informed by starting this column many months ago, and we have watched group activity grow. If you are an organization member, let's hear from you about your group activities.

New York City breaks into the Organizations department with the following interesting information. At a meeting on December 2, the Radio Servicemen's Association of New York announced the election of officers and the establishment of committees for the organization's activities. This organization was formed immediately following the proposals of City Councilman Isaacs for the licensing of Radio Service Technicians in New York City. Its purpose is to establish the professional standing of radio service technicians through an ethical organization and mutual co-operation between the members. The members of the organization have agreed to a code of ethics which will correct many of the alleged abuses that have been attributed to the radio servicemen.

The program includes establishment of an investigation committee which will look into complaints of customers and evaluate them on a fair basis. Educational activities planned will provide training in new radio maintenance techniques to keep members of the organization up to date in the field. Emblems are be-

ing issued to member servicemen which they will display prominently in the windows of their shops.

The officers are Max Leibowitz, President (Mecca Radio and Electric Shop); Norman Jacobson, Vice-President (Mid-City Radio and Phonograph Co., Ink.); Jack Edel, Treasurer and Recording Secretary (Modern Radio Service); Harry Anis, Corres, Secretary (Harry's Radio Service). A drive is under way to enlist every radio service technician in the metropolitan area.

We believe that the following letter shows some of the advantages of the exchange of ideas among organizations: "The Dallas Radio Sales & Service Association has made a very satisfactory rate of progress in the past year, and is continuing to grow. Our greatest achievement was the accomplishment of a similar operating agreement with Radio Stations WFAA, WFAA-FM, as enjoyed by the Philadelphia Radio Service Man's Association. We feel greatly indebted to Mr. David Krantz of that splendid group for his great interest and personal aid to us. It is needless to say that the constant barrage of radio commercials has enhanced the prestige of our membership insignia.

In addition to the above our organization holds regular monthly educational meetings at which both sales and service techniques are presented. For the past several months we have been engaged in an exhaustive study of FM. Also we are promoting a program of FM education for the public.

I trust that the above will give you some idea of our activities, and I can assure you that we are looking forward to another successful year.

T. P. Robinson
Sec't-Treasurer



Servicemen's choice!
in...



● For 32 years Cunningham tubes have given California a wonderful radio climate. That's why Cunninghams continue to outshine other brands. Their top performance and long life make them the outstanding renewal tubes. Vote to use Cunninghams in your work.

See your
CUNNINGHAM DISTRIBUTOR

HENRY RADIO SHOP Los Angeles
RADIO EQUIPMENT DISTRIBUTORS Los Angeles
E. M. KEMP COMPANY Sacramento
SAN FRANCISCO RADIO & SUPPLY CO.
San Francisco
WHOLESALE RADIO & ELEC. SUPPLY CO.
San Francisco





What Does It Take to WAKE You Up?

Present-day expansion of the radio-electronics industry is almost **UNBELIEVABLE**. The tremendous growth of the art is so rapid and in so many directions that already the demand for **TECHNICALLY QUALIFIED** radiomen has created a condition wherein there are many **MORE GOOD JOBS** than there are capable men to fill them.

Every page in this magazine could be filled with such astounding facts concerning career opportunities available to trained radiomen. The point is, what are you going to do about it? Just figure out for yourself how many good jobs are waiting to be filled. You can't say, "I don't need more training." **EVERY** radioman needs to increase his technical knowledge if he wants to keep ahead of the competition that is bound to come... if he wants to go after—and **GET**—the better jobs that offer good money and personal security.

If you have a commonplace job. If you have the ambition to hold a position of greater responsibility with higher pay . . . then a CREI spare time program for self-improvement will help you accomplish your ambition at this opportune time. It costs you nothing to read the interesting facts.

MAIL COUPON
FOR FREE
BOOKLET &
COMPLETE DETAILS



Capital Radio Engineering Institute
16th and PARK RD., N.W., DEPT. RT-3
WASHINGTON 10, D. C.

Mail me **FREE** 24-page booklet, "CREI Training for Your Better Job in Radio Electronics." I am attaching a brief resume of my radio experience, education and present position.

Check one **PRACTICAL RADIO-ELECTRONICS**
Course **PRACTICAL TELEVISION**

Name

Street

City Zone State

I am entitled to training under the G.I. Bill

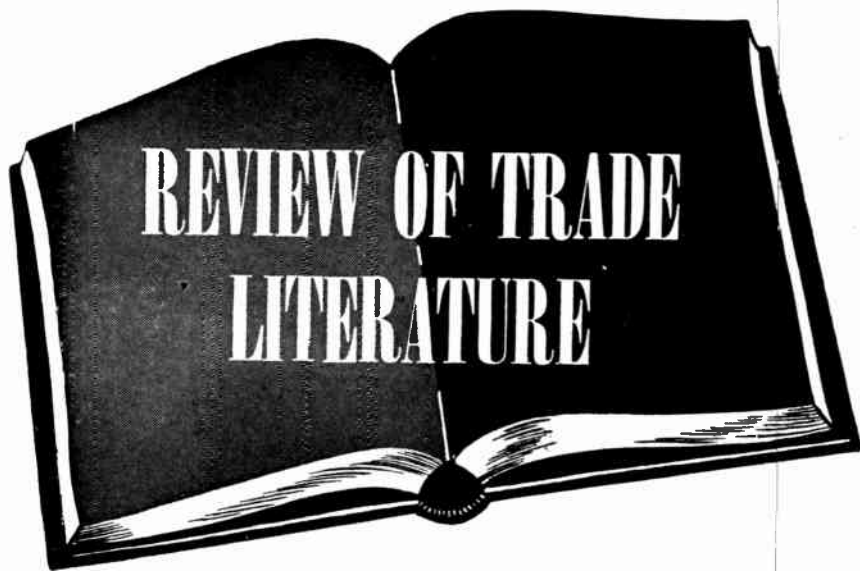

To avoid delay when writing to the manufacturer give issue and page number.

The Hamilton Kent Manufacturing Company has made available a bulletin on REXON Vibration Mounts. This 8-page bulletin describes shock mounts and their characteristics and should be helpful to the serviceman in planning his shop and equipment and for custom installations. For a free copy, write to Hamilton Kent Manufacturing Company, Kent, Ohio.

A complete new 1948 catalog showing popular types of capacitors and radio noise filters used in servicing radios and industrial electronic equipment, is now available from authorized Solar distributors, or directly from Solar Capacitor Sales Corp. Among the new items in Catalog SC-2 are a complete line of Superex paper capacitors, mid-gate hearing-aid capacitors, molded paper capacitors, speedflash capacitors, plastic-protected dry electrolytics, and greatly enlarged listings of "Twist-Prong" electrolytic capacitors.

To obtain this catalog, write to Solar Capacitor Sales Corp., 1445 Hudson Blvd., North Bergen, N. J.

Rogan Brothers, compression molders of plastics, have announced their new illustrated catalog which lists specifications on their complete line of stock molded plastic knobs, control handles, instrument knobs, etc. It also contains useful information on how tool cost savings can be achieved, plus data on the Rogan "deep relief" branding pro-

cess. Copies may be obtained by writing: Rogan Brothers, 2500 W. Irving Park Blvd., Chicago 18, Illinois.

The 1948 edition of the RCA Tube Reference Book, a vest-pocket booklet containing technical data for radio servicemen, engineers, and technicians, has been published and is now available from RCA, Cunningham and RCA Victor tube distributors. A combination technical reference, memo book, diary, and radio directory, the RCA Tube Reference Book contains up-to-date data on RCA receiving tubes, condensed data on over 260 RCA non-receiving tubes, RMA color codes on mica and ceramic capacitors and resistors. It has in addition, a world atlas with maps in full color, including an 8-page section of the United States.

The volume has been expanded this year to include several valuable new features. These include a "replacement directory" covering tubes for industry, communications, and special uses, and a listing of directly interchangeable RCA tube types as well as a listing of similar RCA types. Additional features are a battery interchangeability chart, a glossary of television terms, charts for calculating series resistance and parallel capacitances, and a table of metric equivalents.

"Television Receiver Construction" is the name of a new booklet

→ To Page 36

As great an achievement
as Television itself!

HICKOK MODEL 610

TELEVISION ALIGNMENT GENERATOR



*A brand new idea in
Radio Test Equipment*

1. Directly calibrated in frequency—range from 10 megacycles to 250 megacycles.
2. Sweep width completely variable from 0-15 megacycles.
3. Crystal Controlled.
4. Accurate attenuation in five stages—calibrated directly in output ratios.
5. Plenty of voltage output.
6. High degree of accuracy.
7. Coaxial cable—to give minimum standing wave ratio in output line.
8. Phasing Control.

**Get all
these
Features**

This new Generator, designed and built with the customary HICKOK skill is a "must" for the Service Man who hopes to do any Television Servicing. The eight features listed above give you some idea of the job it will do. But that's not all. There are 5 other outstanding features so revolutionary, so necessary for profitable Television servicing that we will not disclose them until a substantial number of instruments are ready for distribution. We are now in production on this outstanding addition to the famous HICKOK line. Price \$159.00. Write for further information today.

*Plus 5 OTHER
OUTSTANDING
FEATURES*

THE HICKOK ELECTRICAL INSTRUMENT COMPANY
10634 DUPONT AVENUE CLEVELAND 8, OHIO

Built for Service



Servicemen's choice!
in . . .



● You'll find Cunningham tubes running a plurality right in the heart of Texas! That's because Cunninghams are "Lone Stars" when it comes to long life and top performance. That's why they'll bring more customers your way, too!

See your
CUNNINGHAM DISTRIBUTOR

The Shield Co., Inc. Fort Worth
Bill Sutton's Wholesale Electronics,
Fort Worth
Sterling Radio Products Co. . . . Houston
Lavender Radio Supply Co. Tyler

Cunningham Tubes

A product of
RADIO CORPORATION OF AMERICA
Harrison, N. J.

FOR QUICKER SALES AND PROFITS

Show... Suggest... Sell

Webster-Chicago RECORD CHANGERS

The Choice of Music Lovers



\$42⁵⁰ LIST

Slightly higher West of Rockies

**MODEL 156 with
Automatic Stop**

Model 156 embodies the most advanced features of record changer design—a vastly improved pick-up arm that accommodates a cartridge of low needle pressure—automatic shut-off—simpler, faster, more positive changer action.

Model 156-27 supplied with G. E. variable reluctance pickup, \$44⁵⁰



\$33⁷⁵ LIST

Slightly higher West of Rockies

**MODEL 50
for Small Radio-
Phonograph Combinations**

Compactly designed for use with smaller radio-phonograph combinations. Precision-built for trouble-free operation. Base dimensions: 12 x 12 $\frac{1}{2}$ in. Vertical space requirements: 6 $\frac{1}{2}$ in. above, 2 $\frac{1}{2}$ in. below top of mounting board.

Made by the Makers of WEBSTER-CHICAGO

Wire Recorders and Nylon Phonograph Needles

WEBSTER-CHICAGO

5610 BLOOMINGDALE AVENUE • CHICAGO 39, ILLINOIS

Over the Bench

→ From Page 32

dio and its symptoms are of major interest to him or to her, and he likes to hear you sound as though you are interested too. When he is talking to you on the telephone, he is not wasting your time; instead, he is giving you a golden opportunity to do a job of selling—selling yourself and your service. So the next time you hear that bell, come out smiling! ✓ ✓ ✓

Trade Literature

→ From Page 34

describing how to build a complete television receiver. This television receiver uses 18 tubes and is designed to operate on any of the video bands from 44-88 mc. The booklet is arranged to help students and experimenters in building this instruction receiver. A 3" viewing tube is used, and the receiver is light and compact. Arthur Lieb-scher, the author of the booklet, is a lecturer on television at the technical school of Temple University. The chapters include such features as "How Television Works," "Pre-cautions," "Antenna Construction" and "Notes on Soldering" as well as actual construction procedures. The booklet is available at \$1.50 a copy.

Television

→ From Page 22

carrier does not fall below a minimum value during transmission. Otherwise the sound which depends upon the video signal being detected will not be obtained.

The intercarrier system is just one of the many developments which will bring the prices of television receivers into the popular market. ✓ ✓ ✓

RADIO TUBES

First Quality R.M.A. Guaranteed

50% DISCOUNT
off the regular list price

Plenty of hard to get numbers. Order any tubes you need. 25% Deposit on C.O.D. If you send cash we pay postage.

MIDWAY RADIO TUBE CO.

3858 South Parkway Chicago 15, Illinois

TUBULAR ELECTROLYTICS

Fresh stock Fully guaranteed

20 mfd. 150 V. 10 for \$1.79
20-20 mfd. 150 V. 10 for 2.49
8 mfd. 450 V. 10 for 1.85

Postage extra, 25% deposit on C.O.D.
Write for our free bargain lists featuring
"AMERICA'S BEST BUYS"

POTTER RADIO CO.

1314-M McGee Street Kansas City 6, Mo.

THE INDUSTRY PRESENTS



SIGNAL TRACER

The Precision Model 250 Signal Tracer features a four stage, high gain (over 80 db) amplifier and a shielded probe, which has a series capacity of only 3 uuf. The frequency response is linear from 30 to 15000 cps. The instrument is also a vacuum tube voltmeter useful for measuring high impedance voltages and stage gains. A 5-inch PM speaker is built into the cabinet, which is metal and measures 6 $\frac{1}{4}$ " x 12 $\frac{1}{4}$ " x 9". For further information write to Precision Electronics, Inc., 641-643 Milwaukee Ave., Chicago 22, Ill.

HIGH-SENSITIVITY KILOVOLTMETERS

A new series of high sensitivity kilovoltmeters specifically adapted for measurement in television and similar electronic circuits has been announced by the Shallcross Manufacturing Company. All portable, a feature of their design is the fact that little current is drawn from the circuits in making high-voltage measurements. The eight kilovoltmeters in the line provide both DC types, as well as AC-DC types in practically any required voltage combination. They are accurate to 2% for DC and 5% for AC measurements.

Further information will be sent upon request to the Shallcross Manufacturing Company, Collingdale, Pa.

PORTABLE AMPLIFIER

The "Bingo" amplifier, produced by Audar Inc., Argos, Indiana, is a complete portable PA system. It has sufficient power for audience coverage up to 300 or more persons. Speaker and amplifier are contained in a two-toned leatherette carrying case, equipped with 6 foot line cord for use on 115 volts 60 cycles. Total weight is 7 lb. 14 oz., and size of the case is 11 $\frac{3}{4}$ in. by 6 in. by 10 in.



AUTO SPEAKERS

Utah announces three new auto radio replacement speakers. Known as Models SE5S6, SE6S6 and SE7Y6, these Electro-Dynamic speakers are available in sizes of five, six and seven inches. Model SE7Y6 is shown. Including a 3 ohm voice coil and 4 ohm field coil, the speaker mountings are square type. For more information, write to Utah Radio Products, Huntington, Indiana.

STEPPED-UP CAPACITOR VOLTAGES

The voltage ratings of several Aerovox standard paper and oil-filled capacitor types have been extended to meet the elevated voltages encountered in television receivers, as well as in cathode-ray oscillographs. Series "84" (tubular paper capacitors) are now made in ratings up to 10,000 volts D.C.W. The midget-can Series "89" and the round-can Series "12" and "14" are available in extended voltage ratings from 3500 to 7500. Series "14" is available in the double-ended design or with pillar terminals at either end and with two adjustable ring mountings.

CRYSTAL CARTRIDGE

The Astatic Type "LT" crystal phono cartridge has an output of 1.00 volt, avg. at 1,000 cps; minimum needle pressure, 1/4 oz.; cutoff frequency, 4,000 cps; and replaceable Type "T" needle with a precious metal playing tip. Low surface noise and low needle talk are features of the new cartridge. Further information is available from The Astatic Corporation, Conneaut, Ohio.

Built for Service



Servicemen's choice!
in . . .



● Michigan more than meets Cunningham tubes half way . . . because Cunninghams have an unbeatable record of long life and trouble-free service. When you replace with Cunninghams, you can be sure they'll live up to their promises.

See your
CUNNINGHAM DISTRIBUTOR

RADIO SUPPLY & ENGINEERING CO., Detroit
WEST SIDE RADIO SUPPLY Detroit
RADIO TUBE MERCHANDISING CO., Flint
FULTON RADIO SUPPLY CO. . . Jackson
NORTHWEST RADIO Laurium

Cunningham Tubes

A product of
RADIO CORPORATION OF AMERICA
Harrison, N. J.

Everything in RADIO

and electronics

in **ONE** book!

over **1000** pages

A complete, easy-to-read handbook... All the expert knowledge in radio at your fingertips... instant reference in 12 big sections in the **RADIO DATA BOOK** handsomely bound in red & gold.

Plan every operation in radio and electronics with the *Radio Data Book*. This new radio bible will be your lifelong tool... you will use it every day, on the board, at the bench, in the field! Use it for engineering, construction, troubleshooting and testing. The **RADIO DATA BOOK** will be your invaluable aid in design, experiment and in layout. It will help make your production better, faster and easier. In any and every operation in radio and electronics, you will use the **RADIO DATA BOOK!**

The **RADIO DATA BOOK** is a work of complete authority, prepared by engineers with many years of practical experience. They have been assisted by the Boland & Boyce staff of editors skilled in preparing electronics manuals for the U. S. Signal Corps for many years. These men have worked for several years gathering material for this book... all the knowledge of radio principles and operation... all the statistics... all the newest developments in electronics... every possible angle and detail. Eighteen months were spent digesting this material into the most concise, the clearest, and the most readable form. The result is this invaluable manual... The **RADIO DATA BOOK**. Whether you use this book for general reference, for scientific instruction, or for education, one thing is certain—the practical help, the daily usefulness you will derive from it will prove to be worth many, many times its astonishingly low price!

Advanced Sale... first printing. Only 10,000 available... To make sure to get your **RADIO DATA BOOK**, mail your order **NOW!**

CONTENTS

Each section is a **COMPLETE** coverage of its subject... 12 sections 12 books in **ONE!** 1000 pages... Schematics... Accurate photographs... Specially prepared drawings... White on black charts... Diagrams... Isometric projections and exploded view.

- Section 1. **THE 150 BASIC CIRCUITS IN RADIO.**
Every circuit is analyzed and explained in a Johnny-on-the-spot reference for any occasion.
- Section 2. **COMPLETE TEST EQUIPMENT DATA.**
Know more about the test instruments you now have... Find the new ones you want to buy... They're ALL in here—impartially described!
- Section 3. **TESTING, MEASURING AND ALIGNMENT.**
Simplified operation of the Oscilloscope... See what's happening inside any radio circuit... Dynamic alignment—AM, FM and TELEVISION made easy with the Oscilloscope... Scientific use of the Vacuum Tube Voltmeter, Signal Generating Equipment and other basic instruments.
- Section 4. **ALL ABOUT ANTENNAS.**
AM-FM-Television... design, installation, characteristics, construction and feed.
- Section 5. **SOUND SYSTEMS.**
Planning, installing and servicing a PA System. A complete chapter on every component... How to select and combine components... estimating costs... even acoustic requirements!

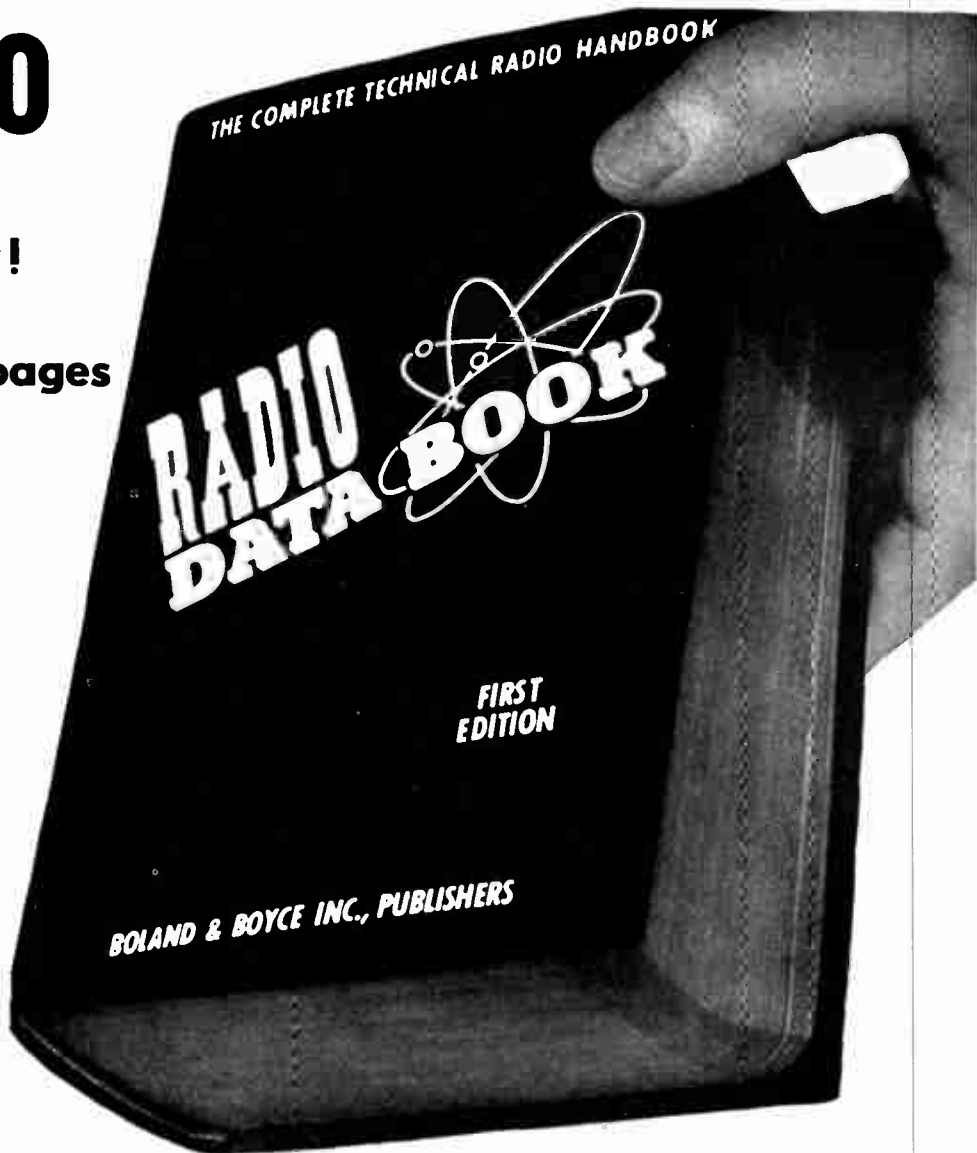

- Section 6. **RECORDING.**
- Section 7. **COMPLETE TUBE MANUAL; Receiving, Transmitting and Commercial.**
A flick of the pages brings you to all the data and ratings of any tube model!
- Section 8. **CHARTS, GRAPHS AND CURVES.**
Quick calculation devices... Plotting curves, nomographs, rules and tables for speedy solutions to radio problems.
- Section 9. **CODES, SYMBOLS AND STANDARDS.**
Handy reference to all radio symbols and abbreviations; code symbols, phrases and characters... Where you want them... When you want them!
- Section 10. **50 TESTED CIRCUITS DESIGNED FOR OPTIMUM PERFORMANCE.**
Find any circuit you want with complete parts lists and specifications... One tube receivers to complete AM, FM and Television receiver circuits... Amplifiers... Transmitters... Test Equipment and Control Circuits... All with the latest engineering refinements.
- Section 11. **DICTIONARY OF RADIO AND ELECTRONIC TERMS.**
- Section 12. **RADIO BOOK BIBLIOGRAPHY.**

12 complete books in one only \$5.00. Less than 42c per book

Mail This Coupon To Your Jobber Today or Direct to:
BOLAND & BOYCE INC., PUBLISHERS RM-3
460 BLOOMFIELD AVE., MONTCLAIR, N. J.

Please send me a copy of
THE RADIO DATA BOOK Enclosed is \$5.00 (\$5.50 Foreign)

NAME
ADDRESS
CITY ZONE.....
STATE

BOLAND & BOYCE INC., PUBLISHERS

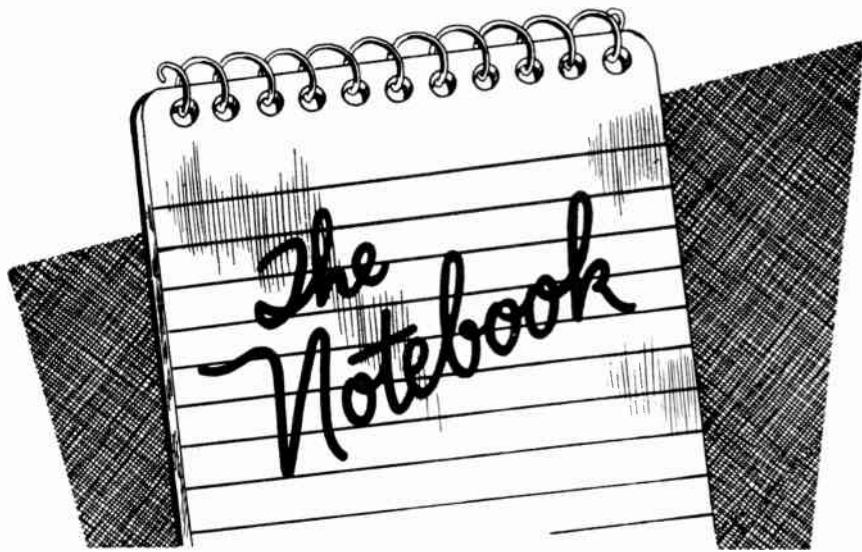

Each month the reader sending in the best suggestion receives a crisp ten dollar bill. For all others published, RADIO MAINTENANCE will pay five dollars. Let's hear from you. All entries become the property of Radio Maintenance.

Coding Socket Wrenches

A GOOD way to save time in handling socket wrenches is to color code them. Paint them either completely (on the handle) or with a dot using the RMA color code. For instance, the smallest would be brown, the next larger would be red, the next orange, etc. In this way, if a wrench is too big or too small for a job, you can immediately spot the proper one.

B. A. Bolten
Stamford, Conn.

Trouble Light

A handy trouble light for examining receivers being repaired can be rigged up as shown in the illustration. An adapter is made and leads from the filament prongs

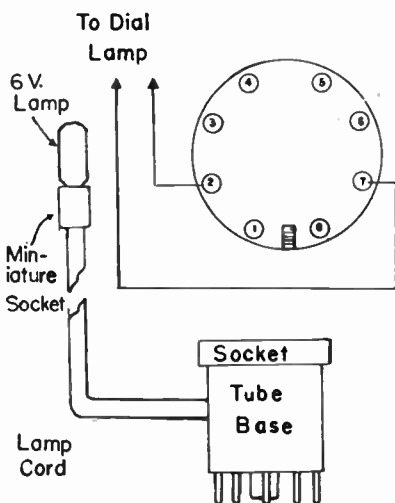

brought out through the side and through a flexible cord to a flash-light bulb. The adapter is the ordinary kind made from an old tube base and socket. The adapter is plugged into a socket in the receiver and the proper tube plugged into the top of the adapter. The tube is then connected properly, and the trouble light will operate.

San Antonio, Texas
Ed. G. Roquet

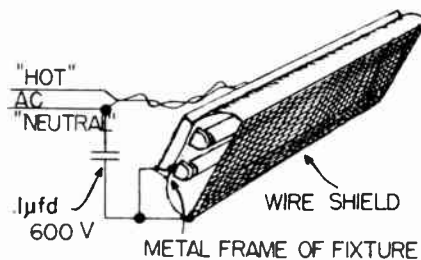

Noise Eliminator

If you have trouble with noise from the fluorescent light over your bench, here's a way to get rid of it. Some coarse mesh wire shielding material is spread over the front of the light as shown. Then you ground the mesh to the AC neutral lead through a .1 µfd 600 V. condenser. You'll probably get a little less light but a lot less noise.

Vic Kecknagel
Vic's Radio Shop
Burlington, Wis.



Servicemen's choice!...
Cunningham Sales Aids



● Don't miss this colorful catalog of Cunningham Sales Aids. It describes the exciting new group of Cunningham posters, comuras, illustrated signs, and many other business builders . . . tells you how these displays bring customer attention to your shop. Get your free copy today from your Cunningham Distributor.



SPECTACULAR VALUES IN BRAND NEW RADIO PARTS ELECTRONIC EQUIPMENT from MID-AMERICA

Never before such amazing values in brand-new radio parts and electronic equipment! Shown here are just a few of the BIG BARGAINS Mid-America has to offer now! Order from this ad—and ask for Mid-America's BIG-BARGAIN BULLETINS. You'll save money on everything!

FM TRANSMITTER

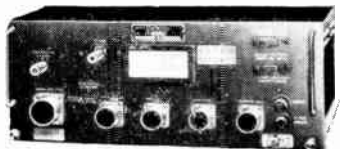

Used as indicator for altitudes up to 4000 ft.—but readily adapted for signaling, control circuits, etc. Contains dynamotor for operation from 27.5 volts. Complete with all 14 tubes: 2-12116, 2-955, 2-9004, 4-12SJ7, 3-12SH7, and VR-150-30. Two antennas, altitude indicator, limit switch, connectors, instruction manual. MA-2198. **\$3795**

Secondary Frequency Standard

Used to identify band edges and frequencies of unknown signals. Unique assembly uses 2-12SL7GT and 1-12SA7. Frequency divider and multiplier circuits provide 1000-cycle modulated outputs on 50KC and 200KC with harmonics up to 18MC. Complete with tubes, schematic diagram, less 200KC crystal. MA-OSG-3T. **\$295**



DACO Tube Tester

Tests performance, leakage and shorts in ALL receiving tubes, even sub-miniature and acorn. PLUS provision for tubes that may be invented. Durable construction is fully shielded; dust-proof case, high-visibility meter, illuminated chart; no books or charts to be misplaced. Simple, fast operation with positive contact slide-switches; tests EVERY tube element. 110 volt AC. 16 1/2" x 14 1/2". MA-2193. **\$2950**

PORTABLE DACO TUBE TESTER

Same construction and operating features as counter model. Enclosed in sturdy case with durable black leatherette covering. 12 3/4" x 12 3/4". MA-2194. **\$3250**

FM and HAM ANTENNA



AN-104-B. 1/2-wave at 100-156 MC; formerly used with SCR-522, 274-N, ARC-5. A pair make an excellent broad-band dipole for FM reception. Coaxial connector in base. Very sturdy; use anywhere. MA-2153. **39c**

Special Filament Transformer

115-volt, 60 cycle primary; 3 secondaries: 2.5V-10 amp, 6.3 VCT-5.5 amp, and 6.3VCT-1 amp. Hermetically sealed for long life; insulation tested at 5000 volts. Porcelain insulated connector lugs. MA-2066. **\$295**

FREE BULLETINS

Order these values now—right from this ad! Send 25% deposit—we ship COD for balance plus postage. Write, too, for Mid-America's BIG BARGAIN BULLETINS that list hundreds of latest, greatest buys—many hard-to-get items—ALL AT UNBELIEVABLE LOW PRICES. Mail orders and catalog requests to store address, attention Desk RM38

MID-AMERICA CO. Inc.
STORE 2412 S. MICHIGAN AVE. CHICAGO 16, ILL.
WAREHOUSE 2307 S. ARCHER AVE. CHICAGO 16, ILL.

BACK NUMBERS Get Them While They Last

JANUARY 1946

THE PROBLEMS OF ORGANIZATION
TELEVISION RECEIVER INSTALLATION
RADIO MAINTENANCE IN AVIATION
USING THE OSCILLOGRAPH FOR
DISTORTION MEASUREMENTS

APRIL 1946

A MIDGET AUDIO FREQUENCY
OSCILLATOR
IF I WERE A SERVICEMAN
AN EQUALIZED AMPLIFIER FOR
MAGNETIC PICKUPS

MAY 1946

PA SYSTEMS
TEST PANEL FOR THE MODERN BENCH
RINGING THE BELL

JUNE-JULY 1946

FUNDAMENTALS OF TELEVISION
VOLUME CONTROL TAPERS
THE ELECTRONIC OHMMETER
VECTOR ANALYSIS

AUGUST 1946

AVC CIRCUITS
FM TROUBLESHOOTING
TELEVISION RECEIVER FUNDAMENTALS
RECORD CHANGERS

DECEMBER 1946

TELEVISION RECEIVERS . . .
THE RF SECTION
TUNING THE INDICATORS
PART II—THE OSCILLOGRAPH . . .
HOW TO USE IT
REPLACING AUTO CABLES

JANUARY 1947

SERVICING BY EAR
TELEVISION RECEIVERS . . . VIDEO
CHANNEL
PART III THE OSCILLOGRAPH . . .
HOW TO USE IT
MINIATURE TUBE CHART

FEBRUARY 1947

THE OSCILLOGRAPH . . . HOW TO USE
IT PART IV
TELEVISION RECEIVERS . . . THE SOUND
CHANNEL
THE AUDIO OSCILLATOR
SELENIUM RECTIFIERS

MARCH 1947

ANTENNAS . . . FM AND TELEVISION
PART I
SERVICING AUTOMATIC RECORD
CHANGERS
OSCILLATORS AND CONVERTERS
TELEVISION RECEIVERS . . . THE VERTICAL
SWEEP

APRIL 1947

ANTENNAS . . . FM AND TELEVISION,
PART II
PHASE INVERTER CIRCUITS
A UNIVERSAL SPEAKER
TELEVISION RECEIVERS . . .
THE HORIZONTAL SWEEP

MAY 1947

THE OPEN AND CLOSE CASES
VOLTAGE DOUBLERS
SIGNAL TRACER
TELEVISION RECEIVERS . . . THE
CATHODE RAY TUBE

JUNE 1947

WHEN THE CUSTOMER ISN'T RIGHT
TEST EQUIPMENT MAINTENANCE
CRYSTAL CONTROLLED SIGNAL
GENERATOR
TELEVISION RECEIVERS . . . THE
POWER SUPPLY

JULY 1947

SERVICING FM RECEIVERS
TEST EQUIPMENT MAINTENANCE, PART II
TELEVISION RECEIVERS . . .
FLYWHEEL SYNC

AUGUST 1947

SPEAKER MATCHING
TEST EQUIPMENT MAINTENANCE, PART III
SERVICING FM RECEIVERS
TELEVISION . . . HF POWER SUPPLIES

RADIO MAINTENANCE MAGAZINE 460 BLOOMFIELD AVE., MONTCLAIR, N. J.

Please send me the back numbers checked here . . .
I am enclosing 35c for each copy, or \$2 for any B copies, or \$3.25 for all 14.

January 1946
 April 1946
 May 1946
 June-July 1946
 August 1946
 December 1946
 January 1947
 February 1947
 March 1947
 April 1947
 June 1947
 May 1947
 July 1947
 August 1947

Have selected B copies . . . enclosing \$2.00
 Send me all 14 . . . enclosing \$3.25

NAME
ADDRESS
CITY
ZONE STATE

30,000 SERVICE TECHNICIANS

Read
RADIO MAINTENANCE
Every Month
Every day is
RADIO MAINTENANCE
day in your shop!

RADIO MAINTENANCE
460 Bloomfield Ave.,
Montclair 1, N. J.

Please send me RADIO MAINTENANCE for:

2 years at \$5.00
 1 year at \$3.00
 Check enclosed
 Bill me later

Name
Occupation
Address
City Zone
State

THIS MONTH'S BEST BUYS IN RADIO!



Here's what servicemen have been waiting for—a frequency modulated FM and TV sweep signal generator. With this new McMurdo-Silver 909 and your oscilloscope, you can visually align FM and TV sets—quickly and easily. Your cost at Almo, \$48.50.



Here's a fine receiver in the low price field. Distinguished Belmont features electrostatically deflected seven inch tube, with reception on all 13 television channels. List price is \$250.00.



Telesweep oscillator gives you quick accurate measurements for television circuits. Frequency range of 5-100 mc and 170-216 mc, sweep width 500kc — 10mc. Maximum output 1 volt. RF probe for point-to-point check. Your cost, \$68.50.



Espey's basic television kit is the receiver for every television beginner to learn the fundamentals of TV. It's easy to assemble; no previous knowledge of television required. There's a pictorial instruction book included to show every step of the way. Your cost is \$69.50, less tubes. Write or stop in for further details on this unusual kit.

PHONE WRITE OR WIRE TODAY TO:

Phone
LO 3-9225

Almo **RADIO CO.**

509 ARCH STREET
PHILADELPHIA, PENNA.

SAY YOU SAW IT IN RADIO MAINTENANCE!



Don't turn your back on Sound Sales!

You—the radio service technician—are in for a lot of money—when you sell and install sound equipment. You can create new markets for sound in your area as well as supply the big ones already there. People are now purchasing sound projectors so they can enjoy "talkies" in their own homes—and it will be your job to install good sound systems for them. We will supply you with all the components you need. We carry only the best lines of sound as well as other radio merchandise. Come in, or call or write us today—say you saw this ad in **RADIO MAINTENANCE**—and we'll help you gain bigger profits.

DYMAC, INC.

RADIO PARTS & ELECTRONIC EQUIPMENT

2329-31 MAIN ST., BUFFALO 14, N. Y.

TEL. PA 2300

World Radio History