

THE 1927

RADIO CALL BOOK

PUBLISHED BY RADIO DOINGS
COMPLETE AND UP-TO-DATE OFFICIAL LIST
OF BROADCAST STATIONS COMPILED BY THE
U.S. DEPARTMENT OF COMMERCE

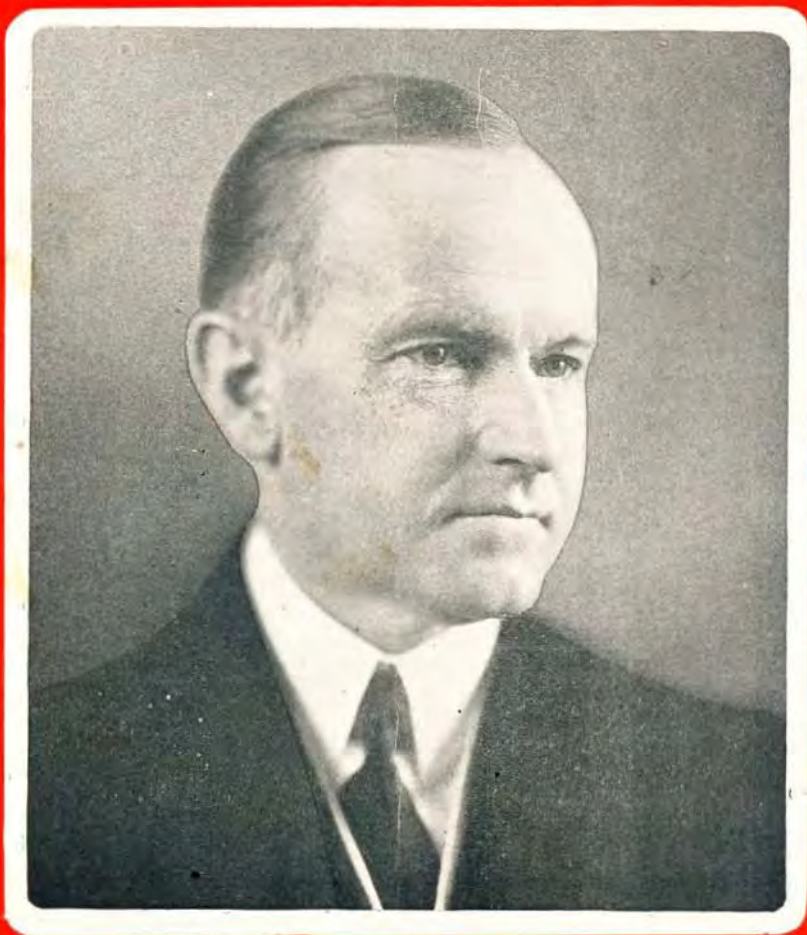

Price 25 Cents

ONCE MORE CROSLLEY

Is Demonstrating Its
Dominant Leadership
in 1927 Radio

Ours is the task and the privilege of distributing Crosley Radio Sets in California. We sell them for exactly what they are—maximum values at minimum cost.

And back of every sale is an organization of specialists who understand dealers' problems and dealers' needs. Our success is the best proof of efficient, friendly, personal service.

KOLSTER CROSLLEY BRANDES
BURGESS BATTERIES RADIOTRONS
TUNGAR AMRAD VESTA
ACME MODERN

Distributed by

H. Earle Wright, Inc.

123 Second St., San Francisco 415 E. Eighth St., Los Angeles



Installed *FREE*
***Runs Any Radio from
 Electric Light Socket***

Think of it—your old "A" and "B" Batteries done away with forever—your Radio power as dependable as your electric lights. It makes no difference what kind of current you have, (50 or 60 cycle), Pemco will give you full satisfaction.

Improved reception is assured with a Pemco—no hum or distortion, but full power all the time. Everything is automatic on a Pemco—there are no switches on it—you turn your radio off and on the same as before.

There is a Pemco Dealer near you, or write one of the distributors today. Run your Radio with Pemco Power—better quality, easier distance, greater economy. Sold on easy terms.

SHERMAN, CLAY & CO.
 948 Santee St., Los Angeles

THE ELECTRIC CORP.
 1050 Santee St., Los Angeles

PACIFIC WHOLESALE RADIO, INC.
 1320 S. San Pedro St., Los Angeles

Pemco

Automatic

"A" and "B" Power Unit

Consider All Things If You Are Trying For Distance

Here are points to check over if you are not bringing in the stations:

1. Learn whether your set was built to bring in distant points—you may be trying to over reach your set's possibilities.
2. Your aerial must be of sufficient length— too short an aerial may be handicapping you.
3. Check over the tubes. One or more may not be operating.
4. Your "A" and "B" power must be right. The correct voltage on each circuit in your set will give you results otherwise unobtainable.

The Willard "A" and "B" Power Units, designed and built by the Engineers who built the famous Willard "B" batteries in use by 175 of the world's broadcast stations, are what you may need to get stations that now seem to be beyond the reach of your set. The voltage control on the Willard "B" power unit permits the raising or lowering of the plate voltage to the exact point in each circuit necessary for the best reception. This is especially important when fishing for distance.

ASK ABOUT WILLARD POWER UNITS
AT
WILLARD SERVICE STATIONS
OR
YOUR NEAREST RADIO DEALER

The 1927 Radio Call Book

Published by

Radio Doings

LOS ANGELES
527-9 Van Nuys Bldg.
Tucker 8468

NEW YORK
17 West 42nd Street
Vanderbilt 4661

SAN FRANCISCO
406 New Call Bldg.
Douglas' 1388

JANUARY 1, 1927

TUNING

Tuning for local and distant stations to get the very best results, which means clear, perfect tones, is very much like driving an automobile or working out a mathematical problem. It takes patience, and you must be exact to get perfect results. It has been my good fortune to bring in many distant stations, and I have obtained the results by following the procedure described below. Make sure that your batteries are at full charge, or if using an eliminator, that it is functioning properly, also that the tubes are in proper condition. If you are convinced that your set is in perfect working condition, then tune in all of the local stations, bringing them to the peak of oscillation and that you have their exact reading, then write the readings in a log for future reference.

Take any graph paper that is ruled off in either ten or twenty sections to the inch (if you haven't a sheet of graph paper it is easy to make one with a ruler and a pencil); write the dial numbers opposite the horizontal lines; such as, ten, twenty, eighty, etc.

Opposite the vertical lines put the meter wave length; such as, 200, 300, 350 and 500. Write the names of your

stations in on the exact meter number and you then have a perfect chart station finder. Transfer from your log the readings of your dial or dials to the chart. If the set is equipped with more than one dial, the first dial being the Antenna Tuning Dial will sometimes vary, due to the length of the antenna, but the second and third dials will nearly always remain constant.

Take a ruler and draw a straight line on your chart from the highest wave length station to the lowest wave length station. This will make it possible, if your set is calibrated correctly, to bring in any distant station within the range of your set.

You are now ready to go after distance. Suppose you want a station which is two thousand miles away, refer to your graph chart and go down the horizontal line of 350 meters until you cross the line that you have drawn on your chart. If the 350 meter line crosses the line that you have marked on your chart it will mean that this distant station should come in, say, at approximately forty on your dial. If you have more than one dial on your set, the same procedure should be followed

(Continued on Page 58)



Buy with confidence, where you see this sign.



RCA ♦ Radiola *super-heterodyne* does not grow old

For the finest radio broadcast reception, we recommend a Radiola and RCA loudspeaker. They are products of the combined electrical and radio knowledge of the Radio Corporation of America, General Electric and Westinghouse.

See Your Authorized Dealer



Illinois Electric Co.
315 S. San Pedro Street
LOS ANGELES

Leo J. Meyberg Co.
1022 Wall Street
LOS ANGELES

Pacific States Electric Co.
236 S. Los Angeles Street
LOS ANGELES

Wholesale Distributors

RCA Radiotrons

are the perfected result of technical research in the radio laboratories of the Radio Corporation of America, the General Electric Company, and the Westinghouse Electric and Manufacturing Company.



The Banta Co.
1805 S. Hill Street
LOS ANGELES

Pacific States Electric Co.
236 S. Los Angeles Street
LOS ANGELES

Chanslor & Lyon
1423 S. Grand Avenue
LOS ANGELES

Reiman Wholesale Elec. Co.
218 E. Third Street
LOS ANGELES

Illinois Electric Co.
315 S. San Pedro Street
LOS ANGELES

Sherman Clay Co.
944 Santee Street
LOS ANGELES

Leo J. Meyberg Co.
1022 Wall Street
LOS ANGELES

H. Earle Wright Co.
415 E. Eighth Street
LOS ANGELES

Wholesale Distributors

At Your Service

Walbert Isofarad Radios

Ranging in Price from
\$75.00 to \$650.00
Some With Battery Elimination

McMillan Radios

The Best Low-Priced Radio on the Market
\$55.00 to \$105.00

Utah Loud Speakers

Best By Test
\$10.00 to \$25.00

Walbert Penetrola

\$35.00

United Cabinets

Most Complete Line of Cabinets on the Coast
\$40.00 to \$250.00

C. W. SMITH CO.

Home of Utah Speakers

1125 Wall Street, Los Angeles, Cal.

WEstrome 3291

THE ADVANCED HANDY TRICKLE-BOOSTER CHARGER

Converts your present battery into an up-to-date "A" Power Unit.

For Either 6 or 4 Volt
Storage Batteries

Absolutely quiet — Uses the long-life, 2 ampere bulb.

Great Flexibility — Long Life — Maximum Efficiency.



The Solution to the Radio "A" Power Problem

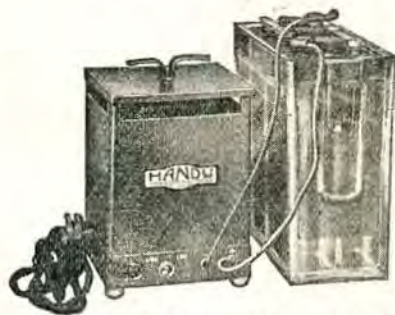

The Handy Trickle-Booster Charger with its "slow and fast" rate feature, gives the radio fan two chargers in one compact unit at a price lower than the standard battery charger. Should be permanently connected.

Ideal for console and built-in battery cabinets.

110 Volts, 50 or 60 Cycle—Complete—\$15.00

Ask Your Dealer for a Demonstration

C. C. LAWTON CO.

1125 Wall Street

Los Angeles

Westmore 3291

Broadcasting Stations by Meters

Wave Length Meters	Call Signal	Fre- quency Kilo- cycles	Location of Station	Power In Watts	Dial Settings			Remarks
					1	2	3	
555	WOBB	540	Chicago, Ill.	5				
545	KFUO	550	St. Louis, Mo.	500				
545	KSD	550	St. Louis, Mo.	500				
545	WTAG	550	Worcester, Mass.	500				
535	KYW	560	Chicago, Ill.	3500				
535	WHA	560	Madison, Wis.	750				
526	WHO	570	Des Moines, Iowa	5000				
526	WNYC	570	New York, N. Y.	1000				
526	WOAW	570	Omaha, Nebr.	1000				
517	WCX	580	Detroit, Mich.	5000				
517	WJIB	580	New York City	250				
517	WJR	580	Pontiac, Mich.	5000				
508	KLX	590	Oakland, Calif.	500				
508	KFQB	590	Fort Worth, Tex.	1000				
508	WIP	590	Philadelphia, Pa.	500				
508	WOO	590	Philadelphia, Pa.	500				
500	KRSC	600	Seattle, Wash	50				
500	KFRU	600	Columbia, Mo.	500				
500	WCSH	600	Portland, Me.	500				
500	WMC	600	Memphis, Tenn.	1000				
492	KGW	610	Portland, Ore.	1000				
492	WEAF	610	New York, N. Y.	5000				
491	WCFL	610	Chicago, Ill.	1000				
484	WOC	620	Davenport, Iowa.	5000				
484	WSUI	620	Iowa City, Iowa	500				
476	KGDI	720	Seattle, Wash.	50				
476	WBAP	630	Fort Worth, Te.	1500				
476	WFAA	630	Dallas, Tex.	500				
476	WTIC	630	Hartford, Conn.	500				
469	WJBT	640	Chicago, Ill.	500				
469	WRC	640	Washington, D. C.	500				

IF YOU CAN'T BRING THEM IN SEE PAGE 4

MOST RADIO PER DOLLAR

IF you think this is merely a slogan for King Radio, then we invite you to go to any of the dealers whose names are listed below. Look at any King Radio. Inspect it. Mark its marvelous construction. See the Cushioned Tube Mounting. The Single Dial Station Selector. Feast your eyes on the mellow beauty of its fine cabinet work. Then listen to it. Wonderful purity of tone. Volume to spare. Selectivity that will amaze you.

After seeing the King, after hearing the King—write down the price you think it should be! Then ask what the price really is! You will not argue—you will know what we mean when we say King Radio is truly "Most Radio Per Dollar."

Distributors for Los Angeles Territory:

THE BANTA COMPANY

1801 S. HILL STREET

LOS ANGELES, CALIFORNIA

"Most Radio Per Dollar"

KING RADIO

Broadcasting Stations by Meters (Continued)

Wave Length Meters	Call Signal	Frequency Kilo-cycles	Location of Station	Power in Watts	Dial Settings			Remarks
					1	2	3	
467	KFI	640	Los Angeles, Calif.	5000				
461	KFNF	650	Shenandoah, Iowa	1000				
461	KMA	650	Shenandoah, Iowa	500				
461	WAPI	650	Auburn, Ala.	1000				
461	WCAE	650	Pittsburgh, Pa.	500				
454	KFOA	660	Seattle, Wash.	1000				
454	KTW	660	Seattle, Wash.	1000				
454	WJZ	660	New York, N. Y.	50000				
448	WMAQ	670	Chicago, Ill.	1000				
448	WQJ	670	Chicago, Ill.	500				
445	KSO	740	Clarinda, La.	500				
441	KLDS	680	Independence, Mo.	1000				
441	WDWF	680	Cranston, R. I.	500				
441	WDWF	680	Cranston, R. I.	500				
441	WMAF	680	So. Dartmouth, Mass.	1000				
441	WOS	680	Jefferson City, Mo.	500				
434	KGCH	663	Wayne, Neb.	500				
434	NAA	690	Arlington, Va.	1000				
431	KFKB	695	Melford, Kans.	1000				
431	WHAP	695	New York City	500				
430	WNAC	697	Boston, Mass.	500				
430	KFXF	697	Denver, Colo.	500				
428	KPO	700	San Francisco, Calif.	1000				
428	WKDR	700	Kenosha, Wis.	10				
428	WSB	700	Atlanta, Ga.	1000				
422	WEDC	710	Chicago, Ill.	1000				
422 326	WKRC	710 920	Cincinnati, Ohio	1000				
422	WLW	710	Cincinnati, Ohio	5000				
416	WBBR	720	Rossville, N. Y.	500				
416	WCCO	720	Anoka, Minn.	5000				
416	WCRW	720	Chicago, Ill.	50				

IF YOU CAN'T BRING THEM IN SEE PAGE 4



Have You Ever Heard Complete Reception?

—Not until you “listen in” to Fada Harmonated Reception, a new development in radio science, will you hear *all* that the air has to offer.

And what a difference that makes!

The superiority of Fada Harmonated Reception over ordinary radio is almost incredible!

Individually and totally shielded stages, together with perfect co-ordination of all items in the receiver and reproducer, form the basis for this remarkable reception.

Fada Harmonated Reception is now being demonstrated —*don't fail to hear it*— Write us for the nearest dealer.

Fada Neutrodyne Receivers—table and furniture models—8, 6 and 5 tubes—\$85 to \$120. Fada Cone Speaker—Table Type \$37. Pedestal Floor Type \$52.50

THE ELECTRIC CORPORATION

1050 Santee St., Los Angeles, Cal.

Phone WEStmore 8341

Broadcasting Stations by Meters (Continued)

Wave Length Meters	Call Signal	Frequency Kilo-cycles	Location of Station	Power in Watts	Dial Settings			Remarks
					1	2	3	
407	WJAF	737	Ferndale, Mich.	50				
405	KHJ	740	Los Angeles, Calif.	500				
405	KMMJ	740	Clay Center, Neb.	1000				
405	WJY	740	New York, N. Y.	1000				
405	WOR	740	Newark, N. J.	500				
400	WHAS	750	Louisville, Ky.	500				
395	KHQ	760	Seattle, Wash.	1000				
395	WFL	760	Philadelphia, Pa.	500				
395	WLIT	760	Philadelphia, Pa.	500				
395	WOAI	760	San Antonio, Tex.	2000				
391	WODA	767	Paterson, N. J.	250				
389	WEAR	770	Cleveland, Ohio	750				
389	WTAM	770	Cleveland, Ohio	3500				
384	KJR	780	Seattle, Wash.	1000				
384	WAAW	780	Omaha, Nebr.	500				
384	WGWB	780	Milwaukee, Wis.	1000				
384	WLWL	780	New York, N. Y.	5000				
384	WMBF	780	Miami Beach, Fla.	500				
384	WWAE	780	Plainfield, Ill.	10				
380	KFBC	790	San Diego, Calif.	100				
380	WGY	790	Schenectady, N. Y.	5000				
380	WHAZ	790	Troy, N. Y.	1000				
375	KFBU	800	Laramie, Wyo.	1000				
375	KTHS	800	Hot Springs, Ark.	1000				
375	KVOO	800	Bristow, Okla.	500				
375	WRNY	800	Coytesville, N. Y.	500				
370	KMTR	810	Los Angeles, Calif.	500				
370	WEBH	810	Chicago, Ill.	2000				
370	WJJD	810	Mooseheart, Ill.	1000				
367	WEAN	817	Providence, R. I.	500				
366	KZUK	820	Bagino, P. I.	500				

IF YOU CAN'T BRING THEM IN SEE PAGE 4

ATWATER KENT RADIO



Atwater Kent Radio 320 by
new tubes and batteries.
Atwater Kent Radio Speak
111 37 140



The Choice of Explorers

Over thousands of miles of barren waste the delicately sensitive Atwater Kent Model 32 brings news of the outside world to isolated explorers.

When life itself depends upon radio communication, you may be sure that these men, trained in a technical knowledge of radio, will select the best receiver that money can buy—price is no object.

This same dependability and great range, this super-sensitiveness and exacting selectivity will be your joy and comfort through the long watches of the night when you go "radio exploring."

Try one out tonight in your own home; your nearest dealer will be glad to make the arrangements, without the slightest obligation to you.

MODEL 32
\$145
(Less Accessories)

RAY THOMAS, INC.

Atwater Kent Distributor

1248 South Hope St.

WESTMORE 6334

Los Angeles, Calif.

Broadcasting Stations by Meters (Continued)

Wave Length Meters	Call Signal	Frequency Kilo-cycles	Location of Station	Power in Watts	Dial Settings			Remarks
					1	2	3	
366	WDAF	820	Kansas City, Mo.	1000				
366	WHB	820	Kansas City, Mo.	500				
365	WBRL	821	Pilton, N. H.	500				
363	WKBW	827	Buffalo, N. Y.	1000				
361	KGO	830	Oakland, Calif.	5000				
361	WHN	830	New York, N. Y.	500				
361	WKBS	830	Galesburg, Ill.	200				
360	KSOO	833	Sioux Falls, S. D.	100				
360	WEW	833	St. Louis, Mo.	1000				
360	WKBM	833	Youngstown, Ohio	25				
360	WQAQ	833	Cliffside, N. J.	500				
357	KRLD	840	Dallas, Texas	500				
353	WJAD	850	Waco, Tex.	500				
353	WWJ	850	Detroit, Mich.	1000				
351	WCGU	855	Lakewood, N. J.	500				
350	WNJ	860	Newark, N. J.	500				
349	KOB	860	State College, N. M.	1000				
349	KWSC	860	Pullman, Wash.	500				
349	WFEI	860	Boston, Mass.	500				
345	WCBD	870	Zion, Ill.	5000				
345	WLS	870	Crete, Ill.	5000				
341	KFAB	880	Lincoln, Nebr.	1000				
341	KSAC	880	Manhattan, Kans.	500				
341	WKAQ	880	San Juan, P. R.	500				
341	WMCA	880	Hoboken, N. J.	500				
340	WJBW	880	New Orleans, La.	30				
337	KFMX	890	Northfield, Minn.	50				
337	KNX	890	Los Angeles, Calif.	1000				
337	WCAL	890	Northfield, Minn.	500				
337	WCAM	890	Camden, N. J.	250				
337	WJAX	890	Jacksonville, Fla.	1000				

IF YOU CAN'T BRING THEM IN SEE PAGE 4

“—remarkably good!”



**ALL-AMERICAN
Reproducer**



**ALL-AMERICAN
Constant-B
Battery Eliminator**

That is the judgment, without exception, of radio experts and enthusiasts who have examined and tested these two fine units—

They mean *better reception*. Both have a great deal to do with finer tone-quality. You owe it to your own enjoyment of radio, to know the facts about these fine-quality accessories.

**ALL-AMERICAN
Reproducer**

For purity of tone this handsome product is outstanding among reproducers. It combines ingeniously all advantages of good cone-type reproducers—and the improved quality provided by a special sounding-board and sounding chamber. A highly sensitive unit which reproduces voice and instruments naturally and clearly. Perfect uniformity is maintained over the entire musical range, whether amplifiers are turned to full volume, or down to a whisper. Absolute freedom from “inherent pitch” prevents low throaty tones or twangy nasal effects.

Price \$27.50

**ALL-AMERICAN
Constant-B**

An attractive compact unit of silent efficiency—insures a dependable supply of uniform plate current. Five output taps, negative, +45, +67, +90, and a power tube tap adapt “Constant-B” to all requirements. A “Detector” control provides voltage variation between 10 to 60 volts. An “Amplifier” control allows a variation of 10 to 120 volts on the intermediate tap, without affecting the 90 volts supplied to first audio stage. A High-low switch adapts “Constant-B” to receivers of various current requirements.

Price \$39.00 Complete with Raytheon Tube

New 1927 Radio Key Book

Learn more about the fundamentals of radio. This *new* 48-page book contains an interesting analysis of radio in language anyone can understand—also complete constructional details of the leading types of circuits. Sent for 10c (coin or stamps) to pay for postage and mailing.

ALL-AMERICAN RADIO CORPORATION

4219 Belmont Avenue, Chicago, Illinois

OWNING AND OPERATING STATION WENR 4 246 METERS

Broadcasting Stations by Meters (Continued)

Wave Length Meters	Call Signal	Frequency Kilo-cycles	Location of Station	Power in Watts	Dial Settings			Remarks
					1	2	3	
335	KFBK	885	Sacramento, Calif.	100				
334	WBRS	761	Brooklyn, N. Y.	100				
333	KGBZ	900	York, Neb.	100				
333	KQW	900	San Jose, Calif.	500				
333	KTNT	900	Muscantine, Iowa	1000				
332	WBZA	900	Boston, Mass.	250				
331	KGCB	905	Oklahoma City, Okla.	50				
331	WBZ	905	Springfield, Mass.	5000				
330	WJAZ	910	Chicago, Ill.	1500				
330	WFRL	1280	Brooklyn, N. Y.	100				
326	WSAI	920	Cincinnati, Ohio	5000				
322	KOA	930	Denver, Colo.	5000				
322	WBNY	1430	New York, N. Y.	500				
319	KOIN	940	Portland, Ore.	1000				
319	WGR	940	Buffalo, N. Y.	750				
319	WSMB	940	New Orleans, La.	500				
317	KPSN	950	Pasadena, Calif.	1000				
316	KFDM	950	Beaumont, Tex.	500				
316	KFWM	950	Oakland, Calif.	250				
316	WAHG	950	Richmond Hill, N. Y.	500				
316	WEMC	950	Berrien Sprgs, Mich.	500				
316	WGBS	950	New York, N. Y.	500				
316	WGES	950	Chicago, Ill.	500				
315	WSBT	952	So. Bend, Ind.	250				
313	KSBA	959	Kennewood, La.	1000				
313	KWKH	959	Shreveport, La.	1000				
309	KDKA	970	E. Pittsburgh, Pa.	10000				
309	WKBO	970	Jersey City, N. J.	200				
306	KOIL	980	Council Bluffs, Iowa	500				
306	KFDY	980	Brookings, S. Dak.	500				
306	KOMO	980	Seattle, Wash.	1000				

IF YOU CAN'T BRING THEM IN SEE PAGE 4

STROMBERG-CARLSON

1. Your purchase price has been invested—not lost. It represents the truest form of permanent Radio value. Stromberg-Carlson prices never have been reduced and are **GUARANTEED** not to be reduced.
 2. Fidelity in reproduction never attained even in the "above the average" receiver. A Stromberg-Carlson covers 7 octaves of undistorted reception. The average is $3\frac{1}{2}$ octaves.
 3. A **WRITTEN** guarantee of satisfaction for one year. Stromberg-Carlson receivers are built for 50 years service, however, the same as their telephone equipment.
 4. Selectivity sufficient for the most exacting Distance Fan, but not with a sacrifice of tone quality in cutting the side bands of the broadcasting station so necessary in perfect reproduction.
 5. Power—plenty of it in reserve when you need it and under perfect control.
 6. Freedom from the petty ailments of ordinary receivers. Stromberg-Carlson construction throughout insures uninterrupted performance over a period of years.
 7. No yearly models nor radical changes in design. No Stromberg-Carlson receiver will become obsolete—its value will remain constant with its performance.
 8. A Stromberg-Carlson will outlast several ordinary receivers.
 9. Ask the man who has a Stromberg-Carlson.
-
-

WESTERN RADIO INC.

Broadcasting Stations by Meters (Continued)

Wave Length Meters	Call Signal	Frequency Kilo-cycles	Location of Station	Power in Watts	Dial Settings			Remarks
					1	2	3	
306	WJAR	980	Providence, R. I.	500				
303	KTAB	990	Oakland, Calif.	500				
303	WGN	990	Chicago, Ill.	1000				
303	WLIB	990	Elgin, Ill.	4000				
303	WMSG	990	New York City	500				
300	KFQD	999	Anchorage, Alaska	100				
300	KSL	1000	Salt Lake City, Utah	1000				
300	KUOA	1000	Fayetteville, Ark.	750				
300	WPG	1000	Atlantic City, N. J.	5000				
300	WRES	1000	Wollston, Mass.	100				
297	KPRC	1010	Houston, Tex.	500				
297	WDXL	1010	Detroit, Mich.	250				
296	KWOR	1000	Cedar Rapids, Iowa	100				
295	WARS	1016	Brooklyn, N. Y.	500				
295	WEPS	1016	Gloucester, Mass.	100				
294	KTBI	1020	Los Angeles, Calif.	750				
294	WAIU	1020	Columbus, Ohio	750				
294	WEAO	1020	Columbus, Ohio	750				
294	WMAL	1010	Washington, D. C.	100				
294	WOCB	1021	Orlando, Fla.	50				
291	KFWC	1030	San Bernardino, Calif.	50				
288	KFKX	1040	Hastings, Nebr.	5000				
288	WJBV	1040	Woodhaven, N. Y.	100				
288	WMBI	1040	Chicago, Ill.	500				
286	WKAR	1050	E. Lansing, Mich.	1000				
286	WQAM	1050	Miami, Fla.	750				
286	WREO	1050	Lansing, Mich.	500				
285	KOWW	1052	Walla Walla, Wash.	500				
285	WICC	1052	Bridgeport, Conn.	500				
285	WKBQ	1052	New York City	10				
283	KGBW	1060	Joplin, Mo.	250				

IF YOU CAN'T BRING THEM IN SEE PAGE 4

The RADIO SUPPLY CO.

Is the Pacific Coast Warehouse for all the new things in Radio—that give you more distance, better tone, easier control and makes your set a real pleasure.

We Have Ready for You:

New Kits for All Sizes and Types of Sets.

Many Makes of Good Battery Eliminators.

Combination "A" Battery and Trickle Charger Power Units.

Trickle Chargers to Give You an "A" Power Unit.

A Fine Assortment of Real Cone Speakers.

The Best in Vernier Dials for Sharp Tuning.

All of the New Heavy Audio Transformers.

Five, Six, Seven and Eight Wire Cables for Battery Leads.

Kits and Parts for the Hi-Q and Equamatic Sets.

All Types of Meters for Testing Your Circuits.

A Big Assortment of Real SLF Condensers.

And Hundreds of Other Devices That Can Be Added to Your Set That Will Make It a Hobby and a Pleasure to You.

Give Your Order to Your Dealer and Have Him Come Here For It

"YOU'LL FIND IT HERE"

DEALERS:

Park Your Car Next Door at Our Expense

RADIO SUPPLY CO.

Wholesale

VAndike 6063

920 S. Broadway Open Evening Till Nine

Los Angeles

Send for Our Latest Catalogue

Broadcasting Stations by Meters (Continued)

Wave Length Meters	Call Signal	Frequency Kilo-cycles	Location of Station	Power in Watts	Dial Settings			Remarks
					1	2	3	
283	KSMR	1080	Santa Maria, Calif.	100				
283	WKBB	1060	Joliet, Ill.	150				
283	WOAN	1060	Lawrenceburg, Tenn.	500				
283	WSM	1060	Nashville, Tenn.	1000				
280	KFAU	1080	Boise, Idaho	750				
280	KGCA	1070	Decorah, Iowa	15				
280	KMOX	1070	St. Louis, Mo.	1500				
280	KOAC	1070	Corvallis, Ore.	500				
280	WNAB	1070	Boston, Mass.	100				
280	WKBJ	1070	St. Petersburg, Fla.	250				
278	KFJM	1080	Grand Forks, N. Dak.	100				
278	KGY	1080	Lacey, Wash.	50				
278	KUSD	1080	Vermillion, S. Dak	100				
278	KWWG	1080	Brownsville, Tex.	500				
278	KWCR	1080	Cedar Rapids, Iowa	500				
278	WAAF	1080	Chicago, Ill.	250				
278	WABO	1080	Rochester, N. Y.	100				
278	WCAU	1080	Philadelphia, Pa.	500				
278	WDZ	1080	Tuscola, Ill.	100				
278	WFEG	1080	Altoona, Pa.	100				
278	WHAM	1080	Rochester, N. Y.	100				
278	WHDI	1080	Minneapolis, Minn.	500				
278	WGBU	1080	Tilford by-the-Sea, Fla.	500				
278	WLB	1080	Minneapolis, Minn.	20				
278	WLBL	1080	Stevens Point, Wis.	500				
278	WMAN	1080	Columbus, Ohio	50				
278	WOQ	1080	Kansas City, Mo.	1000				
278	WRBC	1080	Valparaiso, Ind.	500				
275	KFBB	1090	Havre, Mont.	50				
275	KFDD	1080	Boise, Idaho	50				
275	KFKU	1090	Lawrence, Kans.	500				

IF YOU CAN'T BRING THEM IN SEE PAGE 4

AMERICAN RADIO Co.
 108 East 8th St.
 LOS ANGELES, CALIFORNIA
TUCKER 8028

We Stake Our Reputation On The Magnavox! The Single Dial Control Set That Has No Peer. Distance—Selectivity—Tone—Ease of Operation, All At Your Command With This Set.

D
E
M
O
N
S
T
R
A
T
I
O
N
S
D
A
I
L
Y
U
N
T
I
L
8
P.
M.



F
I
V
E
M
O
D
E
L
S
\$
7
5
A
N
D
U
P

MAGNAVOX

Pomona Store—152 W. Second St.

Phone 1576

Broadcasting Stations by Meters (Continued)

Wave Length Meters	Call Signal	Frequency Kilo-cycles	Location of Station	Power in Watts	Dial Settings			Remarks
					1	2	3	
275	KFSG	1090	Los Angeles, Calif.	500				
275	KQV	1090	Pittsburgh, Pa.	500				
275	WAFD	1090	Port Huron, Mich.	500				
275	WBAK	1090	Harrisburg, Pa.	500				
275	WBT	1090	Charlotte, N. C.	250				
275	WCAC	1090	Mansfield, Conn.	500				
275	WCAO	1090	Baltimore, Md.	100				
275	WEAU	1090	Sioux City, Iowa	250				
275	WFAV	1090	Lincoln, Nebr.	500				
275	WHAD	1090	Milwaukee, Wis.	500				
275	WHAR	1090	Atlantic City, N. J.	500				
275	WJAS	1090	Pittsburgh, Pa.	500				
275	WKY	1090	Oklahoma City, Okla.	100				
275	WMAC	1090	Cazenovia, N. Y.	100				
275	WABZ	1090	Canton, N. Y.	50				
275	WAGM	1330	Royal Oak, Mich.	50				
275	WOCL	1090	Jamestown, N. Y.	15				
275	WORD	1090	Batavia, Ill.	5000				
275	WPAK	1090	Fargo, N. Dak.	50				
275	WSMK	1090	Dayton, Ohio	500				
275	WSWS	1090	Batavia, Ill.	1000				
275	WWL	1090	New Orleans, La.	100				
273	KFAD	1100	Phoenix, Ariz.	100				
273	KFTO	1100	Spokane, Wash.	100				
273	KFIZ	1100	Fond du Lac, Wis.	100				
273	KFKA	1100	Greeley, Colo.	50				
273	KFLZ	1100	Atlantic, Iowa	10				
273	KICK	1100	Anita, Iowa	100				
273	WBAA	1100	W. Lafayette, Ind.	250				
273	WDAE	1100	Tampa, Fla.	250				
273	WEBJ	1100	New York, N. Y.	500				

IF YOU CAN'T BRING THEM IN SEE PAGE 4

Dubilier

Accurate Condensers for all Purposes

**"B" Block
Filter
Condenser**



**13½ Mfds.
\$9.50**

Thousands will make their own "B" Eliminators this fall and winter.

Guaranteed voltage and rated capacity is absolutely essential to make your "B" unit a success.

Dubilier Filter Condensers will meet the most exacting tests. In units of .1 mfd. to 13½ mfd.

Build your own "B" Eliminator and be sure of constant perfect reception.

Manufacturers of the famous Micadons. Used by all the prominent Radio Manufacturers, Air Mail Service, and all the branches of the U. S. Government.

DUBILIER COND. & RADIO CORP.

Pacific Coast Office
532 San Fernando Bldg.
Los Angeles, Cal.

Main Office and Factory
4377 Bronx Blvd.
New York

Broadcasting Stations by Meters (Continued)

Wave Length Meters	Call Signal	Frequency Kilo-cycles	Location of Station	Power in Watts	Dial Settings			Remarks
					1	2	3	
273	WFAM	1100	St. Cloud, Minn.	10				
273	WHK	1100	Cleveland, Ohio	1000				
273	WPCB	1100	New York City	500				
273	WRM	1100	Urbana, Ill.	500				
273	WSBF	1100	St. Louis, Mo.	250				
273	KFPY	1100	Spokane, Wash.	250				
270	KGU	1110	Honolulu, Hawaii	500				
270	WDBE	1110	Atlanta, Ga.	100				
270	WKBE	1110	Webster, Mass.	100				
270	KZKZ	1110	Manila, P. I.	100				
270	WBAO	1110	Decatur, Ill.	100				
270	WGHP	1110	Detroit, Mich.	1500				
270	WGST	1110	Atlanta, Ga.	500				
270	WJAG	1110	Norfolk, Nebr.	200				
270	WJBL	1110	Decatur, Ill.	500				
270	WJBY	1110	Gagsden, Ala.	30				
270	WJWB	1110	New Orleans, La.	100				
270	WKBE	1110	Webster, Mass.	100				
270	WOI	1110	Ames, Iowa	750				
270	WOWL	1110	New Orleans, La.	10				
270	WRK	1110	Hamilton, Ohio	100				
270	WTAW	1110	College Station, Tex.	500				
269	WGM	1110	Jeanette, Pa.	10				
268	KFEQ	1120	Oak, Nebr.	500				
268	KFH	1120	Wichita, Kans.	500				
268	KFRC	1120	San Francisco, Calif.	500				
268	WBBY	1120	Charleston, S. C.	10				
268	WDAH	1120	El Paso, Texas	50				
268	WDRC	1120	New Haven, Conn.	500				
268	WEBW	1120	Bellevue, Wis.	500				
268	WFBM	1120	Indianapolis, Ind.	250				

IF YOU CAN'T BRING THEM IN SEE PAGE 4

Mohawk Radio

One Dial

"SENECA"—The Mohawk Unit drawer for use in phonographs or individual cabinets. \$62.50.

The **"CHEROKEE"**—Mohawk six-tube, one deal, shielded table receiver, at \$70.00.



Chippewa

"WINONA"—Mohawk one dial, six-tube, shielded radio with "B" battery compartments. Walnut hand rubbed piano finish, at \$85.00.

"CHIPPEWA" — Mohawk one dial, six-tube, shielded radio console, with built-in speaker and self-contained battery compartments—two-tone, at \$120.00.

"PONTIAC" — Mohawk one dial, six-tube, shielded radio console, built-in loud speaker, self-contained battery compartment, Walnut hand rubbed piano finish, burl Walnut front, drop-lip with invisible hinges, at \$150.00.

"GENEVA" — Mohawk one dial, six-tube, shielded radio console. Built-in loud speaker in dome of console, battery compartment, dome full piano hinged, front burl Walnut, inlaid, rich rich Walnut hand rubbed piano finish, at \$195.00.

"POCAHONTAS"—Mohawk one dial, six-tube, shielded Super De Luxe Radio Console. Built-in loud speaker, battery compartment, exterior in Colonial design, burl Walnut, rich two-tone Walnut hand rubbed piano finish, at \$310.00.

COOK-NICHOLS CO.

Wholesale Electrical and Radio Supplies

482 South Fair Oaks Avenue
PASADENA, CALIF.

411 South San Pedro Street
LOS ANGELES, CALIF.

Broadcasting Stations by Meters (Continued)

Wave Length Meters	Call Signal	Frequency Kilo-cycles	Location of Station	Power in Watts	Dial Settings			Remarks
					1	2	3	
268	WJAM	1120	Cedar Rapids, Iowa	100				
268	WJEO	1120	New Orleans, La.	100				
268	WNOX	1120	Knoxville, Tenn.	500				
268	WRAX	1120	Gloucester, N. J.	500				
268	WSAX	1120	Portable	100				
268	WSBC	1120	Chicago, Ill.	1000				
273	KFPY	1100	Spokane, Wash.	250				
266	KLZ	1130	Denver, Colo.	500				
266	WBCN	1130	Chicago, Ill.	500				
266	WCAH	1130	Columbus, Ohio	500				
266	WENR	1130	Chicago, Ill.	1000				
266	WMAK	1130	Lockport, N. Y.	500				
266	WTAB	1130	Fall River, Mass.	100				
266	WWI	1130	Dearborn, Mich.	500				
265	WDEL	1130	Wilmington, Del.	100				
265	WGHB	1130	Clearwater, Fla.	500				
265	WKBP	1131	Battle Creek, Mich.	50				
263	KFJR	1140	Portland, Ore.	100				
263	KFMW	1140	Houghton, Mich.	50				
263	KFUT	1140	Salt Lake City, Utah	100				
263	KGCM	1140	San Antonio, Texas	10				
263	KTBR	1140	Portland, Ore.	50				
263	KTUE	1140	Houston, Texas	5				
263	WAAM	1140	Newark, N. J.	500				
263	WABR	1140	Toledo, Ohio	50				
263	WCAD	1140	Canton, N. Y.	250				
263	WBPI	1140	Newark, N. J.	500				
263	WCAR	1140	San Antonio, Tex.	500				
263	WCBE	1140	New Orleans, La.	5				
263	WDAG	1140	Amrillo, Tex.	100				
263	WDGY	1140	Minneapolis, Minn.	500				

IF YOU CAN'T BRING THEM IN SEE PAGE 4



Rear view above shows large compartment with ample space for batteries, battery charger, or battery eliminator, which are entirely concealed from view. Back is open for ventilation of batteries.



(Pat. Applied For)

Model 200, with 22-inch
Cone Loudspeaker



Above is shown the Cone Loudspeaker, with its sounding board, which is quickly and easily removable, allowing instant access to all batteries, battery charger, battery eliminator, or other equipment and wiring.

Model 200

\$35

Console with Cone
Loudspeaker
Ready for Set and
Batteries

This Windsor Cone Loudspeaker Console is equipped with a 22-inch Windsor Cone Loudspeaker. Its top is 30 in. x 17 in. and is 29 in. high. The battery shelf provides ample space for batteries, charger, battery eliminator and other equipment. Beautifully finished in either Mahogany or Walnut.

A Revelation in Radio Reproduction



(Pat. applied for)

Model 210
22-inch Cone
Loudspeaker
with sounding
board and
easel back

\$1800

beauty, just as it entered the microphone.

...
This 22-inch Windsor Cone Loudspeaker, with its sounding board, will reproduce the softest crooning lullaby in a softly lighted room, or the full throated march music of a band in an auditorium—both with perfect fidelity of sound and tone. The Windsor Cone Loudspeaker Console is the greatest value in the world of radio. When compared with the average cost of cone-type loudspeakers of even similar size, the cost of the complete Windsor—cone loudspeaker, sounding board, and console—is amazingly low.

...
The Windsor Cone and Horn Loudspeakers, combined with attractive pieces of furniture in many models, are being demonstrated by recognized dealers everywhere. Go to your dealer today and examine this astonishing new Cone Loudspeaker Console. If he happens not to have one, write to us and we will tell you the name of the nearest store at which you can see and hear one.

NOTE TO DEALERS

Write or wire today for details of the highly profitable Windsor selling franchise.

At last—a cone loudspeaker that reproduces *all* the tones as they are broadcast. From the deep voiced tuba of an orchestra to the softest note of a vocal solo—*every* tone—*every* sound is reproduced in all its

As a piece of furniture, the Windsor Cone Loudspeaker Console is of such manifest high quality and attractive design as to be a welcome addition to any home. Finished in Mahogany or Walnut.

WINDSOR FURNITURE CO.

World's Largest Manufacturers and Originators of
Loudspeaker Consoles

1420 Carroll Avenue, Chicago, Illinois

Los Angeles Branch: 917 Maple Avenue

R. D. 18
WINDSOR FURNITURE
COMPANY,
Electrical Department,
917 Maple Ave., Los Angeles.
Send me FREE and without
obligation circulars of the Windsor line of Cone and Horn Loudspeakers combined with pieces of furniture, and name of nearest dealer.

Name.....
Address.....
City.....State.....
Dealer's Name.....

Broadcasting Stations by Meters (Continued)

Wave Length Meters	Call Signal	Frequency Kilo-cycles	Location of Station	Power in Watts	Dial Settings			Remarks
					1	2	3	
263	WEBZ	1140	Savannah, Ga.	50				
263	WRAV	1140	Yellow Springs, Ohio	100				
263	WSDA	1140	New York, N. Y.	250				
263	WWAO	1140	Houghton, Mich.	250				
261	KFJF	1150	Oklahoma City, Okla.	500				
261	KFMR	1150	Sioux City, Iowa	100				
261	KSEI	1150	Pocatello, Idaho	500				
261	KFQA	1150	St. Louis, Mo.	100				
261	KWTG	1150	Santa Ana, Calif.	15				
261	WABQ	1150	Haverford, Pa.	100				
261	WARC	1150	Medford, Mass.	100				
261	WDAY	1150	Fargo, N. Dak.	50				
261	WEAM	1150	N. Plainfield, N. J.	250				
261	WKAF	1150	Milwaukee, Wis.	500				
261	WMAZ	1150	Macon, Ga.	500				
261	WPSC	1150	State College, Pa.	500				
261	WSKC	1150	Bay City, Mich.	100				
261	WSSH	1150	Boston, Mass.	100				
261	WTAR	1150	Norfolk, Va.	100				
261	WTAZ	1150	Lambertville, N. J.	15				
260	WJBX	1100	Osterville, Mass.	100				
259	WHFC	1160	Chicago, Ill.	150				
259	WKJC	1160	Lancaster, Pa.	50				
258	KFPW	1160	Cartersville, Mo.	20				
258	KFUL	1160	Galveston, Tex.	50				
258	KOCH	1160	Omaha, Nebr.	250				
258	WAAD	1160	Cincinnati, Ohio	25				
258	WADC	1160	Akron, Ohio	500				
258	WCMA	1160	Culver, Ind.	500				
258	WHEC	1160	Rochester, N. Y.	100				
258	WIL	1160	St. Louis, Mo.	250				

IF YOU CAN'T BRING THEM IN SEE PAGE 4

RADIO - AUTO BATTERIES

"One and Two-Year Guarantee"

A CALIFORNIA PRODUCT

QUALITY AND SERVICE
OUR STANDARD

Mail or Phone Orders Will Receive Prompt Attention

Western Storage Battery Company

Manufacturers of

WET and JELLY Batteries of Any Size or Type

Factory and General Offices

140 W. 16th St.

Los Angeles, Calif.

Phone WEStmore 5742

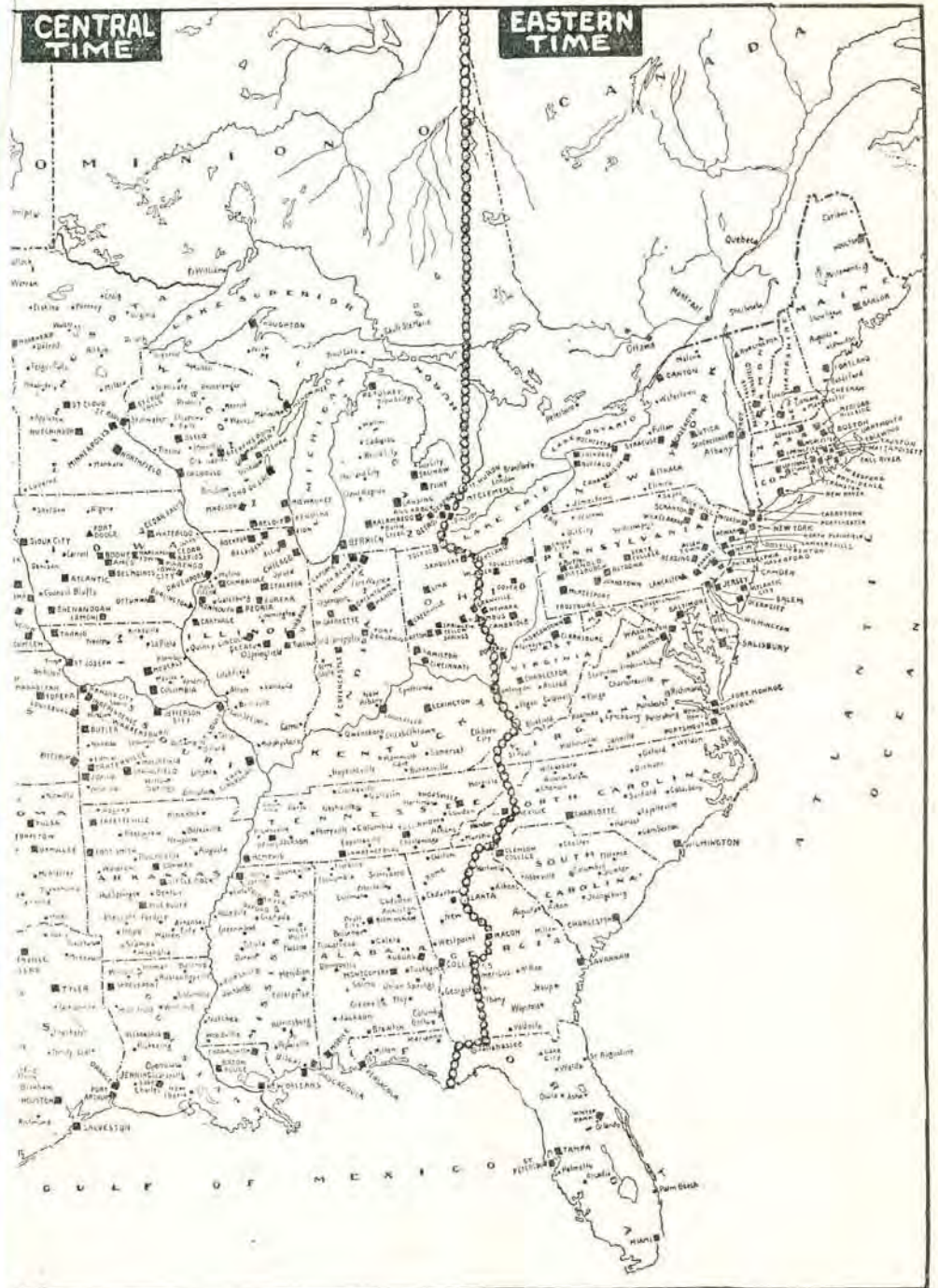
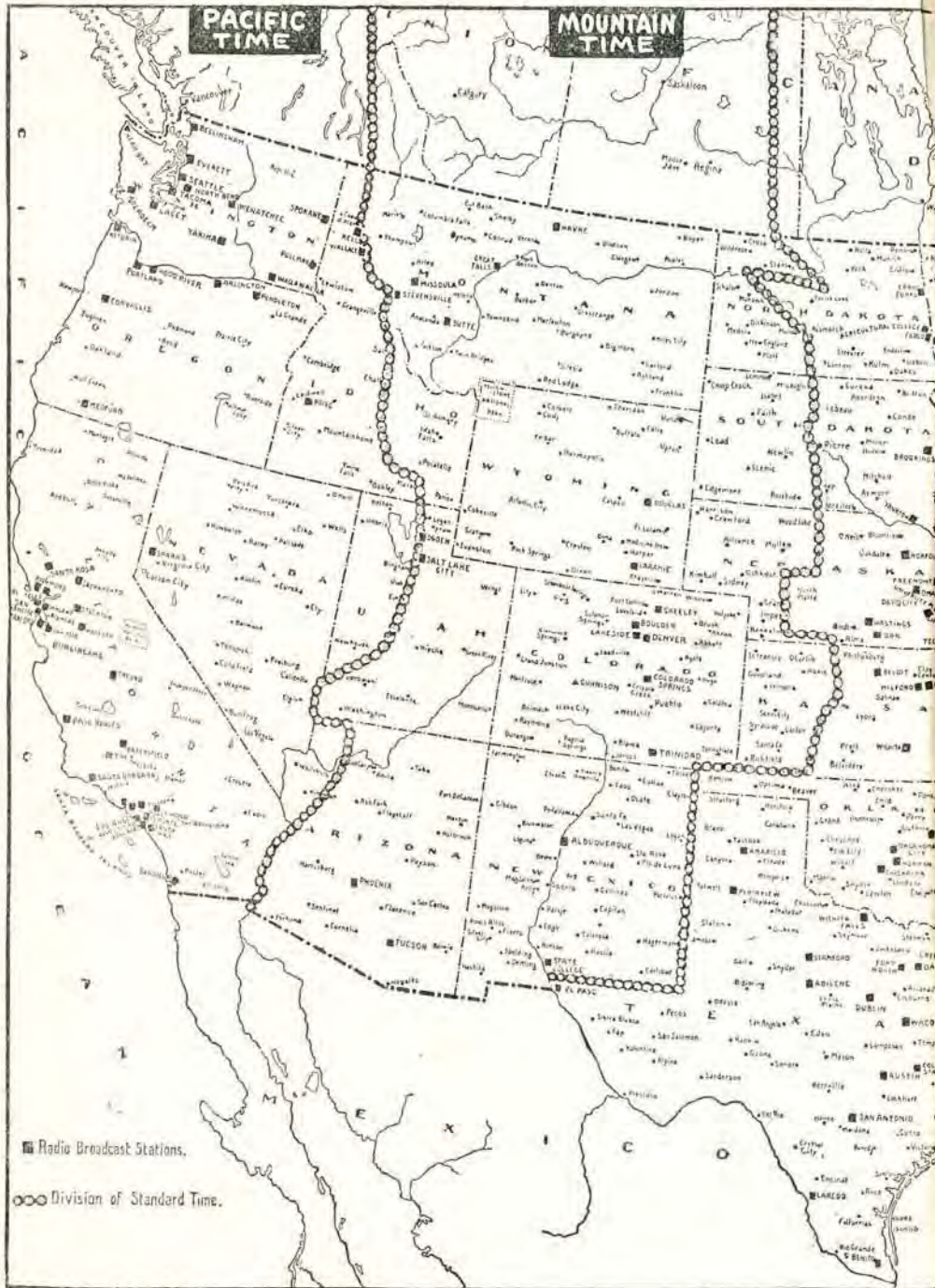

Dealer, Mail this Coupon to your Stewart-Warner Distributor

Installation Receipt for Stewart-Warner Radio

RECEIVED in good condition Date 11-16-26 The following stations have been tuned, with the results as indicated opposite each:

Stewart-Warner Radio, Model 325
Serial No. 25111

Stewart-Warner Reproducer
Five Stewart-Warner Radio Tubes

A satisfactory installation has been made at the address shown below with the Stewart-Warner Equipment, including:

65 ft. Stewart-Warner Aerial Wire
2 Stewart-Warner Insulators
1 Stewart-Warner Ground Clamp
100 Amp. Vesta 6-volt Battery
Kind of "B" Battery used Ray-O-Vac

Remarks: Blue Vitrol ground
I have been instructed by the Stewart-Warner Salesman in tuning, care of the complete equipment, etc., testing of batteries, etc.

Signature of Purchaser Ellen Jensen
Street 10964 Santa Fe Chataworth
City Chataworth State Calif.
County L.A.

Name of Stewart-Warner Dealer
Ch. Drexton and Son
Address Chataworth Phone No. 18-m-5

Signature of Dealer's Representative
Preston & Son
and all Locals

Call Letters of Stations	Dist-terry	Volume
KMOX	St. Louis, Mo.	Low
WHD	Des Moines Ia.	"
KOMO	"	"
KmmJ	Clay Center, Neb.	"
KLZ	Denver, Colo.	"
KY W	Portland, Ore.	"
WDBB	Chattanooga, Tenn.	"
KMO	Jacoma, Wash.	"
WCAW	Omaha, Neb.	"
WJBO	Chicago, Ill.	"
KFKX	Hastings, Neb.	"
KFQB	Fort Worth, Tex.	"
WYU	Scheveetady, N.Y.	"
KVOB	Bristow, Okla.	"
WQAC	Amarillo, Tex.	"
WCCO	Minneapolis, Minn.	"
WEAF	New York, N.Y.	"
JOAK	Tokio, Japan	good
WOS	Jefferson City, Mo.	"
WDAZ	Kansas City, Mo.	"
JOCK	Nagoya, Japan	"
WOAJ	San Antonio, Tex.	"

"DX" Logs like these are brought in with Stewart-Warner Receivers!

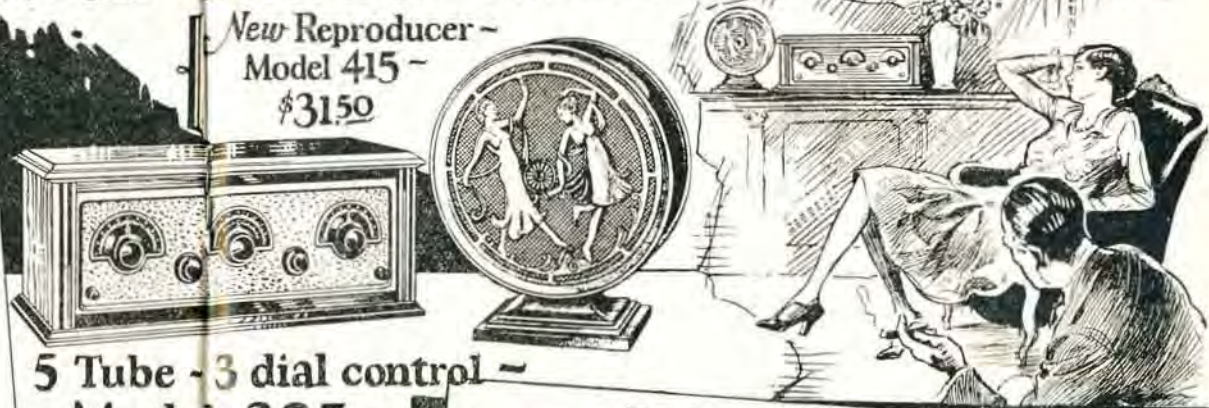

5 Tube - 3 dial control -
Model 325 ~
Only \$77.50
[Without Accessories]

With the issuing of this new call book most readers will want to try for as many "DX" stations as possible. Let us recommend the model 325 Stewart-Warner receiver for this purpose.

Its efficient 5-tube U. S. Navy receiving circuit has proved to be one of the best hook-ups ever designed for distance reception.

The two installation receipts reproduced herewith, signed by the purchasers of Stewart-Warner receivers, show the stations brought in in one evening when the receivers were installed by our dealers.

[Any Stewart-Warner dealer will gladly demonstrate Matched Unit Radio in your own home. The name of the dealer nearest you appears in the center of page of Radio Doings each week.]

Stewart-Warner Products Service Station
[Wholesale Distributors Stewart-Warner Radio]
1366 South Figueroa Street ~ LOS ANGELES

Dealer, Mail this Coupon to your Stewart-Warner Distributor

Installation Receipt for Stewart-Warner Radio

RECEIVED in good condition Date 4-28-26 The following stations have been tuned, with the results as indicated opposite each:

Stewart-Warner Radio, Model 325
Serial No. 15839

Stewart-Warner Reproducer
Five Stewart-Warner Radio Tubes ✓

A satisfactory installation has been made at the address shown below with the Stewart-Warner Equipment, including:

1 ft. Stewart-Warner Aerial Wire
2 Stewart-Warner Insulators
1 Stewart-Warner Ground Clamp
100 Amp. Vesta 6-volt Battery
Kind of "B" Battery used _____

Remarks: Had Own Accessories
I have been instructed by the Stewart-Warner Salesman in tuning, care of the complete equipment, etc., testing of batteries, etc.

Signature of Purchaser R. A. Stalaupe
Street 442 - E. 107 St. City L.A.
County L.A. State Calif.

Name of Stewart-Warner Dealer
Barrows - Cookwright
Address 5545 Sunset Blvd. Phone No. GR. 2525

Signature of Dealer's Representative
M. Johnson and All Local Stations

Call Letters of Stations	Dist-terry	Volume
K.F.S.D.	San Diego, Cal.	Low
K.L.Z.	Denver - Colo.	"
K.F.B.U.	Lorraine, Wyo.	"
KOIN	Portland, Ore.	"
KGW	Portland, Ore.	"
KOIL	Council Bluffs, Ia.	"
KOA	Denver, Colo.	"
KOWW	Walla Walla, Wash.	"
KLY	Oakland, Cal.	"
KJR	Seattle, Wash.	"
KHQ	Spokane, Wash.	"
KPO	San Francisco	"
KFWO	Catalina Island	"
KPRC	Houston, Tex.	"
KQW	San Jose, Cal.	"

DEPARTMENT OF COMMERCE
BUREAU OF NAVIGATION
RADIO DIVISION

AIR-LINE DISTANCES

Table with columns for FROM/TO and various city destinations including Albuquerque, Atlanta, Baltimore, Boise, Boston, Brownsville, Buffalo, Chicago, Cincinnati, Cleveland, Denver, Des Moines, Detroit, El Paso, Fargo, Fort Worth, Galveston, Hastings, Hot Springs, Houghton, Jacksonville, Kansas City, Los Angeles, Louisville, Memphis, Miami, Minneapolis, Missoula, Nashville, New Orleans, New York, Norfolk, Oklahoma, Omaha, Philadelphia, Phoenix, Pittsburgh, Portland, Portland, Richmond, St. Louis, Salt Lake City, San Francisco, Schenectady, Seattle, Shreveport, Spokane, Springfield, Vermillion, and Washington.

Supplement to the List of
Commercial and Government Radio Stations
of the United States

IN STATUTE MILES

Table with columns for various city destinations including Louisville, Memphis, Miami, Minneapolis, Missoula, Nashville, New Orleans, New York, Norfolk, Oklahoma, Omaha, Philadelphia, Phoenix, Pittsburgh, Portland, Portland, Richmond, St. Louis, Salt Lake City, San Francisco, Schenectady, Seattle, Shreveport, Spokane, Springfield, Vermillion, and Washington.

Broadcasting Stations by Meters (Continued)

Wave Length Meters	Call Signal	Frequency Kilo-cycles	Location of Station	Power in Watts	Dial Settings			Remarks
					1	2	3	
258	WLTS	1160	Chicago, Ill.	100				
258	WNAL	1160	Omaha, Nebr.	50				
258	WPCC	1160	Chicago, Ill.	250				
258	WWRL	1160	Woodside, N. Y.	100				
256	KFIQ	1170	Yakima, Wash.	100				
256	KFUS	1170	Oakland, Calif.	50				
256	KRE	1170	Berkeley, Calif.	100				
256	WASH	1170	Grand Rapids, Mich.	500				
256	WBAX	1170	Wilkes-Barre, Pa.	100				
256	WDOD	1170	Chattanooga, Tenn.	500				
256	WHBP	1170	Johnstown, Pa.	100				
256	WKBZ	1170	Ludington, Mich.	15				
256	WMBC	1170	Detroit, Mich.	100				
256	WRAK	1170	Escanaba, Mich.	100				
256	WRHF	1170	Washington, D. C.	50				
256	WRVA	1170	Richmond, Va.	1000				
254	KFEL	1180	Denver, Colo.	250				
254	KFJX	1180	Cedar Falls, Iowa	50				
254	KFJZ	1180	Fort Worth, Tex.	50				
254	KFLR	1180	Albuquerque, N. M.	100				
254	KFWH	1180	Eureka, Calif.	100				
254	KGDA	1180	Del Rapids, S. D.	15				
254	WABC	1180	Asheville, N. C.	20				
254	WCAJ	1180	University Pl., Nebr.	500				
254	WCBA	1180	Allentown, Pa.	15				
254	WEAI	1180	Ithaca, N. Y.	500				
254	WFBR	1180	Baltimore, Md.	100				
254	WFBZ	1180	Galesburg, Ill.	20				
254	WHBC	1180	Canton, Ohio	10				
254	WIAS	1180	Burlington, Iowa	100				
254	WJAK	1180	Greentown, Ind.	50				

IF YOU CAN'T BRING THEM IN SEE PAGE 4

Los Angeles' Leading Crosley Dealer

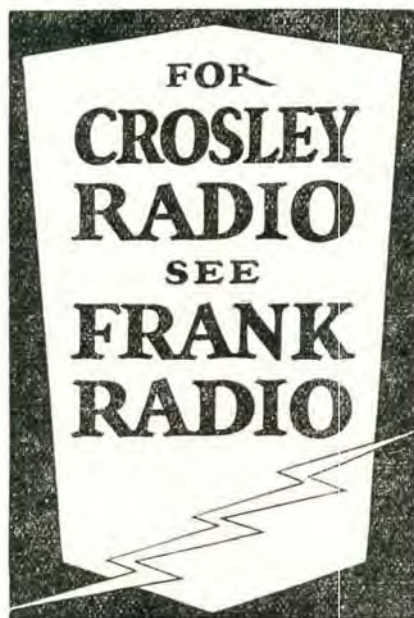

*Downtown Headquarters for Crosley Sets,
Speakers—and Real Service*

*We stock the best of battery eliminators—
carry a full line of radio supplies, but—if the
article isn't right, you won't find it for sale
here.*

Factory Franchised Crosley Dealer

Frank Radio Co.

715 ½ So. Main St
Los Angeles

Broadcasting Stations by Meters (Continued)

Wave Length Meters	Call Signal	Frequency Kilo-cycles	Location of Station	Power in Watts	Dial Settings			Remarks
					1	2	3	
254	WJBB	1180	St. Petersburg, Fla.	10				
254	WNAD	1180	Norman, Okla.	500				
254	WOMT	1180	Manitowac, Wis.	50				
254	WREC	1180	Coolwater, Miss.	10				
254	WSAR	1180	Fall River, Mass.	100				
254	WTAQ	1180	Eau Claire, Wis.	100				
252	KFEC	1160	Portland, Ore.	50				
252	KFHA	1190	Gunnison, Colo.	50				
252	KFOY	1190	St. Paul, Minn.	50				
252	KFPL	1190	Dublin, Tex.	15				
252	KFWB	1190	Hollywood, Calif.	500				
252	KOCR	1190	Brookings, S. D.	15				
252	KOCW	1190	Chickasha, Okla.	200				
252	KWUC	1190	Le Mars, Iowa	50				
252	WFBL	1190	Syracuse, N. Y.	100				
252	WGCP	1190	Newark, N. J.	500				
252	WCFG	1190	Tullahoma, Tenn.	10				
252	WKBL	1190	Menroe, Mich.	15				
252	WKBT	1190	New Orleans, La.	50				
252	WRCO	1190	Raleigh, N. C.	100				
252	WRHM	1190	Minneapolis, Minn.	50				
252	WSRO	1190	Hamilton, Ohio	100				
252	WTAL	1190	Toledo, Ohio	10				
250	KFVY	1200	Abuquerque, N. M.	10				
250	KPWI	1200	San Francisco, Calif.	50				
250	KMO	1200	Tacoma, Wash.	100				
250	KXIB	1200	Manila, P. I.	100				
250	WAGS	1199	Summerville, Mass.	5				
250	WBBC	1200	Brooklyn, N. Y.	100				
250	WCAX	1200	Burlington, Vt.	20				
250	WFBC	1200	Knoxville, Tenn.	50				

IF YOU CAN'T BRING THEM IN SEE PAGE 4

RADIO FOR LESS!

Standard Radio

Parts

Cabinets

Chassis

Sets



RADIO MANUFACTURERS SUPPLY CO.
1000 So. Broadway
LOS ANGELES

ON THE CORNER of 10th & BROADWAY

Broadcasting Stations by Meters (Continued)

Wave Length Meters	Call Signal	Frequency Kilo-cycles	Location of Station	Power In Watts	Dial Settings			Remarks
					1	2	3	
350	WHBA	1200	Oil City, Pa.	10				
250	WHBY	1200	West De Pere, Wis.	50				
250	WKBH	1200	La Crosse, Wis.	500				
250	WIAD	1200	Philadelphia, Pa.	100				
250	WLAL	1200	Tulsa, Okla.	100				
250	WMBB	1200	Chicago, Ill.	500				
250	WLAP	1200	Louisville, Ky.	100				
250	WNAT	1200	Philadelphia, Pa.	100				
250	WQAN	1200	Scranton, Pa.	100				
248	KGBX	860	St. Joseph, Mo.	30				
248	KFIF	1210	Portland, Ore.	100				
248	KFJB	1210	Marshalltown, Iowa	10				
248	KFOX	1210	Omaha, Nebr.	100				
248	KFRB	1210	Beeville, Texas	250				
248	KFYR	1210	Bismark, N. D.	10				
248	KWG	1210	Stockton, Calif.	50				
248	WBRC	1210	Birmingham, Ala.	50				
248	WCSO	1210	Springfield, Ohio	100				
248	WGAL	1210	Lancaster, Pa.	10				
248	WIOD	1210	Miami Beach, Fla.	1000				
248	WMAY	1210	St. Louis, Mo.	100				
248	WNBH	1210	New Bedford, Mass.	250				
248	WSAV	1210	Houston, Texas	100				
246	KDYL	1220	Salt Lake City, Utah	50				
246	KFJI	1220	Astoria, Ore.	10				
246	KFJY	1220	Fort Dodge, Iowa	50				
246	KFSD	1220	San Diego, Calif.	1000				
246	WABX	1220	Mt. Clemens, Mich.	500				
246	WCAZ	1220	Carthage, Ill.	50				
246	WEBD	1220	Anderson, Ind.	10				
246	WIBR	1220	Weynton, W. Va.	50				

IF YOU CAN'T BRING THEM IN SEE PAGE 4

Broadcasting Stations by Meters (Continued)

Wave Length Meters	Call Signal	Frequency Kilo-cycles	Location of Station	Power in Watts	Dial Settings			Remarks
					1	2	3	
246	WQAE	1220	Springfield, Vt.	50				
246	WRR	1220	Dallas, Texas	500				
246	WSOE	1220	Milwaukee, Wis.	500				
244	KFVR	1230	Denver, Colo.	50				
244	KGAR	1230	Tucson, Ariz.	100				
244	KUOM	1230	Missoula, Mont.	500				
244	WATT	1230	Boston, Mass.	100				
244	WAMD	1230	Minneapolis, Minn.	500				
244	WEBR	1230	Buffalo, N. Y.	100				
244	WGBB	1230	Freeport, N. Y.	100				
244	WGBC	1180	Memphis, Tenn.	100				
244	WKBF	1229	Indianapolis, Ind.	100				
244	WNAX	1230	Yankton, S. Dak.	100				
244	WRAM	1230	Galesburg, Ill.	100				
244	WSAZ	1230	Pomeroy, Ohio	50				
242	KFPM	1240	Greenville, Texas	10				
242	KFXH	1240	El Paso, Texas	50				
242	KFXH	1240	El Paso, Texas	50				
242	KLS	1240	Oakland, Calif.	250				
242	WABY	1240	Philadelphia, Pa.	50				
242	WCBH	1240	Oxford, Miss.	50				
242	WCBS	1239	Boston, Mass.	250				
242	WEBC	1240	Superior, Wis.	100				
242	WEBK	1240	Grand Rapids, Mich.	100				
242	KFFP	1240	Moberly, Mo.	50				
242	WHOG	1240	Huntington, Ind.	15				
242	WOOD	1240	Grand Rapids, Mich.	500				
240	KFHL	1250	Oskaloosa, Iowa	10				
240	KFLX	1250	Galveston, Texas	10				
240	KFUM	1250	Colorado Springs, Colo.	100				
240	KFVE	1250	St. Louis, Mo.	5000				

IF YOU CAN'T BRING THEM IN SEE PAGE 4

Broadcasting Stations by Meters (Continued)

Wave Length Meters	Call Signal	Frequency Kilo-cycles	Location of Station	Power in Watts	Dial Settings			Remarks
					1	2	3	
240	KFVI	1250	Houston, Texas	10				
240	KGCG	1250	Newark, Ark.	100				
240	KGCI	1250	San Antonio, Texas	15				
240	KGCX	1249	Vida, Mont.	10				
240	KZM	1250	Oakland, Calif.	100				
240	WABI	1250	Bangor, Maine	100				
240	WCAT	1250	Rapid City, S. Dak.	50				
240	WDBO	1250	Winter Park, Fla.	500				
240	WGBL	1250	Seranton, Pa.	10				
240	WOAX	1250	Trenton, N. J.	500				
240	WSMH	1250	Owasso, Mich.	50				
240	WTRC	1250	New York City	50				
238	KFCB	1260	Phoenix, Ariz.	100				
238	KFWU	1260	Pinesville, La.	100				
238	KFWU	1260	Pineville, La.	100				
238	KFYJ	1260	Houston, Texas	10				
238	WBBP	1260	Petoskey, Mich.	200				
238	WBBP	1260	Petoskey, Mich.	200				
238	KNRC	1260	Santa Monica, Calif.	1000				
238	WHBN	1260	St. Petersburg, Fla.	10				
238	WHT	1260	Deerfield, Ill.	2500				
238	WRAW	1260	Redding, Pa.	10				
236	KFDX	1270	Shreveport, La.	500				
236	KFLU	1270	San Benito, Texas	10				
236	KFOO	1270	Salt Lake City, Utah	250				
236	KFVG	1270	Independence, Kans.	15				
236	KWKC	1270	Kansas City, Mo.	100				
236	WBAW	1270	Nashville, Tenn.	100				
236	WBOQ	1270	Richmond Hill, N. Y.	100				
236	WFBJ	1270	Collegeville, Minn.	100				
236	WGBF	1270	Evansville, Ind.	500				

IF YOU CAN'T BRING THEM IN SEE PAGE 4

Broadcasting Stations by Meters (Continued)

Wave Length Meters	Call Signal	Frequency Kilo-cycles	Location of Station	Power in Watts	Dial Settings			Remarks
					1	2	3	
236	WGMU	1270	Richmond Hill, N. J.	100				
236	WIBA	1270	Madison, Wis.	100				
236	WKBY	1270	Brookville, Ind.	75				
236	WRMU	1270	New York City	100				
236	WTAB	1270	Carthage, Ill.	50				
236	WTAD	1270	Carthage, Ill.	50				
235	WAAT	1276	Hoboken, N. J.	10				
235	WRAH	1276	Providence, R. I.	150				
234	KFUP	1280	Denver, Colo.	50				
234	KGRS	1280	Amarillo, Texas	100				
234	KJBS	1280	San Francisco, Calif.	5				
234	KMJ	1280	Fresno, Calif.	50				
234	WCWK	1280	Fort Wayne, Ind.	250				
234	WIBX	1280	Utica, N. Y.	150				
234	WJBC	1280	La Salle, Ill.	100				
234	WGBX	1280	Orono, Me.	500				
233	KFEY	1290	Kellogg, Idaho	500				
233	KFON	1290	Long Beach, Calif.	750				
233	WDBZ	1290	Kingston, N. Y.	10				
233	WHBQ	1290	Memphis, Tenn.	50				
233	WJBK	1290	Ypsilanti, Mich.	10				
233	WOKO	1290	Peekskill, N. Y.	50				
232	KGDE	1290	Barrett, Minn.	50				
231	KDLR	1300	Devils Lake, N. Dak.	5				
231	KFOT	1300	Wichita, Kans.	50				
231	KFDZ	1300	Minneapolis, Minn.	10				
231	KGCL	1300	Seattle, Wash.	70				
231	KUT	1300	Austin, Texas	500				
231	WBRE	1300	Wilkesbarre, Pa.	100				
231	WCLO	1300	Camp Lake, Wis.	50				
231	WIBZ	1300	Montgomery, Ala.	10				

IF YOU CAN'T BRING THEM IN SEE PAGE 4

Broadcasting Stations by Meters (Continued)

Wave Length Meters	Call Signal	Frequency Kilo-cycles	Location of Station	Power in Watts	Dial Settings			Remarks
					1	2	3	
231	WLBE	1300	Brooklyn, N. Y.	15				
231	KFPR	1300	Los Angeles, Calif.	500				
231	KFQU	1300	Holy City, Calif.	100				
231	WBRE	1300	Wilkes Barre, Pa.	100				
231	WCLO	1300	Camp Lake, Wis.	50				
231	WHBG	1300	Harrisburg, Pa.	20				
231	WIBZ	1300	Montgomery, Ala.	10				
231	WTAX	1300	Streator, Ill.	50				
229	KFLV	1310	Rockford, Ill.	100				
229	KGBU	1310	Ketchikan, Alaska	500				
229	KPPC	1310	Pasadena, Calif.	50				
229	WAIT	1310	Taunton, Mass.	10				
229	WBBL	1310	Richmond, Va.	100				
229	WCBM	1310	Baltimore, Md.	50				
229	WDBJ	1310	Roanoke, Va.	50				
229	WFCI	1310	Pawtucket, R. I.	100				
229	WGBR	1310	Marshfield, Wis.	10				
229	WSAJ	1310	Grove City, Pa.	250				
229	WSAN	1310	Allentown, Pa.	100				
227	KFVN	1320	Fairmont, Minn.	50				
227	KGBS	1321	Seattle, Wash.	1000				
227	WDBK	1320	Cleveland, Ohio	100				
227	WJBR	1320	Omro, Wis.	50				
227	WMRJ	1320	Jamaica, N. Y.	5				
227	WOWO	1320	Fort Wayne, Ind.	500				
226	KFOR	1330	Burlingame, Calif.	50				
226	KFGQ	1330	Boone, Iowa	10				
226	KFKZ	1330	Kirksville, Mo.	10				
226	KFIU	1330	Juneau, Alaska	10				
226	KFOR	1330	David City, Nebr.	100				
226	KFOZ	1330	Hollywood, Calif.	50				

IF YOU CAN'T BRING THEM IN SEE PAGE 4

Broadcasting Stations by Meters (Continued)

Wave Length Meters	Call Signal	Frequency Kilo-cycles	Location of Station	Power in Watts	Dial Settings			Remarks
					1	2	3	
226	WBBM	1330	Chicago, Ill.	1500				
226	WDAD	1330	Nashville, Tenn.	150				
226	WEBL	1330	U. S. (Portable)	100				
226	WEBQ	1330	Harrisburg, Ill.	10				
226	WFBE	1330	Seymour, Ind.	10				
226	WIBO	1330	Chicago, Ill.	1000				
225	WKBC	1333	Birmingham, Ala.	50				
225	WKBR	1333	Auburn, N. Y.	100				
224	KFBL	1340	Everett, Wash.	100				
224	KFQP	1340	Iowa City, Iowa	10				
224	KFUR	1340	Ogden, Utah	50				
224	KFVS	1340	Cape Girardeau, Mo.	50				
224	WBMS	1340	North Bergen, N. J.	10				
224	WKA V	1340	Laconia, N. H.	50				
224	WLBC	1340	Muncie, Ind.	50				
224	WNRC	1340	Greensboro, N. C.	10				
224	WRAF	1340	Laporte, Ind.	100				
224	KFUP	1340	Denver, Colo.	50				
222	KZRQ	1350	Manila, P. I.	500				
222	WBBW	1350	Norfolk, Va.	50				
222	WBES	1350	Tacoma Park, Md.	100				
222	WCOA	1350	Pensacola, Fla.	500				
222	WHBD	1350	Bellefontaine, Ohio	20				
222	WHBF	1350	Rock Island, Ill.	100				
222	WIBG	1350	Elkins Park, Pa.	50				
222	WIBU	1350	Poynette, Wis.	20				
220	KFUU	1360	Oakland, Calif.,	50				
220	KRAC	1363	Shreveport, La.	50				
220	WIBW	1360	Logansport, Ind.	100				
220	WKBI	1360	Chicago, Ill.	50				
220	WKBY	1363	Danville, Pa.	50				

IF YOU CAN'T BRING THEM IN SEE PAGE 4

Broadcasting Stations by Meters (Continued)

Wave Length Meters	Call Signal	Frequency Kilocycles	Location of Station	Power in Watts	Dial Settings			Remarks
					1	2	3	
220	WQAA	1360	Parkesburg, Pa.	500				
219	KFJC	1370	Junction City, Kans	10				
219	KFRW	1370	Olympia, Wash.	50				
219	WHBU	1370	Anderson, Ind.	10				
219	WIBI	1370	Flushing, N. Y.	50				
219	WJBI	1370	Red Bank, N. J.	250				
219	WSVS	1370	Buffalo, N. Y.	50				
217	KFAF	1380	San Jose, Calif.	50				
217	KGDM	1380	Stockton, Calif.	5				
217	WFKB	1380	Chicago, Ill.	500				
217	WOK	1380	Homewood, Ill.	5000				
216	KFQW	1390	North Bend, Wash.	50				
216	KFNJ	1390	Colorado (Portable)	15				
216	WBBZ	1390	Chicago, Ill.	50				
216	WHBL	1390	Legansport, Ind.	50				
216	WHBM	1390	Chicago, Ill.	20				
216	WHBW	1390	Philadelphia, Pa.	100				
216	WIBJ	1390	Chicago, Ill.	50				
216	WIBM	1390	Chicago, Ill.	10				
216	WKBG	1390	Chicago, Ill.	100				
216	WPRC	1390	Harrisburg, Pa.	100				
216	WRST	1390	Bay Shore, N. Y.	250				
215	KPJM	1345	Prescott, Ariz.	15				
214	KFWF	1400	St. Louis, Mo.	250				
214	KFXR	1400	Oklahoma City, Okla.	15				
214	KFYF	1400	Oxnard, Calif.	10				
214	WCLS	1400	Joliet, Ill.	150				
213	KFWV	1410	Portland, Ore.	100				
211	KFWO	1420	Avalon, Calif.	250				
211	WJBU	1420	Lewisburg, Pa.	100				
211	WFBF	1420	Kansas City	25				

IF YOU CAN'T BRING THEM IN SEE PAGE 4

Complete List of All Broadcast Stations in the U. S.

Corrected and Revised to December 31, 1926

Signal Call	Location of Station	Owner of Station	Power (watts)	Wave length	Frequency (kilocycles)
*KDKA	East Pittsburgh, Pa.	Westinghouse Elec. & M. Co.	10,000	309	970
KDLR	Devil's Lake, N. D.	Radio Electric Co.	5	231	1,300
KDYL	Salt Lake City, Utah	Intermountain Broad. Corp.	50	246	1,220
KFAB	Lincoln, Neb.	Nebraska Buick Auto Co.	1,000	341	880
KFAD	Phoenix, Ariz.	Electric Equip. Co.	100	273	1,100
KFAF	San Jose, Calif.	Alfred E. Fowler	50	217	1,380
KFAU	Boise, Idaho	Boise High School	750	280	1,070
KFBB	Havre, Mont.	F. A. Buttrey & Co.	50	275	1,090
KFBC	San Diego, Calif., 5033 Cliff Place	W. K. Azbill	100	350	789
KFBK	Sacramento, Calif.	Kimball-Upson Co.	100	335	560
KFBL	Everett, Wash.	Leese Brothers	100	224	1,340
KFBS	Trinidad, Colo.	School District No. 1	15	238	1,260
KFBU	Laramie, Wyo.	St. Matthews Cathedral	1,000	375	809
KFCB	Phoenix, Ariz.	Nielsen Radio Supply Co.	100	238	1,260
KFDD	Boise, Idaho	St. Michaels Cathedral	50	275	1,090
KFDM	Beaumont, Tex.	Magnolia Petroleum Co.	500	316	950
KFDX	Shreveport, La.	First Baptist Church	500	236	1,270
KFDY	Brookings, S. Dak.	South Dakota State College	500	306	980
KFDZ	Minneapolis, Minn.	Harry O. Iverson	10	231	1,300
KFEC	Portland, Oreg.	Meier & Frank Co.	50	252	1,160
KFEL	Denver, Colo.	Eugene P. O'Fallon, Inc.	250	254	1,180
KFEQ	Oak, Nebr.	J. S. Seroggin	500	268	1,120
KFEY	Kellogg, Idaho	Bunker Hill & Sullivan Mng. & Concentrating Co.	10	233	1,290
KFFP	Moberly, Mo.	First Baptist Church	50	242	1,240
KFGQ	Boone, Iowa	Crary Hardware Co.	10	226	1,330
KFH	Wichita, Kan.	Hotel Lassen	500	268	1,120
KFHA	Cunison, Colo.	Western St. College of Colorado	50	252	1,190
KFHL	Oskaloosa, Iowa	Penn College	10	240	1,250
KFI	Los Angeles, Calif.	Earl C. Anthony, Inc.	5,000	467	642
KFIF	Portland, Oreg.	Benson Polytechnic Inst.	100	248	1,210
KFIO	Spokane, Wash.	North Central High School	100	273	1,100
KFIQ	Yakima, Wash.	First Methodist Church	100	256	1,170
KFIU	Juneau, Alaska	Alaska Elec. Lt. & Power Co.	10	226	1,330
KFIZ	Fond du Lac, Wis.	Daily Commonwealth	100	273	1,100
KFJB	Marshalltown, Iowa	Marshall Electric Co.	10	248	1,210
KFJC	Junction City, Kan.	R. B. Fegan	10	219	1,370
KFJF	Oklahoma City, Okla.	National Radio Mfg. Co.	500	261	1,150
KFJM	Astoria, Oreg.	E. E. Marsh	10	246	1,220
KFJN	Grand Forks, N. Dak.	University of N. Dakota	100	278	1,080
KFJR	Portland, Ore.	Ashley C. Dixon & Son	100	263	1,140
KFJY	Fort Dodge, Iowa	Tunwall Radio Co.	50	246	1,220
KFJZ	Fort Worth, Texas	W. E. Branch	50	254	1,180
KFKA	Greeley, Colo.	Colo. St. Teachers College	50	273	1,100
KFKB	Melford, Kan.	J. R. Brinkley, M.D.	1,000	431	695
KFKU	Lawrence, Kans.	University of Kansas	500	275	1,090
KFKX	Hastings, Neb.	Westinghouse Elec. & Mfg. Co.	5,000	288.3	1,040
KPKZ	Kirkville, Mo.	Chamber of Commerce	10	225	1,330
KFLR	Albuquerque, N. M.	Univ. of New Mexico	100	254	1,180
KFLU	San Benito, Tex.	San Benito Radio Club	10	236	1,270
KFLV	Rockford, Ill.	Swedish Evang. Miss. Church	100	229	1,310
KPLX	Galveston, Tex.	George R. Clough	10	240	1,250
KPLZ	Atlantic, Iowa	Atlantic Automobile Co.	100	273	1,100
KPMR	Stoux City, Iowa	Morningside College	100	261	1,150
KPMW	Houghton, Mich.	M. G. Sateren	50	263	1,140
KPMX	Northfield, Minn.	Carleton College	50	336.9	890
KPNF	Shenandoah, Iowa	Henry Field Seed Co.	1,000	451	650
KFOA	Seattle, Wash.	Rhodes Department Store	1,000	454.3	660
KFOB	Burlingame, Calif.	Chamber of Commerce	50	226	1,330
KFON	Long Beach, Calif.	Nichols & Warriner, Inc.	500	233	1,290
KFOO	Salt Lake City, Utah	Latter Day Saints Univ.	250	236	1,270
KFOR	David City, Neb.	David City Tire & Elec. Co.	100	226	1,330
KFOU	Wichita, Kans.	College Hill Radio Club	50	231	1,300
KFOX	Omaha, Nebr.	Technical High School	100	244	1,210
KFOY	St. Paul, Minn.	Beacon Radio Service	50	252	1,190
KFPL	Dublin, Tex.	C. C. Baxter	15	252	1,190
KFPM	Greenville, Tex.	New Furniture Co.	10	242	1,240
KFPR	Los Angeles, Calif.	Los Angeles Co. Forestry Dept.	600	231	1,300

*KDKA also broadcasts on 63 meters for experimental and re-broadcasting purposes.

Broadcast Stations in U. S., Revised to Dec. 31, 1926

Call Signal	Location of Station	Owner of Station	Power (watts)	Wave length	Frequency (kilocycles)
KFPW	Cartersville, Mo.	St. John's Church	20	258	1,160
KFPY	Spokane, Wash.	Symons Investment Co.	250	273	1,100
KFQA	St. Louis, Mo.	The Principia	100	281	1,150
KFQB	Fort Worth, Tex.	Lone Star Co.	1,000	508	590
KFQD	Anchorage, Alaska	Shoven Supply Co.	100	300	999
KFQP	Iowa City, Iowa	George S. Carson, Jr.	10	224	1,340
KFQU	Holy City, Calif.	W. E. Riker	100	231	1,300
KFQW	Seattle, Wash.	C. F. Klerim	50	216	1,390
KFQZ	Hollywood, Calif.	Taft Radio Co.	50	226	1,330
KFRB	Beeville, Tex.	Hall Bros.	250	248	1,210
KFRD	San Francisco, Calif.	City of Paris Co.	50	268	1,120
KFRU	Columbia, Mo.	Stephens' College	500	500	600
KFRW	Olympia, Wash.	Western Broadcasting Co.	50	219	1,370
KFSD	San Diego, Calif.	Airfan Radio Corp.	1,000	246	1,220
KFSG	Los Angeles, Calif.	Boho Park Evangelistic Assn.	500	275	1,090
KFTL	Galveston, Tex.	Thos. Goggan & Bro. Mus. Co.	50	258	1,160
KFTM	Colorado Springs, Colo.	W. D. Conley	100	240	1,250
KFTU	St. Louis, Mo.	Concordia College	500	545	550
KFTV	Denver, Colo.	Fitzsimmons Gen. Hosp.	50	234	1,280
KFTW	Ogden, Utah	H. W. Peery & C. Redfield	50	224	1,340
KFTX	Oakland, Calif.	Louis L. Sherman	50	256	1,170
KFTY	Salt Lake City, Utah	University of Utah	100	263	1,180
KFTZ	Oakland, Calif.	Mathewson Motor Co.	50	220	1,360
KFVD	Venice, Calif.	McWhinnie Bros.	50	295.4	1,460
KFVE	St. Louis, Mo.	Vernon Broadcasting Corp.	5,000	240	1,250
KFVG	Independence, Kans.	First Methodist Church	15	236	1,270
KFVI	Houston, Texas	Fifty-sixth Cavalry	10	240	1,250
KFVN	Fairmont, Minn.	C. E. Bagley	50	227	1,320
KFVR	Denver, Colo.	Moonlight Ranch	50	244	1,230
KFVS	Cape Girardeau, Mo.	Battery Station	50	224	1,340
KFVY	Albuquerque, N. M.	Radio Supply Co.	10	250	1,200
KFWB	Hollywood, Cal.	Warner Bros. Pictures, Inc.	500	252	1,190
KFWC	San Bernardino, Calif.	L. W. Wall	50	291	1,030
KFWF	St. Louis, Mo.	St. Louis Truth Center	250	214.2	1,400
KFWH	Eureka, Calif.	F. W. Morse	100	254	1,180
KFWI	So. San Francisco, Calif.	Radio Entertainments, Inc.	500	250	1,300
KFWM	Oakland, Calif.	Oakland Educational Society	250	316	950
KFWO	Avalon, Calif.	Lawrence Mott	500	211.1	1,420
KFWU	Pineville, La.	Louisiana College	100	238	1,260
KFWV	Portland, Ore.	KFWV Broadcast Studio	100	213	1,410
KFXB	Big Bear, Calif.	M. O. Heller	500	203	1,480
KFXD	Lozan, Utah	L. H. Strong	10	205	1,460
KFXE	Denver, Colo.	Pike's Peak Broadcast Co.	500	430	697
KFXH	El Paso, Texas	Bledsoe Radio Co.	50	242	1,240
KFXJ	Edgewater, Colo.	R. G. Howell	15	215.7	1,390
KFXR	Oklahoma City	Classen Film Co.	15	214	1,400
KFXZ	Flagstaff, Ariz.	M. N. Costigan	50	205	1,460
KFYF	Oxnard, Calif.	Carl's Radio Den.	10	214	1,400
KFYJ	Houston, Texas	Houston Pub. Co.	10	238	1,260
KFYO	Texarkana, Texas	Buchanan-Vaughn Co.	10	210	1,430
KFYR	Rismark, N. D.	Hoskins-Meyer, Inc.	10	248	1,210
KGAR	Tucson, Ariz.	Tucson News	100	244	1,230
KGBS	Seattle, Wash.	A. C. Dalley	1,000	227	1,321
KGBU	Ketchikan, Alaska	R. R. Thornton	500	229	1,310
KGBY	Shelby, Neb.	A. C. Denning	10	203	1,480
KGBW	Joplin, Mo.	Marlin Bros.	250	283	1,060
KGBX	St. Joseph, Mo.	J. Babercrombie	30	348	862
KGBZ	York, Neb.	Fed. Live Stock Rem. Co.	100	333	900
KGC	Decorah, Iowa	C. W. Greenlee	15	280	1,070
KGCB	Oklahoma City, Okla.	Wallace Radio Inet.	50	331	905
KGCC	Newark, Ark.	Moore Motor Co.	100	240	1,280
KGCH	Wayne, Neb.	Wayne Hosp.	500	434	663
KGCI	San Antonio, Texas	Intern. Radio Co.	15	240	1,250
KGCL	Seattle, Wash.	L. Wassmer	10	231	1,300
KGCM	San Antonio, Texas	R. E. Bridge	10	268	1,140
KGCN	Concordia, Kans.	Elva E. Smith	50	210	1,428
KGCR	Brookings, S. D.	Cutler's Radio Service, Inc.	15	252	1,190
KGCX	Vida, Mont.	First State Bank	10	240	1,249
KGDA	Dell Rapids, S. D.	Home Auto Co.	15	254	1,180
KGDE	Barrett, Minn.	Jaren Drug Co.	50	232	1,290
KGDI	Seattle, Wash.	N. W. Radio Service Co.	50	476	720
KGDJ	Cresco, Iowa	R. Rathert	10	203	1,480
KGDM	Stockton, Calif.	V. G. Coping	5	217	1,380
KGO	Oakland, Calif.	General Electric Co.	5,000	361	830

Broadcast Stations in U. S., Revised to Dec. 31, 1926

Call Signal	Location of Station	Owner of Station	Power (watts)	Wave length	Frequency (kilo-cycles)
KGRS.....	Amarillo, Tex.....	Gish Radio Service.....	100	234	1,280
KGTF.....	San Francisco, Calif.....	Glad Tidings Tabernacle.....	50	207	1,450
KGU.....	Honolulu, Hawaii.....	Marion A. Mulroney.....	500	270	1,110
KGW.....	Portland, Ore.....	Portland Morning Oregonian.....	1,000	491.5	610
KGY.....	Lacey, Wash.....	St. Martin's College.....	50	278	1,080
KHJ.....	Los Angeles, Calif.....	Times-Mirror Co.....	500	405.2	740
KHQ.....	Spokane, Wash.....	Lee Wasmer.....	1,000	395	760
KICK.....	Anita, Iowa.....	Atlantic Auto Co.....	100	273	1,100
KJBS.....	San Francisco, Calif.....	J. Brunton & Co.....	5	234	1,280
KJR.....	Seattle, Wash.....	Northwest Radio Service Co.....	1,000	384.4	780
KLDS.....	Independence, Mo.....	Church of Jesus Christ.....	1,000	441	680
KLS.....	Oakland, Calif.....	Warner Bros.....	250	252	1,240
KLX.....	Oakland, Calif.....	Tribune Publishing Co.....	500	508.2	590
KLZ.....	Denver, Colo.....	Reynolds Radio Co.....	500	266	1,130
KMA.....	Shenandoah, Iowa.....	May Seed Co.....	500	461	650
KMJ.....	Fresno, Calif.....	Fresno Bee.....	50	234	1,280
KMMJ.....	Clay Centre Nebr.....	M. M. Johnson Co.....	1,000	405	740
KMO.....	Tacoma, Wash.....	KMO, Inc.....	100	250	1,200
KMOX.....	St. Louis, Mo.....	Voice of St. Louis.....	1500	280	1,070
KMTR.....	Los Angeles, Calif.....	KMTR Radio Corp.....	500	370	820
KNRC.....	Santa Monica, Calif.....	Kierulff & Ravenscroft.....	1,000	238	1,260
KNX.....	Los Angeles, Calif.....	Los Angeles Express.....	1,000	337	890
KOA.....	Denver, Colo.....	General Electric Co.....	5,000	322.4	930
KOAC.....	Corvallis, Ore.....	Agr. Col.....	500	280	1,070
KOB.....	Stare College, N. Mex.....	New Mexico College of Agr.....	1,000	348.6	860
KOCH.....	Omaha, Neb.....	Central High School.....	250	258	1,160
KOCW.....	Chickasha, Okla.....	Okla. College.....	200	252	1,190
KOIL.....	Council Bluffs, Ia.....	Mona Motor Oil Co.....	500	306	980
KOIN.....	Portland, Ore.....	H. B. Read.....	1,000	319	940
KOMO.....	Seattle, Wash.....	B. F. Fisher.....	1,000	306	980
KOWW.....	Walla Walla, Wash.....	B. A. Moore.....	500	285	1,052
KPJM.....	Prescott, Ariz.....	Wilbur Radio Service.....	15	215	1,345
KPO.....	San Francisco, Cal.....	Hale Bros. and the Chronicle.....	1,000	428.3	700
KPPC.....	Pasadena, Calif.....	Pasadena Presbyterian Church.....	50	229	1,310
KPRC.....	Houston, Tex.....	Pulitzer Pub. Co.....	500	296	1,010
KPSN.....	Pasadena, Calif.....	Pasadena Star-News.....	1,000	315.6	950
KQV.....	Pittsburgh, Pa.....	Douglas-Hill Elec. Co.....	500	275	1,090
KQW.....	San Jose, Calif.....	First Baptist Church.....	500	333	900
KRAC.....	Shreveport, La.....	Cado Radio Club.....	50	220	1,363
KRE.....	Berkeley, Calif.....	Berkeley Daily Gazette.....	100	256	1,170
KRLD.....	Dallas, Texas.....	Dallas Radio Lab.....	500	357	840
KRSC.....	Seattle, Wash.....	Radio Sales Corp.....	50	500	600
KSAC.....	Manhattan, Kans.....	Kans. State Agric. College.....	500	340.7	880
KSBA.....	Kennewood, La.....	W. G. Patterson.....	1,000	313	959
KSD.....	St. Louis, Mo.....	Pulitzer Pub. Co.....	500	545.1	550
KSEI.....	Pocatello, Idaho.....	Broadcasting Assn.....	500	261	1,150
KSL.....	Salt Lake City, Utah.....	Radio Service Corp.....	1,000	200	1,000
KSMR.....	Santa Maria, Calif.....	Val. Ry. Co.....	100	283	1,080
KSO.....	Clarinda, Ia.....	A. A. Berry Seed Co.....	500	445	740
KSOO.....	Sioux Falls, S. D.....	Sioux Falls Broadcast Assn.....	100	360	833
KTAB.....	Oakland, Calif.....	Tenth Ave. Baptist Church.....	500	303	990
KTBI.....	Los Angeles, Calif.....	Bible Institute.....	750	294	1,020
KTBR.....	Portland, Ore.....	Brown's Radio Shop.....	50	263	1,140
KTHS.....	Hot Springs, Ark.....	New Arlington Hotel Co.....	1,000	375	800
KTNT.....	Muscatine, Ia.....	Norman Baker.....	1,000	333	900
KTUB.....	Houston, Texas.....	Whait Elec.....	5	263	1,140
KTW.....	Seattle, Wash.....	First Presbyterian Church.....	1,000	454.3	660
KTOA.....	Fayetteville, Ark.....	Univ. of Arkansas.....	750	300	1,000
KUOM.....	Missoula, Mont.....	University of Montana.....	500	244.8	1,230
KUSD.....	Vermillion, S. Dak.....	Univ. of So. Dakota.....	100	278	1,080
KUT.....	Austin, Tex.....	Univ. of Texas.....	500	231	1,300
KVOO.....	Bristow, Okla.....	S. W. Sales Corp.....	500	375	800
KWCR.....	Cedar Rapids, Ia.....	H. F. Parr.....	500	278	1,080
KWG.....	Stockton, Calif.....	Portable Wireless Tel. Co.....	50	248	1,210
KWKC.....	Kansas City, Mo.....	Wilson Duncan Studios.....	100	236	1,270
KWKH.....	Shreveport, La.....	W. G. Paterson.....	1,000	313	959
KWOR.....	Cedar Rapids, Iowa.....	H. F. Paar.....	100	296	1,000
KWSC.....	Pullman, Wash.....	State College of Wash.....	500	349	860
KWTG.....	Santa Ana, Calif.....	J. W. Hancock.....	15	261	1,150
KWIUC.....	Le Mars, Iowa.....	Western Union College.....	50	252	1,190
KWWG.....	Brownsville, Tex.....	City of Brownsville, Tex.....	500	278	1,080
KWV.....	Chicago, Ill.....	Westinghouse Elec. & Mfg. Co.....	3,500	535.4	560
KZIB.....	Manila, P. I.....	I. Beck, Inc.....	20	250	1,200

Broadcast Stations in U. S., Revised to Dec. 31, 1926

Call Signal	Location of Station	Owner of Station	Power (watts)	Wave length	Frequency (kilocycles)
KZKZ	Manila, P. I., 109 Plaza Moraga	Electrical Supply Co.	100	276	1,110
KZM	Oakland, Calif.	Preston D. Allen	100	240	1,250
KZRQ	Manila, P. I., Manila Hotel	Far Eastern Radio, Inc.	500	222	1,350
KZUK	Bagino, P. I.	F. J. Elser	500	366	823
NAA	Arlington, Va.	United States Navy	1,000	434.5	690
WAAD	Cincinnati, Ohio	Ohio Mechanics Inst.	25	258	1,160
WAAF	Chicago, Ill.	Chicago Daily Drivers Journal	250	278	1,080
WAAM	Newark, N. J.	I. R. Nelson	500	263	1,140
WAAW	Omaha, Neb.	Omaha Grain Exchange	500	384	780
WABE	Harrisburg, Pa.	Harrisburg Radio Co.	10	204	1,470
WAAT	Hoboken, N. J.	F. Bremer	10	235	1,276
WABC	Ashville, N. C.	Ashville Battery Co.	20	254	1,180
WABI	Bangor, Me.	First Univ. Church	100	240	1,250
WABO	Chester, N. Y.	Hickson Elec. Co., Inc.	100	278	1,080
WABQ	Haverford, Pa.	Haverford College Rad. Club	100	261	1,150
WABK	Toledo, Ohio	Scott High School	50	263	1,140
WABW	Wooster, Ohio	College of Wooster	50	206.8	1,450
WABX	Mount Clemens, Mich.	Henry B. Joy	500	246	1,220
WABY	Philadelphia, Pa.	John Magaldi, Jr.	50	242	1,240
WABZ	New Orleans, La.	Coliseum Place Baptist Church	50	275	1,090
WADC	Akron, O.	Portage Hotel	500	258	1,160
WADF	Port Huron, Mich.	Albert B. Parfet Co.	500	275	1,090
WAGM	Royal Oak, Mich.	R. L. Miller	50	275	1,330
WAGS	Summerville, Mass.	Willow Garages, Inc.	5	250	1,199
WAGU	Richmond Hill, N. Y.	A. H. Grebe & Co.	500	315.6	950
WAIT	Taunton, Mass.	A. H. Waite & Co.	10	229	1,310
WAIU	Columbus, Ohio	Elk Country Club	750	294	1,020
WAMD	Minneapolis, Minn.	Hubbard & Co.	500	244	1,230
WAPI	Tucson, Ala.	Ala. Poly. Institute	1,000	461	650
WARC	Medford Hills, Mass.	Am. Radio & Res. Co.	100	261	1,150
WARS	Brooklyn, N. Y.	Amateur Radio Co.	500	295	1,015
WASH	Grand Rapids, Mich.	Baxter Laundry Co.	500	256	1,170
WATT	Boston, Mass.	Edison Co.	100	244	1,230
WBAA	West Lafayette, Ind.	Furdue Univ.	250	273	1,100
WBAK	Harrisburg, Pa.	Penn State Police	500	275	1,090
WBAL	Baltimore, Md.	Consolidated Gas Co.	1000	246	1,220
WBAO	Decatur, Ill.	James Millikin Univ.	100	270	1,110
WBAP	Fort Worth, Tex.	Carter Publishing Co.	1,500	475.9	630
WBAY	Nashville, Tenn.	Braid Elect. Co.	100	236	1,270
WBAZ	Wilkes-Barre, Pa.	John H. Stenger, Jr.	100	256	1,170
WBBC	Brooklyn, N. Y.	Peter J. Testan	100	250	1,200
WBBL	Richmond, Va.	Grace Covenant Church	100	229	1,310
WBEM	Chicago, Ill.	Atlas Investment Co.	1,500	226	1,330
WBEP	Potoskey, Mich.	Potoskey High School	200	238	1,260
WBBR	Rossville, N. Y.	People's Pulpit Assn.	500	416	720
WBBW	Norfolk, Va.	Ruffner Junior High School	50	222	1,350
WBBY	Charleston, S. C.	Washington Light Inf.	10	268	1,120
WBBZ	Chicago, Ill.	O. L. Carrell (portable)	50	215.7	1,390
WBCN	Chicago, Ill.	Foster & McDonnell	500	266	1,130
WBES	Tacoma Park, Md.	Riles Electrical School	100	222	1,350
WBMS	New Bergen, N. J.	G. J. Showerer	10	224	1,340
WBNY	New York City	B. A. Rushome Corp.	500	322.4	1,430
WBOQ	Richmond Hill, N. Y.	A. H. Grebe Co.	100	236	1,270
WBOI	Newark, N. J.	Ira Nelson	500	263	1,140
WBRC	Birmingham, Ala.	Bell Radio Corp.	50	248	1,210
WBRE	Wilkes-Barre, Pa.	Baltimore Radio Exchange	100	231	1,300
WBRL	Tilton, N. H.	Booth Radio Lab.	500	365	821
WBRS	Brooklyn, N. Y.	Univ. Radio Mfg. Co.	100	304	761
WBT	Charlotte, N. C.	So. Radio Corp.	250	275	1,090
WBZ	Springfield, Mass.	Westinghouse Elec. & Mfg. Co.	5,000	331.1	900
WBZA	Boston, Mass.	Westinghouse Electric	250	333	900
WCAC	Mansfield, Conn.	Conn. Agr. Col.	500	275	1,090
WCAD	Canton, N. Y.	St. Lawrence Univ.	250	263	1,140
WCAE	Pittsburgh, Pa.	Kaufmann & Baer Co.	500	461.3	650
WCAH	Columbus, Ohio	Entreklin Elec. Co.	500	265	1,130
WCAJ	University Place, Neb.	Nebraska Wesleyan Univ.	500	254	1,180
WCAK	Northfield, Minn.	St. Olaf College	500	336.9	890
WCAM	Camden, N. J.	City of Camden	250	337	890
WCAO	Baltimore, Md.	Sanders & Stayman Co.	100	275	1,090
WCAR	San Antonio, Tex.	Southern Radio Corp. of Texas	500	263	1,140
WCAT	Rapid City, S. Dak.	So. Dakota State Sch. of Mines	50	240	1,250
WCAU	Philadelphia, Pa.	Durham & Co.	500	278	1,080
WCAX	Burlington, Vt.	Univ. of Vermont	100	250	1,200

Broadcast Stations in U. S., Revised to Dec. 31, 1926

Call Signal	Location of Station	Owner of Station	Power (watts)	Wave length	Frequency (kilo-cycles)
WCAZ	Carthage, Ill.	Carthage Col.	50	246	1,220
WCBA	Allentown, Pa.	Chas. W. Heimbach Camegraph Repair Shop	15	254	1,180
WCBD	Zion, Ill.	Wilbur G. Voliva	5,000	344.6	870
WCBF	New Orleans, La.	Walt Bros. Radio Co.	5	263	1,140
WCBH	Oxford, Miss. (near)	Univ. of Miss.	50	242	1,240
WCBM	Baltimore, Md.	Hotel Chateau	50	229	1,310
WCBR	Providence, R. I. (port.)	Chas. H. Messter, 42 Doyle	100	210	1,430
WCBS	Boston, Mass.	N. L. Dewing	250	242	1,235
WCCO	Anoka, Minn.	Washburn-Crosby Co.	5,000	416.4	720
WCFL	Chicago, Ill.	Chicago Federation of Labor	1,000	491.5	610
WCFT	Tullahoma, Tenn.	Knights of Pythias	10	252	1,190
WCGU	Lakewood, N. J.	C. Gungar	500	351	855
WCLO	Camp Lake, Wis.	E. H. Whitmore	50	231	1,300
WCLS	Joliet, Ill.	WCLS, Inc.	150	214	1,400
WCMA	Culver, Ind.	Culver Mil. Acad.	500	258.5	1,160
WCOA	Pensacola, Fla.	City of Pensacola	500	222	1,350
WCRW	Chicago, Ill.	Clinton R. White	50	416	720
WCSH	Portland, Me.	H. P. Rives	500	500	600
WCSS	Springfield, Ohio	Wittenberg Col.	100	248	1,210
WCWK	Fort Wayne, Ind.	Chester Keen	250	234	1,280
WCWS	Providence, R. I.	C. W. Selen	100	210	1,430
WCA	Detroit, Mich.	Detroit Free Press	5,000	516.9	580
WDAD	Nashville, Tenn.	Dad's Auto Accessories	150	226	1,330
WDAE	Tampa, Fla.	Tampa Daily News	200	273	1,100
WDAF	Kansas City, Mo.	Kansas City Star	1,000	365.6	820
WDAK	Amador, Tex.	J. LaFrance Martin	100	263	1,140
WDAH	El Paso, Texas	Trinity Meth. Church	50	268	1,120
WDAI	Fargo, N. Dak.	Radio Equip. Corp.	50	261	1,150
WDBE	Atlanta, Ga.	22 Luckie St. Gilham-Schoen Elec. Co.	100	270	1,110
WDBJ	Roanoke, Va.	Richardson-Wayland Elec. Crp.	50	229	1,310
WDBK	Cleveland, Ohio	M. F. Broz Fur. Co.	100	227	1,320
WDBO	Water Park, Fla.	Rollins College	500	240	1,250
WDBZ	Kingston, N. Y.	Kingston Radio Club	10	232	1,290
WDEL	Wilmington, Del.	Electric Spec. Co.	100	265	1,130
WDGY	Minneapolis, Minn.	Dr. G. W. Young	500	263	1,140
WDDO	Chattanooga, Tenn.	Chattanooga Radio Co.	500	256	1,170
WDRG	New Haven, Conn.	Doolittle Radio Co.	500	268	1,120
WDXR	Easton, R. I.	Emee W. Flint	500	440.9	680
WDFL	Detroit, Mich.	DXL Radio Corp.	250	297	1,010
WDFC	Tuscola, Ill.	James L. Bush	100	278	1,080
WEAF	New York, N. Y.	National Broadcasting Co., Inc.	5,000	491.5	610
WEAL	Ithaca, N. Y.	Cornell University	500	254	1,180
WEAM	North Plainfield, N. J.	Borough of N. Plainfield	250	261	1,150
WEAN	Providence, R. I.	Shepard Co.	500	367	817
WEAO	Columbus, Ohio	Ohio State University	750	293.9	1,020
WEAK	Cleveland, Ohio	Willard Storage Battery Co.	750	389.4	770
WEAG	Sioux City, Iowa	Davidson Bros. Co.	100	275	1,090
WEBC	Superior, Wis.	Walter C. Bridges	100	242	1,240
WEBD	Anderson, Ind.	Elec. Equip. & Service Co.	10	246	1,220
WEBH	Chicago, Ill.	Edgewater Beach Hotel Co.	2,000	370.2	810
WEBJ	New York City	Third Ave. Railway Co.	500	273	1,100
WEBL	(Portable)	Radio Corp. of America	100	226	1,330
WEBQ	Harrisburg, Ill.	Hate Radio Co.	10	225	1,330
WEBR	Buffalo, N. Y.	H. H. Howell	100	244	1,230
WEBW	Beloit, Wis.	Beloit College	500	268	1,120
WEBZ	Savannah, Ga.	Savannah Radio Corp.	50	263	1,140
WEDC	Chicago, Ill.	E. Denemark	1,000	422	710
WEEI	Boston, Mass.	Edison Elec. Illum. Co.	500	349	860
WEHS	Evanston, Ill.	Robt. E. Hughes	10	203.4	1,480
WEMC	Benon Springs, Mich.	Emmanuel Miss. College	500	316	950
WENR	Chicago, Ill.	All-American Radio Corp.	1,000	366	1,180
WENP	Glooucester, Mass.	R. S. Matheson	100	295	1,016
WEW	St. Louis, Mo.	St. Louis University	1,000	360	833
WFAA	Dallas, Tex.	Dallas News & Dallas Journ.	500	475.9	628
WFAM	St. Cloud, Minn.	Times Pub. Co.	10	273	1,100
WFAY	Lincoln, Neb.	Univ. of Nebr.	500	275	1,090
WFBC	Lexington, Penn.	First Baptist Church	50	250	1,200
WFBE	Seymour, Ind.	John Van de Walle	10	226	1,330
WFBG	Albion, Pa.	William F. Gable Co.	100	273	1,080
WFCL	Pawtucket, R. I.	F. Crook, Inc.	100	229	1,309
WFHJ	Collegeville, Minn.	St. John's Univ.	100	236	1,270
WFBL	Syracuse, N. Y.	Onondaga Hotel	100	252	1,190
WFBM	Indianapolis, Ind.	Merchants Heat & Light Co.	250	288	1,120

Broadcast Stations in U. S., Revised to Dec. 31, 1926

Call Signal	Location of Station	Owner of Station	Power (watts)	Wave length	Frequency (kilocycles)
WFBR	Baltimore, Md.	Fifth Infantry, Md. Nat. Gd.	100	254	1,180
WFZ	Galesburg, Ill.	Knox College	20	254	1,180
WFDF	Flint, Mich.	Frank P. Fallain	100	234	1,280
WFKB	Chicago, Ill.	Francis K. Bridgman	500	217.3	1,380
WFL	Philadelphia, Pa.	Strawbridge & Clothier	500	334.0	160
WFKL	Brooklyn, N. Y.	Flatbush Radio Labs.	100	330	1,280
WGAL	Lancaster, Pa.	Lancaster Elec. Sup. & Const. Co.	10	248	1,210
WGBC	Memphis, Tenn.	First Baptist Church	10	278	1,080
WGBC	Evansville, Ind.	Finke Furniture Co.	500	236	1,270
WGBL	Scranton, Pa.	Scranton Broadcasters, Inc.	10	240	1,250
WGBR	Marshfield, Wis.	Marshfield Broad. Assn.	10	229	1,210
WGBS	New York, N. Y.	Gimbel Bros.	500	315.6	950
WGBU	Tulford, Fla.	Florida Fin. Co.	500	278	1,080
WGBX	Orono, Me.	University of Maine	500	234	1,280
WGCP	Newark, N. J.	D. W. May	500	262	1,190
WGES	Chicago, Ill.	Oak Leaves Broadcasting Corp.	500	316	950
WGHB	Clearwater, Fla.	Ft. Harrison Hotel	500	265	1,130
WGHP	Detroit, Mich.	G. H. Phelps, Inc.	1,500	270	1,110
WGM	Jeanette, Pa.	Verne E. Spencer	10	269	1,110
WGMU	Richmond Hill, N. J.	A. H. Grebe & Co., Inc.	100	236	1,270
WGN	Chicago, Ill.	The Tribune (Drake Hotel)	1,000	303	990
WGR	Buffalo, N. Y.	Fed. Tel. Mfg. Corp.	100	319	940
WGST	Atlanta, Ga.	Ga. School of Tech.	500	270	1,110
WGW	Milwaukee, Wis.	Radiocast Corp.	1,000	384	780
*WGY	Schenectady, N. Y.	Gen. Electric Co.	5,000	379.5	790
WHA	Madison, Wis.	Univ. of Wisc.	750	535.4	560
WHAD	Milwaukee, Wis.	Marquette Univ.	500	275	1,090
WHAM	Rochester, N. Y.	Univ. of Rochester	100	278	1,080
WHAP	New York, N. Y.	Wm. H. Taylor Corp.	500	431	695
WHAR	Atlantic City, N. J.	Seaside Hotel	500	275	1,090
WHAS	Louisville, Ky.	Cour. Journ. & Louisville Times	500	339.8	160
WHAZ	Troy, N. Y.	Rensselaer Polytech. Inst.	1,000	380	790
WHB	Kansas City, Mo.	Sweney School Co.	200	265.6	820
WHBA	Oil City, Pa.	Shaffer Music House	10	250	1,200
WHBC	Canton, O.	Rev. E. P. Graham	10	264	1,180
WHBD	Bellefontaine, O.	Chamber of Commerce	20	222	1,350
WHBF	Rock Island, Ill.	Bearsley Specialty Co.	100	222	1,350
WHBG	Harrisburg, Pa.	John S. Skane	20	231	1,300
WHBT	Logansport, Ind.	C. L. Carroll	50	216	1,390
WHBM	Chicago, Ill.	C. L. Carroll	20	216	1,390
WHBN	St. Petersburg, Fla.	Methodist Church	10	238	1,260
WHBP	Johnstown, Pa.	Johnstown Auto Co.	100	256	1,170
WHBQ	Memphis, Tenn.	St. John's Methodist Church	50	233	1,290
WHBU	Anderson, Ind.	Rivera Theatre	10	218.8	1,370
WHBW	Philadelphia, Pa.	D. R. Kierozie	100	216	1,390
WHBY	West De Pere, Wis.	St. Norbert's College	50	250	1,200
WHBZ	Minneapolis, Minn.	Wm. Hood Dunwoody Ind. Inst.	500	278	1,080
WHCC	Rochester, N. Y.	Hickson Elect. Co.	100	268	1,160
WHFC	Chicago, Ill.	Hotel Flanders	150	259	1,160
WHK	Cleveland, Ohio	Radio Air Service	1,000	273	1,100
WHL	New York, N. Y.	George Schubel	500	361.2	830
WHO	Des Moines, Iowa	Bankers Life Co.	5,000	626	570
WHOG	Huntingdon, Ind.	Broadcasters' Assn.	15	242	1,240
WHT	Deerfield, Ill.	Radiophone Corp.	3,500	238	1,260
WIAD	Philadelphia, Pa.	Howard H. Miller	100	260	1,200
WIAS	Burlington, Iowa	Home Electric Co.	100	264	1,180
WIBA	Madison, Wis.	Times Studio	100	255	1,270
WIBG	Elkins Park, Pa.	St. Paul's Church	50	222	1,350
WIBH	New Bedford, Mass.	Elite Radio Stores	30	209.7	1,430
WIBI	Flushing, L. I.	F. B. Zittel	50	218.8	1,370
WIBJ	Chicago, Ill.	C. L. Carroll	50	216.7	1,390
WIBM	Chicago, Ill.	Billy Maine (portable)	10	216	1,390
WIBO	Chicago, Ill.	Nelson Bros.	1,000	226	1,330
WIBR	Weirton, W. Va.	Thos. A. Owings	50	246	1,220
WIBS	Elizabeth, N. J.	N. J. National Guard	10	202.6	1,480
WIBU	Poynette, Wis.	The Electric Farm	20	222	1,350
WIBW	Logansport, Ind.	L. L. Hill	100	220	1,360
WIBX	Utica, N. Y.	Grid-Leak, Inc.	150	234	1,280
WIBZ	Montgomery, Ala.	Powell Elec. Co.	10	231	1,300
WICC	Bridgeport, Conn.	Bridgeport Broadcast Sta.	500	286	1,052

*WGY also broadcasts on 61 meters for experimental and re-broadcasting purposes.

Broadcast Stations in U. S., Revised to Dec. 31, 1926

Call Signal	Location of Station	Owner of Station	Power (watts)	Wave length	Frequency (kilocycles)
WIL	St. Louis, Mo.	Benson Radio Co.	250	258	1,162
WIOD	Miami Beach, Fla.	Carl G. Fisher	1,000	248	1,210
WIP	Philadelphia, Pa.	Gumbel Bros.	500	508.2	590
WJAD	Waco, Tex.	Jackson's Radio Eng. Labs.	500	352.7	850
WJAF	Ferndale, Mich.	J. A. Fenberg Radio Co.	50	407	737
WJAG	Norfolk, Neb.	Norfolk Daily News	200	270	1,110
WJAK	Greentown, Ind.	Clifford L. White	50	254	1,180
WJAM	Cedar Rapids, Iowa	W. D. M. Perham	100	268	1,120
WJAR	Providence, R. I.	The Outlet Co.	500	305.9	880
WJAS	Pittsburgh, Pa.	Pittsburgh Radio Sup. House	500	275	1,090
WJAX	Jacksonville, Fla.	City of Jacksonville	1,000	337	890
WJAZ	Mount Prospect, Ill.	Zenith Radio Co.	1,500	330	910
WJBA	Joliet, Ill.	D. H. Lentz	50	206.8	1,450
WJBB	St. Petersburg, Fla.	L. W. McClung	10	254	1,180
WJBC	La Salle, Ill.	Humner Furniture Co.	100	234	1,280
WJBI	Red Bank, N. J.	Robt. S. Johnson	250	219	1,370
WJBK	Ypsilanti, Mich.	E. F. Goodwin	10	233	1,290
WJBL	Decatur, Ill.	Wm. Gushard D. G. Co.	500	270	1,110
WJBO	New Orleans, La.	N. Jensen	100	268	1,120
WJBR	Omro, Wis.	Geusch & Stearns	50	227	1,320
WJBT	Chicago, Ill.	J. S. Boyd	500	469	640
WJBU	Lewistown, Pa.	Bucknell Univ.	100	211	1,420
WJBV	Woodhaven, N. Y.	Union Course Lab.	100	288	1,040
WJBW	New Orleans, La.	C. Carlson, Jr.	30	340	880
WJBX	Osterville, Mass.	Henderson & Ross	100	260	1,100
WJBY	Gadsden, Ala.	Elect. Const. Co.	30	270.1	1,110
WJCB	New York City	M. B. Ross	250	517	580
WJCD	Mooseheart, Ill.	Supreme Lodge, Loyal Order of Moose	1,000	370	810
WJCE	Pontiac, Mich.	Jewett Radio Co.	5,000	517	580
WJCF	New Orleans	C. Carlson, Jr.	100	270	1,110
WJCY	New York, N. Y.	Radio Corp. of America	1,000	405.2	740
WJZ	Boundbrook, N. J.	Radio Corp. of America	50,000	454.3	660
WKAF	Milwaukee, Wis.	WKAF Broadcasting Co.	500	261	1,150
WKAQ	San Juan, P. R.	Radio Corp. of P. R.	500	340.7	880
WKAR	East Lansing, Mich.	Michigan State College	1,000	285	1,050
WKAV	Laconia, N. H.	Laconia Radio Club	50	224	1,340
WKBA	Chicago, Ill.	Arrow Battery Co.	200	210	1,430
WKBB	Joliet, Ill.	Sanders Bros.	150	233	1,060
WKBC	Birmingham, Ala.	H. L. Ansley	50	225	1,333
WKBD	Webster, Mass.	K & B Electric Co.	100	270	1,110
WKBF	Indianapolis, Ind.	N. D. Watson	100	244	1,229
WKBG	Chicago, Ill.	C. S. Carrell (portable)	100	216	1,390
WKBH	La Crosse, Wis.	Callaway Music	500	250	1,200
WKBI	Chicago, Ill.	F. L. Schoonwolf	50	220	1,360
WKBJ	St. Petersburg, Fla.	Gost Taber, Inc.	250	280	1,071
WKBL	Monroe, Mich.	Monrovia Radio Co.	15	252	1,190
WKBM	Youngstown, Ohio	Radio Elect. Service Co.	33	360	832
WKBO	Jersey City, N. J.	Cornish Corp.	200	309	970
WKBP	Battle Creek, Mich.	Battle Creek News	50	265	1,131
WKBQ	New York City	Starlight Park	10	285	1,052
WKBR	Auburn, N. Y.	C. S. Hesser	100	225	1,333
WKBS	Galesburg, Ill.	P. N. Nelson	200	361	830
WKBT	New Orleans, La.	First Baptist Church	50	252	1,190
WKBU	Brookville, Ind.	Knox Bat. Co.	75	236	1,270
WKBW	Buffalo, N. Y.	Churchill Evans Assn.	1,000	363	827
WKBY	Danville, Pa.	F. Quick (portable)	50	220	1,363
WKBZ	Ludington, Mich.	K. L. Ashbacher	15	256	1,170
WKDR	Kenosha, Wis.	E. A. Dato	10	428	700
WKJC	Lancaster, Pa.	K. Johnston	50	259	1,160
WKRC	Cincinnati, O.	Kodak Radio Shop	1,000	422.3	710
WKY	Oklahoma City, Okla.	WKY Radio Shop	100	275	1,090
WLAL	Tulsa, Okla.	First Christian Church	100	250	1,200
WLAP	Louisville, Ky., 305 West Breckenridge St.	W. V. Jordan	20	275	1,090
WLR	Minneapolis, Minn.	Univ. of Minn.	500	278	1,080
WLBC	Muncie, Ind.	D. A. Burton	50	224	1,340
WLBE	Brooklyn, N. Y.	J. H. Fruitman	15	231	1,300
WLBF	Kansas City	E. L. Dillard	25	211	1,420
WLBI	Stevens Point, Wis.	Wisc. Dept. of Markets	500	278	1,080
WLBJ	Chicago, Ill.	Liberty Weekly	4,000	302.8	990
WLIT	Philadelphia, Pa.	Lit Bros.	500	394.6	760
WLK	Crete, Ill.	Sears-Roebuck & Co.	5,000	344.6	870
WLSL	Cranston, R. I.	Lincoln Studios	500	441	680

Broadcast Stations in U. S., Revised to Dec. 31, 1926

Call Signal	Location of Station	Owner of Station	Power (watts)	Wave length	Frequency (kilo-cycles)
WLTS...	Chicago, Ill.	Lane Technical High School...	100	258	1,160
WLW...	Harrison, Ohio.	Crosley Radio Corp.	5,000	422.3	710
WLWL...	New York, N. Y.	St. Paul Miss. Society.	5,000	384	780
WMAE...	Cazenovia, N. Y.	Oliver B. Meredith.	100	275	1,090
WMAF...	Dartmouth, Mass.	Round Hills Radio Corp.	1,000	441	680
WMAK...	Lockport, N. Y.	Norton Laboratories	500	266	1,130
WMAI...	Washington, D. C.	M. A. Lesse Co.	100	294	1,010
WMAO...	Columbus, Ohio.	Haskett Radio Station	50	278	1,080
WMAQ...	Chicago, Ill.	Chicago Daily News	1,000	447.5	670
WMAV...	St. Louis, Mo.	Kingshighway Presby. Church.	100	248	1,210
WMAZ...	Macon, Ga.	Mercere University	500	261	1,150
WMBB...	Chicago, Ill.	Amer. Bond & Mortgage Co.	500	250	1,200
WMBE...	Detroit, Mich.	Michigan Broadcasting Co.	100	256	1,170
WMBF...	Miami Beach, Fla.	Fleewood Hotel	500	844.4	780
WMBI...	Chicago, Ill.	Moody Bible Inst.	500	288.3	1,040
WMBJ...	Memphis, Tenn.	Commercial Appeal	1,000	499.7	600
WMCB...	Hoboken, N. J.	Greeley Sq. Hotel	500	341	880
WMBR...	Jamaica, N. Y.	Peter J. Priuz.	5	227	1,320
WMSG...	New York City	Madison Sq. Garden	500	302.8	990
WNAE...	Boston, Mass.	Shepherd Stores	100	250.2	1,070
WNAE...	Boston, Mass.	Shepherd Stores	500	430.1	697
WNAF...	Norman, Okla.	Univ. of Oklahoma	500	254	1,180
WNAI...	Omaha, Neb.	R. J. Rockwell	50	258	1,160
WNAJ...	Philadelphia, Pa.	Lennig Bros. Co.	100	250	1,200
WNAK...	Yankton, S. Dak.	Dak. Radio Apparatus Co.	100	244	1,230
WNBH...	New Bedford, Mass.	New Bedford Hotel	250	248	1,210
WNBK...	Newark, N. J.	Radio Shop of Newark	500	350	1,190
WNOX...	Knoxville, Tenn.	People's T. & T. Co.	500	268	1,120
WNRG...	Greensboro, N. C.	W. M. Nelson	10	224	1,340
WNYC...	New York City	City of New York	1,000	526	670
WOAI...	San Antonio, Tex.	Southern Equip. Co.	2,000	394.5	760
WOAN...	Lawrenceburg, Tenn.	James D. Vaughn	500	282.8	1,060
WOAW...	Omaha, Neb.	Woodmen of the World	1,000	526	570
WOAX...	Trenton, N. J.	Franklyn J. Wolff	500	240	1,250
WOBB...	Chicago, Ill.	Longacre Const. Co.	5	555	540
WOC	Davenport Iowa	Palmer Sch. of Chiropractic	5,000	483.6	620
WOCB...	Orlando, Fla.	Orlando Broadcast Co.	50	294	1,021
WOCI...	Jamestown, N. Y.	Hotel Jamestown	15	275	1,090
WODA...	Patterson, N. J.	O'Dea Radio & Victrola Shop	250	391	767
WOI...	Ames, Iowa	Iowa State College	750	270	1,110
WOK...	Homewood, Ill.	Neutrowound Radio Co.	5,000	217	1,380
WOKO...	Peekskill, N. Y.	Harold Smith	50	232	1,290
WOMT...	Manitowac, Wis.	Mlkadow Theatre	50	254	1,180
WOO...	Philadelphia, Pa.	John Wanamaker	500	508.2	590
WOOD...	Grand Rapids, Mich.	Grand Rapids Radio Co.	500	242	1,240
WOQ...	Kansas City, Mo.	Unity Sch. of Christianity	1,000	278	1,080
WOR...	Newark, N. J.	L. Ramberger & Co.	500	405.2	740
WORD...	Batavia, Ill.	People Pulpit Assn.	5,000	275	1,090
WOS...	Jefferson City, Mo.	Mo. State Marketing Bureau	500	440.9	680
WOWL...	New Orleans, La.	Owl Battery Co.	10	270	1,110
WOWO...	Fort Wayne, Ind.	Main Auto Supply Co.	500	227	1,320
WPAK...	Agricultural College, N. Dak.	N. Dak. Agr. College	50	275	1,090
WPCC...	Chicago, Ill.	No. Shore Cong. Church	500	258	1,160
WPCH...	New York City	People's Broadcasting Corp.	500	273	1,100
WPDQ...	Buffalo, N. Y.	H. F. Turner	250	205	1,460
WPG...	Atlantic City, N. J.	Municipality of Atlantic City	5,000	299.8	1,000
WPRC...	Harrisburg, Pa.	Wilson Ptz. & Radio Co.	100	215.7	1,390
WPRC...	State College, Pa.	Penn. State College	500	261	1,050
WQAA...	Parkeshurg, Pa.	Horace A. Beale, Jr.	500	220	1,360
WQAE...	Springfield, Vt.	Moore Radio News Station	50	246	1,220
WQAM...	Miami, Fla.	Electrical Equipment Co.	750	286	1,050
WQAN...	Seranton, Pa.	Seranton Times	100	250	1,200
WQAO...	Cliffs, N. J.	Calvary Baptist Church	500	360	830
WQJ...	Chicago, Ill.	Cabnet Rainbo Broadcast, Co.	500	447.5	670
WRAF...	Laporte, Ind.	Radio Club, Inc.	100	224	1,340
WRAH...	Providence, R. I.	Stanley Read	150	235	1,276
WRAK...	Escanaba, Mich.	Economy Light Co.	100	256	1,170
WRAM...	Galesburg, Ill.	Lombard College	100	244	1,230
WRAV...	Yellow Springs, Ohio	Antioch College	100	252	1,140
WRAW...	Reading, Pa.	Ave. Radio & Elec. Shop	10	238	1,260
WRAX...	Philadelphia, Pa.	Beracah Church, Inc.	500	268	1,120
WRBC...	Valparaiso, Ind.	Immanuel Lutheran Church	500	278	1,080

Broadcast Stations in U. S., Revised to Dec. 31, 1926

Call Signal	Location of Station	Owner of Station	Power (watts)	Wave length	Frequency (kilocycles)
WRCO	Washington, D. C.	R. C. A.	500	468.5	640
WRCO	Raleigh, N. C.	Wynne Radio Co.	100	252	1,190
WREC	Coldwater, Miss.	Wootens Radio Co.	10	254	1,180
WREC	Lansing, Mich.	Reo Motor Car Co.	500	285.5	1,050
WRES	Wollaston, Mass.	H. L. Sawyer	100	300	999
WRHF	Washington, D. C.	Wash. Radio Hosp. Fund.	50	256	1,170
WRHM	Minneapolis, Minn.	Rosedale Hospital	50	252	1,190
WRK	Hamilton, Ohio	Doron Bros. Elec. Co.	100	270	1,110
WRM	Urbana, Ill.	Univ. of Ill.	500	273	1,100
WRMU	New York, N. Y.	A. H. Grebe Co., Inc.	100	236	1,270
WRNY	Coytesville, N. J.	Experimenter Pub. Co.	500	374.8	802
WRR	Dallas, Texas	City of Dallas	500	246	1,220
WRST	Bay Shore, N. Y.	Radiotel Mfg. Co.	250	215.7	1,390
WRVA	Richmond, Va.	Lazarus & Bro. Co.	1,000	256	1,170
WSAJ	Cincinnati, Ohio	U. S. Playing Card Co.	5,000	325.9	920
WSAJ	Grove City, Pa.	Grove City College	250	229	1,310
WSAN	Allentown, Pa.	Allentown Call Pub. Co.	100	229	1,310
WSAR	Fall River, Mass.	Doughty & Welch Elec. Co.	100	254	1,180
WSAV	Houston, Texas	C. W. Vick	100	248	1,210
WSAX	(Portable)	Zenith Radio Corp.	100	268	1,120
WSAZ	Pomeroy, Ohio	Chase Electric Shop	50	244	1,230
WSB	Atlanta, Ga.	Atlanta Journal	1,000	428.3	700
WSBC	Chicago, Ill.	World Battery Co.	1,000	268.3	1,040
WSBF	St. Louis, Mo.	Stix, Baer Co.	250	273	1,100
WSBT	South Bend, Ind.	South Bend Tribune	250	315	952
WSDA	New York, N. Y.	City Temple	250	263	1,140
WSKC	Bay City, Mich.	World's Star Knitting Co.	100	261	1,150
WSM	Nashville, Tenn.	National Ins. Co.	1,000	283	1,060
WSMB	New Orleans, La.	Maison Blanche Bldg.	500	319	940
WSMH	Owosso, Mich.	Shattuck Music House	20	240	1,250
WSMK	Dayton, Ohio	S. M. K. Radio Corp.	500	275	1,090
WSOE	Milwaukee, Wis.	Sch. of Eng. of Milwaukee	500	246	1,220
WSRO	Hamilton, Ohio	Radio Co. (H. W. Fahrlander)	100	252	1,190
WSRH	Boston, Mass.	Fremont Baptist Church	100	261	1,150
WSUI	Iowa City, Iowa	State Univ. of Iowa	500	483.6	620
WSVS	Buffalo, N. Y.	Seneca School	50	210	1,370
WSWS	Batavia, Ill.	Richmond Harris Co.	1,000	275	1,090
WTAR	Fall River, Mass.	F. R. Daily Herald Pub. Co.	100	266	1,130
WTAD	Carthage, Ill.	Robt. E. Compton	50	226	1,270
WTAG	Worcester, Mass.	Worcester Tel. Pub. Co.	500	545	550
WTAL	Toledo, Ohio	Toledo Radio & Elec. Co.	10	252	1,190
WTAM	Cleveland, Ohio	Willard Storage Bat. Co.	3,500	389.4	770
WTAQ	Eau Claire, Wis.	S. H. Van Gordon & Son	100	254	1,180
WTAR	Norfolk, Va.	Reliance Electric Co.	100	261	1,150
WTAW	College Station, Tex.	Agri. & Mech. Col. of Texas	500	270	1,110
WTAX	Streator, Ill.	Williams Hardware Co.	50	231	1,200
WTAZ	Lambertville, N. J.	Thomas J. McGuire	15	261	1,150
WTIC	Hartford, Conn.	Travelers Insurance Co.	500	476	630
WTRC	New York City	Republican Club	50	240	1,250
WVAE	Plainfield, Ill.	Electric Park	10	354.4	780
WVAO	Houghton, Mich.	Mich. Col. of Mines	250	263	1,140
WWI	Dearborn, Mich.	Ford Motor Co.	500	266	1,130
WWJ	Detroit, Mich.	Detroit News	1,000	352.7	850
WWL	New Orleans, La.	Loyola University	100	275	1,090
WWRL	Woodside, N. Y.	Woodside Radio Lab.	100	258	1,160

TUNING

(Continued from Page 5)

with the other dials. If, after you have placed your dials on the theoretically proper point and the station does not come in, slowly turn the dial back and forth until you get a strong whistle, and then very slowly moving the dial a fraction of an inch with each move,

turn until you get the station at its maximum. This is where the patience comes in, because if you will carefully tune your set until you get to the peak of oscillation, you will be able to bring in the station that you are looking for.

Again we reiterate: If your set is efficient and is capable of bringing in distant stations, all you require is patience and exactitude.

Broadcasting Stations of Canada

Call Signal	Location of Station	Owner of Station	Power (watts)	Wave length	Frequency (kilo-cycles)
CFAC	Calgary, Alta	The Calgary Herald	500	435	690
CFCA	Toronto, Ont.	Star Pub. & Print. Co.	500	357	840
CFCP	Montreal, Que.	Marconi Wireless Tel. Co. of Canada, Ltd.	1,650	411	730
CFCK	Edmonton, Alta	Radio Supply Co., Ltd.	100	517	580
CFCN	Calgary, Alta	W. W. Grant Radio, Ltd.	1,800	435	690
CFCT	Victoria, B. C.	Geo. W. Deaville	500	330	910
CFCY	Charlottetown, P. E. I.	Island Radio Co.	50	312	960
CFGC	Brantford, Ont.	Brant Radio Supply Co.	50	297	1,010
CFLC	Prescott, Ont.	Radio Assn. of Prescott	50	297	1,010
CFQC	Saskatoon, Sask.	The Electric Shop, Ltd.	500	330	910
CFVC	Burnaby, B. C.	Int. Bible Students' Assn.	500	411	730
CFRC	Kingston, Ont.	Queen's University	500	268	1,120
CFXC	N. Westminster, B. C.	Westminster Trust Co.	20	291	1,030
CFYC	Vancouver B. C.	Com. Radio, Ltd.	500	411	730
CHCY	Edmonton, Alta	Int. Bible Students' Assn.	250	517	580
CHIC	Toronto, Ont.	Northern Electric Co., Ltd.	500	357	840
CHNC	Toronto, Ont.	Toronto Radio Res. Society	500	357	840
CHNS	Halifax, Nova Scotia	Northern Electric Co.	100	322	930
CHUC	Saskatoon, Sask.	Internat. Bible Students' Assn.	500	330	910
CHXC	Ottawa, Ont.	J. R. Booth, Jr.	250	435	690
CHYC	Montreal, P. Q.	Northern Electric Co., Ltd.	750	411	730
CJCA	Edmonton, Alberta	The Edmonton Journal, Ltd.	500	517	580
CJGC	London, Ont.	London Free Press Printing Co., Ltd.	500	330	910
CJOC	Lethbridge, Alta.	J. E. Palmer	50	268	1,120
CJSC	Toronto, Ont.	The Evening Telegram	500	357	840
CJWC	Saskatoon, Sask.	Wheaton Elec. Co., Ltd.	250	330	910
CJYC	Scarboro Stn., Ont.	Universal Radio of Canada	500	291	1,030
CKAC	Montreal, Que.	LaPress Pub. Co., Ltd.	1,200	411	730
CKCD	Vancouver, B. C.	Vancouver Daily Province	1,000	411	730
CKKC	Regina, Sask.	Leader Pub. Co., Ltd.	500	297	1,010
CKCL	Toronto, Ont.	The Dominion Bat. Co., Ltd.	500	357	840
CKCO	Ottawa, Ont.	Dr. G. M. Geldert	100	435	690
CKCW	Burketon Jet., Ont.	Canadian Broadcast Corp. (not active)	5,000	330	910
CKFC	Vancouver, B. C.	Ninth Church of Canada	500	411	730
CKNC	Toronto, Ont.	The Can. Nat'l Carbon Co.	500	357	840
CKOC	Hamilton, Ont.	Wentworth Rad. Sup. Co., Ltd.	50	341	880
CKY	Winnipeg, Man.	Manitoba Tel. System	500	384	780
CNRA	Moncton, N. B.	Canadian Nat'l Railways	500	322	930
CNRC	Calgary, Alta	Canadian Nat'l Railways	500	297	1,010
CNRE	Edmonton, Alta	Canadian Nat'l Railways	500	517	580
CNRM	Montreal, P. Q.	Canadian Nat'l Railways	1,000	411	730
CNRO	Ottawa, Ont.	Canadian Nat'l Railways	500	435	690
CNRR	Regina, Sask.	Canadian Nat'l Railways	500	312	960
CNRS	Saskatoon, Sask.	Canadian Nat'l Railways	500	330	910
CNRT	Toronto, Ont.	Canadian Nat'l Railways	500	357	840
CNRV	Vancouver, B. C.	Canadian Nat'l Railways	500	291	1,030
CNRW	Winnipeg, Man.	Canadian Nat'l Railways	500	384	780

Mexican Stations

Call Signal	Location of Station	Owner of Station	Power (watts)	Wave length	Frequency (kilo-cycles)
AMB	Tia Juana, Mexico		301	100	
CYA	Mexico City	Partido Liberal Avanzado	100	540	
CBY	Mexico City	El Buen Tono	500	360	
CYD	Mexico City		—	350	
CYG	Mexico City	Secretaria de Guerra	100	—	
CYJ	Mexico	Mexico City	1000	410	
CYL	Mexico City	El Universal	500	360	
CYO	Monterey	Constantino Tarnova, Jr.	200	280	
CYR	Mazatlan	Rosseter y Cia.	250	440	
CYX	Mexico City	Excelsior Parker	500	333	
CYZ	Mexico City	La Ligua del Radio	100	400	
CZF	Mexico City	Dpt. of Aviation, War Ministry	100	510	
CZA	Chihuahua	Mexican Government	250	325	

British Stations

Call Signal	Location	Operated by	Power In Watts	Wave Length
2 BD	Aberdeen	British Broadcasting Co.	1,500	481.8
2 BE	Belfast	British Broadcasting Co.	1,500	326.1
5 IT	Birmingham	British Broadcasting Co.	1,500	481.8
6 BM	Bournemouth	British Broadcasting Co.	1,500	306.1
2 LS	Bradford	British Broadcasting Co.	200	294.1
5 WA	Cardiff	British Broadcasting Co.	1,500	353
5 XX	Dundee	British Broadcasting Co.	200	288.5
2 DE	Daventry	British Broadcasting Co.	25,000	1600
2 EH	Edinburgh	British Broadcasting Co.	500	288.5
5 SG	Glasgow	British Broadcasting Co.	1,500	405.4
6 KH	Hull	British Broadcasting Co.	200	288.5
2 LS	Leeds	British Broadcasting Co.	200	297
6 LV	Liverpool	British Broadcasting Co.	200	288.5
2 LO	London	British Broadcasting Co.	2,000	361.4
2 ZY	Manchester	British Broadcasting Co.	1,500	284.6
5 NO	Newcastle	British Broadcasting Co.	1,500	312.5
5 NG	Nottingham	British Broadcasting Co.	200	288.5
5 PY	Plymouth	British Broadcasting Co.	200	288.5
6 FL	Sheffield	British Broadcasting Co.	200	288.5
6 ST	Stoke-on-Trent	British Broadcasting Co.	200	288.5
5 SX	Swansea	British Broadcasting Co.	200	288.5

Australian Stations

Call Signal	Location	Owner of Station	Power (watts)	Wave length	Frequency (kilo-cycles)
2FC	Sydney, N. S. W.	Farmer and Company, Ltd.	5,000	1,100	261
2BL	Sydney, N. S. W.	Broadcasters, Ltd.	1,500	353	857
3LO	Melbourne, Victoria	Australian Brdcastg. Co., Ltd.	5,000	371	809
3AR	Melbourne, Victoria	Associated Radio Co., Ltd.	1,600	484	789
5CL	Adelaide, S. Australia	Central Broadcasters, Ltd.	5,000	395	937
6WF	Perth, West Australia	W. Australian Farmers, Ltd.	5,000	1,250	240
7ZL	Hobart, Tasmania	Associated Radio Co., Ltd.	3,000	535	769
4QG	Brisbane, Queensland	Government Radio Service	5,000	385	779

Japan Stations

Call Signal	Location	Operated by	Watts	Meter
JOCK	Nagoya	Nagoya Radio Broadcasting Co.	1,500	360
JOBK	Osaka	Osaka Radio Broadcasting Co.	500	385
JOAK	Tokyo	Tokyo Radio Broadcasting Co.	1,000	375

ONLY \$3.00 A YEAR

Have RADIO DOINGS mailed to your home every week. Fill out blank below. Either mail to us, or your dealer will be glad to take care of it for you. Please indicate whether NEW or RENEWAL.

HORWOOD PUBLISHING CO., 527 Van Nuys Bldg., Los Angeles,
406 New Call Building, San Francisco, California.

Gentlemen: I enclose \$3.00, for which send me RADIO DOINGS for one year.
NEW—RENEWAL. *

Name _____

Address _____

Cuban Broadcasting Stations

Call Signal	Location	Operated by	Wave length	Power (watts)
6EV.....	Caibarien	María J. Alvarez.....	250	50
7AZ.....	Camaguey	Pedro Nogueros	225	10
7SR.....	Camaguey	Salvador Rionda	350	500
6KW.....	Central Tuñicu	Frank H. Jones.....	340	100
6YR.....	Camajuani	Diego Iborra	200	20
6JK.....	Central Tuñicu	Frank H. Jones.....	275	100
7BY.....	Ciego de Avila.....	Eduardo V. Figuerea.....	235	20
6JG.....	Cienfuegos	Eligio Cobelo Ramirez.....	275	10
6BY.....	Cienfuegos	Jose Ganduxe	300	100
2HP.....	Havana	Credito y Construcciones Co... 295	100	
2JP.....	Havana	Julio Power	270	20
2XX.....	Havana	Antonio A. Ginard.....	150	5
2CX.....	Havana	Frederick W. Borton.....	320	10
2AB.....	Havana	Alberto S. Bustamente.....	235	10
PWX.....	Havana	Cuban Telephone Co.....	400	500
2EP.....	Havana	El País	455	400
2BB.....	Havana	Bernardo Barrie	255	15
2MG.....	Havana	Manuel y Guillermo Salas.....	280	20
20K.....	Havana	Mario Garcia Velez.....	360	100
20L.....	Havana	Oscar Collado Orta.....	300	100
2TW.....	Havana	Roberto E. Ramirez.....	230	20
2PK.....	Havana	George A. Lindeaux.....	195	10
5EV.....	Matanzas	Leopoldo T. Figueroa.....	360	10
6HS.....	Sagua la Grande.....	Santiga Ventura	200	10
8FU.....	Santiago	Andress Vinent	225	15
8BY.....	Santiago	Albert Ravelo	250	100
8HS.....	Santiago	Guillermo Polanco	200	20

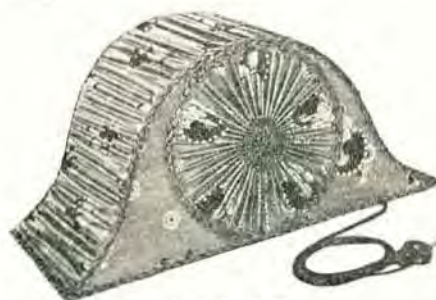

List \$18.50

Announcing

the New

SUNSET**SPEAKER**

AT LAST—A Speaker that fits into home surroundings. Designed by a famous artist. Covered entirely with silk to match your home furnishings. Its wonderful tone quality is only surpassed by its beauty.

Ask Your Dealer

WESTERN MANUFACTURERS COMPANY

20 East Jackson Blvd.
Chicago, Ill.

VAndike
6 2 7 3

1228 West Seventh St.
Los Angeles, Cal.

South American Stations

Call Signal	Location	Operated by	Power (watts)	Wave length
ARGENTINE				
LOH	Buenos Aires	Radio Titanic	500	206.9
LOO	Buenos Aires	Radio Prieto	1000	250
LOQ	Buenos Aires	Tomas Torres	1000	206.8
LOR	Buenos Aires	Diario "Critica"	1000	222
LOS	Buenos Aires	Municipality of Buenos Aires	5000	235.7
LOV	Buenos Aires	Francisco J. Brusa	1000	352.9
LOW	Buenos Aires	Grand Splendid	1000	300
LOX	Buenos Aires	Radio Cultura	500	375
LOY	Buenos Aires	Sociedad Radio Nacional	1000	315.8
LOZ	Buenos Aires	"La Nacion" Soc. A. B. C.	1000	333.3
B2	Buenos Aires	Gino Bocci Hnos.	100	275
A11	Buenos Aires	Gino Bocci Hnos.		
A1	Buenos Aires	Sociedad Radiotelefonica		
B1	Buenos Aires	Francisco J. Brusa	1000	
C1	Buenos Aires	Facultad de Ciencias Medicas		
C2	Buenos Aires	Departamento Nac'l de Higiene		
H4	Cordoba	Antonio Vanelli	20	275
	Cordoba	Sociedad Radio Com. de Cordoba	100	381
HA8	Cordoba	Jorge Coen	50	255
H6	Cordoba	Diario "Los Principios"	20	250
DA-1	Hurlingham, FCP	Felix Gunther		
LOP	La Plata, FCS	Universidad Nacional	1000	425
LOU	Mendoza	Ministerio de Obras Publicas	500	380
M6	Mendoza	Pedro B. Baldassarre	100	348
	Monte Grande, FCS	Argentine Broadcasting Assn.		
LOT	Olivos, FCCA	Eugenio A. Vautier	1000	272.7
H5	Rio Cuarto	Arturo Rodriguez	100	275
F4	Rosario	Manuel Fugardo	100	260
D3	San Fernando, FCCA	Americo Liberti	100	235.3
F1	Sante Fe	Jose Roca Soler	20	279
F2	Sante Fe	Sociedad Rural de Cerealistas	100	270
BRAZIL				
	Bahia	Radio Sociedade de Bahia	500	250-450
	Bello Horizonte	Radio Sociedade de Minas Geraes	500	400
	Ceara	Radio Club Cearense	50	
	Curytiba	Livio Moreira		
	Fortaleza	Radio Club	300	
	Goyanna	Benedicto Ravello		
	Matto Grosso	Radio Club de Campo Grande		
	Minas Geraes	Juiz de Fora	100	
	Para	Radio Club de Para	100	
	Parana		300	370
	Parahyba	Radio Sociedade de Parahyba		
	Pelotas	Radio Sociedade Pelotense		
	Penedo	A. G. Oliveira		
	Pernambuco	Radio Club de Pernambuco	1000	310
	Pernambuco	Cia Radiotelegrafica Brasileira	500	250-380
	Pernambuco	Radio Sociedade de Jader de Andrada		
	Pernambuco	Radio Sociedade de Garanhuns		
	Petropolis	Radio Club de Petropolis		
	Porto Alegre	Radio Sociedade Riograndense	80	381
	SQB	Radio Club do Brasil	500	320
	Rio de Janeiro	Radio Sociedade de Rio de Jan.	1000	381
	Rio de Janeiro	Radio Club do Brasil	500	312
	Rio de Janeiro	National Telegraph Service	500	450
	Sao Paulo	Sociedade Radio Educadora	1000	310
	SQIG	Sociedade Radio Educadora Paulista	1000	450
	Sao Paulo	Radio Club de Sao Paulo	100	350
	Sao Paulo	Radio Bandeirantes	50	370
	Sao Paulo	Dias Carneiro & Cia.	100	380-420
CHILE				
	San Eugenio	Rene Doneaud	230	25
	Santiago	Radio Corporation of Chile	400-600	250
	Santiago	Chilean Radiophone Club	300	200
	CLAA	Ferrocarril Transandino Chileno		200
	CMAA	Carlos Buin Walsen	240	20
	CMAR	Sociedade Radio Chilena	480	1500
	CMAD	Castagneto Felli	220	100
	CMAF	Ministerio de Higiene	400	1250
	CRC	Sociedade Broadcasting de Chile	385	350
	CMAC	"El Mercurio"	360	1000
	CMAE	Radio Comercial	280	500
	CMAG	Pedro Arroyo	250	250
	CMAI	Cia Radio Transandino	260	100
	CMAU	Universidad de Chile	440	100
	ORC		430	
	RC		350	50
	CNA	Harvey Diamond		
	CNAC	Jose Bellalta		
	CMAT	Ministerio de Relaciones Exter.	265	1000

Sources of Interference

We receive numerous inquiries asking for the various sources of interference. Through the courtesy of "Popular Radio" we give a list of fifty-three sources of interference which may be found in the receiver itself or from the outside.

In the Receiver itself or in the Apparatus Connected to it:

1. An improperly tuned receiver.
2. A loose connection in the receiver or broken wires in the headphone or loudspeaker cord.
3. A defective grid leak.
4. A defective tuning condenser—a momentary shorting of condenser plates.
5. A fixed condenser with defective insulation.
6. Loose connections at the batteries.
7. Discharged or weak batteries.
8. "B" battery eliminators (in the electrolytic type under certain conditions).
9. A bad socket.
10. A bad tube.

From Apparatus in the Same House with the Receiver—or in a Neighbor's House:

11. Vacuum cleaners.
12. Sewing machine motors or any commutator motor.
13. A violet-ray machine.
14. Ozonators.
15. Door bells and buzzers.
16. Switching of lamps or other electrical devices.
17. Electrical heating pads with thermostat control.
18. Oil burners that use spark ignition; (certain types.)

19. Washing machines with split-phase type of motor—if the starting switch is defective.
20. Battery chargers of the vibrating type.
21. Battery chargers of the electrolytic type (under certain conditions).
22. Elevator controllers and motors of the commutator type.
23. Bad contact in switch, fuse, socket, or its wiring near lighting wires.

From Outside Sources:

25. Atmospheric static.
26. Regenerative receivers.
27. Sign flashers.
28. Commercial wireless (code) stations.
29. Amateur wireless stations.
30. Induction coils.
31. Electric street cars.
32. Defective rail bonds on street railway systems.
33. Heterodyning of broadcasting stations.
34. Overlapping of broadcasting stations.
35. Telephone ringers.
36. Induction from telephone and telegraph lines.
37. Motion picture machines that use arc lamps.
38. Motors and generators of the commutator type.
39. Electric welding apparatus.
40. X-ray machines.
41. Static machines.
42. Static produced by belts.
43. Electrical manufacturing processes.
44. Induction from high potential circuits.
45. Arcing wire in trees and other grounded objects.
46. Leaking insulators on power circuits.
48. Loose street lamps in sockets.
49. Bad contacts in switches.
50. Lightning arresters.
51. Smoke or dust precipitators.
52. Defective transformers.
53. Defective street light rectifiers

The Sargent Infradyne

The Sargent Infradyne, invented and put on the market by Mr. E. M. Sargent of Oakland, has taken the DX fans by storm.

Tests carried out by experts have proven the Infradyne to be one of the best sets for distance reception.

If you will follow the diagram closely, as shown, making sure that all connections are properly soldered and the set carefully built with the parts described below, you will, without a doubt, have a receiver which will give you great satisfaction.

One Remler Infradyne amplifier; 1 Continental triple vernier condenser; 1 Remler .00035 condenser; 1 tapped inductance (see text for constructional details); 1 Gen. Radio No. 301 30 ohm rheostat; 1 set No. 33 Thorola doughnuts; 2 National type B CCW dials; 7 Benjamin UX sockets; 1 112 Amperite; 2 1-A Amperites; 1 6V-199 Amperite;

1 30 ohm U. S. L. rheostat; 1 10 ohm U. S. L. rheostat; 1 Centralab 50,000 ohm Radiohm; 3 2-in. rheostat dlais; 1 Xaxley filament switch; 1 single closed electrad jack; 1 single open jack; 1 Jewell No. 135 0-5 D. C. voltmeter; 1 Electrad grid leak mounting; 1 Electrad fixed condenser mounting; 1 1-megohm Electrad fused metallic leak or Arthur H. Lynch fixed resistor; 1 2-megohm Dubilier leak or Arthur H. Lynch fixed resistor; 1 Dubilier .0001 mfd. condenser; 1 Dubilier 1 mfd. condensers; 2 Dubilier .0005 condensers, 1 with clips; 1 Dubilier .00025 condenser; 9 Eby binding posts; 1 Formica walnut panel 3/16x7x30; 1 redwood baseboard 3/4x10x34; 2 Amertran De Luxe transformers.

From careful test and construction the Infradyne can be recommended to those who care to and are willing to do careful work.

Power Amplifier and A. C. Current Supply

The demand for newer tubes of a capacity to handle larger output with less distortion has brought with it the need of more economical current supply than that provided by the Dry Batteries. The Storage Battery provides the ideal current supply, but there are many disadvantages, such as dangers of acid and the trouble of keeping the battery at full charge. A power amplifier and A. C. current supply built from the following diagram, if built correctly, will give you a constant source of power, and if properly taken care of, will cause a minimum of trouble.

The outfit has been built of the following parts and give a high degree of satisfaction: A. C. transformer Amer-

tran type PF 52, chokes Amertran type 854, condensers C1 and C3, No. 769, 2 microfarads, C2 and C8 type 770, 4 microfarads Dubilier, while C4-5-6-7 type 766 2 microfarads same make. Do not use lower capacities, and if you have any spare cash, increase the capacities all around 50 per cent, and you will not regret it. R1-2-3-4-5 should be Ward Leonard vitrohms type C resistor or Aerovox Craig register type 980. R6 should be Bradley ohm No. 25. The input transformer should be the second stage De Luxe Amertran. Sockets some good type of UX or CX. The power tube UX-210 or CX-310, and the rectifier tube should be either CX-316B or UX-216B.

Power Amplifier and A. C. Current Supply

00

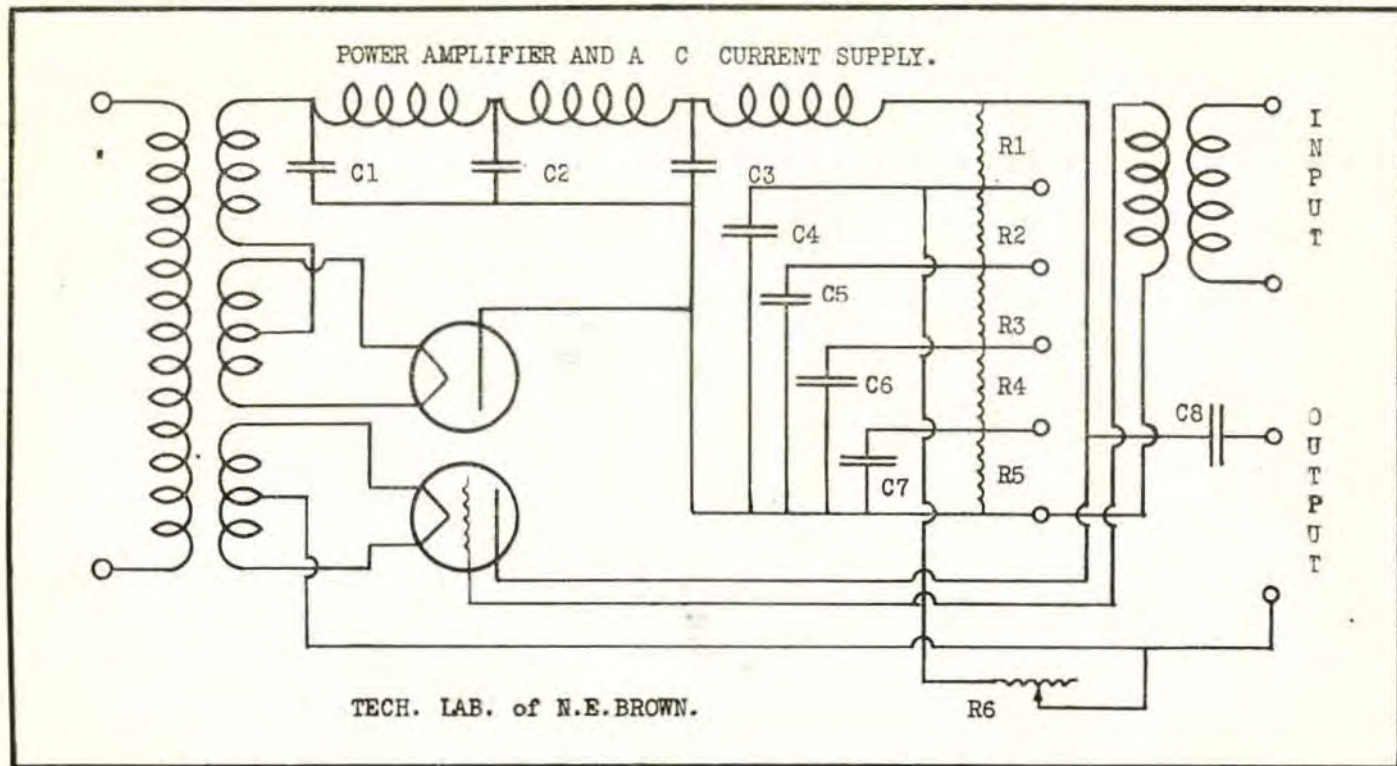

ULTRA- *Phonic* Reproducer

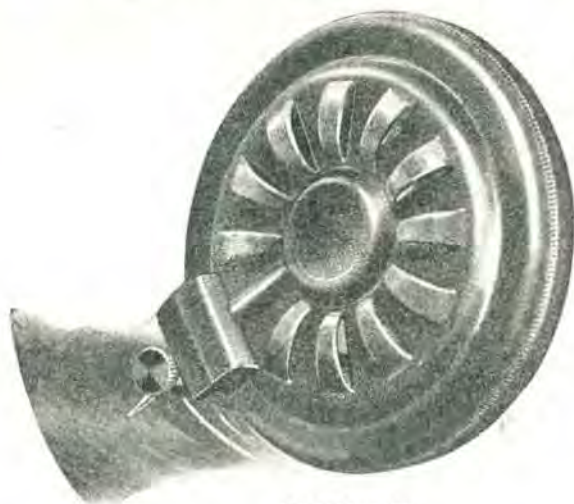

ACTUAL SIZE

In a Jiffy Transforms Your Phonograph

[INTO ONE WHOSE
AMAZING TONE IS
EXCELLED ONLY BY
THE SENSATIONAL
NEWLY DEVELOPED
PHONOGRAPHS]

On Sale at All Radio and Music Stores

LEO J. MEYBERG COMPANY

Exclusive Distributors for California

1022 South Wall Street
Los Angeles

973 Mission Street
San Francisco

Federal Ortho-Sonic Radio



Model E-40

Price without
accessories

\$300

To see and hear a FEDERAL ORTHO-SONIC Receiver is to appreciate what Radio has in store for YOU.

Unequaled tone quality, simplicity of control, beauty of appearance—all are yours if you purchase

A FEDERAL ORTHO-SONIC

Five, Six and Seven-Tube Models, Priced from \$100 to \$400

Four Distinctive Custom Built Art Models

Priced from \$600 to \$1000



Exclusive Wholesale Distributors

YALE RADIO ELECTRIC CO.

1111 Wall St., Los Angeles, Calif. Phone WEStmore 3351

This file including all text and images are from scans of a private personal collection and have been scanned for archival and research purposes. This file may be freely distributed, but not sold on ebay or on any commercial sites, catalogs, booths or kiosks, either as reprints or by electronic methods. This file may be downloaded without charge from the Radio Researchers Group website at <http://www.otrr.org/>

Please help in the preservation of old time radio by supporting legitimate organizations who strive to preserve and restore the programs and related information.