

# RTJ

*Radio & Television* **JOURNAL**

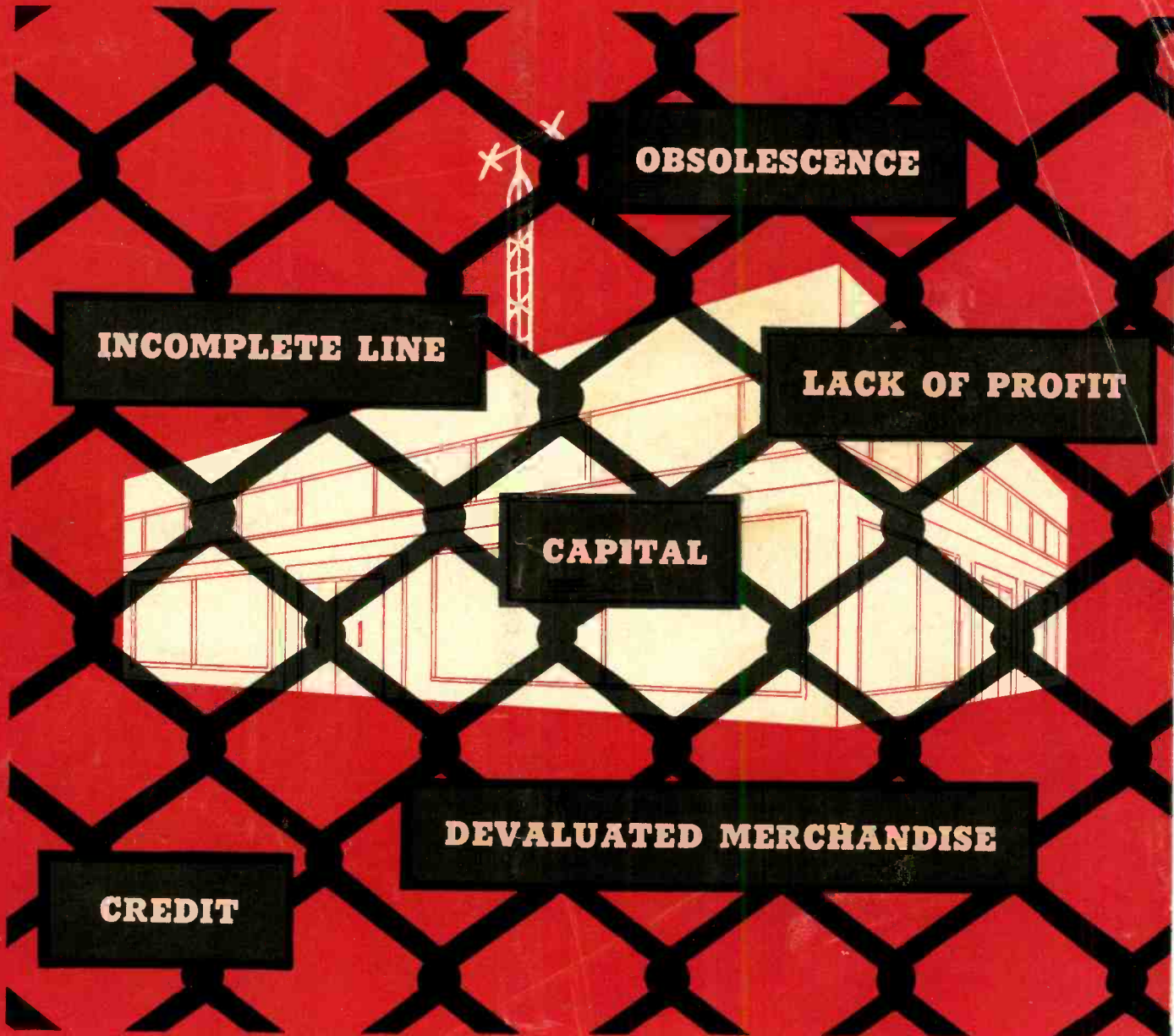

**OBSOLESCENCE**

**INCOMPLETE LINE**

**LACK OF PROFIT**

**CAPITAL**

**DEVALUATED MERCHANDISE**

**CREDIT**

*What Are You Doing  
to Break Through These Barriers  
to Dealer Security?*

**OCTOBER 1951**

# LEWYT'S NEW FALL ADVERTISING DRIVE HEAVIEST in HISTORY!

**24 LEWYT  
ADS IN 10 TOP  
MAGAZINES!**

**17,857  
Radio & TV  
Commercials  
every month!**

**2  
Coast-to-Coast  
NEWSPAPER  
CAMPAIGNS!**

**2 nationwide  
OUTDOOR  
POSTER  
SHOWINGS!**

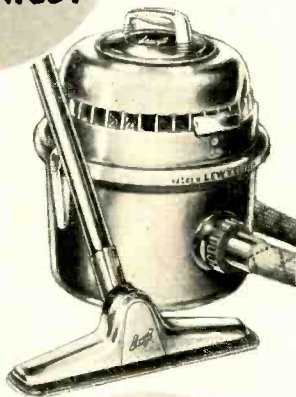

**CAR CARDS!  
DIRECT MAIL!**  
New  
traffic-building  
promotions!

**Famous LEWYT  
MARKET PLACE  
featured in every ad!**

Every Lewyt ad this Fall  
tells your prospects to  
**"STOP AT THIS DISPLAY"**  
for an eye-opening  
10-second demo!

**Again smashing home the 5 biggest sales  
words in the industry—"No Dust Bag to Empty"!**

Never before has such a barrage of advertising been put behind any vacuum cleaner!

Here's how you cash-in! Get your Lewyt Market Place up front where people can see it! Show your salesmen how to exploit floor traffic with profitable 10-second demos!

Use Lewyt's new 16-page book of traffic-building ideas to pin-point attention on your store! Pull-in prospects with new Lewyt TV films that make thousands of home demonstrations for you in a minute! Tie-in with the industry's biggest Outdoor Poster Program!

Take advantage of the best organized co-operative advertising get-up with low-cost car-cards, direct mail, new traffic-boosting promotions! Let everybody know your store is Lewyt headquarters in your neighborhood—and start getting volume out of vacuum cleaners! See your Lewyt Distributor for full details!

**DO IT with LEWYT**



LEWYT CORPORATION,  
Vacuum Cleaner Division,  
Dept. J-10, 60 Broadway, Brooklyn 11, N. Y.

**NOW IT CAN BE ~~TOLD~~ SOLD**

*Shockproof*



**PHONOGRAPH NEEDLE**

**\$1.75**  
RETAIL

Here it is...the most versatile needle in all America today...the DUOTONE SHOCK-PROOF NYLON PHONOGRAPH NEEDLE...at the lowest retail price in all America! Here is your answer to your customers long crying NEED for a needle that will not damage records...should it drop or scratch!

DUOTONE engineering created it...sales acceptance has PROVEN it...a patented...flexible spring steel shaft...and cushioned Nylon bumper...insures the same FEATHER-LIGHT touch of the DUOTONE SHOCK-PROOF NYLON PHONOGRAPH NEEDLE...in spite of any accidental fall or every drop of the record arm...completely protects records and needle points against damage! Even a child could use it on his most precious record!

The most AMAZING sales story ever told...SHOCK-PROOF... GUARANTEED record and needle protection...should pick-up arm be carelessly misplaced or thrust.

- Lack of surface noises!
- Here is the needle that "Doesn't talk back"!
- Faithful fidelity...plus longer life...worthy of acceptance...by its performance...alone!

Yes...it is the most AMAZING needle story ever told...and we are telling YOUR customer about it through the pages of Life...and other great American publications!

**FREE...**

To aid you further...available at no charge to Dealers everywhere...is the famous DUOTONE full-color...NYLON SHOCK-PROOF "In Motion" display. Yes...an attractive...EYE-CATCHING display piece...that allows your customer to TEST the DUOTONE NEEDLE and actually see AMAZING VERSATILITY and PROTECTION.

12 needles mounted on a FULL-COLOR card...each individually packed in a Lucite container...with a built-in magnifying lens...for impulse selling!



**Duotone Company, Keyport, New Jersey**

GENTLEMEN:

Please enter our order for full-color display cards. Each contains 12 nylon shock-proof needles mounted in individual Lucite containers with built-in magnifying lens. (Subject to large dealer discounts.)

NAME .....

ADDRESS .....

CITY ..... STATE .....

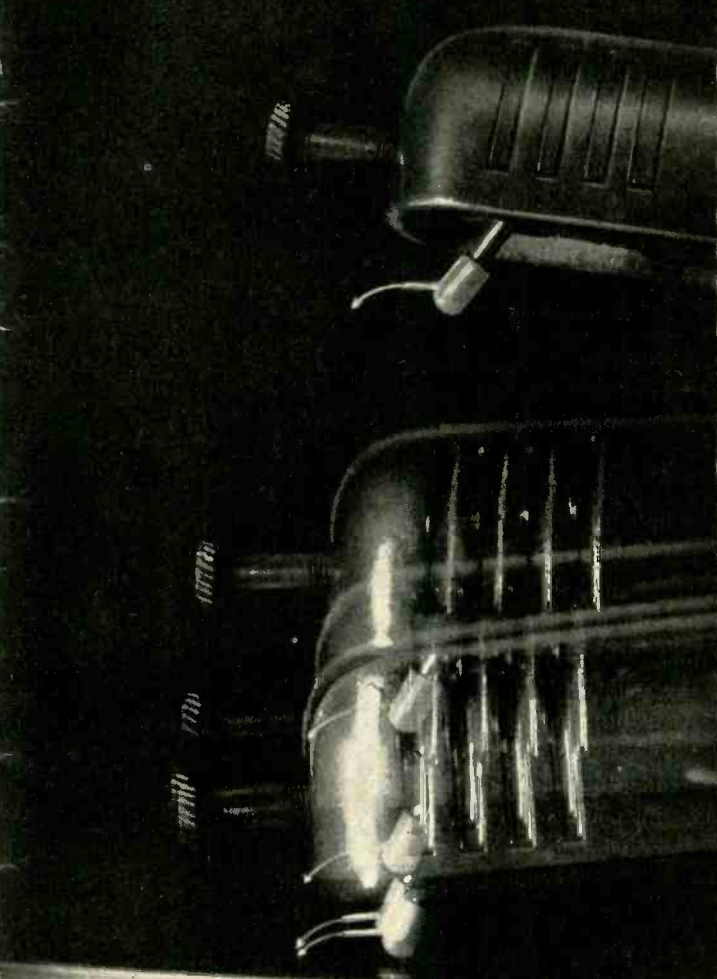

Yes...the DUOTONE SHOCK-PROOF NYLON PHONOGRAPH NEEDLE is pre-sold at America's lowest popular price!



Simply SEE it...and SELL it...the famous DUOTONE silent salesman...means immediate VOLUME and SELF-SELLING!



As Advertised in LIFE

National advertising appears in Life Magazine... as well as other publications... plus feature stories... through the major wire services of the country... TELLING and PRE-SELLING your customers! Display the DUOTONE NYLON SHOCK-PROOF PHONOGRAPH NEEDLE and WATCH THE VOLUME RISE!

**SUBJECT TO ATTRACTIVE DEALER DISCOUNT**  
Canadian Representative: Charles W. Pointon, Toronto  
Export Division: Ad Auriema, Inc., New York

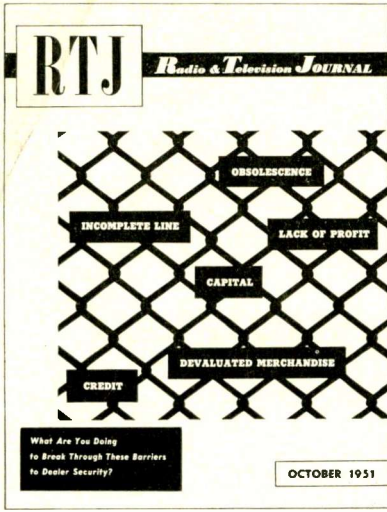

The magazine dedicated to the business of television radio, sound, servicing, phonographs and records

Publisher  
**ALEX H. KOLBE**

Editor  
**NAT BOOLHACK**

Associate Editor  
**JOHN A. RICHARDS**

Business Department  
**AARON LAFER**

Art Director  
**VINCENT T. COSTELLO**

Circulation Manager  
**MARY LOUISE KAUFFMAN**

Pacific Coast Representative  
**ALBERT W. RANDLE**  
2404 W. Seventh St.  
Los Angeles 5, Calif.  
Dunkirk 2-8980

Member of

**CCA**

OVER 30,000

Controlled Circulation Audit, Inc.

**THE COVER**—To combat those barriers to dealer security which are enumerated on the front cover, dealers cannot use the famous words of Jimmy Durante "Dem's the conditions what prevails," as a poor-business crutch. Every dealer must tackle each separate barrier and lay plans now for present and future business prosperity. See pages 22 and 23, this issue.

Vol. 68

No. 10

## IN THIS ISSUE

- Television Roundup** ..... **8, 10**  
A concise review of the month's happenings in radio and television.
- Four Hundred Per Cent Expansion in Seven Years** ..... **12**  
This Stockton, Calif., dealer looks ahead to bigger sales.
- It's the TV Installation Which Nails Down the Sale** ..... **16**  
Goodman's in Jersey City emphasizes service excellence.
- Washington News Report** ..... **18**
- There's More Than Meets the Eye to This Television Store of Miracles** ..... **20, 21, 24**  
One Southern California dealer who did not let "W" curb TV sales.
- Merchandising Memo for November Selling** ..... **22, 23**
- You Ought to Know More About Ernest A. Marx** ..... **28**
- How to Build An Efficient, Low-Cost TV Service Bench...** **36**  
Any dealer can follow these instructions and solve a major problem.
- Illustrated Industry News** ..... **40, 41**

## Departments

- New Products** ..... **26, 27, 42, 44, 48, 51, 60**  
(Radio, Television, Consoles, Phonographs, TV Accessories)
- TV Service Report** ..... **32**
- Picture Pages** ..... **40, 41**
- Industry News** ..... **50**
- News and Notes of Manufacturers and Distributors** ..... **64**
- New Appointments** ..... **65**

RADIO & TELEVISION JOURNAL WITH WHICH IS COMBINED RADIO & APPLIANCE JOURNAL and ELECTRIC APPLIANCE JOURNAL IS THE COMPLETE BUSINESS MAGAZINE FOR RETAIL DEALERS WHO BUY AND SELL RADIOS, TELEVISION RECEIVERS, APPLIANCES, PHONOGRAPHS, RECORDS, MASTER SERVICING COMPONENT PARTS; AND IS PUBLISHED MONTHLY FOR RADIO & TELEVISION DEALERS, JOBBERS, AND SERVICE MEN BY KOLBE PUBLICATIONS, INC., RADIO CITY, 1270 SIXTH AVENUE, NEW YORK 20, N. Y. PHONE: CIRCLE 7-5842. ALEX H. KOLBE, PRESIDENT AND TREASURER. SUBSCRIPTIONS \$3.00 PER YEAR IN U. S. A., ITS POSSESSIONS, SOUTH AMERICA, CANADA AND ALL OTHER COUNTRIES \$4.00 PER YEAR PAYABLE IN AMERICAN CURRENCY IN ADVANCE. PRICE 35 CENTS PER COPY. NO MATERIAL IN RADIO & TELEVISION JOURNAL MAY BE REPRINTED WITHOUT CONSENT OF PUBLISHER.

PRINTED IN U. S. A.

# *Starrett Success* in **PRIVATE BRAND TELEVISION** *is no accident*

**IT WAS PLANNED THAT WAY!**

It was inevitable that from our intimate first-hand knowledge of department store merchandising should come the planned production and co-operative servicing of Starrett sets on which stores can place their own names with absolute assurance of dependable performance — even in fringe areas.

Starrett is now the first choice of more than **60** leading department stores in more than **50** important cities.



**Time you talked it over with** *Starrett*

• The Brightest Star in PRIVATE BRAND TELEVISION

601 West 26th Street, New York 1

**NEW TRAFFIC!**

**NEW VOLUME!**

**NEW PROFITS!**

with the dynamic new

**Revere**

*De Luxe* **LONG PLAY  
TAPE RECORDER**

*Smart dealers everywhere have been quick to recognize the advantages of adding Revere Tape Recorders to their line. But now with the introduction of this sensational new Long Play recorder, an even greater source of new store traffic sales volume and extra profits is assured.*

**A Demonstration Natural!**

One demonstration is often all that is needed to clinch a sale! Customers marvel at Revere's ease of operation and true-as-life sound. Set up a demonstration display and watch the phenomenal results.



**A MIRACLE OF ELECTRONIC ACHIEVEMENT**

**A**T last! Developed after years of electronic research, the sensational new Revere De Luxe Long Play Tape Recorder is truly a brilliant engineering triumph. Note these outstanding features combined in this exciting new model:

**ULTRA-LIGHTWEIGHT**— Compact design and engineering skill make it the lightest-weight and most portable of any automatic long-play recorder.

**EXCEPTIONAL FIDELITY**— Superb

tonal quality, particularly on difficult musical passages has won the praise of leading musicians, singers and critics.

**EXTRA-ECONOMICAL**— Records two full hours of voice or music on a 5-inch reel—using only one-half the ordinary amount of tape.

Add to these, all the regular Revere sales-clinching advantages and you'll agree there is nothing like it anywhere! Write for complete information today.

REVERE CAMERA CO. • CHICAGO 16

**MODEL T-500 De Luxe**, 2-hour play — Complete with microphone, radio attachment cord, 2 reels (one with tape), and carrying case. **\$179.50**

**MODEL TR-600 De Luxe**, with built-in radio, **\$219.50**



**MODEL T-100 Standard**, 1-hour play. With microphone, radio attachment cord, 2 reels (one with tape), and carrying case. **\$169.50**

**MODEL TR-200 Standard**, with built-in radio, **\$209.50**

**Revere** **TAPE RECORDER**

WORLD'S LARGEST SELLING TAPE RECORDER

# America's No. 1 Profit Line for '52!

# Tele King

## PERFECTED TELEVISION

Every time you ring up a Tele King television sale you earn a bigger profit . . . and in the process, you have the added satisfaction of knowing Tele King's smarter styling, finer performance and incomparable values builds increased consumer acceptance for the dealer

For full information about America's No. 1 profit line, see your distributor or write directly to the factory.

*"The Great Independent Serving the Independent Dealer"*

TELE KING CORPORATION • 601 WEST 26th STREET, NEW YORK 1, N. Y.

Radio & Television JOURNAL • October, 1951

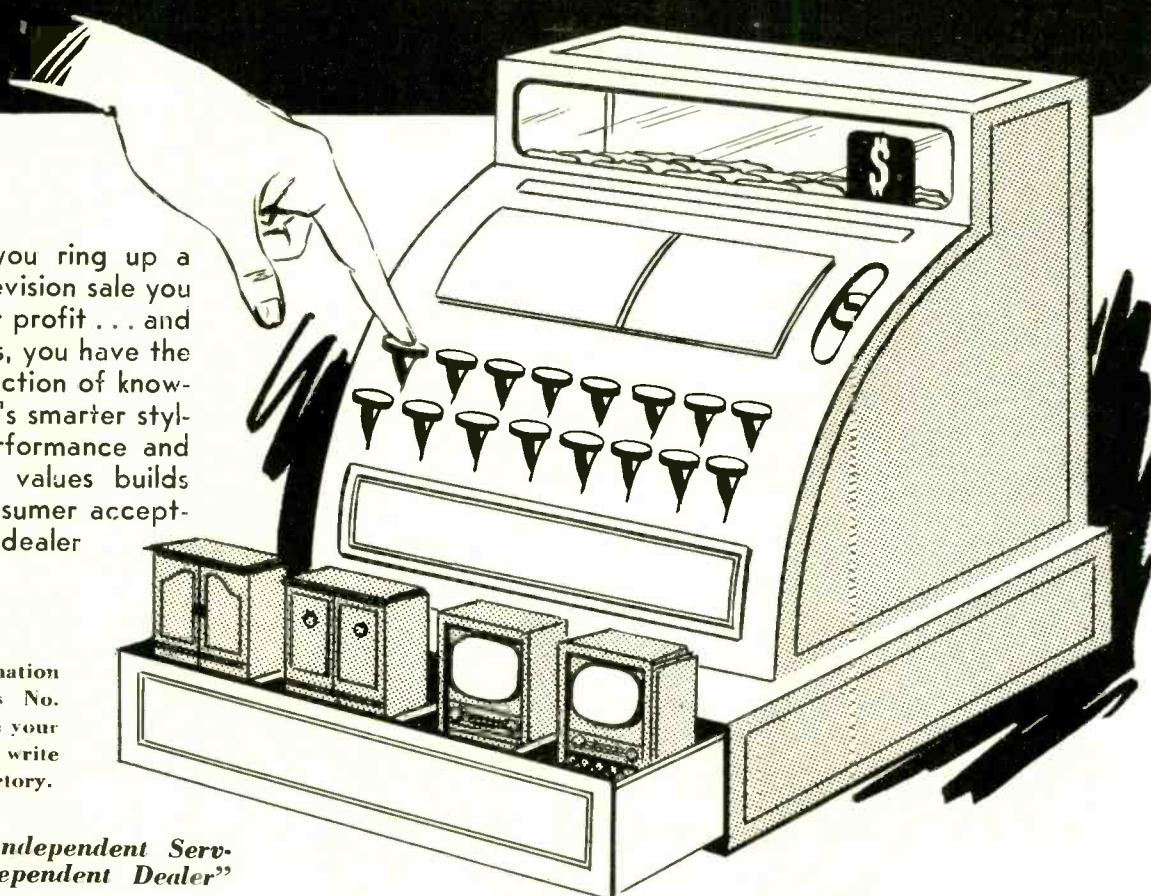

# TELEVISION ROUNDUP

## Seven Points

"What we escaped yesterday might destroy us tomorrow. All that we've been granted is another chance, more time, an opportunity to learn from experience."

Thus spoke Mort Farr, president, National Appliance & Radio Dealers Association, before a recent gathering of the Harrisburg Area Appliance Dealers Association. Farr followed this caution by outlining this seven-point program for dealers:

1) Stop being hoarders. Buy only for the market you honestly feel will be there a reasonably short time from now.

2) Put credit in the best possible shape.

3) Become a better, more aggressive salesman and have every man in your sales and service organization follow suit.

4) Treasure every customer by giving him fast, courteous service.

5) Get and earn full mark-ups. Use price as the appeal on promotional items only. Sell quality and service above all else as the backbone of our business.

6) Get creditors' money out of operating capital, even if it means cutting back on the size of the business. That way additional capital will be available as a reserve and the habit of doing business on other people's money will be broken.

7) Prepare for the future by studying market conditions, product trends, and shifting tides of customer response.

## Product Appeal

Retail salesmanship would be more effective today if management did its part in developing a striking sales story on its own products, according to Charles J. Coward, Kelvinator merchandising manager.

Mr. Coward told a recent meeting of the Rochester Sales Executives' Club that American business must support its sales training programs with strong consumer appeal built into the product, action devices to help the salesman do his job easily, and product integrity.

"Don't condemn salesmanship categorically," Coward said. "Look to your own management operation to be sure first that you have developed in the product a basic reason why the prospect should buy against other competitive brands."

## Good Will TV Sales Ambassador

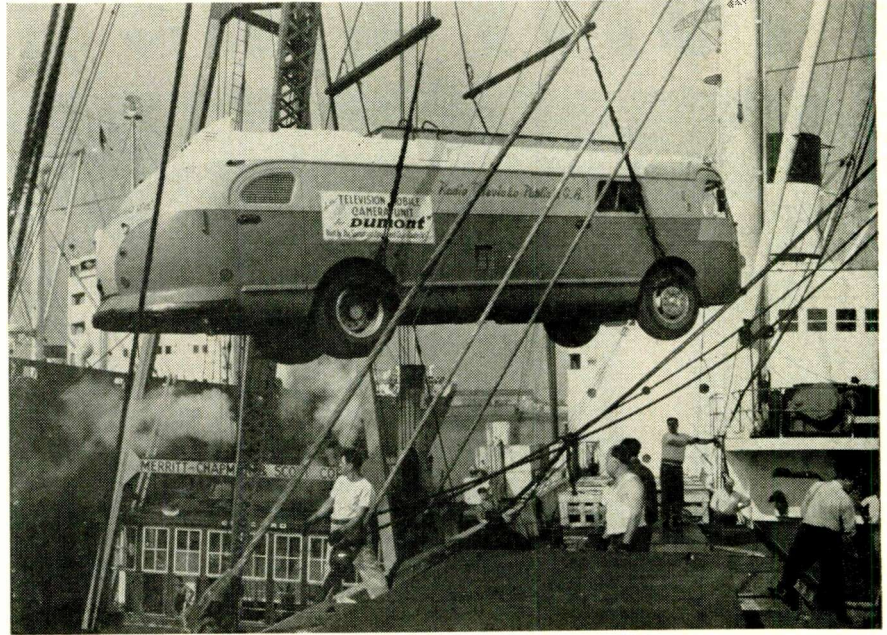

DuMont's "Telecruiser" is South America bound, destined to widen TV's horizons in another quarter of the world. With over \$100,000 in equipment, the DuMont unit is here being loaded aboard a freighter for shipment to Radio-Televisao, Paulista, S. A. of Sao Paulo, Brazil. Brazilians will soon gape in awe at the "miracle of the age."

## Room For Optimism

Four factors point to a pickup in fall television receiver sales, according to Walter L. Stickel, national manager, receiver sales division, Allen B. DuMont Laboratories, Inc.

Speaking at a recent regional sales managers' meeting at the DuMont plant in East Paterson, N. J., Stickel enumerated these factors as follows: 1) the virgin market of better than 50 per cent still exists in TV areas; 2) the replacement market, where more than 40 per cent of the sets in the hands of the public are 14-inch and smaller; 3) the "second set" market, and 4) the opening of the Omaha-San Francisco radio relay system, which makes coast-to-coast television an actuality.

Stickel also stated that TV prices, down to their lowest levels in the industry's history, are forced prices and not realistic or commensurate with the intrinsic value of the merchandise offered. He also stressed the fact that the pickup of business would not be reflected in similarly increased profits because of the high inventory situation and lowered prices to consumers.

Fall optimism, it would seem, must

follow the curve of a dealer's salesmanship.

## A TV Nation

A nation of 50 million television set owners, with stations in range of every community is envisaged by Frank M. Folsom, president, Radio Corp. of America.

"The opening of the new Ultra High Frequency channels for television and the proposed expansion in the Very High Frequency range will mean the establishment of nearly 3,000 television stations, with most of them linked by coast-to-coast and regional networks," according to Mr. Folsom.

The RCA president's remarks were addressed to a recent gathering of 100 broadcast engineers and television consultants assembled for a UHF seminar at Bridgeport, Conn. The seminar was sponsored by RCA and was scheduled to demonstrate the results of RCA's experimental work at the pioneer UHF station operated at Stratford by the National Broadcasting Co.

Wayne Coy, chairman of FCC, was guest speaker. Following Mr. Coy, Dr.

(Continued on Page 10)



Now! only  
— from

# Admiral

# Television

built for the Future

Color TV optional  
... Equipped for UHF!

**20"** — 121K15  
walnut, mahogany  
or blonde wood  
cabinet.



It's another Admiral "exclusive." You can add color *any time* to any Admiral TV set by means of Admiral's sensational 3-way electronic-adaptor-converter... or with color TV companion console.

Color television "optional" offers three distinct advantages: *Bigger pictures* (17" or 20" instead of just a 10" tube)... *Lower Cost*... *Freedom from Obsolescence* (and that goes for UHF, too, because of Admiral's famous Turret Tuner). Get the whole story from your Admiral distributor.

121K15—walnut, only  
**\$279<sup>95</sup>**  
TAX INCLUDED

**17"** — 27K85  
walnut, mahogany or  
blonde. In walnut,  
only **\$259<sup>95</sup>**



All prices slightly higher south and west, subject to change without notice. Excise tax included, tube and parts warranty extra.



best seller in sight!  
**Admiral**  
leads all others in sales!

**20"** — 321K65  
walnut, mahogany or  
blonde. In walnut,  
only **\$469<sup>95</sup>**

# TELEVISION ROUNDUP

(Continued from Page 8)

C. B. Jolliffe, vice-chairman and technical director of RCA said:

"Our tests have proved that television reception on UHF can be just as clear and stable as on VHF, and in some instances, it is even better." RCA's technical director also pointed out that present television set owners will be able to take full advantage of expanded television service in the UHF range.

## For Fair Trade

A recent survey by the National Appliance & Radio Dealers Association into the subject of fair trade disclosed that the survey panel—100 dealers selected for market diversification and range of size—were strongly in favor of fair trade.

Of the 100 dealers surveyed, 68 favored fair trade, five opposed it, and three were undecided. Reasons advanced for opposition to fair trade were: "unenforceable," "gives manufacturers control of our mark-up, which is often set too low," and never properly enforced, it caused discount house operations."

Those favoring fair trade felt it was protection against established brands being used for promotional lures, it put small dealers on a par with large ones, it protected margin on products that require servicing, and it bolstered the ethics of the industry.

## Thomas to Make Small TV Tubes



The first piece of machinery for the manufacture of small TV tubes arrives from England, via the Cunard White Star Cargo Lines, headed for Thomas Electronics, Inc., Passaic, N. J. New machinery is to equip Thomas' plant for the production of small, vacuum tubes for within the set, and for the components replacement market.

## Top Ten Estimates

Television set production among the top ten television manufacturers is estimated at 3,780,000 units for 1951, as over against a 1950 output of 5,337,000, according to an annual industry survey released recently by Television Shares Management Co., investment advisor of Television-Electronics Fund, Inc. Estimates for the entire industry are set at 5,300,000 units as against a volume of 7,500,000 units in 1950.

RCA is expected to top industry production again with production of 700,000 units, compared with 950,000 in 1950, according to the survey. Admiral and Philco are expected to tie for second with 625,000 each. Emerson, General Electric and Motorola are expected to produce 400,000 units each.

## TOP TEN TV PRODUCERS

	Estimated Units	
	1951	(Revised) 1950
RCA	700,000	950,000
Admiral	625,000	875,000
Philco	625,000	875,000
Emerson	400,000	550,000
General Electric	400,000	425,000
Motorola	400,000	660,000
Zenith	300,000	450,000
DuMont	130,000	240,000
Crosley	100,000	140,000
Hallicrafters	100,000	172,000
	3,780,000	5,337,000
Bal. of Industry	1,520,000	2,163,000
Total Industry	5,300,000	7,500,000

## Color TV Seminar

King Edward Hotel, Toronto, Canada, will be the scene of a color seminar during the Radio Fall Meeting of members of the RTMA Engineering Department, the Institute of Radio Engineers and the Radio-Television Manufacturers Association of Canada. The three-day technical session is scheduled for Oct. 29-31, according to Virgil M. Graham, chairman, Radio Fall Meeting Committee.

The color TV seminar is to be held the morning of Oct. 30, and is sponsored by the IRE Professional Group on Broadcast and Television Receivers, D. D. Israel, Emerson Radio & Phonograph Corp., chairman. D. B. Smith,

## Nature's Cure for Monochrome TV



In anticipation of viewer interest over color television, and to further sales of its Kolorvision screen, the Duotone Co., Keyport, N. J., has just completed selection of Miss KOLORVISION. Sandu Scott of New York won the honor. Over 1,000 color photographs were submitted by dealers throughout the nation.

Philco Corp., will preside over the following program:

"The Video Color Signal," by A. V. Loughren, Hazeltine Corp.; "The Color Synchronizing Signal," by R. B. Dome, General Electric Co.; "Colorimetry in Color Television," by F. J. Bingley, Philco Corp.; and "A Three-Gun Shadow Mask Kinescope," by H. B. Law, Radio Corp. of America.

## New Color Tube

Still another development in the television color controversy materialized with the demonstration at the offices of Paramount Pictures Corp., N. Y., of an improved tube that receives television programs in both black and white and color without the need of any color wheel converter.

The tube was developed by Prof. Ernest O. Lawrence of the University of California, winner of the Nobel Prize in physics for his invention of the cyclotron and one of the world's outstanding atomic scientists.

Paul Raiborn, v-p of Paramount, and board chairman of Chromatic Television Laboratories, where Dr. Lawrence's research was conducted, has indicated manufacture of the new tubes will go forward at once. At the same time, Paramount's v-p acknowledged that RCA's tri-color tube performance could scarcely be excelled. Significance of the Lawrence tube, Raiborn suggested, was its economy of manufacture.

# CROSLEY has EVERYTHING your customers want!



The SARAH BERNHARDT—Model DU-17 PHN. French Provincial Combination with 17-inch picture tube in maple veneer. Also available in TV only.

**HE WANTS** assurance that the TV set he pays for today will not be obsolete "tomorrow." He wants TV that is readily adaptable to UHF. He wants TV that is readily adaptable to color. Crosley gives him everything he wants!

**SHE WANTS** beautiful cabinetry that will blend with her own furniture. She knows her television set will get more attention than any other piece of furniture in her home. At last you can show her television that is truly custom-styled. Crosley's authentic styling gives her everything she wants in fine furniture!

**EVERYONE WANTS** the finest in performance, in design, in dependability. That's what you have in store for your customers with Crosley Duo-Frequency TV... backed by Crosley's stand-out advertising and promotion that produce store traffic and help make sales at retail level.

Authentic period room setting by W. & J. Sloane, New York

IN PERFORMANCE... IN STYLING...

## CROSLEY Sets the Pace for 1952 with DUO-FREQUENCY TELEVISION!

*For Today* the clearest, steadiest picture... plus the enduring beauty of authentically styled cabinets.

*For Tomorrow* quickly, inexpensively adaptable to all forthcoming UHF channels... and equipped with built-in color connections for FCC-authorized color.

FOR EVERY ROOM SETTING—authentic styling in 21 Custom Models. Chippendale, Early American, 18th Century, Georgian, Regency, French Provincial and Modern. In beautiful and durable hand-rubbed mahogany and maple veneers, and blond wood finish.

### FOR MAXIMUM ENJOYMENT!

*Ultra-Proved Chassis* adds 100% increase in reserve sensitivity. Brings in excellent pictures even in extreme "fringe areas"... *Permaclear Pictures* on wide-angle screens stay sharper and brighter longer... *Automatic One-Knob Tuning*, simple to tune as a radio—a single control tunes both picture and sound... *No-Glare Removable Picture Window* deflects glare, easily removed for cleaning... these and other advancements make Crosley the outstanding TV line for 1952!

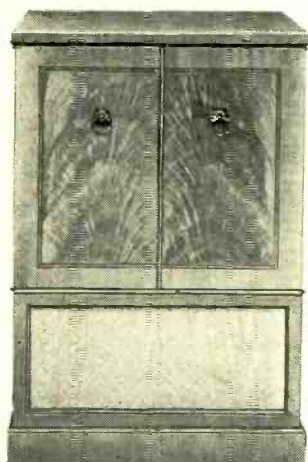

The DAVID GARRICK

Model DU-20 CHB. 18th Century Console. 20-in. picture tube. Blond finish. (Mahogany veneer—DU-20 CHM.)



The LILLIAN RUSSELL

Model DU-17 CDM. Regency Console. 17-inch picture tube. Mahogany veneer.

**CROSLEY**  Cincinnati 25, Ohio

Division

Better Products for Happier Living

Television • Radios • Shelvador® Refrigerators • Shelvador® Freezers • Sinks • Food Waste Disposers • Electric Ranges • Electric Water Heaters • Steel Kitchen Cabinets



• The new, modern version of Breuner's has the last word in music center products for avid customers.

## 400% Expansion in Seven Years!

NORTHERN California has a new version octopus. The sizable community of Stockton boasts a music center, the Breuner Appliance & Music Center, which has expanded no less than four times since 1944. This is business expansion and prosperity in any dealer's language.

For this last venture in spreading Breuner's coverage of the radio, appliance, television and music fields, the most elaborate, up-to-date features of store design were incorporated under one roof. The new building at 616 East Main Street has materialized into one of the outstanding stores in the northern section of the state.

### Colorful Displays

Situated directly across the street from Breuner's main building, there is little clash or conflict with the merchandising done from the older segment of the Breuner organization. The new structure has a main floor devoted entirely to the display of television, radios and pianos. In the 17,000 square feet of selling space on the main floor, white goods are thrown in for good measure. Even a built-in, modern kitchen has been planned to accommodate cooking school and home economist groups.

Interior design has utilized every architectural feature which aids in the selling function. Displays are com-

**This Stockton, California dealer now has 223 employees but looks ahead to bigger and better days**

pactly segregated along the walls and dispersed throughout the main selling area. Salons are arranged for home-like comfort of store customers, especially that portion of the store traffic which likes to linger over a purchase. Ample booths are provided for individualized listening pleasure. Capping these is the elaborate and careful use of color and lighting throughout the store. Soft tones and shades predominate. Hanging spots and concealed lighting heighten the appeal to the eye.



• Every department was especially designed to aid in the selling function.

### Volume Urgency

"When our present building was originally leased in 1944," states Mr. Larry Quimby, store manager, "we believed we had enough space to serve the needs of our customers in Stockton and our neighboring communities, but we are expanding into this new building in the interests of better service and better display."

The urgent needs of increased business volume soon forced Breuner's expansion to more and bigger quarters. In 1948 the Breuner Warehouse was constructed to give top service for all operating departments on a more elaborate and more efficient basis. The warehouse was built all on one floor and covered 70,000 square feet of floor space. The whole warehouse department handles all the service activities connected with the wide range of products in the radio, TV and music industries which Breuner's sells.

### Steady Growth

Because of the steady growth of the Stockton music center, the personnel associated with Breuner's has swelled to some 223 employees. The latest addition to the firm's physical properties added some 25 new persons. This is singularly noteworthy in view of the fact that this year the Breuner organization is celebrating the 95th birthday  
(Continued on Page 24)

here's the  
extra nudge  
to make  
your customers  
buy now!



# NEW LOW PRICES

## ON NEW *Emerson TV*

Everybody talks about prices! Emerson *does* something about them! And Emerson's lower prices make the difference between a sale and a "walk."

Yes, here's the extra nudge to bring prospects into your store so you can make those extra sales *now!* Look to Emerson for good leader values to create store traffic...for easy step-up models for longer profits.

Phone your Emerson distributor today! Do it now! Make the most of this good price news!



20-INCH  
\$279<sup>95</sup>

EMERSON MODEL 697 ENSEMBLE

Built-in antenna. Super-powered Long Distance Circuit. One-knob *Simplimatic* Tuning. Sharper, clearer pictures with *Black Magic Contrast*. Mahogany veneer cabinet ensemble complete with revolving-top table.



17-INCH  
\$199<sup>95</sup>

EMERSON MODEL 696

Built-in antenna. Super-powered Long Distance Circuit. *Full Screen Focus* for pictures sharp and clear edge-to-edge. One-knob *Simplimatic* Tuning. Graceful, curved-top mahogany veneer cabinet.



MODEL 693  
20-inch mahogany console with matching doors



MODEL 699  
17-inch television with 3-speed automatic phonograph

prices plus Fed. excise tax and warranty  
prices slightly higher in South and West

# Emerson LIFE-TESTED Television and Radio

EMERSON RADIO AND PHONOGRAPH CORPORATION, NEW YORK 11, N. Y.

Radio & Television JOURNAL • October, 1951



# SURE . . . you can get TARZIAN Tuners for replacement jobs

And your customers will thank you for it. They'll appreciate it because the overall performance of their receivers will be improved. Tests have shown that you can step up the operation of *many* receivers by substituting a TARZIAN TUNER.

It's the same famous Tuner, which until recently, was available only to original set manufacturers.

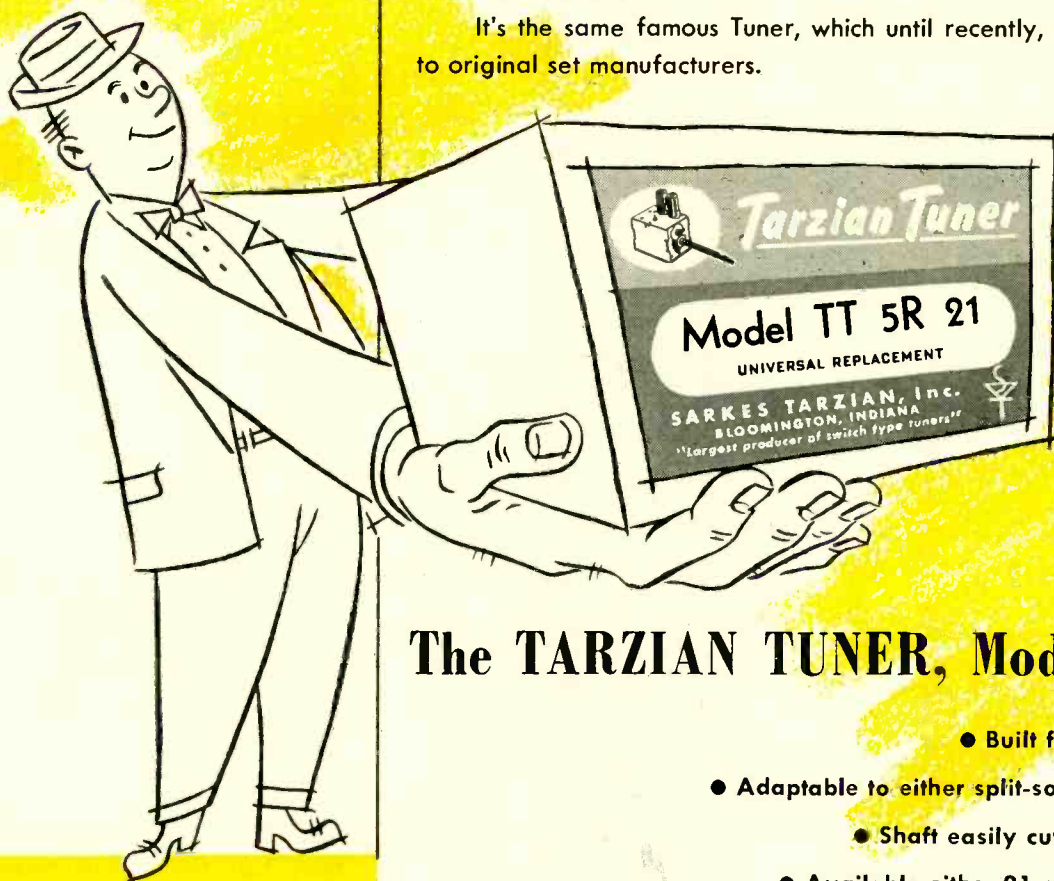

## The TARZIAN TUNER, Model TT-5R

- Built for easy conversion
- Adaptable to either split-sound or inter-carrier
- Shaft easily cut to required length
- Available either 21 or 41 megacycles IF
- Top screw adjustments on traps, IF, RF, and mixer circuits.
- Rear terminal connections easily accessible with extra tie points provided.

Contact your distributor, or write direct for instruction sheet for installation in a 630 type chassis.

**SARKES TARZIAN, Inc., Tuner Div., Bloomington, Ind.**

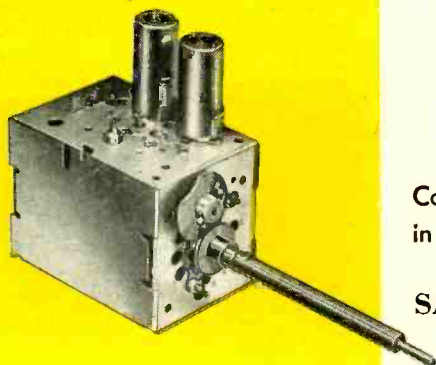

### TARZIAN MADE PRODUCTS



STATIONS WTTT (5000 WATTS) AND WTTV (CHANNEL 10)  
OWNED AND OPERATED BY SARKES TARZIAN IN BLOOMINGTON

*Largest  
Selling Booster*

**AT ANY PRICE!**

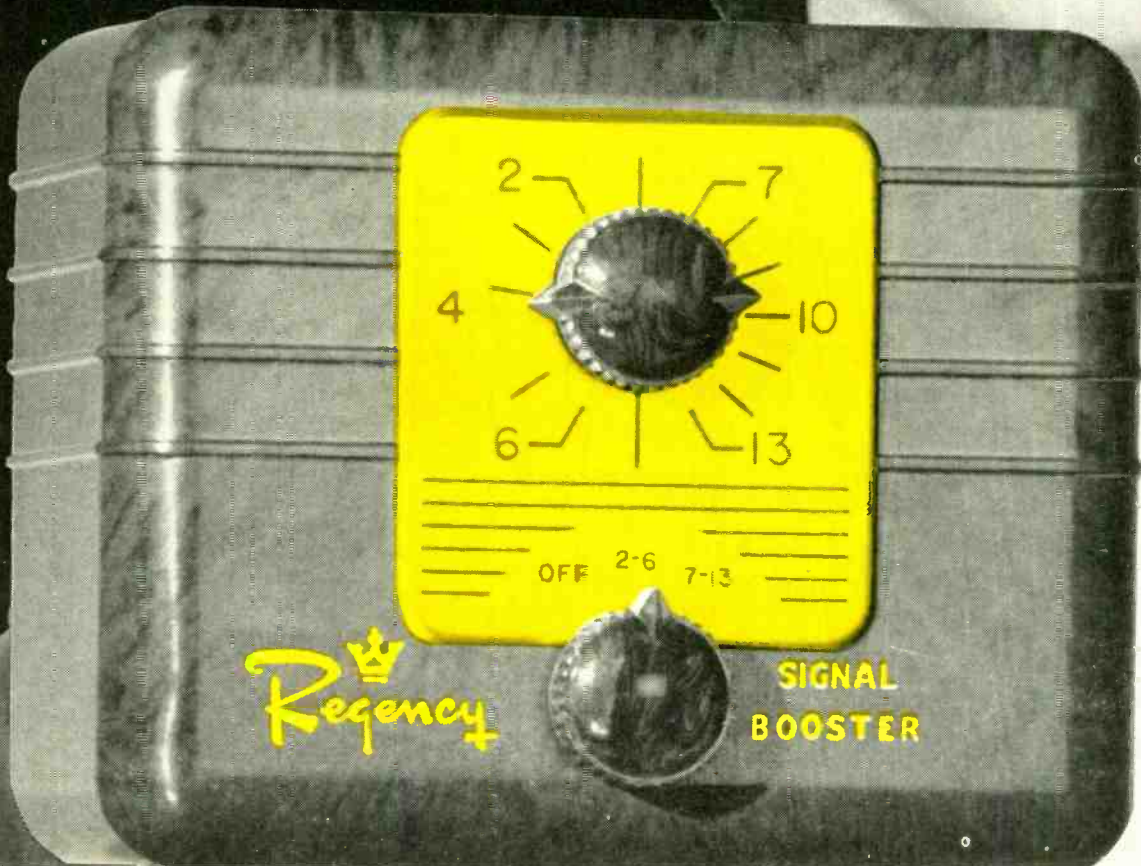



• L. to r., Alfred, Milton, Nathan L., Nathan, and Leon Goodman plan for expanding business.



• Always popular are the TV and special occasion days, when plenty of prizes are the rule.

Properly installed TV sets breed satisfied customers, and satisfied customers bring increased sales. That's the theory on which Goodman's of Jersey City operate their 54-year-old business.

## It's the TV Installation Which Nails Down the Sale

Goodman, founder, now taking an active part in managing the affairs of the business.

### Recommend Stadium

"For any firm starting out in television, we recommend a stadium," states Leon Goodman, sales promotion director.

Anyone hearing such a strange recommendation might raise a quizzical eyebrow. Not, however, if they knew of Goodman's unusual start in television. Through 1947 and 1948 the firm used a large vacant lot, adjacent to the store in the heart of the business district, as a television stadium. From here they demonstrated and sold television to all who would come and look and listen. In time, the crowds increased and, in the people's minds, television came to be associated directly with Goodman's.

The same stadium has taken on a new look today. An oldtimer wandering back in search of the same TV stadium would find a new Goodman's display room in its place. The new building is 107 feet long, but in deference to the firm's customer friends, who have long watched many TV programs on the publicly-demonstrated TV sets, the new structure was set back 16 feet from the sidewalk when it was built. This extra room on the sidewalk was purposely provided for, so as to accommodate a large number of standees. Every night eight or nine television sets are kept running, so that passersby can watch their favorite evening's TV entertainment in Goodman's windows.

### Store View

More important, they can look beyond the TV screens into the length and breadth of the store. Back in the rear, names like RCA Victor, DuMont and Westinghouse indicate the nature of the array of products displayed in the expansive TV salon.

The TV salon is geared to modern selling. A series of seven small parlors make up the selling area. Only low walls, surmounted by three perpendicular chrome rods separate each small parlor from its neighbors. Lamps are generously scattered throughout each little parlor, with period pieces to break up the arrangement and lend a homey atmosphere. Plenty of easy chairs are provided for comfort while customers are viewing programs on a set. Demonstration sets run all day long, and anyone is welcome to drop in and stay as long as he likes.

Adjoining the television salon is the record section, which spreads off into the appliance division in record shelves and showcases. Records also flank one side of the entrance from the street. Window areas are divided between TV and children's record displays.

### Way of Selling

Goodman's has developed a way of doing business over its busy 54 years. For the organization it has become a way of life. For its customers it has reflected a way of selling which is aimed to please.

The firm permits no high pressure selling. All sales people are on salary,

(Continued on Page 62)



• This unique type of outdoor advertising emphasizes Goodman's institutional character in the Jersey City community.

EVERY morning at Goodman's in Jersey City each television installation report gets a careful going over by a top level executive. This firm is interested in having its customers enjoy their television sets. Having a high executive in the company see to it that installations are first-rate is a precaution demanded by their interest in customer satisfaction at all times. This care in building customer satisfaction in all TV sales is reflected in the steady increase in sales which the New Jersey store enjoys. Discounts, "fabulous trade-ins," or private brand offerings are foreign to the Goodman operation.

Though only in television since 1946, Goodman's has been in business in Hudson County, New Jersey, since 1897. Goodman's is a family firm, with a third generation of Samuel





*Look inside—*

see how the Du Mont  
**"CHASSIS STORY"**  
 will DO MORE for YOU

Here's the greatest sales story in television retailing.

It's the story of the Du Mont *chassis* . . . the electronic triumph *inside* every Du Mont Teleset\* that makes Du Monts Do More. It's a fresh story. It's a powerful story . . . *one that only Du Mont can tell*. It's the convincing reason why Du Mont television performance is the finest ever achieved . . . why, dollar for dollar, a Du Mont is the market's best buy.

Call your Du Mont Distributor today. To help you tell your "Chassis Story," he has a brilliant package including

- ★ Die-Cut Displays ★ Window Streamers
- ★ Pennant Sets ★ Consumer Folders
- ★ Novelty Folders ★ Radio Scripts
- ★ TV Spots ★ Newspaper Mats

The "Chassis Story" puts people inside your store, puts profit inside your pocket! Get in on it today!



**DUMONT**

*First with the finest  
 in Television*

\*Trade Mark

©1951, Allen B. DuMont Laboratories, Inc., Television Receiver Division, East Paterson, N. J., and the DuMont Television Network, 515 Madison Ave., N. Y. 22, N. Y.

# Washington Report



## Nickel Poses Crisis

Unless the receiving tube industry is granted relief from present nickel allocation policies, manufacturers will be forced to start cutting production and to release employees by mid-October and delays in deliveries to the military services will result, Glen McDaniel, president of the Radio-Television Manufacturers Association, has announced.

McDaniel's statement followed a special meeting of the RTMA Tube Division, called by Chairman R. E. Carlson, and coincided with a letter to Edmond T. Morris, director of the Electronics Division of the National Production Authority.

Manufacturers have resorted to intensive conservation measures to reduce the industry's use of nickel, the RTMA president made known, with the result that 229 million tubes were produced in the first seven months in 1951 with only two-thirds of the nickel used to produce 191 million tubes in the corresponding period of 1950.

Even with this conservation, in the words of McDaniels, "The receiving tube industry is facing a critical situation because of the shortage of nickel." He advocated revision of present allocations to the rate of 187,000 pounds a month as formerly suggested by the NPA Electronics Division.

## RTMA on TV Sports

Radio-Television Manufacturers Association members stand to benefit by the televising of some college football games, Chairman J. B. Elliott, Sports Broadcasting Committee, has pointed out. Since the National Collegiate Athletic Association has resolved the question of football contests in favor of televising some games, set manufacturers were urged to cooperate with NCAA so that more games may be telecast in 1952.

Elliott's Sports Broadcasting Committee recently forwarded a series of 22 "Suggestions for RTMA Members on Cooperating with Sports Today, for Tomorrow," to all set manufacturers, plus complete information on network TV plans for this fall.

The committee suggested that members cooperate with sponsors and promoters of other sports on TV, and that they urge local distributors to organize

a TV or industry committee in each major market to cooperate with local radio and TV broadcasters and program sponsors in the promotion of sports events.

Tomorrow's extended TV sports coverage can fatten on the TV industry's cooperation with sports telecasting today.

## "Bow-tie" UHF Antenna



Frank M. Folsom, left, president of RCA, is showing Wayne Coy, chairman of the FCC, an experimental model of a new fan, or "bow-tie," antenna designed for use in the proposed UHF television channels. The heads of RCA and FCC were photographed during the recent RCA Engineering Products Department seminar for broadcast engineers and TV consultants, held at the nation's only experimental UHF station, Bridgeport, Conn.

## Craig Reappointed

John W. Craig, Crosley Division, Avco Mfg. Corp., has been reappointed chairman of the RTMA FM Policy Committee, according to an announcement by Chairman Robert C. Sprague, board of directors, RTMA. Mr. Craig, who is also chairman of the RTMA Set Division, will direct the Association's activities in the FM field for the ensuing year.

Other members of the RTMA FM Policy Committee are: H. C. Bonfig, Zenith Radio Corp.; J. B. Elliott, RCA Victor Division; Larry F. Hardy, Philco Corp.; H. L. Hoffman, Hoffman Radio Corp.; E. H. Vogel, General Electric Co.; ex officio, W. R. G. Baker, General Electric Co.; and Robert C. Sprague, Sprague Electric Co.

## "DuMatic" Adapts Color



This model is holding the "DuMatic" switch, a color television adapter, made by Allen B. DuMont Laboratories, Inc. The new switch enables TV viewers to change from 525-line reception to the 405-line system, allowing reception of color programs in black-and-white. The "DuMatic" is 4½ inches long, 3 inches wide and 1½ inches deep, and can be installed in an hour. It bolts to the rear of a TV set.

## Large Rectangulars Favored

Ninety-nine per cent of all television picture tubes sold to television receiver manufacturers in July were rectangular in form and 16 inches and larger in size, the Radio-Television Manufacturers Association reports.

July sales to manufacturers, however, were considerably less than the preceding month due to plant shutdowns for vacations. Cathode-ray tube sales for July totaled 89,144 units valued at \$1,858,930, compared with June sales of 221,759 tubes valued at \$4,664,744.

RTMA also reported that manufacturers' purchases during the first seven months of 1951 totaled 2,641,179 units valued at \$68,387,203.

## Tube Sales Drop

Sales of receiving tubes dropped 50 per cent in July below those of June, Radio-Television Manufacturers Association reports. Plant shutdowns for vacations of both set and tube manufacturers accounted for the sharp decline.

July tube sales came to 13,185,567, compared with June sales of 27,667,099. Of the July sales total, 7,117,435 tubes were sold for new equipment, 4,625,314 for replacements, 1,222,735 for export and 220,083 to government agencies.

Feature these popular combinations from the

# Dual-Beauty line by Stromberg-Carlson

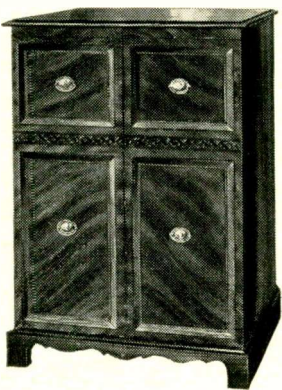

**CHIPPENDALE** Superb period combination, 17" TV . . . AM radio . . . 3-speed automatic record-player. Inclined safety glass to minimize room reflection. Hand-rubbed mahogany veneer cabinet. Model 317 RPM4, \$495°

## 1. BEAUTIFUL PERFORMANCE

- Matchless pictures—new brightness—steadier, sharper with new A. G. C.
- 3-speed fully automatic record-player—more than 4 hours continuous music.
- Outstanding radio . . . superb tone from famous Stromberg-Carlson audio system.

## 2. BEAUTIFUL CABINETS

- Enduring designs, modern or period, fashioned from choice hard woods.
- Ten-step finish with complete hand-rubbing.
- Decorative perfection every woman demands for her home.

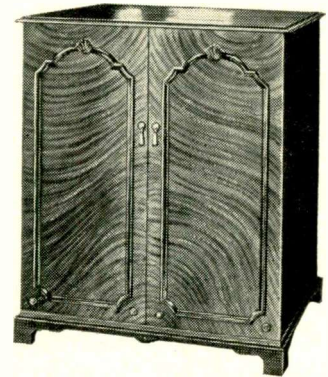

**STANCLIFFE 24"** combination with beautiful pictures as large as your full newspaper page. AM-FM . . . 3-speed automatic record-player. Model 24 RPM, \$975°

**NEW WORLD** Exquisite modern combination. 17" TV . . . AM radio . . . 3-speed automatic record-player. Inclined safety glass. Generous album space. Limed oak veneers. Model 317 M20, \$575°

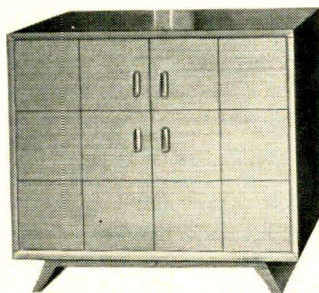

**18th CENTURY** Authentic period instrument. 20" or 19" TV . . . AM-FM . . . 3-speed automatic record-player. Mahogany veneer cabinet. Model 20 RPM, \$785°. Model 119 RPM, \$750°

Every Stromberg-Carlson combination brings you the extra values of Dual-Beauty. Feature Stromberg-Carlson. Let Dual-Beauty sell for you.

Stromberg-Carlson television combinations are priced from \$439.95\*

\*Zone 1. Includes excise tax. Installation, warranty extra.

**"There is nothing finer than a STROMBERG-CARLSON"**

Stromberg-Carlson Company, Rochester 3, N. Y. — In Canada, Stromberg-Carlson Co., Ltd., Toronto



• When this new Alhambra store was opened recently it became Dorn's seventh "House of Miracles."

## There's More Than Meets To This Television Store

**Harry Dorn calls his radio and TV chain the "House of Miracles," but alert selling, consistent promotions, and sound servicing account for his successful business enterprise**

**I**F Harry Dorn has his way all Southern California will come under the sway of his selling magic. At least TV prospects within that geographical area will be within reach of one version of his "House of Miracles," and the potent sales message emanating from each.

This West Coast television dealer has just launched his seventh "Miracle House" on its way to an expected \$500,000 in annual sales at Alhambra, Calif. The new store is expected to swell to \$5 million the annual volume of Dorn's eight-year-old firm. When the new 10,000-square-foot service building and 25,000-square-foot warehouse are finally completed, Dorn will be one step nearer his goal—to blanket every major community in Southern California with his own particular brand of salesmanship and merchandising.

### Promotion Bedrock

In Harry Dorn's selling philosophy lie the keys to his steady growth, and to his rapid rise as a colorful and astute radio and television dealer. More than miracles are necessary to build a successful chain in a scant eight years.

The answer is supplied by Dorn himself. The "House of Miracles" rests on three pillars—aggressive and realistic merchandising, a constant sales training program and heavy metropolitan newspaper advertising.

"Our merchandising policies reflect the tenor of the public's buying habits," Dorn likes to reflect. "The public is

a buying public. It is purchase conscious, even when living costs are high and buying power is at a low ebb. When business declines, it isn't because the people don't want to buy. The plain truth is that the man on the selling end of things has neglected to keep his ears glued to the market soundings."

### Alive to Change

Solid as his approach to selling is, Dorn is not bogged down by conventional clinging to brakes upon the wheels of change. His skill at business tacking was vividly demonstrated in his recent adept handling of an earlier version of the Government's Regulation W.

During the month of January Dorn's volume dropped to \$261,000 and in February to \$260,000. In March, however, a new program was employed which brought sales up to \$365,000 in April and \$450,000 in May. Not only was the firm able to recoup its losses, but it went on to achieve record sales. In the first five months of 1951, volume sales increased \$500,000 more

than the corresponding period a year ago.

The plan was based on a rolling inventory, kept moving by sales at a loss at first. For Regulation W brought this dealer face to face with stalled inventories. But Dorn managed to sell every receiver in stock at a price paid for similar merchandise at the beginning of the year. With the several hundred thousand dollars realized from these sales, Dorn bought new merchandise at savings.

"The increased sales resulting from my lowered prices enabled me to recoup my original losses and emerge with a higher volume than ever before," Dorn says, looking back over the whole merchandising period. "The moving inventory is the answer to such a problem as posed by something like the former version of Regulation W. Unload it, then return to the market and buy up additional goods at reduced distributor and manufacturer prices that will allow you to regain your original losses."



• Harry Dorn



• The "House of Miracles" in Glendale, Calif., is the largest store in the chain of seven. It was opened in 1949. Notice the modern approach to selling in the storefront design — striking signs, modern architecture features, and wide glass areas for window shoppers.

## the Eye of Miracles

### Constant Training

Still another pillar on which rests Dorn's "House of Miracles" is a sales training program that is constantly in effect. Nothing is ever bought without first being sold. New salesmen are aided and guided by individual store managers until an ease and confidence is established which will insure a successful selling program.

An effective feature of Dorn's sales training program is the "Willmark Shopper." These people are employed by the firm to test the salesman's approach to the customer and the selling ability of Dorn's store personnel. Reports turned in by the "shoppers" determine to what extent improvement in sales techniques is necessary. A weekly meeting of sales personnel is scheduled with all store managers. The store managers in turn meet regularly with Dorn's sales manager, Paul Marshall, to iron out problems and study new existing sales conditions.

### Follow-up Ads

Heavy advertising is the third pillar which supports the "House of Miracles." Large dailies in the Los Angeles area carry Dorn's hard-hitting ads. Much of the firm's advertising is directed toward private brand merchandise, with emphasis placed upon na-



• This is the department which Harry Dorn considers one of the most important in his entire organization — the service department. Above, the interior of his present central service location on Santee St., Los Angeles. There are 20 men on this service staff, all assigned to service and repair television. By late October, 10,000 additional square feet will be devoted to service and repair of TV sets.

tional brands when prospects materialize.

No effort is spared to interest the families which are on a budget. Prominently displayed in all advertising are the down payment requirements and term arrangements offered to thrifty shoppers in the middle income groups.

### Flying Saucers

For the grand opening of the Alhambra store, a novel promotional advertising program was employed. The

front page of an eight-page Dorn edition in the local newspaper was devoted entirely to "newsy" stories. Each item carried a head intended to inform the public of a current event or of some happening that might appear in the pages of any newspaper.

One item for example carried the headline, "Flying Saucers Will Be Seen Over the Valley." The headline did what it was intended to do. It attracted the attention of local residents

(Continued on Page 24)

# Radio & Television JOURNAL

## merchandising memo



**By Nat Boolhack, Editor  
Radio & Television Journal**

### Election Day

The first Tuesday in November is Election Day. This year it falls on November 6, and alert merchants are now marking off that day on their sales calendar. While it is true that Election Day is a legal holiday, with all schools and many offices closed, all of the stores are open and it's a grand day for family shopping. Many successful dealers have used good "Election Day Specials" in their advertising, timed for the day before election day to promote sales. Last year, one top television merchant ran an ad on election day which read: "We elect **Blank's** Television for top honors in any home." Another good slogan tying in with this holiday is: "No Matter Who Wins the Election, You'll be the Winner Every Day in the Year by Shopping at the **Blank** Radio & Television Store."

### Football

During November, the interest in football really reaches fever pitch. This year, with coast-to-coast television broadcasting a reality at last, the public interest in this great sport will be greater than ever. Most of the big college games are being telecast, and this provides a grand opportunity for dealers to tie in with the tremendous enthusiasm created by devoting some well designed window displays to the pigskin fanfare. Start planning that special football window display now. Many TV manufacturers have some excellent display material available on the subject of football.

### Armistice Day

Here's another day of observance which occurs in the month of November and offers a fine opportunity for some special promotional efforts by radio and television dealers. While Armistice Day is not a widely observed holiday, it does make folks more shopping conscious because it has the atmosphere of a holiday—and all the stores are open. A good memo for dealers this year is: There's never an armistice in **selling** . . . the successful dealer must always plan the next campaign, and the one beyond that . . . if he is to win the war of moving merchandise.

### Thanksgiving

This is one of our great American holidays . . . a day of prayer and thanks which is part of our heritage of freedom. While it is true that stores are closed on Thanksgiving, many dealers run pre-Thanksgiving day promotions, and very successful they are, too. This day offers excellent opportunities for institutional copy, linking your store and its products to our American Way of Life.

The salesman who goes after an order is the one who comes out with one.

A salesman who knocks his competition never wins, and winning salesmen never knock.

## **Incomplete Lines Handicapping Your Business?**

Sure you're in the radio and television business and you're out to sell as much merchandise as you can. The only thing missing is customers . . . says you! Just send in the customers and you'll supply them with all the television they want. But is that entirely true? Of the TV lines which you do carry, do you have complete representation of the entire line so that the

prospective customer can judge for himself? We're not suggesting that every dealer carry every make of television in his store. But we do say that of the lines you carry, you owe it to yourself and your distributor to have complete lines in stock. You can't sell from an empty wagon.

## **How Are Your Profits?**

Profit is a perfectly good respectable word and one which is the foundation of our free economy. The major reason for your being in business is to show a profit at the end of the year. If you fail to do that, then something's wrong with either you, your business, or the industry you're in. Lack of a fair return is one of the things which today burdens the dealer in radio-television. The next time you're tempted to engage in a price war, start figuring on how it will affect your profit picture. You may find a rather snowy picture which no serviceman but yourself can clear up.

## **Frozen Out?**

Sure, the "Freeze" has been on for three years and you've been left out of the television bonanza. But the freeze will be lifted soon and in the meantime there's no freeze on human ability. Are you planning now for the time when UHF or new VHF stations come to your city?

## **Smiles**

According to the experts it takes 47 muscle movements to frown but only 13 to smile! Do your salesmen greet every customer with a smile when he enters the store? That's small stuff, you say, but oh, how mistaken you can be. A smiling, friendly greeting can set the whole atmosphere for the sale. And besides, a smile makes you sell better, too.

## **Sales Speed**

One of the hazards of this television business is the fact that merchandise becomes obsolete so quickly. Last Spring's model may be every bit as good as the one which just came out, but when the customer comes into your store, he wants the latest model, hot off the assembly line. This places a premium on building the kind of sales organization which can move merchandise fast . . . while it's still new. Remember, you're not in the antique business.

## **Friends**

It is far better to make friends of buyers than to make buyers of friends.

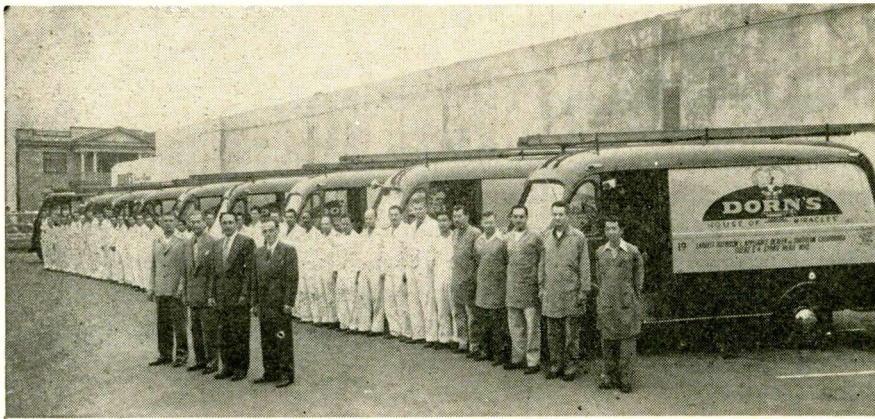

• *Dorn's service and delivery fleet and some of the 100-man service department. There are 12 trucks, ready to make fast and prompt deliveries and take care of the stream of service calls, at any hour of the day or night. The tight supervisory group which runs this efficient service organization stands in the foreground: left to right, Robert Simpson, shop supervisor, David Golden, shipping supervisor, Lawrence Kasden, service manager, and Louis Bernard, assistant service manager.*

(Continued from Page 21)

and shoppers. The story went on to note the opening of Dorn's new store.

What effect this novel idea had on sales during the five-day grand opening was described in the words of Margaret Zalvis, vice-president, who noted that "it was the most successful opening Dorn's ever experienced." Total sales during the five-day period reached between \$55,000 and \$60,000. The new store has shown a consistent daily high in sales among the seven outlets.

#### For the Future

Fifty-six hundred square feet of floor space in the Alhambra store provides a wide showroom display area, and Irving Pass, store manager, takes full advantage of it by displaying some 300 pieces of merchandise. Eighteen new employees swell the total force at Dorn's to 200, which includes a 100-man force in the service department alone.

The long and valuable experience Harry Dorn gleaned from the years he spent with the New York Davega chain has stood him in good stead. The pattern of his operation follows somewhat that of the New York TV chain. General Manager Maurice Landman sees to it that the central buying, warehousing, service and delivery location functions smoothly for the benefit of all the radiating retail outlets.

Harry Dorn started his company in Los Angeles in 1943. For two years his business consisted merely of servicing radios. This was a reflection of a shortage in merchandise due to the wartime emergency. He opened his second store in Huntington Park in 1948 and followed with a third outlet on Broadway in Los Angeles that same year. Two more stores were added in 1949, one on Vermont Ave. in Los Angeles, and the other at Glendale,

Calif. In 1950 the Whittier Blvd. in East Los Angeles was opened and then the most recent on Main St. in Alhambra.

The recent modification of Regulation W has served to increase sales for the Dorn organization. It has made it possible for a wider range of prospects to meet the initial purchase requirements on radio and television products they want to buy. As a result, Harry Dorn reports sales increases of up to 25 per cent, since the regulation was changed. This increase in volume of business has put an even greater strain on an already busy organization. For that reason, Dorn is eagerly awaiting the completion of his new service building around the middle of October.

As for service, Dorn considers this department one of the most important in his organization. Every time the firm invests a dollar in service, he feels, it is investing in the future of the whole organization. With 10,000 square feet of service facilities soon to augment the already existing service organization, the Dorn organization will have that much more efficiency and satisfaction to sell every customer. For customer satisfaction is rooted in sound installations and prompt, efficient service. No dealer on the Coast knows this more than Harry Dorn. To give his customers visual evidence of the faith which he puts in efficient service, pictures of the service shops, staffs, equipment and trucks are put on display in the various stores. Dorn's service clearly is designed to protect a customer's TV set investment.

Looking to the future, Dorn's plans to open three stores a year. The House that Harry Dorn built will continue its miraculous expansion as long as TV frontiers remain open in Southern California.

#### "Catalog-in-Motion"



This display piece has been designed for the Crosley division, Avco Mfg. Co., for use among dealers as a point-of-sale promotion piece. The unit is a "catalog-in-motion," showing eight Crosley TV consoles or combinations in eight room settings ranging from Georgian, Chippendale, and Early American to French Provincial, Regency, 18th Century and Modern. Turning slowly and constantly, the display is eye-catching.

#### Public Reaction to Color Being Tested by RCA

The Radio Corp. of America invited the public in the New York area to view a series of field-test programs transmitted by the RCA compatible color TV system, October 9 through October 19. Tests were coming through on RCA experimental color receivers in the lounge of Center Theatre in Radio City. They were also transmitted from New York to Washington, D. C. for observance by Government officials. Broadcasts over Channel 4, WNBT, were seen also in black-and-white TV sets, since RCA's color system is compatible.

#### 400% Expansion In Seven Years

(Continued from Page 12)

of the founding of the firm.

Throughout its history, the firm has geared its selling to the immediate needs of the Stockton community. At every opportunity it has expanded or elaborated on its establishment to serve the radio and television prospects within that community. Even down to the parking facilities provided to the rear of the new store and the separate entrance off the parking area to the store, no convenience has been too small or too insignificant.

Breuner's strives not only to be the music center for Stockton, but to make it the most outstanding in northern California.



Get ready for **COLOR** with the new

# CBS-COLUMBIA

## Compatible Receiver

*Internally adapted to receive Color  
Broadcasts in Black and White*

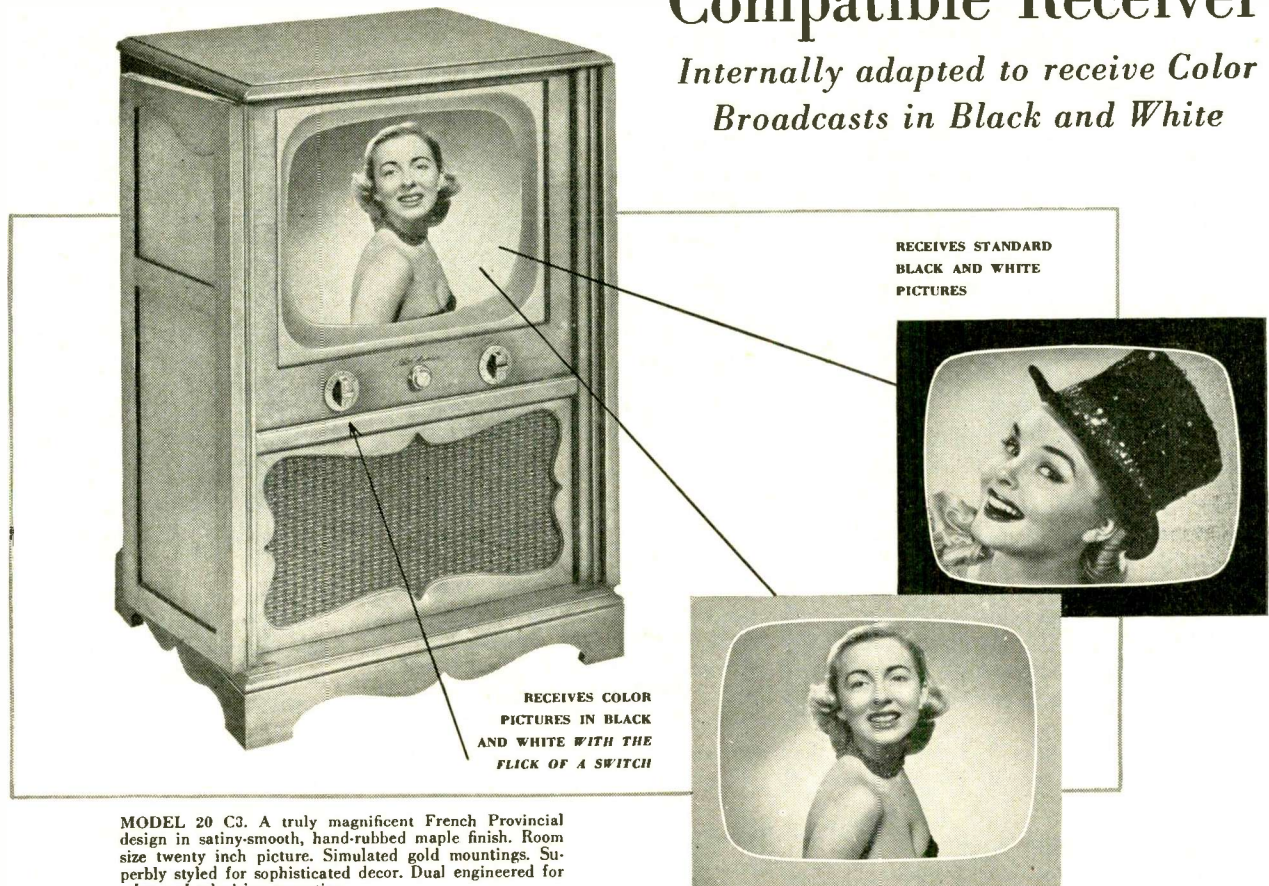

**MODEL 20 C3.** A truly magnificent French Provincial design in satiny-smooth, hand-rubbed maple finish. Room size twenty inch picture. Simulated gold mountings. Superbly styled for sophisticated decor. Dual engineered for advanced television reception.

## You can make Black and White sales *Now* with this Compatible Receiver

**ADAPTABLE TO COLOR** This new CBS-Columbia compatible receiver not only receives color broadcasts in standard black and white with the flick of a switch, but is also equipped with a "built-in" color receptacle for the addition of a *companion color receiver* when color television is broadcast in your area.

**STORE TRAFFIC NOW** The public interest in color television is tremendous! When you announce and display this new CBS-Columbia compatible receiver, you can expect a steady flow of enthusiastic store traffic. Customers that are ready to buy! Newspaper mats and store display material are available for your local promotion.

**PLACE YOUR ORDER NOW** This new CBS-Columbia compatible receiver will definitely revive and stimulate television sales. Don't delay placing your order **NOW** for floor and home demonstration samples. Take full advantage of the sales impact this compatible receiver will create in your area. You're set for sales with CBS-Columbia!

*The Greatest New Name in Television Receivers*

*CBS-Columbia Inc.*

CBS-COLUMBIA INC.  
170 53rd ST., BROOKLYN 32, N. Y.  
Subsidiary of  
COLUMBIA BROADCASTING SYSTEM INC.

*America's Color Pioneers*



# New Products for Autumn Business

Radios  
Television

Consoles  
Recorders

Phonographs  
TV Accessories

## Arvin's Table TV

Manufactured by Arvin Industries, Inc.,  
Columbus, Indiana

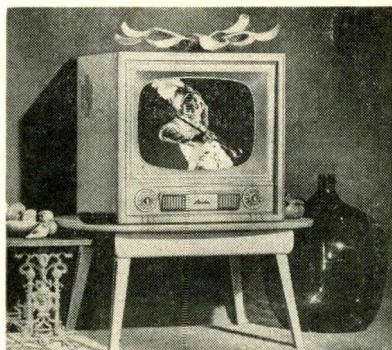

A leader in this firm's line of new television receivers, this blond-finish model is table television on a big scale. Features a 21-inch glare-free picture tube. The custom chassis is the new "Dual Power" type, with 26 tubes, including rectifier and picture tube and "step down" or "step up" power features.

Say you saw it in *Radio & Television Journal*, October, 1951

## RCA's "Rockingham"

Manufactured by RCA Victor Division,  
Camden, N. J.



An adaptation of the Regency design, the "Rockingham" is a 21-inch console TV receiver utilizing a bowed front with full length doors. Improved chassis, with new picture contrast control for automatic maintenance of picture detail, and improved circuits to eliminate white diagonal lines at peak brightness.

## Scott's "Linfield"

Mfd. by Scott Radio Laboratories, Inc.,  
4541 No. Ravenswood Ave., Chicago, Ill.

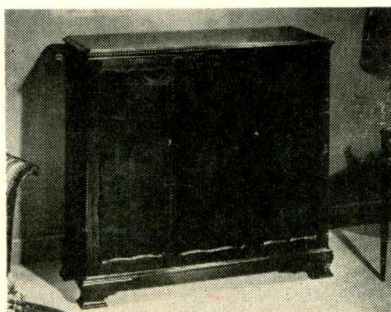

Called the "Linfield," this new three-door console features the 510 FM-AM radio chassis with separate high fidelity amplifier and a three-speed, all-size automatic record player. Hand-crafted cabinet of mahogany has three separately hinged full-length doors paneled in crotch mahogany. Space for storage of up to 200 records.

Say you saw it in *Radio & Television Journal*, October, 1951

## Sylvania's "Washington"

Mfd. by Sylvania Electric Products, Inc.,  
500 Fifth Ave., N. Y.

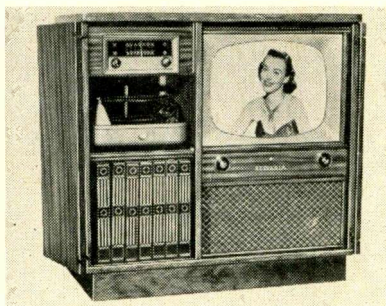

The "Washington" is a combination console at the top of this firm's new Golden Jubilee line of television receivers. The 20-inch screen is surrounded by Halolight, frame of light which provides greater viewing comfort. AM-FM radio and three-speed phonograph are built into the traditionally-styled mahogany cabinet with doors.

Say you saw it in *Radio & Television Journal*, October, 1951

## Admiral TV Combo

Manufactured by Admiral Corp.,  
3800 Cortland St., Chicago 47, Ill.

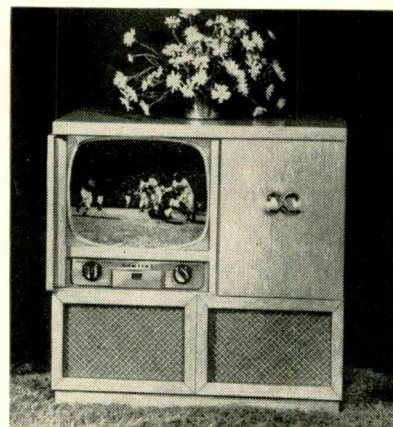

Television, radio and a triple type variety of recorded music are offered in this new TV combination. Features a 20-inch picture tube, Dyna-magic radio and automatic triple-play phonograph for all speeds, all size records. Combination is equipped for ultra high frequency.

Say you saw it in *Radio & Television Journal*, October, 1951

## Phono-Radio by Audar

Manufactured by Audar, Inc.,  
P. O. Box 438-M, Pasadena, Calif.



An early American designed phono-radio combination, which features a 7-tube transformer-powered radio and amplifier with separate bass and treble boost controls, push-pull power output and 8-inch speaker. Record changer plays all sizes, speeds and types of records automatically.

### Stromberg-C's "Mandarin"

Mfd. by Stromberg-Carlson Co.,  
Rochester, N. Y.



A 17-inch television console in African ribbon-striped mahogany which is 37¼ inches high, 29 inches wide and 20 inches deep. Has inter-carrier tuning, super high-gain, low-noise tuner for high gain RF stage and "Trulock" channel selection. Automatic transfer of unused wattage from video to audio section. Phono jack for record player connection. Twelve-inch speaker.

Say you saw it in *Radio & Television Journal*, October, 1951

### Crosley's "Jenny Lind"

Mfd. by Crosley Division, Avco Mfg. Corp.,  
Cincinnati, Ohio



One of 21 models in the new 1952 television line of this firm. Receivers are known as Duo-Frequency TV receivers. Featured in this set is a 17-inch picture tube. Console has full-length doors. Of modern decorator design, and finished in blond mahogany veneer.

Say you saw it in *Radio & Television Journal*, October, 1951

### New CBS-Columbia TV

Manufactured by CBS-Columbia Inc.,  
170 53rd St., Brooklyn 32, N. Y.

A hand-rubbed maple French Provincial cabinet with a 20-inch rectangular tube is offered in this first compatible TV receiver. Additional knob, the "Compatibility Switch," has been added to standard two knob controls. Permits black and white reception while color is being telecast. Built-in receptacle for addition of full color as desired.

Say you saw it in *Radio & Television Journal*, October, 1951



**quality controlled!**  
eureka meets the demand for the perfect TV tube

when it comes to unexcelled picture tube performance, just one great name stands out for —

- ✓ greater clarity
- ✓ longer service
- ✓ proven quality
- ✓ technical skill

The name "Eureka" is your personal guarantee of the finest in picture tube production. The sum total of Eureka's vast electronic skill and resourcefulness is aimed squarely at ultimate customer satisfaction. Every component part is carefully prechecked for maximum efficiency. That's why Eureka Cathode-Ray Tubes are truly dependable.

Write or phone for complete information on 14, 16, 17, and 20 inch rectangular tubes.

**EUREKA TELEVISION and TUBE CORPORATION**  
Manufacturers of Cathode-Ray Tubes and Electronic Products  
69 Fifth Avenue, Hawthorne, New Jersey • Telephone Hawthorne 7-3908

## ERNEST A. MARX

This is another in RTJ's series of articles about leading personalities in radio and television who are contributing significantly to the development of the industry.  
—Editor

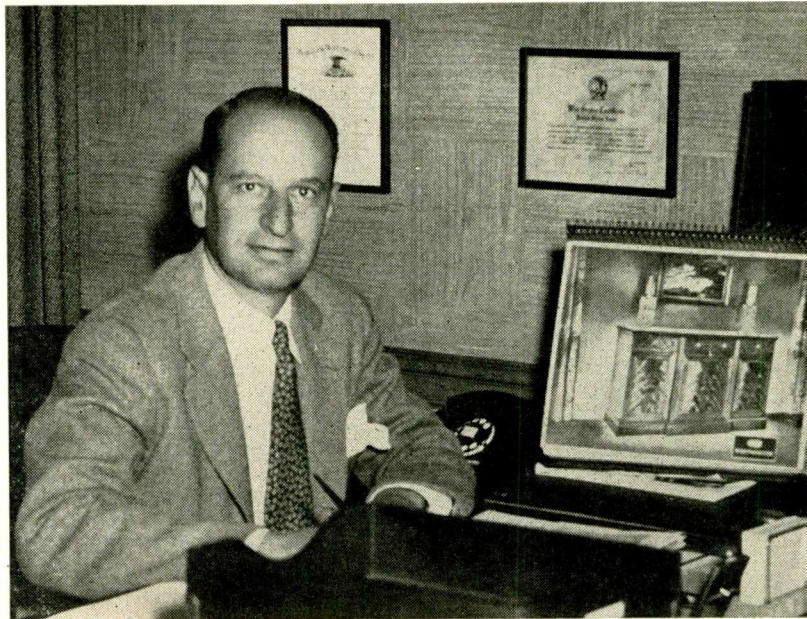

**A**LLEN B. DuMont Laboratories, Inc. has one of the youngest sales and distribution forces in the TV industry. Yet the company ranks among industry leaders and holds a solid position in today's market.

Chief blueprinter of the growth of DuMont's receiver sales division, the firm's most important operating arm, is tall, spruce Ernest Marx who has guided the destinies of the division since 1945. In fact, it was the day after V-J Day that Marx organized the division.

Marx' first contact with DuMont occurred while he was still in the Navy. A Lt. Commander, he was Electronics Officer for the 3rd Naval District. As such, he had charge of a radar school set up for Allied Nations personnel at the Brooklyn Navy Yard. Dr. DuMont, visiting the school, was impressed with Marx' electronic know-how and organizational ability. The two got to talking. As a result, immediately after his release from the Navy, Marx came to the DuMont organization as assistant to the president.

When V-J Day came and DuMont began converting to consumer production, it was Marx who was given the task of organizing its receiver division. The job meant starting from scratch. DuMont had no distributor-dealer organization from pre-war days as did most of its competitors.

On May 7, 1946, Marx conducted the first sample post-war showing of television receivers in this country. When the showing was held at DuMont's 515 Madison Avenue, New York offices, all DuMont had by way of distribution was one distributor—Teldisco, Inc., of Orange, New Jersey—and five dealers in New York to whom it sold direct.

DuMont's basic sales philosophy at that time was to shoot for the top-quality niche in the TV set industry,

and to charge proportionately for its receivers. This philosophy still constitutes an integral part of the company's sales thinking.

As television made its advances on the American scene, Marx began his carefully-planned distributive buildup. In 1947 the company added some direct dealerships in New York and Philadelphia. In 1948 it added distributors in Boston and Cleveland. New York accounts numbered approximately 25.

By the end of 1948, DuMont opened a midwest sales office in Chicago and then in May added a Chicago distributing outlet. The next month, Marx went to the West Coast and lined up a distributor there, in Los Angeles. That gave the company a total of five distributorships.

Then, as preparations were being made for production from DuMont's newly acquired East Paterson, N. J. assembly plant, Marx and sales manager Walter Stickel laid out a *one-year* plan for semi-limited distribution. Together they set a deadline for the establishment of a national distribution and sales organization for DuMont—July 15, 1950.

On July 6, date of DuMont's first national distributor convention in New York, nine days before the deadline, their goal was reached. The number of DuMont distributors had grown to 37. There was DuMont distribution in every major television area in the country and the company had 2,000 retail outlets.

Now that DuMont's national distribution and sales organization is set, Marx is expanding division activities into the export market.

In the foreign market, he faces the same staggering distribution problems he coped with starting in 1946. In most instances his competition, manufacturers of radios, refrigerators and other appliances, has had a twenty year head start on DuMont in the export field.

(Continued on Page 56)

2 great sales-builders

by **TRAD**

20" console

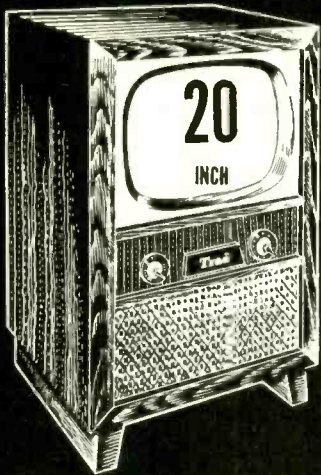

**\$229.95**

LIST PRICE  
(WESTERN  
PRICE SLIGHTLY  
HIGHER)

24" console



**\$349.95**

LIST PRICE  
(WESTERN  
PRICE SLIGHTLY  
HIGHER)

prices include Federal taxes — **LESS FULL DISCOUNTS**

- ★ Standard coil tuner (UHF adaptable)
- ★ Built-in color jack and switch
- ★ 21 tubes, including CRT
- ★ Built-in phono jack and switch
- ★ Co-channel sound
- ★ All mahogany cabinet, decorator finish

*For Private Brand Users  
these units are available under your  
own label and for promotional use.*



*Write, wire or phone — but contact immediately*

**TRAD TELEVISION CORP.**

1001 First Avenue, Asbury Park, New Jersey  
In New Jersey — ASbury Park 2-7447  
In New York — phone WOrth 4-1137



**Trad Builds Better Sets - -  
Better Sets Build Bigger Profits**

# BRACH MUL-TEL COUPLERS GUARANTEED for LIFE!

Over 1/4 million sets in operation . . . without a single equipment failure!

That's a record you can rely on! When you specify a Brach precision-engineered Mul-Tel, you're getting the original TV coupler. The only one that's been field-tested . . . and proved best with over 1/4 million sets. Because the Brach Mul-Tel is built to such rugged specifications, it just will not wear out. That's why every Mul-Tel is guaranteed for life against any mechanical failure!

## CHECK THESE IMPORTANT MUL-TEL FEATURES:

1. No loading effects between connected TV sets.
2. Components have lowest standing-wave ratio.
3. High-pass filter action.

### THE FOUR-SET COUPLER #300-72 OR #72-72

. . . operates four sets from one antenna. Offers new profits as original equipment in new homes, and master antenna installations in apartments, etc. Also ideal for installation in dealer showrooms for demonstrating TV sets. Alert dealers are cashing in on its home builder acceptance . . . plus adding new sales in apartment house master installations. (When used with Brach's low-cost, broad-band amplifier, this unit feeds any number of sets . . . all from one antenna!) — Order 300-72 for 300 ohm downlead; 72-72 for 72 ohm coaxial downlead.

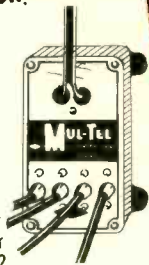

### MATCHING TRANSFORMER #72-300A

. . . is the only one with these two big features: no transfer loss at any TV frequency, plus a high pass filter action which discriminates against diathermy and short wave interference! The perfect transformer for matching 72 ohm downlead to 300 ohm set or 300 ohm downlead to a 72 ohm set.



### THE TWO-SET COUPLER #300-300

. . . operates two sets from one antenna. Stops undesirable trade-ins! Dealers report outstanding success in selling customers on keeping their old sets for the children's room, or basement. The big feature is that with the two-set coupler the customer has no second antenna installation . . . actually improves reception by filter action.



FREE:

Send for these Brach Mul-Tel promotions.

1. "How to sell home TV systems to the Building Industry."
2. Brach 51T promotion catalog on TV antennas and accessories.
3. "How to avoid unprofitable trade-in TV sales."

**BRACH MANUFACTURING  
CORP.**

DIV. OF GENERAL BRONZE CORP.

200 Central Avenue • Newark 4, N. J.



# Decide today

TO SELL

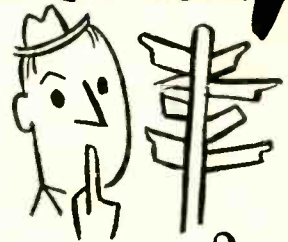

# Philharmonic

For the greatest sales records have been established by PHILHARMONIC in the limited areas able to obtain their line . . . Now—a new and modern plant . . . with increased production . . . makes the PHILHARMONIC line available in additional territories. Now, as before, PHILHARMONIC Television represents exciting low prices—unsurpassed values.

choice  
territories  
open  
for  
franchised  
distributors



In PHILHARMONIC you'll find:—

- Wonderful wide angle picture
- Adaptable to UHF
- Standard turret tuner
- Converter for color
- Built-in antenna
- Black Picture tube
- FM audio circuit
- AFC horizontal hold
- Stabilized vertical hold
- Stabilized brightness control
- Super sensitive — no special arrangements needed for top performance in fringe areas
- 12 channel coverage
- Two knobs—dual controls
- Furniture quality, deluxe cabinetry

Wire or call  
at once!

Get all the amazing facts . . . record breaking sales, immediate delivery, franchised territories.

An Instrument Worthy of the Name

**Philharmonic Radio & Television Corp.**

Main Offices and Plant: New Brunswick, N. J.





# You Can't Miss

with these

# TV PROFIT MAKERS

The perfect Rotator-Booster combination!



**ALLIANCE TENNA-ROTOR** is in a class by itself! No other TV accessory sold to the consumer can equal Tenna-Rotor in volume of sales, public acceptance or in proved performance in the field! More than 600,000 are in use! The new deluxe Model HIR (illustrated above) is fully automatic.

**NATIONAL TELEVISION AND NEWSPAPER ADVERTISING PRE-SELLS!** For more than two years, Tenna-Rotor has been backed by a powerful, continuous TV campaign in every major TV area. Hundreds of thousands of future customers see the eye-compelling Alliance TV spots right in their own homes. That's why Tenna-Rotor and Tenna-Scope offer an unbeatable team of profit makers. Preference for them is already established.

**ALLIANCE TENNA-SCOPE** is a Booster with one simple control. Gives maximum, uniform high gain on all channels — is instantly installed and makes an ideal companion item to Tenna-Rotor. Incidentally, Tenna-Scope, like Tenna-Rotor, is a favorite everywhere!

**ALLIANCE MANUFACTURING COMPANY • Alliance, Ohio**

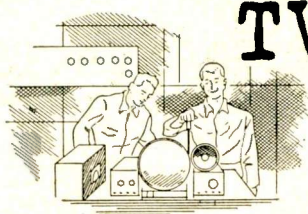

# TV service report

## Self Policing

Milwaukee's proposed municipal ordinance, which sought to impose the most severe licensing restrictions yet on television service dealers and servicemen, was killed last month after the TV dealers of the community gave City Councilmen adequate evidence of their ability to police themselves and their willingness to cooperate with the Better Business Bureau. The fight on the proposed legislation centered about a surge of complaints about television servicing, which resulted primarily from the brief parts shortage existing some time back and which caused a vast amount of misunderstanding on the part of the consumer about the servicing requirements of a television receiver. The activity against the bill was spearheaded by the local NARDA members representing both distributors and dealers and led by Wendal Lewis, general manager of Northern Supply Company and Chairman of the Milwaukee Legislative Chapter of NARDA. Frank Greusel, local Crosley distributor, presented a strong case showing the competence of television dealers to police themselves. Since the start of the year, NARDA (National Appliance and Radio Dealers Association) has been instrumental in the defeat of state licensing measures for television servicemen in Massachusetts, Wisconsin and other areas, basing its opposition to these regulatory measures on the ability of the dealers to police themselves.

## R-TMA Studies TV Service

The importance of television servicing as an integral part of the whole television industry was again demonstrated recently when the Board of Directors of the Radio-Television Manufacturers Association, after a three-day meeting at the Hotel Roosevelt in New York City took steps to solve industry-wide problems arising from TV set servicing. R-TMA President Glen McDaniel was authorized to employ a staff assistant who will devote full time to coordinating activities for improvement of industry practices and policies on TV set servicing. He will work with distributors and dealers on servicing prob-

lems, and will also direct a Service Committee drive to encourage the training of service technicians in vocational and trade schools.

## Big Conversion Market

The more than four million television receivers, two years old or more, in this country, constitute a tremendous potential picture tube replacement and conversion market, according to Bill Scales, general sales manager of DuMont's cathode-ray tube division. "In the period from 1946-1949," says Bill, "2,030,000 sets with 10 inch tubes or smaller, and 2,404,000 larger sets were sold to the public. Each of these set owners represents a potential customer for either picture tube replacement or conversion. It is important that we make replacement and conversion as easy as possible for service personnel. Simplification of picture tube types is a step in the right direction."

## Service Course

An advanced course in television service, including lessons on set conversion, is now being offered by the General Electric Company's Tube Department. Of particular interest are the lessons on set conversion, described as unique by G. A. Bradford, advertising and sales promotion manager for the Tube Department. Radio and TV servicemen can sign up for the course through their distributors; each graduate will receive a sterling silver lapel pin and a thermoplastic plaque embossed with his name. The course stresses application of theoretical material presented in an earlier Tube Dept. course. The first two lessons of the four-lesson course provide illustrated instruction on the recognition and correction of common TV service faults. Descriptions and instructions for use of essential test equipment are also included.

## About Warranties

That perennial fighter for justice in this amazing television industry—Mort Farr, President of the National Appliance and Radio Dealers Association—is again on the firing line, this time with a well-timed blast against the rising practice of forcing retailers to sell non-profit parts of warranties as riders



*"I'll tell you a secret—there was nothing wrong with the set. I was just lonely."*

to their television sales. In a recent wire to James M. Mead, Chairman of the Federal Trade Commission, Mr. Farr stated:

"Since the last FTC meeting on radio-television practice rules, and particularly in the last few weeks, a dangerous industry-wide practice has mushroomed. This is the imposition of so-called 'parts warranties' on the price of television receivers. We feel this is in conflict with public interest because (1) it gives the impression prices are lower than they actually are, and it saddles consumers with an extra charge beyond the advertised price from which they usually derive no real profit, (2) most of these warranties apply only to picture tubes for nine months beyond the standard 90-day warranty that is historically included in the receiver cost, (3) usually picture tubes last well beyond a year, (4) the public is often of the mistaken belief that this warranty gives a measure of protection on service when, actually, it applies only to the picture tube or other parts which the consumer is not qualified to examine for flaws, remove from the set, or replace. From the retailer's viewpoint the practice must be corrected because excluding this cost from the advertised price yet making it compulsory gives a false competitive advantage to certain makes, and frequently all-too-scarce dealer capital is tied up in this intangible rider to low-profit inventories on which no mark-up is allowed by publicized and advertised prices."

*Efficient, profitable TV service is an integral part of every dealer operation. Please send your inquiries to The Editor, Radio & Television Journal, and we will have them answered by outstanding experts in the field.*





**TEAMED**  
for  
**Outstanding Performance**

SEA and AIR  
Official U. S. Navy Photograph

YAGIS AVAILABLE  
PRE-ASSEMBLED  
FOR ALL CHANNELS

**JFD**  
No. 5Y2-No. 5Y6  
JFD 5-Element Low Band YAGI No. 5Y2-No. 5Y6 Series. Custom-cut to exact channel wave length, delivers more powerful forward gain.

For the ultimate in Single Channel television reception there is no finer combination than the



PRE-ASSEMBLED

*Sky Ranger* **YAGI ANTENNA**

COUPLED WITH THE

*Tuck-Away* **TV BOOSTER**

WAFFER - THIN



*Tuck-Away*

TV

**BOOSTER**

Model No.	Channel
V8-2	2
V8-3	3
V8-4	4
V8-5	5
V8-6	6
V8-7	7
V8-8	8
V8-9	9
V8-10	10
V8-11	11
V8-12	12
V8-13	13

JFD MANUFACTURING COMPANY, INC., 6129 16th AVENUE, BROOKLYN 4, N. Y.

ALL MODELS LIST **\$19.95**  
Each

write for literature



**MORE PROFIT OPPORTUNITY**

# THE SYLVANIA

The Greatest  
Selling Feature  
in Television

EXCLUSIVE  
**SYLVANIA**  
**HALOLIGHT\***  
The Frame of Light for  
Greater TV Viewing Comfort

**HALOLIGHT\***

Acclaimed from Coast to Coast!  
The First Application of Scientific  
"Surround Lighting"  
to a Television Screen

**THE MADISON—20"**

Hand-rubbed Mahogany Veneer cabinet. Also available in Blond. The Console that "sells on sight" with HALOLIGHT.

\* Sylvania Trademark



**Makes Picture Look Larger—Seem Clearer**

**ALL THE FEATURES  
YOUR CUSTOMERS  
ASK FOR!**

- Movie-Clear\* Pictures
- Studio-Clear\* Sound
- "Triple-Lock" Gives Rock-Steady Pictures
- Black Tube
- Slanted Picture Window
- Big Cool Long-Life Chassis
- Superior "Fringe Area" Reception



**ALL ALONG THE LINE!**

# GOLDEN JUBILEE LINE

And all these are just a few **SYLVANIA** Exclusives

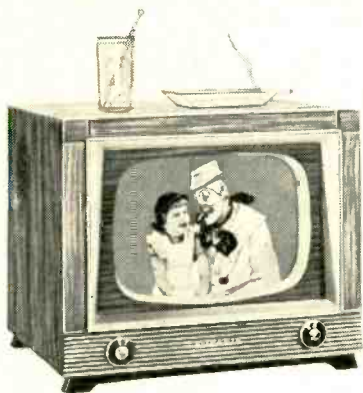

**NEW and NEWS!  
RADIO-CLOCK**

*New, Novel, and NO Competition!*

The only radio-clock combination that is different. Radio-Clock—Automatic Shut-off. They operate independently or together—only one easy-to-use control. Full five-inch speaker, shock-resistant, low speed clock movement. Sturdiest plastic cabinet in 5 Guild colors, also Ebony, Mahogany, Ivory.

**A Golden Jubilee Chassis  
Beautiful Mahogany Grained Cabinet  
High Pressure Laminated Veneer**

**THE GRANT—17".** A sensational, new type of cabinet construction—Liquor-Proof, Burn-Proof, Scratch-Resistant. Cabinet features that clinch a sale in a feature-packed chassis.



**The Ultimate in Design and Cabinetry  
The Exquisite WASHINGTON  
20" Console Combination**

First in Television, Radio and Phonograph Combinations, first in complete home entertainment. Life-size 20" Movie-Clear® TV with HALOLIGHT. AM-FM Radio, 3-Speed Record Player. Hand-rubbed cabinets, selected fine woods.



**NEW and NEWS!  
THE ALL-CHANNEL SYLVANIA  
UHF CONVERTER**

The really simple-to-sell, simple-to-install, simple-to-operate UHF Converter. Can be used with any set of any make, with or without a UHF adapter plug. Receives all channels. No internal changes.

**POWER!  
BIG, COOL  
LONG-LIFE CHASSIS**

Powerful Sylvania high voltage system, "power-projected" pictures of maximum clarity and brightness. "Fringe Area" Chassis illustrated.

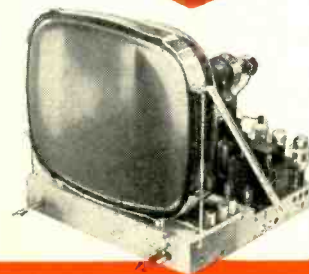
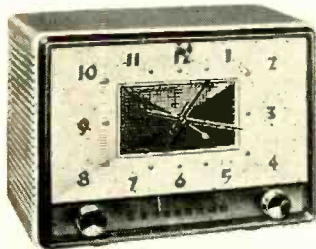

- Wide-Angle Viewing
- Precise Interlace
- Simplified Tuning
- Wide Band Width

# SYLVANIA

Established 1901 — Great Name in Electronics

Television Sets; Radio Tubes; Television Picture Tubes; Electronic Products; Electronic Test Equipment; Fluorescent Lamps, Fixtures, Sign Tubing, Wiring Devices, Light Bulbs; Photolamps; Radios; Sylvania Electric Products Inc., Radio and Television Division, 254 Rano St., Buffalo 7, N. Y.

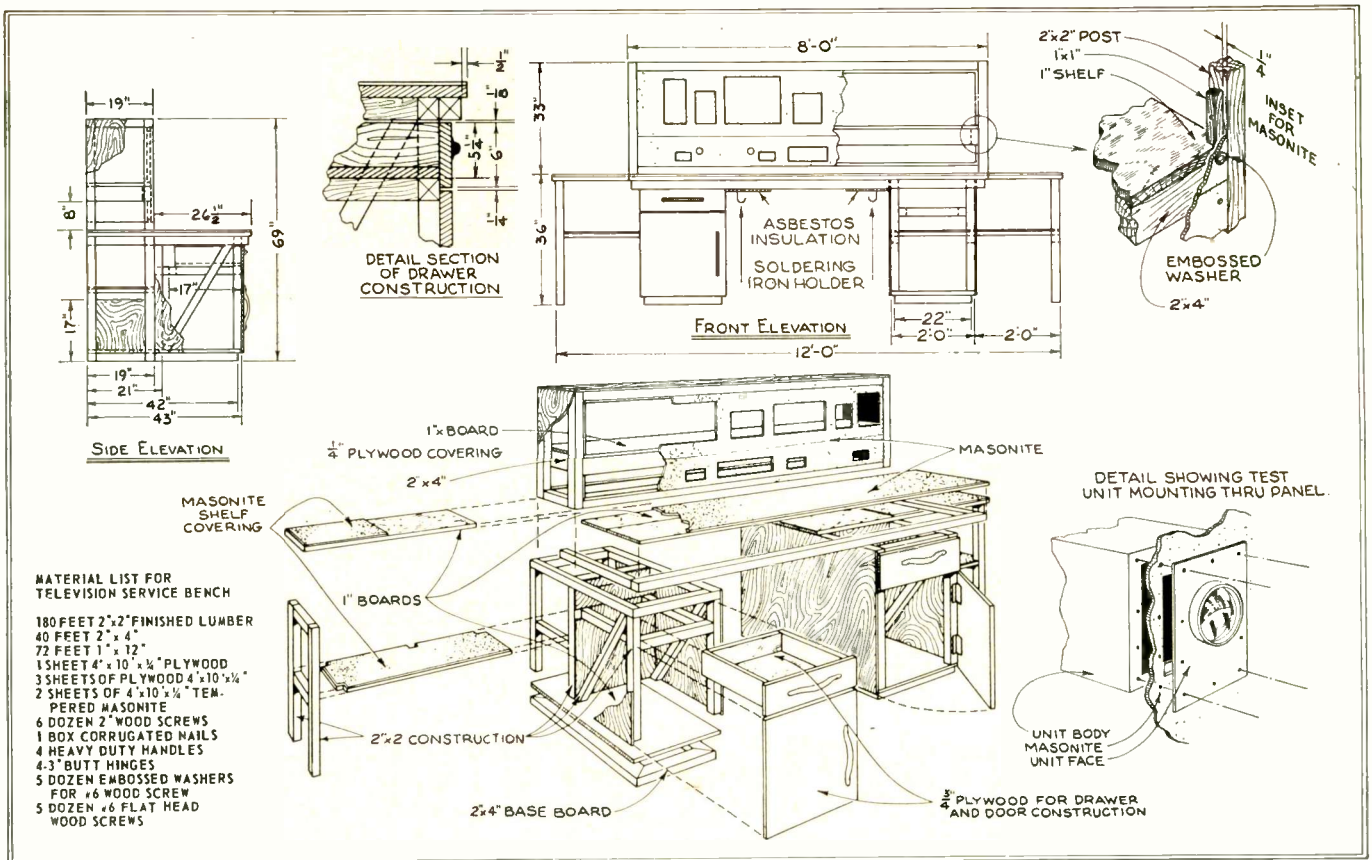

• Detailed drawings of the C.T.I.-designed service bench dissects construction steps.

## How to Build An Efficient, Low-Cost Television Service Bench

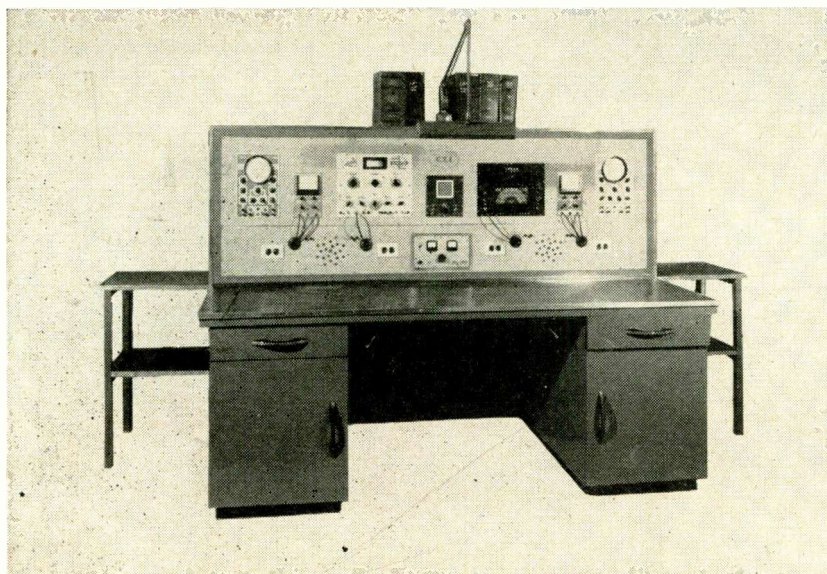

• Compact, economical and efficient, the new TV service bench is designed for two-man operation.

TELEVISION dealers are a little like the amateur mechanic who wants to install a workbench in his cellar but doesn't know how to go about it and wonders how much to spend on it.

There the similarity ends. The amateur mechanic can postpone installing the workbench. But the television dealer is up to his ears in the service business. He must have a service shop, even with a minimum amount of business. The question that plagues each dealer is: How elaborate a shop shall I have, and how do I go about providing for the minimum equipment I need?

The instructors staff of the Commercial Trades Institute of Chicago has come up with an answer to a basic service question which has importance for every television dealer. C.T.I.'s staff designed and engineered a TV  
(Continued on Page 58)

THE PICTURE WITH THE



BILLION DOLLAR BACKGROUND

# Bendix Magic Interlace

## GIVES YOU THE MOST COMPELLING DEMONSTRATION FEATURE in TV

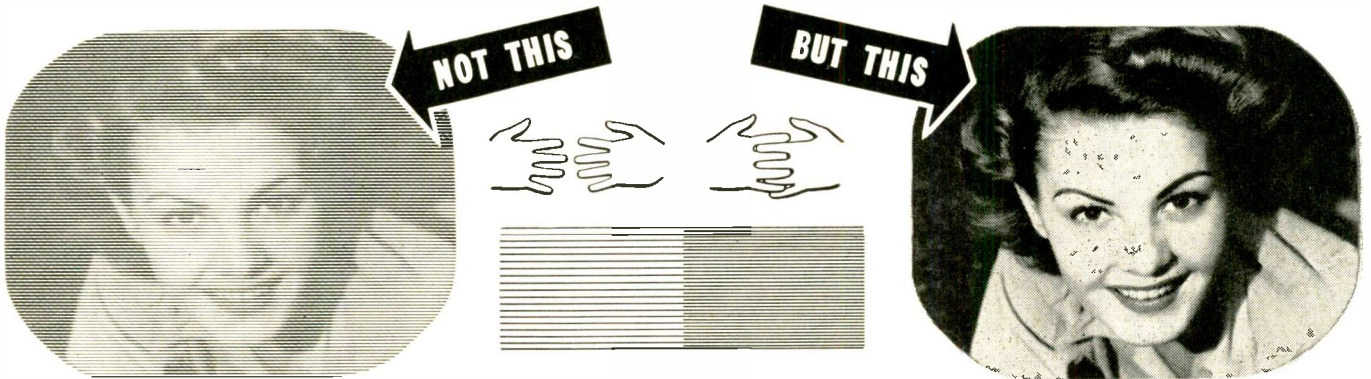

Here's what people see when you turn on a set without Bendix Magic Interlace. The picture is coarse, dull, and incomplete, because the set shows only one of the two series of horizontal lines broadcast from the studio. For a perfect picture, both must be clearly visible.

Look at the sensational difference when you turn on a Bendix Magic Interlace. Magic Interlace makes visible and interlaces both sets of broadcast lines instantly and automatically, and locks them in place. The picture is always clear, solid, complete and easy on eyes—a revolution in realism.

A GREAT LINE . . . A GREAT NAME . . . A GREAT "BUY-NOW" FEATURE

FREE **★** DEMONSTRATION KIT!



It has always worked and it always will—*show people something better and people will buy.* And that is exactly what you do when you show people the amazing difference Bendix Magic Interlace makes . . . how it locks in the extra lines that make a picture live . . . how it produces a new pinnacle of TV realism. All you need to do is demonstrate this great feature—and Bendix demonstration opportunities are easy to get with this merchandising kit that literally compels attention and action. Place your order now for this powerful "buy-now" promotion. It is *free* to every retailer displaying "the picture with the billion dollar background."

Do Business with **Bendix**—IT PAYS!

BENDIX RADIO TELEVISION AND BROADCAST RECEIVER DIVISION • BALTIMORE 4, MARYLAND



# Nobody else but Westinghouse

**Brings NCAA FOOTBALL  
to the TV-Buying Public!**

**40 Top College Teams —  
25 Top Games**

**7 Outstanding Games in each market  
on the NBC-TV Interconnected Network**

Millions of avid football fans are viewing these Westinghouse-sponsored games each Saturday afternoon. Millions of TV prospects are seeing powerful selling-demonstrations of Westinghouse Television superiority.

**Get in on this BIG money-  
making promotion!  
See your Westinghouse  
distributor NOW!**

TV's top dramatic show, WESTINGHOUSE STUDIO ONE, also creates Westinghouse prospects in your market each and every week!

**YOU CAN BE SURE ... IF IT'S**

# Nobody else but Westinghouse

## Gives Dealers These Terrific Sales Advantages:

**ELECTRONIC CLARIFIER.** The sensational new development that produces clear pictures that stay clear! No streaks—no flutter—no flop-over!

**SINGLE DIAL TUNING.** Still the only line offering this advantageous feature.

**SEE COLOR... ENJOY UHF.** When these services are available in your area you can get them on your Westinghouse TV set. A UHF adaptor and color adaptor or converter can be easily attached to connectors at the rear of the chassis.



The **FRENCH PROVINCIAL.** Most beautiful TV cabinet you've ever seen. One of 16 stunning new Westinghouse cabinet designs. Model 655K17.



The **WESTON.** Handsome black plastic table model with 16" picture. Contains every advanced Westinghouse feature, yet has terrific low-price advantage. Model 665T16.



The **LINFIELD.** Full-sized console, mahogany finish, of smart modern design. Clear, sharp 17" picture. Model 664K17.

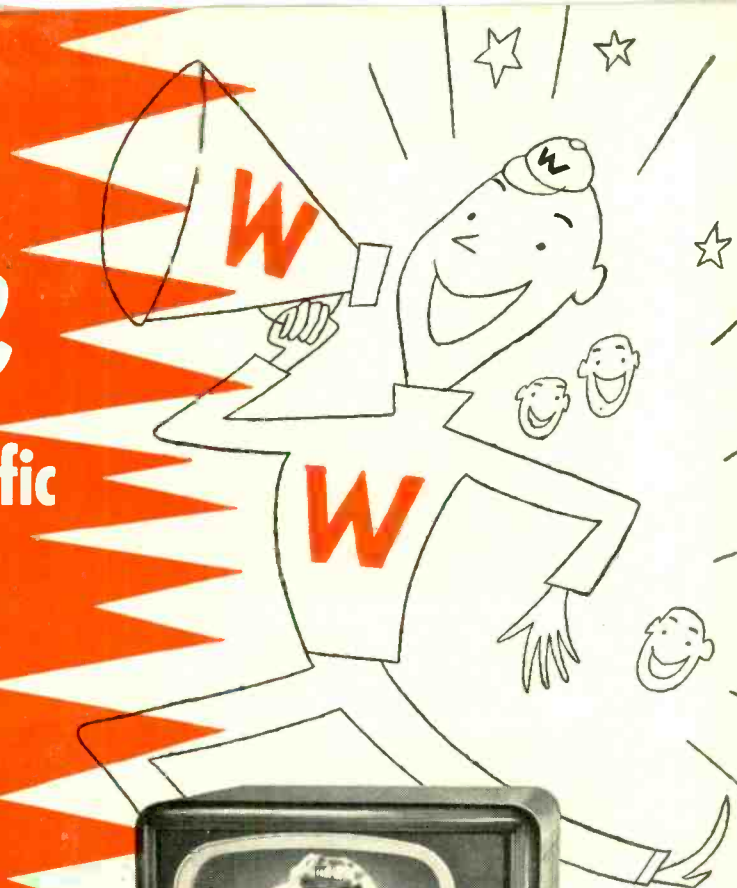

# Westinghouse

WESTINGHOUSE ELECTRIC CORPORATION

TELEVISION-RADIO DIV. • SUNBURY, PA.



• L. to r., E. L. Hadley, adv. and sales promotion mgr., and J. F. Walsh, sales mgr., Westinghouse TV-Radio Division, watch enthusiasm of distributors over firm's new TV sets at recent Los Angeles meeting.

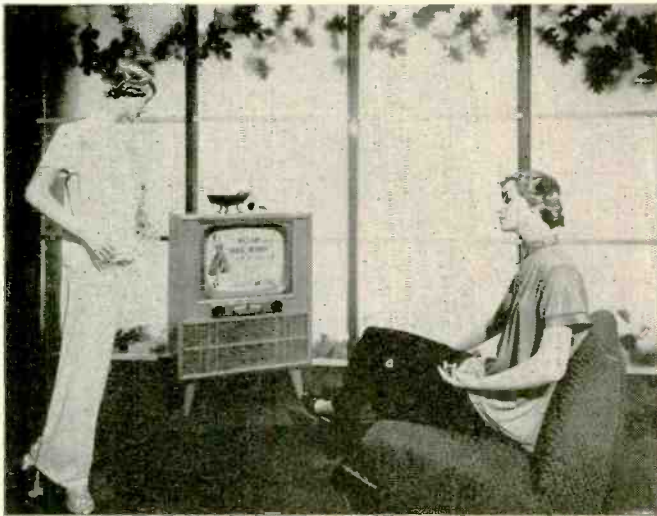

• Television's effect on lingerie styling is vividly demonstrated in this Olympic TV—Mojud product display. Draped mannikins in "homey" setting excite interest both in TV and lounge wear.



• Organizing Intra-Industry TV Committee of NAED are: seated, l. to r., G. Bryant, N. Y., H. Alter, Chic., W. C. Pierce, Jr., R. Rosen, Phila., S. Roskin, Hartford; standing, W. C. Pirie, B. Gross, N. Y., C. G. Pyle, S. F. Louchheim, Phila., and J. J. Campbell.

**RTJ**

*Journal*



• Mrs. R. Van Veen, N. Y., telling the service manager of Emerson-New York, Inc., of the 18 years of listening pleasure since first receiving this Emerson radio as a gift in 1933. Service replaced one tube, first adjustment made, so Mrs. Van Veen could resume rooting for her favorite Giants from the comfort of her home.



• Bruce A. Coffin, left, board chairman, and D. H. Cogan, president, CBS-Columbia, Inc., are on hand to watch the first production model of the CBS-Columbia "Dual" color and black-and-white TV receiver come off the production line at Brooklyn plant.





• Lucky five millionth visitor to RCA Exhibition Hall, N. Y., is eight-year-old Susan Lee Swenk, who received TV console and "45" phono from RCA President Frank M. Folsom.



• Dynamic Stores, N. Y., feature the Brach two-set coupler by promoting "Two Sets for Every Happy Home" through 30 TV spot series. That's Ira Kamen, Brach Mfg., second from left, rear.

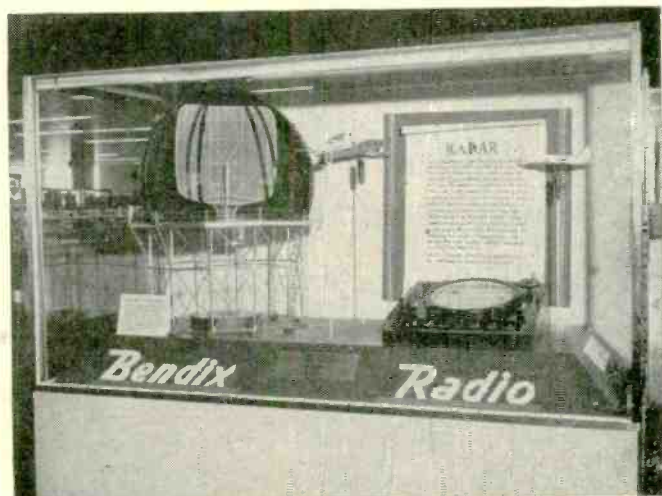

• This Bendix animated display at Baltimore's huge new Friendship International Airport simulates operation of radar.

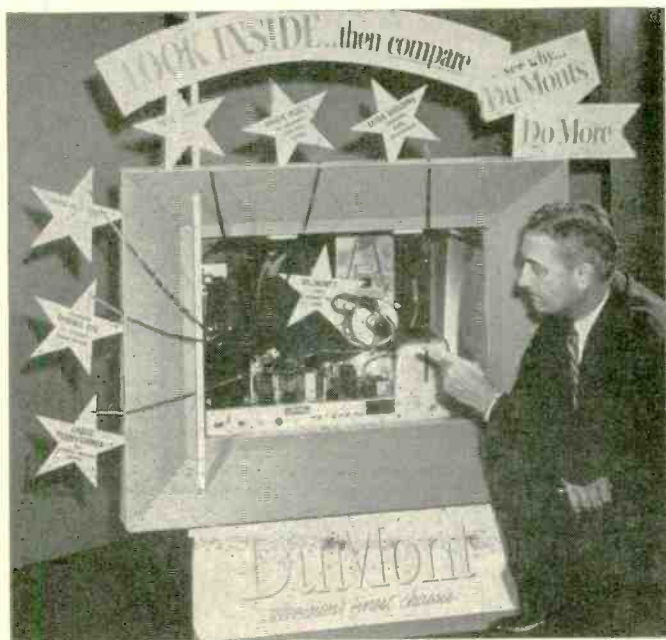

• J. Calvin Affleck, sales promotion manager, DuMont's receiver division, is singling out the features of the new "Look inside... Compare..." promotion kit. Display fits into rear of DuMont 19-inch set.



• Fort Wayne's "Capeharts," inter-hemispheric and national semi-pro baseball champions, are good will ambassadors for the Indiana firm. They are shooting for a 5th semi-pro crown.

## New Equipment for Television Service and Installation

The efficient use of the latest equipment in the installation and servicing of television receivers is one of the major factors in deciding whether the service operation will be profitable. Each month, Radio and Television JOURNAL carries a large volume of advertisements from manufacturers of TV picture tubes, boosters, antennas, rotators, and all types of service accessory equipment which can help you in your business. We suggest that you study these advertisements carefully, cut out those which are of interest to you, and write directly to the manufacturer. The intensive use of our advertising columns is the key to operating in the black.

# The New Precision Engineered OAK BOOSTER!

## for TV-FM by OAK ELECTRONICS \$39.95

The booster that finally satisfies your demands by succeeding where others have failed. The OAK BOOSTER uses Mallory INDUCTUNER (same as used in DuMont, Crosley and Stromberg Carlson TV sets) in a newly engineered circuit on which patent is pending. Provides variable bandwidth to control adjacent channel interference and reduce noise to a minimum. Uses new "Q" multiplier circuit to increase gain enormously.

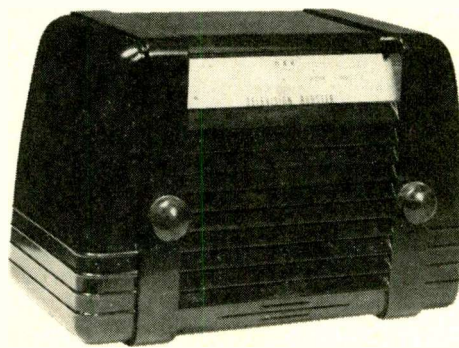

### ↑ THIS KNOB DOES IT:

- Turns on Booster & TV set
- Changes "Q" of circuit from 50 to 300 thru new "Q" multiplier circuit (See May "Electronics")
- Varies bandwidth from 0.5 MC. to 12 MC.
- Allows gain to be controlled from a low value comparable to any other booster, to a high value no other booster can match.

Other boosters use this knob only for On-Off switch, or to switch from low to high channels. OAK REALLY USES THIS KNOB.

- Highest gain of any booster
- Dual Input
- Dual Output
- Gain adjustable from front knob
- Automatic On-Off
- Variable bandwidth controllable from front panel

Only Oak has all the features that count.

FEATURES	BOOSTER CHECK LIST						
	Oak Booster	A	B	C	D	E	F
Automatic On-Off	Yes	No	No	No	No	No	No
Variable Bandwidth	Yes	No	No	No	No	No	Yes
Amplifies Fm	Yes	Yes	Yes	No	No	No	No
75 or 300 Input	Yes	No	No	No	No	No	No
Variable Sensitivity	Yes	No	No	No	No	No	No
Highest Gain 2-6	Yes	No	No	No	No	No	Yes
Highest Gain 7-15	Yes	Yes	Yes	No	No	No	No
75 or 300 Output	Yes	Yes	Yes	No	No	No	No
Widest bandwidth of any booster	Yes	No	No	No	No	No	Yes
Square Wave Type Band Pass Characteristic	Yes	Yes	No	Yes	No	Yes	No

No untuned boosters are rated, as performance is not equal to any tunable boosters.

Write for specifications and discounts  
**OAK ELECTRONICS**  
150 Oak Street, Buffalo, N. Y.

Order Oak Booster from your jobber today

SALES REPRESENTATIVES  
Atlanta, Ga. • Henry Burwell Co.  
Chicago, Ill. • Jarome Kleker Co.  
Cleveland, O. • Edwards & Lohse  
Fort Wayne, Ind. • Walter Bieberich  
Houston, Tex. • H. H. Willison  
Los Angeles • Carl A. Stone Associates  
New York City • Burlingame Associates

### New RCA Arrester

Manufactured by Tube Department,  
RCA Victor Division, Harrison, N. J.

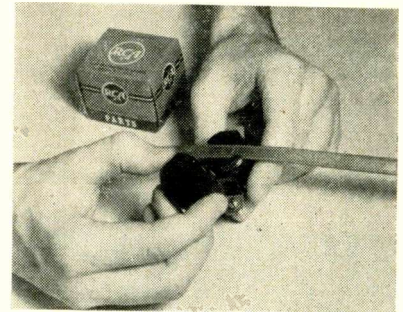

Designed to fit quickly and easily into TV and FM installations, this new lightning arrester can be used for both indoor and outdoor mounting. Fits 300-ohm transmission line with no cutting or splicing. Line goes over open slot in plastic body and plastic cap is screwed down firmly. Four prongs pierce the insulation and contact the wires.

Say you saw it in Radio & Television Journal, October, 1951

### Antenna by Davis

Manufactured by Davis Electronics,  
3047 W. Olympic Blvd., Los Angeles 6, Calif.

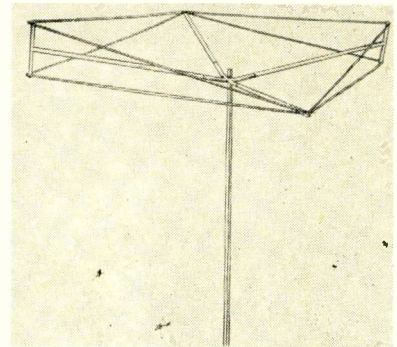

To overcome the problems of fringe and ghost area reception without stacked arrays, this firm has designed this aluminum alloy "Super Rhombic" antenna. Has gain of 12 db; 15-degree tilt, 12 degrees of directivity. Uses space tapered elements. Shipped pre-assembled.

Say you saw it in Radio & Television Journal, October, 1951

Additional new products will be found on pages 26, 27, 44, 48, 51 and 60. For further information, dealers should write direct to manufacturer.



Electron tubes are the nerve ends of military intelligence—in systems set up and maintained by RCA Service Company field engineers.

## *Electron Tube with a military mind*

With the rapid advance of airplanes, tanks, fast ships, and mechanized weapons of war, a swift, sure means of *communication* and *detection* is as important as are the new weapons themselves. It is provided—by electron tubes and electronics.

So important is this area of military intelligence that RCA Service field engineers—here and abroad—have lifted their efforts to new peaks. Working with our Armed Forces, they install and maintain such *communications systems* as short-wave radio and portable radiotelephones.

They work with systems of *detection*, such as radar. They help ships and planes *navigate* with loran and shoran. These engineers are the link between research developments made at RCA Laboratories—and America's military strength.

The number of RCA field engineers has *tripled* since World War II. And they serve where needed, wherever an electron tube's "military mind" can be of military use.

\* \* \*

See the latest wonders of radio, television, and electronics at RCA Exhibition Hall, 36 West 49th Street, N.Y. Admission is free. Radio Corporation of America, RCA Building, Radio City, N.Y. 20, N.Y.

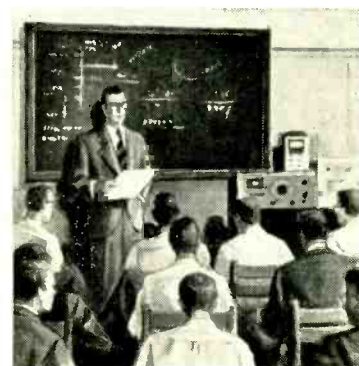

Practical training of military personnel—in classes, factory, and the field—is a basic part of RCA Service Company's work with our Armed Forces.



**RADIO CORPORATION of AMERICA**

*World Leader in Radio — First in Television*

### Giant Lens Projects 15 x 20 Foot TV

Projection of improved 15-by-20-foot television pictures on movie screens is made possible by a new giant image-correcting glass lens developed by American Optical Company and shown here in front of the girl. Spherical mirror at the right, showing girl's face, magnifies TV images and projects them onto the screen. Distortions introduced by the magnification are corrected by the giant lens which will be used in theater television systems like those made by RCA and General Precision Laboratory.



### Kenwood's Mounting Bracket

Mfd. by Kenwood Engineering Co., Kenilworth, N. J.

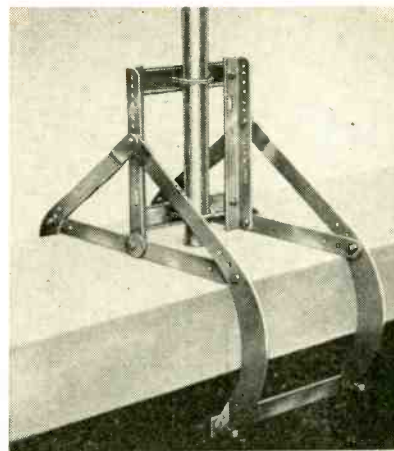

A sturdy frame with four clawlike members to clear a coping and extend to a wall make up this new parapet mounting bracket. It is designed for antenna masts up to 1½ inches in diameter. Claws are of heavy gauge steel. Adjustable cam for any contour adjustment. Can be installed on walls up to 13½ inches in thickness.

Say you saw it in *Radio & Television Journal*, October, 1951

### "Artenna" by Marvel-Lens

Mfd. by Marvel-Lens Industries, Inc., 12 South 12 St., Philadelphia 7, Pa.



Here is an indoor television antenna which is designed also as a piece of functional art in the form of a faun. Hidden inside the faun is modern equipment designed to pull in remote TV stations with on-the-spot clarity. Comes in forest green, chartreuse and ebony.

Say you saw it in *Radio & Television Journal*, October, 1951

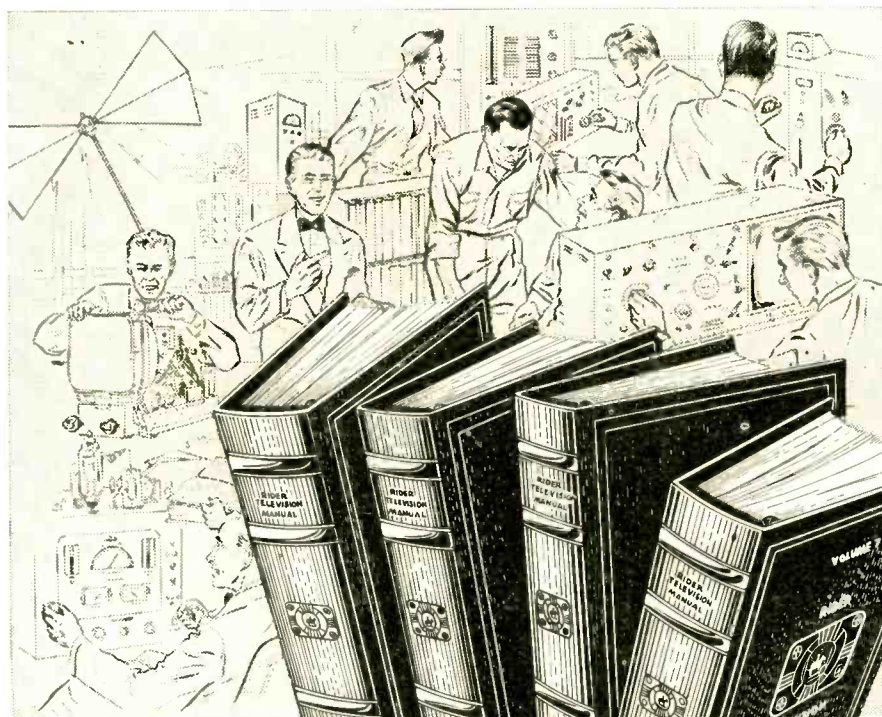

## How To Make More Money

Take less time per call... do a better job. The secret is knowing the complete, accurate, factory-approved answers to every Television and Radio problem. There's only one source for this staggering amount of information... Rider TV Manuals. The only complete television and radio manuals in the world. You'll find that dollar-for-dollar, page-for-page the Rider manual is far less expensive than any other source... and far more valuable for you. Ask your jobber for TV 7... today!



**JOHN F. RIDER Publisher, Inc.**  
480 Canal Street, New York 13, N. Y.

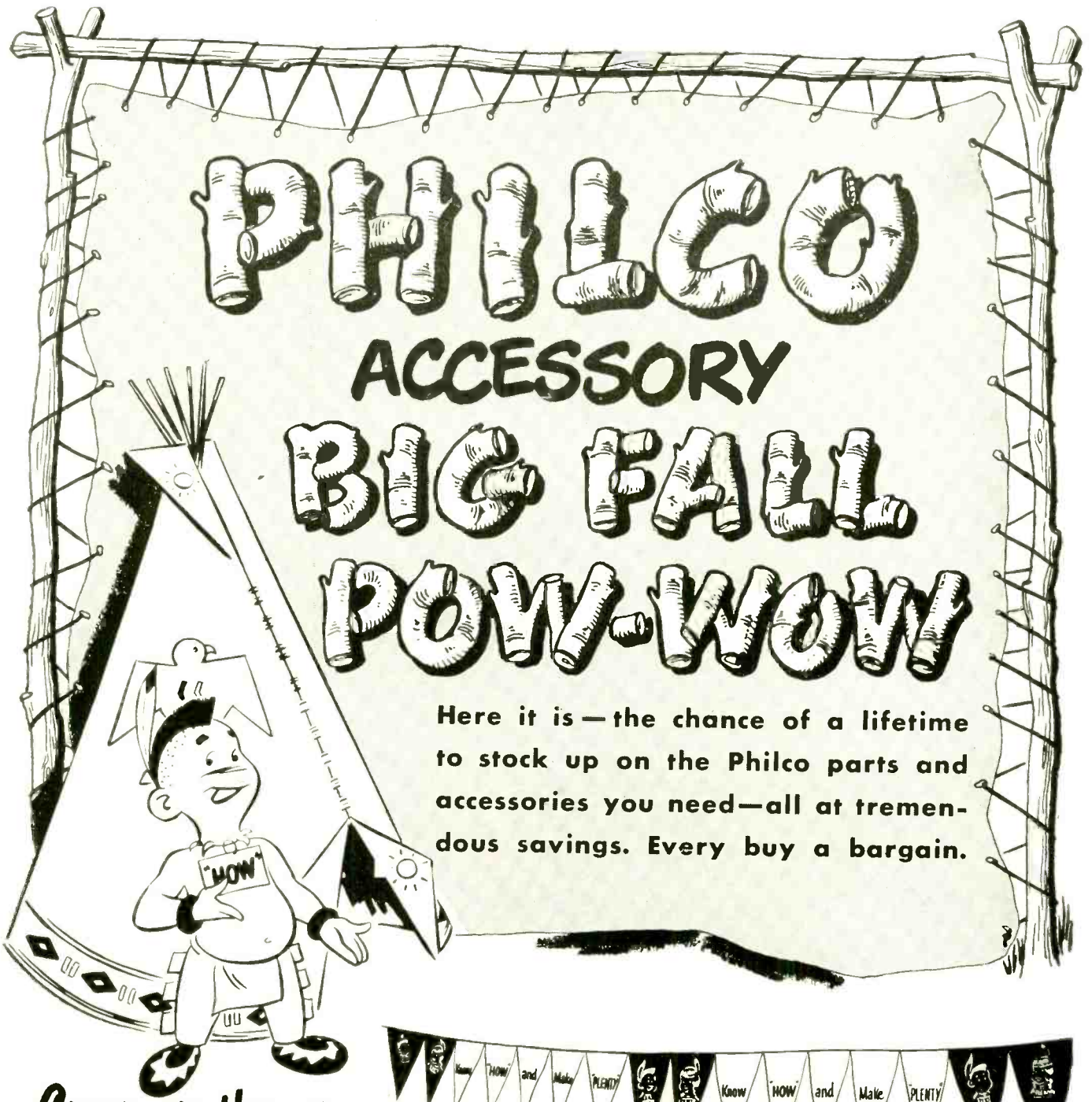

Here it is — the chance of a lifetime to stock up on the Philco parts and accessories you need—all at tremendous savings. Every buy a bargain.

Come on the run to the **BIGGEST BARGAIN SALE IN YEARS!**

Now going on at your **PHILCO DISTRIBUTOR**





At

EVERY YEAR A "BANNER" YEAR IN

← 1949

**PENN TOOK THE LEAD  
with Teletower . . .  
World's Best Seller!**

In 1949, Penn got the jump because of engineering and construction advances offered by Teletower. Among these are universal motor mount easily adaptable to *all* antenna rotors . . . exclusive long-life Telecote finish . . . built-in climbing rungs . . . semi-automatic pilot-hole alignment . . . improved T-X section.

**BUILT-IN BASE. Permits  
Raising Tower on Slope  
After Fastening Base to Roof.**

1950



Big boon to installers . . . Penn's introduction in 1950 of a new type built-in base. Heavy plate takes thrust of tower welded to section of pipe. Tower can be raised on severest slope *after* base is fastened to roof. Installation time is saved . . . hazards reduced. Base is permanently attached and non-removable. Protected by Telecote.

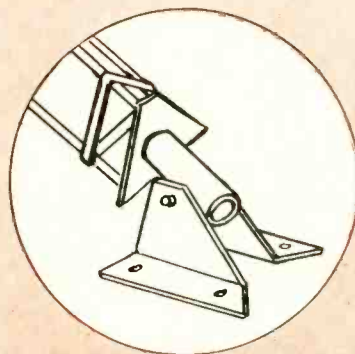

**PENN** Teletowers  
Whiftowers  
enna-Mast

PENN BOILER & BURNER MFG. CORP.  
LANCASTER, PENNA.

"STAY TUNED IN

# *Penn* PRODUCT DEVELOPMENT ENGINEERING



**NEW TOWER. Supports  
250-lb. Head Load  
Without Guying**

**1951** →

A truly revolutionary development in antenna supports... Penn's new tower that maintains 250-lb. head load without requiring a single strand of guy wire. Erection time: 30 minutes! Sensation of the recent RTMA convention at which it was exhibited. Get the facts on this one while it's "hot"... write Teletowers.

**1950**  
↓

**COMPLETE LINE of Tested  
Tenna-Mast Hardware**

In 1950, Penn introduced its popular Tenna-Mast Hardware. Pole-base mount illustrated is made of durable aluminum. Special construction permits mounting on peak of roof so that erection can be made from either ridge or side. Penn various models of Base mounts accommodate pipe or tubing from 1" to 2".



Canadian representative:  
**Atlas Radio Corp., Ltd.**  
560 King St. W.,  
Toronto, Canada.

**WITH TELETOWERS"**

**PENN** Teletowers  
Lift-towers  
Tenna-Mast

**PENN BOILER & BURNER MFG. CORP.**  
LANCASTER, PENNA.

## Antenna Manufacturers Elect Officers

Meeting in Cleveland, during the recent NEDA Show, the Antenna Manufacturers Association elected Harold Harris as President and Ken Brock as Vice President. Mr. Harris is Sales Manager of Channel Master Corporation and Mr. Brock is in charge of advertising and publicity for the Workshop Associates and Ward Products Division of The Gabriel Company. Edward Finkel of J.F.D. Mfg. Co. continues as Treasurer of the Association. New Programs for expanding the Association's activities were outlined at the meeting.

## New GE TV Tube

Mfd. by General Electric Co.,  
Electronics Park, Syracuse, N. Y.

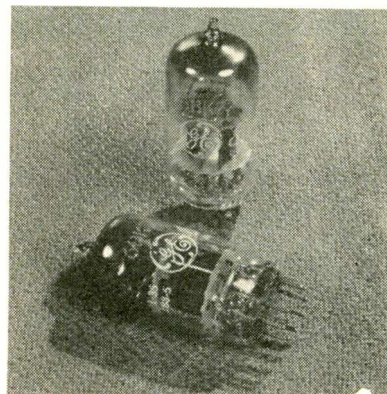

Designed to reduce snow in fringe area reception, the miniature television tube, 6BK7, has a noise factor of only seven decibels as a cascade amplifier at 216 megacycles. Intended primarily for cascade service in VHF reception, the new tube may also be used as a low-noise first-intermediate-frequency amplifier in UHF.

Say you saw it in *Radio & Television Journal*, October, 1951

## Radiart's "Cub" Rotator

Manufactured by Radiart Corp.,  
Cleveland 2, Ohio

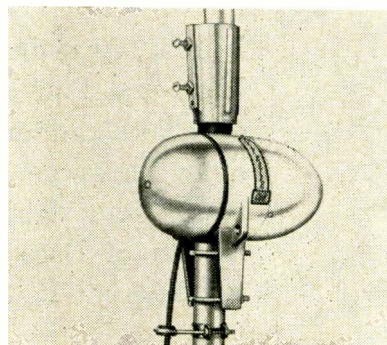

Set up for swift and convenient installation, the Tele Rotor "Cub" rotator features true in-line thrust between antenna and mast. Three-quarter inch steel shaft with in-line, reamed, oilless bearings rotating on a case-hardened steel ball. Same motor as firm's heavy-duty model. Cabinet is mahogany plastic.

Say you saw it in *Radio & Television Journal*, October, 1951

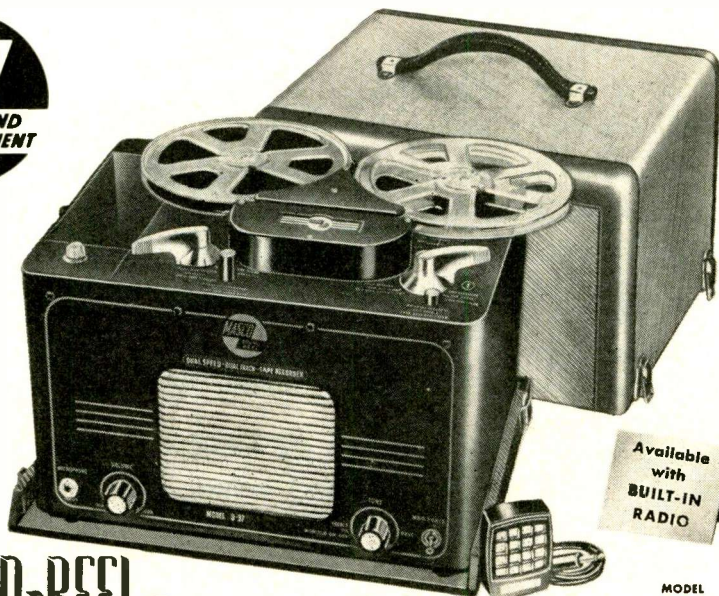

Available  
with  
BUILT-IN  
RADIO

MODEL  
D-37

SOUND-REEL

Dual Speed—Dual Track  
MAGNETIC TAPE RECORDERS

All 5 Points of Superiority Plus

Many More

- Instantaneous push button speed selection, 7.50 in./sec. or 3.75 in./sec., with Automatic Tone-Equalization for each speed
- Full frequency range—professional tone quality
- Up to 2 hours recording and playback time
- Proved Performance, thoroughly field tested and acclaimed everywhere
- Amazingly light weight, yet rugged. Cast zinc & aluminum components

### AVAILABLE IN 6 MODELS

MODEL	DESCRIPTION	LIST PRICE
D-37	(Illustrated) Complete portable recorder with carrying case	\$243.00
D-37R	Complete portable recorder with carrying case, with AM tuner	286.20
DC-37	Complete portable recorder with metal cover and lock	243.00
DC-37R	Same as above but with self-contained AM tuner	286.20
LD-37	Complete recorder less carrying case	221.40
LD-37R	Complete recorder, less carrying case, with AM tuner	264.40

\*Plus Federal Excise Tax  
West of Rockies add 5%

Write for your copy of Tape Recorder Catalog #TR-51

MASCO  
SOUND EQUIPMENT  
Masco Electronic Sales Corp.  
32-28 49th Street, Long Island City 3, N.Y.  
Products of MARK SIMPSON MANUFACTURING CO., INC.

Telephone: RAvenswood 8-5810

### Additional Features

- Capstan driven—negligible wow and flutter.
- Volume level indicator.
- Monitor speaker built-in.
- Record pushbutton prevents accidental tape erasure.
- Inputs... for microphone, for external radio or phonograph.
- Outputs... for earphone monitoring, external speaker or for existing audio system.
- Finish beautiful spruce green hammetone.



**Connection  
for Color**

Provides plug-in jack for attaching an auxiliary Zenith color receiver when available.

**"Fringe-Lock"  
Control Circuit**

Produces and permanently holds finest pictures ever seen in weak or outlying areas.

**Provision  
for UHF**

Permits insertion of tuner strips to receive coming UHF stations without a converter.

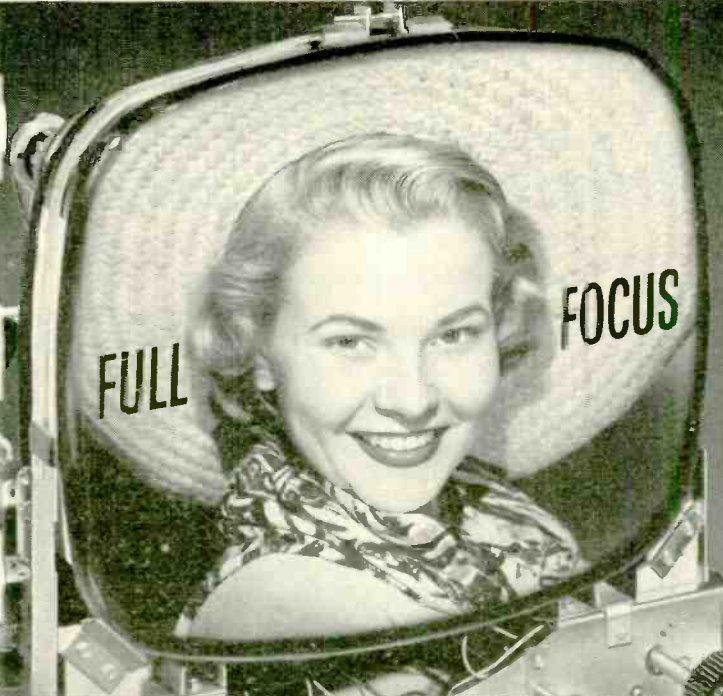

**Blaxide\*  
"Black" Tube**

Brings out rich picture contrast in fully-lighted rooms as eye doctors recommend.

**Automatic One-  
Knob Tuning**

Tunes in perfect-quality pictures and sound with one twist—no knob fiddling.

**Tilted  
Face Plate**

Works with wide angle es-cutcheon to cut down reflections and annoying glare.

*ALL THIS* IN NEW ZENITH "ELECTRONEX" TUBE TV

WITH THE

**WORLD'S FINEST  
"FULL-FOCUS" PICTURE**

At last, the long-time dream of TV science has been realized—perfection in pictures to equal perfection in sound!

Now Zenith's new "Electronex" Tube brings you the "impossible!" A "full-focus" picture—sharp and clear over the entire tube face. A picture that stays in focus even despite the line voltage variations that throw ordinary sets out of focus.

And that's not all! Powered by the amazing new Wonder-Chassis, new Zenith "Electronex" Tube TV is backed by the grandest array of selling features ever offered under one name. Provision for UHF, connection for an auxiliary color receiver, new "Fringe-Lock" Control Circuit, the famous Blaxide\* "Black" Tube—they're all here to make this your biggest, best, most profitable TV selling season ever.

Don't take our word for it... see this great new Zenith line for yourself! Sell features, sell Zenith. Sell new "Electronex" Tube Zenith TV!

**NEW ZENITH RADIO PHONOGRAPHS WITH  
FAMOUS COBRAMATIC\* RECORD PLAYER!**



\*Reg. U.S. Pat. Off.

Television's **BIG NEWS** Line...  
**17 and 20 Inch ZENITH "ELECTRONEX" TUBE TV!**

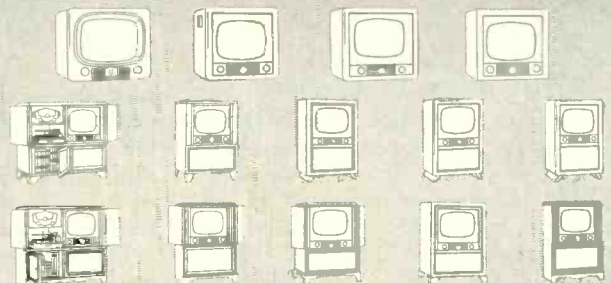

**ZENITH**  
"LONG DISTANCE" RADIO  
and TELEVISION

# Industry NEWS BRIEFS

## Pacific Exhibit Draws 9000

Nearly 9,000 persons registered at the San Francisco civic auditorium recently during the 7th annual Pacific Electronic Exhibit and annual Western IRE convention, according to Alex W. Fry, chairman of the exhibit committee.

One hundred eighty-three exhibitors were represented at the auditorium. Speaking during a business conference, Glen McDaniel, president, Radio-Television Manufacturers Association, reminded his listeners: "In World War II, electronic equipment was considered an aid to the personnel operating planes. But today the airplane is a platform to carry the electronic equipment that does the fighting."

## Trade Veteran Heads Platt Firms

Driving force behind the recently formed Platco Radio, Inc., N. Y. and its affiliate, Platt Electronics Corp., is Murray Platt, a 21-year veteran of the electronics industry. He has worked on procurement, production, government negotiations and other duties during his career.

The Platco firm was formed to manufacture transmitters and receivers for an allied government, and the contract is being completed according to schedule. Platt Electronics distributes government surplus to jobbers and industrials. It also reconditions electronic equipment for use as a complete installation.

## A Milestone For Radio-TV Service

The 25th anniversary of the National Broadcasting Company, being celebrated this year by that radio network, marks a milestone in the growth of the radio and television service industry as well, according to Richard T. Orth, v-p in charge of the RCA Tube Department.

When network radio operation began for NBC on Nov. 15, 1926, Orth points out, there were fewer than five million radio homes in the country. Today, however, there are more than 70 million radio receivers and over 12 million TV receivers in home operation. This growth in distribution has given rise to a tremendous and still growing radio-television service industry.

## NARDA Honored



A. W. Bernsohn, right, managing director, National Appliance & Radio Dealers Association, accepts the American Trade Association Executives' Award of Merit from Wesley Hardenbergh at the association's recent annual meeting. NARDA was honored for its Certified Television Installation and Service Program for its efforts "to protect the buying public and assure it the best installation and maintenance service possible for TV sets . . ."

## Westinghouse Sponsors Fall TV Football

Westinghouse Electric Corp. last month began TV sponsorship of the National Collegiate Athletic Association football games, and is scheduled to continue the TV football coverage of grid struggles through Nov. 24. Admiral Thomas J. Hamilton, chairman of the TV committee of the NCAA, and J. M. McKibbin, vice-president in charge of consumer products for Westinghouse made known the televising plan after months of study by a special NCAA committee representing leading colleges and universities in the nation.

Selected games of some 40 colleges are being covered, either by the interconnected television network, by regional networks or by local stations. Stations in approximately 50 cities carry the contest every Saturday. Teams covering the East, Midwest, South and possibly the Far West may be included on the schedule. In order to provide viewers with top programming, the sponsor has reserved the right to revise the game to be televised, if one of the opposing teams falls below top performance standards.

## Insuline Introduces TV Insulation Kits

A series of eight television antenna installation kits has been introduced by Insuline Corp. of America, Long Island City, N. Y. The simplest kit contains a single conical aerial, a five-foot steel mast, and fifty feet of lead-in wire. The others are progressively more elaborate, the largest containing a stacked conical aerial, ten-foot mast, base mount, guy wire, 100 feet of lead-in, lightning arrestor, clamps and insulators.

## Veri-Best's New Plant Now in Full Production



The Veri-Best Electronics Company's new plant, 655 Main St., Westbury, Long Island, N. Y., is now in full production. Above, the 15,000-square-foot headquarters, which includes the most modern plant facilities, testing laboratory and offices. The site allows room for expansion and for the erection of new buildings. The firm expects to announce other electronics items soon to add to its line of TV antennas.

## FRB Acts to Curb "Dubious" Trade-Ins

The Federal Reserve Board quickly went on record after the recent turbulence over trade-ins, and advised the durable goods dealers operating under Regulation W that only "bona fide" trade-in allowances can be deducted from required down payments for installment-bought items.

Inflated trade-in allowances had mushroomed among radio, television and appliance dealers, following the relaxing of "W." Unloading of top-heavy inventories was the prime reason.

Dealer groups like NARDA speeded up the FRB ruling by promptly registering their objections to the practice. NARDA had urged Congress and the FRB to protect the public and the industry against this abuse of Regulation W.

### Novel Mosley Socket

Manufactured by Mosley Electronics,  
2125 Lackland Rd., Overland, Missouri

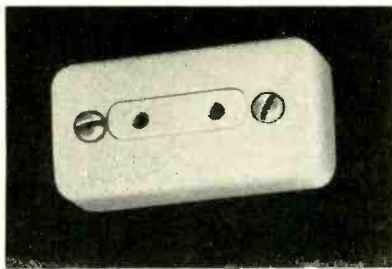

A socket that provides a low-cost connection for standard 300-ohm transmission line. Consists of molded base of clear polystyrene and a cover of molded brown or ivory plastic. Requires 1 3/4 inches by 7/8 inches mounting space and extends 3/8 inches from the surface. Transmission line may enter socket from any direction or pass straight through.

Say you saw it in *Radio & Television Journal*, October, 1951

### Tune-O-Matic TV Booster

Mfd. by Electro-Voice, Inc.,  
Buchanan, Mich.

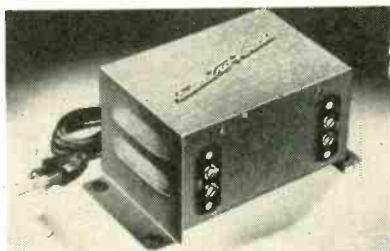

For fringe and intermediate areas, this two-stage, broadband, self-tuning TV booster uses two new type 6BK7 tubes in a low-noise circuit. High usable gain with low internal noise on channels 2-14, automatic turning on or off with TV receiver switch. Finished in baked lacquer copper tone.

Say you saw it in *Radio & Television Journal*, October, 1951

**The Office** of Technical Services, U. S. Department of Commerce, Washington 25, D. C., now has available a number of reports on various phases of television. Of particular interest is the report entitled "PB104414, Training by Television" which explains how the Navy uses TV to train its men.



### Hi-Lo at the PUPPET SHOW

## Sell the Hi-Lo TV Spiral ANTENNA

Model 101\*



... for unsurpassed indoor TV reception!

**\$9.95**  
LIST PRICE

You'll have your customers "on a string", eager to purchase HI-LO . . . the indoor TV Spiral Antenna with top reception. High fidelity plus remarkably sound engineering techniques make HI-LO the fastest selling indoor TV antenna.

Join the alert merchandisers who are now "pulling the strings" for more profits from satisfied customers . . . demonstrate HI-LO.

### ORDER TODAY!

Don't forget . . . the HI-LO OUTDOOR TV SPIRAL ANTENNA!

\*U. S. Patent No. 2,495,579  
Canadian patents 1951

Hi-Lo TV Spiral Antennas are sold through recognized jobbers.



ONLY Hi-Lo provides complete powerful, localized advertising support. Write for full particulars.



## RCA Victor to Enter Air Conditioning Field

Frank M. Folsom, president, Radio Corp. of America, has announced that the RCA Victor Division of RCA will enter the home air-conditioning field, first units to be placed on the market in January, 1952. The air conditioners are to be distributed through the present RCA Victor nationwide organization of independent distributors and retail dealers.

Arrangements have been made for manufacture of the new units by Fedders-Quigan Corp., Buffalo, N. Y., a leading air conditioner manufacturer. A one-third, a one-half, and a three-quarter horsepower unit will be among the first models introduced. These air

conditioners will be of the window type, according to Mr. Folsom, serving to ventilate, dehumidify, and filter out dust, dirt, and pollen. Each will carry a five-year warranty.

"The American public has already demonstrated its acceptance of air-conditioning units for the home, and we look forward to the time when these units will be as commonplace as radios and phonographs," the RCA president said.

Final prices of the units have not yet been set, according to Mr. Folsom, but they will be priced competitively with other air conditioners on the market.

# TUBES

## WILL BE IN SHORT SUPPLY THIS FALL

ORDER YOUR SUPPLIES **NOW** WHILE PRICES ARE STILL LOW

*Check these Features:*

- ALL TUBES INDIVIDUALLY BOXED
- STANDARD R-TMA GUARANTEE
- LOWEST PRICES

**Write, Wire or Phone Today to:**

## NATIONAL TUBE HEADQUARTERS

725 ARCH ST., PHILADELPHIA, PA.

Phone: WALNUT 2-0210

## RMS Reopens Forums

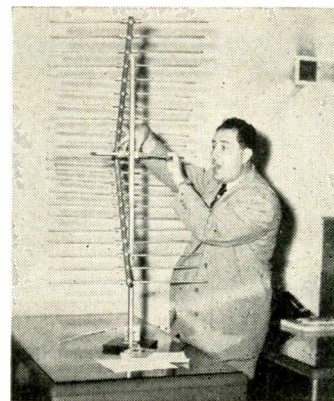

Marty Bettan, sales manager, Radio Merchandise Sales, Inc., N. Y., is shown above introducing the new RMS "Corner Array" antenna with parabolic type gain at an Elmira, N. Y. gathering of TV jobbers and their customers. Technical service forum covered antennas, boosters, open-line transmission wire.

## A Correction

In the September issue of RTJ, the photographs of the two gentlemen pictured below were inadvertently switched. The correct captions appear here.



**B. G. Hickman**

● B. G. Hickman, formerly assistant sales manager, has been named general sales manager of **Sparton Radio - Television**, division of the Sparks-Withington Co., Jackson, Mich. With Sparton since

1941, Hickman had 16 prior years of experience in sales work at the distributor level.

● Raymond K. Burnet has been appointed Cleveland district sales manager for the radio and television division of **Sylvania Electric Products, Inc.** Formerly with Sylvania from 1944 to 1948 in the Radio Tube Division as salesman for original equipment in Chicago, Burnet's territory will include Toledo, Grand Rapids, Akron and Detroit.



**R. K. Burnet**

# LIVING PICTURES

## Make Sentinel LP\* TV Sets



Model 443 CVM1  
The Lauderdale  
21" Screen

*Its  
Eye-Appeal  
is  
Buy-Appeal!*



Model 438 TVM  
The Deerfield  
17" Screen

# *Alive with Sales Appeal!*

### \* LIVING PICTURES—

"We'll take that one!" Those welcome words are cheering *Sentinel* dealers more often today than ever before. Customers eye and buy the new *Sentinel* 1952 LP\*-TV line because the sheer beauty of the cabinetwork and stark reality of Living Pictures are irresistible sales closers.

What's more, *Sentinel* promotions strike a new high in sales-power—more and better advertising and sales promotion help than ever! For a place on the *Sentinel* bandwagon—if you truly want to go places—see your *Sentinel* distributor or contact *Sentinel* direct. Quickly!

# Sentinel

Sentinel Radio Corporation  
Evanston • Illinois

# VEE-D-X

THE WORLD'S MOST POWERFUL  
TV ANTENNAS

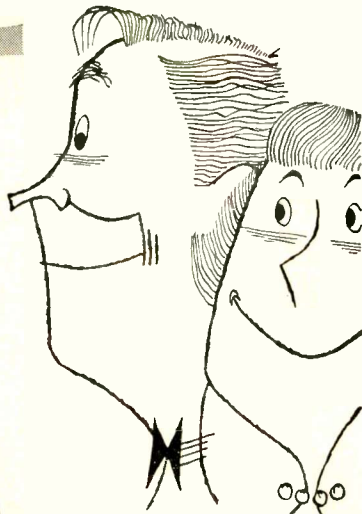

Produce Sharper, Clearer Pictures

## Insure customer satisfaction

The quality of the picture on even the costliest TV set is only as good as the signal received by the antenna. The antenna system you install can be a boon or a bust to you in future dealings with your TV customers. Why take chances on having TV sales backfire? Keep your customers sold on you and they'll keep coming back for additional appliances. Regardless of the TV makes you sell, be sure that you — or your sub-contractor — always install the antenna system that produces the sharpest, clearest picture — genuine VEE-D-X, the world's most powerful antennas.

VEE-D-X antennas are laboratory tested to stand up under all conditions. They are easier and faster to install — strong structurally, and once up, they stay up. Whatever your area, there is a VEE-D-X antenna to insure powerful reception and to keep your customers happy.

Send for the new VEE-D-X catalog containing complete line of VEE-D-X antennas and accessories and valuable technical information.

THE LaPOINTE-PLASCOMOLD CORP.  
Windsor Locks, Conn.

## Three New Inventions Asked for by Sarnoff

In appreciation of Brig. General David Sarnoff's "faith in science, penetrating vision, constructive planning and enduring achievements in the fields of radio, television and electronics," the RCA Princeton laboratories was dedicated the "David Sarnoff Research Center. The dedication occurred at a ceremony commemorating the RCA board chairman's 45th anniversary in the field of radio.

General Sarnoff, in accepting the honor, looked with his scientists into the future, challenging them to make three significant inventions before he reaches his 50th radio anniversary in 1956. The General asked his scientists to invent, 1) an electronic amplifier of light for television, 2) a television picture recorder, and 3) an electronic air-conditioner for the home.

"I realize the challenge to your ingenuity in these three new inventions I am asking for," General Sarnoff said, "but I know that you can solve the problems because you have an enviable record of accomplishment in science."

### The Three Inventions

The specifications for the three inventions were then spelled out by the General. First, an electronic amplifier of light that would provide brighter pictures for television which could be projected in the home or theatre on a screen of any desired size. An amplifier of sound gave radio a "loud-speaker" and an amplifier of light would give television a "big-looker." Sarnoff named it a "Magnalux."

Second, a television picture recorder that would record the video signals of television on an inexpensive tape, just as music and speech are now recorded on a phonograph disk or tape. Such recorded television pictures could be reproduced in the home, or theatre, or elsewhere, at any time. He called it a "Videograph."

Third, an electronic air-conditioner for the home that would operate with tubes, or possibly through the action of electrons in solids, and without moving parts. It should be small, noiseless and inexpensive and should fit into any size room. He named it "Electronair."

General Sarnoff briefly spoke on the project in the RCA laboratories known as "Typhoon." He told of the super-brain, an electronic computer with 4,000 electron tubes, through which guided missile design has been simplified and speeded with mathematical accuracy. The laboratory work made possible has saved the government \$250,000,000, General Sarnoff said.

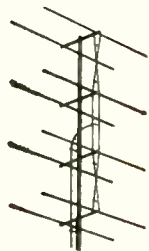

**COLINEAR** — Provides powerful all-channel reception in primary as well as fringe areas where both high and low channel reception is desired. Pre-assembled.

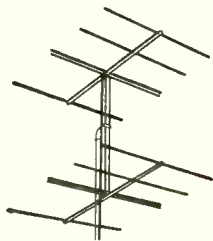

**STACKED ARRAY — FRLY SERIES** — Most rugged pre-assembled heavy duty Yagi. Supplied to match 72 ohm or 300 ohm transmission line.

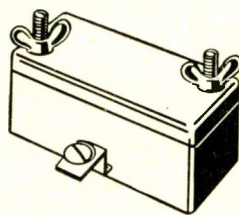

**LIGHTNING ARRESTERS** — Make certain every installation you sell is protected with a lightning arrester. VEE-D-X manufactures four types to meet every requirement for positive protection and fast, easy installation. VEE-D-X arresters are approved by Underwriters Laboratories.

**Go after that EXTRA BUSINESS**  
in fringe areas with

THE WORLD'S MOST POWERFUL COMBINATION for single channel reception

VEE-D-X "JC" YAGI

VEE-D-X OUTBOARD BOOSTER

# Inside Arvin TV

Arvin's new 1952

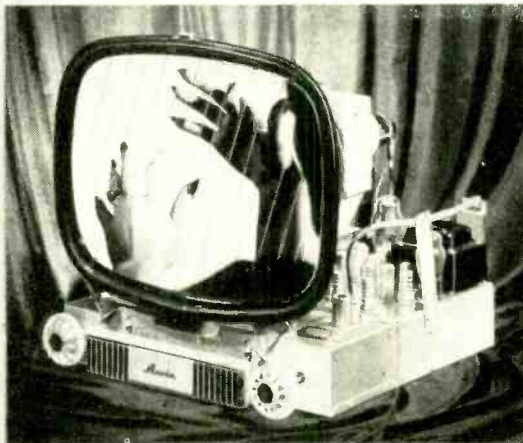

## Dual Power CUSTOM CHASSIS

*Dual Power means EXTRA power—CONTROLLED power!*

*Extra power* from 26 tubes (including rectifiers and picture tube)!

*Extra power* to produce sharp, steady pictures *even beyond* the fringe areas where reception has heretofore been considered impossible—or has been achieved only with a sky-high antenna that costs nearly as much as the set. To appreciate Arvin's *extra power*, check the number of tubes in other TV sets!

*Controlled power*—because special control is necessary with Arvin's enormous power. Uncontrolled, that tremendous power, plus the strong signal from a nearby station, might cause distortion. You wouldn't use a 1,000-watt bulb in a clothes closet.

So Arvin's Local-Distance Switch, on "Local," subdues the power of a nearby signal. On "Distance," it un-

leashes the full strength of the mighty Dual Power Chassis for remote stations. Either way, Arvin's crystal-clear, rock-steady picture simply can't be excelled by any other set, regardless of price.

All Arvin Dual Power Custom sets are available, at moderate extra cost, with UHF tuner built-in—no converter, no strips, no service call needed! It's another Arvin FIRST! And every new Arvin TV can be readily converted to receive color.

When you sell Arvin, you're selling fine TV reception for the distant future—for stations near and far, existing or still unbuilt, VHF or UHF, in black and white or color.

Climb aboard the Arvin Line and go places—with the fastest growing name in television!



Arvin's magnificent new 21" French Provincial in genuine cherry, one of 14 brand-new-for-'52 Arvin Dual Power Custom Sets. Big 17", 20" and 21" screens—table models and consoles—blond, mahogany and cherry finishes—priced at retail from \$249.95 to \$499.95 in Zone 1, including federal tax.

A few protected distributor franchises are still available. Write Ray Spellman, Sales Manager  
ARVIN INDUSTRIES, INC., Columbus, Indiana  
*(Formerly Noblitt-Sparks Industries, Inc.)*

# Arvin TV

*Visible Value*  *You can SELL the difference!*

## Ernest Marx

(Continued from Page 28)

For this assignment, Marx has a record of 15 years experience as European representative of two of the world's largest banking houses to fall back on.

Under his guidance, DuMont's foreign distribution plans are following the same careful, selective pattern which built up its domestic organization. Since October, 1950, Marx has traveled more than 35,000 miles through Europe, and South America, organizing the beginnings of foreign outlets.

It was in December, 1950, that

Marx franchised DuMont's first foreign distributor—Havana, Cuba. Not long after that, following a trip to South America, he franchised outlets in Rio de Janeiro and Sao Paulo, Brazil.

While no distributors have been franchised yet in either Mexico or Europe, both occupy prominent places in Marx' foreign blueprint. To crystallize these plans into actuality, he will shortly leave on another tour, to observe distributor applicants in several foreign countries, and to franchise those best suited to handle the DuMont line.

Marx has set two approaches for DuMont in the export market. The

first is the regular exportation of receivers to those countries having similar standards as those in the United States. The second is the licensing of manufacturers and assemblers in foreign countries.

On his next trip, he expects to cover approximately 25,000 miles, which will give him a total for the year of 60,000 miles, mainly all by air. For a man who hates to fly, that's a lot of air mileage to rack up. But Ernest Marx feels the TV export market is important. Too important for any personal likes or dislikes to interfere with the building of DuMont's foreign distribution system.

# SHERATON SUPER VIDEO DX TELEVISION REACHES OUT FOR WEAK SIGNALS



Yet costs no more  
than ordinary sets

UP TO 200 MILE  
RECEPTION!

**NEW!**  
**CASCADE CIRCUIT  
TUNER**

Latest TV Development  
Minimizes "Snow"  
Expressly Designed for  
Problem Reception Areas  
Adaptable for UHF

The Sheraton Super Video DX TV receiver will bring in better reception up to 200 miles, without the use of boosters. It will work where other sets have failed . . . in fringe areas with an ordinary antenna—in the city with merely an indoor antenna.

The Amazing High Powered Super Video DX 26-Tube Chassis (Incl. 2-Rect.) with 4-Microvolt Sensitivity—TEN TIMES THE SENSITIVITY OF STANDARD SETS.

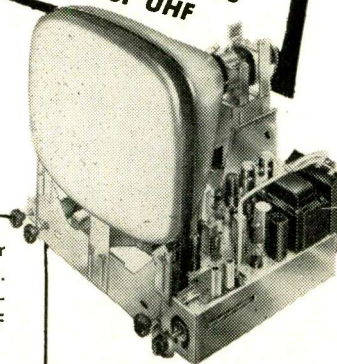

## SHERATON TELEVISION CORP.

Affiliate of Video Products Corp.

Red Bank, N. J.

**DISTRIBUTORS - REPRESENTATIVES Choice Territories Now Available!**  
**CONTACT OUR NEW YORK SALES OFFICE, 2061 B'WAY, N. Y. C.**

## NARDA Appoints Committee Chairmen

Twelve leading retailers of the radio, television and appliance industry were honored recently by appointments to chairmanships of major committees of the National Appliance & Radio Dealers Association, according to Mort Farr, NARDA president.

The committee chairmen include:

H. B. Price Jr., President of Price's, Inc., Norfolk, Va. and NARDA Vice President, has been named Chairman of the Policy Committee.

Julius Kovach, Paramount Good Housekeeping Shop, Kenosha, Wis., Chairman of the NARDA Trade-In Guide Committee.

Joseph Fleischaker, Electric Appliance Store, Louisville, Ky., Chairman of the Awards Committee.

James Lee Pryor, Wilmington, Del., and Herb Names, Herm Names, Inc., Denver, Colo., Co-Chairmen of the Reception Committee.

Richard Galvin, Television Company of Maryland, Baltimore, Chairman of the Publicity Committee.

C. M. Davidson, Davidson & Co., Miami, Chairman of the Resolutions Committee.

F. E. Morrison, Rockford Standard Furniture Co., Rockford, Ill., Chairman of the Entertainment Committee.

Clarence Bode, J. Kornely Hardware Co., Milwaukee, Wis., Chairman of the National Advisory Committee on National, State and Local Unity.

George Hiebing, Davenport, Iowa, Chairman of the National Advisory Committee on Standardization Policies.

Ted Simmons, Hartford, Conn., Chairman of the National Advisory Committee on the Certified Television Installation and Service Program.

E. O. Kuhne, General Radio and Supply Co., Belleville, Ill., NARDA representative to the National Farm Electrification Conference.



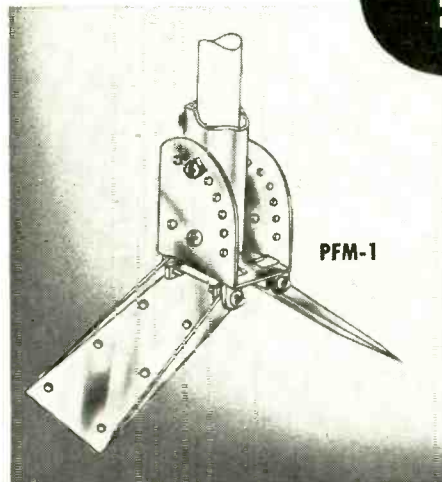
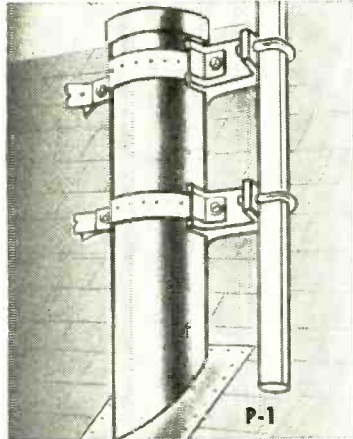
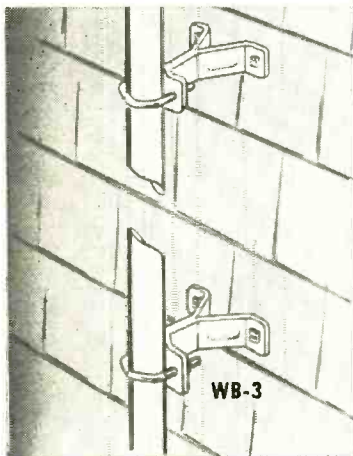
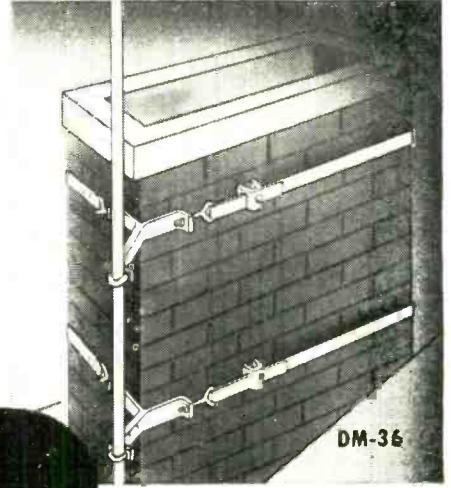
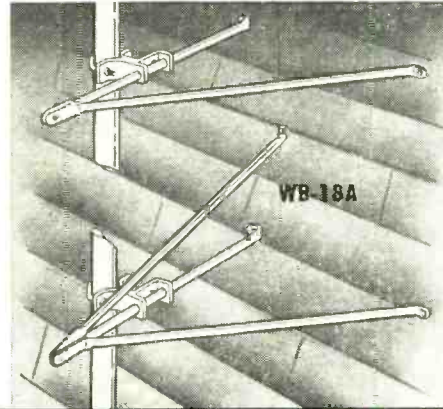
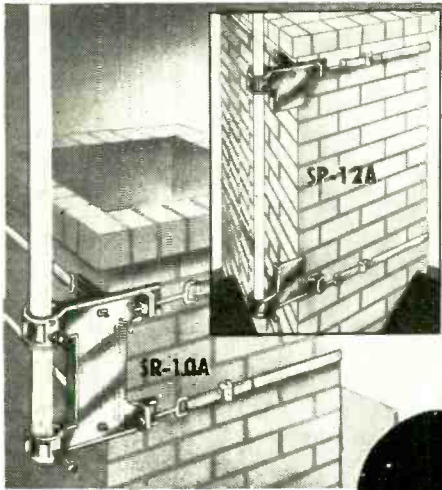

**Only**  
*South River*  
**GIVES YOU SUCH A COMPLETE QUALITY LINE OF Antenna Mounting Accessories**

South River also makes:

- Universal Roof Mounts
- Swivel Flat Roof Mounts
- Chimney Mount Extensions (for extra large crown chimneys)
- Eave Mounts
- Large Mast Adapters
- Screw Eyes
- Mast Stand-offs, Snap-ons
- Guy Clamps—Guy Rings
- Banding
- Electronic Hardware

The following are illustrated:

SR-10A—Chimney Mount Antenna Base*	T-15—Thrift Mount*
SP-12A—Two-Piece Chimney Mount*	DM-36—Duo-Mount Antenna Base*
WB-3—3" Wall Bracket	WB-24—24" Wall Bracket (Also in these sizes: 6"—12"—15"—18")
P-1—Duo Pipe Mount	PFM-1—Peak and Flat Roof Mount
WB-18A—Adjustable Wall Bracket	PFM-2—Peak and Flat Roof Mount
WB3-18A—Combination Adjustable Wall Bracket	

\*U. S. Pat. 2482575

**FREE!** Write for your copy of South River's new catalog, just off the press. Illustrated is the most complete line of the most ingenious and the easiest to install antenna mounts in the industry.

**SOUTH RIVER METAL PRODUCTS CO., Inc.**  
South River, New Jersey

Pioneer manufacturer and outstanding producer of the finest line of antenna mounting accessories in the television industry.

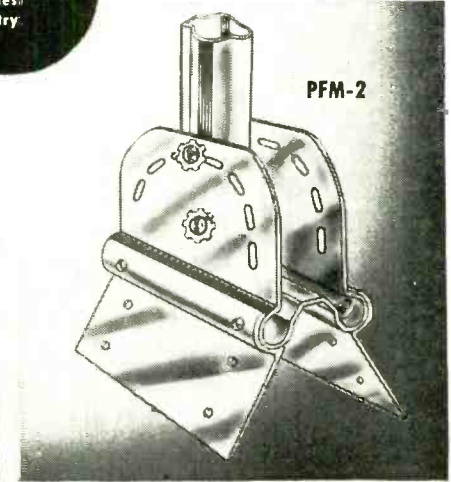
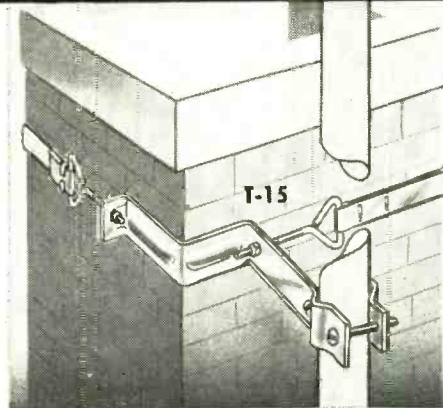
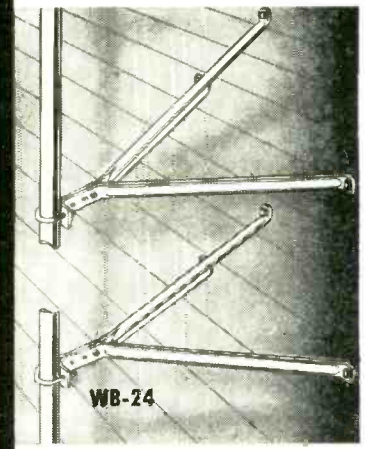
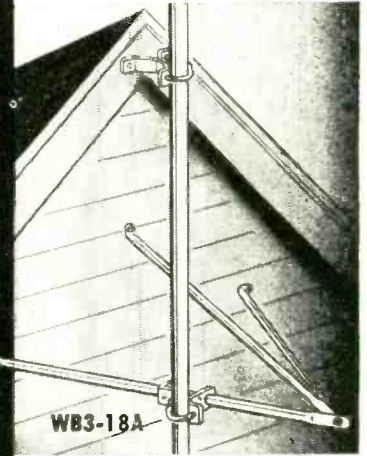

**INLINE\***  
**ANTENNA**

**"AUTO-DIAL"**  
**ROTATOR**

**Perfect  
TV Picture  
COMBINATION**

REISSUE  
PAT. NO. 12,273



Technical men know that Amphenol's patented "Inline" antenna construction means superior electrical characteristics i.e., a single forward lobe to "pick up" the strongest signal — no minor lobes to receive reflected or spurious radiations. When this single lobe is accurately pointed to the desired signal by Amphenol's "Auto-Dial" antenna rotator, technical men know what any layman can see . . . the picture is the best there is!

For the best TV picture on any channel, from any direction, Amphenol's "Inline" antenna and Auto-Dial rotator . . . the unbeatable combination by **AMPHENOL**

**AMERICAN PHENOLIC CORPORATION**  
1830 SOUTH 54th AVENUE CHICAGO 50, ILLINOIS

## Television Service Bench

(Continued from Page 36)

service bench which is practical, efficient and economical.

The compact bench provides for two-man operation, each technician having such basic equipment as the VTVM, signal generator and scope. The model bench shown here is finished in blue and gray, with chrome trim.

Following is the detailed procedure for constructing the C.T.I. Service Bench:

Construction of the Service Bench should begin by building the two stands upon which the entire Service Bench rests. Since both stands are identical, duplication of each part should be made.

The first part of the stand that we shall build will be the base which is of 2"x4" lumber laid flat, and bound together with corrugated nails and 2" wood screws.

A platform of 1" lumber is built next, and mounted flush with the back of the base overhanging the front and sides. The upper framework of the stand is built of finished 2"x2" lumber, whose legs are then screwed to the platform with 2" wood screws.

Considering now that both the left and right stands have been built according to dimensions given, we will now put on the side facings of 1/4" plywood with finishing nails.

Drawers can be made by simply building boxes and adding faces, from 1" boards or 3/4" plywood. The storage compartment door can also be of 3/4" plywood, mounted with 3" butt hinges.

The shelf extension that protrudes from the ends of the Service Bench are to be constructed of 2"x2" lumber, with 1" board shelves covered with tempered Masonite. These shelf extensions can now be interlaced into the stands and secured in place with wood screws.

The table top is also made of 1" boards reinforced with 2"x2" cross-pieces. A 2"x2" trim inset 1/2" from the edges is screwed to the left front and right sides of the table to give additional edge ridgeness. The top is now screwed to the stands with 2" wood screws and 1/4" Masonite is placed on top to give a smooth finished surface.

The instrument rack construction is last, with the frame work built of 2"x2" lumber reinforced with 2"x4", which also provide the shelf rest. The top, side and back can now be covered with 1/4" plywood.

The front panel can be made of 1/4" Masonite or plywood and made in two parts, top and bottom. The division of these panels should lay along the center of the 2"x4" shelf support. The panel when finished can be mounted with wood screws backed up with embossed washers.

The instrument rack is now bolted with machine screws to the stands.

Many receiver cabinets and component parts are damaged because hot irons are placed on top of the bench. This hazard is eliminated by locating the soldering iron in a harness underneath the Service Bench.

The layout of the test panel will be left up to the individual since it will be entirely dependent upon the test equipment available. The cutouts in the test panel for the equipment should be made approximately 3/8" smaller on each side than the maximum widths of the Instrument front panels.

The Service Bench can finally be finished in a color scheme of blue and gray with chrome trim. This combination is highly attractive; however, you may choose colors to harmonize with your interior.

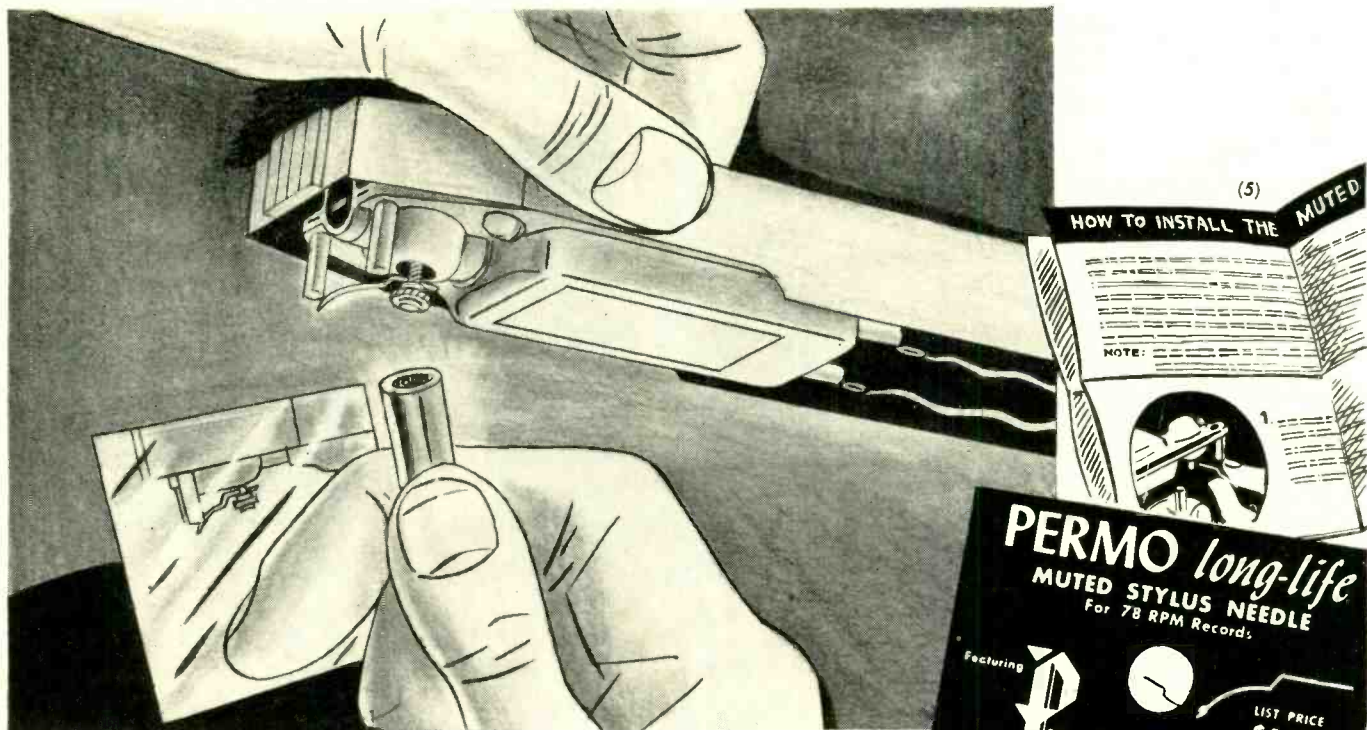

# YOU SAVE TIME — MAKE MONEY — WITH PERMO *long-life* PHONO NEEDLES

Here's why:

**1. COMPLETE "Facts"** — Here is a needle replacement guide that's complete, authentic, *accurate*—one that tells *specifically* what needle goes *where*. It's Permo's "Phonograph and Needle Facts", and Permo took the time to do it right. A guide that gives you *everything* you need to know for fast, easy replacement needle sales.

**2. COMPLETE NEEDLE STOCKS** — Individually packaged Permo Long-Life Phono Needles come to you on convenient display cards. Each display card carries a full set of replacement needles for one manufacturer's sets.

**3. REASONABLE INVESTMENT** — Complete initial needle stocks and "Facts" for all post-war Admiral and Philco sets are yours for less than \$12.00 dealer cost. Make high profits selling the easy-replacement needle line—Permo Long-Life!



**NO FUMBLING!**  
YOU GET EVERYTHING YOU NEED IN ONE PACKAGE

Permo Long-Life Phono Needles are individually packaged with *installation tools* where necessary, *spare parts* (nuts, screws, etc.) and *complete installation instructions*. The C-320 Muted Stylus package (above) for example, contains: (1) needle (2) wrench (3) mirror (4) extra nut (5) installation instructions. You get *everything* you need in one complete package when you buy Permo Long-Life needles.

**NOW AVAILABLE**  
Admiral, Columbia and Philco "Facts" and Replacement Needles. Others coming soon! Write for your free copies of the "FACTS".



**PERMO, INC.** *Champion of Perfection*

6401-33 N. RAVENSWOOD AVE.

CHICAGO 26, ILLINOIS

### New TV by Philco

Manufactured by Philco Corp.,  
Tioga & C Sts., Philadelphia, Pa.

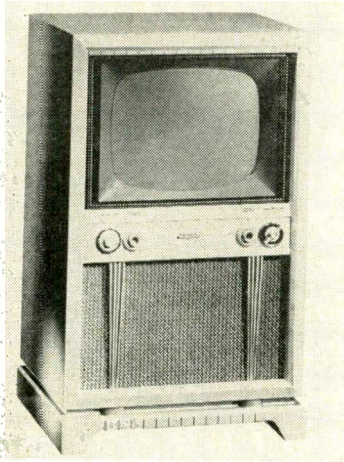

Featuring this firm's balanced beam, which balances the electron beam to produce a uniform focus over the entire screen, this 17-inch television console also has a gray filter face for better contrast. Has new duplex chassis and Colorado tuner; 10-inch round speaker; automatic volume control with bass compensation. Cabinet in blond oak and comb grain white oak veneers.

Say you saw it in *Radio & Television Journal*, October, 1951

### New Westinghouse TV

Mfd. by Westinghouse Electric Corp.,  
Home Radio Division, Sunbury, Pa.



Companion piece to the "Wadsworth," the "Wellington" features a 20-inch rectangular black glass picture tube. Single dial tuning for simultaneous picture and sound tuning. Equipped with electronic clarifier, combination engineering circuit feature for clear and steady picture. Cabinet is in mahogany with full-length doors.

Say you saw it in *Radio & Television Journal*, October, 1951

### New Emerson Radio

Mfd. by Emerson Radio & Phono. Corp.,  
111 Eighth Ave., New York 11, N. Y.



A three-speed automatic phono-radio equipped to play all speed records automatically. Radio has "Super-loop" antenna, Alnico 5 PM dynamic speaker, beam power extra output, tone control, and automatic volume control. Phonograph has self-starting constant-speed motor. Cabinet is of pin-stripe mahogany veneers.

Say you saw it in *Radio & Television Journal*, October, 1951

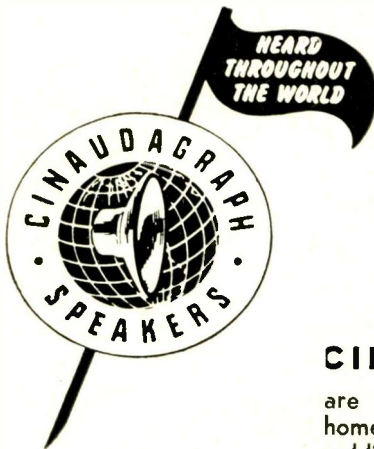

A few choice territories  
are available for  
representation



### CINAUDAGRAPH SPEAKERS

are heard throughout the world in the finest home and auto radios, television receivers and public address and intercommunication systems. Outstanding tone quality over a wide frequency range have earned for them an enviable reputation for excellence in reproduction.

### CINAUDAGRAPH SPEAKERS

are offered in sizes from 2 inches to 15 inches... with PM or Field Coils... and in round, oval, pin-cushion and Cinaxial design. Individually boxed in attractive two-color cartons, they are sold by all authorized distributors. Ask for Catalog 551.

### Interchangeable Radio



A radio cabinet, the style of which could be changed without extensive tooling, is no longer a thing of the future. The General Electric Company's Chemical Division has come up with a radio housing design that has as its basic module a simple rectangular case, with smoothly contoured edges for ease of molding, and which can, with a change of dial knobs, speaker panel, or other extraneous parts, assume the appearance of several diverse styles.

*Cinaudagraph*  *Speakers*  
7334 North Clark Street Chicago 26, Illinois

**FOR AN EVER-WIDENING MARKET**  
**The Incomparable**

**Capehart**

**LEADS THE FIELD FOR**  
**PRESTIGE AND PROFITS!**

Top names invariably reflect top prestige. That's one big reason so many dealers value the Capehart franchise above all. Capehart quality helps them attract the kind of customers that mean more profitable selling. Capehart alone offers the CX-33 chassis that provides the famed Crystal-Clear picture. The Capehart Symphonic-Tone system adds new dimension to television performance. And Capehart's mastercrafted cabinetry appeals to the discriminating of all income brackets. These are just a few of the reasons Capehart is the banner line of so many leading dealers. A few choice dealerships are still available. See your local distributor or write E. Patrick Toal, Director of Sales, Fort Wayne.

**TUNE IN:** Capehart-Farnsworth Corp. presents "VanDeventer in the news," every Sunday over the Mutual network at 1 p.m., E.S.T.

★  
★  
★

**WHEN IN CHICAGO . . .** be sure to visit the Capehart Salon, Room 1118, at the Merchandise Mart.



**The best looking CLOCK-RADIO on the market**

The Capehart Clock-Radio is not only an accurate timepiece, it serves as a tireless servant . . . reminds of appointments, turns on appliances. Really beautifully styled in a choice of colors. A sure sales winner! **\$4995**



**The CAPEHART table model RADIO** Handsomely designed in dark green plastic . . . unbelievably beautiful tone. It's set to make a big splash in the table-radio market . . . boost profits for you! **\$3295**



**The CAPEHART "Shenandoah"** Huge 20-inch tube for Crystal-Clear picture. Modern cabinet in mahogany veneers. Symphonic-Tone. True Capehart value for only **\$38995**

Priced for Zone 1. \*Includes Federal Excise Tax. Warranty and installation extra.



**CAPEHART-FARNSWORTH CORPORATION, Fort Wayne 1, Indiana**  
 An Associate of International Telephone and Telegraph Corporation

# It's the TV Installation Which Nails Down the Sale

(Continued from Page 16)

with end of the year bonuses. There are no commissions.

Service for the modern progressive dealer has become a prominent selling force, and Goodman's is no exception. A group of highly-trained experts direct as well as maintain the large service department. Completion of courses at designated radio and television schools is a pre-requisite for association with Goodman's service department. In addition, certain factory training by manufacturers, such as that offered at the DuMont plant, is a must for service personnel. Full guarantees back up the work performed by Goodman's efficient service staff. To speed the installation and service work, the firm's TV service department maintains a fleet of trucks to provide prompt attention to all service requests and call-backs.

## Behind the Scenes

Not only does Goodman's have an elaborate service department, but it does not hide this strong right arm of its business under a bushel. Leon Goodman points this out by explaining, "One of the best-drawing window displays we ever had was a TV service

window. Large blow-ups pictured the trucks, workbenches in the shop, the personnel, and the chassis of a TV set. These were placed on turntables so that the viewing public could see the complexity of construction of a TV receiver, and could make their appraisal of the value of a capable servicing agency with relation to the purchase of a TV set."

Taking the customer behind the scenes in this way, does not stop with the business end of television and television service. Goodman's also opens its doors on various pleasurable occasions. The year round it stages large and small promotions in which the firm's customers share. Top among such occasions is TV Day, held annually at the Jersey City store. Newspapers carry the news of the great events and direct mail circulations further spread the word. Everyone is welcome and refreshments are served to those who attend. There is a gala television show. Guests are taken on a grand tour of the store and are shown the elaborateness of the efficient service department. Capping the day, there is a grand drawing for prizes.

## First and Always

No promotional program is complete without consistent supporting advertising in the various advertising media. Goodman's believes firmly in getting its message home to its potential customers. Evidence of the roots which the advertising program has is the firm's use of radio spot announcements. Not only are radio spots used in English. They are also used in foreign languages to cut through any lingual barriers of the cross-section Jersey City populace.

Radio-phonograph and television sets in theater lobbies; combinations loaned to church groups when high church officials are broadcasting; TV sets in the hospital sick rooms of customers and leading citizens—these are some of the other ways in which Goodman's sees to it that they are constantly carrying their TV selling message to the public. No single opportunity is missed whereby they can keep television in the limelight of their selling program.

First, last and always, it's television to the fore at Goodman's in Jersey City.

## A SHORT, SHORT STORY. . . .

### "HOW TO MAKE MONEY AND INFLUENCE SALES"

BY TRANS-VUE - JACKSON

1. You buy at "direct from factory" prices!
2. You eliminate middleman's profits . . . they're yours!
3. You sell for less than other brands!
4. You have greater mark-up than on any other line!
5. You buy the finest engineering possible!
6. You sell the smartest furniture!



You buy and sell the finest television obtainable—at prices that are incomparable—anywhere—by anybody.



YOU MAKE MONEY WITH TRANS-VUE-JACKSON!

Give us the opportunity to prove this short, short story. Write, wire or phone. A Trans-Vue-Jackson salesman will show you "How to Make Money and Influence Sales."

**TRANS VUE - JACKSON**

58 E. CULLERTON ST., CHICAGO

Manufacturers of Customized Television

Mr. Nate Boolhack, September 18, 1951  
Kolbe Publications,  
1270 Sixth Ave., New York City, N. Y.

Dear Nat:

The new September issue of Radio and Television Journal has just arrived.

Reading through has impressed me greatly. The material is excellent and the layout, format, and production superb.

You can feel proud of the outstanding results you and your staff are producing.

Sincerely yours,  
George Fried President

GF/RGB  
AUTHORIZED MFRS. SERVICE CO.  
718 Atlantic Ave., Brooklyn 17, N. Y.

## ON THE BEAM



STATIONARY WALL MOUNT  
Model WM-12 with 12" extension  
Model WM-15 with 15" extension  
Model WM-18 with 18" extension  
Model WM-24 with 24" extension

Sturdiest wall mount in the field. "ALCOTE" finish, constructed of heavy gauge steel tubing, assembled with GIANT SOLID RIVETS which will NOT SNAP! . . . Write for FREE catalog and name of nearest distributor.

**Haygren** ELECTRONIC  
MANUFACTURING, Inc.  
436 18th St., Brooklyn, New York

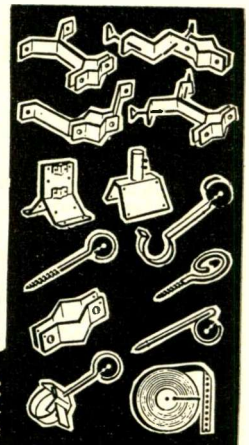



*Demonstration  
Magic!*

... that's the enthusiastic comment of a veteran salesman in a leading midwest music store.

MODEL 2A10

**WILCOX-GAY**

**PUSH-BUTTON  
2-Speed TAPE RECORDER**

***The new push-button feature is an eye-opener . . . a SALES CLINCHER!***

**FOUR-MINUTE DEMONSTRATION TELLS THE "2A10" STORY!**

The Wilcox-Gay "2A10" is demonstration magic. Recording enthusiasts have never known such ease-of-operation. Push-buttons instantly make all adjustments from recording to playback — automatically. The new "2A10" is tops in tape recorders — smart appearance, smooth operation, power, fidelity and tone quality. And this remarkable instrument weighs less than twenty pounds! Sell the exciting new Wilcox-Gay "2A10" — the tape recorder that operates with push-buttons.

**IT'S WHAT THE SALESMAN ORDERED . . . DRAMATIC TO DEMONSTRATE . . . LOW PRICED . . . QUICK-OVER-THE-COUNTER SALE.**

You can't beat the amazing Wilcox-Gay for store traffic, fast turn-over and plus profits.

**SELECT TWO OUT OF THREE DIFFERENT SPEEDS**

**Wilcox-Gay 2A10**

. . . in handsome maroon and grey leatherette carrying case.  
3¾ speed channel for hour of recording on five-inch reel of tape.  
7½ speed channel for the finest high-fidelity recording.

**Wilcox-Gay 2A11**

. . . in smart green and grey leatherette carrying case.  
3¾ speed channel.  
1⅞ speed channel for two hours of recording on five-inch reel of tape.

**ONLY  
\$149.95**  
(Slightly higher  
west of the  
Rockies!)

***Wilcox-Gay "2A10" will appear in powerful two-color ads in national magazines this fall.  
The schedule includes PARADE MAGAZINE and ESQUIRE***

**WILCOX - GAY CORPORATION**

**SALES OFFICES: 385 FOURTH AVENUE, NEW YORK 16, N. Y. FACTORY AND SERVICE: CHARLOTTE, MICHIGAN**

## NEWS AND NOTES OF MANUFACTURERS AND DISTRIBUTORS

● Dick Mattison, president, **Mattison Radio & Television Corp.**, 893 Broadway, N. Y., has made the following representative appointments: Leonard D. Allen, 2401 So. State St., Syracuse, for upper New York; Charles W. Lierau, 10203 McKenney Ave., Silver Springs for Maryland and Virginia; Wyatt & Marshall, Crossville, Tennessee; J. Earl Smith, 505 No. Ervay St., Dallas, for Texas, Oklahoma, Arkansas and Louisiana, and Wallace & Wallace, 1206 Maple Ave., Los Angeles, for 11 western states.

● **Emerson Radio & Phonograph Corp.**, N. Y. and subsidiaries report a consolidated net profit, before provision for Federal income and excess profits taxes, for the 39 week period ended Aug. 4, 1951, of \$5,762,716. This compares with a consolidated net profit, before taxes, of \$6,040,120 for the like period ended Aug. 5, 1950. After provision for taxes, the net profit equalled \$1.57 per share on 1,935,187 shares outstanding.

● A new distributor-sales representative for **Bendix Television and Radio** in Milwaukee has materialized from the association of F. B. Riley, former Bendix TV district manager, and Gordon Wisniewski, president, R. & W. Sales & Service, Milwaukee. Headquarters for the new distributor are at 2131 S. Kinnickinnic Ave., covering the eastern two-thirds of Wisconsin and the upper peninsula of Michigan.

● Leslie M. DeVoe, Indianapolis, Ind., has added Cecil Webb to his organization as associate. Webb and DeVoe will provide extended representation coverage for Oxford speakers. Mr. DeVoe has been serving as sales representative for **Oxford Electric Corp.** in Indiana and Kentucky.

● Paul W. Nief, general sales manager, **Jewel Radio Corp.**, N. Y., announced the appointment of Murray D. Williams, Decatur, Ga., as representative in Alabama, Georgia, Florida and Mississippi, and of Charles E. Pheasant, Indianapolis, as representative in the state of Indiana.

● The **Ward Products Co.**, Cleveland, Ohio, has announced the appointment of Anderson Sales Co., 172 State St., Boston, their New England representative. Anderson Sales will carry the complete Ward line of auto and TV antennas.

● **Radion Corp.** has opened a new factory and general office at 1130 West Wisconsin Ave., Chicago 14, Ill. Radion specializes in the manufacture of indoor television antennas.

● TV-"Q" Custombilt Corp., Paterson, N. J., last month began distribution of its Mirrorized tube with a reflection-free screen. The tubes are made in 12-, 16- and 17-inch sizes.

### 30 Years in Radio



Samuel J. Spector, pictured here, has achieved something of a longevity record in the radio industry, having just celebrated the 30th year of his company, Insuline Corporation of America, which was first organized in 1921 and whose first "factory" was a tiny upstairs loft in lower New York. One of the most widely-traveled men in the radio trade, Spector is widely and affectionately regarded throughout the industry for his activity and willingness to give of his time and effort in furthering industry organization welfare.

### The Largest Selling LIGHTNING ARRESTER At Any Price!

NO. AT102



APPROVED

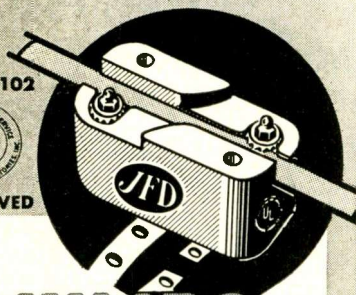

## JUMBO

Protects Home and TV  
Set Against Lightning  
Hazards

\$225  
LIST

U.S. Patent No. D-4664

- Installs anywhere
- No wire stripping, cutting or splicing

(Complete with strap and ground wire.)

OVER 1,000,000 IN USE TODAY!

See Your Jobber or Write for  
Form No. 84



**MANUFACTURING CO., Inc.**  
6113K 16th AVENUE, BROOKLYN 4, N. Y.  
Specialists in Television Antennas and Accessories

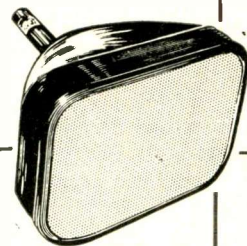

We are supplying several large television set manufacturers with our complete line of new picture tubes.

## NOW! We Can Rebuild Your METAL or GLASS Tubes!

VISIT OUR PLANT & SEE THEM PROCESSED

### Don't Throw Away The Metal Or Glass Blanks . . . They're Worth Money!

- Guaranteed for one year.
- Processed in the same manner as our new tubes.
- Subjected to over 20 testing operations, same as in our new tube manufacture.
- New gun.
- New screen.
- Nineteen manufacturing operations.

Select territories open . . . Write for details.

## GENERAL VACUUM TUBE CORP.

Manufacturers of CATHODE RAY PICTURE TUBES  
45 ELM STREET, ARDSLEY, NEW YORK • Phone: DOBBS FERRY 3-4735



## New Appointments

Sandberg in new Stewart-Warner post, Roth now rep for South River, J. Fine and K. Brock in new Ward-Workshops posts, Hilton asst. mgr. for Crosley Distributing, Karlsruhe president of new Emerson subsidiary, Lee Hadin midwest rep for Arvin

● Irving M. Sandberg has been appointed sales manager of the New York territory, **Stewart-Warner Electric**, the radio and television division of Stewart-Warner Corp., Chicago, Ill. Offices and showrooms will be at 11-25 45th Ave., Long Island City. With the appliance industry for some 28 years, Mr. Sandberg was formerly general sales manager of the Crosley Distributing Corp. of N. Y.



Irving M. Sandberg

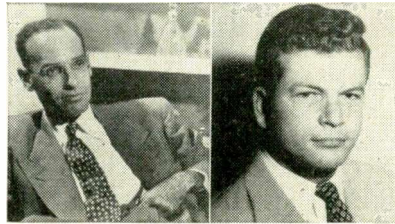

Julius Fine

K. S. Brock

● Julius Fine has been appointed commercial products sales manager for both the **Ward Products** and **Workshop Associates Divisions**, according to an announcement by Gardiner G. Greene, v-p of the Electronics Division, the Gabriel Co., Needham Heights, Mass. Kenneth S. Brock has been named advertising and sales promotion manager of the same divisions.

● Harold E. Karlsruhe has been named president of a new subsidiary company announced by Benjamin Abrams, president, **Emerson Radio & Phonograph Corp.**, N. Y.

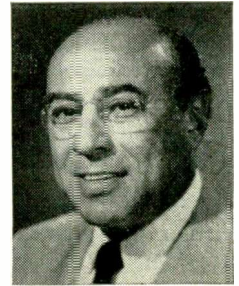

H. E. Karlsruhe

The new company is **Emerson Radio of Michigan, Inc.**, with headquarters at 1301 West Lafayette and occupying 13,500 square feet of office, showroom, and warehousing space. Mr. Karlsruhe, with Emerson for 22 years, was formerly eastern regional sales manager.

● Marty Roth has been named eastern representative for **South River Metal Products Co., Inc.**, South River, N. J. He will assist the firm's distributors in the merchandising of the complete line of antenna mounting accessories. Mr. Roth has been closely associated with television and the electronics business, and has had considerable experience with a television parts distributor.



Marty Roth

● Paul A. Hilton has been appointed assistant manager of the New York branch of **Crosley Distributing Corp.**, with offices at 1775 Broadway, N. Y. Formerly controller and operations manager of the New York branch, Mr. Hilton will now coordinate administration of the company's New York sales, sales promotion and advertising activities.



Paul A. Hilton

● Lee V. Hadin has been appointed television and radio sales representative in the midwestern states for **Arvin Industries, Inc.**, Columbus, Ind. Assigned to a detailed analysis of distributor problems in his area, he will work closely with Arvin TV and radio distributors on sales, merchandising and promotional activities.



Lee V. Hadin

## Saraceni & Gentile, Inc. MANUFACTURERS OF MAJESTIC PRODUCTS



Featuring the Widest Selection of Magnificent Television Cabinets in the Most Beautiful Woods and Hand Rubbed Finishes. Created by Masters of the Trade, in Modern, Chinese, and Traditional Styles. Available in All Sizes, including 24". Ranging from Consolettes to Large Consoles. Inquiries Invited.

Descriptive Literature on Request

Manufacturers Representative  
**TELEVISION COMPANY OF AMERICA**

Showrooms

192 Lexington Ave.

MU 4-5347

New York, N. Y.

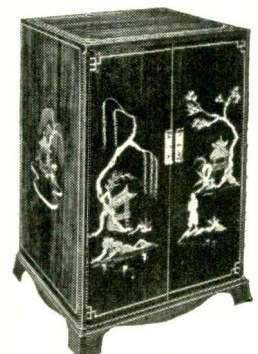

### Inventories

This television business has always been characterized by inconsistencies, and the present period is doing nothing to belie that record. We're referring particularly to the continued liquidation of inventories of television receivers which is still going on, especially in the big city areas. To say that such liquidations are ironic is to understate the case by a wide margin. According to the latest production estimates emanating from Washington, television and other hard goods will be curtailed sharply, and for the year of 1952 some rather drastic production cuts have been announced.

CMP allocations for the fourth quarter of 1951 are down to a fraction of the first half of the year. The inventory situation in both manufacturer and distributor pipelines is not big enough to make up for production cutbacks which loom ahead. True, there are some unbalanced inventory bulges in various sections of the industry but broadly speaking, these are not large enough to counterbalance the setback produced by CMP and the Defense Program. One large TV manufacturer told us the other day that inventories in the hands of his dealers are lower than at any time within the past 18 months and his factory supply of finished receivers provides less than a 30-day fall supply.

We're not predicting that shortages will materialize within the next few weeks (although some veteran industry observers have hinted that actual drought will develop before Christmas). However, it's a situation which bears close watching by every dealer. Today's liquidation might very well develop into tomorrow's profit-maker. Never before in the industry's hectic history has it been so necessary for dealers to play their cards close to the chest; to plan every move on the basis of what happened yesterday and is likely to happen tomorrow.

### ADVERTISERS' INDEX

ADMIRAL CORP. _____ 9 Agency: Cruttenden & Eger	REVERE CAMERA CO. _____ 6 Agency: Jones Frankel Co.
ALLIANCE MFG. CO. _____ 31 Agency: Foster & Davis, Inc.	RIDER, JOHN F. PUBLISHER _____ 44 Agency: Conti Adv.
AMERICAN PHENOLIC CORP. _____ 58 Agency: Burton Browne Adv.	SARKES TARZIAN, INC. _____ 14 Agency: H. L. Ross Adv.
ARVIN INDUSTRIES, INC. _____ 55 Agency: Roche, Williams & Cleary, Inc.	SENTINEL RADIO CORP. _____ 53 Agency: W. W. Garrison & Co.
BENDIX AVIATION CORP. _____ 37 Agency: MacManus, John & Adams, Inc.	SHERATON TELEVISION _____ 56 Agency: Lester Harrison, Inc.
BRACH MFG. CORP. _____ 30 Agency: Conti Adv.	SIMPSON, MARK MFG. CO., INC. _____ 48 Agency: Edward Hamburger Adv.
CBS-COLUMBIA, INC. _____ 25 Agency: Bennett, Walthers & Menadier, Inc.	SOUTH RIVER METAL PRODUCTS CO., INC. _____ 57 Agency: Art-Copy Adv.
CAPEHART FARNSWORTH CORP. _____ 61 Agency: J. M. Mathes, Inc.	STARRETT TELEVISION CORP. _____ 5 Agency: Arthur A. Judson, Inc.
CINAUDAGRAPH SPEAKERS _____ 60	SYLVANIA ELECTRONIC PRODUCTS, INC. _____ 34, 35 Agency: Roy S. Durstine, Inc.
CROSLLEY DIV., AVCO MFG. CO. _____ 11 Agency: Benton & Bowles, Inc.	STROMBERG-CARLSON CO. _____ 19 Agency: Federal Adv.
DUMONT, ALLEN B. LABS, INC. _____ 17 Agency: Campbell-Ewald Co.	TELE KING CORP. _____ 7 Agency: Milton Samuels
DUOTONE CORP. _____ 3 Agency: Marfree Adv. Corp.	TURNER CO. _____ Fourth Cover Agency: W. D. Lyon Co.
EMERSON RADIO & PHONOGRAPH CORP. _____ 13 Agency: Getschal & Richard, Inc.	TELEVISION CO. OF AMERICA _____ 65
EUREKA TELEVISION & TUBE CORP. _____ 27 Agency: Harry Belfor	TRAD TELEVISION CORP. _____ 29 Agency: Alfred N. Miller
GENERAL VACUUM TUBE CORP. _____ 64 Agency: Gelles Adv.	WILCOX-GAY CORP. _____ 63 Agency: Wallace-Lindeman, Inc.
HAYGREN ELECTRONICS _____ 62 Agency: Associated Ad Serv'ce	WESTINGHOUSE ELECTRIC CORP. _____ 38, 39 Agency: Fuller & Smith & Ross, Inc.
HI-LO TV ANTENNA CORP. _____ 51 Agency: Sander Rodkin Adv.	ZENITH RADIO CORP. _____ 49 Agency: Critchfield & Co.
I. D. E. A. (Regency) _____ 15 Agency: Burton Browne Adv.	
JFD MANUFACTURING CO. _____ 33, 64 Agency: Shappe-Wilkes, Inc.	
JACKSON INDUSTRIES, INC. _____ 62 Agency: Filmore Co., Inc.	
JENSEN INDUSTRIES, INC. _____ Third Cover Agency: Paul J. Steffen Co.	
LAPOINTE-PLASCOMOLD CORP. _____ 54 Agency: F. W. Prella Co.	
LEWYT CORP. _____ Second Cover Agency: Hicks & Greist, Inc.	
NATIONAL TUBE HEADQUARTERS _____ 52	
OAK ELECTRONICS CO. _____ 42	
PENN BOILER & BURNER MFG. CORP. _____ 46, 47 Agency: Wilson Browne	
PERMO, INC. _____ 59 Agency: Wm. Hoffman & Associates	
PHILCO CORP. _____ 45 Agency: Hutchins Adv. Co.	
PHILHARMONIC RADIO & TV CORP. _____ 30 Agency: A. D. Adams Adv.	
RADIO CORP. OF AMERICA _____ 43 Agency: J. Walter Thompson	



*many of the products advertised  
in this paper might not  
have been developed!*

**pick the right  
needle with...**



**THE**  
**Jensen**  
**"JENSELECTOR"**

**For Fast, Easy, Replacement Needle Selling**

This new Jensen Needle Guide will give the exact needle replacement number for any record player made, without knowing the model or cartridge number. It's as easy as A. B. C. See your distributor for your "Jenselector" or write directly to Jensen.

*Your local radio parts distributor has Jensen needles in stock*

**Jensen No. 32 Dealer Pack**

This pack contains a balanced assortment of 32 needles of the best proven sellers. Packaged in an attractive plastic box that contains an automatic inventory feature.



**JENSEN** — *The Oldest Name in Sound Engineering*

**Jensen INDUSTRIES, INC.**  
329 South Wood St., Chicago 12, Ill.  
CANADIAN BRANCH  
Duplate Canada Ltd.  
50 St. Clair Ave., West, Toronto 5, Canada

**NO MATTER HOW YOU LOOK AT IT...**



# the **TURNER** is a better **BOOSTER!**

From every angle the new Turner Model TV-1 Booster is the finest on the market today. Under the worst possible fringe area receiving conditions, the TV-1 consistently produces sharper, clearer pictures and crisper, more natural sound.

There are many reasons for the superiority of the Turner Booster, but the two most important are advanced electronic engineering and finest construction using only high quality component parts.

Turner's low-noise-level cascade circuit stabilizes the picture, reduces noise and snow to a minimum... makes viewing a real pleasure.

The Turner TV-1 is simple in operation. A single tuning knob permits fine adjustment for the best reception of picture and sound over all 12 TV channels. And because it tunes continuously from 54 to 216 megacycles, you can use the TV-1 to amplify FM, aviation and mobile radio signals. Three position control switch turns on the TV set only, the TV set and Booster, or shuts off both set and Booster.

The unit is quickly and easily installed. Attaches to any television set. Attractive styling and neutral finish harmonize with any furniture design.

## CHECK THESE SUPERIOR FEATURES

Continuous Tuning - single knob control for finest adjustment to permit best possible reception of both picture and sound.

Cascade Circuit - inherent low noise level circuit with great stability and high signal-to-noise ratio.

Construction - finest quality materials carefully assembled to rigid Turner standards assure years of continuous, repair-free use.

Appearance - handsome cabinet designed to harmonize with any furniture design and finish.

Uses - amplifies FM, mobile and aviation radio signals as well as TV.

Results - most important, the Turner TV-1 produces an excellent picture under conditions which nullify the best efforts of many other boosters.

List Price .....\$57.50

FOR THE BEST POSSIBLE TV RECEPTION, TURN TO

# THE **TURNER** BOOSTER

THE **TURNER** COMPANY, 910 17th Street, N. E. Cedar Rapids, Iowa

In Canada: Canadian Marconi Co.,  
Toronto, Ont., and Branches

Export: Ad. Auriema, Inc.  
87 Dix St., New York 4