

Radio Journal

Los Angeles, California



Radio Show Number. Crystal Hook-up Contest Winners. Getting the Continent on Loop and Speaker. Bagful of New Hook-ups.

"Equatone"

Model



ENJOY the De Luxe Concerts being broadcast by having a receiver that reproduces what is broadcast exactly as it is broadcast.

Get the pure tone quality with sufficient selectivity and without distortion or oscillation.

This receiver will

Get All the Distance

that any of them will and it will be audible when you get it.

ASK YOUR DEALER OR WRITE US FOR BOOKLET.

ECLIPSE MANUFACTURERS, Inc.

Phone: Metro 6607

328 East 3rd Street

Los Angeles, California

THINK—

from Your Pocket Book!

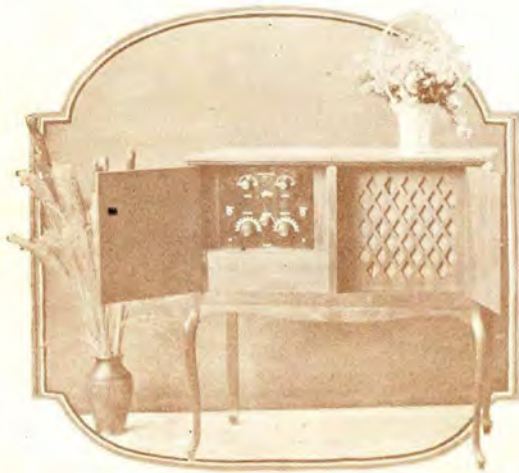

Why should you be spending money every evening attending Cafes, Shows, etc., when we can install an artistic Radio Receiver in your home that will afford you the latest and best dance music and entertainment within a radius of 2000 miles—

ECHOPHONE and NEUTRODYNE sets complete installed from \$55.00 to \$250.00.

Call and see us or phone 430-195.

This new addition to the Echophone Family has a three fold appeal to you. First, its artistic beauty—simple, refined lines. Second, the faithfulness and unusual tonal surety of its reproduction. Third, it is a self contained unit. All Batteries and Loud Speaker enclosed in the Cabinet, ample volume is assured for dancing or entertainment. Truly a set which any home can justly be proud to own.



Complete Line of Equipment

Sets Rewired and
Repaired

OPEN EVENINGS

709 N. Western Ave.

(Cor. Melrose and Western)

Hollywood, Cal.

Every Nite a Silent Nite-----

with the

Creswell Universal Synchrondyne

Receiver

*A Receiving Set That Will Give Satisfaction to
the Most Critical Listener In*

CORCO PRODUCTS

Synchrodyne Transformer, Price \$8.50

Vernierstat, Price \$3.00

Creswell Universal Synchrondyne Receiver.

*Watch for Our Cascade Coupling Transformer (Push Pull) and Our
Anti Capacity Jack Switch.*

LOCAL DEALERS

Ye Quality Radio Shop
6278 Hollywood Blvd.
Hollywood, Calif.

Randall's Radio Shop
427 North Sycamore St.,
Santa Ana, Calif.

Florence Radio & Electric Shop
1737 E. Florence Ave., City

Duvalls
4501 Central Ave., City

Manual Arts Radio Shop,
4154 S. Vermont Ave., City

Pacific Coast Radio,
Ontario, Calif.

J. H. Terry,
Monrovia, Cal.

Daynes Music Company
810 So. Fair Oaks
So. Pasadena, Cal.

Summers Radio,
1105 West First St., City.

Thayer Electric Company,
2908 Whittier Blvd., City.

Venice Radio Shop,
1205 Ocean Front,
Venice, Calif.

Vermont Center Radio Shop,
6119 So. Vermont Ave.,
City.

Washington & Vermont Radio Shop,
1830 So. Vermont Ave., City.

Hancock Electric Company,
102 No. Pacific Blvd.,
Huntington Park, Cal.

Los Angeles, Cal., January 3, 1924.

Continental Radio Co.,
627 S. San Pedro St., City.

Gentlemen,
I am one of the proud possessors of your Creswell Universal Synchrondyne Receiver Circuit, featuring your Transformer Vernierstat and wish to compliment you on the perfection of such a set.

After hooking up my set and stringing up about twenty feet of wire around the room for a temporary aerial, the first station I heard was KFKX, at Hastings, Nebraska. Since that time I have heard stations as far distant as Havana, Cuba, through local interference.

But the novel feature of this set, which I wish to point out is this; by using a graph plotted from wave-lengths and dial numerals, I can set the dial on a chosen station's wave, pull out the switch, and if that station is on the air. I am sure to hear it, if conditions are favorable. This, I believe, is a very desirable feature which is to be had on no other receiver circuit. Yours very truly,

ARLOS R. SEDGLEY.

January 15, 1924.

Continental Radio Co.,
627 So. San Pedro St.,
Los Angeles, Calif.

Gentlemen:

You may be interested in knowing that last Friday evening it was possible for me to hear the new broadcasting station KGO at Oakland, California, very clearly on the loud speaker, with no local interference, at the Ritz Hotel, which is near the corner of 8th and Flower, while KFI which is located one and a half blocks from this hotel, also KHJ located at the corner of 1st & Broadway were transmitting. Neither station was discernible even in the head phones.

Hoping this will be as much interest to you as it is to me.

Yours very truly,
R. B. KING.

CONTINENTAL RADIO CO.

NOTE OUR NEW FACTORY ADDRESS

Phone: Main 3817

416 East Eighth Street Los Angeles, Calif.

FREE COUPON

Continental Radio Co.
627 So. San Pedro Street
Los Angeles, Calif.

Gentlemen:—

Please send without obligation to me the Blue Print of the Creswell Universal Synchrondyne Receiver Circuit. My Dealer's name is

.....
City.....State.....
Name.....
Street.....
City.....State.....

"THE AIR IS FULL OF THINGS YOU SHOULDN'T MISS"



Radio has moved from the laboratory and amateur's work-table out into the refined surroundings of the family living room. In keeping with this new companionship we offer this reliable, long-lived Eveready "B" Battery, in an attractive, new metal case, worthy to stand beside the rich cabinets of fine radio sets.

Eveready "B", 22½ volts, No. 766 with Six Fahnestock Spring Clip Connectors.



When Radio called, Eveready was ready

TWENTY-ONE years ago, when wireless telegraphy had its first birthday, National Carbon Company's dry cell batteries were nine years old. Even then its batteries were world famous as convenient, economical and efficient sources of electric energy.

With the introduction of broadcasting, radio leaped into universal service. Radio engineers used Eveready Batteries as their standard in designing tubes and receiving sets. Eveready engineers, backed by the most complete research and testing laboratories known to the industry, worked with

them to discover how the known dry cell could be improved for radio work.

The fruit of these efforts is the Eveready family of radio batteries, conspicuous for vitality and endurance—the right battery by test and proof for every radio use.

To be certain of battery satisfaction, insist on Eveready Radio Batteries—they last longer. All reliable radio dealers sell them.

Informative and money-saving booklets on Radio Batteries sent free on request.

NATIONAL CARBON COMPANY, INC., New York, N. Y.

Headquarters for Radio Battery Information

If you have any battery problem, write to RADIO DIVISION, NATIONAL CARBON COMPANY, INC. 212-214 Orton Street, Long Island City, N. Y.

Eveready 6-volt Storage Battery



Eveready Radio "A" Dry Cell
Specially manufactured for use with low amperage tubes

No. 764
The Space Saver
Vertical
22½-volt
"B" Battery

No. 767
"B" Battery, 45 volts
Variable taps
Fahnestock Clips

Eveready Three
or "C" Battery
Clarifies tone and
increases "B"
Battery life

EVEREADY Radio Batteries

— they last longer

Radio Journal

Los Angeles - California

Volume Four

JANUARY, 1924

Number One

CONTENTS

SOME OFFICIAL AUSTRALIAN RELAY STATIONS..... <i>Frontispiece</i>	
EDITORIAL COMENT	7
BRINGING IN THE NATION ON LOOP AND SPEAKER.....	
.....L. R. ARMSTRONG	8
EQUATONE RADIO FREQUENCY RECEPTION.....	
.....LIEUT. W. H. H. ANDERSON	10
THE SAN DIEGO CLUB WITH A PURPOSE...DR. A. E. BANKS	11
POUNDING INTO THE ANTIPODES.....	12
RADIO EXPOSITION BIG WESTERN EVENT.....	15
A SIMPLE SET WITH A WONDERFUL WALLOP.....	
.....T. E. NIKIRK	16
FIXING UP THE B BATTERY.....	16
MORE ABOUT BUILDING THE SYNCHRODYNE	
.....S. R. FLORENCE	17
ELECTRICAL UNITS.....PROF. H. LA V. TWINING	18
A REFLEX THAT IS DIFFERENT.....R. B. YALE	19
AN EFFICIENT SINGLE TUBE RECEIVER.....A. L. MUNZIG	20
USE PRECIOUS METALS FOR CONTACT.....DR. J. B. BUEHLER	20
HOW TO TEST YOUR HEADPHONE.....E. T. BAUGHMAN	21
HOW ABOUT YOUR ANTENNA.....M. CHAS. GOODMAN	22
THE RADIO WEE GEE.....	22
A HARVEST OF CRYSTAL HOOKUPS.....	23
IMPROVING THE HARKNESS CIRCUIT TUNED.....	
R. F. REFLEX.....A. L. MUNZIG	25
QUESTIONS AND ANSWERS.....	26
WITH THE WESTERN AMATEUR.....	29
WITH THE RADIO CLUBS.....	32
TRADE TALKS	33
LISTENING IN	34



Radio Journal

is published monthly by Radio Journal Publishing Company, 113 Stimson Building, Los Angeles, California. Telephone 877-726.

EDITORIAL BOARD

Editor.....K. P. FREDERICK
General Manager.....HUGH HARLAN
Advertising.....A. W. MAJORS

SUBSCRIPTION RATES

6 months.....	\$1.50
1 year.....	2.50
2 years.....	4.00
Single Copy, Foreign.....	35c
Canadian or Mexican—	
1 year.....	3.00
Foreign, 1 year.....	3.50
Single Copy	25c

Change of Address—Notify us of any change in your address. Be sure to give both your old and new address.

Because of the fact that intense interest in radio is sweeping the entire country, causing a flood of inventive and research work, much of which will be duplicated, it is necessary to state that in the event of expressions of opinion and various statements from contributors and correspondents appearing in Radio Journal from month to month becoming the subject of litigation in courts, or of controversy in scientific circles, and which may involve questions of priority of invention and a comparison of merit of apparatus, the owners and publishers of Radio Journal positively and unequivocally disclaim any responsibility for any such expressions of opinion or partisan statements.

"Entered as second-class matter May 19, 1922, at the post office at Los Angeles, California, under the Act of March 3, 1879."

The entire contents of Radio Journal, including articles, stories, pictures, diagrams, etc. (unless otherwise credited), copyright 1923 by Radio Journal Publishing Company, which reserves all rights.

Circulation Manager, William Hegeman

Denver Representative,

Ira R. Alexander, 369 Lincoln Street.

Printed in U. S. A.

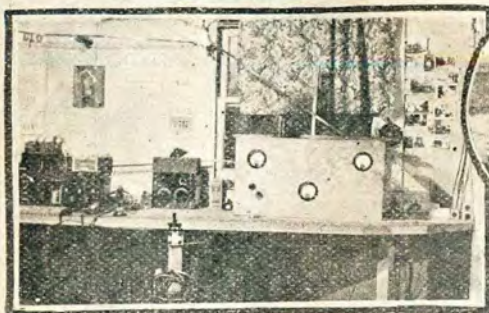

6 ZH



6 ZH

6 CHL



6 PL

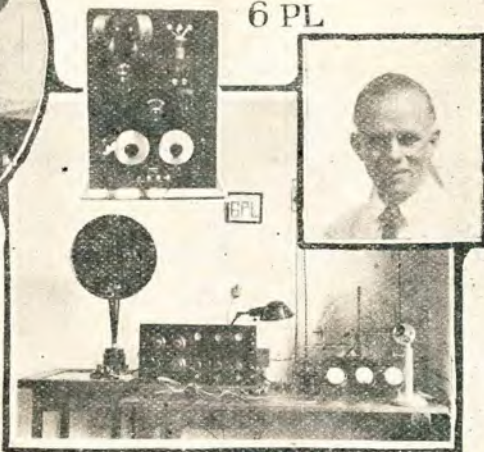

6 NX

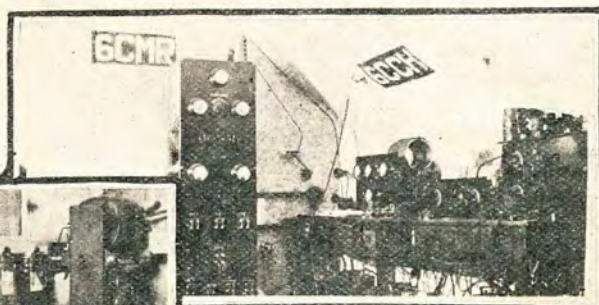

6 CMR 6 CCH



Some of the Official Australian Relay Stations

Editorial Comment

The Year, Fore and Aft

Casting up the books for our annual statement, we find that radio, by and large and for and aft, has no occasion to use the red ink. In the vernacular, we might add that radio is prepared to "step out" some during the good year just started, 1924. But before we pass up the past entirely, let's squint our weather eye backward a year and see where we were at, so to speak, at this time a year ago. We were looking forward then to improvements which have been surpassed many leagues in the year intervening. Vacuum tubes have stepped along with the procession until we have a dozen or so, big improvements, which we hadn't thought of then. We have a multitude of new broadcast receivers, the reflex, the super-heterodyne, the neutrodyne and a host of others not so well known, which have delighted the heart of the hook-up fan and which, incidentally, have filled a real need in the receiver field. For here, as elsewhere, what is one man's meat is another's arsenic. We have developed self contained sets, the indoor loop receiver, the aeroplane, submarine and under the earth receiver; we have developed freak sets without condensers and without tuning inductance and without this and that; we have conquered the waste places and the crowded places until there is no place for the radio-hater to go, at least until he leaves this earth for parts less known but often referred to. But we do not believe there are any such. Dealers did more business in one day in December, 1923, than they did during the whole month of December 1922; and the same dealers have done more business in January, 1924, than they did in December, 1923. In fact, the radio craze, as so many have called it from time to time, has become really a craze, a deep-seated, dyed-in-the-wool conviction that radio is the completion of a perfect existence and that to be without radio is to be missing a good thing of life. Radio is, in truth, the outstanding fact of the age, the one great development which has swept not only America, but which is taking the world by storm, but it differs essentially from the popular conception of a craze in that the radio fan, the listener-in, the set buyer or the set builder, is more enamoured of his radio at the end of the first year than he was at its beginning, and enters upon the second year with all the enthusiasm of one entering upon a new land. So we confidently look forward to a procession of great things from radio year after year until we have reached "the end of our perfect day."

Listeners' Organization

A well developed movement is under way in the southwest to form a concert Listeners' Association, primarily, for the purpose of studying the broadcast listeners' problems with the idea of getting concerted action on needed legislation. Such an organization could accomplish much, if organized and developed along truly radio lines, meaning thereby the greatest freedom for the greatest number compatible with the minimum interference with the rights of others.

Help "Whoop it Up"

We have been "whooping it up" now these many moons regarding radio legislation. Representative White is the man who plans to introduce the new radio bill and he has asked the National Association of Broadcasters, and through them everyone interested in radio, to help him in suggesting what the new bill should cover. Despite the fact that radio is one of the most glorious boons ever handed over to suffering humanity, despite its many delights and wonders, we all have a sneaking idea that it could be improved if the Government would only do this or that. We don't know just exactly whom we mean when we suggest that the government should do it, but we want somebody to do something; abolish high lines, have special cops out to catch static, put the code amateurs to sleep, give the amateurs free reign on the air at any hour, eliminate heterodyning receivers, cut out interfering broadcasters, license all receiving sets—oh, any number of things a lot of folks would suggest. Go ahead. Suggest them. Think over carefully what you believe would improve the radio situation if incorporated into legislative enactment, then write out what you think and send it to Radio Journal. We will turn them over to the National Association of Broadcasters for presentation to Representative White. You never can tell, folks. Maybe you'll solve the radio problem at one fell whack. Anyhow we want your ideas. Send 'em in.

Anent Radio Widows

A popular fictionist friend of ours the other day hailed the coming of the radio widow, to join the ranks of the golf widow and the baseball widow. We don't believe it, not by a jugful of unfermented juice of the California prune. Our experience is all the other way. There may be divorces as a result of quarrels over which station shall be tuned in, and the choice is large and diversity of opinion the rule, but we have yet to find the place where woman takes a back seat for friend husband at the radio. We prefer to believe that when the last sleepy-eyed member of the family has tottered off to bed with head full of Beethoven or "Last Night on the Back Stoop" dad slips quietly up to the set, dons the phones and begins to get his money's worth fishing for distance. If that be radio widow, make the most of it.

For Station Announcers

Station announcers are not uniformly careful about frequent announcement of call letters. The National Association of Broadcasters has received numerous complaints to the effect that many stations fail to give their call letters at the end of each event. Local listeners, of course, know the station, but hundreds of thousands of long distance listeners on the air each night do not. Call letters given immediately after an event and repeated again at the conclusion of the announcement are appreciated by those of the radio audience.

The Nation in on Loop and Loud Speaker

By L. R. ARMSTRONG

It can't be done, sez we, in our best imitation of the blase manner which we have acquired through years of rassling with optimism. We have since been presented with a membership in the Ananias club, free, for nothing. Because it was done and is done. As a prophet we're about as efficient as a plumber. Allow us to present the description of a set which brings 'em all in on the loud speaker via a loop antenna.

THE June, 1923, issue of Radio Journal contained a description of the resistance coupled super-Heterodyne, which was then generally acknowledged the best method for long distance reception. Although transformer coupling of the intermediate frequency amplification was being used, the results did not begin to bring out the possibilities of the circuit and did bring in a lot of complications and trouble.

The radio frequency transformers then obtainable, while efficient for the purpose for which they were designed, did not function well at the frequency best suited to the Heterodyne method of broadcast reception, especially when used with an oscillator constructed along the conventional lines.

To receive, on a loud speaker, a concert or speech sent out from a station two thousand or more miles away, while high-power local stations operating within a few meters wave-length are going full blast, is a problem in itself, especially if one desires consistency and best tone quality in getting these far off programs—and it was with this object in view that the author, after much experimenting, constructed the intermediate frequency transformers, as shown in Figure 3. These are of the air-core type and adjustable as to exact frequency. When the receiver is completely wired, this adjustment is made once and for all and sealed—needing no further change. It is this method of coupling

Mr. L. R. Armstrong will be remembered by Radio Journal readers as the man who wrote a comprehensive article for this publication some months ago on a ten tube super-heterodyne. Mr. Armstrong, a radio engineer of many years experience, decided a year ago that the super-heterodyne was the only true principle upon which long distance broadcast reception could be secured. Since that article appeared, based upon a ten tube set which he had completed and experimented upon for many months, he has worked steadily and consistently to bring the super-heterodyne to the point where it will consistently bring in any station in the United States on a loop aerial, operated on the Pacific Coast. In other words he has developed a set which, to date, is working consistently and regularly on transcontinental reception. Other articles from Mr. Armstrong's pen on the super-heterodyne are to appear from time to time in Radio Journal, and Mr. Armstrong will gladly answer inquiries on this set, if addressed to him care of Radio Journal and accompanied by an addressed, stamped envelope.

Absolutely no neutralizing of capacity effect or shielding is necessary although it is, of course, best to connect the movable plates of the condensers toward the -A lead.

The transformers above described are now being manufactured by a Los Angeles company, under the name, A and A Amplifying couplers.

The construction and wiring of the oscillator is shown in Figures 1 and 2. L and L1 are lateral wound honeycomb coils of 50 turns each. L2 is the same, only of 35 turns. Condenser FC₁ is .002 mf. capacity, and grid-leak R₁ is from 5,000 to 50,000 ohms. Other values not shown on diagram are as follows:

- R₂—2 megohms.
- R₃—1 to 5 megohms.
- R₄—15 to 30 ohm rheostats (optional).
- R—7 ohm power rheostat.
- L3—200 turn honeycomb coil.
- L4—250 turn honeycomb coil.
- L5—200 turn honeycomb coil.
- C3—.001 Varidon.
- C4—single plate vernier.

The operation of this receiver is extremely simple, there being only two controls to tune. The station desired is readily located by oscillator condenser "C" and a rough adjustment of C₁. The setting of C always remains the same for a particular wave length and one may pick any certain stations by returning to that point on the dial. Power rheostat "R" controls the volume. A slight adjustment of C₂ and

the amplifying tubes that brings the excellent results and ease of control.

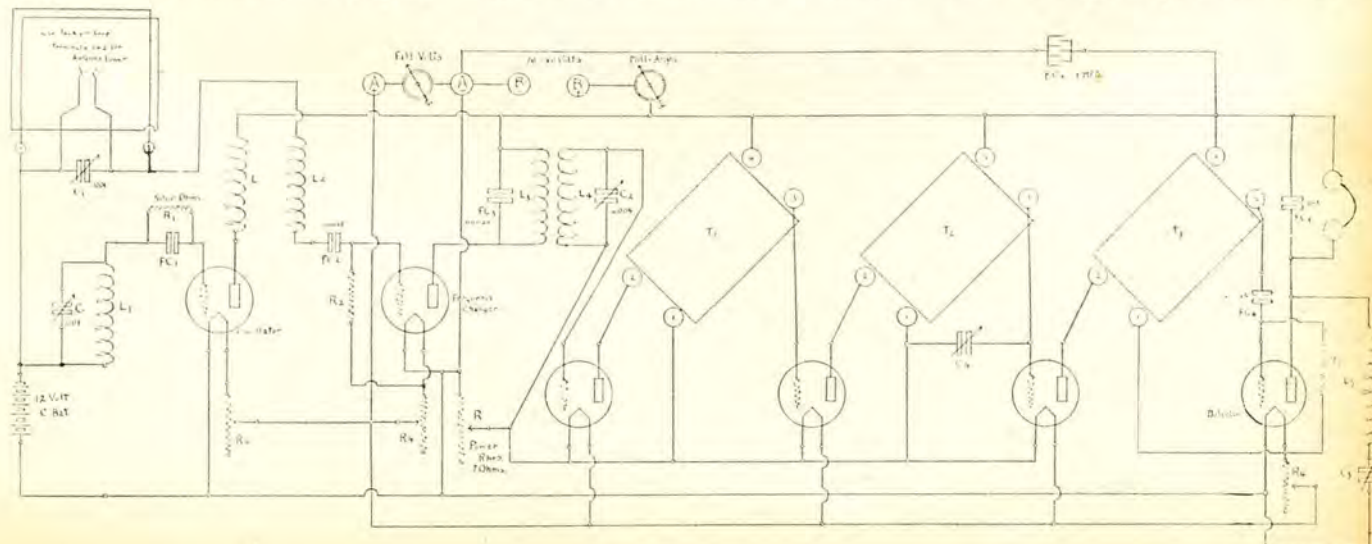

Fig. 1

C_1 is sometimes necessary for extreme distant reception—while C_3 is adjusted in conjunction with the detector rheostat and changed slightly when batteries are freshly charged. It is important to keep batteries well up at all times for best results. 301A tubes are used throughout and a constant plate voltage of about 65 has proven most satisfactory.

For performance, this receiver consistently brings in to Los Angeles, Memphis, Tenn., on 500 meters, while KLX, 509 meters, and KGW, 492 meters, are on the air. WJAZ, Chicago, 448, and WJZ, New York, 455 meters, come in while KFI and KPO are operating, WOO, Philadelphia,

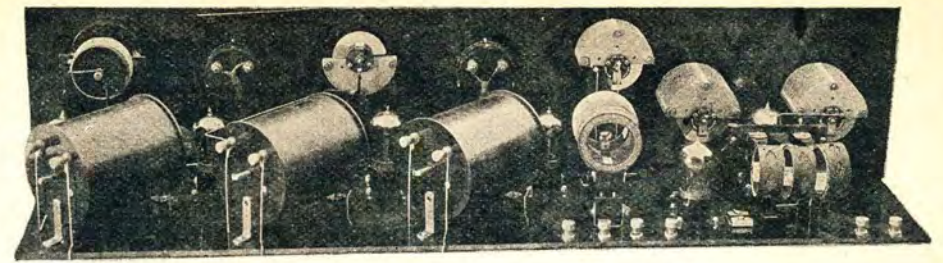

Fig. 3

Calif., enjoyed the concert from the Edgewater Beach Hotel, Chicago, at which time reception was made using a 3-inch spider-web coil in place of a loop.

Undoubtedly the construction of a

St. Paul's New Station

St. Paul made its debut as a permanent radio broadcasting station December 12, with the initial program from the new studio in the St. Paul

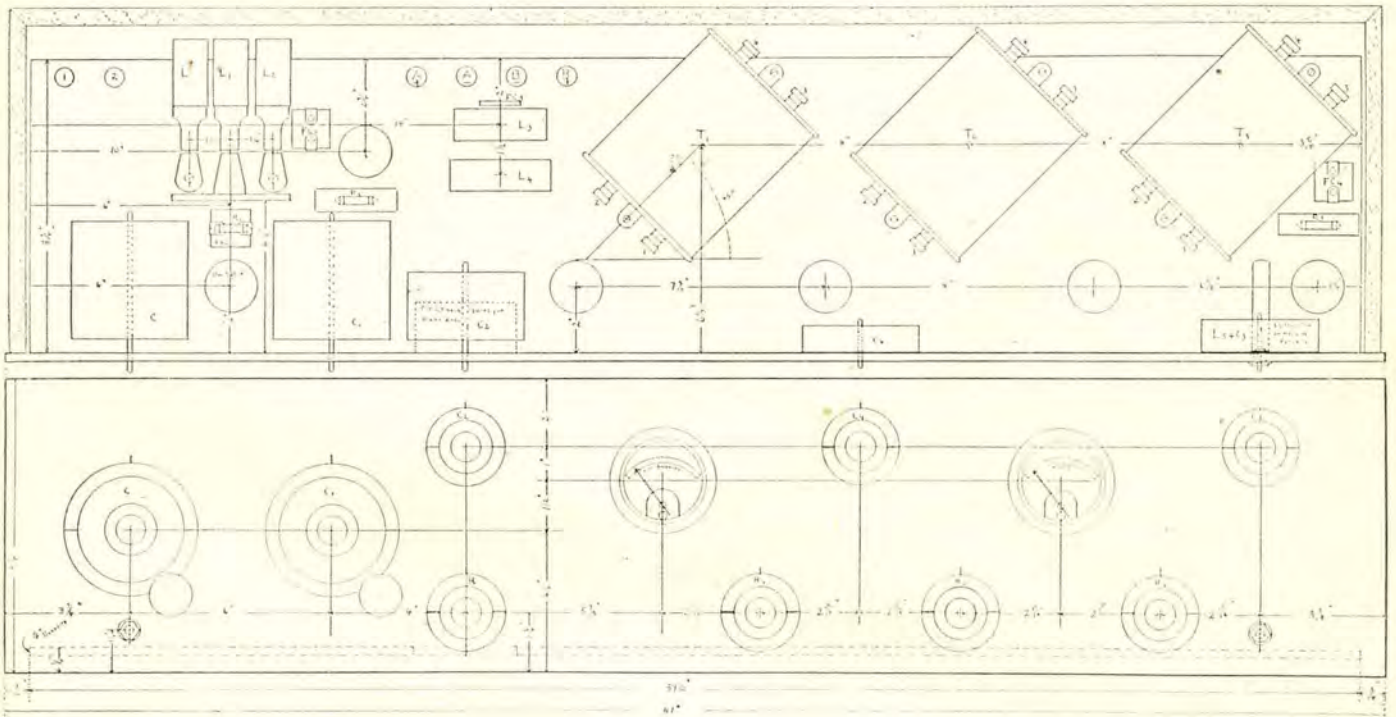

Fig. 2

while Memphis is going strong, and a full concert has been brought in from PWX, Havana, Cuba, with KHJ operating only 5 meters off this wavelength. All reception on a nine turn

receiver along these lines opens up great possibilities to the experimenter, and the author will be glad to answer any inquiries from these so interested, addressed through Radio Journal.

Athletic Club. Programs will be broadcast alternately with those from Minneapolis over WLAG, the Twin City radio central, operated by the Cutting & Washington Radio Corporation in Minneapolis, the St. Paul studio becoming a unit of WLAG. Heretofore irregular St. Paul numbers were broadcast from the Minneapolis studio of an emergency St. Paul studio. Eleanor Poehler, the only woman in complete charge of a radio broadcasting station who has been in executive control of WLAG the last year, will also have charge of the St. Paul studio.

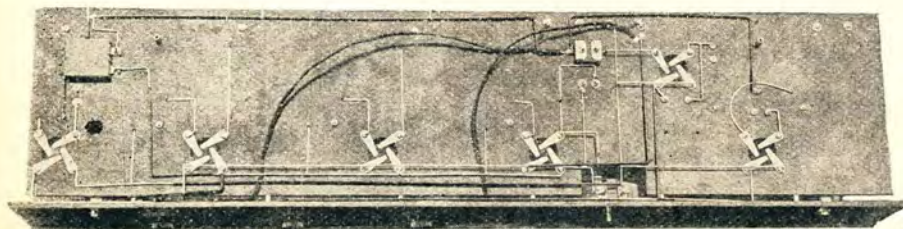

Fig. 4

36-inch loop—and with unequaled clearness and volume, using a Western Electric 7A unit and loud speaker. For Pacific coast stations, including Dallas and Fort Worth, even a loop is unnecessary. An ordinary variometer as an energy collector is sufficient. On New Year's Eve a large room full of people in Hollywood,



Fig. 5

Equatone R. F. Reception Good

By LIEUT. W. H. H. ANDERSON

Mechanically the Equatone receiver equalize the electromagnetic field in each of its respective radio frequency transformers. This eliminates distortion of any given signal, regeneration, re-radiation, and other disadvantages often encountered. Basically this method of handling radio frequency has accomplished something which has puzzled many, as efficient radio frequency amplification has heretofore been more or less of a laboratory achievement. By the method described here it is brought to the point where

ventional radio frequency circuit. The best of equipment is essential, such as insulating material, which plays a very important part in radio frequency amplification. But few parts are used in the building of the receiver, resulting in simplicity of controls. Only two rheostats are used to control five tubes. The radio frequency amplifier tubes are in parallel controlled by one rheostat. The audio frequency filament circuits have set resistance units



SOME LITTLE WIRING JOB, WHAT?

finding by dial reading. As an example, KKK would be found by dial reading such as dial No. 1 at 30, dial No. 2 at 30 and dial No. 3 at 30, with slight variations possibly for maximum volume. A simple plug switch is provided on the front of the instrument for disconnecting the A battery. The accompanying diagram and photos, just released, will give a fair idea of the simplicity of the set.

The receiver described in this article is the result of many years of research work by Lieut. W. H. H. Anderson, former engineer U. S. A., a graduate of the Massachusetts Institute of Technology and now chief electrical engineer of the Eclipse Manufacturers, Inc., of Los Angeles, Calif.

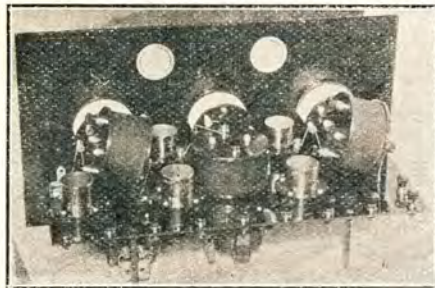

BACK PANEL VIEW OF THE EQUATONE.

the amateur can handle it with ease.

The disadvantages of attempting to combine pure radio frequency amplification with the seemingly impossible problem of eliminating regeneration and tube oscillation has been a wrench in the cogs of radio advancement. This receiver requires several bits of specially designed pieces of apparatus to be successful. The radio frequency transformer is a specially tuned unit and the design is important. Several characteristics of this unit, such as distributed capacity, co-efficient of winding producing the desired coupling, and the mechanical arrangement of coils have been very accurately determined. The circuit is a standard con-

adjusted accurately to the electron emission of the C-301A or UV 201A amplifying tubes. This tube is most suitable for both the radio frequency and audio frequency circuits of the Equatone receiver.

It has a much greater electron emission and better amplifying characteristics, for this circuit at least, than either the old UV 201 or C 301 tubes. Either hard or soft tubes may be used as detector, however, by varying the B battery or plate voltage. The UV 201A or C 301A tubes are commonly known as hard tubes while the UV 200 and C 300 are usually called soft tubes.

The tuning operation is of the balanced type having three variable condensers only, which makes possible the simplest logging or broadcast station

As Ithers See Us

It is interesting to note one British viewpoint, as voiced in the Popular Wireless Weekly, published in England. In "A Review of American Broadcasting Conditions," it says: "The American broadcasting stations are not generally so well designed or appointed as our own, although they appear to be more particular over the regulation of their wave length. After a careful comparison of broadcasting conditions in America and at home, the conclusion is that, although American manufacturers have had considerable more experience and, to a certain extent, more public support than have our own, still, the British listeners-in have a broadcasting service equal and in many respects superior to their American neighbors."

The Zenith-Edgewater Beach station, WJAZ, Chicago, on its experimental call 9XN, has been heard in Samoa, 12 degrees south of the equator, by Operator Roberts of the naval station VMG.

Broadcast Tests

The Trans-Atlantic broadcast tests held during National Radio Week, in which American and British stations alternated in attempting to bridge the Atlantic gave a great impetus to radio and radio week throughout the eastern half of the United States. British stations were received by Americans and American stations by British, and the success of the tests was made possible, not only by the efforts of the stations involved, but by the other stations as well, who sacrificed carefully prepared programs to maintain silence during the test periods.

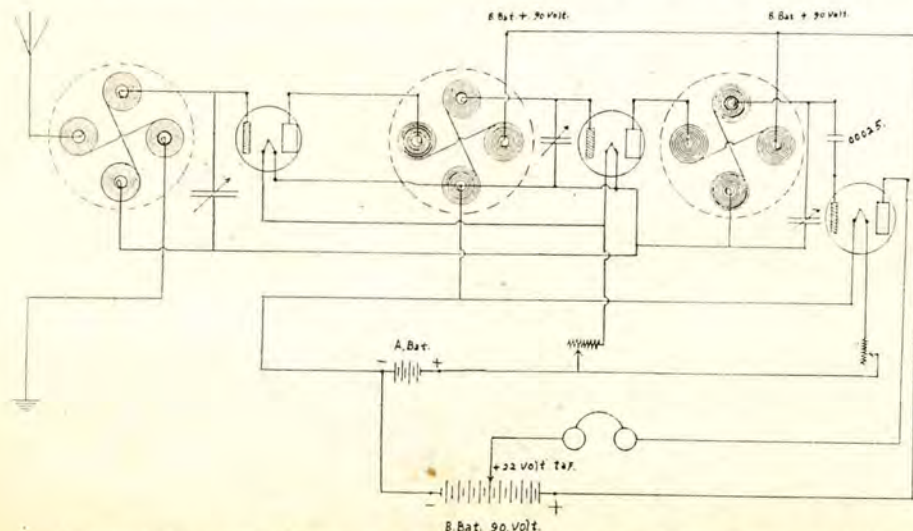

LOOKS LIKE THREE SWISS CHEESES BUT IT IS NOT. THIS, GENTS, IS AN HOOKUP, AND AN UNUSUAL ONE AT THAT.

The San Diego Club with a Purpose

By DR. A. E. BANKS, 6XN-6ZB

San Diego has taken a step which, if there is anything in signs, points a way toward the most effective sort of cooperation between all interested in radio to the end that action on radio problems can be secured. Folks, we still maintain that when Mr. Cabrillo paddled into San Diego harbor he discovered something.

SAN DIEGO "FANS" on the 2nd of November, 1923, completed the organization of what promises to be the largest, the most enthusiastic and progressive as well as one of the most useful radio clubs in the United States. The nominal membership, according to the Secretary's notes, approximates six thousand—and is made up of all those individuals residing in the County of San Diego who are either licensed operators, concert receivers, owners of broadcast stations or interested directly in radio.

San Diego Radio Club could never have succeeded as a powerful cooperative organization without a strong, diplomatic guiding hand at the helm during its formative period. In Judge Eugene Daney, dean of the legal profession of San Diego, and "dyed in the wool" radio enthusiast, San Diego Radio Club has in its first president all that could be desired as an executive head. Mr. Daney has drawn to him a working membership, not a passive one, and the club is doing things for the betterment of radio which will permit of conditions which have heretofore been impossible.

In the first place the old amateur organization, Sunset Radio Club, has joined hands with the broadcast receivers and others, in the making of the new club. It is the theory of the San Diego amateur and broadcast listener that the use of the ether for any specific purpose must be a matter which is interesting to all classes of operators alike. The great desideratum is an organization based upon sound principles, devoted to the general welfare of radio. With cooperative support well developed, the mother organization will take care of all subdivisions of activity and will furthermore fight to the last ditch any forces which threaten any function of the membership. According to the plans of President Daney the business sessions of the club will be more or less infrequent, perhaps once a quarter, at which time matters will be brought up which interest the membership as a whole. On the other hand sectional programs are to be arranged which specifically apply to the various types of membership. That is to say the amateur may have his technical meetings, the broad-

cast listener another type of program, the broadcast station owners their special sessions.

It is certainly refreshing to the older members of the fraternity to note that progress is being made along the lines of using scattered local talent to advantage in this consolidation method. Already interference is about to be placed upon the shelf. As may be realized, San Diego, while ideal from almost all angles except radio reception, has been one of the worst places from this standpoint. The explanation is simple. Being a port city and having powerful Naval radio stations both arc and spark located in its midst, con-

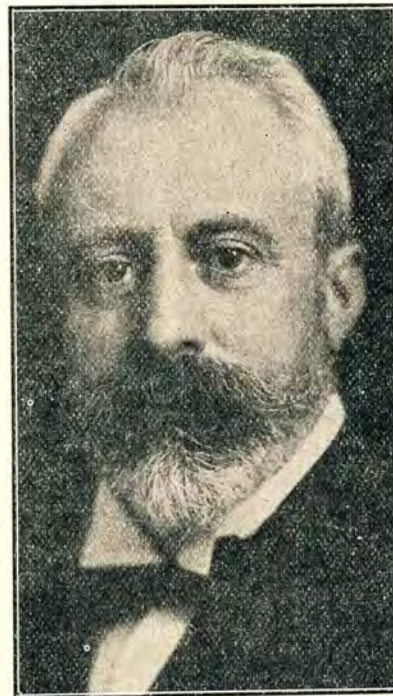

HON. EUGENE DANAY, DEAN OF THE SAN DIEGO LEGAL PROFESSION—"DYED IN THE WOOL" RADIO FAN—AND FIRST PRESIDENT OF SAN DIEGO RADIO CLUB.

tinuous interference from improperly installed, poorly maintained and operated apparatus has been the rule. As a matter of fact there has been a constant wail from the amateurs for over three years. Of late, especially the last twelve months, the listening public has been constantly annoyed, and nothing or next to nothing seemed to follow efforts to obtain relief. Right here is where San Diego Radio Club found its mission.

One of Mr. Daney's first announcements upon assuming the chair was to the effect that he sincerely hoped that the club would manage in some way to rid the ether of useless interference. Colonel Dillon who was present at the meeting spoke of the inadequacy of present law and the desirability for a new one which would be modern in its provision. At the very next meeting Mr. Daney engineered a resolution to Congress and the Senate demanding adequate legislation at the earliest possible moment. He pointed out at the time that if San Diego Radio Club would blaze the way by adopting an appropriate resolution other cities would act similarly and that the result of the concerted efforts of the listening public throughout the United States could have but one result in the end.

As to local interference, here indeed was a delicate subject, yet one which perforce needed a harsh remedy! Notwithstanding the great esteem in which Naval officials are held by all San Diegans, it was felt that the time had come to speak the unadulterated truth to Washington with respect to the atrocious nuisance being maintained at the Naval radio station NPL. The club has notified the Secretary of the Navy that the time has come when the thousands of residents of San Diego and vicinity will no longer tolerate a public nuisance. Resolutions pointing out the futility of spark conditions, and the absurdity of using high powered arcs when incapable of being properly operated, and other matters of practical importance, were adopted. It was urged upon Washington officials that here lay a technical subject requiring the services of trained experts. It recommended that hereafter the Navy depart from the old custom of placing line officers on duty in charge of radio apparatus and further recommended that stations be plentifully supplied with material, personnel, and reserve supplies.

It is expected that throughout the coming twelve months San Diego Radio Club will grow by leaps and bounds. With the betterment of radio reception hundreds of new receiving sets will be installed and since it is a club which requires no initiation fees

(Continued on Page 20)

Pounding Into the Antipodes

WHAT happened in Australia? Folks, so many American amateurs got across in that test that the last of the official report has not as yet been received. The report to date, together with H. Kingsley Love's official report on the way the work was handled on the Australian end follows:

"Wireless Institute of Australia, Victorian Division. Report on Trans-Pacific test October-November, 1923. Observations made at 3BM, BY, JU, the official station.

General—Cwing to the success obtained in the first—May—Trans-Pacific Tests it was decided by the American Organization and the W. I. A. to repeat the test in October.

The first test laid the foundation stone of long distance low powered short wave Trans-Pacific communication. It was hoped that in this the second test useful observations could be made. With this end in view it was decided at an early stage to institute an official observation station, and a combination of 3BM, 3BY, 3JU, with three separate receivers, located under the aerial at 3BM, East Malvern, Victoria, undertook these observations.

It was the duty of this station to experiment on the in-coming signals with various types of receivers under different conditions. The substance of this report is based on the observations made by the operators at the official station.

It will be found that logs from other stations both in New Zealand and

Australia will agree fairly accurately with the general observations of 3BM, JU, BY.

Apparatus—The aerial which is of the trumpet cage type, 65 feet at high end and 55 at the lower end, is switchable to any of the three receivers. 3BM a single stage of tuned radio frequency

amplifier was arranged to take the output of any of the receivers. The amplified signals were then transmitted over about ninety feet of land line to the house where a loud speaker, a pair of Baldwin phones and a dictagraph were installed. In this room, on the few occasions when conditions were good, signals could be read in comfort. The dictagraph was used in the endeavor to obtain a permanent record of Ameri-

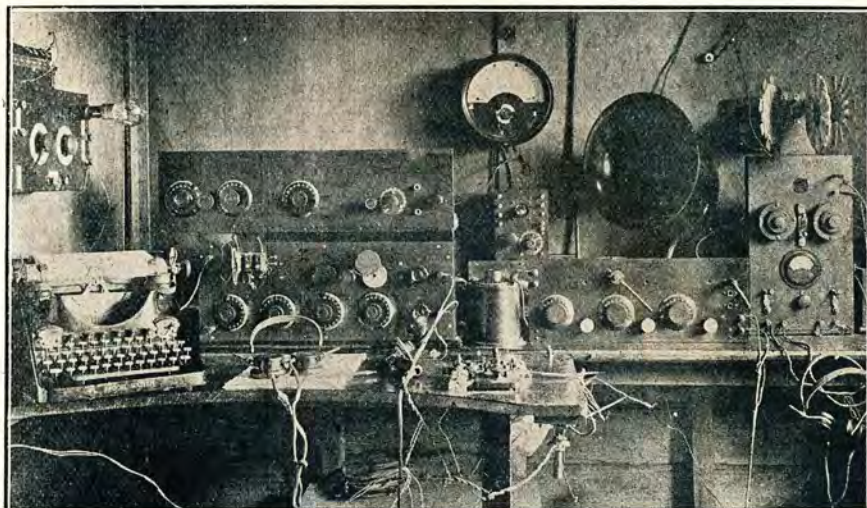

3BM—JU, AUSTRALIA, MOUNTED ON WALL, OSCILLATOR. TOP LEFT HAND TUNER IS 3BY; BOTTOM LEFT HAND TUNER IS 3BM; RIGHT HAND TUNER IS 3JU. 3BM'S TRANSMITTER, WHICH GOT ACROSS TO AMERICA, ON EXTREME RIGHT.

and detector, 3JU, a 2 tuned radio frequency stages detector and a reflex audio. 3BY, 2 steps of tuned anode and one audio.

By this arrangement it was possible to make direct comparisons of the results obtained on the three types of receivers. In addition to the forementioned apparatus a two step audio

can stations. The operators were able on two occasions to make a very fair record of the signals of 6KA (Mr. T. E. Nikirk). Had it not been for intolerable atmospheric conditions, and persistent interference from the spark stations, VIS, and VIM, the signals of 6KA could have been copied and recorded on almost every night they were transmitted. In the circumstances, it is considered that these records are proof of wonderful reception at this end, and demonstrate the remarkable efficiency of the transmitter at 6KA.

Atmospheric Conditions. A careful study of the logs of all stations which are attached hereto, will show that abnormal atmospheric conditions were not only experienced at 3BM. With the exception of three nights, the conditions in Australia were not fit for long-distance reception. The stations which sent the best Morse, sent slowly and repeated their calls frequently were the only ones which had any chance of being received through the bad weather.

It was known at the outset that October is not generally a good month for reception in Australia. It was given a trial however, in an endeavour to demonstrate whether or not the Pacific could be bridged in unfavorable weather conditions. Although October as previously stated is not a good period, the fifteen days of the test were worse than the average October weather. Despite this some-

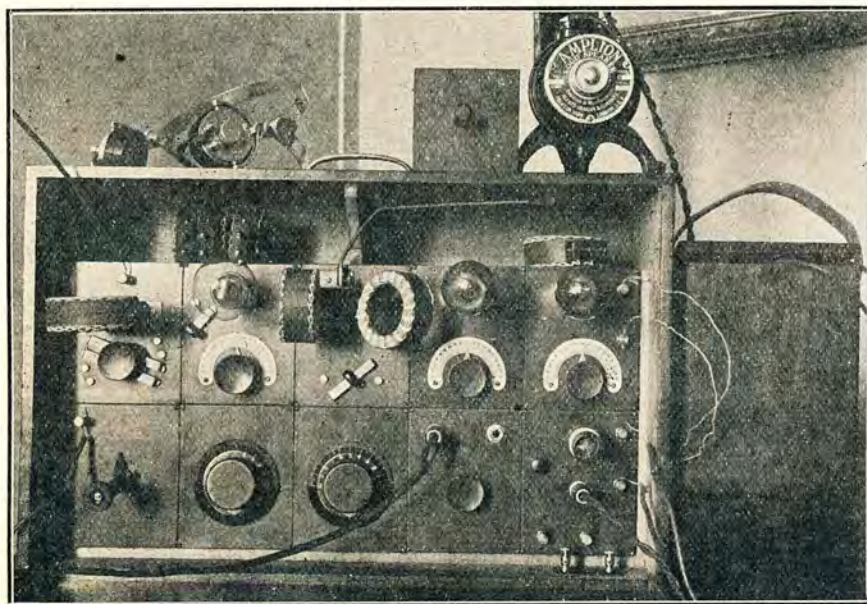

SET OWNED BY W. S. BREDED, 26 JOLIMONT TERRACE, EAST MELBOURNE, AUSTRALIA.—The circuit used in the Trans Pacific Test was one stage H. F. tuned anode coupling, detector, and one stage audio. Some of the stronger American amateurs were heard without the stage of audio. Referring to the photo may be seen from left to right: Aerial coil with series parallel switch, vernier aerial tuning condenser, H. F. valve with Rheostat and cut-out switch, main aerial coil condenser, Anode coil and Reaction coil with shorting switch, Anode coil condenser, Detector valve with Rheostat, Potentiometer, first stage Audio valve with Rheostat, second stage Audio valve. A 38 feet long indoor "L" aerial was used fixed under a gable roof and about 2 feet 3in. above the ceiling joists, made up of 4 strand No. 18 gauge copper wire spaced about 20 inches.

thing over two hundred separate stations were logged during the test.

A careful study of weather conditions was made during the early periods of the test, the remarks in this regard will be noted at the top of each in the combined log for Australia. The weather conditions in New Zealand may be fairly accurately judged by the remarks appearing in the various New Zealand logs. It would seem that receiving conditions generally throughout New Zealand in so far as static is concerned, are very much superior to those obtaining in Australia. There were very few occasions during the test period in Australia when any long transmission could have been accurately logged through fierce atmospherics. A general summary of atmospheric conditions during the test period may be found in one word BAD.

FADING: On the few nights which were comparatively free from atmospherics careful observations were made on fading effects. It was found that fading could be divided into two different classes, the first, periodic fading, and the second, prolonged dead periods.

The former heading included periodic fading of signals of from sixty to one hundred and twenty seconds in and out. On many occasions while observing this effect, complete sentences or messages could not be logged. Under the second heading i.e. dead periods, it was noted that the American signals would suddenly die out, during one night, and only the very strongest stations could be heard very faintly during one of these periods. It is of interest to note that 6KA pushed through these blanket periods at all times but his signal strength was practically inaudible. Usually it took from three to four days for the signal strength to become normal. It is surmised that this effect is due to ionised belts extending across the Pacific. It was considered at first that the effect might have been purely local, but reports received by radio from 4AA, Mr. Bell of New Zealand, indicate that during our worst periods here, the same effect was distinctly noticeable in New Zealand.

Interference: Although experimental stations were working their transmitters during the test period, on wave lengths from 380 to 400 meters, no interference whatever from this source was experienced. Experimenters throughout the Commonwealth after an appeal had been made to them loyally helped the Wireless Institute by closing down transmitters approximating 200 metre wave length. Violent interference was experienced from spark stations, VIS'S harmonic being particularly troublesome. This station had a peculiar knack of starting up



THIS PHOTOGRAPH SHOWS THE AERIAL AT 3BM AND FROM LEFT TO RIGHT A. J. HOLLAND, H. K. LOVE, N. FETHERSTON, R. A. HULL, W. S. BREDEN; MESSRS HOLLAND AND BREDEN OPERATED STATIONS OF THEIR OWN. AERIAL GOT ACROSS.

just as we were bi for 6KA's transmission.

Reception: The times of American transmission were 5:45 p.m. to 8:45 p. m. Melbourne time, and at this time of the year included about one and a half hours daylight. It was considered that very few stations would be heard in Melbourne between 5:45 and 7:15. It was anticipated that reports from New Zealand would cover this period. Observations at 3BM proved that many stations came in particularly well during the day light period. Re-

ference to the logs of other stations will show that this was the case in other parts of Victoria. Types of receiver—Most of the work at the observation station was done on JU, whose apparatus has been previously described. It was found by experiment that the two stages of tuned anode, used by BY produced the greatest amplification of signals but was far too critical for general purposes. The single stage of tuned radio and detector used by BM gave excellent results and should prove to many experimenters that this type of receiver with the possible addition of one or more note amplifiers when conditions permit is all that is required to pick up the American signals. It was found that the logging of American stations resolved itself into very careful tuning and skillful handling of the radio frequency circuits. The work at the official station will prove that nothing out of the ordinary in the way of apparatus was found necessary. This should encourage all genuine experimenters to get their receivers down to two hundred metres and under. Having mastered short wave reception no difficulty will be experienced in finding the American stations.

Other Stations: At the time of writing this report logs have been received from two stations in New South Wales, one station in Tasmania, eight stations in Victoria and three stations in New Zealand. Very excellent work is acknowledged at all

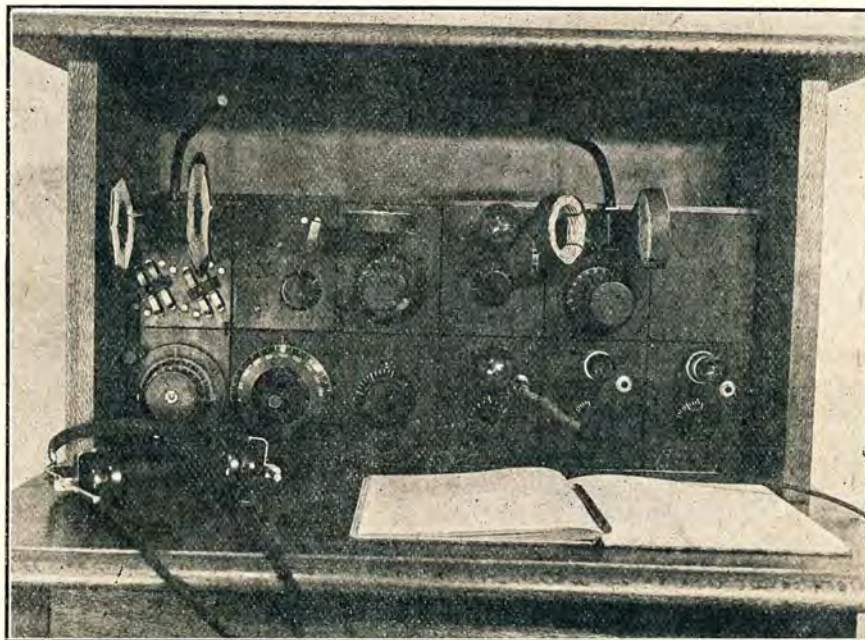

THIS SET OF A. J. HOLLAND, COTSWOLD, ESSENDEN, AUSTRALIA, HAS BEEN BUILT UP PANEL BY PANEL AND HAS BEEN CONSIDERABLY EXTENDED SINCE THE TEST, ONE H. F. VALVE AND DETECTOR, TUNED ANODE COUPLED, WERE USED FOR THE TEST. BOTH VALVES BEING MARCONI DULL EMITTERS. AS NOW ARRANGED THE PANELS ARE:

TOP ROW: 1.—Aerial and closed circuit coils, series-parallel switch and single circuit-double circuit switch; 2.—First H. F. valve, with cut-out switch; 3.—First anode coil and condenser; 4.—Second H. F. valve; 5.—Second anode coil and condenser and reaction coil; 6.—Blank.

BOTTOM ROW: 1.—Aerial Tuning Condenser; 2.—Closed Circuit Condenser; 3.—Potentiometer; 4.—Detector valve; 5.—First audio (resistance coupled); 6.—Second audio (transformer coupled).

THE AERIAL USED WAS A SINGLE WIRE 140 FEET LONG, AND 12 FEET HIGH, RUNNING EAST AND WEST, LEAD-IN AT WEST END.

of these stations as is amply demonstrated by the logs submitted.

New Zealand Organization: The test committee at rather short notice, willingly and quickly organized for the reception and transmission periods in New Zealand. We wish to express our appreciation of the willing co-operation and help rendered by our neighbors.

American End of the Test: Very few experimenters in Australia and New Zealand realize what the organization of these tests has meant in America. The organization work was primarily taken up by the Radio Journal, Los Angeles, California, and the A.R.R.L. Australian experimenters wish to express their deep appreciation of the willing co-operation and hard work undertaken by these bodies. The American experimenters themselves are due for great praise for the wonderful manner in which they stuck to their transmitters during the whole test period. Australian experimenters will do well to remember that while they were receiving the signals of our enthusiastic American friends during the early part of the evening, the Americans were nodding over their keys at any where between one and five o'clock in the morning. It is this spirit which will put the amateur radio man in the forefront of all big radio moves.

Acknowledgements: We have to thank Messrs O. J. Neilsen of Bourke St. Melbourne, for the loan of a two-step Federal audio amplifier. This was used at the official station to make the wax records of 6KA signals. We also wish to thank the Dictaphone Company of Market St., Melbourne for the co-operation and help and the loan of one of their dictaphones. Lastly we wish to thank all experimenters in Australia who either took part in the test or co-operated by standing by during the period.

Final Remarks. We have no hesitation in stating that the tests have been an unqualified success and we trust that those American stations which have been logged will be rewarded for the time they have spent in preparing to get across.

It will be well here to say that should many American transmitters be disappointed in not having been logged, they will be repaid in any future tests if they will remember that their signals have to be read in many cases through strong QRN and QRM. The guide words for American transmitters in the next test should be: SEND SLOWLY, REPEAT CALL SIGNS FREQUENTLY, AND KEEP IN MIND THAT THE RECEIVER IS SEVEN OR EIGHT THOUSAND MILES FROM HOME. Every station that was read by Australian receivers was taken through intense static and inter-

ference and had it not been that the transmitting operators had frequently repeated their calls these stations would not been read at all

By following mail the record of 6KA's transmission will be sent to Los Angeles. This record would have been a good deal better but for persistent fading and bad static. We hope that it will serve, to American experimenters generally, to show at what strength a really efficient experimental station comes in over here. 6KA's note is a bad one to carry out an experiment of this nature on. We have proved that high pure CW notes if strong enough, record remarkably well.

Wishing every American experimenter the best of luck and continued success. Congratulations to all those experimenters whose transmitters have succeeded in getting across.

H. Kingsley Love,
For The Wireless Institute of Australia, Victorian Division.

Another amateur record was set during the trans-Pacific tests Australian amateur signals were read in America. Australian station 3BD was logged twice, once by Frank Creswell, Los Angeles, the reception verified by S. R. Florence, chief signal officer of the Pacific Electric railway, and by Y. Ito, 6ACW, Moneta, Calif. Australian 2CM was logged by M. J. Brown, Wailuku, Maui, Hawaii. These receptions check with official time submitted by Australia.

Australian stations on the air were 2AY, 2CI, 2CM 3AM 3BD 3BM, 3BQ, 3BY, 3DP, 3UX. New Zealand stations on the air were 2AC, 2AD, 2AE, 2AP, 3AA, 4AA. This record, details as to receiver etc., to come, sets a real mark. Next time it is hoped that scores will be logged "this way."

Summary of stations heard in Australia at 8 receiving stations during October tests.
1st. Dis. 1FM, 1AU, 1FV, 1VHT, 1UN.
2nd. Dis. 2JH, 2BM, 2AR, 2RV, 2BY, 2UN.
3rd.. Dis. 3AD, 3YP, 3AF, 3KL, 3NET.
4th Dis. 4JK, 4ZL, 4ER, 4LM.
5th Dis. 5BX, 5ZAV, 5NN, 5GM, 5MT, 5RL, 5PA, 5EC, 5ZS, 5ZM,, 5GO, 5AH, 5ZMK, 5AC, 5DIH, 5AFL.
6th Dis. 6ALV, 6ARB, 6AOS, 6ALW, ABK, ASU, AWT, AON, AT, AUU, AA ALB, ALS, AR, AF, ABO, BF, BBC, BC, BL, BPZ, BDI, BQL, BSR, BUC, BFC, BJQ, BYG, BO, BBW, BOL, BDS, BD, CMR, CBI, CPZ, CFZ, CGW, CMG, CU, CMP, CWE CH CPG, CKR, CM, CP, CA, CKP, CMI, DB, DBC, DKG, EF, EBX, FM, GBK, GKN, GNR, II, IZ, KA, KL, KJ LL, LX, LWW, MG, MGT, MB,

MG, MGT, MB, MU, MO, NW, NG, NX, OS, PLA, PL, PCC, PLZ, PLC, RX, TS, TR, TCZ, UA, VA, VJT, WK, XP, XL, XAR, XAD, ZI, ZL, ZH.

7th Dis. 7AR, AL, AJ, AMR, BO, BLT, BD, BZC, DT, FT, HG, HW, IL, LC LF LE, LR, LBP, UU, UY, VH, ZD, GBL

8th Dis. 8AD, AQ, AGN, AVV, AOO, ARL, BW, BY, BAK, CGE, FU, FZO,, GZ, GF, MZQ, PA, RM, VY.

9th Dis. 9AIM, AVU, BAK, BZI, BRK, BYT, CPR, CL, CAH, CHN, CGL, CK, CTR, DFH, DCH, DQ, DK, DEH, EV, EY, EKY, EEA, KY, KK, KM, LW, LU, MC, NK, RD, RK, ZN, ZX, ZT, DUR.

Stations heard in New Zealand. Heard at 1AC using single valve. L. S. Spackman, 50 Wanganui Ave., Auckland. — IAA, 6XAD, 6SH, 6CMU, 6CFI, 6KA, 6SE, 6ARB, 8RK, 9ZT, 9AMX, 9PFZ, 9AWM, 3XAJ, 4CPE.

Heard at 4AA, F. D. Bell, Shag Valley, Waihemo Otage, N. Z.—1KC, 2CXL, 3ME, 3ALN, 5HT, 5IF, ZAV, FK, OV, BE, HL, AIU, 5ADB, LR, 6CHL, CU, AUY, AWT, ANB, ZI, ISJ, BFP, AOI, RO, CKP, BQL, CEJ, ILV, ACM, CMI, GX, UP, FF, FH, BIH, BFS, CBB, CEF, AO, BYE, MG, 7KS, 7HG, AFE, WX, DC, SPD, 8BDA, VY, FU, PW, XAN, RJ, 9BTL, 7GU, AUY, BQJ, DKY, BZI, AUS, AOU, BIK, AWG, VM, AOM, AAU, AAS, EHI, AED, AVN, CAH, ZV, CTN, DWK, EH, EKY, MC, Can. 5CN.

Heard at 2AC. I. O'Meara, Box 30, Gisborne, N. Z.—2BY, 2AFP, 5DW, ZAV, NN, 6TS, AGW, XL, ZQ, BSG, BGC, CKR, MZ, CGR, MH, BCR, CBW, CWR, ASX, ZV, AOS, ALK, ZA, BEO, KA, ARB, CU, BIH, CFZ, PL, BBC, CMR, BVG, CGW, 8XE, 8BDA, 9BAK, BM ABI CLY, BZI, MC.

Australian receivers giving number of stations received.—3BQ, Maxwell Howden, Hill St. Box, Hill, Victoria, Australia, using 3 valves; heard 102 stations.

3BM, JU, BY, Ferncroft Ave., E. Malvern, Victoria, operated by H. K. Love. Ross A. Hull and H. Holst, using experimental receivers of 2 and 3 valves heard 71 stations.

A. J. Holland, St. Kinnord, St. Essenden, Victoria, using 2 valves logged 34 stations.

E. H. Cox, Elsterwick, Victoria, using 3 valves logged 20 stations.

2CM, C. D. Maclurcan, Brisbane St., Sydney, Australia, using one valve logged 12 stations.

7AA, T. Watkins, Warwick Street, Hobart, Tasmania, Australia, using 3 valves logged 12 stations.

W. S. Breden 26 Joliment Terrace, East Melbourne, Victoria, using 2 valves logged 11 stations.

2ZZ C. Smith Cabramatta Rd., Cremorne, Sydney, Australia, using one valve logged 5 stations.

Many other logs not yet received.

Trans-Atlantic Tests

Near the close of the trans-Atlantic amateur radio receiving tests, organized by the American Radio Relay League, about 150 amateurs throughout North America had reported hearing signals from European transmitting stations and A.R.R.L. headquarters was still besieged with letters and telegrams from every part of the country. With only part of the results obtainable, F. H. Schnell, traffic manager, announced that calls of 35 Europeans had been verified.

Radio Exposition a Big Western Event

Probably nothing points more directly to the place assumed by the Pacific Coast in radio than the big exposition at the Biltmore hotel in Los Angeles. Not only does it mark the progress of radio on the coast, in making it the location of an annual national event, but it will prove a stimulus to renewed endeavor on the part of Pacific States to secure the position to which their genius and initiative entitle them in this new field of human endeavor.

THE second annual radio exposition, at the Biltmore hotel, Los Angeles, February 5 to 10 inclusive, promises to place radio in the dignified position to which it has consistently aspired these several years. On the eve of the big event there is every indication that the event will rank with the two other national expositions held within the past year, the one at New York and the other at Chicago. In fact, in many respects, the current exposition in Los Angeles promises to outdo the others in the quality of the products shown and the new inventions to be on display.

Never has an exposition of this type been held in more beautiful surroundings. The distinction of the Biltmore hotel ballroom, where the exposition covers the main floor and balconies, lends the proper background to an industry which has already taken its place among the largest of the nation.

Long before the date of the show every foot of floor space was reserved and many exhibitors were at work preparing the displays. Many of the country's largest manufacturers have taken large booths and the man or woman interested in radio is certain to find much of interest and a whole year full of real information condensed into this six day exposition. But the exhibits are not all.

An extensive program of addresses and special music has been arranged for each day. Contests will also enliven the event. Each purchaser of an admission ticket will be given an envelope and instructions for the criticism contest. He may write a constructive criticism of any exhibit, or of the whole exposition, and turn it in, in competition with others, for the daily prize of twenty-five dollars to be awarded by the management.

Among the exhibits will be manufacturers, jobbers and retailers, with the manufacturers probably predominating. The Radio Association of Southern California will have a booth wherein they will endeavor to get the listener-in's attention directed toward the problems of the operating "ham" and establish contact for better mutual understanding in days to come.

Two new receivers, involving new circuits and a new principle of reception, will be displayed by the Kilbourne & Clark Manufacturing com-

pany. The same company will probably also display naval and mercantile marine sets, as they are supplying a large portion of the mercantile marine and navy equipment. A complete line of parts will be included.

The Cutting & Washington Radio corporation will display their four models, Mr. E. F. Hussey being in charge of the exhibit.

The Gardner Laboratories will have on display their unique single control, two circuit set.

The Radio Concert Equipment company will feature a number of lines, Allen Bradley, F. A. D. Andrea, Alden Mfg. Co., Burgess Battery Co., Carter Radio Co., Comet Battery Co., Diamond State Fibre Co., Dubilier Condenser, Federal Telephone and Telegraph Co., Gilfilan Bros., Inc., Dictograph Radio Corporation, Yale Electric Corporation, United Radio Corporation, Workrite Radio Corporation, Nathaniel Baldwin, Inc., Signal Electric Co., Electrical Research Laboratories, Shamrock Mfg. Co. and many others.

The Willard Storage Battery company and the Western Auto Electric Corporation will display a complete line of rechargeable A and B batteries.

The Workrite Manufacturing Company plans to display the latest improvements on the neutrodyne as recently perfected by Professor Hazeltine, together with various neutrodynes, including a handsome console model.

Among the other exhibitors will be: Signal Electric Mfg. Co., Barker Brothers, A. H. Grebe Co., Fitzgerald Music Co., Electric Equipment Co., Radio Corporation of America, Leo J. Meyberg Co., Carl A. Stone Co., B. Kruger & Co., Kilbourne & Clark, Inc., Radio Journal Publishing Co., Newbery Electric Corporation, Kierulff & Ravenscroft Co., Gardner Radio Laboratories, Radio Sales and Service Co., Radio Concert Equipment Co., Yale Radio and Electric Co., Kay & Burbank Co., Eclipse Mfg. Co., Colin B. Kennedy Co., the Wireless Shop, Stanford Electric Co., Bristol & Co., Tune Sharp Radio Co., Atwater-Kent Co., Adams-Morgan Co., Dubilier Condenser Co., Magnavox Co., Braun Corporation, Radio Products Co.

J. C. Johnson, manager of the exposition, has just received word from

the company's New York office that Los Angeles has been definitely selected as the site for coming national expositions.

This decision was reached as a result of the splendid co-operation which has been accorded this year's National Radio and Electrical Exposition. Mr. Johnson advises that in all of his experience with shows in various cities of the United States this is the only one where the entire floor space was sold to exhibitors as early as a month preceding the day set for the opening of the exposition. No better evidence that Los Angeles is the radio center of the west could be desired.

The extensive scope this exposition embraces is indicated by the fact that radio manufacturing companies from as distant a point as Massachusetts are coming out here to participate. In fact, there is scarcely any community of importance that caters to the radio industry which will not be represented at this event.

The exposition committee, which is composed of the following men: Mr. A. G. Farquharson, chairman; Mr. Hartley, Mr. Braden, Mr. Scull, Mr. Schifferman, Mr. Anthony, Mr. Daggett, Mr. Lawrence, Mr. Ricker, Mr. Welke, Mr. Dennis, also announces that they anticipate Mayor Cryer—his health permitting—officially to open the exposition with suitable remarks, and that active steps are now being taken to line up a group of interesting speakers each day that the exposition will be open.

Winners of the recently held radio poster contest are:

First prize, C. M. Mayer, 3211 West Fifteenth St., Los Angeles; second prize, Miss Florence Van Sant, 461 West Lexington drive, Glendale; third prize, John Edward Asher, 5872 1-2 Brenwood street, Los Angeles.

According to the director general of telegraphs, an increasing number of requests have been received lately for permits for the establishment of radio broadcasting and receiving stations, says a report from H. Bentley McKenzie, assistant trade commissioner, Mexico City. Broadcasting stations are now subject to a tax of 100 pesos a year, and receiving stations to a tax of 5 pesos per year.

A Simple Set with a Wonderful Wallop

By T. E. NIKIRK

Here's a simple set for simple folks—no that was a slip. It's a simple set for all kinds of folks. Fact is the blamed thing is selective enough to pick out your wife's spring bonnet with some left over; unless your wife's bonnet money is going for tubes this season. We never thought of that. Maybe we have started something, but it is too late to take it back. Anyhow Mr. Nikirk has a set here which will curl the hirsute adornment on an Arkansas razor-back.

THE set I described in last month's issue didn't quite satisfy me so far as simplicity and operation was concerned, so one of simpler design was the result. A few taps were eliminated from both the primary and secondary. An eighty turn secondary, spaced as described in the last issue, with only two taps taken off, one at forty and one at eighty, seemed to cover all wave-lengths from 175 to 750 meters. The primary was tapped at twenty, forty and sixty turns.

The primary was wound on a four-inch tube, and was not space wound. The length of the tube was two inches.



It was split, leaving approximately one-quarter inch space in the center, through which a 3-16 inch rod was placed, fixing the coils so it was possible to revolve it as the secondary of a variocoupler. The three leads were made about seven inches long and

a large loop was taken from the inside of the coil, the end of the loop being fastened to the tap post on the panel. As the rotor was shifted a quarter turn or so this loop allowed plenty of



play. The three-sixteenth brass rod was eight inches long. On the back end of a piece of No. 14 copper wire one inch long was soldered and the wire was shaped to the curve of the

with sealing wax to keep the cardboard tube from sliding to the front, back or side. A bracket, extending three inches from the back of the panel, was made in a sort of V-shape, flat at the ends and flat at the apex or peak.

Holes were drilled in the ends large enough to fit a 8-32 brass screw. A 3-16 inch hole was drilled in the flat place in the center to fit the 3-16 inch brass rod.

The tickler coil was wound, using thirty turns, and was not space wound. The method of mounting is shown in the photos.

Fixing up the B Battery

Many fellows using storage "B" batteries have complained about storage

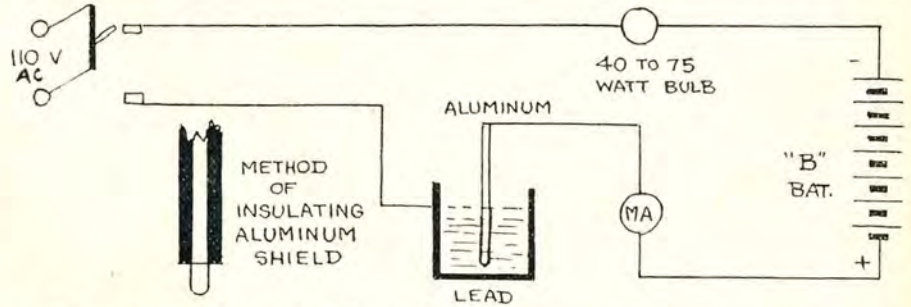

tube. The rod was then pulled through until the copper wire rested on the space between the two halves of the winding. The space was then filled

"B" batteries being no good. Using one myself, my first experience was the same. The difficulty was that the battery would remain charged only two or three weeks, which seemed far from normal. The trouble was either that the battery was not receiving a good charge, or it was not in condition to receive a charge. As each cell was mounted in glass, it was easy to make an inspection. All the cells seemed to be in good shape. A millimeter, reading zero to 300, was then inserted in the charging circuit and a reading of thirty milliamperes was shown, this being all the direct current the battery was receiving.

After talking this over with N. E. Brown, consulting engineer, technical advisor of the Southern California Radio Association, etc., he suggested that I reduce the amount of aluminum in the chemical rectifier. A three-eighths inch aluminum rod, approxi-

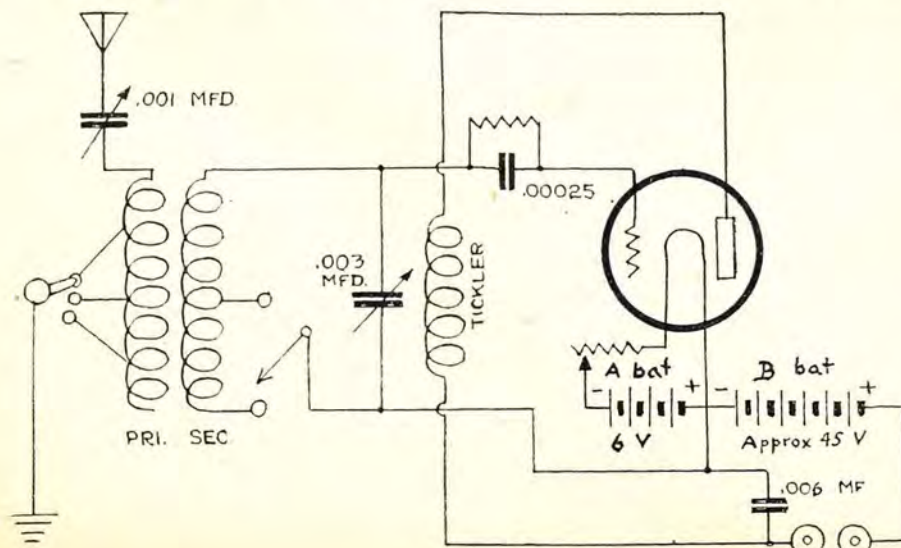

(Continued on Page 19)

More About Building the Synchrondyne

By S. R. FLORENCE, Chief Signal Officer P. E. Ry.

Little things sometimes mess us all up, as the man said when baby bit him with a hatchet. The Synchrondyne created a lot of interest, folks, but many a fan was puzzled because the photos last month gave four tubes and the diagram only two. Of course the two additional tubes were only standard amplifiers but—we give the whole thing this month. Also some more help on building it.

SO many experimenters have been successful in the construction of the circuit described in my last article, the December Radio Journal, that I have been asked to write another, going a bit farther in the mechanical construction of this little wonder receiver.

Due to the fact that long distance reception may be brought in through local reception without the attending

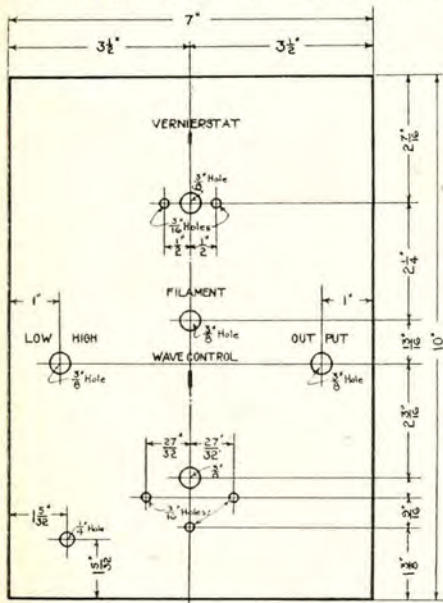

FIG. 2—PANEL LAYOUT IN DETAIL.

distortion and squawks and squeals which are an inherent characteristic of so many new circuits. This circuit has not only been a success in this immediate locality, but has proven up in practically every part of the United States, and although Los

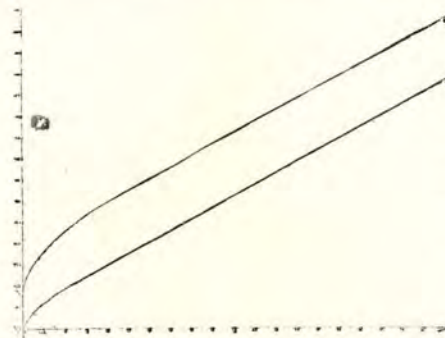

FIGURE 4.—GRAPH OF CURVE SHOWING PERIODICITY OF SET. A LONG WAVE B. SHORT WAVE. ED. NOTE: NOTHING IS SAID OF THE MARCEL OR OTHER WELL KNOWN WAVES.

Angeles is a particularly difficult place for long distance reception, I know of one installation at the New Ritz hotel which is approximately two city blocks from Radio central station KFI, where KGO has been brought in very clear and distinct, without even a noticeable whisper of KFI in the head phones.

In the last issue of Radio Journal I showed a photograph of the set and gave a circuit in the set showing four tubes, and in the drawing only two. A great number of people have attempted to construct a two-circuit receiver with four tubes. The circuit which I showed was merely the receptive circuit, and the other two tubes shown on the set were two steps of standard audio frequency amplification.

This month I am giving the reader the complete circuit of the four-tube receiver. This article is merely for the advance of the science of radio.

I personally enjoy and spend much of my time on scientific experimentation in radio broadcast reception, and this little wonder is the latest and best circuit that I have been able to find among them all. I make this statement because I am convinced that the apparatus required for broadcast reception today must be of unit control,

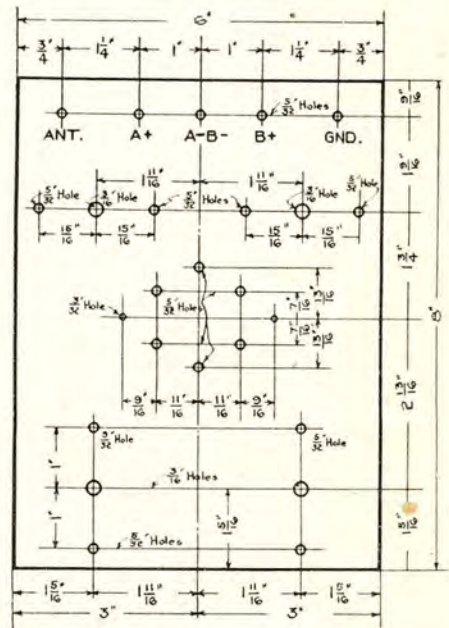

FIG. 3—SUB-PANEL LAYOUT IN DETAIL.

must work on a small antenna, and must not re-radiate. These three factors are embodied in this circuit.

Now to get to the important details of adjustment on the installation of a set of this type. The most essential

(Continued on Page 45)

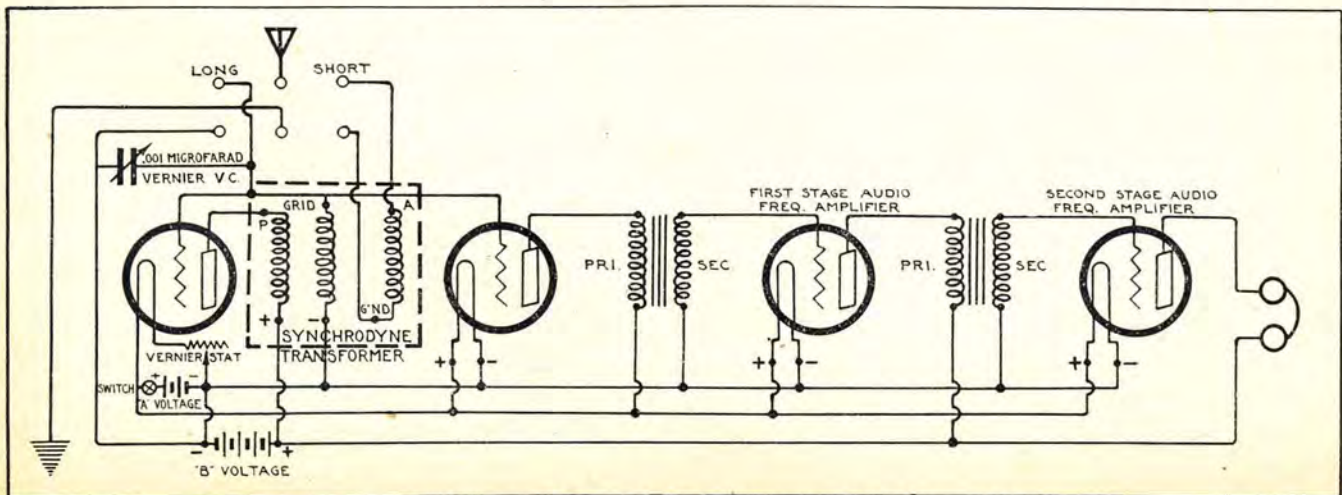

FIG. 1—SYNCHRODYNE WITH TWO STEPS OF AUDIO FREQUENCY.

Electrical Units and Fundamentals

By PROF. H. La V. TWINING

WHEN it was discovered that an electric current flowing, in a closed circuit, would deflect a compass needle, it was immediately seen that so called strength of the current could be measured.

Also, when it was found that two plates, carrying a static charge, would exert a force upon each other which could be measured, it was seen that this force and the difference of potential between the plates, were connected in some mechanical way, but it was a great many years before these relations became known.

The former furnishes means for calibrating ammeters and the latter for calibrating voltmeters.

In order to effect these calibrations it is necessary to define and give name to units of measurement which seem to be of a different order from the usual mechanical units.

The metric system of units is used in all scientific work, because of its great convenience.

This is called the centimeter, gram second system or the C. G. S. system.

lated to these units in order to measure electrical energy.

The fundamental electrical unit is the unit static charge.

1. A unit static charge is one that exerts a force of one dyne upon an exactly similar charge at a distance of one centimeter.

The dyne is $\frac{1}{980}$ of the gram.

2. The dyne is defined as that force which gives a velocity of one centimeter per second to one gram in one second. It is therefore a gravitational unit of force. At the equator a mass will gain a velocity of 980 centimeters per second in one second so that the dyne is $\frac{1}{980}$ of a gram.

3. A unit electro-static field is one that exerts a force of one dyne upon a unit charge placed in it.

Now a unit charge is imagined at the center of a sphere, having a radius of one centimeter.

The area of the sphere is

$$A = 4\pi R^2 \quad [1]$$

Where R is the radius and A is the area in square centimeters. If R is 1, then

$$A = 4\pi \text{ sq. cms.} \quad [2]$$

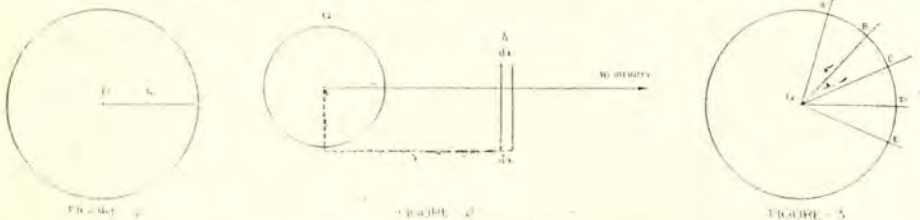

When electrical units are expressed in this system they are said to be expressed in absolute units. i. e. resistance, inductance and capacity can be expressed in centimeters instead of ohms, henrys or farads.

The meter is defined as the one ten-millionth part of the distance from the equator to the poles on the meridian passing through Paris, France. This distance was very accurately measured. A platinum bar was made and the distance thus found was laid off on the bar when at zero degrees centigrade, scratches being made on the bar at each terminal of this distance.

The meter is very nearly 3.27 feet or a little over a yard.

One one-hundredth of the meter is called a centimeter.

The mass of a cubic centimeter of water at 4° centigrade is taken as the unit of mass or weight. It is called the gram. The second is $\frac{1}{86,636}$ part of a sidereal day or $\frac{1}{86,400}$ part of a solar day.

These units are not convenient for measuring electric quantities, but it is necessary to choose units that are re-

Thus we can imagine all the lines of force emanating from a unit charge to be composed of 4π groups.

We can call each group one line of force and we can arrange this unit charge to such a value as to cause this one line to exert a force of one dyne upon a unit charge placed upon it. This would give a unit field per square centimeters, at a distance of one centimeter from the unit charge.

This arrangement also fits the original definition, because the point charges would be one centimeter apart and they would exert a force of one dyne upon each other at that distance since either would be a unit charge in a unit field one centimeter apart. Hence the following universal formula applies:

$$F = \frac{U_1 U_2}{d^2} = \frac{1 \times 1}{1} = 1 \text{ dyne} \quad [3]$$

The capacity of a sphere can be found as follows: Let Qk be an electro-static charge on the surface of the sphere. Let A be the area of the sphere in square centimeters. Let ρ be the density of the charge on the sphere, then

$$Qk = As \quad [4]$$

Let Ck be the capacity of the sphere in C. G. S. or absolute units, then

$$Qk = Ek Ck \quad [5]$$

Where Ek is the electrical potential on the surface of the sphere, all in C. G. S. units. Whenever the subscript k is used it denotes absolute electro-static units. Then

$$Ck = \frac{Qk}{Ek} \quad [6]$$

It is now necessary to define and find the electrical potential Ek.

The difference of potential between two points is defined as the work in ergs necessary to carry a unit quantity or a unit charge from one point to the other against the existing opposition.

The potential on the charged sphere then is expressed in terms of the work in ergs necessary to bring a unit charge from infinity up to the surface of the sphere bearing a similar charge. The full meaning of volts, potential, difference of potential and fall of potential will be fully explained as this development proceeds.

Since work is equal to force times distance, suppose that the unit charge has been brought from infinity up to the point A fig. 2, a distance d from a charge Q on the sphere, bring it a distance dx toward the sphere, then

$$dw = F dx \quad [7]$$

Where F is the force produced at the point A by the field of Q and—

$$W = \int_R^{00} F dx \quad [8]$$

Where W is the total work in ergs to bring a unit charge up to a distance X from Q unit charges

$$\text{but } F = \frac{Qk U_1}{X^2} \quad [9]$$

Substitute this in [8] then

$$W = \int_R^{00} \frac{Qk U_1 dx}{X^2} = Qk \int_R^{00} \frac{dx}{X^2} \quad [10]$$

Since $U_1 = \text{unit charge} = 1$ hence

$$W = Qk \int_R^{00} X^{-2} dx = Qk \left[\frac{X^{-2+1}}{-2+1} \right]_R^{00} \quad [11]$$

$$W = Qk \left[\frac{X^{-1}}{-1} \right]_R^{00} = \left[\frac{Qk}{X^1} \right]_R^{00} = \left[0 - \frac{Qk}{R} \right] \quad [12]$$

$$W = \frac{Qk}{R} \text{ i. e.} \quad [13]$$

The charge on the sphere divided by its radius is the work in ergs necessary to bring a unit charge from an infinite distance up to the surface of the sphere. By definition this is the

(Continued on Page 38)

An Efficient Single Tube Receiver

By A. L. MUNZIG

FOR those who wish to construct a receiver that is quite simple and yet very sensitive, the following description will be of interest. The parts necessary for this receiver are as follows:

- 1 UV199 or C299 tube.
- 2 Variometers.
- 2 .00025 MF. fixed condensers.
- 1 VT socket.
- 1 .001 phone condenser.
- 1 30 ohm rheostat.
- 1 pair phones.
- 8 binding posts.
- 1 7x12 panel.
- 1 pine sub-base 6x11.
- 2 No. 6 dry cells.
- 1 22½ "B" battery.

The circuit is shown in Fig. 1. It will be seen that two variometers are

In its February issue Radio Journal will publish a new circuit by Mr. Munzig, to be known as "The Munzig Circuit." It combines the use of tuned radio-frequency reflex with regeneration. Mr. Munzig claims it to be the super-heterodyne's closest second and insists that it outperforms the neutrodyne six different ways. Photo of the completed receiver and detailed instruction for building will appear in the February issue. Oh, Boy!

that the placing of parts can be seen. It will be noticed that both variometers

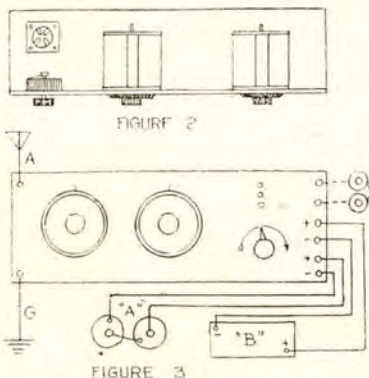
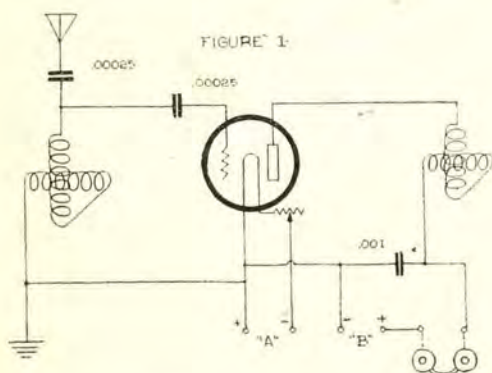

used, one for wavelength control and the other for regeneration. The use of a variometer in the plate circuit allows regeneration to be controlled much easier than if a tickler coil were used.

In Fig. 2. is shown a rear view so

are in juxtaposition. The reason for this is that it is desirable to place inductances in the plate and grid circuits in close proximity to take advantage of the radio-frequencies present.

Panel arrangement is shown in Figure 3.

Use Precious Metals for Contact

By DR. J. B. BUEHLER

AMATEURS who are doing experimental work can improve reception materially by setting up, in their workshop, a small copper cage. I have been surprised at the increased value in various sets when worked within this copper cage. Evaluating this improvement on the basis of at least ten per cent it has been interesting to take the same set outside the cage and, with all other factors the same, note the difference in reception. If you want a new thrill from the operation of your set, play with a copper cage and distance will bring more enchantment.

Another advantage which is being revealed in experimental work which I am now conducting with various sets

is the use of the rare metals, gold cat-whiskers, silver contact points and connections, and similar devices of platinum. These, I find, make a material improvement in all types of circuits. In fact there is almost no limit to the manner in which the more precious metals can be used to improve reception, but this is particularly true of all contact points and connections.

Another improvement which developed co-ordinately with the foregoing experiments has been the use of the same size wire throughout a set. When I began to pay attention to the size wire and bus bar used in wiring a set it occurred to me that there should be considerable advantage in keeping this factor constant. Experiments proved this to be true, and I

have found it to improve reception materially.

Here is the point. Given a set on which reception would normally rate at some figure, say 30. Suppose by the use of a copper cage we increase reception five, by the use of gold and silver contacts, etc., we increase it five more, and then by the use of a wire standard we increase it five more—we have increased the efficiency of the set fifteen or more and with little cost. In fact it will exceed this.

Any questions on this phase of set development will be gladly answered if a self addressed envelope is included. Write care of the Radio Journal.

Dr. J. B. Buehler, who here gives some valuable hints on how to add efficiency to any set, knows whereof he speaks... He was associated in experimental work, with M. B. Sleeper, prior to removing to Los Angeles. Dr. E. E. Free and Arthur Lynch have also been in close touch with Dr. Buehler's experimental work, in which he has worked with John Mills of the Western Electric Corporation, author of "Within the Atom." Since locating in Los Angeles Dr. Buehler is devoting most of his time to research along the lines of radio frequency for the development of hearing for the deaf.

San Diego Club

(Continued from Page 11)

and has no dues, there is no question but that all interested in the art of radio, no matter from what angle, will become members of the organization. In the opinion of Mr. Daney actual business will be a rarity. Two of the primary functions of the club, as he sees it, will be in the arrangement for educational programs, and second, action upon the reports of the QRM or "interference committee" with a view to policing the local ether. As matters now stand in San Diego the radio situation has rosy prospects.

San Diego Radio Club extends greetings to all other radio centers and hopes that efforts will be made to organize the listening public into similar clubs. Individually we can do little but as we all know in union there is strength. We are but exercising our prerogatives when we assert ourselves as desiring this or that reform, correction, or advance in legislation.

Finally the public owes everything in amateur radio—broadcast or otherwise—to the experimenting amateur. The American Radio Relay League is the National organization of amateurs which has coordinated the amateur game to date.

How to Test Your Headphones

By E. J. BAUGHMAN

There is nothing phoney about this phone article. It will hit you right in the diaphragm. Seriously, we didn't know so much fun could be had with a pair of cans. Anyhow, Mr. Baughman herewith gives us an idea of what to find out about head phones and how to find it out; a valuable job well done, as the gentleman said when the undertaker had finished with his mother-in-law.

A BOAT without a rudder or a ship without a sail would mean as much in the line of usefulness as a radio without phones. In an aeroplane the wings sustain the weight, the engine furnishes power but the propeller furnishes the means of delivering the power. Likewise a radio may be divided into its three components, the aerial, the set and the phones.

Phone manufacturing is older than the automobile industry, and is on the same plane with it as far as standardization and quality of product. Just as there are many makes of cars in the automobile industry there are many makes of phones, nearly all of which are good products. Some have longer life, some give greater volume, and some are more comfortable on the head.

Radio phones have developed from telephone receivers. The telephone receivers are wound for low resistance and carry a strong current while the

click will result in a sensitive pair of phones. Next take off the ear piece cap and remove the thin metal disc or diaphragm and hold its edge against the pole pieces held in an inverted po-

An audibility meter may be made using two coils of any convenient diameter having ten turns of wire each. One coil is fastened at one end of the rule (Fig. 2) and is connected in

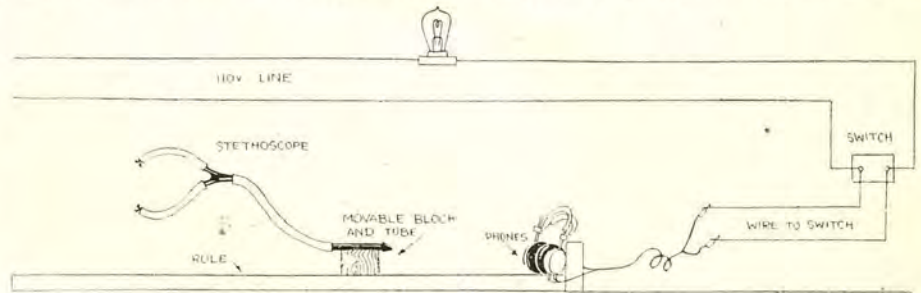

Fig. 1

sition. The magnets should be strong enough to hold diaphragm suspended from its edge.

A rough intensity meter can be made as follows. Connect two leads to the wires running to a 110 volt lighting circuit switch. Touching the ends of the leads together will produce the same result as turning on

series with a buzzer. The two ends of the other coil are connected to the phone to be tested. With the buzzer circuit in operation the coil connected to the phones is moved away from the coil at the end of the rule until signals become inaudible. The distance between the two coils will then be a relative value of the phones audibility.

Good permanent magnets are essential. A method for testing the relative magnetic intensities of different phones is described in Fig. 3. A four inch silk thread is fastened to a very small needle at both ends and the center of the thread is held by a pin stuck in one end of the rule. An individual phone is held upright by a block of wood and the needle placed against it. The phone is then moved away leaving the needle in suspension. The gap is increased until the needle falls. The maximum distance the phone magnets will hold the needle will be a relative measure of the phones magnetic intensity.

In the three relative tests just mentioned a pair of Western Electric phones will furnish a good standard to calibrate other makes by.

The next article will deal with charting, resistance measurements, impedance curves, etc., of all phones on the market today.

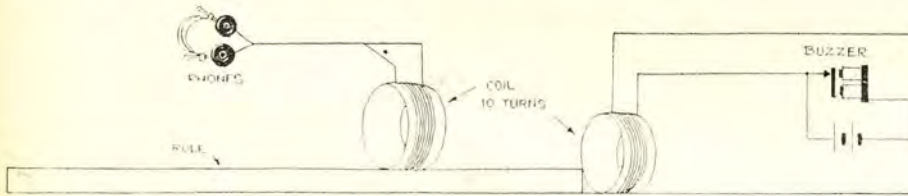

Fig. 2

radio headset is of high resistance and is actuated by a very weak current. The worth of a radio receiver should not be judged by the ohmage or resistance it is rated at, as some phones are wound with high resistance wire having few turns on the coils instead of low resistance wire having a great number of turns, the latter being considered the more efficient method.

How to Select Good Phones

If you are picking a phone for broadcast reception, one which will be worn two to four hours a day, look first for one that fits comfortably on the head. A light head-set having small phones and a headband that is easily adjusted will fill the above requirement. The next consideration will be the sensitiveness of the set, which can be quickly determined by two simple tests. Place the phones over your ears and touch the two phone tips to your tongue. A faint

the switch. Touch the two leads to the two phone tips. A good phone will produce a loud buzzing sound. In connection with this place the phones on one end of a rule (Fig. 1) and a block bearing a glass tube tapered to a small opening and having a stethoscope arrangement on the other.

With the phones buzzing and the stethoscope on your ears move the block away from the phones till the sound produced becomes inaudible. The distance between the phone and block will then be a relative measure of the phones intensity.

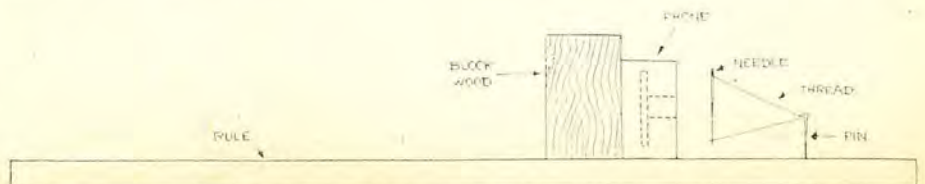

Fig. 3

How About Your Antenna?

By M. CHAS. GOODMAN

THE antenna is a very important feature of your radio installation, and as a rule it receives only passing consideration. It is my intention to hit a few of the high spots on the subject with the idea that possibly a few "fans" may be benefited. For those who have as yet not contracted "distance fever" these remarks will

Some folks may think we are stringing a lot about antennas, but, believe us or not, as the bank robber said to the cashier, the antenna is the tail that wags the dog. Mr. Goodman, radio engineer with Hayden's Electric Service, has turned 'em inside-out several times for our inspection.

not apply, but those who do desire long distance will do well to consider the subject of antenna installation with some care.

Generally speaking, one of the important points connected with proper antenna equipment is well soldered joints. When you bear in mind that the amount of energy conveyed through the air to your antenna is so slight as to be difficult of measurement, you can realize the necessity of preventing all possible leakage from faulty connections.

The installation should be selected carefully. Each insulator should be free from lines or breaks that might retain moisture, and it is not a bad idea to be liberal with the use of insulators, using two instead of one on the antenna proper, spaced about 16 inches apart. A tube of porcelain or other acceptable insulating material should always be used to convey the lead wire into the house.

Another feature frequently overlooked is that of "staying." If you want a steady volume of signals, by all means guy your aerial and poles, and half of your trouble with swinging signals will be overcome. Should a tree be used as one support, a coiled spring should be employed to provide even tension during windy weather.

Antenna wiring in a city is a much more complicated problem than it is in the country. The trouble caused by leaky transformers, by high voltage lines, and even ordinary electric wiring, is quite tangible. It is well to keep antenna and all lead in wires as far from other wiring as possible. Distance from and direction of broadcasting stations make a difference in reception. If you don't believe it, ex-

periment, and you will discover that in a city better reception can be secured from one room than from another. Why this is so is not always clear. Of course local broadcasting will come in with ample volume at almost any point, but I speak of getting distance.

A rule that invariably proves true is that the more the natural period or the longer the electrical length of an aerial, the broader a receiver will tune. Consequently, in many cases, you can sharpen your tuning by decreasing the

fundamental wave length of the antenna. But here comes a problem. The longer the antenna, the more energy it absorbs, so it is necessary to arrive at a compromise to find the exact point at which there is the greatest efficiency.

Our organization has found it expedient to consider a great many different and apparently diverse features in installing an antenna for dependable long distance work, and we believe the designing and building of aerials will become a job for experts as radio science advances.

Absorption losses decrease with the height of an aerial, and it should be at least 20 feet above the ground.

(Continued on Page 49)

The Radio Wee Gee

L EON A. MORGAN, 1839 Maltman Avenue, Los Angeles, Cal., has invented what he terms The Radio Wee Gee. Here is the way he describes it:

I have had lots of fun out of this.

CARD BOARD

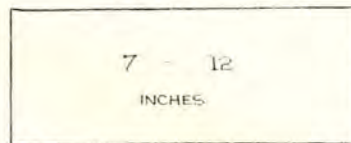

TIN FOIL

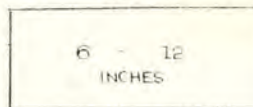

TIN FOIL LEFT END

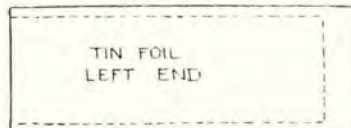

CARD BOARD CENTER

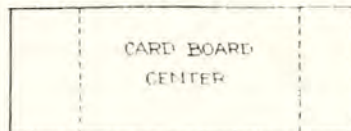

TIN FOIL RIGHT END

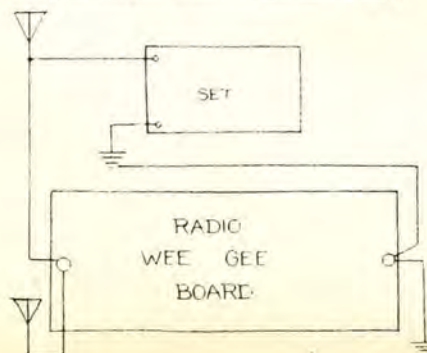
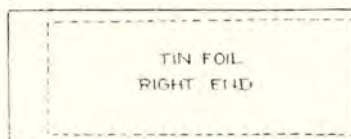

It is only for crystal sets. Cut from thin cardboard a base piece 7 inches by 14 inches. Then cut a sheet of tin foil 6 inches by 12 inches. Lay this on the cardboard with one end of the tin foil even with the left end of the cardboard. Then cut a piece of cardboard 7 inches by 10 inches and place it in the center of the board, leaving two inches on each end. Then cut another sheet of tin foil same size as the first and place it on top, but with one end even with the right hand edge of the baseboard. Then cut another cardboard for the center and another tin foil for the left side and another cardboard and another tin foil and so on until five sheets of tin foil have been placed. Then a last piece of cardboard should be cut 7 by 14 inches and placed on top. Shunt this across your ground and aerial before you get to your set.

Or this may work better: Take four strips of thin board or fibre half inch wide and 7 inches long and put them on the ends of the contraption to hold the ends together. Before making them tight slip two bare wires in between the foil on each end. Connect one on each end to the ground and aerial, then hook ground and aerial to the other two ends.

Then press the finger tips on different parts of the board. In one place you may bring in KFI, or any other local station wherever you are, or you may bring in KHJ or any number of nearby stations, one at a time. It acts like a Ouija board. One can get a lot of fun out of it bringing in various stations by simply pressing on the board in a different place.

If the reception does not come in clear take out a sheet of foil. You will have to adjust the set to bring the reception in clearly with this Wee Gee hooked on. But it will repay you for the trouble in fun.

The Harvest of Crystal Hookups

We will have to postpone that funeral for the crystal set, probably indefinitely, owing to the fact that the central figure to the obsequies insists he is not deceased; not even ailing in fact. We suspected so right along, but so many of his erstwhile friends had assured us of his demise that we were fully prepared to drop an opalescent tear, whatever that is, upon his bier. And then we held a crystal hookup contest and discovered that Mr. Crystal is getting his three squares per day at the same old stand, only healthier than ever

NOW friends, we have been fiddling around with tube sets so much that some of us have almost forgotten the existence of the crystal set, yet we are here to assure Radio Journal readers that there is a vast throng still building crystal sets. How do we know? Because we staged a little contest for crystal hook-ups to find out. We also found out a lot of other

things, such as: that it is a wise judge who knows which to pick out of a mail sack full of crystal hookups; that there is a lot of ingenuity left in America which has been devoted to making the crystal set a real set; and lastly that there are thousands who are taking their first steps in radio via the W. K. crystal.

We are publishing some of the best here, just to give those interested in crystal reception an idea of the variety,

and possibly the different objects, which can be attained in crystal sets. Now who ever heard of feed back regeneration in crystals? Can't be did, you say. Can, says the winner of first prize, George L. Moxley, and he proves it by building one. Claude Peters, winner of the second prize, has devised a hookup which is so blamed selective that there is nothing blamer. Likewise William Scheel built another which looked so good to the be-

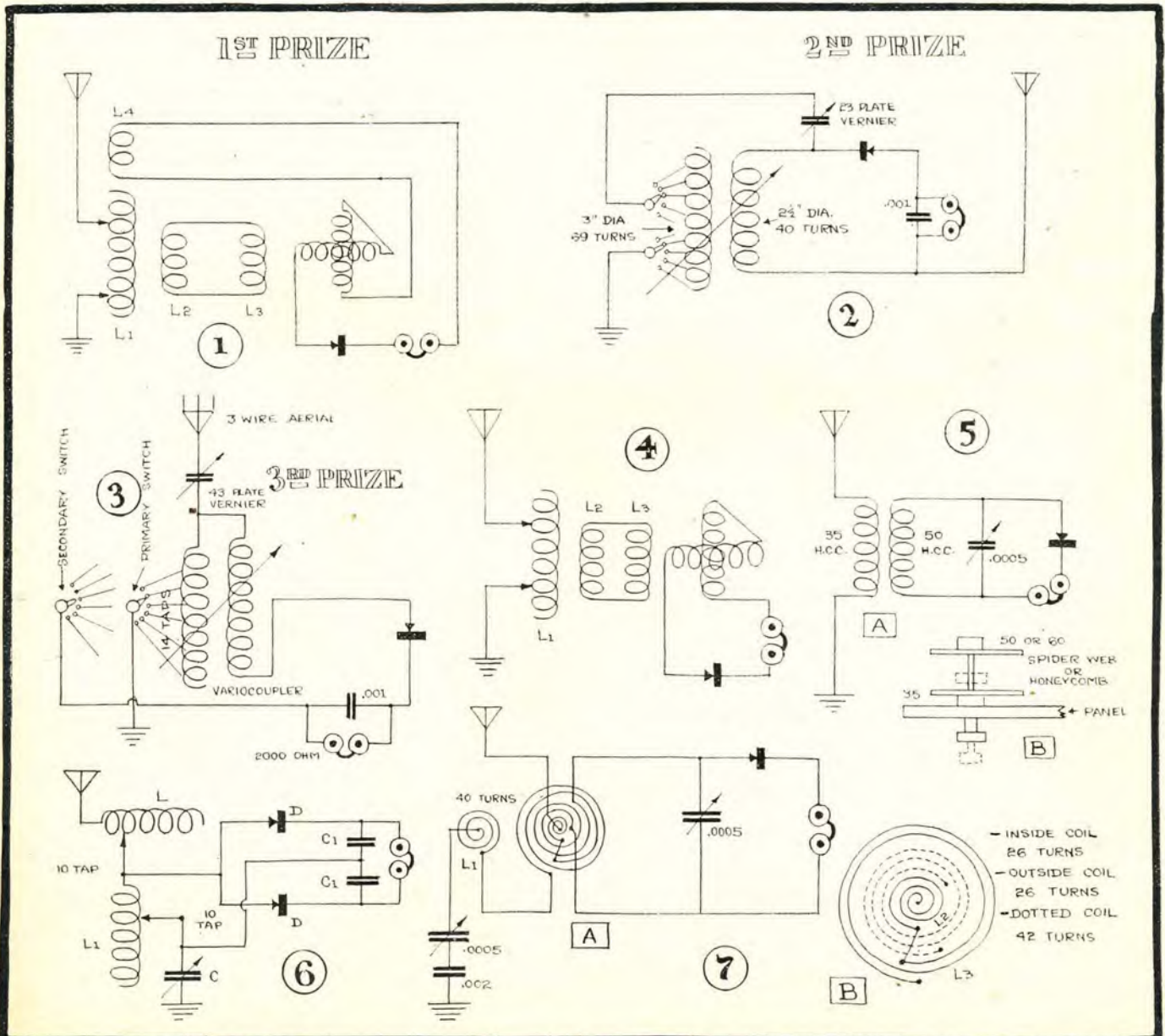

1—GEO. L. MOXLEY, LOS ANGELES; 2—CLAUDE PETERS, LOS ANGELES; 3—WILLIAM SCHEEL, SALT LAKE CITY, UTAH; 4—GEO. L. MOXLEY; 5—H. A. EVEREST, HOLLYWOOD, CALIF.; 6—BENJAMIN FORST, LOS ANGELES; L—AERIAL TUNING INDUCTANCE; L1—TUNING COIL; C—23—PLATE CONDENSER; D—CRYSTALS; C1—PHONE CONDENSER; 7—W. H. KNOX, LOS ANGELES, CALIF. SER; D—CRYSTALS; C1—PHONE CONDENSER; 7—W. H. KNOX, LOS ANGELES, CALIF.

whiskered judges, who seldom look with a kindly eye on anything except a good dinner, that we just had to add a third prize of a year's subscription to Radio Journal and include him. Fact is there are a lot of other prizes we would liked to have awarded, but maybe there will be a next time. Here is what Mr. Moxley has to say about his hookup:

"I tried out the stunt of putting a feedback coil between the phones and the variometer with excellent results. So here is the hookup. We may call it "Feedback Amplification in a Crystal Circuit".

The apparatus is all home made and the coils are all wound on cardboard tubes. L1 is a tapped tuning coil, wound on a 4-inch tube, the first 10 turns tapped every turn and the rest every 10 turns. The variometer is of 24 turns on a 4-inch stator and 28 turns on a 3-inch rotor. L2 is of 3 turns around the tuning coil and L3 of the same number of turns around the stator of the variometer. The tuning coil and variometer are not in inductive relation. L4 is a honeycomb coil of 75 turns wound on a 3-inch tube placed just at the end of the tuning coil. The effect of this arrangement is to add fully 50 per cent to the volume of sound. This is readily manifested by shorting the feedback coil out with a short piece of wire and then removing the wire. I cannot say that the range of the set is in any way increased for I have not yet experimented with it along that line."

Claude Peters writes, "I live two blocks from the Bible Institute (in Los Angeles) and when it is on the air I have found it impossible to tune this station out entirely. Using this hookup I can receive any one of the three stations in Los Angeles without any interference from the other two. I am sure anyone trying out this hookup will be greatly surprised at the way it eliminates other stations."

Mr. Scheel, who lives in Salt Lake, is apparently doing some wonderful work with his crystal set. Here is his letter accompanying his entry:

"In Salt Lake City with my crystal set I am able to pick up KPO, Hale Bros. broadcasting at San Francisco, Calif. At times their music and speech come in fairly loud and clear. I also hear other distant stations, but fail to get their call letters or names."

Descriptions accompanying some of the other crystal hookups which were deemed well worth publication, follow:

"I am submitting a diagram of a "hookup" with which I have gotten exceptional results, as a crystal set. With a 75 ft. aerial, 35 ft. lead-in, 5 miles from KHJ the concerts came in so loud that it was not comfortable to keep the head-set directly over the ears. By putting them out on the tem-

ples I was able to listen comfortably.

Coil No. L1 is movable, and in relative inductance with the other coil. Both are wound on 'spider-web' forms, the secondary, (coil L2) being wound on the same form, in the middle of the primary of 52 turns, divided as shown.

I am firmly convinced that 'spider-web' coils are the best, and I have been working for three months on a two-coil combination that has proven to me about $\frac{3}{4}$ of the wire used in vario-couplers, variometers, etc., can be done away with very nicely, thereby offering less resistance to the incoming signal, and 'coaxing it into your set.'

The 'hookup' I am working on is nothing new, just a simplified arrangement of old principles, whereby the same goal is reached, by using much less wire, and just common everyday 'horse-sense.' But it surely does 'tease in' the signals, but only those of one station at a time."—W. H. Knox, Los Angeles, Cal.

Here is a two-crystal hookup which is a novelty:

"The following is the best hookup for a crystal set that I have tried to date. This circuit is selective and has more than twice the volume of an ordinary crystal set. The antenna loading coil and the condenser in the ground circuit are an absolute necessity in Los Angeles, I have found, as their use makes it possible to absolutely tune out interference.

The object of the two crystals is to rectify each half of the incoming waves. The crystals must be split from the same stone, as I have found by experience that this hookup will work in no other way and give satisfaction.

Any fan can add another crystal to his present set, and by using the two phone condensers, which are necessary to by-pass the radio-frequency component to ground, obtain a marked increase in volume.

The set is tuned in the following manner. The phones are placed across the ground and one crystal, then adjusting each crystal to its most sensitive point. Then place phones across both crystals, and listen in."—Benjamin Forst, Los Angeles, Calif.

"For strength, selectivity and low cost I recommend this hookup. The coil mounting is behind the panel; the coils vary the coupling by pushing the sliding knob. The coils are always parallel which permits wide coupling required for selectivity without decrease of signal strength. The coil mounting is made up of two wooden blocks 1x2" and a six inch length of $\frac{1}{4}$ " wooden rod.

I wind spiderweb coils on cardboard forms, $1\frac{1}{2}$ " inner diameter 9 slots, skipping every other slot in the wind-

ing making a combination honeycomb and spiderweb effect. The condenser is of the book type of hard wood 4x5" lined with tinfoil and spaced with thin parafined paper. A spring holds the leaves together and a $\frac{1}{4}$ " machine bolt with head cut off and dial put on, screws through one leaf and spreads the other for tuning."—H. A. Everest, Hollywood, Calif.

Mr. Moxley also submitted another:

"Now here is one that is quite different from the one I submitted to you yesterday. And it seems quite as selective in tuning local broadcast. L1 is a 100 turn tapped tuning coil, wound on a 4 inch cardboard tube, the first ten turns taped in single turns and the rest every 10 turns. L2 and L3 are each 3 turns, L2 around the tuning coil and L3 around the stator of a home made variometer, the stator being of 24 turns on a 4 inch tube and the rotor of 28 turns on a 3 inch tube. This set is in the experimental stage and none of the parts are mounted on a panel as yet, but the reception is very clear and distinct. The variometer is not supposed to be in inductive relation to the tuning coil and I suspect that it would give good results if they were quite widely separated. I omitted to state before that my lead in gives an antenna length of about 110 feet."—Geo. L. Moxley, Los Angeles, Calif.

The new high powered broadcasting station, WTAM, in Cleveland, O., is rapidly gaining a reputation for long distance transmission, the latest evidence coming in the form of a letter from a listener in England. Although a number of the larger broadcasting stations recently endeavored to bridge the Atlantic during National Radio Week, WTAM, according to the letter, was heard in England before any special efforts were made in Trans-Atlantic broadcasting. The English radio "fan" who wrote the letter, Thomas E. Hamblett, St. Helen's, Lancastershire, stated that he heard the Willard Company's station quite clearly broadcasting its program on Wednesday evening, November 21.

A. F. Combs of Enid, Okla., and M. B. Norman, Eureka Center, Wis., have reported exceptional distance receiving records for three-tube sets. Using receivers of the same type that were designed and built by Dr. Fulton Cutting and Bowden Washington, Minneapolis, Minn., Combs, at Enid, listened to three numbers—vocal, orchestra and piano—broadcast by 2LO, London, Eng., and Norman picked up a station at Glasgow.

Combs verified his feat through 2LO's New York office, and Dick and Adolph Danielson of St. Croix Falls, Wis., were listening in with Norman.

Improving Harkness Tuned R. F. Reflex

By A. L. MUNZIG

A rose by any other name would smell as sweet. But many a gardener has gone Bill Shakespeare one better by cultivating and crossing said rose until it smells sweeter. Mr. Munzig has added a few interpolations of his own to the Harkness circuit and she performs better. Aye, aye, Sir!

THE "Harkness Circuit" has become so popular of late and so many questions have been asked on how to stabilize this circuit, that a small treatise on this will be welcomed by thousands of the readers of Radio Journal.

thousands and is performing better all the time.

The use of a crystal detector has several disadvantages. Some of these are:

- Critical adjustments.
- Non-uniformity of crystals.

FIGURE NO. 1

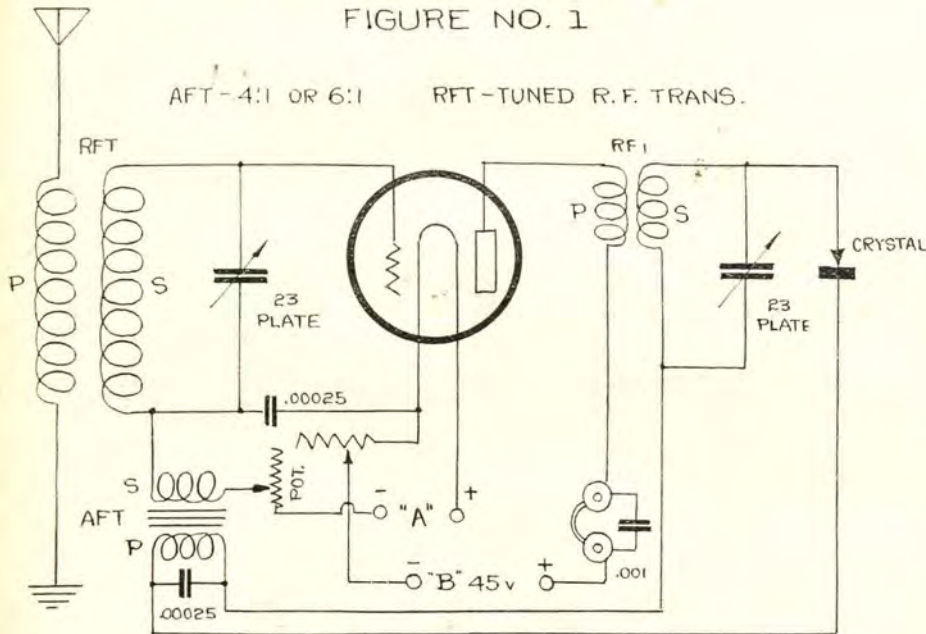

With the majority of these receivers the tendency to oscillate is predominant. The use of a high resistance contact to crystal detector will have the tendency to cause it to break into oscillations. The most sensitive spot of a crystal detector is invariably a high resistance one. Oscillations obviously are not desired in any tuned radio-frequency receiver—for distortion results, re-radiation, etc. On the other hand, some find that the near oscillating point or regenerative point of this circuit will result in remarkable sensitivity. However, this position is hard to hold, thus rendering the circuit very critical and unstable.

In Fig. 1 is shown the "Harkness Circuit" or commonly called tuned RF reflex circuit, with the addition of a compensator in the form of a potentiometer. Rectification is obtained through a crystal detector. This circuit will tune sharper, give greater distance than any single tube reflex circuit heretofore. A circuit similar to this circuit was given in the August issue of Radio Journal in Fig. 13, of an article on the Neutrodyne by the writer. That circuit has been used by

High resistance contact at most sensitive spot.

Rectification not fixed.

The only advantage that I can think of at the present is that a crystal rectifies more perfectly than any method known.

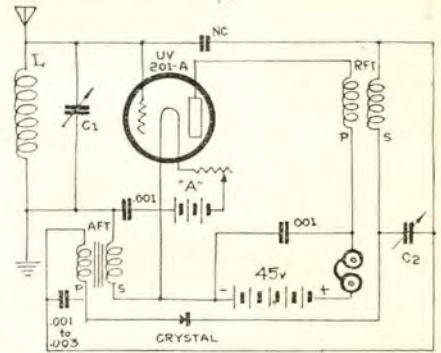

Fig. 3

To get away from the use of a crystal we have used this circuit with another vacuum tube for detection. The circuit is given in Fig. 2. This immediately improved the sensitivity enormously and reproduction was in all points equal to the use of the crystal detector. Furthermore, no adjustments were necessary and we had no trouble whatever in obtaining stability. We found also that with the potentiometer regeneration could be controlled and this increased the sensitivity to, we should judge, four or five times that of the position of the potentiometer at a decidedly non-oscillating position. The set in an oscillating condition is not recommended for pure reproduction of sound.

The circuit given in Fig. 2 is, in our opinion, the most efficient of any reflex method we know of.

The circuits given are equally adapted to the use of drycell tubes such as WD11, WD12, C11, C12, UV199, C299, etc.

FIGURE NO. 2

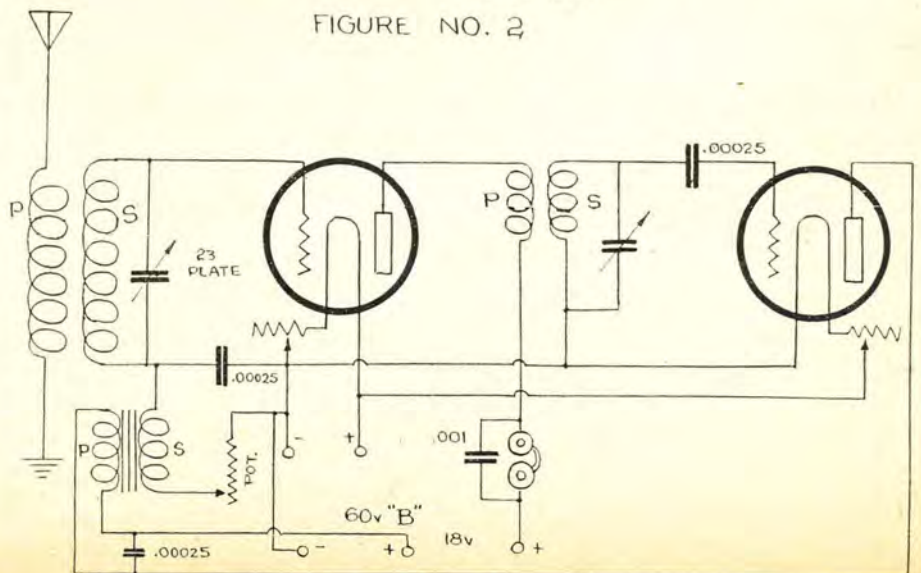

Questions and Answers

Q.—This is the diagram of my set. Could this circuit be made more selective for distance receiving by changing condensers or any other part of this set. As the howl and radiation of this circuit makes it the hardest set to tune. The broadcast station is 200 miles from here. Aerial is 100 feet long. Use W. D. 11 tubes and Federal parts.—Walter Hennes, Spreckels, Calif.

A.—A tickler coil of 50 turns is apparently too heavy for your circuit. Try one of 25 turns, or remove the tickler coil altogether, connecting it across so there is no tickler coil in circuit.

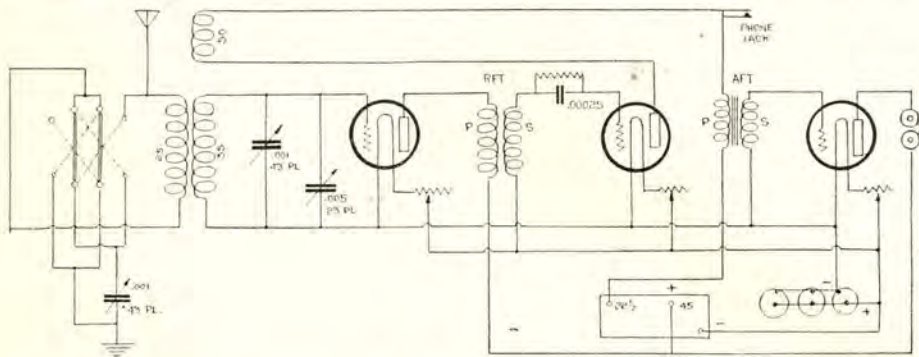

Q.—Is there any broadcasting station owned by a school in Indianapolis with call letters sounding something like WAZ? Is there any place in Indianapolis with call letters something like that? This was between 7:30 and 8:00 here. While listening in to a distant station, I noticed that while I had my hand on the variable condenser knob I heard the station clearly, but when I removed my hand, loud squealing and howling began. What is the cause and how could I remedy it without weakening signals? I have a single tube set with CR-5 hookup.—Arthur Donker, Los Angeles, Cal.

A.—Call letters Indianapolis WLK and WOH. You probably have WOC in mind, Palmer School of Chiropractic, at Davenport, Iowa. Parts affected by body capacity, as you describe, should be set 6 inches behind the panel, or farther. A wood fibre or bakelite rod should be used to attach the knob or dial to such parts.

Q.—What is the best arrangement of parts for a single tube reflex with an extra audio? What leads should be kept parallel, or together, and which should be separated? I have an All-American audio 5-1, and Hedgehog, 3-1. Which is best for reflex and what size by-pass condenser should be used for that transformer? At present my set is noisy and distorted. Will the proper condensers correct this? I am using 199 tubes.—L. R. Finke, Huntington Park, Cal.

A.—Designing a set is limited to space as a general rule. Many who build their own sets claim that when parts of a set are spread all over a table they work far better than when in panel. The 199 tube should not be fastened to table, but set on a rubber sponge, to prevent jarring. All parts of audio and radio frequency circuits should be well spaced and wires the same. It takes just a few minutes to change transformers, and you will have to ascertain yourself which works best in your set. Photos of

arrangements of parts and article on reflex in April issue, 1923, and May issue. Noisy operation may be due to poor B Batteries or by-pass condenser, or to a corroded wire being used as cat whisker.

Q.—Could you tell me of a fair priced transmitter with hookup that you would O. K. for a beginner? Also parts and price of same for the transmitter. Where can I get information for one who is just starting in regarding the laws, age specifications and anything else one is required to know before considering taking the examination

for amateur license.—Edward O'Neil, San Francisco, Calif.

A.—There are so many reliable companies manufacturing the parts you desire. A local dealer could fix you up. Try a Meisner circuit. A copy of Radio Rules and Regulations may be obtained from Supt. of Documents, Gov. Printing office, Washington, D. C. There are many books published on how to obtain an amateur's license. There is no age limit.

Q.—Will you please send me a diagram of the CR5 hookup with 2 stages of amplification. I have such set, but when I plug in the last stage it does nothing but squall. The more I turn the rheostat the more it squalls. I am using a Coast coupler, a variable condenser, 3 rheostats, 2 transformers, 3 C299 tubes and a wave trap, grid leak and condenser, A B and C batteries, 90 volt B batteries. If my hookup is right, what would be the matter?—P. A. Rose.

A.—Your trouble is probably in the second A. F. Transformer. Try reversing primary and secondary leads and this, I think, will clear your trouble. If this is not the trouble, will be glad to send a hookup or correct yours, if you will send it.

Q.—First I want to tell you about your Journal, not because I am looking for any favors but just because its a good book that's all. I am very sorry we don't see more of them in Chicago. Perhaps later on that may be cultivated. I have talked with several radio dealers and many friends about the wonderful information obtained within, I am a subscriber and expect to be one as long as I am a radio fan.

I have made the home-built receiver described by the Roach Brothers in the Sept. issue. I seem to get local stations fair but have had trouble in getting outside of Chicago. I have followed the diagram in every detail, however, description and diagram conflict somehow in regard to the wiring

of the tubes. This has not been clear in my mind. If you can help me out in my efforts to rectify the mistake or mistakes, it will be most highly appreciated.

In the construction of the detector circuit they state to connect K (A+) with the binding post on the tube socket marked +. Do they mean on the Detector tube or the first and second amplifier tubes? In the circuit they have it connected to one side of the detector rheostat.

The transformers would be much clearer in my mind if they were numbered as to their respective leads, (as +—P—G and—). How can I determine which is primary and secondary on the variometers? The set seems to work better without the grid leak for when it is in place it almost eliminates the reception. I use the regulation condenser and leak.—E. J. RYAN, Chicago, Ill.

A.—Radio Journal has forwarded your inquiry of Sept. 26 to us for analysis. To construct the set described in September Journal, follow the text. It is correct. The Detector is a complete unit. The circuit used is loose coupled, short wave, regenerative—with variometer feed back and a variometer tuned grid circuit. Regeneration is obtained in a variometer placed in the plate circuit, using 22½ volts on the plate.

The primary of each variometer is the stationary winding—called stator on the diagram; the secondary is the movable windings—called rotor in the diagram. We do not know the type variometer you are using, so cannot advise. Ours has 50 turns of wire on both stator and rotor, with a 10 turn auxiliary rotor in series, revolving concentricly within, for sharp tuning. Our coupler has 56 turns, tapped off in units, and seven steps of 7 turns each. Ample distances are essential between these units, and the transformers must be shielded with soft iron casings and properly proportioned. What make have you and what are their ratios? We have been quite successful in reaching more than 150 stations and with uniformly good reception.—MAITLAND ROACH.

Q.—Is the Roffy Hetro-Trans as good on amateur waves as one step of Neutrodyne? How are CW signals received on the Hetro-Trans? Would a spark coil CW have sharper tuning and greater distance with a rectifier filter? Where on the Pacific Coast, preferably around San Francisco and Los Angeles, can lead and aluminum plates for a rectifier be purchased?—A. B. Nolan, Davis, Calif.

A.—Results on the Roffy depend upon tubes and construction of each set. Roffy may give better results, as 1 step neutrodyne is not recommended for 200 meter work. CW signals picked up by 1 tube oscillating caused by filament and plate voltage variations. Rectified would be sharper and probably better distance obtained. Several large hardware stores carry aluminum that will serve for rectifiers, but spun aluminum plates may be obtained easily at almost any hardware store.

Q.—I have an Erla Duo reflex receiver made up of an Erla reflex R. F. transformer, a 5-1 ratio All-American audio transformer, a C299 V. T., a Bradleystat, a 23-plate variable condenser, a .001 and a

.002 fixed condenser, and a home-made coupler. I have checked through my hoop-up and there are no mistakes in it. My audio transformer is O. K. as it works when used as an amplifier on a crystal set. The R. F. transformer was tested with phones and battery and there were no open circuits. The crystal detector does not do any work at all as it makes no difference in the volume, and the tube will not oscillate when the cat whisker is off. Will you please give me some information as to the probable cause of the trouble?—J. B. Forster, Los Angeles, Calif.

A.—Dear Sir: Replying to your query, a diagram of your set is needed in order to give you the desired information.

Q.—I am bothered with a knocking sort of a noise in my set which knocks about as fast as the ticking of a watch. Whenever I disconnect the aerial or ground leads the noise almost stops and if I disconnect both leads it stops completely, therefore I don't think the noise is in my set but from the ground. I get this noise the loudest on the trade broadcast wave lengths. I am using a water faucet for a ground, city water system. I live about one half a block from a telephone central office.—W. Paul Morrison, Fortuna, Calif.

A.—Interference from a telephone exchange is possible from their ringing machine making and breaking contact. Again it may be the tube used (if a single circuit receiver) which needs a grid leak. If this does not help try a different location, at a place farther away from the telephone exchange. The trouble is most probably in your set.

Q.—I want some information on the Grimes inxerse duplex circuit. Herewith is diagram which I have reason to think is incorrect as the set is dead except for a series of clicks which can only be stopped by removal of the second tube. I am using a 1000 meter bank wound coupler with a 43 plate variable condenser across the secondary as a tuning unit.—JOHN HAZZARD, Keeler, Calif.

A.—The diagram you submitted some time ago is apparently O. K. The trouble may be due to transformers being hooked up wrong. Try reversing primary leads or secondary leads on all transformers, one at a time; also the tube may be oscillating and burning filament lower may help.

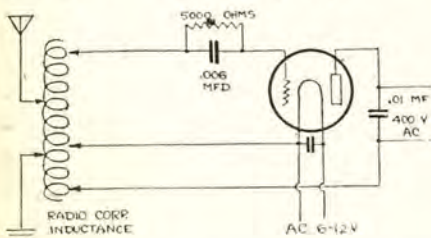

W. H. BAIRD SOUGHT INFORMATION ON ACW TRANSMISSION.

Q.—I have a key, 5 watt tube, 400 volt AC transformer, variable 6 to 12 volt step down transformer, 1MFD and .006MF condenser. I want to rig up some kind of a set to send ACW. Will you kindly draw me a diagram stating what additional apparatus I will have to purchase.—W. H. Baird, Maricopa, Calif.

A.—A 1MF condenser cannot be used when using ACCW, although it may be placed across the filament as a R. F. bypass condenser. Herewith find diagram.

Q.—Would you mind telling me the number of miles the weagent feed back circuit that T. E. Nikirk discussed will cover and what tube would you use for a dry cell battery. Thanks.—Wistar Wright, Forsyth, Georgia.

A.—On the Pacific Coast, eastern coast stations are heard, and one used on the eastern coast reported many Pacific coast stations heard. 299 or 199 tubes or 301A or 201A are best for your purpose.

Q.—I am installing a radio in a new residence now being erected and I am planning to follow the wiring as per the sketch, herewith, having a polarity receptacle in two rooms so that Radiola Grand can be used in either room as desired. Will you be good enough to advise me whether or not you can suggest any changes, and also what length antenna you recommend. I am using a Radiola Grand and my property is located on a bank at the foot of the Orange Mountains, the altitude being two hundred thirty feet.—G. D. Hope, South Orange, N. J.

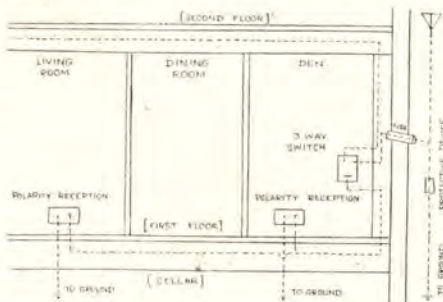

OUTSIDE ANTENNA ABOUT 100 FT. LONG. INSIDE ANTENNA NO. 14 RUBBER COVERED COPPER WIRE ABOUT 40 FEET LONG, KNOB AND TUBE WORK, NOT TO RUN PARALLEL WITH LIGHT WIRES OR GAS, STEAM OR WATER PIPES. INDEPENDENT GROUND CONNECTIONS TO WATER PIPE FOR BOTH RECEPTACLES. SUBMITTED BY GEORGE D. HOPE.

A.—The diagram you sent us will work all right, but it is considered best to run a pair of wires from the set, then the plugs are used to connect phones or loud speaker, which makes it unnecessary to carry set around the house. Radiola Grand generally has self-contained batteries. Keep aerial and ground wires as far apart as possible.

Q.—I note in your August issue that you touch slightly on the Super-Hetrodyne circuit. Your diagram in Fig. No. 14, page 63, is not complete enough, and I doubt if your circuit will give results worth considering. I have just built an 8 tube set of this kind, using 1 osc. tube, 2 detectors, 3 R. F. and 2 A. F., and have good results, static being the only governing factor. Then too, I note that in your circuit you have 4 variable condensers, whereas I am able to operate the entire circuit of 8 tubes on only 2 variable condensers. In regard to the addition of the Neurodyne condensers, I have found that they do not add materially to the circuit, and I believe that this is because in using them you are setting two principals against each other, namely that Hazeltine reduces the high frequency currents by neutralizing them, and Armstrong sets against them another current in opposition, and the audio wave is the difference between the two circuits: therefore these two circuits used on the same receiver would, I believe, have a tendency to conflict.—BIRCHALL HAMMER, Elkins Park, Pa.

A.—The foregoing question, referred to Mr. A. L. Munzig secured the following reply: The circuit as given is incorrect in a way but will function just the same; will work as efficiently as any superhetrodyne using 3 untuned transformers in the intermediate amplifier. Mr. Hammer seems to think he has the ultimate in this design because of the simplicity of control, viz: two variable condensers. The circuits that I submitted for the October issue have but two governing controls—but with the addition

of tuned radio frequency in the intermediate circuit, thus allowing resonance, a feature impossible to obtain with any other known method, and yet when these have been adjusted for maximum response and resonance they need not be touched. Hence two controls are the only tuning necessary in my case.

The addition of neutralizing capacities in any circuit not designed for its use will not function! It will be necessary to use special tuned RF transformers in order to obtain the proper phase relation necessary for neutralization of capacity coupling. Mr. Hammer is mistaken when he states that Prof. Hazeltine reduces the high frequency currents by neutralizing them. It is the internal capacity of each tube that is neutralized by balancing one capacity against another. Read again pages 60 and 63 where this condition is theoretically explained very thoroughly.

In the superhetrodyne circuit no current is set against the frequencies in opposition. This external hetrodyne or excitation, is used to obtain a beat frequency sufficient to change the frequency to lower frequencies or in other words to change the short waves to long waves where capacity coupling is not so noticeable. Hence the ease of neutralizing capacity coupling, which is absolutely essential to the efficient operation of any radio frequency amplifier. The use of the Neurodyne principle will not conflict but will rather render a more stable R. F. amplifier. For as you know the neurodyne is a method to neutralize the internal capacity of the tubes (the tendency to oscillate), rather than to check the flow of oscillations—contrasting with methods such as stabilizers.

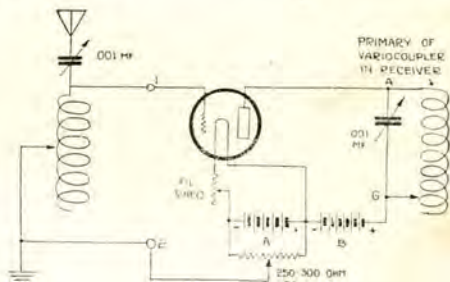

RADIO FREQUENCY HOOKUP FOR C. S. SAITO.

Q.—Mr. Munzig: It was with considerable interest I read your article on Hazeltine's Neurodyne receiver in the August issue of the Radio Journal, and I wish to compliment you on covering the subject so well. I read quite a number of radio magazines and find that most writers try to cover a subject like this with about two paragraphs and two or three pictures. I am taking advantage of your offer to furnish additional information. Enclosed you will find hook-up of my set with which I have received good results. I would like to know if I can use the neutralizing condensers in my set and still use the variometer in place of the neutro transformer. Most of the signals come in very strong on my set but by the time I stop the tubes from oscillating with the potentiometer, the signals are too weak to be under-

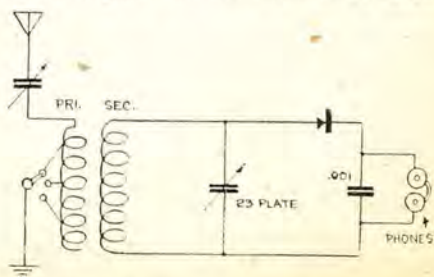

CRYSTAL HOOKUP SOUGHT BY AARON BROCKOW OF LOS ANGELES.

stood I would appreciate it very much if you will show on the enclosed hook-up, just what changes I will have to make to overcome this difficulty. A stamp is also enclosed for your convenience.—E. W. WILLIAMS, Lakewood, Ohio.

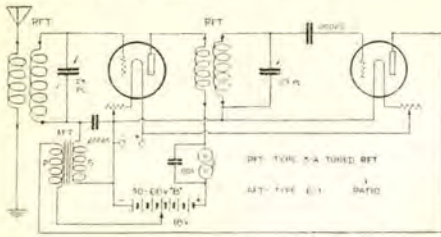

Q—I get lots of information out of questions from the other fans. Please design and specify parts and makes for a receiver using only ready-made parts. I would like to build one stage of radio-frequency and two stages audio. Would you recommend the regenerative type? G. P. KLEIN, Sanger, California.

A.—Several types of regenerative receivers could be used, provided you wish regeneration. However, at present tuned RF amplification is all the go—so suggest you give it a try. In this issue of Radio Journal appears a circuit using tuned RF and reflexing this tube. This circuit is very selective and extremely sensitive.

I am enclosing circuit for one stage RF and two audio reflexing one tube.

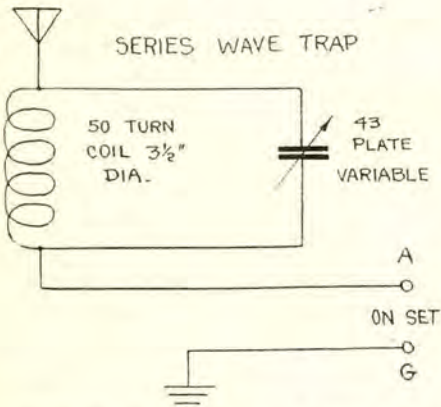

THIS IS A SERIES TRAP ASKED FOR BY B. C. EDMUNDS, EL MONTE, CALIFORNIA.

Q.—Mr. Munzig: Regarding your recent article on Hazeltine's Neutrodyne circuit, we have constructed a two-step amplifier according to your circuit No. 10, Radio Journal, August, 1923. We have had fairly good results approximating our old favorite, The Copp circuit, but not, we believe, outperforming it either as to volume or clarity and we find the Hazeltine outfit much harder to handle especially to get it started oscillating on weak signals. We are using 199 tubes as R. F. amplifiers and the same detector and A. F. amplifiers on both outfits. As yet we have not been able to get any benefit from the neutralizing capacity. When adjusted as suggested, (i. e., wires 3/4 inch apart) loud signals pass readily through either stage with a bulb extinguished. With no neutralizing capacity at all the resistance to signals with a bulb extinguished is greatest but there is no adjustment where signals are entirely stopped. Could you suggest what might be the cause of this and the remedy? Have you experimented with three stages of R. F. with any favorable results? (tuned Neutrodyne of course.) What results have you had with the Super Hetrodyne Neutrodyne?—and what are the valves and constructional data etc., of the three coils coupling the oscillator tube to the circuit. Our experience with an attempt to couple a variable oscillating circuit to the

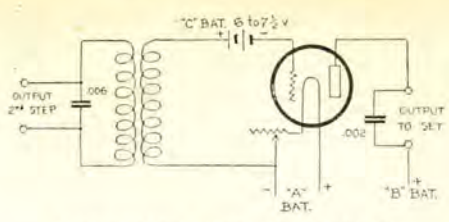

ANSWERING GENE ULLEMEYER.

first transformer was that we could make the outfit squeal and entirely stop reception by adjusting the auxiliary oscillator, but could not improve operation any. If we could find out why we are not able to use neutralizing capacity, perhaps we could improve our set so that we would be as enthusiastic as you are over the new circuit as it is it seems to be an added complication with no added performance.—S. W. SLOAN, Bradner, O.

A.—The trouble with your set is evidently due to the fact that you have the Neutroformers crowded and then it is impossible to neutralize capacity coupling. In that condition it is already overneutralized and any addition of capacity helps the tendency to oscillate that much more.

We expect to use multistage Neutrodyne R. F. this coming Winter. At present am busy perfecting and using a Six Tube Super-hetrodyne using the Neutrodyne method with UV201A tubes. We find that when using UV199's it isn't necessary to neutralize capacity coupling! The secret in this is in a special transformer. The secondary of each is tuned with a 23-plate var. condenser. See October issue Radio Journal.

Q.—I am a poor radio bug since last March. Have experienced many things thru your best magazine Radio Journal and now I want to ask you some questions as follows: How can I reduce the numbers of radio frequency? Is it possible to add the radio frequency amplifier to this circuit? Where can I get "Brown's head-set" 80,000 ohms? I very much appreciate your answers.—Chas. S. Saito, Los Angeles.

A.—Your first question was not clear, as to reducing numbers of radio frequency. Add radio frequency as per diagram herewith. Brown phones are made, we believe, in England up to 8,000, not 80,000 ohms. S. G. Brown, Lmtd., 19 Mortimer St., W. I., London, England.

Q.—Would very much appreciate your advice as to the correctness of the diagram given herewith. In the May issue of Radio Journal, page 264, you gave me a hookup in answer to my query and have I written you since about the marvelous results of this circuit. I haven't got an aerial yet, but last Friday night I received KGW Hoot-Owls, Portland, Ore., on the lamp-socket on detector and 1st stage. Going some?—P. S.: Where should an ammeter be connected on a 2 amp Tungar charger also? —A. W. Rabe, Los Angeles.

A Tungar tube, when running as low as 1/8 amp, has to have the filament lighted at all times, while charging, and circuit herewith will be found to work O. K.

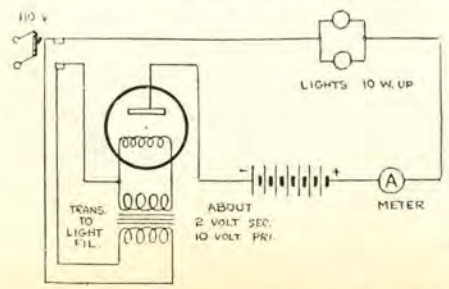

A. W. RABE OF LOS ANGELES SOUGHT THIS DIAGRAM.

Q.—If you happen to know of an efficient circuit employing a 23 plate and 43 plate condenser and variometer with 1-step audio frequency. Would you please give me the hookup? I would like the circuit to be able to tune low enough for amateur reception. Also I would like it to be able to receive broadcast as the folks desire it. I happen to be a "ham" myself so I would like one that would get fairly good "DX."

I have seen several of your hookups in Radio Journal so I thought you would be a very good person to ask about hookups and to get information from. I have done a lot of experimenting but I have not been able to get very many efficient circuits. PHILIP SNYDER, Radio 6 UT, Los Angeles, Calif.

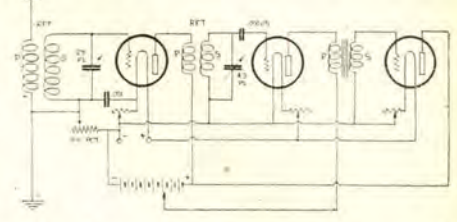

A.—A very efficient circuit appears in the next issue of Radio Journal, both for CW reception and fone. A diagram is enclosed to use with the apparatus you have on hand. Note that it uses one stage of Tuned Radio-frequency with regeneration.

Mr. A. L. Munzig: I have just built a five tube Neutrodyne using your No. 10 hookup in the August issue of Radio Journal. As I am having a little trouble with the set, I am taking advantage of your offer and asking a little advice. I have followed closely your drawing and am using Workrite Neutroformer and 23-plate condensers. Instead of five tubes on the phones I have inserted a detector jack and 1st and 2nd stage jacks. Possibly my trouble is there. I notice your method of hooking up the A. F. transformer is somewhat different than in an Armstrong regenerative set.—BURTON B. BARNES, Los Angeles, Calif.

A.—You should get good results with your outfit, provided it is hooked up right and capacity coupling is neutralized. The fact that the detector and first and second stages are equipped with plug and jacks should not hinder the set from working. It may be also that you have your parts mounted too closely.

Q.—Mr. Munzig: It was with great interest I read your article "Hazeltine's Neutrodyne Receiver" in the August issue of Radio Journal. Of most interest was Fig. 14 of the Super-Hetrodyne Neutrodyne circuit. Quite some comment was raised by many friends as to functioning and constants of circuit. Would it be possible for you to give me this information, as a result of which I know several sets will be made and the performance of same will forward to you should you desire.—EUGENE S. GOEBEL, Philadelphia, Pa. Opr. WJAR and 3HO.

A.—The information you desire is published in the October issue of Radio Journal. A tuned radio-frequency transformer is necessary with a special construction that the Ray-Dee-Artcraft Engineers have worked out, for the proper functioning of the Super-hetrodyne Neutrodyne circuit.

Requiescat En Pax

(Latin for something or other)

What a happy world this earth would be
If you and I could ever see
The day when all our sets will do
Just what their makers claim is true.

With the Western Amateurs

A Department Conducted by A. L. Munzig

With the advent of colder weather DX work has been more in evidence. Everyone seems to be reaching out. The CW Gang as usual do all the consistent DX work. Although the old spark sets seem to be dying out as the months roll by, we can see no good reason why the spark set should be a thing of the past and lapse into oblivion. Every old timer will confess that the greatest pleasure he ever had out of radio was when pounding brass with a good old spark set. Of course the disadvantages of the spark set are obvious—but these faults can be remedied. Let's take this spark transmitting question a little more seriously. Let's perfect the spark transmitter—obtain a lower decrement with a prominent hump on one wave only—and let that wave be 175 meters. Personally we don't want to see the spark set discarded. In its present form, however, it will have to go. Let's get together and improve on the old methods of spark trans-

have been officially logged, with a total mileage of over 105,000 miles. Best DX was KGG at Portland, Oregon, and W. P. A. Y., at Bangor, Maine, however, during the tests of K. F. G. B. last winter at Telegraph Hill, San Francisco, (which is 6XB, by experimental call) with one of the Hawaiian island stations, I was able to easily get their two way, but not on voice with the Hawaiian stations as he was using IC CW. His carrier was all that was audible on voice.

This set is a two-circuit using the tuned plate method for regeneration. I found this method most satisfactory in controlling the regeneration on extremely weak signals. I also have a Reinartz tuner, on which I have obtained excellent results on short wave CW. However, I find that the two-circuit oscillates very freely over a 150 to 600 meter wave, and is a cat's ankle on amateurs. Amateur stations in all districts

difficult to tune. A .0005 variable condenser is shunted across rotor in order to tune rotor with primary. The .00025 variable gives very fine adjustments when tuning the grid, and I find that this method is highly satisfactory in bringing in DX. The potentiometer is a GE-200 ohm and very valuable, especially when a tube is critical to plate voltage. The variometer and Atwater Kent, tunes the plate, giving good regenerative control, and enables tuning to maximum signal strength of incoming station. Three steps of audio are connected in usual way, however, never more than one stage is used unless loud speaker is desired. Most DX is brought in on detector only, as my desire has been to get the DX on one tube. As detector tubes I have had excellent results with a French tube which I was able to bring back from France with me. The UV200's are very satisfactory also, but the old French is hard to beat. My aerial system consists of a single wire inverted L-120 ft. long, and 60 ft. high, water pipe ground. If there are any other hams who have used this circuit, would like to hear of their results.

I am an ardent reader of the Radio Journal and must readily admit that it is a QST No. 2. It was recently recommended to the rest of the Hams of the Radio Club of Dallas, by our president, who is manager of A. R. R. L. for the district. Wishing your paper continued success, I am yours very truly Thomas Russell Gentry, 4030½ Travis Ave., Dallas, Texas.

Short Wave Circuit

In Fig. 1 is shown a circuit that performs exceptionally well on wave-lengths between 100 and 250 meters. One stage of tuned radio-frequency amplification is used. Note that only two controls are necessary. In order to lower the mutual inductance of present variometers it will be necessary to connect the stators and rotors in parallel. The circuit is self-explanatory.

L. L. Hoyt, 6FN of Los Angeles but spending sixty days in Hayward, Calif., writes "receiving conditions are great here now. I will have a list a mile long for you." How about your list, Mr. Amateur. Mail it in.

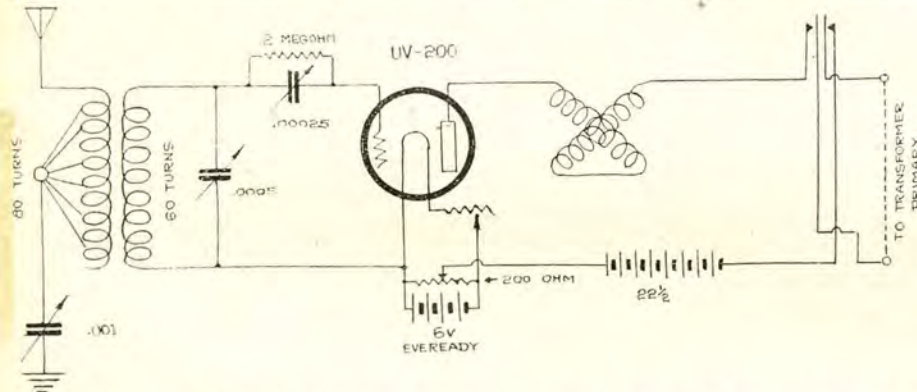

THIS IS THE CIRCUIT USED BY THOS. R. GENTRY OF DALLAS, TEX., WITH WHICH HE HEARS ALL BROADCAST AND AMATEUR STATIONS OF THE UNITED STATES.

THE CIRCUIT USES A VARIOMETER TO TUNE THE PLATE FOR REGENERATION WITH A POTENTIOMETER ACROSS THE "A" BATTERY FOR CLOSE ADJUSTMENT OF DETECTOR PLATE POTENTIAL.

mission—let's keep the spark with us. Just as we have better receiving systems at present for short wave reception, just so we can better our old spark sets. What do you think about it, Gang?

Our old friend 7PN is pounding brass for the Radio Corporation on some vessel in Pacific waters.

A Texas Receiver

There are a lot of fellows who in the days gone by have had transmitters, who are at present "standing by" and listening in. Mr. Thos. Russell Gentry, 4030½ Travis Ave., Dallas, Texas, has before the war had a transmitter, but at present is not doing any transmitting. His description of his receiving outfit is quite interesting and so we quote him as follows:

Amateurs Dept., Radio Journal Publishing Co.—I am submitting to you a photograph and description of my station, which is only receiving at present, but expect to have 20 watts C. W. Radio has been my hobby for several years, I having owned a crystal set before the war, and in those days the old crystal was the only thing. I have always been interested in broadcast stations as well as amateurs, and in fact more time has been spent listening to broadcast during the past year. Last winter my motto was to get a new station every night and I very nearly succeeded, as 133 stations—in 34 states of U. S., 4 in Canada and 1 in Cuba—

have been copied in one night (between a period of 7 P. M. and 4 A. M.).

Description of this set is as follows: Coupler is wound with No. 22 cotton covered wire on both primary and rotor; 80 turns tapped every 10 turns on primary, and 60 turns on rotor. As variable .001 condenser is shown in picture in series with ground, however, this condenser is not absolutely necessary, as the improvement is not noticeable, and makes set a little more

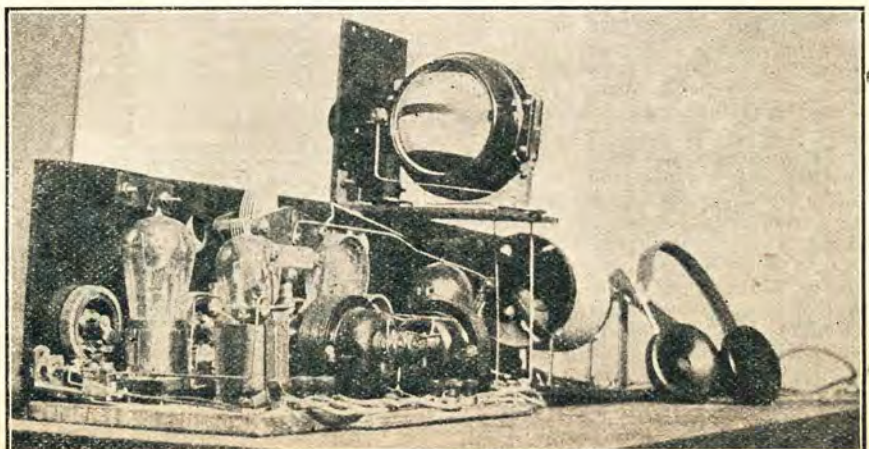

A GOOD SIDE VIEW OF T. R. GENTRY'S RECEIVER WHICH PICKS UP D.X.

5-Watt Work

Herewith a little "dope" for your magazine, which may tend to encourage more "spark-hounds" that five watts will "reach out" at minimum cost, and change their "foggy" ideas.

Radio 6CFM, 5 watts ACCW, Hartley single circuit with a radiation of 1.4 T.C.A. was reported by 1BWJ all A. M. of October 23, which verified accordingly with the log. Also by 1ABF of Longmeadow, Mass., at 5:45 p. m. P.S.T. of November 8, last, which verified to the minute. This station reported me "QRK," while the former said "QSA". The aerial is 52 ft. high and 43 feet long, surrounded by tall buildings on either side, and a counterpoise running at right angles in back of the aerial.

Although this reception does not occur every night, it just comes to show that CW is the thing first, last and always. I might also add that I have been heard many times in the 9th district. Taking it all in all, the old five watter hasn't done so bad having worked over 1000 miles with it and being heard approximately 2800 miles, or around 560 miles per watt A. C.—Sincerely Claude S. Perkins, 6CFM, Los Angeles.

New Station

Radio 6ADH has been issued to H. D. Wilson, according to word from Mr. Wilson at Phoenix, Ariz. The call was formerly held in Idaho. In this department we publish a photograph of his transmitter. The set rests on an iron pipe three inches in circumference, and ten inches above the table. This places the dials and meters immediately in front of the operators eyes and leaves more table room. The transmitter can also be turned around and shoved out of the way without any trouble. The transmitter is 1DH, S tube rectification, six wire cage antenna fifty feet high and fifty long, with six wire counterpoise fifteen feet from the antenna. He employs the Reinartz receiver..

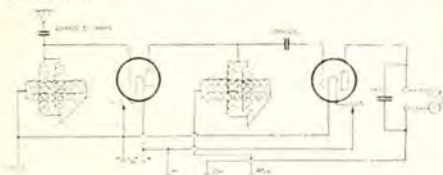

Fig. 1

Amateur Radio Game

To the radio amateur the letters DX call up a vision of immeasurable distance that would have made our ox cart pioneers and forefathers blink in amazement, but is now easily obliterated with the pressure of one's fingers on a brass key. This business of "packing up the old kit bag" for the sake of the wanderlust that is in all of us now has, through radio, a modern version that does not require the lifting of a foot over one's doorstep. That is the major fascination in the wonderful game of amateur radio, the thrill that comes with each new conquest over space and time, ability to reach the ends of the world.

You read on every hand how the possession of a receiving set, from the simple single circuit tuner to the latest model super-hetrodyne, brings "the world into the home", but seldom have you read how easily a radio transmitter can take you out into the world. From the time that such men as Daniel Boone lifted rifles over their shoulders and hit the trail into the wilderness, there has lurked in all of us the strong desire to go beyond our immediate ken. It is the same ambition that led early explorers to this country and made possible the pioneer days that eventually developed in the building of the West.

For a little more than the same amount

of effort that it would take you to equip your home with a radio receiving set, you can install a telegraph code transmitter which is equivalent to a pair of seven league



THIS IS 7NP WHO REGARDS BASEBALL AS A VERY ESSENTIAL RECREATION FOR A REAL DYED-IN-THE-WOOL BOILED OWL.

boots, a railroad pass, or a passport to distant countries. Sixteen thousand young men have done that in this country. It all started with the neighborhood line telegraph, but it has ended in this year 1923 by making amateurs of the world neighbors.

New Bay District Op

A new station here in the Bay District, 6QJ, is owned and operated by Charles Hisserich, 3011 3rd St., Santa Monica, Cal. "Three Blocks From The Pacific". He has been getting exceptionally good results with low power and on the air only since December 12, 1923. Has been qso 3DO, 3AB, 6CEU, 5XD, 9EHS, 7OT, 7FD, 7ABB and heard by 3HS—9DUN. 3AB was using a three circuit receiver with detector when worked. 3HS heard him several nights before 3AB was worked. Also he worked 3AB on a six tube receiver qsa all over the room.

There is nothing exceptional about 6QJ's station. His antenna consists of 4 wires 67'x50' high and 50' long, flat top with cage lead-in. The counterpoise is only 3 wires, fan, directly under the aerial. The transmitter is 5 watts straight Hartley, with 7.5 volts on filaments and 550 chemically RAC on plates, 24 jar rectifier. Drawing 60-80 millies he gets lamp radiation. At the time 5XD was worked 1/2 amp was used on a lower wave than usual. All of this has been done in four weeks.

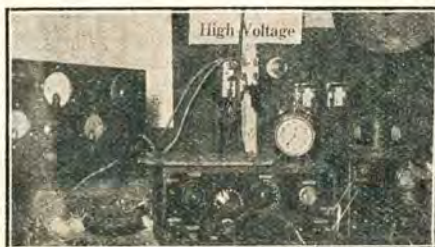

TRANSMITTER AND RECEIVER AT 6ADH, PHOENIX, ARIZONA. NOTE THE SET RESTING ON IRON PIPE BRACKET SO IT CAN BE SHOVED OUT OF THE WAY READILY.

The call 5RG has been re-assigned to Thomas R. Gentry, 4030 1/2 Travis Avenue, Dallas, Texas, 5 watt A. C. C. W. "I will appreciate any reports of my signals being heard," he writes, "and will answer all reports."

Walter Hemrich, 7SC, 7ZT, of Aberdeen, Wash., spent the summer at 7AEB, KDN, at Kukak Bay, Alaska, so was out of touch with Coast ham affairs for some time. Immediately upon his return he communicated with and handled traffic to Bowdoin, WNP 01 November 16, at 1 a.m.

Here's Look See

Following is a description of ether disturbing bottle container, known upon the air as 6JX, 6BVW, 6ZU, and disturbance catchers as pictured. Starting at left is seen a well known instrument, the station land phone, which usually reposes out of the way on a hook, but which the photographer thought looked better on the table. This phone has proved very handy for BCL's who are forever calling when voice is used on the air and requesting selections to be played, etc. Next in order are the receivers, Kennedy Universal and two step to match, and the Grebe CR8, and two step. Since this picture was taken, the Grebe CR8 has been replaced with a new Grebe CR6, with a CR13 coming up. An antenna separate from the transmitting antenna is used for receiving giving the advantage of 'Break in' reception. The output of the receivers is controlled by a plug and jack system on panel under the edge of the operating table. By system of Magnavox loud



"MY CORNER" IS WHAT MR. GENTRY OF DALLAS, TEX., CALLS THIS.

speakers, broadcasting or other radio matter may be enjoyed from any part of the house. Next on the right are seen the telegraph transmitting keys. First the Vibroplex Bug, then the light ICW Buzzer and Chopper key, and mounted upon 1/2-inch bakelite is the CW key, breaking the negative high voltage to the center tap of the specially built Westinghouse filament transformer. On the front of the transmitting panel may be seen antenna current meter, milliameters for both oscillator and modulator tubes, and filament volt meters also for both oscillator and modulator tubes, and between volt-



ANNUAL DINNER, THE MILWAUKEE RADIO AMATEURS' CLUB, INC., MARYLAND HOTEL.—Officers and speakers seated at long table from left to right are, viz: M. F. Szukalski, Jr., 9AAP, Milwaukee A. R. R. L. City Mgr.; E. W. Ruppenthal, 9AYA, Treasurer; E. T. Howell, 9CVI, President and Acting Toastmaster; F. J. Marco, 9CD, President of the Armour Institute (Chicago) Radio Club; R. H. G. Mathews, 9ZN, League Central Division Manager; A. F. Parkhurst, 9RI, U. S. Radio Inspector; C. N. Crapo, 9VD, Milwaukee County A. R. R. L. Dist. Supt.; L. S. Hillegas-Baird, Business Manager; and F. W. Catel, 9DTK, Assistant Treasurer.

meters, the 0 to 2000 volt meter for the plate supply. Next below are the two filament rheostats and below the dials controlling the two double spaced condensers shunted across the plate and grid coils, in the series feed Meissner circuit. All internal wiring of the transmitter is with 3/16 copper tubing. All socket leads are also centered. The set is mounted on 1/2-inch bakelite and a frame of inch and a half angle iron. Three 15 turn pancake coils form the plate, grid and antenna inductances. The power supply is an electric specialty 1500 volt 600 watt motor generator unit. 15 Henry, 10 MFD filter insures pure direct current. Antenna current with 100 watts 1200 volts plate voltage, 400 Mills is 6.2 Amps. The antenna system consists of a 4 wire T antenna, 70 feet from the ground and 60 feet in length. An 18 wire fan counterpoise under the antenna is used for the transmitter, no ground connection being used.

To date signals have been heard in all districts, 41 States, 4 Canadian Provinces, New Zealand, Australia. Above the Arctic circle in Alaska, Hawaii 'every night', Mexico, Panama, and copied by WNP 11 degrees from the North Pole. Have worked east to edge of 8th district, but have more cards from 8s than 5th district. Hope to do much good work this winter with new antenna system. "JX-BVW-ZU" will always QSX Pacific coast traffic, also answer all cards, reports, schedule arrangements, etc. Give us a call. 6JX, 6BVW, 6ZU, owned and operated by Wilford Deming, Jr., 1404 Magnolia Ave., Los Angeles, Cal.

An Aerial Note Book

6EB made a note of a few types of aerials he noted on the outskirts of Los Angeles, Calif., which, he suggests, "may be of interest to the Boiled Owls." Here are his comments: "No. 1, note how the one-wire antenna was attached to the electrose insulator; No. 2, why the spreader for a one-wire antenna; No. 3, lead-in taken from

geles, Calif., which, he suggests, "may be of interest to the Boiled Owls." Here are his comments: "No. 1, note how the one-wire antenna was attached to the electrose insulator; No. 2, why the spreader for a one-wire antenna; No. 3, lead-in taken from

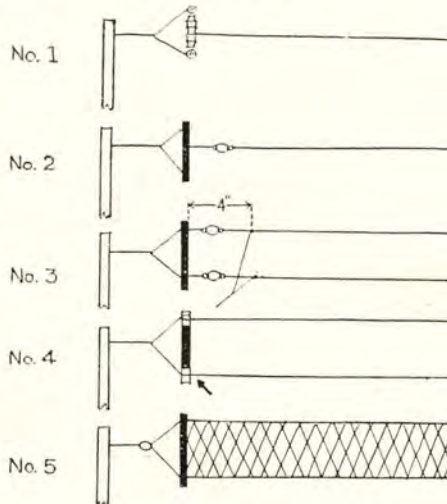

antenna about 4 feet from spreader; No. 4 the insulators here are not doing any good as wires are attached to the bridle; No. 5, here we have two-foot chicken wire for antenna; not quite so bad."

Works Mexico

Station 6EB, L. F. Seefred, Los Angeles Calif., was probably the first Los Angeles amateur CW station to communicate with Mexico. On November 19, 1923, at 2:30 a. m. P. S. T., a CW station was copied at 6EB signing "RF" on a wave length of approximately 350 meters, and sending "CQ". At 2:50 a. m. 6EB called "RF" and asked for "qra". "RF" answered after a long call and said, "qsa, qsa, qrn, qrn! qra Las Moches, Mex., Topolobampo Bay. Name Enrico? Ocho. Intermediate note and fades, but think it is my location, qrn." "RF" had a good D. C. note but also faded bad. A Reinartz tuner with 2 steps of A. F. amplification and no ground were used at 6EB for reception at the time. "RF" was cleared at 3:45 a. m. on account of heavy qrn at both ends.

The CW transmitter at 6EB is a 5 watt tube severely punished with a high voltage diet, being 1000V.—150 mils. from a synchronous rectifier, 8 1/2 V. filament, and 3.4 T.C. at 185 meters. The Hartley circuit with no grid condenser or grid leak was employed.

Radio is developing an entirely new type of vocal artists with voices surpassing in sweetness and technique those of concert and theatrical stage stars, it is declared by Miss Eleanor Poehler, music educational leader of the Northwest and one of the few woman executive directors in complete charge of a large radio broadcasting station. Miss Poehler, as director of the Cutting & Washington Radio Corporation's station, WLAG, popularly known as the Twin City (Minneapolis and St. Paul, Minn.) radio central, has for some time been experimenting with these "radio voices" and developing them.

"This extraordinary invention—radio—is opening a field that is epochal for new artists and giving the public the benefit," said Miss Poehler. "There are thousands of 'radio voices' in this country alone which are of surpassing sweetness, but because they have not the volume required to fill even small halls, have not heretofore been heard outside of small circles of friends."

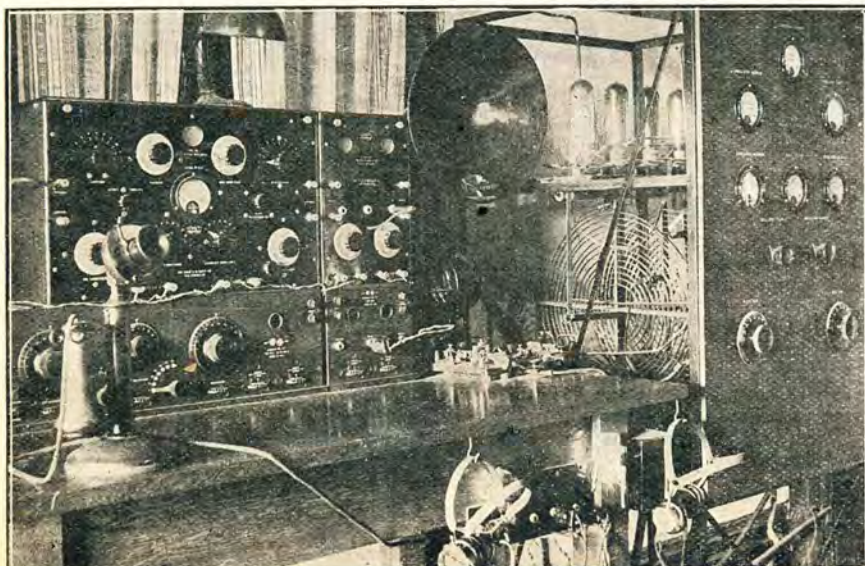

THIS, GENTS, IS 6JX, 6BVW AND 6ZW, OPERATED BY WILFORD DEMING, LOS ANGELES.

Radio Club Activities

C. R. R. L. Meeting

At a recent meeting of amateurs in Winnipeg many important questions were discussed. Mention was made of the opposition to the C. R. R. L. coming from some sources and it was decided that since a considerable number of Canadian amateurs had expressed themselves in favor of the C. R. R. L. it must be certain that these amateurs considered Canada ready for the Canadian Radio Relay League.

"The idea that some seem to have that we are out to buck the A. R. R. L. is entirely wrong," state C. R. R. L. officials. "We are out simply for a Canadian League with the undoubted better influence it would have in protecting Canadian interests."

At the meeting it was decided to "carry on". It was suggested that if a convention is held next fall it might be possible to have a vote taken to see whether the present C. R. R. L. continue in office or not. The meeting expressed their approval of this proposal.

At the invitation of the Committee Mr. J. E. Watkins, president of the Manitoba Radio Association, together with Mr. J. Shannon, Radio Inspector, District No. 4 opened the Canadian Radio Relay League ballot box Monday, December 31, at 5 p.m. and declared the following members elected to office of board of directors:

District No. 3: H. M. Linke, 3BQ, 80 Wellington St., Kitchener, Ont.; Wm. M. Sutton, 3NI, 227 S. Archbald St., Fort William, Ont. District No. 4: S. G. Paterson, 4DY, 612 Beresford Ave., Winnipeg, Manitoba; A. J. R. Simpson, 4DK, 408 McGee St., Winnipeg, Man. District No. 6: B. C. Cool, 4CW, 1601 23rd Ave., N. W., Calgary, Alta.; E. Sacker, 4HF, 11822 78th St., Edmonton, Alta. District No. 5: W. R. Hart, 4DG, 411 18th St., Prince Albert, Sask.; P. H. Jones, 4GH, Buchanan, Sask. District No. 7: W. G. Crisp, 5EJ, 1451 Balfour Ave., Vancouver, B. C.; C. E. Trott, 5AS, Chilliwack, B. C.

Superior California

The "hams" in this part of the country all seem to enjoy your magazine. The last meeting of the year was held by The Superior California Radio Association in Woodland, December 1. Due to much other pressing business only about half of the membership were present but the following towns were well represented, Willows, Sacramento, Grass Valley, Auburn, Modesto, Merced and Walnut Grove.

The evening was started with a turkey supper after which the following officers were elected for 1924. W. Huston, 6ABX, president; E. Steen, 6FH, vice president; B. Laugenaer, 6CBW, treasurer; C. Mason, 6CBS, recording secretary; 6BMY of Sacramento, corresponding secretary.

Following the election of officers a raffle was given by the local club and then the evening finished off with a free for all discussion on everything pertaining to radio and a lot of things that didn't. After adjournment "Boiled Owl Parties" were held at local stations.

The next meeting will be held in Sacramento, the first Saturday in February. All transmitting amateurs invited.

Venice Club

The Venice Radio Club, a brand new organization, was formed in December by a score of amateurs or radio listeners who are embryo amateurs at Venice, Calif. The club is unique in many respects, both as to purpose and procedure. The primary object of the organization is to cooperate for the purchase of radio material which will be of benefit to the entire community. Furthermore it has no dues. This indeed is a radical departure. Assessments may be levied however, from time to time, for the purpose of buying such material, the assessment however first being voted by the organization. The club decided upon a modest initiation fee, and proceeds from this are to be devoted at once to the purchase of a thermo galvanometer, to build up an oscillator for measuring antenna resistance. For the benefit of embryo hams, also, the club proposes to purchase at once an omnigraph, so that members without operating licenses may have the opportunity to study, practice and secure one. The club proposes to affiliate with the A. R. R. L., handle traffic reports, and secure outside speakers, as well as members, to give talks on construction, experimentation and radio data.

Santa Ana Active

The Santa Ana, Calif., radio club's activities have been slowed up by a number of the members moving away from Santa Ana. Nevertheless, those remaining have continued with the same old fight. The last touches having been put on their new headquarters, the code table and equipment have been installed. With this equipment code class is being held every Monday, Wednesday (before meeting), and Friday.

The library is being equipped by donations from various members of the club, which has resulted in the collection of about one hundred and fifty dollars in books and magazines. A shortage in funds due to the club's expenditures on its rooms has held them up on their apparatus. They now have a ten watt set completed for which they are awaiting a call. Receiving sets which are being used by the club include Grebe CR8, Paragon RA10, and Grebe CR5.

Meetings are held every Wednesday night. Programs for each meeting are made at the preceding meeting. Talks on theory and apparatus have featured the last few meetings. President E. L. Humphreys gave an account of his experience in Europe during the war, as a radio operator about the U. S. Flagship. Other talks have been made by different members on subjects included in list decided upon by the members of the club. This list is: Elementary Electricity, Applied Mathematics, Alternating Currents, Storage Batteries, Motors and Motor Control, Principles of Radio Transmission, Spark Sets, Arc Sets, Receiving Sets, Detectors, Amplifiers, Tube Transmission, Measurements.

Some member of the club gives a talk on one of these subjects at every meeting, each subject being taken in turn.—Wm. R. HOOVER, Sec'y.

Milwaukee Dinner

An American Radio League traffic meeting and an annual dinner were the big features in the recent activities of the Milwaukee Radio Amateurs' Club, Inc. At a well attended Saturday afternoon traffic gathering under the chairmanship of C. N. Crapo, 9VD, local operating department officer; U. S. Radio Inspector A. F. Parkhurst, 9RI, Chicago, spoke under the title of "The Relation of the Work of the Department of Commerce to the Radio Amateur;" R. H. G. Mathews, 9ZN, A. R. R. L. central division manager, discoursed on new points and policies of league organization, and F. J. Marce, 9CD, president of the Armour Institute Radio Club, Chicago, described the activities of the Chicago Radio Traffic Association, of which he was recently secretary. A lively discussion ensued in which M. F. Szukalski, Jr., 9AAP, Milwaukee League city manager, made a strong plea for the idea that on the relaying of messages free of charge to the public depended the continued existence of the amateur.

On the evening of the same day the annual dinner was held at which Inspector Parkhurst entertained the gathering with a talk entitled "Reminiscences of an Old-Time Operator." L. S. Hillegas-Baird, business manager and one of the founders of the club, spoke on his pet topic, "The Radio Club in Milwaukee," and Mr. Mathews again enthusiastically addressed the assembly on "The Central Division as a Leader in A. R. R. L. Affairs." Mr. Marce spoke briefly of 100 meter reception, and Mr. Crapo talked on "A Pre-War New England Amateur in Milwaukee," for before the war he was 1AIV and 1EIN and secretary of the Plymouth County Wireless Association, Brockton, Mass.

Previous to the date of the dinner and at a regular club meeting, Karl E. Hassel, 9ZN, research engineer of the Chicago Radio Laboratory, spoke on "The Underlying Characteristics of Receiver Design." The technical committee continues to be active, recent reports being "The Nedal Point," by G. Forrest Metcalf, 9CKW, Wauwatosa; "Experiments in Measurement of Distributed Capacitance," by E. T. Howell, Sc. M., 9CVI; "Synchronous Rectifiers," by J. W. Blauert, 9ELV, and "Wave Traps," by C. F. Quentin, 9CII, South Milwaukee. The society recently entertained D. J. Angus, 9CYQ, an officer of the Indianapolis Radio Club, who, though he came to learn something of this organization, spoke of amateur activities in southern Indiana and their work in connection with railway dispatching.

Contrasted with last year, the technical committee of the Milwaukee Radio Amateur's Club, Inc., is no longer represented by one man investigating and reporting at meetings, but is now the society's largest committee and perhaps its most active. Reports such as "The Relative Efficiencies of Battery-Charger Rectifiers" by R. E. Lathrop, 9ATX, former vice president of the Waukesha Radio Amateur Club, "An Amateur's Notion of the Heaviside Layer Theory" by M. H. Doll, 9ALR, West Allis A. R.

(Continued on Page 38)

Trade Talk

from
Radio Dealers & Manufacturers

Trimm Speaker

The Trimm Radio Manufacturing company of Chicago, Ill., manufacturers of the well known Trimm Professional and Trimm Dependable head sets, have added loud speakers to their line. The new items consist of a composition horn, the base of which is equipped with a special Trimm Jumbo size loud talker unit. This unit is adjustable by means of an adjusting lever, which is conveniently placed on the top part of the base. The adjusting lever provides the means for instantly increasing or decreasing the distance between the poles and the diaphragm for toning down the crash of local stations, and strengthening clarifying weak signals from distant stations. It is successfully operated on one or two stages of audio-frequency amplifications. Plate voltage recommended, 80 to 90 volts.

Trimm Jumbo size loud talker unit which measures 6 inches in diameter, is also made to be used as a phonograph attachment for any standard phonograph. The Trimm Acousticola Grand loud talker is made of cast aluminum. The heavy wall and the scientifically correct shaping of the neck, the throat and the bell are added features.

Corco Moves

The Continental Radio company of Los Angeles, manufacturers of the Creswell Universal Synchrodyne receiver, has already expanded to the point where, after two months, they are moving into new and larger factory quarters at 416 East Eighth street. The new quarters have six times the floor space of the old plant. The demand for the Corco transformer, trade name for the set, is exceeding the output. The transformer is the nucleus of the circuit which eliminates extra variometers and variocouplers found in the ordinary set. The company also manufactures the Vernierstat, which is a finely adjusted rheostat. This, it is claimed, eliminates noises incident to many vernier rheostat adjustments while giving true vernier accomplishment. It consists of two elements of different resist-

ance in parallel, controlled by two contact fingers. The company is soon to announce a new product, the Corco cascade audio frequency transformer for standard as well as push-pull amplification. A new principle is claimed for the core construction of this transformer. It will be mounted in a cast bakelite case.



THIS WINDOW DISPLAY OF TUBES WON FIRST PRIZE OF \$1000. THE PRIZE, AWARDED BY CUNNINGHAM, WAS WON BY THE LESTER RADIO SHOP, 140 SO. SPRING ST., LOS ANGELES, CAL.

Mahoganite Name

"Our attention has been directed to the fact that certain manufacturers of radio materials and parts have recently started to use the name Mahoganite on some of their devices," writes the American Hard Rubber Company. "This name is one of our trade-marks for radio material and for panels, dials and other radio parts. Realizing that the unauthorized use of this name by others in the past may have been inadvertent, we are taking this occasion to bring to the notice of the trade the fact that we own the exclusive right to the use of the name Mahoganite for radio materials and parts and that we shall look upon as an infringer anyone who uses this name upon similar products."

Enlarging Quarters

The Ray-Dee-Artcraft Instrument Co., of Redlands, Calif., is enlarging its present quarters. This company is placing a new receiver on the market, the Ray-Dee-Dyne Receiver, a three tube tuned radio-frequency reflex receiver.

Market Manager

The Th. Goldschmidt corporation, 15 William street, New York city, who are the sole importers for United States and Canada of the N & K imported phones, announces the appointment of Harry E. Sherwin as marketing manager of their organization. Mr. Sherwin was for many years associated with Robert H. Ingersoll & Bro., both in this country and abroad, in the merchandising of Ingersoll watches. He was sales manager of the A. C. Gilbert company of New Haven for many years, and was particularly responsible for the distribution secured for the Polar Cub electrical fan and other Polar Cub electrical specialty products. He recently completed a contract for introducing the Bobolink phonograph book for children, on which a national distribution was secured in less than six months' time.

The Goldschmidt corporation are planning a very aggressive sales and advertising campaign on their N. & K. phones, announcement of which will shortly be made to the trade.

Bradley Switch

The Allen-Bradley Co., Milwaukee, Wisconsin, have added a fourth item to their list of radio products, known as the Bradleyswitch. This is a very compact, completely enclosed, single-pole switch for opening battery circuits. It is mounted by drilling a hole in the radio panel and securing the switch by means of a knurled nut. The switch is operated by pulling or pushing the switch button.

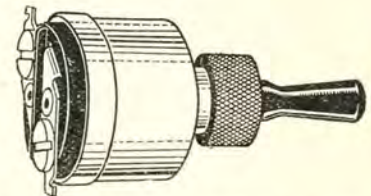

The Bradleyswitch is nickel-plated and the button is polished black, thus conforming with the standard finish used for radio equipment.

C. C. Langevin, secretary of the Atlantic-Pacific Agencies Corporation, on a visit to Los Angeles, Calif., rec-

(Continued on Page 40)

Listening In

From 6BCS and 6ACW

Calls heard and worked by 6BCS and 6ACW at Gardena, Calif., during November:—1BCK, 1BGA, 1YB, 2BGG, 2BNU, 2TS, 3DN, 3YH, 3YO, 4AC, 4CS, 4GW, 4KU, 5ADB, 5ADC, 5ADO, 5AFO, 5AHR, (5AIJ), 5AKF, 5AKN, 5ALR, 5AMA, 5DN, 5DW, 5FX, 5GA, 5GJ, 5GN, 5HQ, 5HT, 5KC, 5KG, 5LR, 5MO, 5NN, 5TJ, (5ZA), 5ZAK, 5ZAV, 5ZN, 5IC. Sixes too numerous. 7ABB, 7ACI, 7ADF, 7ADS, 7AFN, 7AGE, 7AGN, 7AGR, 7AGV, 7AII, 7AKH, 7AOC, 7AK, 7AP, 7BJ, 7EM, 7FD, 7GS, 7IO, 7KS, 7IT, 7LR, 7LY, 7NN, 7OB, 7LU, 7OH, 7OM, 7OT, 7QD, 7QT, 7RI, 7SF, 7SH, 7TO, 7WA, 7WM, 7WS, 7YA, 7ZD, 7ZE, 7ZK, 7ZO, 7ZU, 7ZZ, 8AB, 8AAJ, 8AIO, 8AJD, 8ANH, 8APA, 8APN, 8AXC, 8BCI, 8BCU, 8BDA, 8BFH, 8BFM, 8BJV, 8BYW, 8CHV, 8CRN, 8CTQ, 8CZZ, 8DAT, 8DGO, 8WX, 8XE, 8ZZ, 9AAU, 9ABC, 9ACS, 9ADR, 9AEC, 9AFM, 9AHZ, 9AII, 9AJY, 9AMB, 9AOU, 9APF, 9AUU, 9AV, 9AVN, 9AVS, (9AVU), 9BAK, 9BCF, 9BEH, 9BEZ, 9BHD, (9BII), 9BJK, 9BKF, 9BLY, 9BRI, 9BRK, 9BTL, 9BUN, 9BWA, 9BXQ, 9BZI, 9CAA, 9CAS, 9CAQ, 9CCV, 9CCZ, 9CQD, 9CTO, 9CVC, 9CVS, 9CXS, 9OYW, 9CZG, 9DFH, 9DHQ, 9DKY, 9DPY, 9DRO, 9DTE, 9DYW, 9DZY, 9EDB, 9EEA, 9EIL, 9EKY, 9ELV, 9AN, 9HY, 9MC, 9SS, 9ZT, Canadian 3BP, 3CO, 3IR, 3TB, 4DY, 5CN, (5GO).

WNP working 5ZAV, December 1, 1923.
Sum Australian station calling 1LK, November 18-19.

Wld appreciate a QSL from anyone and w/ QSL hr. New QRA 6ACW Yukio Ita, Moneta, California.

List From 6EA

Calls heard and worked by 6EA:—1FD, (5BE), 5HT, 5KG, 5QQ, 5UO, 5XD, 5ZA, 5ABD, (5AIJ), (5ZAV), 7BJ, 7FL, 7GP, 7GT, 7HG, 7HW, 7IH, (7IW), 7KS, 7LN, 7LR, 7LU, 7LW, 7MC, 7NN, (7OH), 7PF, (7QJ), (7SC), 7SF, 7SY, 7TO, 7VN, 7WM, 7WP, 7WS, (7YA), 7ZD, 7ZF, (7ZN), 7ZT, 7ZU, 7ABB, 7ADG, 7AEA, 7AEK, 7AGV, 7AII, 7XAE, (8BDA), 8BFM, (8BXX), 9BP, 9CK, 9MC, 9VM, 9AIC, 9AMB, 9APF, 9AVZ, 9AZG, 9BHZ, 9BII, 9BJS, 9BLY, 9BRK, 9BZI, 9CAA, 9CJY, 9CVS, 9DFH, 9DKB, 9DKY, 9DLF, 9EKY, 9ZT. Canadian: 5CN, 5GO.

Five watts at station 6EA has been reported heard by WNP at Greenland, 4EB in Georgia, and 8DHQ in Michigan. Best QSO was with 8BDA and 8BXX in West Virginia and Ohio respectively. Seven radiograms were handled with 8BDA.

From 6EB

Calls heard at 6EB, Los Angeles, Calif.—Reinartz, 2 step, and no ground. (Mex. "RF")—Can. 3NI, 4CL, 5CN, (5GO), U. S. 2RK, 3HG, 5ADB, 5ADO, 5AIU, 5EK, (5HT), 5QL, 5TJ, 5XD, 5YT, 5ZA, (5ZAV), 5ZH, 7ABB, 7ACI, 7ADG, 7ADP, 7AEA, 7AFK, 7AFO, 7AGE, 7AGV, 7AIM, 7ALK, (7BB), 7BJ, 7BR, 7CF, 7EB, 7EM, 7GQ, 7GO, 7HG, 7IH, 7IO, 7IT, 7IW, 7JE, 7KS, 7LN, 7LR, 7LW, 7LY, 7NN, (7OH), 7OT, 7PF, 7QD, (7QJ), 7QT, 7QU (7RS), (7SC), 7SF, 7SH, 7SO, 7SY, 7TO, 7TQ, 7UU, 7VE, 7VN, 7WM, 7WS, 7XT, 7YA, 7YL, 7ZN, 7ZR, 7ZT, 7ZU, 7ZX,

8BDU, 8BFH, 8GZ, 9AIM, 9AMB, 9APE, (9APF), 9AVS, 9AVZ, 9BIK, 9BII, 9BJK, 8BLY, 9BZI, 9CAA, 9CCS, 9CCV, 9CFJ, 9CGA, 9CJY, 9CNS, 9CTE, 9DFH, 9MC, 9PF, 9VM, 9XI, 9YAJ, 9ZT.

Overloaded 5 watter used here the last few months. QRZ?

The 5 watter at 6EB has been recently reported heard in Yukon, Canada, West Virginia, Kentucky, Tennessee, Pennsylvania, and by WNP at Greenland. All reports verified by log. Others are destroyed.

6CFM Reports

The following is a list of calls heard and worked at 6CFM:—1YB, 3BP (Can.), 5BE, 5CN (Can.), 5ADB, 5AGJ, 5AIJ, 5ZA, 5ZAV, 5ZAX. All sixes are worked, 6BM, 6GX, 6TC, 6AFG, 6AME, 6AOI, 6ASA, 6ATZ, 6AWT, 6BCJ, 6BIH, 6BKX, 6BMY, 6BTS, 6CAE, 6CEK, 6CHC, 6CIB, 6CJE, 6CKH, 6ZAH, 6ZBA, 7EM, 7EL, 7FL, 7FV, 7GW, 7HG, 7HO, 7IO, (7KS), 7LR, 7NN, 7NY, (7OB), 7OT, 7PJ, 7PX, 7QA, (7QD), 7QY, 7SC, 7SF, 7TO, 7UU, 7VN, 7WP, 7ZG, 7ZO, 7ZX, (7ZZ), 8BDA, 9MC, 9VM, 9ZT, 9AIM, 9AMB, 9APF, 9AVU, 9AVN, 9AVV, 9BEZ, 9BJK, 9BUN, 9BXQ, 9CCZ, 9CFK, 9DFH, 9DKB, (9DTE).

Will all those hearing my 5 watter pse QSL and QRK? All those wishing crds pse QSL. All answered promptly.—Yours truly, CLAUDE S. PERKINS.

List From 6AQZ

Calls heard by 6AQZ last half of November and early part of December:—5ZA, 3GE, 5EB, 6AOS, 6CLR, 6CNH, 6WT, 6BIG, 6CET, 6HC, 6AJD, 6CHZ, 6VF, 6CU, 6CJJ, 6EC, 6SU, 6AVD, 6ZH, 6ADM, 6CAB, 6CIE, 6LI, 6CHE, 6AMG, 6MG, 6AND, 6RM, 6AWQ, 6AJP, 6CHU, 6BUR, 6CFY, 6BSF, 6CMU, 6BSG, 6ALG, 6AGE, 6AWT, 6CMR, 6CKR, 6MH, 6JA, 6BBC, 6CGW, 6AGK, 6BUH, 6BIC, 6AHD, 6GR, 6BCS, 6PL, 6NX, 6CEK, 6AVI, 6AO, 6ARB, 6WZ, 6CID, 6CIG, 6CKP, 6AHG, 6TI, 6CMI, 6MG, 6AIU, 6BUO, 6AHC, 6TW, 6BSG, 6JR, 6BLG, 6ZAR, 6ZAN, 6ACM, 6OL, 6XBJ, 6BNE, 6CKC, 6GD, 6EJS, 6AHP, 6ALV, 6GT, 6KM, 6BEG, 6AME, 6PH, 6BNT, 6CFZ, 6CEE, 6AFG, 6CNG, 6ALK, 6MS, 6BSJ, 6JX, 6DD, 6AON, 6BHS, 6AWX, 6AAK, 6CKR, 6FP, 6CEJ, 6FF, 6ZR, 7BR, 7LN, 7SO, 7ZE, 7TO, 7OT, 7AKH, 7KR, 7WS, 7EB, 7AIF, 7VN, 7PF, 7AK, 7IIS, 7AJY, 9CFY, 9CZR, 9BJK, 9DIF, 9BUN, 9BII.

San Fernando Ham

I have read many of your Radio Journals and thought them good. I also have read many of the receiving reports in it, and since I have been getting very good results with my receiver I thought I would write you.

I have a Clapp Eastham regenerative receiver, with Baldwin phones.

I have heard the following stations:
4DY, 4GX, 4CS, 5ADJ, 5AEU, 5UW, 5AKY, 5AMA, 5LR, 5KM, 5UI, 5ADO, 5TJ, 6's too numerous to mention, 7IO, 7IG, 7OB, 7AEL, 7HW, 8AAJ, 8BDA, 8BCI, 8DAT, 8ZZ, 8FD, 8BFR, 8BJV, 8HN, 8AB, 9CNV, 9AMB, 9BAK, 9DFC, 9EFT, 9BOO, 9DTE, 9DFH, 9MC, 9AYL, 9AIM, 9ZT, 9BLY, 9BZI, 9AEM, 9AHZ, 9CCS, 9AVU,

9APF, 9HK, 9AVE, 9CGA, 9FM, 9OX, 9EEA, 9AWF, 9NU, 9EDB. My receiver is detector only. I heard these in month of November, 1923. I heard these also, WLW, WJAZ, CFCN, WBAP, WOAW, WOC, WAAW.—HORACE ALLEN, San Fernando, Calif.

From 9ZT

All districts worked and three countries heard by 9ZT, D. C. Wallace, Minneapolis, Minn.:

(1ER), (1HX), 111, 1SN, 1XM, 1VV, (1YB), 1YD, 1YK, 1ADA, 1AJA, 1AQI, 1BCG, 1BGK, 1BOQ, (1CKP), (1CMP), 1CRW, 1CSU, (XAQ), 2AH, 2BX, (2GK), 2IG, 2KF, 2KU, 2PA, (2RB), 2RK, 2SH, 2TS, 2WB, (2XQ), 2AFP, 2AGB, 2ANA, 2AWH, 2BKQ, 2BMR, 2BRH, 2BRB, 2BRC, (2BTE), 2BXP, 2BXW, 2CFB, 2CJR, 2CKA, (2CQZ), 2CSL, (2CXD), (2CXL), 2IAQ, 3AB, 3BW, 3HG, 3JJ, 3ME, 3PZ, 3UR, 3VO, (3WF), 3XI, (3YP), 3ABN, (3ADB), 3AJD, 3ALN, 3AUV, 3AVP, 3CFV, 4CR, 4CS, 4DB, 3EB (4FA), 4FG, 4KU, 4MB, 4QF, 5BW, (5CE), (5GA), 5GF, (5GJ), (5GM), (5HY), 5IN, 5JE, 5KC, (5KK), 5KP, 5LR, 5MI, (5MO), 5QL, 5QW, 5SK, (5TJ), (5UK), (5UR), 5WE, 5WO, (5XV), (5ZA), 5ZG, 5ZM, 5AAW (5ABG) 5ABH (5ADH), 5AFQ, 5AGJ, 5AGO, 5AHH, (5AHR), 5AIC, 5DAT, 5ZAS, 5ZAV, 6AK, 6AO, (6CU), 6FH, 6HP, (6KM), 6NX, (6PL), (6VE) 6ZH, 6ZW, 6ADP (6AHP), 6AHU, 6AJD, 6AKZ, 6ALK, (6ALV), 6ANB, 6AOI, 6AOS, (6AVV), (6AWT), 6BBC, 6BBU, 6BBW, 6BCL, 6BFG, 6BIH, 6BIQ, 6BJC, 6BJQ, (6BPZ), 6BRF, 6BUA, 6BUQ, 6BUR, (6BVG), 6CBP, (6CDG), 6CFZ, 6CGW, (6CKR), 6GNH, 6CWA, 6XAD, 6ZAH, (7HG), (7HW), (7IH), (7KS), 7LN, 7LR, (7QJ), 7RY, 7SC, (7SF), 7TO, 7WM, 7WP, (7WS), 7ZI, (7ABB), 7AEA, 7AEL, (7AFN), (7AGE) 7AGR, Canadian 2BN, 2CG (5GO) (5CN) Bowdoin (WNP).

Heard on One Tube

Calls heard on one U. V. 199 by 6CCP, A. B. Nolan, University Farm, Davis, Cal. As the QRA's are not known I will be glad to hear from any one listed.

3CO, 30H, 4CS, 4DQ, 4DF, 5AK, 5AKN, 5ER, 5MO, 5VE, 5ZAV, 5ZP, 6ZH, 6BQY, (6's too numerous), 7ADF, 7AGR, 7OB, 7OH, 7QD, 7SC, (Readable 3 ft fm fones), 7SH, 7TO, 7TT, 7VE, 7ZE, 8AAV, 8AGO, 8AWM, 8BCF, 8BDA, 8BSP, 8BVR, 8ER, 8GZ, 8JJ, 8MZ, 8XE, 8ZM, 8ZW, 8CPX, 8ER, 9AAU, 9APF, 8BAK, 9BJK, 9BLY, 9CCS, 9CJY, 9UH, 9XTQ.

Canadian: 3OH, 4CN, 4DY.
Phone—WLW.

On Indoor Aerial

Calls heard at 6HK using a 22 foot picture moulding aerial and synchrodyne circuit receiver: 1TS, 1CMP, 1IBD, 1YA, 1KS, 1CBN, 2CG, 2ALU, 2CF, 3KO, 3GB, 4DQ, 5EF, 4FT, 4DK, 5BE, 5BW, 5CN (Can.), 5FV, 5FX, 5GM, 5GP, 5HK, 5HT, 5KG, 5LG, 5LJ, 5LR, 5DE, 5ZAV, 5UQ, 5AKM, 5ADB, 5UK, 5EDO, 5AHR, 5ACJ, 7ACI, 7ADF, 7AEA, 7AKH, 7CF, 7EM, 7GO, 7IO, 7KS, 7LR, 7LW, 7OE, 7OT, 7QC, 7QD, 7QJ, 7QU, 7SC, 7SF, 7SN, 7UU, 7WM, 7VP, 7QS, 7XT, 7ZO, 7NT, 7OB, 7ZE, 7LY, 7ADG, 7BDA, 7DAT, 8DF, 8JJ, 8BFM, 8AEB, 9APF, 9CAA, 9AHZ, 9APM, 9AVZ, 9BEZ, 9BII, 9BJK, 9BJM, 9BX, 9CJY, 9CNS, 9DBB, 9DFH, 9DKB, 9DUH, 9EKY, 9MC, 9VM, 9ZY, 9OK, 9APR, 9ATN, 9BD, 9AKT, 9AVV, 9AOU, 9ZT, 9HS, 9EEA, 9ACC, 9AFC, 9AMS, 9AIR, 9CZG, 9QD, 9ABZ, 9DKI.

(Continued on Page 41)

FOR Quality Radio Apparatus

See The Radio Show----Booths Nos. 13 and 19



Cabinet Grand, \$500.00

The Freed-Eisemann NR5 Cabinet Grand Neutrodyne

The most powerful of radio sets with the best of accessories, completely enclosed in a beautiful console cabinet.

For Those Who Want the Best
MAGNAVOX Loud Speakers
after years of competition still remain supreme



Type M 1, \$35.00

See our Display of other Standard Products

Crosley Receiving Sets
Ace Receiving Sets
Ray-O-Vac Batteries
Kellogg Parts
Dubilier Condensers
Eby Binding Posts
Baldwin Headsets
Bradleystats
Radion Panels

Handy Chargers
Cunningham Tubes
Gilfillan Parts
Schwarze Phones
Western Electric Headsets
Weston Voltmeters
Remler Apparatus
Amrad S Tubes
Amrad Sets

THE BRAUN CORPORATION

Wholesale Distributors Only

363 New High Street

Los Angeles, California

KILLS YOUR REFLEX TROUBLES

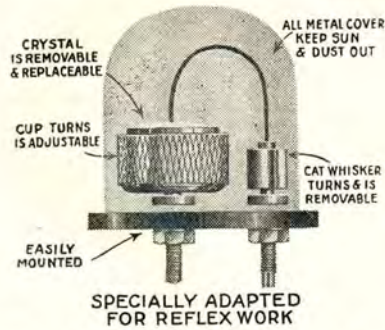

The "LINCOLN" Enclosed Fixed Adjustable Detector

Only a few weeks on the market, and demanded wherever shown. Thousands in use already and every one a satisfied user.

\$2.00

—a new and wonderful appliance which is becoming the leader among detectors. It is always ready for use. It contains a most sensitive crystal and this can be removed and replaced instantly. Being enclosed it is immune from dirt or dust. Thousands now in use after replacing the old detectors.

Jobbers Now Being Appointed

Manufactured by

The Lincoln Radio Co.

115 East 11th St.

Los Angeles, Calif.

See This Detector at the Radio Show.

Clubs

(Continued from Page 32)

R. L. City Manager, and "The Remotely Controlled System at Station 9AAP" by M. F. Szukalski, Jr., are typical of this committee's work. Mr. Doll is chairman.

"Magnetism, and Some Original Experiments in its Manifestation" was the title of an address given before the society by the Rev. John B. Kremer, S. J., A. M., Professor of Physics and Director of Station WHAD, Marquette University. Father Kremer, known as an eminent physicist, has recently become a deep student of radio communication and has evolved a new microphone for broadcasting stations. Another lecture arranged by the program committee was "Tube Transmitter Design" given by Le Roy M. E. Clausung, 9XN, operating engineer at station WJAZ of the Chicago Radio Laboratory. As a program feature a contest in defining technical radio terms was held. Great enthusiasm was aroused, the winners being C. R. Griesbacher 9CYL and M. H. Doll, 9ALR, who were awarded American Radio Relay League emblems.

On the same evening of the weekly meetings, Thursdays only, at 7:15 p. m., a code class for B. C. L's. is held. This is in the Trustees' Room of the Milwaukee Public Museum and has been quite well attended, among those wishing to learn to receive the international Morse Code are two Y L's.

Under the leadership of F. W. Catel, 9DTK, a most successful membership drive has been put over. From a large group of Milwaukee County non-member amateurs a majority has been induced to join the club and the American Radio Relay League, of which this society is a local section. M. F. Szukalski, Jr., 9AAP, the society's vice president, has recently been appointed A. R. R. L. City Manager for Milwaukee and now heads the city's traffic work. An active campaign against spark stations has begun, and attempts to mitigate the spark interference to broadcasting, as caused by commercial transmitters on ship stations, are being made, for it is this interference that is most troublesome to local radio fans.

The traffic committee solicits reports of QRM for investigation. All communications to the club should be addressed to its

(Continued on Page 38)

AT THE RADIO SHOW

Biltmore Hotel, Los Angeles, Feb. 5th to 10th

Don't Fail to See in Booth No. 66 Balcony, that Super-Speaker

The STENTOR

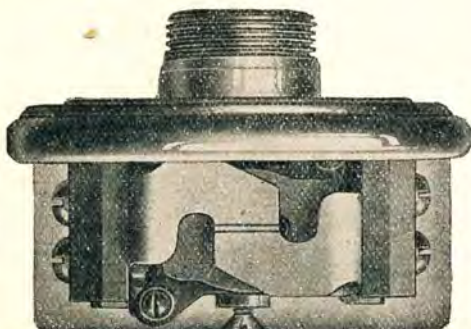

Phantom View of Unit Showing Cantilever Flexure.

Unit with Goose Neck Horn.....	\$22.50
Unit only, nickel-plated,	10.00
Unit only, 18K gold-plated	13.80
Adapter for any Phonograph75

It excels in Tonal Quality, Audibility and Sensitivity. This Super-Speaker embodies a new and novel application of the Cantilever principle which is mechanically and scientifically correct.

The Stentor meets all requirements perfectly, from 1 stage of amplification to a power-panel. See it by all means.

Manufactured by the

Stentorphone Company

627 So. San Pedro St.
Los Angeles California

**We're Ready
---Are You?**

Our stock-room is full of good, fresh, standard radio parts and materials—ready to take care of your wants for this wonderful radio season which is here right now. Our mail order service is better organized than ever—and that means instant deliveries! Mail order with check or money order and we'll get materials to you RIGHT NOW.

Coast Radio Company, Inc.

EL MONTE CALIFORNIA

You Can't Afford to Miss

THE SECOND NATIONAL

Radio and Electrical Exposition

Under the Auspices of

AMERICAN RADIO EXPOSITION CO., Inc.,
of New York

BILTMORE HOTEL

LOS ANGELES, CALIFORNIA

February 5th to 10th, Inclusive

*Unusual and Latest Display
of Radio Equipment*

Program of prominent speakers. Don't fail to enter the daily contest --open to all. Cash prizes of \$25 will be given each day for the best written opinion received on the exposition or on any individual exhibit. Rules of the contest will be obtainable only at the exposition.

ENDORSED AND APPROVED BY

*Radio Division of the Music Trades Association
Los Angeles Chamber of Commerce*

DEALERS

See us at Booth No. 29 during the Radio Exposition. We will have many new items to show you and will be glad to get acquainted with any new dealers who are not on our file. We would like your name for our mailing list.

THE WHOLESALE RADIO ELECTRIC CO.

Formerly
The Radio Concert Equipment Co.
946 South Flower Street Los Angeles, California
824-353 — Phones — 876-464

SPECIAL

COMPLETE SET, \$25.00

SPECIAL

Don't listen to all stations at once. We sell a complete set, including one set head phones and installed, in Los Angeles County, for \$25.00.

Other sets from \$10.00 up. Special sets built to order. We repair any kind of Radio equipment. Also install aeriels and sets of any make.

TERMS TERMS TERMS

Any of our sets sold on easy terms if desired. We take any kind of Radio parts or equipment in trade. Call us up or drop a line.

BURROUGHS RADIO COMPANY

4615 MONETA AVENUE Phone 298-318 LOS ANGELES, CALIF.

Be at Home Every Night to the Best Entertainers!

ACE

Radio "A", "B" and "C" Batteries will keep your radio set in perfect receiving order.

Distributed by

COOK-NICHOLS CO.

411 So. San Pedro Street 871-350 Los Angeles, California

Neutrodyne At The Radio Show See Us at Booth 34

(Licensed) Under Hazeltine Patent No. 1450080

WE SELL DIRECT



WorkRite
Neutrodyne
Model 201A

Distance and
Selectivity
Guaranteed

Price Complete

\$175.00

--and we mean
complete

C. L. ... 1113 1/2 S. Union Ave., lives less than 11 blocks from K F I; he positively eliminated all local broadcasting stations and brought in K P O, KGO, and K G W, with practically same volume as local.

National reception is assured. Please do not confuse it with the long, unsightly assemblies thrown together by the amateur. It is factory built and to very rigid specifications. Come and see for yourself!

Patterson Electric Company

MANUFACTURERS
239 So. Los Angeles St. Phones: 828-139; Main 5884

A complete receiver comprises the following:

- 1 Neutrodyne Set, in genuine walnut cabinet, size 10x16x10.
- 5 Cunningham 301-A Tubes.
- 1 Hobbs Battery or Willard Battery and Charger.
- 1 Trutone Loud Speaker.
- 1 Speaker Plug.
- 4 Large 22 1/2-volt Ever-Ready B Batteries.

NOTE—these sets are made especially for us to our specifications by Kruger & Co. Western Factory Branch of WorkRite Mfg. Co., Cleveland.

Los Angeles, California

(Continued from Page 36)

general office, 601 Enterprise Bldg., Milwaukee, Wis., or its officers may be interviewed at the weekly meetings, which are open to the public.

Highgate, England

The society headquarters have now been moved to Edco Hall, 270 Archway Road, Highgate, N. 6, where all meetings will in future be held. The first meeting in these new premises took place on Friday, November 30, when a lecture was given by Mr. J. F. Stanley, B. Sc., A. C. G. I., F. R. A., entitled "Distortion of Valve Receivers." It was shown how distortion can and does occur in high-frequency circuits, and how the use of reaction increases this distortion by reducing the time constant of the circuit. The behaviour of a valve was then considered when acting as a rectifier, and the relative merits of anode rectification and grid rectification were discussed from the point of view of distortion. It was shown that the valve gives least distortion when working in such a condition as to give the most efficient rectification—a most fortunate circumstance. Low frequency amplifiers were next considered, it being explained how transformer amplifiers tend to give higher amplification on the higher notes than on the bass notes. The remedies for the various causes of distortion were indicated, and a few hints given on how to obtain the maximum volume with the least distortion. The Hon. Secretary, 49 Cholmeley Park, Highgate, N. 6, will be pleased to forward full particulars of the society on application.

Twin City Club

Gentlemen:

The Twin City Radio Club held its regular by-monthly meeting Thursday, January 3, in the mayor's reception room, Minneapolis. Mr. E. A. DeForest, of the same family as Dr. Lee DeForest, gave a talk on new principles of magnetism and of silent and secret radio of zero wave length, and several new principles which he has worked out in the form of inventions and patented. Thomas A. White, sales manager of the Magnavox company, New York office, gave a talk on the principle of the magnavox and power amplification.

A QRA contest was held, which was handled in the form of a spell down. The QRA's of nationally known amateurs were given out by the participants as the secretary read off the call letter. 9BOV won, and won an interference eliminator. This interference eliminator was to be placed in series with the antenna ammeter, and consisted of one porcelain insulator.

The club wave meter was turned over to 9IG for checking up the North Side radio stations to see that they conformed with the statements made on the licenses.

9ZT announced that his new license, "9XAX," arrived, and that he succeeded in working IXAM, John L. Reinhartz, on 56 meters, and that volume on that wave was just as great as any other point on the scale.

ELECTRICAL UNITS

(Continued from Page 18)

potential on the sphere due to the charge Qk, hence

$$E_k = \frac{Q_k}{R} \quad [14]$$

Substitute this in equation [6], then

$$C_k = \frac{Q_k}{R} = R \quad [15]$$

R
(Continued on Page 40)

A & A SUPER HETERODYNE

Build Your Own

Successful results of the Radio Receiver you build depends solely upon three essentials:

1. **THE CIRCUIT.**
2. **THE RADIO FREQUENCY COUPLERS.**
3. **YOUR WORKMANSHIP.**

We can supply and *Guarantee* the first and second essential, and you the third. The Super-Heterodyne is the best method known of obtaining radio reception at short wave lengths. We do not know of any recognized authority on radio reception, or reliable manufacturer of radio apparatus who claims a better method of reception, where maximum distance combined with the highest degree of selectivity is desired.

Radio is a science of high frequencies and electrical stresses. Clarity of speech and pure quality in music, can only be obtained by using scientifically designed *Radio Frequency Couplers*. After years of research and careful experiment we have perfected the A & A Super-Heterodyne Radio Frequency Couplers, accurately tuned and adjusted, so that they can be easily and readily installed by anyone desiring to build their own Super-Heterodyne.

Anyone who is handy with tools can easily build his own Super-Heterodyne with the spare parts he has on hand.

We are now offering complete plans, actual size wiring diagrams and specifications of parts, together with three "A & A Super-Heterodyne Radio Frequency Couplers, for the nominal price of \$50.00. In addition we wish to announce that the advice and assistance of our engineering department is at your disposal at all times without further charge.

We will be pleased to meet you at Radio Exposition, Booth 22, Biltmore Hotel, and discuss with you radio problems.

If your dealer cannot supply you with A & A Super Heterodyne Radio Frequency Couplers and other needed parts, write direct to us and we will ship them immediately, postpaid.

SUPERIOR RADIO COMPANY

432-372

5937 Sunset Boulevard

Hollywood, California

WorkRite NEUTRODYNE Receiving Set

Manufactured under Hazeltine License, Patent No. 1450080

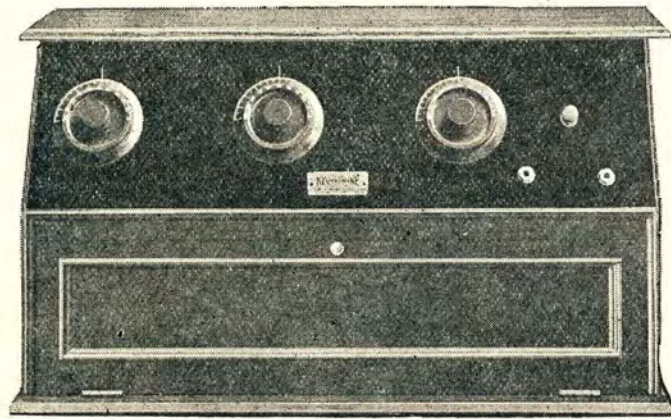

It is
SIMPLE
to
Operate

Buy a
TRUE
Neutrodyne

We are pleased to announce that after eight months continuous research work we have perfected our WorkRite Neutrodyne set. Prof. Hazeltine, inventor of the Neutrodyne circuit, personally assisted us in our factory in Cleveland in attaining this result.

Our branch factory in Los Angeles, under the management of Mr. Kruger, is equipped in every way to produce mechanically perfect sets which at the same time provides an expert service available at any time to all purchasers of WorkRite Neutrodyne sets.

We are now producing our Neutrodynes in three styles:

Type B201A	\$140.00
Type B201B	160.00
Type B201C	175.00
Type B201D	300.00

Without accessories.

We solicit inquiries from jobbers and dealers. Exclusive territory now available.

Neutrodyne marks the dawn of a new era in the science of Radio reception. It is the most wonderful and far reaching, fundamental discovery in Radio during the last ten years for obtaining—

DISTANCE—SELECTIVITY—CLARITY—VOLUME and complete elimination of tube and other extraneous noises. Local stations come in on the loud speaker without antennae or ground. Distant stations come in with antennae and ground on the loud speaker while the local stations are broadcasting, without the slightest interference.

New York City, Chicago, Denver, Honolulu, Fort Worth, Omaha, Hastings, Cincinnati are being brought in daily on the loud speaker, while the local stations are on the air. Stations in Oakland and San Francisco come in with almost the same strength and clarity as local stations.

WARNING: Do not purchase any Neutrodyne set unless it is made under the Hazeltine license; otherwise they are not Neutrodynes and will prove unsatisfactory.

B. KRUGER & CO.

315-317 Stimson Building, Third and Spring Sts., Los Angeles, Cal.

Distributors Pacific Coast and Western States

WESTERN BRANCH FACTORY OF THE WORKRITE MANUFACTURING CO., CLEVELAND, O.

WE EXTEND AN INVITATION TO ALL READERS OF "RADIO JOURNAL" TO VISIT OUR BOOTH NO. 26 AT THE RADIO EXPOSITION, WHERE OUR LATEST MODELS WILL BE FIRST OFFICIALLY SHOWN

Idylls of Coconino

The Old Man sat in his windy den,
A windin' th' spring on his old Big Ben,
His toes were cold, his nose was red.
'Twas thus because of the life he'd led.

That day he'd ridden th' desert far,
To get a package from off the car.
'Twas from back home, the notice said.
And there it lay upon his bed.

He opened the strings. "There, by gum,
I hopes as how 'tis a swig of rum,"
He muttered, and then he cursed a bit.
The darn thing held a radio kit.

A book there was, a magazine,
As told you how 'twas easy seen
This batch of wire and coils and tubes
Would bring th' world to th' door of rubes.

Now Coconino is vast and wide,
All rattlesnakes and sand, sun dried.
But now she shook and trembled till
Th' rattlers rattled, loud and shrill.

Never had cactus or yucca bloom
Heard cussin' like filled th' Old Man's room.
He couldn't savvy it, head nor tail,
An' th' starvin' coyotes heard his wail.
So the Old Man thunk, and cussed, and thunk,
And then he got almighty drunk.
But it did no good. It wouldn't work.
His darned old set just wouldn't perk.
He raced to town till his horse dropped dead,
A buyin' things, and then folks said,
"Old Bill is gone plum loco bad,
"A radio nut, my, ain't it sad!"

But then, one day, a rasp he heard,
And then a whistlin' like a bird.
His hair stood up. His spine grew weak,
But he couldn't get her past that squeak.
So he drunk some more and saw pink rats,
And colored monks and green eyed bats,
And snakes began to crawl and then—
"This is KHJ. It's half past ten."
That set she talked up, just like that.

RADIOLA V
with a Loudspeaker

The famous long distance Radiola that is already giving joy in more than 20,000 homes—with a loudspeaker that makes it a set for all the family. Will pick up distant stations on the loudspeaker—clear, loud, true-toned.

Radiola V
With three dry cell Radiotron tubes, and loudspeaker.
\$142.50



Radiola

Sold and installed by
The ODEON

834 So. Broadway
Los Angeles, California
Phone 823-889

WHAT DO YOU HEAR?

The antenna is to the radio receiver what the trolley wire is to the electric car.

It is the source of energy.

Give your set a chance. Our antenna engineer is prepared to design the most efficient antenna for your set.

LET US GIVE YOU AN ESTIMATE

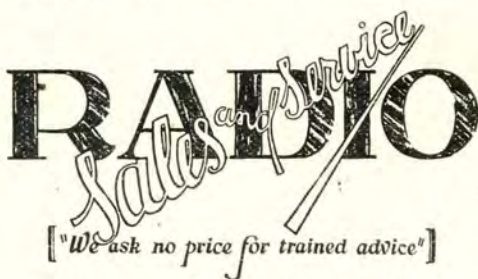

["We ask no price for trained advice"]

Antenna Construction Dept.

826 West Seventh St. - Los Angeles, Calif.
Phone 824-627

LOS ANGELES to CHICAGO
On a CRYSTAL DETECTOR

CRYSTALS are the Best Yet---Keep Yours

At Los Angeles I receive WJAZ Chicago, WOC Davenport and many other distant stations on mine—you can do the same on yours.

I show you how to make your crystal set into the best receiver you could hope to own.

Send \$1.00 for detailed instructions and 2-color wiring chart, or send stamped envelope for further information.

I have no parts or sets to sell.

LOREN E. TAYLOR

2497-A Beachwood Drive, Los Angeles, Calif.

We Repair the Following Radio Tubes
and Guarantee Them

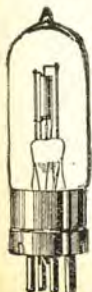

WD-11	\$3.50	DV-6	3.00
WD-12	3.50	UV-199	\$3.50
UV-200	2.75	C-299	3.50
UV-201	3.00	UV-201A	3.50
C-300	2.75	C-301A	3.50
C-301	3.00	DV-6A	3.50

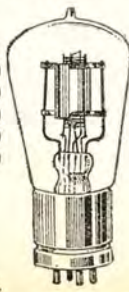

Mail Orders solicited and promptly attended to
Dealers and Agents write for Special Discount

H. & H. RADIO CO.

P. O. BOX 22-J

CLINTON HILL STA.

NEWARK, N. J.

RADIO
BIG MONEY IN A BIG FIELD

Be a RADIO EXPERT. Make big money. Win success in this new unovercrowded field. Trained men needed. Learn quickly, at home in spare time, to construct, install, operate, repair, maintain and sell radio equipment. **3000 TO \$10,000 A YEAR**

RADIO EXPERTS EARN \$10,000 A YEAR

Short course, low cost, easy terms, money back guarantee.

FREE Wonderful tube receiving set of latest design. Range of over 1000 miles. Write today for "RADIO FACTS"

A. E. Mebsaupt, Radio Eng. American Radio Association
4513 Ravenswood Ave., Dept. E1 Chicago

10 INITIALED BINDING POSTS \$1
 Beauties—Sent anywhere by mail on receipt of price. Fine panel design and 100 Station Log Free. Panels drilled. *Wood for beautiful cabinets* cut to size, with instructions for assembling and finishing like rosewood or mahogany. Will secure anything you want in the Radio Line and ship by parcel post, C.O.D. Send us your orders. Satisfaction guaranteed.
MAITLAND AND SPENCER ROACH
 2905 Columbia Avenue. Philadelphia, Pa.

It knocked th' Old Man prone, and flat.
 Just then he saw what he hadn't seen,
 One of them snakes so long and green.
 It had crawled acrost his radio set.
 If it hadn't crawled off he'd be lookin' yet.
 But it gave him th' tip, and he hooked her through,
 And now she works, by gum she do.

Listening In
 (Continued from Page 34)

The following is a list of the best DX heard at 6 BSR, W. Krause, during November and December: 1ER, 1MO, 1AGI, 1DC, 1YB, 1BKQ, 1CMP, 1XW, 1TS, 2AFP, 2RK, 2CLA, 2KF, 2ACL, 2AL, 2BQH, 2EL, 2AKM, 2AGB, 3CO, 3AUW, 3ZT, 3HG, 3HS, 3BGJ, 3OH, 3PZ, 3BUY, 3OE, 3LG, 4EB, 4ZA, 4FN, 4AY, 4AI, 4FT, 4MY, 4EL, 4IK, 4CL, 4SE, 4IA, 4IJ, 4CB, 4FZ, 4CS, 4OA, 4QR, 4IK, 4FS, 4CIA, 4HS, 4BK; Canada 99BX, 9BP, 4CN, 3OH, 3BP, 4FN, 3TB, 4SC, 4CL, 5CN, 3CO, 4DY, 3PZ, WNP.

Most of this work was done on an aerial consisting of 25 ft. of tinned wire size 14 suspended 3 ft. above the ground. Single circuit tuner, det, 1 step. W. E. fones.

Broadcast Station K. X. D. For Sale
 COMPLETE, 20 watt, transmitter, receiver, amplifier, magnavox, motor, batteries, antennae.
PORTABLE TYPE
 GUARANTEED 250 mile range. Letters show this station has been heard in Massachusetts and New Jersey.
Just Right for Private or Semi-Commercial Use
 REASON FOR SALE is lack of proper housing facilities. Priced right for quick action.
THE MODESTO HERALD, MODESTO, CALIFORNIA.

"ACCURACY FIRST"
HARRY W. HAHN MFG. CO.
 Tool and Die Makers
 620 S. San Pedro St. Los Angeles, Calif.
 Phone 885-172
 Bakelite and Rubber Molds, Special Dies and Tools for Radio Mfg. Production engineering, inventions developed, Screw Machine products, wire bending dies, special machinery designed, novelties, stamping and auto accessories.

Be Sure to Patronize Radio Journal Advertisers.—It will Pay You to do so

A well-established corporation in a profitable phase of the Radio business has reached the threshold of a large expansion which will greatly increase its usefulness and profits. I have a small block of the Common Stock of this Corporation which I am offering subject to prior sale. The proposition is sound and the possibility of large profits attractive. Your inquiry will bring the complete story by mail and, of course, will obligate you in no way.

Fayette Marsh
 611 Pacific Finance Bldg.
 Los Angeles California

Tubes Repaired
 GUARANTEED good as new. Immediate exchange if defective.
PRICES
 6-volt Detectors\$ 2.50
 ALL AMPS 3.00
 199-299 3.25
 Our prices on parts and sets are lowest in City.
LESTER RADIO SHOP
 140 S. Spring St. Los Angeles, Cal.
 Metro. 4832
 — OPEN EVENINGS —

Radiola
Dealers and Distributors

CALIFORNIA

Paul Franklin Johnson
 560 E. Colorado St.
 PASADENA, CALIF.
 "Everything Worth While in Radio"

NEW JERSEY

Tri-City Electric Co.
 52-56 Lafayette Street
 NEWARK, N. J.

MINNESOTA

STERLING ELECTRIC COMPANY
 MINNEAPOLIS, MINN.

The Synchrondyne

(Continued from Page 17)

adjustment, and in fact the only adjustment which is required for this circuit, is the proper capacitance, inductance value of the antenna ground system. Some experimenters have attempted to use antenna of too great an L C value with the resultant loss of sharpness of tune, clarity of music, and long distance receptance. I would recommend that, to start adjusting a set to an aerial and ground, that not more than 50 feet of wire be used. For the construction of the antenna ground system, No. 18 enameled magnet wire works very nicely. Then by cutting off a foot or so of wire at a time, until proper long distance reception is obtained without the local broadcasting interference, one may get the proper adjustment for this receiver. I do not recommend the use of a condenser in series with an antenna, because of the fact that, although the C value is reduced, the L value is constantly giving the characteristics of a long antenna. When the antenna ground system is so adjusted that the L C value is lower than the capacitance of the second tube in the circuit, the corona discharged from the generator, or the first tube, will pass to the second tube in the circuit without any re-radiation. This is very important, as the set will not function properly if any re-radiation is caused, and will affect the set to a great extent, on long distance reception. To bring out this corona effect which I mentioned, on the second tube, a gaseous tube may be placed in the second tube socket and a blue haze will be noted emitting from the grid. The size of the haze may be varied by adjusting the vernierstat, which, incidentally, is the important factor in the proper operation of the circuit.

The experimenter will note that the second tube has no so-called B battery. The plate circuit passes from plate to primary of the transformer, and from primary to positive filament. This allows a very low potential to flow through the primary of the audio frequency transformer at a very high current flow.

Note figures 2 and 3 of the drawings on the panel layout. The dimensions given there are for, in the case of wave control, a New York coil 43-plate variable condenser and on the vernierstat, the standard vernierstat which is of local manufacture. The low and high switch is preferably a No. 6 Carter Jack switch and if same can not be obtained a No. 3 Jiffey switch will serve equally well. For a filament lighting switch I am using a Cutler-Hammer switch and am using a single circuit jack on the right-hand side for plugging in on the

(Continued on Page 47)

Baughman Radio Engineering Corp.
 Phone Beacon 8509

A Staff of **RADIO MECHANICAL ELECTRICAL CIVIL** Engineers

Pacific Coast Distributors of

Como Duplex Transformers
\$12.50 per pair

Scientific Phones
\$2.95 per pair

1249 So. Alvarado St., Los Angeles, Cal.

Be Sure to Patronize Radio Journal Advertisers—It will Pay You to do so

The LATEST in HOLLYWOOD

Creswell Universal Synchrondyne Concert Receiver
 F. E. Neutrodyne. — W. E. Loud Speakers

CRESWELL SYNCHRODYNE TRANSFORMER \$8.00
 CRESWELL VERNIERSTAT 3.00

We Carry a Complete Line of the Best Only

YE QUALITY RADIO SHOPPE
 SUN ELECTRIC CO.

6278 Hollywood Blvd. Phone 438-304 Los Angeles, Calif.

Use Pearlco Radio Apparatus For Best Results

**IT IS NEEDLESS TO PAY MORE
IT IS RISKY TO PAY LESS**

SEE complete exhibit of Pearlco Radio Apparatus at the Radio Show.

Pearlco Reflex Transformer	\$ 4.50
Pearlco 23-plate Vernier Condenser.....	\$ 4.50
Pearlco Audio Transformer, 9 to 1, 6 to 1 or 3 to 1 ratios.....	\$ 5.00

FREE HOOKUPS on all the New Reflex Circuits. PEARLCO, one, two or three-tube Erla: one or two-tube Harkness.

Meet Us at Booth 56, at the Radio Exposition

PEARLCO DISTRIBUTORS for California. Dealers: Your discounts are satisfactory.

Yale Radio Electric Co.
 4816-18 So. Vermont Ave. Phone: Vermont 8973
 LOS ANGELES, CALIFORNIA



Pearlco Coupler, pig tail connections.....\$6.50
 New 180 degree Pearlco Coupler.....\$7.00

Make Yourself a Present of
This Lefax Radio Hand Book

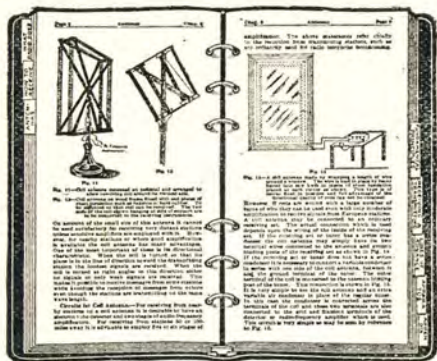

with one year's subscription to
Radio Journal for \$5.00

Or with a two-year subscription to Radio Journal for \$6.00

Lefax Radio Handbook will be sent you, postpaid, with one subscription to Radio Journal, new or renewal, your own subscription or that of your friend, for \$5.00.

Keep Up-to-the-minute in Radio

Lefax Radio Handbook keeps abreast of developments. It is loose-leaf and every month additional pages are sent out covering new developments. All pages are numbered and properly classified and may be inserted in the handbook, thus keeping it *perpetually up-to-date*. This supplement has just been greatly enlarged.

These additional pages are the most reliable source of supplementary reference in the field of radio literature.

Additional loose-leaf pages are mailed to you as they are issued—free of charge for one year. Every Radio experimenter needs this book. *Fill in the coupon below today and get your copy.*



Radio Journal
 113 Stimson Bldg.,
 Los Angeles, Calif.

Enclosed find..... for which please send Radio Journal for (one) (two) years to

Name

City..... State

Street No.....

Also send Lefax Radio Handbook, postpaid, to

Name

City.....State

Street No.....

The Whole Story of Radio

is told in this loose leaf book. Note the rings—they un-snap easily and leaves can be taken out or added as they come in. The material is prepared by the two chiefs of the Radio Department of the Bureau of Standards at Washington, Dr. Dillinger and L. E. Whittemore. Keeping abreast and ahead of radio development is their sole business.

These men are two of the foremost radio experts in the world. You have the opportunity to have these eminent radio experts guide you, too; to point out to you step by step what to do.

Radio Journal, which is included in this remarkable offer, keeps you up to the minute on every phase of radio, amateur, broadcast and commercial. You need both of these publications.

(Continued from Page 45)

loud speaker.. In figure 3, the sub-panel, I have given the center holes for vacuum tube bases. These are given this way so that the experimenter may either put his socket on top or use these holes or fly-cut a hole large enough so that the vacuum tube base may be mounted below the panel.

I find that mounting the vacuum tube base below the panel eliminates all visible wiring and makes a superior product. The lettering on these panels I had engraved locally. I am giving this information that the experimenter may construct for himself the finished product. Note in figure 3 that all the binding posts are mounted on rear of sub-panel, which will make for ease of connection in mounting this type of set in any form of cabinet.

A great many suggestions have come to me of modifications of audio frequency amplification for this circuit. Probably the best of all forms is the one-step audio frequency amplifier and then the push-pull amplifier for the next stage of cascade coupling. I have tried this scheme and find it far superior in several respects. The most important one is that one may get much greater volume on long distance reception with the

(Continued on Page 50)

\$100 **\$100**

Neutrodyne

THE WONDER DISTANCE SET

Fada five tube parts complete with cabinet and tubes, \$100.00
All you pay is for the parts. We build and guarantee the set free
Mail orders, \$25.00 cash, balance, C. O. D.

RADIO SPECIALISTS

425 Roberts Building Third and Main Sts. Los Angeles, Calif.
WALT HUBER "There Is a Difference" LES JONES

See the Journal Ads for Up-to-date Radio Apparatus

HELP LONG DISTANCE!

**HARKNESS
CIRCUIT**

Adaptable to one tube reflex sets. Two tubes can be used to obtain greater efficiency.

Coils, a pair.....\$3.00



**THE COAST
COUPLER**

Complete with special "hookup," factory guaranteed; gives you greater distance.

Mailed anywhere.....\$5.00

Mail check today and make your set efficient

Coast Coupler Company

245 East Seventh Street Long Beach, California



THE NEW IMPROVED ADVANCE UNIT CHARGER

A NECESSITY FOR EVERY OWNER
OF AN AUTO OR RADIO SET

SIMPLE EFFICIENT ECONOMICAL

When your battery needs charging the Advance Unit Charger may be connected to the ordinary alternating lamp socket and your battery will be charged over night. Radio owners find this charger adds to the pleasure of operating set. It is not necessary to move the battery when using the Advance Unit Charger.

Most efficient, rigid and simple construction. Will stand rough use without damage to parts. Very compact. Size five inches square. ONLY ONE WORKING PART. Self polarizing, which means that the battery may be connected to charger either way, or polarity. Will not injure the battery, if left on too long.

GUARANTEED for ONE YEAR AGAINST DEFECTS.

Price, \$18.50

ASK YOUR DEALER

Manufactured by

ADVANCE ELECTRIC COMPANY

1260 West Second Street
Metropolitan 5990
Los Angeles, California

Classified Advertising,

Follow these advertisements every month. Reliable advertisers from all over the country offer their most attractive specials in these columns.

Objectionable or misleading advertisements not accepted. Advertisements received too late for current issue will be accepted for the issue following.

Name and address must be included at the above rate. Cash should accompany all classified advertisements unless placed by an accredited advertising agency. No advertisement accepted for less than 4 lines.

Classified Advertising Rates, 5c per word. Time discounts for consecutive insertions; 3 times, 5%; 6 times 10%; 9 times, 15%; 12 times, 20%. Minimum charge, \$1.00.

PERSONAL

INVENTORS: PROTECT YOUR INVENTION through A. M. Wilson, Inc., Washington, D. C. Over 25 years of efficient, expert, confidential service. Skilled in Radio-Electrical, Chemical and Mechanical fields. Our new illustrated Patent Book, giving much necessary and very useful information which every inventor should know, will be sent free upon request. Prompt and careful attention. Highest references. Moderate fees. Send sketch or model for our careful opinion and preliminary advice. Write today to A. M. Wilson, Inc., (Radio 3ARI), 325 Victor Bldg., Washington, D. C.

PRINTING

RUBBER STAMP with large call letters 50c; Radiogram and Relay Radiogram blanks 25c per hundred, Post Card 60c hundred. Send us your orders. Carolina Printing & Stamp Co., Wilmington, North Carolina.

CALLS HEARD POSTAL CARDS for DX reports. Station call letters in color. Printed on government or plain postals. 80c hundred up. "Used Everywhere—Go Everywhere." Write for samples. Radio Print Shop, Box 582, Kokomo, Indiana.

RADIO EQUIPMENT

WAVEMETERS CALIBRATED with our Bureau of Standards wavemeters. Send us a good variable condenser and we will make it into a wavemeter. Prices reasonable. Correspondence invited. Radio, 6GL, 465 North Lake St., Los Angeles, Calif.

C.W. AND RADIOPHONISTS:—One hundred Ohio and Wagner 110V. sixty cycle A.C. synchronous motors built in 1/4 A.P. frames with 1/2" shafts are yours for \$18.00 each F.O.B., Buffalo, N. Y. Original selling price \$28.50. We also have the parts to attach to these motors to make synchronous rectifiers which will handle 2000 volts. Kimley Electric Co., Inc., 2665 Main St., Buffalo, N. Y.

COUPLERS, 80 turn \$2.00, 90 turn \$2.25, 110 turn \$2.75; variometers \$1.50; complete tuners \$10.00. We make all kinds of coils to order. Special prices on sets. Stiles-Perry, Deposit, N. Y.

WIRE TERMINALS—150 assorted \$1.00, 20 two foot lengths No. 14 square tinned busbar \$1.00, 10 two foot lengths No. 10 special round bus bar \$1.00. Send for samples. Immediate shipment postpaid on receipt of remittance. Radio Engineering Co., 55 Halsey St., Newark, N. J.

RADIO BARGAINS—Any \$6.50 Tube \$5.75; Erla Reflex Transformers, any type \$4.50. Burgess 2156 Batteries \$2.50; Brandes Superiors 5.25; Signal 23 Plate Condenser \$1.75. Everything Guaranteed Perfect. Write for list. Edward Bromley, Jr., Whitewater, Wis.

FOR SALE—Omnigraph, 15 dial, new \$20. Transformers, Audio UV712, Radio UV1714, \$3.50 each. Paragon sockets and type UR542, 50 cents each. Paragon rheostats, 75 cents each. Ellison Thompson, 1301 Findlay Ave., New York.

FOR SALE—Crocker Wheeler motor generator rewound 150 watts, 1000 volts speed 3600 \$75.00. Esco 500 watt, 1000 volts speed 1750 new 150.00. Travis Radio Laboratory, 102 Diaz St., Antonio, Texas.

PACIFIC COAST STATIONS are heard in Pittsburgh with vario-coupler and two Rogers Receiving Radiometers (Condensite molded variometers). Radiometers \$4.00 each. Postage prepaid. Rogers Radio Company, No. 5133 Woodworth St., Pittsburgh, Pa.

CARTER VARIABLE condensers 23 and 43 plate, your choice \$1.00. Automatic Long Range phones 3200 ohms \$3.25. Ceryphone headsets 2000 ohms \$3.00, Brach weatherproof outdoor lightning arresters \$1.00. New York Efficiency variometers \$1.50. Carter Plugs, handle two headsets \$0.40. American hard-rubber dials 4 inch for 1/4 inch shaft \$0.40. Electrore lead-in bushings 6 inch \$0.80. Powell May, Box 241, Knoxville, Tenn.

EDISON ELEMENTS for storage "B" batteries, six to ten cents per pair postpaid, depending entirely upon quantity ordered. I handle only strictly first grade full capacity elements. A. J. Hanks, 107 Highland Ave., Jersey City, N. J.

A WONDERFUL CRYSTAL SET—Can hear all over Philadelphia, and sometimes outside Philadelphia. Price with phones \$10.00, without phones \$4.00. Receiving sets \$25.00 to \$200.00. Guaranteed or money back. Send money order, Williams Radio, 2339 W. 8th St., Philadelphia, Pa.

FOR SALE

A. B. C. of Radio by Waldemar Kaempffert—over 500,000 copies sold at 25c. a copy. One of best beginners' radio books on market. Special price 16c, each, postpaid. Western Radio Supply Co., 418 Stimson Bldg., Los Angeles.

MISCELLANEOUS

GERMAN MARKS, 50c per million; other monies; send 25c for samples and particulars. Stimulate sales, advertise something new. Russian, Austrian, Polish. Write Di. Foti Adv. Co., 561 Washington St., Akron, Ohio.

1,000,000 GERMAN MARKS, \$2; 20,000 Austrian crowns, \$1; 1,000,000 Russian rubels, \$1; all three for \$2.50. AMERICAN SALES CO., Box 1278 San Francisco.

FOR SALE—Broadcasting station, KXD, portable type, complete. Will sell transmitter alone if desired. Address, The Modesto Herald, Modesto, California.

FOR SALE—C.W. and Phone Transmitter, 10 watts. Electric Specialty 100 w., 500 volt generator, 110 volt 50 cycle motor; \$100 complete with tubes, microphone, key, buzzer, etc. Address Box B-42, Radio Journal.

FORMS to cast Tin Soldiers, Marines, Indians, Trappers, Hunters, and my Air Pressure Cannon Machine. Moulds from \$1.25 up to \$3.50, casting 3 to 4 pieces at once. Write for catalogue. Ht. Schiercke, 1034 72nd St., Brooklyn, N. Y.

Homespun Tobacco—Chewing—5 lbs., \$1.25; 10 lbs., \$2.50; 20 lbs., \$4.50. Smoking, 5 lbs., \$1.25; 10 lbs., \$2.00; 20 lbs., \$3.50; Farmers' Union, Mayfield, Ky.

MAIL ORDER METHODS—\$50 WEEK, evenings, I made it; mail order business. Booklet for stamp tells how. Sample and plain, 25 cents. Free 12 articles worth \$3. Alraj Scott, Cohoes, N. Y.

WE SHOW YOU HOW TO EARN BIG MONEY easily with our casting forms making Whistling Birds, Wild Animals, Crowing Roosters, Automobiles, Baseball Players, Statue of Liberty, Indians, Toy Soldiers, Cowboys, Barking Dogs, Wag Tail Pups, Miniature casting of Capitol, Bathing Girl Souvenirs and others. No experience necessary. We furnish you with molds and necessary outfit from \$3.50 up. We buy large quantities of finished goods at highest prices. Spot cash. Send for catalogue and information free. The Improved Metal Casting Co., 342 East 145th Street, New York.

LEARN CHEMISTRY AT HOME.—Dr. T. O'Connor Sloane, noted educator and scientific authority, will teach you. Our home study correspondence course fits you to take a position as chemist. See our full page ad on page 295 of this issue. Chemical Institute of New York, 66 West Broadway, New York City.

OPERATE A TIRE REPAIR SHOP!—Big Profits! Oldham made \$2,200 in 4 months. Evans averages \$1000 week. We teach you and furnish full equipment for \$100 up. Write quick. Haywood's 1331 South Oakley Ave., Chicago.

WANTED—Investor with \$5,000 cash for one of the most meritorious business propositions on the Pacific Coast. Paying now,—increasing every month, with an unlimited future. Investor may be silent or active, man or woman. Glad to answer all inquiries. Address: BUSINESS, P. O. Box 1056, Los Angeles, California.

SCHOOLS

TELEGRAPHY—BOTH MORSE AND WIRELESS taught thoroughly and quickly. Tremendous demand. Big salaries. Wonderful opportunities. Expenses low; chance to earn part. School, established fifty years. Catalog free. Dodge's Institute, Cour St., Valparaiso, Ind.

RADIO FANS AND PROFESSIONALS—How many of you know the correct CODIFICATION of all characters, punctuations and signs (such as \$, per cent, etc.). We dare say that nine out of ten don't know them correctly! Our instructor who has had 35 years' experience, eight years of which were with Uncle Sam as MORSE and RADIO TELEGRAPHER, has just published the first and only CHART known to give fully a true and correct CODIFICATION of ALL characters used in both codes. This CHART is indispensable to all up-to-date beginners and veterans alike. Fifty cents (money order preferred) will bring CHART, also much information extremely interesting to BOYS and GIRLS; because, with this information and a little PEP on your part, you can qualify shortly (as scores of our graduates have done) and secure positions paying \$1,500 to \$3,000 yearly. (See Civil Service Bulletins 215, 357 and 54.) We are registered with the U. S. C. S. Com. at Washington, and can help you. AMERICAN TELEGRAPHIC STUDIO, BOX 793, WORCESTER, MASS.

AUTOMOBILES

AUTOMOBILISTS—A pair of "Is-It-Lit" reflectors attached to your headlights will tell you when driving whether they are lighted. Two styles \$1.05 and \$1.58 the pair. The H. D. S. Co., 79 Walnut St., Somerville, Mass.

Fords run 34 miles on gallon gasoline. Other cars show proportionate saving. Wonderful new carburetor. Starts easy in coldest weather. Fits any car. Attach yourself. Money back guarantee. Sent on 30 days' trial. Agents wanted. Air Friction Carburetor Co., Dept. 3222, Dayton, Ohio.

11

CALIFORNIA DEALERS AND JOBBERS ARE MAKING MORE MONEY TODAY

Last week they bought

CRYSTALS
DIALS
COILS
SWITCHES
BINDING POSTS
CONDENSERS

From

COLUMBIA COIL COMPANY
Vancouver, Washington

629

CALIFORNIA DEALERS AND JOBBERS ARE STILL PAYING HIGHER PRICES FOR THE SAME GOODS. WE SELL FOR LESS

Why send East for goods when we are shipping our products to the largest distributors in Chicago, New York and Philadelphia? Let us prove it pays you to buy on the Pacific Coast. Save the transportation and get immediate shipment.

COLUMBIA COIL CO.
VANCOUVER WASHINGTON

Antennas

(Continued from Page 22)

For regenerative receivers the shorter antenna is apt to prove the most efficient because of the low voltage induction. The neutrodyne receiver tunes sharper and in consequence gets long distance better on the shorter aeriels. Remarkable results have been obtained on 65-foot antennae.

Increasing the number of wires does not increase the fundamental in proportion to the length of the aerial, unless widely separated, and even then not in direct ratio, on account of capacity effect tending to shorten the natural period. If your space is limited, try spreading the wires.

If bothered with interference, try laying a piece of insulated wire on the ground for an aerial; then use different combinations, such as ground and this wire on aerial post of your receiver; reverse, and so on.

As a last suggestion, let me say this: Quit experimenting with costly parts for your receiver and erect one or more antennae, a counterpoise, a capacity ground, and then experiment with various combinations. The chances are you will be surprised at the results, and you may wish to thank me for the hint.

Bok Peace Plan

Everyone has been reading about the Edward W. Bok peace plan award. While it has little to do with radio, this publication, in common with many others, is giving its readers the opportunity of voting on the plan. So fill in the coupon published herewith:

THE PLAN IN BRIEF

Proposes

I. That the United States shall immediately enter the Permanent Court of International Justice, under the conditions stated by Secretary Hughes and President Harding in February, 1923.

II. That without becoming a member of the League of Nations as at present constituted, the United States shall offer to extend its present cooperation with the League and participate in the work of the League as a body of mutual counsel under conditions which

1. Substitute moral force and public opinion for the military and economic force originally implied in Articles X and XVI.
2. Safeguard the Monroe Doctrine.
3. Accept the fact that the United States will assume no obligations under the Treaty of Versailles except by Act of Congress.
4. Propose that membership in the League should be opened to all nations.
5. Provide for the continuing development of international law.

(Put an X inside the proper box.)
Mail promptly to

If you wish to express a fuller opinion also, please write to the American Peace Award.

Radio Journal, Los Angeles, Cal.

Do you approve the winning plan in substance? Yes No

Name
Address
City..... State.....

Are you a voter?.....
The American Peace Award
342 Madison Ave., New York City

LOUDEST AND MOST POWERFUL RADIO CRYSTAL

DX-ALENA, the Sensational, Synthetic, Guaranteed Radio Crystal. Each Crystal tested on Broadcasting 50 miles distant. Fifty cents postpaid. DEALERS should get our attractive proposition.

EVERETT RADIO COMPANY
Distributors

5207 Dorchester Avenue, Chicago, Ill.

RADIO

All standard makes of Radio Parts, Radio Sets from \$75.00 to \$825.00. Demonstration at your convenience at home.

EQUIPMENT SALES CO.

Phone 641-79
402 B Street San Diego, Cal.

"BUILD YOUR OWN" With "RASCO" Parts!
If you need small radio parts in a rush, "RASCO" will supply them cheaper, better and quicker than any one. Be sure to get our great 68-page catalog. Over 500 different parts. 300 illustrations. This catalog contains 75 Vacuum Tube Hook-Ups, all values being shown. Due to great cost, catalog sent only upon receipt of 15c, stamps or coin.
Radio Specialty Co., Inc.
100B Park Place, New York

The
Greyhound of the Air
Junior

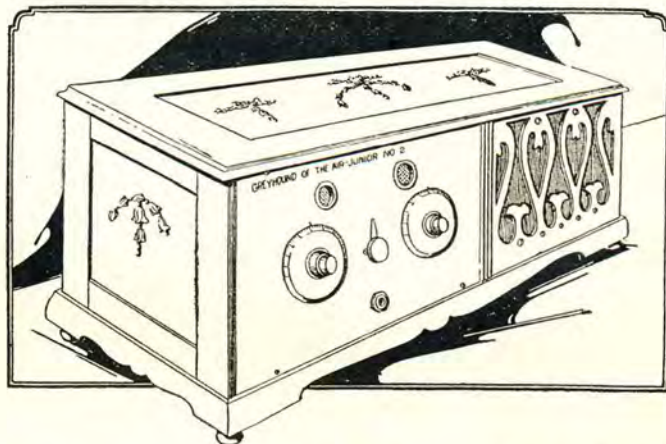

The radio experts at Hayden's have just perfected a Junior Model of the Greyhound of the Air. It comes in a beautiful two-tone cabinet, mahogany finish, and is entirely self-contained. Loud Speaker is built in.

This new production has interesting long distance range, and is unsurpassed in clearness of tone and selectivity. The same care and attention to minute detail has been given to its construction, that prevails in the manufacture of the Greyhound, Senior. Prices run from

\$100 to \$150

DEALERS are invited to correspond with Mr. F. L. Graves, of the Wholesale Department, at our Jefferson Street Store, for an attractive proposition.

Hayden's Electric Service

TWO STORES

506 W. Washington St.
Phone 289-877

1177 W. Jefferson St.
Beacon 3672

Los Angeles, California

Operate a Loud Speaker on One Tube

We have a new wonder circuit that will efficiently work your loud speaker on a single tube on local stations. Over 2000 miles have been covered loud and clear with phones. Parts are few and inexpensive. Easy to build. Send 25c for hook-up and complete instructions. LEUMAS RADIO LABORATORIES, 311 Fifth Ave., New York.

(Continued from Page 47)

use of a much smaller antenna which, in turn, will give much sharper tuning, and then for local reception when local broadcast is required with great volume this form of amplification will give it without distortion. The ex-

perimenter will note, in figure 4, a curve plotted for my set. This curve is a standard and is not dependant upon condition of A or B battery potentials. With this curve it is possible to turn to any wave length and get a direct reading upon the dial. For example, if I wish to tune in the new station WMC at Memphis, Tenn., and knowing the wave length to be 526 meters, we will take 526 meters and get it on the dial. It is then possible to set it turn on the filament switch and by a slight adjustment for extreme accuracy, tune the station in if it is broadcasting at that time. This will give a very definite degree of accuracy. This set may be used as a wave meter for it has definite settings for wave length within its periodicity.

The writer will be glad to answer all questions addressed to him, care of Radio Journal.

Of interest to radio fans is the course of instruction offered by the University of California extension division starting January 4. This course is known as radio telephone and is given by Arthur Paul Hill, radio transmission engineer of the Pacific Telephone and Telegraph company of Los Angeles. The class meets from 7 to 9 in the evening, room 616, Junior Orpheum building.

Two Wonderful Trips

Mt. Lowe A Two-Hour Scenic Trip from Los Angeles

Five Trains Daily from Main Street Station, Los Angeles: 8, 9, 10 a. m.; 1:30, 4 p. m.

FARE \$2.50 Round Trip

Excellent Hotel Accommodations at Alpine Tavern—Moderate Prices

ORANGE EMPIRE TROLLEY TRIP

A Complete Tour Through the *Orange Realm 150 miles of Travel, visiting interesting points.

9:00 a. m. from Main Street Station

FARE \$4.00—Guide-Lecturer

Illustrated Folders at Information Bureaus

PACIFIC ELECTRIC RAILWAY
LOS ANGELES, CALIFORNIA

Use Ray-Dee-Artcraft

ANNOUNCING---a new and better super-hetrodyne receiver. A different principle. More sensitive. BLUE PRINT, ONE DOLLAR.

Tuned RF Transformer

Type 3-A. 275-575 meters

---in the famous

HARKNESS CIRCUIT

[Guaranteed to perform in this circuit]

---and get better RESULTS

Price only \$1.25 each. At your dealers or direct from the factory prepaid.

**The Ray-Dee-Artcraft
Instrument Company**

REDLANDS

CALIFORNIA

---Watch for the
**Ray-Dee-Dyne
Receiver**
and the
**Munzig
Circuit**

The Super-hetrodyne's
closest second



ELECTRICAL RESEARCH LABORATORIES

2515 South Michigan Avenue

CHICAGO

A N O P E N L E T T E R

To Readers of Radio Journal :

Our attention has been called to an advertisement of the Wireless Shop in the October-November issue of this publication. This advertisement, while carefully avoiding mention of specific names, nevertheless, through such references as "research laboratory," "one of the country's largest radio manufacturers," "large Chicago radio manufacturer," has been interpreted in many quarters as directed against ourselves.

In order to allay any misapprehension resulting from this advertisement, alleging appropriation of the Perflex circuit exploited by the Wireless Shop, we desire to submit the following facts:

1. First publication of any circuit embodying the duo-reflex principle of amplification, enabling vacuum tubes to do triple duty, was made in Radio News of April, 1923. The circuit in question was the Erla one-tube circuit, now famous as the most powerful single-tube circuit ever built.

2. Our laboratory records, scrupulously accurate and monthly attested to, show that the origin of this notable improvement, in our research division, antedated its publication by substantially a year.

3. All Erla circuits, including the Erla Triplex (three-tube) circuit in controversy, are based on the original Erla principle of duo-reflex amplification. In fact, so as more accurately to describe the Erla Triplex (three-tube) circuit, the name was changed to Erla Three-Tube Duo-Reflex circuit some time ago.

4. Erla Duo-Reflex circuits, including the three-tube circuit mentioned, are fully protected by application for letters patent in the United States and foreign countries.

These facts speak for themselves. Only through discovery of the basic principle of Erla Duo-Reflex amplification, enabling vacuum tubes to operate simultaneously as amplifiers of received radio frequency, reflexed radio frequency and reflexed audio frequency currents, has the nationwide popularity of Erla circuits been established and maintained. For further information, ask your dealer or write for Erla Bulletin No. 16. Address Dept. U.

Electrical Research Laboratories

TUNE SHARP

VARIOMETERS AND VARIOCOUPLERS

Moulded in Natural Color Genuine Bakelite
Wound with Double Green Silk Wire



Split Variometer No. A-99.....\$6.50

Our VARIOMETERS are so designed that they may be used as a standard or split Variometer, having four terminals, two for Stator and two for Rotor.

If your favorite dealer or jobber cannot secure TUNE SHARP RADIO products for you, write direct. Separate instruments will be mailed pre-paid if remittance accompanies order.

Jobbers and dealers not familiar with this remarkable line should get in touch with us at once.

Demand TUNE SHARP INSTRUMENTS of your dealer or jobber and you will get the best that money can buy.

We will be glad to meet you at the Radio Show, February 5th to 10th, at the Biltmore Hotel.



Pyramid Bank Wound
1000 meter, No. A-101.....\$8.00

Our A-101, 1000 Meter Variocoupler is a very popular instrument. As it is pyramid bank wound it takes up very little space and yet tunes to 1000 meters.

Address all Inquiries to

CARL A. STONE

General Sales Agent

538 SAN FERNANDO BLDG.

LOS ANGELES, CALIF.

District Sales Representatives in all Principal Cities

Manufactured by

TUNE SHARP RADIO EQUIPMENT CO.

Licensee of General Bakelite Co.

6220½-22 So. Vermont Ave.

Phone: Vermont 5040

Los Angeles, California

This file including all text and images are from scans of a private personal collection and have been scanned for archival and research purposes. This file may be freely distributed, but not sold on ebay or on any commercial sites, catalogs, booths or kiosks, either as reprints or by electronic methods. This file may be downloaded without charge from the Radio Researchers Group website at <http://www.otrr.org/>

Please help in the preservation of old time radio by supporting legitimate organizations who strive to preserve and restore the programs and related information.