

May
1923

25c

Radio Journal

Los Angeles, California

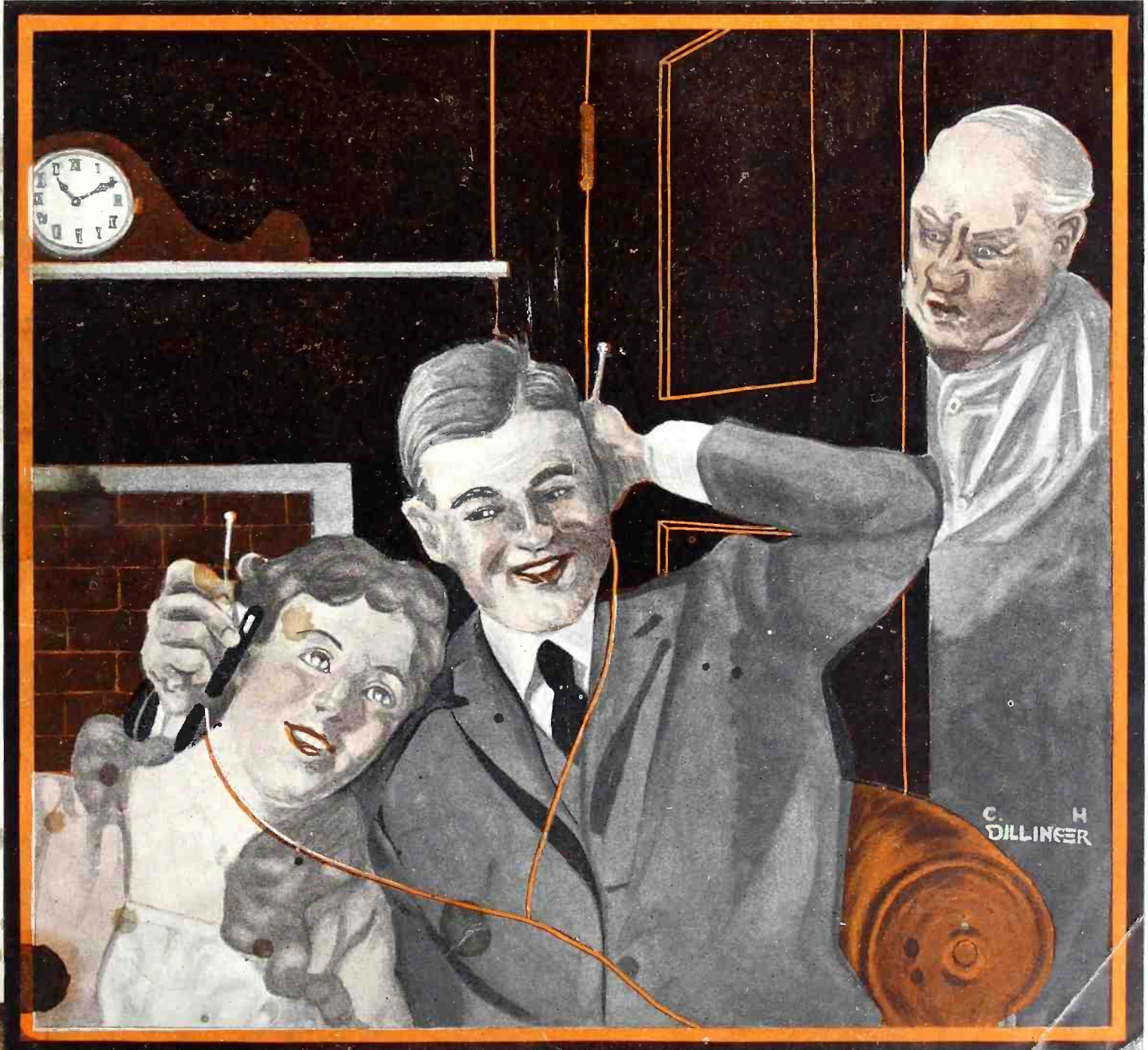

The Great Australian Trans-Pacific Tests

A Few Good Reasons Why You Should Demand The Advance Unit Charger

Most efficient, rigid and simple construction. Built on an entirely new idea, which insures satisfactory operation.
 Will stand rough use without damage to parts.
 Very compact. Size five inches square. Handsome appearance.
 Renewal parts after long service, fifty cents.
 Self polarizing, which means that the battery may be connected to charger either way, or polarity.
 Battery in ordinary condition can be charged over night.
 Low price in comparison to the quality of apparatus.
 The saving of much inconvenience, time and expense which will pay for the machine in a short time.
 Will not injure the battery if left connected after the battery is fully charged.
 Guaranteed for a period of one year.

Price, F. O. B. Los Angeles, \$18.50

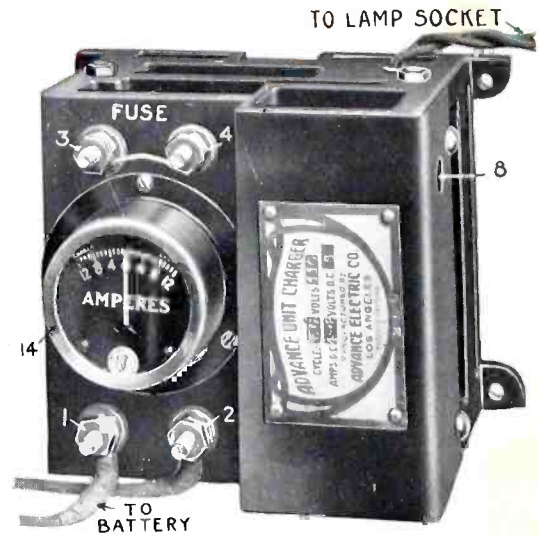

ADVANCE UNIT CHARGER FOR AUTO AND RADIO BATTERIES

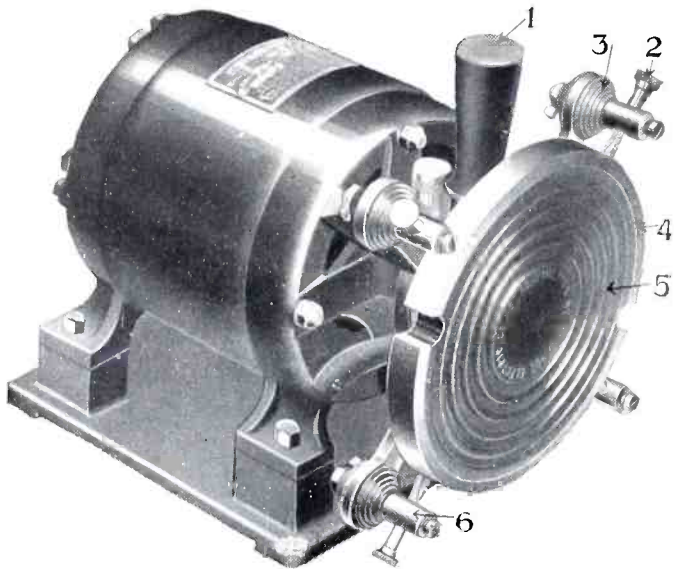

Advance C. W. Rectifier

"Advance" C.W. Rectifier

Rectifies A. C. from 500 to 3000 volts for the plate. Moulded bakelite disk (5) corrugated on sides to stand high voltage.

Moulded bakelite bushings (3) which overlap in center, insuring perfect insulation between polished aluminum brush arm support.

Nickel-plated brush holder (6) with adjustable gauze brushes which may be shifted to the proper non-spark position.

This rectifier is being used by some of the best known amateurs in Southern California as 6 E. N.—6 Z. R., 6 E. B., 6 E. A., 6 Z. A. L., and many others who are getting excellent results.

These rectifiers are guaranteed for one year. And to give service and satisfaction.

Price complete with motor \$40.00. Disk to fit your motor with complete brush assembly \$15.00.

Advance Precision Condenser, Made in Vernier and Plain, That Has Met With the Approval of Those Who Demand the Finest

Beautiful in appearance. All trimmings polished nickel. Vernier shaft 1, threaded $8/32$ adjustable by set screw 10 to accommodate any thickness panel or dial. Bakelite bearings 7— $1/4$ inch shaft both ends. Stop 9 full length of rotor. Nickered acorn nuts 5 which insure strength. Rotor spacers 11— $3/8$ inch diam., machine turned. All spacers aluminum to .001 inch insuring perfect alignment of plates.

Stator spacers 12— $3/8$ inch diameter. Spring 13 perfect contact and friction for vernier plate. Rotor tube 2— $1/4$ inch diam., brass nickeled. End collar 3 Adjustable for alignment. Mounting posts 4— $5/16$ inch round $6/32$ so spaced to accommodate any diameter dial. Brass nickeled spacers 6— $3/8$ inch diam. accurately machined. This condenser must be seen to be appreciated.

Vernier	Price	Plain	Price
		3 Plate	\$1.90
		5 "	2.25
		9 "	2.75
11 plate	\$ 5.65	11 "	3.00
13 "	5.80	13 "	3.15
23 "	6.00	23 "	3.40
31 "	7.00	31 "	4.15
43 "	8.00	43 "	4.60
63 "	10.00	63 "	6.85

Liberal Discounts to Dealers and Jobbers
ADVANCE ELECTRIC CO.

1260 West 2nd St., Los Angeles Phone Pico 5990
 Manufacturers F. W. Falck Engineers

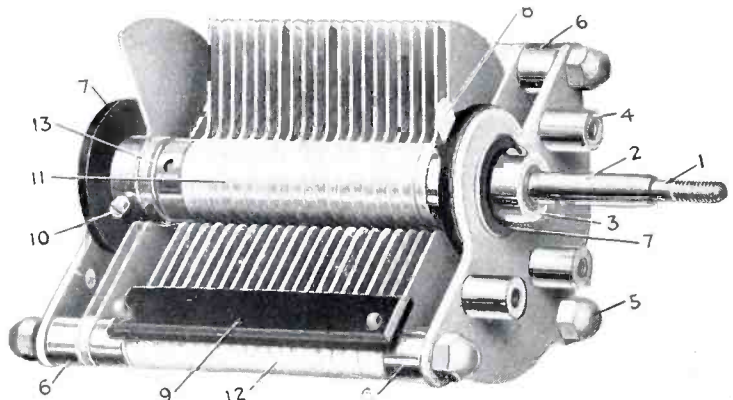

Build This Set for "Worth While" Results

Easy to Build--Inexpensive in Cost

This Letter Shows the Wonderful Results With This JM-6 Set

PARAGRAPHS FROM VOLUNTARY TESTIMONIAL LETTER

Norfolk, Va.

As an owner of one of your JM-6 Amplifiers it may interest you to know that I am obtaining excellent results with this amplifier on a loop antenna. The type of loop employed by me is as follows: Solenoid or flat type, 10 turns of No. 18 flexible lamp cord stranded and insulated, three feet between each cross piece or twelve feet around for each turn; leads from loop to amplifier about eighteen inches. With this loop and the JM-6, the following stations are only the most distant ones I have heard:

WBZ, Springfield, Mass. WWI, Dearborn, Mich.; KOP and WWJ, Detroit, Mich.; WLAG, Minneapolis, Minn.; WHB, Kansas City, Mo.; KSD, St. Louis, Mo.; KFAP, Butte, Mont. WJZ, Newark, N. J.; WDY, Roselle Park, N. J.; KFAF, Denver, Colo.; KHJ, Los Angeles, Calif. WEAJ, New York City; WGY, Schenectady, N. Y.; WHAZ, Troy, N. Y.; WSY, Birmingham, Ala.; NOF, Anacostia, D. C.; NAA, (Arlington) Radio, Va.; WWX, Washington, D. C.; WDAL, Jacksonville, Fla.; WGM, and WSB, Atlanta, Ga.; KYW and WDAP, Chicago, Ill.; WLK, Indianapolis, Ind.; WOC Davenport, Iowa; WJAL, New Orleans, La.; WNAC, Boston, Mass.; WGI, Medford Hillside, Mass.; WEAH, Wichita, Kansas; WKY, Oklahoma City, Okla.; WOAI, San Antonio, Texas; KZN, Salt Lake City, Utah WHA (9YY), Madison, Wis.; WLW, Cincinnati, Ohio; WFI, Philadelphia, Pa.; KDKA, E. Pittsburgh, Pa. WKN, Memphis, Tenn.; WFAA, Dallas, Texas; WBAP, Forth Worth, Texas; WEAL, Orange, Texas WLAJ, Bellows Falls, Vt.; WKAQ, San Juan, P. R.; WWX, Havana, Cuba, and CKAC, Montreal, Canada.

Very truly yours,

(Signed) W. W. ROBERTS,

P. O. Box 660, Norfolk, Va.

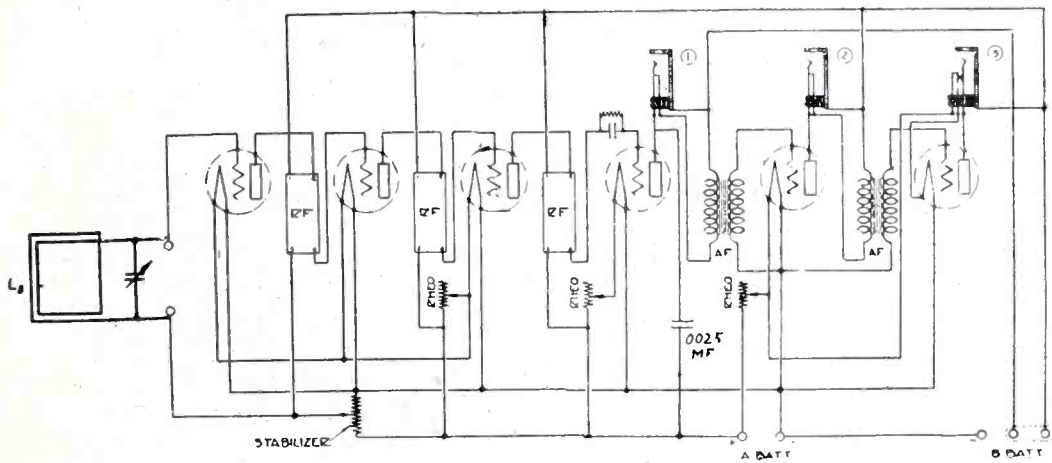

JM-6

3 DX-1 Radio frequency transformers @ \$6.40	\$19.20	2 1422-W Federal Jacks @ \$.85	1.70
3 DX Transformer mountings @ \$.90	2.70	1 1435-W Federal Jack	1.00
6 Parkin Sockets @ \$.60	3.60	1 Mica grid condenser and leak	.60
3 Fada Rheostats @ \$.75	2.25	1 Mica Bypass condenser	.50
1 UV-200 Detector tube	5.00	2 3-1 Thordarson Amplifying Trans-	9.00
5 UV-201 Amplifier tubes @ \$5.50	27.50	formers @ \$4.50	
1 Paragon potentiometer (stabilizer)	1.75	7 Binding posts @ \$.10	.70
			<hr/> \$75.50

If standard tubes are not available use Myers Hi Mu Tubes which sell at \$5.00 including receptacles. Other items required if not already possessed, are a loop, a storage A-battery, 45-volt tapped B-battery at \$5.50, No. 247A General Radio Mounted condenser for tuning loop, \$6.00. If you do not want to make your own JM-6 we have them all made up for \$100 without tubes or batteries.

THE RADIO STORE OF PAUL FRANKLIN JOHNSON

560-562 East Colorado Street

PASADENA, CALIFORNIA

"Everything Worth While in Radio"



A. H. GREBE & CO., Inc.
 Richmond Hill, N. Y.
 Western Branch
 451 East 3rd St., Los Angeles, Cal.



Write for
 "Musings of
 Dr. Mu."

“What is whispered — in
 the ear is heard miles away.”
 said Mencius.
 The wise radioist hears voices
 a thousand miles
 away with a **Grebe Receiver.**

Doctor Mu.

Licensed under Armstrong
 U. S. Pat. No. 1113149



Volume Two

MAY, 1923

Number Five

CONTENTS

HIRAM PERCY MAXIM AND GEO. S. WALKER	- -	<i>Frontispiece</i>
EDITORIAL	- - - - -	239
THE ODIC RAY, ITS ORIGIN AND NATURE	- - - - -	240
	EDGAR L. HOLLINGSHEAD	240
WORLD'S MOST BEAUTIFUL STATION	- - -	L. TOROMAN 242
NEW 1,000 WATT SET	- - - - -	242
KDKA'S NEW STATION	- - - - -	242
LOADING COIL WITH SIMPLE RECEIVING SET	- - - - -	243
	U. S. BUREAU OF STANDARDS	243
NOTES ON THE REFLEX CIRCUIT	- -	EDWIN S. WATKINS 245
THE JOBBER'S BIG PROBLEM	- - - - -	I. S. LESSER 246
SPANNING THE PACIFIC	- - - - -	246
THE ANONYMOUS MESSAGE, A STORY	RAYMOND W. SHIREY	247
THE GREAT AUSTRALIAN TRANS-PACIFIC TESTS	- - -	249
HIGHLY EFFICIENT AMPLIFYING UNIT	- -	T. E. NIKIRK 251
DEFINITIONS AND FUNDAMENTAL CONCEPTIONS	- - - - -	252
	PROF. H. LA V. TWINING	252
JUST A FEW WORDS ABOUT BROADCASTING	J. P. DANKO	255
5,000-MILE BROADCAST	- - - - -	256
KHJ SETS A NEW RECORD	- - - - -	256
THE SCIENCE OF INVENTION	DANIEL NELSON CLARK, LL.B.	257
ON THE AIR, BROADCAST SCHEDULE	- - - - -	259
YANKEE BROADCASTING THRILLS BRAZIL	J. W. STROEBEL	261
OFT IN THE STILLY NIGHT	- - - - -	JESSIE E. KOEWING 262
FIRST BE SURE	- - - - -	262
QUESTIONS AND ANSWERS	- - - - -	263
TRADE TALKS	- - - - -	265
RADIO CLUB ACTIVITIES	- - - - -	266
RADIO WONDER WORKER FOR CIVILIZATION	- - - - -	267
	RAY LYMAN WILBUR	267
RADIO JOURNAL'S \$500 PRIZE CONTEST	- - - - -	268
AMATEUR'S DEPARTMENT	- - - - -	272
LISTENING IN	- - - - -	273
LESTER PICKER BROADCASTS	- - - - -	283
CLASSIFIED ADVERTISEMENTS	- - - - -	284
WITH THE EDITOR	- - - - -	290

Radio Journal

is published monthly by Radio Journal Publishing Company, 113 Stimson Building, Los Angeles, California. Telephone 62512.

EDITORIAL BOARD

Editor.....K. P. FREDERICK
 Technical Editor...LEX B. BENJAMIN
 Art Editor.....C. H. DILLINGER
 General Manager.....HUGH HARLAN
 Advertising.....A. W. MAJORS

SUBSCRIPTION RATES

6 months.....\$1.50
 1 year..... 2.50
 2 years..... 4.00
 Canadian or Mexican—
 1 year..... 3.00
 Foreign, 1 year..... 3.50

Change of Address—Notify us of any change in your address. Be sure to give both your old and new address.

Because of the fact that intense interest in radio is sweeping the entire country, causing a flood of inventive and research work, much of which will be duplicated, it is necessary to state that in the event of expressions of opinion and various statements from contributors and correspondents appearing in Radio Journal from month to month becoming the subject of litigation in courts, or of controversy in scientific circles, and which may involve questions of priority of invention and a comparison of merit of apparatus, the owners and publishers of Radio Journal positively and unequivocally disclaim any responsibility for any such expressions of opinion or partisan statements.

"Entered as second-class matter May 19, 1922, at the post office at Los Angeles, California, under the Act of March 3, 1879."

The entire contents of Radio Journal, including articles, stories, pictures, diagrams, etc. (unless otherwise credited), copyright 1923 by Radio Journal Publishing Company, which reserves all rights.

Chicago Representative, Young & Ward, 308 North Michigan Ave.; New York Representative, Geo. W. Stearns, Flatiron Bldg.; Denver Representative, Ira R. Alexander, 369 Lincoln Street.

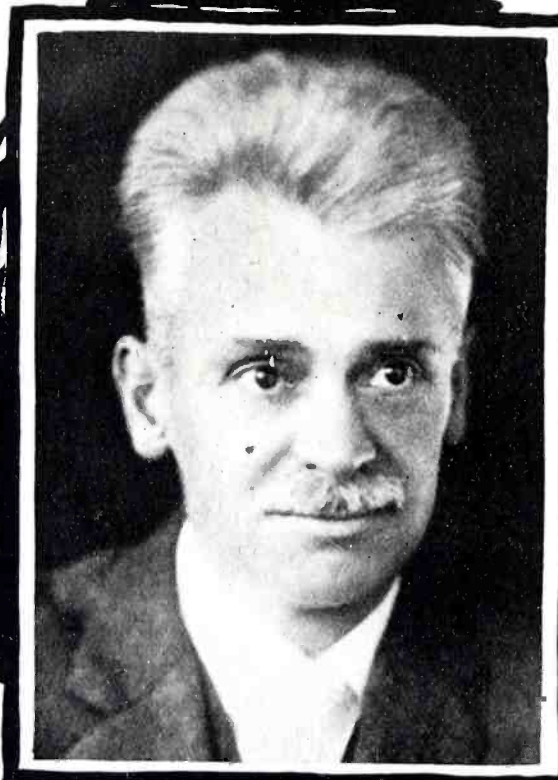

HIRAM PERCY MAXIM
PRESIDENT - AMERICAN RADIO
RELAY LEAGUE.



INTERNATIONAL
NEWSREEL
PHOTO



GEO. S. WALKER
PRESIDENT - NATIONAL
BROADCASTER'S
LEAGUE,



Editorial Comment

New Ether Styles

Congress failed to pass the White Bill. This left radio to struggle along under the badly strained law of 1912. A conference of all the interests in radio was hastily called, met in Washington, formulated a set of admirable, but sweeping regulations re-adjusting the entire scheme of broadcasting. Secretary Hoover read them over, praised them, considered them a bit too sudden to be put into effect all at once but issued, forthwith, a new set of regulations based on the recommendations of the committee looking toward the ultimate carrying out of the entire plan. "For internal broadcasting the department proposes to co-operate with the various stations with a view to developing a systematic assignment of wave-lengths to the various stations," he said. Here are the new classifications:

Class A stations—that is, stations equipped to use power not exceeding 500 watts. In this class it is proposed that the radio inspectors, in co-operation with the station owners, shall assign distinctive wave lengths to each station so far as is possible in the area from 222 to 300 meters. No station will be required to change from 360 unless it so desires.

Class B stations—that is, stations equipped to use from 500 to 1000 watts. In this class it is proposed to similarly offer to license these stations on special wave lengths from 300 to 345 and from 375 to 545 meters, having regard to the maintenance of some ship work on 450 meters and again no station will be required to change from 360 unless it so desires.

Class C stations—comprising all stations now licensed for 360 meters. In this class no new licenses will be issued for stations on 360 meters until the plan is entirely realized. Stations which do not wish to move under the general plan may remain at 360 meters, but they will necessarily be subject to some interference at best. It is thought that by the above plan the stations can be gradually brought into accord without hardships.

Under the plan amateurs are given the whole area from 150 to 220 meters, instead of being fixed upon 200 with special licenses at 375. The special licenses hitherto issued for amateurs at 375 will now be issued at 220. Certain special cases will be taken care of otherwise. It is proposed, in co-operation with the amateur associations, to develop an assignment of wave bands in classifications so as to somewhat relieve the present interference among amateurs. It will be remembered that the number of wave bands which can be used among the short wave area assigned to the amateurs is greater in proportion than among the longer wave lengths, and these arrangements expand the area hitherto assigned to amateurs.

The outstanding features of the new regulations are that they permit the use of a wide range of wave lengths, they give each station a chance at individuality and should remove a big load of interference from every department of radio. Two obstacles prevented the immediate development of the entire conference report, recommending the use of all wave lengths between 222 and 545 meters for public broadcasting. These were the hardships an arbitrary, enforced re-adjustment might bring to many broadcast stations already differently

equipped, and the ship to shore communication, some of which is handled on 300 meters and some on 450 meters. In accordance with the new classification it is expected that various stations, particularly where two or more big B stations are operating in the same city under the old 400 meter basis, will re-adjust wave lengths to the end that nearly all may operate at the same time.

What will be the result? The broadcast listener, if he has a set with anything like tuning ability, will be able to tune in or out on any station within his range with much more ease than in the past. In fact true interference between broadcast stations should be practically eliminated.

And what of the amateurs? We will wager a new necktie that, after they have tried out the new scheme of things for a time, they will be satisfied that they have a bigger and better field in which to operate than at any time in their history.

In fact the result of this conference convinces us, all over again, that there are more ways to kill a cat than by hitting him over the head with a nut cracker, and that probably some of the other ways are best after all, notwithstanding the reputation of our most revered United States Congress as official slayer of felines.

Freedom of The Air?

Is there any such thing as freedom? If by freedom is meant license to do what one pleases at the expense of others, no. If by freedom is meant the right to individual action along established lines, yes. So it is that freedom of the air is becoming more and more a perplexing problem. In Illinois a bank president is attempting to get a court injunction against the operation of an amateur station near his home, alleging interference with telephone service. A big scientific question is involved here, as well as the right of every amateur and every broadcaster. Always, with the coming of a new service or a new invention, there develops the battle between the old and established order of things and the new. In Germany, many years ago, a city legally decreed that street lights should be barred because they would menace the health, morals and happiness of the populace by inducing them to stay out nights, catch cold, be held up and live hilariously, whereas an all wise providence had decreed that it should be dark of nights. Come, come! We must be getting on, but the conclusion is obvious.

Even Standing Room

The frontispiece, on the opposite page in this issue, is more than photographs of two men who have attained prominence in divergent fields of radio; it is a graphic representation of the two great interests in radio, neither commercial in the strict sense of the word, neither antagonistic in the larger meaning of the word, but each representing interests which, on occasion, have clashed here and there upon what might be termed the frontiers of radio. Leaning back in our swivel chair, however, we can glance out of our unwashed office window and see plenty of room for all, and many more to come, in this greatest of new adventures in life, radio.

The Odic Ray--It's Origin and Nature

By EDGAR L. HOLLINGSHEAD

We'll bet a worn out shoe horn that we could make a fortune with an Odic Ray outfit by training its rays on a drug store scale and then inviting the overfed public, worrying about its weight, to find a weight it desires. Imagine the dowager of 200 weight finding that she tips the scale beam at a paltry 135. But, seriously, folks, Mr. Hollingshead has developed something in his laboratory which staggers the imagination—and our imagination is accustomed to lots of staggers at that.

SOME years ago I became convinced that matter did not depend upon physical properties for its weight, but upon the speed of the atoms making up the molecules, and I began searching for a process by which a force could be generated that would be high enough in point of speed to change the atomic speed of matter. Knowing that it would be impossible to release or generate such a force out of any form of matter, I turned my attention to the study of the nature of electricity and other natural forces.

Believing that man could not conceive of a force unless there were something moving, I therefore believed that all forces must be made up of substance in motion. The substance that forms the natural "body" of forces or so-called laws of nature is not matter in the sense that the term is ordinarily used, but a substance so fine and vibrating at such a high rate of speed that it cannot be comprehended by any faculty of man excepting his reason. Thus considering the nature of electricity, reason tells us that we must have a substance traveling at a very high rate of speed, and that this substance must be governed and con-

trolled by the same principles that govern all substance or matter. There must be one general principle governing the formation of substance throughout the universe. In other words, the substance or body of electricity, termed "amperage," must be made up of infinitely small eddies of force,—the same as ordinary matter is.

As is well known, in matter we have three distinct classes of eddies of force, which seem to be a perfect counterpart of a solar system. We have, namely, the molecule, made up of atoms traveling around in definite orbits; we have the atom, made up of electrons, also traveling in orbits; and the electron has been found to be made up of still smaller particles, also traveling in circular progression. Thus we have three distinct phases of force in matter. We also have three distinct phases of action in the body or amperage of electricity. The world is more or less familiar with the positive and negative sides or phases of electricity, but I have proved by experimentation that there is a dominant or third phase in all forces. That is, there is a positive, a negative, and a dominant or solar manifestation, and these three

phases of force are at definite distances apart in the point of speed, and their relationship is like three, six and nine on a rule.

Considering electricity or any of the so-called natural forces of nature from this standpoint, we find that we have

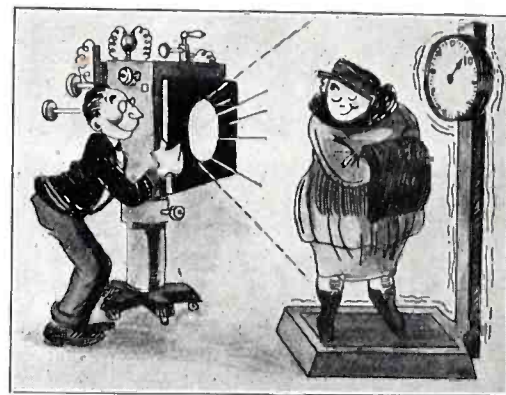

THE NEWLY-DISCOVERED ODIC RAY OUGHT TO CUT HER WEIGHT, IF NOT HER BULK, AND TICKLE HER TO DEATH. AND IT COULD BE MADE TO PAY.

in reality two forces in one:—we have a rectilinear action and also a rotating action in all forces. We can illustrate this action by considering a stream of water. Suppose we have a stream of water flowing at twenty miles per hour; the atoms making up the molecules of this water are traveling in circular progression at thousands of miles per seconds. This same condition I have proved to be existent in the nature of electricity, and I have also proved that these eddies of force making up the body or amperage of electricity can be broken up and the force corresponding to the electronic force in matter released. This force I have given the name of "Odic Activity," due to the principles employed in releasing or generating the same.

I have found that the rate of speed of Odic Activity can be changed; its polarity reversed, and its direction of discharge controlled, as I have changed its rate all the way from where it would affect a photographic plate the same as ordinary light clear up to a point where it has disintegrated matter the instant it touched it. The only difference there can be between one ray of light and another is its difference in speed, plus a possible difference in polarity or character.

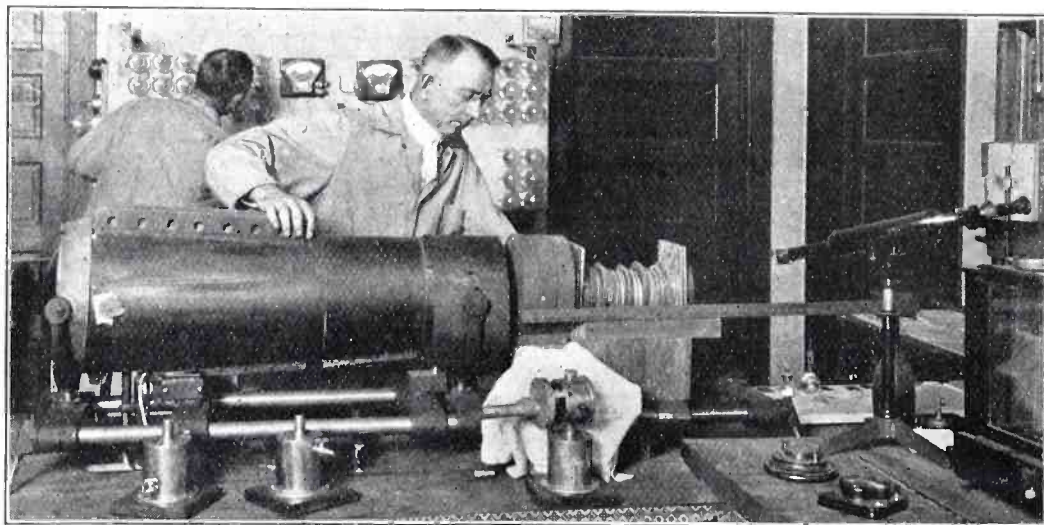

—Radio Journal Photo

EDGAR L. HOLLINGSHEAD, INVENTOR, IS HERE SHOWN PETTING HIS MASTERPIECE, WHICH, IF HIS THEORIES AND CLAIMS PROVE TRUE, WILL REVOLUTIONIZE ELECTRIC SCIENCE. THIS IS A CLOSE-UP OF THE ODIC RAY MACHINE WHICH, BY DIRECTING A CERTAIN RADIATION KNOWN AS THE ODIC RAY, CAN COUNTERACT OR DESTROY THE FORCE OF GRAVITY, PIERCE ANY SOLID OR DESTROY ANY MATTER COMPLETELY. IN THE PHOTO IT IS SHOWN JUST AS IT TOOK A PHOTO THROUGH $11\frac{1}{2}$ INCHES OF SOLID LEAD AND $5\frac{1}{2}$ INCHES OF SOLID STEEL WITH AN EXPOSURE OF FIVE SECONDS.

Hence, it will be seen that since the polarity or character of the Odic Ray can be altered or changed, it is possible for it, when properly applied, to duplicate any of the "rays" or rates of force known, between ordinary light and the point of disintegration of matter. This range or rates of force will encompass the X-ray, the Radium rays, the Ultra-violet rays, and various rates that are known but which have not been named.

As all matter is known to be formed of molecules, atoms and electrons, or of infinitely small particles of substance traveling at great speed in circular progression, reason proves to us that matter does not depend upon physical properties for its weight, but does depend upon the speed of these particles of substance, which sets up or causes a resistance to the flow of a force of nature passing into the earth. And as the predominating force that is known to be traveling into the earth is called "gravitation," the atomic speed or force stored up in these minute eddies of force must be resisting gravitation, — thus causing what we call weight.

With this hypothesis in mind, I found that by the use of the Odic Ray the degree of speed of these eddies could be altered, and this resistance changed, thus changing the weight of matter. In over a hundred different tests, I have changed the weight of practically all of the base metals, having changed aluminum approximately twenty per cent. And to prove that the principle was correct, I have reversed the process and increased the weight back to normal, and to heavier than normal, thereby proving beyond a question of doubt that the weight of objects depends upon atomic force and not upon physical properties.

At other tunings of the ray, it has caused solid substance to disintegrate

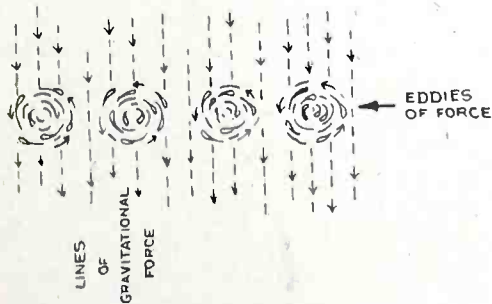

THESE LITTLE WHIRLYGIGS ARE SUPPOSED TO REPRESENT THE MANNER IN WHICH EDDIES OF FORCE INTERFERE WITH GRAVITATIONAL FORCE IN ANY SOLID, THUS CAUSING THE LINES OF GRAVITATIONAL FORCE TO PULL THE SOLID TOWARD THE EARTH. THE THEORY IS THAT BY ALTERING THESE EDDIES OF FORCE SO THAT THEY WILL NOT INTERFERE WITH GRAVITATION THE FORCE OF GRAVITATION CAN BE ENTIRELY OVERCOME.

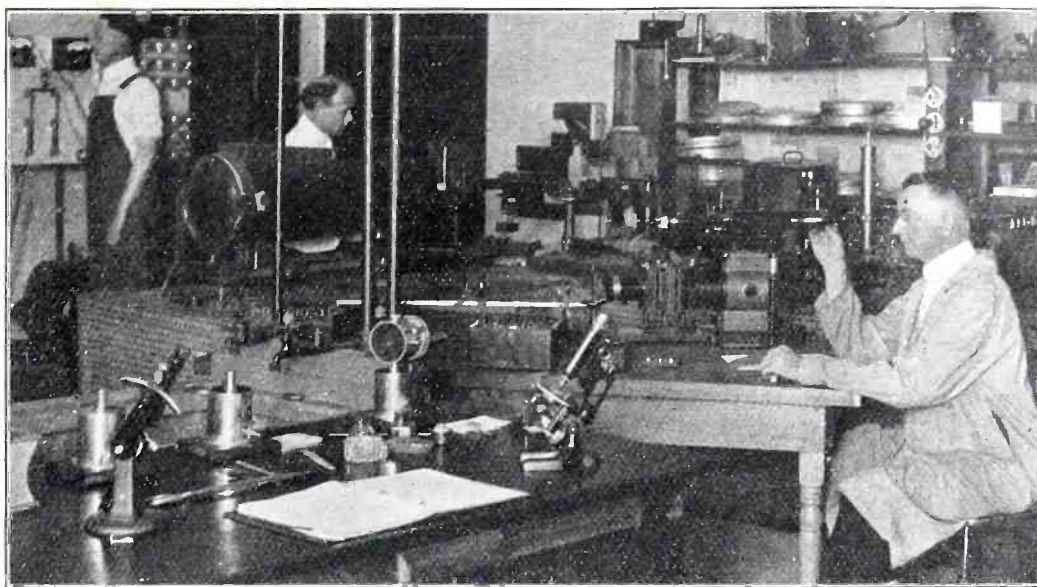

—Radio Journal Photo

IF WE KNEW HOW TO TWIDDLE ALL THIS JUNK AROUND AND MAKE IT DO THINGS WE WOULDN'T BE EDITING A MAGAZINE. WE WOULD BE DISCOVERING THINGS INSTEAD. THIS IS ONE WEE CORNER OF THE EDGAR L. HOLLINGSHEAD LABORATORY AT PASADENA, WHERE THE ODIC RAY WAS DISCOVERED AND THE MACHINE FOR CONTROLLING IT PERFECTED. MR. HOLLINGSHEAD, THE INVENTOR, IS SEATED LOOKING THROUGH SOMETHING AT SOMETHING ELSE.

the instant the ray touched it, without explosion and leaving no smoke, ash or residue.

If the theory held by many physicians, and apparently proved by Dr. Abrams of San Francisco, is correct, that a disease germ is simply a unit of force that is out of harmony with the body in which it manifests, then there seems to be a vast field of usefulness open to the Odic Ray, as the ray could be tuned so as to be in harmony with a normal body (and thus naturally out of harmony with the vibration of a disease germ), and if the speed of the ray were raised sufficiently high it would certainly destroy the disease.

It is a generally accepted theory that electricity is generated by cutting lines of force. If this were all there was to the generation of electricity, it would be possible to cut any kind of lines of force, such as heat, light, or sound, and produce electricity; but as the fact remains that we must have magnetic lines of force, we see that there is another part to the process of generating electricity that is not commonly understood,—and that is resistance. We are forced to realize that as an armature whirls in a field of magnetic energy it is resisting a force; and, since resisting a force will slow it down or retard its speed, we are forced to realize that we are generating electricity by slowing down or retarding the speed of magnetic energy and transforming it into electricity. This can be proved to our reason by taking as illustration, a two-pole generator with an armature revolving between the two poles, the armature being made of nothing but a fine screen or wire, the two poles being tanks of

water, and the lines of force shooting from pole to pole a stream of water. If the armature was standing still it would have very little resistance to the flow of the water, but the instant you started turning the armature, the faster it was turned, the more water would pile itself up on the face of the armature. And this is precisely what we are doing in the generation of mechanically made electricity — we are resisting the body or substance part of magnetic energy, slowing down its speed to that of electricity.

This same process can be carried through the whole seven forces of nature; that is to say, if you resist gravitation by a piece of lodestone or magnetic iron, which has an atomic speed of just such a nature as will resist gravitation and slow it down one-eighth of an octave of nature, you create magnetic energy. Resist magnetic energy by an armature whirling in a field of force and you generate electricity. Resist electricity properly and you will produce an arc; resist the arc by a combustible material and you will cause flame or heat; resist the flame or heat by the oxygen and nitrogen in the air and you have sound; resist this one substance (as all force must have a substance part), properly again, in the form of amperage of electricity, in a vacuum, and you will produce an element, helium. Thus we see that by varied degrees of resistance we can start in with the force called gravitation and, step by step, resist that force down until we have reached cohesion; and thus we see that there is only one force throughout nature, but many differences in degree and character of this one force.

(Continued on Page 286)

World's Most Beautiful Station

By L. TOROMAN

SOME of these days when you pick up XDA, picture to yourself for a moment a broad and rambling lake, wonderfully beautiful coves, sparkling fountains, gaily clad merrymakers, a splendid palace—all these comprising what is probably the world's most beautiful broadcast station, located in Chapultepec Park, Mexico City. At least the photographs reproduced herewith give us the notion that when good broadcasters pass on they will land in an Elysian layout something like this.

All of which is by way of preface to the remark that XDA, Mexico City Radio Broadcast Station, is located in yon palace, with mahogany furniture and upholstered chairs and soft-footed servants and everything. And the lake and the boats and pretty señoritas and everything go with the outfit.

In fact, Mexico is by no means trailing along in things radio. Not by several ohms and a pair of watts. In fact, they have grand ideas and work them out, as this nifty little shack would indicate.

Mexico owns and controls its telegraph system and, as an adjunct, the government has already installed something like thirty wireless stations in remote places, and there are still some places in Mexico which would be considered a bit remote. Governor Lugo of Lower California, known in the vernacular as Bajo California, is

one of the nation's leading radio enthusiasts. He's got a regular palace, a sort of court castle and country house combined, wherein he has installed the best outfit he can buy, and entertains friends, guests and politicians with good United States broadcast from Los Angeles, San Diego, San Francisco, Salt Lake, and even Kansas City. In fact, his hacienda has become so popular through this radio outfit that all talk of revolution on the west coast has subsided, apparently.

New 1000 Watt Set

WJZ, the Radio Corporation-Westinghouse radio station at Newark, N. J., has a new transmitter, rated at double the power of its predecessor, or 1000 watts. It is considered greatly superior in the details of its transmitting, modulating, and generating system.

All radio broadcasting transmitters of the Westinghouse Electric & Manufacturing Company are checked periodically in order to determine their condition and characteristics by such instruments and devices as oscilloscopes, modulation meters, etc. It is thus possible to determine accurately what per cent of the radiated wave is modulated, the exact performance of the modulator, speech

amplifiers, and other devices, and the manner in which the microphone "pick-up" functions.

The new transmitter at WJZ includes a number of new features. Instead of using generators to develop the high-voltage plate current as is the common practice now, a power rectifier was installed, which was designed by D. G. Little, Westinghouse electric engineer. Oscillograph pictures show no "ripple" in the current wave.

The new transmitter consists of four oscillators modulated by five modulator tubes of special design. A feature of this transmitter is that it has a meter which shows the per cent of modulation at every instant.

KDKA's New Studio

KDKA, the broadcast station of the Westinghouse Electric & Mfg. Co., at East Pittsburgh, Pa., has been established in a new studio which is located one mile from the actual broadcast station. The studio will be operated by remote control which has been perfected to a high degree by Westinghouse radio engineers. Remote control of the broadcast station means that the studio operator will turn the broadcasting apparatus on and off from the studio when the actual program starts and this feature will eliminate any delay between numbers on the program.

When KDKA was first started, the broadcast studio was located next to the broadcasting apparatus, and the station operator made all connections between the studio and station. This meant that the studio operator in attendance would have to first signal the station operator to turn on the broadcasting apparatus and then give the signal to the artist to start, at the same time throwing the microphone, or pick-up, switch. Owing to this method of dual control, which was in force at all broadcast studios, there were unavoidable delays between selections owing to the difficulty in synchronizing the work of the studio and station operators. With the remote control method in which everything is controlled from the studio, these delays will be entirely eliminated, and there will be broadcast a smoother program which will be run off in the manner in which vaudeville acts follow one another on the bill.

Allen H. Babcock, 6ZAF, of Berkeley, Calif., has been appointed to fill the unexpired term of A. E. Bessey, 6ZK, who has resigned as director of the American Radio Relay League in the Sixth District. Mr. Babcock is consulting electrical engineer for the Southern Pacific Co.

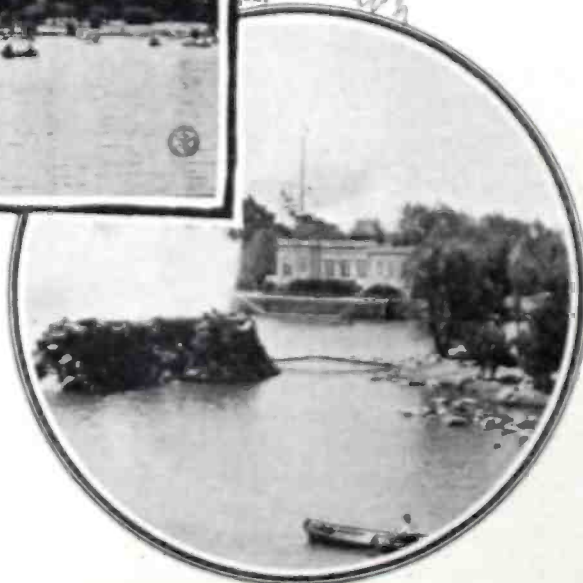
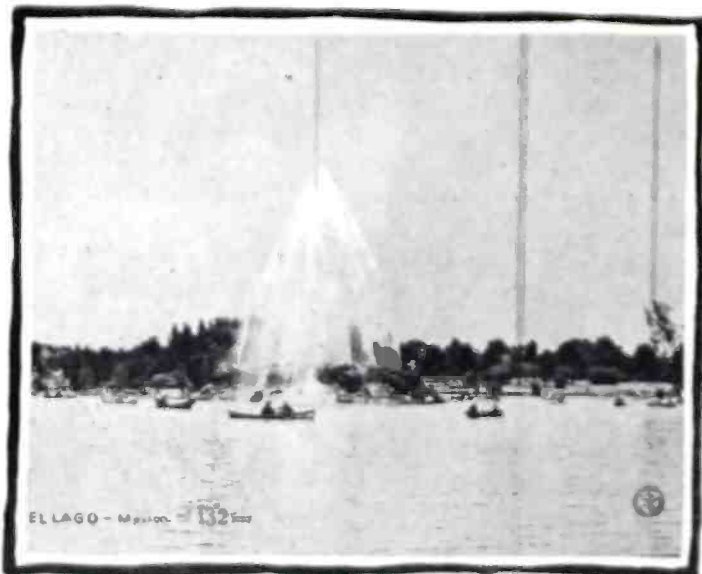

WHEN OUR SHIP COMES IN WE ARE GOING TO RIG UP A STATION LIKE THIS IN OUR BACK YARD, AND MAYBE KEEP A FEW DUCKS. THESE TWO PHOTOS DEPICT THE EXTERIOR AND SURROUNDINGS OF THE MOST BEAUTIFUL STATION IN THE WORLD, XDA, IN CHAPULTEPEC PARK, MEXICO CITY.

Loading Coil with Simple Receiving Set

By U. S. BUREAU OF STANDARDS

With the possibility of new wave lengths appearing in the broadcast field a loading coil, such as herein described, will take a load off many a set builder's mind. The article, Letter Circular LC47 of the Bureau of Standards, Washington, D. C., describes a means of increasing wave-length range of sets already described in previous issues of Radio Journal. We are loaded with more articles of the same helpful character for subsequent issues.

THIS circular describes a loading coil which is used in conjunction with the single-circuit radio receiving set described in Bureau of Standards Circular No. 120. (Published in June, 1922, issue of Radio Journal.) The experimenter who is interested in using it in connection with the two-circuit set described in Circular No. 121, (published in the February, 1923, issue of Radio Journal), is referred to the section entitled, "Use with Two-Circuit Set," near end of this paper.

The purpose of the loading coil is to enable the receiving equipment to respond to wave frequencies between 100 and 500 kilocycles per second (that is, wave lengths between 3000 and 600 meters). In other words, the loading coil increases the wave frequency (wave length) range of the receiving set. The receiving set described in Bureau of Standards Circular No. 120, has a wave frequency (wave length) range of between 500 and 1500 kilocycles per second (wave

lengths between 600 and 200 meters).

The use of the loading coil will increase the receiving distance of the equipment, because many stations using the lower wave frequencies (longer wave lengths) use a high-power radio transmitting set. For example, the station NAA at Arlington, Va., uses a wave frequency of about 113 kilocycles per second (2650 meters wave length) and uses sufficient power to be heard a distance of about 200 miles when the loading coil described in this Circular is used with the receiving equipment previously described. At night this distance may be considerably increased.

The cost of the parts for the loading coil is approximately \$3.

Description.—A loading coil is simply a coil of wire connected to the rest of the receiving equipment in such a manner that a variable number of its turns are included in the circuit between the antenna and the ground connection. When longer wave lengths (lower wave frequencies) are received, more turns are used on the coil.

The loading coil is shown at A in Figure 1A, and consists of 300 turns (about 5 ounces) of No. 28 double-cotton-covered copper wire wound on a round cardboard box $5\frac{3}{8}$ inches in diameter by about 8 inches long. An

oatmeal box is used for the cardboard tube with the cardboard cover glued to one end. Certain of the turns are provided with taps which are connected to switch contacts so that the number of turns included in the circuit can be varied. One end of the wire is fastened at the closed end of the tube by weaving it through two holes $\frac{1}{2}$ -inch apart and $\frac{3}{4}$ -inch from the end. The free end of the wire projects about 10 inches. The wire is wound on the tube in a single layer so that the turns lie closely and evenly together. When 10 turns have been wound, a 10-inch tap is taken off. The method of winding and also one method of taking off the taps has been explained in Circular No. 120. Instead of using the simpler method of taking off taps as described in Circular No. 120, a somewhat more difficult and correspondingly more satisfactory method is used on this loading coil. After the given number of turns of wire have been wound on the tube, a hole is punched through the tube just underneath the last turn and, by using a small blunt tool or stick, a 10-inch loop of the wire is pushed through this hole. A second hole is punched through the tube about $\frac{1}{2}$ -inch farther along the circumference and the loop pushed through this

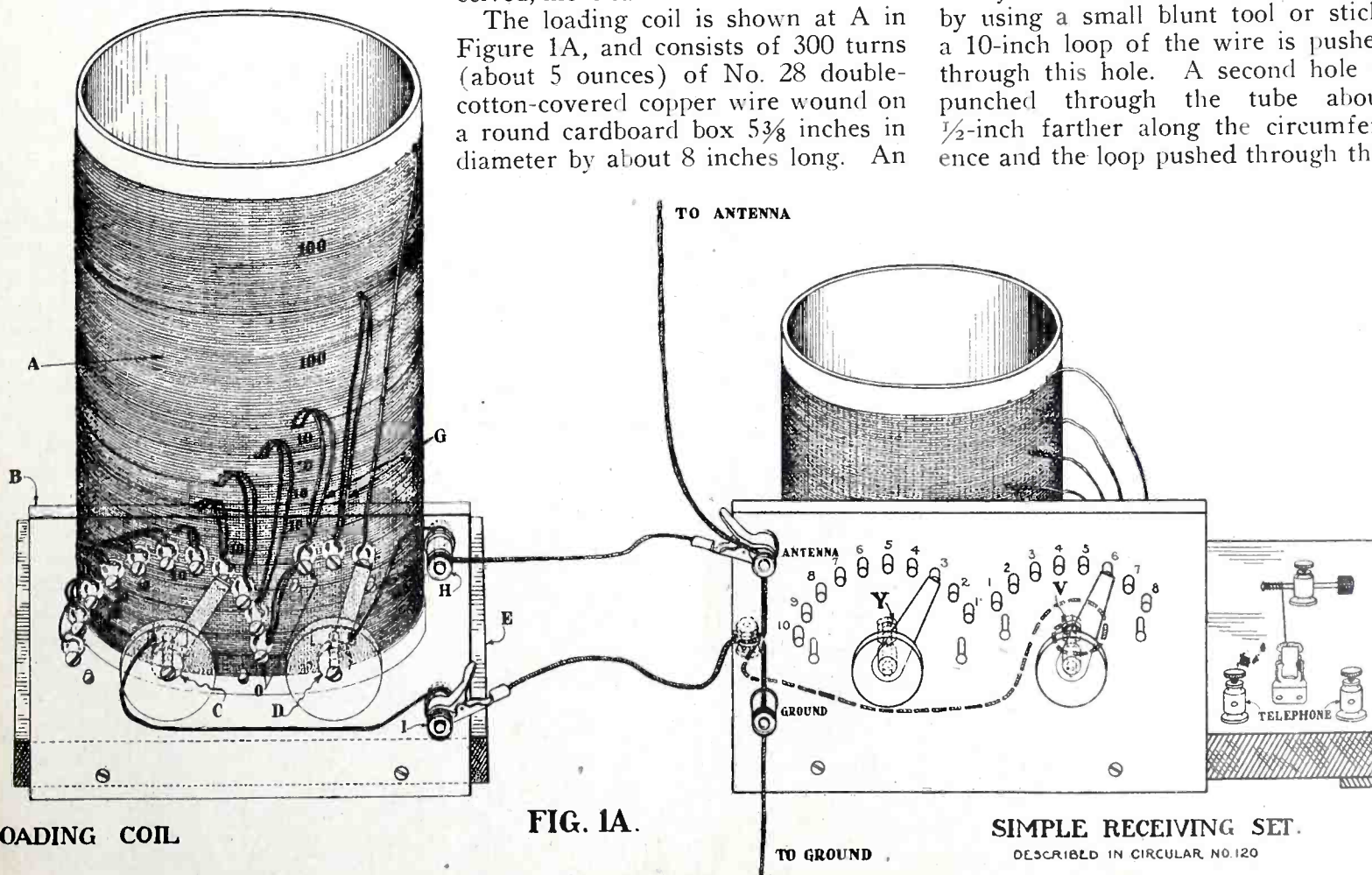

LOADING COIL

FIG. 1A.

SIMPLE RECEIVING SET.
DESCRIBED IN CIRCULAR NO. 120

hole to the outside of the tube again. The loop may or may not be twisted as it emerges from the second hole. See Fig. 1B. When 10 more turns have been wound, another tap is taken off in the same manner. The arrangement of these taps is shown in the left half of Fig. 1A. It will be noticed that there are 13 taps on the completed coil, counting the two ends of the wire at the start and finish. Each tap is slightly offset from the preceding one so that the line of completed taps progresses about half way around the coil, as indicated in Fig. 1A. After

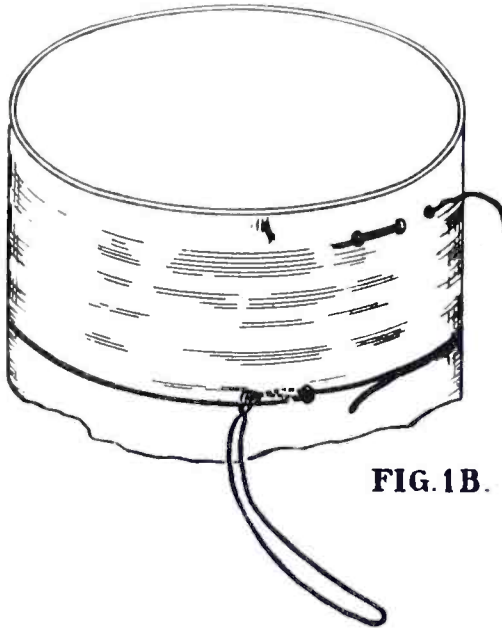

FIG. 1B.

the wire is wound on the cardboard tube or oatmeal box it is placed in a warm oven to drive off the absorbed moisture. After the tube has dried for some time and while still warm, melted paraffin is brushed over the tube, inside and out. The paraffined tube is put back in the oven for a few minutes in order to more thoroughly impregnate the tube.

The switch panel B is made from a piece of dry wood about 7 inches long, $4\frac{1}{2}$ inches wide and $\frac{1}{2}$ -inch thick. Its general construction is similar to the switch panels described in Circulars Nos. 120 and 121. The two switch arms, C and D, which are used with this panel have also been described in Circular No. 120. Having drilled the holes for the two switcharm bolts, the switch arms are placed in position and the knobs rotated in such a manner that the ends of the contact arms describe arcs upon which the contact points are to be placed. The holes for the switch contact bolts are then drilled; the spacing between contacts depending upon the width of the end of the switch arms, as well as upon the kind of contacts which are used. For the switch arm C there are 11 contacts and for the switch arm D, 3, as shown. The wood base E is a block of wood about 7 inches square and $\frac{3}{4}$ -inch thick.

Assembly and Wiring.—Before any

of the parts are assembled the base and panel are treated with paraffin as described in Circular No. 120, or they may be thoroughly dried and coated with a good grade of varnish which will not absorb moisture. Shellac is not used. The panel B is fastened to the base E and the coil A is placed in position so that the row of taps faces the rear of the panel. The coil is fastened in this position by small wood screws passing through the cardboard end, each screw being provided with a washer. The two switch arms with the necessary contact bolts are placed in position on the panel. A wire connection is made between switch arm D and binding post H and between switch arm C and binding post I as explained in Circular No. 120, or a spring washer is slipped over each switch-arm bolt at the rear of the panel and the wires soldered to these. See Fig. 1C. The several taps from the coil are cut off to a length sufficient to reach from the coil to the contacts. The insulation is scraped from the ends of the wires and the ends of the double taps twisted together below the point G, Fig. 1A. The taps are fastened between the nuts and washers of the proper contact bolts as shown in the left half of Fig. 1A.

This loading coil is used in connection with the receiving set described in Circular No. 120. The method of making the connections is shown in Fig. 1A. A 10-inch copper wire with a battery clip at one end is fastened to the binding post H with the clip attached to the receiving set binding post marked "antenna." The wire originally leading from the back of the "antenna" binding post was connected to the back of the switch arm bolt V.

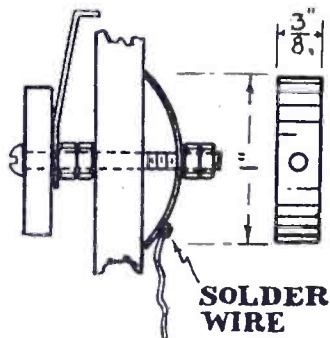

FIG. 1C.

This wire is removed from the back of the "antenna" binding post and attached to a new bolt or binding post fastened to the baseboard of the simple receiving set. This bolt or binding post is located just at the rear of the receiving set binding post marked "ground." A 10-inch piece of copper wire is attached to this new bolt or binding post with a battery clip attached at the end toward the loading coil binding post I. The wire leading from the crystal to the rear of the "antenna" binding post, as described in Circular No. 120, remains as it was.

If this wire was originally connected as described in Letter Circular No. 43, or directly to the switch-arm bolt V, it is removed and connected to the rear of the "antenna" binding post. All other wiring is as described in Circular No. 120.

Method of Operating.—The wire leading to the antenna is connected to the binding post marked "antenna" and the wire leading to the ground is connected to the binding post marked "ground" as before. In order to receive messages transmitted at wave frequencies between 500 and 1500 kilo-cycles per second (wave lengths between 600 and 200 meters) the switch arms C and D on the loading coil panel are both set on the contacts marked O. When receiving at the shorter waves (200 to 600 meters), it is better to remove the battery clip from the "antenna" binding post and put the clip previously attached to I in its place, that is, attach the wire from the new binding post to the "antenna" binding post. The loading coil is thus entirely disconnected from the receiving set and should be removed some distance from it. The operation of the receiving set is then exactly the same as described in Circular No. 120. In order to receive messages transmitted at wave frequencies less than 500 kilocycles per second (wave lengths over 600 meters) the load coil is again connected as shown in Fig. 1A and the switches on the loading coil panel are adjusted so that the proper number of turns is included in the circuit. The switches on the panel of the original receiving set are set so that they include all of the wire on the coil, (i. e., set switch arm Y on contact point 10 and switch arm V on contact point 8, Fig. 1A. The switch D on the loading coil panel is set to the extreme left on contact O, and the switch arm C is rotated slowly over its entire range. If signals are not heard, the switch arm D is set on the next contact to the right and the switch arm C is again rotated over all of its contacts. If the signals are still not heard, the switch arm D is placed on the contact to the extreme right and the switch C again rotated over its contacts. When the transmitting station is heard, the signals may be improved by adjusting the right-hand switch arm V of the original receiving set, and the same time changing slightly the setting of the switch arm C.

Use with Two-Circuit Set.—The loading coil as described herein has been found quite satisfactory in extending the wave length range of the single-circuit receiving set described in Bureau of Standards Circular No. 120. The experimenter may be interested to try various ways in which to

(Continued on Page 286)

Notes on The Reflex Circuit

By EDWIN S. WATKINS

Why four out of more than 100 failed in building the reflex circuit set described in last month's issue of Radio Journal is here told in detail by the author of the original article. So much success has attended the construction of this set that the causes for failure are interesting to every set builder.

SINCE describing the reflex circuit in last month's issue of Radio Journal, about one hundred sets have been built according to the writer's knowledge. Of this hundred there have been four known failures, the causes of which are the object of this article.

The first set which came to my notice contained enough soldering paste to solder the rest of the ninety-nine sets. As was mentioned in the original article, soldering paste can do more than any other one thing to keep a radio set from functioning properly. To make a good radio joint the end of the wire as well as the terminal to which it is to be connected should be touched with a small bit of paste, tinned and then wiped clean before connecting together. The latter operation is done merely by the application of heat from the soldering iron to the joint. If, perchance, paste should permeate the insulation of jacks or other fibrous materials in the set, a tooth brush immersed in some grain alcohol serves as the best cleaning fluid.

Set number two really presented a complicated problem due to the fact that it was perfectly wired; apparently had good apparatus (although not of standard make) and was well arranged. Testing of each individual unit of the set revealed the fact that the distributed capacity of the radio frequency transformers was far in excess of the allowable happy medium required for efficient radio frequency amplification. Replacement of these transformers with those of a make which were known to be good enabled us to obtain the usual excellent results which accompanied reflex circuits. It might be mentioned here that about eight out of ten of the present day radio frequency transformers fail to give anywhere near the results claimed for them. Poor arrangement of windings; slip shod methods of assembly and improper designing, sometimes done by one who knows little or nothing about radio, are the most common causes of inefficient radio frequency transformers. It pays in the end to secure one of a type which you absolutely know will function properly.

By-pass condensers are the object

of much discussion in radio magazines at the present time—and rightly so. When a man spends four or five long evenings doing an excellent job of wiring on a receiving set and spends most of his week's wages in the purchase of equipment for that set, he naturally expects a commensurate return for his time and money. However, in thousands of cases, by-pass condensers are the cause of his discouragement. When purchasing fixed or by-pass condensers it is well to scrutinize carefully the insulation between the electrodes. Even mica, if it is too thin, is a poor insulator. It should be of at least five mil thickness. Another good dielectric for fixed condensers is the heavy grade of

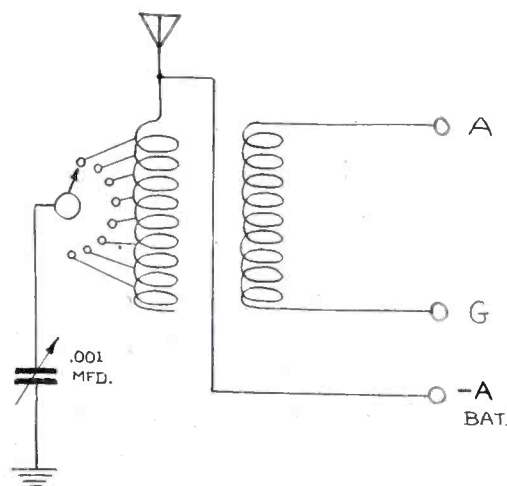

POST MARKED A GOES TO "ANTENNA" BINDING POST IN APRIL ISSUE, C CONNECTS TO "GROUND" BINDING POST. NOTE THAT THE ANTENNA SIDE OF THE PRIMARY INDUCTANCE IS CONNECTED TO THE NEGATIVE SIDE OF THE "A" BATTERY. THIS ELIMINATES THE ANNOYING INDUCTION HUM FROM POWER AND LIGHTING CIRCUITS.

empire paper. This material will usually stand a voltage breakdown as great, or greater, than five mil mica. Under no consideration should condensers made with paraffine paper (usually lunch paper) be used. The third receiving set was just a case of poor condensers.

When a receiving set begins to squeal and howl, especially if it is a reflex receiver, it will be well to look for grid and plate wires running parallel to one another. The fourth failure which came to my attention

was due to nothing other than parallel wiring. Although spaghetti was used to cover the wires and prevent any short circuits, the wiring was bunched so as to cause interference and consequently oscillation due to regeneration which could not be compensated for by means of the potentiometer.

Noisy operation of the receiver, if not caused by poor B batteries or by-pass condensers, is usually due to a corroded wire being used as a cat whisker on the crystal detector.

Havana, Cuba, and Atlanta, Georgia, are the best records for long distance receiving to date on the reflex set. However, some splendid results have been obtained using a two-foot loop consisting of fourteen turns of one hundred forty-four strand Litzen-dracht wire spaced three-eighths of an inch apart. San Francisco, Calif., has been very clearly heard from Los Angeles, using the above loop. Furthermore, this reception was done while both of the local stations were operating on a wave within twenty meters of that of the San Francisco station. This reception cannot be considered as consistent for the set as it was done only on one occasion. With the outside aerial such reception is very common.

For use in an automobile within twenty miles of the broadcasting stations a small loop nine inches on a side wound with number twenty magnet wire is giving excellent results.

Many requests have come to the writer as to the best tuning arrangement to use on a reflex when working with an outside antenna. It has been found that the usual double circuit tuner shown in the accompanying diagram performs most efficiently. At least fifty-five and not more than sixty-five turns of wire should be used on the secondary of the variocoupler to secure the maximum results from the set at three hundred sixty and four hundred meters. The loop tuning condenser then acts as the secondary condenser. When using this method the loop should not be in the jack.

We who have tried and are using the reflex receiver after junking the old regenerator sets can only say to those who haven't tried it that you are missing one of the most satisfactory thrills of your radio experiments.

The Jobber's Big Problem

By I. S. LESSER

THE radio industry, as a business proposition, is going through a transition period which must eventually lead to the adoption of those sound business principles which prevail in other lines of industry. And with the transition period comes a multitude of perplexing conditions which dealer, jobber and manufacturer must, through cooperation and mutual understanding, face and solve before the industry can come into the promised land.

The Pacific Coast, due to its distance from the larger manufacturing centers of the east, is not in close touch with its source of manufactured products, which has brought about a condition a bit unusual and not found in industries more mature in years. Jobbers on every hand find that they have difficulty in retaining anything like exclusive lines, or that they are even protected against direct competition from the factory, though all blame this condition largely upon lack of knowledge of the situation on the part of the manufacturers.

"For example," said one jobber. "I stocked a certain line with the understanding that it was to be exclusive. My salesman started out to push it, the orders began coming in, and within a few months I had been able to place a large standing monthly order with the manufacturer. Then along comes a dealer, a man to whom I had been selling goods regularly. Without any intent, other than to secure a better price, he wrote the factory, sending them an order direct. Did the factory refer the account to me and tell me to deliver the goods? It did not. It shipped the order direct to the dealer and gave him the factory price. Another dealer learned of this, sent in an order, and the result was that I was left with a large stock which failed to move."

Then there is the factory representative. Now a real factory representative is all right, and there are many of them in the field. But some are not. Another jobber, telling his troubles, said that one factory representative had called on a number of retail dealers, regular customers of the jobber, and said: "Here, you are a jobber. You are entitled to the factory price.

The factory representative sells him a small order. He goes to another customer of the same jobber, sells him a small order, and so on. The factory representative notifies his concern that he has opened half a dozen new jobbing accounts, the factory is happy for the time being, and its regular jobber is left in the hole. What is the result? Everyone is a jobber it seems, at least to the jobber, and he cannot push the products of that factory any longer.

"The factories should have someone who knows a thing or two about merchandizing come out and look the field over," said another jobber. "We do not demand the earth. All we want is to be able to supply a legitimate trade with legitimately manufactured goods and make a fair profit, one which will enable us to remain in business. The coast dealers need the jobbers. They must have someone to call on for goods when they need it. They cannot deal for any length of time directly with the factory. But the factories themselves, by their lack of knowledge of conditions on the coast, are making it very difficult for jobbers to do business."

"Exclusive lines," said still another jobber. "There are none, at least, darned few, and we haven't lined any up as yet. A jobber should be entitled to a certain field, if he is to spend money exploiting a factory product. I do not want them all, couldn't handle them if I had them, but I do want to know that the lines I am pushing, and the promotion work I do, is not all

going into another jobbers pocket. Let him push his lines and I will push mine. It will make for legitimate competition on a true business basis and build for strength in the entire industry."

If the jobbers of the coast, or any section of the coast, will get together, talk over their troubles, take them up with the factory and get the whole question threshed out in its true light, there should be no difficulty in solving a problem which seems, today, to be perplexing not only the jobber, but the retailer and manufacturer as well.

To Span the Pacific

Radio Station 6BVG, located at 1926 Delta Street, Los Angeles, Calif., is owned and operated by Stuart F. Wainwright. The station has been designed in accordance with the more recent methods of radio communication and consideration has been given to the many small details of design and construction so necessary for successful operation. The station is situated on a hill and the mast, an 83-footer, supports a 7-wire almost vertical fan aerial on a 16 foot spreader. A 14-wire counterpoise 70 feet long and 30 feet wide covers practically the whole back yard.

In the picture the panel to the left is a 20 watt DC CW transmitter. By means of a sectionalizing switch the set may quickly be changed over into a 10-watt phone using two tubes as oscillators and two as modulators with Heising modulation. The reverse-feedback circuit is used. The direct current plate supply is obtained from the E. S. Co. motor-generator

(Continued on Page 276)

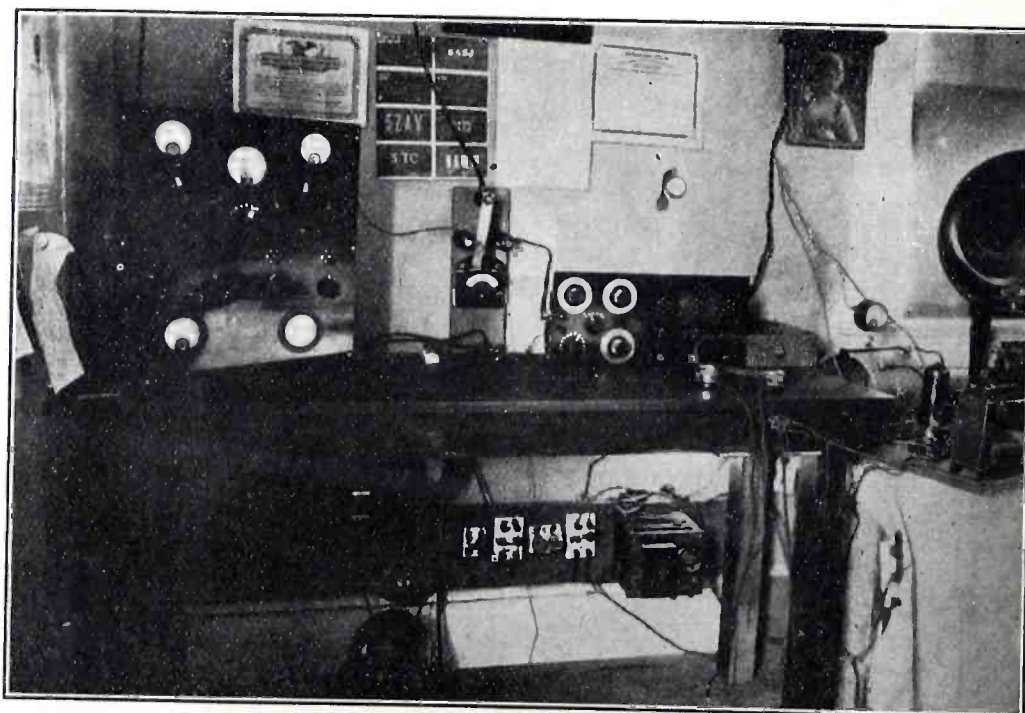

THIS IS 6BVG, OWNED AND OPERATED BY S. F. WAINWRIGHT OF LOS ANGELES, WHO PLANS TO POUND THROUGH TO AUSTRALIA WITH IT MAY 1. LOOKS LIKE A REAL "HAM" LAYOUT, WHAT?

The Anonymous Message

By RAYMOND W. SHIREY

With every step taken by science along the upward path we return again and again to fundamental truth and fundamental sentiment, old as mankind; that divine spark which separates man from all other manifestations of creation. Science but lends a hand in emphasizing these age-old relationships. In this story, radio, that newest of the sciences, brings to millions a fuller understanding of the meaning of the word "mother"—all because one man learned it well at his mother's knee.

TO the average city boy the home life of Richard Meade would have been insipid, monotonous, and unhappy, but to him it was the mecca of all his delights. Here in this little humble home he lived with father and mother. His childish mind knew of nothing better, and so it was to him an isle of golden dreams. There were no beautiful lawns, or broad walks lined with flowers around the house in which they lived; no servant would have answered the door should you have called there. It was very unpretentious when compared with the average city residence, yet in that little home the atmosphere of love filled every corner.

Richard had lived there all his life with just father and mother. He was one of those unfortunates with neither brothers or sisters, and knew little of the great things taking place in the busy world outside. His ten years had brought to him a knowledge far different from the average boy's. He had no playmates and never had attended school like other boys of his age, his mother had been the substitute for both of these. Because of this an unusually close companionship had been developed between them. She had been his teacher and playmate until the time came when he should be sent to preparatory school. Their evenings were spent in reading books, with a discussion of them afterward between father and mother, to which Richard listened with absorbing ears. He always looked forward to the evening time when mother would read from one of the many books they had. Perhaps it was a story, the biography of some great man, a book on science, or poems; it was all interesting when read by mother because of the explanations she was always able to give.

Richard remembered well the discussion which had followed the reading of a certain article on radio. All through the piece father had shown his skepticism and disgust at such "tom-foolery" as he termed it. It was easy to see the statements made by the author did not have his approval, but mother read on just the same and

waited with interest the discussion which would follow. When she had completed the reading his father gave his opinion without any hesitation.

"Such foolishness," he said in a disgusted tone. "It is just the imaginary whim of a dreamer getting the people to pay him for writing his fantastical illusions."

"Well, amazing things are being done in the field of science, and I wouldn't say it can't be done," Mrs. Meade answered.

"It is too absurd to even think about," he added, not relenting any from his former attitude. "Just think of a man predicting that sometime in the future messages will be sent across the continent by wireless, or that a man will be able to talk into a mechanical device and have others hear him a thousand miles away." He even refused to take further part in the discussion and went off to bed.

Some nights later mother was again reading from a book of poems and quotations. She came upon the following and read it with keen interest, for the thought given in the quotation was her whole philosophy of life. "I expect to pass this way but once. Any good, therefore, that I can do, or any kindness that I can show to my fellow men, let me not defer or neglect it, for I shall not pass this way again." She read it aloud again and then added, "I wonder who wrote those words, it is signed, 'anonymous.'"

"What does anonymous mean, mother?" Richard asked.

"It means the man who wrote the quotation is unknown, the word means 'without name.'"

"And why didn't the man want his name known, mother?"

"Well, sometimes there are people who write things and let them stand on their own merits. They do not desire any credit for the work they have done."

"But mother, just the other day you told me people always wanted credit for everything they did."

"And so they do, my boy, but there are a few people who try to see how much they can do for others instead

of seeing how much they can do others for. These are the ones who get the most out of life, for they seek to serve rather than be served, and out of that service for others they gather strength and courage to serve themselves. This I should like to have you always remember. Service to your fellow men is the greatest thing in life. I don't want you to grow up to be an alibi man, giving no consideration to anyone except yourself. He is the one who devotes all his energy to finding an excuse for not making good on the job, while, if he had devoted the same amount of effort to his task as he did to finding an alibi, he wouldn't have needed the excuse. Do the task they assign to you, and if you fail you will receive credit for making an honest attempt. I shall not judge your success by the wealth you obtain, but by the obstacles you overcome and the service you do."

On Richard's thirteenth birthday he received a watch from his mother and a pony from his father. The excitement of progressing from plain numerals into his teens all in one day was an event of paramount importance. The possession of material wealth was visible symbol of advancement toward manhood. Later he was to have the privilege of attending a preparatory school which would take him away from home. When the time came he would use the privilege. To attend a school where boys and girls spend a more or less beneficial period of four years in preparing for college was the one thing which must be given Richard regardless of the sacrifice necessary. The school should have the duty of cultivating his mind, but his mother depended upon her own motherly wisdom to select the things which would educate his heart and create within him the ideals which would make the type of man she wanted him to be.

But her ambitions were never realized. The impartial hand of death robbed Richard of his parents. The unexpected call of his loved ones had placed upon Richard a responsibility his puerile shoulders were hardly ready to carry.

World's Most Beautiful Station

By L. TOROMAN

SOME of these days when you pick up XDA, picture to yourself for a moment a broad and rambling lake, wonderfully beautiful coves, sparkling fountains, gaily clad merrymakers, a splendid palace—all these comprising what is probably the world's most beautiful broadcast station, located in Chapultepec Park, Mexico City. At least the photographs reproduced herewith give us the notion that when good broadcasters pass on they will land in an Elysian layout something like this.

All of which is by way of preface to the remark that XDA, Mexico City Radio Broadcast Station, is located in yon palace, with mahogany furniture and upholstered chairs and soft-footed servants and everything. And the lake and the boats and pretty señoritas and everything go with the outfit.

In fact, Mexico is by no means trailing along in things radio. Not by several ohms and a pair of watts. In fact, they have grand ideas and work them out, as this nifty little shack would indicate.

Mexico owns and controls its telegraph system and, as an adjunct, the government has already installed something like thirty wireless stations in remote places, and there are still some places in Mexico which would be considered a bit remote. Governor Lugo of Lower California, known in the vernacular as Bajo California, is

one of the nation's leading radio enthusiasts. He's got a regular palace, a sort of court castle and country house combined, wherein he has installed the best outfit he can buy, and entertains friends, guests and politicians with good United States broadcast from Los Angeles, San Diego, San Francisco, Salt Lake, and even Kansas City. In fact, his hacienda has become so popular through this radio outfit that all talk of revolution on the west coast has subsided, apparently.

New 1000 Watt Set

WJZ, the Radio Corporation-Westinghouse radio station at Newark, N. J., has a new transmitter, rated at double the power of its predecessor, or 1000 watts. It is considered greatly superior in the details of its transmitting, modulating, and generating system.

All radio broadcasting transmitters of the Westinghouse Electric & Manufacturing Company are checked periodically in order to determine their condition and characteristics by such instruments and devices as oscilloscopes, modulation meters, etc. It is thus possible to determine accurately what per cent of the radiated wave is modulated, the exact performance of the modulator, speech

amplifiers, and other devices, and the manner in which the microphone "pick-up" functions.

The new transmitter at WJZ includes a number of new features. Instead of using generators to develop the high-voltage plate current as is the common practice now, a power rectifier was installed, which was designed by D. G. Little, Westinghouse electric engineer. Oscillograph pictures show no "ripple" in the current wave.

The new transmitter consists of four oscillators modulated by five modulator tubes of special design. A feature of this transmitter is that it has a meter which shows the per cent of modulation at every instant.

KDKA's New Studio

KDKA, the broadcast station of the Westinghouse Electric & Mfg. Co., at East Pittsburgh, Pa., has been established in a new studio which is located one mile from the actual broadcast station. The studio will be operated by remote control which has been perfected to a high degree by Westinghouse radio engineers. Remote control of the broadcast station means that the studio operator will turn the broadcasting apparatus on and off from the studio when the actual program starts and this feature will eliminate any delay between numbers on the program.

When KDKA was first started, the broadcast studio was located next to the broadcasting apparatus, and the station operator made all connections between the studio and station. This meant that the studio operator in attendance would have to first signal the station operator to turn on the broadcasting apparatus and then give the signal to the artist to start, at the same time throwing the microphone, or pick-up, switch. Owing to this method of dual control, which was in force at all broadcast studios, there were unavoidable delays between selections owing to the difficulty in synchronizing the work of the studio and station operators. With the remote control method in which everything is controlled from the studio, these delays will be entirely eliminated, and there will be broadcast a smoother program which will be run off in the manner in which vaudeville acts follow one another on the bill.

Allen H. Babcock, 6ZAF, of Berkeley, Calif., has been appointed to fill the unexpired term of A. E. Bessey, 6ZK, who has resigned as director of the American Radio Relay League in the Sixth District. Mr. Babcock is consulting electrical engineer for the Southern Pacific Co.

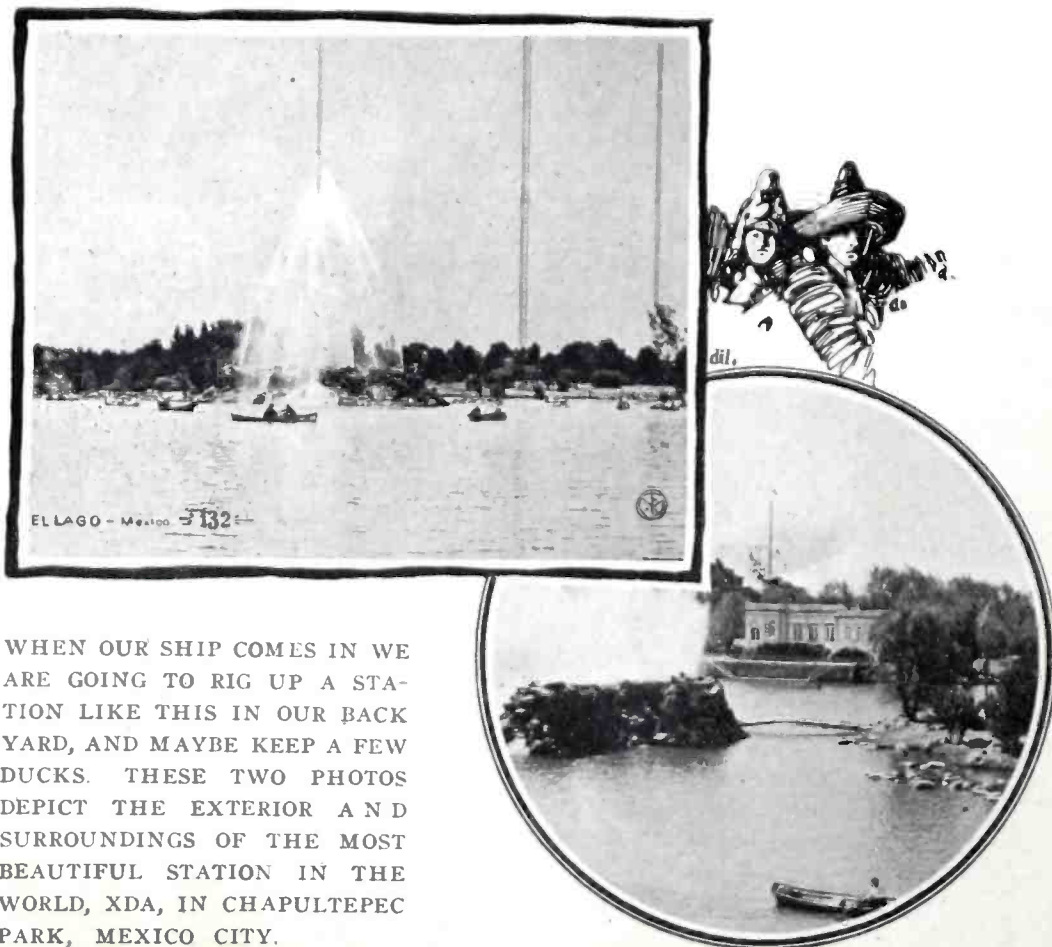

WHEN OUR SHIP COMES IN WE ARE GOING TO RIG UP A STATION LIKE THIS IN OUR BACK YARD, AND MAYBE KEEP A FEW DUCKS. THESE TWO PHOTOS DEPICT THE EXTERIOR AND SURROUNDINGS OF THE MOST BEAUTIFUL STATION IN THE WORLD, XDA, IN CHAPULTEPEC PARK, MEXICO CITY.

Loading Coil with Simple Receiving Set

By U. S. BUREAU OF STANDARDS

With the possibility of new wave lengths appearing in the broadcast field a loading coil, such as herein described, will take a load off many a set builder's mind. The article, Letter Circular LC47 of the Bureau of Standards, Washington, D. C., describes a means of increasing wave-length range of sets already described in previous issues of Radio Journal. We are loaded with more articles of the same helpful character for subsequent issues.

THIS circular describes a loading coil which is used in conjunction with the single-circuit radio receiving set described in Bureau of Standards Circular No. 120. (Published in June, 1922, issue of Radio Journal.) The experimenter who is interested in using it in connection with the two-circuit set described in Circular No. 121, (published in the February, 1923, issue of Radio Journal), is referred to the section entitled, "Use with Two-Circuit Set," near end of this paper.

The purpose of the loading coil is to enable the receiving equipment to respond to wave frequencies between 100 and 500 kilocycles per second (that is, wave lengths between 3000 and 600 meters). In other words, the loading coil increases the wave frequency (wave length) range of the receiving set. The receiving set described in Bureau of Standards Circular No. 120, has a wave frequency (wave length) range of between 500 and 1500 kilocycles per second (wave

lengths between 600 and 200 meters).

The use of the loading coil will increase the receiving distance of the equipment, because many stations using the lower wave frequencies (longer wave lengths) use a high-power radio transmitting set. For example, the station NAA at Arlington, Va., uses a wave frequency of about 113 kilocycles per second (2650 meters wave length) and uses sufficient power to be heard a distance of about 200 miles when the loading coil described in this Circular is used with the receiving equipment previously described. At night this distance may be considerably increased.

The cost of the parts for the loading coil is approximately \$3.

Description.—A loading coil is simply a coil of wire connected to the rest of the receiving equipment in such a manner that a variable number of its turns are included in the circuit between the antenna and the ground connection. When longer wave lengths (lower wave frequencies) are received, more turns are used on the coil.

The loading coil is shown at A in Figure 1A, and consists of 300 turns (about 5 ounces) of No. 28 double-cotton-covered copper wire wound on a round cardboard box $5\frac{3}{8}$ inches in diameter by about 8 inches long. An

oatmeal box is used for the cardboard tube with the cardboard cover glued to one end. Certain of the turns are provided with taps which are connected to switch contacts so that the number of turns included in the circuit can be varied. One end of the wire is fastened at the closed end of the tube by weaving it through two holes $\frac{1}{2}$ -inch apart and $\frac{3}{4}$ -inch from the end. The free end of the wire projects about 10 inches. The wire is wound on the tube in a single layer so that the turns lie closely and evenly together. When 10 turns have been wound, a 10-inch tap is taken off. The method of winding and also one method of taking off the taps has been explained in Circular No. 120. Instead of using the simpler method of taking off taps as described in Circular No. 120, a somewhat more difficult and correspondingly more satisfactory method is used on this loading coil. After the given number of turns of wire have been wound on the tube, a hole is punched through the tube just underneath the last turn and, by using a small blunt tool or stick, a 10-inch loop of the wire is pushed through this hole. A second hole is punched through the tube about $\frac{1}{2}$ -inch farther along the circumference and the loop pushed through this

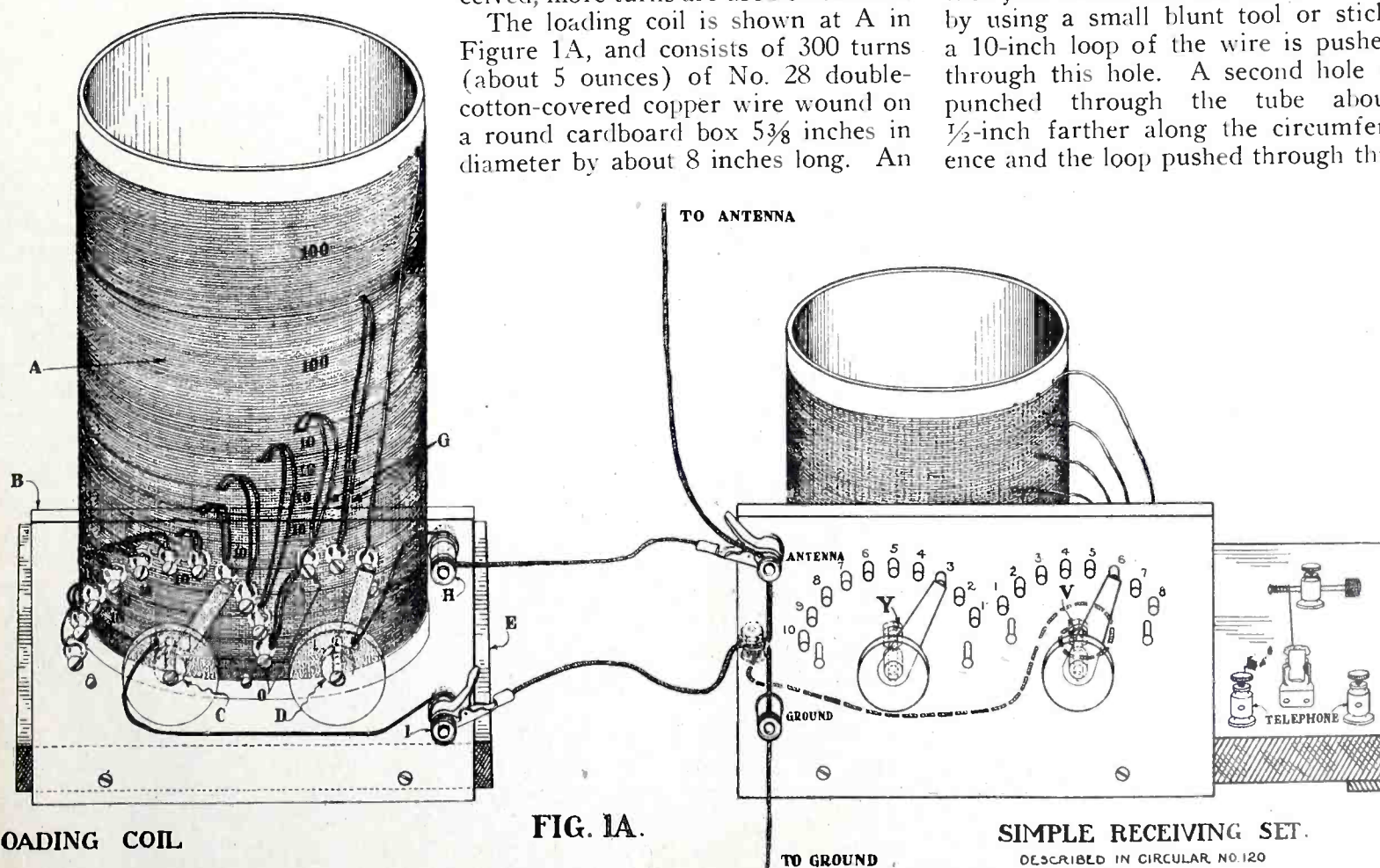

LOADING COIL

FIG. 1A.

SIMPLE RECEIVING SET.
DESCRIBED IN CIRCULAR NO. 120

The Jobber's Big Problem

By I. S. LESSER

THE radio industry, as a business proposition, is going through a transition period which must eventually lead to the adoption of those sound business principles which prevail in other lines of industry. And with the transition period comes a multitude of perplexing conditions which dealer, jobber and manufacturer must, through cooperation and mutual understanding, face and solve before the industry can come into the promised land.

The Pacific Coast, due to its distance from the larger manufacturing centers of the east, is not in close touch with its source of manufactured products, which has brought about a condition a bit unusual and not found in industries more mature in years. Jobbers on every hand find that they have difficulty in retaining anything like exclusive lines, or that they are even protected against direct competition from the factory, though all blame this condition largely upon lack of knowledge of the situation on the part of the manufacturers.

"For example," said one jobber, "I stocked a certain line with the understanding that it was to be exclusive. My salesman started out to push it, the orders began coming in, and within a few months I had been able to place a large standing monthly order with the manufacturer. Then along comes a dealer, a man to whom I had been selling goods regularly. Without any intent, other than to secure a better price, he wrote the factory, sending them an order direct. Did the factory refer the account to me and tell me to deliver the goods? It did not. It shipped the order direct to the dealer and gave him the factory price. Another dealer learned of this, sent in an order, and the result was that I was left with a large stock which failed to move."

Then there is the factory representative. Now a real factory representative is all right, and there are many of them in the field. But some are not. Another jobber, telling his troubles, said that one factory representative had called on a number of retail dealers, regular customers of the jobber, and said: "Here, you are a jobber. You are entitled to the factory price.

The factory representative sells him a small order. He goes to another customer of the same jobber, sells him a small order, and so on. The factory representative notifies his concern that he has opened half a dozen new jobbing accounts, the factory is happy for the time being, and its regular jobber is left in the hole. What is the result? Everyone is a jobber it seems, at least to the jobber, and he cannot push the products of that factory any longer.

"The factories should have someone who knows a thing or two about merchandizing come out and look the field over," said another jobber. "We do not demand the earth. All we want is to be able to supply a legitimate trade with legitimately manufactured goods and make a fair profit, one which will enable us to remain in business. The coast dealers need the jobbers. They must have someone to call on for goods when they need it. They cannot deal for any length of time directly with the factory. But the factories themselves, by their lack of knowledge of conditions on the coast, are making it very difficult for jobbers to do business."

"Exclusive lines," said still another jobber. "There are none, at least, darned few, and we haven't lined any up as yet. A jobber should be entitled to a certain field, if he is to spend money exploiting a factory product. I do not want them all, couldn't handle them if I had them, but I do want to know that the lines I am pushing, and the promotion work I do, is not all

going into another jobbers pocket. Let him push his lines and I will push mine. It will make for legitimate competition on a true business basis and build for strength in the entire industry."

If the jobbers of the coast, or any section of the coast, will get together, talk over their troubles, take them up with the factory and get the whole question threshed out in its true light, there should be no difficulty in solving a problem which seems, today, to be perplexing not only the jobber, but the retailer and manufacturer as well.

To Span the Pacific

Radio Station 6BVG, located at 1926 Delta Street, Los Angeles, Calif., is owned and operated by Stuart F. Wainwright. The station has been designed in accordance with the more recent methods of radio communication and consideration has been given to the many small details of design and construction so necessary for successful operation. The station is situated on a hill and the mast, an 83-footer, supports a 7-wire almost vertical fan aerial on a 16 foot spreader. A 14-wire counterpoise 70 feet long and 30 feet wide covers practically the whole back yard.

In the picture the panel to the left is a 20 watt DC CW transmitter. By means of a sectionalizing switch the set may quickly be changed over into a 10-watt phone using two tubes as oscillators and two as modulators with Heising modulation. The reverse-feedback circuit is used. The direct current plate supply is obtained from the E. S. Co. motor-generator

(Continued on Page 276)

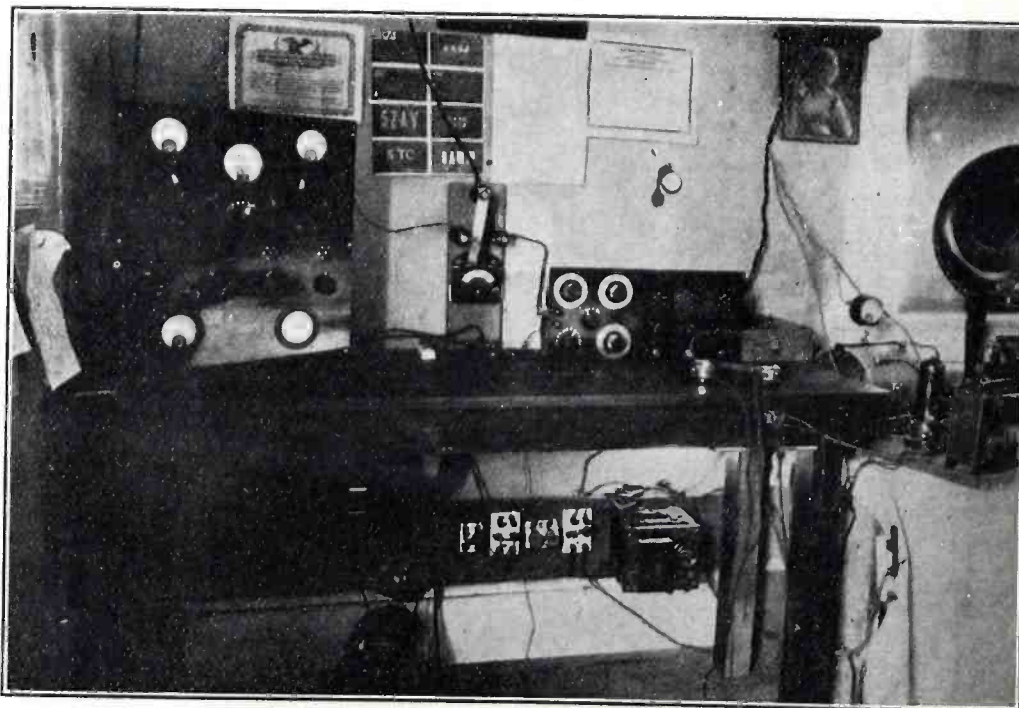

THIS IS 6BVG, OWNED AND OPERATED BY S. F. WAINWRIGHT OF LOS ANGELES, WHO PLANS TO POUND THROUGH TO AUSTRALIA WITH IT MAY 1. LOOKS LIKE A REAL "HAM" LAYOUT, WHAT?

The Anonymous Message

By RAYMOND W. SHIREY

With every step taken by science along the upward path we return again and again to fundamental truth and fundamental sentiment, old as mankind; that divine spark which separates man from all other manifestations of creation. Science but lends a hand in emphasizing these age-old relationships. In this story, radio, that newest of the sciences, brings to millions a fuller understanding of the meaning of the word "mother"—all because one man learned it well at his mother's knee.

TO the average city boy the home life of Richard Meade would have been insipid, monotonous, and unhappy, but to him it was the mecca of all his delights. Here in this little humble home he lived with father and mother. His childish mind knew of nothing better, and so it was to him an isle of golden dreams. There were no beautiful lawns, or broad walks lined with flowers around the house in which they lived; no servant would have answered the door should you have called there. It was very unpretentious when compared with the average city residence, yet in that little home the atmosphere of love filled every corner.

Richard had lived there all his life with just father and mother. He was one of those unfortunates with neither brothers or sisters, and knew little of the great things taking place in the busy world outside. His ten years had brought to him a knowledge far different from the average boy's. He had no playmates and never had attended school like other boys of his age, his mother had been the substitute for both of these. Because of this an unusually close companionship had been developed between them. She had been his teacher and playmate until the time came when he should be sent to preparatory school. Their evenings were spent in reading books, with a discussion of them afterward between father and mother, to which Richard listened with absorbing ears. He always looked forward to the evening time when mother would read from one of the many books they had. Perhaps it was a story, the biography of some great man, a book on science, or poems; it was all interesting when read by mother because of the explanations she was always able to give.

Richard remembered well the discussion which had followed the reading of a certain article on radio. All through the piece father had shown his skepticism and disgust at such "tom-foolery" as he termed it. It was easy to see the statements made by the author did not have his approval, but mother read on just the same and

waited with interest the discussion which would follow. When she had completed the reading his father gave his opinion without any hesitation.

"Such foolishness," he said in a disgusted tone. "It is just the imaginary whim of a dreamer getting the people to pay him for writing his fantastical illusions."

"Well, amazing things are being done in the field of science, and I wouldn't say it can't be done," Mrs. Meade answered.

"It is too absurd to even think about," he added, not relenting any from his former attitude. "Just think of a man predicting that sometime in the future messages will be sent across the continent by wireless, or that a man will be able to talk into a mechanical device and have others hear him a thousand miles away." He even refused to take further part in the discussion and went off to bed.

Some nights later mother was again reading from a book of poems and quotations. She came upon the following and read it with keen interest, for the thought given in the quotation was her whole philosophy of life. "I expect to pass this way but once. Any good, therefore, that I can do, or any kindness that I can show to my fellow men, let me not defer or neglect it, for I shall not pass this way again." She read it aloud again and then added, "I wonder who wrote those words, it is signed, 'anonymous.'"

"What does anonymous mean, mother?" Richard asked.

"It means the man who wrote the quotation is unknown, the word means 'without name.'"

"And why didn't the man want his name known, mother?"

"Well, sometimes there are people who write things and let them stand on their own merits. They do not desire any credit for the work they have done."

"But mother, just the other day you told me people always wanted credit for everything they did."

"And so they do, my boy, but there are a few people who try to see how much they can do for others instead

of seeing how much they can do others for. These are the ones who get the most out of life, for they seek to serve rather than be served, and out of that service for others they gather strength and courage to serve themselves. This I should like to have you always remember. Service to your fellow men is the greatest thing in life. I don't want you to grow up to be an alibi man, giving no consideration to anyone except yourself. He is the one who devotes all his energy to finding an excuse for not making good on the job, while, if he had devoted the same amount of effort to his task as he did to finding an alibi, he wouldn't have needed the excuse. Do the task they assign to you, and if you fail you will receive credit for making an honest attempt. I shall not judge your success by the wealth you obtain, but by the obstacles you overcome and the service you do."

On Richard's thirteenth birthday he received a watch from his mother and a pony from his father. The excitement of progressing from plain numerals into his teens all in one day was an event of paramount importance. The possession of material wealth was visible symbol of advancement toward manhood. Later he was to have the privilege of attending a preparatory school which would take him away from home. When the time came he would use the privilege. To attend a school where boys and girls spend a more or less beneficial period of four years in preparing for college was the one thing which must be given Richard regardless of the sacrifice necessary. The school should have the duty of cultivating his mind, but his mother depended upon her own motherly wisdom to select the things which would educate his heart and create within him the ideals which would make the type of man she wanted him to be.

But her ambitions were never realized. The impartial hand of death robbed Richard of his parents. The unexpected call of his loved ones had placed upon Richard a responsibility his puerile shoulders were hardly ready to carry.

So for years Richard attended the great school of Life. Nature had wrapped the great mantle of silence over all her domain a great many times, and with the passing of years came the progress created by the mind of man. Richard had seen the predictions of the man whom his father had called a dreamer come true. Radio was now a vital part of a progressive world. He wished his father might know the unbelievable accomplishments which had been made far beyond the prescience of the author years ago.

From the incipient stages of advancement in radio the class of non-believers had gradually diminished. All were agreed as to the great benefits of the men who had been called dreamers years ago. The great science had passed from an experiment to a necessity. The farmers marketed their crops by the daily reports given from the great broadcasting stations. It was the farmer's source of information during the day and the family's popular amusement in the evening. Across the arid deserts and miles of rolling plains, over the high Rockies, went thousands of daily wireless messages, which were the guiding factors in the world of commerce. The great ships at sea talked daily with the land they had left, and with those who awaited them at their journey's end. Universities were giving extension courses by radio to those who found it impossible to attend the institutions of learning. From the big broadcasting stations ministers sent out the teachings of the Man of Galilee reaching untold thousands who never entered the doors of a church. And still the dreamer labored on in his recon-dite efforts to fathom the unknown possibilities in the great science.

With the passing of years, Time had placed its indelible marks on Richard's brow. His hair had turned grey, which added to the dignity that comes with age. The expression of his face showed clearly the happy soul which dwelt within. His eyes watched with constant alertness for the opportunity to be of service to those about him. For years he had been just a reporter on a busy metropolitan newspaper in the city where he had first gone. He was known to all associated with the big daily as "Old Rich." No one in the organization could remember back to the time when he was not there. He had rendered more little acts of kindness to the employees than all the others combined. Helping others was his avocation, and for his ever thoughtfulness of those about him and his constant desire to make the pathway of life a little happier for his fellowmen he had the love and esteem of every person in the big organization.



FOR TWENTY MINUTES HE PLEADED.

* * *

"We will begin the new features at once," said Mr. Wayne, the managing editor of the Times, as he spoke to his staff. "On each important anniversary we must have a speaker talk from our broadcasting station. The Sunday program has proven one of the best things we have started. The people are realizing what they are constantly missing by not having a radio set to hear these wonderful programs daily. On Lincoln's and Washington's birthdays we will make a special effort to get men of national reputation to deliver patriotic messages. The community has shown its appreciation of our excellent service by letters of congratulation, and in a more remunerative way by a stupendous growth in our circulation. In addition to this we shall start the contest, which will run indefinitely among our readers. We will pay them cash prizes for articles written on topics of the day. We will print these in the paper, every effort being made to ameliorate any conditions which have brought criticisms upon us. I want each of you to put forth more energy in helping us to be of greater service to the public."

The plan proved a success from the start. The readers of the Times took more profoundly to the idea than the editor had anticipated. The contributions increased each day. The winners called promptly when their names were announced, and displayed their inexplicable joy in taking part in the writing contest. There was one writer who had won more prizes than any of the others, yet he never called for the guerdon to which he was entitled. These articles had a peculiar style and always contained some human appeal. They were always signed "Anonymous," with no intimation of the author's real name or address. Mr. Wayne had made every possible

effort to learn the name of the unknown writer, but every attempt had proven futile.

Some months later, "Old Rich" was in the editor's office and, during the conversation, noticed some books on Mr. Wayne's desk. His eyes fell upon one from which his mother had read during his boyhood.

"Mr. Wayne, could I borrow this book for a while?" he asked, holding up the volume.

"Why certainly, 'Rich.' I've got a lot of notes written on the pages and use it almost every day, so be careful not to lose it."

"No sir, won't even take it from the building. Just want to read some old verses, that's all. Mother used to read to me from this book when I was just about as old as your boy."

"Old Rich" sat leaning over his desk a week later studying the book his mother had read from years ago. He read the anonymous article, and recalled the explanation his mother had given him. He remembered her antipathy for the man who was always giving alibis. During his life he had never offered any excuse for not succeeding in his job given him. "Do the task assigned to you and if you fail you will be given credit for an honest effort." The words had been one of his aphorisms all through life.

Laying the book aside he closed his eyes and pictured again his mother. Already the editor had asked the readers for their contributions for Mother's Day. This was the one article he wanted accepted more than any of the others. He wrote it in plain, simple words, but they carried a message from his heart. He eulogized mother everywhere. Mother was the sweetest word in all the human language. She was God's masterpiece of creation. And still more marvelous was the fact that from the millions of mothers who live today each of us would select our very own, were we given the power of choice. For she is the one who patched our small garments, tied up little wounds and made them well by the kiss she placed on the injured part. It was mother who had built up a house of life from a million loving services. It was mother who with our many friends rejoiced with us in the hours of triumph, and she only who stood by when dark shadows fell. Words failed "Old Rich" as he endeavored to express the appeal he desired. There are some things which cannot be told in words, just as there are things no artist can paint. He labored with all the effort he could command and then felt discouraged at the fiasco he had made. He was about to complete the article and place it away with the other manuscripts he had

(Continued on Page 285)

The Great Australian Trans-Pacific Tests

'Twas the night of May 1, and all through the house, not a creature was stirring, except about a billion DX artists and their clattering brass. Anyhow that is by way of introducing the subject of the first, great and, we hope, annual Australian Trans-Pacific test for amateurs, to start May 1 and end with a complete victory for everyone, we trust.

THEY are off. Before many a Radio Journal reader has completed the digesting of the contents of this issue, amateur brass pounders from all parts of the country will be hard at it, trying to drive their messages across 7,000 miles or more of land and water to the antipodes in the Australian Trans-Pacific tests, in the longest distance test ever attempted by any large body of amateurs.

Stations are being rebuilt by the score, new antennas rigged, more power provided for and, in Australia, the stage is all set for receiving the calls of Americans. New Zealand amateurs are going to listen in and report on calls, as well as Australia, which will add a new country to many an American amateur's string of trophies.

Applications are still piling in as this is being written, calls and time assignments are being made, and a week before the tests start every entrant will have received his call letter and time assignment from the committee.

And when the reports are all in—give us a bit of sympathy, folks—the task of compiling that list and notifying the successful aspirants is going to be some job in itself. Anyhow we spent our last thin dime on a cable to J. Malone, Esq., controller of wireless in the prime minister's cabinet in Australia and H. Kingsley Love of Melbourne, chief of the Victoria section of the Australian Wireless Institute, notifying them that everything is all set to start May 1. "Prepare for the greatest shakeup the Australian ether has ever experienced," was our final advice. To the amateurs of America we leave the task of "shaking it."

The committee who made the tests possible, and with whom Radio Journal co-operated in putting them over, follows: R. J. Portis, president of the Long Beach Radio club, the Long Beach club as a whole being sponsor for the tests; Lester Picker, 6ZH, San Diego; Hyman M. Fink, 6BRG, Los Angeles; C. DuVall, 6BRS, Venice, Calif.; M. P. Gilliland, 6ACB, Pasadena, Calif.; Charles E. Taylor, 6AIB, Long Beach, Calif.; Jack Betterley, 6AQW, San Bernardino, Calif.; T. E. Nikirk, 6KA, Los Angeles; C. Thompson, 6UQ, San Fran-

cisco; Lewis Falconi, 5ZA, Roswell, New Mexico; Harold Duvall, 6EN, Los Angeles, Calif.; Wm. D. Reynolds, 9ZAF, Denver, Colo.; W. A. C. Hemrich, 7SC, 503 Melrose Ave., Seattle, Wash.; and Gunner Marshall, 6ZY, Hawaii.

But behind this there proved to be a bigger committee, made up of real enthusiastic amateurs from all sections of the country, clubs and organizations, who did more than their share, in the brief time allowed them after the initial announcement, to get the word of the tests home to amateurs in their sections, and to help in many other ways.

Some of the amateurs are going to try to get across on five watts, some on ten, some on 500 watts, and some on sparks. Many have already made real records in the transmitting field. Here are excerpts from a few of the letters Radio Journal has received:

Best wishes for the entire success

of the trans-Pacific tests. Lawrence Snell, 6APV.

I have 10 watts here, radiation 4.5 amperes with 1500 volts rectified A. C. on plates, aerial 60 and 40 feet high and 65 feet long and fan counterpoise. Have been heard in Hawaii, Mexico City, and Pennsylvania. Geo. Rufener, 6BEQ, Route 1, Box 76-A, Puente, Cal.

Since I blew out my 50 watt tube March 24, I hooked up a 5 watt tube and through a new device of my own, I was able to put on 1500 volts (synchronous rectifier), 150 milliamperes, and radiate 3.5 Thermo Couple amperes on 215 meters. Have had this in operation since March 28 and have succeeded in actually working 1200 miles, and reported by Northampton, Mass., as very qsa on the 5 watter, but this has not been fully verified as yet. Lyndon F. Seefred, 343 S. Fremont Ave., Los Angeles, Calif. Radio 6EB.

HIRAM PERCY MAXIM, PRESIDENT
CHAS. H. STEWART, VICE-PRESIDENT

F. H. SCHNELL, TRAFFIC MANAGER

A. A. HEBERT, TREASURER
K. B. WARNER, SECRETARY

THE AMERICAN RADIO RELAY LEAGUE



EXECUTIVE HEADQUARTERS
HARTFORD, CONNECTICUT

OFFICIAL ORGAN: Q & T
KENNETH B. WARNER, EDITOR
STANLEY M. MATHES
NORTHWESTERN DIRECTOR
511 BURWELL AVE.
BREMERTON, WASH.

12 April 1923.

Radio Journal

113 Stimson Building,
Los Angeles, Cal.

Gentlemen:

Today, amateurs throughout the Northwest are receiving your bulletins relative to the Australian Trans-Pacific Tests, that are to be shortly held under your sponsorship

I wish at this time to convey to you my personal gratitude and great appreciation for the interest that you are giving to Amateur Radio, and feel sure that any efforts expended by you in benefit of the amateurs, will be reflected by them in augmented endeavor, greater perfection and increased value to the Nation.

Hoping that the tests will be attended with the greatest possible success and that the results will exceed those anticipated I remain,

Very sincerely yours,

Stanley M. Mathes
Stanley M. Mathes.

Northwestern Director, A.R.R.L.

My power is fifty watts with synchronous rectifier, using about thirteen hundred volts on the plate with normal milliamperes at 170 and normal radiation at four and one-half thermo couple amperes, using nine-wire counterpoise, etc. Howard C. Seefred, Los Angeles, Calif.; 6EA.

My station has been copied as far as 4,000 miles distance away, including Boston, Mass., and New York several times. Have also been copied in 25 other eastern states. Harold Smith, 3415 Glen Albyn Drive, Los Angeles, Calif.; 6MH.

My power is 100 watts straight D. C. from 1,000 volt M. G. Rad. 8.7 T. C. on C. W. on 1 C. W. 7 T. C. amperes. Our signals were reported nine times in Hawaii during the past ten month. Our DX is as follows: 46 states, all districts; 5 districts, Canada; Hawaii, Porto Rico, Alaska,

Panama, Mexico and 2550 miles east of New York City. We receive the most and best reports from the Pacific coast. Robt. W. Thielke, 9BZI, Ackley, Iowa.

I hope for favorable returns from the test as I have been heard in three-quarters of the states in the Union, Canada, Alaska, Mexico, Hawaii, etc. Under separate cover I am making formal application for my small transmitter, 6CCJ, which has a working range in excess of 2000 miles.

This is my small transmitter but it has been heard in several countries and at many points outside of a circle drawn around Los Angeles with a radius of 2000 miles. I am especially anxious to have this transmitter entered as it would be a much greater honor to get "across" on ten watts than fifty. This is certainly an excellent idea and may success accompany the TP. Tests! Charles F.

Felstead, 6CU and 6CCJ, 2010 6th Ave., Los Angeles, Calif.

I have before me a page from the Radio Journal for April describing the proposed Trans-Pacific tests to take place during May, and I wish to say that it has the approval of the radio gang in this section of the country. I believe that I can get across, having come within 1500 miles of there. I have worked seven districts in one night and have been heard in forty-four states, etc. Royal V. Howard, 7LR, N. W. Division Publicity, Mgr. ARRI. 1546 Oak St., Eugene, Ore.

Now here is a last minute chance for every amateur who has failed so far to enter the tests. Fire in your entry, you will be placed in the free for all period—a code word will be assigned you—and you can tickle the Australian ether all you please. So fire it in today. Address Australian Trans-Pacific Tests Committee, care of Radio Journal, 113 Stimson Bldg., Los Angeles, Calif.

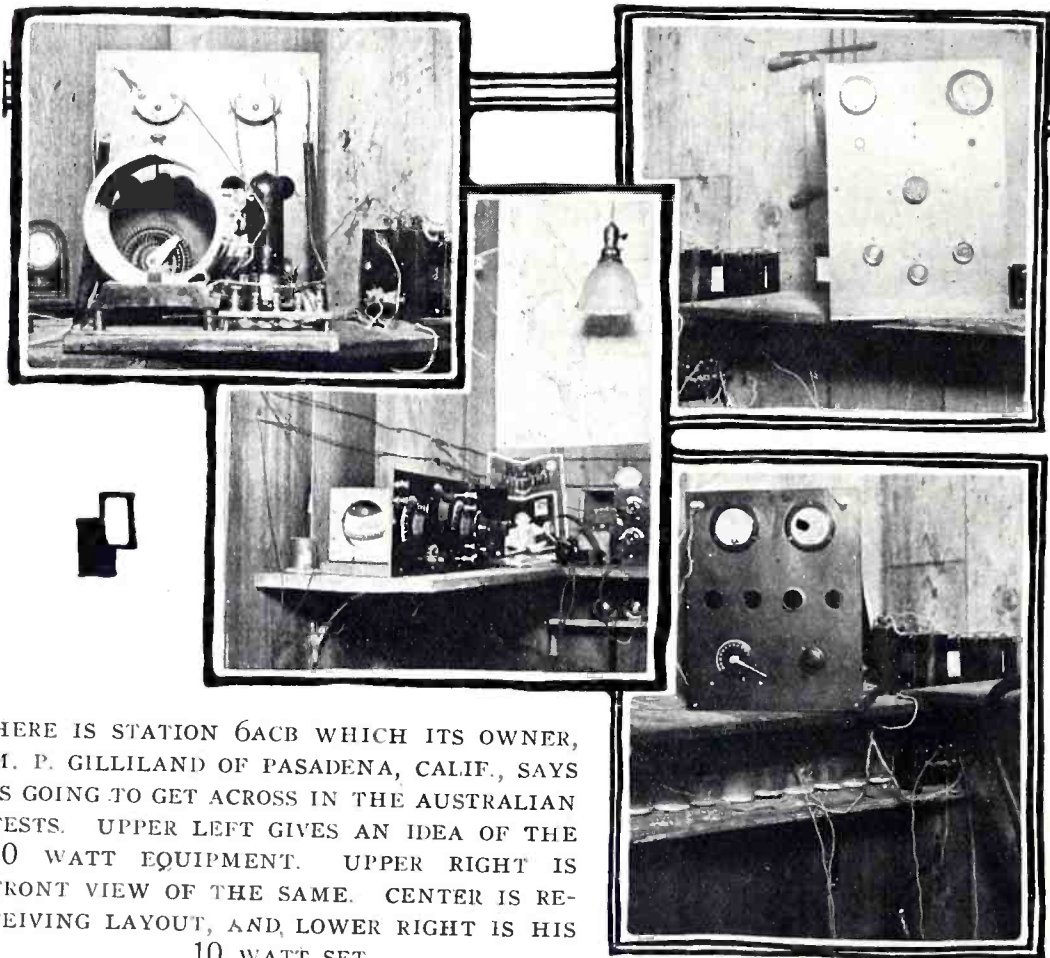

HERE IS STATION 6ACB WHICH ITS OWNER, M. P. GILLILAND OF PASADENA, CALIF., SAYS IS GOING TO GET ACROSS IN THE AUSTRALIAN TESTS. UPPER LEFT GIVES AN IDEA OF THE 50 WATT EQUIPMENT. UPPER RIGHT IS FRONT VIEW OF THE SAME. CENTER IS RECEIVING LAYOUT, AND LOWER RIGHT IS HIS 10 WATT SET.

The photos herewith illustrate the apparatus for transmission and reception at 6ACB owned and operated by M. P. Gilliland of Pasadena, Calif. There are two transmitters and two receivers. A fair amount of dx work has been accomplished with both. The fifty watt transmitter, which is in constant use, has been heard as far east as Chicago already. The smaller ten watt transmitter has broken records while using but half power, five watts. It has been heard in Canandaigua, N. Y., with an audibility such that signals were copied all over the place on two steps of audio amplification

and a magnavox. It has also been reported heard in East Orange, N. J., many times, very QSA.

The receivers at 6ACB are as follows: Standard regenerative with variometers and one step audio frequency and an auxiliary unit of tuned radio frequency, Grebe style and Reinartz circuit with no amplification of any kind. Both of these sets have succeeded in bringing in East Coast dx QSA.

The antenna is supported from a sixty-six foot tower and a forty foot mast. It is an inverted L four wire with six wire counterpoise.

DX worked 1500 hours of operation, 2:30 to 5:00 a. m., every morning. Q. R. M. here fierce from smelter generally and sometimes impossible to do any work. George C. Miller, 3615 East F St., Tacoma, Wash.; call 7WX.

I am certain that this test will be a great success and greater than the Trans-Atlantic, as the distance is very much greater. Thanking you for your kindness to me, I am, with best regards, Lester Picker, Radio 6ZH, San Ysidro, Calif.

And then there is D. B. McGowan (we always suspect that his leeward hook may be Dennis), assistant inspector for the Sixth district, who will hit it up with 6ZE; and Horace Greer of Oakland, 6TI, who has DX'd Japan a couple of times, Alaska five times, Mexico, Panama, and off the coast of Australia, as well as 1350 miles east by northeast of New York; and then there are the Whittier high school and the Venice high school, and many others, all in California and—shucks, the list is too darned long to spill here. A. K. Balantyne, representative of the Wireless Institute of Australia, who is on a trip around the little, old world, stepped in to assure the committee that Australia is on its toes and rarin' to go. His only regret is that he will be in Los Angeles and not Australia on the receiving end of the big tests.

While it is not possible to publish anything like all of the entries at this time, here are a few of the first to reach the desk of the committee, just

(Continued on Page 267)

Highly Efficient Amplifying Unit

By T. E. NIKIRK

Ever hear the stars fiddle? Neither have we, but we venture the assertion that if there is any fiddling going on in the milky way Mr. Nikirk will hear it. The famous builder of 6KA here tells our readers how to duplicate his highly efficient amplifying unit.

THIS amplifier has been built and has proven very satisfactory in reproducing both music and telegraph signals, giving splendid satisfaction both as to quality and quantity. The 6-volt C battery is the feature of this amplifier. The purpose of this C battery is to help in quality and also to cut down the plate current at a high voltage, such as 125 volts, and still maintain the same volume. This has proven a big saving in the purchase of B batteries.

The .006 mf by-pass condensers across the jacks also assist in the quality of the received signal. The windings of the transformers are indicated as 1, 2, 3 and 4. The outside end of the primary winding No. 1 of the first amplifying transformer should be hooked to the plate of the conductor output. The outside of the secondary winding No. 2 of the first amplifying transformer should be hooked to the grid. The second transformer outside windings are hooked to their proper places, as in the diagrams.

When this idea of outside turns is maintained throughout the amplifier, squeals, howls and other miscellaneous noises, which are due to improper hookup of transformers, are eliminated.

It is suggested that the ratio of the first amplifying transformer be 6 or 8 to 1, although others work very satisfactorily. The second transformer should have a ratio of from three or four to one. When this amplifier is hooked to the receiver as described in the April issue, the same A battery can be used, with care taken to maintain proper polarity. The additional high voltage battery can be attached in series with the detector B battery. The plate supply for the detector can still be tapped at the same voltage, or raised if desired. The maximum voltage, or the best voltage obtainable up to 125 volts, can all be applied to the amplifier tubes.

Additional tie-in between the A and B batteries is not required in the amplifier, as this is already cared for in the detector circuit. This applies to other detecting sets as well as the one described in the April issue.

We suggest this jack to simplify construction. The filament lighting

jacks are satisfactory when hooked up properly, but many have met with disaster due to improper connections in hooking up the combination jack with consequent danger or damage to filaments. It is further suggested that a master switch be placed in the storage battery lead to disconnect all filaments at once, not making it necessary to run all rheostats around to zero. This saves considerable trouble in starting the set up again. A push-pull switch is very satisfactory.

We do not try to specify how the set builder should construct his panel, as the panel construction has little or nothing to do with the operation of the set. We would suggest taking a piece of wood the desired size, laying it off to meet the parts to be mounted, —then if the first arrangement does not prove satisfactory, ditch it and try another.

No. 16 soft drawn copper wire may be pulled over the handle of a vise and sufficiently hardened to maintain its position in the set. Use rubber tubing, spaghetti, garden hose, fire hose or anything else you feel like, for insulation.

Extra care should be taken in the soldering on the jacks. Rosin core solder, or regular half and half solder with the aid of a little rosin, should be used. The acids in soldering pastes are usually undesirable, and sometimes cause considerable trouble. The 201 A tubes have proven very satisfactory on my own set, with an amplifying constant of 8, which is slightly higher than that of the ordinary 201 tube, the constant of which is $6\frac{1}{2}$.

Radio Publicity

Government officials are becoming more and more convinced of the value of radio as a means of publicity. This was noticeably true of the income tax drive. Collector Goodcell of the Los Angeles district addressed taxpayers in every state in the union through KHJ, the Los Angeles Times station, and the President and other Washington officials listened in to verify the results of this test. Mr. Goodcell broadcast tax information every Wednesday from this station during the drive and replies, suggestions and requests for further information were received from all the states and Hawaii.

An address on education, written by John J. Tigert, U. S. Commissioner of Education, for Radio Journal, was broadcast in March from NAA and other addresses on governmental topics are to follow.

William J. Wintringham, 56 Boylston street, Cambridge, Mass., hears KHJ, the *Los Angeles Times* radio broadcast, via a loop aerial placed behind picture moulding. He is on the third floor of an apartment building and employs a home-built receiving set.

Here's something to fool with on higher wave lengths. The Arlington Naval radio station, NAA, is broadcasting weather forecasts and warnings each day, Sundays included, at 10:05 a. m. and 10:05 p. m., on a wave length of 710 meters.

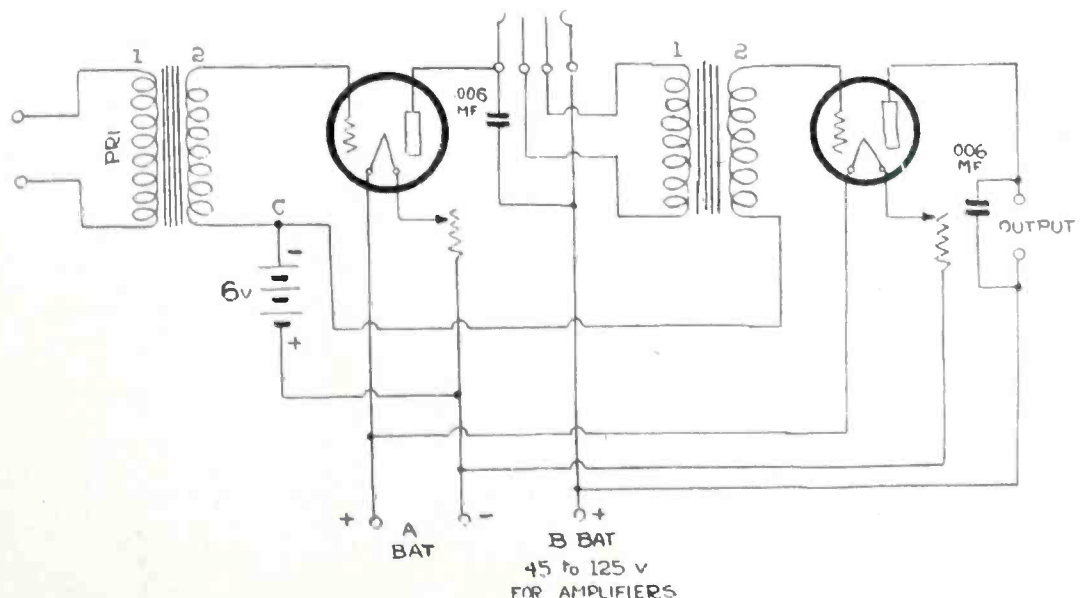

Definitions and Fundamental Conceptions

By PROF. H. La V. TWINING

Here is some material to ponder over. In his years of experimental work Mr. Twining has checked up the findings of mathematical scientists by means of laboratory experiment—which has resulted in some startling conclusions. This article, with those which preceded and to follow, gives the student of radio some real information on the nature of electric phenomena, mass, gravitation, etc., which are essential to the fullest understanding of the great art. Likewise this series of articles is challenging the attention of the scientific world.

AS has been pointed out before, the mathematical investigator attaches great importance to his mathematical conclusions, in fact he is apt to regard them as infallible. The physicist knows very well that certain phenomena can occur in a variety of ways either one of which may be true.

The mathematical analysis along any one of the ways, leads to the same result, i.e. it accounts for the physical facts. The question then arises, which is the true way and which is the false way?

This latter question can be answered by experiment only. As a simple case in hand, take a voltaic cell, with zinc and copper for the poles and copper sulphate and water as an electrolyte.

The electrical pressure is produced by the tendency known as solution tension. Zinc and copper atoms break loose from the plates and fly off into the electrolyte. Why they do this is not known, but one might surmise that water is a better conductor of electrostatic lines of force than the ether between the two atoms that compose the molecule, so that the electro-static lines of force which are concerned in binding the atoms together let loose and spread out in the water. At any rate the zinc atom jumps off into the electrolyte carrying two positive charges with it, since the zinc is divalent. Fig. 1 represents three atoms

that have left the zinc plate, each one carrying two positive charges, leaving six negative charges on the plate. Since the chemical action takes place at the zinc plate, the solution tension from the zinc to the liquid is greater than from the copper to the liquid. Hence the resultant movement of the positive charges in the liquid is from the zinc to the copper. The zinc plate is thus positively charged underneath the liquid and negatively charged outside of the liquid by the negative charges. The copper ions are thus crowded back onto the copper plate, and the positive charges flow from A to B inside of the cell again neutralizing the negative charges left originally on the copper plate when the six copper atoms left the copper plate.

The negative electro-static lines at D reach over and drive negative charges from the upper part of the copper plate at E, leaving it positively charged down to the part of the copper plate that is beneath the liquid. The copper plate is thus charged negatively beneath the liquid and positively above it.

This can be proved by the use of a voltmeter. If the positive terminal be put at E and the negative at D, it will deflect in the right direction. Now if the terminal wires coming from the voltmeter consist of rubber-covered wire with only the tips exposed, the positive terminal must be put on the

zinc plate under the liquid and the negative terminal on the copper plate under the liquid in order to get it to deflect in the proper direction, thus validating the above statements.

Now if a copper conductor connects D with E a negative current flows from D to E, since the positive charges cannot flow through solid conductors. At the same time zinc ions flow from A to B within the cell and negative SO_4 ions flow from B to A. The positive and negative ions flow in opposite directions inside of the cell, and only the negative charges flow through the copper conductor from D to E in the outside circuit. These results are known to be true by experiment. The rate of flow is the same both outside and inside the cell. Ohm's Law is true in any case, i.e. the mathematical expression for these relationships is the same in all cases. If the flow consists of negative charges from negative to positive, or of positive charges from positive to negative or of the opposite flow of both charges, then

$$E_t = I (R_b + R_e)$$

Where E_t is the total pressure in volts that the cell is capable of giving, or in other words it is the terminal voltage of the cell through the voltmeter itself. I is the current through the voltmeter and cell, R_b is the internal resistance of the cell in ohms, and R_e is the resistance of the voltmeter. This law would hold just the same whether the flow consisted throughout of negative charges in one direction in the circuit, or whether it consisted of the flow of positive charges in the opposite direction, or whether it consisted of the flow of both charges simultaneously in opposite directions. Thus the mathematical expression or investigation of a series of phenomena does not necessarily reveal all that is going on. Hence if we rely upon the mathematical deductions alone, we are liable to be led to false conclusions.

Until recently it was assumed that the current through the copper conductor flows from the positive pole to the negative pole, and this conclusion was thoroughly believed by all until it was upset by experiment.

The electrical potential between the

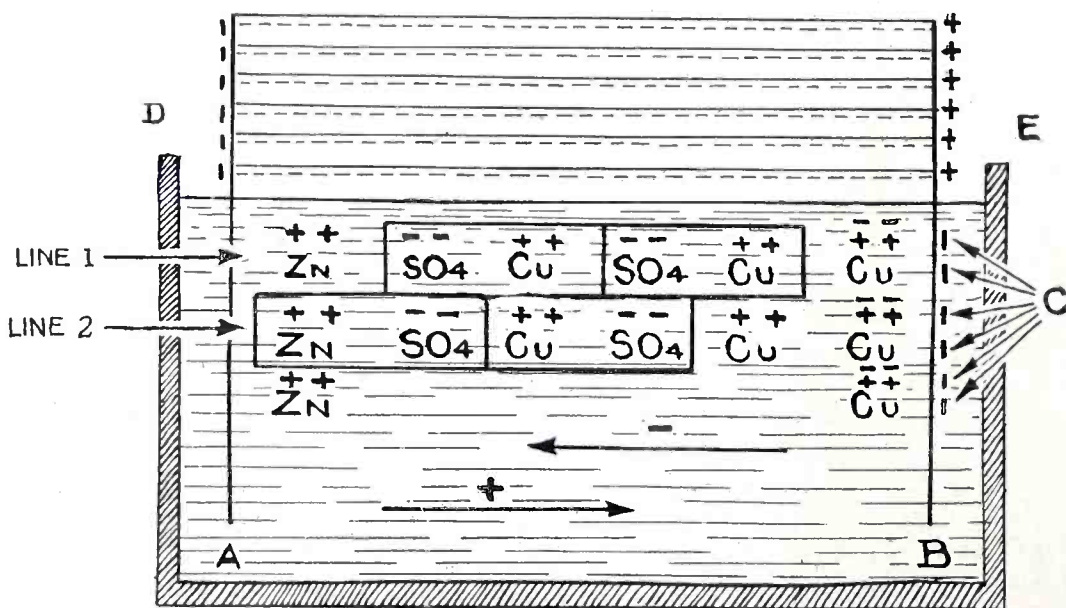

FIG. No. 1

zinc and copper plates is double, consisting of a positive drop from the copper to the zinc, and of a negative drop from the zinc to the copper, and the difference of potential between the two terminals consists of their difference, thus,

$$E_p - (-E_n) = E$$

or $E_p + E_n = E$

where E_p is the positive drop, E_n is the negative drop and E is the resulting voltage of the cell.

If two voltaic cells A and B are connected by a glass tube filled with the electrolyte as shown in Fig. 2, a

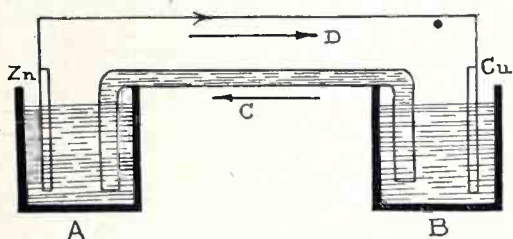

FIGURE No. 2

compass needle, when placed at C under the tube in which the charges are flowing in opposite directions, will deflect to the same amount and in the same direction as it does when placed under the copper conductor at D in which only negative charges are flowing from the zinc to the copper. The two experiments herein mentioned have been performed by me personally so that I know that they are experimental facts.

Thus all conclusions based on mathematical relationships must all be tested by experiment before they can be safely presumed to be true.

Thus Einstein in his assumption of gravitational fields based upon mathematical considerations of relativity is probably entirely wrong in his physical conclusions. We have no physical evidence of the existence of gravitational fields at all, and the whole action of gravitation can be accounted for upon entirely different grounds.

His mathematics is all right but his physical conclusions may not be right and in all probability they are not right, as has been pointed out in previous articles.

The pressure theory of gravitation advanced many years ago was shot all to pieces by the mathematicians, but it does not follow that the mathematicians were right. It would be interesting to re-examine this theory in the light of recent advances in our knowledge, and it might be found that the objections of the mathematicians to the Le Sage theory of gravitation are really not valid. In Fig. 1, line 1, the relations are shown before chemical action takes place. In line 2 when the electric circuit is completed, the zinc has seized the SO_4 ion, releasing a copper ion, which in turn seizes the adjoining SO_4 ion, thus chaining

across until finally the released copper ion deposits on the copper plate, after having been neutralized by a negative charge coming from D. Thus the levulons from the cell come out of the zinc and go into the copper plate where they stay. The current inside of the cell consists of the opposite flow of charges that never get into the external circuit at all, and although the rate of flow in all parts of the circuit is the same, the charges of electricity in the external and internal circuits, which constitute the rate of flow are different in each case.

Ideas both mathematical and physical must be submitted to the test of experiment and examination on the part of others besides the originators, before the errors can be eliminated which always enter more or less into the thinking of even the ablest men and experimentors that the world has produced. This elimination is very often a long and laborious process, and no one should hesitate to put forth ideas that seem to possess merit. Whatever is right will survive and whatever is wrong will sink into oblivion where it properly belongs.

An understanding of the construction of the atom is important if one is to understand radio phenomena that is rapidly coming to the front and that is being forecasted by the experiments being conducted in the research laboratories of the world. The Bohr atom is the one that now holds the attention of those interested in this line.

Rutherford suggested this and Bohr developed the mathematical relationships connecting it to the radiation of light. The mathematical explanation is not perfect but it fits the fact in a remarkable manner and a short review of it may be very helpful.

The Bohr conception consists of a central positive charge in the hydrogen atom having a mass 1845 times the mass of an outward negative charge, which moves around it with a speed sufficient to produce the frequencies exhibited in the spectra of glowing hydrogen gases. The examination of this subject by Bohr is extremely mathematical. Many different investigators have contributed to the development of the subject, both mathematically and experimentally and one cannot go into the historical side of it here.

The following are some of the questions which have been answered or which must be answered in the future:

Are there any gravitational effects inside of the atom, and what are the values and the law? What are the electro-static effects inside the atom, and what is the law? Are there any electro-magnetic effects and what is the law? What are the energy rela-

tions that exist between the positive and negative charges in radiation of light and how is this radiation effected? What are the constants connected with this radiation, etc.?

The following demonstration as to the mass and the charge, and the radius of the hydrogen atom is due to J. J. Thompson. At present the mathematical line of investigation will only be indicated, later a fuller demonstration may be given, if desirable.

Suppose in Fig. 3 an electric charge to move along the line AOX with a velocity V . Denote the electric charge by E , and the distance AB by R , then the strength of the magnetic field produced at B by the electro-static line AB is equal to

$$H = \frac{EV \sin M}{R^2} \quad (1)$$

where H is the strength of the field in lines or dynes. This formula is based upon the well-known law of inverse squares as to distance, and the product of the two causes, E and $V \sin M$ in the production of an effect H . The moving charge is surrounded by an electric field H which tangles with the ether rolling up a magnetic field BSK in a plane at right angles to the line of motion AOK. Therefore this H is the magnetic force at B. The total energy expended by the moving charge per unit volume at B is

$$W_1 = \frac{H^2}{8\pi} \text{ ergs} \quad (2)$$

where W is the work. This formula will be demonstrated later. Square H in formula (1) and substitute it in (2) then

$$W_1 = \frac{E^2 V^2 \sin^2 M}{8\pi R^4} \text{ ergs} \quad (3)$$

This is the energy per unit volume at B. To get the total energy expended in rolling up the total magnetic field by the total electro-static field it is necessary to integrate this formula for all space surrounding the charge. The following formula is the result of such integration.

$$W_1 = \frac{E^2 V^2}{3a} \quad (4)$$

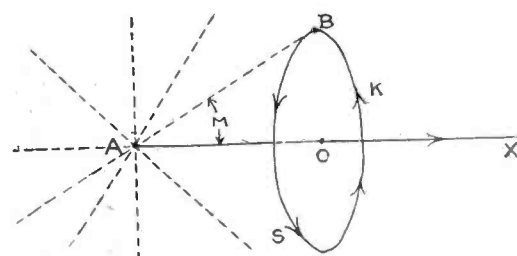

FIGURE No. 3

where "a" is the radius of the moving charge. Assuming this charge to have a mechanical mass M with which the charge is associated, it requires the

following amount of energy to give it the velocity V,

$$W_2 = \frac{MV^2}{2} \text{ ergs} \quad (5)$$

Adding (4) and (5) to get the total energy involved, we have

$$Wt = \frac{MV^2}{2} + \frac{E^2V^2}{3a}$$

$$\text{or } Wt = \frac{V^2}{2} \left(\frac{M}{1} + \frac{2E^2}{3a} \right) \quad (6)$$

In formula (6) M is the mechanical mass in the general acceptance of the term. The second member of the bracket is the electrical mass, or the electrical equivalent of mass.

The full demonstration of these formulas will be given later if it is desirable. Now the question arises, what is the relation between the mechanical mass and the so-called electrical mass. The electrical mass is entirely due to the velocity V and to the radius "a" of the charge.

Kaufmann performed experiments upon alpha particles given off by radium, determining the ratio of the mass to the charge, i.e. he measured the total mass ratio to the charge at high speeds, the total mass including both the electrical and mechanical masses. He found that the mass increases with speed, as indicated by the two citations below.

Velocity of the charge,	2.36 (10) ¹⁰
Ratio 1.5	Calculated ratio 1.65
Velocity of charge	2.85(10)
Ratio 3.1	Calculated ratio 3.09

Thus the measured ratios of mass to charge agree very closely with the calculated ratios of mass to charge, assuming that the mass is all electrical. The formulas for the calculation of the mass of the charge are rather complicated and are omitted here. The indications are then that the mass is all electrical, and that this mass is due then to the velocity of the charge and also to its distribution in space.

This shows that the electrical and mechanical mass are one and the same thing. Since the mass of the electron is 9 (10)⁻²⁸ grms and the positive charge is 1.66 (10)⁻²⁴ grams.

We have

$$\frac{2E^2}{3a} = 9 (10)^{-28}$$

3a

and

$$\frac{2E^2}{3b} = 1.66(10)^{-24}$$

3b

the positive and negative charges having the same value, "a" being the radius of the negative charge and "b" being the radius of the positive charge. The value of E in electro-static units is 4.774 (10)⁻¹⁰; this must be reduced

to electro-magnetic units since we are dealing with electro-magnetic relationships. The ratio between the two systems is 3 (10)¹⁰ the velocity of light so that

$$\frac{4.774(10)^{-10}}{3(10)^{10}} = 1.59(10)^{-20} \text{ magnetic unit charge.}$$

Substituting the value of E in the above formulas we have for (a) and (b)

$$a = \frac{2(1.59)^2(10)^{-40}}{3(9)(10)^{-28}} = 2(10)^{-13}$$

centimeters and

$$b = \frac{2(1.59)^2(10)^{-40}}{1.66(3)(10)^{-24}} = (10)^{-16}$$

centimeters.

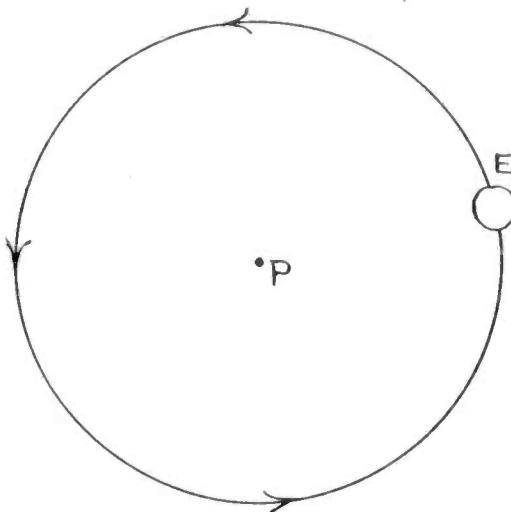

FIGURE No. 4

The radius of the hydrogen atom is 10⁻⁸ centimeters. The radius of the atom is thus seen to be two hundred thousand times the radius of the negative charge, and a hundred million times the radius of the central positive charge.

Relatively the space between the central positive charge, Fig. 4, P is immense compared with the radius of the atom. The distance between the sun and the earth relative to the diameter of the sun is about one hundred. The levulon E circulates around the central dextron P, Fig. 4 at a relatively enormous distance, and hence we are justified in assuming that the inverse law of the square of the distance holds inside of the atom. The gravitational attraction between the two charges is as follows: If spherical masses of metal, each having a mass of one gram be suspended by long threads, the centers of the spheres being one centimeter apart, the gravitational attraction between them is found experimentally to be 6.6(10)⁻⁸ dynes. This is known as the gravitational constant. Now the force of gravitation is directly proportional to the product of the masses concerned and inversely proportional to the square of the distance between them, so that in the case of the hydrogen

atom the force of gravitation inside of the hydrogen atom is,

$$F_g = \frac{(9)(10)^{-28}(1.66)(10)^{-24}(6.6)(10)^{-8}}{10^{16}} = 1.63[10]^{-41}$$

This force is very minute and it is almost infinitely too weak to hold the electron in its orbit. The electrostatic force is as follows:

$$F_e = \frac{[Ed][El]}{R} = \frac{[4.774]^2 [10]^{20}}{10^{16}} = 22.79[10]^4 \text{ dynes}$$

The value of this electrostatic attraction is expressed in dynes instead of unit poles. It must be divided by 4π to express it in unit poles. The electrostatic attraction is thus about (10)³⁸ times greater than the gravitational attraction. It is to be observed that the value of the charge constituting the dextron and the levulon is the same in both cases, but the mass of the dextron is 1845 times the mass of the levulon, because the radius of the dextron is 1/1845 of the radius of the levulon. This mass does not mean quantity of matter but it depends upon the distribution of the material composing it, and the speed with which it may be moving.

In the next paper the electromagnetic forces will be calculated and some application of this to inertia will be worked out.

Summary

1. Mathematical findings are not necessarily true, and they must be tested by experiment.
2. Mathematics is a powerful instrumentality for analyzing physical phenomena.
3. Mass is a function of speed and distribution of the composing material.
4. We know nothing about matter and energy intrinsically.
5. But we know that all atomic matter whatsoever is composed of positive and negative charges of electricity, and nothing else.
6. Gravitation is not the controlling force inside the atom.
7. The electrostatic force is comparatively very large.

The Arbitration Society of America has been founded through the foresight of a former New York judge, Moses H. Grossman, which is expected to do much toward the settlement of the disputes which inevitably will arise in the course of progress in radio. There is a New York State Arbitration Law which provides that parties involved in an actionable difference may have their differences legally settled by arbitration. Deans of law schools, bankers, business and professional men are on the present Board of Governors,

Just a Few Words About Broadcasting

By J. P. DANKO, Radio Engineer

Now that Congress has shot its last wad of beeswax without potting any radio legislation, Mr. Hoover must continue to do business at the same old stand and with the rusty old equipment of 1912. There's waves enough to go round but he can't dispense them. Ideas on what should be done are as numerous as fleas on an elephant. Mr. Danko, a well-known radio engineer, presents a hatful for your earnest and careful inspection.

RETROSPECTION, to the true disciple of progress, is usually of less interest than prospect; yet the two are so correlative that, invariably, one must draw on the past to properly diagnose the present and the veiled future. The following suggests itself from considerable experience with similar conditions of congested "Radio Traffic Channels."

The matter of greatest import to the radio public, at the present time, is the most efficient distribution of broadcasting stations, their operation and assignment of wave lengths, schedules, etc. The plan herein advocated, may lend itself to a solution of the problem of "jamming" the air with overlapping noises, squeals and whistles that the average listener grinds out of the average apparatus while tuning about for other than local stations.

Federal Control

First in importance is the matter of wavelengths. All broadcasting of the better kind, as indulged in by class B stations, should be inaugurated and controlled by the government so that unification of purpose and action may be obtained. This new art contains too many valuable educational possibilities to be thrown aside after the novelty wears off, or used indiscriminately by those private enterprises which, at best, can devote only temporary interest to it, because of the great cost of installation and upkeep of the desirable type of station. Some public spirited combines such as the General Electric, Western Electric, and Westinghouse companies, also the large newspaper institutions of the big cities, have done and are still doing exceptionally well; but how long can they keep up such expensive advertising?

The correct solution, then, is in federal and civic co-operation of a chain of broadcasting stations throughout the United States, distributed geographically, and linked into a sort of Loew's or Keith's circuit of radio entertainment.

It is proposed that all cities of 200,000 population, and situated at least 500 miles apart, be equipped by civic and federal allotments with broad-

casting stations of at least five K.W. output. Surely, no city of this size is so poverty stricken as to be unable to support a medium capable of such unlimited educational and progressive possibilities. Such an arrangement would give us, for instance, Portland, Oregon; Spokane, Wash.; San Francisco, Los Angeles, Cal.; Salt Lake City, Utah; El Paso, Dallas, Tex.; Denver, Colo.; Billings, Mont.; Kansas City, Kans.; Minneapolis, Minn.; Chicago, Ill.; St. Louis, Mo.; Cincinnati, Ohio; Atlanta, Ga.; Key West, Fla.; New Orleans, La.; Pittsburgh, Pa.; Washington, D. C.; Newark, N. J.; Raleigh, N. C.; Buffalo, N. Y.; Boston, Mass.

Of course, the actual allocation would depend more on the desirability of the selected town with reference to its geographic position and the number of people to be reached. Such a chain of stations would be allotted individual wavelengths of mutually non-interfering values, and selected from a band set aside for radio broadcasting only, possibly 400 to 1500 meters. The system used in radio telephony is readily adaptable to close bunching of the wavelengths.

The most widely separated stations should have the greatest difference in their respective waves for this reason:—suppose Newark operated on 500 meters, Washington on 600, Chicago on 800, Los Angeles on 1500 meters and so on. It would be possible then, to tune in Los Angeles by a Newark "sectionist" without interference from local or nearby stations on account of the wide divergence of the transmitted waves and the critical selectivity or sharpness due to distance. On the other hand, if Newark operated on 500 meters and Los Angeles on 600, the Newark "sectionist" would experience some difficulty in excluding the strong local signals while tuning for the distant ones, for he would have to contend with a kind of "explosive zone" interference when Newark would come in over a relatively wide range of tuning, covering the much weaker distant signals. Only the more advanced type of receiving sets are capable of the necessary selective adjustments. However, should he desire to listen to Washington, only 300 miles

away, even though on 600 meters, the Washington signal would be considerably stronger than the Los Angeles signal, and could be tuned in clear of the local broadcasting by the application of precise adjustments with rather loose coupling. A national broadcasting program for each station could be published daily in all newspapers so that the listening public may choose the subject most interesting to each individual.

Experience with conditions throughout the United States suggests that stations experiencing much atmospheric disturbance be allotted the longest wavelengths of the band, while those with least trouble from this source be assigned the shortest waves for this reason:—Stray interference or static, as it is commonly called, seems most pronounced as the wavelength increases. However, if the local station is on the long end of the band, it can be tuned in easily over the static even though necessary to use the loop antenna, on account of its relatively strong power; while should one desire to listen to some distant station operating on the lower values, any diminution of stray disturbances will greatly assist in the reception of the weaker sounds. Thus, by a judicious distribution of wavelengths, broadcasting can be utilized to the greatest benefit of the majority.

Localize Service

Each section may have several local private or civic stations limited to 50 or possibly 100 watts in the more isolated districts, for the purpose of furnishing dance music or entertainment for strictly local use. All such stations, due to their limited interfering range, may be operated on the same wave, 360 meters for example, and in extreme cases, when several such stations compete in the same district, schedules as exist at present can be prescribed.

One may say that such a plan disregards the present radio telegraphic communication systems by encroaching on their allotted group of wavelengths. Not at all. Practical radio transmitting waves range from, let us assume, 100 meters to 50,000 meters, and if necessary, even this range can

be extended! From such a choice, practical groups or bands are available for all purposes, viz., the air service where short transmitting antennae are necessary, the amateur, broadcasting, ship communication, commercial, governmental and experimental, merely by applying the sectional plan to the world at large.

To make broadcasting of the utmost value through its educational and entertainment possibilities, it must be done in such a manner that it will reach the greatest possible number of listeners. To receive a weak signal, requires apparatus of great sensitiveness and, to be sure, of rather expensive upkeep and design beyond the purse of those to whom it would bring the most benefit. Consequently, would it not be more efficient and economical to install several high powered transmitters than to make it necessary to operate a million or more of costly, individual, multiple tube receiving sets?

One of the most exasperating conditions prevalent in practically all the large cities, is the "cut throat" competition indulged in by intelligent concerns. Would it not be of greater moment to all concerned if there were only one real, concentrated broadcasting station to the operation of which, the various concerns interested would contribute. Through co-operative, progressively allotted schedules, each would receive due benefit and credit beside giving the public the very best in programs.

Civic Enterprise

However, it is most gratifying to note that recently, several of the former small broadcasters have combined under one leadership in the erection of a "Central Station." This step is to be commended, but how long can such an unprofitable enterprise be kept up by private interests. Surely, a small sum could be appropriated out of the public funds for the maintenance of a Municipal Central Station instead of depending on private capital. How many of us would not gladly dig down into our pockets for an extra cent of taxation if we could be assured of interesting and enjoyable daily programs?

And now a word or two regarding "tuning" and adjustments. Of course, the desirable receiving set is one with minimum controls and maximum selectivity. Such a combination can be closely approximated in the loose coupled, three circuit regenerative tuner with a calibrated secondary circuit. Perhaps many of you have noticed that each signal can be obtained from an almost infinite number of settings or adjustments of the condenser, coil turns, and coupling between the various coils, but of all these, there is

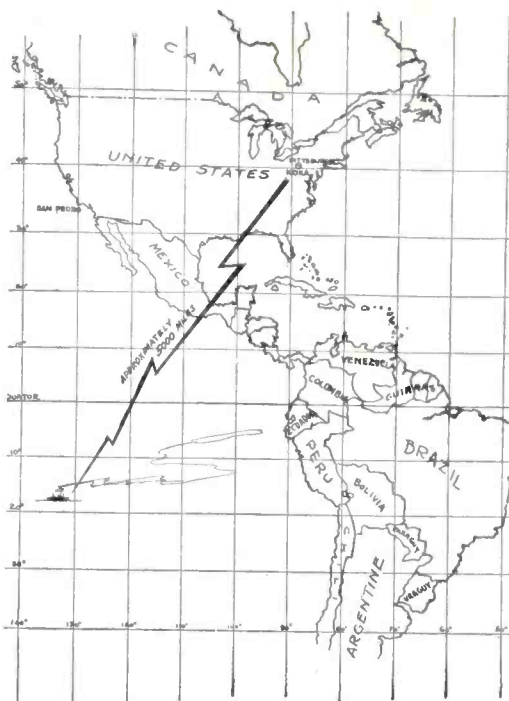

MAP SHOWS THE DISTANCE RADIO WAVES TRAVELLED IN CARRYING KDKA'S CONCERT TO SHIP OFF THE COAST OF PERU.

only one adjustment or correlation of the units which gives maximum response. This, necessarily, is the resonant adjustment, in other words, when the condenser, coupling, and inductance values of the receiving set are identical with those of the transmitting set at the broadcasting station. Consequently, if all calibrations were recorded in terms of capacity, inductance and coupling instead of in wavelength values, and the transmitting station would announce its adjustments, this would greatly assist the average layman in the setting of his receiver to the point of maximum signal, especially in long distance reception. This would be an ideal condition and is hardly expected to develop into general practice unless some very simple, inexpensive and practical methods of calibrating are discovered.

But first, by all means, let us have co-operation and programs WORTH LISTENING TO!

5000 Mile Broadcast

Broadcasting a concert 5,000 miles is the record of KDKA, the radiophone broadcasting station on the Westinghouse Electric & Manufacturing Company building, located at East Pittsburgh, Pa., the pioneer broadcasting station of the country.

This latest achievement of KDKA, which first started operating November 2, 1920, was brought to the attention of the Westinghouse broadcasting officials upon the receipt of a postal card from E. G. Osterhoudt, radio operator of the SS. "J. A. Moffett," in which he tells of hearing KDKA while off the coast of Peru, a distance of approximately 5,000 miles.

The card, which was mailed in San Pedro, California, contained the following message:

"KDKA: At 9:30 p. m. (local time), on October 5, while off the Peruvian coast, 3,453 miles south of San Pedro, California, I heard your phone on 360 meters, playing "Stumbling." The RN was quite heavy, but I am positive that it was your phone. I am using a honeycomb set with an audion detector (Audiotron). Please verify, if possible, and oblige, very truly yours, E. G. Osterhoudt, Opr., SS 'J. A. Moffett,' care Radio Corp. of America, 109 Stuart St., San Francisco, Calif."

KHJ Also Sets Record

When Herbert Hoover, Secretary of Commerce and arbiter of radio telegraphy and telephony in the United States, spoke at KHJ, The Los Angeles Times radiophone, November 26, 1922, the entire speech was picked up aboard the S. S. Carpalaka, a freight vessel, 425 miles east-northeast of New York City, or a distance of approximately 3500 miles airline from Los Angeles. This was the best record held by KHJ until recently. Now comes the word that KHJ was heard New Year's night in British Samoa by American Vice Consul, Quincy F. Roberts, on a single tube receiving set. This is a real record, inasmuch as Apia, where the American Vice Consul is situated, is 4800 miles southeast of Los Angeles, or almost 5000 miles. Vice Consul Roberts writes that he has sent for amplifiers and a loud speaker with which he hopes to entertain residents of Western Samoa with concerts from KHJ, The Times 500-watt Western Electric transmitter. 1923, he writes, will long be remembered by those in the consular service at Apia because of American voices and music being heard there coming across the sea for the first time.

To Log Ether Reefs

The American Radio Relay League is planning to log all atmospheric interference with radio transmission on broadcast wave lengths everywhere in the United States and make up charts from the data thus assembled. The logging will be done by operators appointed by the league, who will listen every evening between 7 and 10:30. The league expects to put the plan into effect soon.

The International Commission for Aerial Navigation requires that radio apparatus be carried on passenger aircraft carrying ten or more persons.

The Science of Invention

By DANIEL NELSON CLARK, L.L. B.

The world is but now entering upon the radio age. Many of us have often wondered and pondered upon what men and affairs must have been when the world was entering upon the stone age, or the iron age. It is our privilege to witness the transition period into another great age, probably the greatest of them all. Mr. Clark, of the United States supreme court and California bars, in approaching this series of articles on invention and patents, does so from the scientific, historical and legal viewpoints.

INVENTION stands, in relation to civilization, as living water, found in the desert, stands for a famished traveler. Mankind is growing up, but how soon the vigor of manhood, in all its inspiring manifestations, will be reached, we know not. Philosophically, all civilization has its appeal to truth, universally derived and manifested, though this appeal has,



at all times, been mixed with prejudices, passions and confusions, civil, military and ecclesiastical. Like the dawn of a sense of responsibility in youth, when it discovers that life is neither easy nor aimless, it then begins to slowly advance in the acquirement of knowledge, science and philosophy, until, at last, that composure of mind, necessary for true development, is attained. Slowly and surely the living waters of invention and discovery wend their way, in the desert of time, through endless wars, cruelties, inquisitions, superstitions and oppressions, until at last we behold the oasis of brotherhood, expressed in the common purposes of mankind, just as surely and effectually, and by no less a reason than, as ultimate truth is manifested in the harmony and interdependence of true science and true religion, both of which are philosophically consecrated in the ascertainment and expression of the Divine scheme displayed in all natural laws regulating the development of, and the movement in, the universe.

Mighty Iconoclast

Before this Iconoclast, the colossal statues of blunder, folly, egotism, ignorance, superstition, intolerance, creed and dogma (all standing in inverse ratio to civilization) fall and the golden cup of reason, conveying the living waters to the famished lips of mankind, is no longer poisoned.

Today, though largely developed within the last fifty years, we have a vast amount of detailed data which, if it can be organized into science and incorporated into our intel-

lectual body, will greatly accelerate the science of invention and, even

Something New

Mr. Clark is a patent attorney of more than twenty years experience in Washington and Los Angeles. His practice requires a wide range of information, with the result that, aside from his legal requirements, he is a scientist as well.

He has recently published a brochure entitled "The Universal Law of Organic Progress," in which is found an expression of a constant for all organic development and which has attracted much scientific interest.

This is the first of a series of articles written by Mr. Clark expressly for the Radio Journal, the general trend of the series being towards historical and philosophical treatment of the Science of Invention and its relation to our present civilization. We know that our readers will find these articles of great interest from many aspects. The exact number of these articles is, at present, uncertain, but the closing articles will relate more specifically to what invention really is and to patentability thereof. All of which will greatly add to the general store of our readers' knowledge, especially in view of the rapid development in the science of Radio.

Particular attention of our readers is called to the distinction made by Mr. Clark in his statement concerning electricity as a material force and its regeneration, by the intervention of the magnet, into the electromagnetic. Such a conception is both new and unusual, and well worthy of careful consideration.

These articles should be followed carefully for their instructive, historical and scientific value and also because of the discursive relation existing between them from the first to the last.

more effectually, display the inexorable union of invention to civilization. Thus, from dim antiquity, emulating the order of evolution, with its slow progress, and, generally speaking, with its slow indefinite and incoherent intellectual processes resulting in the survival of the fittest, we now behold, even from our present state of human development, the rising of civilization above the mist of ages to our present relatively high position, wherefrom, archaeologically, if not ethnologically, we may look down upon the sub-human record fossilized, geologically, and displayed even in the "Neanderthal Man," who was probably incapable of speech and doubtless possessed a low and corresponding intellectual development; then we may observe how mankind grew and grew, through the ages, and by the process of evolution, until we attain our present state; and in this mental environment we may conceive him eventually capable of the full range of diaphason, though he obviously has not as yet reached it, and, moreover, there are too many who even now agree with Xerxes, at Thermopylae, in the tearful expression that "human beings are many but men are few."

Lost Geniuses

Since the dawn of history we may see, here and there, the scintillating influence of some inventive genius. Yet history fails to record the name of, or describe, the genius who invented language, either spoken or written and, likewise, fails to disclose the details of that inarticulate hesitancy, or that intellectual or expedient refinement, with which this aforesaid inventive genius must have blushing chattered to his fair and blushing mate, either in the Valley of the Euphrates, or of the Nile, or in the jungles of Africa. Who invented the wheel, the lever or the screw we know not. Memnon, the Egyptian, whose gigantic orientated statues, situate upon the west bank of the Nile and near the tombs of the lately and highly advertised King Tutenkhamun and near the ruins of ancient Thebes, and whose statues are facing the east and the rising of the sun as if looking for another dawn, claims to have invented

the alphabet. But he was evidently wrong, but not for the same reason the would-be inventor of the philosopher's stone was wrong, since it now transpires that written language, alphabetically constructed and grammatically arranged, was used in other lands for centuries prior to that of Memnon.

Yet it is readily conceivable that the development of language, both spoken and written, finds a necessary complement in, if not it is a concomitant of civilization in general, establishing, as it is predicated upon, the Science of Invention in particular, for each new scientific invention, or discovery, not only increases our range of knowledge, adding new details to art, proving or disproving our postulations of natural and universal laws, as well as affording us a better comprehension of the truths universally and uniformly manifested in the development of, and the movement in, all organisms, but, also, as each new scientific invention or discovery arises, its ramifying effects eventually extend to every other branch of the whole science, as is well illustrated in the invention of transparent glass which resulted in the development of optics and led to the microscope; then the microscope led to our increasing knowledge of chemistry, biology and associated branches of science, while, on the other hand, then came the telescope widening our range of astronomical information, and, finally, came the spectroscope providing us with a means of not only analyzing light, but also a means by which the direction of motion and the velocity of celestial bodies may be ascertained. By means of the spectroscope we have learned the direction and rate of motion of our solar system, through interstellar space, though we still have a few astronomers who believe they can ascertain the distance of Sidereal Systems by means of triangulation derived from parallaxes.

Makers of History

Thus we see, from the invention of transparent glass, how its ramifying influence involved a vast and relative rearrangement of almost every phase of human existence and knowledge and even made the camera and the motion pictures possible, giving enjoyment to the masses and, possibly, affording an inverse amount of scientific and philosophic understanding.

From the time of the development of the school of philosophy by Thales of Meletus, and the establishment of his collegiate institution at Tarsus (from which St. Paul was a graduate), the earliest conceptions of the spherical arrangement of the earth, sun, moon and stars were formulated. Then came Anaxagoras, of Helicarnassus, and a friend of Pericles. This

Anaxagoras developed the theory of the sphericity in, and the atomic, if not the electronic, arrangement of matter in all organic developments, going so far as to indicate that, in his opinion, not only was the sun spherical (though he assumed the geocentric

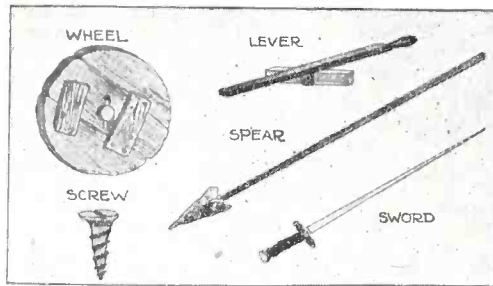

THINK OF THE DUCATS THE INVENTOR OF THE WHEEL COULD HAVE RAKED IN IF HE COULD HAVE PATENTED THE IDEA. WHO INVENTED THE WHEEL, THE LEVER, THE SCREW, THE SPEAR AND A LOT OF OTHER THINGS LIKE THAT? IF YOU EVER FIND OUT, A BATCH OF BIG SCIENTISTS WILL HAVE AN APPOINTMENT WITH YOU.

arrangement of the solar system), but that it was probably "as big as all the Poloponnesus." Then came Aristotle, the Macedonian, the teacher of Alexander the Great, developing his works upon mechanics and philosophy. This Aristotle possessed a mind highly balanced and of great practical application, as well as of great width, breadth and thickness of knowledge. He was a great dependor upon, and respecter of, developed facts, civil, military and religious, as well as mechanical, scientific and philosophic, advancing even the conclusion that the monarchical form of government was better than the republican, or democratic, since it had already manifested itself as being the most substantial and staple of governments by having a head within which both power and authority converged in the enactment and enforcement of law. He also developed the theory of equity from which our courts of equity were ultimately derived, having defined equity to be "a correction of that wherein the law,

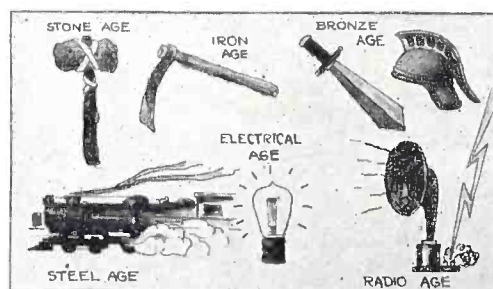

FROM ROCKS TO RADIO MIGHT BE THE TITLE FOR THIS LITTLE PICTURE, REPRESENTING THE STONE AGE, IRON AGE, BRONZE AGE, STEEL AGE, ELECTRICAL AGE, AND RADIO AGE, THE LAST BEING THE ONE UPON WHICH MAN IS JUST ENTERING.

by reason of its universality, is deficient." He advocated, also, the temperance of justice by the rule of reason (not a bad idea) and said that speech was given to man that he might "know what is just and what is unjust and unjust, just as surely as writtote did not go far enough. Speech is given to man that he might thereby acquire (as Solomon might express it) "wisdom and understanding," all of which precedes a knowledge of the just and unjust just as surely as written language antedated some of the gutters of our modern journalism.

Remote Invention

It would be interesting, if accurately possible, to draw an outline of history of invention prior to, at the time of, and from, the building of the great pyramids, temples and canals, of Egypt; the invention and use of both spoken and written languages; the invention of the alphabet; the discovery of gold and silver and the invention of their use as money; the inventions of crockery, the spear, sword, axe, wheel, wedge, wimble, lever, screw, masts and sails, down to the invention of the wooden horse with which the Athenians entered and destroyed Troy; or from the invention of the mariner's compass, the development of arithmetic, geometry, trigonometry, the development of astronomy leading to the cycles of eclipses calculated by Calippus, the invention and development of the mechanics of Aristotle and Archimedes, the aqueducts of Rome, the invention and location of the lighthouses at Alexandria, the sundial, surveying, printing, paper, the water mill, the Hero steam engine, the invention of transparent glass, of woolen and linen fabrics, the needle, microscope, telescope, thermometer, barometer and spectroscope; the scientific discovery of electricity, the invention of the steam engine, steamboat, the voltaic battery, the horse railroad and steam railroad, matches; the identification of lightning as electricity by Franklin; followed by the invention of the telephone, the graphophone, the automobile, wireless telegraphy, and last, but not least and possibly the most important of all, the radiophone; but time and space does not, in these articles, permit even their historical or philosophical treatment. However, both for the purpose of illustration, and because the trend of these articles is towards radio, it might be well to trace historically, the development of our present knowledge of electricity, though this can only be here traced very superficially. Moreover, as there is in electricity a certain amount of abstractness, because of its very nature and its material manifes-

(Continued on page 278)

"ON THE AIR" Schedule of Broadcast Stations of California. Corrected to May 1, 1923.
Notice of changes welcomed.

	3p.m.	4p.m.	5p.m.	6p.m.	7p.m.	8p.m.	9p.m.	10p.m.	11p.m.
Sun.	KUO-360-S.F. KFHJ-360-Santa Barbara	KFI-400-Anthony, L. KRE-360-Fresno	KUO-360-S.F. KRE-360-Berkeley	KJS-360-Bible, L. A. KFFA-360-San Diego	KFB-360-San Diego KFD-360-S.F.	KFB-360-San Diego KFD-360-S.F.	KIS-360-Bible, L. A. KHJ-400-Times, L. A. Meyberg-360-L. A.	KFI-400-Anthony, L. A. KDN-360-S.F.	KFI-430-Anthony
Mon.	KUO-360-S.F. KFBK-360-Sacramento KFD-360-Hanford KFH-360-Santa Barbara	KFCL-485-Stk. Yds. KWL-360-Stockton KFAW-360-Stockton KAW-360-Fresno	KUO-360-S.F. KDN-360-S.F. KIQ-360-Stockton	Exam. 360 KFBK-360-Sacramento KFAW-360-San Diego KWH-485-Exam.	KFAW-360-Santa Ana KFD-485-S.F. KFI-360-Anthony, L. A. KHJ-400-Times, L. A. KDZH-360-Fresno	KFB-360-San Diego KFD-360-S.F. KPH-360-Santa Barbara	KFC-485-Stk. Yds., L. A. KHJ-400-Times, L. A. Herald-360-L. A.	KFI-430-Anthony KIQ-360-Stockton KFD-485-S.F. KDY-360-San Diego KXD-360-Modesto KPH-360-Santa Barbara	KFI-430-Anthony
Tue.	KFBK-360-Sacramento KUO-360-S.F. KPH-360-Santa Barbara	KUS-360-City Dye, L. A. KFC-485-Stk. Yds., L. A. KWL-360-Stockton KFAW-360-Stockton KAW-360-Fresno	KUO-360-S.F. KDN-360-S.F. KIQ-360-Stockton	Exam. 360 KFBK-360-Sacramento KFAW-360-San Diego KWH-485-Exam.	KJS-360-Bib. Inst. KHJ-400-Times, L. A. KWL-360-Stockton KXD-360-Modesto KFD-485-S.F.	KFB-360-San Diego KFD-360-S.F. KPH-360-Santa Barbara	KFC-485-Stk. Yds., L. A. KHJ-400-Times, L. A. Western Radio-360-L. A. KPO-400-S.F. KLS-360-S.F.	KFI-430-Anthony KIQ-360-Stockton KFD-485-S.F. KDY-360-San Diego KXD-360-Modesto KPH-360-Santa Barbara	KFI-430-Anthony
Wed.	KFBK-360-Sacramento KUO-360-S.F. KPH-360-Santa Barbara	KFC-485-Stk. Yds. KWL-360-Stockton KFAW-360-Santa Ana KAW-360-Fresno	KUO-360-S.F. KDN-360-S.F. KIQ-360-Stockton	Exam. 360 KFBK-360-Sacramento KFAW-360-San Diego KWH-485-Exam.	KJS-360-Bible, L. A. KHJ-400-Times, L. A. KFI-360-Anthony, L. A. KWL-360-Stockton KXD-360-Modesto KFD-485-S.F.	KFB-360-San Diego KFD-360-S.F. KPH-360-Santa Barbara	KFC-485-Stk. Yds., L. A. KHJ-400-Times, L. A. Herald-360-L. A. KUO-360-S.F. KFD-485-S.F. KDY-360-San Diego KFBK-360-Sacramento KAW-360-San Jose	KFI-430-Anthony KIQ-360-Stockton KFD-485-S.F. KDY-360-San Diego KXD-360-Modesto KPH-360-Santa Barbara	KFI-430-Anthony
Thu.	KUO-360-S.F. KFBK-360-Sacramento KPH-360-Santa Barbara	KFC-485-Stk. Yds., L. A. KWL-360-Stockton KFAW-360-Santa Ana KAW-360-Fresno	KUO-360-S.F. KDN-360-S.F. KIQ-360-Stockton	Exam. 360 KFBK-360-Sacramento KFAW-360-San Diego KWH-485-Exam.	KFAW-360-Santa Ana KHJ-400-Times, L. A. KFI-360-Anthony KWL-360-Stockton KXD-360-Modesto KFD-485-S.F.	KFB-360-San Diego KFD-360-S.F. KPH-360-Santa Barbara	KFC-485-Stk. Yds., L. A. KHJ-400-Times, L. A. KJS-360-Bible, L. A. Meyberg-360-L. A. KPO-400-S.F. KIQ-360-Stockton KLS-360-S.F.	KFI-430-Anthony KIQ-360-Stockton KFD-485-S.F. KDY-360-San Diego KXD-360-Modesto KPH-360-Santa Barbara	KFI-430-Anthony
Fri.	KUO-360-S.F. KFBK-360-Sacramento KFD-360-Hanford KPH-360-Santa Barbara	KUS-360-City Dye, L. A. KFC-485-Stk. Yds. KWL-360-Stockton KFAW-360-Stockton KAW-360-Fresno	KUO-360-S.F. KDN-360-S.F. KIQ-360-Stockton	KUS-360-City Dye, L. A. KFC-485-Stk. Yds. KWL-360-Stockton KFAW-360-San Diego KWH-485-Exam.	KHI-400-Times, L. A. KFI-360-Anthony KWL-360-Stockton KXD-360-Modesto KFD-485-S.F.	KFB-360-San Diego KFD-360-S.F. KPH-360-Santa Barbara	KFC-485-Stk. Yds., L. A. KHJ-400-Times, L. A. Herald-360-L. A. KIS-360-S.F. KDY-360-San Diego KWL-360-Stockton KMI-360-Fresno	KFI-430-Anthony KIQ-360-Stockton KFD-485-S.F. KDY-360-San Diego KXD-360-Modesto KPH-360-Santa Barbara	KFI-430-Anthony
Sat.	KUO-360-S.F. KFBK-360-Sacramento KPH-360-Santa Barbara	KFC-485-Stk. Yds. KWL-360-Stockton KFAW-360-Stockton KAW-360-Fresno	KUO-360-S.F. KDN-360-S.F. KIQ-360-Stockton	KUS-360-City Dye, L. A. KFC-485-Stk. Yds. KWL-360-Stockton KFAW-360-San Diego KWH-485-Exam.	KHI-400-Times, L. A. KFI-360-Anthony KWL-360-Stockton KXD-360-Modesto KFD-485-S.F.	KFB-360-San Diego KFD-360-S.F. KPH-360-Santa Barbara	KFC-485-Stk. Yds., L. A. KHJ-400-Times, L. A. Western Radio-360-L. A. KDN-360-S.F. KDY-360-San Diego KWL-360-Stockton KMI-360-Fresno	KFI-430-Anthony KIQ-360-Stockton KFD-485-S.F. KDY-360-San Diego KXD-360-Modesto KPH-360-Santa Barbara	KFI-430-Anthony

DAILY SCHEDULE PRIOR TO 3 P. M.

	SUNDAY	MONDAY	TUESDAY	WEDNESDAY	THURSDAY	FRIDAY	SATURDAY
6-6:30 a. m.	KUS	KUS	KUS	KUS	KUS	KUS	KUS
7-7:30 a. m.	KUS	KUS	KUS	KUS	KUS	KUS	KUS
9-10 a. m.	KUO	KUO	KUO	KUO	KUO	KUO	KUO
10-10:30 a. m.	KHJ-KLX-KJS KJQ	KFCL-KFDB	KFCL-KFDB	KFCL-KFDB	KFCL-KFDB	KFCL-KFDB	KFCL-KJS-KFDB
10:30-11 a. m.	KFI-KHJ-KPO- KLX-KJQ	KFB	KFB	KFB	KFB	KFB	KJS-KFDB
11-11:30 a. m.	KFI-KPO	KUS-KFDB	KFB	KFB	KFB	KFB	KFB
11:30-12 a. m.	KJS-KPO	KUS-KLS	KLS	KLS	KLS	KLS	KLS
12-12:30 p. m.	KPO-KJS	KLS-KUS-KFCL	KLS-KUS-KFCL	KLS-KUS-KFCL	KLS-KUS-KFCL	KLS-KUS-KFCL	KLS-KUS-KFCL
12:30-1 p. m.	KLS-KJS	KLS-KHJ	KLS-KHJ	KLS-KHJ	KLS-KHJ	KLS-KHJ	KLS-KHJ
1-1:30 p. m.	KJS-KXD	KPO-KDN-KWH	KPO-KDN-KWH	KPO-KDN-KWH	KPO-KDN-KWH	KPO-KDN-KWH	KPO-KDN-KWH
1:30-2 p. m.	KXD	KQW	KQW	KQW	KQW	KQW	KQW
2-2:30 p. m.	KUO	KDN-KWH-KQW	KDN-KWH-KQW	KDN-KWH-KQW	KDN-KWH-KQW	KDN-KWH-KQW	KDN-KWH-KQW
2:30-3 p. m.	KUO-KFHJ	KFDB-KUS	KFDB-KNX	KFDB	KFDB-KUS	KFDB-KUS	KFDB-KUS
		KFDB-KUO-KUS- KFHJ	KFDB-KUO-KFHJ	KFDB-KUO-KFHJ	KFDB-KUO-KUS- KFHJ	KFDB-KUO-KUS- KFHJ	KFDB-KUO-KFHJ

"ON THE AIR" Schedule of Western Broadcast Stations outside California.
Corrected to May 1, 1923. Reduced to Pacific Time.

	3 p.m.	4 p.m.	5 p.m.	6 p.m.	7 p.m.	8 p.m.	9 p.m.	10 p.m.	11 p.m.	
Sun.	CFCE-440-Vancouver, B. C. KDW-360-Seattle, Wash.		KGB-360-Tacoma	KGW-400-Portland, Ore. KDYW-360-Phoenix	KFDA-360-Baker, Ore. KLZ-360-Denver	KRCC-360-Wallace, Idaho		CFCE-440-Vancouver, B. C. CJCB-400-Nelson, B. C. WFAA-400-Dallas, Tex.	KGG-360-Portland	
Mon.	CFCE-440-Vancouver, B. C. KDZE-360-Seattle, Wash. KDW-400-Portland, Ore.	WFAA-360 KFEJ-360-Portland, Ore.	KGG-360-Portland, Ore. XDA-5500-Mexico	KDYW-360-Phoenix, Ariz. BEI-400-Camp Lewis WFAA-360-Dallas, Tex. KDY-360-Salt Lake, Utah	KQY-360-Portland, Ore. KFCB-360-Phoenix, Ariz. KJR-360-Seattle, Wash. KMO-360-Tacoma KOB-360-New Mexico WBAP-400-Forth worth, Tex.	KJRW-360-Seattle, Wash. KFCB-360-Wallace, Idaho WBAP-400-Forth Worth KFAU-360-Boise, Idaho KZLN-360-Salt Lake, Utah KGN-360-Portland	CJCB-400-Nelson, B. C. CFCE-440-Vancouver, B. C. KFAU-360-Medford KFAU-360-Boise, Idaho CKCD-410-Vancouver, B. C. KDW-400-Portland, Ore. CFCE-440-Vancouver, B. C. KGN-360-Portland	KFAU-360-Medford CKCD-410-Vancouver, B. C. KDW-400-Portland, Ore. CFCE-440-Vancouver, B. C. KGN-360-Portland KDZE-360-Seattle, Wash. KFAU-360-Eugene		
Tue.	CFCE-440-Vancouver, B. C. WPA-360 KDZE-360-Seattle, Wash. WFAA-360 KFEJ-360-Portland, Ore.	WFAA-360 KFEJ-360-Portland, Ore.	KGG-360-Portland, Ore.	KQY-360-Portland, Ore. KMO-360-Tacoma KFEJ-485-Portland KDY-360-Salt Lake, Utah BEI-400-Camp Lewis KDYW-360	KFEJ-485-Portland KDY-360-Salt Lake, Utah WFAA-360-Dallas KLZ-360-Denver KJR-360-Seattle, Wash. WDAH-360-El Paso, Tex. WBAP-400-Forth Worth, Tex. KPAD-360-Phoenix, Ariz. KFEJ-360-Tacoma	KHQ-360-Seattle KFAU-360-Boise KFCB-360-Wallace, Idaho KFDH-360-Tucson KFDH-360-Tucson CFCE-440-Vancouver, B. C. CJCB-400-Nelson, B. C. CJCB-420-Vancouver, B. C. WFAA-360-Dallas, T	KFCB-360-Wallace, Idaho KFDH-360-Tucson CFCE-440-Vancouver, B. C. CJCB-400-Nelson, B. C. CJCB-420-Vancouver, B. C. WFAA-360-Dallas, T KJR-360-Seattle, Wash. KFAU-360-Medford KGG-360-Portland, Ore. KZLN-360-Salt Lake, Utah	CFCE-440-Vancouver, B. C. CKCD-410-Vancouver, B. C. CFCE-440-Vancouver, B. C. CJCB-420-Vancouver, B. C. WFAA-360-Dallas, T KJR-360-Seattle, Wash. KFAU-360-Medford		
Wed.	CFCE-440-Vancouver, B. C. WPA-360 KZLN-360-Salt Lake, Utah KDZE-360-Seattle, Wash. KDW-400-Portland, Ore.	WFAA-360 KFEJ-360-Portland, Ore.	KGG-360-Portland, Ore.	KQY-360-Portland, Ore. KDY-360-Salt Lake, Utah KDY-360-Great Falls, Mont. XDA-5500-Mexico KFEJ-360-Tacoma KFCB-360-Phoenix, Ariz. KJR-360-Seattle, Wash. KDYW-360-Phoenix BEI-400-Camp Lewis KFEJ-485-Portland WBAP-400-Forth worth, Tex. KMO-360-Tacoma	KDY-360-Salt Lake, Utah KFDA-360-Baker, Ore. WBAP-400-Forth Worth, Tex. KGB-360-Tacoma, Wash. KFAU-360-Boise KGG-360-Portland CKCD-410-Vancouver, B. C. CFCE-440-Vancouver, B. C. CJCB-400-Nelson, B. C. CJCB-420-Vancouver, B. C.	KHQ-360-Seattle, Wash. KFAU-360-Boise KFCB-360-Wallace, Idaho KFDH-360-Tucson KFDH-360-Tucson CFCE-440-Vancouver, B. C. CJCB-400-Nelson, B. C. CJCB-420-Vancouver, B. C. WFAA-360-Dallas, T KJR-360-Seattle, Wash. KFAU-360-Medford KGG-360-Portland, Ore. KZLN-360-Salt Lake, Utah	KFCB-360-Wallace, Idaho KFDH-360-Tucson CFCE-440-Vancouver, B. C. CJCB-400-Nelson, B. C. CJCB-420-Vancouver, B. C. WFAA-360-Dallas, T KJR-360-Seattle, Wash. KFAU-360-Medford KGG-360-Portland, Ore. KZLN-360-Salt Lake, Utah	CFCE-440-Vancouver, B. C. CKCD-410-Vancouver, B. C. CFCE-440-Vancouver, B. C. CJCB-420-Vancouver, B. C. WFAA-360-Dallas, T KJR-360-Seattle, Wash. KFAU-360-Medford		
Thu.	CFCE-440-Vancouver, B. C. WPA-360 KDZE-360-Seattle, Wash. KDW-400-Portland, Ore. KZLN-360-Salt Lake, Utah KLZ-360-Denver	WFAA-360 KFEJ-360-Portland, Ore.	KGG-360-Portland, Ore.	KQY-360-Portland, Ore. KDY-360-Salt Lake, Utah KDY-360-Great Falls, Mont. XDA-5500-Mexico KFEJ-360-Tacoma KFCB-360-Phoenix, Ariz. KJR-360-Seattle, Wash. KDYW-360-Phoenix BEI-400-Camp Lewis KFEJ-485-Portland WBAP-400-Forth worth, Tex. KMO-360-Tacoma	KDY-360-Salt Lake, Utah KFDA-360-Baker, Ore. WBAP-400-Forth Worth, Tex. KGB-360-Tacoma, Wash. KFAU-360-Boise KGG-360-Portland CKCD-410-Vancouver, B. C. CFCE-440-Vancouver, B. C. CJCB-400-Nelson, B. C. CJCB-420-Vancouver, B. C.	KHQ-360-Seattle, Wash. KFAU-360-Boise KFCB-360-Wallace, Idaho KFDH-360-Tucson KFDH-360-Tucson CFCE-440-Vancouver, B. C. CJCB-400-Nelson, B. C. CJCB-420-Vancouver, B. C. WFAA-360-Dallas, T KJR-360-Seattle, Wash. KFAU-360-Medford KGG-360-Portland, Ore. KZLN-360-Salt Lake, Utah	KFCB-360-Wallace, Idaho KFDH-360-Tucson CFCE-440-Vancouver, B. C. CJCB-400-Nelson, B. C. CJCB-420-Vancouver, B. C. WFAA-360-Dallas, T KJR-360-Seattle, Wash. KFAU-360-Medford KGG-360-Portland, Ore. KZLN-360-Salt Lake, Utah	CFCE-440-Vancouver, B. C. CKCD-410-Vancouver, B. C. CFCE-440-Vancouver, B. C. CJCB-420-Vancouver, B. C. WFAA-360-Dallas, T KJR-360-Seattle, Wash. KFAU-360-Medford		
Fri.	CFCE-440-Vancouver, B. C. WPA-360 KLZ-360-Denver KDW-400-Portland, Ore. KZLN-360-Salt Lake, Utah KDZE-360-Seattle, Wash. KFEJ-360-Tacoma	WFAA-360 KFEJ-360-Portland, Ore.	KGG-360-Portland, Ore.	KQY-360-Portland, Ore. KDY-360-Salt Lake, Utah KDY-360-Great Falls, Mont. XDA-5500-Mexico KFEJ-360-Tacoma KFCB-360-Phoenix, Ariz. KJR-360-Seattle, Wash. KDYW-360-Phoenix BEI-400-Camp Lewis KFEJ-485-Portland WBAP-400-Forth worth, Tex. KMO-360-Tacoma	KDY-360-Salt Lake, Utah KFDA-360-Baker, Ore. WBAP-400-Forth Worth, Tex. KGB-360-Tacoma, Wash. KFAU-360-Boise KGG-360-Portland CKCD-410-Vancouver, B. C. CFCE-440-Vancouver, B. C. CJCB-400-Nelson, B. C. CJCB-420-Vancouver, B. C.	KHQ-360-Seattle, Wash. KFAU-360-Boise KFCB-360-Wallace, Idaho KFDH-360-Tucson KFDH-360-Tucson CFCE-440-Vancouver, B. C. CJCB-400-Nelson, B. C. CJCB-420-Vancouver, B. C. WFAA-360-Dallas, T KJR-360-Seattle, Wash. KFAU-360-Medford KGG-360-Portland, Ore. KZLN-360-Salt Lake, Utah	KFCB-360-Wallace, Idaho KFDH-360-Tucson CFCE-440-Vancouver, B. C. CJCB-400-Nelson, B. C. CJCB-420-Vancouver, B. C. WFAA-360-Dallas, T KJR-360-Seattle, Wash. KFAU-360-Medford KGG-360-Portland, Ore. KZLN-360-Salt Lake, Utah	CFCE-440-Vancouver, B. C. CKCD-410-Vancouver, B. C. CFCE-440-Vancouver, B. C. CJCB-420-Vancouver, B. C. WFAA-360-Dallas, T KJR-360-Seattle, Wash. KFAU-360-Medford		
Sat.	CFCE-440-Vancouver, B. C. WPA-360 KLZ-360-Denver KDZE-360-Seattle, Wash. KDW-400-Portland, Ore.	WFAA-360 KFEJ-360-Portland, Ore.	KGG-360-Portland, Ore.	KQY-360-Portland, Ore. KDY-360-Salt Lake, Utah KDY-360-Great Falls, Mont. XDA-5500-Mexico KFEJ-360-Tacoma KFCB-360-Phoenix, Ariz. KJR-360-Seattle, Wash. KDYW-360-Phoenix BEI-400-Camp Lewis KFEJ-485-Portland WBAP-400-Forth worth, Tex. KMO-360-Tacoma	KDY-360-Salt Lake, Utah KFDA-360-Baker, Ore. WBAP-400-Forth Worth, Tex. KGB-360-Tacoma, Wash. KFAU-360-Boise KGG-360-Portland CKCD-410-Vancouver, B. C. CFCE-440-Vancouver, B. C. CJCB-400-Nelson, B. C. CJCB-420-Vancouver, B. C.	KHQ-360-Seattle, Wash. KFAU-360-Boise KFCB-360-Wallace, Idaho KFDH-360-Tucson KFDH-360-Tucson CFCE-440-Vancouver, B. C. CJCB-400-Nelson, B. C. CJCB-420-Vancouver, B. C. WFAA-360-Dallas, T KJR-360-Seattle, Wash. KFAU-360-Medford KGG-360-Portland, Ore. KZLN-360-Salt Lake, Utah	KFCB-360-Wallace, Idaho KFDH-360-Tucson CFCE-440-Vancouver, B. C. CJCB-400-Nelson, B. C. CJCB-420-Vancouver, B. C. WFAA-360-Dallas, T KJR-360-Seattle, Wash. KFAU-360-Medford KGG-360-Portland, Ore. KZLN-360-Salt Lake, Utah	CFCE-440-Vancouver, B. C. CKCD-410-Vancouver, B. C. CFCE-440-Vancouver, B. C. CJCB-420-Vancouver, B. C. WFAA-360-Dallas, T KJR-360-Seattle, Wash. KFAU-360-Medford		

Daily Schedule prior to 3 p.m.

	SUNDAY	MONDAY	TUESDAY	WEDNESDAY	THURSDAY	FRIDAY	SATURDAY
6:30-7 a. m.		WBAP	WBAP	WBAP	WBAP	WBAP	WBAP
7:30-8 a. m.		KLZ	KLZ	KLZ	KLZ	KLZ	KLZ
8-8:30 a. m.		WFAA	WFAA	WFAA	WFAA	WFAA	WFAA
8:30-9:00 a. m.		WFAA	WFAA	WFAA	WFAA	WFAA	WFAA
9-9:30 a. m.		WBAP-KLZ	WBAP-KLZ	WBAP	WBAP-KLZ	WBAP-KLZ	WBAP-KLZ
10-10:30 a. m.		KFEJ	KFEJ	KFEJ	KFEJ	KFEJ	KFEJ
10:30-11 a. m.		KDZE-KFEZ- WFAA	KDZE-KFEZ WFAA	KDZE-KFEZ WFAA	KDZE-KFEZ WFAA	KDZE-KFEZ WFAA	KDZE-KFEZ WFAA
11-11:30 a. m.	KTW	KLZ	KLZ	KLZ	KLZ	KLZ	KLZ
11:30-12 a. m.	KTW						
12-12:30 p. m.		KFEJ	KFEJ	KFEJ	KFEJ	KFEJ	KFEJ
12:30-1 p. m.	WFAA	KFEJ-CJCE	KFEJ-CJCE	KFEJ-CJCE	CJCE	KFEJ-CJCE	KFEJ-CJCE
1-1:30 p. m.	WFAA	WBAP-KLZ	WBAP-KLZ	WBAP-KLZ	WBAP-KLZ	WBAP-KLZ	WBAP-KLZ
1:30-2 p. m.	WBAP	WBAP	WBAP	WBAP	WBAP	WBAP	WBAP
2-2:30 p. m.	WBAP						

Yankee Broadcasting Thrills Brazil

By J. W. STROEBEL

We have always associated Brazil with nuts, geography and breakfast. Now we must add radio. J. W. Stroebel, Yankee chief operator of the first big broadcast station in South America, takes us above the clouds in describing SPC. It's a dandy place to jump off.

BRAZIL, that progressive South American Republic, which is now celebrating the 100th Anniversary of its Declaration of Independence by holding Centennial celebrations in the beautiful city of Rio de Janeiro, is being entertained by a Yankee radio telephony broadcasting station.

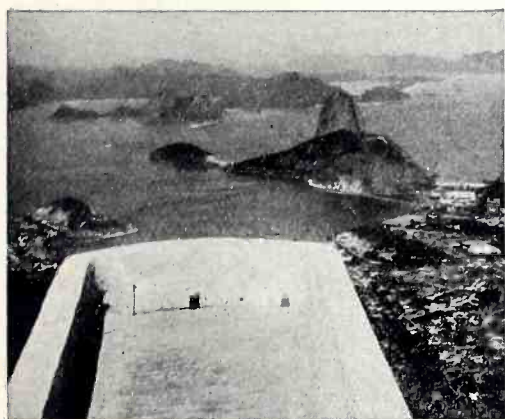

HERE'S THE EYEFUL THE OPERATOR GETS WHEN HE LOOKS DOWN FROM SPC ONTO RIO DE JANEIRO AND ITS HARBOR.

The necessary governmental concession to erect and operate a short wave experimental broadcasting station during the Centennial, was easily secured by L. A. Osbourne, president of the Westinghouse Electric International Company, who was in Brazil while the feature attractions of the Centennial were being made. Mr. Osbourne also secured the co-operation of the Brazilian Light & Traction Company in finding a location and later in rendering program and operating assistance.

The complete arrangements were

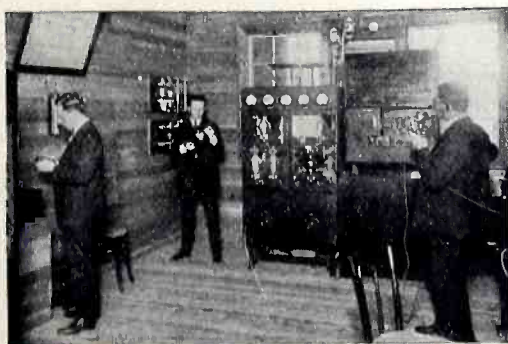

HERE'S THE INSIDE OF SPC'S BROADCAST STATION. ONE OF THESE LUCKY CHAPS CAN STEP OUT OF THE WINDOW— BUT DOESN'T. THIS 750 WATT STATION BROADCASTS ON 450 METERS.

cabled to East Pittsburgh, where engineers built a powerful equipment.

Entering the beautiful city of Rio de Janeiro the most impressive sight is the exquisite mountainous background of the city and particularly "Corcovado," an almost perpendicular mountain with its summit over 2000 feet above sea level.

"Why erect high masts when such a mountain is so near by?" queried the radio engineers.

"Can we get the location?"

This question was answered in the affirmative by F. A. Huntress, general manager of the Tramway Light & Power Company, who own the cog wheel railway that climbs "Corcovado." He also stated, "We can supply 120 volt or 2200 volt, 50 cycles alternating current on the mountain top for the radio outfit."

The party set out to explore the mountain crest. The first 2000 feet of ascent, or five-mile ride from Rio de Janeiro, was made in 30 minutes, and the final climb of 125 feet by following the foot path to the circular observation tower on the top.



HERE'S THE OPERATOR'S SHACK ABOVE THE W. K. CLOUDS. THE ANTENNA WIRE AND COUNTERPOISE BASE CAN BE SEEN ABOVE THE TREES.

A quick survey of the available space on the crest disclosed a narrow path about 120 feet long, leading to a concrete parapet on the edge of the precipice.

The crest of "Corcovado" had always been used as an observation point, but the radio-telephony engineers saw more than mere scenery—they had a view of the prospective invisible radio audience in numerous ships at sea, and the millions in the capital city several thousand feet below.

The mountain ranges and their peaks, while beautiful to look upon were viewed as obstacles to be over-

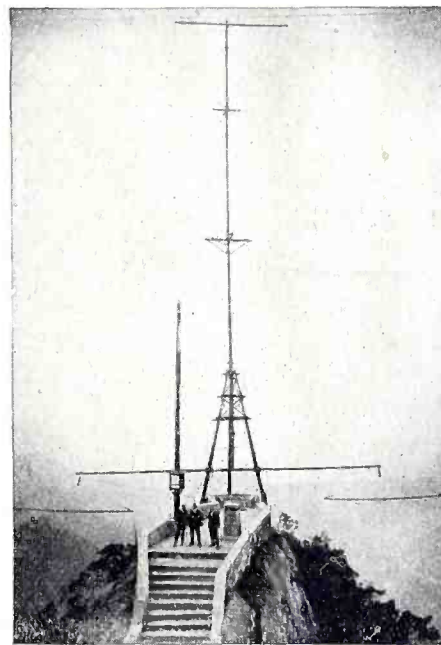

SPC'S MOUNTAIN-TOP ANTENNA MAST. COUNTERPOISE WIRES ARE STRETCHED CLEAR OF THE MOUNTAIN SIDES DOWN TO THE TERMINAL BUILDING OF THE COG RAILWAY BELOW.

come in broadcasting to the distant cities and towns in Brazil. The tropical vegetation also suggested the climatic differences from the United States where these engineers were active in developing KDKA at East Pittsburgh, WBZ at Springfield, Mass., WJZ at Newark, N. J., and KYW at Chicago, Ill.

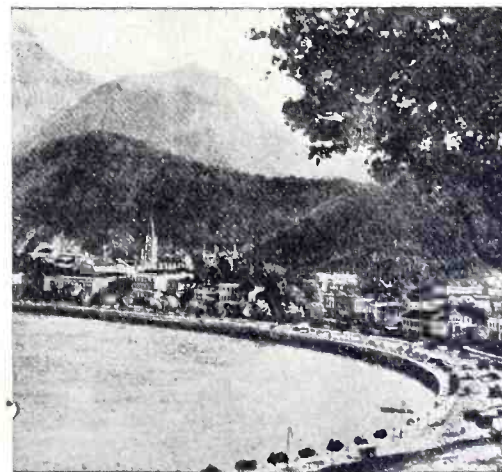

SPC, WESTINGHOUSE BROADCAST STATION IN BRAZIL, IS ON THE MOUNTAIN PEAK OF "CORCOVADO," OVERLOOKING A DIRECT DROP OF 2000 FEET TO THE BASE OF THE MOUNTAIN AND THE CITY. OPERATING AND BROADCAST ROOM ARE OFTEN ABOVE THE CLOUDS.

(Continued on Page 282)

Oft in The Stilly Night

By JESSIE E. KOEWING

WE TAKE great pleasure in introducing to our radio audience someone whom you all know about, but probably have never had the opportunity to hear—Mr. Blank." That is the way we broadcasters like to start a program, and I believe it is what the great invisible audience likes to hear. Hearing a great man speak—someone you have read about and heard about, and whose picture you know by heart—actually speaking to you in your own home—that is what is really thrilling



MISS KOEWING

about radio. And I firmly believe that the station that produces the most celebrities is the one that is going to be most popular with the "invisibles."

Don't misunderstand me. I mean that we should have music, too, but not only music. I think there ought to be a law against some of the amateur musicians who broadcast. It is a shame to use up perfectly good air that way. I hear that one station is planning to have an amateur night when anyone can perform. Can you imagine what it will sound like? The Society for the Prevention of Cruelty to "Listeners-In" should object.

Then, besides the embryonic musicians, the air is "jammed" with the latest prices on preserves and pickles, and one night I heard a woman giving child impersonations from one station. They are painful, anyway, and over the radio!—words fail. Then she gave an imitation of a new-born baby. I fear it was the cause of the dissolution of many a happy engagement.

Now, all is not music that's radioed, but there is much that is fine. The relaying of the concerts by fine orchestras, the wonderful organ recitals that are being broadcast on Sundays, and the complete operas which are given monthly from our station, WOR, of L. Bamberger & Co., at Newark, N. J., are really worthy of radio. We have the complete orchestra and cast assembled at the station to give these operas, and they have proved exceedingly popular.

I think it is absolutely up to the broadcasters to make the most of the wonderful opportunity to serve the public. I consider it a great privilege to have been placed in charge of the work of choosing appropriate topics and enlisting the co-operation of lead-

ing scientists and entertainers, and arranging the programs sent out from this big station. Any musician wishing to broadcast from WOR, unless known to me as an artist of merit, must submit to a test of his voice or his ability to play his instrument before he is put on a program. This also applies to lecturers. I feel that we owe it to the public to give them only what will really interest them. Therefore, no propaganda or advertising are permitted, nor any subject that might offend or bore the majority. But the surface has only been scratched in broadcasting, and there are doubtless thousands of ways to entertain our audiences that we have not yet thought of, and that are up to us to find.

Up to now radio has been like a new baby, and because it could speak at all everyone thought each little lisped word was wonderful. But now that it is getting older I feel that it is not going to be treated like a spoiled child any more, and if it does not show that it is really going to do things worth while it won't continue to be made a pet.

First Be Sure

Every little while a listener in radio land becomes incensed at a neighboring amateur who transmits during concert hours and mixes up dah-de-dah-dahs with the bewitching strains of the Something-or-other Blues, a foxtrot. So annoyed, the listener works up a fine mess of un-neighborly feelings and presently descends upon the luckless amateur with fire flashing finely from the nostrils.

In such a case the amateur has several choices. He can make one dive for the cyclone cellar and try to wait out the storm, but this is only temporizing with the menace. He can hand the visitor a bundle of back numbers of this magazine, in the hope that having read them he will find himself informed on the causes of his trouble, or he can actually turn teacher himself and help the outraged person to a fuller understanding of why this is thus.

Because in mighty few cases is the transmitting amateur the guilty party. The respect for the rules of the game that characterizes good sportsmen everywhere is shown in our art with a fullness that is gratifying and sometimes surprising. No amateur willfully gets very far over the borderline of his allotted region. Between the general neighborhood of 200

meters and the lowest broadcasting band lies an ample margin.

But when we consider the ability of receiving sets to gather in the wavelengths we find a different story. Single circuit tuners there are that are so catholic of taste that they may be depended on to get everything going, whether the taps are patronized at all or not. On many a simple and otherwise satisfactory set, whether of the crystal or tube type, one can hear 200 meter amateurs, 360 and 400 meter broadcasting stations, all at the same time. This is not as it should be. The chief charm of the good modern receiving set is the ability to exclude what is not wanted while giving the best obtainable results from the energy that is not excluded.

There is no longer any need of reception interference between waves even if they are numerically close together. The good of the art will be distinctly forwarded by the installation of selective sets, of any of the good types. We have described some of them in these columns, the amateurs have long been using them and are ready with the advice their experience makes available, and their use will allay that uncomfortable feeling of warmth around the collar when the otherwise inaudible amateur neighbor comes on the air.

For after all, the maligned amateur has done something to warrant his existence. Though he does not in the least demand it, he has a claim on our respect and sympathetic understanding. He has been in all cases licensed by the Federal Government,—twice, in fact, once as an operator and once as a station. To achieve these licenses he has had to learn several things well—the code and the facts as to radio regulations. He is policed rather rigidly by the governmental agencies that licensed him, and in addition is held somewhat strictly to account by his fellow operators. It was to him that we turned as a nation in time of war-stress. He responded. Yet we have never heard an amateur claim that the amateurs won the war; a true mark of distinction. So let us be cautious about passing along too freely the blame for any interference that may arise unless we are secure in the possession of the real facts.

It is estimated that in the United States there are 1,500,000 radio receiving sets, representing at least twice that number of listeners-in.

* * *

The National Radio Chamber of Commerce is making an effort to increase the number of educational institutions that are giving extension courses by radio. Forty-seven colleges and universities are broadcasting educational and musical programs.

Questions and Answers

Q.—I am using two 5-watt tubes with British Aircraft circuit and broadcast listeners with fairly selective sets at a distance of two miles are reporting interference from my transmitter, which seems to be tuned sharply on 200 meters. What do you think the trouble is?—R. V., Omaha, Neb.

A.—The British Aircraft circuit is of the conductive coupled type of transmitter and is known to transmit a broad wave within a radius of several miles. An inductively coupled circuit would sharpen the wave and probably stop the interference at the distance you mention.

Q.—Is a center tap for filament lighting transformer always necessary?—B. M. Chino, Calif.

A.—No, it is not necessary in ordinary CW or ACCW transmitter. But when voice is desired the center tap should be hooked to the inductance and two .5 or 1 mf condensers should be used, one from the center tap to one side of the filament and the other from the center filament tap to the opposite side of the filament. The potential on these is hardly ever above .5 volts so any telephone or spark coil condenser can be used satisfactorily.

Q.—Is it possible to apply 550 volts AC to the plate of a 5 watt tube without the current being rectified?—E. M., Los Angeles.

A.—It is possible, but extreme care must be exercised and the voltage be applied gradually to make sure that the tube will stand it. Oftentimes 1,000 volts AC has been applied to 5 watt tubes, some standing up and some going to pieces.

Q.—In the article by Mr. Barron appearing in the March issue he refers to the L750 honeycomb coil as the most practical fixed wave receiver for commercial work.

I have been a radio fan since 1920 and have constructed several sets and am now operating two short wave and a "honeycomb" receiver but have never been able to get any satisfactory results on 600 meters. Would you kindly send me under separate cover a diagram of the set he speaks of, giving dimensions, capacities, etc.? With very best wishes for the further success of your paper.—W. H. Baird, Box 486, Maricopa, Calif.

A.—The coil referred to was L75 honeycomb shunted with a 43 plate condenser. The antenna coil was L75, with tickler coil 100. Diagram on this page will give data and capacities of other parts.

Q.—Why is it that there is such a tremendous difference in the rating of English and American valves (transmitters)? An English Mullard 20 watt tube takes, I think, 8 volts on filament at about 1.5 amperes at the most—12 watts, while an American 5 watt tube takes 7.5 volts and 2.35 amperes on the filament—17.5 watts, approximately, while the plate voltage is, in both cases, about the same. The difference in power consumed seems to be too great, considering that one is a 20 watt and the other is a 5 watt. R. SLADE, Belfield House, Waimataitai, Timauo, New Zealand.

A.—The filament current is not taken into consideration in the output of any vacuum tube. For example, one could not take the power consumed by a rotary gap motor as the input on the power transformer. American manufacturers rate their tubes on the output and foreign manufacturers rate theirs on input. This will explain the 5 and 20 watt rating though the power is practically the same.

Q.—What is a good hookup for a 5 or 50 watt tube?—K. L.

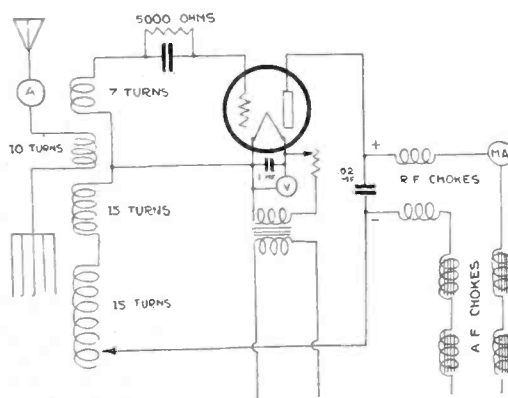

A.—We would refer you to the diagram of 6KA's set in the February issue, page 86, for a diagram of the set built by 6KA. This diagram, altered slightly to fit 5 and 50 watt tubes, is published herewith. Seven turns are used in the grid circuit instead of five. Coupling between two units, as referred to, does the tuning. Care must be taken, when the set is first put into operation, to keep the two units fairly close together. Turns

in the antenna coil will, of course, vary with the size of the antenna. .01 condensers will do the work effectively but .02 or .03 would be better. 250 turn honeycomb chokes are used in each leg. The outside diameter of the pancake coils is 14 inches. Bakelite strips are 1 3/4 inches wide with pancakes cut in on each side of the strips, although the diameter may be cut and smaller spacing between turns used.

Q.—I am a subscriber to Radio Journal. As I was reading the April issue I happened to see that radio set built by Mr. Welch of 1503 South Third St., Alhambra. Can you send me the hookup?—WILLIAM ENGEL, JR., 153 East 47th Place, Los Angeles.

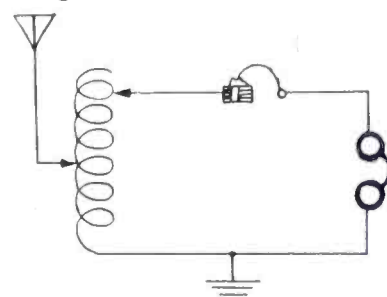

A.—Hookup of Mr. Welch's "simplest set" is published herewith. You will note that the crystal set is here reduced to its simplest elements, without using even a single condenser.

Q. I have been reading your Journal and would like to ask a few questions. Are they getting good results with peanut tubes on long distance? And about what is the distance they will pick up? Want to get a set but am in doubt what kind to get. Could you give me directions for construction of a peanut tube set that would be practical for say up to 500 miles? What will it cost? Also about what will the set cost?—C. C. LORENZ, Belvidere, Neb.

A.—Cases of reception at a distance of 1,000 miles have been known on a single peanut tube but nothing like this distance can be received consistently. The C R 5 hookup published in last month's Radio Journal will do nicely for peanut tube. One step of amplification, however, is recommended as more successful and reliable than the one tube. Diagram for successful amplifier is contained in this issue. You will need a dry cell, at about 50 cents; 22 1/2 volt B battery at about \$3; socket, 75 cents;

rheostat, \$1; phones, \$8 to \$15; coils or tuner, varying prices; two variable condensers, 43 and 27 plate, \$4 and \$3; by-pass, 50 cents; switch post, wire, binding posts, panel, etc., about \$5 more.

Q.—When I raise my filament voltage from $7\frac{1}{2}$ to 8 I get increased radiation. Will this shorten the life of the tube very much?—Carl Grube, Denver, Colo.

A.—It will shorten the life of the tube slightly, but if the increased radiation is more interesting than the purchase of new tubes, that filament voltage of 5 volts may be maintained.

Q.—Enclosed please find hookup of a 3 honeycomb coil regenerative circuit. I have built a set like it, but having a little trouble with the proper functioning of same, I would be very much pleased if you give me advice on the following questions:

1.—I am using standard 3 coil mounting and coils (De Forest) connecting coils. Primary 150 center coil is secondary 75 and last coil "Tickler" 100. Should secondary coil be outside, primary coil in center?

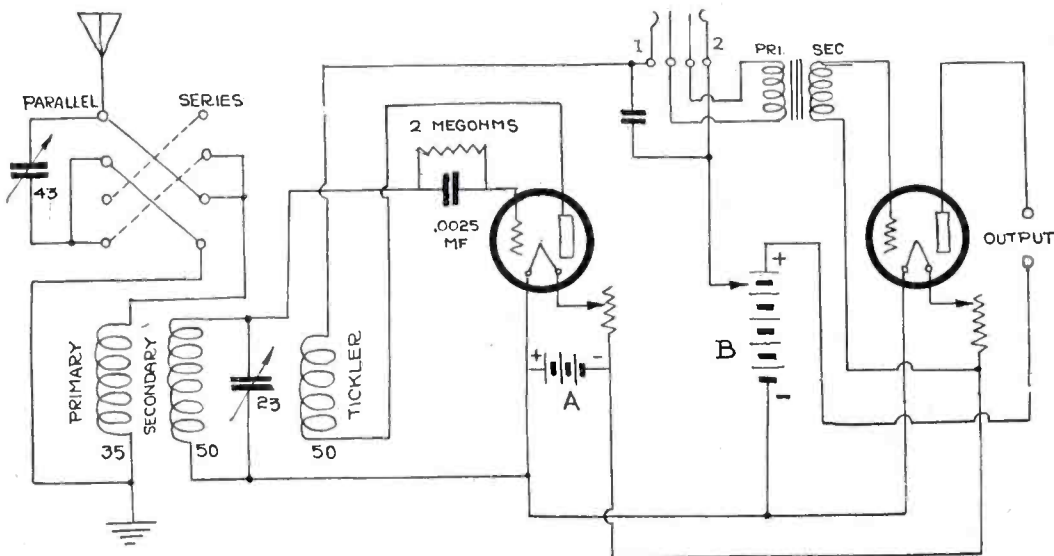

2. Anti capacity switch is being used as in sketch. Is same in parallel or series? In this position of switch the primary condenser is dead. It does not make any difference which way I put switch. Why is it?

I am using one A battery, but separate B batteries. A black 45 volt in detector circuit, with $18\frac{1}{2}$ volt tap on potentiometer. The set regenerates either way by moving the primary coil or tickler coil. The negative terminal of B. B. in detector circuit is dead end. If connected to $+-$ position of A B, set ceases to function.

Panel is 9" by 24". I am using U. S. Tool condensers and Federal transformers with radiotron UV 200-201 tubes. Bradley-stat on detector and Freshman's variable grid leak and .00025 condenser. No. 14 bare copper wire for wiring with spaghetti tubing.—A. W. RABE, 152 $\frac{1}{2}$ Hill Street, Ocean Park, Calif.

A.—Your coils should be arranged in the following order: first antenna, second, secondary; third, tickler. The antenna coil should be approximately 35, depending on the size of the antenna, although 50 can be used when the grid condenser is in series. A 50 turn honeycomb coil would do nicely for the secondary, a 50 or 75 in the tickler, depending on the character of the tube and plate voltage used. Your parallel or series switch is O. K. The tie in between the second and fourth contacts is not necessary but, as your hookup shows it, it would make no material difference. A rheostat is generally placed in the negative leg of the A battery and the secondary lead to the filament is tied to the positive side of the A battery. A by-pass condenser .0025 or slightly larger, would do very well across the jack so it will by-pass when the plug is either in or out. This will be across the two outside prongs of the jack. If the tube does not oscillate, reversing the connections on the tickler coil may cause it to oscillate if the rest of the hookup is correct. The same B battery

can very readily be used for detection and amplification. The negative side of the A battery should tie to the positive side of the filament battery. New diagram making slight changes in your hookup herewith.

Spanning the Pacific

Radio transmission was maintained between the President Lincoln and KFS, the San Francisco station of the Federal Telegraph Company, from the time that vessel left San Francisco until she was 470 miles south of Hongkong.

The record showed that messages were interchanged between the vessel and the shore station on November 15, when the ship was 3315 miles west of Honolulu; on the seventeenth, when she was 160 miles west of Yokohama; on the nineteenth, when she was 55 miles west of Kobe; on the twentieth,

when she was 465 miles west of Kobe; on the twenty-sixth, when she was 55 miles south of Hongkong, and the twenty-seventh, when she was 470 miles south of Hongkong.

The sending set aboard the steamer, the most vital part of the ship-to-shore communications link, was, like those aboard the nine other vessels of the "President" class, a five kilowatt Federal arc built to operate on 2400 meters wave length. The supplementary spark set, a one-half kilowatt device operating at 600 meters wave length, was not used in this work, as communication with arc-equipped vessels always is carried on with the arc when possible, owing to the greater carrying power of that form of radio transmission and the lesser congestion of the air on the higher wave length on which it is operated.

This arc set is one of the 300 sets the Federal Telegraph Company manufactured for the Navy during the world war. After the close of hostilities many of these were sold to the shipping board and installed on its vessels. Others of the same lot were turned over to the army transport service and the post office radio service, and are in use there today.

The transmission from KFS was with that station's regular arc, a specially built affair designed for operation on 2400 meters wave length and connected with an aerial delicately balanced and adjusted to meet that requirement exactly. This arc was designed for marine work exclusively. Its carrying power is something of a byword among radio operators aboard ship, as it is heard frequently in the Mediterranean, and always has been able to work with ships at any distance up to the limit of their apparatus' carrying power.

The sending aerial is a double span hung between 300-foot towers, the wires of the aerial being sixty feet apart. Reception at KFS was on a ten-foot loop aerial, also designed especially for work on 2400 meters wave length. This aerial contains about 750 feet of copper cable and the loop is pivoted so that it can be turned to obtain the best possible reception.

Both sending and reception aboard ship were over the regular overhead aerial. The standard navy receiving set, with vacuum tube reception and two stages of audio amplification was used aboard the ship.

Even the conservative makers of dictionaries have succumbed. Frank H. Vizetelly, lexicographer and managing editor of Funk & Wagnall's New Standard dictionary, announces that "radio broadcasting" has just been included in the orthodox family of words.

Trade Talk

from
Radio Dealers & Manufacturers

Making Radio History

Radio history was made recently through the efforts of Thorne Donnelley and Elliot Jenkins, in charge of broadcasting at Station WDAP, Drake Hotel, Chicago.

On the S. S. Berengaria, clearing 600 miles a day, and which sailed from New York January 30, Miss Florence McDonald had installed a standard Zenith receiving set. From January 30 to February 4, every day at appointed hours, both early and late in the evening, messages were flashed by Mr. Donnelley, the actual voice being transmitted, heard and recognized aboard the Berengaria which was speeding on its way to France.

Each time an erroneous statement regarding the distance of the Berengaria would be made (newspaper men picked the number haphazard out of a hat a few minutes before the broadcasting) would come back the answer from the steamship, giving the incorrect distance as well as the correct distance, now 250 miles out, then 275 miles out, again 1286 miles out, again 1824 miles and so on until the maximum distance was reached.

This was the first successful attempt to reach a voyaging ship from an inland station, on a predetermined schedule. No special tubes were used by the Drake station. No special tubes were used in the Zenith receiving set.

Stabilizing Industry

Over the signature of its president, Frederick Dietrich, and that of its vice-president and sales manager, M. G. Rypinski, C. Brandes, Inc., has issued a statement concerning the present status of radio and its outlook for the future.

It was the general opinion of the meeting that the industry is rapidly becoming stabilized and that its mushroom period of growth, which parallels the mushroom growth of the automobile industry a few years ago, is practically over. This being the case, competition will, of course, be saner during the coming year than it has been in the past. A 15% increase in business during 1923 over last year was predicted. This is so conservative an estimated increase, in view of the in-

tensification of interest in radio and the licensing of an increasing number of Class B stations, that it would seem to be a dependable prophecy.

Buys New Plant

Tune Sharp Radio Equipment company has just purchased a complete bakelite plant, according to H. D. Hattel, known to the Los Angeles

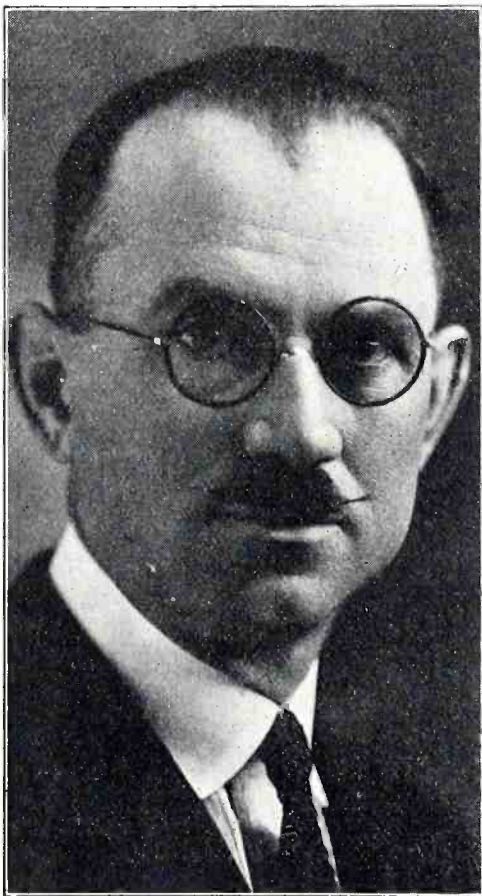

THIS IS H. D. HATTEL, MANUFACTURER OF A WELL KNOWN LINE OF RADIO EQUIPMENT, OF LOS ANGELES.

radio trade as "Tune Sharp" Hattel, and will soon be turning out its own natural color bakelite rings, covered with green silk double covered wire, for its variometers and vario-couplers. The plant is already equipped with screw machines, punch presses and other machinery necessary for manufacturing its special product, pyramid bank wound coils up to 4,000.

Mr. Hattel, himself, is somewhat of a radio pioneer, in that he began transmitting by wireless as early as 1900. In those days, he said, if he and a friend managed to get their

signals across the distance of two blocks intervening between their homes they thought they had accomplished wonders. Three blocks was considered a tremendous transmission range. As a graduate electrical engineer Mr. Hattel came to the Pacific Coast in 1910, but did not actively enter the radio manufacturing business until he established his present factory, about a year ago. His plant is located at 6220½-6222 Vermont Avenue, Los Angeles, Calif.

New Attachment

The Gilbert H. Downey Company, 7 South Seventeenth Street, Philadelphia, Pa., have completed and have ready for distribution their new "E-C" (Easy Change) Phonograph Attachment for the Victor and Columbia Phonographs. This attachment is complete with special loud speaking unit (with cord) and aluminum case which fastens on to the tone arm of the phonograph after the reproducer is removed. There are no set-screws to injure the unit.

Business Training

Business training is essential to the distribution of any line, and this holds emphatically true in radio. The man who has distributed something else, who has learned to co-operate with other merchants, and who realizes the necessity for introduction of sound business methods into the distribution of radio equipment, is the man who is going to enter the business and stay with it successfully.

Reorganize Chamber

Following a meeting of the Board of Governors of the National Radio Chamber of Commerce, it was announced that the Chamber would be re-organized to take into its membership individuals, either directly or through Regional Chambers of Commerce, including the audience or the listeners, manufacturers, jobbers, dealers, broadcasters, amateurs, the press, and organizations and institutions interested in radio, comprising educational, scientific, religious, civic, political and other bodies.

(Continued on page 280)

Radio Club Activities

New Zealand Rules Out

The Waimataitai, Timauo, New Zealand Club, sends the following: The restrictions which are just out are a little better than we thought they would be. We all think your magazine is one of the best going. The chief points of the restrictions follow:

Amateur station for reception only (including reception from broadcasting stations,) fee /-. Amateur transmitting and receiving station (Grade II) £1-0-0 P.A. Amateur transmitting and receiving station (Grade I) £2-0-0. Experimental transmitting and receiving station, £3-0-0. Private broadcasting station, £2-0-0. Toll broadcasting station, £5-0-0 per annum.

Examination fees: Amateur Operator, Grade I, 5/-. Amateur Operator, Grade II, 5/-.

Classification of transmitted waves:

(Type A1) C. W., Key modulated; (Type A2), I.C.W.; (Type A3), C.W., modulated by speech; (Type B), Damped waves. (The use of damped waves is prohibited except for research work on approved lines, and subject to special written consent. The call signs are on the same principle as the U. S. call letters.

Every operator shall execute a Declaration of Secrecy.

Grade I amateur must be able to send and receive at rate of 10 words per minute and also pass an examination dealing with working principles of a transmitter.

Wave lengths—(a) A general wave for all classes (excepting Type B), 150 meters; (b) Band for Radio-telephony (Type A3), 151-160 m.; (c) Band for I.C.W. (Type A2), 161-170 m.; (d) Band for C.W. (Type A1), 171-180 m.

Power permitted for Grade I, 50 watts. Grade II amateur must send and receive at 8 words per minute. Grade II amateur must use a common wave of 140 m. for all types (excepting Type B). Maximum power for Grade II, 5 watts.

Amateur transmissions shall not take

place between the hours of 7 and 8 p. m. (N.Z.M.T.)

No circuit must be used in which one coil is used as a reaction coil inductively coupled to the antenna coil.

Band for experimental stations equals 390 to 410 m.; maximum power equals 50 watts.

For broadcasting stations on band 190 to 250 m., maximum power equals ¼ k.w.

For broadcasting stations 260 to 385 m., maximum power equals ½ k.w.

A penalty of £50 fine or six months imprisonment is liable for any breach of regulations.

There are many other regulations, but they deal more with the details, so I am not sending them.

Yours sincerely,

R. SLADE,

Belfield House, Waimataitai, Timauo, N. Z.

Discuss New Circuits

Reflex and Flewelling circuits came in for a large share of the discussion at the March 19 meeting of the Southern California Radio Association in Los Angeles. F. Watkins discussed several reflex sets and the discussion on both types soon became general. Filters were also discussed and suggestions made as to various means of A. C. rectified and generator outputs. The subject was left open with plenty of room for further opinion.

The question of forming an organization similar to the Hoot Owl club of Portland, Ore., was broached and favorably received. Several names were proposed from which a selection will probably be made. Monday nights, between 11 p. m. and 1 a. m. will probably be selected as the hours and Anthony's station, KFI will probably be the broadcast studio. KGW does not admit anyone beyond a radius of 150 miles to membership.

The forthcoming Australian Trans-Pacific tests were discussed and enthusiastically received by the membership. Practically the entire membership of the association,

which is backing the enterprise, will be entered.

Milwaukee Incorporates

The Milwaukee Amateurs' Radio Club has been incorporated under the laws of the State of Wisconsin as a non-stock body, and its name changed to The Milwaukee Radio Amateurs' Club, Inc. The incorporators were L. S. Baird, C. N. Crapo, and L. J. Topolinski, the society's general counsel through whose efforts state incorporation was brought about. In addition to including the past purposes of the club and those of the American Radio Relay League, Inc., the articles of organization provide that the society may own and operate an amateur radio station and may associate itself with the A.R.R.L. as a Milwaukee section or local chapter.

Meetings continue to be held weekly at 7:45 P. M., Thursdays, in the Trustees' Room of the Milwaukee Public Museum. Marian Szukalski, Jr., owner of station 9AAP, the only Milwaukee station to have its signals span the Atlantic in the recent A.R.R.L. trans-Atlantic tests, presented a paper on the design and operation of his station at a recent meeting. E. G. Nickle and E. A. Cary, both of station 9ATO and members of the society's publications committee, are continuing their weekly digest reports of current radio literature. R. E. Lathrop, 9ATX, vice president of the Waukesha Radio Amateur Club, represented Wisconsin at the Michigan State A.R.R.L. Convention held at Flint, Mich., and upon his return gave the Milwaukee Club's members a lengthy report.

Dist. Supt. C. N. Crapo, 9VD, announced in his monthly report that A.R.R.L. traffic was growing in Wisconsin by leaps and bounds, and that State Manager B. A. Ott, 9ZY, was offering a silver cup, known as the Wisconsin Cup, to the stations which monthly handle the greatest number of messages. Club members are now out for this honor. City Manager I. H. Strassman, 9AHO, has reported that steps were being taken to rid the air of unlicensed stations.

L. S. BAIRD,
Business Manager.

Helena, Montana, Active

A very active and enterprising club of Radio amateurs is found in Helena, Montana. At present there are about twenty active members, six of whom hold first grade certificates and two have special amateur ratings.

Officers are C. J. W. Tibbets, 71E, president; Franklin Miller, vice-president, and Ernest A. Elge, 70G, secretary. Meetings are held regularly at the club rooms at 20 South Main St. The club has the use of a Navy Buzzer Instruction set, which is used in practice for sending and receiving.

Why not use Radio Journal Classified Ads to sell it or trade it for you? Radio Journal readers are buyers.

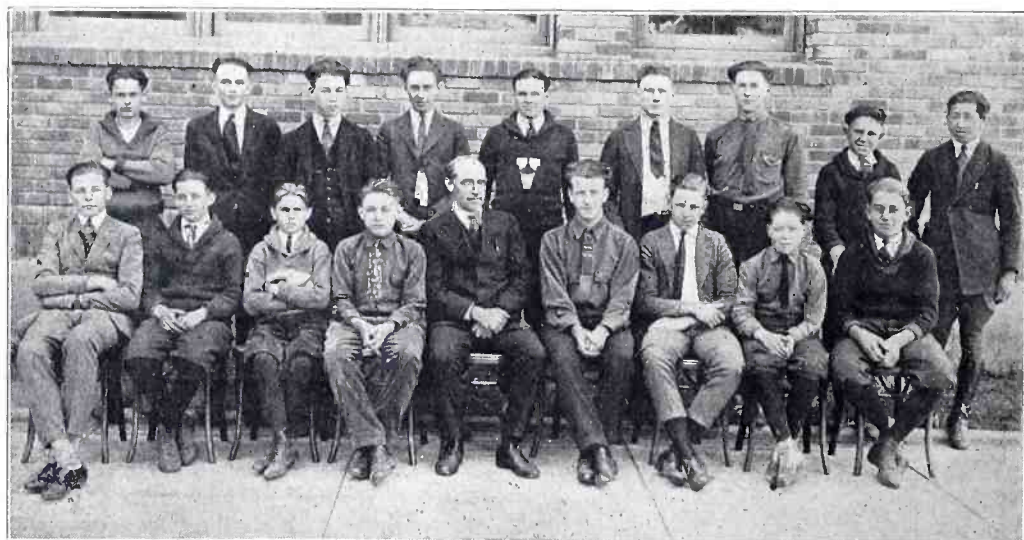

PROF. E. R. HADLEY, HEAD OF THE PHYSICS DEPARTMENT OF THE VENICE, CALIF., HIGH SCHOOL AND THE VENICE RADIO CLUB. THIS HIGH SCHOOL IS ONE OF THE MOST FINELY EQUIPPED, IN A RADIO WAY, IN THE COUNTRY.

Highgate Society, London

Of the three or four British amateur Transmitting Stations heard in America during the recent trans-Atlantic tests, it is with pleasure that we have to announce that one of these stations is owned and worked by a member of this society. The station referred to is 2SH, owned by Mr. F. L. Hoff, who is therefore one of the very few British amateurs to have been heard on the other side of the Atlantic.

The following lectures have been given during the last month:

"Secondary Cells," by Mr. H. Andrews, B. Sc., A. C. G. I.

The historical development of the accumulator was first described, the work of Ritter, Grove, Plante and Faure being especially mentioned. The Edison Cell was then dealt with, the difference in construction between this and the ordinary lead-acid cell being explained. The mechanical construction and chemical action of a modern type of accumulator was described.

"How to Make Your Set Efficient," by Mr. F. L. Hoff. Several useful hints on the construction and working of a receiving set were given.

"From Crystals to Poly-valve," by Mr. L. F. Stanley, B.Sc., A.C.G.I. In this lecture the various stages in the development of a large experimental station were explained.

The Hon. Secretary of this Society is Mr. L. T. Stanley, B.Sc., A.C.G.I., 49 Cholmeley Park, N. 6, London.

Superior California

The second meeting of the Superior California Radio Association was to be held April 14 at the Sacramento Y. M. C. A. at 8:30 p. m. Members expressed the conviction that a live organization for radio in upper California would be built up soon. The organization is laying plans to incorporate.

Twin City Club

Twin City Radio Club of Minneapolis, Minnesota, continues to have its meetings in spite of the approach of Spring.

Prof. C. M. Jansky of the University of Minnesota, gave an interesting stereopticon lecture on vacuum tubes, followed by a moving picture on the broadcasting station WLAG. Prof. Jansky in addition, gave a talk on the previous Hoover conventions at Washington. He left following the meeting, for Washington to participate in the latest Hoover conference.

At the next meeting, loop transmission will be discussed by several prominent members of the Club, who have been making tests along those lines with considerable success.

D. C. WALLACE,
Pres. Twin City Radio Club.

Deputy Inspector Guest

At the last meeting of the Southern California Radio Association, T. E. Nikirk presided, in the absence of Hall Berringer, the president. B. B. McGowan, deputy inspector for the Sixth District, told of his trip over the Sixth and part of the Ninth and Fifth Districts. He had the lack of static in the sixth called forcibly to his attention by his visit to other districts, he said, and said that coast amateurs should be thankful they live in the sixth. Mr. Hoyt, a visitor from the Northwest, spoke of the activities of his organization and matters of amateur interest. The association voted to make initiation fees nominal.

Radio Wonder Worker for Civilization

No one can even surmise what the development of the radio may mean in human civilization. Because of the elimination of space it is inevitable that it will hasten the day when members of the human family will understand each other better. It will be a wonderful antagonist of provincialism, the present curse of Americans.—Ray Lyman Wilbur, President, Stanford University.



Australian Tests

(Continued from Page 250)

to give amateurs an idea of who will be on the air when the big jamboree starts May 1:

All in Los Angeles: W. E. Deming, 6BVW; T. E. Nikirk, 6KA, 6XBC; Harold Duvall, 6XBA; S. F. Wainwright, 6BNG; V. M. Bitz, 6ZG, 6JD; A. L. Park, Jr., 6QW; L. McDowell, 6BVS; Charles F. Filstead, 6CU, 6CCJ; L. Watson, 6BVE; Newton R. Winner, 6BRF; Thompson Scott, 6BQY; Charles E. Stuart, 6BUN; Edward S. Tuttle, 6BWE; L. H. Bailley, 6BVZ; L. Obert, 6BVF; H. J. Palethorpe, 6CFY; H. R. Wertz, 6CFW; G. F. Luskin, 6CHU; C. H. Lewis, 6BWL; Lawrence Snell, 6APV; D. W. Sholley, 6CHJ; Roy Adams, 6CBN; Lawrence Snell, 6APV; Marcellus Peter, 6BQG; Harold Smith, 6MH; A. L. Blodgett, 6ALG; A. E. Harris, 6UP; Howard C. Seefred, 6EA; Lyndon F. Seefred, 6EB; L. W. Kilgore, 6VV; Sichie Wade, 6GI, 6XAH; Paul Langrick, 6ATB; B. H. Dennis, 6ZN, 6XAN; R. Sherman, 6BQP.

C. E. Duncan, 6ARB, Berkeley, Calif.; H. H. Howell, 7TQ, Medford, Ore.; E. M. Lindberg, 7AFJ, Olympia, Wash.; A. M. Snell, 6BQL, San Francisco; Noel A. Pearce, 6II, Sacramento, Calif.; M. K. Baughman, 7VO, Medford, Ore.; A. W. Williford, 6ASK, Alameda, Calif.; B. Molinari, 6AWT, San Francisco; A. Martini, 6CHL, San Francisco; A. M. Snell, 6CHL, San Francisco; S. Bradshaw, 6RK, San Francisco; Dr. N. S. Fairweather, 6BQJ, San Francisco; H. Mauseo, 6AMZ, San Francisco; H. Tattenham, 6AAU, San Francisco; C. Thompson, 6UQ, San Francisco; Pierce Parsons, 6VM, San Francisco; C. W. Holdeman, 6AGJ, San Francisco; F. J. Tuentment, 6NX, San Francisco; F. Nickson, Jr., San Francisco; E. R. Adams, 6CAI, San Francisco; L. P. Bell, 6AEA, San Francisco; H. Eng-

widit, 6HC, San Francisco; E. Staats, 6BF, San Francisco; J. H. Balsley, 6BFU, San Francisco; H. Johnston, 6CGL, San Francisco; A. Hoeflich, 6AOU; R. Warner, 6CMM, San Francisco; R. Kinkead, 6BPL, San Francisco; D. C. McRae, 6RM, Salt Lake City; James F. Brady, 6AUP, Alameda, Calif.; Norton Clapp, 6BJE, Pasadena, Calif.; Roderick Ward, 6WH, Pasadena; Herbert J. Breuer, 6JN, Emeryville, Calif.; Geo. E. Conner, 6QM, Lewiston, Calif.; Wm. Delp, 6BFP, Oakland; R. A. Kinkaid, 6BPL, Palo Alto, Calif.; David H. Atkins, Piedmont, 6BNO; E. B. Finseth 6BOB, Placentia; P. E. Riopel, Hollywood, 6BNX; D. L. O'Brien, 6VK, Oakland; Geo. Becker, Jr., 6BIP, Winnemucca, Nev.; Harlow Blair, 6AFH, Monrovia; R. M. White, 60L, Glendale; R. V. Howard, Eugene, Ore., 7LR; Wm. Voltz, 6HV, Phoenix; B. R. Cole, 6TU, Los Gatos, Calif.; P. E. Peyton, 7MU, Salem, Ore.; L. Giannini, 6UP, San Francisco; Geo. C. Fensky, 6ABK, Oakland; James H. Brown, 6BQP, Long Beach, Calif.; B. S. Pigg, 6APW, Glendale, Calif.; C. DuVall, Venice, Calif., 6BRS; E. T. Treen, 6BMC, Santa Monica, Calif.; J. R. Winn, 6BEO, Venice, Calif.; E. W. Willis, 6BPB, Santa Monica, Calif.; Brook Sawyer, 6XAS, South Pasadena, Calif. E. DeK. Leffingwell, 6BUW, Lamanda Park, Calif.; Ted Vokel, 6BOD, Pasadena, Calif.; S. Monsen, 6BQW, Pasadena, Calif.; M. P. Gilliland, 6ACB, Pasadena, Calif.; Lester Picker, 6ZH, San Ysidro, Calif.; Whittier, H. S. Radio Club, 6ABS; G. A. Starbuck, Whittier, Calif., 6CGJ; L. E. Smith, 6BUR, Whittier, Calif.; Theodore Shaw, 6AVN, Claremont; Pete Dilts, 6BH, Pasadena, Calif.; Altadena Radio Laboratory, Altadena, Calif., 6XR; A. P. King, Pasadena, 6BRJ; Ormond Lempke, South Pasadena, 6WV; Meade W. Powell, Warren, Ariz., 6GS; D. E. Chambers, San Diego, 6ANH; Horace Greer, Oakland, 6TI; H. S. Westlund, Portland, 7WK; W. E. Burk,

(Continued on Page 277)

CR9 Grebe Set---FREE

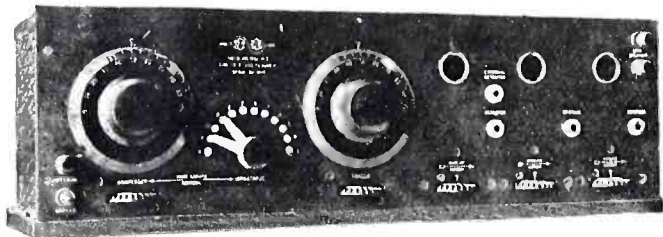
GREBE CR₉

With RORN, worth \$190
It is the Grand First Prize in
Radio Journal's Great Illustrated Radio Term
Contest.

The Type CR-9 is the ideal equipment for those interested in the reception of C. W. and Radio Broadcasts. The simplicity of its operation is without parallel. Adjustment of wave length and Regeneration is made rapid, accurate and positive by the use of specially designed rubber-tired wheel "Verniers" in conjunction with Grebe tapered grip indicating dials. The operator may "listen-in" on Detector, 1st Stage or 2nd Stage, merely by inserting the telephone plug in the proper jack. As only the tubes in use are lighted, a saving in the life of the vacuum tubes and a conservation of the filament and plate batteries is effected.

To the CR-9 is added the RORN amplifying unit. It is unlimited as to wave length range and gives the greatest possible Amplification that can be obtained from a Vacuum Tube.

Important Notice. Should the winner of the First Prize in this Contest so desire he may have the option of either the Grebe CR-9 with RORN as described above or the Grebe CR-8 with RORK and RORN at the retail value of \$195.

\$500.00 worth of Radio Parts, an I. C. S. Radio Course and Grebe CR9 with RORN are FREE for a few minutes work.



RORN

The plan is this—Radio Journal will publish a series of 18 Illustrated Radio Terms; 6 offered in the April issue; 6 are on Page 271 of this (May) issue, and 6 will appear in the June issue. Each one of the 18 pictures will suggest some common Radio Term. Study the pictures, think of the best Radio Term suggested by each picture, write them on the coupons and mail them to Radio Journal.

Forty Prizes, ranging in value from \$2.50 to \$190.00, will be given by Radio Journal for the Forty best lists submitted in this Illustrated Radio Term Contest, complying with the Rules and Regulations of the contest as set forth on Page 269.

It costs you nothing to enter this Contest and win a prize. The only requirement is that ONE subscription to Radio Journal for one year be sent in with each set of answers. This subscription may be your own, or that of some neighbor, friend or relative; and it may be either a New or a Renewal subscription.

Please remember that ONLY ONE subscription is necessary for the entire Contest. You may send the subscription in with your suggested Radio Terms with Coupon No. 1, which appeared on Page 211 of the April issue, or you may send it in with Coupon No. 2, which appears on Page 271 of this (May) issue, or with Coupon No. 3, which will be in the June issue of Radio Journal.

We suggest, however, that you send the subscription in with Coupon No. 2. Then you will have it done. But if it isn't con-

venient to send your own subscription or if you haven't time to secure a subscription from someone else to send with Coupon No. 2, then by all means send in your answers on Coupon No. 2, secure the necessary subscription later and mail it in with Coupon No. 3.

**THE MAIN THING IS TO
START NOW!**

The contest closes July 1st and you have until that date to send in a subscription. But don't put it off too long. When the matter is turned over to the judges on July 1st your complete list of suggested Radio Terms will not be considered unless you have sent in one subscription.

Grand List of Prizes on Page 270

\$500 Worth of Radio Prizes

Hundreds are entering Radio Journal's Great Illustrated Radio Term contest--Why don't you?

Rules and Regulations

These rules contain all the information you will need in competing for a prize in the Illustrated Radio Term Contest. Read them carefully.

1. Radio Journal's Illustrated Radio Term Contest is open to everybody everywhere, except employees and agents of Radio Journal and their families.

2. The Contest consists of a series of 18 Illustrated Radio Terms in every day use. Six of these pictures appeared in the April issue of Radio Journal, six are printed in this, the May issue, and the remaining six in the June issue. With each set of six pictures a coupon will be printed with spaces provided for the participant to write plainly the Radio Terms which he or she believes to be suggested by each picture. The participant's name and address must appear on each coupon.

3. The set of suggested Radio Terms means one coupon for each six pictures, the coupon being numbered from 1 to 3 and the pictures from 1 to 18. Each coupon should be clipped, filled out and mailed to the Radio Term Contest Dept., Radio Journal, 113 Stimson Bldg., Los Angeles, Calif., as they are printed. Don't wait until you have all three coupons filled out, mail each one in as soon as you can.

4. There are no entrance fees. The only requirement is that ONE yearly, paid-in-advance subscription to Radio Journal at \$2.50 must accompany each complete set of 18 answers. This subscription may be secured anywhere in the United States. It may be that of a participant or any other person. It may be either New or Renewal.

FIFTH PRIZE

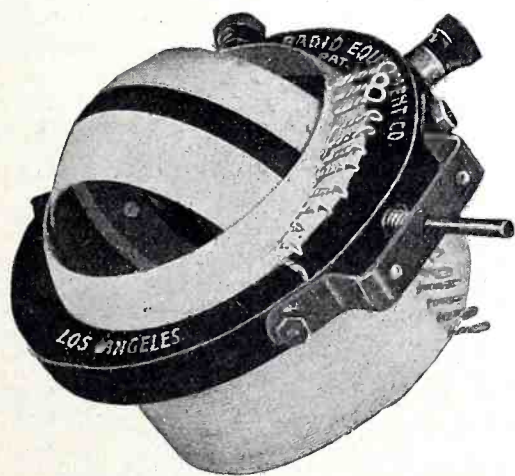

"Tune Sharp" Variocoupler

This efficient Variocoupler is very close tuned. For sharp tuning and selectivity it is one of the best. Strong and durable, yet light, and has no permanent core.

NINTH PRIZE

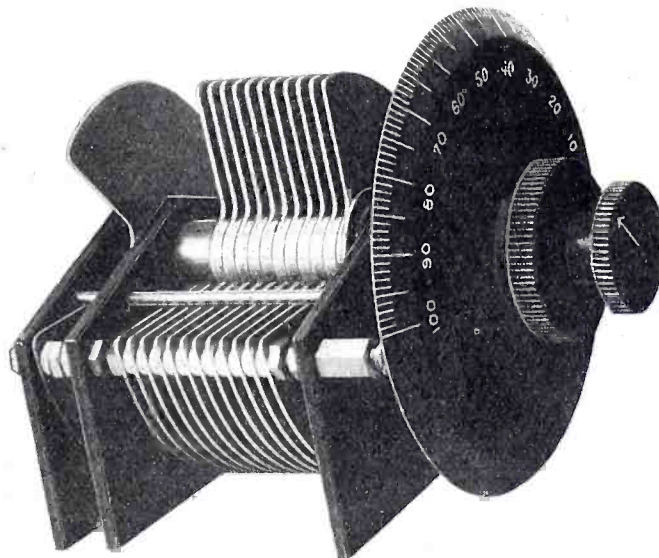

"Wireless Shop" 43 plate Vernier Condenser with Dial
One of the most efficient Verniers on the market. Accurately made and beautifully finished.

5. There is no limit to the sets of answers any participant may send in. The only requirement is that each complete set must be accompanied by ONLY ONE yearly, paid-in-advance subscription to Radio Journal at \$2.50.

6. The qualifying subscription may be sent in with Coupon No. 1; Coupon No. 2 or Coupon No. 3. It must reach the office of Radio Journal by midnight before July 1st, 1923, at which time the contest closes.

7. The Radio Terms submitted must be correct as to spelling. The Directory of Radio Terms published by Radio Journal will be considered as final authority in this respect. This Directory contains all the Radio Terms used in this Contest. It may be obtained of Radio Journal at 10c per copy, postpaid.

8. Participants may enter the Contest any time before the final closing date. Copies of the Illustrated Radio Terms and accompanying coupons may be secured free of charge from Radio Journal any time during the contest.

9. The best Radio Terms to fit the pictures are not as yet known. Selections of the best Radio Terms and the prize winners will be made by a committee of three judges, whose names will be announced in the June issue of Radio Journal and who will have no connection with Radio Journal. Participants enter the Contest with the understanding that the decisions of the judges will be final. The right is reserved for the judges to reject any set of answers not complying with these Rules and where unfairness is evident.

10. The prizes will be awarded to the participants submitting complete sets of answers with the highest number of best Radio Terms. In the event of a tie for any one prize, each tying participant will receive the full prize tied for.

Group No. 2 of 6 Illustrated Radio Terms is on Page 271

Group No. 1 appeared in the April issue. If you haven't it, drop us a card and we will mail it Free.

Hurry and Win One of the 40 Prizes

Which One Do You Want?

Here They Are

First Prize—Grebe CR9-RORN.....	\$190.00
(or Grebe CR8-RORK-RORN.....)	\$195.00)
Second Prize—International Corr. School Course in Radio.....	\$ 85.00
Third Prize—Whitson's "Stentor" Loud Talker.....	\$ 40.00

Directory of Radio Terms Will Help You Select the Right Ones

Radio Journal has published an eight-page booklet containing all the Radio Terms needed to win a prize in this big Contest. The price is 10c per copy, postpaid.

Besides making it easy for anyone to pick out the Radio Terms suggested by the pictures, this booklet is a valuable directory of Radio Terms for everyone interested in Radio.

Study the pictures carefully, then go thru the lists of Radio Terms in this Directory and select the term you think is most appropriate for each picture and write it down on the coupon in its proper place. It's easy. It's fun.

The Directory of Terms will also give you the correct terms and will avoid mis-spelling. The committee of judges, in their selection of the best terms, will be governed by the ones listed in this Directory.

The Directory of Terms contains over 500 Radio Terms, listed alphabetically.

It is not required that you buy a copy of the Directory of Terms. You may be able to think of enough to fill out the set of 18 pictures. Yet it will be far more convenient to have a copy. Then you can take your time in studying the pictures and be sure of selecting the best Terms.

Use the Coupon to send for your copy. IT MAY WIN YOU A \$190.00 RADIO SET.

Date.....

Radio Term Contest Dept.,
Radio Journal,
113 Stimson Bldg.,
Los Angeles, California.

Here is 10c (coin or stamps) for a copy of the Directory of Radio Terms.

Name.....

Street and No.....

City..... State.....

Fourth Prize—Thordarson Transformer, 450 Watts.....	\$22.50
Fifth Prize—Tune Sharp, Bank Wound, 4000-Meter Variocoupler.....	14.00
Sixth Prize—Pair Western Electric Head Phones, 2200 Ohms.....	12.00
Seventh Prize—Wireless Shop No. 41 Amplifier Unit, with RF Transformer.....	8.50
Eighth Prize—Coast Commercial Co. Choke Coil.....	8.00
Ninth Prize—Wireless Shop, 43 Plate Vernier Condenser, with dial.....	7.20
Tenth Prize—Federal Amplifying Transformer.....	7.00
Eleventh Prize—Tune Sharp 860 Meter Variocoupler.....	6.50
Twelfth to Fifteenth Prizes—4 Tune Sharp Variometers.....	6.00
Sixteenth Prize—Workrite Variocoupler....	5.00
Seventeenth Prize—All American RF Transformer.....	4.50
Eighteenth to Twenty-third Prizes—5 K. D. Variometers.....	4.00
Twenty-fourth to Twenty-eight Prizes—5 Radsco 23-plate Variable Condensers..	3.60
Twenty-ninth Prize—Set of 3 V. T. Sockets	3.00
Thirtieth to Thirty-fourth Prizes—5 400 Ohm Potentiometers.....	2.50
Thirty-fourth to Fortieth Prizes—7 Cabinets, Phillipine Mahogany, (fin- ished or unfinished), size 5¾ by 6½ by 15½.....	2.50



What Common Radio Terms do These Pictures Suggest?

Pick Them Out NOW! Group No. 2

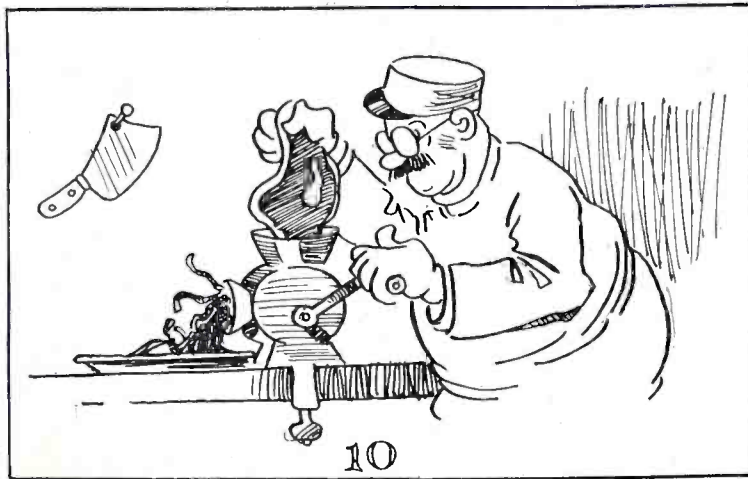
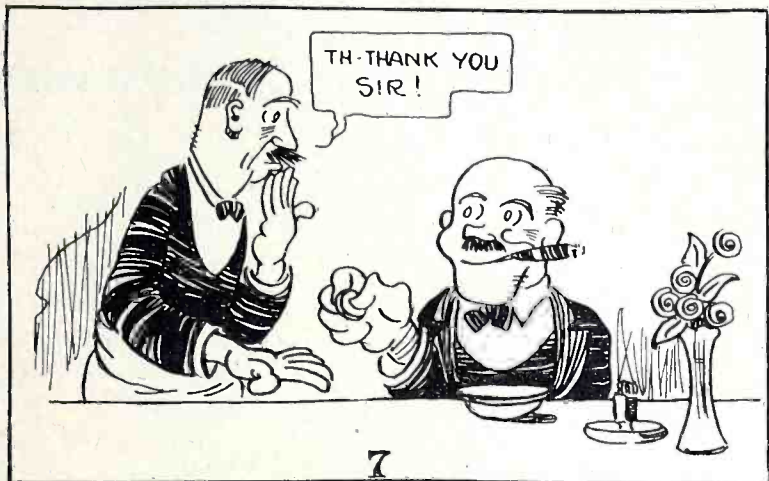

It is not necessary to send the picture. Clip out and mail Coupon only.

Radio Journal's Radio Term Contest Coupon No. 2

(Write your Radio Term Suggestions Very Plainly)

Picture No. 7

Picture No. 8

Picture No. 9

Picture No. 10

Picture No. 11

Picture No. 12

Contestant's Name.....

Subscriber's Name.....

Contestant's Address.....

Subscriber's Address.....

A new or renewal subscription to Radio Journal for 1 year together with \$2.50 must accompany this coupon or coupon No. 3, to be published in the June issue. Only 1 subscription is necessary for the entire contest.

Amateurs' Department,

Loading the Tubes

Here is a tip on how to load that five watt tube and make it stand the racket, that should be appreciated by all transmitting fans. F. W. Falck, 6BFP, of the Advance Electric company, made the discovery and now gets double or treble duty out of his five watters. He secures a base from a burned-out five watt tube, any kind will do, and carefully removes every

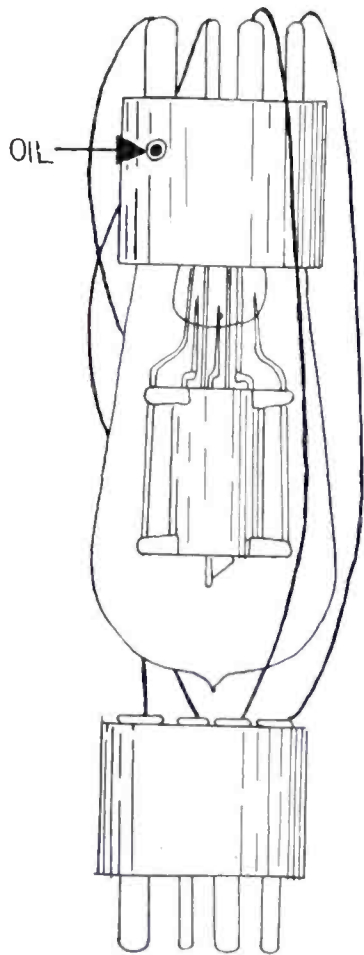

HERE IS THE FIVE WATT TUBE WITH CONNECTIONS, THE WAY IT APPEARS IN THE SET, TOGETHER WITH THE OIL HOLE FOR FILLING THE BASE WITH LIGHT OIL. THIS METHOD OF MOUNTING IS THE INVENTION OF F. W. FALCK, 6BFP.

vestige of the tube. This he places above a good five watt tube and wires the terminals of the burned-out base to the corresponding terminals on the good tube, as shown in the illustration. Then he drills an oil hole, or hole large enough to admit the tip of a small oil can, in the base of the good socket, as per illustration, and fills this with oil. Then he stands the whole thing on its head, mounting the tube

by means of the base of the burned out tube, as in the illustration. The oil seals the base of the good tube, preventing its burning out. It helps conduct off the heat, keeping the glass tube with its vacuum cool, and increases the output of the tube about twice, according to Mr. Falck, who is operating such a tube outfit and getting away with it in fine shape.

Unique Crystal Set

Editor, Radio Journal:

I do not know all there is to know about radio of course but I have built a crystal set which, I am told, is unique and on which I secure some remarkable results. The peculiar part of it is that I used instructions and hookup for a regenerative tuning type receiver for my crystal set, a hookup designed for a tube set. However, instead of hooking my secondary to any "filament" I attached it to my crystal detector in place of the tube.

An idea of the finished job can be secured from the accompanying photograph. I use an aerial one end of which is eighty feet above the ground,



JOHN D. PETTIT, 1967 CARMEN AVENUE, DIDN'T KNOW A THING ABOUT RADIO UNTIL HE PICKED UP HIS FIRST COPY OF RADIO JOURNAL A FEW MONTHS AGO. SINCE THEN HE HAS BUILT THE SET PICTURED AND GETS REMARKABLE BROADCAST RECEPTION.

keep my intake well away from the eaves of the house, and bring it in through a bookcase built in the wall, employing a top shelf of the bookcase for my set when it is not in use. The

ground is soldered to a water pipe under the house. John D. Pettit, 1967 Carmen Avenue, Los Angeles.

Phonograph Speaker

Here is a doohikus that has solved the loud speaker problem for Art Humphry of Los Angeles and may do it for you—but don't ruin your phonograph. Mr. Humphry drilled

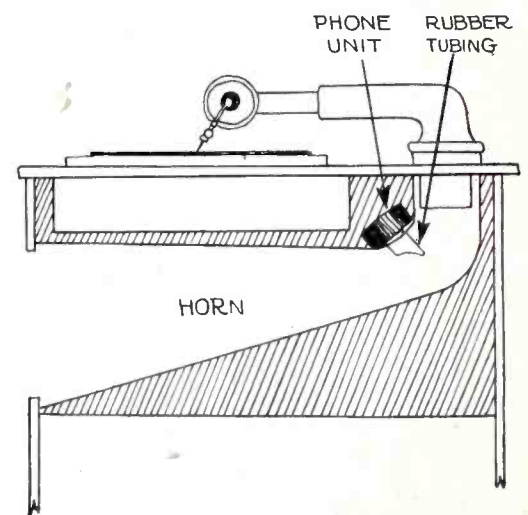

a hole through the horn of his phonograph, about as diagrammed, inserted a bit of rubber tubing, into which a connection from his single-phone unit fits, and he has what he calls a "joe dandy" speaker for his radio outfit.

Experimental Call

T. E. Nikirk, well known pounder behind 6KA, has been assigned his experimental station call 6XBC. This is the second assignment for Mr. Nikirk, as the first call was recalled by the department owing to conflict in letters. Harold Duvall, 6EN, has also been assigned his new call, 6XBA. Both amateurs live in Los Angeles.

Broadcasters who risk the loss of their licenses by giving their names and addresses to acknowledge calls, should study the U. S. "Radio Service Bulletin," which points out that direct communication is positively NOT authorized.

* * *

Probably the cheapest radio toll service in the world is that of the Avalon station WFH, with a rate of one cent a word between East San Pedro and Avalon, Calif. (ferry service).

FITZGERALD'S

For the Advancement of Music

De Forest Reflex Set

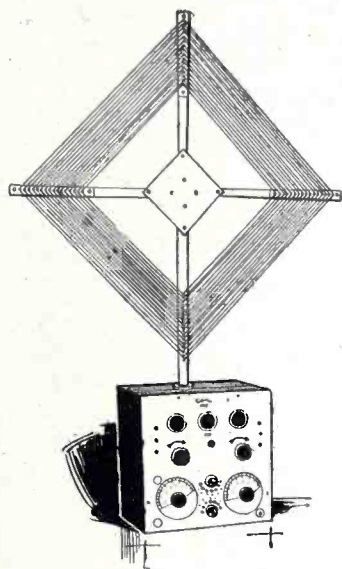

This set may be used either with inside loop aerial or outside antennae. Its simplicity [single knob control], elimination of extraneous noises and super sensitivity make possible an unusually long receptive range. The D 7-A has a wave length of from 200 to 550 meters. It is a combination of radio and audio frequency---6 stages with only three tubes.

\$132.50

RadioCraft Regenerative Radiophone Receiver

Receiver MR-6 is a complete interpanel outfit, comprising an MT-200 tuner panel, MP-100 detector panel and two MP-200 amplifier units. The standard LC-100 triple coil mounting is provided, enabling easy changes of honeycomb coils. CV-1503 and CV-1003 condensers and three circuit feed back circuit is used. DeForest rheostats, receptacles, gridleak and switches are employed. Will receive signals on wave lengths of 175 to 25000 meters.

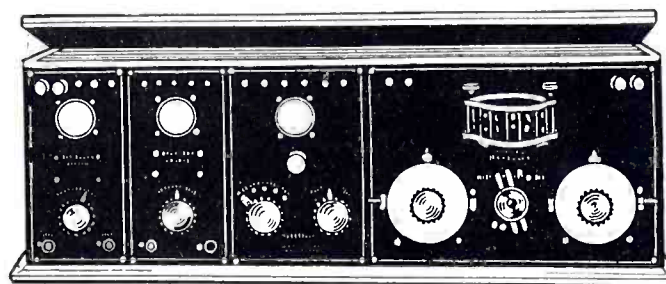

\$118.75

RadioCraft Regenerative Two-Step Amplifier

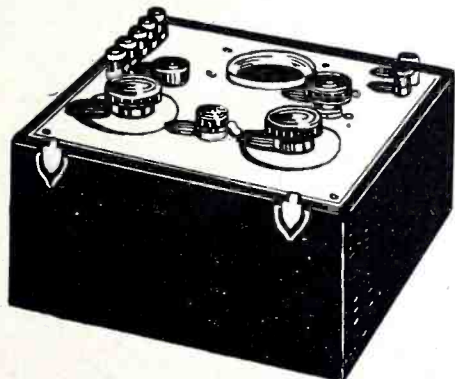

D-5 may be used with any tuner-detector unit. The Two-Step Amplifier contains two DeForest F-500 rheostats, two DeForest R-500 tube receptacles, two carefully designed audio-frequency transformers, and three jacks, permitting use of detector only, or one or two steps of amplification.

\$35.00

DE FOREST RADIO DEALERS

Howland & Dewey
Electric Appliance Co.
Charles E. Holland
Yale Electric Co.
Advance Bicycle Shop
AA-1 Radio Shop
Stanford Electric Co.
United Sales Co.
Hensel Electric Store
Mohawk Battery Company
F. McCurtain
Southern California Radio Co.
Normandie Radio Shop

(All above firms in Los Angeles, Cal.)

Universal Radio & Research, Pasadena, Cal.
Nielson Radio Supply, Phoenix, Ariz.
Claude Chess, Monrovia, Cal.
Valley Commercial, Calexico, Cal.
Radio Telephone Shop, Santa Paula, Cal.
McClay Ignition Works, Santa Ana, Cal.
Frank Nosworthy, Santa Maria
G. F. Sparling, Inglewood
Fred F. Newport, Laguna Beach
Wasco Drug Company, Wasco.
Creswell Brunswick Shop, Redondo Beach.
Eagle Rock Hardware & Furniture Company, Eagle Rock
E. F. Savage, San Francisco
Co-operative Battery Company, San Francisco
W. D. Soper, Ojai, Cal.

Kahn & Keville, San Francisco
Ben Virden, Oxnard
Brown Music Co., Ontario
Anaheim Ignition Depot, Anaheim, Cal.
O. B. Radebaugh, Flagstaff, Ariz.
Ventura Radiator Works, Ventura, Cal.
Merrifield Music Co., San Luis Obispo, Cal.
LeRoy Electric Co., Alhambra, Cal.
Orange Tire Hospital, Orange, Cal.
Norman N. Wilson, Balboa, Cal.
Equipment Sales Co., San Diego, Cal.
Brown Music Co., Ontario, Cal.
Eklund Music Co., San Diego, Cal.
Prest & Dean, Long Beach, Cal.
Long Beach Radio Co., Long Beach, Cal.

The Fitzgerald Music Co. is the Sole Distributor for DeForest Equipment in This Territory

RADIO DIVISION PHONE 10849



LOS ANGELES

HILL STREET

AT 727 - 729

CALIFORNIA

CHARGE YOUR RADIO BATTERY at HOME for a NICKEL



PATENTED ARMATURE
The HOMCHARGER'S only moving and wearing part, replaceable after thousands of hours' use for \$1.00. Tungsten contacts now used exclusively. Will not stick, corrode or wear excessively.

Enjoyable concerts and maximum receiving range are obtained only when your battery is fully charged.

THE HOMCHARGER

charges your "A" or "B" battery OVER NIGHT for a nickel without removing it from your living room. Operates silently—charging rate governed automatically. No muss—no trouble—no dirt—requires no watching.

The HOMCHARGER is the ONLY battery charger combining all of these necessary features. SELF-POLARIZING—FIVE to EIGHT-AMPERE charging rate—UNDERWRITERS' APPROVAL—beautifully finished in mahogany and old gold—UNQUALIFIEDLY GUARANTEED. Over 100,000 now in use.

The minute you buy a radio set you need a Homcharger—get it then. All good radio and electrical dealers sell it complete with ammeter, etc., for \$18.50. \$25.00 in Canada.

Write for FREE circular showing why the HOMCHARGER is the BEST battery charger at any price.

MOTORISTS — THE HOMCHARGER will also charge your AUTO Battery.

Western Distributor, **BERTRAM SMITH**
516 San Fernando Bldg.
Los Angeles, Calif.
THE AUTOMATIC ELECTRICAL DEVICES CO.
140 West Third St.
Cincinnati, Ohio

Largest Manufacturers of
Vibrating Rectifiers in the World



Auto Men Wanted!

Everywhere in California auto men are wanted. Trained mechanics, chauffeurs, battery experts, machine shop foremen, garage managers; all draw big pay. Learn the business quickly and easily in our big training shops. No previous experience necessary. Any man of any age can learn. Tools and equipment FREE. Work guaranteed to earn room and board while learning. Only expense is for low tuition. Write for FREE 72-page illustrated book of facts. Explains everything.

NATIONAL AUTOMOTIVE SCHOOL

"Oldest and Best in America."

Dept. 124, 811 S. Figueroa St.
Los Angeles, Cal.

Listening In

Real DX Music

Editor, Radio Journal:

I have been a reader of Radio Journal for over six months and sure like it fine. It is the best magazine out. Will you put these on the Listening In page? I use a Colin P. Kennedy short-wave receiver and one step. Here are the stations I have heard:

California: KVQ, J. C. Hobeht, Sacramento; KFI, Earl C. Anthony, Los Angeles; KFDB, Merc. Trust Co., San Francisco; KLP, Colin P. Kennedy, Los Altos; KUY, Coast Radio, El Monte; KUO, Examiner Pub. Co., San Francisco; KFBK, Kimball Upson Co., Sacramento; KWH, Examiner, Los Angeles; KLS, Warner Bros., Oakland; KWG, Portable Wireless, Stockton; KHJ, L. A. Times, Los Angeles; KJJ, The Radio Shop, Sunnyvale; KLX, Tribune, Oakland; KYJ, Meyberger Co., Los Angeles; KDYN, West Radio Corp., Redwood; KZM, Oakland; KPO, Hale Bros., San Francisco; KJS, Bible Institute, Los Angeles.

Utah: KZN, Deseret News, Salt Lake; KDYL, Telegram, Salt Lake.

Washington: KMO, Love's Elec. Co., Tacoma; KDZT, Rhodes, Seattle; KFC, Post-Intelligencer, Seattle; KTW, Presbyterian Church, Seattle; KDZ, R. Bellingham, Bellingham; KDZI, Elec. Supply Co., Wenatchee; KFBL, Leese Bros., Everett; KFV, Foster-Bradbury, Yakima; KFCE, F. A. Moore, Walla Walla; KGY, St. Martin's College, Lacey.

Montana: KFAP, Standard Pub. Co., Butte; KDYS, Tribune, Great Falls; KBIN, Tribune, St. Paul.

Colorado: KFAF, Western Radio, Denver; KLZ, Reynolds, Denver; DN4, National Guard, Denver.

Idaho: KFCC, Wallace; KFAN, Electric Shop, Moscow.

Oregon: KFAY, Medford; KGG, Halleck & Watkin, Portland; KFE, Meier & Frank, Portland; KGW, Oregonian, Portland.

Nevada: KFAS, Reno Motor Supply, Reno.

Canada: CFBN, Grant Radio, Calgary, Alberta; CFAC, Herald Pub. Co., Calgary, Alberta; CFBC, Northern Radio, Vancouver Island.

British Columbia: CKCK, Melrose-Bell, Regina; CJCE, Sun, Vancouver; CFCA, Star, Toronto; CTCG, Free Press, Winnipeg.

KFAD, McArthur Bros., Phoenix,

Arizona; WDAF, Star, Kansas City, Missouri; WHB, Sweeney School, Kansas City, Missouri; KSD, Post Dispatch, St. Louis, Missouri; WBAP, Star Telegram, Fort Worth, Texas; WGM, Atlanta Constitution, Atlanta, Georgia; WOAY, Birmingham, Alabama; WFAA, Dallas News, Dallas, Texas; WOC, Palmer School, Davenport, Iowa; KYW, Westinghouse, Chicago, Illinois; WEA, American Telephone Co., New York City, New York; PWX, Cuban Telephone Co., Havana, Cuba; WSB, Atlanta Journal, Atlanta, Georgia; WMAT, Paramount, Duluth, Minnesota; WLAG, Cutting Radio, Minneapolis, Minn.

That is my list of stations. I do not get many new ones for I listen to KHJ and KPO every night. I get the Star at Kansas City and KSP and Chicago every night and three or four Canada ones also. Yours truly,

FLOYD DENNIS.

516 Ash Street. Pendleton, Oregon.

From 25 to 95

Editor, Radio Journal: The following stations have been copied by me using a two-circuit tuner and a "Wireless Shop" detector and two-stage amplifier, Western Electric phones: 2FP, 4CC Canadian, 4CN Canadian, 5CN Canadian, 5FH, 5EC, 5ZH, 5JZ, 5AKB, 5ZK, 5ZA, 5ADO, 5CT, 5ADB, 5ANX, 5XD, 6s too numerous, 7IC, 7ZL, 7TQ, 7SC, 7JJ, 7JU, 7KE, 7LR, 7LW, 7OT, 7PF, 7BJ, 7HI, 7HJ, 7QI, 7ZO, 7LN, 7ZU, 7YK, 7YK, 7ZT, 7ZN, 7ZO, 7QI, 7NZ, 7VE, 8CR, 8CCU, 8ZW, 8ZY, 8YD, 8CF, 8AB, 9EEA, 9AAP, 9BJK, 9BX, 9CJJ, 9CNS, 9AYU, 9APM, 9AMB, 9FV, 9LZ, 9DWN, 9BTO, 9ZN ALL C. W.

Hoping you will have a little space for this in one of your coming issues, I remain yours,

W. KRAUSE,

BSR-EX-IBCH, 801 Catalina St., L. A.

Heard in New Zealand

Editor, Radio Journal: Since Nov. 5th, 1922, I have heard about 50 American amateurs. They are: 6KA, 9YAJ, 9BED, 9UU, 6BCR, 5PX, 6KU, 9AJP, 9CNS, 6XAD, 6EM, 9AWM, 6PD, 6XWI, 8ZY, 6ZI, 6AVD, 6ANH, 6AWP, 6ZMI, 7SC, 6JD, 9GK, 6ZZ, 7GS, 6ARB, 6BUN, 9BSG, 6IF, 6AJF, 5ZAK, 5XT, 8BXX, 5PB, 9XAC, 7ZU, 9ANS, 6BQC, 5GJ, 9DPD, 5SF, 5XAJ, 1EL, 7LR, 9DGE, 6GG, 9CXP, 9AYU, 6VM, 6BO, 9LG, 6TI, 8CEI, 2FP and several others I am not sure of, including one spark station who called 6UAD at 9:32 p. m. (New Zealand mean time) on Jan. 31, 1923. I am still using a single valve; at present a V2N.

R. SLADE,

Belfield House, Waimataitai, Timauo, N. Z.

Distant Broadcast

Editor Radio Journal: Being a reader of your magazine, Radio Journal, I have taken interest in your Calls Heard Column which I think is the best part of any radio publication. Following is a list of stations which I have heard in the last six months:

WDAH, Texas; WFAA, Texas; WAAW, Nebraska; WBAP, Texas; WLAV (30 watts six five watt tubes), Florida; WDP, Chicago, Ill.; WWJ, Michigan; WCAH, Ohio; WFI, Pennsylvania; WBF, Mass.; CFCN, Calgary, Alta., Canada; CHBC, Calgary, Alta., Canada.

I have letters of acknowledgement from all of the W's listed above, and more on the way that are not listed.

KSD, Mo.; KDYS, Montana; KFAN, Idaho; KFZ, Washington; KFC, Washington; KFV, Washington; KTW, Washington; KGB, Washington; KGY, Washington; KFAE, Washington; KFFE, Oregon; KGG, Oregon; KGN, Oregon; KGW, Oregon; KFDA, Oregon; KFAY, Oregon; KDYU, Oregon; KFAF, Denver; KLZ, Denver; KFDL, Denver; KOB, New Mexico; KFAD, Arizona; KDYW, Arizona; KDZA, Arizona.

More recent records are: WGY, Schenectady, N. Y., WHB, Kansas City, Mo., and WLAZ, Warren, Ohio.

California stations too numerous to mention.

Yours very truly,
A. B. BUTTERS,
1152 S. Serrano Ave., Los Angeles, Cal.

Detector Record

Editor, Radio Journal: I enclose a list of stations I have heard, with just a detector. It seems that quite a number of my friends have radios that are past the Two Hundred Dollar mark, and can't get what I am getting on a home-made set, and my set is open for inspection. With regard to the distances I receive, here they are: KFAF, KGG, KGW, KFAY, KZN, KDYL, KVO, KUO, KPO, KDYM, KDPT, KMJ, KZM, KLX, KLP, KWG, KFBD, CANADA (did not catch the call letters), WBAP, WCAR, KSD, KDYS.

I caught a station in Illinois, also one in Chicago, but did not get the call letters, just heard him say Chicago. Trusting this may be a record in long distance, for just a detector tube, I remain sincerely yours,

HARRY T. DEVERE,
Los Angeles, Cal.

From 2FP

2FP has messaged 6BES that he is glad to work him. This information was relayed to 6BES by 6KA, who worked 2FP, using 50 watts to raise him and two fifties to work. J. K. Hewitt, 252 Neptune Ave., Brooklyn, is 2FP. T. E. Nikirk reports that he read 2FP on two steps of amplification and that signals could be read 150 feet from the phones. T. E. Nikirk is 6KA and W. A. Starzinger is 6BES

Crystal Record

Editor, RADIO JOURNAL:

It may be of interest to some of the amateurs and, no doubt, to some who call themselves something else, to know what can happen on the simplest kind of crystal detector hookup. My son had been trying for two months to get broadcasting from WNAC and WGI not over thirty miles distant when suddenly he did get something, something beyond his fondest dreams. He got what he thought was WGI, thirty miles away, but it proved to be

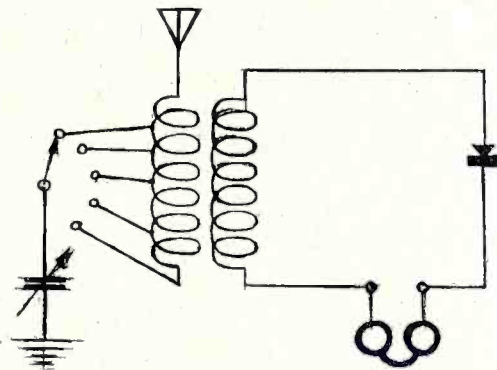

WGY, 268 miles distant. Since then, by adding the variable condenser shown in the diagram, he has received WJZ, WOR, WEA, WFI, WEAN, WBZ and last, but not least, Montreal, Canada. We believe nine-tenths of his good reception record due to good crystal. He gets them unmounted and generally splits them, being careful not to touch the virgin surface. A fine catswhisker works the best, adjusted so as to barely touch the crystal. This hookup consists of primary with 11 taps for tuning, secondary on cardboard tube inside the primary, detector and phones. Being one of your constant readers, and thinking this might be of interest I am, yours for radio, E. G. Haney, 111 Glen St., Whitman, Mass.

(Continued on Page 276)

The Autostat A Super Radio Rheostat

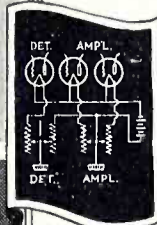
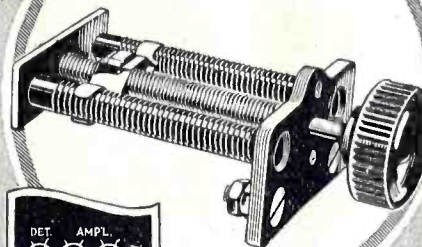

Can be used with 6-volt or WD 11 detector tubes, two amplifying bulbs or one 5-Watt power tube.

The difference between a jumbled mass of signals coming from everywhere and the "sharply-tuned" concerts received clearly and distinctly from far-away stations depends largely upon the careful adjustment of your detector filament current.

Heretofore, sharp tuning has only been partially obtained thru skillful "hair-breadth" manipulations of the filament rheostat. But with

The Autostat A Super Radio Rheostat

these much-sought-for results can be secured by anyone. Just "twirl the knob"—a full turn produces a finer adjustment than a "hair's-breadth" turn on any other.

Economical—neat—small—compact. No carbon to break or change resistance. Unqualifiedly guaranteed. Popularly priced—\$1.35.

If the Best is none too good for the set you are building or have bought, see the Autostat at any good radio or electrical dealer Today. Or write direct for Free Bulletin which shows why the Autostat is radio's Best rheostat.

DEALERS — JOBBERS
Write or wire for Radio's most attractive merchandising proposition.

Western Distributor, BERTRAM SMITH
516 San Fernando Bldg.
Los Angeles, Calif.
THE AUTOMATIC ELECTRICAL
DEVICES CO.
140 West Third St.
Cincinnati, Ohio

Builders of Precision
Rheostats since 1914

Order by Mail — From Radio Yale

BETTER PRICES
QUALITY
SERVICE

COMPLETE PARTS FOR TWO STAGE AMPLIFIER

Consisting of Chedsea Audio Transformers, 2 V. T. Sockets, 2 Rheostats, 2-2 Circuit Jacks, 1 6x9 Panel, 8 Binding Posts, Buss Bar, etc. **\$11.95**

COMPLETE PARTS FOR C. R. 5 CIRCUIT

1 Vario-coupler (on Bakelite tube wound with green silk), 1-23 Plate Variable Condenser, 2-3" Moulded Dials, 1 V. T. Socket, 1 Rheostat, 1 Jack, 8 Binding Posts, 1 6x12 Panel, 1 Tap Switch, Taps, Stops, Buss Bar, etc. **\$10.80**

Everything for Radio from a Cat Whisker to a Loud Speaker. Send money order or cashier's check. No C.O.D. WE PAY THE POSTAGE.

YALE RADIO CO. 4816 SOUTH VERMONT AVENUE
Los Angeles, California Dept. B.

Edeson Radio Phones Adjustable Diaphragm Clearance

We guarantee satisfaction, or your money refunded. The adjustment feature places our phones on a par with the world's greatest makes. Our sales plan eliminates dealer's profits and losses from bad accounts, hence the low price. Better phones cannot be made. Immediate deliveries. Double 3000 Ohm sets, \$3.98; 1500 Ohm single set, \$2.50. Circular free.



Edeson Phone Co. 6 Beach St. Dept. 8 Boston Mass.

YOUR OLD BURNED-OUT TUBE WITH \$2.50 GETS YOU A NEW ONE

Send us your old burned out 6-volt Radio Tube and we will send you a new, guaranteed 6-volt Detector or Amplifier for \$2.50. Either remit or we will send C. O. D. Immediate deliveries.

RADIO TUBE LABORATORIES, INC.
776 Broad Street Newark, New Jersey

The Perfect Condenser

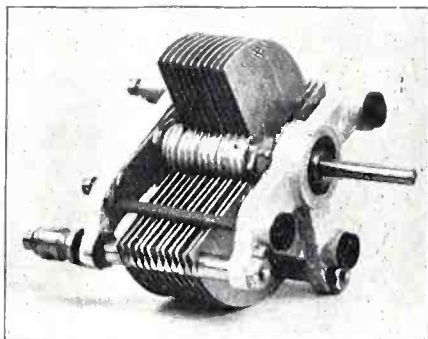

The Grigsby Condenser

Plates that are absolutely straight with a roughened surface which adds to capacity. The most critical radio expert will find nothing to improve or add. Ready to connect up and use. Adjustable tension on the plates prevents binding or slipping. Soldering clips. Spiral copper spring soldered to rotary shaft. Insulated stop for rotary plates. Prices no higher than for inferior condensers.

23 plate	\$3.00
23 plate Vernier	5.00
43 plate	4.00
Grigsby Switch	1.35
Grigsby Variable Grid Leak	1.25
Grigsby Variable Grid Leak, .00025 Condenser	1.50

Immediate delivery. Postage prepaid. Send money order or stamps, not over \$1.00.

Write for our prices on all other equipment. Courtesy to dealers.

Radio Exchange & Service

L. H. GIDDINGS, Manager
316 American Bank Building
Bdwy 733 Los Angeles, Calif.

ONE TUBE—ONE CONTROL
AUTOMATIC REGENERATION
150,25,000 Meters
AND AN AUDION, ULTRA-AUDION
HOOKUP

NO Rheostat, Storage Battery, Variocoupler, Variometer, 3-coil Mounting, Variable Inductance, Taps, Dead End Losses or Radio Frequency. Complete Hookup, cuts, instructions, everything. Nothing left for you to guess about. No stamps or checks. Build your own receiver and save 50% or more and get better results. RADIO EXPERIMENTAL LABORATORY, Box 194 H, Berkeley, Cal.

Any One Can Build a Receiving Set at Small Cost

Complete, easily-followed directions, with hook-ups and diagrams, are given in the booklet

How to Make a Simplified Crystal Detector Receiving Set

15c

Get your order in early. Stamps accepted with mail orders

RADIO JOURNAL PUB. CO.
113 Stimson Bldg., Los Angeles

(Continued from Page 275)

From Minneapolis

Here's a delightful batch of "calls heard," sent in by D. C. Wallace, 9ZT, 54 Pennsylvania Ave., N. 33, Minneapolis, Minn., for February and March. Read 'em and weep:

(1AW), 1FD, 1GV, (1HX), 1IL, 1QP, 1RD, 1TS, 1XU, 1BAN, 1BES, (1BKQ), 1BOQ, 1CDI, 1CJA, 1CMK, 1CMP, 2CQ, 2FP, 2KF, 2NZ, (2OM), 2RZ, 2XL, 2XZ, 2AFP, 2AGV, 2BMR, (2BRB), 2BZV, 2CBW, 2CCD, 2CKL, 2CPA, 3AB, 3AX, 3CX, (3FP), 3FQ, 3FS, 3GC, 3HG, 3HK, 3IL, 3KM, 3SU, 3SW, 3TR, 3YO, 3ZO, 3ZP, 3ADX, 3ALN, 3APR, 3ARO, 3BJC, 3BNG, 3CAN, 4DN, 4FS, 4HW, (4KM), 4AAC, (5BE), (5BW), (5EK), (5EL), (5MO), (5JJ), (5KC), (5KN), (5KW), (5MO), (5NZ), (5PB), (5PX), (5SK), (5UZ), (5WH), (5ZA), (5ZH), (5ADB), (5AEC), (5AHD), (5AIB), (5XAB), (5ZAS), (5ZABA), 6CU, (6EA), 6EB, 6GF, (6IF), 6IR, (6JN), 6JX, 6KA, 6MH, 6ZH, 6ZW, (6ZZ), (6AAK), 6ABK, 6ABX, 6AGJ, 6ANH, 6APW, 6AWT, (6AWX), 6BEG, 6BJQ, (6BOE), (6BUN), 6BVF, 6BVG, (6CAJ), 6CGW, (6XAD), 7EC, (7EQ), (7JW), 7LF, (7LR), 7LU, (7PF), 7WX, (7ZN), 7ZO, (7ZU), 7ZV, 7ZY, (7ABB), 7AFW, (7AIY), (8AA), (8AB), (8CF), (8CP), (8FU), (8JJ), (8NV), (8PB), (8QK), (8UC), (8VY), (8WA), (8WV), (8ZD), (8ZN), (8ADK), (8AIZ), (8AIO), (8AKC), (8APT), (8APW), (8ASZ), (ATX), (8AVD), (8BBE), (8BCY), (8BEN), (8BGL), (8BGQ), (8BIB), (8BOE), (8BOG), (8BRD), (8BUC), (8CAP), (8CBI), (8CGJ), (8CMI), (8CPD), (8CUR), (8CVU), (8DAA), Canadian, 3BQ, 3CO, (3DE), 3GK, 3OJ, (3SI), (3NI), 3UC, 3XN, 3ZL, (4BV), (4CN), (4CO), 4DQ, (4HH), 4KL, 3NB, (9AL), (9BX).

Spanning the Pacific

(Continued from Page 246)

seen on the floor. Using normal filament voltage and 650 volts on the plates the radiation is about 2.3 Weston thermo amperes. Next in line is the aerial switch and storage battery voltmeter just below. Then comes the three circuit regenerative receiver. The coupling in this receiver is exceedingly loose. The signal strength has been sacrificed for selectivity. 2 FP in Brooklyn, N. Y., has been copied nicely.

The apparatus at the extreme right is not a new type of receiver with loud speaker attached but an embryonic 50-watt transmitter termed by many local hams a "Stone-crusher." It consists of an R. C. A. inductance, 50-watt tube, stoppage condenser, a filament heating transformer and a .6KW discarded power transformer furnishing 2300 volts for the plate supply. Using "pure" AC the radiation is about 4 Weston thermo amperes. Filter condensers, control switches and a Homcharger are mounted below on the rear of table.

Since the picture was taken this tuner has been discarded for the Reinartz tuner, using a very small aerial and one step of amplification. Superior results on CW are obtained.

The Reinartz is extremely selective and once the tube is oscillating, the amateur wave band can be covered with the 17-plate tuning condenser.

On the wall may be seen a couple of early commercial licenses of the vintage of 1911 and 1913 with approximately 125,000 miles of sea travel to their credit.

Though not a high powered station, 6BVG has been logged at many stations on the east coast as well as in Canada, Alaska, and Hawaii. The best DX report comes from a ship operator 4300 miles west of Los Angeles.

Are you in the big \$500 Radio Journal Contest? See page 268 of this issue.

STATEMENT OF THE OWNERSHIP, MANAGEMENT, CIRCULATION, ETC., REQUIRED BY THE ACT OF CONGRESS OF AUGUST 24, 1912

Of Radio Journal, published monthly at Los Angeles, California, for April 1, 1923.

State of California, County of Los Angeles—ss.

Before me, a Notary Public in and for the State and county aforesaid, personally appeared Hugh Harlan, who, having been duly sworn according to law, deposes and says that he is the Business Manager of the Radio Journal and that the following is, to the best of his knowledge and belief, a true statement of the ownership, management (and if a daily paper, the circulation), etc., of the aforesaid publication for the date shown in the above caption, required by the Act of August 24, 1912, embodied in section 443, Postal Laws and Regulations, printed on the reverse of this form, to-wit:

1. That the names and addresses of the publisher, editor, managing editor, and business manager are:

Publisher, Radio Journal Publishing Co. (Inc.), Los Angeles, Calif.

Editor, K. P. Frederick, Los Angeles, Calif.
Business Manager, Hugh Harlan, Los Angeles, Calif.

2. That the owner is: (If the publication is owned by an individual his name and address, or if owned by more than one individual the name and address of each, should be given below; if the publication is owned by a corporation the name of the corporation and the names and addresses of the stockholders owning or holding one per cent or more of the total amount of stock should be given.)

Radio Journal Publishing Co. (Inc.), Los Angeles, Calif.

Hugh Harlan, Los Angeles, Cal.

Anna E. Harlan, Los Angeles, Calif.

A. C. Humphry, Los Angeles, Calif.

K. P. Frederick, Los Angeles, Calif.

3. That the known bondholders, mortgagees, and other security holders owning or holding 1 per cent or more of total amount of bonds, mortgages, or other securities are: (If there are none, so state.)

None.

4. That the two paragraphs next above, giving the names of the owners, stockholders, and security holders, if any, contain not only the list of stockholders and security holders as they appear upon the books of the company but also, in cases where the stockholder or security holder appears upon the books of the company as trustee or in any other fiduciary relation, the name of the person or corporation for whom such trustee is acting, is given; also that the said two paragraphs contain statements embracing affiant's full knowledge and belief as to the circumstances and conditions under which stockholders and security holders who do not appear upon the books of the company as trustees, hold stock and securities in a capacity other than that of a bona fide owner; and this affiant has no reason to believe that any other person, association, or corporation has any interest direct or indirect in the said stock, bonds, or other securities than as so stated by him.

5. That the average number of copies of each issue of this publication sold or distributed, through the mails or otherwise, to paid subscribers during the six months preceding the date shown above is (This information is required from daily publications only.)

HUGH HARLAN,
Business Manager.

Sworn to and subscribed before me this 12th day of April, 1923.
(SEAL) GIRARD F. BAKER,
Notary Public in and for said County and State.
(My commission expires April 13, 1926.)

(Continued from 267)

Portland, 7TT; Wm. Morton, Portland, 7RV; P. S. Burtchaell, San Francisco, 6AHE; R. L. Lithgow, Long Beach, Calif., 6BJB; J. Rickerberg, Pomona, Calif., 6ALO; C. M. Fitch, Pomona, 6BFG; B. Molinari, 6AWT, San Francisco; G. W. Burkhardt, Montebello, Calif., 6BMS; W. A. Starzinger, 6BES, Watts, Calif.; Dr. J. E. Waters, 6EC, Anaheim, Calif.; Dr. A. E. Banks, San Diego, 6ZB.; A. Simmons, San Diego, 6BJY; H. M. Hucke, J. A. Duggan, Woodland, Calif., 6ARF; W. Huston, Woodland, Calif., 6ABX; R. W. Thielke, Ackley, Ia., 9BZI; Beverly Laugenor, Woodland, Calif., 6CBW; Lyndon Farwell, Los Gatos, Calif., 6UW; D. B. McGowan, San Francisco, 6ZE; W. F. Kitchens, El Paso, Tex., 5AKY; Geo. C. Miller, Tacoma, Wash., 7WX; E. C. Garette, Colusa, Calif., 6CC; Geo. Rufener, Puente, Calif., 6BEQ; Vancouver, B. C. 5GO.

Hall Berringer, president of the Southern California Radio Association, has accepted a position with C. R. Kierulff & Co., jobbers of radio equipment in Los Angeles, Calif. Mr.

Berringer is widely known, both to business interest and amateurs in radio.

Build Your Own

Home built sets are the subject of a contest just launched by the Newbery Electric Corporation, 724-26 South Olive street, Los Angeles. Sets are to be constructed of any make of material, purchased anywhere. The winning sets are to be exhibited by the Newbery company and photographs of the winners will be published in Radio Journal. "The home builder of radio equipment has been the inspiration and guiding star in radio," said Manager Schifferman of the radio department, "and this contest is designed to stimulate and inspire further research in the field of radio reception. We may discover another Edison, who knows."

Another Contest

The Wireless Shop, 1262 West Second street, Los Angeles, Calif., has launched a contest with valuable prizes for the best records for reception on the reflex set. All records

must be postmarked not later than midnight June 15, all must be verified by at least three people, a description of the set and antenna used must accompany all entries, preferably a photograph. Announcement of the winners will be made in the August issue of Radio Journal.

Home Radio

At Barker Bros. you will find that not only are the best grades of equipment carried, but also that specialists in installation of equipment, and in instruction, are at your service.

Here the whole field of radio activity is considered, not as a mere plaything, but at its true value in the scientific world.

Complete outfits and all supplies and accessories of the better kinds and grades available here.

**KENNEDY
EQUIPMENT**

Kennedy Radio Receivers and Amplifiers were designed by the men who planned such famous stations as Bordeaux, Annapolis, San Diego and others.

Barker Bros.

Complete Furnishers of Successful Homes
BROADWAY, BETWEEN SEVENTH AND EIGHTH
LOS ANGELES, CALIFORNIA

A MESSAGE FROM M.A.R.S.

To Radio Fans Everywhere:

When your friend suggests that you get that new Radio Set, he implies that you should get it from M. A. R. S. the 100% RADIO SHOP, where you get 100% Radio Service.

SPECIAL: Complete set material for FLEWELLING Circuit, less tube and batteries and cabinet, \$20.00 postpaid. All highest grade material.

MANUAL ARTS RADIO SHOP

4154 S. VERMONT AVE.

VERMONT 7836

LOS ANGELES, CALIF.

Why the **MACDRY** Battery is Superior for RADIO USE

It eliminates the whistling or hissing sound so annoying where the old-fashioned wet or acid battery is used for Radio purposes. It saves the necessity for service at regular intervals, adding water, etc. It is recommended for use in homes as there is no spillage of acid or chemicals to damage rugs, furniture, etc.

REQUIRES
NO WATER
ACID
ATTENTION

MAC-DRY
The Modern Battery
Guaranteed *Three* Years
Lasts Longer



Mack
Battery
Co.

SAN FRANCISCO, CAL.
Branch:
987 Post Street
Phone, Franklin 3133

LOS ANGELES, CAL.
Factory and General Office
Alameda, Cottage and
Roseberry Streets
Phone 293-129

LOS ANGELES, CAL.
Branch:
1214-16 S. Figueroa St.
Phone 612-92

CHICAGO, ILL.
2015 Michigan Ave.
Phone, Calumet 5522

DeForest Company Sold

Outright purchase of the entire business, good will and patents of the DeForest Radio Telephone and Telegraph Co. has been announced by President E. H. Jewett of the Jewett Radio and Phonograph Co. of Detroit. Associated with Mr. Edward Jewett in the purchase are Theodore Luce, former Detroitier now associated with the New York and Chicago bond house of A. C. Allyn; Frank W. Blair, President of the Union Trust Co. of Detroit; H. M. Jewett, President of the Paige-Detroit Motor Car Company; and several other capitalists and radio experts.

As the result of the purchase, the Detroiters come into possession of 181 radio patents, among them the basic rights to the three-electrode audion bulb, which is an essential part of every long distance radio receiving or sending set.

The purchase also includes the fine new plant of the DeForest Company at Jersey City, the largest individual plant in the world devoted solely to radio manufacture, at which DeForest inventions are manufactured commercially.

Dr. DeForest remains with the company under a long-time contract as consulting engineer.

Science of Invention

(Continued from Page 258)

tations, though it possesses, to a remarkable degree, a fundamental relation to life, if not in all developments of all organisms, becoming as it is the underlying force bringing about all organic differentiation in matter, it has, to most of us, if not to most of our so-called experts or scientists, a high degree of arcana, or mystery.

That electricity is material, actuated by material powers and motions and along material lines, is at all times evident, since, like water, it uniformly follows the lines of greatest traction and least resistance. A knowledge of electricity was possessed by the ancients. It has been said that they knew of the electrical properties of amber, of which fact we have been informed by Pliny, the historian. Even before Pliny, however, in the early days of Thales of Meletus, to whom, with other philosophers, we have above referred, the active power of electricity and its magnetic regeneration in motion, as in amber, was known, and the conclusion was developed of the existence of *electrum* (as it was known in Latin). It has been asserted that the ancients knew how to collect electrical "fire" from the clouds or atmosphere; and that Tullus Hostilius lost his life performing some sort of a stunt, probably by flying a kite, or otherwise, as was done by our illustrious Benjamin Franklin. Etymologists have carried the discovery of electricity back into Grecian mythology, having indicated that Jove obtained his surname of Eliacus because of his knowledge and use of electricity, but this probably is as highly conjectural as it may be mythological.

The first known scientific discovery of electricity was effected by Dr. W. Gilbert in 1660, details of which were published by him in a work entitled "De Magneto." Dr. Gilbert was followed in his pursuits by celebrated scientific characters, including such as Boyle and others. Then came the galvanic battery with the entry of Benjamin Franklin, verifying the fact that the "thunderbolts of Jove" were of electricity as found in the galvanic battery. Many fatal accidents have resulted from experiments made by persons ignorant of the science. On the 6th of August, 1753, at Petersburg, Professor Richmann lost his life by endeavoring to draw the electric fluid from the clouds into his house (possibly Franklin got his idea from the late Professor). Then Samuel F. B. Morse invented the telegraph, utilizing the electro-magnetic waves. Then Alexander Graham Bell enters upon

Radio KUS Sings a Spring Song

Spring housecleaning is much different now than in the old days. The old carpet beater has taken its place in the world's junk pile along with the "coal oil lamp" and the "horse and buggy." Today women are having their

Rugs and Carpets Cleaned by the Famous Jenkins Process

This service is no farther away than your telephone. Phone South 120 or 270-71—and the City Dye Works men will be on hand when you want them.

J. S. Jenkins
CITY DYE WORKS
3000 CENTRAL AVE.

Uptown Stores, 417 W. 7th St.
Branch Stores: 224 S. Western Ave.; 6529 Hollywood Blvd.; Pasadena, 390 E. Colorado; Long Beach, 4 Pine Ave.; Ocean Park, 140 Pier Ave.

Hartsook
Photographs

Studios in

All California Cities

ORPHEUM BUILDING

41 Grant Avenue
San Francisco

636 South Broadway
Los Angeles

the stage of invention with his telephone, followed, at a respectable distance, by Marconi with his wireless apparatus for the propagation of these electro magnetic waves, out of all of which the wireless telephone—the radio of today—was evolved.

Spectroscopical analysis of the physical condition of nebular formations, in various states of evolution, shows that all organic development in the primordial arrangement in matter brings about heat, light and electricity, though, in my opinion, electrical motions are the most primordial of all, with heat and light as secondary and consequential developments. Manifestly as electricity develops in all forms of matter, according to kind, from its most primordial down to its highest state of heterogeneous arrangements, it must necessarily be a complement of all existence and becomes, as it were, a fulcrum in the redistribution of power and motion in matter, in all stages of evolution through which the material universe has passed and is passing; all of which may be substantially described by saying that there is a gradual transmutation of matter from a gaseous through a liquid to a solid state, or from a spherical gaseous, a colloidal liquid, to a polyhedral solid, all involving progression from slow indefinite motions through the process of the concentration of matter, its differentiation into elements, involving its transmutation of motion, until these elements have increased in number as displayed in their present high state of heterogeneity, possessing the greatest amount of contained motion, in the least amount of matter of the highest quality, involving the least amount of specific heat and the highest atomic weight.

Throughout this process of evolution involving the differentiation of organic matter and transformation of organic motion, the entire process is everywhere accompanied by the generation and utilization of electrical forces, associated with the development of heat and light, all varied in both amount and kind according to the nature of, the movement in, and the pressure and density possessed by these elements, resulting in relative velocity and definite wave lengths.

It is believed that the velocity of organic movement in matter increases by the law of areas involved in the electronic arrangements of matter which, of course, means that all organic velocity will be varied inversely with the square of the distance from the common center of motion and gravitation, just as we find it substantially displayed (though it is not here accurately expressed) in the planetary movements around the sun in our solar system. However this may be,

all of these movements in matter are material, as counter-distinguished from those of radiant forces such as gravitation, electro-magnetic waves, heat and light, and are all governed by fixed and immutable laws.

The remarkable state of equilibrium manifested throughout all organic development is found, and visibly expressed, not only in the material combinations, integrations, differentiations and redistributions, of matter, as it is organically generated nearer and nearer towards the common center of gravitation and motion, but this equilibrium is also manifested in that equipoise existing between the amount of electro-magnetic waves, accompanied also by heat and light, generated by magnetism gravitationally propagated, according to the law of the inverse squares, as this material organic progression takes place with reference to the center of gravity and motion. In other words, as there is a gradual concentration of elements, involving the gradual transformation and differentiation of elemental matter and its combinations and its contained motion, as its distance to the common center and its power of association is varied, there is an inverse variation of motion manifested in this matter, as well as in the kind of elements generated thereby, all held, at all times, in a state of equilibrium, according to the force regenerated in the various and heterogeneous electro-magnetic waves, and in the heterogeneity of heat and light, all propagated away from this common center of motion and gravitation. This remarkable arrangement is manifested in all organic developments and without a single or possible exception.

Thus we see, electrically speaking,

Tune in to **WDAP**
—the powerful broadcasting station at
The DRAKE
Lake Shore Drive and Upper Michigan Avenue, Chicago.
From Porto Rico to lonely ranches in Alberta and Saskatchewan, from sunny San Diego to Quebec, and even a thousand miles out in the Atlantic and Pacific Oceans, programs from **THE DRAKE** are picked up. You'll be particularly well repaid by tuning in Tuesday, Thursday, Saturday, and Sunday evenings—concerts include selections by **THE DRAKE** Ensemble Orchestra.
WDAP Station is but a single interesting feature of **THE DRAKE**, Chicago's finest hotel. When in Chicago be sure to stop at **THE DRAKE**. See how concerts are broadcasted, and enjoy the world famous service and surroundings of this wonderful hotel. Information on request.
Under the Blackstone Management, the world's standard in hotel service.

RADIO
WE SUGGEST YOUR SELECTION from the largest assortment of parts and supplies or anything pertaining to Radio in the city. **COMPLETE STOCK OF RADIO SETS—De Forest, Sunnyvale, Kennedy and Radio Corporation.**
Mail orders solicited.
Equipment Sales Co.
402 B Street, corner of 4th San Diego, Calif.

Exchanges, Trades and Sales
are being made every day by Radio Journal Want Ads. Why don't you use them? 5c per word with a minimum of 20 words. Send Money Order to Radio Journal, 113 Stimson Bldg., Los Angeles, Calif.

Loud Talkers HOW TO BUILD THEM
By H. W. Secor, Associate Editor "Science and Invention"
This book describes how to build two distinct types of Radio Loud Talkers, using the simplest parts possible, which the experimenter can make himself or saving at least half the price of a commercial Loud Talker by having the difficult parts made in a local machine shop.
Book has 46 pages, 25 illustrations, bound in beautiful two color cover.
Price, prepaid, \$.25.
Order from your dealer or direct from us. Write for descriptive circular of other Radio Books
THE E. I. COMPANY
233 Fulton Street New York City

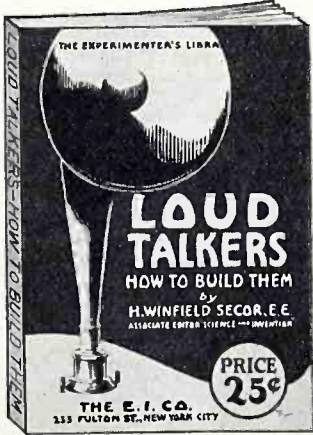

Hit it anywhere! **MAGNETITE RADIO-CRYSTAL**
The most sensitive Crystal Detector on the world market. Unaffected by handling or moisture and will render efficient service indefinitely. Price 50 cents at ALL DEALERS—or mailed direct. **GUARANTEED** by

GIBBONS-DUSTIN RADIO MFG. CO.

OWNERS AND NATIONAL DISTRIBUTORS

518 WEST 9TH STREET

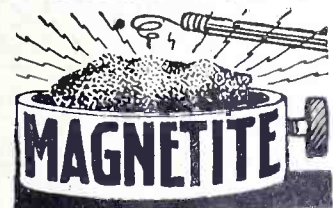

LOS ANGELES, CALIF., U. S. A.

that the electronic element has its motions generated organically into electricity and transmuted to, and expressed in, the form of the electro-magnetic waves and forces, all of which are propagated equally in all directions by the regeneration thereof, from which it is inductively evident that although electricity itself has a material force, it follows, like water or other liquid combination of elements under heat, the line of greatest traction and least resistance, and its motion when so regenerated becomes electro-magnetic, finding its relative equivalent in a corresponding transmutation in the molecular and atomic motions and their rearrangements and redistributions of matter on the one hand and the radial propagation of gravitation, heat and light on the other. Hence, it follows that magnetism intervenes to bring about transmutation through the electronic, atomic and the molecular, and, therefore, a corresponding regeneration of these forces must be had in order to produce a transmutation of heat and light into the electro-magnetic.

The constant organic value of an organism is measured by the sum of its atomic mass actuated upon the line of organic gyration, holding all orbital bodies as units in relation thereto according to the sum of the atomic mass

so actuated, times the orbital velocity within equal units of time, times the square root of like units of radial distance from the line of gyration.

This statement of organic value is comprehensive of all electrical motions and developments from those involving the material transformations to those involving the transmutation of radiant energy involving the heterogeneous wave lengths, as manifested from the electro-magnetic to that of heat and light, if not of gravitation also.

In the next article it is my intention to historically and philosophically follow the trend of scientific development leading to our present patent laws. Then, later, to enumerate the elements of invention and discovery under these patent laws, followed further by some discourse upon the patentability of inventions in general and the protection afforded under our patent system to inventors and discoverers, all of which should be of interest as the argument is pursued, particularly in view of the fact that we are just now merging into the radio age, having only very recently advanced through the stone, iron, bronze, steel and electrical ages.

Are you in the big \$500 Radio Journal Contest? See page 268 of this issue.

Trade Talks

(Continued from Page 265)

THE AUTOSTAT

Representing one of the most radical advancements in Radio Filament Control, the Autostat, developed in the engineering laboratory of the Automatic Electrical Devices Company, Cincinnati, Ohio, also manufacturers of the Homcharger, has made its appearance this month and is available for general sale.

The Autostat, known as a super radio rheostat, gives the most precise control of filament current, inasmuch as it is not necessary to turn the knob a hair's breadth to get a fine adjustment, since there are forty complete turns of the knob between maximum and minimum resistance, compared to three-quarters to three turns on all others.

Its construction is radically different, too. Two parallel mounted, wire-wound, fire-proof resistance tubes are connected in series by a micrometer-operated slider—the length of wire in circuit depending upon the location of this slider.

It is claimed that one full turn of the Autostat knob produces finer tuning than a hair's breadth adjustment on any other—that it brings in distant stations loud and clear and

"GOOD RADIO PRODUCTS"
"Low Prices"

Back Panel Switches

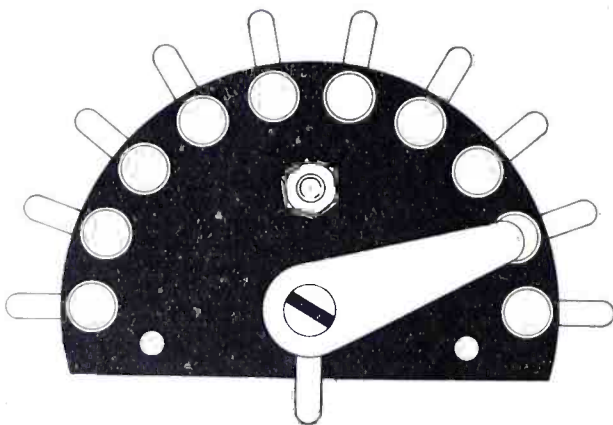

Patent right
protected

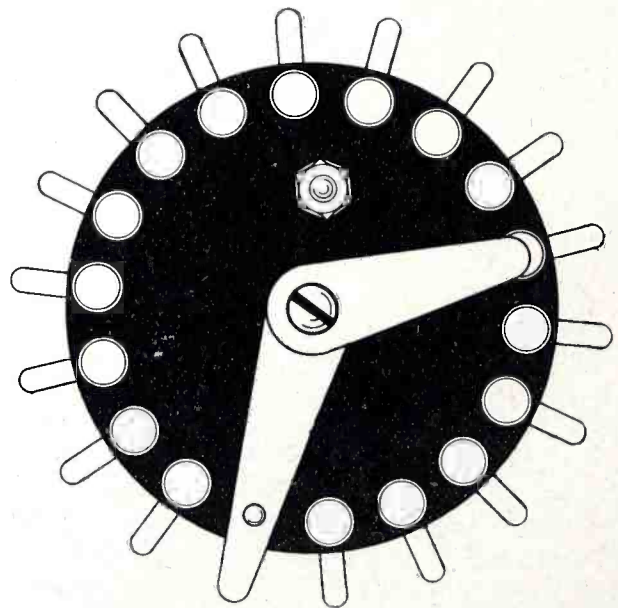

None Better at Any Price
Liberal Discounts to the Trade

L. A. DEALERS
Radio Stores Co., 398 So. Spring
Radio Sales & Service, 820 W. 7th
Lester's Radio & Electric Co.,
140 South Spring

Radio Lab and Mfg. Co.

Telephone 19208

215 Court St.,

Los Angeles, Cal.

FINISHED BAKELITE PANELS. CUTTING and ENGRAVING

Reasonable Prices

tunes in those elusive stations that heretofore have remained unheard. It gives a uniform change in resistance with each turn of the knob, possessing practically "zero" resistance at full-on position.

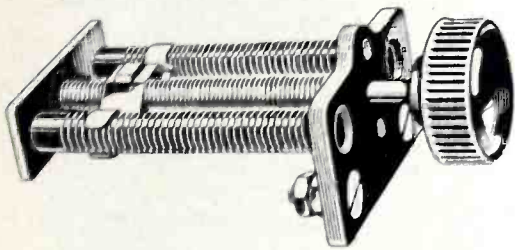

COMPACT AUTOSTAT REPRESENTS BIG ADVANCE IN RADIO ENGINEERING.

The Autostat is compact in size, neatly mounted, requiring less space than any other. Furthermore, it is a most economical rheostat inasmuch as only one Autostat is necessary to control two amplifying bulbs. It can also be used with six volt or W. D.-11 Detector tubes, or one 5 watt power tube.

The Autostat is popularly priced at \$1.35 and is unqualifiedly guaranteed by the manufacturer.

For further information, we would suggest writing the Automatic Electrical Devices Company at 140 West Third Street, requesting their new bulletin No. 646.

New Radio School

Big improvements are going forward at the Los Angeles Radio Institute, of which G. E. Knudsen is superintendent, at 625 South Hope street. A super-heterodyne set, Kolster loop, vacuum pump, Kolster decimeter and 1KW phone set are being added to the equipment of the already well established institution. Before many months the school expects to have to enlarge its quarters, as it is already cramped for class rooms. Courses are given in CW and spark transmitting and receiving, the construction of vacuum tubes, and special work to individuals or small group classes in any phase of radio. Superintendent Knudsen became a commercial radio operator in 1910 and has worked in the radio field, either in laboratories or in the field, since that time, with DeForest, United, Marconi, etc. The new school opened in February and is now teaching large evening classes, with special classes during the day.

To realize the steady interest maintained in amateur radio telegraphy, one has only to note the number of general and restricted licenses issued since January first, a gain of six hundred and one amateurs in two months.

When writing to advertisers mention Radio Journal.

ANNOUNCEMENT

CAT WHISKER RADIO CRYSTALS are the product of El Picacho Mining Co., Inc. They are mined, tested and prepared for the consumer by that Company in their RADIO LABORATORIES, maintained at 1423 West Pico St., Los Angeles, Calif., for that purpose.

BY COMPARISON these crystals are of the MOST SENSITIVE MINERAL EVER MINED.

THE ULTIMATE will be: A CAT WHISKER CRYSTAL; after you have tried all the rest. Whether it is a reflex circuit or just a straight crystal set, you will be amazed at its sensitiveness.

Dealers and Jobbers, write to
RADIO LABORATORIES
1423 West Pico St. Los Angeles, Calif.

Mounted, 50c Unmounted, 35c



G. E. KNUDSEN
Superintendent

Classes 5 Days—5 Nights Per Week



S. O. S. Radio Needs You

Unlimited Opportunities in this field
Train Yourself in America's Finest and Best
Equipped Radio School

Tuition
\$10 per Month, Night Class
\$12.50 per Month, Day Classes

Our Equipment Consisting of a 2KW Federal Arc Marconi and Deforest Spark—Super-Heterodyne Receiver—Radio Compass—1 KW Radio Telephone Transmitter—Those who are interested in a Correspondence Course write for Particulars Regarding Same

INSTRUCTING ENGINEER

625 SOUTH HOPE ST., Third Floor LOS ANGELES, CALIF.

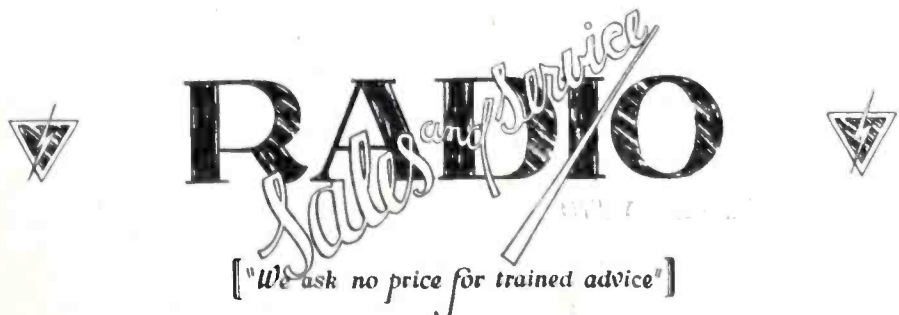

820 West Seventh St. - Los Angeles
824-627

Prompt and Efficient Service
The Best of Radio Equipment
Reliable Information

B. H. Dennis

O. S. Garretson

Are You Equipped to Win Success?

Here is your opportunity to insure against embarrassing errors in spelling, pronunciation, and poor choice of words. Know the meaning of puzzling war terms. Increase your efficiency, which results in power and success.

Webster's New International

DICTIONARY is an all-knowing teacher, a universal question answerer, made to meet your needs. It is in daily use by *hundreds of thousands* of successful men and women the world over.

400,000 Words, 2700 Pages, 6000 Illustrations. 12,000 Biographical Entries, 30,000 Geographical Subjects.

GRAND PRIZE, (Highest Award)
Panama-Pacific Exposition.

REGULAR and INDIA-PAPER Editions

WRITE for Specimen Pages. FREE
Pocket Maps if you
name Radio Journal.

G. & C.
MERRIAM
CO.

Springfield
Mass.,
U. S. A.



Music transmitted from the United States was picked up in Germany for the first time on February 24, according to word from Lichterfelde, a suburb of Berlin.

Thrills in Brazil

(Continued from Page 261)

Two 125-foot masts were erected on the verge of the precipice on which are stretched a 153-foot six-wire antenna between two 26-foot spreaders. The counterpoise consists of two sections of five wires each, mounted on two 26-foot spreaders which are balanced on the ends of the 70-foot horizontal poles bolted fast to the mast on the summit. The counterpoise wires are stretched clear of the mountain sides, down about 100 feet to the tops of two poles located near the terminal building of the railway where the wires converging symmetrically form a 10-wire cage which leads into the radio telephone operating room. The hum of the 220 volt alternating-current motor was eliminated by a filter system made up of microfooid condensers and large choke coils.

A single wire antenna was strung from the mountain top to the operating room, about 125 feet below, for receiving messages. A speech amplifier is located in the operating room.

The call letters "SPC" were assigned to the station, and the first concert was broadcast on August 15. This concert was "picked up" by many receiving stations, and three days later the "American Legion," 151 miles out at sea, reported hearing the signals clearly. The S. S. "West Nores," 175 miles out, received the signals with one tube only.

The first week of broadcasting completely captured the Southern republic. The Grand Opera House, rivaling any in the United States from

point of architecture, has been equipped with a microphone, connected by amplified lines of SPC's mountain top station, and both afternoon and evening performances are broadcast.

An amplified line has also been installed in the Monroe Mansion for broadcasting from Rio. The mountain top studio, in the same building

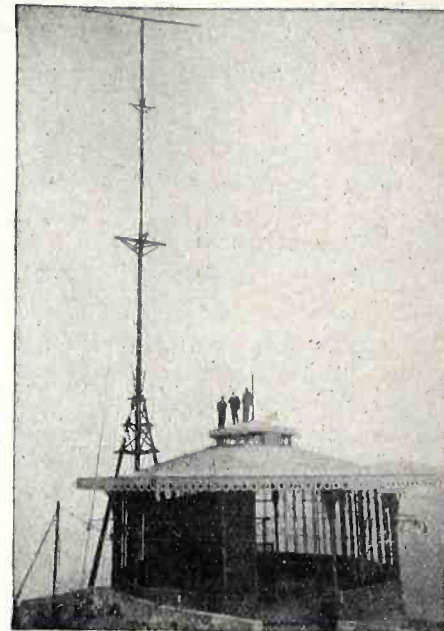

ANTENNA MAST ON MT. CORCOVADO'S CREST, ABOVE THE CLOUDS, WITH 153 FOOT SPAN FOR A SIX WIRE ANTENNA.

with the operating room, is duplicate in size and arrangement of KDKA at East Pittsburgh, Pa.

The artists whose concerts are broadcast in the United States find it difficult to visualize their audience. Those who give concerts from SPC's mountain top studio, after looking out to the ships at sea and in the harbor at Rio, with a million population at their feet, as well as viewing the Centennial buildings and the presidential palaces, can easily visualize the world as an amphitheatre and the mountain top as the stage.

Even though it is prohibited to sell radio receiving sets in Brazil, the twenty millions of Brazilians now have an opportunity to listen in to the broadcasting through the various receiving sets at the Centennial Exposition. Several loud speakers have been installed in the exposition grounds—one outside of the Monroe Palace and another outside of the American building. The President of Brazil and his official family listen in through a very attractive receiving station installed in the President's Palace.

Tests are being made with an automobile to determine the peculiarities of inland radio reception. Various governmental officials are interested in the experiment but the question in Brazil is the same as in the United States—"What is the future of radio

RADIO SERVICE CO.

337 So. Western Ave.

LOS ANGELES, CALIF.

Manufacturers of Radio Supplies and
Equipment

THE VICTOR

Lowest priced high grade adding machine built.
Standard construction, guaranteed, none better.

Cash Register Exchange

408 So. Los Angeles St.

Pico 3207

Phone for demonstration



telephony?" Brazil has been active in radio telegraphy for quite some time.

SPC has a unique position in the radio telephony broadcasting field. At various times the station and antennae are in or above the clouds. Rio de Janeiro is practically on the boundary line between the Temperate and Torrid Zones. The climate is varied by the mountain range Serra do Mar which runs along the coast. The dry season will soon change to the warm and wet season and its subsequent tropical storms. Precautions are being taken to prevent electrical interferences.

The observances and records of SPC will, therefore, assist in studying the peculiarities of the air so far as radio telephony is concerned. The experiences of this station in penetrating the Equator and the Torrid Zone, when co-related with the data being compiled by other stations and close students of the new science, will no doubt result in listing peculiarities of the atmosphere unknown to science today.

In this it will parallel the study of the peculiarities of the ocean bottom which were a closed secret before the laying of the Atlantic cable by Cyrus Field.

Picker Broadcasts

Lester Picker, 6ZH, KFN, has replied to our inquiry about his broadcast license, as follows:

"Yes, I have been granted limited commercial land station license, KFN. This license is limited for communication only with the yacht "Spray" (KDYB) owned by the Gray Bros. at Del Mar, Calif. The Gray brothers are well known to the older amateurs, having the amateur station 6MZ.

"The license was obtained for the sole purpose of working with the yacht while it was out cruising. I expect to use my old 1/2 KW spark transmitter and the wave length will probably be 300 and 450 meters. Very sorry I have no pictures of the spark set but here is a description of it: The transmitter consists of an Acme 1/2 KW transformer, Surdam rotary, non-synchronous gap, glass plate condenser in oil and large oscillation transformer. The set hasn't been tried yet on the higher wave, so don't know what the radiation will be. The transmitter on the yacht is a 1/4 KW quenched affair off an aeroplane.

"The yacht probably won't be ready to go out for a couple of months yet, so nothing has been done with the spark and it is still on 200 meters. I don't know what Mr. Gray's plans are but I don't believe they will sail a very long distance. Only cruise around down lower California, probably."

Listen to the "Voices of the Air"



LONG
DISTANCE
RADIO

TRADE MARK



Easy
to
Tune

Very
Select-
ive

Every Night is
"Silent Night"
ON A ZENITH

The Zenith has an effective range of
2500 miles

Let us prove the superiority of the Zenith by a free demonstration in your home

Catalogue mailed free upon request

Sold and Installed by

PLATT MUSIC COMPANY

620 South Broadway
Los Angeles, Calif.

Main 1150

101-03

Every Radio Student Needs

"Principles of Radio Communication"

By Professor J. H. Morecroft

\$7.50

Six yearly subscriptions to
Radio Journal will bring it to
you gratis.

Subscription Blanks Mailed
on Request

RADIO JOURNAL PUB. CO.
113 Stimson Bldg., Los Angeles

PATENTS

To the Man
With an Idea

I offer a comprehensive service for his legal protection and the development of his invention. Years of experience in the scientific field enable me to render efficient aid and advice to those unfamiliar with the procedure necessary to protect for them the fruit of their brain and hands.

Write or Call

D. N. CLARK

825-826 San Fernando Bldg.
Los Angeles, Calif.

Classified Advertising

Follow these advertisements every month. Reliable advertisers from all over the country offer their most attractive specials in these columns.

Objectionable or misleading advertisements not accepted. Advertisements received too late for current issue will be accepted for the issue following.

Name and address must be included at the above rate. Cash should accompany all classified advertisements unless placed by an accredited advertising agency. No advertisement accepted for less than 4 lines.

Classified Advertising Rates, 5c per word. Time discounts for consecutive insertions; 3 times, 5%; 6 times 10%; 9 times, 15%; 12 times, 20%. Minimum charge, \$1.00.

AGENTS WANTED

Free Sample "Rain Shield Wiper"—retails \$1; cost you 25c (300% profit). Invention just out. Sold on clear and rainy days. Every automobilist buys quickly. No cloth. No paste. No mechanical attachment. 1 rub keeps windshields clear 48 hours against rain, snow storms. Prevents accidents. Riley made \$108 three days. Slocum makes \$10 hour. Experience unnecessary. Wonderful pocket sideline. Write quickly for your free sample. Nu-life Corporation, Hartford, Connecticut.

Amateur Agents wanted in every city and town to sell radio apparatus. A few stocking agencies will open. Delfelco, 12 Meeting Street, Pawtucket, R. I.

Agents wanted everywhere to sell those Wonderful California Herbs for Rheumatism. People from all over the U. S. have written us the last five years about the extraordinary results from these marvelous herbs. Send for free booklet. Pound \$1 postpaid. Rheumatism Herb Company, Sawtelle, California.

Agents—Try our needle cushions. Big profits. Good sellers. Sample 15c. Peters Mail Order House, 12 Harrison Avenue, Gardiner, Maine.

Ambitious men, write today for attractive proposition, selling subscriptions to America's most popular automobile and sportsman's magazine. Quick sales. Big profits. Pleasant work. Digest Pub. Co., 9523 Butler Bldg., Cincinnati.

Stop Daily Grind. Dependable Plans Free. Easy silvering mirrors, headlights, tableware, etc. Clarence Sprinkle, Dept. 71, Marion, Indiana.

AUTOMOBILES

Automobile Mechanics, Owners, Garagemen, Repairmen, send for free copy America's Popular Motor Magazine. Contains helpful instructive information on overhauling, ignition wiring, carburetors, batteries, etc. Automobile Digest, Butler Bldg., Cincinnati.

Fords run 34 miles on gallon gasoline. Other cars show proportionate saving. Wonderful new carburetor. Starts easy in coldest weather. Fits any car. Attach yourself. Money back guarantee. Sent on 30 days' trial. Agents wanted. Air Friction Carburetor Co., Dept. 3222, Dayton, Ohio.

BATTERIES

Edison B. Battery Units—One positive and one negative plate for 10c. 18 sets will make a 24-volt battery. Wilkinsburg Wireless Shop, 711 Penn Ave., Wilkinsburg, Pa.

BB Batteries. Make Your Own Rechargeable from standard pasted plates. Negative or positive at \$.10. Jars for same \$.05. A sample postpaid for \$.30. A complete stock of parts ready for immediate shipment, Magnavox, vacuum tubes, receivers, etc. Electric Service Shop, Bradford, Ill.

BOOKS—CATALOGS

Radio Dealers and Booksellers Attention! Attractive 16-page booklets. No. 1—"How to Build a Beginners' Simplified Receiving Set." No. 2—"How to Build a Simple Loose-Coupler Receiving Set" with diagrams to illustrate. Sale price 15c. marked on copies. Price to dealers \$8.50 per hundred. A fast seller. State assortment, or number of booklet wanted when ordering. Money orders by mail only. Dillinger, 115 Stimson Bldg., Los Angeles.

Radio Dealers Attention! Attractive folder with back blank for your advertisement. "Construction of a Simple Vacuum Tube Detector Set," with diagram with every part pictured as it actually appears in complete set. \$5 per hundred. Try a sample lot of 50 for \$3. Money orders by mail only. Dillinger, 115 Stimson Building, Los Angeles.

A. B. C. of Radio by Waldemar Kaempffert—over 500,000 copies sold at 25c. a copy. One of best beginners' radio books on market. Special price 16c. each, postpaid. Western-Radio Supply Co., 418 Stimson Bldg., Los Angeles.

CHEMISTRY

\$2 buys Industrial Alcohol Book-Catalog Free; Pure Copper Cans Tubing, Testers, Caratz. Box 2571. Boston.

CORRESPONDENCE SCHOOLS

Used correspondence school courses only one quarter original price; bargain list 1000 courses free; used courses bought. Students' Exchange, 47A West 42nd Street, New York.

Double entry bookkeeping mastered in 60 hours; guaranteed; diploma. International Bookkeeping Institute, Springfield, Missouri, Desk 10.

FOR SALE

FOR SALE—Cheap, 10 W phone, 20 W C. W. or 1 C. W. transmitter, well built, 6 meters, complete, less Generator. All letters answered. H. Fink, 820 West 7th Street, Los Angeles, Calif.

For Sale—\$30—Audion detector set, single tube, complete with phones and new UV200 tube. Address 2X, 113 Stimson Bldg., Los Angeles, Calif.

FOR SALE—High Class Table Type Radio outfit—two steps radio frequency-detector—two steps audio. Magnavox coupled to standard wood phonograph horn. Price complete with tubes and B Battery \$275.00. This is a real bargain. May be seen in Los Angeles. Address, Radio Journal, Box 200.

Audion Detector Set, with tube, brand new (not second-hand), in fancy box. Price, \$40. Address Box B-1, Radio Journal.

Ten per cent discount on all standard radio goods. Prompt service. Superior two-step Amplifier, \$25.00. QST Radio Service, Williamsport, Pa.

MISCELLANEOUS

Homespun Tobacco—Chewing—5 lbs., \$1.25; 10 lbs., \$2.50; 20 lbs., \$4.50. Smoking, 5 lbs., \$1.25; 10 lbs., \$2.00; 20 lbs., \$3.50; Farmers' Union, Mayfield, Ky.

Learn Shorthand at Home. Take down your messages with ease. Special Low Offer. Secretary, 1552 Broadway Avenue, Grand Rapids, Mich.

Ladies, Do Your Own Hemstitching and picotting, attachment fits any machine, sent collect \$2.50. Agents wanted. Colorado Attachment Co., Box 2210, Denver, Colo.

MAIL ORDER METHODS—\$50 WEEK, evenings, I made it; mail order business. Booklet for stamp tells how. Sample and plain, 25 cents. Free 12 articles worth \$3. Alraj Scott, Cohoes, N. Y.

Amrad Tuner and Detector Two Step, \$90.00. Clapp-Eastham H.R. receiver with H.Z. amplifier, mahogany, \$65.00. Magnavox R3, \$40.00. All new, perfect condition. Send money-order. Ridgewood Orchard, Winchester, Va.

Sell or Trade for Radio Parts, 15 Dial Omnigraph A1 condition. Write Wesley Kinan, 32 North Avenue, Canandaigua, N. Y.

Crystal Set That Gets Radio Concerts. Build it right, boys. Plans and full instructions for building at low cost, high grade fine adjustable crystal receiving set, fifty cents postpaid. Dept. R2, Shaw Mfg. Co., Galesburg, Kans.

Become a Landscape Architect. Dignified, Exclusive Profession. Little competition. \$5,000.00 to \$10,000.00 income for experts. Easy by our method. Begin earning 3 weeks after you enroll. Write today. American Landscape School, 11B, Newark, N. J.

RADIO-APPLAUSE Post Cards. Encourage broadcasting by such acknowledgment. 2 dozen, 25c, postpaid. D. J. SPANGLER, Elkhart, Ind.

PERSONAL

PATENT FOR SALE—Foldable screened rocking chair, adapted for porches, country places, hospitals, seashore. Two articles in one invention. Address Stransky, 200 Greenway Ave., Darby, Pa.

Radio Salesman wants position in radio store or plant. Experienced licensed operator with selling experience. Address V-53 Radio Journal.

"Patents and Trade-Marks," 64-page book free. Excellent references. 23 years experience. Robb, Robb & Hill, 1419 Hanna Bldg., Cleveland, Ohio; 958 McLachlen Bldg., Washington, D. C.

Louis Castro, Instructor in Spanish, Italian and French. Evening classes, Heartt-Dreyfus Studios, Gamut Club Bldg., 1044 So. Hope Street. Studio phone 15001; Residence phone Garv. 5497.

Bookkeeping in a week. Dukes, 1857-59 Walton Avenue, New York.

PRINTING

Amateur Call Cards—We print 500 amateur call cards for \$4.50 in black or for \$6.25 in red and black. Post Card size and stock. Great fun to report your "Calls Heard" to fellow amateurs. Mail money order and copy to California Printing Co., 117 Stimson Bldg., Los Angeles, Calif.

RADIO EQUIPMENT

The Clarion Headset: Comfortable head-band. Magnets of finest tungsten steel. Cases are of aluminum which cannot be cracked or broken. Quality workmanship. Guaranteed to bring in as good or better results as any phone on the market selling for twice the cost. Price \$5.00. Send Money Order and address CITIZENS WIRELESS SERVICE, Hornell, New York.

SUPER-SIMPLICITY CIRCUIT—Hear Europe, Asia, Africa and Australia's long wave stations and LOCAL broadcasting, on ONE TUBE, one control. NO rheostats, storage battery, variocouplers, variometers, three-coil mountings, variable inductance, taps, switches, dead end losses or radio frequency. Cuts, hookup, everything. Nothing to guess about. Price \$1.00. RADIO EXPERIMENTAL LABORATORY, Box 194-H, Berkeley, California.

Radio Dealers Attention! Attractive folder with back blank for your advertisement. "Construction of a Simple Vacuum Tube Detector Set," with diagram with every part pictured as it actually appears in complete set. \$5 per hundred. Try a sample lot of 50 for \$3. Money orders by mail only. Dillinger, 115 Stimson Building, Los Angeles.

Radio Dealers and Booksellers Attention! Attractive 16-page booklets. No. 1—"How to Build a Beginners Simplified Receiving Set." No. 2—"How to Build a Simple Loose-Coupler Receiving Set" with diagrams to illustrate. Sale price 15c. marked on copies. Price to dealers \$8.50 per hundred. A fast seller. State assortment, or number of booklet wanted when ordering. Money orders by mail only. Dillinger, 115 Stimson Bldg., Los Angeles.

SCHOOLS

Bargain—Regular \$85.00 International Correspondence School Radio Course. First check for \$42.50 takes this course. Address X. Y. Z., care Radio Journal.

Lincoln-Jefferson University. Home study in Academy College, Theological, Law, Music, Pharmacy. Business and Graduate schools, leading to degrees. Box G, 64 W. Randolph Street, Chicago.

The Anonymous Letter

(Continued from Page 248)

sent in when he was called to the phone.

It was during this brief time that Mr. Wayne had occasion to use the book he had loaned "Old Rich." He went to the reporter's desk and found the book lying by some papers. He could not help but recognize the articles already submitted to him under the name of "Anonymous." He read the incompleated article in the machine and finished with tear dimmed eyes. The editor started to take the book, paused thoughtfully a moment, and then placed it back where he had found it. "Old Rich" should never know that he had been there.

The Times announced the finest program it had ever attempted, to be given Mother's Day. The best orchestra in the city had been secured to furnish the music. A famous speaker from the East would deliver the Mother's Day message. Every radio fan was urged to invite his friends to listen in on the big number. It would be the best of all the feature programs given by the paper.

Mother's Day arrived, and the orchestra was ready to begin the opening number. The shaggy headed leader stood in front where all could see him. With a tap of his baton he called the musicians to attention. Then, at a given movement of his hand, the great orchestra began to play. Each player used all the technique he could command as they played the almost forgotten melodies heard in childhood. A few of the employes had dropped in to hear the musical program. As each sat there with a carnation in his coat he pictured the loveliness of his own mother who had sung the same familiar tunes the orchestra now played. When the last notes of the closing number died away a messenger boy handed Mr. Wayne a telegram. Hurriedly he opened the yellow envelope and read: "Sickness prevents me from keeping my appointment with you as your Mother's Day speaker. Have waited to the very last in the hope that I might be able to come. Sorry to disappoint you. N. D. E."

The seriousness of the situation flashed upon Wayne immediately. It was not only the lack of a speaker, but the fact that the Times had fallen down on the biggest program it had ever undertaken. The thousands who were listening in on the program would be disappointed. A speaker must be secured. It was impossible to get one of the local speakers at this time. He glanced about the room and his eyes fell on "Old Rich." Why not

have him speak to the waiting thousands. Appearances did not count now, it was the message the man spoke into the metallic receiver. As the spectators followed the musicians from the room Mr. Wayne called, "O 'Rich'! Will you come here a moment?" He turned and closed the door, as "Old Rich" came forward.

"'Rich,' the great speaker has failed us, and there is no one to take his place. We used your article on 'Mothers' in the Times this morning. It was selected by the judges from hundreds of others. I want you to

(Continued on Page 289)

"BUILD YOUR OWN" With "RASCO" Parts!
 If you need small radio parts in a rush, "RASCO" will supply them cheaper, better and quicker than any one. Be sure to get our great 68-page catalog. Over 500 different parts, 300 illustrations. This catalog contains 75 Vacuum Tube Hook-Ups, all values being shown. Due to great cost, catalog sent only upon receipt of 15c, stamps or coin.
 Radio Specialty Co., Inc.
 808 Park Place, New York

Rasco

AMRAD Reflex Receiver



SIMPLE MANIPULATION...CLEAR RECEPTION
ECONOMICAL

Uses One Tube for Dual Amplification

No Storage Battery Required
Operates on Dry Cells

Price \$40

This set is capable of expansion by means of the Amrad Units
Greater Amplification may be obtained at moderate cost

The Braun Corporation

WHOLESALE DISTRIBUTORS

Remler Products
Bradleystats
Baldwin Head Sets
Kellogg Parts

Cunningham Tubes
Ray-O-Vac Batteries
France Battery Charger
Gilfillan Products

Lefax Handbook
Coto-Coil Products
MagnaVox

AMRAD APPARATUS

363 New High Street

Los Angeles, California, U.S.A.

TOURIST BUREAU

Radio Journal has had many requests from radio fans the country over for information concerning resorts, hotels and other institutions of California, catering to tourists. Hence this Tourist Bureau has been created. If you do not find here the information desired kindly write the Tourist Bureau, care of Radio Journal, 113 Stimson Bldg., Los Angeles, Calif., and descriptive circulars will be mailed you. This service is free.

YE STUART INN—RADIO CONCERTS

S. A. Fox, Prop. Foothill Boulevard—East of Glendora, Cal. (Near Los Angeles)
Good Things to Eat. Phones Glendora 586—San Dimas 577

IDYLLWILD

THE GEM OF SOUTHERN CALIFORNIA'S
MOUNTAIN RESORTS

Wonderful all the year. Housekeeping and Inn Accommodations. Good School in Camp. Give the Children the Benefit of the Mountain Air and the Great Out of Doors. Write for Reservations.

Idyllwild, Inc., Idyllwild, Riverside Co., California

SAMARKAND

Santa Barbara's Unique Persian Hotel

"OMAR'S
GARDEN
OF
ALLAH"

Set on its own hill of thirty acres amid a riotous bloom of flowers, overlooking mountains and sea. Ten minutes from beach and golf links. Fifty bridal suites. Cuisine of peculiar excellence, 3½ hours by train or motor from Los Angeles. Special rates now. For booklet and information, address CHARLES BEDELL HERVEY, Caliph, Santa Barbara, Calif.

"IN ALL THE WORLD NO TRIP LIKE THIS"

SEE THE WONDERFUL SUBMARINE GARDENS

at CATALINA ISLAND

THROUGH THE FAMOUS GLASS-BOTTOMED BOATS

One of Catalina's Many Unique Attractions

Catalina trains leave P. E. Station, Sixth and Main, at 9:00 a. m. daily. Steamer sails at 10. You are back in early evening.

Tickets, information and free illustrated folders

6th and Main Sts.—CATALINA TICKET OFFICE—Los Angeles, Calif.

23

BANKING OFFICES

IN LOS ANGELES, HOLLYWOOD, PASADENA, LONG BEACH, GLENDALE, SOUTH PASADENA, EAGLE ROCK, HIGHLAND PARK, BURBANK, LANKERSHIM, SANTA MONICA, MONTEBELLO, SAN PEDRO, HUNTINGTON BEACH.

SECURITY TRUST
& SAVINGS BANK
SAVINGS COMMERCIAL TRUST

Capital and Surplus - \$10,525,000
Resources Exceed - \$180,000,000

Simple Loading Coil

(Continued from Page 244)

extend the wave length range of the two-circuit set such as is described in Bureau of Standards Circular No. 121. For the general guidance of the experimenter, the following methods will give results, with varying degrees of satisfaction: use of the loading coil in one of the two circuits and no loading in the other (this means that one of the circuits will not be tuned to the wave); use of loading coil in the primary, together with a fixed condenser in parallel with the variable condenser; use of loading coil in one of the two circuits and winding more wire on the coil in the other circuit.

Approximate Cost of Parts.—The parts listed below are those used in the loading coil. The receiving set parts are listed in Circular No. 120. The two sets of parts constitute a complete receiving equipment which has a rather wide range of wave frequencies as explained in the first part of this Circular. The approximate cost of the complete equipment is therefore the sum of the amount given below and the amount given in Circular No. 120.

5 ounces No. 28 copper wire, double cotton covered.....	\$0.80
2 battery clips.....	.20
2 switch knobs and blades, com- plete	1.00
14 switch contacts, nuts and washers60
1 cardboard box (5¾" dia. x 8" long)
3 binding posts45
Wood for panel and base.....
Paraffin
Total.....	\$3.05

The Odic Ray

(Continued from Page 241)

If the atomic speed in matter is resisted in a uniform way, that is to say, if you resist the speed of the three phases—the positive, the negative, and the dominant—and keep them in their natural relation to each other, you will not alter the character or the tensile strength of the substance; but the Odic Ray has proved that just in and to the degree that you change this normal relation of the three phases of force in matter you change the character of said matter.

There are many things the Odic Ray will do that I might describe in this article, many of which would be considered impossible by the scientific world of today; but as this would probably arouse much criticism on the part of students along this line, I will content myself by citing the few applications of the Ray as cited above.

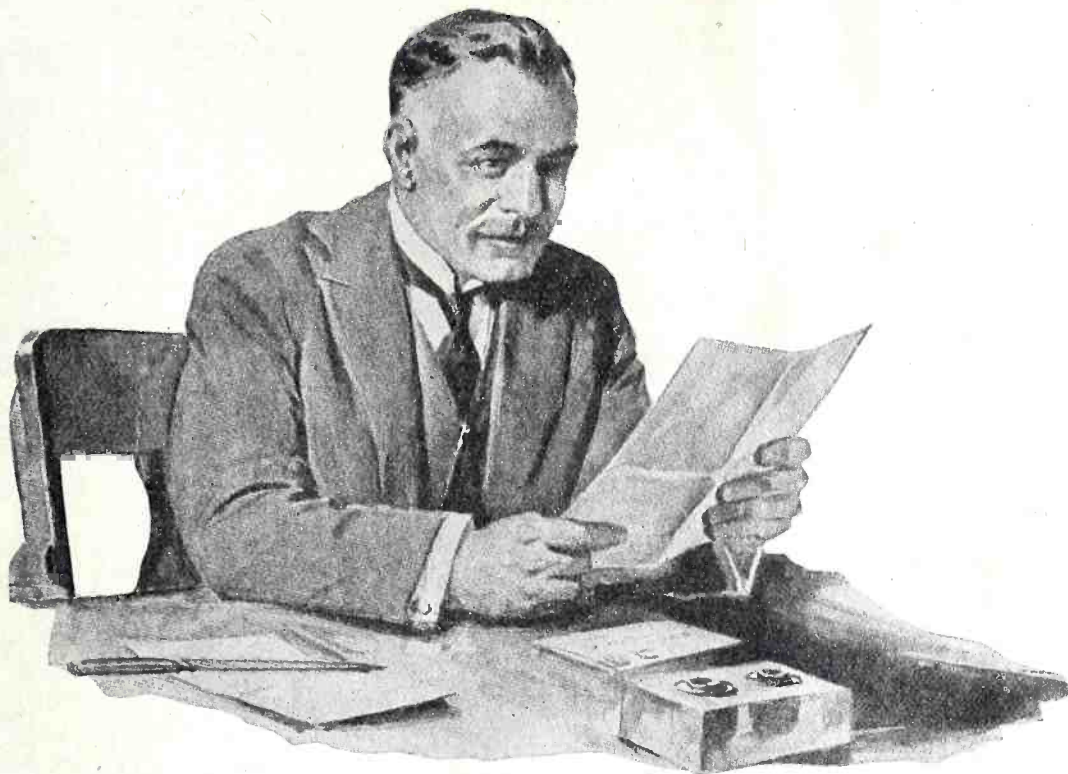

“Blake is the Man!”

“I told Hartley he was a ‘comer’—and this confirms my judgment! Listen to this letter:—

Dear Sir:

You will no doubt be glad to know that James H. Blake, one of your employees of whose excellent work as a student we have been advising you each month, has completed his course and has been granted a diploma.

International Correspondence Schools

“That settles the manager question. The man who cares enough about his future to invest some of his spare time in training is the kind of man we want in this firm’s responsible positions.

“That \$5,000 salary will mean a lot to Blake and his family. But he’ll earn it—and make good use of it. I’ll send for him now! It’s a pleasure to promote a man who deserves it.”

How do you stand when your employer checks up his men for promotion? Is there any reason why he should select you?

Ask yourself these questions fairly. You must face them if you expect advancement and more money. For now, more than ever, the better positions are going to men with special training.

Fortunately, there is an easy, fascinating way for you to get this special training. One hour a day spent with the I. C. S. in the quiet of your own home will prepare you for the position you want in the work you like best.

Every mail brings letters from I. C. S. students telling of advancements and in-

creased salaries won through spare-time study. In a single year, the increases voluntarily reported by I. C. S. students totaled more than \$2,000,000!

These advancements and increases in salary are not only in the technical subjects such as Electrical, Mechanical and Civil Engineering, Architecture, Chemistry, etc., but in Salesmanship, Advertising, Business Management, Accounting, etc.

Whatever the course, if it is an I. C. S. course, you can be sure it represents the best thought of men who are leaders in that field and is drawn from their practical experience.

Can you still turn away from Opportunity? Can you still go on, putting in your days at the same old grind, getting the same pay envelope, with the same insufficient sum, when such a little thing can be the means of changing your entire life?

Why not at least find out what the I. C. S. can do for you? It takes but a moment to mark the work of your choice,

SEND FOR THIS BOOKLET “Who Wins and Why?”

A gripping business story that raises a vital question and answers it in a manner that will interest every man—or woman—who wants to get ahead and seeks to learn how. 48 pages. Sent on request. Use the coupon.

International Correspondence Schools
Box 4004, Scranton, Penna.

tear out and mail the coupon printed below. There’s no obligation and not a penny of cost. Yet that one single act may be the means of changing your whole life. Today—not “Tomorrow”—is the day to take your first definite step forward.

----- TEAR OUT HERE -----

INTERNATIONAL CORRESPONDENCE SCHOOLS Box L. A., Scranton, Penna.

Without cost or obligation on my part, please send me your 48-page booklet, “Who Wins and Why” and tell me how I can qualify for the position or in the subject before which I have marked an X in the list below:

- | BUSINESS TRAINING DEPARTMENT | |
|---|---|
| <input type="checkbox"/> Business Management | <input type="checkbox"/> Salesmanship |
| <input type="checkbox"/> Industrial Management | <input type="checkbox"/> Advertising |
| <input type="checkbox"/> Personnel Organization | <input type="checkbox"/> Better Letters |
| <input type="checkbox"/> Traffic Management | <input type="checkbox"/> Foreign Trade |
| <input type="checkbox"/> Business Law | <input type="checkbox"/> Show Card Lettering |
| <input type="checkbox"/> Banking and Banking Law | <input type="checkbox"/> Stenography and Typing |
| <input type="checkbox"/> Accountancy (including C.P.A.) | <input type="checkbox"/> Teacher |
| <input type="checkbox"/> Nicholson Cost Accounting | <input type="checkbox"/> Civil Service |
| <input type="checkbox"/> Business English | <input type="checkbox"/> Railway Mail Clerk |
| <input type="checkbox"/> Bookkeeping | <input type="checkbox"/> Com. School Subjects |
| <input type="checkbox"/> Private Secretary | <input type="checkbox"/> High School Subjects |
| <input type="checkbox"/> Business Spanish | <input type="checkbox"/> Illustrating |
| <input type="checkbox"/> French | <input type="checkbox"/> Cartooning |

- | TECHNICAL AND INDUSTRIAL DEPARTMENT | |
|---|--|
| <input type="checkbox"/> Electrical Engineering | <input type="checkbox"/> Architect |
| <input type="checkbox"/> Electric Lighting | <input type="checkbox"/> Contractor and Builder |
| <input type="checkbox"/> Electrical Wiring | <input type="checkbox"/> Architectural Draftsman |
| <input type="checkbox"/> Mechanical Engineer | <input type="checkbox"/> Concrete Builder |
| <input type="checkbox"/> Mechanical Draftsman | <input type="checkbox"/> Structural Engineer |
| <input type="checkbox"/> Machine Shop Practice | <input type="checkbox"/> Plumbing and Heating |
| <input type="checkbox"/> Railroad Positions | <input type="checkbox"/> Textile Manufacturing |
| <input type="checkbox"/> Gas Engine Operating | <input type="checkbox"/> Chemistry |
| <input type="checkbox"/> Civil Engineer | <input type="checkbox"/> Pharmacy |
| <input type="checkbox"/> Surveying and Mapping | <input type="checkbox"/> Automobile Work |
| <input type="checkbox"/> Mine Foreman or Engineer | <input type="checkbox"/> Navigation |
| <input type="checkbox"/> Steam Engineer | <input type="checkbox"/> Agriculture and Poultry |
| <input type="checkbox"/> Wireless | <input type="checkbox"/> Mathematics |

Name.....
Street Address.....
City.....State.....

Occupation.....
Persons residing in Canada should send this coupon to the International Correspondence Schools Canadian Limited, Montreal, Canada.

INTERNATIONAL CORRESPONDENCE SCHOOLS

Offices in leading cities throughout the United States and Canada

Where the Best Trained Men and Women Come From

Part Time Education

Light office positions will be provided for students desiring to earn tuition.

You EARN while you LEARN.
Call, write or 'phone for further
information in regard to part-
time education.

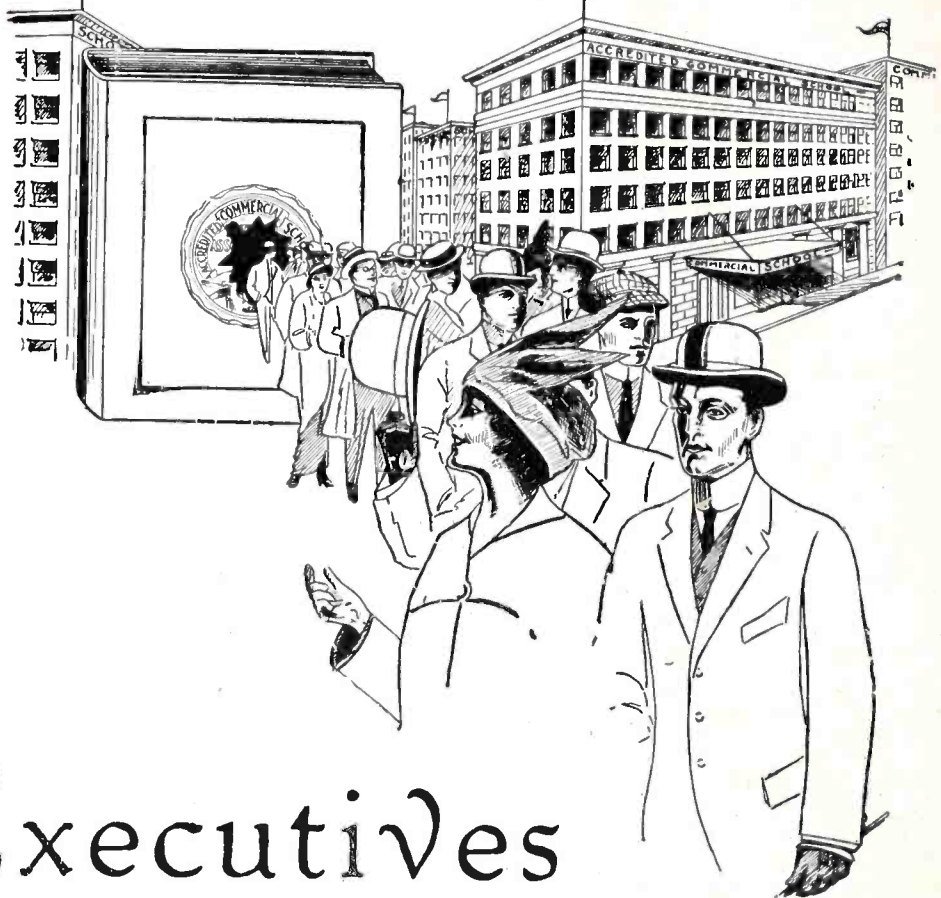

Future Executives

SECRETARY, ASSISTANT MANAGER,
ACCOUNTANT, SALES-MANAGER,.....

Which of these Executive Positions do You hope to fill?

Have you a high school education or its equivalent? If so you are eligible for enrollment in a special class now forming. We offer a COMPLETE SECRETARIAL TRAINING, including an INTENSIVE course in Salesmanship and Business Efficiency. Students desiring to do so may earn the tuition fee by assisting with light office work. These student part-time positions do not require previous office experience.

The motion-picture industry, banking corporations, the automobile and oil industries have openings for TRAINED EXECUTIVES, men and women capable of taking an active part in the management, buying, selling, etc. We are unable to meet the demand for this class of office help.

Telegraphy---\$175.00 a Month

How many young men and women receive \$175.00 a month as a beginning wage? THINK IT OVER. You will do well to investigate our evening classes in telegraphy.

Mackay Business College

Ninth and Main Sts., Los Angeles, Cal.

17th year under the personal direction of F. D. Mackay

(Continued from Page 285)

read your contribution, just as though you were speaking to a great audience; and after you have finished reading, keep on talking. I am going to leave the room and I want you to speak into that mechanical device just as you pound out your thoughts on the old typewriter. Imagine you are alone and just talking to yourself. Call the orchestra when you have finished. They will complete the program with a musical number."

Before "Rich" could raise his voice in protest Mr. Wayne had left the room. Rich stood for a moment in silence, undecided whether to follow instructions or not. It was asking a great deal for him to take the place of a famous man on a second's notice. He would make some excuse to the editor, but as he walked toward the door there came again the picture of a woman whose hair was tinged with grey; he heard her voice speaking as plainly as he had in years gone by, "I don't want you to grow up to be an alibi man. Do the task assigned to you, and if you fail they will give you credit for having tried." He paused with his hand on the door. Taking the manuscript from his pocket he walked over to the transmitter and began to speak the words he knew from memory.

At the close of the written theme he was not quite so nervous. He could not see the huge audience who heard his voice, neither could they see him, nor did they know but that he was the famous man from the East. For once in his life he was the noted man speaking to a mighty throng scattered throughout the broad land. From the experience of a lifetime he told his own feelings. For twenty minutes he pleaded, asking each one to show more appreciation of his mother before she was gone. To those away from home he pictured the joy a Mother's Day letter would give, and if she were present, "go place your arms around her neck and tell her she is the sweetest, dearest mother in all the world." His message was short and spoken with a sincerity that even the great man could not have duplicated. He

stepped to the door and called the orchestra. Whether he had failed in the task assigned him or not he did not know. He had tried his best, without offering any excuse, and his message had come from his heart; a heart educated by his mother many years ago.

A week later Mr. Wayne called "Old Rich" into the office, and showed him a pile of letters coming from all parts of the country complimenting the Times on the splendid Mother's Day program. Many of the letters had asked for the speaker's name and address, so they might write and personally thank him.

"I shall answer each of the letters, 'Rich.' What address shall I give them?"

"Just tell them 'Anonymous' in care of the Times," he said with a smile.

Some of Our Feature Lines

"Master" Radio Products	Sunbeam Batteries	Madera Clear Speakers
Tune Sharp	Baldwin Phones	K. R. Tubes
Howard Parts	Murdock Phones	Radio "Argentite" Crystal

COOK-NICHOLS CO.

Wholesale Only—Special Manufacturer's Discount

411 South San Pedro Street, Los Angeles, Cal.

Pico 3741

Where Service and Quality Meet

Build Your Own ---Win a Prize!

GET BUSY, radio set builders. You have a chance to win some very valuable radio prizes in our free-for-all competition.

Crystal sets or tube sets---any kind of a hookup you choose ---just build your idea of a good set, and enter it in our contest.

No need of getting your parts here; buy them anywhere. Nobody is barred. No red tape, no strings. You have a good chance to win!

Call or write for particulars.



With the Editor

Radio Journal, and probably many of its readers, was interested in a newspaper account of what purported to be another invention in the field of voice photography for synchronizing sounds with motion pictures, with the publication of a news account of a demonstration given by E. H. Colpitts, assistant chief engineer of the Western Electric company. We wrote Mr. Colpitts, and are publishing his reply to disabuse the radio public of the notion that he has entered the "talking movie" field.

Editor, Radio Journal:—This is in reply to your letter of January 24th referring to the talking motion picture film which I exhibited in Chicago. I am afraid there has been considerable misunderstanding in regard to the device in question, and it is probable that this misunderstanding is partly due to incorrect newspaper reports.

The film which I exhibited is one which was prepared under our direction to illustrate in a popular manner what takes place inside of a vacuum tube, and it occurred to us that there would be some element of novelty if we removed the captions from the film and explained the various pictures by means of phonograph records operat-

ing in conjunction with a suitable microphone and a Western Electric loud-speaking receiver.

In the device which I exhibited no attempt was made to have the motions of an actor accompanied by the spoken word, but simply to describe the pictures by means of a brief lecture recorded on phonograph disks which were operated in synchronism with the motion picture projector.

The phonograph records which we used were made in our own laboratories by using a microphone similar to that used with our public address system, and a recording mechanism which we made up specially for the purpose.

It is probable that the device would have some value in connection with the educational films, and this seems to be its chief sphere of application.

Very truly yours,
E. H. COLPITTS,
Assistant Chief Engineer.

Ned Lawrence, widely known to a host of radio readers as editor of the radio department of the Los Angeles Evening Herald, is recovering from a severe attack of influenza and pneumonia. Fox Case occupied the radio chair at the Herald during Mr. Lawrence's illness.

Radio Journal last month published an appeal for aid in supplying parts for a radio set for Lloyd A. Johnson of Los Angeles. In a letter to Radio Journal, the young man sets forth our reasons for endeavoring to get him a set, better than we could:

"I am only fifteen years old, and have been in bed since I was seven. This will be a great thing for me. I don't wonder Mr. Williams is a happy man, with such a fine set. Thanking you for your interest in getting me a radio set, I remain,

"LLOYD A. JOHNSON,
5501 1/2 Moneta Ave.,
Los Angeles, Calif."

Along comes T. U. Bentley of Los Angeles with the offer to build the set if other readers of Radio Journal will furnish the parts. So step in line, folks. Here is an opportunity to make life worth while by helping the other fellow. Send contributions of parts or money by mail, express, foot, special messenger or ox team to "Helpful Radio," care of Radio Journal, 113 Stimson Bldg., Los Angeles, Calif.

Are you in the big \$500 Radio Journal Contest? See page 268 of this issue.

New Home for Tune Sharp

Owing to the increasing demand for TUNE SHARP instruments we were compelled to enlarge our plant and add to our equipment. We are now in a position to supply Tune Sharp Variometers and Variocouplers from our new plant at 6220 1/2 and 6222 So. Vermont and in a very short time will be on full production and be able to make prompt delivery.



Variometer \$6.00



Standard \$6.50
860 Meters

JOBBERS now stocking TUNE SHARP instruments

Western Radio Elec. Co.
637 S. Hope St.
Los Angeles, Cal.

Cook-Nichols Co.
411 S. San Pedro St.
Los Angeles, Cal.

Walter W. Biddick, Inc.
1316 So. Grand Ave.
Los Angeles, Calif.

C. R. Kierulff & Co.
757 So. Los Angeles,
Los Angeles, Calif.

PYRAMID Bank Wound
1000 meter \$ 8.00
2000 meter \$10.00
3000 meter \$12.00
4000 meter \$14.00

Dealers Now Stocking TUNE SHARP Instruments

Newbery Electric Co.
724 S. Olive St.
Chas. A. Holland
2603 North Broadway
Los Angeles
Motor Car Supply Co.,
920 S. Broadway
Heath Electric Co.
1077 N. Western Ave.

Barker Bros.
716 S. Broadway
L. A. Duncan
2934 West Pico
Manual Arts Radio Shop
4154 S. Vermont Ave.
The Normandie Radio
Shop
5069 Hollywood Blvd.

Aylsworth Electric Co.
129 N. Market St.
Inglewood, Calif.
P. L. Heldner
Azusa, Cal.
The Electric Corporation
836 S. Los Angeles St.
Los Angeles, Cal.

Universal Radio and
Research Co.
199 S. Fair Oaks Ave.
Pasadena
Radio Sales & Service
820 West 7th St.
Paul Franklin Johnson,
562 E. Colorado St.
Pasadena, Cal.

Hayden Electric Service
521 W. Washington
1177 W. Jefferson
R. R. Coleman
Pasadena, Cal.
Highland Park Electric
Shop
5203 Pasadena Ave.

Tune Sharp Radio Equipment Co.

6220 1/2-6222 Vermont Avenue

Vermont 5040

Los Angeles, Calif.

\$25.00

In Merchandise Will Be Given to the Person Doing

The most consistent and long distance reception on either loop, or antenna,
or both, using a

Reflex Receiver

CONSTRUCTED WITH WIRELESS SHOP AMPLIFYING UNITS
Contest Closes Midnight, June 15th—Judges Will Be

A. W. Majors, Radio Journal - K. P. Frederick, Editor, Radio Journal - Edwin S. Watkins, Writer of Article on Reflex Set
SEND YOUR RECORDS WITH VERIFICATION BY THREE PEOPLE

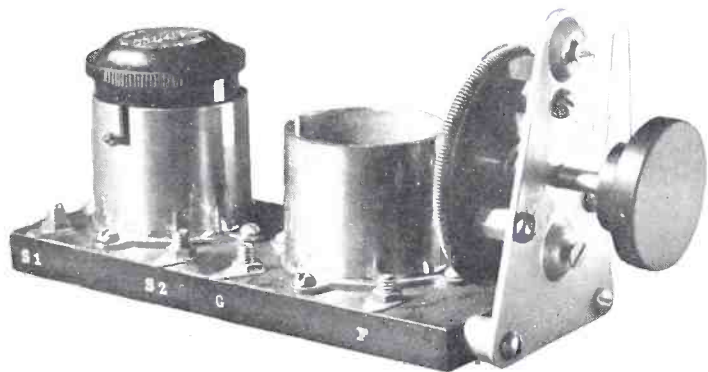

Standard Units

Radio Frequency Unit Complete
as Shown

\$8.50

TRANSFORMER ALONE
To Be Used in Standard Metal Shell
Socket

\$4.00



Audio Frequency Unit—Correct Ratio of Winding for Reflex Circuits, Complete \$8.50
Transformer Only \$4.00

10c in Stamps and Your Name Below Will
Bring You Our Booklet
Showing the Construction of Three Different
REFLEX RECEIVERS. Our Latest Bulletin Included

Name.....

Address.....

RJ5

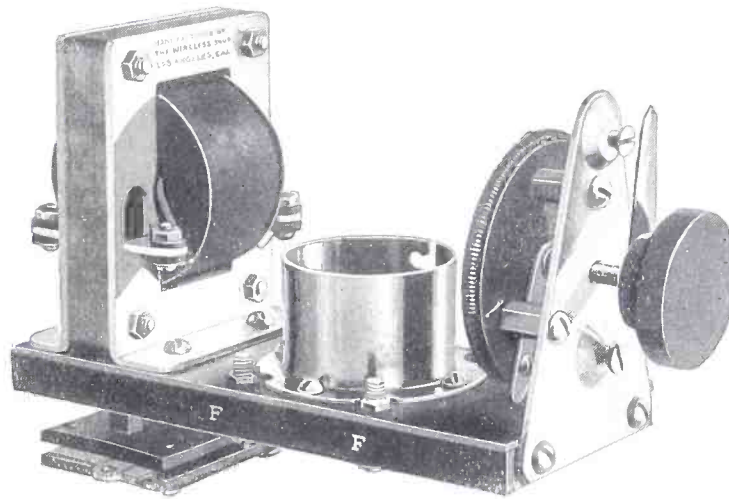

OUR SERVICE DEPARTMENT WILL ASSIST YOU, GRATIS

THE WIRELESS SHOP

A. J. EDGCOMB

PACIFIC SOUTHWEST'S LARGEST RADIO MANUFACTURERS

OFFICE AND FACTORY
1262 W. 2nd St.

STORE NUMBER 2
1853 S. Hope St.

And Now We've Been Appointed Western Jobbers for
the Entire Line Manufactured by the

Western Electric COMPANY

Our rapidly expanding business and the increasing use of, and demand for, radio equipment has compelled us to secure several additional lines of radio supplies. Our appointment as Pacific Coast Jobbers for the complete line of the Western Electric Company will enable us to maintain the same high standard of service to the trade that has always been a feature of "Coast Service"

We sell Wholesale Exclusively. A phone call
or postcard will bring you our new price list.

LOUD SPEAKING TELEPHONE SET



When connected to a well-designed vacuum tube radio receiving set and supplied with the necessary current, it will reproduce and amplify all forms of broadcasted speech and music with the highest degree of clarity and tone quality

Western Electric.....No. 10-A

TELEPHONE HEAD SET

Meets the most exacting requirements. Unusually light weight and comfortable, yet of the most rugged construction. Especially efficient over a wide frequency range. Designed to reproduce the low notes of the church organ as well as the high notes of the violin.



Western Electric...No. 1002-C

We are Jobbers and Distributors Exclusively
for a Complete Line of Radio Equipment

Dealers: Telephone or Write for Our New Price List

Coast Commercial Company

Formerly Radio Supply Company of California

239 South Los Angeles Street

Telephone 824831

Los Angeles, Calif.