

FEBRUARY, 1933

Radio Engineering

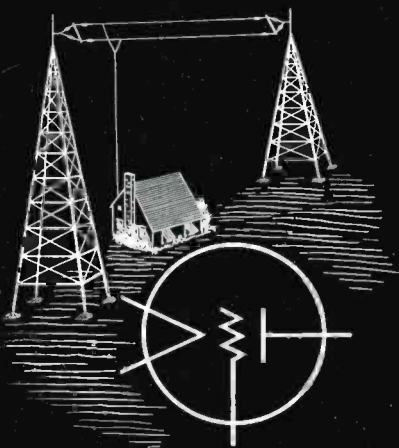

IN THIS ISSUE



SUPPRESSION OF NOISE IN RADIO RECEIVERS

By Edgar Messing

PROGRESS IN TUBES FOR RADIO

SHORT-WAVE TRANSOCEANIC TELEPHONE
RECEIVING EQUIPMENT

By F. A. Polkinghorn

A FREQUENCY MONITORING UNIT FOR
BROADCAST STATIONS

By R. E. Coram

VOL. XIII, NO. 2 FEBRUARY, 1933

The Journal of the
Radio and Allied Industries

PROVEN!

RACON'S NEW TYPE "B" ELECTRIC DYNAMIC UNITS WIN UNIVERSAL ACCLAIM BECAUSE OF PERFORMANCE



Compare these values in the new Type B Units.

- ¶ PEAK POWER ratings as high as 60 watts.
- ¶ CONTINUOUS POWER ratings as high as 30 watts.
- ¶ FIVE different sizes from which to select the unit that fits the requirements and fits your pocketbook.
- ¶ NON-RUSTING cadmium-plated metal parts—waterproof assembly—and the finest workmanship you've ever seen.
- ¶ QUALITY, unapproachable in naturalness, realism and wide range.

There is added economy, too, in the higher acoustic efficiency of the new Type B. That means more units per amplifier, more acoustic power output per electrical watt input, more coverage, more profit on each p.a. job.

The four sizes illustrated meet every loudspeaker requirement from the small trumpet p.a. rental to the magnificent far-reaching chime-carillon system. Call on our Engineering Department for the full benefit of a nation-wide field experience.

Every Raccon product is guaranteed by the largest independent manufacturer of air-column speakers, having adequate financial resources to substantiate every claim and a wide field organization to meet every service demand.

Note: Old-style Raccon Units can be rebuilt to the Type B head at a nominal charge. Write us.

For New Catalog, address
Department P. E. I. It contains valuable information.

RACON Horns and Units are Covered by U. S. Patents Nos. 1,507,711; 1,501,032; 1,377,270; 73,217; 73,218; 1,722,448; 1,711,514; 1,761,489; 1,832,608; 1,834,327; 1,835,739; 1,845,210; 1,878,360.

RACON ELECTRIC CO. INC. 52 East 19th Street, New York City
London, England Toronto, Canada

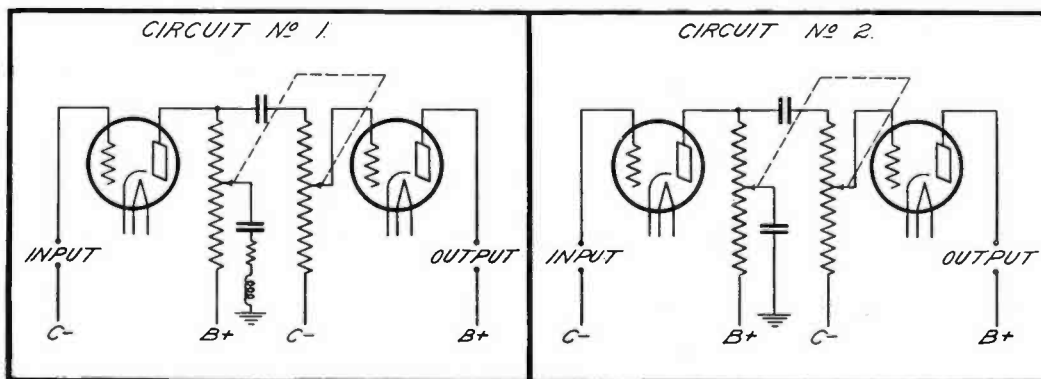

Tone Compensation through the full range of control with

Chicago Telephone Supply Co. Combination Volume and Tone Compensating Control

IT is a well known fact that the sensitivity of the human ear is greatest in the central audio range and that the sound pressure of notes in the low or high ranges of the audible frequency band must be greater than those in the center of the band for each note in the entire audible range to produce the same apparent loudness. As the volume is decreased this difference becomes greater and is of most importance near the low volume position, so unless proper compensation is provided through the FULL RANGE of control the desired effect is lost.

Correct Tone Compensation Is Necessary at Every Point Through the Range of Control

If all audible frequencies present in the output are to be heard in the proper relative intensity the correct amount of tone compensation must be provided AT EVERY POINT FROM THE HIGHEST VOLUME POSITION TO THE LOWEST VOLUME POSITION. With either of the tone compensating circuits shown above it is a very simple matter to determine a gradient that will give the correct compensation at all points. No over-compensation and no under-compensation through any part of the range.

Smooth Control of Volume Through Entire Range of Control

The Chicago Telephone Supply Co. tone compensating circuits in no way detract from the volume control and permit the maintenance of a straight line attenuation curve without the necessity of employing critical or expensive volume control gradients.

Write the Engineering Department of the Chicago Telephone Supply Co. for further information concerning tandem controls especially adapted to tone-compensated volume control.

CHICAGO TELEPHONE SUPPLY CO.

HERBERT H. FROST, Inc. SALES DIVISION

ELKHART, INDIANA

RADIO ENGINEERING

Reg. U. S. Patent Office



Western Editor
ULMER G. TURNER

Editor
DONALD McNICOL

Managing Editor
F. WALLEN

Vol. XIII

FEBRUARY, 1933

Number 2

Contents

	PAGE
EDITORIAL	4
A CHRONOLOGICAL HISTORY OF ELECTRICAL COMMUNICATION—TELEGRAPH, TELEPHONE AND RADIO.....	5
SUPPRESSION OF NOISE IN RADIO RECEIVERS <i>By Edgar Messing</i>	7
PROGRESS IN TUBES FOR RADIO.....	10
SHORT-WAVE TRANSOCEANIC TELEPHONE RECEIVING EQUIPMENT..... <i>By F. A. Polkinghorn</i>	12
A FREQUENCY MONITORING UNIT FOR BROADCAST STATIONS <i>By R. E. Coram</i>	18
ELIMINATING SPARK PLUG DISTURBANCE IN AUTOMOBILE RADIO	20

Departments

NEWS OF THE INDUSTRY.....	24
NEW DEVELOPMENTS OF THE MONTH.....	26
INDEX OF ADVERTISERS.....	30

PRACTICAL STEPS IN NEW PRODUCT DEVELOPMENT

MANAGEMENT'S first obligation in the development of a new product is to state its requirements as completely as possible. This statement should cover:

1. The field to be covered by the new product.
2. The intended retail price and selling ratio or else the allowable factory cost.
3. Specific requirements as to performance.
4. Specific requirements as to appearance.
5. General marketing scheme.
6. Anticipated production quantity.
7. Allowable expenditures for new production equipment.
8. Desired production date.

The engineer's first step in his actual development work will be the formulation of tentative specifications to meet the requirements of the management. In this work he will need reports and data from sales, advertising, research, service, and patent departments. In addition, he will call upon the purchasing department for preliminary quotations, and on the production department for tooling advice. This is particularly important, for lack of cooperation here may result in quite needless expenditures for new production equipment, or unnecessarily high production cost.—D. G. SMEL-LIE, *Director of Development and Design, Hoover Co.*

BRYAN S. DAVIS
President

JAS. A. WALKER
Secretary

Published Monthly by

Bryan Davis Publishing Co., Inc.
19 East 47th Street
New York City

SANFORD R. COWAN
Advertising Manager

J. E. NIELSEN
Circulation Manager

Chicago Office—1221 Rosemont Ave.—Charles H. Farrell, Mgr.
St. Louis Office—505 Star Building—F. J. Wright
Kansas City, Mo. Office—306 Coca Cola Building—R. W. Mitchell
Cleveland Office—Millard H. Newton, 416 National Bldg.

Philadelphia Office—1315 N. 13th St.—H. S. Thoenbe.

San Francisco Office—155 Sansome St.—R. J. Birch
Los Angeles Office—946 S. Broadway—R. J. Birch
New Zealand—Tearo Book Depot—Wellington.
Melbourne, Australia—McGill's Agency.

Entered as second class matter August 26, 1931, at the Post Office at New York, N. Y., under Act of March 3, 1879. Yearly subscription rate \$2.00 in United States. \$3.00 in Canada and foreign countries.

How 840 manufacturers last year found a simple way to make secure assemblies at much lower cost

To try Self-tapping Screws for making fastenings costs nothing, and requires only a few minutes. And in 7 out of 10 cases it pays. Last year 840 manufacturers who tried these unique Screws, found them to be a much cheaper means of making certain assemblies. It was simple to adopt the Screws, too, since no changes in design or special tools are required.

Consider your own product. Does it require fastenings to sheet metal, steel, cast iron, die castings, brass, Bakelite, slate, ebony asbestos? If it does, you may be able to make the fastenings more securely, at lower cost by using Self-tapping Screws.

Examples of economies effected by Radio industry

In assembling Philco radios, Hardened Self-tapping Sheet Metal Screws

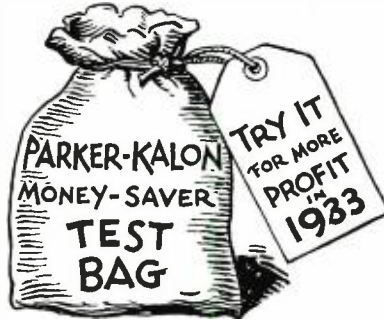

have eliminated scores of tapping operations on each receiver. The saving in one year amounted to \$16,000, and Philco engineers found that the Self-tapping Screw assemblies were more secure under vibration than assemblies made with machine screws.

By replacing hex head machine screws with Hardened Metallic Drive Screws as a means of assembling parts of a well-known speaker, a saving of 50 per cent in time and labor was effected, and desirable fastening strength was added.

Stromberg-Carlson engineers state: "By using Self-tapping Screws in place of machine screws we were able to eliminate 29 tapping operations on each set. This not only saved expense incident to tapping, but also avoided assembly delays caused by waiting for tapping to be done."

To obtain the substantial assembly economies and other advantages which Self-tapping Screws bring to

radio manufacture, it is not necessary to have a volume production like that of Philco, Stromberg-Carlson, and other large concerns. The percentage of economy on a single unit per day is the same as on a thousand sets per day.

Get the Money-Saver Test Bag and learn what you can save

A simple trial on your own work will show what Self-tapping Screws can do for you. It takes but a few minutes—costs nothing. Return the coupon below with a brief description of one or more of your assemblies. Our Fastening Specialists will study your assembly problem and send you unbiased recommendations with a Money-Saver Test Bag of samples for you to try. Use the coupon now for more profit in 1933.

Which Self-tapping Screw Meets Your Need?

Type "Z" Hardened Self-tapping Sheet Metal Screws
For making fastenings to sheet metal up to 6 ga., aluminum, die castings, Bakelite, etc. Turn Screw into drilled, pierced or molded hole. It forms a thread in the material as it turns in. Can be removed and replaced.



Type "U" Hardened Metallic Drive Screws
This type of Self-tapping Screw is used for making permanent fastenings to iron, brass and aluminum castings, steel, Bakelite, etc. Hammer Screw into drilled or molded hole. It forms a thread in the material as it is driven.



PARKER-KALON *Hardened* Self-tapping Screws

PAT. IN U. S. AND FOREIGN COUNTRIES



PARKER-KALON CORPORATION, DEPT. L, 190-198 VARICK STREET, NEW YORK, N. Y.

Tell me whether assemblies described on attached sheet can be made cheaper with Self-tapping Screws. I'll make a "Money-Saver Test" if you send samples and recommendations—Free.

Name and Title.....
Company.....
Address.....

E d i t o r i a l

FEBRUARY, 1933

AUTO RADIO

NO more suggestive reference could be made signifying the extent to which automobile radio installation has progressed than to call attention to the fact that 86 per cent of the automobiles displayed at the automobile show held in New York in January were wired for radio receivers.

The fear widely expressed two years ago that the presence of a radio receiver in operation in an automobile in motion on the road would tend to distract the attention of the driver, causing possible lack of careful driving in traffic, has from experience been found to be not well founded. Notwithstanding that there are several hundred thousand automobiles now equipped with radio receivers the automobile authorities in states that have conducted inquiries have not reported adversely upon the practice of operating receivers in moving vehicles.

If the receivers installed in cars have a time usefulness corresponding approximately with the life of the average automobile here is a replacement market for receivers which will call for new radio equipment per car considerably more frequently than receivers are replaced in homes.

There are approximately 25,000,000 automobiles in use in the United States. The number of these cars which make up the market for radio receivers, even if but one half of the total number of cars, presents opportunity of large magnitude for receiver sales, and proportionately for radio tubes and parts.

ADDING REVERBERATION

THE unquestionable advantage of adding reverberation to voices broadcast, in certain situations, is being availed of by NBC in some studios.

In a 12 foot square "echo room" the hollow reverberation effect is produced when a loudspeaker is actuated from the studio room from which the actor speaks. A microphone in the echo room picks up the loudspeaker output, plus the reverberation pro-

duced by the smooth, live walls of the chamber, passing it on to the radio transmitter.

Provision also is made to pick up the speech directly from studio to control room, the output from the echo room being mixed with this to produce the desired effect.

RECEIVER SALES IN CANADA

THE "Empire Content" designations which came out of the Ottawa Economic Conference of 1932, plus the interest in Canada in broadcasts from London, has called attention to the radio receiver market in the Dominion. It is reported that there are 74.32 receivers per 1,000 of population in Canada, or a total of 770,436 receivers. On the farms of the country there are 116,354 receivers, which totals but 16 instruments for each 100 farms, or but 36.09 receivers per 1,000 of farm population. A noticeable swing upward in employment and buying power should materially improve the outlook for radio sales.

OBSOLETE TUBES

IT appears that some manufacturers of tubes are paying a ruinous price that they may say: "we carry a complete line."

To care for the occasional demands from service organizations for a half dozen tubes long since superseded by more modern types, some manufacturers are in the habit of making up a new batch of the old tubes rather than advise the dealer that the type is obsolete.

This would seem to be one of the situations that sensible trade cooperation could remedy. Has the time not arrived for the tube manufacturers to courageously adopt and publish a list of tubes that are obsolete and which will not longer be supplied as replacement?

Donald Mc-Nicol
Editor.

A chronological history of electrical communication

—telegraph, telephone and radio



This history was begun in the January, 1932, issue of RADIO ENGINEERING, and will be continued in successive monthly issues. This history is authoritative and will record all important dates, discoveries, inventions, necrology and statistics, with numerous contemporary chronological tie-in references to events in associated scientific developments. The entries will be carried along to our times.



Part XIV

1879 (Continued)

- (529) At an industrial exhibition held in Berlin, Germany, Werner Siemens exhibits an electric railway car equipped with a 5 h.p. motor. The track was about one mile in length.
 - (530) The American Rapid Telegraph Company, organized, (February) with a capital of \$3,000,000. (This company remained in existence about four years.)
 - (531) T. A. Edison introduces a practical incandescent electric lamp.
 - (532) Stephen D. Field introduces the dynamo to replace primary batteries for telegraph main line current supply.
 - (533) Black and Rosebrugh, in Canada, invent a system of simultaneous telegraphy and telephony.
 - (534) Sir William Crookes, in England, experiments with electric discharges in vacua; developing the radiometer and forms of Crookes' tubes.
 - (535) A French-American submarine cable is laid.
 - (536) The National Bell Telephone Company organized (March 13) with a capital of \$850,000, taking over the New England Telephone Company and the Bell Telephone Company.
- 1880**
- (537) The Thomson-Houston Electric Company introduces an electric lighting system, the basis of which is Elihu Thomson's three-coil arc dynamo and automatic regulator.
 - (538) The American Electric Company organized with works at New Britain, Conn. (In 1884 this company merged with the Thomson-Houston Electric Company, the works being moved to Lynn, Mass.)
 - (539) Faure, in France, and Brush, in the United States, make improvements in storage battery plates.
 - (540) The Great North Western Telegraph Company organized, in Canada, May 7.
 - (541) Emile Berliner, of Boston, secures a patent for an electric telephone, September 3. (Patent number 233969.)
 - (542) The steam-yacht *Columbia* is equipped with an incandescent electric light system.
 - (543) Two Edison "Jumbo" dynamos are shipped to England for use in electric lighting. W. J. Hammer and E. H. Johnson engineered the work.
 - (544) Professor Trowbridge, in the United States, shows that signaling may be carried on over a distance of one and one-half miles by electric conduction through the earth.
 - (545) Instruction in electrical engineering is begun in American universities.
 - (546) The Metropolitan Telegraph and Telephone Company, New York, is organized.
 - (547) The Mutual Union Telegraph Company organized with a capital of \$600,000. (October 4.)

- (548) Canadian Pacific Railway telegraph extensions begun in Canada.
 - (549) An electric locomotive is exhibited at the Edison laboratories, Menlo Park, N. J.
 - (550) The manufacture of lead covered cables is begun.
 - (551) A new transatlantic telegraph cable is laid by the Anglo-American Telegraph Company, using the shore ends of the abandoned cable of 1866. The new cable is completed in the record breaking time of twelve days.
 - (552) Charles H. Wilson, of Chicago, prepares a technical paper dealing with inductive disturbances between parallel wires used for communication purposes. Suggests remedies.
 - (553) R. C. Clowry succeeds Anson Stager as general superintendent of the Western Union Telegraph Company, Chicago, April 1.
 - (554) An Association of Old-Time Telegraphers is formed, the first meeting is held at Cincinnati, Ohio, September 7.
 - (555) In Paris, France, there is an Edison telephone exchange with 350 subscribers. The carbon transmitter and Phelps receiver are used.
 - (556) Alonzo T. Boone, of Chicago, procures patent No. 225,268 covering a system of underground electric conductors.
 - (557) Edward Weston, Newark, N. J., procures patent No. 225,312 covering the invention of an electric lamp.
 - (558) The American Bell Telephone Company, with offices at 95 Milk St., Boston, has as officers: W. H. Forbes, president; W. K. Driver, treasurer, and Theodore N. Vail, general manager. The company is capitalized at \$10,000,000. (In December, 1899 this property was transferred to the American Telephone and Telegraph Company.)
 - (559) The Western Union Telegraph Company now has a capital stock of \$41,073,410. Out of \$45,500,000 net earnings during the previous fourteen years, \$23,000,000 have been paid in dividends, \$5,500,000 in interest, and \$17,000,000 have gone into plant and other assets. The company now has 233,534 miles of wire and 9,077 offices, handling 29,215,509 messages per year.
 - (560) The Union Electric Signal Company, of Boston, exhibits an automatic track circuit railroad signal system.
 - (561) Henry C. Nicholson, of Kenton, Ky., procures a patent for a multiple telegraph system. (Patent No. 232,749.)
 - (562) James M. Brookfield, of Brooklyn, N. Y., procures patent No. 9,292, covering a mode of forming insulators. (Original patent No. 103,555, dated May 31, 1870.)
 - (563) Theodore M. Frost, of Brooklyn, N. Y., procures patent No. 233,407 covering the invention of a printing telegraph system.
 - (564) Thomas S. Hall, of the Hall Railway Signal Company, Meriden, Conn., procures patent No. 234,031 covering the invention of electric switch apparatus for railroad tracks.
 - (565) Theodore F. Taylor and Gerrit Smith, of New York, procure patent No. 234,347 for an automatic telegraph system.
 - (566) The Western Electric Company, Chicago, issues twelve small catalogues of electric apparatus, the set of catalogues sells for twenty cents. Anson Stager is president, Enos M. Barton, secretary, and Elisha Gray, electrician of the company.
 - (567) There are 54,319 telephones in use in the United States.
- 1881**
- (568) A number of United States patents are granted to Orazio Lugo, of New York, covering telegraph systems using dynamo electric machines, and for telegraph signaling by means of induced currents.

TONE COMPENSATION—pioneered by Allen-Bradley

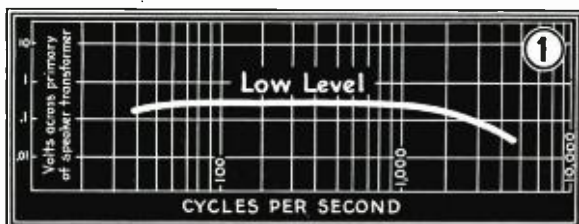

ORDINARY Volume Control without Tone Compensation

Curve No. 1 illustrates how all frequencies are equally attenuated when the volume is reduced with the ordinary type of volume control. Due to the characteristics of the ear, the low and high frequency tones are reduced in loudness much more than the middle register.

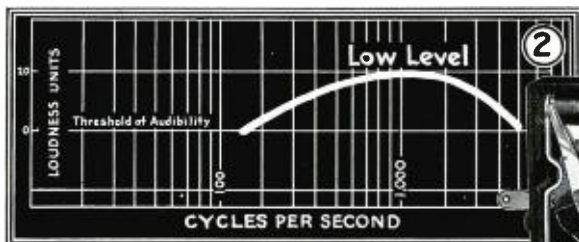

Hence, at low levels a radio set with this type of control sounds thin and unsatisfactory—a common fault of most radio receivers.



Bradleyometer Volume Control with Tone Compensation

The Allen-Bradley Company has pioneered an outstanding improvement in audio volume control. It is the Tapped Bradleyometer which does not attenuate all frequencies equally as shown in curve 3, and therefore sustains the loudness of the low and high frequency tones at reduced volume. See curve 4.

With Bradleyometer control, the receiver quality is sustained at low as well as high levels.

Allen-Bradley engineers will gladly cooperate with set manufacturers in designing low-level tone compensation systems.

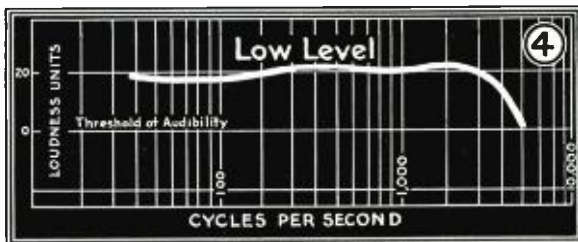
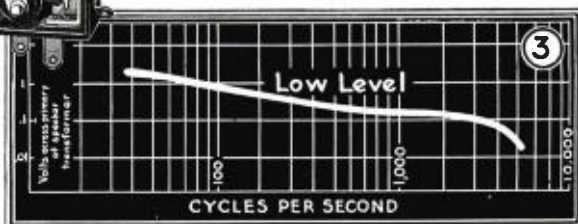

Allen-Bradley Resistors

The Choice of the World's Largest Radio Manufacturers



BRADLEYUNITS

Bradleyunits are the solid molded fixed resistors used by the largest manufacturers of radio receivers. Their production represents years of pioneering research in the production of stable, fixed resistors.

Bradleyunits are made in five sizes, with or without leads, and are R. M. A. color-coded for resistance value identification. Do not risk the reputation of your receiver with poor resistors. Use Allen-Bradley resistors and forget your resistor troubles.



BRADLEY SUPPRESSORS

Bradley Suppressors are special solid molded resistors, used by prominent car manufacturers to provide individual resistors for each spark plug and for the common cable to the distributor on radio-equipped cars.

They increase the resistance of the high tension ignition system and minimize the disturbing oscillations in the ignition circuit which interfere with the radio receiver in the car. When used with suitable by-pass condensers in other parts of the circuit, shielded ignition cables are unnecessary.



ALLEN-BRADLEY COMPANY, 126 W. Greenfield Ave., Milwaukee, Wisconsin

RADIO ENGINEERING

FOR FEBRUARY, 1933



Suppression of noise in radio receivers

QAVC, NSC, or simply "squelch"

By EDGAR MESSING*

OF the technical advances featured in this season's receivers one of the most interesting and outstanding, from the viewpoint of the set owner, is automatic inter-channel noise suppression. It is known as qavc (quiet automatic volume control); in advertisements it is automatic noise suppression control or NSC, and in other circles it is just plain "squelch."

Its introduction needs no apologies and should merit appreciation from the set owner as a welcomed technical improvement, and from the sales department as an obvious feature and easily understood advantage.

For High Grade Receivers

It is in good receivers employing avc that squelch finds its greatest field of use. These receivers usually have sensitivities that range from a fraction of a microvolt to approximately 10 microvolts absolute. Such sensitivities mean that in most localities the residual noise level will give relatively large and annoying outputs unless the manual volume control is reduced. When a strong carrier is tuned in, this noise, of course, disappears because the avc operates to decrease the sensitivity of the set.

It is this noise between stations that squelch aims to eliminate. Manual muting controls have heretofore been used

to serve the same purpose. These controls ordinarily took the form of separate buttons that the operator depressed with one hand while tuning with the other and have that obvious disadvantage. The depressed button either short-circuited or opened the audio system.

Automatic squelch enables the operator to tune over the band, hearing only desired stations; that is, those having a signal strength sufficient to produce a satisfactory signal-to-noise ratio, and hearing nothing but these stations. Further:

1. Since nothing is heard but desirable stations; and
2. since these stations cannot be heard until they are almost exactly tuned in;
3. and remain audible only so long as they are very close to resonance, the receiver appears to be highly selective. This point is of importance because of the apparent broadness of avc sets.

Fig. 1A shows the operational diagram of a receiver employing the system. A is the radio-frequency amplifier, which in a superhet will include oscillator, detector, r-f. and i-f. stages. B is the audio detector; C the audio amplifying system, and D the avc and squelch control.

D, it will be noted, taps the output of the signal amplifier to control it in the usual manner and uses the same

monitoring voltage for audio control or squelch. This arrangement is economical in that a single monitor can be used to actuate dual controls. Fig. 1B shows a functional schematic to accomplish squelch in a more obvious way. E may be simply a mechanical relay that is normally open until sufficient level is received to operate it and so close the circuit between detector and audio amplifier.

Both of these diagrams are indicative of one manner of accomplishing noise suppression—the use of a squelch control whose action once completed does not affect the normal characteristics of the receiver. There is, however, a school of thought that reasons along different lines.

The situation, they say, is this:

1. It is desired to eliminate noise between stations.
2. Such noise represents field strengths of finite values.
3. Therefore, simply adjust the sensitivity of the set so that no signal at or below the noise level will be heard.

Fig. 2 illustrates the basic difference between the methods. Curve a represents the normal response curve of a receiver, b is the response when a relay is used to accomplish squelch, and c is the output-input relationship when noise suppression is accomplished by decreased sensitivity.

To produce curve b the designer de-

*Engineer, United Radio Laboratories.

cided that any input below p represented noise or unsatisfactory signal and arranged the set parameters so that noticeable output would be available once the threshold p was passed. And to make the output available as soon as possible after the threshold is passed the slope of the line from p to q is made as great as possible.

If we assume that any input value p will produce an undesired output, we force the designer of squelch by sensitivity control either to follow the mandate rigorously and produce c or compromise and produce a response intermediate between a and c . The intermediate curve will be, of course, a partial solution only.

Time avc Should Begin

Curve c is most objectionable in one respect—the shifting of the avc threshold. It is desirable from the standpoint of fading elimination and tuning indicator sensitivity that avc begin as soon as possible. The threshold value bears a definite relationship to sensitivity and the more sensitive the set the sooner the avc may be allowed to operate. Furthermore, there is still a surprisingly large number of persons who look for distant station reception. Dealers, too, are becoming educated to the idea of a station on every division, and demand sensitive receivers.

The squelch relay system then has the merit that a sensitive set's advantages can be used without admitting the concomitant noise. Further, it is truly "automatic" noise suppression.

The sensitivity control method has the advantage that it is simpler to achieve. The manner in which such controls may be exercised is well known and needs no discussion here. The squelch relay method is more interesting and more likely to be adopted.

Fig. 3 illustrates the usual scheme of securing automatic noise suppression. V1 is the controlling tube, V2 the controlled audio amplifier tube, and V3

the control voltage producer which may be the diode audio detector as illustrated or a separate control tube.

It will be noted that V1 and V2 are directly coupled. The operating voltages for both tubes are obtained from the resistors forming a bleeder circuit across the voltage supply. The cathode bias for V2 is the bleeder drop across R4 plus whatever voltage is present across R2 due to the plate current of V1 through R2. The bias for V1 is supplied by that portion of the drop across R8 which is between the grid and cathode of V1.

When no signal is presented to the diode there is no current through R8 and therefore V1 has no biasing voltage. The plate current of V1 will become appreciable and will be determined by the available plate supply voltage—the bleeder drop across R1. The voltage across R2 will become sufficiently large to cut off V2 and prevent it from operating. The circuit constants can be arranged so that V2 remains cut off until a certain value of signal is impressed on V3.

When a signal is put on V3 voltages are developed across R8. Qualitatively, we know that a d-c. voltage and an audio voltage, depending on modulation, is produced. We are not concerned for this discussion with other voltages.

Part of this voltage, and the value of this fraction depends on the volume control setting, is impressed on V2 through C2. A part is also impressed on V1 and across C1 through R9.

Considering V1 we note that C1 is made large enough to short-circuit effectively any a-c. voltage from appearing on the grid. The d-c. impressed, of course, acts as a bias and decreases the plate current of V1. If the circuit has been arranged to let this particular signal through the increased bias on V1 will be large enough to run its plate current characteristic to cut-off. There will be no drop across R2 then and the only bias on V2 will be the fixed drop across R4—normal ampli-

fier bias. V2 then functions as a regular amplifier for the a-c. impressed through C2.

The function of R9 is to prevent C1 from short circuiting the a-c. produced across R8. R3 is made large so that R2 and R1 similarly do not load R8.

If, however, the incoming signal is not large enough to cut off V1 the effect will be to reduce the drop across R2 and therefore the bias on V2. Fig. 4 illustrates the points of operation on the Eg- I_p curve of V2 of the three conditions just discussed. Point a represents the bias with no input on V3, b the bias region when V1 is not quite cut off and c the operating point with a strong incoming signal.

Dotted line O in the same figure can be used to illustrate a requirement of V2. A tube having a characteristic such as O will not operate when the bias is at a but will operate anywhere in the region b . And since operation in this region is operation along the curved portion of the characteristic the response from V2 will be distorted.

It is obviously desirable then that the region between the verge of cut-off, d for curve P , and the point of normal operation c be made as small as possible for it is in this region that distorted reception will occur.

Preferable Tube

Of course, not only remote cut-off tubes of the variable mu type will cause this distortion, but triodes also whose cut-off biases differ materially from the normal bias will have a large b region. For this reason tubes such as the 57 would be preferable to the 56, or 58 for V2.

Fig. 3 shows V3 as a single diode performing the simultaneous functions of audio detector and squelch control. An individual diode can, of course, be used for each purpose or the squelch function can be combined with the avc

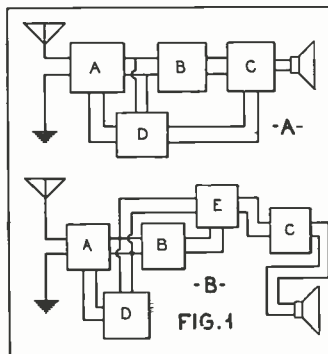

Fig. 1. Functional diagrams of receiver employing "squelch".

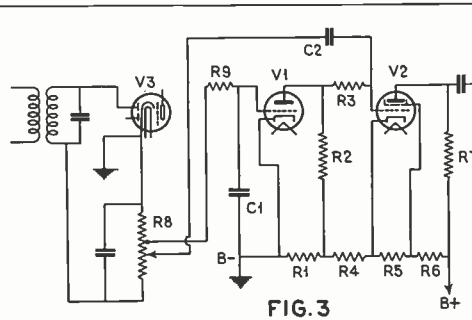

Fig. 3. A generic method of "squelching".

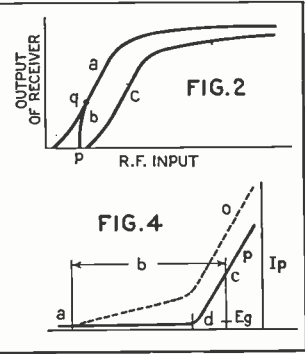

Fig. 2. Comparison of noise suppression methods.

Fig. 4. Modes of operation at V_g .

control. Fig. 5 illustrates these schemes.

Fig. 6 illustrates the squelch circuit of a commercial receiver. A 55 tube is employed to secure avc, squelch control and audio detection, while the triode section controls the audio amplifier.

The important constants that determine when squelch will occur are R1, R2, and R3. Squelch must occur before the avc threshold is reached. If the avc begins working first it will keep the sensitivity down so that the set may never "unsquelch." For example, in the receiver using the squelch circuit of Fig. 6, the avc delay was adjusted so that the avc threshold was at 15 microvolts (30 per cent modulation) input, the drop across R2 was 37, R1 was 50,000 ohms, and R3 one-fourth megohm. The squelch voltage at no signal across R1 was 26 volts. Under these conditions no sound was heard from the speaker until the receiver input reached 10,000 microvolts.

R2 was then adjusted so that the drop across it was 20 volts. With the avc still set for a 15 microvolt input threshold the receiver unsquelched simultaneously with the start of avc action. The voltage across R1 at zero carrier was 12 volts.

The effect of variation of R3 may be shown from the following: R1=35,000 ohms, R2 adjusted for 45 volts, R3=1/4 megohm.

Receiver unsquelched at 20 microvolts:

R1 and R2 as before but R3=1/2 megohm.

Receiver unsquelched at 100 microvolts:

R1 values were not critical; the change in plate voltage, and therefore plate current change, tended to compensate for the change in load resistance. R2 voltages must be adjusted within the limits set by the requirements of the other members of the bleeder and, of course, affect the squelch threshold directly.

Some control method must be pro-

vided to accommodate various noise levels. If the circuit is set to squelch at 15 microvolts input, for example, it will void its purpose in a locality where 25 microvolts is the noise level.

Three methods have been hinted at —R1, R2 or R3 variations. Additionally, various methods of set sensitivity controls such as antenna potentiometers and signal amplifier bias rheostats could be used. Still other methods include variations of tube parameters of the controlled audio amplifier tube, and delay of current through the resistor developing voltage for the controlling tube's grid.

Desired Stations

Each of these arrangements is practicable and is used on one set or another now on the market. The continuously variable control is often used with these methods but has the disadvantage that the operator may set it to operate at a signal strength corresponding to the signal strengths of stations it is desired to hear. Reproduction will then be poor. When properly operated squelch should end well below the signal strength of desired stations.

An arrangement which is more or less foolproof was suggested to the writer by J. M. Stinchfield. The squelch circuit is set for an average noise level and can be changed only by a screwdriver adjustment located on the rear of the chassis. A switch in the front panel control allows the operator a choice of squelch or no squelch. This arrangement permits quiet operation for local reception and high sensitivity for low level reception. Such a switch may open or short, R1 in Fig. 6. The serviceman who installs the set may make the chassis adjustment to suit local conditions.

This switch arrangement system also has the distinct advantage that automatic noise suppression can very easily be demonstrated.

Earlier in this paper the effect of

squelch on apparent selectivity was mentioned. The effect of avc on selectivity has not been accorded the amount of discussion it deserves.

With avc the normal selectivity of a receiver is apparently worse than without automatic control. This is due to the attempt of the avc to keep a constant output as the operator tunes through the signal. If a great deal of selectivity is ahead of the avc control device this is especially obvious because the avc changes most quickly. Further, with extreme selectivity preceding the avc it is even possible that distortion and overload will occur in the first amplifier stages before the avc begins working. Too little selectivity ahead of the avc invites the danger of an adjacent channel local causing the avc to function on weak signal reception.

Effect on Selectivity

Squelch is obviously a decided help in improving the apparent selectivity. As the operator tunes through the station a distinct break occurs and there is no dragging over. If the squelch is accomplished by a separate tube whose input is very sharply tuned the squelching can take place within 2 kc. of resonance so that the break is very sharp and clean-cut. The advantages of this system are that it compels correct tuning, eliminates the necessity for a visual indicator, eliminates the mush on each side of exact resonance, and improves the apparent selectivity. The disadvantage is that tuning even to one acquainted with the cause and effect is difficult. It is very easy to entirely skip stations and if the avc time-constant is appreciable it becomes almost impossible to tune the station in. There are, however, several commercial models using this system and it is expected that much work will be done along these lines this year.

Fig. 6 shows that the avc input is taken from the plate circuit of the tube (Concluded on page 22)

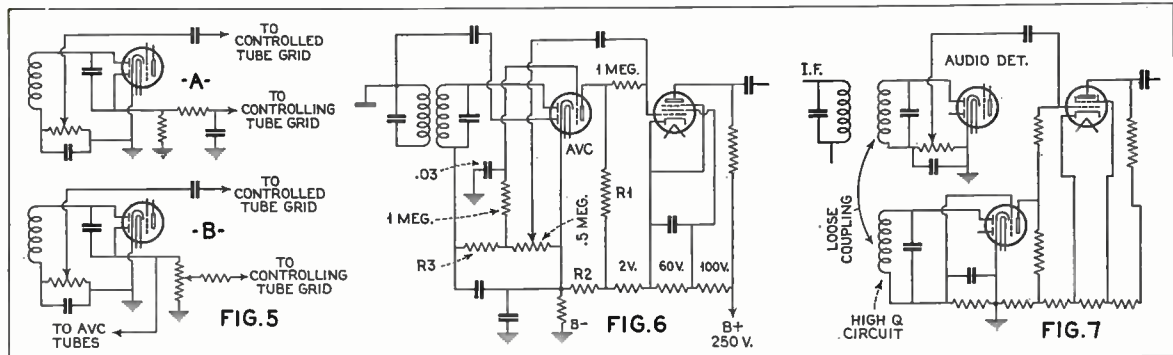

Fig. 5. Separate audio diode combined avc and "squelch" diode.

Fig. 6. "Squelch" circuit of a commercial receiver.

Fig. 7. Circuit to achieve high "squelch" circuit selectivity.

Progress in tubes for radio

THE RCA Radiotron Company, Inc., and E. T. Cunningham, Inc., have announced four new types of tubes. The 25Z5 is a full-wave, high-vacuum rectifier of the heater-cathode type for use in suitable circuits designed to supply d-c. power from an a-c. power line. This tube is of particular interest because of its adaptability to the design of "transformerless" receivers of either the "universal" type or the "a-c. operated" type.

In "universal" receivers, the 25Z5 may be used as a half-wave rectifier, while in the "a-c. operated" type, it may be used as a voltage doubler to provide about twice the d-c. output voltage obtainable from the half-wave arrangement. This two-fold application is made possible by the use of a separate base pin for each cathode.

The heater of this tube has been designed to facilitate its economical operation in series with the heaters of other tubes in the radio set. The employment of a 25-volt heater permits the construction of a receiver having reduced heat dissipation in the fixed series resistor. Furthermore, the heater-cathode design permits of close electrode spacing and provides high rectifying efficiency.

The 25Z5 is constructed compactly in a small dome-top bulb and requires a minimum of space for its installation.

Voltage-Doubling Rectifier Considerations

In rectifying circuits using tubes, current flows between cathode and plate only during the time when the voltage on the plate is positive. Such circuits in their simplest form employ a single diode which rectifies the a-c. supply on alternate half-cycles. The output of a single diode consists of uni-directional pulses of current and voltage. These pulses may be smoothed by means of a suitable filter.

If two diodes are employed, each half-cycle of the a-c. supply may be rectified. The conventional circuit using two diodes is known as a full-wave rectifier. The features of such a rectifier in comparison with a half-wave rectifier are: Approximately twice the output current with essentially the same d-c. voltage output; and more economical filtering due to the doubled frequency of the output pulsations.

In comparison with the full-wave connection, another arrangement of two diodes is of interest. In this case, two diodes, one of which is reversed with respect to the other, are connected to two condensers. This arrangement provides rectification of each half-cycle of the a-c. supply. Furthermore, during the period that a diode is rectifying, the condenser across the other diode is discharging through the load and the conducting diode. As a result, the voltage across the load is the sum of the d-c. output voltage of the conducting tube and the discharge voltage of the condenser. The total d-c. voltage across the load, therefore, is approximately twice the d-c. voltage obtainable from a half-wave rectifier. For this reason, this circuit is known as a voltage-doubler. Like the full-wave circuit, the doubler circuit gives an output having a ripple frequency twice that of the supply line.

In the design of a voltage doubler using this circuit, large capacitances are necessary to give good regulation of the d-c. output voltage at higher values of load current. A point of interest to the set designer, however, is that the voltage rating of these condensers is determined not by the d-c. output voltage, but by the peak value of the a-c. supply.

TENTATIVE RATING AND CHARACTERISTICS, RCA-25Z5, C-25Z5

Heater voltage	2.5 volts
Heater current	0.3 ampere
A-C plate voltage per plate (r.m.s.)	125 max. volts
D-C load current	100 max. ma.
Maximum overall length	4 1/4"
Maximum diameter	1 9/16"
Bulb	ST-12
Base	Small 6-pin

Application

As a half-wave rectifier, the 25Z5 is designed for service in "transformerless" receivers of the "universal" type. In such service, the two plates are connected together at the socket so as to act as a single plate; likewise, the cathodes are connected as a unit. Conditions for this method of operation are given under rating and characteristics.

As a voltage doubler, the 25Z5 is adaptable to service in "transformerless" receivers of the "a-c. operated" type and is capable of supplying approximately twice the d-c. output voltage of the half-wave circuit.

Power Amplifier Triode, 2A3 (Multifilamentary Cathode)

The 2A3 is a three-electrode, high-vacuum type of power amplifier tube for use in the power output stage of a-c.-operated receivers. It possesses new capabilities for delivering exceptionally large, undistorted power output. A pair of these tubes in a Class A push-pull stage operating at 300 volts on the

plates can supply 15 watts of undistorted power.

The exceptionally large power-handling ability of the 2A3 is the result of its design features. Among these are its extremely high mutual conductance and its highly efficient cathode of unconventional form. The cathode is composed of a large number of coated filaments arranged in series-parallel combination to provide a very large effective cathode area.

TENTATIVE RATING AND CHARACTERISTICS, RCA-2A3, C-2A3

Filament voltage (a-c. or d-c.)	2.5 volts
Filament current	2.5 amperes
Direct interelectrode capacitances (approx.):	
Grid to plate	13 μμf.
Grid to filament	9 μμf.
Plate to Filament	4 μμf.
Maximum overall length	5 3/8"
Maximum diameter	2 1/16"
Bulb	ST-16
Base	Medium 4-pin

Single-Stage Amplifier (Class A)

Operating Conditions and Characteristics:

Filament voltage (a-c.)	2.5 volts
Plate voltage	250 max. volts
Grid voltage	-42* volts
Plate current	60 ma.
Plate resistance	765 ohms
Amplification factor	4.2
Mutual conductance	5500 micromhos
Load resistance	2500 ohms
Power output (5% second harmonic)	3.5 watts

Push-Pull Amplifier (Class A)

Operating Conditions:

	Fixed Bias	Self-Bias**
Filament voltage (a-c.)	2.5	2.5
Plate voltage	300 max.	300 max.
Grid voltage	-62*	-62*
Plate current (per tube)	40	40
Load resistance (plate to plate)	3000	5000
Total harmonic distortion	2.5	5
Power output	15	15

*Grid volts measured from mid-point of a-c. operated filament.

**For this condition, the values given are on the basis of momentary average power output as distinguished from the continuous average power output of the fixed-bias condition. The power output and percentage distortion are functions of the duration and magnitude of the signal which through variation in plate current causes fluctuating grid bias. Obviously, a filter associated with the biasing resistor will tend to stabilize the grid bias. The duration of stabilization increases with the time constant of the filter; the longer the period, the longer the power peaks can be maintained.

The 2A3, because of its exceptional power-delivering ability, offers the designer of a-c. receivers a new means for obtaining high undistorted power output.

As a power amplifier (Class A), the 2A3 is adaptable either singly or in push-pull combination to the power output stage of a-c. receivers. Recommended operating conditions are given under rating and characteristics.

It will be noted that the values recommended for push-pull operation are different than the conventional ones usually given on the basis of characteristics for a single tube. The values shown for push-pull Class A operation

cover operation with fixed-bias and with self-bias, and have been determined on the basis of no grid current flow during the most positive excursions of the signal swing and of cancellation of second harmonic distortion by virtue of the push-pull circuit.

If a single 2A3 is operated self-biased, the self-biasing resistor should be approximately 700 ohms. This same value is also recommended for use with two 2A3's in push-pull. In either case the resistor should preferably be shunted by a suitable filter network to minimize grid bias variations produced by current surges in the biasing resistor.

Any conventional type of input coupling may be used provided the resistance added to the grid circuit by this device is not too high. Transformers or impedances are recommended. When self-bias is used, the d-c. resistance in the grid circuit should not exceed 0.5 megohm. With fixed-bias, however, the d-c. resistance should not exceed 10,000 ohms. The use of resistances higher than these may cause the tube(s) to lose bias due to grid current with the result that the plate current will rise to a value sufficiently high to damage the tube(s).

An output transformer should be connected in the plate circuit of the 2A3 in order to transfer power efficiently to the loudspeaker. Recommended values of load resistance for single-tube and push-pull operation are given under rating and characteristics.

Power Amplifier Pentode, RCA-2A5, C-2A5

Uni-potential Cathode Type with 2.5-Volt Heater

The 2A5 is a power amplifier pentode of the heater-cathode type for use in the audio output stage of a-c. receivers. It is capable of giving large power output with a relatively small input-signal voltage. Because of the heater-cathode construction, a uniformly low hum-level is attainable in high quality power amplifier design.

A single 2A5 in the output stage is capable of supplying about 3.0 watts, while two 2A5's in a push-pull stage can deliver in excess of 6.0 watts.

The power-handling ability of the 2A5 is essentially the same as that of the 59 with pentode connection, but the latter type has a greater flexibility of application to power amplifier design. The two types, however, are not directly interchangeable because of the difference in base connections.

Like the 59, the 2A5 is characterized physically by the dome-top bulb, and the rigidity of electrode assembly. In size, the 2A5 is somewhat smaller than the 59.



RCA Radiotron
RCA25Z5
Cunningham C25Z5



RCA Radiotron
RCA2A3
Cunningham C2A3



RCA Radiotron
RCA2A5
Cunningham C2A5

TENTATIVE RATING AND CHARACTERISTICS

Heater voltage (a-c. or d-c.)	2.5 volts
Heater current	1.75 ampere
Plate voltage	250 max. volts
Screen voltage	250 max. volts
Grid voltage	-16.5 volts
Plate current	34 ma.
Screen current	6.5 ma.
Plate resistance	10000 approx. ohms
Amplification factor	220 approx.
Mutual conductance	2300 micromhos
Load resistance	7000* ohms
Power output (7% total harmonic distortion)	3.0 watts
Maximum overall length	4 11/16"
Maximum diameter	1 13/16"
Bulb	ST-14
Base	Medium 6-pin

*A load resistance of 9000 ohms will give approximately the same power output and same total harmonic distortion as 7000 ohms.

Application

The 2A5, because of its heater-cathode construction, consequent low hum-level, and a large power output, is recommended to designers for output use in a-c. receivers employing a pentode-power stage.

As a power amplifier (Class A), the 2A5 may be used either singly or in push-pull combination. Recommended operating conditions are given under rating and characteristics.

If a single 2A5 is operated self-biased, the self-biasing resistor (408 ohms) should be shunted by a suitable filter network to avoid degenerative effects at low audio frequencies. The use of two 2A5's in push-pull eliminates the necessity for shunting the resistor (204 ohms).

Any conventional type of input coupling may be used provided the resistance added to the grid circuit by this device is not too high. Transformer or impedance coupling devices are recommended. If, however, resistance coup-

ling is employed, the grid resistor should not exceed 250,000 ohms with self-bias; without self-bias, the value should be limited to 100,000 ohms.

An output transformer should be used in order to transfer power efficiently to the speaker. The optimum value of load resistance for a single tube is given under rating and characteristics. For push-pull operation, the plate to plate load resistance should be twice that for a single tube. For best results, the impedance in the plate circuit of the 2A5 should be as uniform as possible over the entire audio-frequency range.

Heavy-Duty, Full-Wave Rectifier, RCA-5Z3, C-5Z3 (High-Vacuum Type)

The 5Z3 is a high-vacuum rectifier of the full-wave type intended for supplying rectified power to radio equipment having very large direct-current requirements. In comparison with the '80, the 5Z3 will furnish approximately twice the d-c. load current at higher d-c. output voltages. The coated filaments employed in the 5Z3 provide an efficient source of electron emission, and reach their dull-red operating temperature quickly.

TENTATIVE RATING AND CHARACTERISTICS

Filament voltage (a-c.)	5.0 volts
Filament current	3.0 amperes
A-C. voltage per plate (r.m.s.)	500 max. volts
D-C. output current	250 max. ma.
Maximum overall length	5 3/4"
Maximum diameter	2 1/16"
Bulb	ST-16
Base	Medium 4-pin

(Continued on page 22)

Short-wave transoceanic telephone receiving equipment†

Commercial Transoceanic Telephony by Radio Requires Exact Engineering

By F. A. POLKINGHORN*

THE commercial importance of a single radio channel used for transoceanic telephone communication is such as to permit considerable effort being placed upon obtaining the most efficient and satisfactory operation from each unit of equipment. In this paper, it is proposed to discuss, in a general manner, the receiving equipment used on the short-wave transatlantic telephone channels to England and some of the methods of analysis used in attacking problems encountered in the design of the receiving equipment.

Fields Obtained

A highly important factor in radio reception is the signal-to-noise ratio obtainable. This is, in most cases, a function of the field strength received. The field strengths obtained at the high frequencies are highly variable, ranging from a value well below that necessary to give the faintest audible signal to perhaps 60 db. above a microvolt per meter (1 millivolt per meter), depending upon the time of day, the season of the year, and magnetic conditions. They are also a function of the particular path, the fields obtained over the North Atlantic path between New York and England being affected by magnetic storms to a greater extent than over any other important path. Mr. Burrows has shown¹ in a very graphical manner the field which may be expected at various times of the day over the transatlantic channel to England. One of his graphs is shown in Fig. 1. The lines on the graph are

lines of equal field strength and the values are in decibels above one microvolt per meter. It must be remembered that the values shown are for a particular season and are averages only. Even though the figure may show that a field of 20 db. above a microvolt per meter (10 microvolts) is to be expected, the presence of a magnetic storm on a particular day may reduce the field over the North Atlantic to a value so far below that required for commercial operation that it is probable that an increase of the transmitted power to several hundred kilowatts (the ordinary carrier energy radiated by the transmitter is about 15 kw.) would not give an audible signal. During such times, transatlantic service must be given over the long-wave channel which radiates about 50 kw. in the vicinity of 60 kc., and which is likely to be somewhat better than usual during a magnetic storm.

As can be seen from Fig. 1, the time at which the field strengths at the vari-

ous frequencies are highest is not the same for all frequencies, and consequently, it has been found necessary to have available three or four frequencies of roughly 7,000 kc., 9,000 kc., 13,000 kc. and 19,000 kc., in order to insure that service can be given under all normal conditions. In practice, it is the custom to use a particular frequency so long as it is satisfactory, and then shift to the next frequency.

In the operation of the receiving station at Netcong, New Jersey, considerable effort is made to use the frequencies available to the best advantage. A monitoring group known as a "channel efficiency bureau" is maintained to advise the operators of the best frequency at a given time and of the best time to shift to another frequency. The monitoring group also makes periodic measurements of the field strength and frequency on all channels which may be in operation and of such other short-wave stations as may be of interest. On each day, when operation is commenced on a particular frequency, the operator advises the channel efficiency bureau of the amount of attenuation it is necessary to place in his receiver to obtain a standard output, and this information is compared with the normal value for the field being obtained. This gives a check on the condition of the receivers, transmission lines and antennas.

Use of Directive Antennas

Knowing the field strength which he can expect, the problem that confronts the station designer is how to make the best use of it. Since the minimum commercial field may be only a fraction of a microvolt per meter, the receiver must have considerable gain. In receivers having high gains, noise will be generated in the first circuits and tubes by the thermal agitation of the

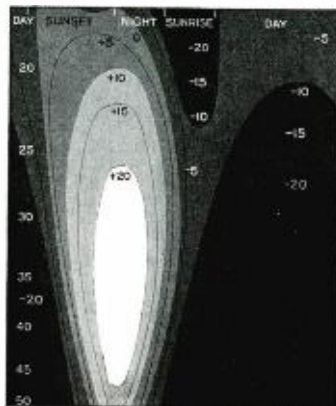

Fig. 1. Average field strength surface for June, 1926, db. above 1 microvolt per meter for 1 kw. radiated.

†Presented before the Radio Club of America.
*Member of the Technical Staff, Bell Telephone Laboratories, Inc.
¹C. R. Burrows' "The Propagation of Short Radio Waves Over the North Atlantic," Proc. I. R. E., Vol. 19, pp. 1634-59, Sept., 1931.

electrons which are moving about in every conducting substance. This noise is ordinarily called "Johnson noise," after its discoverer, or merely "thermal noise." The maximum Johnson noise energy which can be drawn from a circuit is independent of its resistance but the noise voltage varies as the square root of the resistance. If the signal is to override this noise satisfactorily when weak signals are being received and static is very low, it is essential that a maximum of voltage be applied to the input of the receiver for any given field. Antennas having a high signal pickup are, therefore, used at the receiving station. Fortunately at high frequencies it is comparatively easy, by means of what is usually called a directive antenna, to obtain a high signal collecting power as well as directivity. A directive antenna is essentially a number of elementary antennas so arranged that the output of all the elements is combined to good advantage when waves arrive from a certain direction and is combined less advantageously for waves arriving from other directions. The increase in voltage which may be obtained with a directive antenna is ordinarily from 10 to 16 decibels (3 to 6 times) over what would be obtained with a single half-wave vertical antenna.

When receiving near New York on frequencies above 10,000 kc., the receiver noise is likely to be higher than static for the larger part of the time, while for frequencies of less than 10,000 kc., static is more prominent and is likely to be the limiting noise.

The ratio of signal-to-static can also be improved by the use of directive antennas in most cases. The directive antenna increases the desired signal. If the static arrives from the same direction as the signal, it is also increased and no improvement in signal-to-noise ratio over a non-directional antenna will result, while if the static all comes from a direction from which the antenna gives no output, an infinite

Fig. 2. End view of Bruce array.

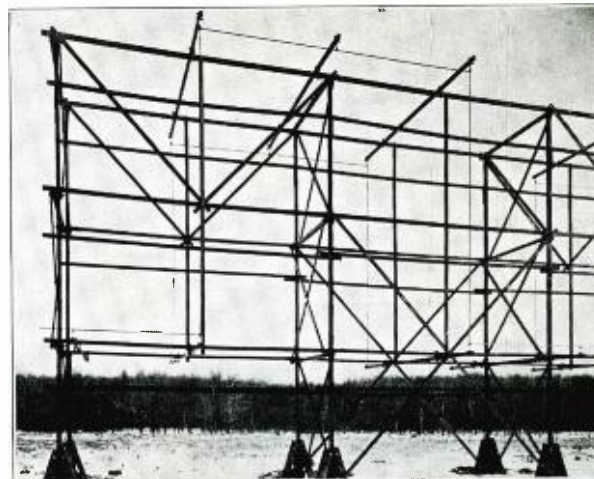

improvement over a non-directional antenna is obtained. The customary improvement obtained is somewhere between these two extreme cases and on the average may approximate the condition where the static comes equally from all directions so that the improvement in signal-to-noise ratio over a non-directional antenna is equal to the improvement in signal pickup of the antenna² over a non-directional antenna.

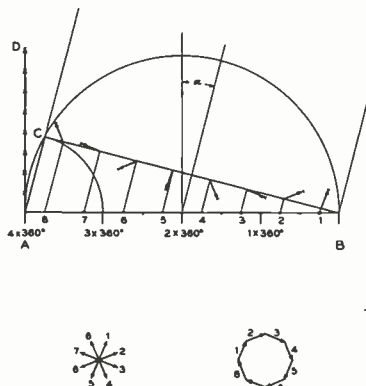

Fig. 3. Graphical computation of radiation from a plane array.

The directive antennas used for reception in the Bell System have been of two types. The first was called a "Bruce Array" and consisted of a number of quarter wavelength vertical elements spaced a quarter wavelength apart and connected to each other alternately at the top and bottom. Fig. 2 shows an end of one of these antennas. The direction of maximum reception is at right angles to the length of the antenna.

In practice, two curtains having the same construction are used, the second curtain being placed a quarter wave-

length behind the first. The output transformer is placed next to the front curtain and connected between the front and rear curtains. A wave arriving from the front induces a voltage in the front curtain and, passing on, induces a voltage in the reflector curtain a quarter cycle interval later. The voltage induced in the reflector must then be transmitted back to the antenna, requiring an additional quarter cycle interval. The transformer, therefore, has voltages 180° out of phase impressed on its terminals and a maximum of output is obtained. Waves arriving from the rear of the antenna induce a voltage first in the reflector curtain. This voltage is transmitted along the lead to the output circuit, arriving in phase with the voltage induced in the antenna curtain and thus giving no difference in voltage across the output transformer.

The directional pattern of an antenna is best expressed by a three-dimensional figure and is customarily found by mathematical calculation. It is possible, however, to make approximate computations of the horizontal or vertical characteristics graphically in some cases.³ Assume, for instance, that a transmitting antenna AB Fig. 3 consisted of a large number of elements in broadside relation and having currents of equal magnitude and phase. In a direction in front of the antenna the radiation from all elements will add up and may be represented as the sum of the small vectors (Fig. 3). At an angle α , such that the distance from one end of the antenna to a distant point is one wavelength less than from the other end, the sum of the radiation from the various elements will be zero, i.e., the vectors will form a closed circle; and when the angle is such, that the differ-

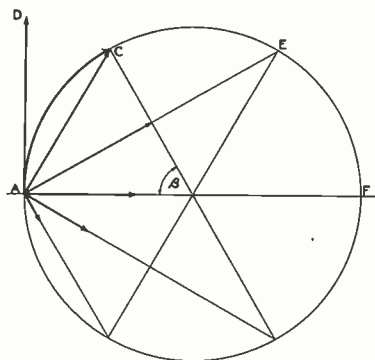

Fig. 4. Diagram for obtaining amplitude of radiation in a given direction.

² For details of improvement caused by directive antennas at Netcong, N. J., see article, "High Frequency Atmospheric Noise," by R. K. Potter, Proc. I. R. E., Oct., 1931.

³ See article, "Beam Wireless Telegraph," by N. Wells, in The Electrical Review (London), May 25, 1928.

ence in distance is one and one-half wavelengths, the vectors will again add up to give a lobe in the directive diagram. The amplitude of the lobe will not, however, be as great as the major lobe, as all of the vectors will not be adding up in exact phase but rather will be adding up in the form of a circle and a half in which the diameter of the circle is the length of the lobe in the diagram.

The amplitude of the radiation in

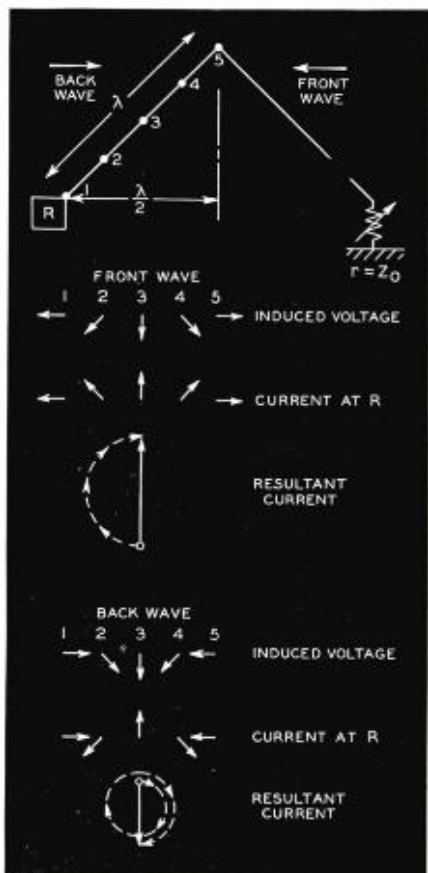

Fig. 5. Addition of voltages in an inverted "V" antenna, equivalent to half of a horizontal rhombic antenna.

This explanation has been made in terms of a transmitting antenna for simplicity but applies equally well to a receiving antenna.

The second type of antenna which has been used for receiving purposes in the Bell System is called a horizontal rhombic antenna and consists of wires forming a rhomboid or diamond-shaped figure, supported above the ground on poles. At one corner of the rhomboid, a transmission line is connected and at the diagonal corner a resistance. Horizontally polarized waves arriving at an angle above the horizontal from a direction opposite to the end connected to the transmission line induce a voltage into the various units of the antenna which add up across the transmission line terminals. A wave arriving from the opposite direction induces a similar voltage which is dissipated in the resistance at the front end of the antenna. The directive properties

of this antenna are a complex function of the angles between the sides of the antenna, the length of the sides and the height above ground⁴ and are not quite as simply shown by vector diagrams as in the previous case. The manner in which the voltages add up in one-half of the antenna can be seen in Fig. 5, which was originally drawn for an inverted V-antenna working to ground.

Transmission Lines

Since directive antennas are quite large and it is not desirable to place several antennas in too close proximity, transmission lines are used when several antennas are located on the same plot. A very convenient type of line is the concentric line described by Sterba and Feldman in the Proceedings, Institute Radio Engineers for July, 1932. An examination of the equations for the loss in a concentric line shows that, contrary to low frequency experience, for high frequencies there is an optimum ratio of the diameter of the inside and outside conductors of 3.6 corresponding to an impedance of approximately 72 ohms. The loss is only slightly higher, however, for ratios from 2½ to 5 times. Three sizes of concentric line have been found convenient; ¾ inch, ¾ inch and 1¾ inches, outside diameter. The

various directions can be found from the diagram, Fig. 4. The angle β is 1/6 of that from the front to the first null. The vector AD is the sum of the unit radiations from the various elements in the front direction. At the angle 1/6 α the vectors form the arc of a circle subtending the angle β . The cord of the arc represents the radiation in the direction β . The radiation in the direction 2β from the front can be found in a corresponding manner, and is equal to one-half the vector AE. At 3β the vector would be 1/3 AF and so on. If the antenna has a reflector the diagram thus found must be multiplied by a cardioid, which is the diagram obtained with one of the antennas and one reflector element considered alone.

⁴Proc. I. R. E. Vol. 19, pp. 1406-1433, for Aug., 1931.

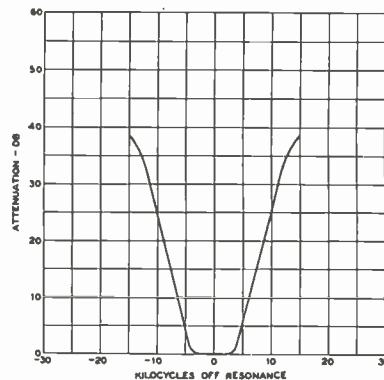

Fig. 7. Selectivity of transoceanic telephone receivers.

¾ inch size, constructed with Isolantite insulators spaced every inch or two, has been found convenient for inside wiring as it can be bent by hand, and jacks and cords can be used for patching from one receiver to another. The sections of the 1¾ inch line are joined by means of copper water pipe unions. This size serves admirably for long runs out of doors. Neglecting the effect of insulators the loss in the line in decibels varies inversely as the diameter, directly as the square-root of the frequency and amounts to 1 db. per 1,000 feet at 22,000 kc. for the 1¾ inch copper line. The loss in the insulators of the large size of line is very small while with the ¾ inch line it is an appreciable part of the total.

Some of the concentric transmission lines have been placed in a sinusoidal form, to allow for expansion, and about a foot above the surface of the earth. Other lines have been buried under the surface of the soil, and in this case no provision need be made for expansion.

Receivers

The receivers used on the transoceanic channels were designed in 1928

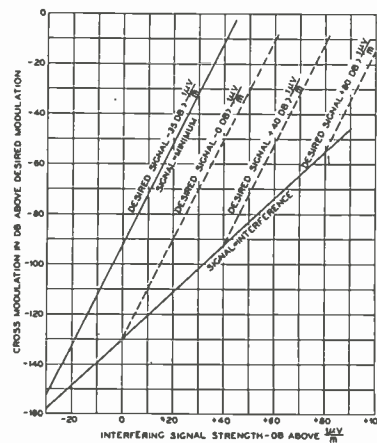

Fig. 9. Effect of volume control on cross modulation in a receiver.

and are of the double detection or super-heterodyne type. They are mounted on three relay racks as shown in Fig. 6. The left bay contains two stages of high-frequency amplification, the first detector and one stage of intermediate-frequency amplification as well as two testing oscillators, one for high frequency and the other for intermediate frequency. The second bay contains a voice-frequency amplifier, a variable attenuator of 120 db., the intermediate amplifier of six stages of three-element tubes, the second detector and the volume control circuits. The third bay contains fuses; protective lamps for each plate circuit, plate, filament circuit and line jacks and meters which can be cut into the plate or filament circuits by inserting a plug into the proper jacks, a volume indicator and a shelf with telegraph key and sounder.

In the design of these receivers every effort was made to obtain the highest quality and signal-to-noise ratio. The fidelity and selectivity of the receiver is shown in Fig. 7. This curve represents the intermediate-frequency selectivity corrected for audio-frequency equalization.

At frequencies of 12,000 to 20,000 kc. the static is likely to be low enough so that receiver noise is a limiting factor. In a well designed receiver, an effort is made to have substantially all the receiver noise originate as Johnson or thermal noise in the first circuit. The thermal noise voltage is proportional to the square-root of the circuit impedance.

If the first circuit noise is to override the first tube and second circuit noises, the impedance of the first circuit must be high. An analysis of the equation

for the ratio of first tube grid voltage to transmission line voltage, when impedances are matched, and the equation for the impedance of the circuit, shows that the noise and signal increase in direct proportion as the impedance of the circuit is raised. By connecting the transmission line across the whole coil instead of tapping the coil to match the

transmission line impedance, an improvement in the signal-to-noise ratio on the first grid of 3 db. is possible. However, this condition is not generally a practical one as the signal voltage on the transmission line is not stepped-up before reaching the first grid and is, therefore, not likely to be of sufficient magnitude to override satisfactorily the first tube noise. Where a transmission line from antenna to receiver is used the signal-to-first-circuit-noise ratio will be less than if no transmission line were used by the amount of the loss in the transmission line. To overcome this the first circuit, together with the first tube and its output circuit may be placed at the antenna. This arrangement forms a repeater which may be supplied with power over the high-frequency transmission line by the use of suitable filters.

Cross-modulation may be particularly troublesome in double detection receivers having high-frequency amplification for the reason that the first detector of a double detection receiver is inherently a non-linear device.

The matter of cross-modulation has been treated by writers in a mathemati-

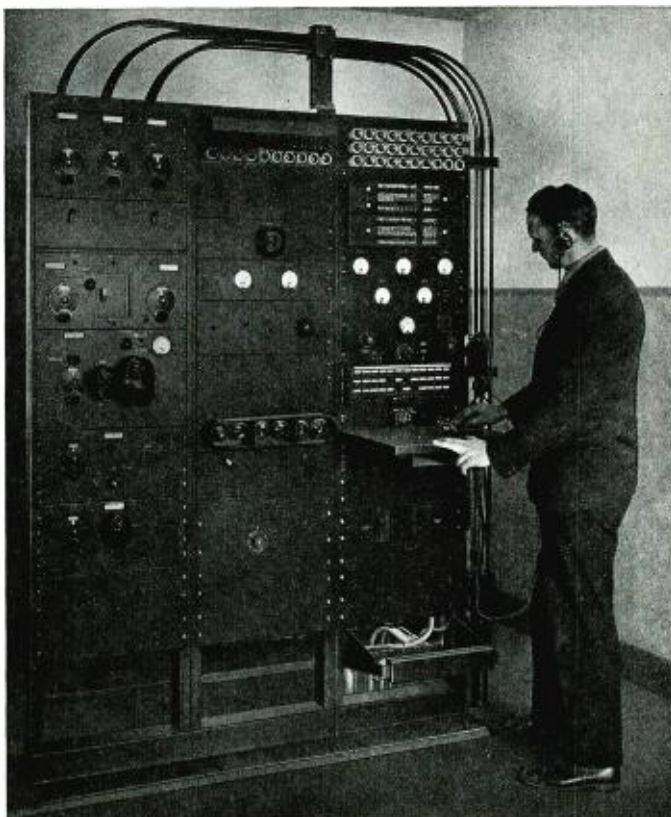

Fig. 6. Receiver used on transoceanic telephone channels.

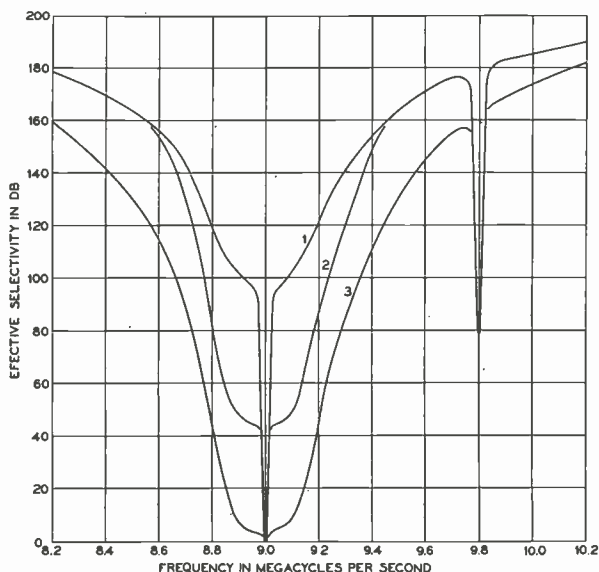

Fig. 8. Variation of effective selectivity caused by cross modulation.

Curve 1. No cross modulation.

Curve 2. 0.1 volt of interfering signal on grid at resonance.

Curve 3. 1.0 volt of interfering signal on grid at resonance.

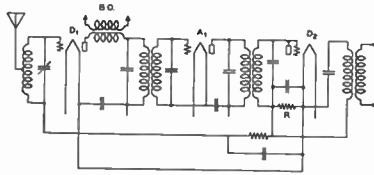

Fig. 10. Schematic diagram of double detection radio receiver with automatic volume control.

cal way. To obtain a physical picture of cross-modulation consider that two signals are impressed upon an amplifier, one wanted and one unwanted. It can be seen that the unwanted signal will sweep the operating point for the wanted signal back and forth. If the amplification is not the same at all points, the amplitude of the wanted signal will be changed periodically in accordance with the modulation of the unwanted signal.

Cross-modulation can be explained rather simply in terms of algebraic equations. By the ordinary trigonometric transformations it can be shown that if two voltages

$$P \cos pt + Q \cos qt$$

are applied to an amplifier, the output current of which is represented by the usual power series

$$i = a_0 + a_1 e + a_2 e^2 \dots$$

the important component of the resulting current is

$$i = \cos pt [a_1 P + \frac{3}{4} a_3 (P^2 + 2 PQ^2)]$$

If the voltage $Q \cos qt$, which we will call the unwanted signal, is modulated to the degree M by a frequency $g/2\pi$, the previous equation, after dropping negligible terms, can be written

$$i = a_1 P \cos pt [1 \times (-) Q^2 M] \cos gt$$

It will be noted that this equation is that of a modulated wave in which

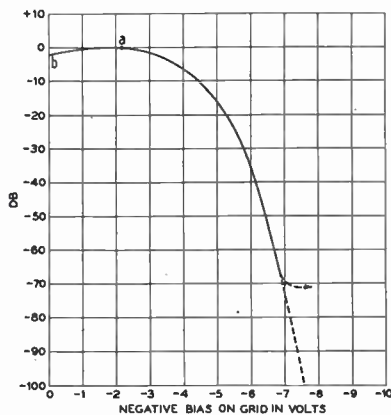

Fig. 12. Variation of efficiency of the first detector of the transoceanic receivers with change in grid bias.

$Q^2 M$ is the degree of modulation.

This equation indicates that the cross-modulation is proportional to the ratio of the third power coefficient to the first power coefficient, and to the square of the amplitude of the unwanted signal.

Where the cross-modulation occurs in a heterodyne detector the degree to which the desired signal is modulated by the undesired signal is proportional

to $\frac{a_3}{a_1} Q^2 M$. Both of the equations

which have been given have neglected the effect of higher order terms. These terms may not be negligible and have to be considered in some cases.

The effect of cross-modulation upon the effective selectivity of one of the transoceanic radio receivers, as originally installed, is shown on Fig. 8. Here the upper curve shows the total selectivity as the sum of the high-frequency selectivity and the intermediate-frequency selectivity. If the unwanted signal is very weak this will be the effective selectivity of the receiver. However, for stronger unwanted signals the effective selectivity is reduced and is given by the other curves. In this

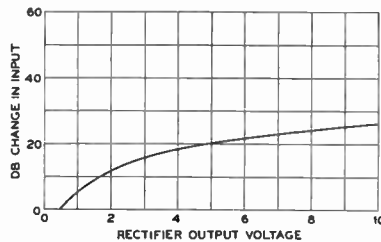

Fig. 11. Volume control rectifier output voltage.

particular receiver the cross-modulation occurred almost entirely in the first detector. By applying automatic volume control to the high-frequency amplifier tubes the amplitude of the unwanted

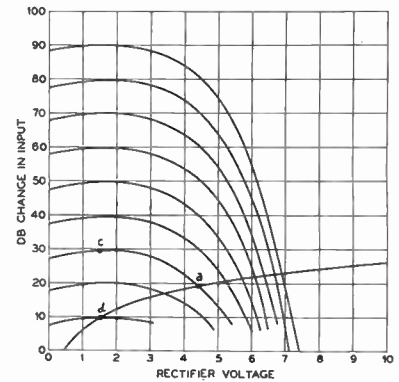

Fig. 14. Diagram for graphically obtaining automatic volume control characteristics of receiver.

signal on the first detector can be reduced when the wanted signal is high and the amount of cross-modulation cut down.

Fig. 9 shows how the amount of cross-modulation can be conveniently plotted when it occurs all at one place. The upper left curve gives the amount of the cross-modulation in the receiver when the wanted signal is so low as not to operate the automatic volume control. The lower curve gives the modulation when the wanted and unwanted signals are kept equal. Since the amount of cross-modulation varies as the square of the interfering signal other lines representing various values of unwanted signal can be drawn in with a slope of 2:1 through the intersection of the bottom line and a given value of abscissae.

Another matter of interest in the design of a radio receiver is to be able to predict the operation of the automatic receiver with automatic volume control is shown on Fig. 10. The system is the conventional one where the rectified output of the second detector is used to decrease the efficiency of the first detector. In Fig. 11 the variation of the rectified output of the second detector

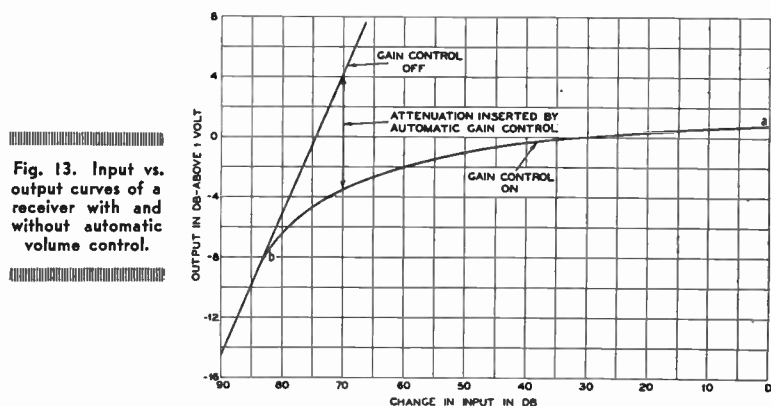

Fig. 13. Input vs. output curves of a receiver with and without automatic volume control.

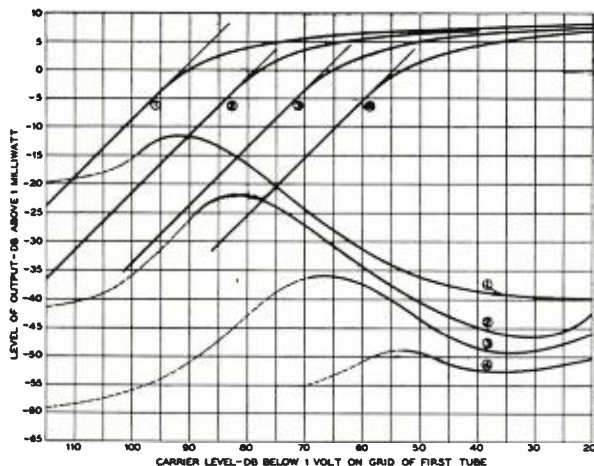

Fig. 16. Signal and set noise output of radio receivers.

(volume control rectifier) with input is shown. This curve would be a straight line if both ordinate and abscissae were in the same units. The variation of the efficiency of the first detector with variation of the negative bias is shown on Fig. 12. If the variation of receiver output with input were plotted the curve of Fig. 13 would be obtained. This curve can be synthesized from the previous figures in the manner shown in Fig. 14. In this figure, the detector efficiency curve has been retraced at intervals of 10 db., representing changes of that amount in signal intensity. Consider the signal to be such as to give a rectifier output of 1½ volts and the output of the rectifier to be the +10 db. indicated by the intersection of the rectifier output curve and the lower detector efficiency curve (point d). If the detector bias were held constant and the input raised 20 db. the output would also go up 20 db. to the point "c." If the rectifier is allowed to change the detector bias in the usual manner, however, the rectifier output will increase to "a" and the detector efficiency decrease from "c" to "a." The net increase in output when the automatic volume control is connected is seen to be 9 db. for the 20 db. increase in input. An increase of 10 db. more in input will increase the output only 2 db. Further increases in input give smaller and smaller increments in output.

If all of the intersections are plotted, using the ordinates found on Fig. 14 and steps of abscissae of 10 db. the curve of Fig. 13 will be obtained. If abscissae in absolute values are desired it is necessary to determine one point such as the point "b" by observing the output for a particular given input.

Considerable information of interest can be obtained from Fig. 13. If it is assumed that the abscissae figures are inputs in db. below one volt the maximum gain of the receiver is approximately the value of abscissae for an out-

put of 1 volt. It is seen to be 74 db. This is actually the approximate intermediate-frequency gain of the transoceanic receivers, exclusive of high frequency amplification and first circuit

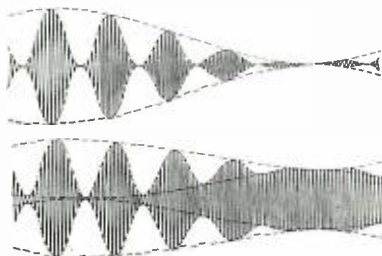

Fig. 15. a. (Top view.) Modulated signal with fading. b. (Bottom.) Signal with varying modulation.

transformation ratio. A reduction in gain of the receiver would result in the whole diagram being moved to the right only. The attenuation inserted by the automatic volume control is, in the absence of overloading which is assumed in the curve, the difference in ordinate between the conditions of automatic volume control on and off.

Where an attempt is made to obtain

an automatic volume control of high speed (i.e., to follow fast fading) trouble may be experienced from distortion caused by the modulation on the received signal operating the volume control. The graph of a signal of constant mean amplitude but of varying modulation amplitude is shown in (b) Fig. 15. A fading signal having constant modulation is shown in (a). Since the mean amplitude of a wave of varying modulation is constant, it is evident from the curve (b) that no re-modulation at speech or syllabic frequencies will be obtained from the automatic volume control system if the volume control rectifier is linear but that a fading signal will vary the output of the volume control rectifier.

The point where attenuation is inserted by an automatic volume control must be carefully chosen if the maximum signal-to-noise ratio is to be obtained at all times in a receiving system in which the receiver noise is a limiting factor. If the gain approaches zero at any time, in say the first few stages of the receiver, the first circuit noise will no longer be controlling but much of the noise will come from the stage following the section of zero gain. For this reason it is, therefore, desirable to insert attenuation at as late a stage as possible in a receiver, but in practice a compromise must be reached with the requirement that the attenuation should be inserted at an early stage to prevent cross-modulation, as previously mentioned.

If the signal and set noise volumes at the output of a radio receiver of high gain are measured, a plot similar to Fig. 16 will be obtained. The upper curves show the variation in signal and the lower curves the variation in noise for maximum gain and for lesser gains obtained by inserting attenuation in the intermediate-frequency amplifier. The upper curves of signal and noise are for full gain in the receiver. Starting from

(Concluded on page 20)

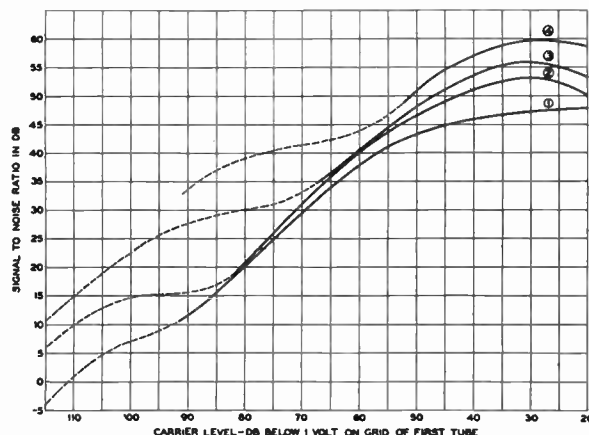

Fig. 17. Signal to set noise ratio of radio receiver.

A frequency monitoring unit for broadcast stations

By R. E. CORAM*

THOUGH near in point of time, it is technically a far cry back to the days when broadcast stations were all assigned to the same wavelength of 360 meters and the resulting interference annoyed only the few enthusiasts for distant reception. Today a wide frequency range is carefully apportioned among stations, and regulations against interference increase in stringency. A recent general order of the Federal Radio Commission requires each radio station to insure that its carrier frequency does not deviate more than fifty cycles from the designated value. The order is in reality a promise that conditions of radio reception will be further improved for those enthusiasts, now numbering millions, who live far from metropolitan centers and depend on distant stations for their radio programs.

In order to make frequency adherence a certainty, the Commission has also ordered that all stations provide means independent of the radio transmitter by which the carrier frequency of the station may be checked. It is for this use that the No. 1-A frequency monitoring unit has been developed. By it the carrier frequency of a station can be checked against a reference frequency. As the source of the reference frequency, the new equipment employs the No. 700-A oscillator, a highly stable unit whose frequency is controlled by a

quartz plate. The operating principle of the monitoring unit is to combine in a detector the output voltage from this oscillator together with a portion of the carrier voltage from the radio transmitter. Any difference between these two frequencies appears as a beat note. This note, through the medium of a relay, controls the indication of a meter which is calibrated to read directly in cycles per second the difference in frequency.

Compact Oscillator

The oscillator is a compact unit of two compartments in which the quartz plate and the entire oscillator circuit are assembled. The quartz plate is mounted in a heavy copper casting which approximates a thermally equipotential shell. The heater resistance is embedded in the bottom of the casting and just above it is located the bulb of a mercury thermostat. After the quartz plate and oscillator circuit are calibrated in accordance with the carrier frequency assigned by the Commission, the lid of the aluminum container is sealed in place.

In any type of frequency measuring equipment where an unknown frequency is compared with a fixed reference frequency, there must be an accurate means of measuring the difference between them; and for convenience this means should be as simple and as easily manipulated as possible. While there

are numerous methods available, the one employed in this case is considered the most logical type for use where simplicity, accuracy, and freedom from trouble are paramount.

The output voltage from the No. 700-A oscillator is amplified by a screen-grid tube and applied to the grid of a detector tube. A similar amplifier increases the voltage obtained from the unknown source and applies it also to the detector tube. The difference-frequency voltage developed in the plate circuit of the detector is applied to the winding of the polarized relay S (Fig. 1). The armature vibrates at the difference-frequency and alternately charges the condenser C1 from the detector plate voltage supply and discharges it through the direct current milliammeter F. The circuit constants are so proportioned that the condenser is in effect completely charged and discharged during each cycle of the relay armature. The resulting current through the meter is directly proportional to the number of condenser discharges in a given time, and the meter is therefore calibrated with a uniform scale in cycles per second. If the difference-frequency becomes relatively low (5 cycles per second or less), the damping of the meter is no longer sufficient to produce a steady deflection, and the meter needle will pulse once for each beat between the two carriers. By this method it is possible to adjust the radio transmitter to zero beat with respect to the reference oscillator after observing the meter swings over a short period of time.

To ascertain whether the radio transmitter is low or high with respect to the reference oscillator, the operator presses a push button which adds a small capacity to the reference oscillatory circuit and thus lowers its frequency. Instructions on the face of the meter remind the operator that a decrease in the reading when the button is pressed means that the transmitter frequency is low, and vice versa.

In order to make the No. 1-A frequency monitoring unit completely

* Radio Development, Bell Telephone Laboratories, Inc.

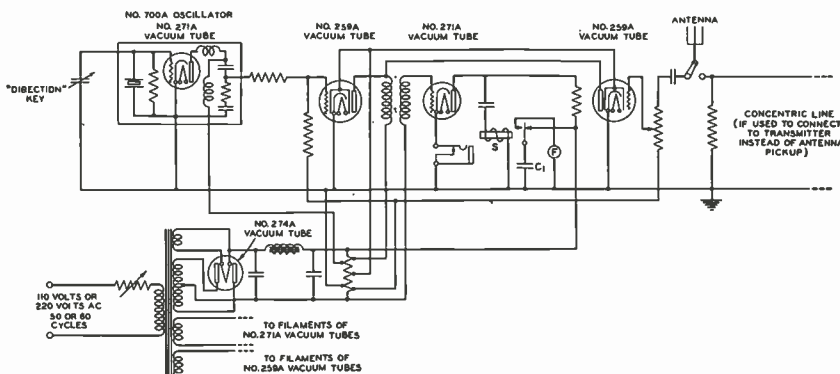

Fig. 1. The new frequency monitoring unit beats a portion of the station carrier with the output of a 700-A oscillator and measures the frequency of the beat note.



operable from the commercial a-c. power source and hence eliminate cumbersome batteries, tubes whose cathodes are indirectly heated are used wherever a-c. hum would be detrimental. A full-wave rectifier supplies plate power to the oscillator, detector and amplifier tubes. A voltmeter indicates the oscillator plate voltage, which can be adjusted by means of a rheostat in the primary circuit of the transformer. The unit is equipped with a cord and plug for attachment to a 110 volt, 50 or 60 cycle, a-c. circuit. With a slight modification, the unit can be operated from a 220-volt, 50 or 60 cycle circuit.

For temperature control purposes, in addition to the mercury thermostat and heater resistance which are included in the No. 700-A oscillator, it is necessary to have a sensitive relay through which the opening and closing of the thermostat contacts will control the current supplied to the heater resistance. In this unit a three-element gas-filled tube is employed for the purpose. A transformer supplies filament, grid, and plate voltages for the tubes and the plate current flows through the heater resistance. When the thermal chamber reaches its proper operating temperature, the thermostat contacts close. This applies an out-of-phase potential to the grid of the tube, preventing the flow of plate current. With normal operation this action is repeated at about

Fig. 2. The amount of departure of the station from its assignment can be read directly on the right-hand meter.

one minute intervals and is indicated by the flashing of a small lamp connected in the heater circuit.

If a spare oscillator is periodically used in the transmitter, a three-cornered comparison system may be established

Fig. 3. In the compact arrangement of the monitoring unit, the 700-A oscillator is at the left.

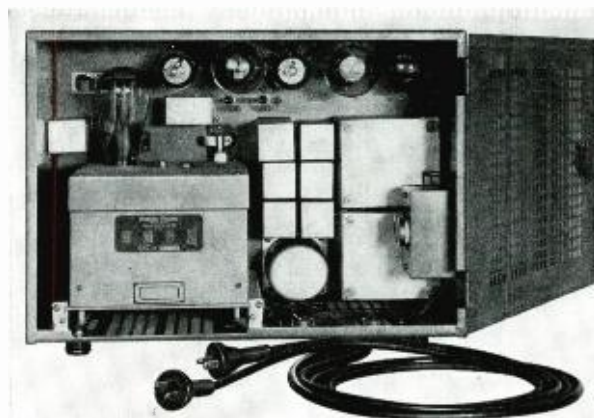

▲ ▲ ▲

LOOK FOR THESE IN MARCH ISSUE

In the March issue of RADIO ENGINEERING will appear important technical articles dealing with applications of the new Wunderlich "B" tube; the new Westinghouse Concentrator broadcast antenna system, and other articles of importance to radio engineers.

so that even a slow drift in any oscillator's frequency cannot pass unnoticed.

The use of a relay in the plate circuit of the detector contributes to this monitoring unit a feature unique among equipment of its type. This feature is the ability to measure the carrier frequency whether or not the carrier is modulated. The relay has no "sense of amplitude" but only a "sense of frequency." Thus the unit can be connected wherever its installation is most convenient: at any stage in the transmitter, or even to a small antenna nearby.

The range of usefulness of this sort of equipment is determined by its adaptability to all the conditions that are likely to be encountered in radio stations. While the unit will ordinarily be coupled to some circuit in the radio transmitter or connected to a small antenna in the operating room, there are station officials who would like to be able to check the transmitter frequency even though the station is several miles away. With this in mind, the input circuit has been designed so that it may be fed not only through a transmission line or from an antenna at the station but also from one of the amplifier stages in a radio receiver. Such a radio receiver can even be used at the same time to monitor the program.

Eliminating spark plug disturbance in automobile radio

By JESSE MARSTEN*

THE use of resistors for suppression of interference created by spark plug ignition has become universal in automobile radio. At present it is probably the simplest and most economical way of combatting this source of noise. The radio type of resistor is almost universally employed in this application, first because of its relatively low cost and second because of its non-reactive properties.

Suppressors used in moving vehicles are necessarily subjected to conditions of mechanical stress, temperature and humidity of a more aggravated order than those prevalent in stationary equipment housed under shelter. This imposes more stringent mechanical and electrical requirements on resistors for such use, and it is the object of this article to show how these are being met.

The general shapes and dimensions of suppressors for moving vehicles have assumed a fairly standard design, illustrated in Figs. 1 and 2. The spark plug suppressor is provided with a lug terminal with two holes permitting either vertical or horizontal mounting on the plug, and a screw terminal for the cable connector. The distributor suppressor is provided with a spring or plug terminal for insertion in the common distributor socket, and a socket terminal designed to receive the common distributor cable.

Few Parts

Vibration conditions are very severe, depending upon the speed of and the type of vehicle, necessitating rugged construction of the suppressor, consisting of as few parts as possible. The method of connecting cable leads to suppressors contributes to the necessity of this requirement. While in most vehicles a standard flexible rubber-



Fig. 1.

covered cable is employed, in some vehicles flat springs under heavy tension constitute the connecting means. Under vibration this imposes considerable strain on the suppressor, which if not strong enough, will break at its weakest point, generally in the lug terminal. Thin weak sections in such terminals,

*International Resistance Co.

easily bent by hand, should, therefore, be avoided.

The necessary mechanical strength and freedom from loosening of parts can best be obtained by the use of as few parts as possible, and by eliminating weak mechanical joints. This has been accomplished in the suppressors illustrated by the use of only a single part in each terminal, this part being cast in metal. All joints such as those secured by eyelets, rivets, or cement have been eliminated, making it almost impossible to loosen or break the terminals.

Humidity conditions under which suppressors operate vary from very low



Fig. 2.

to 100 per cent relative, as on a rainy day. Suppressors should be unaffected mechanically or electrically under such extremes. The means provided for securing the terminals to the resistor should be such as to prevent loosening of the terminal under conditions of high humidity. Protection should also be provided against undue change in resistance value. The former is achieved in the suppressors illustrated by the use of metal and ceramic parts, which are unaffected by moisture, and the latter is achieved by the use of moisture proofing treatment.

Low Temperature Coefficient

Due to proximity of the suppressors to hot engine parts, it is necessary that elevated temperatures should not harm suppressors. This necessitates a resistor element of relatively low temperature coefficient, in order that change of value be not excessive. Curves of the temperature characteristic of the resistor element of these suppressors show that a change of temperature from 25° C. to 125° C. produces a change of only about 4 per cent in resistance value.

It is essential that as perfect a contact as possible be obtained between the terminals and the resistor element. An imperfect contact, or very high resistance contact, may be the equivalent of

the insertion of a small series gap which may introduce sparking under the high ignition voltages. Contact to the resistor element should, therefore, be as direct as possible. Parts employed in effecting contact should be such that their original shapes remain unaffected by changes in temperature, since any deformations will impair contact to the resistor element.

In the construction illustrated, these requirements have been kept in mind. Due to the moulded or cast construction, the terminal and cast metal are integral and may be considered as one piece. Contact is made directly from the resistor element to terminal, therefore, with no intermediate parts, since the resistor element is also cast in the metal. Suitable treatment of the resistor ends also provides exceedingly low contact resistance. No intermediate parts are employed between the actual terminal and the resistor element which may change with temperature.

SHORT-WAVE TRANSOCEANIC TELEPHONE RECEIVING EQUIPMENT

(Continued from page 17)

a very weak signal, where the noise is greater than the signal the signal output increases directly with received field while the noise increases slightly, due probably to non-linearity in the second detector for very small inputs. When the point is reached where the volume control takes hold, the noise starts to decrease and the signal remains nearly constant. The noise decreases almost linearly with the received field until a point is reached where the gain of the first three stages in the receiver, upon which the automatic volume control operates, approaches zero. The noise thereafter remains nearly constant for increases in field.

The difference between the signal and noise curves is the signal-to-noise ratio which has been plotted on Fig. 17. For input voltages around 65 db. below one volt on the grid of the first tube (about the minimum point of actual operation) it makes little difference whether the gain of the receiver is reduced or not but for higher fields it is desirable to reduce the gain in the receiver by inserting attenuation near the output end of the receiver.

How to apply the Flexible Shaft for Remote Control of Radio

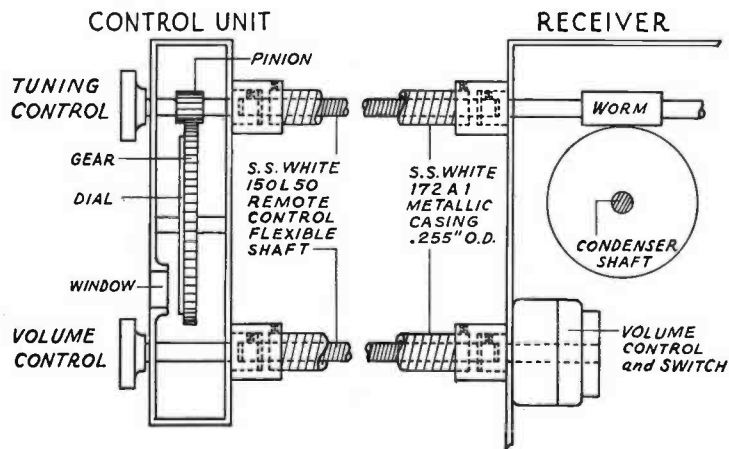

For satisfactory TUNING control a geared arrangement (see drawing) is essential, and the higher the ratio of gear to pinion, the smoother and more sensitive will the tuning be. For general use, a 16 to 1 ratio gives very good results. For VOLUME control, direct drive is usually satisfactory.

S. S. W. 150L50 Shaft was developed specifically for remote control. Its torsional deflection, even in long lengths, is slight, and is equal for either direction of rotation. When the shaft is geared as shown, deflection is virtually eliminated.

S. S. W. 172A1 Metallic Casing, of small diameter, was also specially designed for remote controls.

Anyone interested in this application, may have full data on request. Also, our engineers are ready to help work out any specific application of the flexible shaft for remote control. Just let us have the essential details.

THE ABOVE DRAWING is intended simply as a diagram and not a working drawing. It illustrates a method of application that is simple and engineeringly sound. If you are interested in specific details we shall be glad to supply them.

The S.S. WHITE Dental Mfg. Co.
INDUSTRIAL DIVISION
 152-4 West 42nd St., New York, N. Y.

MAKERS ALSO OF THE RENOWNED S. S. WHITE MOLDED RESISTORS FOR ELECTRONIC EQUIPMENT

SYNTHANE

Laminated Bakelite

Dependable Uniformity in Electrical and Mechanical Properties

- DIELECTRIC STRENGTH • LOW WATER ABSORPTION**
- STRUCTURAL STRENGTH • LOW SURFACE LEAKAGE**
- CLEAN PUNCHING • MACHINEABILITY**
- IMPACT STRENGTH • APPEARANCE**

SYNTHANE

CORPORATION OAKS · PENNA

OFFICES IN PRINCIPAL CITIES
Sheets, Tubes, Rods, Fabricated Parts
Silent, Stabilized Gear Material

International Radiotelegraph Conference in Madrid

ONCE each five years, representatives of the various nations of the world hold a conference to make agreements concerning international telegraph, telephone and radio services. These agreements are ratified by treaty and become the law of the world in so far as these matters are concerned. The International Radiotelegraph and Telegraph Conferences held in Madrid began September 3 and ended December 10, 1932, when a single convention was signed by the delegates of 77 countries, with many reservations. The size and scope of the conferences is obvious when it is realized that the program called for discussion of more than 4,000 questions relating to various aspects of communications. The meetings were attended by 386 government delegates, 163 representatives of private interests, 129 invited participants, and 21 members of the staff of the International Telegraph Bureau. The next conference will be held in Cairo, Egypt, in 1937.

The purpose of the conferences was to revise the Washington Radio Convention of 1927 and the Telegraph

Convention signed in Paris in 1925. The outstanding achievement at Madrid was the fusion of these two treaties into a joint convention known as the International Telecommunications Convention, which is supplemented by three main sets of regulations as follows: Telegraph, Telephone, and Radio. The Radio Regulations are divided into two parts, General and Supplementary. The only documents signed by the American Delegation were the International Telecommunications Convention, General Radio Regulations, and the Final Protocol to the General Radio Regulations. The new convention will become effective January 1, 1934.

Code Language and Rates

Of primary interest to the users of international communication services is the decision to abolish ten-letter code words, which was unsuccessfully opposed by both the American and British delegations, including the representatives of the British Dominions and Colonies. Code words will be counted and charged for at the rate of five letters to the word, with no restrictions

as to vowels and formation, the charge to be sixty per cent of the full rate for extra-European traffic (traffic between the United States and all foreign countries, except Canada and Mexico, is of the extra-European regime or system). It was also agreed that figures or groups of figures might be used in code messages to the extent of half of the text of the telegram, including the signature. A new feature is the requirement of a minimum charge for five words in all code messages.

No change has been made in the existing charge for ordinary plain language messages or for half-rate deferred services. Although night-letter services have been in effect for several years, this class of service was not officially recognized in the international telegraph regulations. The Madrid Conference, however, adopted it as part of its regulations on the basis of a charge of one-third of the ordinary rate, with a minimum charge for 25 words. Week-end letters were abolished. The urgent rate was reduced from three times the ordinary rate to two times.—*Foreign Communication News, Department of Commerce.*

PROGRESS IN TUBES FOR RADIO

(Concluded from page 11)

Application

The 5Z3 is well suited for supplying rectified power to radio equipment having very large direct current requirements. In such equipment, the performance of this tube is similar to that of any other high-vacuum rectifier.

Filter circuits of the condenser-input or the choke-input type may be employed provided the recommended maximum plate voltage and output current given under rating and characteristics are not exceeded.

If the condenser-input type of filter is used, consideration must be given to the instantaneous peak value of the a-c. input voltage which is about 1.4 times the r.m.s. value measured from plate to filament with an a-c. voltmeter. It is important, therefore, that the filter condensers (especially the input one) have a sufficiently high breakdown rating to withstand this instantaneous peak value. It should be noted that with condenser input to the filter, the peak plate current of the tube is considerably higher than the load current. With a

large condenser in the filter circuit next to the rectifier tube, the peak current is often as much as four times the load current.

When, however, choke input to the filter is used, the peak plate current is considerably reduced. This type of circuit, therefore, is to be preferred from the standpoint of imposing less severe operating conditions on the tube. Choke input will give a somewhat lower d-c. output voltage than condenser input for a given a-c. plate voltage, but improved regulation will be obtained.

SUPPRESSION OF NOISE IN RADIO RECEIVERS

(Concluded from page 9)

preceding the audio detector and squelch control. Here the AVC selectivity is less than that of the audio and squelch circuits and the tendency to keep the output constant when off-tune is lessened. Making the secondary a sharply tuned circuit is a further aid only in so far as audio fidelity is not affected.

Fig. 7 shows a circuit employing a highly selective squelch control.

To utilize squelch the curve of receiver sensitivity should be practically

a straight line with frequency. Slightly less sensitivity at the high-frequency end is admissible and may be desirable. A good design might normally squelch everything below 20 microvolts at 600 and 1000 kc. and everything below 25 microvolts at 1400 kc. The time-constant of the squelch receiver must not be long or the set will be too hard to tune; a value of about .05 seems to be satisfactory for a circuit not too sharply squelched.

CHICAGO RADIO ENGINEERS ELECT 1933 OFFICERS

AT the annual meeting of the Chicago Section of the Institute of Radio Engineers, the following 1933 section officers were elected: Robert M. Arnold, chairman; John F. Church, Jensen Radio Manufacturing Co., vice-chairman; Donald H. Miller, re-elected secretary-treasurer.

The 1933 national convention of the Institute of Radio Engineers will be held in Chicago in June during Engineering Week of the World's Fair—A Century of Progress. Elaborate plans for an interesting and successful convention are being made.

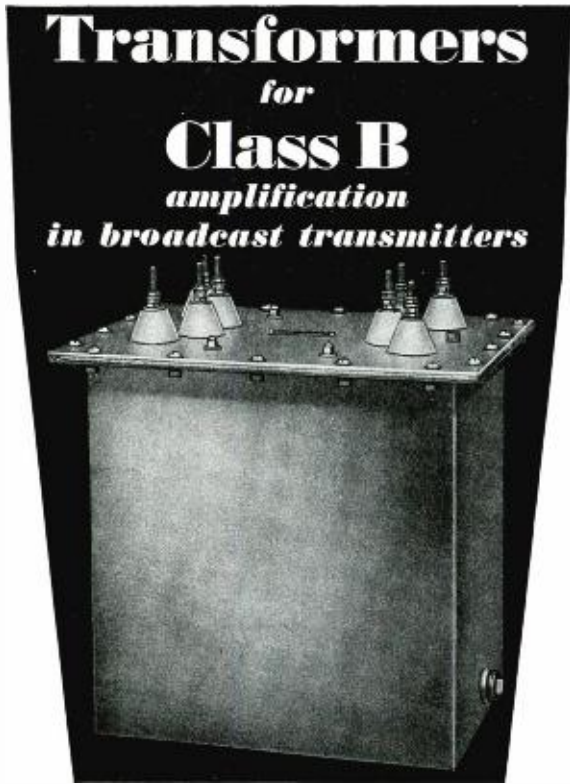

Transformers
for
Class B
amplification
in broadcast transmitters

Output transformer for use between push-pull, class "B" stage using 204-type tubes and a class "C" amplifier. Operating level + 50dB; primary 1500-1500 ohms; secondary 4750 ohms; tested at 15,000 volts; oil insulated.

FOR six months AmerTran engineers have been studying all problems associated with Class B Amplifiers. With this experience as a background a complete line of audio-frequency transformers (input and output) has been especially designed for use with tubes suitable for Class B operation.

Large output transformers for use in Class B Amplifiers of broadcast transmitters are of the design illustrated above and have the following features:

1. Oil immersed with Isolantite bushings. This permits insulation testing at a voltage which is considerably in excess of any peak which might be experienced in actual practice.
2. Welded aluminum tank provides complete r.f. shielding.
3. Wire used in primary and secondary windings is of a size which insures low d.c. resistance and ample current capacity.
4. Primary sections are balanced within 0.5% and the same phase angle exists in each section.
5. Core laminations of the best quality high-permeability alloy are operated at a low density.
6. Coil structure insures low distributed capacity, low capacity coupling, and high inductance coupling.
7. High efficiency insured by excellent regulation, constant input impedance, and unusually satisfactory frequency characteristics throughout the band of 30 to 10,000 cycles.

Complete information on transformers for use with a specific type of tube will be mailed promptly on request.

AMERICAN TRANSFORMER COMPANY
180 Emmet Street Newark, N. J.

The AmerTran line includes transformers of every description for audio amplification and radio transmission.

AMERTRAN
Audio Transformers

Now Ready!

THE IMPROVED 1933

ACRACON*

Electrolytic Condensers

BIGGER and better performance than ever! Semi-dry units in round aluminum, cardboard, or metal filter types. Wet unit particularly suitable for inverted vertical mounting above the chassis. Write for specifications and characteristics that prove Acracon's leadership!

*The Acracon Line Includes
A Condenser of Every Type*

BY-PASS CONDENSERS

for general purpose by-pass and replacement work.

"MIKE" CONDENSERS

small tubular condensers in aluminum tubes for use where fractional capacities are desired.

Write Today for 1933 Catalog. Just Out!

CONDENSER CORP. of AMERICA

259 Cornelison Ave., Jersey City, N. J.

Factory Representatives In:

Chicago Cincinnati St. Louis San Francisco
Los Angeles Toronto

And Other Principal Cities

* Patents pending on all Acracon features.

NEWS OF THE INDUSTRY

"OILDAG" AS A RADIO PARTS LUBRICANT

The moving parts of a radio receiving set are not provided with cups or ducts for the admission of lubricants. In the assembly of the receiver, these parts are usually treated with a light oil or grease, thus providing the only lubrication the set receives.

The parts requiring lubrication such as variometers, variable condensers, and the automatic tuning mechanism are subjected to the elevated temperature usually existing within a receiver resulting from the heat generated by the vacuum tubes and resistances. With constant use of these parts under such conditions, the lubricant is soon consumed. The controls cease to function smoothly and the resulting wear produces clearances which are undesirable and avoidable.

Concentrated "Oildag" may be applied to the bearings, shafts, etc. either before or after assembly of the device. While most manufacturers prefer to apply "Oildag" to the parts with the aid of a brush during assembly, application may be made upon completion of the device by means of a squirt can equipped with a very fine nozzle.

It is recommended that the material be used in the concentration in which it is sold, although it may be blended with a neutral grade of mineral oil if a lubricant of different viscosity or lower graphite content is desired.

Manufactured by Acheson Oildag Company, Port Huron, Mich.

RADIO TRANSMITTERS

Experimenting, or operating with the new tubes and circuits for radio telegraph or telephone transmission require that the transmitter have power supplied from a source with good regulation, low ripple and which will not cause interference. Such power supply can best be obtained by use of parts and circuits that are specially designed and engineered for use with mercury vapor rectifier tubes.

Modern apparatus is now being marketed by the Delta Mfg. Co., 39 Osborne St., Cambridge, Mass.

RADIO TUBES TO FRANCE

Radio International, 18 Rue de Saisset 18, Montrouge (Seine), France, desires representation arrangements in France for American radio tubes. This well established company is an outlet for high grade tubes.

PACKING, GASKETS AND WASHERS

The Felt Products Manufacturing Company, 1508 Carroll Avenue, Chicago, has recently issued a very complete handbook on industrial packing material. This interesting book not only contains descriptions and lists of uses for which each material is suited, but also actual samples of thirty-six different materials, for gaskets, washers, strips, etc.

NEW MICROPHONE SERVICE

The microphone engineering department of Central Electric Laboratories, Saginaw, Michigan, announces a new repair service on all makes and types of carbon microphones. Outstanding features of this service include complete refinishing of all metal parts as well as laboratory testing to very rigid specifications, making the instrument like new, both in appearance and performance. Descriptive literature is available on their new 12-C double-button stretched diaphragm microphone. The 12-C is a high quality product, mechanically, and is electrically correct.

SALES IMPROVING

Orders received by the General Electric Company for the quarter ended December 31 amounted to \$27,351,658, compared with \$25,665,402 for the third quarter of 1932.

RESISTOR FOR THE FP-54 TUBE

In January RADIO ENGINEERING was described the FP-54 tube. It is stated that for proper operation this tube requires a very high resistance unit. The Central Scientific Company, 460 East Ohio St., Chicago, advise that their No. 4850 variable megohm resistor and high potential divider meet the requirements.

TRANSMITTER POWER SUPPLY

Something new for radio has been released from the laboratory of the Universal Microphone Co. (Inglewood, Cal).

This is a "4 in 1" unit power supply (voice or c.w.) for short-wave transmitters, designed specially for the new '47 tube crystal controlled transmitter.

The assembly calls for a power transformer delivering 550 volts on either side of the center tap, two filament windings, one for lighting the '83 rectifier and another for lighting the '47 tube.

HOW TO TEST RADIO RECEIVERS

By actual practice, servicemen have learned that voltage and resistance measurements provide a rapid and effective means of servicing 95 per cent of the troubles found in broadcast receivers. Where voltage measurements are used alone the trouble may be found to be in one portion of the circuit but the actual component or components causing the trouble are not always located. If resistance measurements are used alone, practically every component must not only be measured but also compared with the known proper resistance. Therefore, the instrument absolutely necessary for the economical test kit is a quick change volt-ohmmeter.

This instrument is designed to provide,

with minimum adjustments, the essential voltage, and resistance measurements and continuity tests encountered in radio set servicing. A single set of binding posts and a quick change tap switch make it possible to select the continuity test and any of the following voltage or resistance ranges without the necessity of changing test leads to different binding posts or pin jacks.

Voltage Ranges	Resistance Ranges
10 volts	2.5 3,000 ohms
100 volts	25 30,000 ohms
500 volts	250 300,000 ohms
1000 volts	2500 3,000,000 ohms

Manufactured by the Shallcross Mfg. Co., Collingdale, Penna.



New Shallcross meter.

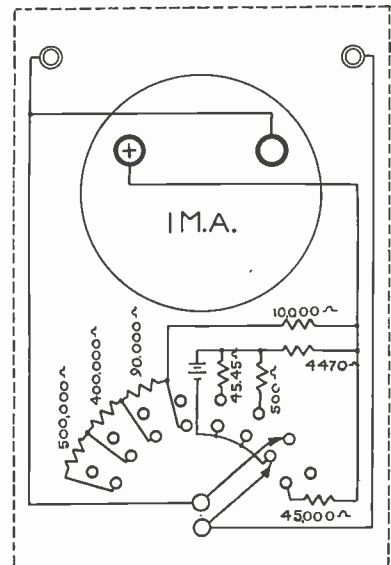

Volt-ohmmeter hookup.

RESINOX

*for simplicity in manufacturing
for economy in production . . .*

Resinox Molding Compounds are not tricky to use—they simplify molding operations and hence contribute to maximum economy in production.

Specify Resinox

MOLDING RESINS
MOLDING COMPOUNDS
LAMINATING VARNISHES

RESINOX CORPORATION

A subsidiary of Commercial Solvents Corporation
and Corn Products Refining Co.

230 PARK AVENUE

NEW YORK CITY

PRECISION WIRE WOUND RESISTORS

better High Resistance Units that cost no more!

Used by leading Manufacturers and Service Men in Applications that require dependable, low cost units.

Voltmeter Multipliers
Meter Shunts
Photo Cell Circuits
Bridge Assemblies
Circuit Analyzers
Attenuators
Decade Boxes



TYPICAL PRECISION RESISTORS WITH RATINGS FROM .25 OHMS TO 5 MEGOHMS

PRECISION wire wound resistors have distinct advantages—aside from price! Every connection between terminals and wire element is hard soldered. The double insulated wire receives two baked coats of enamel insulation. Extremely accurate, acid, oil and moisture-proof resistors result!

T - L - H PADS MADE TO YOUR SPECIFICATIONS

PRECISION RESISTOR COMPANY

113-115 FRELINGHUYSEN AVE., NEWARK, NEW JERSEY

MICROPHONES

for every purpose

CONDENSER TYPES



(MODEL S-2)

For professional and amateur requirements and P. A. work. Good tone quality—greater sensitivity—essentially flat response with no distortion or blasting. Milled bronze removable head-case of cast aluminum, crackle lacquer finish. Two stages of amplification. A remarkably fine condenser microphone with 25 ft. shielded cord and tubes included at list price of \$65.00.



(MODEL L-2)

Made for Broadcasting and for those who want a better condenser microphone. Precision built like the finest instrument. Housing eliminates sound reflection. Two stages of amplification. Range 40 to 10,000 cycles. This unit is of unusual sturdy construction with performance plus qualities. List price \$225.00, cord and tubes included.

TWO BUTTON

CARBON TYPES



(MODEL 40)

Resistance per button 200 ohms with low hiss level. Highly polished chromium plated finish; pure gold (24 k) contacts; and gold plated diaphragm. An all-around general purpose microphone. Sells at \$10.00 list.



(MODEL 90)

A "super" carbon type microphone. Precision built—outperforms other carbon microphones. Body of all bronze construction, udlite finish (cadmium plate); gold plated heat treated duralumin diaphragm. List price \$50.00.



(MODEL 80)

Made for P. A. work, paging, call systems, etc. Adaptable to many sound requirements. 200 ohms per button and has a frequency which is practically flat with range from 75 to 6,000 cycles. Chromium plated finish and reproduces with clear life-like tone. \$20.00 list price.

(MODEL 70)

SEC Hand Microphone—same unit as Model 40 described above but is highly damped to give better performance for this type of work. Bakelite handle with switch, black crystal and chromium finish. List price \$15.00.



Order from your dealer, jobber or direct from factory. All SEC microphones guaranteed. Also a complete line of Amplifiers, Speakers, and Equipment for all types of Sound Work. Send for catalog.

SOUND ENGINEERING CORP.

416 N. LEAVITT ST.

CHICAGO

ILLINOIS



RESISTORS FOR CHANGING OVER FROM '81 TUBES TO '83's

D. T. Siegel, general manager of the Ohmite Manufacturing Company, announces that this company is now making two special values in the Red Devil line. These units have resistance values of .4 ohm and .83 ohm and are intended for use in replacing two type '81 tubes in a power pack with a single type '83 tube. These special value resistors are now carried in stock by Ohmite distributors.

The use of the '83 tube requires enough resistance to be inserted into the filament line to drop the voltage from 7.5 to 5.0 volts. On sets which have a single filament winding on the power transformer, the .83 ohm Red Devil is inserted in the filament line. For sets which have a center-tapped winding, it is better to use a .4 ohm resistor in each side of the filament line. This keeps the transformer in balance and prevents hum.

A choke must be used with the '83 tube. This should be about 6 henrys, 250 ohms, and able to pass 100-150 mils. In some sets the chokes will be found in the negative lead. Also, it may help in some cases to put small chokes in the plate leads of the tube.

The main reason for using the '83 tube, aside from the more satisfactory operation is the great saving in price.

NEW PHOTOELECTRIC CONTROLLER

New in the field of light sensitive control is the "Photo-Troller" recently announced by Westinghouse. The device fulfills the need for a rugged industrial device which can be actuated by a phototube or by delicate contacts carrying only



a few microamperes. Due to its flexibility and low cost, the Photo-Troller is specially adapted to applications such as counting, limit switch, door opening, automatic weighing, etc.

The phototube or sensitive contact oper-

ates a sturdy grid-glow tube directly which in turn closes a contactor capable of initiating any desired operation. Thus, delicate intermediate relays are eliminated and greater reliability is obtained than in any device previously offered. The Photo-Troller is assembled in a sheet metal cabinet with convenient door and knockouts. Units are available for any commercial voltage or frequency except d-c. The device contains a complete power supply for all auxiliaries including the light source. Various light sources are available to operate at distances up to 22 feet from the phototube.

Auxiliary devices are available for use with the Photo-Troller which adapt it to a large number of unusual machine and process applications. These include phototube housings for mounting either on the main cabinet or at distances up to 10 feet distant, and light sources of similar design. The phototube and light source housings are of cast aluminum and available in splash proof designs for mounting near sprays or in dusty locations. The flexibility, simplicity, and low cost makes the Photo-Troller useful in solving problems heretofore not done photoelectrically.

TUBE CHECKING ADAPTER

This new No. 950XYL universal tube checking adapter enables any tube checker to be brought up to the minute by checking the 15, 19, 29, 33, 36, 37, 38, 39, 41, 42, 44, 46, 47, 49, 52, 55, 57, 58, 59, 64, 65, 67, 68, 69, 70, 80, 82, 83, 84, 85, 88, 89, 293, 295, 985, 986, C-2, C-4, G-2, G-4, GA, LA, PA, PZ, PZH, Wunderlich-A and Wunderlich-B tubes.

All these forty-seven tubes are checked in this adapter when used in the UY screen grid socket of a tube checker hav-



ing a filament voltage switch: with tube checkers having 14, 25 and 30 volt filament potentials the 14, 17, 43 and 48 tubes can also be checked with the 950XYL in addition to the above tubes.

Manufactured by the Alden Products Co., 715 Center St., Brockton, Mass.

ADJUSTABLE PYROHM RESISTORS

After intensive work, the Aerovox Corporation, 70 Washington St., Brooklyn, New York, announces a new line of adjustable Pyrohm (vitreous enamel) resistors designed to meet all voltage divider

requirements and other uses where adjustable heavy-duty resistors are required.

These new resistors are similar in general design and construction to the standard Aerovox Pyrohm resistors, except that each unit is provided with an adjustable slider contact lug so arranged that any desired value from zero to the maximum value can be obtained by a quick and easy operation.

They are made of the highest grade resistance wire, wound on refractory tubing



and coated with a porcelain enamel. The terminal contacts are made by brazing the resistance wire to the lugs at a temperature almost equal to that at which the enamel melts, hence insuring positive contacts against opening in service.

By means of a special method, a narrow strip of the wire windings along the length of the unit is left free of enamel in order that contact may be made with the adjustable slider at any point of the exposed wire. However, while the surface of the wire is exposed, the enamel between the turns holds them firmly in place. Markings on the side of the unit permit reasonably accurate setting of the adjustable lug to obtain any desired value of resistance without the necessity of actually measuring the resistance with a meter.

Aerovox adjustable Pyrohm resistors are rated in strict accordance with the RMA code, as follows: Type No. 952, 25 watts; Type No. 954, 50 watts; Type No. 956, 75 watts.

All units are $\frac{3}{8}$ inch in diameter, while the lengths are 2, 4 and 6 inches for types No. 952, 954 and 956 respectively. The resistance values range from 1 to 50,000 ohms.

MICA CONDENSERS

Significant improvements in the design and manufacturing methods have resulted in a new mica condenser having low losses, stability of calibration, temperature compensation, and several other features common in condensers of the precision-standard type. Yet the cost of the new unit is little more than that of the commercial types used as grid- and by-pass condensers. These have been developed by the General Radio Company, Cambridge A, Mass.



EVERY
RADIO SET
A PUBLIC
ADDRESS
SYSTEM

The RADIO-MODULATOR

AN ORIGINAL DEVELOPMENT OF THE LABORATORIES OF SHURE BROTHERS COMPANY

Here is the latest development in the Sound Industry! Merely attach the Shure RADIO-MODULATOR to any radio set and you have an efficient and low priced Public Address System. The RADIO-MODULATOR fills all requirements for a Public Address System for those who cannot afford the price of a separate amplifier system.

There are hundreds of uses for the Shure RADIO-MODULATOR in clubs, public meetings, demonstrations, with home movies, etc.

SHURE BROTHERS COMPANY

Manufacturers-Engineers

S.N. SHURE, Pres.

337 WEST MADISON ST.

Easily and safely connected to any radio set. Not a toy—the quality is comparable to that of the best radio stations.

Shure RADIO-MODULATOR, beautifully finished in grained walnut, complete with tubes, button current cell, 50 ft. of microphone cable, SHURE Model 5N 2-Button Microphone and Stand. List price, complete, \$33.50. Usual discounts apply.

Send for complete technical and descriptive information.



TYPE 586 POWER-LEVEL INDICATORS

High accuracy and high sensitivity are the features of this power-level indicator. In addition to audio-frequency monitoring they can be used for gain or loss determinations and for equalization measurements on voice circuits.

PRICES (Cabinet Mounting)

—10 to +36 db \$60.00
—20 to +36 db \$75.00

Relay rack models are also available.

Complete information will be furnished on request.

GENERAL RADIO COMPANY
CAMBRIDGE, MASSACHUSETTS

Voltage and Resistance Measurements

95% of radio-set troubles can be located quickly and accurately with the



SHALLCROSS

No. 681

Quick-Change Volt-Ohmmeter

10-100-500-1000 volts
1 ohm to 3 megohms

This instrument is very easy to build. The important parts required are a 1-milliampere D.C. meter and the SHALLCROSS Resistor Kit No. 681.

Send 6c in stamps for Bulletin 681-M, describing the service man's most useful test instrument.





—NEW!
MORRILL
Uncased Condensers

Especially compact. A product of outstanding quality. The ultimate in reliability. Send for circular E-1.

2 MFD—600 Volts—
Size: 2" x 1 1/4" x 7/8".

MORRILL & MORRILL
30 CHURCH STREET NEW YORK CITY
Sole U. S. A. Distributors of the Siemens & Halske condensers and resistors.

REMLER REMOTE CONTROL AMPLIFIER and Microphone Power Supply AC Operated



List Complete
\$225

Highly efficient. Portability simplifies installations. Level indicator; attenuator calibrated in decibels. 3 stages amplification bring mike level to maximum + 10 DB for phone line input. 20" x 9" x 11". Weight 40 lbs.

Send for particulars. Attractive trade discounts.

REMLER COMPANY, Ltd.
19th and Bryant St. San Francisco

... for Tubes • Resistors • Relays ...

Carbonized Nickel
Selvage Mesh (patented)
Filament Wire
Grid Wire



RESISTANCE WIRE
Nickel Chrome
Copper Nickel
Nickel Wire
and Ribbon

GILBY WIRE
MEANS
MAXIMUM PRODUCTION
With MINIMUM SHRINKAGE
GILBY WIRE COMPANY
150 Riverside Ave., Newark, N. J.

FREE

13th ANNIVERSARY RADIO CATALOGUE



124 pages containing thousands of the greatest radio and electrical values at real bargain prices.

Send for your copy now!

American Sales Company
Wholesale Radio Distributors
RE-44 West 18th Street
New York City

ON MY WAY TO NEW YORK AND THE PICCADILLY



... best hotel I know!
Near everything, just 200 feet from Broadway. Modern, hospitable, and comfortable. Like the Manager, like the rates — \$2.50 single, \$3.50 double, for a room with bath!

THE HOTEL - PICCADILLY
45th St. • W. of Broadway • New York
WILLIAM MADLUNG, Mgr.

HOTEL LENOX
NEW LOWER RATES

—but the same dependable service, comfortable rooms and excellent meals that have made this hotel famous among seasoned travelers everywhere.

Convenient location: 3 minutes from Peace Bridge to Canada, 20 miles from Niagara Falls.

Rates: Single, \$2 to \$3.50; Double, \$3 to \$6, Family suites \$6 up.

For booklet and free official AAA road map write
CLARENCE A. MINER, President, 140 North St. near Delaware

BUFFALO, N. Y.

• **TAUREX** •

THE FULL-WAVE RECTIFIER FOR D.C. MILLIAMMETERS
Maximum Current Capacity, 15 M. A. size 1/4 by 3/8 inches.
Price \$3

LEO TAUSSIG
3245—37th Street Long Island City, N. Y.

Waxes and Meltable Insulating and Weather-proofing Compounds

IMPREGNATION—Condensers, Coils, Rubber-Covered and Weather-Proofed Wire, Telephones, and Electrical Cables, Etc.

SEALING COMPOUNDS—Coils, Condensers, Batteries (Wet and Dry), Pot Heads, Cables, Wiring Devices and Specials.

FINISHING—All grades of Weather-Proof and Rubber-Covered Wire.

SPECIAL COMPOUNDS made up on specifications.

CANDY & COMPANY, INC.
35th STREET and MAPLEWOOD AVENUE CHICAGO, ILL.

CATHODE RAY TUBES

for ALL STANDARD UNITS

No longer is it necessary to pay high prices for cathode ray tubes. Du Mont tubes are now interchangeable with other tubes and are available in all standard sizes. Adapters are available permitting the use of Du Mont tubes in any standard cathode ray power unit. These tubes are rugged, thoroughly engineered, and low-priced. They excel in uniformity, long life and brilliancy. Reliable commercial performance can be expected.

A complete line of associated equipment consisting of power supply, sweep circuit, adapters, tube holders, etc., are now available. Technical data on cathode ray tubes and equipment is available upon request.

ALLEN B. DUMONT LABORATORIES
Upper Montclair, N. J.

BRASS—BRONZE—COPPER

NICKEL SILVER—ZINC

PHOSPHOR BRONZE

In Gauges .001 and Thicker. 1/16" to 16" Wide

HOT TIN COATED METALS IN COILS AND STRIPS

THE BALTIMORE BRASS CO.
1206 WICOMICO ST., BALTIMORE, MD.

For Your Experimental Department

A tube of 500 assorted lugs and terminals — hot tinned for easy soldering.

Price \$1.00

We are also prepared to handle production stampings.

Write Us for Quotations

F. R. ZIERICK MFG. COMPANY
70 E. 131st ST., NEW YORK CITY

NOW!

\$100

PROTECTION GUARANTY
TO YOUR INSTRUMENTS WHEN
PROTECTED BY

LITTELFUSES

LITTELFUSES will positively protect your meters, radios, tube testers, etc. Stock sizes 1/100, 1/32, 1/16, 1/8, 1/4, 3/8, 1/2, 3/4, 1, 1-1/2, 2 amps. capacities.

LITTELFUSES are also made in 1000-, 5000- and 10,000-volt ranges.

Write for New Cat. No. 5 complete details
LITTELFUSE LABS., 1782 Wilson Ave., Chicago, Ill.

● WAXES, COMPOUNDS ● ● and VARNISHES ●

for insulation of condensers

- transformers, coils, power packs, pot heads,
- sockets, wiring devices, wet and dry batteries,
- etc. . . . WAX SATURATORS for braided wire
- and tape. WAXES for radio parts . . . Com-
- pounds made to your own specifications if you
- prefer.

● ZOPHAR MILLS, INC. ●

FOUNDED 1846

Court and Lorraine Streets Brooklyn, N. Y.

● Agents: Ralph B. Clark, 2907 Calumet Ave., Toledo, Ohio

● H. A. B. Sneve Co., San Francisco, Seattle, New Orleans

PIEZO-ELECTRIC CRYSTALS

Since 1925 we have been recognized as the RELIABLE PRODUCERS of POWER CRYSTALS. We are at your service to supply your needs. Special prices for quantity lots. Your request will bring our price list.

SCIENTIFIC RADIO SERVICE

"The Crystal Specialists"
124 JACKSON AVE. (University Park), HYATTSVILLE, MD.

LAMINATIONS

for Audio & Power Transformers

SPECIALIZED METHODS—YEARS OF EXPERIENCE

Wide Variety of Stock Standard Sizes

Dimension and Price Sheets on request

We Also Make

PERMANENT MAGNETS—DIES—TOOLS—
METAL STAMPINGS

Facilities for prompt service

Thomas & Skinner

Steel Products Co. 1100 to 1120
E. Twenty-third St.
INDIANAPOLIS, IND.

NEW DAVEN LADDER ATTENUATOR
FOR USE AS MIXER WITH DYNAMIC MICROPHONES

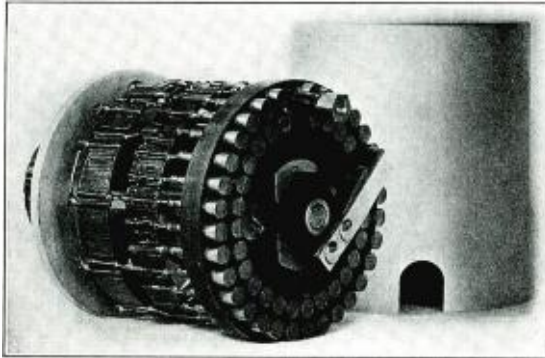

The Present Attenuator Is the First Ever Made Which Is Entirely Free from Disturbing Noises

NOISE LEVEL—160 db. Unexcelled as a Mixer Pad, may also be used as a "T" Pad and Master Control in broadcasting, sound recording and P. A. Systems. Size: 2 3/4" dia. x 3 1/8" deep, net weight 11 ounces, 30 Steps à 1.5 DB. 500/500, 250/250, 200/200, 50/50 and 25/25 ohms from stock.

ALSO "H", "T", "L" & POT'S, VOLUME INDICATORS, DECADE BOXES, ETC.

Write for Catalogue 532

THE DAVEN COMPANY
158-160 SUMMIT STREET NEWARK, NEW JERSEY

ACME WIRE
PRODUCTS

All Acme Products are made to recognized commercial standards, including those of National Electric Mfrs. Assn., Radio Mfrs. Assn. and American Soc. for Testing Materials...

COILS
MAGNET WIRE WOUND

AERIAL WIRE
STRANDED AND SOLID

MAGNET WIRE
ALL INSULATIONS

PARVOLT CONDENSERS
FILTER AND BY-PASS—ALSO FOR POWER FACTOR CORRECTION

VARNISHED INSULATIONS
CAMBRIC, SILK, PAPER, TAPE

THE ACME WIRE CO., NEW HAVEN, CONN.
For over 25 years, suppliers to the largest radio and electrical manufacturers

INDEX OF ADVERTISERS

A	G	S
Acme Wire Co., The..... 30	General Radio Co..... 27	Scientific Radio Service..... 29
Allen-Bradley Co..... 6	Gilby Wire Co..... 28	Shakeproof Lock Washer Co..Third Cover
American Sales Co..... 28		Shalleross Mfr. Co..... 27
American Transformer Co..... 23	L	Shure Brothers Co..... 27
	Littelfuse Laboratories 29	Sound Engineering Corp..... 25
B		Synthane Corp. 21
Baltimore Brass Co., The..... 29	M	
	Morrill & Morrill 28	T
C		Taussig, Leo 28
Candy & Co..... 28	P	Thomas & Skinner Steel Products Co. 29
Central Radio Labs..... 32	Parker-Kalon Corp. 3	Thordarson Elec. Mfr. Co..... 32
Chicago Telephone Supply Co..... 1	Precision Resistor Co..... 25	
Clarostat Mfr. Co.....Back Cover		W
Condenser Corp. of America..... 23		White Dental Mfr. Co., The. S. S.... 21
	R	Z
D	Remler Co., Ltd..... 28	Zlerick Mfr. Co., F. R..... 29
Daven Company, The..... 30	Resinox Corporation 25	Zophar Mills, Inc..... 29
DuMont Labs., Allen B..... 29		

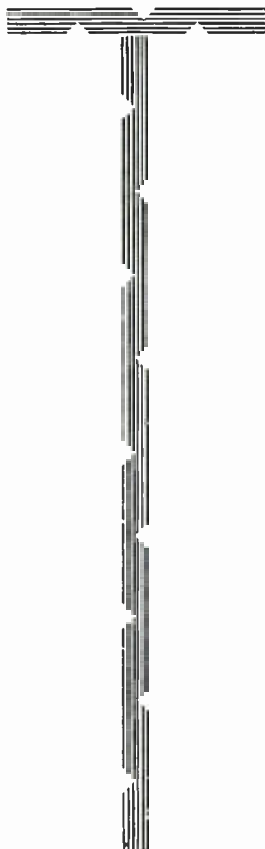

THE Group Subscription Plan for RADIO ENGINEERING enables a group of engineers or department heads to subscribe at one-half the usual yearly rate.

The regular individual rate is \$2.00 a year. In groups of 4 or more, the subscription rate is \$1.00 a year. (In Canada and foreign countries \$2.00.)

The engineering departments of hundreds of manufacturers in the radio and allied industries have used this Group Plan for years, in renewing their subscriptions to RADIO ENGINEERING.

Each subscriber should print his name and address clearly and state his occupation—whether an executive, engineer, department head, plant superintendent, or foreman, etc.

Remember this Group Plan when *Your* Subscription Expires

(Radio Engineering)

**Bryan Davis Publishing Co, Inc.
19 East 47th Street
New York, N. Y.**

Los Angeles

Chicago

St. Louis



when Centralab Quality costs so little?



IN these days when the usual order is "cut quality to cut prices" Centralab steadfastly maintains that typical high quality at any cost.

And . . . Centralab Resistors steadily climb to new heights of popularity on a wave of genuine performance . . . best of all . . . Centralab Resistors cost so little more.



Get this service carton of 10 Centralab Fixed Resistors which list at \$2.50 for only \$1.25. FREE: the new QUICK REFERENCE WALL CHART showing resistance combinations at a glance.

CENTRAL RADIO LABORATORIES, MILWAUKEE, WIS.



THORDARSON DESIGNS NEW TRANSFORMERS

Keeps in Step with Requirements of New Tubes

SPECIAL TO RECEIVER
MANUFACTURERS:

Makers of radio tubes are making a very significant contribution to the industry with the new type power tubes. These tubes permit maximum amplification with practically no distortion in reproduction.

New Transformers Necessary

This development in the tube field calls for change in transformer design—both in the coupling and the power transformers, in order to accomplish the desired results and achieve the ultimate aims of the tube engineers.

Thordarson Engineers Meet the Demand

Thordarson engineers have developed transformer designs especially to meet the conditions which these new tubes impose, so Power and Coupling Transformers are now available for all new type tubes. Thordarson engineers are in a position to collaborate with manufacturers of radio receivers on their engineering problems. Specifications for your new receivers will be given prompt attention. . . . Thordarson Electric Manufacturing Company, 500 West Huron Street, Chicago, Illinois.



SHAKEPROOF

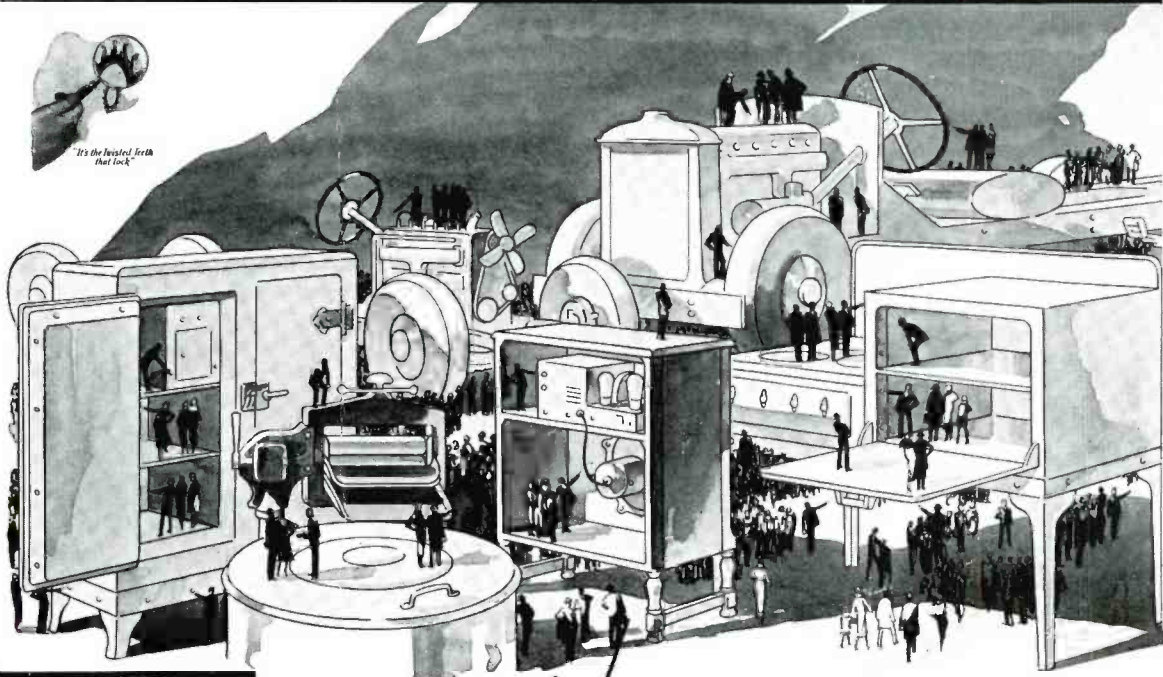

HERE'S *definite* EVIDENCE OF SHAKEPROOF'S SUPERIORITY

LOOK over America's fastest selling metal products—the automobiles, radios, stoves, refrigerators, etc.—that are the leaders in their respective lines today. See for yourself what kind of Lock Washers they use and take notice that wherever vibration is likely to cause damage, a Shakeproof Lock Washer is provid-

ing perfect protection. This wide acceptance of Shakeproof's locking principle has been realized simply because actual performance has proved it to be the best. Get thoroughly acquainted with Shakeproof Products—send the coupon below for our catalog and free samples today!

Shakeproof representatives are located in the following cities:

- New York
- Philadelphia
- Boston
- Pittsburgh
- Schenectady
- Detroit
- Cleveland
- Milwaukee
- Toledo
- Cincinnati
- Dallas, Tex.
- Birmingham, Ala.
- Los Angeles
- San Francisco
- Seattle
- Toronto, Ont., Can.



SHAKEPROOF Lock Washer Company

{Division of Illinois Tool Works}

2509 N. Keeler Avenue

Chicago, Illinois

Coupon Gentlemen: Kindly send us your complete catalog and price list. Also, please send us testing samples as indicated.

Type..... Size.....

Type..... Size.....

Firm Name.....

Address.....

City..... State.....

By..... Title.....

Type 12. Internal. For S. A. E. and Standard Machine Screws

Type 11. External. For Standard Bolts and Nuts

Type 15. Countersunk. For all Countersunk Screws

Type 20. Locking Terminals. For Radio and Electrical Work

U. S. Patents
1,419,564—1,604,122
1,697,934—1,792,387
Other Patents Pending. Foreign Patents.



"P18" Control With Built-In Power Switch



"P58" Control Without Switch

There's None Better Than

CLAROSTAT

TRADE MARK REG. U. S. PAT. OFF.

IN every industry one manufacturer always stands out as the acknowledged leader. Of course, many factors are responsible for this distinction. The leader must always be one step ahead of competition, both in the engineering advancement and merit of his product—and in price—the ultimate deciding factor.

Clarostat Products are leaders! Every unit produced by this company must, therefore, combine finer, more exact electrical characteristics—and satisfactory pricing.

All Clarostat Wire Wound Controls are extremely compact, quiet, smooth-operating and trouble-proof in operation.

The main feature of these units is their positive reliability. The resistance elements are wound with the highest grade of resistance wire obtainable, on carefully selected and tested Bakelite strips. Tapers are obtained by the time-tried and tested method of proper spacing, shape of winding form and the use of wires of the proper resistance characteristics, eliminating all doubtful characteristics that are usually introduced by so-called "new stunts" and "revolutionary" methods of obtaining taper characteristics.

Clarostat Products are built to meet the most rigid specifications regardless of cost. Exhaustive accelerated life tests prove conclusively that our units stand up for years under hard service without appreciable wear or change in characteristics.

Free Engineering Service

Clarostat engineers have made special, intensive studies of the needs of various circuits which require the use of wire wound or graphite element volume and tone controls, and the design of units of special resistance and taper characteristics to best suit such requirements.



Clarostat Replacement Line Ballast



"CIT58" T Pad Control Without Switch



"M1" Circular Hum-Dinger

Let Us Know Your Control Problems!

CLAROSTAT MFG. CO. INC.

285 NORTH 6th STREET

BROOKLYN, N. Y.

