

# RADIO ENGINEERING

Vol. VII

SEPTEMBER 1927

Number 9

## A New Tuned Power Amplifier

A combination of tuned double impedance and push-pull amplification

## Public Address Systems

Constructional and operating data for heavy-duty commercial type equipment

## The Design of Small Power Transformers

Covering the calculation of constants for transformers up to 500 watts

## The Photo-Electric Cell

The first of a series of three articles by Dr. Robert C. Burt, who is an authority on the subject

## Special Servicing Equipment

The first of a series of articles written expressly for the Service Man and Custom Set Builder

## A New A.C. Tube

A four-prong tube with a heater element and a high potential, low current filament

## NEXT MONTH

Special charts covering characteristics and uses of new type vacuum tubes



20¢ per Copy

Sold Only by Subscription—

\$2.00 per Year

The Technical Magazine of the Radio Industry

# Mathematics

## or Results—

### Which?

**Y**OU can't get away from "variables" in the radio power unit. Line voltage fluctuations, changes in receiver tubes, differences in rectifier tubes, lowered rectifier output with age, unequal drain for different yet inter-related circuits—well, there are many "variables" present and for which you must compensate with suitable resistance values.

Of course, if you are an expert mathematician and engineer, preferring to work the slide rule than to enjoy radio programs, then by all means get the fun out of figuring the necessary resistance values. And don't forget to change the resistors from time to time to compensate for the changing conditions.

But if you are just the average radio enthusiast, seeking the best results with the least trouble, then use variable resistors to take care of all "variables." And when you say variable resistor—that means CLAROSTAT, the recognized leader.



**THE POWER CLAROSTAT**

A husky variable resistor for handling real power. In several turns of knob, it covers wide range. Handles up to 40 watts of energy. Obtainable in three resistance ranges—0 to 10 ohms for line-voltage and primary group voltage control; 25-500 ohms for series-connected filament control with B-voltage tap resistances in series; 200-100,000 ohms for series-connected filament control, with or without shunted fixed resistance. And there are countless other uses. Price \$3.50.



**THE STANDARD CLAROSTAT**

Too well known to require lengthy introduction, this device has more applications than ever. It is the ideal B-voltage tap control, providing the precise voltage for each circuit and for any type of tube. In several turns of its knob, it offers a universal resistance range of from practically 0 to 5,000,000 ohms, with a current-carrying capacity of 20 watts. The Clarostat is noiseless, non-packing, foolproof and indestructible within its working capacity. Price \$2.25.

Both Power and Standard CLAROSTATS are finding wide use in the heavy-duty B-eliminators and the A-B-C power units now coming into favor. Read in the Fall issue of "Radio Listeners' Guide" how Perry S. Graffam, well-known radio engineer and designer, has selected both types for the simplest solution of the resistance controls for the filament and plate circuits. And note how in many other popular layouts, Clarostats are specified because there is no other variable resistor which combines the great resistance range, the fine adjustment, the positive operation, the complete absence from noise, the large current-carrying capacity, and the long life found in every Clarostat.

There is also the Heavy Duty CLAROSTAT, where heavy-duty conditions are met—and the Midget—the half size CLAROSTAT.

**CAUTION!** *Strenuous efforts are being made to imitate CLAROSTAT. Look for the name stamped on the shell for your protection.*

**GET THE FACTS!**

*Write us regarding Clarostats and how you can apply them in that new or even in the old radio power unit. Better still, send a quarter for our big 32-page book, "The Gateway to Better Radio," which contains a vast fund of information on radio in general.*



**AMERICAN MECHANICAL LABORATORIES, INC.**

*Specialists in Variable Resistors*

281-287 NORTH SIXTH STREET :: :: BROOKLYN, N. Y.

# CLAROSTAT

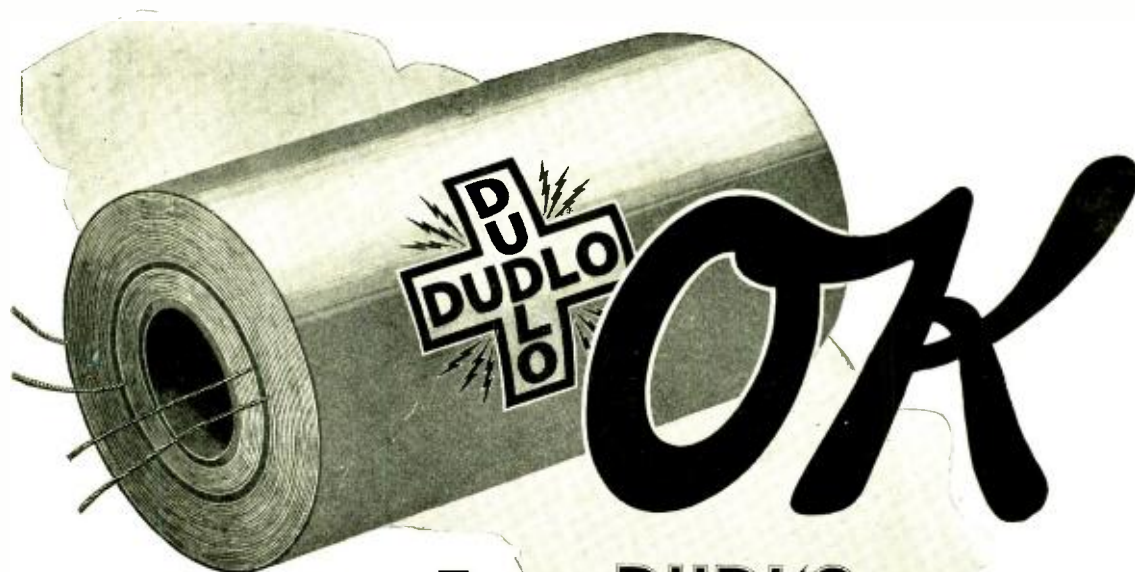

**Every DUDLO Coil  
must be O. K. in every respect**

*—number of turns*

*—no short circuits*

*—dimensions*

*—resistance*

*—output*

Complete satisfaction is assured to Dudlo customers because each individual coil is thoroughly tested and accurately checked in every way possible.

Dudlo coils must be up to specifications. There is no passing mark short of perfection.

Here in the world's coil headquarters has been developed the most complete testing apparatus in the industry. Special methods and equipment have been developed that would be impossible with any but the largest volume.

Unlimited volume, deliveries on schedule and exact adherence to specifications make Dudlo the logical source of supply for magnet wire and windings.

**DUDLO**

**DUDLO MANUFACTURING CORPORATION, FORT WAYNE, INDIANA**

56 EARL STREET  
NEWARK, N. J.

160 NORTH LA SALLE STREET  
CHICAGO, ILL.

4153 BINGHAM AVE.  
ST. LOUIS, MO.

274 BRANNAN ST.  
SAN FRANCISCO, CALIFORNIA

## EDITORIAL

**S**TANDARDIZATION has set a new course for the institutes of higher learning in the United States. Where at one time the average student attending a University took a general course of studies, unless he was preparing himself for the cloth, the bar or one of the other ancient professions, he now prepares himself for highly specialized work. Time has proven that such specialized training gives the youth of today an advantage over his forefathers who digested culture in college and spent the rest of their lives learning business.

Though specialization may mar somewhat the romantic and cultural side of life if carried too far, it is, nevertheless, a most excellent means for obtaining success, providing one visualizes success as the accumulation of earthly wealth.

Every industry is specialized. With the exception of drug stores, department stores and a few other such freaks of human endeavor, we find that specialization also enters the small business. For all of this, however, we are decided on the point that specialization has not been carried far enough in the radio business even though there is a growing tendency on the part of dealers, jobbers and distributors, and possibly a few manufacturers, to center their activities within very narrow limits. Radio dealers in small communities are slowly giving up the parts business and letting professional set builders take the profit from this line if they are capable of doing so. Dealers are centering their activities on the selling of complete sets and the usual accessories such as loud speakers, tubes, power units and so forth. With one stroke they have managed to simplify their entire business routine and in the long run are managing to make considerably more profit even though they stock less merchandise. It would not be surprising to find them emulating automobile dealers to the extent of handling receivers manufactured by one concern only. There is no logical reason why it could not be done for as long as people are interested in radio they will be in the market for new radio sets. They will not hold on to obsolete receivers any more than the average person will keep an automobile for more than a year or two without trading it in for a new one. We admit the point that automobiles wear out while on the other hand radio receivers, if properly taken care of, will last a lifetime. However, engineering ability has not reached the saturation point by any means and we are going to find that the market will be flooded every year with new receivers that are distinct improvements over the older models. There is enough selling talk behind that one factor to convince the average mortal that his old set is not of sufficient merit to be displayed, and certainly not operated, in the presence of company.

Since radio is improving in all ways the market for complete receivers is bound to increase each year. With such a large business in the future one small community should be capable of supporting five or six radio dealers specializing in certain makes of receivers. Imagine the saving to the dealer and also the amount of satisfaction derived by the customer in regards to servicing alone.

It is about time for the parts manufacturers to do a bit of specializing themselves. It is quite impossible in the present day for one manufacturer to maintain a supreme position in a number of competitive lines. If he is turning out condensers, resistance units, audio transformers, chokes, and so forth, there is too much waste energy both in production and sales, and if we are able to judge by experience, he could specialize on any one line and not only eliminate complications and waste, but turn out a considerably better product.

There is entirely too much competition in the parts field, and it is rather futile for manufacturers to continue the making of numerous products and still hope to survive. After all, no man ever devised the best mousetrap or sold the greatest number of them if his mind was divided between the trap and a new sounding horn for an automobile.—M. L. MUHLEMAN, *Editor*.

# RADIO ENGINEERING

The Technical Magazine of the Radio Industry

Edited by M. L. MUHLEMAN  
Associate Editor, John F. Rider

Vol. VII. SEPTEMBER 1927 No. 9  
Seventh Year of Publication

## CONTENTS

Public Address Systems.....	905
<i>By C. J. Brown</i>	
The Photo-Electric Cell, Part I.....	908
<i>By Dr. Robert C. Burt</i>	
The Design of Small Power Transformers..	911
<i>By Ole M. Hovgaard</i>	
Self-Adjusting Ballasting Rheostats .....	913
<i>By S. R. Ruttenberg</i>	
What Governs the Power Handling Capacity of an Amplifier?.....	914
<i>By A. R. Wilson</i>	
A New A. C. Tube.....	916
<i>By Zeh Bouck</i>	
Resistor Table .....	917
A New Tuned Power Amplifier.....	918
<i>By E. E. Hiler and R. W. Cotton</i>	
NEMA Defines Radio Terms.....	920
The Manufacture of Solid Resistors.....	921
<i>By E. Stuart Capron</i>	
The "Old Glory" Radio Equipment.....	923
<i>By Bert E. Smith</i>	
Wire Homes for Radio.....	924
Parts Manufacturers and Custom Set Builders .....	926
<i>By Jack Grand</i>	
Plan to Cut Service Costs Outlined.....	927
Scientific Service Equipment.....	928
<i>By John F. Rider, Associate Editor</i>	
Prof. Morecroft's "Principles of Radio Communication" .....	931
Voltage Amplification Bridges, Part II... ..	932
<i>By E. W. D'Arcy</i>	

## Departments

Constructional Developments.....	935
News of the Industry .....	940
New Developments of the Month.....	942
Buyers' Directory .....	956
Index to Advertisers.....	958

## RADIO ENGINEERING

52 Vanderbilt Avenue, New York, N. Y.

Published monthly by RADIO ENGINEERING MAGAZINE, Inc. Publication office, Lyon Block, Albany, New York. Editorial and business offices, 52 Vanderbilt Ave., New York, N. Y. Printed in U. S. A. Yearly subscription \$2.00 in U. S. and Canada; ten shillings in foreign countries. Entered as second class matter at the postoffice at Albany, New York, January 8, 1925, under the act of March 3, 1879. New York advertising office, B. S. Davis, 52 Vanderbilt Ave. Chicago advertising office, E. H. Moran, 307 N. Michigan Ave.

## A "Million-Dollar" Front For Your Receiver



FRONT VIEW

**H**AMMARLUND waited to produce a drum dial that would make the single-control of tuning condensers really practicable.

Local stations can now be tuned in over the entire wave band by the simple movement of two fingers. Distant stations, requiring a finer adjustment, are brought in by a slight realignment of the individual halves of the dial.

Viewed from the front, the new Hammarlund Drum Dial gives to any receiver a delightful, professional finish. The bronze escutcheon plate, richly embossed and oxidized, endows the panel with a classic beauty.

*The New*  
**HAMMARLUND**  
*Illuminated*  
**Drum Dial**

*An up-to-the-minute tuning improvement every set-builder will want to install.*

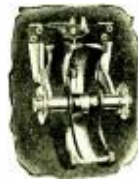

BACK VIEW

**Mechanical Features**

Over-size die-cast frame; Bakelite drums, with knurled edges; translucent celluloid wavelength scales, illuminated by a small electric light, with handy switch, connecting with the "A" Battery circuit. Adaptable to all standard panel proportions.



**HAMMARLUND MANUFACTURING COMPANY**

424-438 W. 33rd Street, New York

*Already many leading radio designers have officially specified Hammarlund Precision Products for their latest circuits.*

**For Better Radio**  
**Hammarlund**  
PRECISION  
PRODUCTS

*Dealer inquiries invited concerning several other new and appealing Hammarlund developments, having a wide sales appeal.*



# MR. RADIO EMPLOYER!

## *Do You Need Some Good Men?*

Radio employers who wish to make additions or replacements within their organizations should call on our Free Employment service for assistance. Men usually available at any point in the United States or Canada on 48 hours notice. There is absolutely no charge for this service, either to the employer or to the employee.

We can supply men qualified for work in manufacturing plants, research and designing laboratories, or broadcast stations; licensed men for commercial land and sea operating jobs; Radio-trained salesmen for the manufacturer, jobber, or retailer; men who are competent at Radio service, installation, construction, and repair.

If you need a trained Radio man for any kind of work, or if you expect to need one in the near future, see if we can't help you. Write, describing the position and the sort of man you desire. You'll be informed promptly if we have the man you need available. Address correspondence to M. B. Taylor, Manager, Employment Department, National Radio Institute, Washington, D. C. A free monthly bulletin, listing men available and their qualifications, is published by this department. Your request will bring it to you regularly. Please refer to "RADIO ENGINEERING."

(We conduct the oldest and largest Radio home-study school in the world, and our students and graduates are to be found in almost every Radio organization of importance. Our course of practical training is recognized by the U. S. Government, which allows our graduates the customary points of credit toward any Radio license they may wish to take out. See announcement on opposite page.)

# Want More Money?

## You Can Increase Your Earning Power By Learning More About Radio

If you're making a penny less than \$50 a week, you're not getting what you ought to get out of Radio.

Thoroughly-trained men—men whose knowledge of Radio is completely rounded out on every point—earn all the way up to \$250 a week.

Radio is a new industry with plenty of fine positions unfilled. There are countless opportunities in Radio for a man to earn a splendid salary. But these are not opportunities as far as you are concerned, unless you're fully qualified for them.

The only way to qualify is through knowledge—training—**Practical, complete training**, that fits you to get and to hold a better position in the Radio field.

### See If This Free Book Can Do You Any Good

I publish a 64-page book, printed in two colors and filled with facts and photos relative to Radio and its opportunities.

I don't say this book will help you, but it **does help** such a large percentage of those who read it that I can afford to send it to all who ask for it—free. You may get only a single idea out of this book that will be of any value to you. Or every line of it may give you a message.

**A message to men now in the Radio business. And another to men who would like to be in.**

*I have helped all sorts of men to advance themselves in Radio.*

*Lots of them, men who knew absolutely nothing about Radio when they first wrote me. Some who didn't know the difference between an ampere and a battle-axe.*

*Others, graduate electrical engineers who wanted special work in Radio. Licensed sea operators who were way behind on the "RCL stuff." "Hams" by the score.*

*Last but not least, the service and repairman or salesman who wanted to advance or go into the Radio business on his own. And the man already in on his own, who wanted to look forward to a more solid and permanent Radio future.*

*My free Book—see coupon below—tells about my helpful methods, and cites the experiences of a hundred men—giving photos and addresses.*

At any rate, fill in the coupon below and look it over. It costs you nothing but a two-cent stamp, and you place yourself under no obligation. I won't even send a salesman to call on you. And there's always a chance that that two-cent stamp may make quite a difference in your future.

### What My Radio Training Is

Under my practical system, a man can study at home in his spare minutes, and get a thorough, clear, practical and expert knowledge of Radio in from 4 to 12 months. The time required depends on his previous knowledge, his ability, and the time he can spare for study. He keeps right on with the job he has—no necessity for his leaving home or living on expense.

Then as soon as he's ready for a better position I'll help him to get it and to make a success of his work. (See announcement on opposite page.)

This proposition is open to anybody who is not satisfied with his job, his prospects, or his Radio knowledge. Regardless of how much you know already (or if you don't know the first thing about Radio technically) I'll fit my methods to suit your needs.

If you want to enter into any correspondence about your own situation, anything you write will come directly to me and will be held strictly confidential.

Tear the coupon off now before you turn the page, and mail it today.

**J. E. Smith, President,  
NATIONAL RADIO INSTITUTE  
Washington, D. C.**

*Oldest and Largest  
Radio Home-Study  
School in the World*

*Originators of  
Radio Home-  
study Training*

J. E. SMITH, President,  
National Radio Institute,  
Dept. K-99, Washington, D. C.

Please send me your free book about the bigger opportunities awaiting the thoroughly trained Radio man. At present I (am) (am not) in the Radio business.

Name .....

Address .....

Town ..... State .....

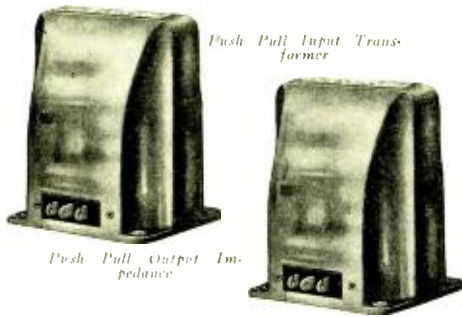

## The New Symphonic Push Pull gives great power with quality

**Y**OU who love rich bass notes and tonal brilliancy will find this beautiful pair of Samson brush-copper-finished audio units—Push Pull Input Transformer and Push Pull Output Impedance—as far ahead of the old-style push pull transformers as the Samson Symphonic Transformer is ahead of the old audio transformer.

These units have brought back into its own the push pull circuit, which eliminates tube harmonics and was only condemned because of the poor transformers that were used.

With two type 171-power tubes having but 180 volts on their plates as much undistorted volume can be obtained as with a type 210 tube having 400 volts on its plate in an ordinary amplifying circuit—and two type 210 tubes can be used with these units for dance-hall volume.

The Samson Symphonic Push Pull Input Transformer will satisfactorily work into tubes up 50 watts capacity.

Unfiltered AC current may be used on the filament in push pull circuits without hum in either first or second stages, or both stages.

The Push Pull Output impedance eliminates the distortion always found in any transformer—no matter how well it is made.

Broadcast stations and laboratories, where a minimum of distortion is required, have used Samson Push Pull Audio Units for the past year. This is the first announcement of the availability of these units for public use.

Ask for data on our new Symphonic Inter-stage Push Pull Transformer.

Send for free reprint article on a complete audio amplifier.

**Samson Electric Co.**

Main Office:  
CANTON, MASS.

Manufacturers  
Since 1882

Factories at Canton and Watertown, Mass.

## An Important Improvement At Trifling Cost

**UNION  
RADIO  
TIP JACKS**

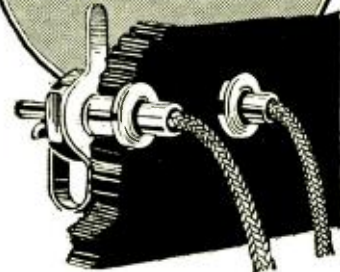

**A** SMALL item, it's true—but very important to the radio manufacturer because radio buyers recognize their superiority over old-fashioned, clumsy binding posts.

Union Radio Tip Jacks assure positive contacts and permit instant insertion or removal of cord tips. Simple in design—no parts to work loose or break. Heavily nickel plated, they make every panel more attractive—a very important feature. They are *Standard Equipment on Many of the Finest Receiving Sets.*

### To Dealers

Retailing at 25c a pair, Union Radio Tip Jacks are a real profit maker because they sell fast and repeat.

Firmly grip all wires from No. 11 to No. 24 B & S gauge. Three sizes for all panels. Type A (Standard) for 3/16" to 1/4" panels. Type B (Special) for panels, cabinet walls and partitions from 5/16" to 1/2" thick. Type C (Standard) for panels up to 1/8" thick. Packed in self-selling cartons of 1/12, 1/2 and 1 gross pairs.



### Identification Tags

Hard red fiber ovals marked with proper identifications of battery connections, such as A—, B—, B 67, B 90, etc. Prevent shorting battery or blowing tubes. Packed 100 in box of one designation only. Retail price \$1.00. Also in set of 9, retail price 10c.

### To All Branches Of The Trade

Send for illustrated circular and samples of these fast selling radio products, and details of our attractive proposition.

**UNION RADIO CORPORATION**  
124 ~ SUSSEX ~ AVENUE ~ NEWARK ~ N.J.  
NEW YORK ~ OFFICE ~ 40 ~ EAST ~ 34<sup>TH</sup> ~ STREET





# FIRST RELEASE!

## MORECROFT'S PRINCIPLES of RADIO COMMUNICATION

(Second Edition)

Completely Revised and Up to Date

by

**JOHN H. MORECROFT**

Professor of Electrical Engineering, Columbia University  
Past President Institute of Radio Engineers

assisted by

**A. PINTO**

Electrical Engineer, Otis Elevator Co.

and

**W. A. CURRY**

Assistant Professor of Electrical Engineering, Columbia University

1001 Pages  
831 Illustrations  
\$7.50

Practically a New Book—in-  
cluding all new developments  
but retaining the good fea-  
tures of the old. See page  
931 for review.

*Saves Hours of Calculation*

### RADIO FREQUENCY MEASUREMENTS

by

**E. B. MOULLIN, M.A., A.M.I.E.E.**

It contains formulas for measurements that the experimenter in the past had to derive for himself. Theories are made practical by examples. Practically every measurement is illustrated by an example. There are copious instructions about the manipulation of apparatus. The use of the vacuum tube voltmeter is described.

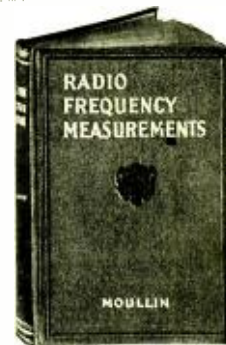

For use while measure-  
ments are in progress.  
This book shows how the  
latest discoveries in R.F.  
measurements are practi-  
cally applied.

*Note:* Your subscription, or the renewal or extension of your subscription saves \$1.00 toward the purchase price of any of the above publications.

Just add \$1.00 to the price listed opposite the book desired. Send check or Money Order to RADIO ENGINEERING, 52 Vanderbilt Ave., New York City, and you will receive a full year's subscription to RADIO ENGINEERING and the book (postpaid) by return mail.

## Let Radio Engineering Assist When You Are Adding to Your Technical Library

*See offer at foot of this advertisement*

### ENGINEERING WORKS

RADIO FREQUENCY MEASUREMENTS.....	by E. B. Moullin, M.A., A.M.I.E.E.	\$10.00
Every Radio Laboratory should have this book. Formulas save hours of calculation.		
THERMIONIC VACUUM TUBE.....	by H. J. Van der Bijl, M.A., Ph.D.	5.00
EXPERIMENTAL ELECTRICAL ENGINEERING.....	by Vladimir Karapetoff	5.00
(and Manual for Electrical Testing)	(Prof. EE., Cornell Univ.)	
VECTOR ANALYSIS.....	by Joseph G. Coffin, B.S., Ph.D.	2.50
THEORY OF VIBRATING SYSTEMS AND SOUNDS.....	by Irving B. Crandall	5.00
	Bell Telephone Labs.	
PRINCIPLES OF RADIO COMMUNICATION.....	by Prof. J. H. Morecroft	7.50

### GENERAL PUBLICATIONS

PRINCIPLES OF MODERN RADIO RECEIVING.....	by L. Grant Hector, Ph.D.	5.00
PRACTICAL RADIO CONSTRUCTION AND REPAIRING.....	by Moyer & Wostril	2.00
ELEMENTS OF RADIO TELEPHONY.....	by H. C. Ballard, Jr., M.E.	1.50
WIRELESS PICTURES AND TELEVISION.....	by T. Thorne Baker	2.50

*Note.*—Radio Engineering will be glad to give information concerning the above works and other radio and engineering books, in which subscribers may be interested.

## Set Manufacturers:

What are you offering the unsold market?

Millions of homes still have no radio. Why? Because the average radio set does not satisfy a critical ear.

Forward looking set manufacturers are compensating for loud speaker deficiencies by including the Hiler System in their new models. They are offering to the unsold market, receivers which pass the critical ear test.

**RISING CHARACTERISTICS on LOW FREQUENCIES**

are obtained with

## HILER TUNED DOUBLE IMPEDANCE

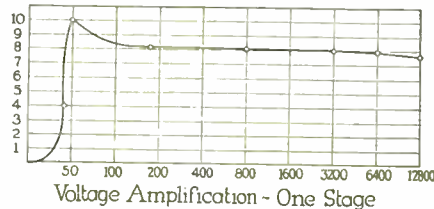

A curve flat from 150 to 10,000 cycles and rising between 150 and 30 cycles offsets the falling characteristics of loud speakers and output circuits. A sharp cut-off below resonant peak prevents motor-boating. Four times power output feature retained. Naturalness as well as clearness is result of accurate laboratory research on loud speakers and double impedance amplifiers. Combinations of tuned and untuned stages can be made to fit any condition, thus producing straight line results as you hear it.

*Licenses for the use of the DOUBLE IMPEDANCE System are being issued to a limited number of established manufacturers—Infringers will be prosecuted under Patents 1589692 and 1615224. (Other patents pending.)*

*Demonstrations may be arranged by appointment.*

**HILER AUDIO CORP.**

10 Argyle Terrace, . . . . . Irvington, N. J.

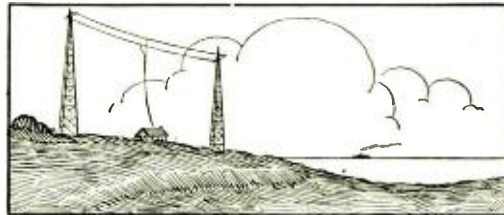

## Public Address Systems

*Construction and Operating Data for Heavy-Duty Commercial Type Equipment*

By C. J. Brown\*

YOU have doubtless listened many times to public announcements of important proceedings or sporting events that have reached your ears through the medium of a public address system. By public address system is meant a certain type of amplifying equipment operating directly at the scene of action, obtaining input through one or more properly placed microphones and serving the audience through large reproducers usually placed at an elevation. This class of equipment has been very highly developed and is giving excellent service, often under trying conditions. Although the components of a modern public address system represent the acme of audio amplifier engineering practice, very little has been published about the actual layout, construction and use of this type of equipment.

Aside from its use in public address work and in practically every broadcast station, high and low power amplifiers of the p. a. type are in daily use in hospitals, hotels, clubs and similar institutions and especially in hospitals have brought many happy hours to the patient listeners. It has been deemed worthwhile, therefore, to provide simple design data and explanations that will enable professional set builders to enter this field of high-power super-quality amplifiers. We will show in this article the progressive development of a complete amplifying equipment comparable to those used in public address work and broadcast transmission. It was thought better to first describe an amplifier that would be a composite of modern speech input and power amplifiers rather than a specified commercial unit. Therefore the constructor will find himself in possession of a device both practical so that he can learn the intricacies of public address work and one that at the same time gives extra-fine quality and great power.

### Details of Amplifier

Fundamentally this amplifier consists of an input tube circuit for microphone adaption, a first stage of the impedance-resistance coupled type, a second stage of high-gain transformer

coupling and a last power stage of the push-pull type. Although the unit can be built on a panel with sub-base assembly, it will be found easier to assemble it on a fairly thick wooden base with open wiring. This method allows greater freedom in adjusting, balancing and wiring changes in the field. The complete wiring scheme is shown in Fig. 1. First note above the letter A, which indicates the filament

control is through ballasts. Although larger commercial amplifiers have individual filament rheostats and meters the cost and additional controls involved were not considered practical for this amplifier and very satisfactory results have been obtained with the ballasts used.

Taking in detail the various stages of the amplifier we start at the microphone input. Connections are provided for the standard type two-button instrument which is controlled by a cam switch so that it can be cut off at the instrument if desired. Single-circuit jacks are wired into each outside leg so that a milliammeter can be plugged in to balance the microphone. This balancing is done by means of the 200 ohm variable resistor shown connected to the mid-point on the low side of the microphone input transformer. This transformer has a 200,000 ohm variable resistor across the high side for gain control. The input coupling tube is a high mu tube, 180 volts should be applied to the plate of this tube with not more than 3 volts "C" bias. The adjustment of the voltage values on this stage should be carefully made to assure distortionless coupling.

The first stage is impedance-resistance coupled. The 500,000 ohm grid leak is variable and functions as a gain control also. Interconnected at this point is the first control switch, which is three-pole double-throw. When thrown to one side it cuts in the input tube and arranges the amplifier for use with the microphone. Thrown opposite the input tube is cut out and the radio receiver connected to the first impedance stage. Thus the amplifier can be quickly switched from the microphone to the receiver for public address work.

### Operating Characteristics

The first stage tube is usually the 201-A type. 135 volts should be applied to this tube with 9-12 volts "C" bias. The output of this tube feeds the high-gain transformer. Across the secondary of this transformer is a .5 meg resistor. Since the first impedance-coupled stage has a practically flat frequency characteristic it is desirable, if possible, to carry out this

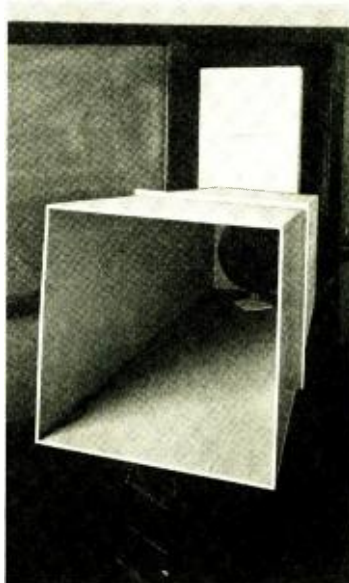

Fig. 3. A cone speaker, placed in a large wooden projector for public address work.

terminals, that both six and eight volt connections are provided. Through a four-pole double-throw cam switch either 171 or 210 tubes can be used for the power stage without otherwise disturbing the filament wiring or controls. Thus for home or store use it might be found satisfactory to use 171 tubes. But if the equipment were to be used to handle a large crowd outdoors 210 tubes might be found more adaptable to the power required. As a rule two storage batteries prove the most practical for filament current. Filament

\* 52 Vanderbilt Ave., N. Y. C.



of Technology, held in June. Ordinarily the exercises are held outdoors but arrangements are made so that in event of inclement weather everything can be transferred and continued in the Armory. Obviously it would be difficult to move the assortment of equipment, such as can be seen in the photograph and have it reassembled and working in a few minutes. The problem was solved by mounting everything on a movable truck and although, strangely enough it did not rain, the operators were ready for any emergency. In addition, after the exercises, it was simply necessary to wheel the truck to the parking place provided for it, until the next call for the equipment to serve a useful purpose. It will be gathered from the above that a public address system can be mounted on a small truck and readily transported from place to place, to the ultimate profit, we believe, of the owner.

A small board containing one tube and transformer will be noted in front of the phonograph. It might be explained that this is a single-stage amplifier used when the microphone is being employed in the close-talking position, in which case its sensitivity is much greater than when used for distant talking, as on the platform.

#### Problem of Projection

The problem of projecting a special program to great crowds over a considerable area, has apparently stumped many well-meaning experimenters and we hope that the following suggestions will prove of aid in their future public address work. Since most radio men lean greatly in favor to the cone type speaker they have tried to use this speaker for outdoor work. Many things usually happen when the attempt is made. In the first place, on account of the diffusion of sound as it leaves the cone, a great deal of power is required to assure proper hearing of the broadcast at every point in the

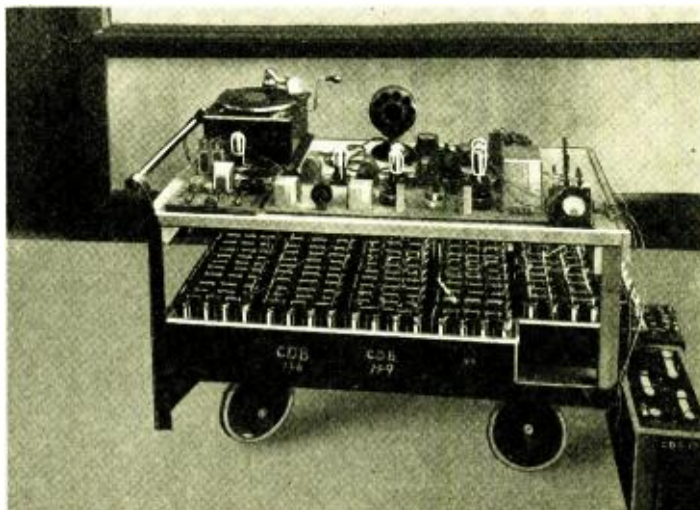

Fig. 2. Portable speech amplifier together with a microphone and small phonograph with an electrical pick-up. Note the storage "B" batteries.

desired range. As a rule this power is not available and the demonstration is usually a failure. In addition, the changes of direction of the wind produce results that more than disturb the proper hearing of the program. Several times well-meaning radio dealers have proposed to install about six cone reproducers around a large hall or field and when they had gone to considerable trouble to do this encountered species of "singing," reflection and foreign noises that made the ultimate sounds harmonize well with a steam calliope. It can be set down as a working fact for proper public address operation that the sound *MUST* be projected out to the listeners and not allowed to take the handiest means of reaching the assembled ears. How to do this inexpensively and efficiently will be evident by reference to Fig. 3 and the following description of the projector shown.

The reproducing unit consists of a cone speaker of the same type as is used for home reception which is placed at the small end of a square sound chamber. This sound chamber is built of beaver-board or similar material. It is in four pieces, each of which are six feet long, two feet wide at one end and three feet wide at the other end. It is well to reinforce the structure at two or three points along the length. A perforated baffle is placed at the small end, close to which the reproducer is placed.

#### Psychological Considerations

A typical installation of two of these reproducers is shown in Fig. 4. The projectors will be noted hanging out of windows one on each side and above the speaker's microphone. The following points to be carried out in suspending projectors will be evident from this picture. It is always desirable to have the projectors some distance above the heads of the listeners and pointing directly at them. This particularly applies to work where the audience are seated in a square in front of the platform. The projectors must also be so placed; usually by trial before the public use of the system, that the singing and reflection mentioned above are avoided. These two troubles occur through feedback between the projectors and the microphone and the only way to eliminate them is to place the projectors properly with respect to the microphone. If the projectors are incorrectly placed it will be evident to the speech maker in a peculiar way, i. e., he will imagine himself to be talking out of the back of his neck. A most disconcerting feeling!

Another reason for mounting the projectors at least twenty feet above the audience is something of a psychological one. If they are out of the direct line of vision between the audience and the speaker the coordination between sight and hearing is such that



Fig. 4. A typical public address projector installation. Two large speakers can be seen protruding from the end windows in the building.

the sound will actually appear to be coming from the speaker and the system therefore appear to be rendering excellent service. Direct projection also has the benefit of simplifying volume control, because if a speaker is talking loudly as a rule the high frequencies will predominate and if volume and projection are not properly controlled the instinct of the audience will tell them that something unnatural is occurring and interfere, perhaps seriously, with the program.

Projectors are as a rule connected in parallel, especially when they have the same impedance. For the interconnecting it is important to remember that twisted pair wire should always be

used. Where a number of matched impedance projectors are to be used they can often be worked nicely in a series-parallel connection. Where the projectors are of different impedances they should be wired in series.

### Acoustic Damping and Reverberation

In setting up a system it should also be remembered in adjusting that the audience in a hall has a certain effect on the acoustic damping of the room. In some cases certain resonance effects will interfere with the system but these usually appear only in connection with the pick-up apparatus or

transmitter. If an attempt is made to hide or otherwise enclose the pick-up device detrimental results will follow. While it is all right to screen the pick-up to protect it from injury, no attempt should be made to completely shield it.

When used in halls or large auditoriums reverberation may occur. If the effects are troublesome improvement can usually be had in operation by placing materials about which will damp the sound in space. Although the equipment described in this article has been only in audiences up to 5000 people it is felt that the system will handle at least 10,000 people with up to six projectors.

# The Photo-Electric Cell

## A Technical Explanation of Photo-Electric Effects and an Example of the Operation of the Photo-Electric Equation

By Dr. Robert C. Burt, E.E.

*This is the first of a series of three articles by Dr. Burt. The second and third articles will cover the use and methods of using the Photo-Electric Cell.*—EDITOR.

THE most common forms of energy are mechanical energy, heat, chemical, electrical, magnetic, sound and light energy. Some of the things we wish to do with these forms of energy are, to capture them from their natural sources, to store, transport, transmit, measure, record, observe, control, transform them into other forms of energy, and to control one form of energy by another. For example, mechanical energy exists in the form of water flowing in streams. We capture this from nature by hydraulic turbines. We store this by holding the water at an elevation in reservoirs. Mechanical energy is carried in storage by everyone who has a watch; it is transferred by belts and is measured by dynamometers, which may be recording.

The effects of mechanical energy are common to observation. Its control is commonly by clutches, brakes, etc., and it controls other forms of energy by means of electrical contacts, triggers on guns, etc. That is to say, a small amount of mechanical energy applied to the trigger of a rifle controls a large amount of chemical energy. A similar story might be written about other forms of natural energy. But when we come to energy in the form of light, we find that the story is rather brief in spite of the fact that light energy is perhaps one of the most important to the human race.

### Light Energy

Light energy is captured from nature almost solely by plant growth. To

store it, except in minute amounts by phosphorescent chemicals, is impossible. Since it cannot be stored, it cannot be transported in storage. It transmits itself, but its measurement is a thing of considerable difficulty, and recording is even more difficult. To control its formation from other forms of energy is usually relatively easy, but for it to control any other form of energy is very difficult. Its transformation into other forms of energy is greatly limited by lack of suitable means.

In this discussion of light we must not forget that light, as ordinarily accepted, is distinct from radiant heat, and hence the energy as light is really quite small. If heat be absorbed out of sunlight, the remainder is a very small amount of energy. This energy cannot be transformed into usable mechanical energy. It may be transformed into heat, but the resulting heat is very small. It is transformed into chemical energy by many natural processes of growing tissues, especially in plants. It never makes a sound, it has no magnetic effect which can be detected by ordinary magnetic detecting devices, and it is transformed from one wave length of light to another with extreme difficulty.

From this one sees that while light energy is of such great importance to the human race, the things which it can be made to do are greatly limited. It can make us see, it can be recorded by a camera and it can be transformed into electrical energy by the photo-electric cell.

### The Photo-Electric Cell

How brief a recital this makes compared with the recital of electric energy, which can be transformed quickly into other forms of energy, which by

simple means controls almost any form of energy, and yet which itself is by nature so infrequently applied to the human system. It is very fortunate for us that one of our first light detecting instruments—the photo-electric cell—controls so universally applicable an energy as electricity. The human race has had for many years mechanical prime movers, mechanical legs and arms, and it has had electrical heaters, chemical heaters and so on, but the human race has been dependent upon the human eye for its detection and record of light. If the photo-electric cell can be made by a simple process to take the place of the human eye in certain places, it can be of great service to mankind.

The photo-chemical processes are well known to most of us. Such processes are common in plants, and have been brought to a high degree of perfection in photographic materials, but these processes usually have a time element involved which is too long to permit their use in the quick control of things we wish done on the spur of the moment. For instance, we can arrange a camera to record the motion of a thief in a room, and that may be of assistance in tracing him after the theft has been committed and the thief has made his get-away; but how much better it would be if we had a photo-electric watchman to turn in the alarm when the thief entered the building, instead of waiting, perhaps hours, before turning in the report. It is for purposes of this kind that the photo-electric cell may be of value to us.

### The Photo-Electric Effect

The photo-electric cell process is distinct from the photo-chemical process in that light and electrons

alone take part in it. If a zinc plate be suspended by a silk thread and charged with electricity from a static machine, it will hold its charge for a long time. If, however, the light from an arc lamp be allowed to shine upon the zinc plate, it will be found that, if the plate is charged negatively, it will lose its charge very rapidly under the action of the ultra violet light from the arc lamp; but, if the plate is charged positively, it will retain its charge quite as well when the light is allowed to shine upon the plate as when the light does not shine upon it. This simple experiment will serve to illustrate the effect known as the photo-electric effect. Since the plate loses the negative charge, but not the positive, it is evident that the light causes the zinc to release electrons which are expelled from the zinc by its negative charge, just as heating the filament in a vacuum tube allows the filament to release electrons.

Different metals than zinc will also release electrons when the light shines upon them. Experiments have shown that the light most powerful in its ability to release electrons from metals is the light of highest frequency, that is violet or ultra violet. The common metals such as iron, copper, gold and platinum will release electrons only under the action of strong light in the extreme ultra violet; whereas experiment has also shown that certain of the metals, such as sodium and potassium, will release electrons under the action of visible light. The difference in the willingness of the various metals to release electrons is probably in part responsible for their chemical activity. It is quite evident that gold and platinum are less active chemically than zinc, and in the same way zinc is less active chemically than are sodium and potassium. In fact, sodium and potassium are so active they cannot be kept in the atmosphere without quickly combining with the oxygen and the water vapor of the atmosphere, and this combination renders their surface insensitive photo-electrically to visible light. It is for these reasons that photo-electric cells are made of sodium, potassium or similar metals and are made in the form of vacuum tubes, so that their surface may be preserved from chemical combination which will impair its photo-electric sensitiveness.

### Photo-Electric Equation

Einstein's photo-electric equation is as follows:

$$h\nu - h\nu_0 = \frac{1}{2} mv^2.$$

This is the fundamental physical equation of photo-electricity. It was originally proposed by Professor Albert Einstein and the confirmation of it by experimental physicists, R. A. Millikan and others, gave no little impetus to the corpuscular theory of light known now as Quantum theory.

This equation is in terms of units used by the physicists, but not so com-

mon to engineering. The entire group of units are called the "absolute CGS units"; C for centimeter, G for Gram and S for second.  $h$  is Planck's Radiation constant;  $6.54 \times 10^{-27}$  erg. sec.  $\nu_0$  is the frequency of the long wave-length limit for the given surface. Lower frequency light than  $\nu_0$  will not release electrons from this surface, regardless of how intense the light is.

$$m = \text{mass of electron} = 9 \times 10^{-28} \text{ gram.}$$

$$v = \text{velocity of ejected electron in centimeters per second.}$$

As an example, let us take a pure sodium surface of say long wave-length limit, about  $4360 \times 10^8 \text{ cm} = 687 \times 10^{12}$  cycles per sec.



A high vacuum photo-electric cell without appreciable fatigue.

If we now multiply by  $h$ , we have the work in ergs to get one electron free from the sodium; or,

$$6.54 \times 10^{-27} \times 687 \times 10^{12} = 4500 \times 10^{-15} = 4.5 \times 10^{-12} \text{ ergs. This is called the work function of the surface.}$$

Since work done by moving an electrical charge through an electrical field is,

$$\text{work} = Ee.$$

where  $E$  is the field in CGS volts (300 of the ordinary engineering Volts = 1 C G S volt) and  $e$  is the

charge moved. Now  $e$  for an electron is  $4.8 \times 10^{-10}$  CGS units of charge, equal to  $1.6 \times 10^{-19}$  coulombs.

$$\text{Now } 4.5 = 10^{-12} = \text{work} = Ee.$$

$$\text{Hence, } E = \frac{4.5 \times 10^{-12}}{4.8 \times 10^{-10}} = .9375 \times 10^{-2} = .009375 \text{ CGS volts.}$$

$$300 \times .009375 = 2.81 \text{ volts.}$$

Now we have a very clear picture of just what happens. When light of wave-length  $4360 \times 10^8$  centimeters strikes pure sodium, it has just energy enough to cause the sodium to release an electron, and the work done by the light is equal to work done by a field of 2.81 volts on a free electron. This does not mean that 2.81 volts will pull an electron out of sodium under ordinary conditions, because we can not apply this 2.81 volts in the small distance that the sodium nucleus exerts its force on the electron.

Now suppose we were to expose our sodium surface to that strong violet line in the mercury spectrum, of wave length  $3660 \times 10^8 \text{ cm}$ . Our energy now will be

$$h\nu = 6.54 \times 10^{-27} \times \frac{3 \times 10^{10}}{3660 \times 10^8} = 5.36 \times 10^{-12} \text{ ergs;}$$

but since it requires only  $4.5 \times 10^{-12}$  ergs to remove the electron, we have  $(5.36 - 4.5) \times 10^{-12} = .86 \times 10^{-12}$  ergs left over. This energy will appear as velocity of the electron. Now, since velocity (kinetic) energy is equal to  $\frac{1}{2} mv^2$ , where  $m$  is the mass in grams and  $v$  equals velocity in cm/sec, the mass of the electron being  $9 \times 10^{-28}$  grams,

$$v^2 = \frac{.86 \times 10^{-12} \times 2}{9 \times 10^{-28}} = 19.2 \times 10^{15}$$

$$v = 4.39 \times 10^{17} \text{ cm/sec.}$$

Hence, one can easily figure that the velocity with which the electron leaves the surface is  $4.39 \times 10^7$  cm per second, which is equal to 270 miles per second.

In the same manner, knowing the work relation  $Ee$ , we can compute the equivalent accelerating voltage to be about .54 volts.

The above example will be sufficient to indicate how calculations are made. Of course many other calculations can be performed, into the detail of which we will not go now. The important thing here is that short waves (that is, light near the violet end of the spectrum) are more powerful photo-electrically than longer waves. Also, there is a wave-length which will just release electrons and any longer wave length will not produce the photo-electric effect. This wave-length, known as the long wave-length limit, has a certain energy, and, as before stated, this energy is called the work function of the surface.

### Long Wave-Length Limit

This work function is different for each different photo-electric surface, which means that the long wave-length limit is different for different materials. For zinc this long

wave-length limit is in the near ultra violet, while for platinum it is in the far ultra violet, not far from the limit of the air transmission. With a pure sodium surface, the long wave-length limit is some place in the green, which means that the pure sodium surface will show photo-electric effect for green, blue and violet light, as well as for the ultra violet, but it will not show photo-electric effect for wave-lengths longer than the green; that is, for yellow and red. Certain chemical compounds of these photo-active elements have long wave-length limits further toward the red than the pure metal, and while exact figures are not available, it is generally believed that the hydride of some of these metals may be even sensitive to wave-lengths longer than the red, to which the eye is sensitive. On the other hand, it is also known that such chemical compounds will show photo-chemical action under the light which produces the photo-electric effect, and hence the surface changes its sensitiveness when strong light is applied for any length of time. This change in sensitiveness of the photo-electric effect is called fatigue. It is an extremely unfortunate situation because it results in the sensitiveness of this type of photo-electric cell not being constant, but changing with the previous history of the cell. Such hydride cells, however, have a special field in work requiring red light.

The most recent reference, G. B. Welch Proc. Nat. Ac. Scie. 13, 111, '27, gives the following long wave length limits.

Lithium	5260 Angstroms
Sodium	6800
Potassium	above 10,000
Rubidium	" "
Caesium	" "

Since the photo-electric effect is in any case small, due to the small energy in light, it was necessary before the days of amplifiers to do everything to obtain higher currents. It was with this in view that Professor Jacob Kuntz introduced the noble gases, helium, neon and argon, into his early photo-cells, but impurities in the gas resulted in surface-effects causing fatigue. Furthermore, if too high a voltage were applied to the cell, it would arc and frequently cells were thus burned up.

Photo-electric cells are now being prepared with pure surfaces in extremely high vacuum. These cells are without fatigue and are very stable and reproducible, giving the same results from day to day and week to week, irrespective of extreme variations in service conditions. Furthermore, gas filled cells and cells with hydride surfaces are being improved and the amount of fatigue reduced. Many able experimenters are working on the whole problem of the photo-electric cell, which is destined to play an increasingly important part in scientific and industrial developments, particularly in connection with television.

APPENDIX

The CGS units serve to define all physical quantities, so with your permission will define some of them. The centimeter is a unit of length; it equals .3937 inches. The gram is the unit of mass, one cubic centimeter of pure water at 4° centigrade has a mass of one gram. The second is as we know, one 86,400th of a mean solar day. The unit of force of the CGS system is that force which when applied to one gram of mass will increase its velocity at the rate of one centimeter per second for each second the force is applied. Now it is found that the force of gravitation upon any mass, if allowed to exert itself unhindered, causes its velocity to change at the rate of 980 centimeters per second in one second. In other words, the force of gravity on a mass of one gram is 980 force units. The force unit is called a dyne. As I have said, gravitational force on one gram of mass is 980 dyne, but this must now be modified somewhat because the force of gravitation is different at different places on the earth's surface; at the poles it is greater, at the Equator and on mountain peaks slightly less, than 980 dynes, but the mass of one gram is absolutely the same everywhere. On the moon or in free space, where there is no gravitational force, a gram of mass is the mass of one cubic centimeter of water at 4° C, and the force of one dyne is the same everywhere; but the force of gravitation varies from place to place.

The CGS unit of work is the erg and it is the work of one dyne of force acting over one centimeter of distance. Hence, it requires 980 erges of work to lift one cubic centimeter of pure water one centimeter.

The Exponent

Now I know that many of you will think that these are very little units and that is true, when you are talking about things like the velocity of light, but it is a very large unit when talking about electrons. So it is a happy medium for a science in which both are used, but to our rescue comes a little giant known as the exponent. It is a little number on the mezzanine floor behind the main floor (thus 3<sup>2</sup>) in which three is the number and two is the exponent and means simply multiply three by itself. Again 10<sup>3</sup> means 10 x 10 x 10 which is 1000. Now we see that when used with 10 the exponent means the number of zeroes after the one, thus 10<sup>6</sup> is one million and 10<sup>9</sup> is one billion. Now, when we multiply two exponent tens together, we just add the exponents; thus 10<sup>2</sup> x 10<sup>3</sup>=10<sup>5</sup>, or 100 times 1000 equals 100,000, and since 100,000 divided by 100 equals 1000, we can say 10<sup>5</sup> x 10<sup>-2</sup>=10<sup>3</sup>. That is, dividing by 100 is multiplying by one-hundredth and this is dividing by 10 twice or multiplying by 1/10 twice, so one tenth becomes 10<sup>-1</sup> and .01 equals 10<sup>-2</sup>.

Now our numbers can be written just like this:—

10 = 10 <sup>1</sup>	1 = 10 <sup>0</sup>
100 = 10 <sup>2</sup>	.1 = 10 <sup>-1</sup>
1000 = 10 <sup>3</sup>	.01 = 10 <sup>-2</sup>
	.001 = 10 <sup>-3</sup>

To multiply, we add exponents and to divide we subtract exponents. Now a little number like the velocity of light, which is only 30,000,000,000 (thirty billion) centimeters per second, becomes 3 x 10<sup>10</sup> cm per second and

100,000,000 cm becomes 10<sup>-8</sup> cm, which is one angstrom, the common unit used in measuring wave lengths of light.

The Radio Beacon

Radio beacons offer a most promising development in facilitating air navigation of the future. Three types are now being used to supplement other means of guidance. The directive type sends out special frequencies enabling pilots to follow a course in total darkness or fog, and is especially adaptable for transoceanic flying.

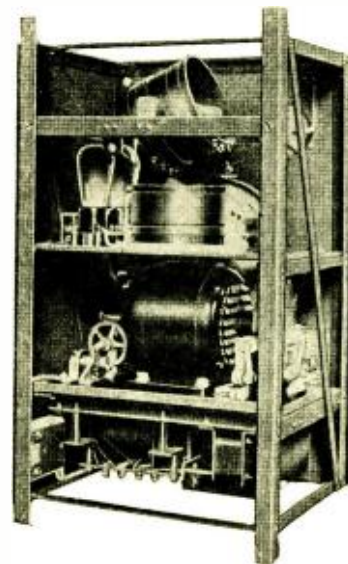

Photo, courtesy of the Bakelite Corporation

The beacon for navigation at sea, illustrated here, was invented by Dr. F. A. Kolster, chief research engineer of the Federal Telegraph Company. The instrument operates as a low powered transmitter of a characteristic signal on a wave of 850 meters.

Marker beacons placed along a land route serve as mileposts; the telephone type informs the aviator of weather conditions, during the flight.

Lieutenants Maitland and Hegenberger, the army flyers who were the first to reach Honolulu in a non-stop flight, used the directive type of radio beacon. They stated the belief that "in the near future the radio beacon will revolutionize not only air navigation but sea navigation."



# The Design of Small Power Transformers

*Determining the Most Suitable Design for Transformers Up to 500 Watts*

By Ole M. Horgaard, Member I. R. E.\*

UNTIL recent years, the design of very small transformers was a subject of rather limited interest, they appearing mainly in the form of bell-ringing transformers and a number of transformers for special purposes. With the advent of power supplies for radio sets the small transformer started to assume an economic importance and most of the concerns manufacturing transformers found that they could add a very profitable series of items to their line of products by entering this field.

Initially, the same methods of design were applied to these transformers as the manufacturers had been applying to their larger transformers. Soon, however, competition became very active and the customers of these transformer manufacturers—the radio manufacturers—found that they were paying too high a price. They, in their turn, had found out that one thing they could not sell the public was efficiency and good engineering design in transformers. The public did not care about the efficiency of a device whose total power consumption was practically negligible, and furthermore they had been educated to expect low overall efficiency by the battery chargers using gaseous types of rectifiers. The final result has been that most of the transformers sold for use in "A" chargers and low voltage rectifier circuits run very close to the maximum allowable temperature limits. The transformers used for high voltage or "B" rectifiers usually do not heat since their design is commonly quite generous. The reason for this is that in the "B" transformer there is usually a step-up ratio of six or seven and if the core area was made too small the total number of turns used and, therefore, the weight of copper would become excessive. The main object in the design of a step-up transformer is, therefore, first to strike an economic balance of copper to iron, and secondly to keep the amount of copper a minimum in order to get the best possible regulation. Due to the above considerations it is not possible to apply standard transformer design, and it is the purpose of this article to show how it is possible to arrive at reasonable design constants, based on experience, that will result in transformers something like what may be seen on the radio market.

### Core Dimensions

In the design of any piece of apparatus involving as many variables as are found in transformer design it is usually customary to make a certain

number of assumptions, thereby limiting the number of variables. Of course these assumptions are nothing more or less than choosing reasonable values for some of the variables and henceforth considering these variables as constants. Any of the variables may be chosen but all are not equally suitable. The best results from empirical equations are obtained when those variables which are chosen for constants may be given a wide range of values without seriously affecting the accuracy of the resulting design. In transformer design the core dimensions are probably those allowing the greatest variation.

There are two types of transformers, the core type and the shell type; named after the shape of their magnetic circuits. Core type of transformers have an iron circuit shaped as shown in Fig. 1A and shell type of transformers have an iron circuit shaped as shown in Fig. 1B. The present day tendency seems to be to use the shell type of core for small transformers in preference to the core type, probably because the leakage flux is less and the problem of mounting the transformer in relation to the other instruments in the circuit is less difficult.

Referring to Fig. 1, we may derive a general expression for the volume of the core in terms of the three principal dimensions. A square cross section of core has been assumed in both cases in order to gain simplicity, but having found that a certain cross section of core is necessary, the dimensions to give this cross section may be varied through a wide range of values without seriously affecting the accuracy of the design. It is generally not considered good practice to stack the laminations more than 1.75 times the

width of stock since the mechanical strength of the assembly becomes poor and the product grotesque looking. The general dimensions assumed in the shell type of core are approached in practice but are slightly modified in order to conserve material or gain mechanical strength. By proper choice of dimensions it is thus possible to make the general expressions for the volume of iron, in terms of the width of material, the same for both core and shell types of transformers. In order to still further simplify the expression for volume, a number of standard laminations from different manufacturers were measured and the values of the dimensions A and B obtained as multiples of the core width C. These values were then substituted in the formula and the resultant volume expressed as a function of the dimension C. The laminations measured, both core and shell type, were found to give results varying from 8.4 to 13 times the cube of the width of stock and an average value was chosen resulting in the equation:

$$\text{Volume} = 11 C^3$$

The next step in our development is to make reasonable assumptions regarding the losses to be expected in transformers of certain sizes. Transformers as a general rule are one of the most efficient pieces of apparatus made, having efficiencies in the neighborhood of 98 per cent or even more, but such a great efficiency in small transformers, apart from being unnecessary, is prohibitive from a cost consideration. The writer has found the following range of efficiencies to be fairly representative of what may be found in the field. Transformers less than 50 watts, 82% efficiency, from 50 to 100 watts, 87% efficiency, and transformers from 100 to 500

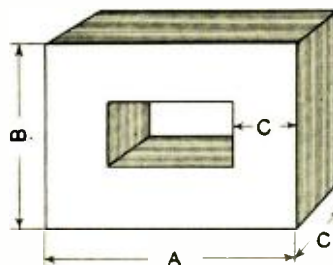

FIG. 1A

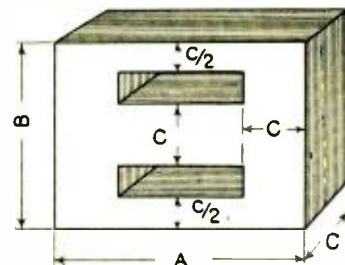

FIG. 1B

$$\begin{aligned} \text{VOLUME} &= ABC - [(A-2C)(B-2C)C] \\ &= ABC - (ABC - 2BC^2 - 2AC^2 + 4C^3) \\ &= 2AC^2 + 2BC^2 - 4C^3 \end{aligned}$$

Representative sketches delineating the function of the formula for deriving core volume.

\* Engineering Dept., Briggs & Stratton Corp.

watts, 92% efficiency. This does not mean that there may not be found small transformers of greater efficiency but rather that the general run of transformers used in the radio industry have about this general range. The losses may then be split up somewhat as follows:

- 0 to 50 watts.....10% core loss
- 50 to 100 watts..... 7% core loss
- 100 to 500 watts..... 5% core loss

**Flux Density**

It is now necessary to make a third assumption, namely the flux density at which it is desired to operate the transformer. Although anything from 30,000 to 70,000 lines per square inch may be found in practice a good average value seems to be 64,500 lines per square inch. From tables found in various handbooks and from manufacturers' data the losses at this flux density, in common transformer steels varies from one to two watts per

pound, although it may be considerably lower in the special high silicon sheets. The writer has chosen to consider the loss as 1.44 watts per pound and the density of the iron as 7.7. From these considerations we can arrive at the loss as 0.4 watts per cubic inch of iron. Knowing the rating for which we wish to design the transformer we have thus a measure of the volume of iron needed in order that our losses shall not exceed the above chosen value. Equating this volume to the above obtained volume for the core, in terms of the width of core material, we may obtain a relation between the watts rating and the area of cross section of the core. Since the principal losses in a transformer core are due to hysteresis we obtain the best design constant by considering the core area as a function of the square root of the watts rating.

To give an example of the method of procedure:

Given a transformer of 50 watts

rating. Our preliminary assumptions call for a core loss of 7% or 3.5 watts.

$$\text{Volume of iron} = \frac{3.5}{0.4} = 8.75 \text{ cu. in.}$$

$$\text{Therefore } 11C^3 = 8.75 \text{ cu. in.}$$

$$C = 0.926 \text{ in.}$$

$$\text{Area } C^2 = 0.857 \text{ sq. in.}$$

$$\text{Desired expression Area} = \text{Constant } \sqrt{\text{Watts}}$$

$$\text{Constant} = \frac{\text{Area}}{\sqrt{\text{Watts}}} = \frac{0.857}{\sqrt{50}} = 10.12$$

This constant is the thing we are after, and it will be found that its value will vary with the different watts rating and also with the different assumed efficiencies. It has consequently been necessary to assume an average value for each of the three design ranges and the values given below are correct within a few percent for the range used. A single constant might be assumed to cover the entire range but the result would be that for transformers of small rating the design would be rather generous and for transformers in excess of 200 watts too scrumpy. It must be borne in mind that in the development of these design constants the primary purpose has not been good, but rather economical design as dictated by the demands of the present market. The constants chosen were as follows:

$$0 \text{ to } 50 \text{ watts} \dots \text{Area} = 0.140 \sqrt{\text{Watts}}$$

$$50 \text{ to } 100 \text{ watts} \dots \text{Area} = 0.129 \sqrt{\text{Watts}}$$

$$100 \text{ to } 500 \text{ watts} \dots \text{Area} = 0.125 \sqrt{\text{Watts}}$$

In order to facilitate the use of the above data it has been plotted in the form of a nomographic chart as shown in Fig. 2. It is merely necessary to lay a straightedge from the proper point on the staff of design range to the desired watts on the watts staff and the intersection with the area staff will give the required area. The design constants have been so chosen that this is the net area needed. For instance, should the area needed be 0.72 square inches and the width of material be one inch, the net piling should then be 0.72 inches. To obtain the gross or actual physical piling this should be multiplied by 1.1 or 10% added, giving 0.79 inches. Inasmuch as cores are usually piled to some definite fraction of an inch, the piling in this case would probably be 0.875 inches or 7/8".

**Primary Turns**

Having found the core area, it is now necessary to determine the correct number of turns to be used in the primary of the transformer. This may be derived from the standard transformer equation;

$$E = 4.44 N f \phi_m 10^{-8}$$

$$= 4.44 N f A B_m 10^{-8}$$

or where

N is the number of primary turns

f is the frequency, usually 60 cycles

$\phi_m$  is the maximum flux

A is the net area in square inches

$B_m$  is the maximum flux density in lines per sq. inch

**.. EXAMPLE ..**  
**50 WATT, 110 VOLTS**  
**CORE; 1.0 SQUARE IN., NET.**  
**PRIMARY; 648 TURNS.**

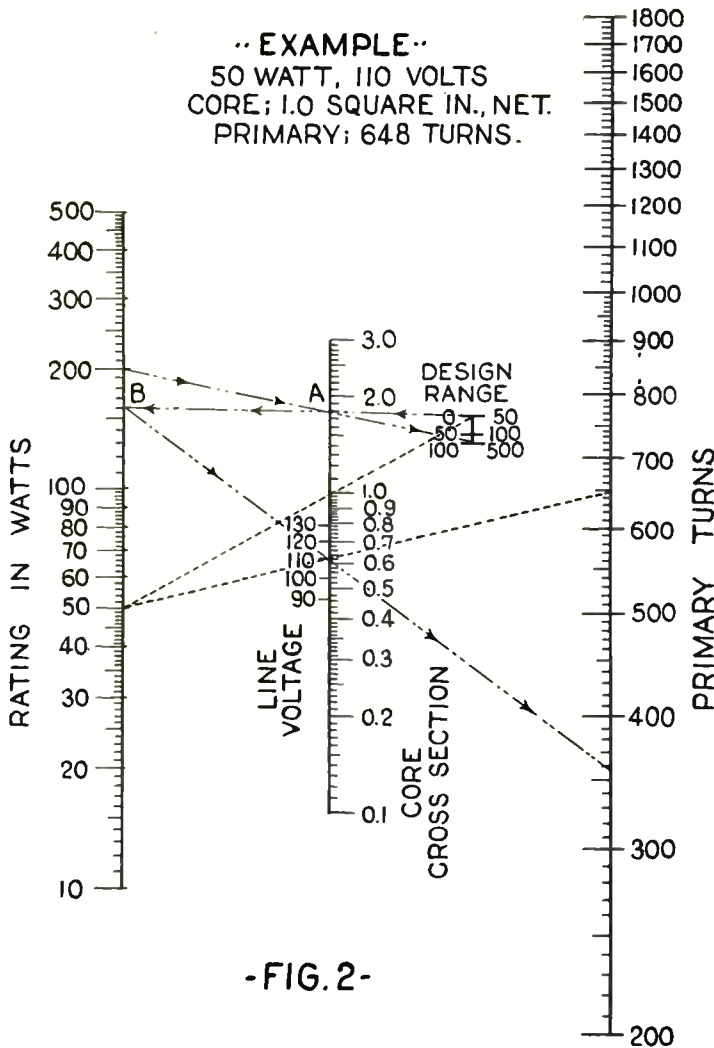

**- FIG. 2 -**

Nomographic chart for determining constants for small power transformers up to 500 watts.

From our previous work we are now in a position to substitute in the above expression the equivalent for the net area in terms of the watts for which the transformer is designed, giving:

$$N = \frac{5.8 E}{K \sqrt{\text{Watts}}}$$

Where the factor K is dependent on the range of watts for which we are designing, and E is the line voltage at which we wish to operate. Substituting the proper value for K we get:

$$N = \frac{41.4 E}{\sqrt{\text{Watts}}} \text{ zero to fifty watts}$$

$$N = \frac{45.0 E}{\sqrt{\text{Watts}}} \text{ fifty to one hundred watts}$$

$$N = \frac{46.4 E}{\sqrt{\text{Watts}}} \text{ one hundred to five hundred watts}$$

It will be seen that if we refer to the zero to fifty watt range the number of turns are only changed by some nine to twelve percent by the different correction factors. Referring again to Fig. 2, the correct number of turns are found by laying a straightedge from the proper watts on the watt staff, through the proper line voltage on the line voltage staff and the intersection with the turns staff will give the correct number of primary turns.

A definite example is given in the case of a fifty watt transformer. It will be seen that by following the dotted lines that the correct net core area would be 1.0 square inches and the correct number of primary turns 648. As has been explained, the net core cross section must be multiplied by a stacking factor to obtain the gross core area, and this gives us 1.1 square inches. The piling to be recommended for a core one inch wide would be 1-1/8 inches. The staff of turns is laid off to be correct for the design range from zero to fifty watts since this is the range most commonly used. It is however, possible to graphically correct for the variation of the design constant in determining the number of turns. This may be done as follows: A second example is shown giving the method of procedure in obtaining the design constants for a 200 watt transformer. This transformer lies in the design range from 100 to 500 watts, so a straightedge is laid from 200 watts to the proper design range. Following the dash dot line it will be seen that this intersects the area staff at "A" giving the net area as 1.78 square inches. This point is marked "A". Since the turn staff is designed

for the zero to fifty watt range, we must now lay the straightedge from the zero to fifty mark on the design range staff through the point "A" and note its intersection with the watts staff. This will give us a correct value for the watts, notably 162 watts. From this point, marked "B", we lay the straightedge through the desired line volts, in this case 110 volts, and find the correct number of primary turns at the intersection with the turns staff. This gives 358 turns for the primary of the transformer.

Due to the fact that the assumed efficiencies are different, the design constants differ, and it is possible to obtain three designs for any given transformer but with different efficiencies according to the design range used. This somewhat extends the usefulness of the chart but at the same time complicates matters a bit and is only pointed out to emphasize the fact that the three design ranges are not intended to be overlapping.

Having found the number of primary turns it is a simple matter to determine the number of secondary turns by multiplying by the voltage ratio desired and adding ten percent to allow for voltage drop due to regulation.

## Self-Adjusting Ballasting Rheostats

Covering the theory and operation of automatic voltage regulators

By S. R. Ruttenberg\*

A 10 to 20% voltage variation is not serious in the operation of motors, lamps or toasters. But on the other hand, there are devices which require more exact regulation—and a radio set is one of them.

The early regulators used in radio

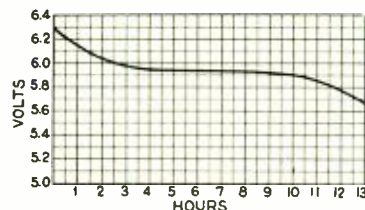

Fig. 1. Typical voltage curve of a six volt lead sulphuric acid storage battery.

were the ordinary hand rheostats. These were quite satisfactory for experienced operators and in fact necessary with a good many of the more critical tubes of former years. With the introduction of the much improved radio tubes and the interest of the general public in radio, automatic control became a necessity.

### Necessity for Voltage Regulators

Let us first look into the reason for

voltage regulators and then pursue the various types which might be used. All forms of batteries, wet or dry, vary in voltage with the amount of current drained from them and the time of discharge. The lead sulphuric acid storage battery has a smaller voltage variation than most other types. A typical characteristic curve of the former is shown in Fig. 1. You will note that the voltage of even this battery varies a great deal. Dry cells decrease in voltage much more rapidly with use and age.

A vacuum tube is a comparatively sensitive and delicate instrument. The filament is usually made of a very fine wire and designed to operate between narrow limits. Any variation, either above or below, from the standard specifications materially affects the life and efficiency of the tube. A regulator of some kind is therefore imperative.

### Ballast Wire Regulators

When you look through the various types of automatic voltage regulators offered by the whole electrical industry, you will find that there are extremely few which are suitable for radio work. It is, of course, too expensive and bulky to use sensitive relays. The only regulator that can really be used is the ballast wire type, but this does not include a great many of the so-called "ballasts" which are

nothing but a piece of ordinary resistance wire. A ballasting wire is a very interesting and rather technical device. It operates on the combined peculiarly rapid change in electrical resistance of certain metals, and the rapid decrease in heat conductivity of certain gases with temperature.

First we will describe what a ballast wire does and then how it works. Suppose we connected one in series with a battery rheostat and ammeter, and connect a voltmeter across the ballast wire. Now, let us increase the voltage across the ballast wire from 0 to about 2.5 volts (Fig. 2). At first the ballast wire acts like a fixed resistance. But after the current reaches about .2 amperes, the resistance increases rapidly as shown by the required voltage. At

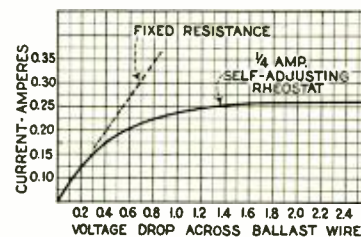

Fig. 2. Voltage-current curves of a fixed resistance and a ballasting wire resistance.

\* Chief Engineer, Radiall Company.

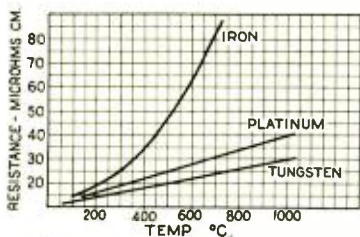

Fig. 3. Resistance - temperature characteristics of three important metals.

about .25 amperes, the resistance or voltage across the ballast wire increases considerably with very little change in current. It is this flat part of the curve which is useful in keeping the current constant in any desired circuit. It must be understood, of course, that a ballast wire resistance must be designed to have its flat portion or ballasting range at practically any desired current. This can be done by changing the dimensions of the filament or the specification of the surrounding gas.

**Characteristics of Various Metals and Gases**

Let us look for a moment into the effect of various changes in the construction of a true ballasting resistance. Fig. 3 shows how several typical metals change in resistance with temperature. You will note that iron has a very rapid change in resistance with temperature. This property changes a great deal with the purity of the iron used. Extremely small amounts of impurities will have a detrimental effect on the curve. Even impurities of less than 1/10 of 1% will considerably decrease the slope of the curve.

Now let us look into the question of gases. Most gases are rather poor conductors of heat. The lighter gases are the better heat conductors. Hy-

drogen is one of the best. The heat conductivity of hydrogen, however, decreases very rapidly with temperature. This is shown in Fig. 4. As would be expected, the conductivity also changes very rapidly with pressure (Fig. 5). The change of conductivity with pressure and temperature are two extremely important factors which must be kept in mind in the design of a ballast tube.

**Principle of Operation**

Let us now go back to the experiment as shown in Fig. 2 and see how the ballast actually works. As the current increases, the filament heats up and increases in resistance. This in turn heats the surrounding gas, which causes a decrease in its conductivity. Now a further increase in current causes the wire to heat up more, increasing its temperature still further. The surrounding gas is now a poorer conductor. Less heat is taken

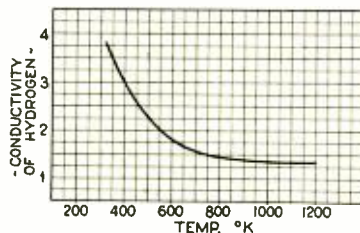

Fig. 4. Heat conductivity curve of hydrogen.

away from the wire. It therefore increases in temperature and resistance much more than the first increase in current. In other words, above approximately 400°C, the wire increases in resistance for two reasons. First, because of its increase in resistance due to the heating effect of the current. Secondly, because of the heating effect caused by the decrease in heat conductivity of the surrounding gas.

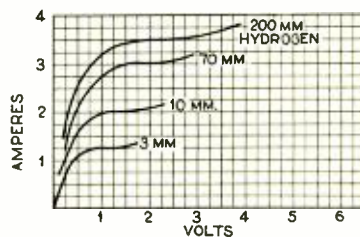

Fig. 5. Curves showing the change in the conductivity of hydrogen under varying pressure.

This dual action is further complicated by the increase in pressure within the tube due to the increase in temperature of the gas. Increased pressure causes the filament to carry a higher current as shown in Fig. 5.

From the above discussion we find that the ballast resistance is composed of two fundamental parts. One, a filament which increases rapidly in resistance with temperature such as pure iron and one or two alloys. Secondly, the filament must be hermetically sealed into a glass tube surrounded by an inert gas. This, therefore, calls for a construction similar to an incandescent lamp. All seals through the glass must be made with wire which has the same coefficient of expansion as the lead glass used. The machinery used in the manufacture of a ballast is similar to that used in the manufacture of lamps. It would be beyond the scope of this paper to include a description of the machinery used, since this is a study in itself.

The principle of ballasts can be applied to many commercial problems outside of radio. In fact it is very surprising that it has not had a wider use in ordinary commercial work. The reason for this is probably the lack of knowledge of the principle of ballasts. Radio has paved the way for a general introduction; the future will, no doubt, see its wider application.

# What Governs the Power Handling Capacity of an Amplifier?

*Some interesting facts regarding power amplification*

By A. R. Wilson\*

AS the novelty of radio has gradually disappeared, and more interest is taken in it purely as an instrument to reproduce with fidelity both music and speech, the listener and engineer have given more and more thought to the tonal qualities of the broadcast receiver. The vast radio audience today is first of all concerned in how well it can hear. How far is a secondary consideration.

It would seem to the average listener

inexperienced in radio experimentation that all that is necessary to increase volume is the addition of a stage or two of audio frequency amplification to his existing equipment. This is true to a certain extent, but as we are interested only in *Quality Volume*, the design of the apparatus used in the "stage or two" of audio frequency amplification is of great importance.

A speaker, which does the actual reproducing of sound, is an energy operated device and as the energy is derived from the last audio tube alone, the undistorted volume obtainable

from a speaker is wholly dependent upon the energy output of this tube and no other. The energy is measured in milliwatts and the following table gives the power output of the tubes now in common use, with the plate voltage necessary to obtain full output:

Tubes	Undistorted Output	Plate Voltage
120	110	135
226	160	180
112	195	157
171	700	180
210	1500	425

\* Engineering Dept., General Radio Co.

### Permissible Grid Swing

In order to secure the maximum power output that a tube is capable of delivering, it is necessary that a sufficiently large voltage be placed on the grid of the tube to operate at its maximum output. At the same time certain conditions, however, must be satisfied to prevent distortion in the tube itself. First, the grid must not be allowed to become sufficiently positive to draw any appreciable amount of grid current, and second, the plate current must at no portion of the cycle be allowed to fall so low that distortion be caused by curvature of the plate current curve. The input voltage which may be applied safely to a tube without causing grid distortion is fairly well indicated by the grid bias voltage. Actually the effective grid swing permissible in volts R. M. S. is  $\sqrt{2}$  or .707 times the grid bias.

### Frequency and Waveform Distortion

The solution of the problem of Quality Volume is threefold, embracing tubes, transformers and speakers wherein distortion of various sorts and causes tends to develop. It may be well to state here that there are two apparent forms of distortion to guard against in any audio amplifier: frequency distortion and waveform distortion. Frequency distortion, which really is not distortion at all, but the relative differences in the amplification of different frequencies is caused by one of two things, either a coupling device that is not capable of even performance over the audio range, or the improper matching of impedances of the different circuits. It is extremely important from a frequency viewpoint that the impedances of the various circuits bear a definite relation to each other. To secure a maximum transfer of voltage from one circuit to another (and we are interested in this respect only in voltage and not in energy), the impedance of the transformer primary should be at least two or three times that of the tube circuit at the lowest frequency which we wish to amplify. Waveform distortion in the amplifier itself is caused by either an overloaded tube or saturation of the core of the audio transformers. With the present-day standards of transformers, however, the latter from a practical standpoint may be entirely disregarded. Obviously the remedy for an overloaded tube is the reduction of the input signal or the increase of grid bias and plate voltage, thus permitting the tube to be worked on the straight portion of its grid voltage plate current curve.

Assuming one to have an audio amplifier and tubes of the standards of two or three years ago, the most radical improvement in quality would be brought about by the replacement of the last audio tube by one of the new power tubes, such as the 171 or 210. This would increase the power handling capacity of the amplifier 50 to 100 times and this power handling capacity of an amplifier is something that is not

very well understood by the average man, yet it is extremely important if faithful reproduction is to be obtained. In order to produce the same intensity to the ear, say at 60 cycles, many times as much power is required as at 1000 cycles. A somewhat disconnected yet fitting illustration would be the comparison between a Tuba player and a Cornet player in a brass band. The Tuba player expends much more energy, but to the ear the Cornet is louder. In the case of the loudspeaker far greater power is needed to supply the energy than was heretofore thought necessary to reproduce bass notes properly, and it is even very doubtful if the tubes on the market today are capable of supplying to the speaker enough energy to reproduce these low frequencies with the same intensity as the higher frequencies, unless a 50 or 100 watt power tube is used. This would require a type of plate supply device, which from an economic point of view, would be entirely out of the question.

While it would seem that increasing the energy output of an amplifier would result in extremely loud reproduction, this is not necessarily true. A loud sound may be doubled in intensity—that is, the energy doubled—and the ear may hardly detect the change. This fact will explain in some measure why many people are not able to note the difference in the volume produced by a 171 and 210 tube, although the maximum output of the 210 is double that of the 171. Everything else being equal, the reproduction, when using the 210, should appear much better on the lower frequencies—actually it is about the same, because the lower plate impedance of the 171 permits a greater transfer of energy from tube to speaker at these frequencies.

### Power Handling Capacity Limited

The power handling capacity of an amplifier using present day transformers is more or less limited by that of the tubes used, since the largest possible portion of the negative side of the grid voltage plate current curve is available for the actual plate voltage used. While resistance or straight impedance coupled amplifiers are better from a purely frequency standpoint, the power handling capacity is decidedly limited, as there is a certain rectifying action of a strong signal caused by the time action of the grid condenser and leak, and their purpose, even from a frequency standpoint, is often defeated by the improper use of tubes. A man will quite frequently pay from \$10.00 to \$20.00 for an impedance coupled amplifier only to use a 201-A tube in the last stage, and it is very doubtful if the improvement in quality in this case is even noticeable to the ear. This is only another example of insufficient power required to reproduce bass notes, although the frequency characteristic of an impedance or resistance coupled amplifier is essentially a straight line from 30 cycles

upward. A very interesting laboratory experiment along these lines proved that where a pure 60 cycle note from a vacuum tube oscillator was fed directly into the grid of a 210 tube, the full output of this tube did not produce even an audible sound at this frequency. All low frequencies are not entirely lost, however, as their harmonics are reproduced, but with such less intensity, and the fundamental pitch is usually obtained by the beat note of a second and third harmonic.

In reviewing the subject of power handling capacity of an amplifier, there are many other more important phases to consider than the particular method of coupling (transformer, resistance, or impedance). It is a well-known fact that no better quality can be expected than is radiated from a broadcasting station or that can be faithfully reproduced by the loudspeaker—regardless of what coupling method or combination of methods may be used.

Bearing in mind that the frequency range of the better broadcasting stations is something like 80 cycles to 5000 cycles, and the better loudspeakers cut off at 80 cycles at the lower end and 7000 cycles at the upper end, also remembering that the better transformers in use today are capable of even amplification between 60 cycles and 6000 cycles, the selection of the amplifier tubes and proper operation for maximum efficiency of those tubes should receive more consideration than is generally given to amplifier tubes, particularly the last stage tube from which the loudspeaker is operated.

### SAFETY DEVICE FOR OSCILLATORS

In order to prevent the grid or plate voltages of a power oscillator from reaching an unduly high value, or the grid current from suddenly reversing in direction, and thus causing serious damage, a method of shunting the danger points with a two element tube has been developed. Referring to the diagram, the direction of the grid

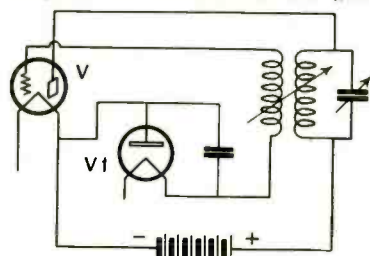

Circuit of the safety device for power oscillators.

current is liable to be reversed if the secondary emission from the grid should at any time exceed the primary emission. To prevent this contingency the two element tube  $V_2$  is inserted in the grid lead as shown. Any attempt at reversal is now frustrated by the unilateral conductivity of the safety tube  $V_2$ .—(Wireless World.)

# A New A.C. Tube

*Incorporating numerous features which make it adaptable to standard receivers*

*By Zeh Bouck\**

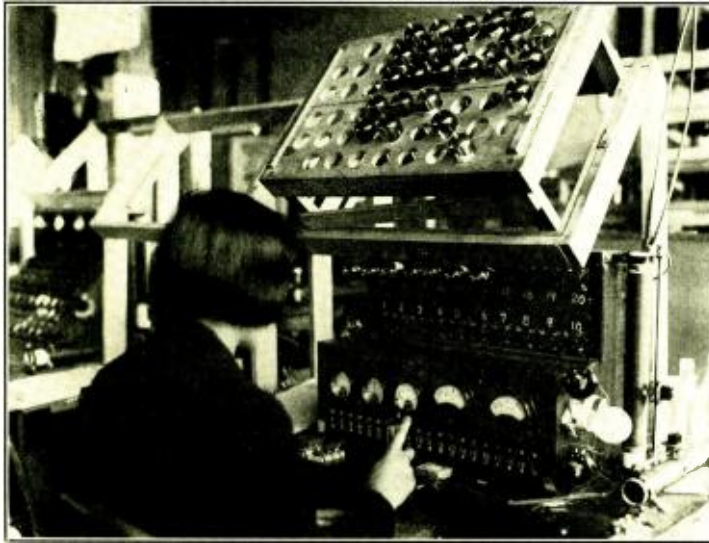

Special testing equipment for A.C. tubes. Each tube is carefully tested for hum, by both visual and aural tests.

WHILE alternating current filament tubes are the solution to many of the service man's problems, they are not altogether emancipated from obligatory encumbrances. The use of alternating current tubes immediately frees the service man from details associated with storage batteries, dry batteries, trickle charges, hydrometers and the usual intricacies of battery operation. But the service man's obligations with A.C. operation, while hardly commensurate with the difficulties encountered with battery operation, are by no means negligible. It would seem that the designers of many A.C. tubes neglect the fact that the burden of their operation necessarily falls upon the individual expert and the servicing department of radio retailers.

The problems of the service man have been second only in consideration to the technical aspects of an efficient A.C. tube in the design of the new A.C. amplifier, detector and power tubes, the mechanical and electrical characteristics of which solve many of his problems without adding thereto. All three types of tubes are of the indirectly heated cathode variety, which facilitates a consistency in the filament wiring, eliminating the necessity of unusual grid returns, potentiometers, etc., and providing an assurance against hum far better than the guarantee of raw A.C. amplifying tubes.

The tubes, as will be noticed in the accompanying photograph, are mounted on a standard four prong base, fitting the conventional UX socket. This arrangement is made possible by connecting one side of the heater to the cathode. It is, therefore, possible to adapt standard receivers to the use of these tubes without changing the sockets or running overhead wires.

### High Potential Filament

Several electrical characteristics of this tube indicates a departure from conventional practice. The most radical of these is the adoption of a high potential, low current filament as contrasted with the usual reverse arrangement. High current, low voltage filaments have been popular in all previous types of A.C. tubes due to the

idea that the hum factor could be lowered by reducing the electrostatic field set up by the potential across the filament, which increases proportionately with the filament potential. The new A.C. tube has been designed with an opposed principle in mind, namely, that the electromagnetic field, which increases in proportion to the current, is less readily shielded than the electrostatic field.

In indirectly heated cathode tubes, the shielding of the grid and plate elements is effected altogether by the cathode surrounding the heater filament. The shielding thus takes the form of a metal sheath surrounding the radiating element.

As Morecroft and Turner have pointed out in the *I.R.E. Proceedings* of August, 1925, this form of complete sheathing offers no impediment whatever to the expansion of an electromagnetic field. However, experimental evidence seems to indicate that a certain degree of electrostatic shielding is obtained in this way. It is, therefore, logical to design a heater filament operated from a rather high voltage and carrying a low current.

The present tube heater operates from a filament potential of 15 volts and passes a current of .35 ampere. Aside from the desirable electrical characteristics of such a filament, its design permits the operation of the tubes, connected in parallel, from a toy step-down transformer, such as the Ives, and which is readily available. Another item of interest to the service man.

The filament heater of the tube is of carbon, operating at a temperature considerably lower than that of the usual carbon incandescent light, thereby insuring exceptionally long life to the tubes. While the tubes on life test as yet show no indication of approaching the end of their usefulness, comparison of the filament consuming 4.5 watts to the candle power with a

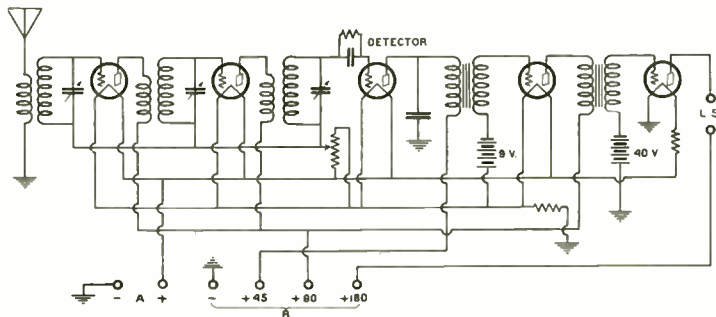

Fig. 1-A. A conventional five tube tuned R.F. receiver circuit which can be easily converted into an A.C. set, as shown in Fig. 1-B.

\* In Consultation, Arcturus Radio Company, Newark, New Jersey.

filament of the usual carbon lamp consuming 3.5 watts per candle power would indicate a theoretical life well in excess of 1,000 hours.

The tube also departs from conventional practice in the elimination of any insulating material between the heater and the cathode. It is extremely difficult to eliminate gases from such insulating material due to the fact that during evacuation they are heated only to moderate temperatures by conduction and radiation and are under no bombardment.

The valvular characteristics of the detector and amplifier tubes are as follows: Plate impedance at 90 volts, 9,500 ohms; mutual conductance 1,100, amplification factor 10.5; plate, grid capacity 10 mmf.

Power tubes have characteristics similar to the 171 amplifier.

### Adaptation of Receivers

As is implied by the parallelity of filaments and the use of standard sockets, the adaptation of receivers to A.C. operation employing these tubes, is greatly facilitated. While the alteration of different circuits necessarily holds problems of varying



One of the A.C. tubes devoid of its glass enclosure. The heater element can be seen protruding from the top. The usual fifth prong common to A.C. tubes of this type, is eliminated by connecting the heater element to the negative leg of the filament. Receivers using these tubes can be operated from D.C. if desired without making circuit changes.

nature and degree of complexity, a consistent application of intelligent generalities should insure a success in practically all instances.

### Rewiring Receivers for A.C. Operation

Many receivers require only one or two alterations to adapt them to operation with these tubes. The accompanying diagram indicates the principles of the alteration. Fig. 1A shows a conventional five tube tuned r.f. receiver, stabilized and volume controlled by returning the r.f. grids through a potentiometer. Fig. 1B shows this circuit worked over for A.C. operation with the four prong A.C. tubes.

While the diagram speaks for itself, it is desirable to stress the salient points associated with the change. All

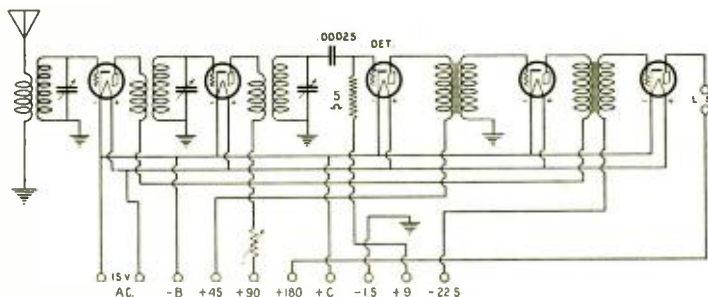

Fig. 1-B. The circuit of Fig. 1-A slightly altered to make it adaptable to A.C. operation, using the tubes described in this article.

grounds must be eliminated from the filament circuit. The filaments are wired in parallel. While it is desirable though not essential that the filament wiring be twisted or laced, the wires must be close together. All grid returns excepting the power tube are grounded, and the necessary biases secured by connecting the bias potential to ground and the remaining side of the battery to the minus filament post or posts on the tube or tubes to be biased.

The detector tube grid is returned directly to the cathode (filament plus post) and a positive bias of 9 volts is applied to the grid through a five megohm leak. A grid condenser is used, in the conventional manner, detection still being effected by grid current rectification.

The power tube is biased in the same way, only the polarity is re-

versed and a negative potential of 22.5 volts is applied to the grid with a plate voltage of 180.

### Change Volume Control When Necessary

It is impracticable to use a rheostat with A. C. tubes. Also any volume control, such as a potentiometer, which functions by varying the grid bias to the r. f. tubes, will introduce hum on certain adjustments.

Efficient control of regeneration and volume can be effected by placing a variable 0 to 50,000 ohm resistor in series with the plate potential to the r. f. amplifier or across an r. f. secondary.

The writer will be glad to assist interested readers desirous of rewiring particular receivers for A. C. operation.

Table showing current carrying capacity and allowable voltage that can be applied to resistors of 3, 10, 25 and 50 watts capacity (Courtesy of H. G. Richter, Chief Engineer, Electrad, Inc.)

WATTS	3		10		25		50	
	Amperes	Volts	Amperes	Volts	Amperes	Volts	Amperes	Volts
Resistance								
1	1.730	1.73	3.163	3.163	5.000	5.000	7.070	7.070
1.5	1.410	2.115	2.572	3.858	4.083	6.124	5.773	8.659
2	1.224	2.448	2.235	4.470	3.420	6.840	5.000	10.000
2.5	1.097	2.742	2.000	5.100	3.154	7.885	4.474	11.185
3	1.000	3.000	1.835	5.505	2.939	8.817	4.083	12.249
3.5	.970	3.395	1.689	5.911	2.672	9.342	3.778	13.223
4	.866	3.44	1.579	6.316	2.500	10.000	3.420	13.080
5	.774	3.87	1.414	7.070	2.236	11.160	3.154	15.770
7.5	.632	4.734	1.154	8.655	1.826	13.695	2.581	19.357
10	.547	5.470	1.000	10.000	1.598	15.980	2.236	22.360
15	.447	6.705	.816	12.240	1.298	19.470	1.829	27.435
20	.389	7.78	.708	14.160	1.119	22.380	1.598	31.960
25	.346	8.65	.632	15.800	1.000	25.000	1.414	35.350
30	.316	9.48	.577	17.310	.912	27.360	1.298	38.940
35	.292	10.220	.534	18.690	.844	29.540	1.197	41.895
40	.274	10.960	.500	20.000	.791	31.610	1.119	44.780
50	.245	12.250	.447	22.350	.700	35.000	1.000	50.000
75	.200	15.000	.365	27.375	.574	43.050	.816	61.350
100	.173	17.300	.316	31.600	.500	50.000	.700	70.000
150	.141	21.150	.258	38.700	.432	61.800	.577	86.550
200	.122	24.400	.223	44.600	.353	70.600	.500	100.000
250	.109	27.250	.200	50.000	.316	79.000	.447	111.750
300	.100	30.000	.182	54.000	.294	87.800	.432	129.600
350	.087	33.250	.169	59.150	.269	94.150	.378	132.300
400	.086	34.400	.158	63.200	.250	100.000	.353	141.200
500	.077	38.500	.141	70.500	.224	112.000	.316	158.000
750	.063	46.650	.115	86.250	.186	139.500	.257	192.650
1000	.054	54.000	.100	100.000	.158	158.000	.220	220.000
1500	.044	66.000	.081	121.500	.129	193.500	.182	273.000
2000	.038	76.000	.070	140.000	.112	224.000	.159	318.000
2500	.034	85.500	.063	157.000	.100	250.000	.141	352.500
3000	.031	93.000	.057	174.000	.091	273.000	.129	387.000
3500	.030	105.000	.053	185.500	.085	297.500	.119	416.500
4000	.027	108.000	.050	200.000	.079	316.000	.111	444.000
5000	.024	120.000	.044	220.000	.071	355.000	.100	500.000
7500	.020	150.000	.036	270.000	.058	445.000	.081	607.500
10000	.017	170.000	.031	310.000	.050	500.000	.070	700.000
15000	.014	210.000	.025	375.000	.043	645.000	.057	855.000
20000	.012	240.000	.022	440.000	.035	700.000	.050	1000.000
25000	.010	265.000	.020	500.000	.031	775.000	.044	1100.000
30000	.009	300.000	.017	510.000	.029	870.000	.043	1290.000
35000	.009	315.000	.015	525.000	.026	910.000	.037	1290.500
40000	.008	320.000	.014	560.000	.025	1000.000	.035	1400.000
50000	.007	350.000	.013	650.000	.022	1100.000	.031	1550.000
75000	.006	450.000	.011	825.000	.018	1350.000	.025	1875.000
100000	.005	540.000	.010	1000.000	.015	1500.000	.022	2200.000

# A New Tuned Power Amplifier

*A combination of tuned double impedance and push-pull amplification of a decidedly flexible nature.*

By *E. E. Hiler<sup>1</sup>* and *R. W. Cotton<sup>2</sup>*

This new system of amplification has many points to its credit. The tuned push-pull output stage can be adjusted to meet the pleasure of the individual ear. Furthermore, super-power amplification can be had, if desired, at small expense, as any tube up to and including a fifty watt tube can be used in the push-pull stage, matched against a 201-A.—EDITOR.

WITH the advent of popular priced power tubes and means for supplying the high voltage necessary for their operation the old reliable method for obtaining large undistorted power output by means of the push-pull arrangement has been temporarily overlooked by the enthusiasts of the high voltage amplifier. This is due largely to the fact that the current supply devices would not handle two power tubes at once and also due to the expense necessary for the upkeep of two large tubes,

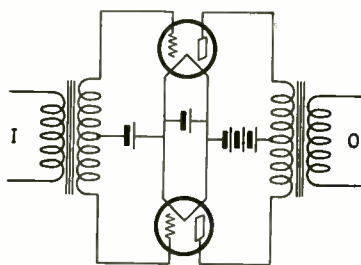

**- PUSH-PULL AMPLIFIER -**

Fig. 1. Schematic diagram of standard transformer coupled push-pull amplifier.

We admit that the original push-pull amplifier was a big step ahead and certainly worth the money, if it was well made; but push-pull amplification received a good deal of discredit because of the inferior apparatus placed on the market by some manufacturers, and also because of a lack of knowledge concerning the system. This, coupled with the fact that since then there have become available fine power tubes, improved A. F. transformers, impedances, etc., helped to shove the push-pull amplifier into the background.

The current supply devices on the market at the present time are fully capable of supplying sufficient current for the operation of two power tubes in a push-pull amplifier. Considering

the fact that improved design has worked its way into the manufacture of push-pull transformers and, something new, push-pull output impedances, one can safely assume the responsibility of an amplifier of this sort and without any qualms.

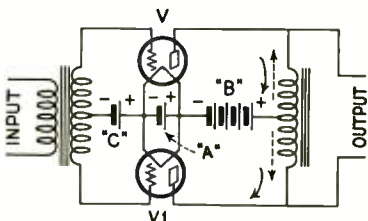

Fig. 2. The same as Fig. 1 with the exception that a push-pull impedance is employed in the output; a preferred method.

The push-pull units work very nicely into the new tuned power amplifier to be described, as the cores are made of high phase-angle iron and both primary and secondary windings have high impedances. The secondary winding of the push-pull transformer has an inductance in the vicinity of 800 henrys which provides a double frequency hump when tuned.

The tuned double impedance amplifier with its loudspeaker compensating hump at low frequencies has taxed the power tube to its limit, making it necessary to use lower impedance tubes for the last stage to overcome the loop characteristic distortion due to the low impedance of the loudspeaker at the low frequencies.

### Nature of Distortion

Distortion is of two kinds or dimensions. Frequency distortion, well known by its voltage amplification curve plotted against cycles per second, illustrates the one type. While amplitude distortion, commonly called "overloading," constitutes the other kind of distortion. Frequency distortion

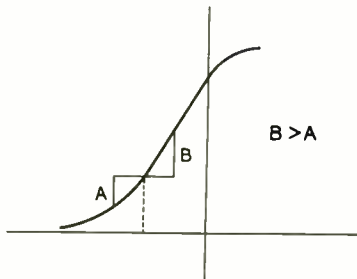

Fig. 3. Characteristic curve of vacuum tube.

can be subdivided into two kinds according to the cause. First, unequal amplification of frequencies due to resonant effects often extremely magnified by audio frequency regeneration. And secondly, variation in amplification due to the relation between the external impedance of the apparatus and the internal resistance of the tubes.

### Loop Characteristic Effects

Amplitude distortion can also be subdivided into two classes. Loop characteristic effects are placed first because they are first in their appearance after a certain volume is reached and it is caused by the changes occurring in the actual voltage drop across plate and filament. Its action is postponed by increasing the magnitude of

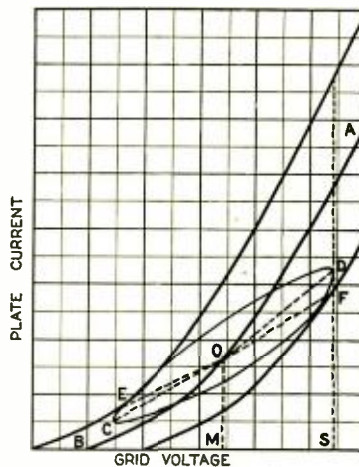

Fig. 4. Loop Characteristic curve of vacuum tube.

the external impedance of the apparatus, with relation to the internal impedance of the tubes and by increasing the voltage of the "B" supply with respect to the voltage changes of the signal. But its action is neutralized by 180° phase relations such as the push-pull arrangement. Second in appearance is the amplitude distortion caused by the grid swinging (with signal) beyond that potential known as "zero potential with respect to filament." This effect is also capable of further analysis. One component is the effect on the external impedance relation due to the grid to filament effective resistance being lowered from an indeterminately large value to an actual value. This happens because

<sup>1</sup>Hiler Audio Corporation.  
<sup>2</sup>Samson Electric Company.



whenever the grid is positive, electrons are attracted to it from the filament and current is said to pass from the grid to filament when there is a low D. C. resistance path for the current to travel through from filament to grid on the outside of the tube. Such a path is offered by the secondary of a transformer, the grid leak, or the grid choke. The other component is the temporary effect on the amplification factor of the tube caused by the sharp bends in the dynamic characteristics of the tube at the upper and lower extremes of the amplitude swing of the grid.

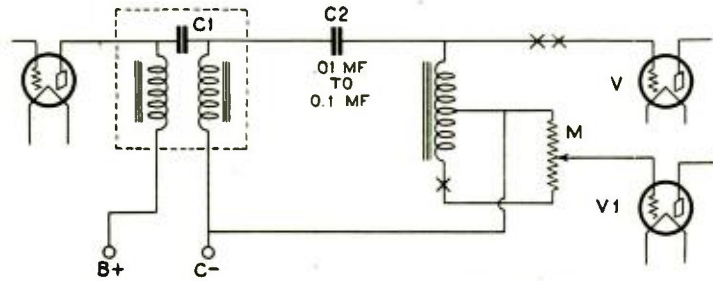

Fig. 6. Showing tuned push-pull output arranged for use with dissimilar tubes. Tube V, is matched to tube V1 by adjusting the input voltage through variation of M.

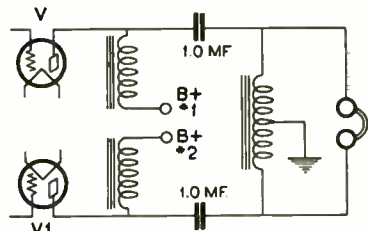

Fig. 8. Separate output filter chokes are required when different plate voltages are used on tubes V and V1

The dynamic characteristic of a tube, represented by the curve for plate current plotted against grid potential, is not a straight line, i.e. besides the sharp bend at the upper and lower end the curve is continually bending upwards. Providing the first component mentioned above can be minimized in its effect on the external impedance, the curve of the characteristic can be utilized to extend the upper extreme of the grid swing beyond the zero potential line. (See Fig. 3).

**Result of Combination**

A way in which to combine the automatic elimination of loop characteristic distortion offered by the push-pull arrangement and the compensating frequency characteristic of the tuned double impedance was sought but at the same time the limiting values of the power supply were observed and also the cost of additional

power tubes. The result of the work is a combination which is inexpensive and yet, at the same time, retains the advantages of both systems. It might be well at the start to review the general principles and reason for employing push-pull amplification for the last stage. This is well described in Van der Bijl's "The Thermionic Vacuum Tube" on page 261. Fig. 1 gives the usual circuit and Fig. 2 gives a recent modification. In Fig. 2 the

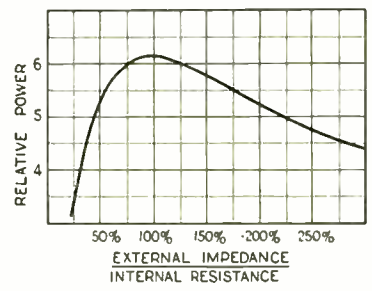

Fig. 5. Relative power curve showing change with variation of impedance.

dotted arrow shows the direction of the D. C. current and it is apparent that the saturation of the iron is prevented by the opposing fields of the current. The solid arrow represents the direction of the fundamentals of the signal at any one instant and at this same instant the dotted arrows also happen to represent the direction of certain disagreeable harmonics de-

veloped by the tubes. The reason for these harmonics is due to the curved characteristic of the tube (Fig. 3) and also to the loop characteristic (Fig. 4) as previously outlined. The higher the external impedance in relation to the internal impedance, the less these harmonics will be noticed, but the maximum "power" in the loudspeaker cannot be obtained with values necessary to make the harmonics negligible. (See Fig. 5.) The result is that with such a large external impedance the power necessary to operate the speaker would involve grid voltage swings beyond the proper working range of the tube. We can, therefore, see that the use of power tubes (with low impedance and high heat radiating qualities) and high voltages or constant resistance structures, as described in July RADIO ENGINEERING, are of value but are limited by the fact that they simply postpone the commencement of noticeable harmonic distortion.

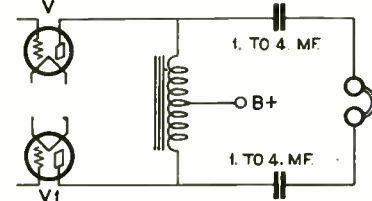

Fig. 7. The two coupling condensers insulate the loudspeaker from the high plate voltage.

**Double Tuning Effected**

The new input circuit for the push-pull double impedance combination is shown in Fig. 6. C1 is contained in the double impedance unit and C2 is connected between this unit and the split coil. Providing the inductance of this coil is properly chosen, double tuning can be obtained in this stage giving additional emphasis to the low frequencies which can now be handled with round, full tones. The modulator "M" is a 250,000 ohm resistance with adjustable contact and is used in case the two tubes do not have the same characteristics. It is only necessary to adjust one of the tubes to the other and the adjustment need not be changed unless the tubes are changed. At the point marked "X" can be inserted a "C" battery, with plus to grid,

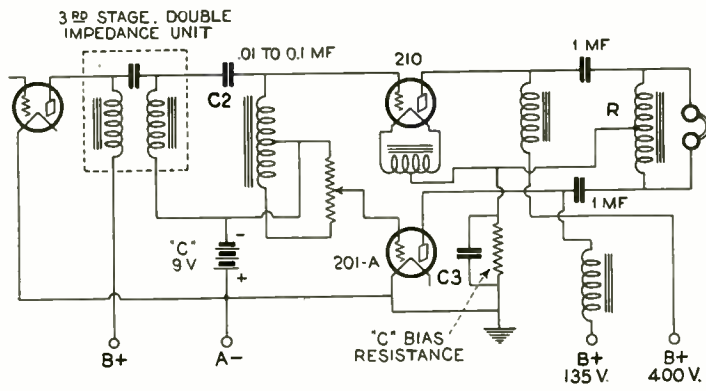

Fig. 9. Complete circuit arrangement for tuned push-pull output using a 210 power tube and a 201-A type tube. This unit produces remarkable results.

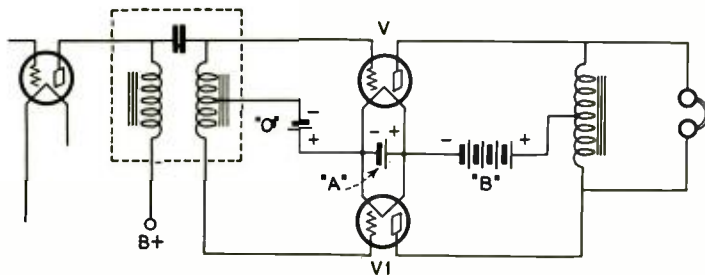

Fig. 10. A simplified arrangement which, while good, will not equal the circuit shown in Fig. 9. Tubes V and V1, must be of the same type

if it is necessary to use a different bias on the tube V. For instance tube "V" can be a 171 and tube "V1" a 201-A. As at "XX" the "C" battery for the 171 could be placed with the minus end to the grid and then a small "C" battery connected at the point marked C—. The idea of the modulator is that the distortion in tube "V1" could normally be greater than that in tube "V" under the conditions mentioned above. Therefore we cut the input to tube "V1" until the distortion factor is approximately the same as that of tube "V," and so institute a perfect balance between the two.

The output circuit is usually the same as that of Fig. 2 except when it is desired to insulate the speaker from the high voltage or to place different voltages on each of the tubes. The first case is illustrated by Fig. 7 and the second by Fig. 8.

Where a "C" bias resistance is used for the last tubes and the filaments are fed with raw A. C. the small hum usually present from such an arrange-

ment is also balanced out. Suppose, however, that instead of two 171 tubes with a common "C" bias resistance and filament A. C. supply and output circuit of Fig. 7, we had a 210 with 400 volts on the plate and its own "C" bias resistance and filament A. C. supply, on one side and a 201-A with 135 volts "B" and 9 volts "C" bias on the other. Then it would be necessary to put a 1 mfd. condenser across the "C" bias resistance and the circuit would resolve itself into that of Fig. 9.

Unless condenser C3 is used in this case, the A. C. in the loudspeaker return "R" would have to pass through the bias resistance to get to the filament of tube V1, or if R were connected direct to ground then the A. C. would have to pass the other way through the bias resistance to get to the filament of tube "V". The reason for not allowing the A. C. to go through the bias resistance is that the phase relation of the feed-back to the grids tends to kill the action of one tube and distort the signal on the other. Therefore, it is necessary to

use condenser C whenever the filaments of tube V and V1 are *not* connected from the same source of power. In the latter case the loudspeaker return "R" would go direct to the filaments of both tubes since they could be connected in parallel.

### Comparative Results

In conclusion, the simplest possible complete hook-up would be that of Fig. 10 but this would not provide for double tuning, proper balancing of tubes, flexibility of "B" voltages or insulation of loudspeaker. One amplifier built along these lines had a 201-A with 135 volts "B" balanced against a 50 watt tube with 1,200 volts on the plate. Another had a combination of two 201-A's with 135 volts "B" and when compared with a single 50 watt tube with 1,200 volts "B" it gave remarkable results. Even with a quick switchover arrangement you could not tell which set was working after having adjusted the humps in the 201-A set to offset the lower internal impedance of the 50 watt outfit. Compared to a single 210 with 400 volts on the plate the same pair of 201-A's was a considerable improvement. The outfit shown in Fig. 9 gives about as much undistorted volume as anyone could ever want. Recently, two 210's with 400 volts on each was used in this arrangement for an outdoor audio broadcast of the Dempsey-Sharkey fight using as a loudspeaker only one 18 inch Western Electric cone and one RCA Model 100 cone. The unusually large crowd had no difficulty at all in hearing the entire broadcast.

## Nema Defines Radio Terms

**T**O quicken progress in radio various terms have been accurately defined by the standard-making body of the National Electrical Manufacturers Association, among which is a recent definition covering distortion. This is defined as "a change in wave form as in passing through a circuit or transmission medium. A wave form may be distorted by (a) the presence in the output of components having frequencies not present in the original wave due to circuit elements having non-linear characteristics; (b) a change in the relative amplitude of the component frequencies due to variation in transmission efficiency over the frequency range involved; (c) a change in the relative phase of the component frequencies. Two or more of these forms of distortion may exist simultaneously."

### Fading

Fading is defined in the NEMA standards as the variation of the signal intensity received at a given

location from a radio transmitting station as a result of changes in the transmission path.

### Swinging

Swinging is defined as the variation in intensity of a received radio signal resulting from changes in the frequency of the transmitted waves.

### Attenuation

Attenuation is "the reduction in power of a wave or a current with increasing distance from the source of transmission."

### Interference

Interference is "the confusion of reduction due to strays, undesired signals or other causes, also that which reduces the confusion."

### Radio Channel

In the Transmitter section of the new edition of the NEMA Radio Standard channel is defined as a band of frequencies or wave lengths of a

width sufficient to permit its use for radio communications. The width of the channel depends upon the type of transmission.

### Band of Frequency

Band of frequency is defined as a continuous range of frequencies extending between two definite frequencies.

### Radio Finder

Recent activity in aviation radio is reflected in the new standards which among other items define a uni-directional radio finder as "a radio receiving device which permits determination of the direction (without 180 degrees ambiguity) of waves as received from a transmitting station.

### Radio Beacon

A radio beacon is a radio transmitting station in a fixed geographic location which emits a distinctive and characteristic signal for enabling mobile receiving stations to determine bearings.

# The Manufacture of Solid Resistors

*An interesting account of the development of an abrasive material which has found a place in the radio field*

By E. Stuart Capron\*

**D**URING the past five years, tremendous strides have been taken in the development and manufacture of radio receivers. The design and quality of radio equipment, in general, has been improved. It was not many years ago when a grid leak consisted of a few pencil marks drawn on a piece of paper or between binding posts on the wooden baseboard. The resistance of such a leak was uncertain, unreliable, variable and microphonic.

The next step was to coat a piece of paper with india ink or to impregnate the paper with carbon, grip it in some manner and enclose it in a glass tube. This was the type which was being manufactured when radio became the most popular of indoor sports. At the door of this type of grid leak can be laid much of the trouble which developed after a few months and necessitated calling in a "radio-service" man.

Today, advanced receiver manufacturers specify and require of grid leak manufacturers a reliable, non-microphonic resistance which is unaffected by atmospheric contact. Such a precision instrument or electrical device is attainable only with the development of a "solid" type of grid leak. There are two forms of "solid" types; one being the so-called "metallic" type of grid leak, and the other is the "rock-like" Carborundum grid leak. Both

\* Radio Research Division, The Carborundum Co.

Below: A section of the Furnace Department. Each furnace is approximately 50 feet long, six feet wide and eight feet high.

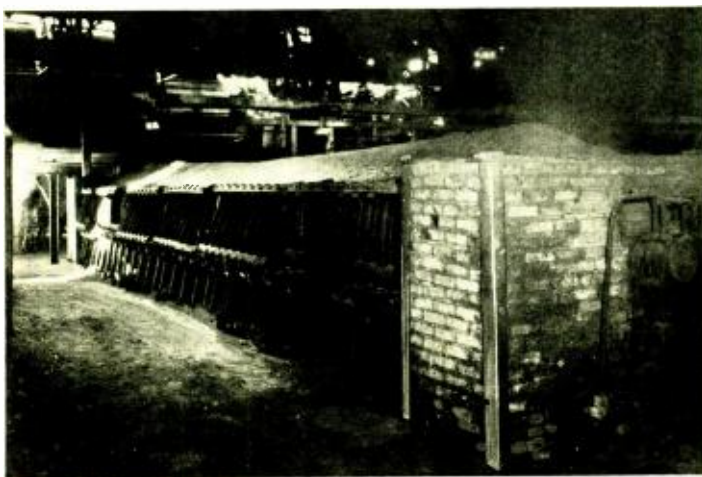

\*Allen D. Cardwell Mfg. Corp.

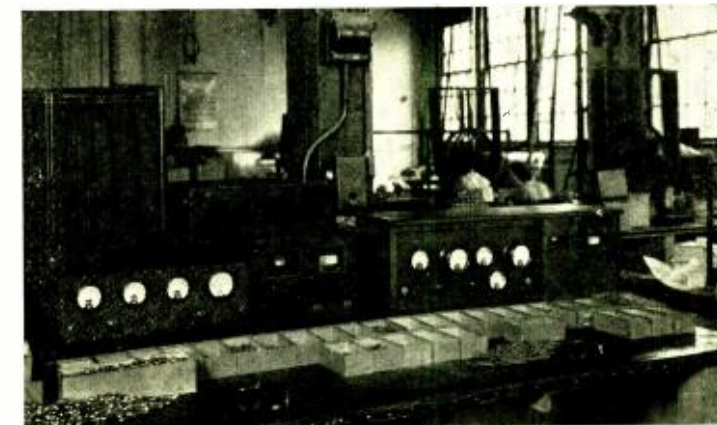

Above: Classification test equipment using delicate galvanometers. Left: Waterproofing impregnation bath.



are attainable only through the use of high temperature.

### The Story of Carborundum

The story of Carborundum is indeed an industrial romance. It is a romance of fact that sounds more like the romance of fiction. The story begins with Edward Goodrich Acheson in his small shop in the little town of Monongahela City, Pa., in the year 1891. Inspired by a series of electrical experiments with Thomas A. Edison, he conceived the idea of electrically creating a substance that would take the place of emery, corundum, and other similar materials furnished by Mother Nature.

To a tiny iron bowl filled with a mixture of clay and coke, he fastened one lead wire from his electrical generator. The other lead wire he wrapped about a piece of carbon, which he plunged into the mixture. He then applied enough current to fuse the mass. When the shell of the fused mass in the bowl was opened, he found a few tiny, bluish, diamond-like crystals which he called Carborundum because he believed the new substance to be the result of combining carbon and corundum. After many repeated heats of his small bowl, he obtained several ounces which was sold for gem polishing at 40 cents a carat or at the rate of \$880 per pound, to the lapidaries of New York, for polishing precious gems.

A little later, 1895, when the great power development at Niagara Falls was announced Dr. Acheson built a plant at Niagara Falls and made the second contract with the Niagara Falls Power Company, calling for a thousand

FOUR SCHEMATIC TUBE TYPES AND WAVELENGTH RANGE COVER A WAVELENGTH RANGE OF 450 TO

OPERATE WITH VARYING RESISTANCE. THE KEY IS UNDER THE RUBBER DIAPHRAGM ON TOP.



the resistances are impregnated with waterproofing material at 150 degrees

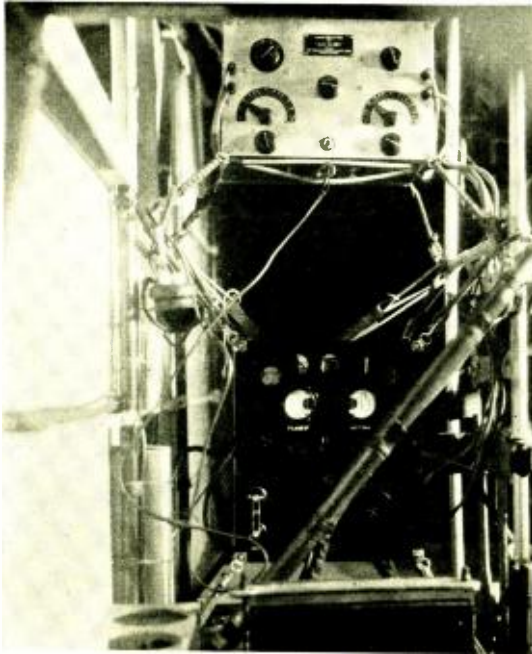

General view of the radio installation on the Fokker monoplane Old Glory. The main transmitter can be seen near the bottom of the photo. The shielded receiver, above the transmitter, is strapped to the framework of the fuselage.

### Automatic Transmission

The automatic device just referred to, is a tiny wind driven fan, which is geared to a commutator with the segments so connected that the transmitter will continually send out WRHP, the call letters of the plane. This is left connected at all times when the operator is neither transmitting nor receiving any special message.

### The Antenna

The antenna reel contains approximately 600 feet of special antenna wire to the end of which are attached small brass and lead fish which keep the antenna extended to its full length. Approximately 200 feet of antenna is used, and the additional wire on the reel makes it possible, if one length

is broken off by the plane coming too close to the waves, or other obstructions when over the land, to attach another fish to the broken end of the wire, reel it out and go back on the air again. It will be recollected that on the recent San Francisco-Hawaii flight; the plane approached so close to the surface of the water that the antenna dragged, and was broken off, and thereafter the aviators were unable to secure communication. If they had been equipped with sufficient antenna wire this trouble would have been averted, and enough additional wire is carried in the *OLD GLORY* equipment to allow operation to continue even though the antenna be lost twice.

All parts of the whole outfit at which any sparking may occur are so arranged that they are absolutely

flame-proof, and no possible ignition of gasoline fumes can occur from electric sparks caused by the radio in case of an accident.

### Range of Transmitter

The reliable range of the transmitter is 150 miles, but with a very similar outfit the Byrd Expedition messages were received from a distance of over 1,500 miles, and it is only natural to presume that a similar maximum range applies to the *OLD GLORY* set.

The useful range of the transmitter is greatly increased by the fact that 900 cycle alternating current is used for the plate supply in place of the usual direct current, as the tone of the transmitter signal, instead of being a whistle of varying pitch, is a steady sound about like the musical note "A" two octaves up from middle "C" played on the violin. This tone is readily recognized when heard, and ship and commercial operators at no time have any trouble in copying the transmission from the big Fokker plane, even though there are a number of other transmitters operating on almost the same wavelength at the same time.

Unfortunately, however, this freedom from interference which applies to the transmitter does not apply to the receiver, for while transmission is subject to much less difficulties from the airplane, reception is subject to many more. The throbbing of the big Jupiter motor practically deafens both pilots causing their eardrums to temporarily lose sensitivity to sounds of any kind. Crackles and crashes caused by the plane's own ignition system keep the air apparently full of "static" all the time, and instead of having a beautifully clear musical tone like they are sending out, they are forced to try to pick out the signals they are trying to read from a welter of indiscriminate spark and continuous wave signals which are confusing even to the most experienced of ship operators, who are undoubtedly the finest in the world.

## Wire Homes for Radio

*Custom Set Builders and Radio Contractor-Dealers find a large business in the installation of radio outlets*

ALMOST without exception the owner of a radio is intrigued when seeing an installation of radio outlets for the first time. It is not surprising, therefore, that many electrical contractor and radio contractor-dealers have taken advantage of the idea and are adding to their profits from the sale and installation of radio outlets.

One of the leading trade publications in the electrical and radio field is making a survey of the number of radio outlet installations made up to this time. The total number will prob-

ably be surprising. Large as it may be, there are one or two points in this radio house-wiring business that must appeal to every radio and electrical dealer and contractor interested in increasing his profits.

The first point is the many installations that have been made in certain sections of the country. In some communities radio house-wiring has taken hold like a fad, excepting that, unlike a fad, the radio outlets serve a real purpose and as a result their popularity will steadily increase.

Another interesting thing about the

radio wall plates is that one installation invariably leads to another and another. One home owner gets the idea—the dealer takes care of him, but hesitates about stocking the plates. Then, after the installation is made, another customer calls for plates—and still another and a nice business develops.

### Gain of Convenience

The electrical industry has done a great deal towards popularizing electrical convenience outlets. No new house is complete unless it is equipped

with electrical convenience outlets to take care of the normal needs of the home. There are outlets for the lamps, outlets for the cleaner and other appliances—there are outlets for practically every purpose and the buyer, renter or builder of a house or apartment will not be satisfied without them. Happily the electrical man has been foresighted and in many sections of the country the Red Seal House must also include the convenience of radio outlets.

Why not? What outlet is more of a convenience than the outlet that makes it practical to connect a loud speaker in the kitchen, on the porch, in the bedroom or any room? It is not necessary to adjourn to one room to enjoy the radio when radio outlets are available. And what is handier than an outlet bringing in the aerial wire and ground wire, ready to plug into from the sets! It is sometimes as much of a necessity as a convenience to keep the batteries in the basement or a closet out of the way. But, more of this later.

**Gain of Money**

Show your prospect how he will make money or save money and half the job of selling is done. Radio outlets do make money or save money. The radio wired house or apartment is more easily rented or sold because it has this latest modern convenience. Ask yourself which house you would buy or which apartment you would rent—all other things being equal—the one with or without the radio outlets.

Then—who sets up the radio when a family moves into a new home or apartment? If it isn't one of the youngsters, it is the old youngster himself. About the first thing he looks for is a place to bring in his aerial and ground wires. Zip! goes a hole in the window sash. Bang! Bang! go disfiguring nails in the baseboard. Damage is done to the woodwork. When the family moves out the holes look bad. A radio outlet for aerial and ground connections would have prevented this damage, thereby saving money for the owner.

The Lutheran Hospital of California which is wired for radio throughout.

Photo, courtesy of Yaxley Mfg. Co.)



**Satisfaction of Caution**

Guarding against damage to the woodwork, however, is only one of the safeguards of radio outlets. Sometimes batteries are liable to spill and work havoc with rugs and floors. With a radio outlet the batteries and charging equipment may be placed in the basement or some other out of the way place. With the use of an automatic power control with charger equipment, the filament switch in the set is the only switch to use.

But aside from the great utility and convenience of the radio outlets, the added pleasure they bring to the home sells most prospects. Sonny, or Daddy for that matter, may have a radio set of his own make that looks like an infernal machine, but brings in the music just the same. The basement is the only place for the set. All right—put it in the basement, but bring the music to other rooms of the house so that all may enjoy it.

Or if the receiver is a beautiful piece of furniture, fit to grace the parlor, why spoil it with a mass of wires lying around, or confine its pleasures to the parlor. Oftentimes the family would like the speaker on the porch—and, not unlikely, another speaker could be enjoyed at the same time in the same room.

And speaking of pleasure—not the

least of the pleasures the average family gets out of the radio is the pride it takes in the set and equipment. It may be the tone of voice that the owner of a radio-wired home uses in speaking of his installation that helps sell the other man on the good idea of it—as one installation has a way of leading to another.

**Low Cost**

Space does not permit the going into of figures in regard to the cost of installation of radio house wiring. Certainly the cost per outlet installed should not exceed the cost per electrical outlet installed and in many cases it should run less.

Some of the manufacturers now have bulletins giving complete wiring suggestions. Then, there are attractive circulars and other sales helps available. One manufacturer has mounted the radio outlets on a display stand to help get over the idea.

And, remember, while radio outlets are used in apartments and homes and are virtually standard equipment now for hospitals and hotels, there are many young fellows in every community who buy the plates as shelf goods to make their own installations.

**Radio Industry Well Represented in Business Field**

The radio field is well represented in a group of forty-one leading business executives who have organized an Advisory Board of the American Management Association, feeling that improved management methods are essential in maintaining present prosperity and that knowledge of such methods should be spread more quickly throughout business.

J. G. Harbord, Pres., Radio Corporation of America; E. K. Hall, Vice-Pres., American Telephone & Telegraph Company; Edgar S. Bloom, Pres., Western Electric Company; E. M. Herr, Pres., Westinghouse Elec. Mfg. Co. and B. L. Worden, Pres., Cutler-Hammer Mfg. Co., are on the Board. A wide range of industries and some of the largest corporations in the country are represented.



The Los Altos Apartment Homes of Los Angeles, fully equipped with radio outlets.

Photo, courtesy of Yaxley Mfg. Co.)

# Parts Manufacturers and Custom Set Builders

*How the manufacturer can co-operate with Custom Set Builders—*

*By Jack Grand*

*Mr. Grand has been in the radio business for many years and his experience covers a wide field. At present, he is doing special design work for manufacturers, distributors and dealers. He is in daily contact with Custom Set Builders and has a very definite knowledge of their requirements. The suggestions he offers in this article should be of interest to every manufacturer who is serving the custom set builder.—EDITOR.*

**E**VERY reputable manufacturer of radio parts and kits no doubt does everything in his power to place the best possible merchandise on the market. Then, he does his utmost to bring his items to the attention of the public. The usual procedure is to advertise the product in all possible periodicals read by the consumer. As a rule, the advertisements give a glowing account as to what the items will accomplish. This is necessary to arouse public interest and to create a demand so that sales resistance is cut down when wholesalers and dealers are approached.

After the items appear on the market, circulars are sent to dealers, which are laid in some conspicuous spot where customers help themselves. These consumer circulars, after being read are supposed to stimulate the sale of the item or items specified. What really happens is, the interested consumer looks at the literature, reads casually and usually discovers the literature is so fundamental that it is not interesting and therefore immediately discards it.

The money expended for this type of literature is wasted by the mere fact that these circulars do not bring results. However, do not assume from this that literature is not a necessity. Bear in mind that educational literature is valuable towards the welfare of any well established manufacturing enterprise, especially if directed to the professional set builders, generally known as "Custom Set Builders."

## *Facts Wanted*

The Custom Set Builders have recently made their appearance and have proven themselves an important asset to the radio industry. This brings out the fact that they are now contenders for the attention of the manufacturer. They demand more than glowing accounts—they demand facts.

The Custom Set Builders are a group of individuals who build sets

for friends and others whose confidence they have gained. They are the service men of their community; repairing and replacing parts, always being called upon in case of trouble. These set builders can be classed in two groups; some build sets in their spare time only while the others devote their entire time to the business. In either case a considerable amount is spent in the construction of sets.

## *Large Monthly Output*

The part time group probably average from two to five sets per month, expending from \$100 to approximately \$500 per month. On the other hand, the builders devoting their entire time probably average from five to fifteen sets per month which is a very conservative estimate, and the money spent by these men can be well judged by the manufacturer. It would be well for manufacturers to consider these groups.

All sections throughout the country have their group of Custom Set Builders. The popularity of a kit or group of parts in any community is dependent on the preference of the Custom Set Builders. They build the type of set giving them the least trouble and one requiring very little service. In other words, they build the sets that are most familiar to them—the set on which they have the most information.

It is readily seen that the Custom Set Builders are very important and valuable to the manufacturer. The manufacturer must convince them that his product is best suited for their needs, and the manufacturer therefore must give the Custom Set Builders all the attention that is given to the wholesaler and dealer, if not more. The dealer will only stock merchandise that is in demand and it is very evident that if a number of set builders demand a certain item, the dealer certainly will see to it that his customers are supplied. The majority of Custom Set Builders are making it their business to know all there is to know about the radio industry and the quality of parts. Dealers have brought this to the attention of the manufacturers and quite a few are publishing technical information and are sending all this data to the dealers.

Some of the enterprising manufacturers are doing this sort of work at the present time and it would be well if the others followed suit.

One company publishes monthly some of their laboratory experiments, and include in this report real meaty

information regarding characteristics of tubes and other apparatus as well as design and constructional hints which are of great help to the professional man. This monthly report goes a great way towards selling the company's products to the Custom Set Builder.

Mention is again made that practically all this data is being sent to dealers. Greater benefit would be derived by the manufacturer if these pamphlets and technical information were sent direct to the Custom Set Builders. In fact, it is the duty of manufacturers to place all available technical data regarding their products into the hands of Custom Set Builders.

We have neither the time nor the money to carry out tests on new products or to determine how we can get the most out of them. After all, why should manufacturers assume that Custom Set Builders have all the inside dope on power amplifiers, special r.f. circuits, A. C. receivers, etc. If they don't assume this why do they mail out literature on their products with not a word regarding its proper use? That is, literature devoid of technical information and schematic diagrams. We are intelligent enough and sufficiently well grounded in theory to know that every set, every amplifier and every power pack has some hitch to it; possibly a very small one, but in any event we are entitled to know what it is without having to learn—by experience, which in many cases proves costly. If we have the confidence and respect of the manufacturers we are in a much better position to do business with him.

## *Suggestions for Manufacturers*

The following are suggestions offered to the manufacturer by a professional set builder so that mutual co-operation may be effected for the financial welfare of both.

1. Secure a list of Custom Set Builders and place them on your mailing list.

2. Send technical data for every new item to be put on the market.

3. Rate all the condensers by capacity values instead of code numbers; for example, .0005 mfd. condenser or .00025 mfd. instead of 123-B or some other type of code. If possible give full details of your type of condensers showing why they are superior to other makes.

4. Rate all transformers as to current carrying capacity, the D. C. resistance of the windings, the induct-

ance at certain frequencies and specify type of core used. This forms a basis of comparison and if this particular type of transformer appeals to the builder, no smooth talking salesman will be able sell him anything else.

5. Rate all coils as to the wave length they will cover and specify the capacity of condenser they are designed for.

6. Rate all radio frequency and audio frequency chokes giving their inductance values and state at what values of current and frequencies these are given. Do not call them long wave or short wave chokes or retard coils but specify the inductance in milli-henrys and if possible, include a frequency curve showing the relative inductance.

7. When advertising a new item instead of merely saying it produces a certain result state where it is to be placed to produce that result and the answer will be—greater returns.

8. When giving details of a new circuit, do not overlook the point that hints should be given as to the possibilities of troubles, where to look for trouble and how to remedy it, peculiarities of the circuit, etc.

9. Institute a *reliable* technical information service particularly for the Custom Set Builder, and see to it the letters are replied to within the week, not within the month.

It will be found that this sort of co-operation by the manufacturer will instill confidence in the set builder to the degree that this particular manufacturer's merchandise will be preferred, meaning an increase in sales and a very satisfactory outlet.

The writer personally has sales experience of many years besides being a set builder and has come in contact with a large number of other Custom Set Builders. The suggestions offered above are the results of years of experience and observation.

---

## Plan to Cut Service Costs Outlined

*Registration of service men after examination to decrease turn-over*

---

THE great turnover in service men during the peak of the season is one of the greatest difficulties of the radio trade. The cost in breaking in a new man greatly increases the percentage cost of service and installation. In order to cut this expense to the greatest extent the Wisconsin Radio Trade Association has inaugurated a plan of examination and registration of service men to be carried on in conjunction with an employment bureau.

The main idea is that all service men now operating in the city should be registered at the headquarters of the association, with full data concerning their experience and ability, and that whenever they are not working, they leave notice at the office so that they may be placed immediately, saving time for both the employer and the service man.

The full details of the technical examination are not as yet worked out, but the Retail Section is completing plans. Two points are certain, however. Aside from the usual theoretical examination, the men will have to pass actual tests with regard to commercial models. No matter how thoroughly a service man may be grounded in the theoretical side of radio, unless he knows the commercial models, the time necessary for him to trace out the wiring and method of hooking up the set would be excessive if he were not acquainted with the actual chassis.

With the plan in full operation the dealer who needs a service man will only find it necessary to call the association office and ask for one. The complete details as to his ability, in so far as they can be obtained through examinations and inspection, will be on file. Two or three men may be sent over for the employer to make a selection from.

All retail members of the association will be asked to register the service men they now have in their employ so as to keep the records complete on them. The plan at present calls for the endorsement of the service man's card when he leaves the employ of one member. This will keep the data at the office of the association complete and will be an additional check upon the man's character and workmanship.

Each man who has been registered will receive a card which will form his credentials. The insignia of the association will be prominent upon it and it is hoped through advertising to create a demand for registered service men. There will be a small fee connected with the examinations and registration to defray the expenses of the association in connection with this work. Some few of the more important service men who have been interviewed so far concerning the plan are highly in favor of it, since it will place a premium on ability and cut out a great many of the inefficient and ignorant service men who are now mak-

ing it difficult for all of them to obtain positions.

This move on the part of the association will be of great assistance in organizing one branch of the trade which has been neglected. One point which has come up since the plans have been discussed is that of following the regulations of the fire underwriters. It is the general opinion that before the lapse of many years the state will require licensing of all service men just as it requires licenses of plumbers and electricians at present. There are rules concerning the installation of radio sets in force now by the board of fire underwriters which receive scant attention from most installers of radio sets. In co-operation with the merchants who handle radio and through the registration of service men it is hoped that these rules may be followed a bit more closely for the good of all concerned.

### National Radio Week

Plans for the National Radio Week that will mark the annual Radio World's Fair, beginning on September 19 in Madison Square Garden, are being rapidly rushed to completion. One of the most important events will be the forum to be conducted by noted leaders in the field of radio research and merchandising, a symposium that will interest every follower of broadcasting as well as the 250,000 visitors to the exposition.

The "Big Day" is Sept. 21, when amazing new scientific discoveries will be revealed in the "Theatre of Wonders," the principal feature of this year's Radio World's Fair, and that evening will occur the annual Radio Industries Banquet, with its feast of entertainment broadcast throughout the United States.

Last year National Radio Week was inaugurated by a big parade. This will not be held this year, but the honor guests of the exposition will be officially welcomed to the city by Mayor Walker.

Co-operating in the demonstration of the tremendous development of radio all over the world will be the Union Internationale de Radiophonie, the organization supervising European broadcasting, and a chart emphasizing the success of the re-allocation of wave-lengths over there will be shown. A greeting to the fans of America will come again from the British broadcasters, and there will be news galore relative to advances made in the transmission of programs in every civilized country.

More than 10,000 dealers in radio will hold their annual conferences at the Radio World's Fair. They will meet with manufacturers and their agents at the morning sessions, which are closed to the public. Representatives of a score of leading foreign firms will be on hand to give evidence of the tremendous gain in exporting American receivers and accessories.

# Associate Editor Radio Engineering

RADIO ENGINEERING has the pleasure of announcing the appointment of Mr. John F. Rider as Associate Editor.

Mr. Rider is well known in the radio field for his developmental work. He has acted as consultant engineer for numerous manufacturers and at one time was Chief Engineer of the J. W. Jones Co. For his own personal technical experimentation and research Mr. Rider has equipped one of the most complete laboratories in New York City where he is continually doing special work. The results of this work are shown in the several basic radio patents to his credit and many manufacturers have been licensed to market the products he has developed. Further results of his research are shown in the articles on new circuits and adaptations which appear in a host of newspapers throughout the country, and pages from his Laboratory Scrap Book published each week in the Radio Section of the New York Sun.

Magazine editorial work is nothing new for Mr. Rider. For some time he was connected with The Radio Dealer, also as an Associate Editor. He is to prepare each month a special article for RADIO ENGINEERING. These articles, primarily on Servicing and Laboratory Equipment and written more expressly for the Service Man and the Professional or Custom Set Builder, will be of practically equal interest to the Engineer, the Technician, the Student and those in all branches of the Radio Industry.

Mr. Rider's first article, in his new capacity with RADIO ENGINEERING appears below.



John F. Rider

## Scientific Service Equipment

*Details of inexpensive measuring apparatus and how to use it to best advantage in testing and servicing work*

*By John F. Rider, Associate Editor*

THE occasion frequently arises during the course of a day's work when the radio professional could well use special equipment for measurement work. Special equipment for this work, when purchased on the open market from a manufacturer or a group of manufacturers who specialize in the construction and sale of special measuring equipment, would entail financial expenditures which the radio professional could not afford. The result is that the man does not buy the equipment and does not carry out the work he had in mind.

Fortunately, however, it is possible to construct various types of scientific measuring equipment for a small fraction of the financial expenditure involved, were one to buy the unit complete from the manufacturer. This

article will deal with the constructional details of several such units. The first is the vacuum tube voltmeter, the most versatile measuring unit available to the radio professional. In my experience I have encountered many individuals who never heard of a vacuum tube voltmeter, who could not associate a vacuum tube with the term "voltmeter." Perhaps the term is foreign to some of the readers of this page? In that event a few words pertaining to the unit will not be amiss.

### *Vacuum tube voltmeter*

Explained in the simplest language, the vacuum tube voltmeter is a calibrated detector tube. In other words the action of the signal applied to the grid of the vacuum tube manifests an effect upon the plate current in the

plate circuit. By placing upon the grid of the tube utilized in the voltmeter combination, a predetermined value of D. C. potential and observing the effect of this D. C. potential upon the plate current, it is possible to calibrate the instrument in terms of input A. C. for certain plate current variations. This is the vacuum tube voltmeter.

Perhaps you are wondering why this sort of measuring device is used. The reason is simple to understand. The vacuum tube voltmeter drain upon the circuit is so small that it is entirely negligible. In other words, we can measure the potential across two points in a circuit without changing the characteristics of the circuit; simply because the measuring instrument does not constitute a load upon the circuit being measured. This is



contrary to all conventional types of voltmeters, whether for A. C. or D. C. All of the conventional types of A. C. or D. C. meters consume a certain amount of energy in order to actuate the mechanism, with the result that their utility in the radio field is limited to points where the drain does not cause any detrimental effects. A concrete example of this is found in the voltmeter designed for use to indicate "B" eliminator output voltages while the eliminator is in operation. At the advent of the eliminator the standard type of voltmeter was applied, with the result that the voltage indication was not the true indication, because of the heavy additional drain imposed upon the eliminator when the indicating voltmeter was placed across the load. The result was the development of a voltmeter with a high internal resistance, one which would draw very little current and give a true indication of the output voltage.

These faults with D. C. instruments are even greater with A. C. instruments, because in the average radio measurement work, the additional drain of the conventional A. C. meter completely demoralizes the measurement. In addition measurement work is carried out on all frequencies from 15 cycles per second to perhaps 5,000,000 cycles per second, and the average A. C. meters are calibrated for work at 60 cycles. Hence the use of the vacuum tube voltmeter, whose utility extends from the minimum to the maximum frequency with equal facility.

**Impedance measurements**

Let us consider the application of the vacuum tube voltmeter to a problem often encountered by the radio professional but very seldom solved with conventional equipment. This is the measurement of inductance at low audio frequencies. The measurement of the impedance value of audio

chokes at low frequency with a bridge system requires a bridge calibrated for the frequency. This is very seldom available in the average laboratory. The measurements of the impedance of an audio frequency choke with the milliammeter, voltmeter calls for instruments particularly calibrated for the frequency and then for calculations. But with the vacuum tube voltmeter it is possible to ascertain the value of impedance of the choke at whatever frequency is available without resorting to computations or special equipment; the only special equipment being necessary is the tube voltmeter unit, the construction of which is simple, inexpensive and can be built of parts found in every laboratory. Hence such measurements are possible at a low cost and with very little trouble.

The equipment necessary are two tube voltmeters arranged in a push-pull system, the description of which will be given in a subsequent paragraph. The measurement is made by

matching a non-inductive resistance against the unknown impedance until a certain balance is obtained. When this balance is obtained, the impedance value of the choke is equal to the value of resistance required to obtain the balance. Simple enough.

The wiring diagram of the layout for determining the impedance of chokes is shown in Fig. 1. The tubes used are of the 201-A type. Each of the milliammeters in the plate circuits has a full scale of 1.5 milliamperes D. C. The filament rheostat is a 10 ohm unit. The potentiometer is a 400 ohm unit. The by-pass condensers in the plate circuits are 1. mfd. units. The "C" bias battery is variable up to 15 volts. The grid-filament circuit of each tube is connected to a double pole double throw switch as shown. When the switch is in the S position, the grid-filament circuits are shorted and adjustments of the operating characteristics of the tubes can be made. When in the T position, the tubes are ready for the test. The calibrated resistance is connected to the two terminals of the T side of switch No. 1 and the choke to be measured is connected to the two terminals on the T side of switch No. 2. The A. C. source is connected to the terminals marked "A. C. Input."

**Method of Test**

Let us follow through with a test. We have a plate impedance whose impedance value we wish to determine at a frequency of 60 cycles. The switches are set to open position. The potentiometer is set at the midpoint. The "C" bias is set at 10 volts. The two switches are now set to the S position. The "C" bias and the potentiometer are now varied until the plate current meters indicate a few milliamperes and both read alike. The variable resistance and the

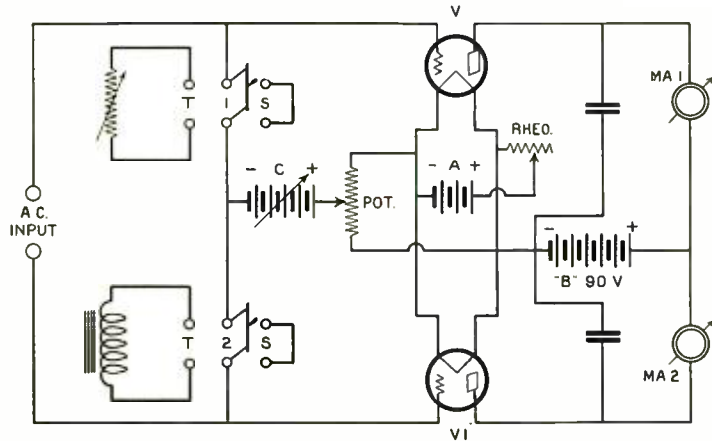

FIG. 1

Schematic diagram of equipment for determining the impedance of chokes. A. C. signal is not applied when switches are in "S" position

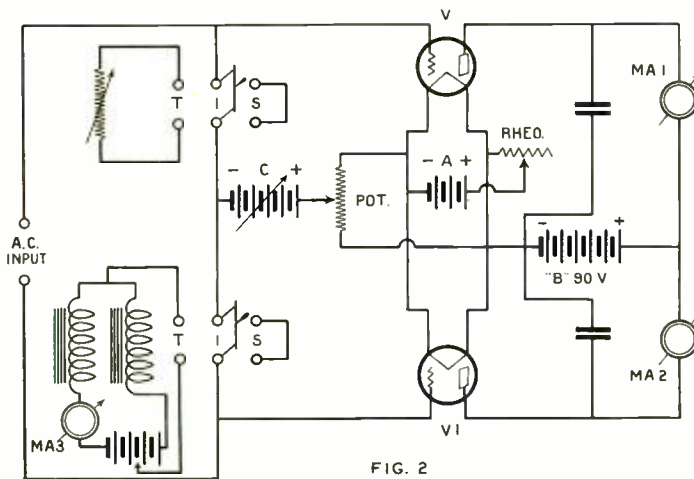

FIG. 2

A system similar to that of Fig. 1 but adapted for the measurement of chokes with a D. C. current following.

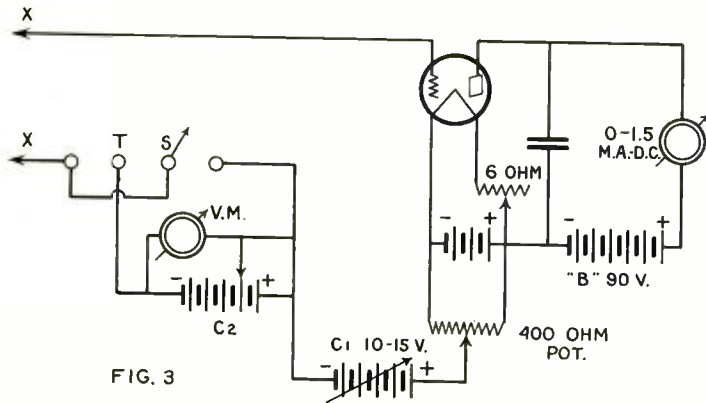

FIG. 3

A vacuum tube voltmeter suitable for the measurement of A. C. in audio amplification circuits.

choke to be tested are connected to their respective terminals. The resistance is set arbitrarily to 20,000 ohms. The switches are shifted to the T position and the A. C. signal is applied. We note that the meter swing on tube V is different than that of the meter connected to tube VI. We then vary the resistance and note that as we increase the resistance the meter connected to tube V approaches the set-

ters. The resistance is varied in the usual manner and the value of resistance when the two tubes are in balance is equal to the impedance of the choke with the amount of D. C. indicated on the meter, flowing through the windings.

**Audio frequency measurements**

A tube voltmeter suitable for the measurement of A. C. in audio amplification circuits is shown in Fig. 3. This type of tube voltmeter is suitable for the measurement of the output voltage of audio amplifying transformers with a constant frequency input. In this type of tube voltmeter we operate on the lower bend of the grid voltage plate current characteristic. By means of the "C" bias the potentiometer we adjust the tube so that a value of A. C. will only deflect the meter needle upward, and without any A. C. signal input the needle registers 50 or 100 microamperes. The adjustment of the voltmeter tube is made with the switch in the S position and

the contacts X connected across the transformer. Then the switch is set to the T position and the A. C. applied to the test circuit so as to pass through the transformer. The meter needle will not be deflected upward. We now add into the circuit additional negative bias from the "C" battery until the plate milliammeter registers the normal deflection (without A. C. input). The voltage shown upon the voltmeter V. M. is equal to the A. C. voltage applied to the grid of the tube. A finer degree of control of the balancing voltage can be obtained by using the potentiometer arrangement shown in Fig. 3-A. The method of using this type of voltmeter in audio circuits is shown in Fig. 4A and 4B. This system cannot be used in circuits where both A. C. and "B" potential are encountered; for example, to measure the voltage developed across

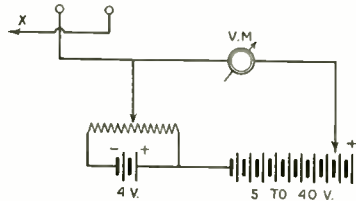

FIG. 3A

A finer degree of control than of that shown in Fig. 3 can be had with the potentiometer arrangement shown above.

ting of meter No. 2. At a setting of approximately 68,000 ohms the two meters read alike. The two tubes are now balanced, the voltage developed across the resistance is equal to that developed across the choke. The impedance of the choke is therefore equal to the ohmic resistance value of the resistance in the other tube circuit. The impedance of the choke is therefore 68,000 ohms at 60 cycles. The testing frequency need not be 60 cycles. It may be any audio frequency desired by the person interested.

**Measurement with current flowing**

In some instances the impedance of chokes is desired when a certain amount of D. C. is flowing through them. The method of measurement is the same as described in the preceding paragraph. The wiring layout for this test is shown in Fig. 2. Two similar chokes are used, and the battery tapped in the middle supplies the D. C. for the chokes. The meter indicates the current flow. By splitting the battery as shown, no D. C. voltage is applied to either of the tube volt-

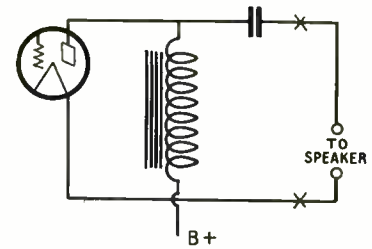

FIG. 4B

For determining the voltage developed at the point of the loudspeaker the vacuum tube voltmeter is connected to the points marked X.

the loudspeaker when the "B" supply is passing through the speaker. For such measurements another system is required and will be discussed at a later date.

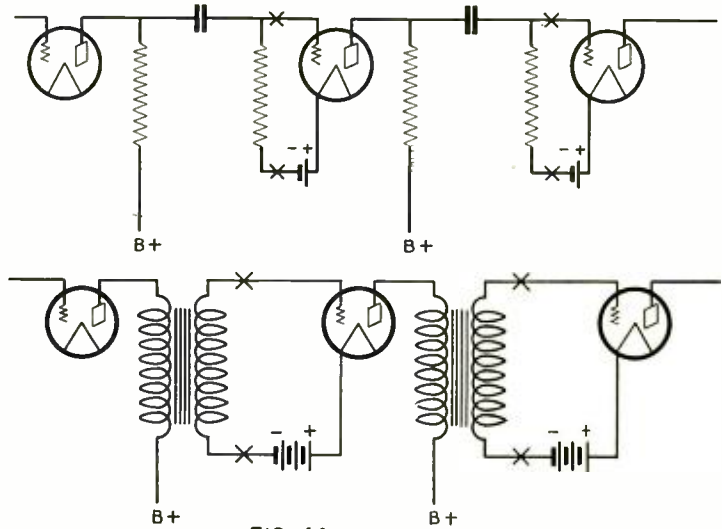

FIG. 4A

The voltages developed in the above circuits can be measured by connecting the vacuum tube voltmeter across the points marked X.

**Testing T. R. F. receivers**

A method of determining the point at which a multistage tuned radio frequency receiver is out of resonance cannot but be of interest to the service man. No doubt many men have employed this arrangement, but there are many who have not and it is given for their benefit. Fig. 5-A shows the wiring diagram of a three stage tuned radio frequency receiver controlled from one point. In other words, all the condensers are either geared together or are on one shaft. Be that at it may, the receiver has developed a fault and tunes broadly. The problem is to ascertain which stage is out of tune.

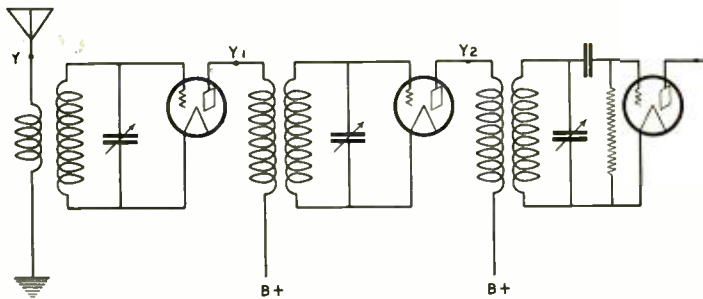

FIG. 5A

If the lead X of the modulated oscillator shown in Fig. 5B is connected in turn to Y, Y1 and Y2 it can be determined which stage of R. F. is out of resonance.

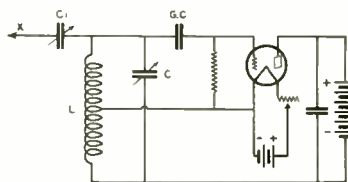

FIG. 5B

Circuit diagram of a modulated oscillator for testing T. R. F. receivers, etc.

A modulated oscillator of the type shown in Fig. 5-B is constructed. The exact coil and condenser dimensions for C and L are unnecessary. They should be of the correct electrical constants to cover the usual broadcast

frequency spectrum. The condenser C1 is a small vernier of 15 or 20 m-mfd. The grid condenser is conventional and the grid leak should be varied until the desired modulating frequency is obtained. This radio frequency oscillator is self modulating.

The receiver to be tested is adjusted for resonance with any station on the air. Then the aerial is removed from the receiver. This should be possible with receivers arranged for single control, since provision for accurate balance without the aerial is incorporated in the design of the receiver. The lead X from the vernier condenser C1 in Fig. 5-B is first connected to the point Y which can be the aerial post of the receiver. The signal input into the receiver can be varied by manipu-

lating the condenser C1. The receiver is adjusted for maximum resonance with the locally generated oscillator signal. The receiver dial setting for this condition is noted. Then the lead X is shifted to the plate connection of the first radio frequency tube (Y1). The receiver is again returned to maximum resonance and the receiver tuning dial setting noted. Then the lead X is shifted to the plate terminal of the next radio frequency amplifying tube (Y2) and the procedure repeated. And so on, if there are more stages of R.F. If the broadness of tuning was due to lack of resonance, one of the stages will show a marked difference in setting for the same input frequency. The stage differing the most is out of resonance.

# Enlarged Second Edition of Prof. Morecroft's "Principles of Radio Communication"

*Practically a new book, including all new developments but retaining the good features of the old*

**PRINCIPLES OF RADIO COMMUNICATION**, by Prof. J. H. Morecroft, Professor of Electrical Engineering, Columbia University; Past President, Institute of Radio Engineers. Assisted by A. Pinto, Electrical Engineer, Otis Elevator Co. and W. A. Curry, Assistant Professor of Electrical Engineering, Columbia University. Published by John Wiley and Sons, Inc., New York. 6 x 9 inches. 1001 pages, 831 figures, cloth covers. Price \$7.50.

Since the publication of the first edition of this book in 1921, it has enjoyed a remarkable success. Today "Morecroft" is known wherever Radio is known. Among Radio men, "Morecroft says" is a common expression and indicates the influence of his book on every phase of this rapidly expanding industry. The reason is simple enough. It is scientifically thorough and exact. The principles relating to the theory and practice of radio are comprehensively and accurately explained leaving nothing to guess work.

Outlining the changes made in the new edition, Professor Morecroft says:

"The new material incorporated in this edition so increased the size that it was thought advisable to delete much of the first edition. A considerable part of the chapter on Spark Telegraphy has been taken out, therefore, and two chapters of the earlier edition have been deleted. The chapter on radio measurements, and that on experiments, have been omitted."

"Notable additions to the older edition occur in Chapter II, IV, VIII and X. In Chapter II many new data on coils and condensers at radio frequencies are given. In Chapter IV, dealing with the general features of radio transmission, new material on field strength measurements, reflection and absorption, fading, short-wave propagation, etc., has been introduced. In Chapter VIII (radio telephony) a great deal of material on voice analysis has been added; the performance of loud-speaking telephones, frequency control by crystals, etc., has been discussed. In Chapter X, dealing with amplifiers, the question of dis-

tionless amplification has been thoroughly dealt with, some of the material being given for the first time. The question of radio-frequency amplification, balanced circuits, push-pull arrangements, etc., have been explained."

The early part of the work deals with the behavior of circuits when excited by very high frequencies as used in present radio practice. The actual behavior of tubes in typical circuits is covered in a more thorough manner than has been attempted in other texts, and practically all the theoretical deductions are substantiated by experimental data. A chapter has been devoted to each important phase of the radio art: Sections of the work are devoted to resistance, inductance and capacity, laws of oscillating circuits, vacuum tubes and their operation in typical circuits, continuous-wave telegraphy, radio telephony antennae and radiation, wavemeters and their use, and amplifiers. Throughout, the treatment has the merit of clearness and thoroughness, the curves and diagrams used for illustrating the text matter being particularly excellent.

# Voltage Amplification Bridges

Covering the theory and construction of a vacuum tube voltmeter and voltage amplification bridge

By E. W. D'Arcy\*

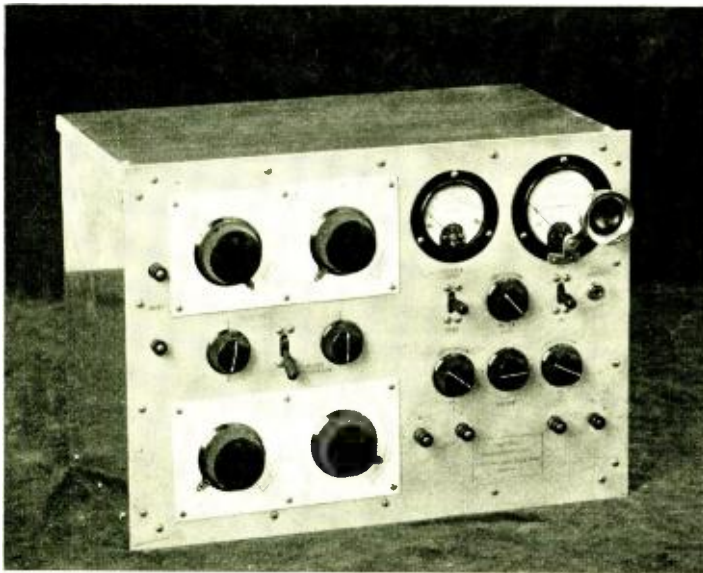

Fig. 9. The completed voltage amplification bridge. A magnifying glass is attached to the milliammeter so that accurate readings of the fine scale can be taken.

## PART II

In this article Mr. D'Arcy takes up the theory, design, and construction of vacuum tube voltmeters, their adaption to measurement purposes, and switch arrangements to switch the voltmeter from the input to the output of the transformer under test. Also a way to measure the filtering efficiency of a transformer or filter.—EDITOR.

**I**N measurements of voltages at radio frequencies, ordinary systems of electro-mechanical devices fall down. This is chiefly due to the minuteness of the currents used in radio work and the exceptionally high frequencies used, which makes it practically impossible to have a high frequency voltmeter. If it were possible to have a direct reading voltmeter that would stimulate the characteristics of a tube in regard to filament and plate resistance and capacity, at the same time being sufficiently sensitive to measure voltages of the order of 5 microvolts and up, it would probably do away with an enormous amount of difficulty in measuring work, providing, of course, it would respond equally well to all frequencies. This, we all agree, is impossible, so the thing we finally decide to use is a vacuum tube voltmeter. Vacuum tubes are useful as voltmeters solely on account of the rectification and detection char-

acteristics of the vacuum tube. It introduces no unusual load conditions in the radio circuit, therefore, is the logical type of measuring device for measuring output voltages. It can be calibrated from either direct current or low frequency alternating current, and will maintain its calibration for a sufficient period of time to make it practical in use.

The theory of a vacuum tube is very well known and it is really unnecessary to go into a detailed discussion of theories in regards to vacuum tubes in this article. Suffice it to say, a vacuum tube voltmeter is any vacuum tube made to rectify and having its space current calibrated in terms of voltage applied to the grid of the tube.

### Vacuum Tube Voltmeters

We will now take up the different types of vacuum tube voltmeters, their advantages and disadvantages, and finally we will take up the vacuum tube voltmeter used in measuring transformer characteristics.

In Fig. 1 is shown a vacuum tube voltmeter which is used where accuracy is not required in measurements of voltage. It utilizes a direct voltage comparison potential in which there is a source of supply such as the "C" battery, a voltage divider connected across it, and a voltmeter to measure the potential at which the arm is at all times. The voltmeter is connected to

the circuit to be measured, the potentiometer arm is turned so that there is no voltage being supplied by the "C" battery, the switch S-1 is closed, a reading is taken on the milliammeter in the plate circuit of the vacuum tube, the switch is then opened, the voltage to be measured is turned on, and the "C" battery voltage is varied until it equals the voltage being measured, at which time the meter in the plate circuit will show the same deflection as it would with the switch S-1 closed. The voltmeter, connected across the potentiometer and "C" battery, then indicates the voltage that is being measured. This system, while it is reasonably accurate, will not allow small voltages to be measured and, therefore, is not the best type of voltmeter to use in a voltage amplification bridge.

A little better system is shown in Fig. 2, as it protects the plate milliammeter from too much abuse due to the grid circuit being opened and closed. It is, however, just about as efficient as the circuit in Fig. 1, having the same drawbacks, and therefore is not the logical circuit for a vacuum tube voltmeter to be used in laboratory work.

The circuit shown in Fig. 3 is the most sensitive type of vacuum tube voltmeter that has been made. This is due to the fact that a system of grid rectification is used with a corresponding increase in sensitivity, thus allowing much smaller voltages to be measured. The difficulty that we experience with a straight circuit of this type is that the plate current milliammeter necessarily has to be a high current meter. This, of course, means that we are not much better off with this system than with any of the others due to the fact that we can not take advantage of the superior sensitivity of this type of system and use a galvanometer to correspond with the increased sensitivity.

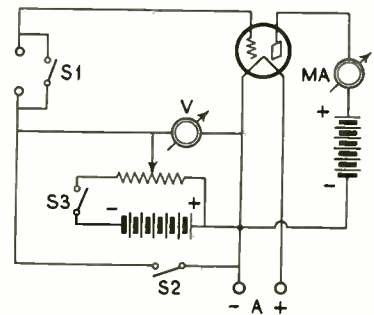
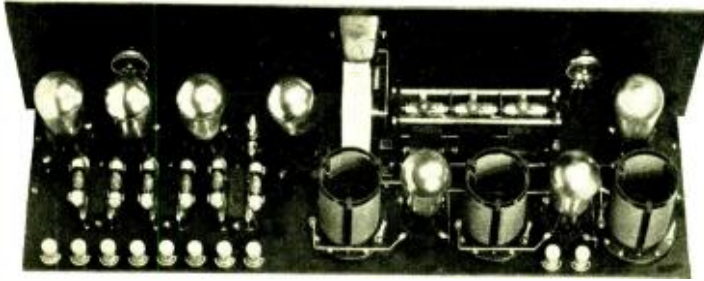

Fig. 1. A simple vacuum tube voltmeter circuit which can be used if accuracy is not required.

\* Engineer, Dar-Mac Laboratories.



Rear view of the Aero-Seven receiver. The three tuning condensers, on a common shaft, are controlled by a single drum dial.

lent frequency characteristics and can be relied upon to give excellent amplification of all of the audio frequencies actually broadcasted.

Referring to the inside view of the receiver, the two shields on the left hand side house the first two radio frequency stages. The two right-hand shields house the third radio frequency stage and detector. The dual control drum dial, mounted between the shields, operates the separate units.

The volume control on the receiver is in the form of a six-ohm rheostat which controls the filament current to the three radio frequency tubes.

**LIST OF PARTS REQUIRED**

- 4—"III-Q" Auto-couple Coils.
- 4—85 M. H. R. F. Chokes.
- 4—.0005 mfd. Variable Condensers.
- 1—Illuminated Drum Dial.
- 1—.00025 mfd. Grid Condenser.
- 1—.001 mfd. By-pass Condenser.
- 3—.5 mfd. By-pass Condensers.
- 1—A. F. Transformer (2 to 1 ratio).
- 1—A. F. Transformer (3 to 1 ratio).
- 1—Pair Grid Leak Clips.
- 1—6 ohm. Rheostat.
- 1—Battery Switch.
- 1—2 meg. Grid Leak.
- 6—U. X. Tube Sockets.
- 2—Self-adjusting Rheostats (1/4 amp.).
- 1—Self-adjusting Rheostat (1/2 amp.).
- 1—7-Wire Battery Cable and Connector.
- 3—Binding posts.
- 1—"III-Q" Six Foundation Unit. (Includes drilled and engraved panel, steel chassis, four aluminum shields, extension shafts and miscellaneous hardware.)

**The Aero-Seven**

The AERO-SEVEN is a receiver particularly well adapted to the purpose of the custom set builder. Its various features appeal strongly to the consumer while the simplicity and standardization of construction recommend it to the Custom Set Builder.

The schematic wiring diagram of the AERO-SEVEN is shown on this page. In general it consists of a potentiometer stabilized r.f. system outputting to a three stage resistance coupled amplifier. The tuned r.f. stages are



Panel view of the Aero-Seven receiver.

controlled by a triple condenser, making the receiver single control in respect to tuning. The potentiometer controls volume and sensitivity while the r.f. rheostat may be brought into play for extreme variations.

There are seven tubes in the receiver. The first tube is essentially a coupling device between the antenna system and the first tuned circuit by which antenna variations are prevented from affecting the tuning alignment of the first condenser section. However, noticeable amplification is secured in this utility. A 1,000 ohm resistor connected between antenna and ground inputs to the first tube,

The r.f. inductors are especially designed for use with high mu tubes, making it possible to take full advantage of their amplifying characteristics.

Small compensating condensers associated mechanically and electrically with each gang of the triple condenser make it possible to compensate capacitive discrepancies in the wiring.

The remaining electrical details are indicated on the diagram. The resistor values and the positioning of the tubes should be carefully observed.

**Building the Receiver**

A highly efficient and simple layout is suggested in the photographs. This layout will recommend itself to the expert likely to build more than one set, due to the fact that the panels can be secured cut and drilled. However, any other logical design may be adopted. It is only necessary that care be observed in the spacing and wiring of the r.f. components to preserve perfect tuning alignment and to reduce interstage coupling.

**LIST OF PARTS REQUIRED**

- 1—Foundation unit.
- 1—R.F. choke.
- 3—R.F. transformers.
- 1—Drum dial.
- 1—Battery switch.
- 1—200 ohm potentiometer.
- 1—6 ohm rheostat.
- 1—1,000 ohm rheostat.
- 1—1 ohm fixed resistance.
- 1—.00025 mfd. grid condenser.
- 1—.001 mfd. by-pass condenser.
- 2—.5 mfd. by-pass condenser.
- 10—Binding posts.
- 6—Standard U.X. sockets.
- 1—Floating U.X. socket.
- 1—.0005 mfd. triplet condenser.
- 1—Grid leak mounting.
- 1—.5 meg. grid leak.
- 1—High-mu resistance coupled audio kit.
- 5—High-mu tubes.
- 1—201-a type tube.
- 1—Power tube, 112 or 171 type.

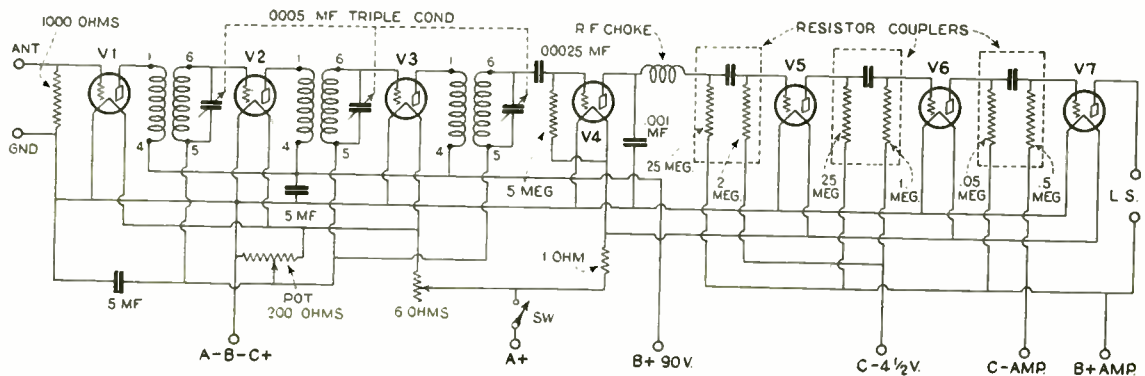

Schematic diagram of the Aero-Seven receiver. The aperiodic antenna circuit, wherein a fixed resistance is employed, makes possible the use of a single tuning control.



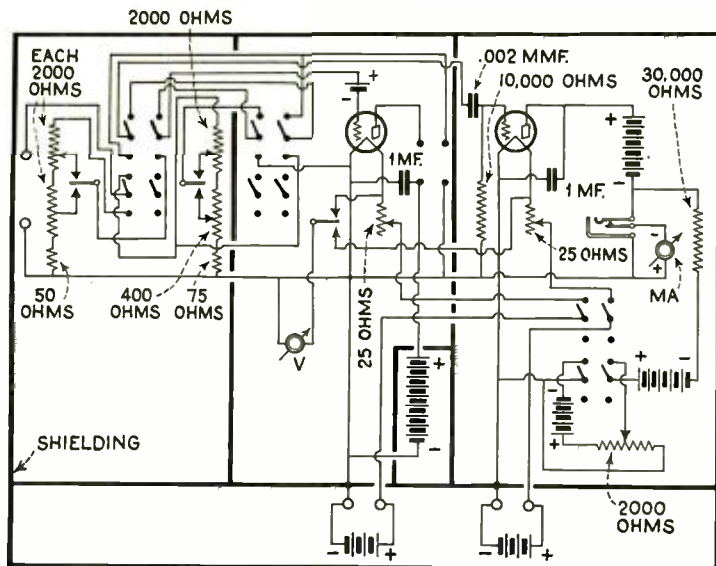

Fig. 8. Circuit diagram of the complete voltage amplification bridge shown in Fig. 9.

tering efficiency of either a transformer or filter system, that is, its *rejectance* properties. By the term *rejectance* we mean the voltage the transformer will not pass. To clarify this explanation, voltage amplification curves taken on transformers give the acceptance curve of a transformer but not the filtering efficiency or rejectance of a transformer. In other words, assuming a curve as shown in Fig. 7 we would say that this transformer is very selective, but on making a rejectance test on the filtering efficiency of this transformer we find that it is very broad and inefficient in its filtering capacity. This curve is made by varying the frequency until the peak amplification of the transformer is obtained and then making a reading on the galvanometer in the plate circuit of the vacuum tube voltmeter, of the output voltage supplied by the transformer under test. We then vary the frequency (for simplicity of explanation, we will use degrees on the driver scale instead of frequencies), say 10 degrees. We increase the voltage input to the tube and transformer under test until the same output voltage is obtained. This increase in voltage is stated in terms of rejectance, that is, twice the voltage would be a rejectance of two, three times the voltage would be a rejectance of 3, and so on, and we find that this more closely approaches the conditions the filter will face in actual operation. On a test of this kind some filters that show very good voltage amplification curves, on account of capacity between windings and high resistance, show a very broad rejectance curve. For this reason we have in the bridge under discussion facilities for multiplying the power supplied. These are called the "rejectance arms" of the bridge. These calibrations go up to 40 times the original voltage supplied at the peak frequency.

of the transformer. This system makes it possible to check the filtering efficiency of any transformer or filtering system.

In regards to the mechanical side of this arrangement it can be seen in Fig. 8 that there are two 2000 ohm potentiometers with a small 50 ohm fixed resistance. These are all connected in series with the 50 ohm resistance at the filament end of this resistance bank. The 50 ohm fixed resistance determines the normal voltage which is used at the peak reading of the transformers.

### Construction

In describing the construction of the bridge shown in Fig. 9, we will start at the input side of the bridge and work through the different equipment used. Tracing the circuit from the input posts, we find it goes to the cam-switch. This cam switches the

voltage divider and voltage multiplier systems so that we may use the bridge for either rejectance or acceptance tests. The rejectance part of the bridge consists of two potentiometers, each one being 2000 ohms in resistance. The voltage amplification part of the divider consists of one 2000 ohm potentiometer, one 400 ohm potentiometer, and one 75 ohm resistance.

The next thing we take up is the cam-switch arrangement, which switches the vacuum tube voltmeter to a position so that the output of the transformer under test can be measured, to a position to measure the input to the bridge. The vacuum tube voltmeter arrangement is the same as that shown in Fig. 4. The resistance E is a fixed resistance which equals the filament-to-plate resistance of the tube being used as a vacuum tube voltmeter. The bucking out battery D equals the voltage being applied to the plate of the tube. The battery C is a 7 1/2 volt "C" battery across which is connected a 2000 ohm potentiometer which acts as a voltage divider. This arrangement cancels out the steady space current which the tube takes. In the bridge shown in Fig. 8 there are facilities for plugging in an external meter. The meter mounted on the face of the panel is a comparatively high current milliammeter, being a meter that reads 0 to 1.5 milliamperes. This is used for balancing the current through this meter system to zero, which prevents danger from overload to a sensitive galvanometer. The filament voltmeter has its negative side grounded and its positive side connected to a switch arrangement to measure either the voltage across the filament of the first tube or the voltage across the filament of the vacuum tube voltmeter. The potentiometer for balancing the milliammeter is mounted directly on the face of the panel. The filament switch, when it opens up all of the filament circuit, also opens up all of the bucking out battery circuits, thus preventing shorting of the batteries when the bridge is not in use.

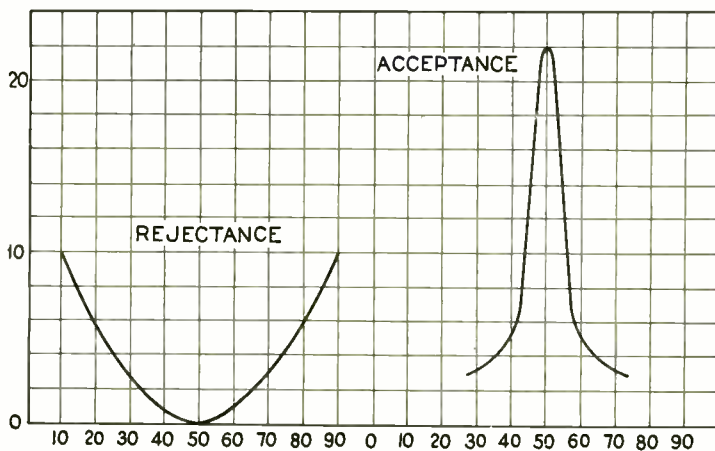

Fig. 7. Acceptance and rejectance curves taken on the same transformer using the voltage amplification bridge.

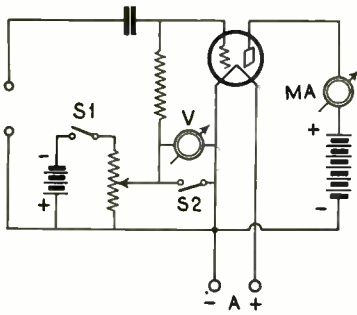

Fig. 2. A vacuum tube voltmeter circuit which affords protection to the plate milliammeter.

The circuit in Fig. 4 is the most suitable type of vacuum tube voltmeter for bridge measurements. With this system extremely low voltages can be measured. In fact, it is possible to measure voltages down as low as 5 or 10 microvolts. The trick in this circuit is that a system of bucking out the constant space current is used. This allows the use of a 0 to 80 microammeter in the plate circuit with a corresponding increase in sensitivity, which the use of a galvanometer would indicate. In a grid rectification system of detection, upon the signal being impressed upon the condenser and leak combination, it causes a negative potential to be applied to the grid, which means that the space current decreases in value corresponding to the applied voltage. In connecting up a galvanometer in the plate circuit in this way, it is necessary to reverse the connections of the meter terminals, so we may obtain a deflection upwards on the meter scale instead of downwards.

The circuit in Fig. 5 is the most universally used vacuum tube voltmeter in laboratory work. It is an extremely sensitive vacuum tube voltmeter and also a very stable sort of system. It, therefore, is the one we will consider later on in the article on adapting vacuum tube voltmeters to bridge measurements.

**Voltage Amplification Bridges**

The bridge shown in Fig. 5 is one of the oldest type of bridges known. It is called the peak voltage method of

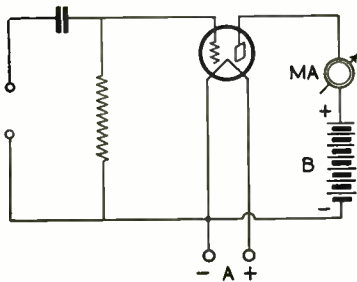

Fig. 3. The most sensitive type of vacuum tube voltmeter employing a system of grid rectification.

measuring voltage amplification. In this system of measurement the voltage input is first measured and then the voltage output from the coupling device being used is measured, and the voltage input is divided into the voltage output, giving the voltage amplification. This is a complex old affair that was extremely inefficient and unreliable. As a rule, voltages from 1/10 to 1/2 volts were supplied to the first tube, and the voltage output from the transformer under test was correspondingly high, so that when iron core transformers were tested a person could hardly approximate the frequency at which it operated best on account of the varying inductance of iron core impedances with variations in load, and it was practically impossible to get any reliable sort of curve of the voltage amplification of iron core transformers. The operation was outlined in connection with Fig. 1, measurements being made of both the input and the output voltage from the transformer being tested. This is a very inefficient, unreliable and complex system of determining the voltage amplification of a transformer.

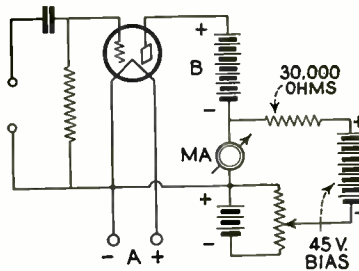

Fig. 4. This arrangement allows the measurement of extremely low voltages.

We will now take up Fig. 6, which is the first real improvement in bridge measuring devices. It consists of a voltage divider which we shall call resistance A. This voltage divider, or potentiometer, has a calibrated scale reading directly in fractions of the total resistance, that is, 1/2, 1/3, 1/4, 1/5, and so on, up to 35. It is calibrated in this manner so that the input voltage can be decreased to 1/2, or any of the fractions just mentioned. It also consists of a vacuum tube which is used to equal the plate impedance and amplification constant of an ordinary tube in a radio set. This, coupled with the transformer, makes it possible to measure the voltage amplification of a transformer and tube together. We also have the vacuum tube voltmeter arrangement as described in the section pertaining to Fig. 4.

**Operation**

In operation, the switch is thrown to the position where the vacuum tube voltmeter is connected directly across the input to the bridge, a reading is taken of the voltage applied, the

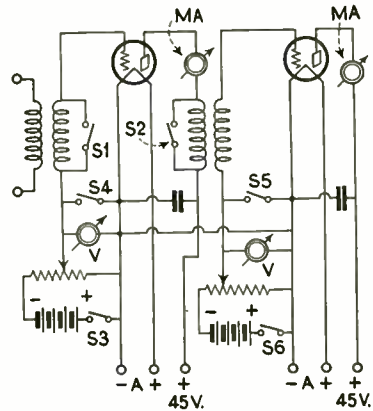

Fig. 5. A laboratory type vacuum tube voltmeter which is both sensitive and stable.

switch is then thrown to the other position cutting in the tube and transformer under test. The voltage divider arm is then varied until the same voltage output from the transformer is indicated. The fraction of the resistance used then will indicate the amplification of the tube and transformer being tested, that is, if it requires 1/2 of the input voltage with the transformer and the tube in circuit to give a certain definite deflection on the plate current meter, which deflection has been obtained by measuring the input voltage, then the transformer and tube under test will amplify the incoming signal two times, which means it would have a voltage amplification of 2. This really is the only way at the present time of making comparative measurements of the efficiency of transformer and tube combinations.

**Rejection Properties of Transformer**

At this time, before we go any further into the discussion of bridges, we will take up a much newer phase of transformer testing, that of establishing a standard of comparison for fil-

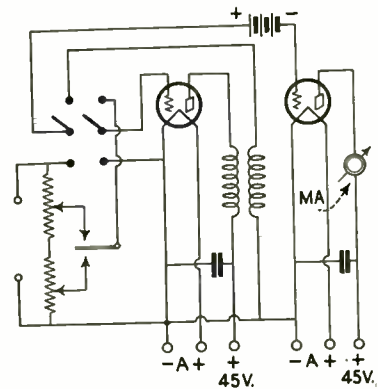

Fig. 6. Bridge measuring system, including a vacuum tube voltmeter for measuring voltage amplification.



### The Radio News Special Short Wave Broadcast Receiver

Mr. Kendall Clough describes a special short wave broadcast receiver in the October issue of *Radio News*. This set is designed to cover waves from 15 to 550 meters by the use of plug-in coils and contains a number of new ideas in short wave practice.

The receiver comprises a regenerative detector wherein the amount of feed-back to the grid is controlled by a variable capacity (C2), and two stages of transformer coupled audio frequency amplification. The commonly used grid condenser and grid-leak have been found unsatisfactory for a short wave receiver as such a

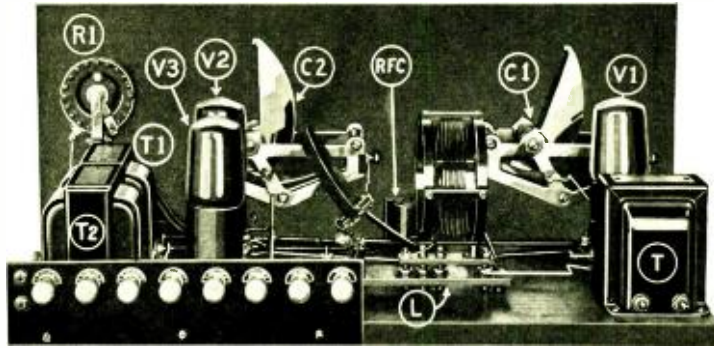

Above: Rear view of the Radio News Special Short Wave Receiver: Below: The circuit diagram of the short wave receiver. Note that the secondary winding of an A.F. transformer is used as a grid leak.

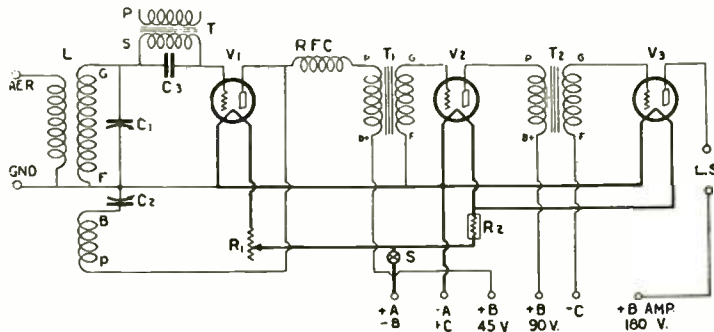

combination has low impedance for radio frequency currents and a high impedance for audio frequency and direct currents. The impedance employed should, on the contrary, have a low impedance for radio frequency currents and a high impedance for audio frequency currents, yet low resistance for direct currents. In order to satisfy these terms, the secondary winding of a 2 to 1 ratio audio transformer shunted by a .0001 mfd. fixed condenser is used in place of the usual grid-leak and condenser.

**LIST OF PARTS REQUIRED**

- 3—Plug-in Coils (L).
- 1—.00014 Mfd. S. L. F. Variable Condenser (C1).
- 1—.00025 Mfd. S. L. F. Variable Condenser (C2).
- 1—.0001 Mfd. Grid Condenser (C3).
- 1—20 ohm. Rheostat (R1).
- 1—Self-adjusting Rheostat, 3/4 amp. (R2).
- 1—R. F. Choke (RFC).
- 3—A. F. Transformers, 2 to 1 ratio (T, T1, T2).
- 1—Filament Switch (S).
- 3—C. X. Sockets.
- 2—Vernier Dials.
- 8—Binding Posts.
- 2—Tip Jacks.
- 1—Baseboard, 8" x 17" x 1/2".
- 1—Panel, 7" x 18" x 3/16".
- 1—Binding Post Strip 8 1/2" x 2" x 3/16".

#### TUNED DOUBLE IMPEDANCE PUSH-PULL AMPLIFIER

The latest improvements in tuned double impedance amplification developed by E. E. Hiller have been in-

corporated in a new audio frequency amplifier designed by *Kenneth Harkness*. As indicated in the accompanying wiring diagram, the amplifier has three stages of double impedance amplification, the third stage being a new combination of the double impedance and "push pull" systems.

The use of push-pull amplification in the output stage greatly increases the undistorted power output of the amplifier as compared with amplifiers using only one tube in the last stage, and eliminates second harmonic distortion.

In all other respects the amplifier

has the same characteristics as the standard tuned double impedance amplifier. Low frequencies, below 200 cycles, are accentuated to offset the poor response of the average loud-speaker, resulting in uniform loud-speaker output from 40 to 10,000 cycles. There is no "motor-boating" and "tube blocking" is completely eliminated.

The Tuned Double Impedance Push-Pull Amplifier can be attached to any receiving set, without tools and without making any changes in the set itself.

The Double Impedance Push-Pull Coupler and Push-Pull Output Unit were especially designed for use in this amplifier. The first and second stage units are standard tuned double impedance couplers, as used in the first and second stages of all other types of double impedance amplifiers. This information may prove useful to readers who have built standard double impedance amplifiers. The new features of the push-pull amplifier can be added without going to much expense, the only new parts required being the two special push-pull units mentioned above and an extra tube socket.

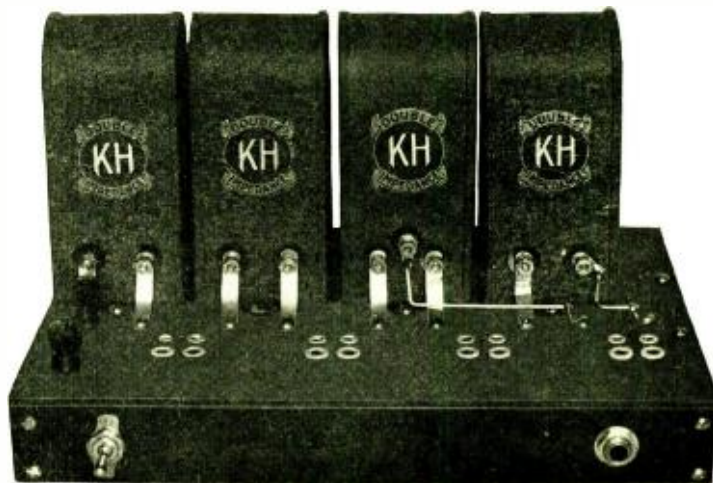

The completed tuned double impedance push-pull amplifier. Note that the third unit has an extra terminal. This is the center tap on the push-pull grid impedance.

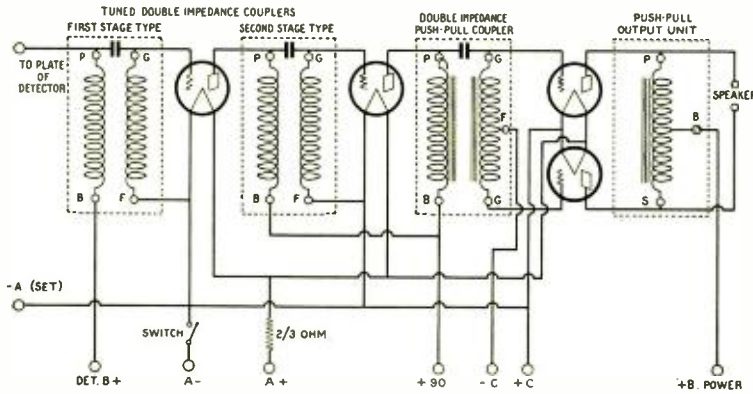

Schematic diagram of the tuned double impedance push-pull amplifier; an adaptation of the new system described by Mr. Hilier in this issue.

**PARTS REQUIRED**

- 2—Tuned Double Impedance Couplers (first and second stage types).
- 1—Double Impedance Push-Pull Coupler.
- 1—Push-Pull Output Unit.
- 1—Bakelite panel, 6-3/8" x 10", with four tube sockets attached.
- 2—Bakelite strips, 1 1/4" x 10".
- 1—Pair steel sub-panel brackets.
- 1—Battery switch.
- 1—Loudspeaker jack.
- 1—Fixed filament resistance, 2/3 ohm.
- 9—Binding posts.
- 2—201-A type tubes.
- 2—112 or 171 type tubes.

**The Custom-Built Roberts Knock-Out**

The Custom-Built Robert's Knock-Out, designed by H. G. Cisin of the Allied Engineering Institute, is a receiver which will give splendid practice and satisfactory results to the novice. The circuit is a standard Robert's reflex. The reflex principle permits one tube to do the work of two, so that although only three tubes are required, four tube results are obtainable. There is one stage of radio frequency amplification, a detector and two stages of audio frequency amplification.

One of the most important advantages derived by custom set constructors is the fact that they can build their receivers to suit their local conditions and requirements. The Custom-Built Robert's has been designed

especially for those who want a simple up-to-date receiver, for bringing in local broadcasting. It has a minimum number of parts and as a result the first cost is unusually low and maintenance costs are also small.

In this receiver, two variable condensers (6 and 11) are operated by means of a single dial. An insulated coupling (12) is used to connect the

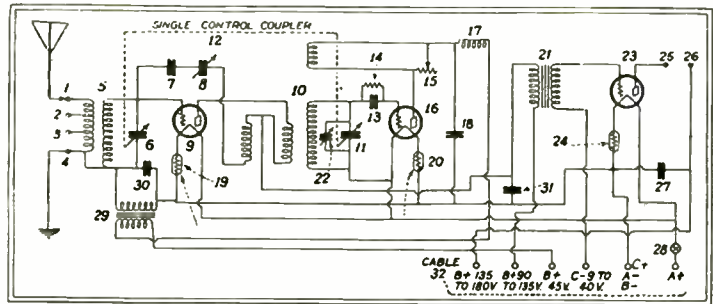

Circuit diagram of the Custom-Built Roberts Knock-Out receiver; a form of reflex.

**LIST OF PARTS REQUIRED**

- 2—Self-adjusting rheostats, 1/4 amp. (19, 20).
- 1—Self-adjusting rheostat, 1/2 amp. (24).
- 1—Filament switch (28).
- 2—.0005 mfd. variable condensers (6, 11).
- 1—9 plate midget variable condenser (22).
- 1—85 MH radio frequency choke (17).
- 3—U.X. tube sockets (9, 16, 23).
- 2—A.F. transformers, 2 to 1 ratio (21, 29).
- 1—.001 mfd. by-pass condenser (7).
- 1—.0005 mfd. by-pass condenser (18).
- 1—.0001 mfd. by-pass condenser (30).
- 1—.002 mfd. by-pass condenser (31).
- 1—.05 mfd. by-pass condenser (27).
- 1—Coupler coil (10).
- 4—Binding posts (1, 2, 3, 4).
- 1—Antenna coupler (5).
- 1—Vernier dial.
- 1—Variable resistance, 0 to 2,000 ohms (15).

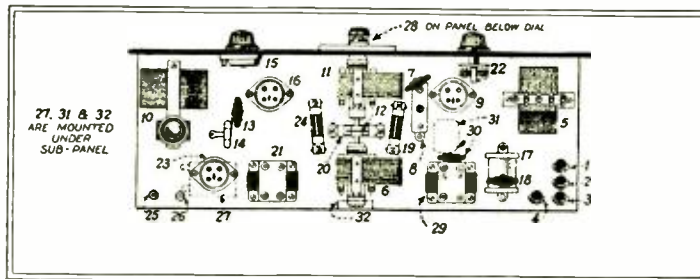

Constructional layout of the Custom-Built Roberts Knock-Out receiver.

- 1—Adjustable condenser, 1.8 to 20 mfd. (8).
- 1—2 meg. resistor with mounting (14).
- 1—.00025 mfd. grid condenser (13).
- 2—Cord tip jacks (25, 26).
- 1—Insulated coupling unit for variable condensers (12).
- 1—Battery cable with connector plug and mounting (32).
- 1—Roll hookup wire.
- 2—201-A type tubes.
- 1—112 type tube.
- 1—Panel, 7" x 21" x 3/16".
- 1—Sub-panel, 7" x 21" x 3/16".
- 1—Cabinet.

### My Own Audio Amplifier

Under the above title, Mr. John F. Rider describes the constructional details of an audio amplifier which he considers to be the supreme unit, after experimenting and comparing for a period of five years. The audio amplifier is the one utilized by him at his own home and which has received favorable comment from musical critics and other individuals well versed in acoustics and musical lore.

The unit consists of a stage of transformer coupled push-pull audio amplification and a stage of impedance-capacity coupled push-pull audio amplification, four tubes being utilized in the amplifier. The frequency characteristics of this amplifier have been found to be such as to produce in conjunction with a good loudspeaker a harmony of frequency relationship most closely approximating the ideal and most pleasing to the ear of the listener. After all, the final judge of the capabilities of an audio amplifier is the person listening to the music emitted from the speaker;—in this respect the amplifier described, when used in conjunction with a well stabilized radio receiver has been classed as "ne plus ultra."

One can appreciate the power handling ability of this amplifier by considering the fact that the input tubes are two 112s and the output tubes are two 171s. The plate voltage applied to the 112 tubes is 135 volts and to the

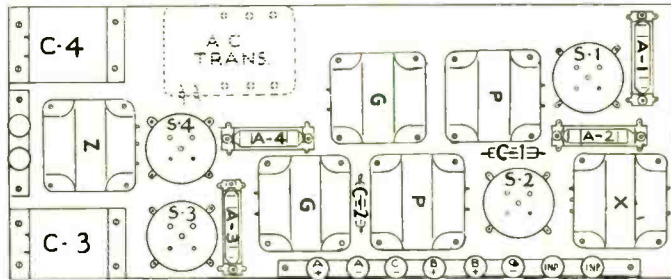
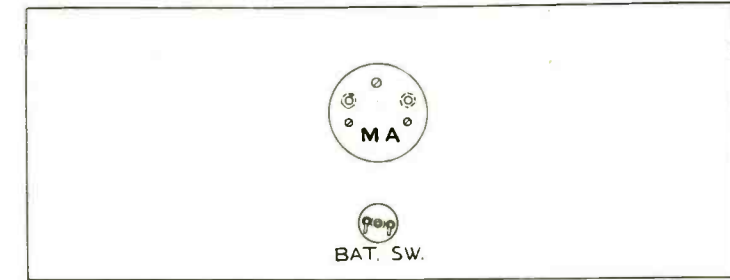

Layout plans of Mr. Rider's special impedance push-pull power amplifier.

171 tubes 180 volts. In this way the greatest bugaboo of audio amplification, tube overloading, is greatly minimized. A plate milliammeter func-

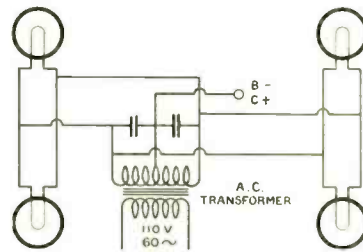

Connections which can be used for A.C. filament supply in the impedance push-pull amplifier.

tioning as a distortion meter is connected in the plate circuit of the output tubes.

This meter indicates the plate

current fluctuation of the plate circuit of the output tubes. Its function is to facilitate the adjustment of the "B" and "C" voltages applied to the 171 tubes and to indicate tube overloading. A fluctuation when the signal is passing through the tube, greater than 10% of the steady plate current reading is used as an indication of grid current in the output tube grid circuits and adjustments are made to reduce the signal input to the correct value. Under normal conditions when this amplifier is fed from a single stage of audio in the receiver, absolute distortionless amplification is obtained, consistent with all the volume necessary for the home.

The wiring diagrams and other constructional details are shown in the accompanying drawings. The unit can be used for either D.C. or A.C. on the filaments.

#### LIST OF PARTS REQUIRED

- 4— $\frac{1}{2}$  ampere, self-adjusting rheostats (A1, A2, A3, A4).
- 2—Coupling condensers, .01 mfd. (C1, C2).
- 2—Plate impedances (P).
- 2—Grid impedances (G).
- 1—Push-pull output impedance (Z).
- 1—Push-pull input transformer (X).
- 2—Filter condensers, 4 mfd., 400 volt (C3, C4).
- 4—U. X. tube sockets.
- 1—Battery switch.
- 1—Milliammeter, 0 to 50 M.A., D.C.
- 1—A.C. transformer with output of 5 volts and 2 amps.
- 10—Binding posts.
- 1—Panel (7" x 18" x 3/16").
- 1—Baseboard (7" x 18" x 3/4").
- 2—Vacuum tubes, 112 type.
- 2—Vacuum tubes, 171 type.

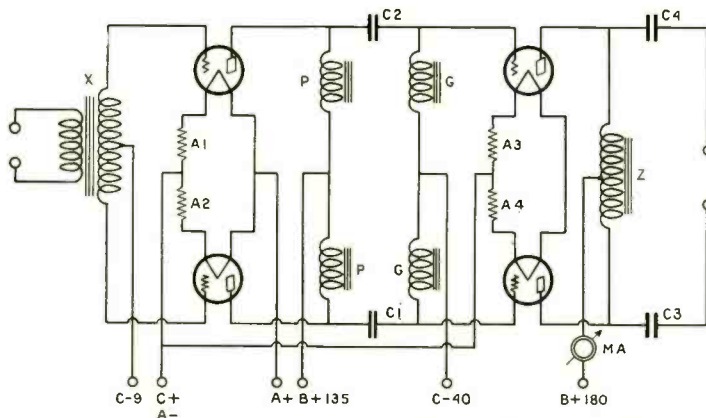

Complete circuit diagram of the impedance push-pull amplifier.

# NEWS OF THE INDUSTRY

## Atwater Kent Becomes R.C.A. Licensee

The most important case in the history of radio patent litigation has been settled, it is announced, by an agreement signed recently between the Atwater Kent Manufacturing Company and the Radio Corporation of America. The agreement came as a result of negotiations carried on by A. Atwater Kent, and David Sarnoff, Vice President and General Manager of the Radio Corporation of America.

The licensing agreement, it is stated, provides for payment by the Atwater Kent Manufacturing Company to the Radio Corporation of America of royalties on sales of radio receiving sets manufactured by the Atwater Kent Manufacturing Company since January, 1923, when the latter organization began the production of tuned radio frequency receivers.

The agreement also provides for the payment of royalties on future sales of such sets made by the Atwater Kent Manufacturing Company. The terms of royalties, it was announced, are based on the standard R. C. A. licensing agreement of 7½ per cent.

Aside from the payment of royalties by Atwater Kent, and the freedom which it gives his company to go forward without being hampered by the lack of basic patents or the distractions of litigation, the licensing agreement will have no other effect upon the radio industry, which is on a vigorously competitive basis.

## Mohawk Takes R.C.A. License

Gustave Frankel, President of the Mohawk Corporation of Illinois, announces that Mohawk has received the R. C. A. license which gives Mohawk full access to, and use of the patents under control of R. C. A., the General Electric Co., the Westinghouse Electric & Mfg. Co., and the American Telephone & Telegraph Co.

## Detroit Radio Show

The Detroit Radio Show, under the auspices of the Radio Trade Association of Michigan, is scheduled for October 3rd to 9th, 1927, at the Convention Hall, Detroit, Michigan.

The Association promises a real treat for this show in the form of a new type of wall display system for exhibits by parts manufacturers and dealers of parts for custom built sets.

This feature is the Wall Display Niche Plan. By means of this plan the manufacturer's product will be displayed within a small framed niche, having a velvet or other decorated background and fully equipped with lighting facilities. Several of these niches will make up a complete wall display unit and it has been arranged to have three such units in the show.

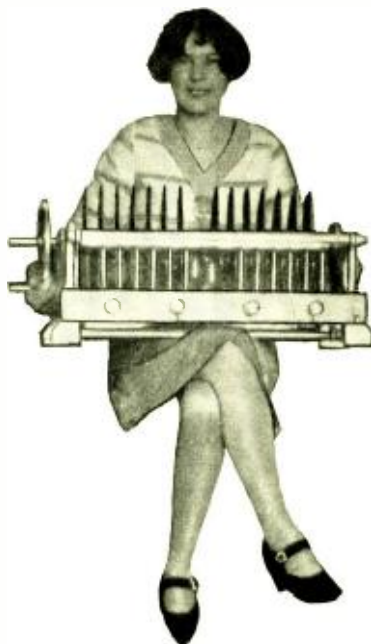

A variable condenser what is! This is the type generally used in the transmitting circuits of broadcast stations.

(Photo, courtesy of the Allen D. Cardwell Mfg. Co.)

The show management is anticipating great results from this innovation of the "silent salesman" idea.

## Freed-Eisemann Appoints New Distributors

Announcement has just been made of the appointment of a new distributor, the Superior Lamp & Auto Equipment Co., 152 West 52nd Street, New York City, who will operate in Manhattan and Bronx. This concern also maintains an office at Newark, N. J., which branch has also been appointed Freed-Eisemann distributor to operate in Northern New Jersey.

The Wholesale Radio Equipment Company, of 115 Leonard St., New York City, with branch office at 37 William St., Newark, N. J., will continue to serve Freed-Eisemann dealers in Manhattan, Bronx and Northern New Jersey.

## New Edition of NEMA Radio Standards

The Third Edition of NEMA Radio Standards, September, 1927, will be available about August 15th.

This issue has doubled the number of standards contained in the second edition of March. The new addition contains about 400 standards as follows: 105 General Standards; 81 Transmitter Standards; 100 Receiver Standards; 52 Battery and Socket Power Standards; 56 Vacuum Tube Standards.

Appendices, occupying a total of 43 pages on Radio Symbols, Revised Underwriters' Rules, I. R. E. Preliminary Standards and a complete cross index, add to the value of the book.

## Amplion Corporation Moves

The Amplion Corporation of America, manufacturers of loud speakers, announce the removal of their business to 531-535 West 37th Street, New York City. Their receiving department is now located at 532 West 38th St., New York City.

## Friedman-Snyder Company at New Address

The Friedman-Snyder Company who represent the H. H. Eby Mfg. Co., the Mayolian Corporation, the Kurz-Kash Company, the Wizard Company, and the Langbein-Kaufman Radio Company, have announced the opening of their new offices at 9-15 Park Place, New York City.

## Briggs & Stratton Corp. Appoint New Sales Manager

Mr. C. F. Crane who has been connected with the Briggs & Stratton Corp., for some time past has been appointed Sales Manager of the Radio Division to succeed Mr. W. W. Carroll. Mr. Carroll is leaving the Company to become manager of the Carryola Company of America, with headquarters at Milwaukee.

**ZAPON**  
**PYROXYLIN**  
**LACQUERS**  
**For Every**  
**Industrial**  
**~Purpose~**  
*The Recognized Standard Since 1884*  
**THE ZAPON COMPANY**  
**STAMFORD, CONN.**  
 NEW YORK · CHICAGO · LOS ANGELES · CLEVELAND  
 NEW HAVEN · OAKLAND · DETROIT  
 SAN FRANCISCO

## How to Select a Resistor

Every radio engineer is confronted by two important questions when he selects a resistor—“How accurate is it?” and “How long will it maintain its accuracy under the average load?” Until the resistor answers these two with perfect satisfaction, all other questions are unnecessary.

Here's how Hardwick, Field, Inc., answers them:

1. Harfield Resistors can be supplied to you as accurate as plus or minus 1%, if you wish.
2. Under average load conditions, all Harfield Resistors are guaranteed to maintain the accuracy your order specifies.

Tell us about the resistor you want and let us send you a sample with prices. Write Hardwick, Field, Inc., 215 Emmet Street, Newark, N. J.



## IF —

- A designer wishes some specialized information to help him meet a problem.
- A dealer would like technical data to aid him in his selection of lines.
- A production manager wishes to learn about sources of supply.
- A professional or custom set builder wants dope about a new circuit or system.

*they write Radio Engineering*

Radio Engineering usually has this data available at a moment's notice. If not, it is obtained from the proper source and passed on to the person who is interested. Additions have been made to our editorial and service staffs to make possible an Information Bureau for your use.

**Address: Reader's Information and Service Bureau**

*Perhaps you don't get the magazine regularly. The coupon below is for your convenience*

**Radio Engineering Magazine, Inc.,**  
 52 Vanderbilt Ave., N. Y. City.

Enclosed find \$2.00 for which enter my subscription to Radio Engineering \$3.00 for 1 yr. beginning with the next issue. \$1.20 for 2 yrs.

Name.....  
 Address.....  
 Town and State.....

C  
O  
N  
D  
E  
N  
S  
E  
R  
S



Condenser Unit (unmounted)

C  
O  
N  
D  
E  
N  
S  
E  
R  
S

**CONTRACT WORK EXCLUSIVELY**  
 The Concourse Electric Co. devotes their entire time and energy in assisting manufacturers to meet special condenser conditions. We are Fixed Condenser Specialists. Today we are serving 95 per cent of those manufacturers we served two, three and even four years ago. That speaks of one thing—Satisfactory Service. Our Engineering Department solicits the opportunity of working with your staff in meeting exacting requirements.

**CONCOURSE ELECTRIC COMPANY**  
 294 East 137th St., New York, N. Y.

C  
O  
N  
C  
O  
U  
R  
S  
E



Condenser Assembly for 350 to 400 Mil. Series Wired Power Sets

C  
O  
N  
D  
E  
N  
S  
E  
R  
S

# NEW DEVELOPMENTS OF THE MONTH

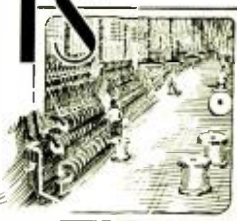

## Samson Filter Choke

The 30-henry Choke No. 380, manufactured by the Samson Electric Co., Canton, Mass., is designed to meet the requirements in "B" eliminator and other circuits where chokes carrying up to 80 milliamperes direct current are required, and where these chokes will need to have inductances of 30 henrys. This particular choke is mounted in a case approximately 1½ times the size of the standard Samson



Samson Filter Choke.

audio units case, and having a very similar physical appearance. The direct-current resistance of this choke is but 200 ohms. The efficiency, therefore, is very high, and the drop in direct voltage relatively small.

The Samson 30-henry Choke No. 312 has the necessary characteristics for use in circuits where the direct current must reach values as high as 120 milliamperes, and where the inductance value must be 30 henrys. This choke has the same physical dimensions as the No. 380. Its direct-current resistance is 200 ohms.

## Samson Power Block

The Power Block No. 713, manufactured by the Samson Electric Co., Canton, Mass., is designed to furnish



Samson Power Block.

the necessary energy from a 105-110-115-120-volt 60-cycle power supply for 180 volts direct current at 50 milli-

amperes. Although this block is rated at 50 milliamperes, it is capable of furnishing currents up to values as high as 80 milliamperes. The Power Block No. 713 contains, in addition to the two chokes mentioned above, one special "B" eliminator transformer. All leads are brought to a terminal block on the face of the unit where connections are readily made. In addition, the transformer has windings for supplying the filament current of a UX or a CX-380 tube, and an additional winding for supplying the filament current of one 171 tube. The transformer in this unit is rated at 30 watts.

The Power Block No. 718 is arranged to supply from 105-110-115-120 volts 60-cycle power supply 200 volts direct current up to 80 milliamperes.

The Power Block No. 210 is designed to furnish from a 105-110-115-120-volt 60-cycle power source 500 volts direct current up to 80 milliamperes. This combination is especially suited for a "B" supply for the 210 tube, and therefore may be associated with any amplifier where a large power output or a small relatively undistorted power output is desired.

## "Braidite"

"Corwico" Braidite is a hook-up wire made from either solid or

"Braidite" hookup wire.



stranded tinned copper wire covered first with a cotton wrap and then with a cotton braid. The product is then impregnated with a damp proof compound making it impervious to moisture and adding to its insulating qualities. The chief merit of this product lies in the fact that in order to make a soldered connection, it is unnecessary to strip back the insulation. The braid is simply pushed back while the soldering is done and then replaced thus forming the neatest possible connection.

Braidite comes in five colors: red, green, yellow, brown and black. It is made by the Cornish Wire Works, 30 Church St., New York City.

## General Radio Low Voltage Transformer

Among the new parts for A. C. operation now being made by the General Radio Co., Cambridge, Mass., is



General Radio Low Voltage Transformer.

the type 440-A Low Voltage Transformer. This transformer provides voltages for all popular tubes and sufficient current for all ordinary receiver requirements, state the manufacturers, and according to them filament supply is available for filament, separate heater, power and rectifier tubes. They also set the capacity at a total load of 70 watts on 105-125 volts, 60 cycles alternating current.

## General Radio Center Tap Resistance

To fit the requirements of the new A. C. tubes this center tap resistance unit has been designed. The center tap



General Radio Center Tap Resistance.

provides the point of connection for the positive grid and negative plate potential sources. The type 439 is designed to fit directly across the tube socket, relieving the necessity of a separate mounting.

# CUSTOM SET BUILDING

Radio sets, "made to the measure" of local conditions, are assuming greater importance than ever before. Thousands of set-building organizations and individuals are now functioning to supply the public with custom-built receivers adapted to individual requirements.

Beginning with this issue, *Radio Engineering* will cover this phase of radio activity from A to Z. How to start and operate a custom-set building establishment—how to contact with and *sell* the consumer—testing, installation, servicing, etc.

In conjunction with this material, literally scores of different construction sets, amplifying systems and power supply systems will be reviewed and described.

Readers of *Radio Engineering* are invited to send in the name or names of technical men, professional set builders, service men, students, etc., who will be interested in this material. We will be glad to send sample copies of the magazine to anyone recommended by our present readers.

*New Two-Year Subscription Rate, \$3.00*

RADIO ENGINEERING MAGAZINE, Inc., 52 Vanderbilt Ave., N. Y. C.

Enclosed find check—money order— } for \$2.00  
 } for \$3.00 for which send me

Radio Engineering for { 1 year, commencing with October, 1927.  
 { 2 years,

Name.....  
Street.....  
City.....  
State.....

Please Check Below

I am a  Dealer  Mechanic  Jobber  Manufacturer  Engineer  Prof. Set Builder

Anything Else.....  
.....

### General Radio 5-Prong Socket

This new socket is designed for the UY-227 or C-327 type vacuum tube, which has a five-prong base. Contacts

General Radio  
5-Prong  
Socket



are made to the sides of the tube prongs with double gripping springs. The base is of moulded bakelite. Made by the General Radio Co., Cambridge, Mass.

### F.M.C. Speaker Filter

The F. M. C. Speaker Filter manufactured by the Ford Radio & Mica Corp., 111 Bleecker St., New York, is enclosed in a neat black crystalized metal case with a Bakelite insulation board on one side holding and insulating a pair of phone jacks into which the loud speaker cord is inserted; and a phone cord on the other side which is inserted in the loud speaker terminals of the radio set.



F.M.C. Speaker Filter.

It is designed to be used as a filter to keep the high current required in the plate circuit of power tubes out of the windings of the loud speaker. It not only protects the loud speaker from excessive high current flow, but improves the quality of reproduction because the constant D. C. strain is entirely eliminated from the speaker windings.

It is easily connected to any receiver and provides ample protection for the loud speaker where power tubes are used in the receiver.

### Briggs & Stratton Power Units

The Briggs & Stratton Corporation, Milwaukee, Wis., announce a complete line of "Basco" light-socket radio power units, which will be available for the fall radio trade. This line includes:

Combination "A" and "B" power, "A" unit, "B" unit, and 2½ ampere charger.

The leader of the line is the combination "A" and "B" power—a compact unit that is adapted to operation with any 6-volt radio set of from 1 to 10 tubes. This unit, as well as the "A" power independent unit, employs a glass-jar Exide "A" battery, which is charged during idle radio periods by an automatically controlled, integral charging unit. Power is delivered to the radio set from the battery only—the power line is automatically shut off from the filament circuit during operation of the radio set. This eliminates the possibility of line noises or rectifying hum, which sometimes develop when "A" power is delivered direct from the lighting circuit to the tube filaments.



"Basco" "A" and "B" Power Unit.

Neither the combination "A" and "B" nor the independent "A" unit employ a trickle charge. The charging unit is automatically turned on when the radio switch is turned off. Charging continues until the used voltage has been fully replenished and the charging unit then automatically shuts off. A high initial charging rate is used, with a gradual taper-off as the battery voltage is built up.

A new feature introduced in the Basco combination "A" and "B" and "A" units, is a special emergency switch, used only for reconditioning the battery after it has stood idle for a considerable period of time. By simply turning this switch on, the battery is recharged and the former automatic operation then continues.

An oil film is placed on top of the electrolyte solution in the cells, the object of this being to eliminate gassing and spraying of solution. The glass jar, with high and low water levels indicated on the glass, eliminates any chance of filling cells with water to the point of overflowing.

### Belden Radio Lightning Arrester

The Belden Manufacturing Company, 2300 S. Western Avenue, Chi-



Belden Lightning Arrester

cago, Illinois, have added an improved radio lightning arrester to their large list of radio accessories.

This arrester is of the non-air-gap type, sturdy in construction and with a heavy porcelain body which provides a weather-proof enclosure for the electrodes. It is a reliable radio protector and may be installed either inside or out-of-doors. Approved by the National Board of Fire Underwriters.

### Radio Receptor Powerizers

The Radio Receptor Co., Inc., 106 Seventh Ave., New York City, have just given out their advance announcement on the Powerizer line.

The Powerizer Units, giving both filament and plate supply for receiving sets, are now being made in various models.

Powerizer P-1 is for use with standard receiving sets. Powerizer PXY-1 is made for use on sets with the UX226 and UY227 tubes and has incorporated in it the necessary filament supply taps; at the same time supplying "B" current for the set and "C" voltage for the power tube. Another type is the PXY-2, incorporating two stages of audio amplification with the UX226 and the UX210 in the first and second stages respectively.



Radio Receptor Powerizer.

Special outfits are also made in the Powerizer line among which are the Powerizer PXY-1 Radiola 20 Special Unit, the Atwater Kent Special Powerizer and the Powerizer PX-2. The latter is made to function in connection with electrical pick-ups for phonographs.

### New Greene-Brown "B" Power Units

Three new "B" power units are being marketed by the Greene-Brown Mfg. Co., 5100 Ravenswood Ave., Chicago, Ill. The new Greene "B" 5-6-7 model is suitable for all receivers using 1 to 7 tubes, with maximum rated capacity 35 milliamperes at 135 volts. The new Greene "B" III-Power model, "big brother" to the Greene "B" 5-6-7, has six output voltage terminals; B—45+, 67+, 90+, 135+ and 180+ volts. This model will operate all re-



# TUBE TRUTHS

YOU —

the ENGINEER  
the MANUFACTURER  
and the USER

are more interested in the simple truths about a tube than in the flourishes of a clever advertising pen.

We have prepared technical and non-technical data on the complete line of ARCTURUS tubes — detector, amplifying and power tubes. The alternating current heater tubes with the four prong base.

This data is yours on request.

We have endeavored to tell the story of A.C. operation, and the characteristics of ARCTURUS tubes with an impartiality seldom associated with the confident knowledge of an unusually fine product.



The Arcturus Radio Co.

255 Sherman Ave.,

Newark, N. J.



**To Tell the World Again!**



Metallized Grid Leak or Resistor



Bakelite Molded Condenser



Filter Condenser



Pure Metal Grid Leak or Resistor



Polytrole Tube Ballasts



Metal Base Rheostats and Potentiometers

AGAIN the advertising of the Polymet Manufacturing Corporation will tell the world of the high quality and dependability of Polymet Products. This national advertising begins with the September issues of the leading trade and fan papers thruout the country and will be run in conjunction with a very comprehensive newspaper campaign to continue thru the entire selling season. Live dealers are now stocking Polymet Products. They are the staples of the industry. Don't neglect these staples—they bring customers to your store.

*Send for our latest catalog which includes several of the most popular power circuits*

See our exhibit at Radio World's Fair, Madison Square Garden, New York City—Sept. 19th to 24th. Booth No. EE15.

**Polymet**  
Manufacturing Corp.  
599 Broadway, N. Y.

**POLYMET PRODUCTS**

ceiving sets of 1 to 10 tubes having heavy current draw not to exceed 55 milliamperes at 180 volts.



Greene-Brown "B" Power Unit.

Both units are equipped with simple control for all line voltage fluctuations. Designed for receiving sets of 1 to 12 tubes, the Brown "B" Super-Power is made for extra heavy duty work on extremely sensitive sets. The rated capacity is 80 milliamperes.

### Remote Control for Receiving Sets

The Algonquin Electric Company, Inc., 245 Fifth Ave., New York, has now brought out a "Remote Control"



Algonquin Mechanical Remote Control.

by which a set may be operated by one control only and at a distance from the instrument.

By means of this "remote control" the set owner may control his set from across the room—in this case a mechanical connection—or he may purchase an electrical control and install his set anywhere he likes around the premises.



Algonquin Electrical Remote Control.

The set owner can attach "Remote Control" to his old set—provided it is a single control instrument, by simply removing the dial, attaching "Remote Control" and making one simple hook-up to the rheostat terminal.

### Acme Power Units

Recent developments include two new current supply units, a "B" unit

and a combination "A & B" unit, being manufactured by the Acme Electric Manufacturing Co., 1444 Hamilton Ave., Cleveland, Ohio.

The "B" unit is made in two types, the BE 40 recommended by the makers for six and eight tube sets, and the BE 60 for sets employing any number of tubes. Power tubes may be used with either and both have two variable controls. The capacity of the BE 40 is given as 40 milliamperes at 150 volts and of the BE 60 as 60 milliamperes at 180 volts.

The "A & B" socket power unit is also made in the same two sizes as the "B" unit. It consists of a 40 ampere-hour storage battery plus an Acme BE power supply unit, trickle charger and automatic control switch.



Acme "A" and "B" Power Unit.

The AB-1, 40 mills at 150 volts has one external control placed in the primary side of the power transformer with fixed internal resistors. The AB-2 has a capacity of 60 mills at 180 volts and is supplied with three controls, one external and two internal. Both are automatic in operation and controlled by a switch at the set.

### The "Voltrol" Variable Resistor

Automatic Appliances, Inc., of Dayton, Ohio, are manufacturing a variable resistance of the compression type. According to the manufacturer, the Voltrol cannot pack nor will pounding or jarring change the resistance value to which it is adjusted.



"Voltrol" Variable Resistor.

Voltrol is manufactured in two sizes. VR-1 has a range from 0 to 500,000 ohms and VR-2 a range from 0 to 5 megohms.

### Dongan Low Voltage Transformer for New A C Tubes

Another power supply transformer has been added to the long list announced during the past year by the

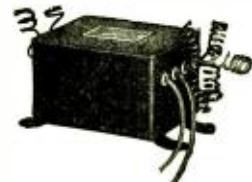

Dongan Low Voltage Transformer.

Dongan Electric Manufacturing Company of Detroit.

This newest transformer, No. 4586 Low Voltage A C Power Supply Transformer, is designed for use with the new RCA-A. C. Power Tubes, UX 226 amplifier tubes and UY 227 detector tube. Incidentally the No. 4586 transformer will function also with the 171 power amplifier tube.

### New Aerovox Bypass Condenser

Two condensers designed by the Aerovox Wireless Corp. for bypass work in receivers, amplifiers and eliminators where the working potential is not greater than 200 volts D. C., have been announced.



Aerovox Moulded Bypass Condenser.

This type of condenser is moulded in bakelite, sealed with a non hydroscopic wax and is impervious to moisture after completion. Filter condensers moulded in bakelite for bypass work are available in capacities up to 1 mfd.

### Centralab Fourth Terminal Potentiometer

Each of these units provide one resistance adjustment that is fully variable from the panel in usual potentiometer fashion, and a second adjustment on the same resistance that may be used either as a fixed or variable voltage tap.

These new units are wound with wire of ample size to carry the maximum output of any "B" eliminator. The frame of the unit is made up of metal and asbestos. Manufactured by Central Radio Laboratories, 16 Keefe Avenue, Milwaukee, Wisconsin.

Write for Full Details  
on the New Improved



No ordinary standards of performance can be applied to the 1927-1928 Hi-Q Six Receiver. Last year recognized as the fullest value available on the market for its price; this year the fullest value in radio at ANY PRICE. Last year a five-tube set, this year a six-tube masterpiece, with complete isolation of four-tuned circuits; automatic variable coupling, complete adjustable aluminum shielding, steel chassis, illuminated drum dial control and other important features. Designed by ten foremost American radio engineers, this remarkable instrument must achieve even greater popularity than any other receiver developed by this organization. Full particulars with illustrations and diagrams will be sent upon request. No charge or obligation.

Associate Manufacturers

- |                      |                         |                       |
|----------------------|-------------------------|-----------------------|
| Carter Radio Co.     | Benjamin Elec. Mfg. Co. | Hammarlund Mfg. Co.   |
| Radiall Company      | Co.                     | International Resist- |
| Sampson Elec. Co.    | H. H. Eby Mfg. Co.      | ance Co.              |
| Sangamo Elec. Co.    | Yaxley Mfg. Co.         |                       |
| Westinghouse Micarta | Acme Wire Co.           |                       |

HAMMARLUND-ROBERTS, INC.  
1182 Broadway Dept. G. New York

PHOTO-ELECTRIC CELLS  
THE BURT CELL

- WITHOUT FATIGUE
- HIGHLY SENSITIVE
- ABSOLUTELY REPRODUCIBLE
- INSTANTANEOUS IN RESPONSE

The BURT-CELL is made by a new method and should not be confused with any other photo-electric cell. By a special process of electrolysis, the photo-electric metal is introduced into a highly evacuated bulb directly through the glass wall of the bulb, giving photo-electric material of absolute purity. The superiority of the BURT-CELL is due to these features, making possible results never before obtainable.

Write for Bulletin No. 271

DR. ROBERT C. BURT  
Manufacturing and Consulting Physicist  
327 S. Michigan Ave., Pasadena, Calif.

The Builder's Supply House

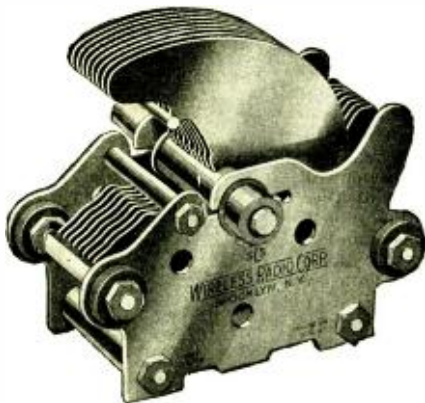

Manufacturers and Custom Builders

Manufacturers and Custom Builders are invited to communicate with us. A complete line of parts at economy prices. Midgets, Gans, Neutralizing and Special Type Condensers—Transformers—Dials—Theostats—Brackets.

WIRELESS RADIO CORPORATION  
43 Varick Ave. Brooklyn, N. Y.

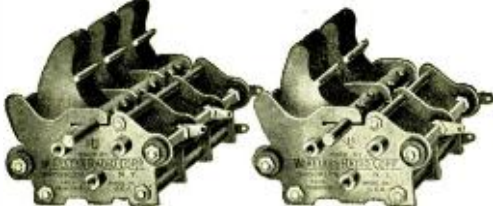

CARTER

NEW  
CARTER Vitreous  
Enameled Resistors



Wire wound

Coated with vitreous enamel to protect wire from mechanical injury and oxidation. This hard, glassy enamel has the same rate of expansion as the porcelain tube and the resistance wire, thus permitting operation without damage.

Guaranteed permanently accurate within 5 percent of rated value.



In Canada:  
Carter Radio Co., Ltd.,  
Toronto





**UNITED  
SCIENTIFIC  
TYPE UXB**

## MANUFACTURERS JOBBERs and DEALERS:

THE manufacturer and jobber will find the United Scientific, type UXB Condenser, capable of solving every condenser problem. Jobbers and dealers can make money stocking this universal precision instrument, which is adaptable to ANY circuit. It can be mounted for all sorts of drives and ganged in any number.

**Characteristics:**

1. Patent leveled brass rotor stator.
2. Precision spacing that assures accurate calibration.
3. Removable shaft can be adjusted to any desired length. Adapable to ganging in any number.
4. Universal mounting permits clockwise or counter clockwise rotation. Provided with integral frame lugs for sub-panel mounting.
5. Modified straight-line frequency curve to take care of present day broadcasting wavebands.

This new condenser is made in .00035 and .0005 sizes. May be had in single, double, triple and quadruple models. The extremely low price of this quality instrument is another reason why you should use it.

**Make Further Inquiries TODAY**

See Our Exhibit at the  
**FOURTH ANNUAL RADIO WORLD'S FAIR**  
New Madison Square Garden, New York  
September 19th to 24th Inclusive  
Booth - 1 Section Z

**UNITED SCIENTIFIC LABORATORIES, Inc.,**

80-82 Fourth Avenue

New York City

Branch

Offices

Chicago  
Cincinnati

St. Louis  
Los Angeles



Boston  
Minneapolis

Philadelphia  
San Francisco

Canadian Offices:

London, Canada.

## WHAT'S NEW?

RADIO ENGINEERING asks manufacturers, dealers, and promoters to send in monthly information about their new products, campaigns, changes in personnel, exhibits, etc. At the same time the technical staff would like literature for the use of the Readers' Service and Information Bureau. Many already are setting a precedent by sending RADIO ENGINEERING systematized monthly data. We want more—we want all of you in.

**GET IN LINE!**

Let "NEWS OF THE INDUSTRY" and  
"NEW DEVELOPMENTS OF THE  
MONTH"

*Grow with You.*

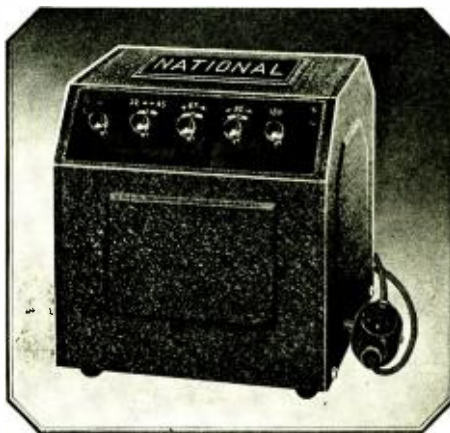

AN ENTIRELY NEW AND  
UNIQUE

**Heavy Duty Better-B**

Supplies detector voltages from 22 to 45, adjustable; R. F. voltages from 50 to 75; A. F. voltages from 90 to 135. Power tube voltage 180 fixed. Tubes and by-pass condensers are protected against excessive and harmful voltages. An Exclusive Feature. **DESIGNED FOR LASTING SERVICE WITH LIBERAL FACTORS OF SAFETY.**

A Strictly Heavy-Duty  
Power Unit

Output rating is 70 mils at 180 volts. Uses R.C.A. UX-280 or Cunningham CX-380 Rectron. Licensed under patents of Radio Corporation of America and Associated Companies. For 105-115 volts, 50-60 cycles A.C. List price with cord, switch and plug, \$40.00. Rectifier Tube \$5.00. Write National Co., Inc., W. A. Ready, Pres., Malden, Mass., for new Bulletin E-123.

Type 7180

A "B" That's Built for Service

At Booth 5—Sect. F. F., New York Radio World's Fair—  
Booths 94 & 95, Boston Show

# NATIONAL



## High Resistance Voltmeter For The Set Owner



Pattern No. 139

The need for a low priced high resistance voltmeter, sensitive enough to give comprehensive readings when used for B-eliminator voltage checking and suitable also for general circuit and battery testing, has been obviously felt by set owners and builders since B-eliminators have found general use.

In the Jewell Pattern No. 139 B-eliminator voltmeter the set owner will find all the fine qualities of an expensive high resistance voltmeter, but at a reasonable cost. The Pattern No. 139 is of the same permanent magnet moving coil D'Arsonval movement, as are the larger types of high resistance meters. Movement parts are silvered, and the scale is silver etched with black characters. The instrument is pleasing in appearance and well adapted to its intended use.

See this new voltmeter at your dealers or write us for descriptive circular No. 1103.

### Jewell Electrical Instrument Co.

1650 Walnut Street -- Chicago

"27 Years Making Good Instruments"



B. A. 1. Balanced Armature Unit 3 11/16" x 3 5/16".

## New AMPLION

Balanced Armature Units—for air-column or Cone

They embody many impressive new features to insure quality in any set.

1. Diaphragm with point of application off center to reproduce successfully, high and low frequencies.
2. Straight bar magnets of finest English Tungsten steel—the most efficient type of construction.
3. Armature pivoted sturdily to insure permanent efficiency.

Our Engineering Staff is always at the disposal of Set Manufacturers.

THE AMPLION CORPORATION OF AMERICA  
531-535 West 37th Street, New York City



## Read the AMSCO RESISTOR HAND BOOK

By ZEH BOUCK

Write for Bouck's new book on Resistor uses and requirements, with tables and data on Eliminator construction and operation.

Gives complete details of the new AmSCO Metaloids—the non-hygroscopic, permanent and accurate resistors.

Price 25c postpaid.

AMSCO PRODUCTS, INC.  
Broome & Lafayette Streets  
New York City



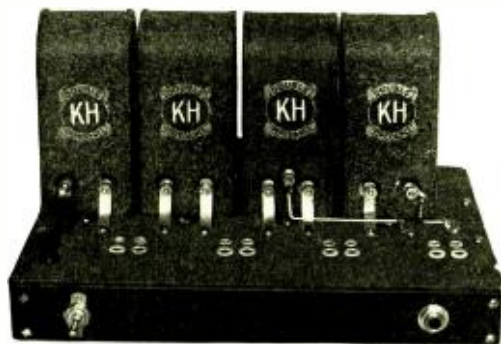

# HARKNESS

## Tuned Double Impedance Push-Pull Amplifier

ALL the latest improvements in the Hiler system of tuned double impedance audio amplification are included in this new amplifier designed by Kenneth Harkness and licensed under Hiler audio patents. The push-pull output stage eliminates the last trace of distortion. The amplifier can handle more volume and the tone quality is better than ever.

### Makes Tone Perfection a Thrilling Reality!

The reproduction of this new amplifier is more realistic than anything you have ever heard before. Speech and music are reproduced in pure, rich, natural, full-rounded tones. Every musical note, from the deepest bass to the highest treble, is heard with full volume and with all its distinctive tone-color. Never before has it been possible to re-create musical sounds with such marvelous fidelity.

### You Can Make Big Money on Sales

The Harkness amplifier will greatly improve the volume and tone quality of your set. You can attach it in a few moments, without tools, and without making any changes in your set. Then demonstrate it to your customers and you can sell them by the score - at a real profit. One of our dealers sold 15 amplifiers in two weeks - a profit of nearly \$250.00.

### Your Satisfaction Guaranteed — Order NOW!

The Harkness amplifier is unconditionally guaranteed. Mail your order today and the amplifier will be sent you by return. Attach it to your set and hear the improvement. If you are not entirely satisfied, return the amplifier and your money will be instantly refunded. Only a limited number of amplifiers are available at the special low price of \$19.50. Mail your order NOW!

Prices to Dealers and Set-Builders  
**Tuned Double Impedance Push-Pull Amplifier**  
 Complete, ready to operate } **\$19.50**  
 List \$35.00

**Tuned Double Impedance Push-Pull Amplifier Kit**  
 (1st and 2nd stage couplers, push-pull coupler and push-pull output unit) } **\$12.75**  
 List—\$23.50

**Pair of Push-Pull Units**  
 (Push-Pull Coupler and Output Unit) } **\$7.50**  
 List—\$12.50

## K. H. Radio Laboratories, Inc.

Kenneth Harkness, Pres. & Chf. Engineer.

181 Sullivan St., New York

Platinum Radio **ARMOR** Filament Tubes

*"A Tube For Every Need"*

Quality **Selectivity** Volume  
**SUPERIOR**

Desirable jobbing territories still open.

Armstrong Elec. & Mfg. Co., Inc., Newark, N. J.

**6503 MILES** on loud speaker with the new **DAVEN BASS NOTE RECEIVER**

**THE Daven Bass Note Receiver** will satisfy any distance fan, witness the authenticated loud speaker record of E. A. Johnson, Hoquiam, Washington, who got 4QG Brisbane, Australia, not once, but several times.

We have a special proposition for every dealer and every set builder in the country. Write on your letterhead for the new Daven plan on this new kit. Kit includes every part down to the last screw, but does not include cabinet or tubes.

**COMPLETE KIT \$68.50**

*We'll show you how to make money with the new Daven Bass Note Kit—Write today for full particulars.*

**DAVEN RADIO CORP., 170 Summit St., Newark, N. J.**



Ehlert's Super Excellent Desk

### PROFESSIONAL SET BUILDERS

Ehlert's beautiful Cabinets are made in 8-10 and 12 inch depths for any special advertised circuit, 27 styles in Consoles, Desks, Tables, Speaker models and High Boys.

Any cone speaker up to 21 1/2" high can be put into our desk or speaker models. Same will swing out with the door when opening, leaving ample space and easy access to accessories.

All models carried in Chicago stock. Write today for complete descriptive catalogue.

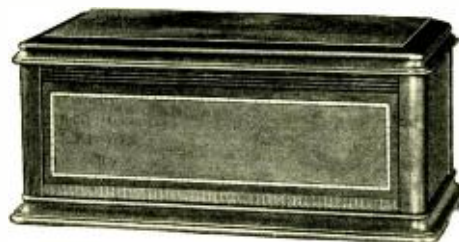

Ehlert's Super Excellent Table Cabinet

### EHLERT RADIO FURNITURE COMPANY

2468 LINCOLN AVE., CHICAGO

*Sept 28*



—reduces its advertising rate

17%

—not by cutting rates — but by an INCREASE IN CIRCULATION

THE Net Paid circulation of RADIO NEWS for the six months period ending June 30th of this year shows an INCREASE over the six preceding months of 31,838 copies per month. This means that you are getting 17% more circulation now, without additional cost.

It has been steadily increasing its circulation leadership of 3 times that of any other Radio monthly.

RADIO NEWS should head your list of consumer and dealer publications.

*Advertising Forms for the December Issue Close Oct. 1st*

**Experimenter Publishing Co., Inc.**  
230 Fifth Ave. New York, N. Y.

*Representatives*

CHICAGO: L. F. McClure, 720 Cass St.  
KANSAS CITY: Davies, Dillion and Kelly, 15 West 10th St.  
SAN FRANCISCO: A. J. Norris-Hill Co., 5 Third St.  
LOS ANGELES: A. J. Norris-Hill Co., 412 W. 6th St.  
BOSTON: T. F. Magrane, Park Square Bldg.  
PHILADELPHIA: Harry E. Hyde, 548 Drexel Bldg.

RADIO NEWS the largest publication in its field with a national and foreign distribution offers a more complete coverage at a *lower cost* than any other medium.

RADIO NEWS can put your products on the dealers' shelves and in the hands of the consumer in the shortest possible time.

This means more turnover for you and greater dealer satisfaction.



RADIO NEWS has **Greatest Dealer Circulation**

More dealers in the United States read RADIO NEWS, than any other Radio publication.

Manufacturers can reach the very choicest and most active Radio buyers, set builders and completely cover the Trade Field at once through RADIO NEWS.

No other medium offers this double effectiveness or circulation.

More information on this trade circulation and other facts on RADIO NEWS can be obtained from our nearest office, a list of which are shown in the center panel.

# NEW AERO CHOKE COILS

## The Aero Choke 60

Modern circuits of high sensitivity demand the use of radio frequency chokes in certain parts of the circuit. The Aero Choke-60 is designed to have a uniform choking action over a wide range of wave lengths, including Broadcast bands and Amateur Short Wave bands as well. Many chokes employed on short waves have an unpleasant characteristic of showing so-called "holes" in the tuning range, which is present also on the broadcast band but in a minor degree. These faults are corrected in the Aero Choke 60. Price, \$1.50.



## The New Aero Choke 248

The Aero Choke 248 is especially designed for operation in Aero Transmitter kits 2040K, 4080K, and 9018K, and other circuits. Aero Choke 248 presents a high impedance or choking action over the usual amateur wave lengths. It is wound with a conductor sufficiently liberal to handle transmitters up to 100 Watts. Price, \$1.50.



**AERO PRODUCTS, Inc.**  
Dept. 17  
1772 Wilson Ave., Chicago, Ill.



## ! ATTENTION !

# SERVICE STATIONS

We wish to establish reliable service stations for resistance coupled amplification, power supply circuits and Lata-Balsa reproducers in all parts of the world.

Radio Service men write for our attractive proposition.

**ARTHUR H. LYNCH, Inc.**

General Motors Bldg., 1775 Broadway at 57th St.,  
New York, N. Y.

## Pep Up Your Set

Model "N"  
Vario  
Denser



## X-L PRODUCTS

Easier tuning—correct tube oscillation—more volume and clearness with an X-L VARIO DENSER in your circuit.

Specified and endorsed by foremost radio authorities in all leading circuits. MODEL "N" Micrometer adjustment easily made, assures exact oscillation control in all tuned radio frequency circuits. Neurodyne, Roberts 2-tube, Browning-Drake, Silver's Knockout. Capacity range, 1.8 to 20 M Fd. Price \$1.00.

MODEL "G" Obtains the proper grid capacity on Cockaday circuits, filter and intermediate frequency tuning in super-heterodyne and positive grid bias in all sets. Capacity range, Model G-1 .00002 to .0001 Mfd. Model G-5 .0001 to .0005 Mfd. Model G-10 .0005 to .001 Mfd. Price each with grid clips, \$1.50.

X-L PUSH POST—Vibrations will not loosen, releases instantly. Price, each 15c

Also in strip of 7 on black panel marked in white. Price, \$1.50.

FREE New, up-to-date book of wiring diagrams showing use of X-L units in the new LOFTIN-WHITE constant coupled radio frequency circuit, and in other popular hook-ups. Write today.



**X-L RADIO LABORATORIES** 2423 Lincoln Ave.  
CHICAGO, ILL.

**Lowest Wholesale Prices.**

## Set Builders

We furnish jobs for you. (No fee.)

Capable set builders needed in every community to build Ultra-dyne, Victoreen, Hammarlund-Roberts, Loftin-White, Browning-Drake, Alden Truphonic, Camfield and other popular circuits.

Big money for you if you can qualify. Register at once, giving full particulars regarding experience and references.

**Allen-Rogers Incorporated**  
Kit Headquarters  
118 East 28th St., New York, N.Y.

# FREE

## TO SET BUILDERS AND DEALERS

Write today for our new 1928 Catalog. Shows the latest and best nationally advertised radio equipment. Lists all popular circuits of the year including Tyrman Ten, Magnaformer, Silver Super, Aero Seven, Daven, and numerous others. All parts in stock ready for shipment. No delays. Lowest prices given to Professional Set Builders and Dealers. Write today for this catalog.

**MILLER-WELLES CO.**

18-D West Kinzie Street Chicago, Ill.

# YOUR BIG NEW 1928 CATALOG IS READY

CONTAINING

Complete list of all the standard kits, such as the new Cockaday LC-28, new Hammarlund-Roberts Hi-Q-6, Infadyne, Browning-Drake, Mello-Heald 14, World Record Super-10, Camfield 9, Silver Super, Magnaformer, Nine-in-line and others.

SEND FOR IT TODAY

Write Now

**S. HAMMER RADIO CO.**

305 Atkins Ave. Brooklyn, N. Y.



# WRS is for PROFESSIONAL SET BUILDERS G.H.Q.

## GENERAL HEAD QUARTERS

For many years WRS has been catering to "Hams", experimenters and professional set builders.

We have studied their needs and requirements and have kept steady pace with the latest developments in RADIO so that we are now recognized as GHQ for KITS, SPECIAL APPARATUS and RADIO ACCESSORIES.

Now you can get from one source, in one shipment EVERYTHING—exactly as outlined or specified by the recognized radio authorities and designers.

Think of the SAVINGS—in time, in effort and MONEY. No more delayed shipments from a dozen different sources, no substitutions.

And, WRS offers the most generous trade discounts. The coupon in the corner will bring you our latest catalogue. You can't afford to be without this veritable radio encyclopedia. Complete and up to the minute. DON'T DELAY. SEND FOR IT TODAY.

**WHOLESALE RADIO SERVICE CO.**

6 Church St.,  
New York City.

NEW  
SAMSON  
POWER  
PACK

PACENT  
PHONOVOX

LOFTIN  
WHITE

S.M.  
UNIPACKS

KARAS  
EQUAMATIC

BREMER  
TULLY  
COUNTERPHASE  
SIX

NEW!  
REMLER  
INFRA-DYNE

Hammarlund  
ROBERTS  
HiQ

Wholesale Radio Service Co.  
6 Church St., New York City

Send me your BIG CATALOGUE and place my name on your list to receive the Latest News in Radio.

Name .....

Street .....

City ..... State .....



**It's a Winner!**

# TRUVOLT

**An All-Wire Variable Voltage Control**

B-Eliminators and socket power are coming into general use. Every fan using house current will buy Truvolt to perfect his power devices, because:

- 1—Greater radiation area keeps it cool, on principle of Lindbergh's air-cooled motor.
- 2—Permanent accuracy; long life; made all of wire.
- 3—Potentiometer control; positive electrical contact.
- 4—Nichrome wire resistance with 30 exact readings.

Eight stock types with resistances up to 50,000 ohms. All rated at 25 watts. List \$3.50 each.

*Also full line of wire resistances.*

Write for descriptive circular and full information.  
Dept. 19A, 175 Varick Street, New York  
**"This Is An Eliminator Year"**

# ELECTRAD

# RADIO PANELS

to your order

Small or Large Quantities

BAKELITE  
HARD RUBBER  
LAMINITE

Drilling, Engraving,  
Lithographing,  
Stamping, Punching

**CORTLANDT PANEL ENGRAVING CO.**  
79 Cortlandt St., New York  
— ALL CIRCUIT PANELS IN STOCK —



## Audio Frequency Transformers

A new standard in audio frequency amplification! Tone quality—volume—everything a transformer should give—in the utmost degree with Ferranti.

A.F. 3..... \$12.00  
A.F. 4..... 8.50  
O.P. 1..... 10.00



**Ferranti, Inc.**  
130 W. 42nd St.  
New York, N. Y.

# EBY SOCKETS



The new and improved Eby Socket has 3 Big Features that lift it head and shoulders above its competitors.

1. Contact—a 3 point wiping spring contact the full length of the prong. The contact prongs are snugly enclosed by the material of which the socket is moulded. The prongs cannot spread.
2. Appearance—moulded in Phenolic material with a beautiful stipple finish—the top the exact size of tube base. Small, beautiful and completely contained.
3. Unique Design—easily mounted, either above or below Bakelite, metal or wood. ONE UNIVERSAL MODEL.

**THE H. H. EBY MFG. CO., Inc.**  
4710 Stenton Ave. Philadelphia, Pa.  
*Makers of the Famous Eby Binding Posts*

# Cardwell Condensers

SPECIAL  
MANUFACTURER'S  
TYPE

Write for  
information  
and  
prices

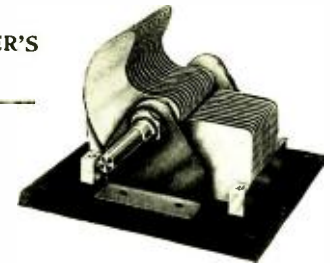

81 Prospect Street ~ ~ Brooklyn, New York



The LOGICAL  
Filament  
Control

# AMPERITE

The "SELF-ADJUSTING" Rheostat

AMPERITE is not a fixed resistor or so-called filament ballast. It is the only self-variable tube filament control—insuring just the proper filament current for each and every tube automatically. Does away with all rheostats on panel. Simplifies wiring and operation. Precludes tube damage from under or excessive "A" current, increasing tube life and always guaranteeing maximum tube performance. It is therefore indispensable.

*We co-operate with dealers and custom builders.*

**Radiall Company**  
50 Franklin St., New York, N. Y.

## PROFESSIONAL DIRECTORY

For Blueprints, Additional Data and Information on  
**The Custom Built ROBERTS-KNOCKOUT**

Reviewed in this Publication  
Send \$1.00 to  
**ALLIED ENGINEERING INSTITUTE**  
250 West 57th St., New York City  
*Radio Engineers and Designers*

*Custom Work a Specialty*  
**H. & F. RADIO LABORATORIES, Inc.**  
*Radio Engineers*  
168 Washington St.  
New York City  
Consulting "SUPER-HETERODYNE" Experts

### PROFESSIONAL SET BUILDERS

You can make more money by using DAR-MAC Precision Products in the custom-built sets you build for your clients. Write today for full information.  
**DAR-MAC LABORATORIES**  
19 So. Wells St., Chicago *2/28*

*Radio Engineering and Engineering Advertising*

### ZEH BOUCK

*Laboratory*  
502 West 143rd St., New York City  
Tel. Edsecombe 9513

### Federated RADIO TRADE SCHOOL

*General Instruction on Service and Set Building*  
Write for Catalog  
**RADIO TRADE ASSOCIATION OF MICHIGAN**  
4464 Cass Ave. Detroit, Mich.

### AUSTIN C. LESCARBOURA

*Technical Publicity for Manufacturers*  
*Laboratory Office*  
Croton-on-Hudson, New York Tribune Bldg.  
Tel. Croton 390 New York City, N. Y.

## TESTING OF RADIO APPARATUS

Condensers calibrated at Radio Frequencies.  
Station Wave Lengths measured and checked—Tube Characteristics determined.  
Wave Meters, Standard Capacities and Inductances calibrated.

### ELECTRICAL TESTING LABORATORIES

80th St. at East End Avenue

New York City, N. Y.

## SHIELDING TERMINALS—ANGLES—DIES



15

METAL STAMPINGS  
TO ORDER

Our Battery of Automatic Presses assures quick service—economy in cost—engineering accuracy.

*MAY WE QUOTE YOU  
ON YOUR WORK?*



38

**F. R. ZIERICK MACHINE WORKS**  
6-8 Howard St., Dept. R. E. New York City

## DIAMOND CUT PRECISION COILS

*for every circuit*

Custom set builders are invited to use us as their supply house for coils for any purpose and in any quantity. We supply coils for practically every set review in RADIO ENGINEERING.

Precision Coils are space wound on diamond cut Bakelite and are guaranteed within 1% of rated inductance. Duo Solenoid, Tuned R. F. and other types.

*Specified for the  
LC-28*

### Lynch Improved Aristocratic

*Send for new 1928 catalog.*

**PRECISION COIL COMPANY, Inc.**  
209 Centre St. New York, N. Y.

## COIL WINDING

Manufacturers of Transformers, Eliminators, Receivers and Power Supply Equipment are invited to send us specifications.

Years of satisfactory service to the leading radio manufacturers.

*We guarantee to follow specifications*

**IRVINGTON VARNISH & INSULATOR CO.**  
IRVINGTON, N. J.

## POWERTONE

36-in. Giant Cone Speaker

### KIT, including stand, \$12

YOU GET—1 Front Sheet (designed); 1 Back Sheet; 2 Metal Baffle Rings; 1 Mounting Bracket; 1 set Apex Fittings; 1 POWERTONE UNIT; 1 Stand; 1 Tube Cement; 1 set Screws, Nuts, etc.

#### FULL INSTRUCTIONS

Can be assembled by any one in 1/2 hour.  
Dealers:—Ask for our attractive proposition.

**POWERTONE ELECTRIC CO.**  
221A Fulton St. New York City  
1 Flight Up.—Cort. 6209



# Buyers Directory of Equipment and Apparatus

Readers interested in products not listed in these columns are invited to tell us of their wants, and we will inform the proper manufacturers. Address Readers' Information Bureau.

Addresses of companies listed below, can be found in their advertisements—see index on page 894.

- ADAPTERS:**  
Bakelite Corp.  
Carter Radio Co.
- AERIALS, LAMPSOCKET:**  
Dubilier Condenser Corp.
- AMMETERS**  
Jewell Elec. Inst. Co.  
Westinghouse Elec. & Mfg. Co.
- AMPLIFIERS, RESISTANCE:**  
Amsco Products, Inc.  
De Jur Products Co.  
Electric-Motive Eng. Co.  
Polymet Mfg. Co.
- ARRESTERS, LIGHTNING:**  
Bakelite Corp.  
De Jur Products Co.  
Jewell Elec. Inst. Co.
- BASES, VACUUM TUBE:**  
Bakelite Corp.  
Zierick Machine Wks.
- BATTERIES, DRY:**  
National Carbon Co.
- BINDING POSTS:**  
Bakelite Corp.  
Eby, H. H. Mfg. Co.  
X-L Radio Labs.
- BOXES, PACKING:**  
Tift Bros.
- BRACKETS, ANGLE:**  
Zierick Machine Wks.
- BRACKETS, SUBPANEL:**  
Bruno Radio Corp.
- BRASS:**  
Copper and Brass Research Ass'n.
- CELLS, PHOTOELECTRIC:**  
Burt, Robert C.
- CHOKES, AUDIO FREQUENCY:**  
Irvington Varnish and Insulator Co.  
National Co.
- CHOKES, RADIO FREQUENCY:**  
Cardwell, Allen D., Mfg. Co.  
Silver Marshall, Inc.
- CHOKES, B ELIMINATOR:**  
Dongan Elec. Mfg. Co.  
General Radio Co.  
Irvington Varnish and Insulator Co.  
Modern Elec. Mfg. Co.  
National Co.  
Samson Electric Co.
- CLAMPS, GROUND:**  
Aurora Electric Co.
- CLIPS, SPRINGS:**  
Aurora Electric Co.
- COILS, CHOKE:**  
Dudlo Mfg. Co.
- COILS, IMPEDANCE:**  
Dudlo Mfg. Co.
- COILS, INDUCTANCE:**  
Aero Products, Inc.  
Bruno Radio Corp.  
Hammarlund Mfg. Co.  
Irvington Varnish and Insulator Co.
- National Co.  
Precision Coil Co., Inc.
- COILS, MAGNET:**  
Acme Wire Co.  
Dudlo Mfg. Co.  
Irvington Varnish and Insulator Co.
- COILS, RETARD:**  
Aero Products Co.  
Hammarlund Mfg. Co.
- COILS, SHORT WAVE:**  
Aero Products Co.  
Hammarlund Mfg. Co.  
Precision Coil Co., Inc.
- COILS, TRANSFORMER:**  
Dudlo Mfg. Co.  
Irvington Varnish and Insulator Co.
- CONDENSERS, BY-PASS:**  
Concourse Elec. Co.  
Dubilier Condenser Corp.  
Globe Art Co.  
Polymet Mfg. Corp.
- CONDENSERS, FILTER:**  
Concourse Elec. Co.  
Dubilier Condenser Corp.  
Globe Art Co.  
Polymet Mfg. Co.
- CONDENSERS, FIXED:**  
Amsco Products, Inc.  
Cardwell, Allen D., Mfg. Co.  
Concourse Elec. Co.  
Dubilier Condenser Corp.  
Electrad, Inc.  
Globe Art Co.  
Micamold Co.  
Polymet Mfg. Corp.
- CONDENSERS, MIDGET:**  
Amsco Products, Inc.  
Cardwell, Allen D., Mfg. Co.  
Hammarlund Mfg. Co.
- CONDENSERS, MULTIPLE:**  
Amsco Products, Inc.  
Cardwell, Allen D., Mfg. Co.  
Hammarlund Mfg. Co.  
United Scientific Laboratories.  
Wireless Radio Co.
- CONDENSERS, FIXED TRANSMITTING:**  
Dubilier Condenser Corp.
- CONDENSERS, VARIABLE TRANSMITTING:**  
Cardwell, Allen D., Mfg. Co.  
Hammarlund Mfg. Co.
- CONDENSERS, VARIABLE:**  
Amsco Products, Inc.  
Bruno Radio Corp.  
Cardwell, Allen D., Mfg. Co.  
Hammarlund Mfg. Co.  
National Co.  
Samson Electric Co.  
United Scientific Laboratories  
Wireless Radio Co.  
X-L Radio Laboratories.
- CONNECTORS:**  
Saturn Mfg. & Sales Co.
- CONTROLS, ILLUMINATED:**  
Martin-Copeland Co.  
National Co.
- COPPER:**  
Copper & Brass Research Ass'n.
- CURRENT CONTROLS, AUTOMATIC:**  
Radlall Co.
- DIALS:**  
Bakelite Corp.  
Eby, H. H. Mfg. Co.  
General Plastics, Inc.  
Martin-Copeland Co.  
National Co.
- DIALS, VERNIER:**  
Martin-Copeland Co.  
National Co.
- ELIMINATORS, B BATTERY:**  
American Transformer Co.  
Dongan Elec. Mfg. Co.  
Martin-Copeland Co.  
National Co.  
Paragon Electric Co.
- ELIMINATORS, UNITS FOR:**  
Dongan Elec. Mfg. Co.  
Paragon Electric Co.
- FILAMENT CONTROLS, AUTOMATIC:**  
Radlall Co.
- FOIL:**  
U. S. Foil Co.
- GALVANOMETERS:**  
Jewell Elec. Inst. Co.
- GRID LEAKS:**  
Amsco Products, Inc.  
De Jur Products Co.  
Dubilier Condenser Corp.  
Electrad, Inc.  
International Resistance Corp.  
Lynch, Arthur H. Co.  
Micamold Co.  
Polymet Mfg. Corp.
- HEAD SETS:**  
Bakelite Corp.
- HORNS, MOLDED:**  
Bakelite Corp.
- IMPEDANCE UNITS, TUNED DOUBLE:**  
Ford Radio and Mica Corp.  
K. H. Radio Laboratories.  
Muter Leslie Co.  
Paragon Electric Co.
- INDUCTANCES, TRANSMITTING:**  
Aero Products, Inc.
- INSTRUMENTS, ELECTRICAL:**  
Jewell Elec. Inst. Co.
- INSULATION, MOULDED:**  
Bakelite Corp.  
General Plastics, Inc.  
Westinghouse Elec. Mfg. Co.
- JACKS:**  
Aurora Elec. Co.  
Carter Radio Co.  
Electrad, Inc.  
Union Radio Co.
- JACKS, TIP:**  
Carter Radio Co.  
Union Radio Co.
- KITS, LOUDSPEAKER:**  
Powertone Co.
- KITS, RECEIVER:**  
Allen Rogers Co.  
Daven Radio Corp.  
(Bass Note)  
Hammarlund-Roberts, Inc., (Hi-Q)  
Hammer Radio Co.  
Miller-Wolles Co.  
United Scientific Laboratories. (Pierce-Aero)  
Wholesale Radio Service Co.
- KITS, SHORT WAVE:**  
Aero Products, Inc.
- KITS, TESTING:**  
Jewell Elec. Inst. Co.
- KITS, TRANSMITTING:**  
Aero Products, Inc.
- KNOBBS:**  
Bakelite Corp.
- LACQUER:**  
Egyptian Lacquer Co.  
Zapon Co., The
- LABORATORIES:**  
Electrical Testing Labs.
- LEAD-INS:**  
Mucher, J. J.
- LOCK WASHERS:**  
Shakeproof Lock Washer Co.
- LUGS:**  
Mucher, J. J.  
Zierick Machine Wks.
- MAGNETS, SPEAKER:**  
Bullens, D. K. Co.
- METERS:**  
Jewell Elec. Inst. Co.  
Westinghouse Elec. & Mfg. Co.
- MOUNTINGS, RESISTANCE:**  
Mucher, J. J.
- NAME PLATES:**  
Crown Name Plate & Mfg. Co.
- NUTS:**  
Shakeproof Lock Washer Co.
- PACKING:**  
Tift Bros.
- PANELS, COMPOSITION:**  
Bakelite Corp.  
Westinghouse Elec. & Mfg. Co.
- PANELS, METAL:**  
Cortland Panel Engraving Co.  
Crowe Nameplate Co.
- PAPER, CONE SPEAKER:**  
Seymour Co.
- PLUGS:**  
Bakelite Corp.  
Carter Radio Co.  
De Jur Products Co.  
Polymet Mfg. Co.  
Saturn Mfg. & Sales Co.  
Yaxley Mfg. Co.

**POTENTIOMETERS:**

Amsco Products, Inc.  
Carter Radio Co.  
Electrad, Inc.  
Federal Radio Corp.  
Micamold Co.  
United Scientific Laboratories.  
Ward Leonard Electric Co.

**RESISTANCES, FIXED:**

Amsco Products, Inc.  
Carter Radio Co.  
Daven Radio Corp.  
De Jur Products Co.  
Electrad, Inc.  
Muter, Leslie F., Co.  
Electro-Motive Eng. Corp.  
Hardwick, Field, Inc.  
International Resistance Corp.  
Lynch, Arthur H., Co.  
Micamold Co.  
Polymet Mfg. Corp.  
Ward Leonard Electric Co.

**RESISTANCES, VARIABLE:**

American Mechanical Labs.  
Amsco Products, Inc.  
Carter Radio Co.  
Daven Radio Corp.  
De Jur Products Co.  
Electrad, Inc.  
Electro-Motive Eng. Corp.  
Federal Radio Corp.  
Hardwick, Field, Inc.  
International Resistance Corp.  
Polymet Mfg. Corp.  
Ward Leonard Electric Co.

**RHEOSTATS:**

Amsco Products, Inc.  
Carter Radio Co.  
De Jur Products Co.  
Polymet Mfg. Corp.  
United Scientific Laboratories.  
Wireless Radio Co.

**SCHOOLS, RADIO:**

National Radio Institute.  
Radio Trade Ass'n of Mich.

**SETS, RECEIVING:**

United Scientific Laboratories.

**SHIELDING, METAL:**

Copper and Brass Research Assn.

Crowe Nameplate Co.  
Zierlek Machine Wks.

**SOCKETS, TUBE:**

Amsco Products, Inc.  
Bakelite Corp.  
Eby, H. H., Mfg. Co.  
Saturn Mfg. & Sales Co.  
Yaxley Mfg. Co.

**SOLDER:**

Chicago Solder Co. (Kester).  
Silva Products, Inc.  
Westinghouse Elec. & Mfg. Co.

**SPEAKERS:**

Amplion Corp. of America.  
Engineers Service Co.

**STAMPINGS, METAL:**

Zierlek Machine Wks.

**STRIPS, BINDING POST:**

X-L Radio Laboratories.

**SUBPANELS:**

Bakelite Co.  
Westinghouse Elec. & Mfg. Co.

**SWITCHES**

Aurora Electric Co.  
Carter Radio Co.  
Saturn Mfg. & Sales Co.  
Yaxley Mfg. Co.

**TESTERS, B-ELIMINATOR:**

Jewell Electrical Inst. Co.

**TESTERS, TUBE:**

Jewell Elec. Inst. Co.

**TESTING INSTRUMENTS:**

Jewell Elec. Inst. Co.  
Westinghouse Elec. & Mfg. Co.

**TESTING KITS:**

Jewell Elec. Inst. Co.

**TESTING LABORATORIES:**

Electrical Testing Labs.

**TRANSFORMERS, AUDIO:**

Dongan Elec. Mfg. Co.  
Federal Radio Corp.  
Ferranti, Ltd.  
Ford Radio and Mica Corp.  
Hiler Audio Co.  
K. H. Radio Laboratories.  
Muter, Leslie F., Co.  
Paragon Elec. Co.  
Radiart Laboratories Co.  
Samson Electric Co.  
Walker, Geo. W. Co.  
Wireless Radio Co.

**TRANSFORMERS, B-ELIMINATOR:**

Dongan Elec. Mfg. Co.  
Ford Radio and Mica Corp.  
Hiler Audio Co.  
K. H. Radio Laboratories.  
Paragon Elec. Co.  
Samson Electric Co.

**TRANSFORMERS, FILAMENT HEATING:**

Dongan Elec. Mfg. Co.

**TRANSFORMERS, OUTPUT:**

Dongan Elec. Mfg. Co.

**TRANSFORMERS, POWER:**

Dongan Elec. Mfg. Co.  
Ferranti, Ltd.  
Hiler Audio Co.  
National Co.  
Samson Electric Co.

**TRANSFORMERS, R. F., TUNED:**

Cardwell, Allen D. Mfg. Co.

**TRANSFORMERS, R. F., UNTUNED:**

Dubilier Condenser Corp.

**TUBES, A. C.:**

Arcturus Co.  
Armstrong Elec. & Mfg. Co.

**TUBES, RECTIFIER:**

Arcturus Co.  
Armstrong Elec. & Mfg. Co.  
Q. R. S. Company, The.  
Universal Elec. Lamp Co.

**TUBES, VACUUM:**

Arcturus Co.  
Armstrong Elec. & Mfg. Co.  
Q. R. S. Company, The.  
Supertron Co.  
Universal Electric Lamp Co.

**UNITS, SPEAKER:**

Amplion Corp. of America.

**VARNISH INSULATING:**

Irrington Varnish and Insulator Co.

**VOLTMETERS, A. C.:**

Jewell Elec. Inst. Co.  
Westinghouse Elec. & Mfg. Co.

**VOLTMETER, D. C.:**

Jewell Elec. Inst. Co.  
Westinghouse Elec. & Mfg. Co.

**WASHERS:**

Shakeproof Lock Washer Co.

**WIRE, ANTENNA**

Acme Wire Co.  
Dudlo Mfg. Corp.  
Roebbing, J. A., Sons, Co.

**WIRE, BARE COPPER:**

Acme Wire Co.  
Dudlo Mfg. Co.  
Roebbing, J. A., Sons, Co.

**WIRE, COTTON COVERED:**

Acme Wire Co.  
Dudlo Mfg. Corp.

**WIRE, ENAMELED COPPER:**

Dudlo Mfg. Corp.

**WIRE, LITZENDRAHT:**

Acme Wire Co.  
Dudlo Mfg. Corp.

**WIRE, PIGTAIL:**

Dudlo Mfg. Corp.

**WIRE, SILK COVERED:**

Dudlo Mfg. Corp.

**WIRE, TINNED COPPER:**

Acme Wire Co.  
Dudlo Mfg. Corp.  
Roebbing, J. A., Sons, Co.

Your "B" Battery Eliminator will give you better service

with

**Q·R·S**  
Trade Mark Registered

Gaseous

**Rectifier Tubes**

**ARE BETTER**

60 Milliamperes - \$4.50

85 Milliamperes - 4.50

400 Milliamperes - 7.00

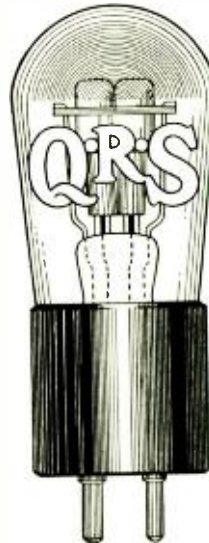

Ask for Catalog of full line of Standard Tubes.

**Guaranteed**

The standing of the Q. R. S. Company, manufacturers of quality merchandise for over a quarter of a century, establishes your safety.

Orders placed by the leading Eliminator Manufacturers for this season's delivery, approximating Four Million Dollars' worth of Q.R.S. Rectifier Tubes, establishes the approval of Radio Engineers.

Ask any good dealer.

The **Q·R·S** Company  
MUSIC

Manufacturers

Executive Offices:

306 S. Wabash Ave., Chicago

Factories: Chicago—New York—San Francisco—Toronto,  
Canada—Sydney, Australia—Utrecht, Holland

Established 1900

References—Dun, Bradstreet, or any bank anywhere

# Are you a RADIO SERVICE MAN?

**This Model 519 Radio Set Tester will make real profits for you.**

The Weston Radio Set Tester enables you to make several times more service calls a day, because not more than ten minutes are required to make a complete check-up on any D. C. or Battery Eliminator operated set. Your profits increase in proportion to the number of daily jobs you can handle—not only in service charges, but through increased sale of accessories.

With the Model 519 you can make the following tests:— Filament and plate voltages; A, B and C battery supply; plate current of each tube, with zero or C battery bias; voltage of B-Eliminator; open transformer windings in the Audio Circuit; open circuits within the set; and shorted or reversed wiring. You can do all this while the radio set is actually in operation.

The illustration shows the complete outfit. It is mounted in a strong mahogany case with leather carrying handles. The instrument has three voltage ranges—200-80-8, and 20 milliamper range.



1000  
ohms per volt

**One dealer serviced 2500 sets in six months with one of these instruments.**

Not as unusual as it seems—hundreds of others are doing it. You, too, can make a similar record and become the radio servicing authority in your community. This tester is simple to operate. A complete instruction book shows you, step by step, how to make every test.

You can master it easily in a few minutes' time. A few turns of the Rotary Switch, located near the dial of the instrument, is all that there is to it. The real work is automatically done for you inside, by means of the ingenious mechanism which provides speed in performing all the required tests.

A short demonstration will show you the amazing possibilities of this set for servicing profits.

See your dealer, or write to us for complete information.

**WESTON ELECTRICAL INSTRUMENT CORPORATION**

200 Weston Ave.



STANDARD THE WORLD OVER  
**WESTON**  
Pioneers since 1888



Newark, N. J.

## INDEX OF ADVERTISERS

A	PAGE	E	PAGE	P	PAGE
Aero Products, Inc.	952	Electrad, Inc.	954	Precision Coil Co.	955
Allen-Rogers	952	Electrical Testing Labs.	955	Professional Directory	955
American Mechan. Labs.		Experimenter Pub. Co.	951		
Inside Front Cover				Q	
Amplion Corp. of America	949			Q. R. S. Music Co.	957
Amsco Products, Inc.	949	F			
Arcturus Elec. Co.	945	Ferranti, Inc.	954	R	
Armstrong Elec. Co.	950			Radiall Corp.	954
Aurora Electric Co.	959	H		Radiart Labs. Co.	959
		Hammarlund Mfg. Co.	899	Roebling, J. A. Son's Co.	959
		Hammarlund-Roberts, Inc.	947		
		S. Hammer Radio Co.	952	S	
		Hardwick-Field Co.	941	Samson Elec. Co.	902
B		Hiler Audio Co.	904	Seymour Paper Co.	959
Bakelite Corp.	Back Cover			Shakeproof Lock Washer Co.	960
Dr. Robert C. Burt	947	I			
Buyers Directory.	956-957	Irvington Varnish & Insulator Co.	955	T	
				Tift Bros.	959
C		J		U	
Cardwell Allen D. Mfg. Corp.	954	Jewell Elec. Inst. Co.	948	Union Radio Corp.	902
Carter Radio Co.	947			United Scientific Labs.	948
Chicago Solder Co.	960	K		United States Foil Co.	959
Concourse Elec. Co.	941	K.-H. Radio Laboratories	950		
Cortlandt Panel Eng. Co.	954			W	
D		L		Weston Elec. Inst. Co.	958
Daven Radio Corp.	950	Lynch, Arthur H.	952	Wholesale Radio Service Co.	953
Dongan Elec. Mfg. Co.				Wireless Radio Corp.	947
Inside Back Cover		M			
Dudlo Mfg. Co.	897	Miller-Welles Co.	952	X	
				X-L Radio Labs.	952
E		N			
Eastern Tube & Tool Co.	959	National Co., Inc.	948	Z	
Eby H. H. Mfg. Co.	954	Nat. Radio Inst.	900-901	Zapon Co.	941
Egyptian Lacquer Co.	959			Zierick, F. R. Mach. Wks.	955
Ehbert Radio Furniture Co.	950	P			
		Polymet Mfg. Corp.	945		
		Powertone Elec. Co.	955		

# TINFOIL

FOR CONDENSERS

All grades of  
TIN FOIL  
LEAD FOIL  
COMPOSITION FOIL  
ALUMINUM FOIL

UNITED STATES FOIL CO.  
LOUISVILLE KENTUCKY

# WIRE

STRAND—Antennae (plain or enameled)—Double Galvanized.  
WIRE—Antennae (plain or enameled) Connecting and Ground (Rubber) covered, braided or plain.  
BUS BAR—Litzendraht—Loop.  
MAGNET (Cotton or Silk).

John A. Roebing Son's Co.  
Trenton, N. J.

# AURORA



Contract work for Manufacturers  
All types of jacks, switches, lead-ins with switch, indoor aerials, grid leak mountings and prongs. Dealers and Jobbers—An attractive Proposition awaits you.

AURORA ELECTRIC CO.

Main Office and Factory 14-18 Dunham Place, Brooklyn, N. Y. Chicago Representative Aaron, Siedman Co., 32 Randolph St.

# LACQUERS

FOR THE

# RADIO INDUSTRY

The Egyptian Lacquer Manufacturing Co.

Dept. R. E.

90 West St., New York City

## Magnaformer

Set Builders, be first—send NOW for the NEW Magnaformer 9-8 Hook-up. The Commander-in-Chief of 1928 Circuits. Now being featured in the Radio Magazines. The very last word in Receivers. Two years ahead of field in Design and Performance. Amazing tone quality. A fiend for distance. Double amplification each I.F. stage. A world of volume. No interference. Its equal has never been achieved. A beautiful looking job. Easy to build. Just the set to build for yourself or for others. Full size circuit blue prints and NOVEL wiring diagram, complete wiring instructions and detailed story of development and accomplishments of Magnaformer, the perfect Long Wave Transformer sent at once for 10 cents. SEND NOW Be first.



RADIART LABORATORIES COMPANY  
19 S. La Salle Street Dept. 116 Chicago

# Announcing!

## Etco New Size Tapper



"Sensitive as your Finger Tips."

- No. 1 Etco Tapper—capacity 1/4-inch.
- No. 2 Etco Tapper—capacity 3/4-inch.

Users of the No. 1—1/4-inch capacity Etco High Speed Tapping Attachment will welcome the announcement of this New Size Etco—the No. 2—capacity up to 3/4-inch.

Etco Tappers eliminate tap breakage, whatever the cause. A "green" operator can bang the bottom of a tapped hole using an Etco and still not break the tap—he has no friction to adjust.

Where Etco Tappers have been installed tap breakage has been eliminated and production increased 100 to 500%.

Try an ETTCO TAPPER for ten DAYS. No obligation for the Trial.

Eastern Tube & Tool Co., Inc. 600 Johnson Ave. BROOKLYN, N. Y.

Custom Set Builders Specify

# ALHAMBRA

CONE SPEAKER PAPER

ALHAMBRA PAPER gives ABSOLUTELY EXCELLENT FORM RESONANCE. It has no resonance point of its own. Just as



the cone speaker is supreme in radio reproduction, so also is ALHAMBRA supreme in imparting the utmost in tone quality.

Just as 9 out of 10 Radio Speaker Manufacturers use ALHAMBRA exclusively—so do the vast majority of skilled professional builders insist upon ALHAMBRA only.

Cone speaker manufacturers, dealers and custom builders are invited to communicate with us concerning their requirements for the coming season. ALHAMBRA is furnished in sheets suitable for cone speakers of 1 1/2 inches to 36 inches diameter—special sizes to order. Prompt shipment guaranteed.

The SEYMOUR CO., 323 W. 16th St., New York City

## PACKING PROBLEMS SOLVED

We can overcome your packing difficulties, whether you ship large sets or small sets—heavy power equipment or fragile speakers—whether the weight is ten pounds or five hundred pounds. Our years of experience in the radio shipping field are at your command without obligation.



TIFFT BROS.

8 Broadway, New York City

Shipping Cases for Difficult Problems

## At last— A lug terminal made especially for riveting!

*Positively will not  
turn, twist or wiggle  
loose.*

*Costs no more than  
ordinary plain lugs.*

No more loose terminals after riveting. SHAKEPROOF Locking Lug Terminals are now to be had in brass for this purpose. The Twisted Teeth eliminate the evils of turning, twisting and loosening.

This riveting terminal is made of tinned spring brass. Its low cost will appeal to the manufacturer who appreciates the importance of eliminating play.



Type 21  
(Made for No. 6 and No. 8 screws)

With Shakeproof brass lugs under rivets, assembly comes through properly lined up (Shakeproof lugs cannot twist or turn), thereby speeding up soldering operations and reducing production costs.

*Ask for free test samples today!*

## SHAKEPROOF

*Lock Washer Company*

2511 North Keeler Ave., CHICAGO

Division of Illinois Tool Works

## The right flux for radio can *make* a manufacturer The wrong flux can quickly *break* him

After costly experiments scores of radio manufacturers have found there is but *one* safe flux for radio soldering—rosin.

Rosin, an organic mixture, is a *non-conductor* and *non-corrosive*. The glass-like surface of this material does not readily lend itself to the collection of dust (carbon particles) as will the sticky organic greases of paste. Nor will rosin attract moisture from the atmosphere; the chlorides of pastes and fluids will. *Moisture plus carbon particles defeat the best insulations produced. Moisture plus chlorides direct a slow but determined corrosive attack upon supporting metals.* Such slow corrosion in wiring causes a steadily increasing resistance to the flow of electrical energy.

Kester Rosin-Core Radio Solder scientifically combines radio's premier flux, rosin, with a solder alloy of unvarying quality. The use of Kester Radio Solder furnishes the user with a means of accomplishing *safer, faster and cleaner* set wiring.

Manufacturers using Kester Rosin-Core Solder are assured that no part of their production will ever be returned or fall into discard through the corrosive and conductive action of a chloride flux.

*Our experimental and research laboratory has assisted many manufacturers in the solving of their soldering problems. A post card will bring you further information without obligation.*



## KESTER SOLDER

*Rosin-Core*

CHICAGO SOLDER COMPANY

4224 Wrightwood Avenue, Chicago, U. S. A.

*Originators and*

*World's Largest Manufacturers of Self-fluxing Solder*

WILLIAMS PRESS, INC., NEW YORK—ALBANY





## Practical, Economical AC Operation

- with the new AC Tubes
- and Dongan Low Voltage Transformer



No. 4586  
for UX 226 tubes  
and UY 227 tubes

**List \$8.00**

Power Transformer (list \$15) and Double Choke (list \$15) for ABC 350-400 m.a. rectifier tube. Gives you a completely electrically-operated set.

Order from your dealer —or send check or money order to factory direct.

You can replace the A battery and charger with the ideal AC current supply by using the new UX 226 amplifier tubes and the UY 227 detector tube—and the Dongan AC Power Transformer.

No. 4586 AC Power Transformer is designed to function also with UX 171 Power Amplifier tube; No. 4587 with UX 210 Power Amplifier tube.

Only a few slight changes are required to operate your set with this ideal AC power supply.

### Headquarters for Power Unit Parts

Manufacturers of sets and power units have come to regard Dongan as the logical headquarters for parts (transformers and chokes) for the latest approved types of eliminators. For all types of tube and rectifier units Dongan engineers have perfected authorized parts. This close cooperation of the Dongan laboratories with the tube manufacturers, plus the advantageous pro-

duction facilities in the Dongan plant, offers the ideal source of supply.

Set and Eliminator manufacturers are invited to make use of these facilities.

Dongan Low Voltage Transformers for the new AC Power Tubes are ready for the manufacturers (mounted or unmounted types).

**DONGAN ELECTRIC MANUFACTURING COMPANY**

2995-3001 Franklin St.

DETROIT, MICHIGAN





*Bakelite Molded bobbins and Bakelite Laminated end plate used in Rola Speaker, made by The Rola Company, Oakland, Cal.*

## Bakelite Materials reduced production cost more than 50 per cent

**T**HESE little bobbins of the Rola Speaker were formerly made of brass, and their finishing required several operations. Through forming them of Bakelite Molded four operations were eliminated, production speeded, discards practically ceased, design was improved and cost reduced 50 per cent.

Even greater economies were effected through using Bakelite Laminated instead of brass for the end plate shown, as seven operations were eliminated, bringing

about a reduction in cost of 60 per cent. The uniformity of dimension secured was an additional advantage.

The advantages and economies of Bakelite materials for all classes of radio equipment are bringing about their adoption for a steadily increasing variety of radio parts. We invite you to enlist the services of our engineers and research laboratories in adapting Bakelite Material to your individual needs. Write for Booklet 38.

### BAKELITE CORPORATION

247 Park Ave., New York, N.Y. Chicago Office, 635 W. 22nd St.  
**BAKELITE CORPORATION OF CANADA, LTD.**, 163 Dufferin St., Toronto, Ont.

# BAKELITE

REGISTERED

U. S. PAT. OFF.



THE MATERIAL OF A THOUSAND USES

The registered Trade Mark and Symbol shown above may be used only on products made from materials manufactured by Bakelite Corporation. Under the capital "B" is the numerical sign for infinity, or unlimited quantity. It symbolizes the infinite number of present and future uses of Bakelite Corporation's products.