

RADIO Engineering

A Magazine of Technical Accuracy for the
Radio Set Builder, Engineer and Manufacturer

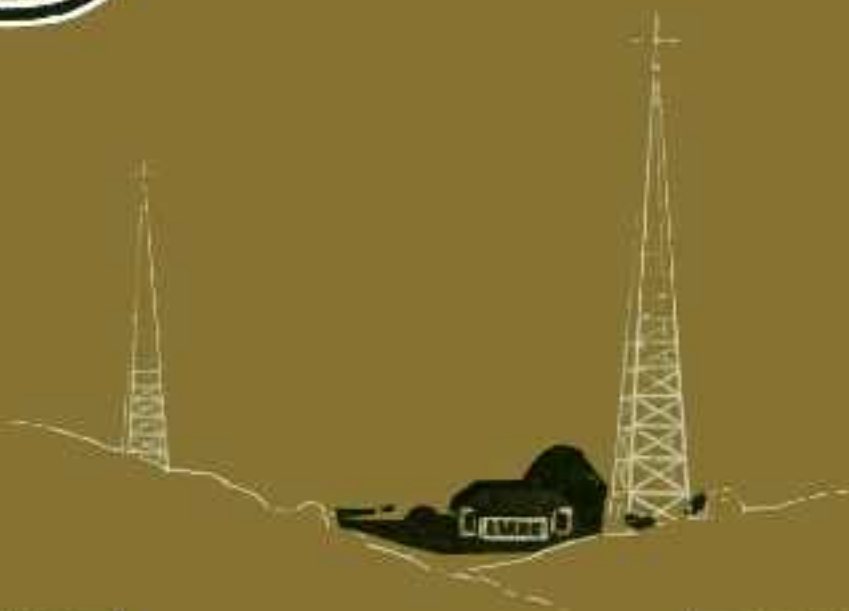

Edited by
M.B.SLEEPER



SEPTEMBER 1925

VOL. V NO. 9

Worthy of their Job



Pacent Shock-proof Autoplug,
No. 50.....Price 69c
No. 52G (with gold plated metal
parts).....Price \$1.00



Regular Movable Nipple Type
Six-Spring Automatic Jack,
No. 30.....Price 90c
24 other models priced from
40c to 80c.



Pacent Universal Plug,
No. 40.....Price 25c



It's the job of Pacent Parts to give clear, flawless reception. Their reputation among engineers and amateurs proves them worthy of it. The mechanical perfection of Pacent plugs and jacks is not accidental. It is the result of 18 years of constant study and development. That is one of the reasons why 40 leading manufacturers rely on Pacent Radio Essentials for their sets. You'll find real satisfaction in following their lead.

All the best dealers carry complete stocks of Pacent Parts. Write today for interesting illustrated catalog.

PACENT ELECTRIC COMPANY, Inc.

91 Seventh Ave., New York City.

Chicago
Washington
San Francisco

Philadelphia
Indianapolis
Minneapolis

St. Louis
Boston
Birmingham

Buffalo
Detroit
Pittsburgh

Canadian Licensees: White Radio, Limited, Hamilton, Ont.

Pacent

RADIO ESSENTIALS



It's a *genuine* UV-201-A
only when it bears
the name Radiotron
and the RCA mark



WD-11, WD-12, UV-199, UV-200, and UV-201-A are the type names of Radiotrons. They belong to Radiotrons only. To be sure you are buying the genuine, look for the name Radiotron and the RCA mark on the base. Then you are sure of quality.

Radio Corporation of America

Chicago

New York

San Francisco

Radiotron

REG. U.S. PAT. OFF.

AN RCA PRODUCT

RADIO ENGINEERING

Edited by M. B. SLEEPER

Fifth Year

Vol. V, No. 9

Contents—September, 1925

	Page
How to Build the RX-1	433
Selenium and Photo Electric Cells, Chapter III.	442
Rosin Core Solder	444
Editorial.	445
Specifications for Construction Kits	447
Why Not Do Your Own Molding?	455
Separating Crowded Stations	459
Experiments with the All-Amax Senior	461
Working Data on Standard Radio Products, No. 10.	465
With the Manufacturers.	466
Advertisers' Index	492

Radio Engineering, September, 1925, Vol. 5, No. 9. Published monthly by M. B. Sleeper, Inc., Publication office, Lyon Block, Albany, New York. Editorial and General offices, 32 Vanderbilt Ave., New York, N. Y. Printed in U. S. A. Yearly subscription \$2.00 in U. S. and Canada; ten shillings in foreign countries. Entered as second class matter at the postoffice at Albany, New York, January 9, 1925, under the act of March 3, 1879.

BAKELITE

REG. U.S. PAT. OFF.

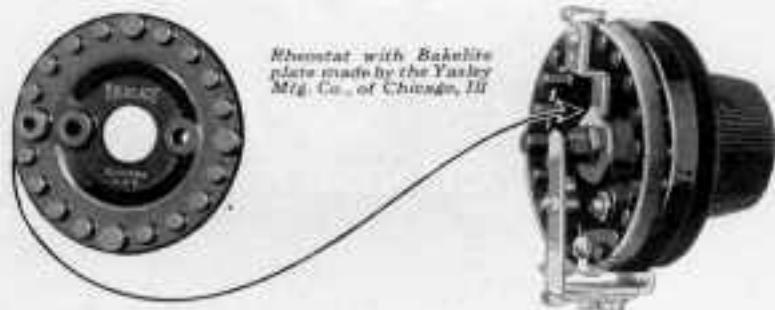

Rheostat with Bakelite plate made by the Yaxley Mfg. Co., of Chicago, Ill.

Bakelite replaced steel and fibre stampings —and lowered cost

Sixteen operations, including plating, were eliminated, manufacturing cost reduced 18 percent, and appearance and performance improved through molding the plate of the Yaxley Rheostat of Bakelite.

More and more, Radio Engineers are finding in Bakelite a material that makes possible the practical development of their ideas. Its applications for both radio sets and accessories are constantly increasing.

As an effective aid to the inventive genius of Radio Engineers and Manufacturers, Bakelite occupies a unique position. Our engineers welcome opportunities to cooperate with manufacturers in adapting Bakelite to their needs.

Write for Booklet 38

BAKELITE CORPORATION

247 Park Avenue, New York, N. Y.
Chicago Office: 636 West 22d Street

Bakelite is a trademark of the Bakelite Corporation, 247 Park Avenue, New York, N. Y.

BAKELITE
is the registered trade name for the plastic resin, which only can be used by the Bakelite Corporation.

THE MATERIAL OF A THOUSAND USES

AMSCO

ANNOUNCES A
SPACE - SAVING
S.L.F. CONDENSER

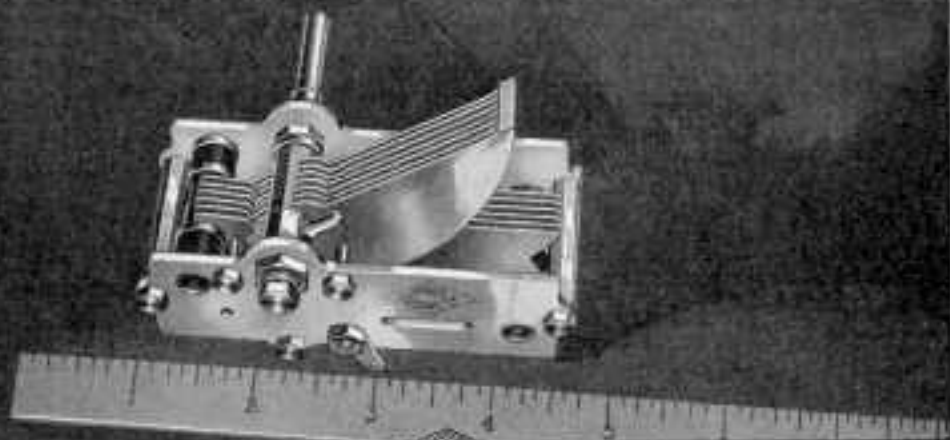

*Half a Heart is
the secret.*



*Half a Heart is
the shape of the
tuner plates.*



*Half a Heart is
the new symbol
for efficient S.L.F.
variable con-
densers.*



Solved! The space problem of the straight-line frequency condenser. The new AMSCO Allocating Condenser is ingeniously designed to save room in the cabinet—yet spreads the stations evenly around the dial, according to frequency. Greatly improves the selectivity of the set—and simplifies tuning. Three sizes—Single or Siamese.

Ask your dealer—or write Dept. B

AMSCO PRODUCTS, INC.
Broome and Lafayette Streets, New York City
MAKERS OF MELCO SUPREME RADIO RECEIVERS

AMSCO
 PRODUCTS
 ARE SPECIFIED BY
 STROMBERG-CARLSON FREED-
 EISEMANN PRIESS RADIO *et*

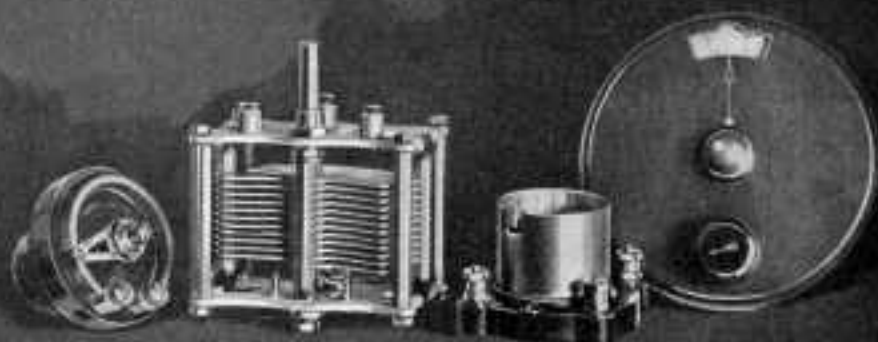

Set builders who strive for electrical and mechanical perfection inevitably come to AMSCO. Look behind the panel of the finest sets, and you will find the AMSCO trademark, the sign of *engineered* radio parts. Standardize on AMSCO Condensers, Vernier Dials, Rheostats, Potentiometers, Sockets and Binding Posts—each the best that can be made, and made to match each other.

Ask your dealer—or write Dept. B

AMSCO PRODUCTS, INC.
 Broome and Lafayette Streets, New York City
 MAKERS OF MELCO SUPREME RADIO RECEIVERS

NEW—The Amoco Vernier Dial—at a popular price. The right ratio for precision tuning.



Are They With You?

RADIO ENGINEERING is written expressly for the technical men in manufacturing, jobbing, and retailing organizations, and for professional set builders.

By reaching this specific class, Radio Engineering offers an important and useful service to advertisers, at rates commensurate with the naturally restricted circulation, which is afforded by no other publication.

Radio Engineering gained the confidence and holds the interest of this group not only by articles which present conservatively the developments of the art but by setting many original design precedents which have been adopted throughout the industry.

By holding this group of readers Radio Engineering does not merely justify its existence—it offers advertisers an opportunity to talk directly to the men upon whose approval orders and contracts must depend. No sales plan, no salesman can succeed against these men.

What effort are you making to win their confidence in your products, and their approval of them?

Radio Engineering readers absolutely control the buying power of the Radio Industry

This is the second of a series of six advertisements published to show frankly and truthfully, the exact status of Radio Engineering as a publication—its circulation, range of influence, editorial policy, class of readers, position as an advertising medium, and why it has been accepted as the leading technical magazine of the Radio Industry.

2



Get Distance With Howard "Low Loss" Parts

Cost is secondary in the making of Howard
"Low Loss" Parts

The first consideration is in the building of
the best in order to give you the satisfaction
and long life you have a right to expect. All
Howard parts are so guaranteed



RHEOSTATS
POTENTIOMETERS
FIXED CONDENSERS
BINDING POSTS
SWITCH LEVERS
SOCKETS
PLUGS, etc.

Those dealers who specialize in the better grade
parts feature those marked Howard

Write for circulars

HOWARD RADIO COMPANY

451-469 East Ohio Street, Chicago

Only
specialists
can make
good fixed condensers

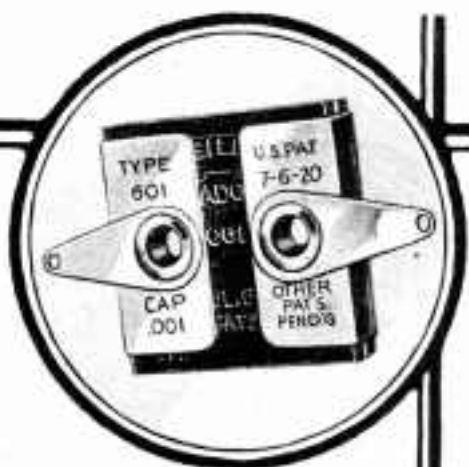

THE small fixed condensers in your radio set are there to help you get clear reception. If these little condensers are not made *most accurately* the quality of reception you get—even though your set may be excellent in all other respects—will be greatly impaired.

You will find that nearly all sets made—in fact over 90% of them—are equipped with Dubilier Micadons. This is the name by which all Dubilier fixed condensers are known.

Be sure your set—whether you buy it or build it—is equipped with Micadons. They are made by *specialists*.

Dubilier
CONDENSER AND RADIO CORPORATION



Fig. 1. The RX-1 has the air of fitting gracefully into home surroundings. Installed here in a Jewett radio HighBoy, it does not make the living room look as if it had been turned into a workshop.

How to Build the RX-1

The RX-1 is the only successful non-regenerative set ever developed in the history of radio—a set which accomplishes the things until now thought impossible

THE RX-1 receiver is a positive revelation as a receiving set. Not simply one radio set, the RX-1 is more than a hook-up, it is a system of design as distinctive as the regenerative or super-heterodyne systems. As an individual engineering development, it can be applied to a variety of types, of which the model B4 has been selected as the first model to be disclosed because it meets the widest requirements.

It can be used to improve the reception from a super-heterodyne, it will take the kinks from a reflex set, it is suitable, as in the B4 model, to combine with tuned R. F. amplification.

Development of the RX-1 System: Since the discovery of the feed-back circuit for regenerative reception, every circuit developed has employed regeneration in one form or another, or else a circuit which normally oscillated, such as

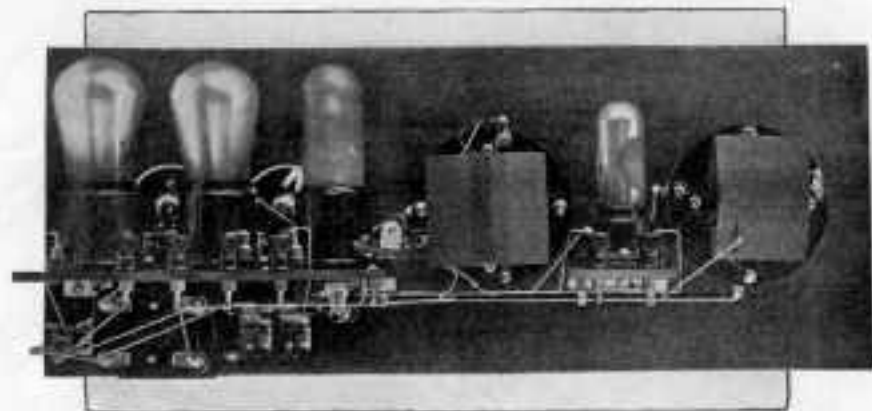

Fig. 2. Scientific precision in every detail assures permanently satisfactory results from operation by the most inexperienced B. C. L.

the neutrodyne, has been provided with neutralizing devices to stop oscillations and allow the circuit to work just under the oscillating point, leaving it in a regenerative condition.

Regeneration, unfortunately, is unstable. Therefore, any set which depends upon this factor for its efficiency will break into oscillation at the low waves if it is efficient on the high waves. In designing a tuned R. F. set, it has been customary to cut down the primary turns on the R. F. transformers to prevent oscillations by using the minimum amount of inductance in the plate circuits. This is not effective, as has been set forth in a most instructive paper by Byron Minium, reprinted from QST by the Walbert Manufacturing Company. Oscillations are not stopped because tuning the secondary of an R. F. transformer has the effect of tuning the primary, which makes the circuit oscillate anyway. The real result accomplished is to make the R. F. transformer extremely inefficient, producing what amplification it does give by regeneration.

Realizing that regeneration, whatever the circuit to use it, whatever the device to control it, results in critical tuning, howling, poorer quality, and interference at other receiving stations, we set about to develop at the Darien Laboratory a strictly non-regenerative receiver, a set which would operate at exceedingly high efficiency, yet with a circuit so inherently sensitive that it would not be necessary to even approach the unstable condition

of oscillation to produce full efficiency.

The RX-1 absolutely meets these requirements. And it was in the development work on this set that we discovered the RX-1 principle. Briefly stated, it centers around the use of a high impedance detector tube, preferably one which acts as a rectifier rather than an amplifier, followed by a stage of resistance coupled amplification.

Many other factors, however, contribute to the success of the B4. There is not a question about the design of the B4 that cannot be answered by a direct reply. There is no camouflage, no side-stepping. The design is so fundamentally reasonable that if you ask ten men who are familiar with the elementary principles of radio, they will all agree upon the usefulness of each element in the set or in the circuit.

From the nucleus of the RX-1 principle, we have been able to incorporate distinct features, such as the long tube life, three or four times greater than in the past, by getting full volume with the tubes operating 20% below their normal filament voltage. B battery life is greatly extended because of the low current drain. All tuning, over the entire wavelength range, is done without adjusting any auxiliary controls such as a potentiometer, vernier, rheostat—nothing but the two condenser dials.

Design Details of the B4 One of the controlling elements in set design is the expense. Consider any circuit. You can build it into a set which

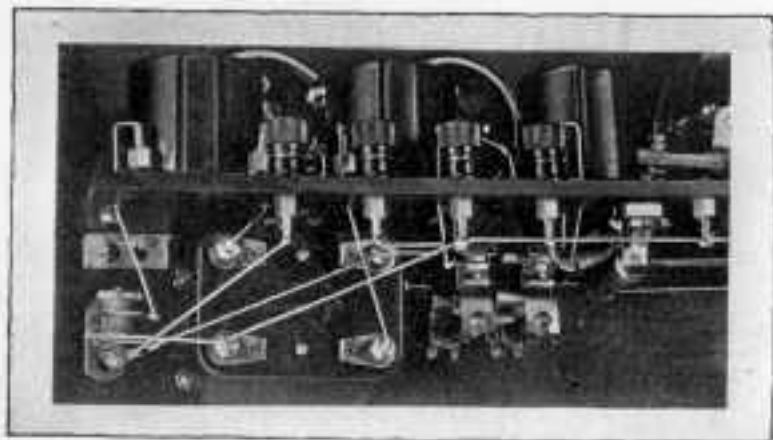

Fig. 3. Close-up view of the A. F. amplifier, illustrating particularly the use of Laxtite soldering terminals.

will cost perhaps forty dollars if you use cheap parts, or eighty dollars if you use the best throughout. That is not true with the B4. The parts for this model were chosen for efficiency, regardless of price. Yet the total cost of the parts comes to the astonishingly low amount of thirty-two dollars! It isn't necessary to compromise because of expense. If you spent more you couldn't make the set better.

In the tuning circuit there are Rathlum S. L. W. condensers and Eastern pickle-bottle coils. Since the RX-1 is not subject to radical change and improvement, we figured that an RX-1 set is good for several years of operation. For that reason, we wanted condensers protected from dust. Losses introduced from that source in an open condenser are far greater than those eliminated by the familiar low-loss design. Moreover, the design of the bearings on these condensers insures indefinite service. The wavelength separation is much greater than with S. L. C. plates, and enough for good tuning.

Pickle-bottle coils are as nearly perfect, from the standpoint of low losses, as coils can be made in practical form. Because of their negligible capacity, they give, in combination with S. L. W. condensers, curves which are as near S. L. F. as spider web and woven coils do with S. L. F. condensers. In radio frequency resistance they are far superior to the

various types of coils just mentioned.

You will notice that the Daven resisto-coupler is of the new design, with no fixed condenser showing. Here again is an improvement, for Daven has developed this coupler to give an impedance changing by only a few per cent over the audio frequency range. Resistance coupling to the first A. F. amplifier was employed to produce maximum amplification from the D-21 Sodian, and at the same time it prevents the slightest bit of distortion.

Those who think that resistance coupling takes more from the B battery than transformer coupling will be surprised to find that only 22 volts are applied to the coupling resistance, and that the current is only 0.25 milliamperes, or 0.0055 watt, while an ordinary detector with a transformer would take 45 volts at 6.0 milliamperes, or 0.27 watt. This is 45 times as much energy as is drawn by the D-21 Sodian.

Again, you may be surprised to see that the transformer in the second A. F. stage has a low ratio. This does not mean that a low-ratio transformer of another make would be preferable to the high ratio. This applied only to the Samson type. In order to get perfect reproduction from cone loud speakers, particularly the Western Electric, we found it essential to use a transformer having the lowest possible capacity in the secondary winding. Consequently, it was necessary to use the helical-wound

Samson transformer. The effect of eliminating capacity will be noticed if a 0.0005 mfd. condenser is put across the secondary of the Samson. Because of the high volume delivered from the first stage, the 1-3 ratio gave better quality and as much volume as the 1-6 type.

The other parts have been chosen with equal regard to their design and the convenience of using them. A 24-in. panel was used on the original model, but it was reduced to 18 ins. in the final design for the B4 model. However, this did not effect the operation in any way—a

graved, if you wish, altho the patterns do not show letters for engraving.

Assembly and Wiring A set as fine as the RX-1 deserves the best possible workmanship. Use Wirit for the connections. Straighten it by stretching. Then cut it into 18-in. lengths. You will find it a pleasure to solder connections to the Lastites, for they are easy to use and, what is very important, act as their own lock nuts, since the wires keep them from turning. If you use soldering paste, dip the wire $\frac{1}{8}$ in. into the paste. Then put it in the Lastite and solder it. With rosin core

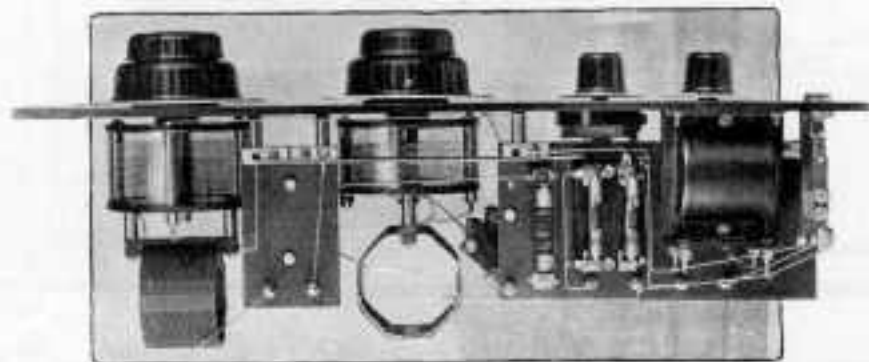

Fig. 6. This bottom view explains the wiring as it is shown in the picture wiring diagram. Notice how short the leads have been made.

further indication of the entire absence of regeneration, which in other sets causes howling from inter-transformer coupling.

Laying out the Panels No panel layouts are given here, but they are included with the set of full-size Dataprints. You will notice that the patterns for the front panel give the arrangement as it appears at the rear. This allows all marking to be done at the back. Dimensions are given where accurate limits must be maintained.

Two holes must be counterbored or deeply countersunk under the large tube panel. This is to allow the socket mounting nuts to come flush with the under side of the panel because the resisto-coupler fits directly beneath.

Be careful to press lightly and to turn the drill fast so as to keep the holes clean and free from chipping. You can purchase the set of panels drilled and en-

solder, melt a little solder on the top of the Lastite, tin the wire, and then, holding the wire in place, apply the iron to the tip of the Lastite until the heat remelts the solder and allows the wire to slip into the hole.

Where two wires are shown going to one Lastite, put only the first one in the hole. On the other wire, make a little hook, and solder it to the first wire near the tip of the Lastite.

Following are the explanatory notes which accompany the assembly and wiring instructions in Figs. 4 and 5. In addition, there is a checking list in Fig. 5. When you make a connection, put a check beside the terminal number. If a terminal is listed twice, two wires go to it. When you have finished, if all the numbers are not checked, you have missed a wire. Small letters, such as a, b and c, indicate joints which are not

made to instrument terminals.

Note 1. Lastites are indicated in the picture wiring diagrams by hexagons with the terminal numbers inside. They can be seen in Figs. 2, 3, and 7. If the screws are too long, put a nut on the screw, cut it off to the right length, and remove the nut. This cleans the thread. Notice the lugs E1, E3, G1, G2, G4. Lug E1 is at the front end, fastened to the pillar connecting with the variable plates, and E3 is at the rear, on the pillar holding the fixed plates. G1 is at the front on the pillar holding the fixed plates, G2 is at the rear, on the pillar

Note 8. Have the plate and grid terminals of the resisto-coupler at the rear of the tube panel. The wiring is put on exactly opposite to the terminal markings, but that is all right.

Note 9. Have the plate and B+ terminals at the bottom.

Note 10. Condensers supplied with the complete construction kit are drilled for screws to fasten the coil mounting pillars to the condenser end plates. Otherwise, holes must be made with a No. 18 drill. The holes are $2\frac{1}{4}$ -ins. apart on a line drawn thru the center of the shaft, and parallel with the straight edges of

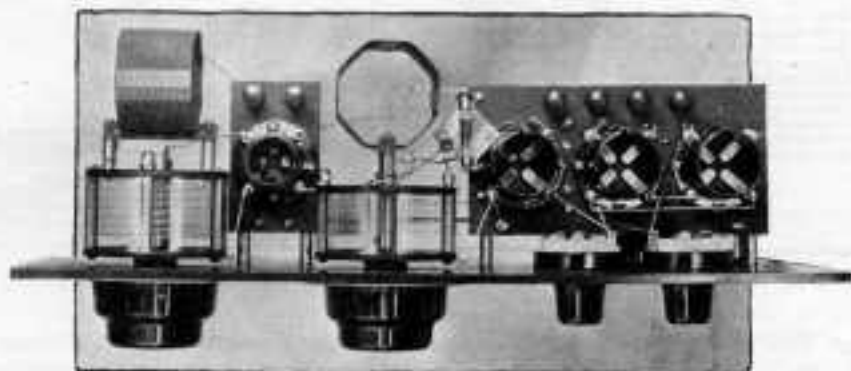

Fig. 7. Attractive appearance has been achieved in working out a mechanical arrangement which gives highest electrical efficiency.

holding the fixed plates, while G4 is similar to E1. E2 and G3 are Lastites on the screws from the pillars connecting with the variable plates.

Note 2. The adjacent mounting screws on L and P must be cut off so that they will be flush with the bottom of the panel, to allow the mounting of M.

Note 3. Put a lug between the rear of the front panel and O.

Note 4. Cut the head from a $\frac{1}{2}$ -in. screw, and thread a Lastite on the screw. Then put the screw thru the panel and N, and secure the screw with another Lastite instead of a nut. This makes the top and bottom terminals N1.

Note 5. Cut the head off a $\frac{1}{2}$ -in. 6-32 screw, put a Lastite on the screw, and use this to fasten T on U. This Lastite is terminal e.

Note 6. Put lugs between T and V and the front panel.

Note 7. Insulate this wire with tubing.

the fixed plates of the condensers.

Note 11. F1 is a lead from the secondary, F3 is the other secondary lead, and F2 and F4 are leads from the fine-wire primary coil inside.

Note 12. Terminal c is a Lastite mounted beneath the panel, held by a $\frac{1}{4}$ -in. 6-32 R. H. screw. This is to support the wire running to the lead F4.

Note 13. A clock-wise dial must be used with the Rathbun S. L. W. condensers. Have the 100 division mark coincide with the line on the panel when the plates are totally interleaved.

Testing and Operating As soon as the wiring is completed, connect the 6-volt A battery as shown in Fig. 8. Put the rheostats in the OFF position, and insert the telephone plug. The UV199 should light when it is put in the socket. Place the D-21 Sodian in the detector socket, and turn up the left hand rheostat, looking at the set from the

neering, 52 Vanderbilt Avenue, New York City, and mark the envelope "RX-1 Report."

Special For the benefit of those who
RX-1 want to wind their own coils,
Data the following data is given on
the number of turns and dimensions.
The antenna coil has 58 turns of No. 22
D.S.C. wire wound on a hexagonal form
2 $\frac{1}{4}$ ins. across the
flats. The antenna
tap is brought out at
the 15th turn.

The RX-1 R.F. transformer has 70 turns of No. 22 D. S.C. wire wound on a hexagonal form 2 $\frac{1}{4}$ ins. across the flats. Inside this winding, at the end of the secondary coil, which is connected to the filament circuit, the primary is wound with 20 turns of No. 40 D.S.C. wire. The primary turns should be bunched together just as closely as possible. It is important to use No. 40 wire, for results are quite different with heavier wire.

A number of preserves and pickles are packed in bottles of this size. They make excellent forms because, after the coils are wound, the bottles can be broken out.

The extreme simplicity of the circuit leaves very little possibility for trouble. Some suggestions may, however, be helpful. Do not use an antenna series condenser. If the results seem unsatisfactory, try the 199 in another set to make sure it is O.K. If it burns with excessive brilliance, measure the voltage across the filament terminals on the socket using a high resistance voltmeter. Do not use a pocket voltmeter for that will not give an accurate indication.

If the Sodian appears faulty, change the detector voltage. We have found, after testing a number of Sodian tubes, that they are exceedingly uniform, so that there should be no trouble from that source. Do not use nondescript resistance units in the resisto-coupler, or full amplification will not be obtained. If the transformer appears faulty, test the

primary and secondary for open circuits, using a battery and telephones. If there are no breaks in the winding, the battery should cause a loud click in the phones. Test also between the primary and secondary. This should give no click at all or possibly a very slight sound, but much weaker than when the battery and phones are put across the primary and secondary.

When the jack is inserted and the tubes are lighted, remove one of the phone cord tips. This should make a strong click in the loud speaker. If it does not, there is an open in the plate circuit of the last tube.

Do not substitute inferior parts in place of those specified as the cost of this outfit is so reasonable that it is not necessary and even the slightest alterations in the design are very liable to upset the different circuits and very greatly cut down the efficiency and performance of the set.

It is not always possible to make the schematic and picture wiring diagrams look alike. In case of doubt, therefore, follow the picture wiring diagram. Then your design and the results will be exactly like our original model. If the results aren't right, don't blame the drawings unless you have followed them in every detail.

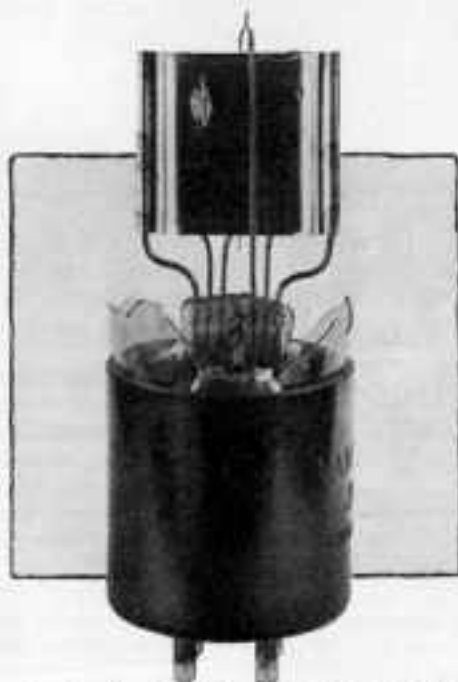

Fig. 9. The 3-VA Van Horne tubes for the A. F. amplifiers, operating at 3 volts on the filament and drawing 0.12 ampere, gave as much volume as the $\frac{1}{2}$ -ampere types. It is not necessary to change the rheostat.

Selenium and Photo Electric Cells

Chapter III. Essentials of Selenium cell construction and forms discussed—by Samuel Wein

Bell.¹⁸ A very simple cell constructed by Bell, was made with two brass ribbons separated by a suitable insulating strip which is slightly narrower than the brass ribbons, so as to leave an open space between the edges of the strip. The whole is then coiled into a flat spiral, in order to give it a more convenient form for exposure to the action of light. The groove formed by the insulating strip, between



Fig. 8. An interesting method of arranging the electrodes of a selenium cell.

the two conducting strips, is filled with selenium.

Another form of cell construction made by Bell and Tainter¹⁷ consists in piling up a number of brass discs separated from one another by mica, arranged to make grooves between the brass plates. Into this space the selenium is worked in and annealed.

The brass plates are electrically connected in two sets of alternate plates, between which the circuit is completed by the annular rings of selenium filling the channels around the brass plates.

Tainter.¹⁷ Fig. 8 shows a cell made by counterboring a metal plate *a* at *c*. This is provided with a series of tapered holes of smaller diameter near the outer surface of the plate *a*. The portion *b* is a plate provided with a series of pins arranged to pass into the middle of the holes when the two plates are properly placed together. The pins are smaller in diameter than the holes leaving a series of annular spaces between the pins and

the plate *a* surrounding them on top.

An insulating washer is placed between them. These are fastened together by screws passing through the plates and insulated by washers under the screw heads. A wire forming one side of the circuit is inserted under the head of one of the screws and the other wire is attached to the binding post. Selenium forced in between the pins and the plate complete the circuit.

Mercadier gives the details²⁰ of a cell construction which consists of two brass ribbons No. 40 B. & S. gauge, 20 ft. long and $\frac{1}{2}$ -in. wide, insulated by parchment paper and rolled together. The ends of cylinder thus formed are ground, polished, and covered with a film of selenium.

Townsend¹⁹ groups together a series of brass plates about 2 ins. long, $\frac{1}{2}$ -in. wide and about 40 B. & S. gauge in thickness. These plates are previously tinned so as to facilitate the adherence of the selenium. Holes are drilled as shown in Fig. 9, and between each plate is placed a sheet of mica. Alternate plates are

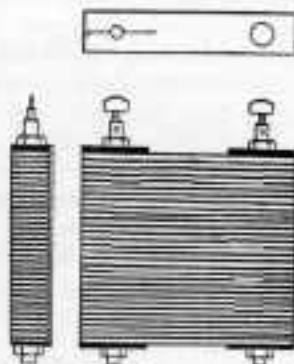

Fig. 9. This gives a large area in the many small paths thru the selenium.

connected by the brass rods passed through them. These rods serve as binding posts as well. The surfaces of the pile of plates are coated with selenium.

Cherry²¹ improves the mechanical construction of this particular type of cell as follows: A disc of non-conducting material is provided with a small core projecting for $\frac{1}{2}$ -in. on one side. Upon this projecting portion are wound four copper strips separated by insulating strips of paper. These copper strips lead out from the core 90° apart and are wound upon the core to make up the full diameter of the disc. The paper insulates the copper strips from one another throughout the winding but it does not extend beyond the outer edges. The selenium is spread over the surface of the spiral.

The inner ends of the strips are run to binding posts. In case it is desired to use the cell to exhibit a relatively lower range of resistance, the binding posts can

be connected to put the strips in parallel, i.e., so that the current can pass from two copper strips to the other pair through the film of selenium. In case a higher resistance is desired, the connections between the binding posts are arranged so that the current will have to travel across the entire extent of the film of selenium from the innermost copper strip to the outermost layer. Another selective wiring arrangement whereby a still higher range of resistance can be obtained, is to use the inner and outer strips. This results in rendering inactive the selenium between the two intermediate strips.

REFERENCES

- ²¹ Bell. United States Pat. No. 225,199 Dec. 7, 1930.
²² Bell and Talbot. U. S. Pat. No. 235,497 Dec. 14, 1930.
²³ Talbot. United States No. 215,390 Dec. 14, 1930.
 Lumiere Elec. Vol. 4, page 295, 1931.
 Compt. Rend. Vol. 92, page 382, 1931.
²⁴ Townsend. Elect. Rev. vol. 28, page 324; 1909. Elect. vol. 33, page 987, 1907.
²⁵ Cherry. United States Pat. No. 1,447,646 Mar. 6, 1922.

Official Browning-Drake Data

THROUGH the courtesy of the National Company of Cambridge, Mass., we have been given permission to publish the official data on the new type of Browning-Drake tuned R. F. transformer. Here it is as Mr. Browning gave it to us:

The main tube is 4-5/16 in. long by 3 in. in diameter. The secondary winding starts $\frac{3}{4}$ in. from the end at which the rotor is mounted. It has 77 turns of No. 20 D. S. C. wire, occupying a length of $2\frac{3}{4}$ in. on the tube. The slot for the primary winding is 3/64 in. deep by 9/64 in. wide, carrying 24 turns of No. 30 D. C. C. wire.

The shaft of the rotor is 5/16 in. in from the opposite end of the tube. The rotor itself is $\frac{3}{4}$ in. long by $2\frac{1}{2}$ in. in diameter, carrying two slots in each of which are wound 20 turns of No. 28 D. S. C. wire.

This winding data has been developed mathematically and has been further checked by experiments made over a period of many months to arrive at the

exact constants to give maximum amplification and the dimensions should not be varied in any detail. The secondary is of the correct size to use with a 0.00025 mfd. variable condenser.

Radio Export Shipments

American manufacturers and exporters of radio sets and parts are actively increasing their sales in foreign countries, according to the Department of Commerce. Exports of this merchandise from the United States during the first six months of 1925 totalled \$4,068,442 as against \$1,826,246 for the corresponding period of 1924, and \$6,030,914 for the year ending December 31, 1924.

The monthly average for exports of radio apparatus from the United States for the first six months of 1925 was \$678,074, as compared with a monthly average of \$205,576 for the entire year 1924. That American radio manufacturers and exporters are endeavoring to sell throughout the entire world is evidenced by the fact that during the first three months of the current year, shipments of radio apparatus from American ports were destined to 75 foreign countries.

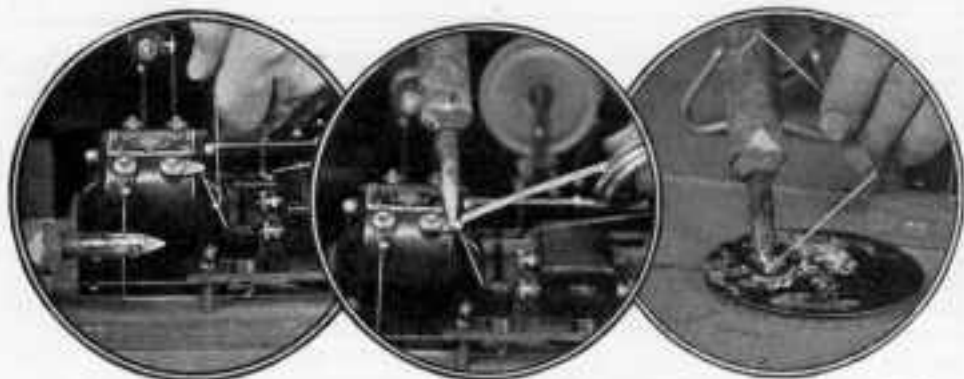

Make the butt joint with a hook. Heat the lug until it melts the solder. Keep the iron in a pool of solder.

It's Easy If You Do It Correctly

The perfect joint requires rosin-core solder, plenty of heat, and enough time to let the solder flow

"MY set is hooked up correctly but it doesn't work. What is the trouble?" The safe answer to that question is that the connections probably run to the right places, but they aren't connecting or the set would work.

Rosin core solder has become the accepted material for radio work, following the precedent set in telephone work by the A. T. & T. and Western Elec-

tric. The following suggestions are given

Some factory superintendents think that rosin core solder is slower to use than paste, but it does not work out that way in practice, for rosin can be worked faster, if it is used correctly, because the tip of the iron stays clean indefinitely, while with paste it must be filed off frequently.

The following suggestions are given



Left: The perfect joint is smooth and clean, without excess solder. Right: Compare this joint with the other, irregular lumps of solder, put on with a cool iron, do not indicate an electrical connection. This may provide a "rosin joint" which can be snapped off with the fingers.



tric. In radio sets, the possibility of troubles from corrosion is not as important as the presence of grease from soldering paste left around the joints. This collects dust—which consists largely of carbon particles—and creates low-resistance paths thru which the current leaks off where it shouldn't go.

Rosin, on the other hand, does not tend to spread, if it gets between two wires it does no harm because of its high insulating properties, and its shiny sur-

face does not hold the dust and dirt.

from actual experience with Kester rosin core solder on production work:

Let the tip of the iron rest in a cup of solder when it is not in use. This keeps the point at an even temperature. Do not melt solder onto the joint. Heat the joint and then apply the solder, using as little as possible. Hold the iron on the joint until it is hot enough to make the solder flow freely. Use tinned wire and lugs stamped from tinned copper sheet. Do not use dipped nickel lugs.

RADIO ENGINEERING

M. B. SLEEPER, Editor

F. A. SKELTON, Managing Editor

Published monthly by

M. B. SLEEPER, Inc.

Publication Office, Lyon Block, Albany, N. Y.

Editorial and General Offices

A-52 Vanderbilt Ave., New York, N. Y.

Chicago Advertising Office

E. H. Moran, Bell Building

307 North Michigan Ave., Chicago

Twenty cents per copy in the United States and Canada; in foreign countries one shilling. Two dollars per year, twelve numbers in the United States and Canada; ten shillings in foreign countries. Copyright 1925 by M. B. Sleeper, Inc.

Vol. V SEPTEMBER, 1925 No. 9

EDITORIAL

WITH September first to mark the beginning of our fifth radio season, there is wide speculation as to the expectancies of the several hundred concerns who will participate in the biggest year the industry has ever known.

So many men speak of radio in terms of the automobile industry. "Crosley is the Ford of radio." "Music Master, with their new financing, will occupy the position of General Motors."

In many respects, automobiles offer close and useful comparisons; in others, no parallels can be drawn. The errors are introduced by human factors that do not influence motor cars sales greatly.

Radio is built around the intangible. It doesn't run on a gallon of gasoline, measured out and poured into a tank. It is operated by something to which not one of our five senses will respond. Radio doesn't steer to the left or right, up hills and around curves—It is adjusted by essentially meaningless dials to clear hazards which, tho recorded only by the ear, are as real and sometimes as impassable as a river without a bridge. One does not drive a radio from St. Louis to Atlanta. No, one merely tunes and hopes to bring Atlanta to St. Louis.

What is the result? The psychology of the public attitude toward radio sets and motor cars is entirely different. A gasoline gauge indicates the need for more fuel. Oil must be changed at every thousand miles as clocked by the indicator. Performance can be gauged by

the speedometer. Tires must be pumped up when they look flat.

But a radio set is as good as it sounds. It may be all right even when it doesn't sound that way, while some people are satisfied with what they hear because they don't know better.

Thus the B. C. L. has learned that to get the most value from the investment in a radio set he must have a fair technical knowledge himself or else he must have a source of information at his service. The intangible radio is a challenge; the obvious automobile is an accepted fact.

Consequently, Walter Eckhardt will not be able to make the public believe that the combination of Music Master sets, batteries, tubes and loud speakers is the finest in the country just by saying so in the Saturday Evening Post. Not this year, for the man who knows will settle that for himself, and the man who doesn't has a friend who can tell him. Nor can Powell Crosley continue to forge ahead on the basis of prices alone. The engineering skill represented by the Ford is not equalled by any car at any price.

There is another element to our human factor. These men who know are wrong as often as they are right. Sometimes they are right or wrong in different ways.

Opinion plays such an important part in radio, sometimes promoting theories which are scientifically unsound, and as often creating prejudices which are entirely unjustified. Manufacturers have been changing back and forth from engineer-salesmen who antagonize the dealers' and jobbers' radio experts by allowing themselves to be drawn into theoretical discussions, and non-technical salesmen who lose their nerve and run in confusion from a technical question.

Radio expert will read when they won't listen. They are antagonized by argument, tho they spend money for well-illustrated propaganda.

Music Master or Crosley leadership in sales depends upon leadership in scientific development accompanied by a selling campaign which includes educational plans to make the technical merits understood and appreciated. Manufacturers must accept the effects of the intangible and put them to work.

M. B. SLEEPER,
Editor.

Build this phenomenal new radio in 45 minutes



The revolutionary Erla Circloid-Five Factory-Built Kit—
as you receive it.

Price \$49.50

This new type kit is factory assembled. Ready cut, flexible, solderless leads make it ridiculously easy to wire. Amazing new inductance principle brings results hardly thought possible. Send for book, *Better Radio Reception*.

NOW anyone can build the finest of receivers in only a few minutes. No more wire bending or soldering. Merely attach a few ready cut, flexible eyeletted leads and the job is done. The finished set is unsurpassed even by the costliest factory-built receiver.

But most amazing is the new inductance principle incorporated in this last word in kits—called the Erla Circloid principle of amplification.

Four vital improvements result from this great discovery, which are not found in ordinary sets.

1. **Greater Distance:** Erla *Balloon *Circloids have no external field, consequently do not affect adjacent coils or wiring circuits. This enables concentration of proportionately higher amplification in each stage, with materially increased sensitivity and range.

2. **More Volume:** Increased radio frequency amplification made possible by Erla Balloon Circloids gives concert volume to distant signals inaudible with receivers of conventional type.

3. **Increased Selectivity:** Erla Balloon Circloids have no pick-up quality of their own. Hence only signals flowing in the antenna circuit are amplified. Static is greatly reduced for this reason.

4. **Improved Tone Quality:** The self-enclosed field of Erla Balloon Circloids eliminates stray feed-backs between coils and consequently goes away with mashing of signals and distortion. Tone is crystal clear and perfectly lifelike.

Write for free information on kit—also book

See how 45 minutes of fun will give you the newest and most nearly perfected set known to radio science. Easy as A-B-C to finish. Examine it at any Erla dealer's, or send the coupon for full information, illustrations and diagrams free. Also ask for remarkable new book, "Better Radio Reception," describing the sensational new Circloid principle. Enclose 10c for mailing and postage on book.

ELECTRICAL RESEARCH LABORATORIES
Dept. 149, 2500 Cottage Grove Ave., Chicago
*Trade Mark Registered.

ELECTRICAL RESEARCH
LABORATORIES,

Dept. 149, 2500 Cottage
Grove Ave., Chicago,
U. S. A.

Send me free information on kit. Enclose 10c for postage for book "Better Radio Reception."

Name.....
Address.....
City.....State.....



This sign identifies authorized Erla distributors. All are equipped to give complete radio service.

Dealers Exclusive franchises are available to high class dealers in localities still open. Write or wire immediately.

Specifications for Receiving Set Construction Kits

The data presented have been carefully compiled with the assistance of the manufacturers represented. By removing these pages from the magazine you will have a complete reference file on receiving set construction kits. Next month this section will be devoted to A.F., I.F., and R.F. transformers.

Manufacturer	Material and size of fr. panel	Material and size of base	Number and type of tubes	Circuit	Type, Audio amplification	Auto. Switch	Blindnut amt. & prob.	Control	Neutral and Supply
Arco, (Chicago, Ill.)	Aluminum 7 x 24"	3-ply wood 7 x 20 1/2"	4 - U. V. 201 A's 1 - 5-41 Solenoid	Reflex with crys.	3-Stage Audio	None	One FL Switch with Keycontact	Variable	No All parts, Leuco, Iocbs
Arco, (Chicago, Ill.)	Aluminum 7 x 24"	5-ply wood 7 x 23 1/2"	4 - U. V. 201 A's	Reflex	1 - 8, Trans. Aud. 1 - R. Imp. A. A.	None	One FL Switch One Loop Operation	Variable	No All parts, Leuco, Iocbs
Arco, (Chicago, Ill.)	Aluminum 7 x 24"	Wood 6 x 22"	4 - U. V. 201 A's	Tuned Radio Frequency	Trans. Audio	One	One FL Switch Three Filter	Plain	Yes Most All Parts
Brewer - Tuffe (Chicago, Ill.)	Aluminum 7 x 24"	Wood 10 x 25"	3 - U. V. 201 A's	Bremar-Tally	Optional	One	One FL Switch One Induce Ant. w/ Loop	Variable	Yes Only R, Z, Resistor
Brewer - Tuffe (Chicago, Ill.)	Aluminum 7 x 24"	Wood 10 x 23"	3 - U. V. 201 A's	Bremar-Tally	Optional	One	One FL Switch One Induce Ant. w/ Loop	Variable	Yes Only R, Z, Resistor
Darmstadt, (New York, N. Y.)	Formica 7 x 18 x 1/8"	Formica 6 1/2 x 2 1/2 x 3/8"	1 - U. V. 201 1 - 5-41 Solenoid 2 - U. V. 201 A's	Imp-1	1 Resistor 1 Transformer	One	FL Control Two Antenna Jack	Plain	No All parts
Electrical Research (Chicago, Ill.)	H. B. 7 x 18"	Wood 8 1/2 x 17 1/2"	2 - U. V. 201's	Reflex	Trans. Audio	One	One FL Switch One Loop	Plain	No All Parts
Electrical Research (Chicago, Ill.)	H. B. 6 x 7 x 3/8"	Wood 7 x 4 1/2 x 1 1/2"	1 - U. V. 201 A	Reflex	Trans. Audio	One	One FL Switch One Ant. & Grid.	Plain	No All Parts
Electrical Research (Chicago, Ill.)	H. B. 7 x 14 x 3/8"	Wood 7 1/2 x 14 x 3/8"	2 - U. V. 201 A	Reflex	Trans. Audio	One	One FL Switch Two Ant. & Grid.	Plain	No All Parts
Electrical Research (Chicago, Ill.)	H. B. 7 x 18 x 3/8"	Wood 7 1/2 x 7 x 3/8"	2 - U. V. 201 A	Reflex	Trans. Audio	One	One FL Switch Thermastat. & Grid.	Plain	No All Parts
Electrical Research (Chicago, Ill.)	H. B. 7 x 18 x 3/8"	Wood 17 1/2 x 8 1/2 x 3/8"	4 - U. V. 201 A	Reflex	Trans. 3-tube	One	One FL Switch Four Ant. & Grid.	Plain	No All Parts
Electrical Research (Chicago, Ill.)	H. B. 7 x 18 x 3/8"	Wood 17 1/2 x 8 1/2 x 3/8"	3 - U. V. 201 A	Reflex	Trans. 4-tube	One	One FL Switch Four Ant. & Grid.	Plain	No All Parts
Electrical Research (Chicago, Ill.)	H. B. 7 x 18 x 3/8"	Wood 17 1/2 x 8 1/2 x 3/8"	4 - U. V. 201 A	Reflex	Trans. Audio	One	One FL Switch One Ant. & Grid.	Plain	No All Parts
Electrical Research (Chicago, Ill.)	H. B. 7 x 21 x 3/8"	Rich Panel Backplate	3 - U. V. 201 A	Radio Frequency	Trans. Audio	One	One FL Switch One Ant. & Grid.	Plain	No All Parts
Electrical Research (Chicago, Ill.)	H. B. 7 x 18"	Wood 7 1/2 x 17"	3 - U. V. 201 A	Reflex	Trans. Audio	One	One FL Switch One Ant. & Grid.	Plain	No All Parts
Electrical Research (Chicago, Ill.)				Tuned Radio Frequency	Trans. Audio	Two	One FL Switch Two Ant. & Grid.	Plain	No All Parts
Electrical Research (Chicago, Ill.)				Tuned Radio Frequency	Trans. Audio	Two	One FL Switch Two Ant. & Grid.	Plain	No All Parts
Prudenz, (New York, N. Y.)	Colorm 7 x 18"	Colorm 7 x 12"	3 - U. V. 201 A	Tuned Radio Frequency	Trans. Audio	Two	One FL Switch Two Ant. & Grid.	Plain	No All Parts

Address-Entity, City, State	Model (New)	Wood	4 - U. V. 201 A	Tuned Radio frequency	Trans. Audio	Two	Two Ant. & Grid.	Plats	Yes	All Parts
Johnson, W. F., Inc., (New York, N. Y.)	(New York, N. Y.)	None	4 - U. V. 201 A	Two Circuit Trans. Control Radio Frequency	Trans. Audio	One	One Fil. Switch Three Ant. & Grid.	Variable	All Parts
Kearney, Hartman Corp., (Newark, N. J.)	Radio Column 7 x 18"	None	2 - Any type	Controlless	Trans. Audio	One	One Fil. Switch One Ant. & Grid.	Plain	Yes	All Parts
Kearney, Hartman Corp., (Newark, N. J.)	Radio Column 7 x 18"	Column 8 1/2 x 6 1/2"	2 - Any type	Controlless	Trans. Audio	One	One Fil. Switch One Ant. & Grid.	Plain	Yes	All Parts
Kearney, Hartman Corp., (Newark, N. J.)	Radio Column 7 x 18"	None	2 - Any type	Radio Frequency	Radio Frequency	One	One Fil. Switch Two Ant. & Grid.	Plain	Yes	All Parts
Lizbeth Radio (Chicago, Ill.)	Corp., Bakelite 7 x 12 x 1 1/2"	Wood 6 x 11" x 1 1/2"	1 - U. V. 201 A	Regenerative	Trans.	One	One Fil. Switch One Ant. & Grid.	Plain	No	All Parts
Lizbeth Radio (Chicago, Ill.)	Corp., Bakelite 7 x 18 x 1 1/2"	Wood 6 x 17 x 1 1/2"	2 - U. V. 201 A	Regenerative	Trans.	Two	One Fil. Switch Two Ant. & Grid.	Plain	No	All Parts
National Co., (Cambridge, Mass.)	Browsing Desk	Cable & Con- tinuous Ultra
Neely-Baack, Inc., (Phila- delphia, Pa.)	Bakelite 26 1/2 x 8 x 1 1/2"	10 - U. V. 201 A	Super Heterodyne	Trans.	Two	Switch One Either	Variable	All Parts
Phony Radio Corp., (New York, N. Y.)	Bakelite 7 x 10"	Wood 7 x 8"	2 - U. V. 201 A	Ultra-dyne	Trans.	Three	One Fil. Switch Antenna Either	Ultra Var- iant	All Parts
Radical Man. Co., (Chicago, Ill.)	Bakelite 24 1/2 x 1 1/2"	Wood 7 x 8 x 1 1/2"	1 - U. V. 100	Reflex	None	None	Plain	No	All Parts
Radical Man. Co., (Chicago, Ill.)	Bakelite 7 x 18 x 1 1/2"	Wood 7 x 17 x 1 1/2"	2 - U. V. 201 A	Reflex, 1-Cascade	None	None	Plain	No	All Parts
Rayson Electric Co., (Canton, Mass.)	Formica, 7 x 19 x 1/2"	Formica, 7 x 17 x 1/2"	1 - D-23 Sedan 2 - U. V. 201 A	T. C.	2 Trans.	Two	Fil. Switch Two Antenna	Variable	Yes	All Parts
Silver - Marshall, (Chicago, Ill.)	Inc., Bakelite 7 x 14 x 1 1/2"	Wood 7 x 22 1/2"	7 - Any type	Super Heterodyne	Trans.	Two	Switch One Either with Ant. Comp.	Either	No	Essentials
Silver - Marshall, (Chicago, Ill.)	Inc., Bakelite 7 x 18 x 1 1/2"	Bakelite 17 1/2 x 4 1/2"	0 - Any type	Modified Preamp & F. Amp.	Trans.	Two	Switch One Either	Either	Yes	Essentials
Silver - Marshall, (Chicago, Ill.)	Inc., Bakelite 7 x 24 x 1 1/2"	Wood 7 x 22 1/2"	7 - Any type	Super Heterodyne	Trans.	Two	Switch One Either with Ant. Comp.	Either	No	Essentials
Silver - Marshall, (Chicago, Ill.)	Inc., Bakelite 7 x 24 x 1 1/2"	None	4 - Any type	Tuned Radio Fre- quency	Trans.	Two	Switch One Antenna	Either	Yes	Essentials
Silver - Marshall, (Chicago, Ill.)	Inc., Bakelite 10 x 7 x 1 1/2"	Bakelite 7 x 2 1/2"	3 - Any type	Two	None	All Parts or Essentials
Silver - Marshall, (Chicago, Ill.)	Inc., Bakelite 10 x 7 x 1 1/2"	Bakelite 9 x 6 x 1 1/2"	2 - Any type	Two	None	All Parts or Essentials
Stangell Radio Man. Co., (Newark, N. J.)	Only 3-Cold
United Scientific Lab., (New York, N. Y.)	(New York, N. Y.)	7 x 17"	4 - U. V. 201 A	Tuned Radio Fre- quency	Trans.	Two	Switch Two Antenna	Plain	No	Only Con- t. Base & Grid
Worlock Man. Co., (Cleve- land, Ohio)	(Cleveland, Ohio)	Wood 7 x 24 x 1 1/2"	4 - U. V. 201 A	Neotodyne	Trans.	Two	Switch Two Antenna	Plain	Yes	All Parts Only 3-Cold Elec. & Non- Ino. Cont.

ULTRA-LOWLOSS CONDENSER



CAP 0005 mfd.

\$5.00

As positive as Big Ben

SET Big Ben at seven and at seven o'clock you're bound to get the alarm.

Just so, the Ultra-Lowloss condenser can be set at any wavelength—the corresponding station will come in clear and sharp. You know instantly where to turn, once a station of known wavelength is located. Makes tuning easy—direct—positive. Special Cutlass Stator Plates spread wavelengths evenly over a 100 degree scale dial so that each degree represents $\frac{1}{3}$ meters.

Ultra-Lowloss condensers are designed by R. E. Lacault, originator of the famous Ultradyne Receivers, and built upon scientific principles which overcome losses usually experienced in other condensers.

At your dealers, otherwise send purchase price and you will be supplied postpaid.

Design of low-loss coils furnished free with each condenser for amateur and broadcast wavelengths showing which will function most efficiently with the condenser.

To Manufacturers Who Wish to Improve Their Sets

Mr. Lacault will gladly consult with any manufacturer regarding the application of this condenser to his circuit for obtaining best possible efficiency.

ULTRA-LOWLOSS CONDENSER



Cutlass Stator Plate exclusive to an Ultra-Lowloss feature.



A gemstone of calibration and Lacault design.



ULTRA-VERNIER TUNING CONTROL

Simplifies radio tuning. Pencil-ferret a station on the dial—thereafter, simply turn the finder to your pencil mark to get that station instantly. Easy—quick to mount. Eliminates fumbling, guessing. Furnished clockwise or anti-clockwise in gold or silver finish. Gear ratio 20 to 1.

Silver \$2.50 Gold \$3.50

PHENIX RADIO CORPORATION 40 116-D East 25th Street 40 New York

Antenna Tuning Condensers

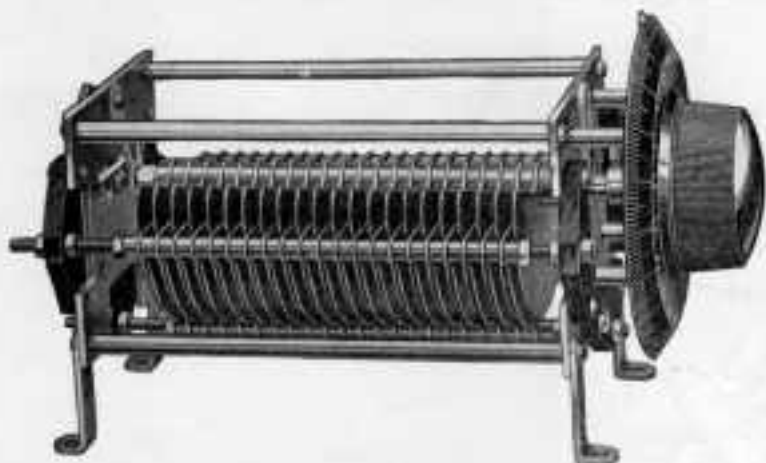

Built to amateur specifications for the amateur.

Type 150—3000 150 MMF (.00015 MF)

3/16" spacing (ordinarily known as double spacing), 3000 volt flashover. Fine for 5W and normal 50W sets. Proper size for primary circuits. Price, \$7.50.

Type 450—3000 450 MMF (.00045 MF)

3/16" spacing, like those NATIONAL supplied to N. R. R. L. Price, \$16.50.

Type 100—6000 100 MMF (.0001 MF)

3/8" spacing, 6000 volt flashover, for the overloaded "50" and the "250" W. Plenty big enough for the primary, too. All prices include 4" Velvet Vernier Dial. Price, \$11.50.

NATIONAL Company can supply you with 5 or 3 plate Receiving Variables for that short wave receiver.

Send for Bulletin 106 R. E.

NATIONAL COMPANY, INC.

Engineers & Manufacturers

110 Brookline Street,
Cambridge, Mass.

Of Course



RECEPTRAD

Manufacturers of the First Successful
BATTERYLESS SET

Can Supply You With the Best of
Audio Transformers—Filter Inductances, Chokes, etc.
High Capacity Condensers, 1 to 50 M. F.
B-Eliminators—Complete Filter Systems

RADIO RECEPTOR CO., Inc.

106—7th Avenue

New York, N. Y.

Through the Locals ALL-AMAX Reaches Out

Every ALL-AMAX Set, wherever it may be, brings to its owner his choice of all the beauties in the air. Every day come more and more letters to our office telling of the almost unbelievable long distance reception which has rewarded the owners of ALL-AMAX.

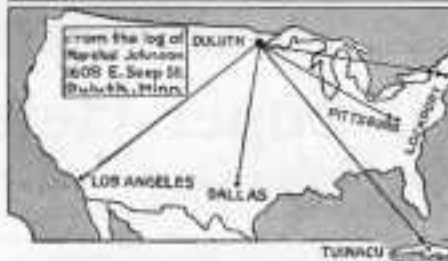
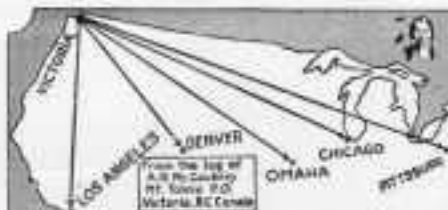

Remember, too, that ALL-AMAX is completely mounted on panel and base-board. Simple photographic instructions make wiring easy.

ALL-AMAX SENIOR, (three tube and detector) Price, \$42.00

ALL-AMAX JUNIOR, (one tube and detector) Price, \$22.00

ALL-AMERICAN RADIO CORP., E. N. RAULAND, President,

4217 W. Belmont Ave., Chicago

ALL-AMERICAN



3-Stage Resistance Coupled Amplifier Kit No. 1-C

Price **\$6.75**

Contains 3 "Electrad" Resistor Couplers, 1-00025, 1-005 and 2-056 "Electrad" Certified Mica Condensers, 1 condenser mounting, 2 "Electrad" Certified Grid Leaks, 4 "Electrad" Certified Resistors. Only other parts needed are sockets, one rheostat, binding posts and bus bar.

ELECTRAD¹_{NC}
428 Broadway, New York City

C-10 Super Heterodyne

DETAILED CONSTRUCTION BLUE PRINTS

The most sensitive and selective Super-Heterodyne set ever designed. It combines tuned radio frequency amplification with an improved Super-Hot circuit, using 10 tubes. Full-size construction blue prints for this famous model can now be obtained from the Radio Engineering Blue Print Department.

Price: Five Dollars Per Set

Note: These prints give all data, parts lists, and other information necessary to build the C-10 model.

M. B. SLEEPER, Inc.
A-52 Vanderbilt Ave., New York City



NAVY MODEL C-10 Super-Heterodyne

The Highest Class Receiver in the World

For any Circuit

Prompt shipment can be made on tested, standard apparatus of the following manufacture:

E. I. S., Inc.
General Radio
Willard
Benjamin Electric
Allen Cardwell
Dubilier
Western
Jewell
Western Electric
Radio Corporation
Music Master
Cutler Hammer
Federal

Formico
Magnavox
Arner Trans
Acme
Frost
Kallig

Wave length range 50-600 meters with removable Coils.
Panel Dimensions 28 3/16 in. x 8 in. x 1/4 in.
Only two major tuning adjustments.
Total amplification almost 2,000,000 times.

A high powered 10-tube Broadcast Receiver capable of receiving over 3,000 miles under favorable conditions, and having a degree of selectivity far in advance of others.

We believe the Navy Model C-10 represents final superiority over any receiver now being manufactured or even contemplated for broadcast reception.

Attractive illustrated literature gladly mailed upon request. Write direct to

NORDEN-HAUCK, INC.
Engineers

1617 Chestnut Street, Philadelphia, Penna.



The New B-T Tandem Condenser

The same high efficiency and unequalled construction that put the B-T "Lifetime" Condenser in the front rank is now available in tandem form. More than just a double condenser,—two carefully balanced units on one frame, working from a single shaft. Independent auxiliary "trimmers" provide the accurate balance vitally necessary in correct tandem design.

A product that really fulfills its purpose,—Simplified Control.

B-T "Torostyle" Transformers

Exhaustive research and years of experience in avoiding inductance pitfalls are behind this coil.

Arranged for short leads and easy wiring. Used in the patented B-T "COUNTER-PHASE" circuit.

Write for descriptive literature.



B-T
"TOROSTYLE" FOR
EASY WIRING

Better Tuning

Don't buy straight line frequency condensers till you've read "BETTER TUNING." We make both kinds and tell both sides. Send 10c for a copy or 30 cents for a year's subscription. Issued bi-monthly.

Bremer-Tully Mfg. Co.
532 S. Canal St., Chicago

SM
SUPER
PARTS

Setting New Standards!

Silver-Marshall Super Parts are daily setting new standards of electrical and mechanical excellence among radio engineers and set-builders. The new silver-plated straight-line-wavelength condensers are an example of the high quality of S-M Products, while the new bakelite-cased 210 and 211 Intermediate transformers are being acclaimed the biggest advance in radio development for this season.

Send for Free Circulars of Complete Line of S-M Parts and Magazine descriptions of the Super-Autodyne and All-Wave Super, developed by McMurdo Silver.

Silver-Marshall, Inc.

108 S. Wabash Avenue
CHICAGO, ILL.

Save Money

If you can use any of the materials listed below very low prices will be quoted for quantity orders

- C-H Resistor units, variable 220 to 340 ohms, 7 steps
- C-H Resistor units, tapped 1000-2000-3000 ohms
- 2500 lbs. No. 29 enamelled wire
- 100 lbs. No. 30 enamelled wire
- Also mica asbestos tubing,
- .015 grey paper, .005 varnished paper
- 20 M. F. Mershon condensers, ea. \$4.00
- 40 M. F. Mershon condensers, ea. \$4.50

C. J. BROWN

52 Vanderbilt Ave.
New York City, N. Y.

What is QUALITY In Radio Reception?

**Answer: Absence of the
sense of transmission**

SAMSON engineers strive to make possible the realization of the true meaning of Quality in Radio Reception. The success of their efforts is demonstrated in the fact that professional radio constructors almost invariably choose SAMSON Parts when building sets for their personal use.

Samson Radio Products

"The standard for comparison"
in addition to those illustrated are Double Rotor Coupler, \$7.50, Samson Long Wave Frequency Transformers for building the Cotton Super, \$4.50, Samson T-C Assembly, \$65 and Samson Transcript Kit, \$14.75. All Samson Radio Parts are guaranteed. Send for Data Sheet 17.

SAMSON ELECTRIC CO.

Manufacturers since 1882
Canton, Mass.

*Sales Representatives in Principal
Cities*



Samson H. W. Audio Transformer: "The Standard for Comparison." Only transformer with famous Samson Helical Wound Coils. Ratios—3:1 and 6:1. Price, \$5.



Samson Radio Frequency Choke Coil clarifies reception. Price, \$1.50.

Samson Neutralizing Condenser. Capacity .000025 mfd. to .000285 mfd. Price, \$1.75.



Radion parts improve every condenser

TO REDUCE condenser losses to the smallest possible point, all insulating parts must be of the highest efficiency. Built to order exclusively for radio purposes, Radion meets the most exacting tests for high insulating qualities.

Radion's 5 points of superiority

RADION excels in these 5 most important characteristics required of an insulating material:

- Lowest angle phase difference.
- Lowest dielectric constant.
- Highest resistivity (megohms cm).
- Lowest power factor loss.
- Lowest absorption of moisture.

THE makers of the best condensers are utilizing Radion to a greater and greater extent every day. We manufacture Radion parts for nearly all the leading condensers now made.

We invite manufacturer's inquiries

SET manufacturers also find Radion "the supreme insulation" for panels, dials, sockets, etc. We invite manufacturers to send us samples and specifications of panels and all other insulated parts of radio instruments or radio sets. We are always glad to co-operate fully in meeting their requirements.

AMERICAN HARD RUBBER COMPANY
Dept. MNS, 11 Mercer St., New York City

RADION

The Supreme Insulation

Why Not Do Your Own Molding?

The first of a series of articles on Bakelite molding, describing the equipment, space, personnel, and the cost of installing departments for small, medium, and large production. This data has been obtained thru the cooperation of the Hydraulic Press Mfg. Company.

WHY don't you mold your own Bakelite parts? Perhaps, like most of the other manufacturers, you think this is an absurd question because you know you can't do it. But can't you? And if not, why? Your reason is not lack of space, because a molding department capable of handling considerable production takes up very little room. It isn't because of the cost of the machinery, for the equipment is inexpensive, nor can it be that you don't know how, for it is simple enough to learn.

Of course, job molding shops have always thrown a shadow of mystery around Bakelite molding, giving the impression that elaborate and expensive machinery is necessary, and that secret processes are employed, without which successful molding is impossible.

The truth of the matter is that the development work carried on by the manufacturers of molding presses and the Bakelite Corporation, by whom the raw material is sold, has reduced the production of Bakelite parts to simple, known factors from which the guesswork has been removed. Moreover, technical service supplied from these sources assures the radio company of successful results.

There are three general types of molding presses, designed to meet individual requirements—The small presses capable of handling moderate production on knobs, dials, sockets, and even large pieces, the heavier, faster types for big quantities, and the high speed automatic presses which produce thousands of pieces per week.

Due to the increase in the demand for radio sets and parts during recent years,



Fig. 1. The hydraulic press is a simple machine, requiring no special mounting. It can be set up anywhere in the shop.

there has developed an enormous business in molded Bakelite parts. This demand, of a seasonal nature, has resulted in the springing up of a multitude of job shop molders who, when furnished with the manufacturers' dies, will supply the necessary molded parts.

The obvious drawback to purchasing parts in this way lies in the seasonal nature of the demand. A job-shop must operate on a 24-hour basis during the height of the radio season even though the personnel has been increased to the maximum. After the peak of the season has passed, the business diminishes until during the dull period of the radio year the average molding shop will be practically devoid of workmen. The mere skeleton of an organization is retained as the basis for next season's business.

With this picture of seasonal supply and demand in view, it is easy to foresee that during the peak of the radio season, parts will not be delivered on time or, being produced hurriedly, are not fully up to the standard of accuracy that is

required, molds will be roughly handled in the attempt to make speed, and an altogether unsatisfactory condition results.

Due to this unavoidable state of affairs, and to the fact that the industry as yet has not become stabilized to the point where all-year-round production of radio parts of a given design is practical, some of the more progressive and larger manufacturers have installed their own molding press equipment.

It is the purpose of RADIO ENGINEERING to present a series of articles describing the equipment necessary for the production of molded bakelite parts suitable for the radio industry, with the idea of aiding those who are contemplating the installation of molding equipment or feel the need of a molding equipment, and those who have need of a molding department but who have been deterred from giving the matter full consideration because of a feeling that the cost of equipment and technical molding experience necessary were beyond them.

In the molding process, the Bakelite resin is incorporated with various filling ingredients, such as asbestos, pulp or fibre, to produce a material for molding purposes—usually in powder form.

This powder is poured into steel molds—conforming to the shape of the piece desired—and subjected to a pressure of about 2,000 lbs. per square inch, in heated presses. The heat and pressure first soften and compress the charge, causing it to completely fill out the mold, and then bring about a chemical reaction which rapidly converts it into the hardened and finished product. The piece is exact in every detail and ready for use as it comes from the mold. Metal inserts can be accurately and rigidly imbedded during the molding operation. No machining, polishing or other finishing operation is needed.

Bakelite differs widely in its properties from other plastics, such as rubber, celluloid and shellac compositions, its outstanding characteristics being chemical inertness and stability. It has no softening point, and will withstand temperatures up to 300° F.

Bakelite is a phenolic condensation product, manufactured only by the Gen-

eral Bakelite Company and sold by them to the molding trade as a material fully compounded and ready for use. It is made in accordance with certain well-defined formulas, which insure a product of specific and recognized properties.

Manufacturers desiring to start a radio molding department for production on a comparatively small scale basis can do so at small expense. As a rule the job shop requires that the radio manufacturer pay for the molding dies. Consequently, every manufacturer has his

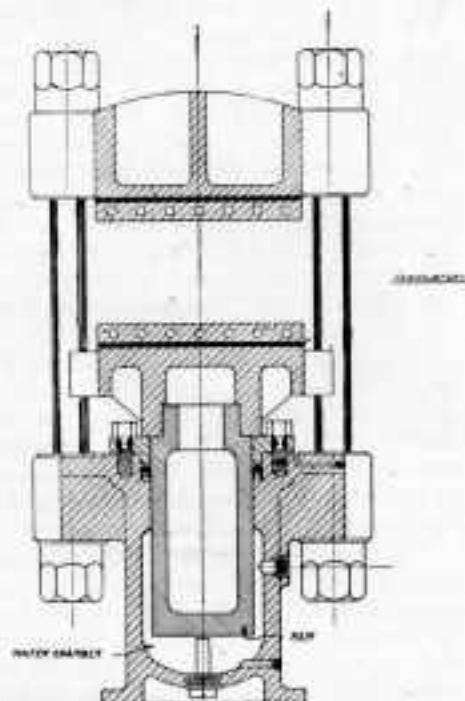

Fig. 2. Cross section of a hydraulic press, showing the water chamber and the ram which lifts the lower plate to compress the molds

molds available for use in his own presses. The second item of equipment is the hydraulic press. The very term hydraulic press is usually much misunderstood by those who have had no experience with such equipment. It does not, as many assume, require a continuous stream of water to operate it. The press consists merely of two pressure surfaces which are brought together like a huge clamp and held in that position by means of a ram acting in a steel



Fig. 3. Half a dozen strokes with the hand pump and full pressure is applied to the press. A reservoir is provided, so that the same water is used over and over again.

cylinder. Water forced into the cylinder under the ram, by means of a small hydraulic pump, builds up the necessary pressure to force the platens together. When this pressure is released, the water flows back to the pump reservoir and is used over and over again.

To cause the bakelite powder to soften and flow into the crevices of the mold, it is necessary that the molds be heated, both before and after being placed in the hydraulic press. It is the effect of heat under pressure that causes the Bakelite to flow, and then to set. Therefore, the presses used in the molding industry are equipped with plates of cast iron or steel, heated by steam, gas, or electricity.

Where steam is available, it probably affords the cheapest method of heating. Roughly speaking, a pressure of 125 to 130 lbs. is necessary to create the proper temperature. The older types of presses equipped with cast iron plates have been superseded by presses equipped with light steel plates, drilled with passages for steam heating.

Most radio manufacturers are not equipped with steam boilers suitable for the required pressure. Some overcome the difficulty by using one of the small types of gas fire boilers, which are on the market. As no great volume of steam is required to heat the plates, such a boiler will operate a small installation in a very satisfactory manner.

Recently, however, there has been perfected an electrically heated plate for molding presses, which is furnished with temperature control. One set of two of these plates, 20 by 20 in., in constant operation consume approximately $2\frac{1}{2}$ K. W. H. or 5 K. W. per hour per press.

For the hydraulic pressure, many of the smaller molding shops use combination two-pressure hand pumps, such as is shown in Fig. 3. This pump is mounted alongside the press and first fills the press cylinder with low pressure water after which a few strokes, with the high pressure plunger, bring the pressure end of the cylinder up to the required point.

Other shops use power driven hydraulic pumps and still others, where there are many presses, find it more economical to use motor operated hydraulic pumps feeding into an accumulator, thus creating a reservoir of high pressure water, which immediately actuates a press cylinder upon opening the control valve.

Those who desire to start their molding on the most economical basis for comparatively small production will find it to their advantage to purchase their presses equipped with two-pressure hand pumps as illustrated in Fig. 3. Such pumps have an additional advantage for those who are not familiar with molding, in that it is not possible to break the pins or inserts with a hand pump whereas, unless proper precautions are taken, this can occur when operating presses with accumulator equipment.

Inasmuch as one ton per square inch is required to mold the majority of bakelite articles, and even slightly higher pressures for certain large shapes, it is obvious that the manufacturer starting his own molding plant should not handicap himself by purchasing presses of inadequate size or capacity.

Experience indicates that hot plate presses with platens 20 by 20 in. are the most adaptable for general use. This type is shown in Fig. 1. In order to insure that presses with plates of this size will have sufficient pressure capacity to handle the full number of square inches of molding material that can be put in molds on such platens, it is desirable that the press run be not less than 10 in. in diameter, and that the press be suitable for approximately 118 tons pressure.

This press, Fig. 1, of 118 tons pressure capacity, equipped with electrically heated plates, hand pump, connecting pipe, and pressure gauge, as shown in Fig. 3, offers a mobile unit, which can be placed wherever most convenient. It requires no special foundation or piping and can be purchased for somewhat less than \$1,000.00 per complete unit.

Such a press is capable of molding up to approximately 118 square inches of Bakelite if in ordinary shapes. A special shape such as a 4 or 5-socket assembly

cast en bloc would probably require somewhat higher pressure. It must be borne in mind that although the platens of these presses have an area of 400 square inches, this type of molding requires hand molds and the actual area of the molded Bakelite part is comparatively small as compared with the outside area of the mold. Assuming, therefore, that it was desired to produce three 4-in. dials at one operation and that sufficient hand molds were available to run the press to maximum capacity, it would be possible on a very conservative basis to produce 36 such dials per hour.

In addition to the press equipment described above, it is necessary to have a hot plate entirely separate from the press so that the molds can be heated before being filled with the Bakelite powder. One hot plate can be used to serve two presses.

These hot plates can be heated by steam or electricity. In addition, a small arbor press, costing \$35.00, is required to strip the dies after they are removed from the press.

In the next article on molding, which will appear in the November issue, actual working data will be given for the layout of a small molding department, with production data for pieces of various kinds and sizes.

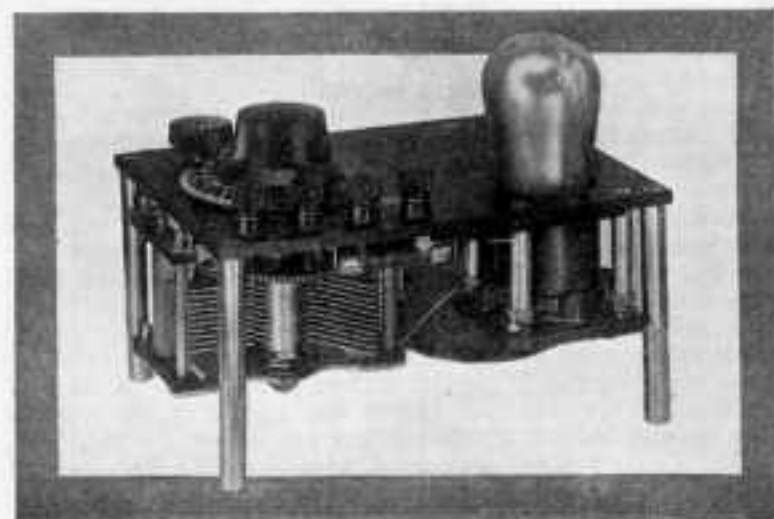

The accompanying illustration is published in response to numerous requests for a picture of the oscillator described in the June, 1926, issue. A schematic diagram was given on page 310 of that number.

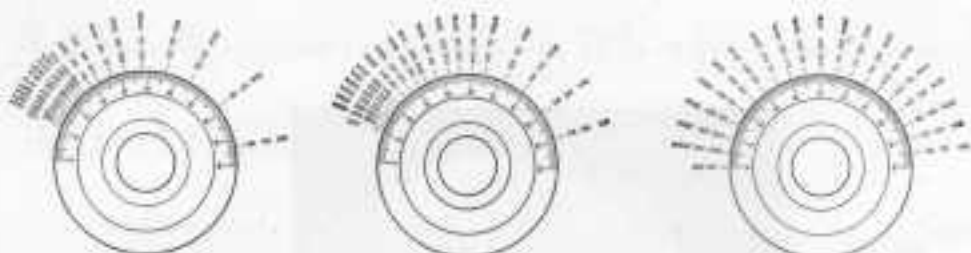

Fig. 1. Showing the dial logging with straight line capacity condensers, most widely used in the past, straight line wavelength condensers, and the logging with straight line frequency condensers on S. L. F. dials applied to S. L. C. condensers.

Separating Crowded Stations

The only thing complicated about straight-line frequency tuning is the name it has been given. It is simply a method of distributing the stations more evenly on the dials

THE newly adopted practice of rating broadcasting stations by their frequency instead of wavelength, as has been the custom in the past, has caused much confusion because there seems to be no reason, easily explainable for the change. The confusion is actually due to the fact that it was a mistake in the beginning to use the term wavelength.

We always refer to the frequency of A.C. power supply as 60 cycles or 120 cycles, or whatever it is. We discuss audio frequency currents in terms of cycles. A 60-cycle current has a wavelength of 5,000,000 meters. An A.F. current of 500 cycles has a wavelength of 600,000 meters, but we do not refer to it in that way.

Radio frequency currents have been an exception, for no good reason, and to rate them in cycles instead of wavelength is only righting an old mistake.

This is particularly true in tuning because interference between two stations depends directly upon the difference in the frequency of the oscillations they radiate, and only indirectly upon the wavelength.

Radio waves or oscillations travel at a speed of 300,000 meters per second. If there are many waves per second—high frequency—each one will only travel a short distance before the next starts—short wavelength—while if the waves or oscillations per second is reduced, each wave will travel farther before the next

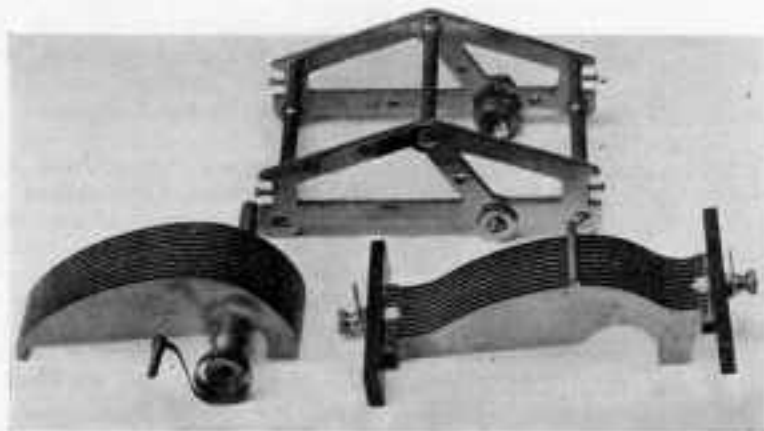
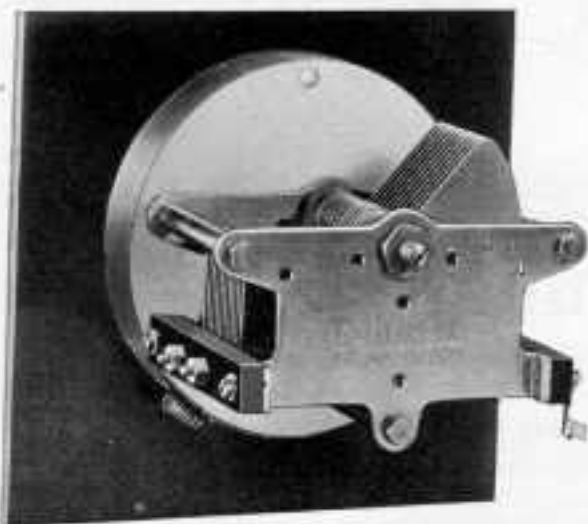

Fig. 2. A detail view of the rotor, frame, and stator of the Karas S. L. F. condenser. Note the extra bracing on the rotor and stator units, and the sturdy construction of the frame.



The mechanism of the Rathbun S. L. F. converter is enclosed in a brass shield, fastened to the panel. The condenser is then secured to the rear plate of the shield.

starts, giving a longer wavelength.

To show why the frequency rating gives a better picture of station separation, look at the table below. The Bureau of Standards has found that stations should be separated by 10,000 cycles or 10 kilocycles.

Wavelength in meters	Corresponding frequency in Kilocycles
428	700
434	690
441	680
448	670
454	660
461	650
469	640
476	630
484	620
492	610
500	600
508	590
517	580
526	570
535	560
545	550

Frequency Increase constant

Since the stations are adjusted to even steps of frequency difference, it is logical to have them separated evenly on the tuning dials of our receiving sets. That cannot be done with the ordinary condensers

for the reason which is apparent from the following formula:

$$f_{k.c.} = \frac{5034}{\sqrt{L \text{ cms.} \times C \text{ mfd.}}}$$

This formula shows that the frequency to which a tuning circuit will respond depends upon the inductance and the capacity in the tuning circuit. If the inductance is kept constant, and the capacity varied, the frequency to which the circuit will respond changes. However, a given increase in capacity does not give the same frequency increase over the tuning range because the frequency varies with the square root of the capacity.

For example, to tune from 1,500 to 1,400 k.c., with a fixed coil of 500,000 cms. inductance requires that the condenser be increased from 0.000020 mfd. to 0.000026 mfd., a change of only 0.000006 mfd. But to tune from 600 to 500 k.c. calls for a variation of 0.00014 to 0.00020 mfd., an increase of 0.000060 mfd.—10 times the first increase.

Then, if every 10 degrees variation on the dial is to give 100 k.c. change in tuning, it is obvious that rate of capacity change must vary from a small increase

(Concluded on page 463)

Some Experiments with the All-Amax Senior

Describing an experimental circuit which gives some interesting results. No additional instruments are necessary

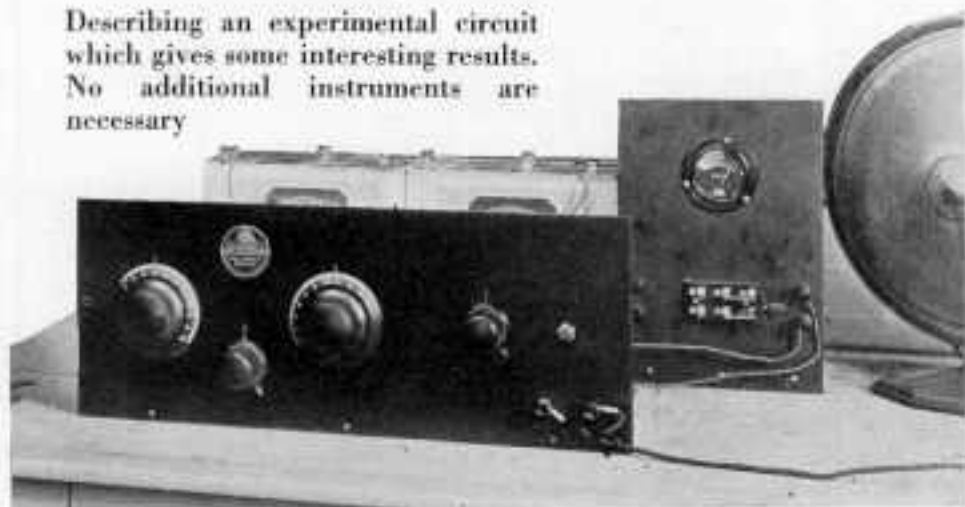

Fig. 1. The All-Amax receiver ready to operate. Notice the storage battery panel, equipped with a voltmeter and charge-discharge switch.

THE everlasting impulse to experiment with everything was responsible for the data given in this article. No matter how good a radio set is, and the reputation of the standard All-Amax reflex is well established, there is always the temptation to see what an outfit will do with a different hook-up.

The All-Amax is a splendid set for experimenting because of the particular instruments provided, and because of their arrangement. On the front panel are two variable condensers, two Carter rheostats, crystal detector, and terminals for the phones. Mounted on the base panel are three standard sockets, two universal couplers for tuning, two A. F. and one R. F. transformer, and a binding post strip.

Ordinarily, these instruments are connected for reflexing, giving one stage of tuned R. F., a stage of transformer coupled R. F., crystal detector, and two stages of A. F.—the equivalent of a five-tube outfit.

We tried a variety of other circuits just to see what would happen. Some were only fair, some sensitive and selective but unstable, breaking into oscillation too easily, but of these one gave excellent

results, particularly as to quality, because it took full advantage of the pure rectification from the crystal detector.

Fig. 2 gives the circuit. The antenna is connected in series with the primaries of both universal couplers. The secondary of one, tuned by the left hand condenser, goes to the R. F. amplifier tube. It is coupled thru the R. F. transformer to a crystal detector and then, thru an A. F. transformer, to the first A. F. amplifier tube and on to the second stage.

So far, the circuit is like the conventional R. F. set. The change comes in using the secondary of the other coupler either as an absorption circuit or a wave trap to cut out interfering stations. Owing to the constants of the R. F. transformer, the first tube oscillates over the entire wavelength range. Coupling the tuned absorption circuit to the antenna acts as a control to stop the oscillations. In subsequent experiments we took the primary of the absorption coupler out of the antenna and put it between the point at which the secondary of the tuning coupler secondary and variable condenser are connected together, and the filament. We also put it directly in the tuning circuit, between the secondary and the condenser

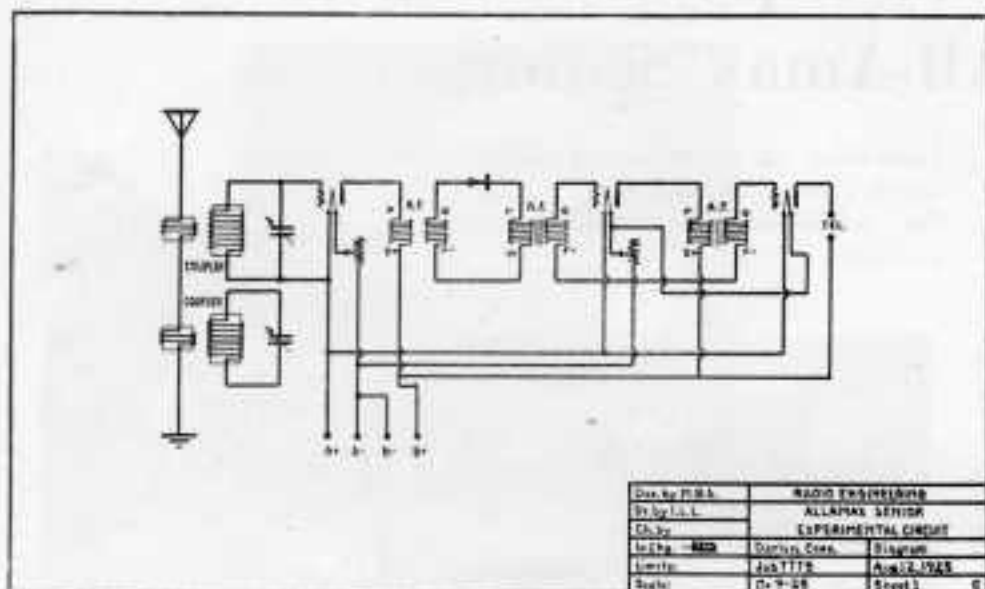

Fig. 2. Schematic diagram of the experimental circuit for the All-Amax Senior construction kit.

in the tuning circuit.

The absorption control of oscillations was most successful and easiest to handle in the latter position, much superior to the results of the circuit in Fig. 2, because the absorption condenser could be calibrated, and the regulation was closer.

Detailed views of the outfit, taken at the Darien Laboratory, are given in Figs. 1, 3, and 4. There are some interesting

possibilities in a circuit of this type, employing tuned R. F. with a crystal detector.

Such a method is entirely practical, in view of the recent developments in detector crystals and construction of the detectors themselves. Particularly on inexpensive receivers, there is a saving in cost by eliminating a tube and socket, and by reducing A and B battery consumption. Moreover, if the R. F. amplifier is in a

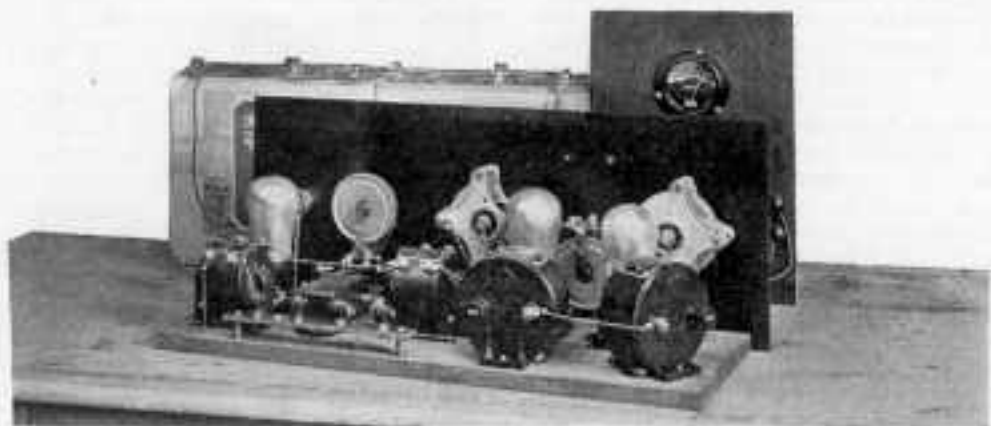

Fig. 3. The absorption coupler and tuning inductance are mounted at an angle at the right hand end of the base panel.

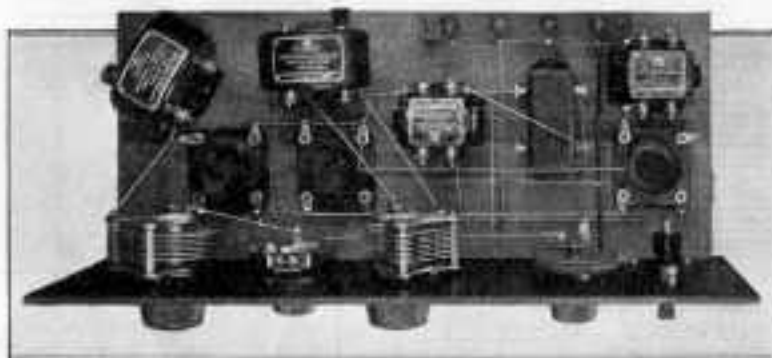

Fig. 4. Top view, illustrating the layout of the parts. Note the enclosed, semi-adjustable crystal detector. The kit is supplied with the parts all mounted on the front and base panels.

regenerative condition, it does not introduce as much distortion as a regenerative detector. With a crystal detector, which

cannot oscillate, the regeneration in the R. F. amplifier does not have an appreciable effect.

Separating the Crowded Stations

(Continued from page 460)

per 10 degrees to a large increase per 10 degrees.

That's why condensers which give straight-line frequency tuning must have such oddly shaped plates. One of the first S.L.F. condensers to be put on the market this fall is the Karas type, shown in Fig. 1. This is, by the way, the best finished condenser we have seen, solid and strong with beautiful workmanship in every detail. The combination of highly polished nickel on the end plates with gold plating on all the other parts gives it a most attractive appearance, while the soldering is so neat as to be practically invisible.

The S.L.F. tuning makes the adjustment of the condensers far easier and more satisfactory than with what we now call straight line capacity control, for the high frequency—short wave—stations are not bunched together at the lower end of the dial, with the low frequency—long wave—stations spread far apart at the upper end. This is illustrated in Fig. 2. Still, a low ratio vernier dial, we would suggest perhaps 5 to 1, is very helpful with the S.L.F. control.

Fortunately, it is possible to get S.L.F. adjustment on the old style S.L.C. condensers by using an S.L.F. connecting

dial. Both Rathbun and Walbert are producing dials of this type. They are made with a variable-ratio gearing, so that for the first 10 degrees on the dial the condenser plates are turned only a tiny bit, increasing the amount of change until on the last 10 degrees of the dial the plates turn through a considerable arc.

The Walbert type is made with the gearing arranged in such a way that the dial is concentric with the condenser shaft and fastened to it, preventing any play from wear on the parts between the dial and the shaft. A 12 to 1 gear ratio is provided for fine tuning.

Because of a difference in design, the Rathbun dial is slightly off-set from the shaft. It has a 2 to 1 ratio. One of the special Rathbun models is shown in Fig. 3, with a Cardwell S.L.C. condenser mounted on it. An ordinary dial is used on the front. The standard type, however, has a large knob at the front, made hollow to accommodate the mechanism.

As soon as the public has become familiar with S.L.F. tuning, it is certain that the awkward, uneven distribution of stations on the dials will be tolerated no longer. In fact, sets not equipped for S.L.F. control will be under a severe handicap during the coming season.

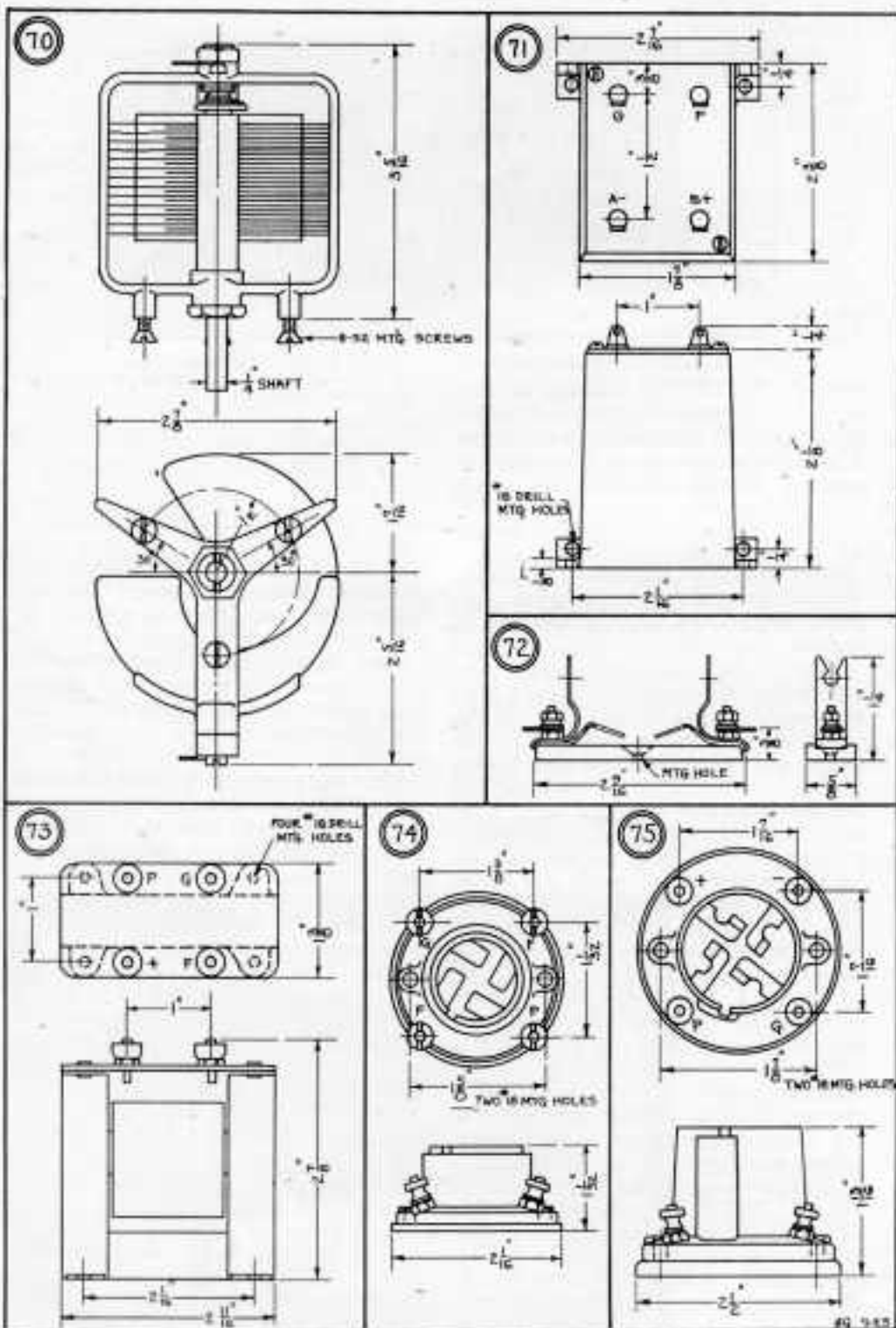

Data Sheet No. 10

70. PHENIX CONDENSER: This 0.0005 mfd. variable condenser represents a new departure in both mechanical and electrical design. The stator plates are all soldered to a rigid metal block which is in turn supported by one narrow strip of insulating material placed outside of any possible electrostatic field. In addition, the stator plates are of a cutlass shape so as to give a straight line wave length variation. The rotor plates are semicircular, provided with a pig-tail connection. Sufficient rigidity is obtained by the two cross spiders, so that no end plates are necessary. The instrument is mounted by means of three 8-32 flat head machine screws.

71. SILVER-MARSHALL 60 K. C. TRANSFORMER: These transformers are made in two types, the Two-ten and Two-eleven, both having the same external dimensions. The Two-ten is a long wave interstage transformer peaking at 60 K. C. and passing a frequency band 11 K. C. wide. It has an extremely small silicon steel core and has a turn ratio of 1 to 23. The Two-eleven is a sharply tuned transformer peaking at 60 K. C. in conjunction with the special fixed condenser supplied, which is to be connected across its primary. It is of the air core type and is designed for use at the output end of the intermediate amplifier before the detector tube. The turn ratio is 1 to 10. The transformers are enclosed in a metal case with soldering tabs brought out at the top. An angle lug at each side permits of mounting the case in either a horizontal or vertical position. Each transformer is supplied with an amplification curve plotted from an actual laboratory test on the instrument.

72. ELECTRAD GRID LEAK AND CONDENSER MOUNTING: This mounting is designed to take the standard sized tubular grid leaks and fixed mica condensers. The base is of Bakelite, and the clips of nicked brass. Both binding posts and soldering lugs are provided for connection. A center hole in the base is provided for mounting.

73. KELLOGG AUDIO TRANSFORMER NO. 504: This instrument is made in both 1 to 3 and 1 to 4½ ratios. It has a shell type core and is unshielded. It is the same as the more expensive types, except that the mounting has been simplified to make it adaptable for use by set manufacturers. The binding posts are located at the top for convenience. Four mounting holes are provided at the bottom.

74. NA-ALD UV-199 SOCKET: This socket is made of Bakelite and is very compact. The four phosphor bronze contact strips make excellent contact with the tube prongs. The socket shell is reinforced throughout by ribbing. Four terminals are located down near the bottom so that wiring is kept near the baseboard. The nuts are slotted so that they can be tightened with an ordinary screw driver.

75. NA-ALD 201-A STANDARD SOCKET: This socket for standard tubes possesses many interesting features. The shell is made of Bakelite. The phosphor bronze contacts are laminated to provide greater resiliency. The sides are bent around so that when the tube is inserted the springs not only make contact with the bottoms of the prongs, but the upper contact also cuts into the side, scraping off all corrosion and making a good contact.



Freeman's B battery eliminator, selling at \$25.00, uses a vacuum tube rectifier.

The distribution of N. & K. phones and loud speakers will now be handled by Neufeldt & Kuhnke at 46 East Houston Street, New York City. This does not indicate any important changes in the organization, however, as a number of the men handling N. & K. business at the Goldschmidt Corporation will be identified with Neufeldt & Kuhnke. They have just announced a new type of N. & K. loud speaker, built around the standard telephone unit, but very much changed in outward appearance.



Throwing the little switch makes the Beede meter show the filament or plate voltage.

An important expansion of the Dongan Electric Mfg. Company is indicated by the announcement of the Dongan Electric Manufacturing Company of Canada, Ltd., with factory and offices at Walkerville, Ont., Can. This expansion is a natural result from the large amount of business which has been handled up to the present time from the Detroit factory. The Canadian repre-

sentatives will be W. F. Kelly, 104 West Richmond Street, Toronto; I. D. Livinson, 5335 Park Avenue, Montreal, and T. W. MacKay, 807 Electric Railway Chambers, Winnipeg.

A new series of condensers and resistance units introduced by Micamold will appeal to designers of radio equipment. About the same size as the conventional fixed condensers, the Micamold condensers are entirely encased in molded bakelite. This not only fixes the capacity permanently but seals the plates against moisture. The Micamold resistor units are made by molding the resistance element into bakelite under 50

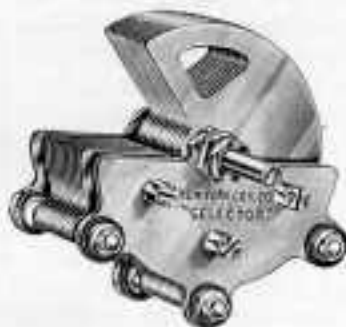

New York Coil has added a lower priced line of condensers.

tons pressure. They are of dimensions suitable for mounting in standard grid-leak clips.

The Formica Insulation Company has purchased the controlling stock in the Veri-Chrome Laboratories of Cincinnati. This gives them control of the Veri-Chrome process for marking radio panels. Apparently some of the distributors of Formica panels have been licensed to employ this new process which replaces machine engraving.

The Twentieth Century Radio Corporation, of Brooklyn, New York, has been appointed as Eastern representative for the Mayolian Radio Corporation, manufacturers of the Mayolian B supply.

The HAMMARLUND

Straight-Line-Frequency Condenser

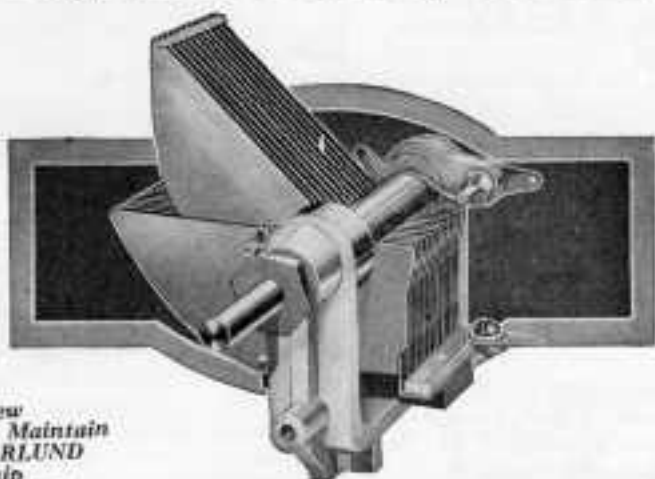

These New Features Maintain HAMMARLUND Leadership

Straight-line Frequency, spacing stations equally over the dials.

Single-hole mounting.

Only one small strip of highest quality insulation, placed outside of electro-static field.

Full ball-bearings at both ends of rotor-shaft.

Soldered brass plates, electrolytically treated against corrosion.

Heavy aluminum non-warping frame, grounded through rotor.

Separate "hand-capacity" shield supplied for use if needed.

New Adjustable balancing device.

Tie bars on rotor and stator plates assure permanent accuracy of spacing.

The most rugged condenser of its type.

Distributes Stations Evenly Over Your Dials

The great radio development for 1926 is the S-L-F Condenser. It was inevitable, owing to the multiplicity of broadcast stations and the inability of old type condensers to separate them properly.

The public erroneously classifies radio stations according to wave-lengths, whereas they operate actually on particular frequencies allotted by the Government, ten kilocycles apart. The peculiar shape of the S-L-F Condenser plates is designed to separate and evenly distribute these frequency groups over the dials.

The new Hammarlund S-L-F Condenser is an engineering masterpiece, with that superior neatness of design and electrical efficiency always distinguishing Hammarlund workmanship.

It is clean-cut, more compact and will stand more abuse than any condenser of similar type.

Made in all standard capacities

Write for descriptive folder

HAMMARLUND MANUFACTURING CO.
424-438 W. 33rd St. New York

For Better Radio
Hammarlund
PRECISION
PRODUCTS

McMurdo Silver is only satisfied with what he has until he can get something better. Now the Silver-Marshall 201 intermediate and 211 filter transformers are being made with molded bakelite cases, replacing the aluminum housings previously supplied. This has improved the appearance of the transformers considerably.

H. H. Eby, not satisfied with a virtual control of binding post manufacture for radio equipment, has now moved to 4710 Stenton Avenue, Philadelphia, where, if they can't make Eby binding posts better, they will at least be able to make more of them.

Fantail as a trademark for B. M. S. telephone jacks has helped greatly in putting across the advantages of the



Van Horne is creating public confidence by furnishing an individual calibration with each tube. This helps in matching, too.

spread-out terminals which make soldering so much easier than when the lugs are brought out close together.

The stamping of high silicon steel for A. F. transformer laminations has developed into a highly specialized process. Funk & Shore, of New York City, have recently completed a thorough investigation of turning out laminations of 0.003 to 0.03 inch in thickness and from

0.5 to 5.0% silicon contents. This has involved not only a study of the correct selection of steel for the stamping dies but the determination of the correct speed at which the presses can be run. Oxide of iron forms a scale on silicon steel which rapidly destroys the cutting edges of the dies, introducing a complication which is not ordinarily encountered in punch press operation.

Following the success of the Cello-meter as equipment for automobiles, the Cellokay Manufacturing Corporation of New York has recently produced a special model, to be used on radio receiving sets, by means of which the exact condition of the storage battery can be determined without the necessity of testing with a hydrometer. The Cello-meter is a special type of voltmeter, equipped with an operating button and a load resistance. When the button is pressed, the load is put on the battery circuit and the voltage measured. The manner in which this is done provides accurate indication of the condition of the storage battery. The method is such that the same meter can be used with any size of storage battery.

Aero B is the name of a new tube rectifier, employing one UV201-A, recently introduced by the Glenn L. Martin Company of Cleveland, Ohio. It is understood that this B battery eliminator was developed during the course of special work conducted in connection with aircraft equipment for the United States Army.

A complete line of pocket and panel meters for radio sets is now in production in the factory of the Beede Electrical Instrument Company, Penacook, N. H. In the larger size there is a switch operated double-reading voltmeter for 0 to 10 and 0 to 100 volts and a series of single reading meters from 0 to 10 amperes, 0 to 10 volts, and 0 to 100 volts. In the small sizes, there is a double reading voltmeter, 0 to 10 and 0 to 100 volts and single reading voltmeter, 0 to 10 volts. The larger size is 2¼ ins. in diameter overall, and the small, 1-11/16 ins. in diameter.

DAVEN TUBES

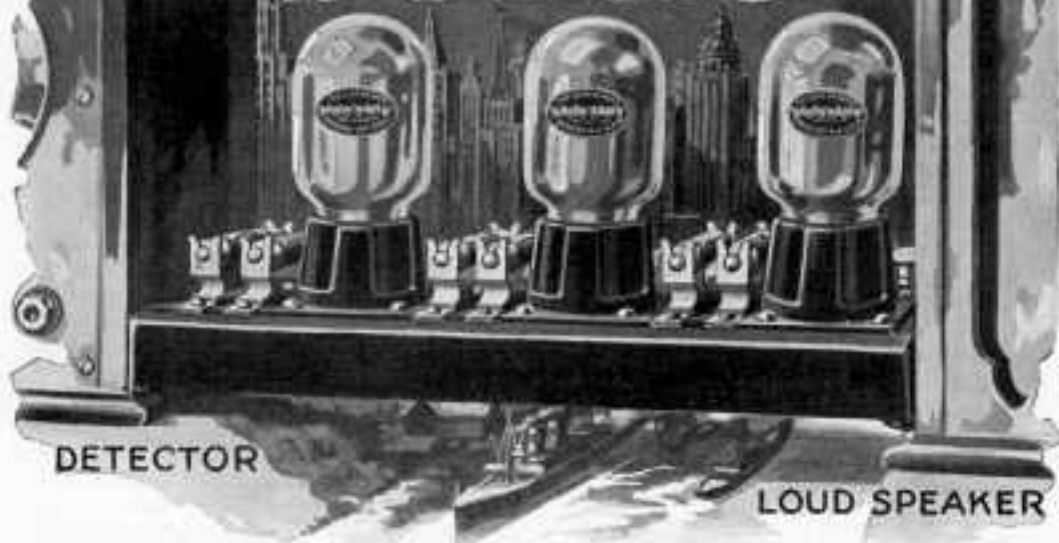

The Bridge To Amplification Without Distortion

Daven engineers were pioneers. They blazed the way for others to follow. They designed and built the first Resistance Coupled Amplifier offered the public. They found resistance coupling in an experimental stage. They perfected it.

Daven Resistance Units, Amplifier Kits and Super-Amplifiers are accepted by the foremost authorities in Radio as standard. The Daven Super-Amplifier, for use in any known set or circuit, is priced at \$15.00.



RESISTOR MANUAL.
Manufacturers of high grade sets are turning to Resistance Coupled Amplification. The authority is *The Resistor Manual*. At your dealer's, 25c; or by mail, 35c.

A NEW TUBE BY DAVEN

To meet the exacting requirements of Resistance Coupled Amplification the Daven Radio Corporation has created a new product—the **DAVEN HIGH MU VACUUM TUBE** Type MU 20. It is designed for one specific purpose only—to increase the amplification of the Daven Resistance Coupled Amplifier so as to exceed that of ordinary audio frequency coupling. The *Daven High Mu* is a 6 volt, $\frac{1}{2}$ ampere tube with an amplification constant of 20. The price is \$4.00. *Daven Power Tube* Type MU 6 is recommended for last or output stage. Price \$5.00. *Daven products are sold only by good dealers*

The Radio Store
DAVEN RADIO CORPORATION

Resistor Specialists
Box 51, E. Pat. N.J.

NEWARK

NEW JERSEY

USE THIS FREE COUPON

Daven Radio Corporation
128-130 Summit Street
Newark, New Jersey

Please send me the following on Resistance Coupled Amplification:

- Check one.
- Resistor Manual, 25c is enclosed.
- Complete Catalog (free)

Name:

Address:

Please Enclose: Good money letter, bank or post, or 34c stamps and we will pay by express, insured—no communication with you.

THE BIG LITTLE THINGS OF RADIO

Pacent Electric is preparing to make deliveries on a new series of parts which include a straight line frequency condenser, a vernier dial indicator, a universal socket for the new type of radio-trans, and an improved A. F. transformer.

Several changes have been announced by W. H. Frasse in the organization of the Daven Radio Company. Mr. K. R. Moses, formerly sales promotion manager at Crosley Radio, has become the sales manager, while W. A. Balevre, who has done so much to advance the development of resistance coupled amplification, is now advertising and sales promotion manager. G. D. Harris will represent Daven in Illinois, Wisconsin, and Indiana, making his headquarters at 332 South Michigan Avenue, Chicago, while Fred Garner, with headquarters at 209 Baltimore Bldg., Kansas City, will cover Iowa, Nebraska, Kansas, and Missouri.

Fall models show a decided tendency toward the use of pointers on tuning instruments, operating with scales engraved on the panels. Adjustments are made by small geared knobs. This style was probably set by the Western Electric Company in the design of their Super-Heterodyne equipment. There may be some manufacturing advantages in this arrangement but, from the point of view of the operator, it is not highly satisfactory in that it is difficult to read the high and low ends of the scale. With a fixed line on the panel and a rotating dial, however, the reading is always made in the natural vertical position.

It is expected that the new Kolster sets, a splendid line just introduced this fall, will be built in the factory of the C. Brandes Company. The Kolster line is a new undertaking for the Federal Telegraph Company of California, the concern which has built so many commercial and government arc stations.

Set manufacturers will do well to investigate the new Gould Unipower, a very neat and attractive combination Gould storage battery and Balkite charger. This works directly from the A.C. lighting cir-

cuit. When the current is turned on the charger puts a small current into the storage battery, so that it is not necessary to give the battery a regular charge as is the case with a separate charger. The most popular sized Unipower fits into the right-hand compartment on a Radiola Super-Heterodyne.

The Radio Master Corporation of America, Bay City, Michigan, is bringing out one of the handsomest lines of radio cabinets we have ever seen. In design, finish, and the use of the wood grain they are exceptionally beautiful.

IN RADIO RETAILING for August there appears a statement in the advertisement of the Bosworth Electric Manufacturing Company that puts to shame the attempts of other concerns to make claims which are not substantiated in practice. "Using the fifth tube, any station on this continent can be brought in usually with excessive volume." There is no doubt but what this claim slipped past the watchful eye of the advertising manager for no publication from McGraw-Hill would knowingly allow an advertiser to make such an absurd claim.

General Radio, Cambridge, Mass., is now building a tandem condenser for multiple tuning. The condensers are made in three sizes, 0.00025, 0.00035, and 0.0005 mfd. in each unit. The three types sell for \$5.75, \$6.15 and \$6.50 respectively.

A. H. Grebe is almost the only set manufacturer that made an outfit last year good enough to be sold this year with only very minor changes which do not alter the appearance of the set at all, although they have perfected small details which make important contributions to the net results. Here again Grebe is setting precedents which other concerns will have to follow. The answer given in the Synchrophase to the question of handling three dials simultaneously deserves special commendation. The arrangement employed makes any one dial operate all three or each dial can be turned separately.



**Type S
Audio Transformer**
Special quality in this handsome mounted transformer. Attractive price.



**Type CSB
Audio Transformer**
One of 35 types exclusively for set mfgs. Performance equal to any.



**Type N
Voltmeter**
One of 5 types. Range 0-7, 0-50, 0-100 volts. A guaranteed, high grade instrument.



**Type B—A. C. Tube
Transformer**

DONGAN

Audio Transformers and Voltmeters

42 Set Manufacturers Use Them

It is only natural that Dongan can continue to manufacture Audio Transformers that suit the requirements of the great majority of receiving set manufacturers. Many of the men in today's organization have been designing and building Dongan Transformers for 15 years.

Better Audio Transformers priced specially for set manufacturers; a reputation for quality always maintained; deliveries when you need them—all are assured Dongan customers.

This year many sets achieve a new sales appeal by the use of Dongan Voltmeters. Built into the set Dongan Voltmeters become most essential to fans who like to keep performance up to par. Accuracy throughout the scale is a dependable feature of Dongan Voltmeters.

Jobbers :- Dealers

The Radio Public is demanding reliable merchandise like Dongan Transformers and Voltmeters. You will find Dongan parts the last word in design, construction and appearance. Our discounts allow you a generous profit—Dongan Repeat Sales assure it.

**For B-Eliminators use
Dongan Transformers
and Chokes.**

DONGAN ELECTRIC MANUFACTURING CO.

2995 Franklin St., Detroit, Michigan

"Transformers of Merit for 15 Years."

NEW!



No. 486 Eveready Layerbilt "B" Battery. 45 volts. Length, 8 3/16 inches. Width, 4 7/16 inches. Height, 7 3/16 inches. Weight, 14 1/2 pounds. Price, \$3.50.

The greatest improvement

ABSOLUTELY new in construction—perfected through years of research, the new Eveready Layerbilt "B" Battery is as superior to the old type as a tube set is to a crystal.

Heretofore, all dry "B" Batteries have been made up of cylindrical cells—no one knew how to make them any other way. The new Eveready Layerbilt is made of *flat* layers of current-producing elements compressed one against another, so that every cubic inch inside the battery case is completely filled with electricity-producing material. Layer-building heightens efficiency by increasing the area

of zinc plate and the quantity of active chemicals to which the plate is exposed.

After the most rigid laboratory tests, more than 30,000 of these new Eveready Layerbilt "B" Batteries were manufactured and tested by use under actual home receiving conditions. These tests proved that this new battery is far superior to the famous Eveready Heavy-duty Battery No. 770, which up to now we have ranked as the longest lived "B" Battery obtainable.

On 4-tube sets, 16 mil drain,
it lasts 35% longer.

On 5-tube sets, 20 mil drain,
it lasts 38% longer.

Radically different!



It's all battery. With every cubic inch packed to capacity, it contains about 30 per cent more electricity-producing material. All chance of loose or broken connections avoided by contact of full area of carbon plate against zinc plate. The scientifically correct construction.

ever made in "B" Batteries

On 6-tube sets, 24 mil drain,
it lasts 41% longer.

On 8-tube sets, 30 mil drain,
it lasts 52% longer.

The new Layerbilt principle is such an enormous stride forward in radio battery economy that we will bring out new sizes and numbers in this Layerbilt form as fast as new machinery is installed. For the present, only the extra-large 45-volt size will be available.

Buy this new Eveready Layerbilt No. 486 for heavy drain service. It far exceeds the performance for which Eveready Radio Batteries always have been famous and is, we be-

lieve, by far the most economical source of "B" current obtainable.

Manufactured and guaranteed by
NATIONAL CARBON CO., INC.
New York San Francisco
Canadian National Carbon Co., Limited
Toronto, Ontario

EVEREADY HOUR
EVERY TUESDAY at 8 P. M.

(Eastern Standard Time)
Beginning September 23rd, 8 P. M.
(Eastern Standard Time)

For real radio enjoyment, tune in the "Eveready Hour." Broadcast through 100,000—

WEAF New York	WEAR Cleveland
WEAR Pittsburgh	WJAF Cincinnati
WEEI Boston	WWJ Detroit
WFL Philadelphia	WOOD Minneapolis
WBR Buffalo	W. P. M. St. Paul
WCAE Pittsburgh	WGC Rochester

EVEREADY

Radio Batteries

-they last longer



A Pioneer Leader

AmerTrans continue from month to month as one of the *best* selling audio transformers.

There is ample volume, and the "tone-keen" characteristic of AmerTrans furnishes a pleasant, distinct reception value—most appreciated by the critical listener. In fact, there is no more efficient and permanent working part in any set than a pair of AmerTrans.

Buy AmerTrans by the Pair from an Authorized Amer-
Tran Dealer.

They are made in two types, one quality—A F 6, ratio 5:1, and A F 7, ratio 3½:1. Price, either model, \$7.00.

AMERICAN TRANSFORMER
COMPANY

173 Emmet Street, Newark, N. J.

"Transformer builders for over
twenty-four years."

AMERTRAN



Free!

You want the best in equipment at the lowest price. That's how you make customers and *keep* them.

Poor gridleaks, for example, are dear at any price. You ought to know the Eagle Variable Gridleaks—reliable, accurate, perfect control from 0 to 50 Megohms.

So sure are we of their superior qualities that we make this

Special Offer

For a limited time only we will send any radio dealer, jobber, or manufacturer one Eagle Variable Gridleak for test.

No charge—just fill in the coupon below and mail.

Eagle Electric Mfg. Co.
40 So. 8th St., Brooklyn, N. Y.

The Eagle Electric Mfg. Co.
40 So. 8th St., Brooklyn, N. Y.

Send me 1 Eagle Variable Gridleak for test as per offer and the big radio and electrical catalog.

Name

Address

Panel Meter No. 400



(Exact Size)

BEEDE PANEL METERS Are Accurate, Durable and of High Resistance

Eliminate trouble by giving complete information on the panel

Increase efficiency of any set

Manufacturers will find that the slight cost of the meter will be more than offset by the decrease of servicing necessary without a meter.

*Tells condition of
both A & B Battery*

Attractive Prices to Manufacturers

Mfg. by

Beede Electrical Inst. Co.
Penacook, N. H.

*Manufacturers of all types of radio
voltage and ammeters.*

New York Office, 98 Park Place

Union Radio Tip Jacks Sell On Sight

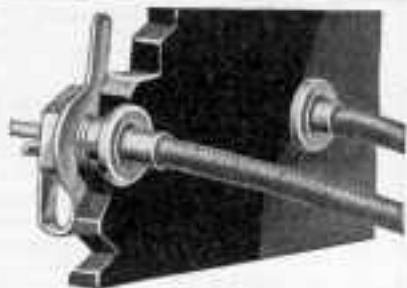

at **25c** a pair

Put a display carton of Union Radio Tip Jacks on your counter and watch them sell. Their many advantages over binding posts win the approval of fans everywhere. THAT'S WHY SO MANY LEADING SET MANUFACTURERS HAVE ADOPTED THEM AS STANDARD EQUIPMENT FOR THEIR SETS.

Three Sizes for All Panels, Cabinet Walls and Partitions

Packed in "self-selling" counter displays in 1/12, 3/4 and 1 gross pairs.

Type A for panels, etc. 1/16" to 1/8" thick.
Type B for panels, etc. 5/16" to 3/4" thick.
Type C for panels, etc. up to 1 1/2" thick.



IDENTIFICATION TAGS—Hard red film oval with various designations as "A", "B", and many others. Threaded on screw wires they hold which is watch and see lines of tracing no. A reliable safeguard. Top hole, 3/16" diameter, will take any wire up to 1/4". Packed 100 in a box of one designation only. Small price \$1.00.

TUBE SOCKETS—Machined combination highly polished. Phosphor bronze contact sections. Reinforced bakelite shell. Fine standard tubes. Small price 10c.

DIAL ADJUSTERS—Pacilla minute adjustment of dial. Very necessary for fine tuning. Detail price 6c.

**RETAILERS WHOLESALERS
SET MANUFACTURERS**

Write for samples, literature and price lists. Ask for illustrated brochure "X".

UNION-RADIO-CORPORATION
124 - SUSSEX AVENUE - NEWARK, N.J.
NEW YORK OFFICE - 116 WEST 32ND STREET
43000

RX-1 Dataprints

Save \$1.25—Get a set of RX-1 dataprints FREE by subscribing to Radio Engineering Magazine for one year. The cost of the Dataprints plus a year's subscription, is \$3.25. Send in \$2.00 for a year's subscription and the RX-1 Dataprints will be mailed to you without charge.

**ONLY
DATA-
PRINTS
ARE
SO
COMPLETE**

1. Parts list
2. All constants
3. Battery connections
4. Picture wiring diagram
5. Schematic wiring diagram
6. Terminal checking list
7. Step-by-step instructions
8. Names of manufacturers
9. Full-size panel patterns
10. Accuracy in every detail

RX-1 results can be obtained only with RX-1 design, results never before considered even possible with a non-regenerative circuit, results which cannot be equalled with a set which oscillates. Be the first in your city to have the complete information given in the RX-1 Dataprints.

No special equipment except the coils and Sodian, no complicated wiring, no expensive parts—but RESULTS.

COMPLETE SET OF FIVE FULL-SIZE DATAPRINTS..... \$1.25

BLUEPRINTS for STANDARD SETS

- REINARTZ RECEIVER, one of the most popular models ever described in Radio Engineering. A splendid set for all around broadcast work. Type 3300, 4 sheets..... \$1.00
- HAYNES TUNER, known as the "One Thousand Miles for Fifteen Dollars" set. 2 sheets..... .50
- BROWNING-DRAKE 199, the standard B-D design, built for dry cell operation. It is equipped with four UV-99 or C-299 types. Type 7000, 5 sheets..... 1.25
- BROWNING-DRAKE 201-A, using one UV-199 and three 201-A tubes, arranged to operate on a 6-volt storage battery. Type 6600, 6 sheets..
- BROWNING-DRAKE FIVE, equipped with a 3-step resistance coupled amplifier. Uses one UV-199 and four 201-A's. The finest of all the B-D receivers. Type 7500, 5 sheets..... 1.25
- COTTON SUPER, peer of long distance receivers, and the simplest of all eight-tube supers in design and construction. Type 7200, 7 sheets.... 1.75
- 2-STEP AF AMPLIFIER, designed for use with any type of receiving set where additional amplification is required. Type 3100, 3 sheets..... .75
- SAMSON T. C. SET, the latest construction kit for tuned R. F. reception. Can be used with the Sodian detector. 3 sheets, with parts list, checking list, and assembly instructions..... .75

M. B. SLEEPER, Inc. Technical Publisher
A-52 Vanderbilt Avenue New York City

NOW You Can Build A REAL One Dial Set!

COMPENSATED

MULTIPLE



VARIABLE

CONDENSER



[Patents Pending]

This new U. S. L. Multiple Condenser has been given the most thorough and impartial tests by manufacturers and laboratory experts throughout the country. All agree that it is the

Only Practical One Dial Control Unit

Evenly matched and balanced; 100% perfect electrically and mechanically; can be built into any T. E. F. circuit. It is a straight line, low loss unit making the sharpest tuning quick and easy. Capacity: .00035 mfd. per unit. Order a sample today.

Price \$13.50 including Bakelite dial and two knobs

BRANCH SALES OFFICES

Boston—Philadelphia—Chicago—Minneapolis
St. Louis—Omaha—San Francisco

UNITED SCIENTIFIC LABORATORIES 84 FOURTH AVE. NEW YORK CITY

The Great
Manufacturers'
Exposition
Attended by
Leading
Jobbers and
Dealers

The Official

1925

R.M.A. Show

THE SECOND RADIO WORLD'S FAIR NEW YORK CITY

U. J. HERRMANN, MANAGING DIRECTOR

SEPTEMBER 14th to 19th

MONDAY NOON TO SATURDAY MIDNIGHT

ENTIRE EXHIBITION ON GROUND FLOOR
IN THE LARGEST HALL IN THE WORLD

258th Field Artillery Armory

NEW YORK OFFICE
170 FIFTH AVE.
NEW YORK CITY



Only RX-1* Can Give These Results

This is not an idle claim but a statement of fact based upon well-known principles familiar to every radio engineer.

RX-1 excels thru sheer advancement in design, offering new delights in radio entertainment by the employment of new methods—obviously genuine improvements quickly recognized and appreciated by the merest novice.

RX-1 results are as different as the audion of to-day is different from the cat-whisker detector which has tried the temper of many a patient soul.



The RX-1 is the culmination of all past experience in designing radio receiving equipment.

There is nothing radical about RX-1 performance except the exhibition of results which can be achieved thru the new level of standards set for the RX-1 design.

Features which appear utterly new are readily created in the selection of the most perfect parts known to the art, employed in a circuit which is absolutely non-regenerative.

For example, it combines an A battery consumption of one-half ampere with a modulation control capable of operating a Western Electric cone speaker with perfect quality.

With WOR operating forty miles away at 405 meters, CHYC, only 6 meters higher, can be brought in from Canada without interference.

Unusual results are to be expected. No other set at any price includes all the refinements of the RX-1—condensers protected from dust, low resistance pickle-bottle coils, Daven equalized impedance resisto-coupler, D-21 Sodion tube detector, Samson low-ratio transformer now recognized as the world's standard for perfect amplification.

And in appearance, RX-1, with its symmetrical arrangement of controls, is fit to mount in the finest cabinet,

yet so compact as to grace the smallest table.

Examine the RX-1 design, study its exclusive features, then build an RX-1 for yourself and you, too, will marvel at the tremendous power of this non-regenerative receiver. Complete set of parts, except tubes, for the RX-1, Model B4, with plain dials, including drilled and engraved panels and every item to the smallest screw and nut, illustrated assembly instructions—\$32.50.

Two Accurate vernier condenser dials and two Accurate rheostat dials—\$8.50. Tested D-21 Sodion detector \$5.00 plus 10¢ insurance—Set of two RX-1 coils \$6.00.

**Trade mark registration applied for. These parts are sold under M. H. Sleeper license.*

Address your orders to A-52 Vanderbilt Ave., New York City

DURRANT RADIO, Ltd.

ANNOUNCING

the

new

RATHBUN STRAIGHT LINE FREQUENCY CONVERTER

THE modern radio receiver has abundant tone, volume and power—now it may have perfect, *simplified control*.

The Rathbun Straight Line Frequency Converter is adapted for use on your receiver — every receiver — without change of equipment — except the condenser dials. Each station is given a distinct reading at a uniform distance from the next. Real logging becomes a fact. The stations are distributed with flawless precision over 360°—one complete revolution of the Dial. There is no limitation or crowding as on controls using only half a dial. Radio control is simplified.

The Rathbun Straight Line Frequency Converter provides straight line frequency tuning with ordinary capacity condensers. It is interchangeable with any condenser—on any receiver. It is sold with the guarantee of reliability and satisfaction attached to all Rathbun Radio Apparatus.

See and Try it—at Your Dealer's
If your dealer cannot supply you, send Money Order (\$3.50 each) and your order will be shipped promptly by Parcel Post prepaid.

Rathbun Manufacturing Co., Inc.
Jamestown New York

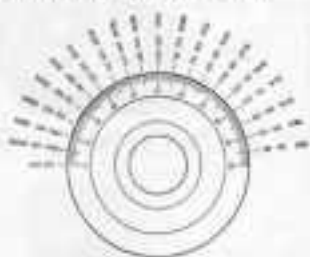

Practically even sensation over half the dial with a Straight Line Frequency Converter.

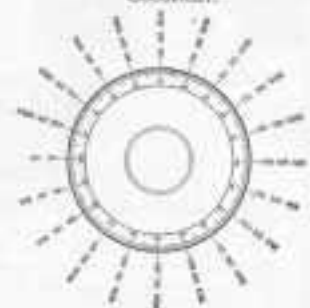

Complete and equal separation of stations over the entire dial with the Rathbun Straight Line Frequency Converter.

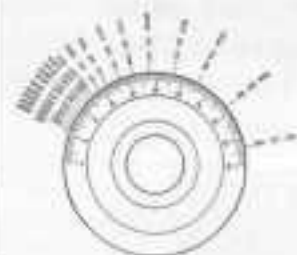

Stations indicated in kilocycles and wavelengths showing crowding with an ordinary capacity condenser.

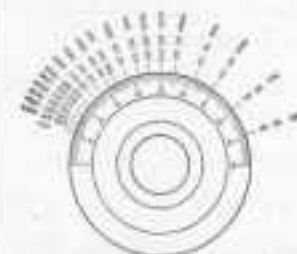

Stations partially separated and tuning slightly improved with a Straight Line Wave Length Condenser.



DeJUR

ONE HOLE MOUNT
RHEOSTATS

Always specified by the foremost radio engineers when they build circuits in which they demand the utmost efficiency. Easiest to mount; no back panel fussing; perfect contact always; genuine Bakelite throughout; contact slider and shaft made in one piece.

At all dealers

DeJUR PRODUCTS CO.
Brooklyn and Lafayette Sts. New York



PATENTS APPLIED FOR



Obsolete

Take the
"GUESS"
Out of Tube
Control

\$1.10
Everywhere

with

Specified by
Mr. M. B. Sleeper
in the
R. X. 1 Circuit

RADIALL COMPANY
Dept. 44-11, 30 Franklin St., New York City

Write for
FREE
Hook-ups



AMPERITE
The "SELF-ADJUSTING" Rheostat

EBY

PATENTED

BINDING POSTS

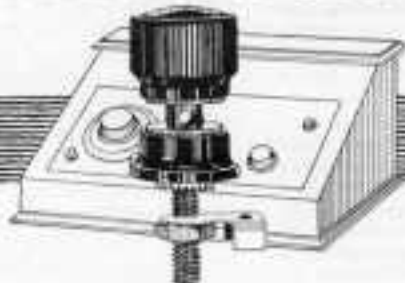

Standard Equipment
On 150 Manufacturers' Sets

Unswerving built-in superiority made them select EBY posts. They are your logical choice, too. Furnished either plain or engraved in twenty-five different markings and the base of every post is clearly marked EBY.

The Tops Don't Come Off

15c. — At All Dealers — 15c.

The H. H. EBY MFG. CO., Phila., Pa.

Our by pass condensers
will improve your product
and save you money.

Capacities .006 to 5 MFD.



Our Mica Fixed Condensers
Need No Comment—

for years their quality has been the
standard of comparison.

"Not to investigate is to lose money."

NEW YORK COIL CO.
338 Pearl St., New York, N. Y.

Pacific Coast Representative:
Murshank Sales Co.

928 Ins. Exch. Bldg., Los Angeles, Cal.



EASTERN

pickle bottle

COILS

FOR THE

R X-1

No Oscillation!—A four tube circuit that needs no neutralization.—Tremendous volume—Long distance range—Distortion eliminated.

The R X-1 is smooth working, non-reradiating and extremely selective. It has only two controls, is easy to operate, and is remarkably simple and economical to build.

Without recourse to regeneration to sharpen the tuning, but relying entirely on high efficiency through the elimination of losses in the coils, the major source of losses in all tuning circuits, a sharpness of tuning has been achieved that makes it possible to cut out Newark at 405 meters, and bring in Montreal at 411 meters, at New York City.

A difference of six meters is not remarkable at the low waves, but it is most unusual at wavelengths above 400 meters, for, at the longer wavelengths, the best neutrodynes and tuned R. F. receivers are rather broad and, in addition, drop off in amplification.

We refer you to the article in this issue for complete details of this phenomenal circuit.

EASTERN PICKLE BOTTLE COILS are specified for this circuit, by
M. B. SLEEPER.

Type R X-1 Coils complete—\$6.00

EASTERN PICKLE BOTTLE COILS are also designed for perfect performance in the Roberts Circuit (\$8.50 per set), Beowling-Drake (\$8), DX Superdyne (\$8 per set), J Circuit (\$6), and for Tuned R. F. for .0005 or .00035 condensers (\$2 per coil).

At your dealers or direct, postpaid.

EASTERN COIL CORPORATION

22 Warren Street

Dept. R. E.

New York

**LAST
AS
TITE**



Lastite

CENTERED
TERMINAL

RX-1 Receiver employs the Lastite Soldering Terminal, and it is recommended to all builders of radio apparatus, because the Lastite provides the only unfailing Standard means for totally eliminating loose connections; and because the Lastite is the neatest, strongest, and most easily used terminal.

Lastites are made to fit, so they can be installed wherever common terminals are used. On any radio instrument or part, and in any place in radio circuits where terminals are essential.

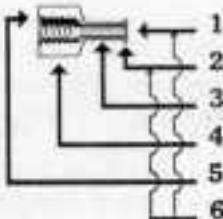

- 1** Tube in which bus wire is inserted preparatory for being soldered. Tube will hold any size bus wire up to No. 14.
- 2** Thin, circular flange to which bus wire is soldered. The Lastite is thoroughly tinned, inside and out.
- 3** Thin wall of bus wire tube conducts little heat. Tube tapers toward the flange.
- 4** Quarter-inch hexagonal base nut.
- 5** Terminal base nut is threaded to fit 6-32 and 8-32 screws.
- 6** The tube and flange of the Lastite, being centered, vibration cannot act as leverage to work it loose. A bus wire locks it—permanently.

PA TENTS APPLIED FOR

Manufacturers and Distributors,
write or telegraph for samples

William Stevens Co.
27 Hammatt Road, Rosindale, Mass.



PATENTED
(For any mounting)

MOUNTFORD

Plunger Type

VARIABLE GRID LEAK

MOUNTFORD GRID LEAKS, both Variable and Fixed, are individually tested for accuracy of range, consistency of resistance and perfection of construction. They are not affected by weather or temperature.

Mountford Grid Leaks have been adopted by the largest builders of Radio Sets in the United States.

List Price:

Variable type, 14 to 20 Meg.....50c each
Fixed type, 14 to 15 Meg.....25c each

Special values to order.

C. E. MOUNTFORD

Manufacturer of Grid Leaks and Mountings

465-467 Greenwich Street, New York

*Manufacturers, Distributors and Jobbers
write for special discounts.*

MOUNTFORD PRODUCT—

an asset to any set

WIRIT CUTS COSTS

Every Manufacturer Should Consider

These Points—

1. Wirit is No. 18 tinned copper wire tempered to make it extra stiff.
2. Wirit can be worked faster than heavy bus bar.
3. Wirit is just flexible enough to relieve the strains on the soldered joints—no damage in shipping.
4. Wirit costs less per foot.
5. Wirit can be used with Lastite terminals.
6. Wirit requires less heat to solder.
7. Wirit was originated and is recommended by M. B. Sleeper, one of the most expert radio design and production engineers in this country.

Sample spool of WIRIT, 100 ft., 90c—

Special prices to manufacturers

JAMES GOLDMARK CO.

83 Warren Street, New York City
Bars, Silk, Cotton, Enameled and Litz Wire



\$12 50

Instantly adjustable to local acoustic conditions. Made of bursax, a scientific material that eliminates false tone vibration. 9 in. high, 6 1/4 in. square base. Unusual and artistic shape. Neatly finished in black with chrome ornamentation. A real radio bargain.

Clear Strong Tone

all through the room

PLUG in on your set with this new type N & K Imported Loudspeaker, Model S. Stand it in any part of the room. Clear, natural, strong tone floods the air—music full of richness and harmony—voices that are those of live human beings. And you say to yourself "There's one of the finest instruments I ever made."

Only \$12.50 gives you this new speaker. Gives you the famous N & K distinctness and naturalness of tone. Gives you a strong volume that makes you look at the little instrument in amazement. Gives you a saving in space over almost every speaker you ever saw.

This is indeed the speaker YOU have been waiting for.

If your dealer is not yet displaying it, write us for free folder and full description. It is strictly worth the few moments it takes to put your name and address on a postcard.

THE GOLDSCHMIDT CORP.—NEUFELD & KUHNKE DIV.
Dept. K9, 15 William St., New York, N. Y.



Imported

LOUDSPEAKER

MODEL S





New— RADIO PANEL INSTRUMENTS

(Diameter of case—2 inches)

Just the instrument that set owners have been looking for. Maximum accuracy contained within a 2-inch diameter case.

Send for special circular No. 776.

Jewell Electrical Instrument Co.

1650 Walnut St. - - Chicago

25 years making good instruments.

A New HI-MU Tube

The HI-CONSTRON TUBE Model 101 A

A CLEARTRON PRODUCT

For Resistance Coupled Amplifiers



The Hi-Constron is a Hi-Mu tube with an amplification constant of 20 that has been especially designed for Resistance Coupled Amplifiers. The Hi-Constron was the first Hi-Mu tube offered for sale to the general public and is the result of years of research work.

Others may imitate the Hi-Constron as to its appearance but none surpass its quality.

LIST PRICE, \$3.00

We also manufacture: CT 201A; CT 199 Small Base; CT 199 Standard Base; CT 400 Rectron for B Battery Eliminators.

List price—above types.....\$2.50

CLEARTRON

GUARANTEED RADIO TUBES

28 West 44th St. Factory—West New York, N. J. New York, N. Y.

Tuning Marvelously Simplified with KARAS ORTHOMETRIC Condensers

The condenser that brings in KDKA where it belongs — at 53 on the dial.
Remember, 52 of the 100 wavelengths must come in below KDKA—

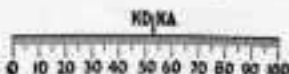

For Over 30 Years,
Makers of
PRECISION Electrical
Apparatus



Spreads Stations Evenly Over the Dial — No Crowding Whatever

The Karas Orthometric Condenser positively separates all adjoining wave lengths by EQUAL distances on the dial, giving full benefit of the 10 Kilocycle frequency separation fixed by the Government.

Ordinary condensers jam 70 on the 100 Government allotted wavelengths into the first 30 points of the dial—even straight-line-wavelength condensers crowd 57 of them below 30.

With Karas Orthometrics each point of the dial corresponds exactly to one of the 100 allotted wave lengths. The result is marvelous simplicity in tuning—better, clearer reception.

The Karas Orthometric is a "job" that will delight the eye of the mechanical critic. Made entirely of brass—frame die stamped, not cast. Every joint soldered. Grounded frame and rotor. Adjustable cone bearings. Spring copper pigtail.

If Your Dealer is Not Yet Supplied Order On this Coupon!

We are supplying dealers and jobbers as fast as our factory output permits. If your dealer is not yet supplied, order direct on the coupon. Send no money. Simply pay the postman on delivery. Order today!

**Money-
Back
Guarantee!**

KARAS Orthometric Condensers are positively guaranteed to give you thorough satisfaction. Any time within 30 days they may be returned for full refund.

KARAS ELECTRIC CO.,
40-53 No. Rockwell Street, Chicago
Please send me . . . Karas Orthometric Condensers, size indicated below. I will pay the postman \$. . . plus postage, on delivery. This order is subject to your 30 day Money-Back Guarantee.

Size wanted

Name

Address

Dealer's name
If you send cash with order, we'll send Condensers postpaid.



Ordinary Condenser Arrangement of Wavelengths

Ordinary straight capacity condensers crowd 70 of the 100 wavelengths into the first 30 points of the dial.



Straight Line Wavelength Condenser Arrangement

Even with the recent straight-line-wavelength condensers 57 of the 100 wavelengths are crowded into the first 30 points of the dial.



KARAS ORTHOMETRIC CONDENSER Arrangement of Wavelengths on Dial

The New Scientific Karas Orthometric Condensers insure absolutely equal separation on the dial, of all wavelengths throughout the entire broadcasting range.

Sizes and Prices

23 plate .0005, Mfd.,	\$7.00
17 plate .00037, Mfd.,	6.75
11 plate .00028, Mfd.,	6.50

4th Annual NATIONAL RADIO EXPOSITION

Grand Central Palace, New York

September 12th - 19th incl.

- the fourth successive national exposition representing all the leading manufacturers of the radio industry;
- the only great radio exposition of 1925 to be held in the metropolitan center of New York;
- the greatest spectacle of the year in the scientific, industrial and business progress of radio!

Business Office:
AMERICAN RADIO EXPOSITION CO.
122 Fifth Avenue, New York

HAROLD BOLSTER, Director
J. C. JOHNSON, General Manager

"IMPREGNATED"



Our New Double Resistor Mounting

Supplied with
Resistors
and
Grid Leaks



Supplied with
.006
MICA
Condensers

Your Own Name or Trade Mark on Any Item We Mfg.

TRIDOT

Registered Trade-Mark

TRIDOT ELECTRIC CO., INC.
16 HUDSON ST., NEW YORK CITY

AERODYN CO., 1780 B'WAY., N. Y. C., FACTORY SALES AGENTS

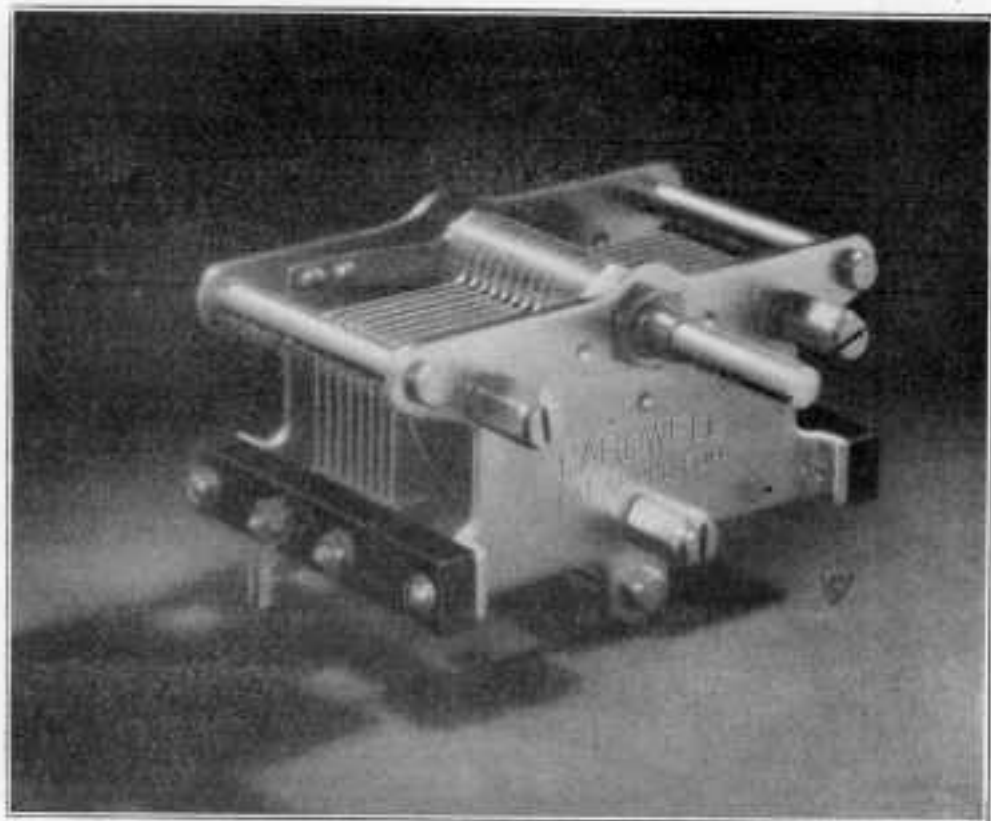

Insist on **CARDWELLS**

The *first* "low-loss" condensers

CARDWELL invented the original *low-loss* condenser, using metal end plates and a grounded rotor. The phrase "low-loss" was in fact first applied to Cardwell Condensers by engineers to distinguish these highly efficient condensers from the ordinary varieties.

Cardwell Condensers have been universally adopted by radio editors, experts, and professionals. Cardwells have become the standard of comparison.

Performance is the only real test of a condenser. And Cardwell Condensers have proved their superiority because of their scientifically correct design—small area of con-

tact between insulation and stator supports, rigid three-point frame, permanent alignment, accurate adjustment, etc.

Such details permit exceptional distance records, smooth tuning free from noise, and prevent changes in capacity at given settings.

Use Cardwell Condensers in all receivers. There's a Cardwell Condenser for every requirement—seventy-six different types. A post-card brings you an education on condensers.

Allen D. Cardwell
Manufacturing Corporation
81 Prospect St., Brooklyn, N. Y.

The Heart of the Set



Manufacturers desiring to increase the efficiency of their sets should pay particular attention to the selection of resistors, fixed and grid condensers, for these little devices play a most important part in the final performance of any receiver.

The Micamold Fixed Condensers, Grid Condensers, Grid Mountings and Resistors have proven their superiority over all other similar parts now on the market. Let us send you a set of samples for your engineers to test and.



Micamold

REG

MICAMOLD RADIO CORPORATION

Flushing and Butler Avenues

Brooklyn, New York



Patented
April
27, 1931

Other
U.S. and
Foreign
Patents
Pending

Ideal

Accuratune dials were selected for the new RXI receiver, described in this issue, because, to quote Mr. M. B. Sleeper, the designer, "we have found that they meet every requirement for extremely fine adjustment."

MYDAR RADIO CO.
11 CAMPBELL ST., NEWARK, N. J.

ACCURATUNE

DURHAM Metallized High Resistors



Metallized filaments are ready to meet any tests. Give us your requirements. Then we will submit a design—special if need be—that will be guaranteed absolutely. Send data now.

MODERATE PRICES

	Plain	Plural
Over 1/2 meg.	40c	60c
Under 1/2 meg.	80c	12c

Manufacturers write for discounts.

INTERNATIONAL RESISTANCE CO.

728 Sansom St., Philadelphia

Announcing the Balkite Trickle Charger at \$10 and the new Balkite "B" at \$35

A



Balkite Trickle Charger

Charges both 4 and 6 volt radio "A" batteries at about .5 amperes. Usable in 3 ways: (1) As a regular charger with a low capacity storage battery for sets now using dry cells. (2) With storage battery sets of few tubes. (3) As a "trickle" or continuous charger for storage battery sets of as many as 8 tubes. See 5 1/2 in. long, 2 3/4 in. wide, 5 in. high. Operates from 110-120 AC 60 cycle current.

Manufacturers are offering switches which turn on Balkite "B" and turn off the charger when you turn on your set. This makes the current supply for both circuits automatic.

Price \$10

West of Rockies, \$10.30
Slightly higher in Canada



Balkite Battery Charger

The most popular battery charger on the market. It can be used while the radio set is in operation. Charging rate 2.5 amperes. Operates from 110-120 AC 60 cycle current. Special model for 50 cycles.

Price \$19.50

West of Rockies, \$20
Slightly higher in Canada

The Balkite Battery Charger is today the most popular charger on the market. It is the only charger commonly used while the set is in operation. Balkite "B" II is also well known. It replaces "B" batteries entirely and supplies plate current from the light socket.

We now announce the Balkite Trickle Charger at \$10. This low-rate charger is especially adapted to use with sets of relatively low "A" current requirements—any dry cell set and storage battery sets with few tubes. Owners of dry cell sets can now make a very compact and economical installation with a Balkite Trickle Charger and a low capacity storage battery of the type offered by battery manufacturers this fall.

We also announce the new Balkite "B" at \$35. This new model will serve sets of five tubes and less. It fits in your present "B" battery compartment.

Noiseless—No bulbs—Permanent

All Balkite Radio Power Units are entirely noiseless in operation. They have no moving parts, no bulbs, and nothing to adjust, break or get out of order. Each is a permanent piece of equipment with nothing to replace. They require no other attention than the infrequent addition of water. They require no changes or additions to your set. They are guaranteed to give satisfaction.

Manufactured by
FANSTEEL PRODUCTS COMPANY, Inc.
North Chicago, Illinois

FANSTEEL
Balkite
Radio Power Units

B



Balkite "B"

Eliminates "B" batteries. Supplies plate current from the light socket. Operates with either storage battery or dry cell tubes. Keeps "B" circuit always operating at maximum efficiency. Requires no attention other than adding water about once a year.

Will serve any set of 5 tubes or less. Occupies about same space as 45 volt dry "B" battery. Operates from 110-120 AC 60 cycle current.

Price \$35

Slightly higher in Canada



Balkite "B" II

Same as the new Balkite "B" but will fit any set including those of 10 tubes or more. Operates from 110-120 AC 60 cycle current. Special model for 50 cycles.

Price \$55

Slightly higher in Canada

The Gould Unitpower is equipped with a special Balkite Radio Power Unit



What happens inside your set?

A good looking receiver—beautiful dials, knobs and switches—but what happens inside the set. Does every nerve in the brain of your set function to give you the best possible results? Do you get good reception? That's what counts!

When it comes to rheostats, you don't have to experiment to get a good one. Add a Stasco Rheostat to your set. Its exclusive feature of a spring contact plate makes possible permanent contact. Eliminates annoying flickering of tubes. And that means greater and clearer reception.

Made of bakelite only. Five different designs. With either black or mahogany knobs.

Manufacturers: Add Stasco Rheostats to your sets and watch the orders increase. They're backed by a guarantee. Write for further particulars.

Sheffield Trimming & Stamping Corp.
211 Centre St., New York City

Also manufacturers of Bezels, Potentiometers, Battery Test Clips, etc.

Stasco Rheostat



Pat. Pending
Bridge max. exp. .00045 M.S. Frequency max. exp. \$150 .00027 M.S.

The Crowning Refinement

No matter how good a set you have designed, the Chelton Midget can make it better—by permitting finertuning. Shunted across terminals of main condenser, it gives hair-line adjustment. No redesigning—just mount it anywhere on panel. No additional losses introduced. Requires only 1½" space.

CHELTON

Low Loss Midget Vernier

Remember, the Chelton is the ORIGINAL Midget variable condensers. All others are imitations. Useful also as a STABILIZER in most circuits.

Write for full information

CHELTON ELECTRIC COMPANY
Stanton Ave. & Rockland Street
PHILADELPHIA

The KELLOGG SYMPHONY REPRODUCER



Bring the artists into your very own, as realistic as the reproduction.

Place yours, the most different in reception, suitable as a present that you are carried away by its beauty.

True reproductions retain all of the coloring of the artist.

Complete made is a treat, every instrument can be heard, clear and full.

Magnetic if a phono control—used exclusively in the Kellogg—this is the new principle that betters them wondrous in radio reception.

No cross vibrations, no shattering, every note true. The Kellogg unit is available for use with a phonograph, and will reproduce voice or music with a full, sweet, clear tone. A popular instrument—the Kellogg Symphony Reproducer is a revelation in Tone—Volume—Clarity. The attractive black wooden finish is appropriate for the finest drawing room.

A prominent radio engineer writes: "Every time I get a new loud speaker I try it out against another make, and still I get the Kellogg. I have never found one which, with good quality, compares in volume. The Kellogg, however, is as true as the ear can tell, equal in volume and has a far greater tone. For your own information, I have used the loud speaker for entertainment at home because, while the volume is not great, the tone seems to be very good. However, the Kellogg is better in quality and considerably ahead of the other in volume. I think you have done a wonderful job in this latest speaker."

With every Kellogg Radio Part, Use—In the Test.
KELLOGG SWITCHBOARD & SUPPLY CO.,
Chicago, Ill.



Oh boy
KESTER
Rosin Core
Radio SOLDER

Sure is Safe and Simple
 APPROVED BY RADIO ENGINEERS
 A QUALITY PRODUCT
 CHICAGO SOLDER COMPANY

4124 Weybroad Av., Chicago, U.S.A.

Manufactured and Sold in Accordance with
 the Standards of the Radio Engineers
 YOUR DEALER IS AN S. P. S. S. S.

MUTER

**DEPENDABLE
 FIXED
 CONDENSERS**

MICA INSULATION
 BRASS ELECTRODES
 ACCURATE CAPACITIES



Used by Leading Set Builders

SAMPLES AND QUOTATIONS
 PROMPTLY FORWARDED

LESLIE F. MUTER COMPANY
 76th AND GREENWOOD AVE.
 CHICAGO ILLINOIS



All who are thoroughly informed on the sound science of advanced radio principles are quick to recognize in Apex Vernier Dials qualities that are imperative to the utmost of Radio utility, value and beauty of appearance.

**APEX VERNIER
 DIALS**

provide widest possible range of selectivity and a degree of positiveness seldom acquired. Greatly increase the usability of any set and bring in those distant stations that are a joy to every true radio enthusiast. Positively no back lash. Artistic design. Ratio 12 to 1. Adaptable to any 1/2 inch condenser shaft. Handsonely finished in: Royal Brass, \$2.00; Satin Silver, \$2.50; DeLuxe Gold (24K) \$3.50, list.

Apex Rheostat Dials

are designed with an inimitable touch of beauty that imparts a tone of elegance to the most attractively designed set. Size 2 inches. Fit any 1/2 inch shaft. Royal Brass Finish, 75c—Satin Silver Finish, 85c—DeLuxe Gold (24K) \$1.00, list.

Complete descriptive matter upon request.

APEX ELECTRIC MFG. COMPANY
 Quality Radio Apparatus
 1410 West 59th Street, Dept. 928, CHICAGO



**Adjustable to any position
 Wiring always taut
 Guaranteed for a Lifetime**

The Aalco is made of genuine walnut, handsomely finished, with all metal parts highly nicked. Length 24 in., Normal Height 30 in., Wave length Range 120-600 meters.

Price \$15.00

AALCO RADIO LABS.
 6338 Cottage Grove Ave., CHICAGO.

Made to
EXCEL
Not to Compete



SHORE
Audio Transformers

No frills or excess materials. Just quality, efficiency, and Low Cost. Play safe this year by sticking to Shore.

Type "A"—Commercial Model, shielded.

Type "B"—For manufacturers: adds efficiency to any set, makes them sell and stay sold.

We also make special duty transformers, choke coils, "B" Battery eliminator filter parts, designed to specifications. Send us your requirements.

To the experimental amateur we offer a valuable engineering service.

Order a sample Shore transformer for testing purposes.

SHORE
Electric Company, Inc.
64 University Place
New York

INDEX OF ADVERTISERS

	Page
A	
Aakre Radio Labs.....	491
Acme Apparatus Co.....	Inside back cover
Acro Products, Inc.....	490
All American Radio Corp.....	451
American Hard Rubber Co.....	454
American Transformer Co.....	474
Amso Products, Inc.....	428-29
Apex Electric Mfg. Co.....	491
B	
Bakelite Corporation.....	427
Beebe Electrical Inst. Co.....	475
Bremser Tully Mfg. Co.....	455
Brown, C. J.....	451, 494
C	
Carlwell Co., Allen D.....	487
Chicago Solder Co.....	491
Cleartron Vacuum Tube Co.....	484
D	
Daven Radio Corp.....	469
Delcor Products Co.....	480
Design Electric Mfg. Co.....	471
Dublier Condenser & Radio Corp.....	452
Durrant Radio, Ltd.....	478
E	
Eagle Electric Mfg. Co.....	474
Eastern Coil Corp.....	481
Ely Mfg. Co., The H. H.....	480
Electrad, Inc.....	452
Electrical Research Labs.....	441
F	
Fansteel Products Co.....	489
Funk & Shore.....	495
G	
Goldmark Co., James.....	482
Gottschmidt Corp., The.....	483
H	
Hammarlund Mfg. Co.....	467
Howard Radio Co.....	451
Hydraulic Press Mfg. Co.....	493
I	
International Resistance Co.....	448
J	
Jewell Electrical Inst. Co.....	454
Jones, H. B.....	494
K	
Karas Electric Co.....	485
Kelllogg Switchboard & Supply Co.....	490
Kurtz-Kasch Co.....	496
M	
Metro Electric Mfg. Co.....	493
Mixson-Radio Corp.....	488
Mountford, C. E.....	482
Muter Co., Laska F.....	491
Mydar Radio Co.....	488
N	
National Carbon Co.....	472-73
National Co., Inc.....	490
National Radio Exposition.....	496
New York Coil Co.....	489
Noerden-Hanck, Inc.....	452
P	
Pacnet Electric Co.....	Inside front cover
Phenix Radio Corp.....	449
R	
Radiall Company.....	489
Radio Condenser Co.....	453
Radio Corporation of America.....	425
Radio Patents Corp.....	495
Radio Receptor Co., Inc.....	451
Radio World's Fair.....	477
Rathbun Mfg. Co.....	479
S	
Samson Electric Co.....	454
Sheffield Trimming & Stamping Corp.....	490
Shore Electric Co., Inc.....	492
Silvers-Marshall, Inc.....	451
Sleeper, M. B., Inc.....	426, 432, 476, 494
Steinert & Co., Wm.....	495
Stevens Co., Wm.....	482
T	
Truitt Electric Co.....	486
U	
Union Radio Corp.....	473
United Scientific Labs.....	477
W	
Walbert Mfg. Co.....	Back Cover

SAVE YOUR SET!



METRO KEELOCK SWITCH

You lock your set automatically when you leave it. Don't your radio set disappear at the same rate?

The KEELOCK SWITCH protects your set from people (particularly children) who are not familiar with radio and who can cause irreparable damage to your tubes and batteries. The KEELOCK combines the advantage of the regular push-pull switch with absolute safety. Two keys and separate "on-off" sign with each switch. Ltd. Co.

Manufacturers also of the well known Metro Solisette Jacky Triangle and Dowkey and Metro Kessitate. We specialize in supplying the needs of set manufacturers.

These Products are carried by the better dealers. If not in stock write us direct.

METRO ELECTRIC MFG. CO.

121 Prince St. New York City

MANUFACTURERS!

New Design

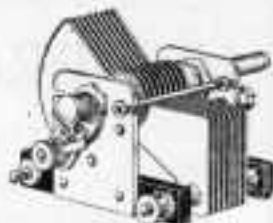

Stops Trouble with Condensers

At last, set manufacturers can obtain a condenser that can be relied on to perform exactly as the circuit designer calculated. Our new model fulfills every requirement of the latest ideas in radio engineering. Minimum losses consistent with good construction. Permits open tuning on low waves. Sturdy. Compact. Will stand the most critical tests for either electrical or mechanical soundness. Capacities guaranteed.

Manufacturers: Write for sample and prices

RADIO CONDENSER CO.

CAMDEN, N. J.

World's Largest Exclusive Radio Condenser Plant

H.-P.-M. Bakelite Molding Presses assure economical production and perfect parts



H. P. M. Bakelite Molding Presses are the best paying investment in the radio production field. They pay for themselves in a short time.

No matter what the operating conditions are, parts calling for the utmost precision and perfection are turned out by even inexperienced operators on H. P. M. Presses.

Into H. P. M. Presses is built fifty years of press engineering experience. You can depend on H. P. M. Bakelite Molding Presses for economical production and perfect parts.



HYDRAULIC PRESS MANUFACTURING CO.
Mt. Gilead, Ohio

C. J. BROWN

Sales Representative

SAMSON ELECTRIC CO.
Transformers, etc.

W.M. STEVENS CO.
Lastites

McWILLIAMS
Selenium Cells, Relays

Specializing in sales promotion and assistance to retail stores and technical service and co-operation with radio factories

PHONE VANDERBILT, 4996
OFFICE, 52 VANDERBILT AVE.,
West side of Grand Central Station at 42d Street,
NEW YORK, N. Y.
NEW YORK, N. Y.

Test this Inductance in any T-R-F Circuit



Note the immediate transference improvement in sensitivity—and the almost insensitible systems with which filament matters cease to be.

The Aero-Cell Inductance System brings into resonance an exactly balanced inductor of an exceptionally low high frequency resistance, its lower circuit resistance and lower distributed capacity. Measure these characteristics of the Aero-Cell. These are made possible by a patented construction, 50% Air Dielectric! Duplicate Air Spaced Windings!

The complete Aero-Cell tested radio frequency kit consists of an antenna coupler with a variable inductor and 3 Aero-Cell HF Transformers together with nickel plated mounting brackets sold for \$11.00. At your dealer or direct. Write for free booklet "Radio Frequency Losses and their Prevention."

Manufacturers! Write us for prices and samples.

AERO PRODUCTS, INC.
217 No. Desplaines St. Chicago
Successors to Henninger Radio Mfg. Co.

How to Build

LONG DISTANCE

RADIO RECEIVING SETS

by

M. B. SLEEPER

A NEW book, just off the press, describing the construction of the most successful of the sets which have been shown in Radio Engineering.

INCLUDED in the sets described are the Silver Super Autodyne, a 6-tube super-het which gives results equal to the 8-tube types—the new Samson T. C. set, just perfected this fall—the Browning-Drake 199 receiver which out-performs all dry cell outfits—and the Browning-Drake Five, a development made in our Darien Laboratory, which is now more popular than any other 5-tube construction kit, due to the sensitiveness of the B-D circuit and the quality of the Daven Super Amplifier.

Price 25c postpaid

M. B. SLEEPER, INC.
A-52 Vanderbilt Avenue,
New York.

I^a_dM REGISTRY

The men whose names are listed below are prepared to handle all emergency work, take care of batteries, and replace tubes. Their charge is \$1.50 per hour, not including travelling time except to unusual distances.

The charge for listing in this section is 50c. for one month, \$2.00 for six months, \$5.00 for twelve months, payable in advance. The * indicates that we have received letters from six set owners stating that the man after whose name the * appears has handled their I and M work satisfactorily.

A REGISTRY OF RADIO INSTALLATION and MAINTENANCE SERVICE MEN WHO INSTALL, MAINTAIN, and REPAIR RADIO EQUIPMENT

D. C., Washington—A. C. BURG
U. S. Soldiers' Home. Tel. Col. 750 Br. 41

Ill., Chicago—WEILAND & CO.
6711 Stewart Ave. Tel. 1124 Normal

Mass., Boston—H. A. NICKERSON
201 Devonshire St. Tel. Cong. 5156

Mich., Detroit—J. E. JOHNSON
91 Gladstone Ave., Tel. Empire 8581j

Minn., Minneapolis—GEO. A. BECKER
4709 Wentworth Ave. Tel. Locust 6291

N. Y., New York—APEX RADIO CO.
123 Liberty St. Tel. Rector 3176

N. Y., New York—HERBERT MULLER
954 Lexington Ave. Tel. Rhldr. 3905
154 Nassau St. Beck. 8040

N. Y., New York—MONROE RADIO LABS.
177 Greenwich St. Tel. Cort. 4485

N. Y., New York—RADIO CONST. LABS.*
71 W. B'way. Tel. Walker 2143

O., Kent—KLADAG RADIO LABS.*
Kline Bldg. Tel. 127

PATENT SERVICE

FOR THE MANUFACTURER—

We have retained experienced patent lawyers to create patent situations around the manufacturer's products.

FOR THE INVENTOR—

We aid and assist in the development of his inventions and represent him in negotiations with manufacturers. In meritorious cases we finance the work.

RADIO PATENTS CORP.

INC. 1917

247 Park Ave. New York City.

SCREW MACHINE PRODUCTS & SPRINGS

Wm. STEINEN & CO.

297 Washington St.

NEWARK - - N. J.

TEL. MARKET 9077

Radio Manufacturers Everywhere Are Losing Money

One of the largest lost a million dollars in 1924-25 because he insisted on quadrupling his factory facilities and then lost the demand for his product.

Expensive equipment becomes obsolete over night because of change in design. At best, equipment is only engaged six months of the year. This doubles the depreciation overhead.

We have a plant that operates twelve months in every year. Our operating personnel know their jobs and are not constantly being hired and fired on account of varying production demands.

Let us figure on your requirements of stamped Metal parts in any quantity.

Funk & Sharr, 50 Church St., New York City,

Selling Agents for

THE MILLER LOCK CO., Contract Department, Frankfort, Pa.



The 4" Dial with large knob—the 4" completely graduated dial—and the pointed knob for etched and engraved panels

Here are three models from the *new* Kurz-Kasch Aristocrat Line of Dials and Knobs. No matter what set you own or manufacture, or what kind of panel it has, or what kind of condensers you use—
The Kurz-Kasch Aristocrat Line will make *that* set more beautiful and more efficient.
Over 250 Radio Manufacturers use Kurz-Kasch Products.

Genuine Kurz-Kasch products bear this trademark on the back of each part—Accept no substitutes.



The KURZ-KASCH CO Dayton Ohio



Section of the New Acme FREE-EDGE CONE Loud Speaker, showing the two free-edge cones.



After 5 years and 256 experimental models—Acme is proud to put its name on this Loud speaker

HERE in our laboratories at Cambridge, our radio engineers and sound experts have been at work, ever since broadcasting started, striving to perfect an ideal type loud speaker.

Two years ago, after having made, studied and tested 233 models, we obtained a very good horn type loud speaker. But our radio and sound engineers determined to go even further,

After 23 months more of experimenting: making and testing 53 additional loud speaker models they at last developed the ACME Free-Edge Cone Loud Speaker.

As far as it is humanly possible to judge we feel certain that we have the finest loud speaker ever produced. This new type loud speaker does away with inherent resonance common in other types. Because of this improvement the new Acme now brings out the low notes and soft over-tones never before obtainable in any loud speaker.

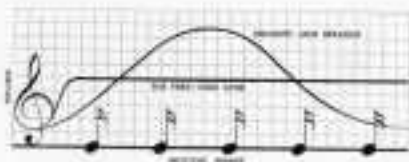

NOTE the equal volume over the musical range with the free-edge cone in contrast to the ordinary loud speaker.

The latest development in radio reproduction is the cone type loud speaker but the double Free-edge Cone is a further advancement because resonance is eliminated and faithful reproduction obtained over the whole musical range.

ACME
~for amplification

Claude Harris

President, Acme Apparatus Company

Send for the new edition of our famous book: "Amplification without Distortion" telling the why and the how of perfect radio reception.

ACME APPARATUS COMPANY,
Dept. H4, Cambridge, Mass.
Gentlemen:

I am enclosing 10 cents (U. S. Coin or stamp) for your booklet "Amplification without Distortion".

Name

Street

City State

Convert

WALBERT
made it first

Your Old Condensers to Straight Line Frequency

with
the
NEW

WALBERT SLF VERNIER DIAL

Construction Data

1. Easily installed
2. Concentric mounting
3. Takes standard shaft-projection
4. No friction mounting (no slippage)
5. Heavy gears (smooth action)
6. All-Bakelite knob
7. Nickel-silver dial (not plated)
8. Precision graduations
9. Hairline pointer

WALBERT engineers have developed a new VERNIER DIAL that imparts Straight-Line-Frequency characteristics to any semi-circular plate condenser.

No more crowding of stations at low-wave-lengths. The SLF VERNIER DIAL separates stations at low wave-lengths just as easily as at high wave-lengths.

The strong, positive and ingenious mechanism contained in the knob gives small increases in capacity at low wave-lengths and progressively greater increases at higher wave-lengths while knob and pointer revolve at uniform speeds.

A standard 12-to-1 VERNIER DIAL giving SLF characteristics to any ordinary condenser. Write for prices.

JOBBER AND DEALERS: Deliveries September 10th. Orders filled in rotation as received. Catalog copy and cuts ready August 15th

WALBERT MANUFACTURING COMPANY

931 Wrightwood Avenue, Chicago, U. S. A