

**Radio-
Electronics**

Special Projects

The magazine for people who build electronic projects

#6

\$2.25
SPRING
1983

48784

DC TO-DC
SWITCHING
CONVERTER

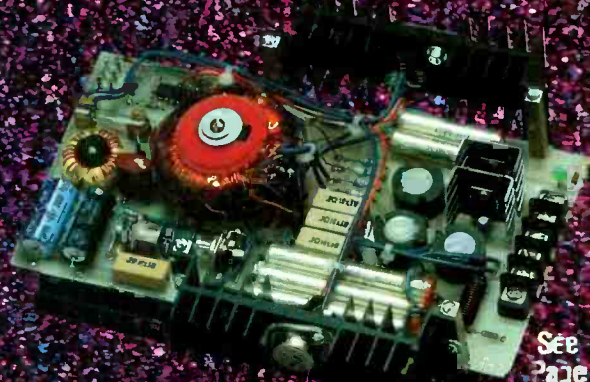

See
Page
7

ACTION PROJECTS

- Darkroom Countdown Timer
- Automatic Light Dimmer
- Satellite TV-Sound Receiver
- Low-cost Auto Regulator
- Ultralinear Ohmmeter
- Space-Age Intercom
- 2 Electronic Games
- Bench-Top Power Supply

FIRE-ZONE
ALARM
MODULE



See
Page
33

VEHICLE
ELECTRONIC
CHIME

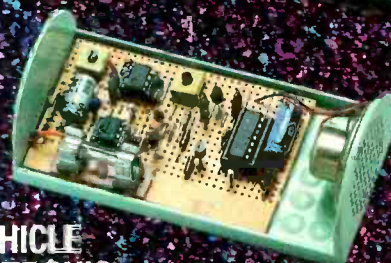

See
Page
22

BUILDERS' TIPS ON:

Winding RF Coils

Swinging to Wire-Wrap

6-N-2
AMPLIFIED
FIELD
STRENGTH
METER



See
Page
20

PLUS—

Loaded Coin

You flip—it decides!



Radio- Electronics

Copyright © Gernsback Publications Inc., 1980

**SPECIAL REPRINT
BUILD A BACKYARD SATELLITE TV RECEIVER**



**Sixth Printing: Sold Out!
Seventh Printing—Just Off Press!
Reprints Now Available!**

Don't miss out again!

Send away today for your 36-page booklet containing a complete reprint of all seven articles in the series on Backyard Satellite TV Receivers by Robert B. Cooper Jr.

This all-inclusive report gives you all the data you need to build your own Backyard Satellite TV Receiver.

- TELLS ALL ABOUT domestic satellite communications, with full details on how you can pull those elusive TV signals from space.
- LEGAL REQUIREMENTS, technical specifications, and how you, the

home constructor, can meet them. Find out what mechanical and electronics skills you need.

■ RECEIVER CHARACTERISTICS, technical details and specifications, along with examples of actual receivers built at comparatively low cost.

■ ANTENNA DESIGN... and exactly how you can build a spherical antenna, while keeping total earth-station cost for the complete system under \$1,000.

■ THE FRONT END is critical when you build your own system. We help you explore several different ap-

proaches to making one that will work for you.

■ RECEIVER-SYSTEM hardware, and how it goes together to bring you direct-from-satellite TV reception in your own home.

To order your copy:

Complete coupon and enclose it with your check or money order for \$7.00, plus \$1.00 for postage and handling. We will ship your reprint within 6 weeks of receipt of your order. All others add \$4.00 for postage. New York State residents must add 58c sales tax.

**Radio-
Electronics**

Satellite TV Reprints
45 East 17th Street
New York, N.Y. 10003

Please print

(Name)

(Street address)

(City)

(State)

(Zip)

I want _____ reprints @ \$7.00 each, plus \$1. Handling & Postage.
I have enclosed \$ _____. N.Y. State residents must add sales tax.

What are the limits?

Special Projects is a unique magazine. Without my saying so, you know that the entire issue is devoted to the electronics experimenter who is dedicated to building projects at all levels of interest and proficiencies. There must be limits as to the simplification and complexity of projects in each issue; otherwise we could possibly publish plans to track the MX missile, or the like. So allow me to take a few words to describe the self-imposed limits of our editorial coverage.

First, we do not plan to become a computer magazine. Too many magazines are taking that route and leaving a great number of project builders high and dry. To some, publishing economics dictates the policy of "run for the money." Our policy is to stay with our friends who support us. Yes, there will be lean years and fat years—but always good years! That is why you can expect four jam-packed **Special Projects** issues in 1983. Your loyalty to your hobby has made this policy possible.

Will we ignore computer projects? No, we will not. You can always expect to find something for all electronics hobbyists in every issue of **Special Projects**—at least we will try. For example, our lead story on page 7 is "DC-to-DC Switching Converter" especially designed for microprocessor circuits that are intended for 12-volt vehicles. It can also be used to power CMOS and TTL circuits that require *hassle-free* DC power. Now that's not too *computerish*—is it?

Second, we will always offer projects for the beginner. You know the type—one IC and a simple printed-circuit board that usually can be purchased. We believe that those projects are for beginners, or at least we prepare them that way—but lo and behold, even the pros build them. Evidently the reduced degree of construction skill and theory knowledge does not hold back the "professional" builder. We definitely place a limit on the cost which in many cases is predetermined by others—parts suppliers. We try to limit project parts lists to items that are usually available from your junkbox, local distributors, or mail-order companies who specialize in supplying small quantities to project builders at a reasonable price!

So you see, our articles cover interests from the basic neophyte to the "professional" project builder. And it is our sincere hope that we make many new friends and assist them from the neophyte stage of development to the ol' pro!

Before closing, I suggest that you turn right to page 42 and read the article, "Voltage Calibrator." We think it is a winner. Also, check our "Electronic Chime" on page 82. Here's a project to which you listen, and do not see. And don't miss the two electronic game projects on pages 31 and 47. If they seem alike, look closer. You may want to combine them to gain all their features in one project, then design a few more features into this growing project.

Hold on there! You have the issue in your hands—you scan it, then read it from cover to cover. That will give the staff some time to get started on the next issue of **Special Projects**.



Julian S. Martin, KA2GUN
Managing Editor

Radio- Electronics Special Projects

Vol 1, No 6

7 DC-TO-DC SWITCHING CONVERTER

The computer age sees many hobbyists building microprocessors projects for the automobile only to have them self-destruct when connected to the car's 12-volt DC supply. Now, a dependable power supply delivers rock-steady DC.

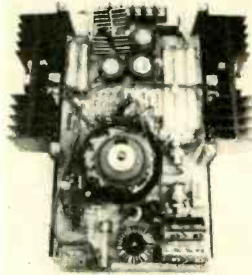

13 LOADED COIN

Flip a coin and the results are predictable—even-up for heads and tails. Sometimes you may want an easier method than chasing an errant coin, or may desire odds that are "loaded" in your favor. This unique project is just what the desk-top needs for the constant decision maker burdened with yes-or-no decisions.



27 AUDIO SUBCARRIER RECEIVER

So, what if you can pull in those satellite TV movies? If they're without sound you are still living in the Charlie Chaplin era. Stop reading lips and build this tunable, subcarrier, TVRO receiver.

31 THE AMAZING LASER GAME

Space Command has ordered you to shoot down all enemy spacecraft that enter your sector. Your lasers are activated and your radar tracker tells you one is overhead—zap! Is it a hit?

38 BIPOLAR TRAIN CONTROLLER

The toy train set your child received for Christmas may be sidetracked because it doesn't get up and go like the real thing



47 PHOTON TORPEDO

Electronic games are fun because the action takes place with fast-moving lights. This game adds the realism of sound. Your Photon Torpedo revs up then unwinds as it is fired. The alien craft lets out a mournful groan when it is blasted away.

56 AUTODIM LITE DIMMER

Imagine, dimming the lights in a child's room over a 30-minute period to simulate the calming effect of a sunset. And, you don't have to blackout completely. You select the rate and the level for the lighting effect you want.



71 JUNKBOX REGULATOR

There's no reason to plunk down the price of steak dinners for four when you need a voltage regulator for your foreign car. This inexpensive project outperforms the regulator now in your car, and has dashboard control.

76 BENCH-TOP POWER SUPPLY

If amateur servicing is your game, you'll need a power supply for CB transceivers, auto radios, color TV receivers, VCR's, and other electronic gadgets. You can call up AC and DC voltages, measuring them also.

79 WIRE-WRAP

Here's a new life style for the project builder. Wire-wrapping interconnecting leads for one-of-a-kind projects offers the builder the opportunity for compactness like printed-circuit boards with the option of circuit changes without penalty.

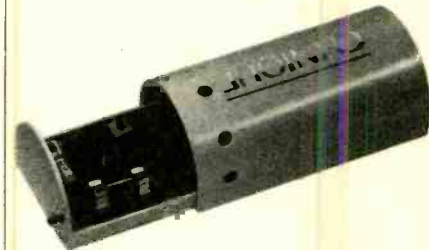

89 AUTOMATIC COUNTDOWN TIMER

Taking time pulses for the AC power line, this project counts backwards in either minute or second intervals to control timing periods for etchant baths and darkroom exposure times.

92 MAKE YOUR OWN RF COILS

Electronics and car racing are alike in that it's how you make the turn that determines the success of your effort. That is especially true when winding radio-frequency coils.

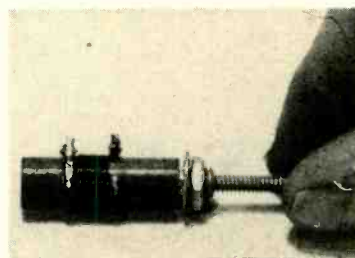

96 ELECTRICAL SAFETY

The three-prong plug for your home-made projects is a must for safety purposes, and it can prevent serious damage to the project itself in the event of an accidental short. However, you have to hook it up right.

20 AMPLIFIED FSM

The pointer on the run-of-the-mill Field Strength Meter lies like a lead sinker when a handie-talkie output is measured. Our 6- and 2-meter band unit is powered to amplify, and detects signals with a Wheatstone bridge circuit.



23 FIRE ALARM MODULE

The fire alarm in your home goes off just after 3 A.M. and wakes you from a deep sleep. Is the fire in the kitchen, den, garage, children's room—where? You don't panic at all. One glance at the glowing LED light near your bed tells you it is in the kitchen—you can act now!

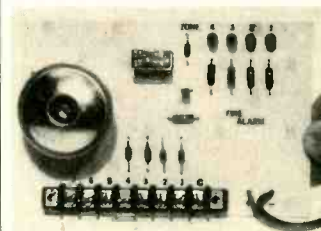

42 VOLTAGE CALIBRATOR

Voltage calibration raises the level of inexpensive manufactured and home-brew test equipment up to and sometime equal to lab standard accuracies. This tiny rock-stable unit has less drift than the continents have.

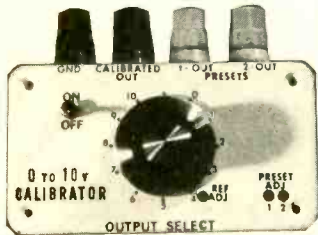

61 DIGITAL CLOCK- THERMOMETER

Sure, you want the correct time in an easy-to-read digital format—but why not know the inside and outside temperatures at the same time at very little extra cost? This project tells you how!



67 SPACE AGE INTERCOM

Frequency pulse modulation and detection is something you usually only read about. Now you can put theory into action with a two-wire pulse modulation transmitter that carries the human voice, without static, to remote sites

Hugo Gernsback (1884-1967) founder
M. Harvey Gernsback, editor-in-chief
Larry Steckler, CET, publisher
Art Kleiman, editorial director
Julian S. Martin, KA2GUN
managing editor
Josef Bernard, K2HUF,
technical editor
Carl Laron, assistant editor
Dan Rosenbloom,
production manager
Robert A. W. Lowndes, production
associate
Stefanie Mas, production assistant
Joan Roman, circulation director
Arline R. Fishman,
advertising coordinator

Cover photo by Robert Lewis
Composition and interior design by
Mates Graphics

Gernsback Publications, Inc.
200 Park Ave. S., New York, NY 10003
President: M. Harvey Gernsback
Vice President: Larry Steckler

ADVERTISING SALES

Stanley Levitan
Radio-Electronics
200 Park Ave., South
New York, N.Y., 10003
212-777-6400

MIDWEST/Texas/ Arkansas/Okla.

Ralph Bergeñ
The Ralph Bergen Co.
540 Frontage Road—Suite 325
Northfield, Illinois 60093
(312) 446-1444

PACIFIC COAST Mountain States

Marvin Green
Radio-Electronics
413 So. La Brea Ave.
Los Angeles, Ca 90036
(213) 938-0166

SOUTHEAST

Paul McGinnis
Paul McGinnis Company
(212) 490-1021

82 ELECTRONIC CHIME

If your neighbor has a car with musical chimes, or even electronic voices, then now is the time for you to get rid of that horrible buzzer in the family heap. Make your car sound modern and you'll keep it another inflation-free year.



85 ULTRALINEAR OHMMETER

That non-linear, crunched-up ohmmeter scale has been around long enough! Now, this project can indicate 1000-ohm and 1-Megohm values on the scale without touching the range control—and with the same scale accuracy.

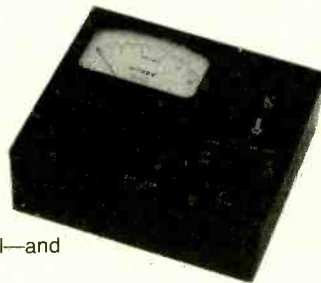

97 CHAMELEON

Sure, it looks like just another adjustable power supply for IC circuits but, there's more! It goes down to 2.0 volts DC. And, as a bonus, the gadget can be used as a current source or a current sink. All connections and switches are on the front panel.

4 LETTERS

We get letters from our readers and we share them with you.

6 NEW PRODUCTS

Take a peak at what's new in the marketplace for your shop.

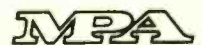

LETTERS

CONSTRUCTION TIP

Dear Editor:

I assembled a small timing circuit on a solderless circuit board and then proceeded to reconstruct it on a perf-board, using flea clips. Well, after all the trouble I experienced I said the next time I'd leave the project permanently on the solderless board. The time came when I had to assemble the same gadget again with some modifications for a friend's home. Out came the solderless boards and the construction was completed on it. I then epoxy'ed the parts in place at a cost of only \$1.75 more than it would have cost had I removed the parts and reconstructed the project on a perf-board. From here on in that will be the way I go.

AL DARCY
Kent, Washington

Sometimes, Al, the way you go will be best, but epoxy is a bit too much. What happens when you want to make a circuit change later on, or a repair is necessary. Will the contacts between the solderless board and wire leads be good indefinitely? I prefer to use a pre-made PC board that duplicates the solderless board's layout. Thus, you yank a part, insert it in its corresponding position on the PC board, and solder. Do one part or jumper wire at a time. That's the way I'd go.

HERE WE GO AGAIN

Dear Editor:

I can recall when the auto buffs got real excited as the first digital displays started appearing in cars. There was a craze to install digital voltmeters, clocks, outside thermometers, and the like. Now, with the introduction of your "LED Tachometer" last issue we can expect a new analog revolution. As for me, I prefer a sound source that buzzes when I pass the double-nickel mark on my speedometer.

RAY MUDD
Knoxville, Tennessee

I know of one parent who wanted to tie electrodes to his son's leg so that he got a jolt whenever he exceeded the speed limit. The idea straightened out his son's speeding problem to a degree. The boy presently works in a parking lot where he enjoys backing up cars into parking slots at velocities near the speed of sound. As for digital vs. analog dials—fads make life interesting. Frankly, analog dials can be read and comprehended faster than digital dials. I think the analog dial per-

mits the driver to spend more time looking at the road and less at the dashboard.

WRONG DOPE

Dear Editor:

I yanked the buzzer from my car because I can't stand the noise it makes. One of my buddies tell me that the removal of the buzzer will put an imbalance into the car's electrical system and the wiring harness may burn. Why should that happen?

K. DEMPEE
Montreal, Canada

No way? The only thing that can burn is you—after you have locked yourself out of the car. But don't put that miserable buzzer back into the car. Instead, hook up our "Electronic Chime" project starting on page 82 of this issue. Your car can have the sound of the 80's.

LOOK AT IT THEIR WAY

A friend of mine tells me that his company buys IC's for only a few pennies. Why must I pay \$2.50 for a 7400 chip off the peg board?

JOHN MCGRATH
Ocean, New Jersey

I looked up the wholesale price for the 7400 chip in the surplus section of a trade newspaper. It sold for 15¢. There was a small catch—I had to buy \$200 worth of chips and pay the shipping. If you are willing to invest \$200 for an assortment of chips, go ahead. In fact, should you bring together a group of experimenters and share the cost, you have made yourself a good deal. But, be sure to plan way ahead so that the next time you need a CMOS 4012A chip it will be in stock in your junkbox.

WANTS GAMES

Dear Editor:

Do you think you can get some game projects into Special Projects?

RED SMITH
Detroit, Michigan

Glad you asked because we included two and one-half games in this issue. The half-game is "Loaded Coin" (see page 13) which is more of a novelty item than a true game. Yes, Red, we like games and want to publish as many good game projects as we can find. What makes a game interesting to our

staff is the novel and effective way ordinary IC chips are used to make exotic games. We can't hope to compete with Pac-Man and the like, but we can publish game circuits that help us to understand circuit design better. The more we know as designer-hobbyists, the better we can enjoy our leisure hours.

OUT OF THE DARK

Dear Editor:

Your "Opto Power Switch" article in the last issue of **Special Projects** was a godsend. I was able to string ordinary bell wire over two hundred feet to control an electrical pump without resorting to very expensive electrical wiring and underground cables. I tied a lamp circuit to the pump's relay and placed it in the shed's window. Now, I get an indication when the pump is running automatically; and I can run it manually with the same indication. This winter will be a warm one for me, because I will cut down the number of trips to the shed whenever I suspect power failure or pump failure. You gents are OK in my book!

JOHN MORTON
No. Kansas City, Missouri

One other reader tells us he uses the same technique to heat up his garage, either remotely or by thermostat control, using the Opto Power Switch. It seems that in cold weather the thermostat comes on when the temperature drops below 40°F. When the reader wants the garage heated so he can use the workshop portion during cold weather, he turns on the heating system by shorting out the thermostat using the Opto Power Switch about one-half hour before he leaves the house. He said that he went to all that trouble, because he plans to install an air conditioner unit this summer and wants to use the opto device to control it also. That's why, he explained, he used a 20-ampere relay in the heating system's 10-volt thermostat circuit.

DESIGNER'S HELPER

Dear Editor:

I've been assembling circuits on solderless boards for so long, I can't recall doing it any other way. In fact, I have assembled my own Universal Designer somewhat like that given in the Winter issue of **Special Projects**. My project is good, but I have to take my hat off to the Editors for finding this project and publishing it. I am combining the fea-

(Continued on page 102)

Electronics Paperback Books

Quality Paperbacks at Affordable Prices

BUY 12 PAY FOR 10—TAKE 2 FREE!



- 30 SOLDERLESS BREADBOARD PROJECTS BOOK-1.** \$5.75. Wherever possible the same parts are used in several projects. Even a first-time builder can complete these circuits.
- HOW TO GET YOUR ELECTRONIC PROJECTS WORKING.** \$5.00. Helps you troubleshoot and repair home-built projects of every description.
- MINI-MATRIX BOARD PROJECTS.** \$5.00. A variety of projects that can all be built upon a mini-matrix board that has 10 strips and is 24 holes long.
- MODERN OP-AMP PROJECTS.** \$5.00. Wide range of specialized op-amp circuits including no-noise, no-distortion, ultra-hi input impedance, etc.
- MULTI-CIRCUIT BOARD PROJECTS.** \$5.00. 21 fairly simple projects that can all be built on a single printed-circuit board. All are powered by a 9V battery.
- IC PROJECTS FOR BEGINNERS.** \$5.00. Inexpensive digital and linear ICs are used to assemble this selection of circuits intended for the beginner.



- ART OF PROGRAMMING THE 16K Z801.** \$6.25. Topics include full screen scrolling, PEEK & POKE, plus actual working programs.
- THE 6809 COMPANION.** \$5.00. Written for the average assembly language programmer. A discussion of 6809 features & reference work for the 6809 programmer.
- PRACTICAL COMPUTER EXPERIMENTS.** \$4.50. Fills in background to microprocessor by constructing typical computer circuits using discrete logic components.
- ART OF PROGRAMMING THE 1K Z801.** \$5.00. How to use the features of the Z801 in programs that fit the 1K machine and are still fun to use.
- INTRODUCTION TO BASIC PROGRAMMING TECHNIQUES.** \$5.00. Based on author's own experience in learning BASIC and helping others to learn to program.
- A MICROPROCESSOR PRIMER.** \$4.50. Painless approach to computing for the beginner. Step-by-step explains computer operations and assembly.

- FIRST BOOK OF HI-FI SPEAKER ENCLOSURES.** \$4.50.
- SOLID STATE NOVELTY CIRCUITS.** \$3.50.
- 28 TESTED TRANSISTOR PROJECTS.** \$4.25.
- SOLID-STATE SHORTWAVE RECEIVERS FOR BEGINNERS.** \$4.50.
- 50 PROJECTS USING IC CA 3130.** \$4.50.
- 50 CMOS IC PROJECTS.** \$4.50.
- HOW TO BUILD ADVANCED SHORTWAVE RECEIVERS.** \$5.00.
- BEGINNERS GUIDE TO BUILDING ELECTRONIC PROJECTS.** \$5.00.
- ESSENTIAL THEORY FOR THE ELECTRONICS HOBBYIST.** \$5.00.
- FIRST BOOK OF TRANSISTOR EQUIVALENTS & SUBSTITUTES.** \$3.75.
- PRACTICAL COMPUTER EXPERIMENTS.** \$4.50.
- ENGINEERS & MACHINISTS REFERENCE TABLES.** \$3.50.
- SECOND BOOK OF TRANSISTOR EQUIVALENTS & SUBSTITUTES.** \$4.50.
- 52 PROJECTS USING IC 741.** \$4.00.
- BEGINNERS GUIDE TO MICROPROCESSORS & COMPUTING.** \$4.50.
- V MOS PROJECTS.** \$5.00.
- HOW TO USE OP-AMPS.** \$5.75.
- AUDIO PROJECTS.** \$5.00.
- MODEL RAILWAY PROJECTS.** \$5.00.
- CB PROJECTS.** \$5.00.
- HOW TO GET YOUR ELECTRONIC PROJECTS WORKING.** \$5.00.
- MULTI-CIRCUIT BOARD PROJECTS.** \$5.00.
- ELECTRONICS SIMPLIFIED CRYSTAL SET CONSTRUCTION.** \$4.50.
- ELECTRONIC HOUSEHOLD PROJECTS.** \$4.50.



- POWER SUPPLY PROJECTS.** \$4.50. Contains designs and construction details for almost any power supply the experimenter is likely to need.
- REMOTE CONTROL PROJECTS.** \$5.00. Radio-control infra-red, visible light, & ultrasonic systems are all included, along with methods of applying them.
- ELECTRONIC TEST EQUIPMENT CONSTRUCTION.** \$4.50. Construction details of a wide range of test equipment the experimenter can build at home.
- ELECTRONIC PROJECTS USING SOLAR CELLS.** \$5.00. Simple circuits that have numerous applications around the home.
- ELECTRONIC TIMER PROJECTS.** \$5.00. Timing circuits for almost any application the experimenter might need. A most valuable reference.
- COUNTER DRIVER & NUMERICAL-DISPLAY PROJECTS.** \$4.50. Features applications & projects using various types of numerical-display devices.



- PRACTICAL ELECTRONICS CALCULATIONS AND FORMULAE.** \$7.50. A basic reference work that bridges the gap between complicated technical theory & cut and tried methods.
- INTERNATIONAL DIODE EQUIVALENTS GUIDE.** \$5.75. Helps you find substitutes for the many different types of semiconductor diodes in use today.
- INTERNATIONAL TRANSISTOR EQUIVALENTS GUIDE.** \$7.50. Products of more than 100 manufacturers are listed & cross-referenced with possible replacements.
- HOW TO MAKE WALKIE TALKIES.** \$5.00. Describes equipment for low-power handheld operation. 112 pages of must reading for the dedicated experimenter.
- ELECTRONIC CALCULATOR USERS HANDBOOK.** \$3.95. Presents formulae data, methods of calculation, conversion factors & more from the view of the calculator user.
- LINEAR IC EQUIVALENTS AND PIN CONNECTIONS.** \$8.25. Shows equivalents & pin connections of a popular user-oriented selection of linear ICs.

- ELECTRONIC SYNTHESIZER PROJECTS.** \$4.50.
- 50 CIRCUITS USING GERMANIUM, SILICON & ZENER DIODES.** \$3.75.
- 50 PROJECTS USING RELAYS, SCR'S & TRIACS.** \$5.00.
- 50 (FET) FIELD-EFFECT TRANSISTOR PROJECTS.** \$4.50.
- 50 SIMPLE LED CIRCUITS.** \$4.25.
- 50 CIRCUITS USING 7400 SERIES IC'S.** \$4.50.
- 50 SIMPLE LED CIRCUITS BOOK 2.** \$3.95.
- PROJECTS USING 555 IC'S.** \$5.00.
- PROJECTS USING LM3900 IC'S.** \$4.75.
- RADIO CONTROL FOR BEGINNERS.** \$4.50.
- ELECTRONIC GAMES.** \$4.50.
- SINGLE IC PROJECTS.** \$4.25.
- RADIO CIRCUITS USING IC'S.** \$4.50.
- ELECTRONIC PROJECTS FOR BEGINNERS.** \$5.00.
- ELECTRONIC MUSIC & CREATIVE TAPE RECORDING.** \$5.00.
- ELECTRONIC SECURITY DEVICES.** \$5.00.
- HOW TO BUILD YOUR OWN SOLID-STATE OSCILLOSCOPE.** \$5.00.
- SECOND BOOK OF CMOS IC PROJECTS.** \$4.25.
- PRACTICAL CONSTRUCTION OF PRE-AMPS, TONE CONTROLS, FILTERS AND ATTENUATORS.** \$3.75.
- BEGINNERS GUIDE TO DIGITAL TECHNIQUES.** \$3.75.
- ELECTRONIC HOUSEHOLD PROJECTS.** \$4.50.
- ELECTRONIC MUSIC PROJECTS.** \$4.50.
- POPULAR ELECTRONIC PROJECTS.** \$3.75.
- PROJECTS IN OPTO-ELECTRONICS.** \$5.00.



- ANTENNA PROJECTS.** \$5.00. Covers practical antenna designs including active, loop & ferrite types that are easy & inexpensive to build.
- RADIO STATIONS GUIDE.** \$4.75. Comprehensive listing of transmitters around the world. Presents location, frequency, power.
- LONG DISTANCE TV RECEPTION (TVDX) FOR THE ENTHUSIAST.** \$5.00. Practical & authoritative introduction to this unusual aspect of electronics.
- CB PROJECTS.** \$5.00. A number of useful and interesting designs for CB accessories. Speech processor, interference filter & more.
- CRYSTAL SET CONSTRUCTION.** \$4.50. Packed full of easy to duplicate designs for crystal radio receivers.
- AN INTRODUCTION TO RADIO D.I.X.** \$5.00. Listen, in your name, to broadcasts originating thousands of miles away. Tells how you can do it.

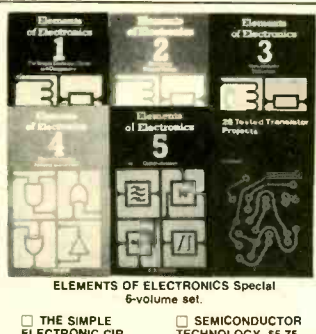

- THE SIMPLE ELECTRONIC CIRCUIT & COMPONENTS.** \$5.75. All the fundamental theory needed to lead to a full understanding of the simple electronic circuit and its components.
- ALTERNATING CURRENT THEORY.** \$5.75. Alternating current theory without which there can be no comprehension of speech, music, radio, or Television.
- MICROPROCESSING SYSTEM & CIRCUITS.** \$7.50. A truly comprehensive guide to all of the elements of a microprocessing system.
- SEMICONDUCTOR TECHNOLOGY.** \$5.75. Everything you always needed to know about solid-state devices in one volume.
- COMMUNICATIONS.** \$7.50. Covers most modern communication systems. Line, microwave, submarine, satellite, digital multiplex, radio & telephony.
- AUDIO.** \$9.00. Chapter after chapter investigates every important aspect of audio circuitry.
- SPECIAL OFFER—COMPLETE SET OF ALL SIX VOLUMES—a bargain that saves you \$6.25—SPECIAL PRICE \$35.00 FOR THE COMPLETE SET.**

ELECTRONIC TECHNOLOGY TODAY INC.
P.O. Box 83, Massapequa Park, NY 11762

Number of books ordered

Total Price of Books\$.....

Sales Tax (NY State Residents)

Shipping (75¢ 1st two books, 30¢ ea additional)

TOTAL ENCLOSED\$.....

Name.....

Address.....

City..... State..... ZIP.....

Prices good until April 30, 1983

NEW PRODUCTS

DMM, Model DM25, is a 3½-digit digital multi-meter with a basic DC accuracy of $\pm 0.2\%$ of full scale. It will measure DC volts from 0.1 volt to 1,000-volts; DC current from 0.1 mA to 200 mA; AC volts from 1 volt to 600 volts, and resistance from 1 ohm to 2 megohms.

Features include overload protection on all



CIRCLE 710 ON
FREE INFORMATION CARD

ranges, fuse-protected current and resistance ranges (to protect against excessive overload), automatic zeroing and polarity, and over-range and low-battery indication. An automatic limiter circuit will allow up to 140-volts AC to be applied on all ohms ranges without blowing the fuse.

The **Model DM25** measures 5.4 × 3.4 × 1.4 inches, weighs 10.5 ounces, and has an 0.4-inch display. It is powered by a standard 9-volt battery (included). Also included are safety-type test leads, carrying case, and instructions. Both the battery and the fuse are located in an easy-access compartment; there are no screws to remove.

The **Model DM25** is priced at \$69.25.—
Universal Enterprises, Inc., 14270 N.W. Science Park Drive, Portland, OR 97229.

SOLDERING SYSTEM, Model 9000, allows tip temperature to be varied from 420° to 800°F with a resolution of ± 10 degrees. Solid-state circuitry, including the newest microcircuit IC's, sample the tip temperature 120 times-per-second. LED's on the temperature controller instantly display each 20-degree temperature increment reached, creating a bar chart that clearly represents the tip temperature to within $\pm 10^\circ\text{F}$.

The heating element, which combines a heater and sensitive tip-temperature sensor, recovers tip temperature after each solder joint. The smaller heating element also



CIRCLE 711 ON FREE INFORMATION CARD

makes possible a thinner handle that is cooler than other models.

Electronic circuitry in the controller prevents tip-temperature overshoot that could easily cause faulty soldering. The controller can be calibrated by a front-panel adjustment, using room temperature as a reference. For ultra-precise soldering, any temperature within the temperature range can be calibrated to be accurate within 5°F.

The **Model 9000** is priced at \$150.00.—
Ungar Division, Eldon Industries, 100 W. Marville St., Compton, CA 90220.

(More on page 101)

BREADBOARDING IS A PIECE OF CAKE WITH A P PRODUCTS CIRCUIT-STRIPS.™

How much easier can building electronic circuits be?

With A P PRODUCTS Circuit-Strips,™ there's no need for perf boards, no need for soldering. All you have to do is plug in components and interconnect them with ordinary #22 AWG solid hook-up wire. There's even a molded-in alpha-numeric grid for fast and easy identification of every tie-point in the circuit.

The secret of Circuit-Strips success is the spring clip terminal that provides an excellent connection on any size lead up to .032". Circuit-Strips are compatible with DIPs of all sizes and a wide variety of discrete components which can be used over and over again.

Circuit-Strips feature 610 plug-in tie-points, and have a capacity of up to 6 14-pin DIPs. Model #923253 is available with Alloy 770 terminals at only \$14. Model #923749 is available with gold-plated Alloy 770 terminals at only \$28.

Call TOLL FREE, 800-321-9668 for the name of the distributor near you. (In Ohio, call collect: (216) 354-2101)

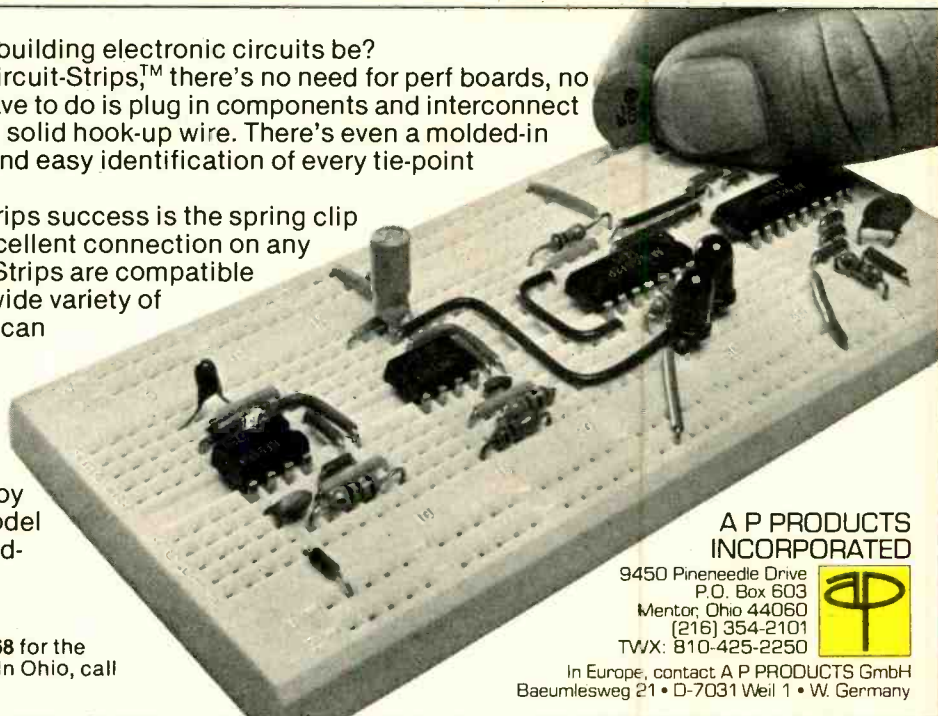

A P PRODUCTS
INCORPORATED

9450 Pineneedle Drive
P.O. Box 603
Mentor, Ohio 44060
(216) 354-2101
TWX: 810-425-2250



In Europe, contact A P PRODUCTS GmbH
Baeumlesweg 21 • D-7031 Weil 1 • W. Germany

DC-TO-DC SWITCHING CONVERTER

DAVID CONWAY

IN RECENT YEARS THE USE OF MICROPROCESSORS HAS BECOME common in many automotive applications. Because of the expanding flexibility that microprocessors offer, they are frequently implemented in computerized ignition and fuel injection systems, cruise control management, and engine monitoring.

Many microprocessors now operate from a single +5 volts regulated power supply. Others may require inputs of +12 volts, +5 volts, and -5 volts. Those voltages are uniquely different from the +12 volts supplied by the automotive battery/alternator system and need to be converted to a more stable DC voltage source.

One way to convert +12 volts supplied by the automotive electrical system to +5 volts for single-supply microprocessors would be to use a standard three-terminal IC power regulator. That method has two drawbacks. First, it would not be a feasible design to produce a -5-volt supply. Second, the three-terminal regulator output is not isolated from transients and would require protective devices. Those devices usually consist of diodes, Zener diodes, filters, or decoupling schemes which enable the regulator to survive the

extreme voltage transients that are generated when the engine is running and the alternator is charging the battery.

Most automotive charging systems produce transients in the order of 1 volt to 10-volts peak-to-peak. However, those transients

may reach as high as 400- to 600-volts for several microseconds. Another type of transient produced by the charging system is a negative voltage (-50 volts) generated by self-induction in the alternator field winding when the vehicle is turned off.

Those voltage transients cover a broad spectrum and are unique to each 12-volt automotive system. They are dangerous to semiconductor devices and are responsible for "glitches", fluctuating logic levels, false triggering, and resetting of registers, which result in invalid computation. In extreme cases those voltage transients could destroy the three-terminal voltage regulator as well as the microprocessor and other supporting integrated circuits.

A better way to isolate between the 12-volt automotive electrical charging system and the regulating circuit which supplies power to the microprocessor circuit could be achieved by use of the DC-to-DC Switching Converter. That novel power supply

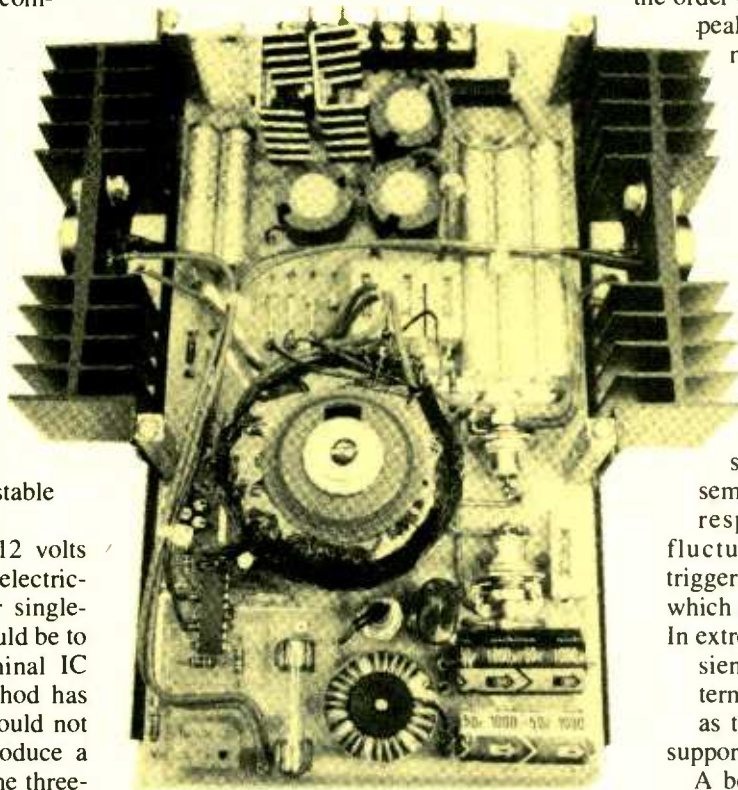

Computerized automotive circuits need not experience destructive spikes or poor voltage regulation on the highways!

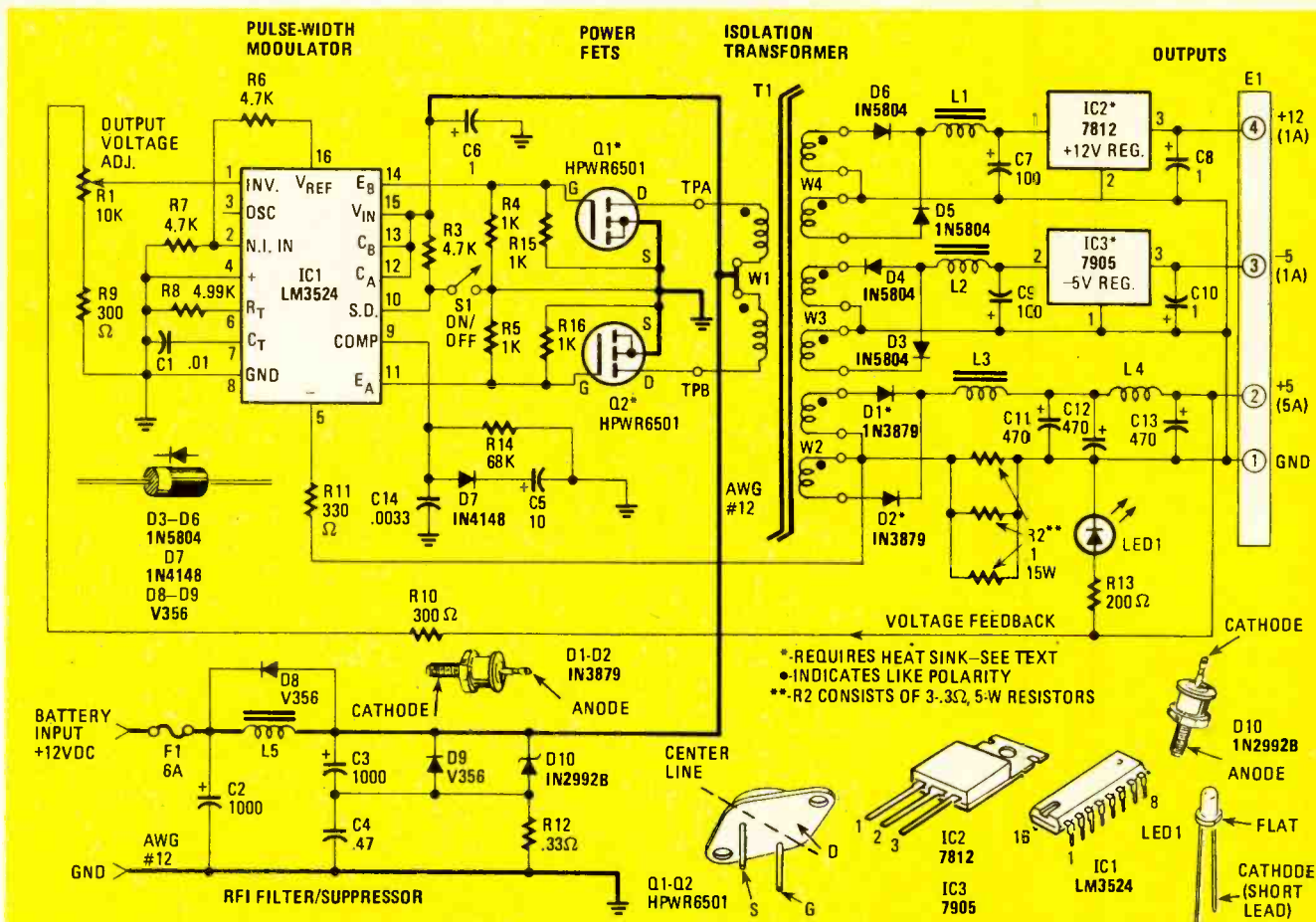

FIG. 1.—SCHEMATIC DIAGRAM FOR THE DC-TO-DC SWITCHING CONVERTER looks easy enough to assemble in one evening—and it is easy, providing that you have the printed-circuit board for the project. The manufacturing of a double-sided board at home may be difficult unless you have considerable experience. You may want to fabricate a smaller board just for the pulse-width modulator circuit containing IC1 and associated parts. After the DC-to-DC Switching Converter is wired and adjusted, you may want to replace on/off switch S1 with a wire jumper since the switch is not needed thereafter.

design provides three main functions: isolation, impedance transformation and voltage regulation. Isolation and impedance transformation are accomplished by a high-frequency toroidal transformer. Regulation of the output voltages are maintained by pulse-width modulation.

The drawbacks of the three-terminal IC power regulator circuit do not exist in this design. The voltage inputs of the IC power regulators are connected to the separate secondary circuits of the transformer, providing electrical isolation from transients.

Theory of operation

The DC-to-DC Switching Converter is wired in a push-pull amplifier configuration comprising power MOS field-effect transistors Q1 and Q2 which are driven by IC1, an LM3524 switching regulator IC, which provides pulse-width modulation control and drive signals for Q1 and Q2. See Fig. 1. The converter has complete over-current protection by sensing the current delivered by the +5-volt regulated output. The current is continually monitored by the current sense amplifier within the LM3524.

Outputs available from the converter are +5 volts at 5 amperes, +12 volts at 1 ampere and -5 volts at 1 ampere. The +12-volt and -5-volt outputs are obtained from IC power regulators may be safely obtained because of the isolation provided by the high-frequency toroidal transformer T1.

When using a microprocessor which only requires +5 volts as a single power requirement, the additional secondary windings W3 and W4 which supply power to voltage regulators IC2 and IC3 may be eliminated. The rectifier diodes, filter capacitors, and inductors, which support IC2 and IC3 are also eliminated completely from the circuit—further simplifying the power supply design. The +5 volts at 5-ampere output was chosen to be the main regulated output and is controlled by the LM3524 pulse width modulator IC1.

Regulation is maintained by a feedback loop, the +5-volt output is connected to the inverting input of IC1 through potentiometer R1. The internal circuit of the LM3524 (IC1) is shown in Fig. 2. The output voltage of the +5-volt output may be adjusted by R1. Paralleled resistor combination R2 limits the maximum output current to 6 amperes to provide component protection. Switch S1 is the power on/off switch for the unit. When S1 is open the shutdown pin on IC1 is forced high through R3, transistors Q1 and Q2 no longer receive their gate drive signals and high-frequency transformer T1 remains inoperative. Closing S1 allows IC1 to oscillate allowing Q1 and Q2 to drive T1 which supplies voltage to the output load. Power on is indicated by a green LED, which is connected to the regulated +5-volt output.

Construction details

The circuit described may be built on a printed circuit board or vector board with point-to-point wiring. The circuit-

PARTS LIST FOR DC-TO-DC SWITCHING CONVERTER

SEMICONDUCTORS

D1, D2—1N3879 6-ampere, 50-volt power rectifier
 D3-D6—1N5804 2.5-ampere, 100-volt power rectifier
 D7—1N4148 or 1N914 silicon signal diode
 D8, D9—V356 Power diode: 3-amperes at 600 PIV
 D10—1N2992B 39-volt, 10-watt Zener Diode
 IC1—LM3524N regulating pulse-width modulator chip
 IC2—LM7812 +12-volt regulator chip
 IC3—LM7905 -5-volt regulator chip
 LED1—light emitting diode
 Q1, Q2—HPWR6501 power FET

RESISTORS

R1—10,000-ohm trimmer potentiometer, PC board mount
 R2—.1-ohm, 15-watt, 10%, wire-wound (make from three .3 or .33-ohm, 10%, 5-watt wire-wound resistors)
 R3, R6, R7—4700-ohm, 5%, 1/4-watt
 R4, R5, R15, R16—1000-ohm, 5%, 1/4-watt
 R8—4990-ohm, 1%, 1/2-watt
 R9, R10—300-ohm, 5%, 1/4-watt
 R11—330-ohm, 5%, 1/4-watt
 R12—.33-ohm, 10%, 5-watt wire-wound
 R13—200-ohm, 5%, 1/4-watt
 R14—68,000-ohm, 5%, 1/4-watt

CAPACITORS

C1—0.01- μ F disk ceramic
 C2, C3—1000- μ F, 50-WVDC electrolytic
 C4—.47- μ F, 100-WVDC film
 C5—10- μ F, 25-WVDC electrolytic
 C6—1- μ F, 50-WVDC electrolytic
 C7, C9—100- μ F, 50-WVDC electrolytic
 C8, C10—1- μ F, 25-WVDC tantalum
 C11—C13—470- μ F, 25-WVDC electrolytic
 C14—.0033- μ F disk ceramic

COILS AND TRANSFORMERS

T1—Transformer use Indiana General IR8208 toroidal core. See text for coil-winding information
 L1, L2, L3—Coils use Indiana General F2037-1-TC9-315 toroidal core. See text for coil-winding information
 L4—Air-core coil. See text for coil-winding information
 L5—Coils use Indiana General IR8217 toroidal core. See text for coil-winding information

HEAT SINK

2—Wakefield 421K or 401K heat sinks for Q1-Q2 (or use Digi-Key HS117 or Jameco Dude 4)
 2—Heat sink for TO-220 IC chip. Use clip-on type or Digi-Key HS114
 2—"L" brackets with 1 sq. in. area to mount D8 and D9
 1-Tube of thermal grease

ADDITIONAL PARTS AND MATERIALS

E1—4-terminal barrier terminal strip for PC-board mount
 F1—6-ampere, 3AG fuse with brass mounting clips for PC-board mount
 S1—SPST toggle switch (after adjustment procedure this switch may be replaced with wire jumper
 #12 solid-copper wire with plastic insulation, #18 and #22 solid-copper wire with enamel coating, PC-board materials, power transistor insulating mounting hardware for Q1 and Q2, nylon hardware to mount L1, L2, and L3, optional power-input jack for PC-board mount, wire, solder, hardware, and spacers, etc.

PRINTED-CIRCUIT BOARD AVAILABLE

The printed circuit board is available from Conway International, Ltd., 290 25th Avenue, S.W., Cedar Rapids, Iowa 52404. Write for details and enclose a stamped, self-addressed envelope.

ry should be housed in a metal enclosure to shield the radio frequency interference generated by Q1, Q2 and T1. Refer to Figs. 3, 4 and 6.

Whether using a printed-circuit board or point-to-point wiring, the power FETs Q1 and Q2 must be connected in the following manner: The source(s) leads of Q1 and Q2 should be grounded using AWG No. 12 wire. Resistors R15 and

R16 should be soldered directly to the gate (G) and source(s) leads of Q1 and Q2. Resistors R4 and R5 are located on the PC board. Connections between IC1 and gates terminals of Q1 and Q2 should be as short as possible to prevent spurious oscillation from occurring on the gate drive signals. The drain leads of Q1 and Q2 should be connected directly to the primary winding of transformer T1.

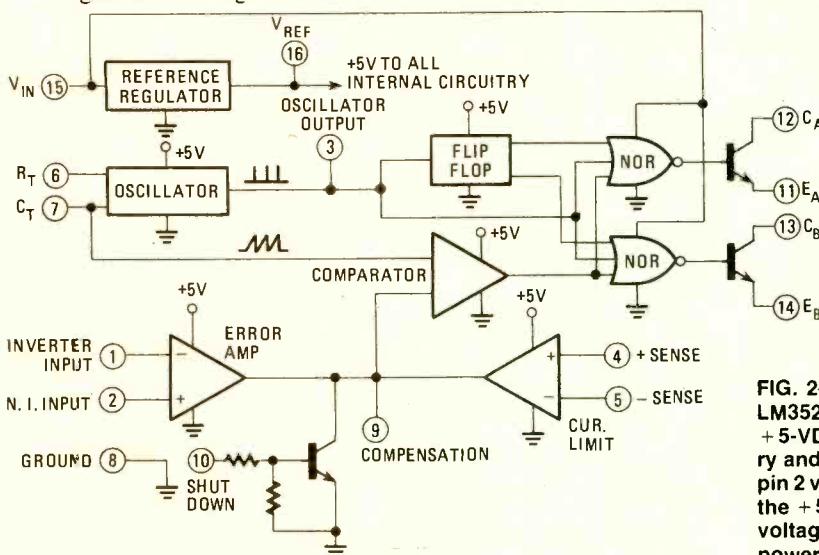

Transformer

The output transformer, T1, is constructed on a 2.4-inch diameter, toroidal transformer core. The toroidal core was chosen because of its simple winding properties while still maintaining high efficiency. Primary winding W1 is wound first and is made up of 23 bifilar turns using AWG No. 18 enamel-coated copper wire.

FIG. 2—FUNCTIONAL BLOCK DIAGRAM of the innards of the LM3524 takes some of the mystery out of the IC1 box in Fig. 1. +5-VDC reference voltage in the chip powers the internal circuitry and can be tapped at pin 16. That reference voltage is tied to pin 2 via a 4700-ohm resistor to the error amplifier. Pin 1 samples the +5-VDC regulated output (see Fig. 1) and produces the error voltage control signal that eventually controls the switching of power transistors Q1 and Q2 for DC regulation control.

FIG. 3—TOP FOIL SURFACE template of double-sided, printed-circuit board seems to have lots of unnecessary open spaces. One look at the photos will soon correct that miscomprehension. The majority of the converter's parts are located on this surface after assembly.

Secondary winding W2 is wound on the core next. This winding is made up of 18 bifilar turns of AWG No. 18 enamel-coated copper wire. Secondary winding W3 is made up of 22 bifilar turns AWG No. 18 enamel-coated copper wire. The last secondary winding, W4, consists of 50 bifilar turns using AWG No. 22 enamel-coated copper wire. When winding T1, turns should be spaced evenly around the core for all windings. Wrap a final layer of transformer tape over the core to secure the windings.

A word about the reason for bifilar windings used in the making of toroidal-core transformer T1: The author suggests that the builder wind both halves of the center-tapped windings at the same time so that in the event one more or less winding turn is accidentally made, both halves of the center-tapped winding will have the same number of turns. As a bonus, with both halves of the winding wrapped side-by-side, the induced voltages in each half of the windings are more likely to be exactly equal. The solid dots near the ends of the windings of T1 in Fig. 1 indicate induced in-phase voltage relationships to all other windings, or like polarity.

Output inductors

The output inductors are wound as follows: L1, L2, L3 are identical. Wind 3½-turns of AWG No. 18 enamel-coated copper wire through each core. The cores are secured to the PC board using nylon hardware. L4 is an air-wound inductor. Wind close together 15 turns AWG No. 18 enamel-coated copper wire on a ¼-in. diameter form, then discard the form. L5 is made-up using 50 turns on more than one layer AWG No. 14 wire on a toroidal form.

Heat sinks

Voltage regulators IC2 and IC3 should be mounted on heat sinks. The TO-220 package of IC2 and IC3 allow clip-on heat sinks. Thermal compound should be applied between the regulator and the heat sink. Power rectifier diodes D1 and D2 also need to be mounted on a suitable heat sink which need be only "L" mounting brackets. Q1 and Q2 are packaged in a TO-3 case. Each power device (Q1 and Q2) should be mounted on a Wakefield 421K or 401K heat sink with thermal compound be-

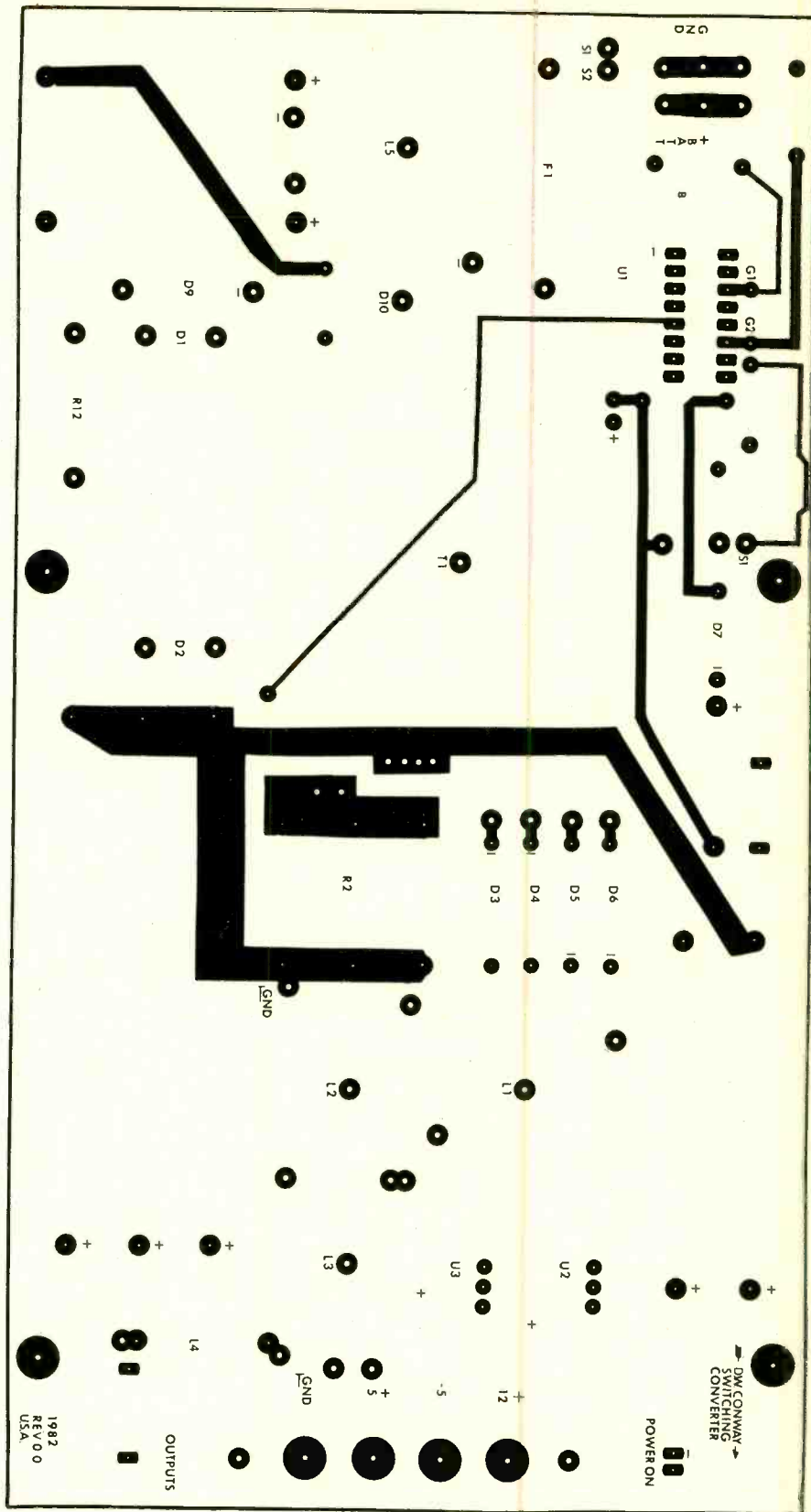

tween heat sink and the TO-3 case. When the supply is used with loads which require maximum output current of all three voltage outputs, use Wakefield heat sink type 421K on transistors Q1 and Q2. Should you use an unknown-rated heat sink, compare physical size to known units, match and add a safety factor.

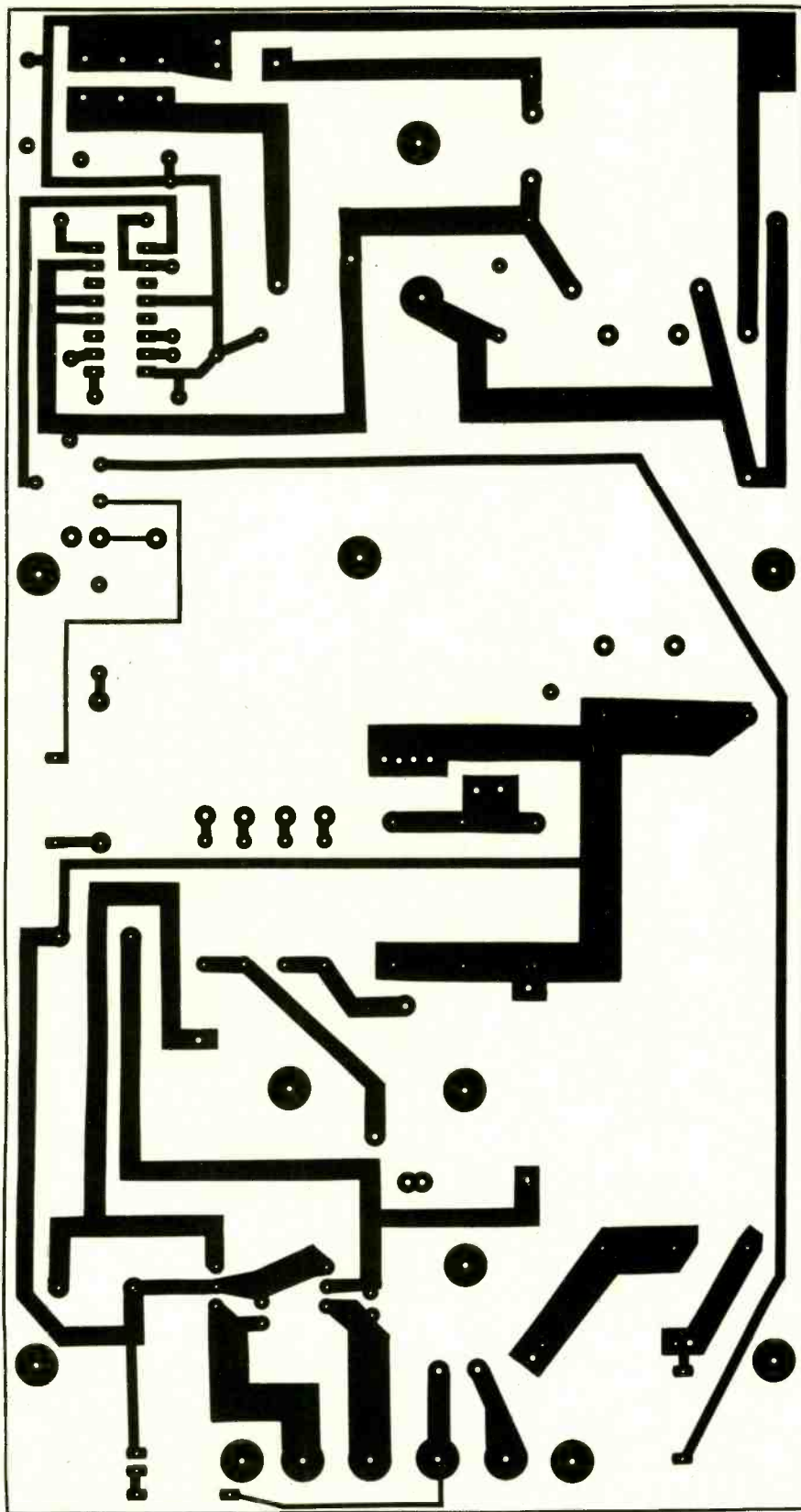

FIG. 4—BOTTOM FOIL SURFACE template for the double-sided, printed-circuit board shows some very wide copper-foil tracks interconnecting the parts mounted above it. Considering the currents in the circuit, do not attempt to fancy up your home-brew version with thin copper paths.

Power-up sequence

The wiring should be checked for accuracy, especially Q1 and Q2, and the polarity of diodes and capacitors.

Before power can be applied to the DC-to-DC Switching Converter, the switching operation of Q1 and Q2 needs to be checked. The best means of checking oscillation of IC1 is with an oscilloscope. Gate drive waveforms should be 180 degrees out-of-phase from each other and oscillating at ± 25 kHz. However, if test equipment is not available, a simple visual test may be carried out to determine if Q1 and Q2 are switching properly. That test is carried out as follows:

Disconnect the drains of Q1 and Q2, and connect the test circuit shown in Fig. 5 to the drains labeled TPA (Test Point A) and TPB in Fig. 1. Parallel a 20- μ f capacitor across C1. A 1-ampere, 12V regulated power supply should be connected to the +12-volt battery input of the converter. The test circuit in Fig. 5 should also be connected to this +12V supply. When S1 is turned on the LED's in the test circuit should blink back and forth but should not be on simultaneously. If the LED's are inoperative, check IC1, Q1 and Q2 for wiring errors. If the switching test is satisfactory, turn S1 off, remove the 20- μ f capacitor which is paralleled across C1 and disconnect the test circuit from test points A and B, and reconnect the drain leads of Q1 and Q2 to primary winding W1 of transformer T1. The DC-to-DC Switching Converter is now ready to be tested.

Connect the ground lead of the DC-to-DC Switching Converter to a power supply capable of supplying at least 8 amperes at +12 VDC. A 5-ohm, 10-watt resistor should be connected in series with the power supply +V output and the converter battery 12-volt input. Connect a voltmeter across the +5-volt output but do not connect any loads to the converter outputs. S1

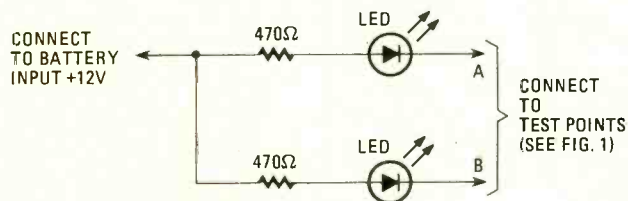

FIG. 5—THE GATE DRIVE TEST CIRCUIT can be assembled from junkbox parts. Tack solder the parts together without snipping the leads short. That way, after the test procedure has been completed, the parts may be used in other projects.

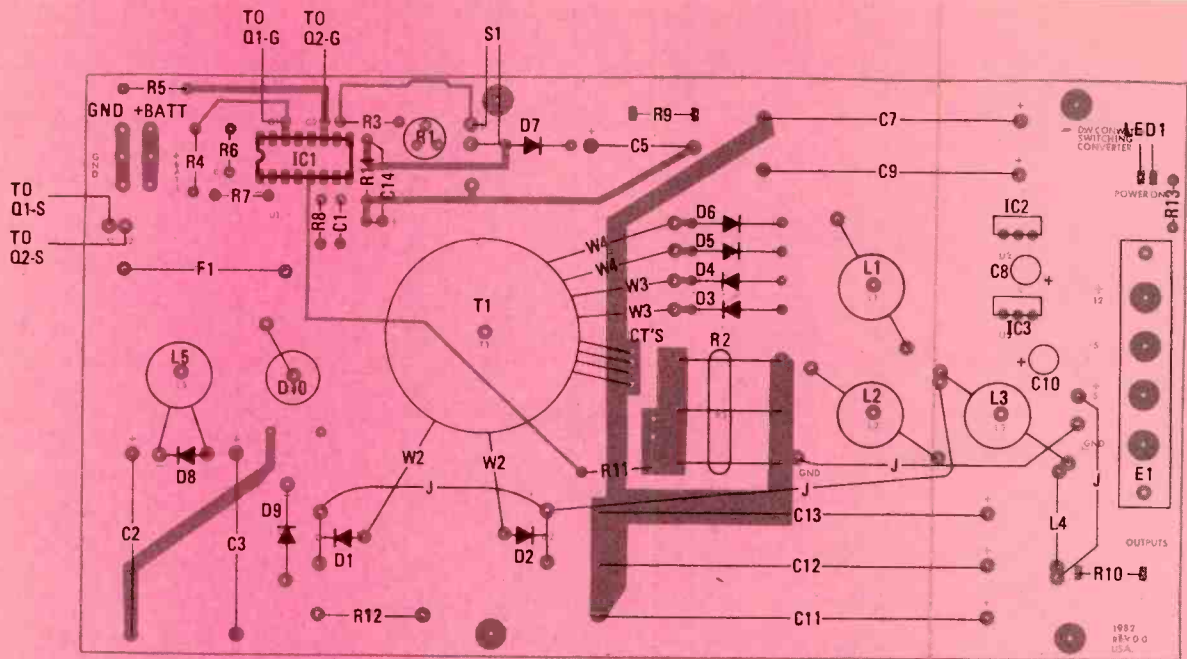

FIG. 6—PARTS-LOCATION DIAGRAM shows the position of parts mounted on the top and bottom surfaces of the board. The gray foil pattern is for the top surface only. The bottom-surface foil pattern is not shown. Diode D8 mounts under the board on the leads of inductor coil L5 which are left about 3/4-inch long so as to serve as terminal pins. Be sure that D8 makes good contact with the leads and foil.

should be turned on and the green power "on" LED should glow. Adjust R1 for a +5V output.

The supply may now be tested with a load. With S1 turned off connect a 1 ohm, 30-watt resistor across the +5-volt, 5 ampere output. The 20 ohm, 10-watt resistor may now be removed from the power supply and the converter input should be connected directly to the power supply supplying +12 volts for testing. Turn S1 on and readjust R1 for +5V. When the converter is adjusted properly using the +12V test supply, it should then be connected to the +12-volt automotive electrical system. Minor adjustments of R1 may be necessary. When the unit is fully tested it may be connected to the microprocessor project.

Conclusion

The DC-to-DC Switching Converter will convert the

+12-volt input to the regulated output voltage(s) required by a single or multiple supply microprocessor. The simplicity of the converter allows the possibility of additional output voltages than the ones discussed. T1 may be easily rewound scaling the number of turns to the desired output. When rewinding T1 for other output voltages R1, R8, and C1 values may need some experimentation. After any modification always following the same power-up sequence to avoid destruction of transistors Q1 and Q2. Isolation between the +12-volt automotive electrical system insures reliable operation of the microprocessor projects as they are not subjected to destructive transients associated with 12-volt automotive electrical systems. Additionally, in areas where brown-outs are very common, the DC-to-DC Switching Converter can be operated off an unregulated 12-15-volt DC supply which is either line powered or line recharged. SP

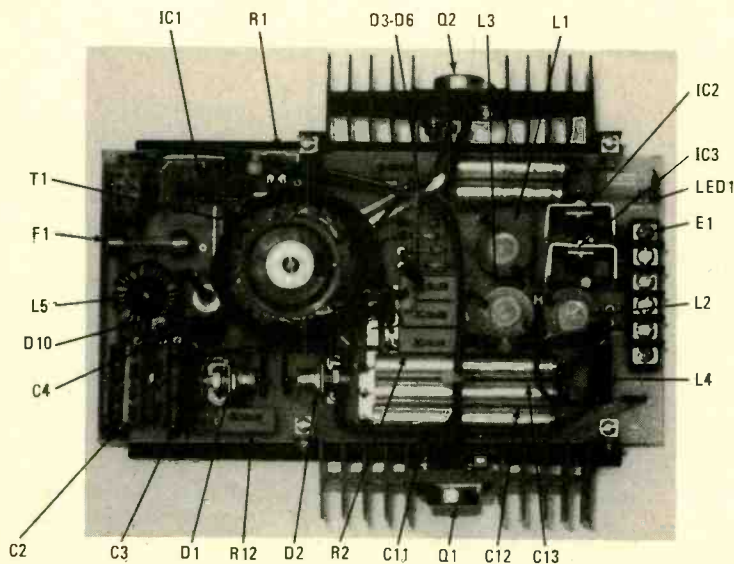

TOP VIEW of the completed DC-to-DC Switching Converter showing parts location. Note that the heat sinks for transistors Q1 and Q2 are slightly outboarded to insure maximum cooling. Fuse F1 is mounted on the board, however, when the unit is packaged in a metal cabinet or box, it should be relocated on the box surface so it may be rapidly replaced if necessary. Likewise, LED1 should be outboarded as a power-on indicator light. Exactly how you mount your PC board is up to you. Be sure to include ventilation holes in the box or cabinet over and under the outboarded heat sinks. All soldering points should shine when bright light hits them; otherwise, you may have a cold solder joint on your board.



LOADED COIN

***A simple project
provides random outcome
with selectable odds!***

ERICH A. PFEIFFER

MINTED COINS WERE KNOWN TO THE OLD ROMANS, AND SO IT might have been a centurion who came upon the idea to decide an issue by tossing a coin. The odds of heads or tails coming up have always been the same, namely 50:50 or even chances. This construction project is the electronic equivalent of a loaded coin for which the odds of the outcome can be selected at will, between 10:90 and 90:10. Thus, its name—Loaded Coin.

How it is done

The schematic diagram of the Loaded Coin is shown in Fig. 1. Chip sections IC1-a and IC1-b form a flip-flop multi-vibrator which has a squarewave output at pin 4. That squarewave is connected to the D (Data) input of a D-type flip-flop IC2-a. Whenever the voltage at the C (Clock) input of IC2-a, pin 3, makes a transition from low to high, the voltage at its D input is stored and appears at its Q output (pin 1) and, inverted, at its \bar{Q} output (pin 2). If the voltage at Q is low, the green light-emitting diode, LED1, will be lit; if the voltage at \bar{Q} is low, the red light-emitting diode, LED2, will be on.

The function of IC2-b is not that easy to understand without explanation. The circuit is not used as a flip-flop but acts as a non-inverting amplifier with pin 8, the high impedance input, and pin 13, the output. Resistor R12 and the resistance of a human finger in contact with the touch plates form a voltage divider. Normally the voltage at the amplifier input (pin 8) is high. If you touch the plates, the input goes low. Resistor R11 protects the CMOS IC from the hazards of static electricity. Capacitor C2 provides some positive feedback and causes the output of the amplifier (pin 13) to change rapidly from low to high, and vice versa, even if the input signal changes slowly.

Normally pins 8 and 13 of IC2 and pins 1, 8, and 13 of IC1 are high. The flip-flop formed by IC1-a and IC1-b is stopped and both LED's are turned off. Because CMOS circuits in the steady state draw only negligible currents, the battery drain is

almost zero and no ON/OFF switch is needed. When the touch plates are touched, the voltage at pin 13 of IC2 goes low, causing the appropriate light-emitting diode (LED1 and LED2) to be turned on and the flip-flop to begin to oscillate. When the finger is removed, the voltage at pins 13 and 3 of IC2 goes high and the "coin is tossed;" that is, the voltage that happened to occur at the output of the flip-flop is stored and displayed on one of the LED's. Because of C3 and D3, the voltage at pins 1, 8, and 13 of IC1 cannot follow and so the flip-flop keeps on running and the selected LED stays on. Only when C3 is discharged through R10 (about 4 seconds later) are the LED and the flip-flop turned off.

If the square wave generated by the flip-flop is symmetrical—that is, if its high and low part are equally long—the chances of storing a high or a low voltage are also equal. With R1, however, one can change the duty cycle of the signal from where it is high 10% of the time to where it is high 90%, without changing its frequency (which is about 100 kHz). The chances of storing a high voltage vary accordingly, and potentiometer R1 can therefore be directly calibrated with the odds of getting a red (LED2) or a green (LED1) display when the finger is removed from the touch plates.

Construction

The foil diagram for the Loaded Coin given in Fig. 2 can be used to manufacture your own printed-circuit board. Should you have the know-how and like to tackle the etching, go ahead. If not, look into the Parts List where a source for a printed-circuit board is given. Fig. 3 offers an X-ray view of the printed-circuit board with component parts in position.

All parts of the Loaded Coin circuit, with the exception of the battery and the touch plates, are mounted on the printed-circuit board. If a potentiometer of American manufacture is used, it may be necessary to increase the diameter of the mounting hole from $\frac{5}{16}$ to $\frac{3}{8}$ inches. The front panel is best

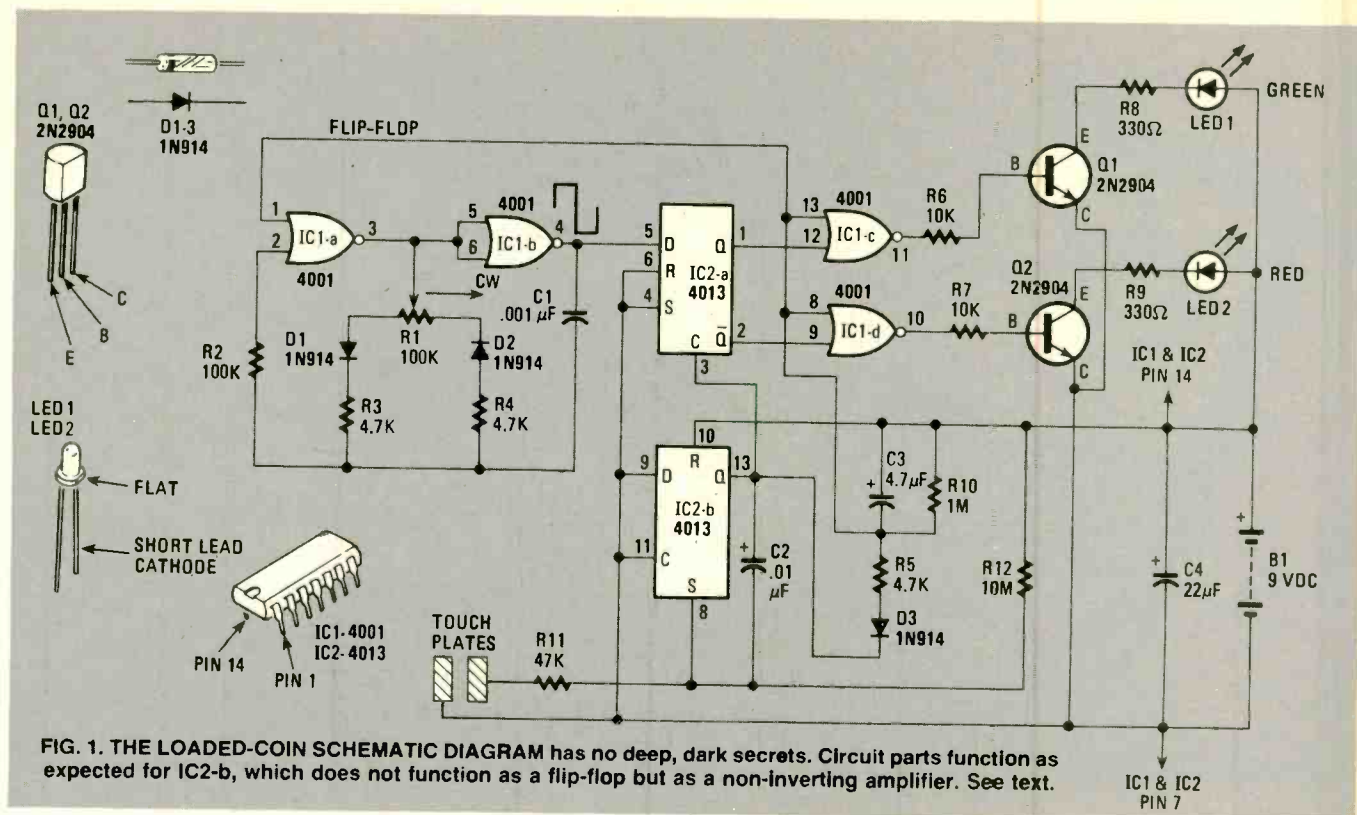

drilled before assembly of the electronics part, using the printed-circuit board as a template (or use foil diagram in Fig. 2) for marking the position of the holes from the underside. The holes for the LED's should be $\frac{3}{16}$ -inches in diameter. For the touch plates, four $\frac{1}{2}$ -inch holes are drilled in the form of a square, approximately $\frac{3}{8}$ -inches large. Two short pieces of #20 or #18 bus wire, bent in the shape of a U, are inserted from the front and are bent closed at the rear to form two parallel touch plates, which are connected with insulated wire to the printed-circuit board at the pads marked "T." A piece of adhesive tape should be placed over the connections to the touch plates to prevent accidental shorting.

The printed-circuit board is mounted in the box with the foil side facing the front plate. The LED's, therefore have to be mounted so that they protrude through the holes in the printed-circuit board to be in the right position. The flange of

potentiometer R1 is used to attach the printed-circuit board to the front panel. You may or may not want to mount the face plate under the nut of R1 at this time. The face plate (see Fig. 4) can be added later after all troubleshooting has been done. It's up to you. The washer supplied with the potentiometer is not thick enough to provide sufficient space for the component leads, but a makeshift washer can be bent from a piece of #16 wire.

Checkout

After assembly and connection of the battery, the Loaded Coin should function as follows: When the touch plates are touched, one of the LED's should light up. The readout is actually the result of the previous trial. The "coin is tossed"

FIG. 2. THE SAME-SIZE COPPER-FOIL DIAGRAM for the printed-circuit board is given for those who prefer to etch their own circuit boards. The board's small size may permit the salvaging of scrap board unused from a previous project.

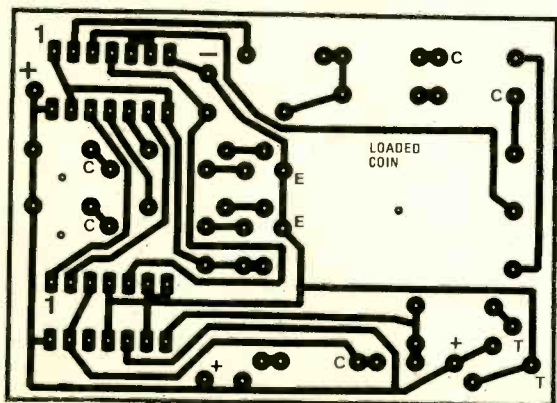

WORM'S EYE VIEW of the bottom of the Loaded-Coin front panel with the printed-circuit board mounted on it. Except for four external leads, the entire circuitry is assembled onto the board. Use the printed-circuit board as a template to locate holes for the LED's and potentiometer R1.

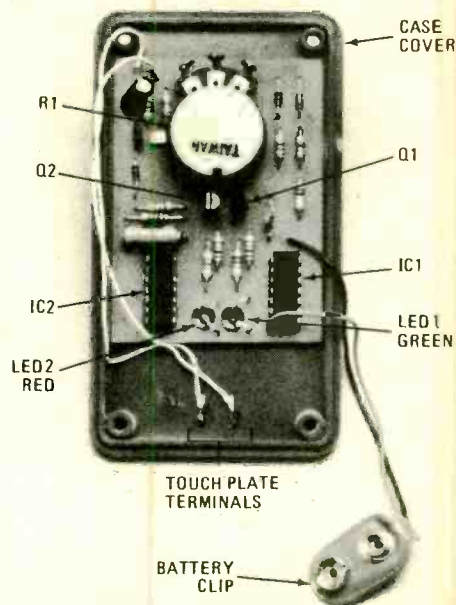

FIG. 3. PARTS-LOCATION DIAGRAM for the Loaded-Coin project is given here. The foil side of the printed-circuit board is shown down with the X-ray view of the foil provided for clarity.

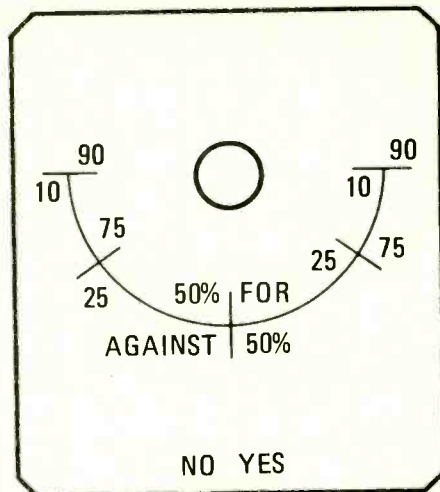
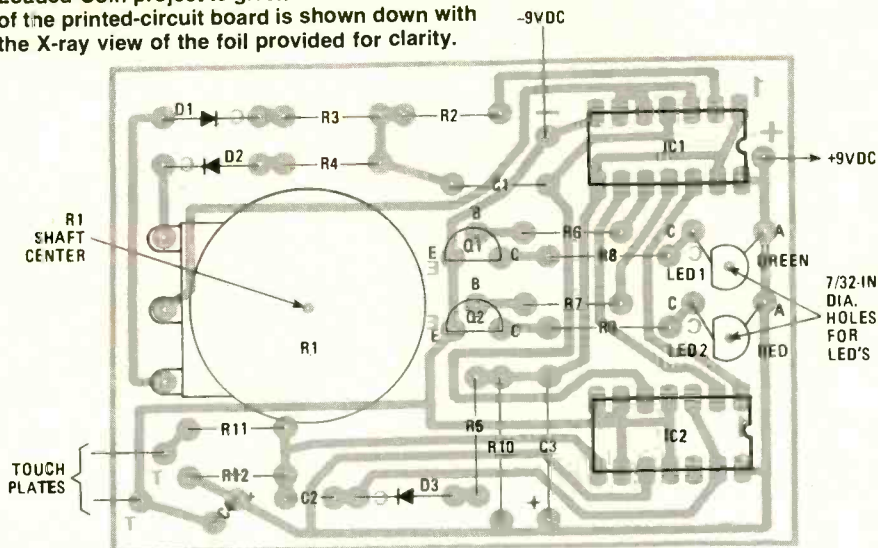

FIG. 4. COPY THIS DIAGRAM to produce a front-panel label for your Loaded-Coin project. Should you decide to opt for the etched, pre-drilled printed-circuit board, the supplier also provides a self-adhesive label. See Parts List.

when the finger is removed and the display may or may not change depending on random chance. The odds adjustment requires a simple calibration, as the electrical halfway-point of the potentiometer does not usually coincide with the mechanical halfway-point. If an oscilloscope is available, the waveform at pin 4 of IC1 can be observed and the knob rotated on the potentiometer shaft until the 50:50 setting results in a symmetrical wave.

If no oscilloscope is available, a voltmeter can be used as follows: Connect the meter across the battery and note the voltage reading while touching the touchplates. Then move the + lead of the meter to pin 4 of IC1 and rotate the potentiometer until the reading is exactly 1/2 of the first measurement. Then, without changing the potentiometer setting, mount the knob so that it points to the 50:50 mark. If no meter is available, the odds can be determined by counting the outcome of a large number of "coin tosses." For 100

tosses one usually gets between 47 and 53 YES readings if the Loaded Coin scale has been properly calibrated. And, if no oscilloscope and voltmeter are available, and you can't count, think seriously about not building the Loaded Coin.

SP

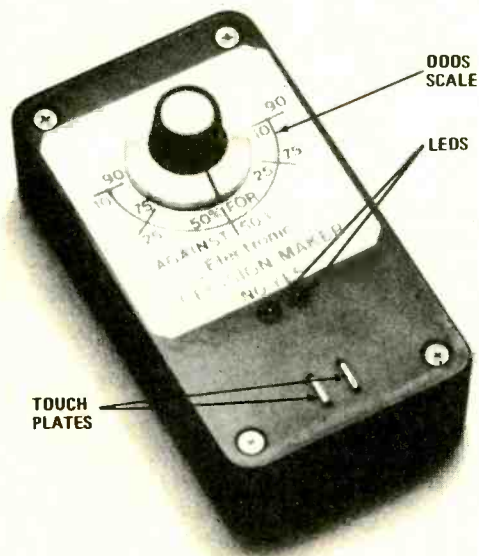

LOADED COIN all assembled in its Radio Shack stock blue-plastic project case. Note that knob is set for a 50/50 chance. For other settings, be sure you are bigger than the other player.

PARTS LIST

SEMICONDUCTORS

D1-D3—1N914 silicon switch diode
 IC1—4001 CMOS quad 2-input NOR-gate integrated circuit
 IC2—4013 CMOS dual D-type flip-flop integrated circuit
 LED1, LED2—Light-emitting diode, one green and one red

Q1, Q2—2N2904 NPN transistors (Radio Shack 276-1603)

RESISTORS

Resistors are 1/4-watt unless otherwise noted

R1—100,000-ohm linear potentiometer
 R2—100,000-ohm
 R3, R4, R5—4700-ohm
 R6, R7—10,000-ohm
 R8, R9—330-ohm
 R10—1-Megohm
 R11—47,000-ohm
 R12—10-Megohm

CAPACITORS

C1—.001- μ F, 15-WVDC disk
 C2—.01- μ F, 15-WVDC disk
 C3—4.7- μ F, 35-WVDC electrolytic (Radio Shack 272-1012)
 C4—22- μ F, 15-WVDC electrolytic

ADDITIONAL PARTS AND MATERIALS

B1—9-volt transistor battery
 Project case 4 $\frac{1}{16}$ × 2 $\frac{7}{16}$ × 1 $\frac{1}{16}$ -in. cover (Radio Shack 270-221), 9-V battery clip, printed-circuit materials, knob (Radio Shack 274-414), wire, solder, etc.

Printed-circuit board, etched and drilled, and front panel printed on adhesive-backed, coated label stock for \$4.95 including handling and postage. California residents add \$.30 sales tax. Order from: Hexadaisy Products, P.O. Box 1532, Laguna Beach, CA 92652.

MASTER THE "NEW ELECTRONICS" WITH MCGRAW-HILL'S Contemporary

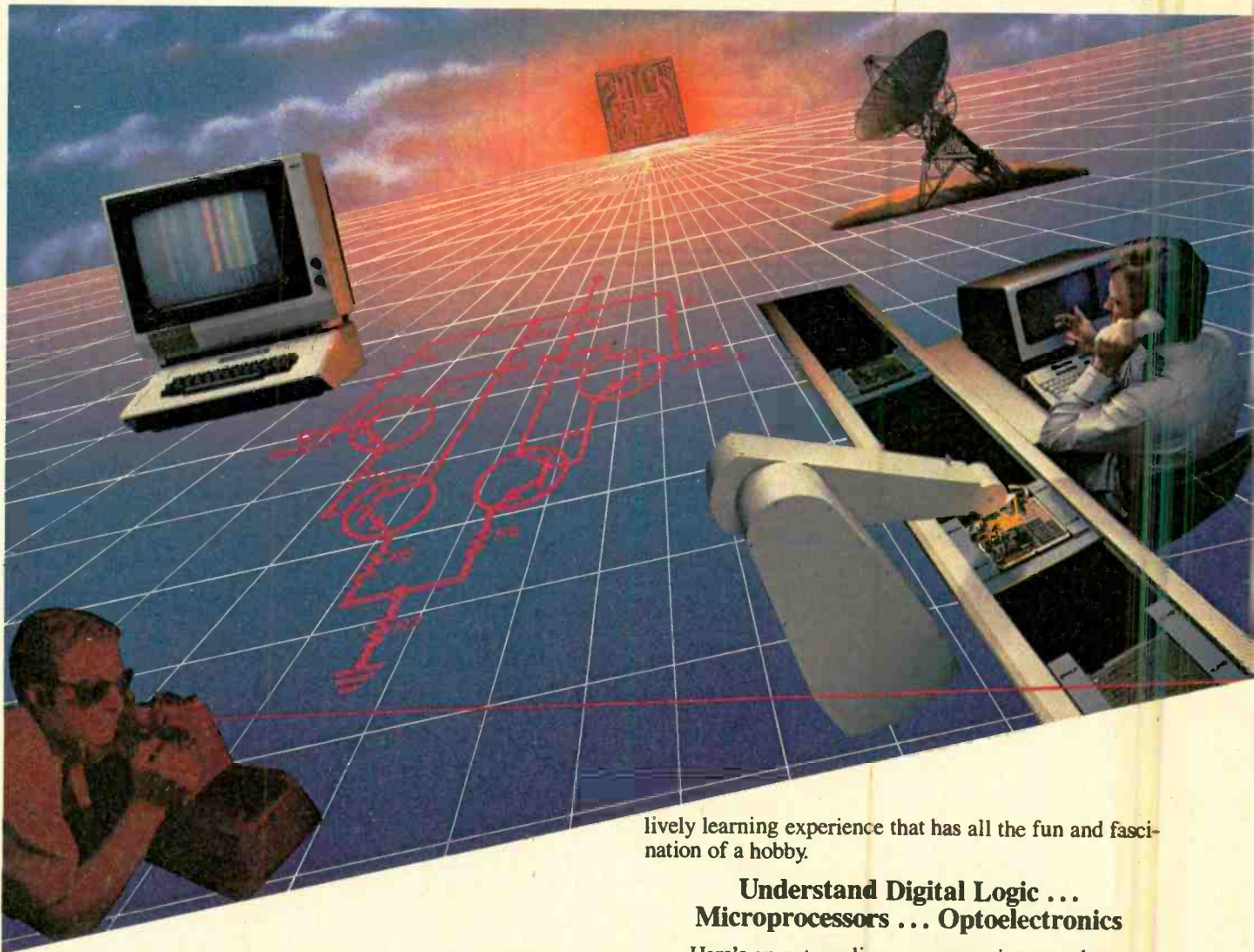

Now you can meet the challenges of today's incredibly rapid changes in electronics quickly and easily. This professional level electronics learning series is as innovative as the circuitry it explains and as fascinating as the experiments you build and explore!

From digital logic to the latest 16-bit microprocessor, you master one subject at a time with McGraw-Hill Concept Modules sent to you one at a time, once a month, to make up the complete CONTEMPORARY ELECTRONICS SERIES. Each module of the fifteen in the Series is a unique blend of "hands-on" experience, interactive audio cassettes, and vividly illustrated printed support materials. Together they will prepare you for tomorrow's better jobs or advancement in your present position by staying current with today's electronics revolution. Professional in every respect, yet it's a

lively learning experience that has all the fun and fascination of a hobby.

Understand Digital Logic ... Microprocessors ... Optoelectronics

Here's an extraordinary opportunity to update your understanding of today's most important technological changes in electronics. You can start from scratch or use the Series to update yourself. You cover the latest integrated circuits, including TTL, CMOS, and ECL digital circuits; op-amps; phase-locked loops; microprocessors; and opto devices such as LEDs and LCDs.

Perform Electronic Experiments

With your first module you'll use the latest digital integrated circuits to build an oscillator circuit that demonstrates digital signals—verified visually by the flash of light emitting diodes (LEDs) and audibly by tones produced through the mini-speaker that is provided.

You'll know the differences (and similarities) between electronics and electricity, learn the concepts applicable to all electronic circuits. With the first module, you will be able to identify the major passive components, like resistors, capacitors, inductors, diodes and

Electronics Series

transformers, and active components such as transistors and integrated circuits.

Each Concept Module goes right to the heart of the matter. You waste no time on extraneous material or outdated history. It's a fast, efficient, and lively learning experience, a nontraditional approach to the most modern of subject matter.

Construct and Use a Prototyping/Design Laboratory

What's more, when you reach the midpoint of your

YOU COVER EVERY SUBJECT IN CONTEMPORARY ELECTRONICS

- Digital logic
- Digital gates (TTL, CMOS, ECL, NMOS)
- Flip flops, counters and registers. Op-amps and applications
- Power supplies (plus IC and switching regulators)
- Combinational logic circuits (ROMs, PLAs, decoders, etc.)
- Circuit analysis. AC theory. LCR networks
- Transistors (bipolar and FETs), diodes, thyristors
- Integrated circuits (linear and digital)
- Oscillators and function generators
- Modulation and demodulation
- Optoelectronics
- Digital multimeters and scopes
- Microprocessors

With each new module you'll receive a McGraw-Hill Action-Audio Cassette, a proven successful method of programmed, interactive instruction. Each tape creates a dynamic dialogue that not only quickly communicates the facts, but makes you feel that you're participating, as you respond to questions and listen to problems being solved.

Your ability to rapidly make this knowledge your own is further aided by a strikingly original technique for using diagrams, illustrations, and schematics to drive home points made as you listen to the cassette. The same carefully indexed binder that contains this material also includes the instructions

to guide you through hands-on experiments. Finally, having completed the Series, you can be awarded a Certificate of Achievement from the McGraw-Hill Continuing Education Center upon passing an optional final examination.

Series, you will have constructed a professional Prototyping/Design Laboratory which will become a valuable learning tool throughout the remainder of your studies. This Prototyping/Design Lab contains a signal generator, logic switches, pushbuttons, and LED indicators. It rivals professional instruments that are widely used in industrial laboratories for electronic design and development as well as testing and measuring. Because of its versatility, it is an instrument that you will use again and again, even after you have completed your Contemporary Electronics Series.

to guide you through hands-on experiments. Finally, having completed the Series, you can be awarded a Certificate of Achievement from the McGraw-Hill Continuing Education Center upon passing an optional final examination.

Update Your Knowledge of the New Electronics

This program is for you whether you're a scientist who can use electronics to improve or speed up your investigations... a teacher who'd benefit from a refresher in contemporary components, circuits and applications... a manager or supervisor in an electronics related industry or business... an engineer in another field who finds electronics playing an ever more important role in your work... someone looking to find new direction in this wide open field... or the kind of person who wants to understand what's going on in the world around you.

McGraw-Hill's Contemporary Electronics Series offers you the quickest and probably least expensive learning method available today, and the only one with "hands-on" experience.

No Risk, No Obligation

And we invite you to prove all this to your own satisfaction—without risk and without committing yourself in any way.

Return the reply card and we'll send you the first module and other materials for a free 14-day examination. If you're not absolutely satisfied, and certain that this is an enjoyable as well as highly effective way to learn, simply return the module to us along with the unpaid bill and that will be the end of it.

If you wish to continue, we'll ship the remaining modules automatically, about once a month, for only \$19.95 each plus \$2.25 for shipping and handling. Remember, each module comes on the same 14-day free examination basis, with no obligation to pay for any module you don't want to keep.

Return the reply card now. It'll bring you the first module Contemporary Electronic Components and Circuits... your first step in becoming an expert in the "new electronics." There's no risk or obligation.

If the card is missing write to:



Contemporary Electronics Series
McGraw-Hill Continuing Education Center
3939 Wisconsin Avenue, NW
Washington, DC 20016



With your first module you'll receive this professional solderless breadboarding system. It enables you to connect components and build electronic circuits easily and quickly. It's used throughout the series and can be used later to design, build and test your own circuits.



6-N-2 AMPLIFIED FSM

***One-evening project
packs supersensitivity
needed to check-out
flea-powered HT's on
the Amateur bands***

HERB FRIEDMAN

THE 6-N-2 IS AN AMPLIFIED field strength meter (fsm) specifically intended for the pipsqueak signals of six- and two-meter HT's (handie-talkies); and that includes the new 49 MHz "100-milliwatt" unlicensed HT's, as well as the wireless telephones. Sensitivity is such that the output of the service-grade *dip oscillator* is sufficient to pin the FSM's meter, as will a few watts fed into a "base" antenna a few stories above the FSM.

The supersensitivity of the 6-N-2 FSM is due to two things: firstly, the input is tuned to the operating frequency of the HT (or transmitter) by L1 and C1 (see Fig. 1); secondly, diode D1 and transistor Q1 are germanium rather than silicon. Their breakover voltage (0.25V) is less than that of silicon (0.65V), hence, the meter will respond better to an unusually low-input signal level.

The 6-N-2 project is intended strictly as a *junk box special*. Except for the cabinet, the components are the kind you should have lying around from old stripped projects and equipment, or parts that can be purchased at rock-bottom cost from *surplus* dealers. For example, tuning capacitor C1, which sells new for as much as \$5, was purchased from a surplus dealer for 89 cents.

How it works

The FSM is intended to utilize any type of germanium PNP transistor with an h_{fe} higher than 90 or 100. It doesn't matter what the leakage is, because the transistor is used as a DC amplifier in a bridge circuit which will cancel out any false meter reading. The bridge circuit (see Fig. 1) consists of fixed resistors R3 and R4, BALANCE potentiometer R2, and Q1's collector-to-emitter impedance. In normal use, control



R2 is adjusted so that with no signal being received the meter pointer indicates a zero reading. If transistor Q1 has extremely low leakage, R2's adjustment will have no effect on the meter's calibration; it will indicate zero under no-signal conditions regardless of the adjustment of R2's value.

The input signal is provided by the antenna, which is a short length of stiff wire or a telescopic antenna salvaged from a transistor radio. Attach the antenna to insulated binding post BP1. The received RF signal is tuned by open-air coil L1 and FREQUENCY capacitor C1, the resultant peaked RF signal being rectified by diode D1. The DC output from D1 is applied through GAIN potentiometer R1 to Q1's base—the greater the DC applied to Q1, the higher the reading of meter M1.

Because of the bridge-circuit configuration, and the use of germanium semiconductors throughout, meter M1 has a non-linear response to very weak signals; a small increase in RF results in a large increase in the meter reading. Small changes in signal strength, or very weak input signals, don't get lost at the bottom of the scale.

Construction

Other than using a metal cabinet, almost anything goes; so feel free to make substitutions almost at will. Any DC meter movement from $50\mu\text{A}$ to 1 mA can be used. Use whatever is the least expensive should a purchase be required. The bridge configuration will zero any meter no matter how sensitive, so don't try to match the meter to the transistor's leakage. Most convenient operation will be provided with a meter movement sensitivity of $500\mu\text{A}$ or 1 mA.

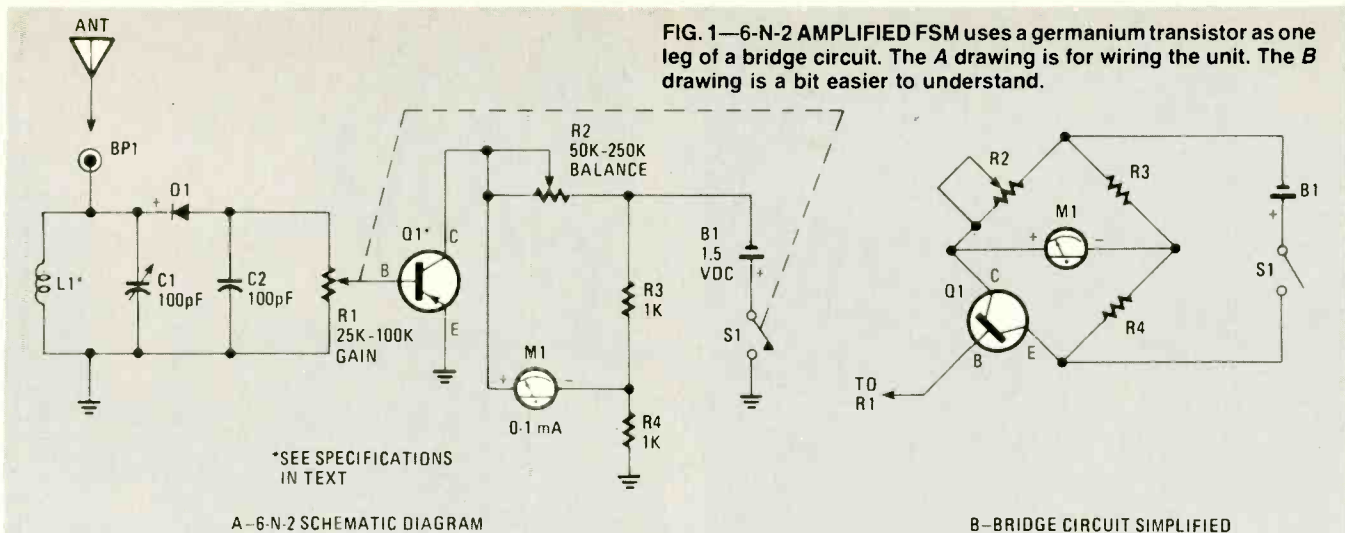

PARTS LIST

SEMICONDUCTORS

D1—Germanium general purpose signal diode, 1N60, or equivalent

Q1—PNP germanium transistor, 90 H_{ie} or better, see text

CAPACITORS

C1—100-pF variable capacitor, Hammarlund type MAPC-100-B or equivalent, see text

C2—100-pF, disk type

RESISTORS

R1—50,000-ohm potentiometer with on/off switch S1, see text

R2—50,000-ohm potentiometer, see text
R3, R4—1000-ohms, ½-watt, 10%

ADDITIONAL PARTS AND MATERIALS

B1—1.5-V penlight (AA) dry cell

BP1—Insulated binding post, 5-way type preferred

L1—3 turns of #16 magnet wire wound on ⅜-in. form with coils spread to ¼-in. width, see text and photos

M1—50-μA to 0-1 mA DC meter, see text

S1—SPST switch, part of R1

Aluminum box cabinet, battery holder, antenna, knobs, hardware, solder, wire, etc.

Capacitor C1 must be 100 pF to cover both 6 and 2 meters. If you use a higher rating it won't matter as long as you're close, say 150 to 200 pF. All that will happen is that the tuning will get *crowded*. Try to avoid going over 200 pF because then the capacitor's *minimum* value might turn out to be excessive for 2-meter coverage.

To allow for the use of salvage parts, R1 can be anything from 25,000 to 100,000 ohms; R2 can be 50,000 to 250,000 ohms. The lower values are preferred for a *broad* adjustment range, but this is not critical. Either linear or audio taper potentiometers may be used.

Take care that you get the polarity correct when installing the battery holder; the positive terminal is connected to ground through power-switch S1.

Wrap it up

The only critical part of the project is tuning-coil L1. If not wound correctly the FSM will tune either 6 or 2 meters, but not both. Coil L1 is made from #16 solid wire. If you can't locate any #16 magnet or coil wire, you probably can purchase a few feet of ordinary #16 solid copper wire at your

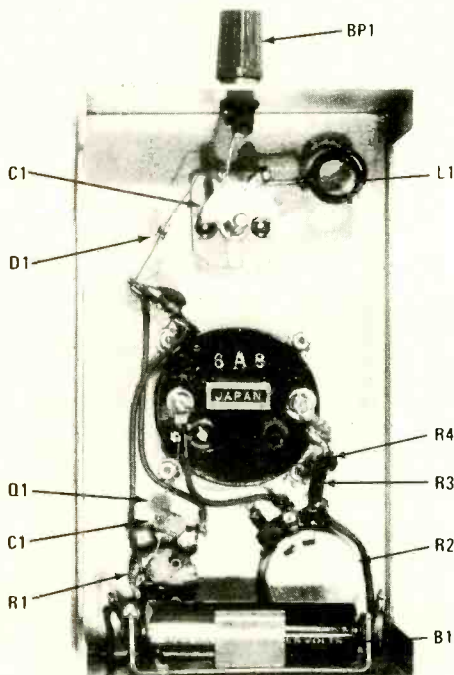

The layout isn't all that critical as long as coil L1 is at least ¼ inch from the nearest metal surface. If you find that L1 is too close to the cabinet, don't bend its leads. Instead, unsolder L1 from the capacitor and shorten the leads.

The antenna can be a stiff section of wire or a telescopic rod salvaged from a transistor radio. Finger points to a banana plug that is jam-fit to the metric threads at the base of a telescopic whip antenna (see text).

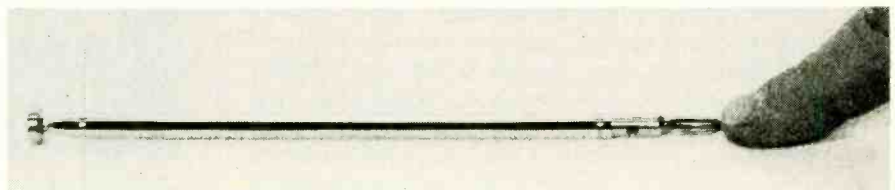

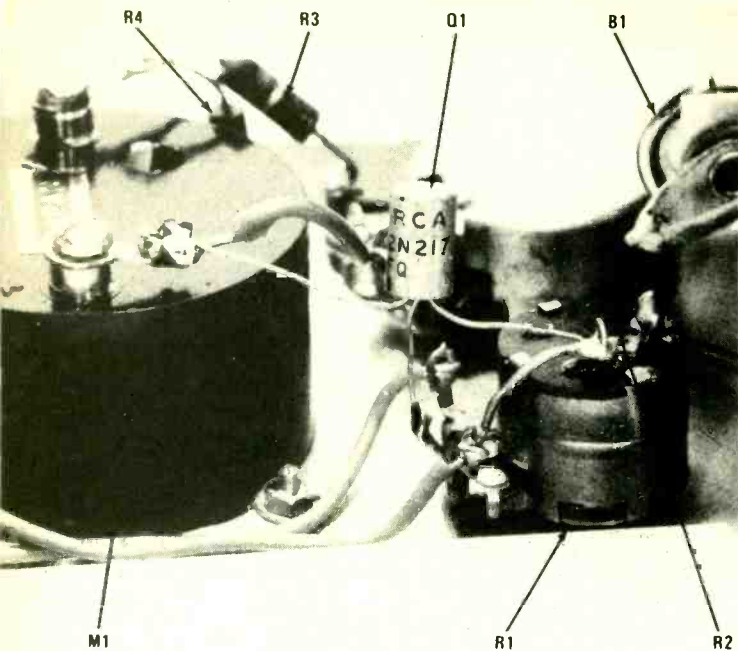

All wiring including the transistor leads is point-to-point. Position the panel components so that the transistor's connections can easily span to the required solder points without extending the leads. Neatness counts. Also, avoid cold solder joints.

local electrical supply store. Electrical wire is somewhat softer than magnet and coil wire, but it's not much of a difference.

To prevent the coil from "unwinding" when you're finished, first *tensilize* the wire. Clamp one end in a vise and then pull gently on the free end (use pliers if necessary) until you see the wire go "dead slack". Then using a 3/8-inch drill bit shank (not the flutes) as a coil form, wind three tight turns. Shape the ends of the coil at right angles as shown in the photographs, and then spread the coil by pulling on the ends until the overall coil length is exactly 3/4-inch. Note that you measure the coil from the start of the first turn to the end of the last turn. Don't make your measurement across the *top* of the coil. Also, the coil's leads are not included in the measurement: the dimensions start and end precisely on the start and end of the coil winding; leads are not included in the overall length.

Secure coil L1 to capacitor C1 and install L1/C1 as a single assembly. It will be easier to solder L1 to C1 if you "tin" L1's leads first. If you used magnet wire for L1, remove about 1/2 inch of the varnish insulation with sandpaper or a suitable abrasive cloth. If you used enameled wire, you can scrape off the insulation with a knife. If you used copper electrical wire, there is no insulation other than the plastic wire insulation, which is removed before you start to wind the coil.

Finishing touches

Assemble the meter using the general layout shown in the photographs. Keep in mind that BP1—the antenna binding post, must be insulated from the cabinet.

The antenna can be about 12 inches of stiff wire or a metal coathanger section, or you can use a telescopic antenna salvaged from an old radio. If you attach a banana plug to the end of the telescopic antenna, it will plug into the typical 5-way binding post. Since the metric thread on the end of the antenna won't match the "American" thread on the banana

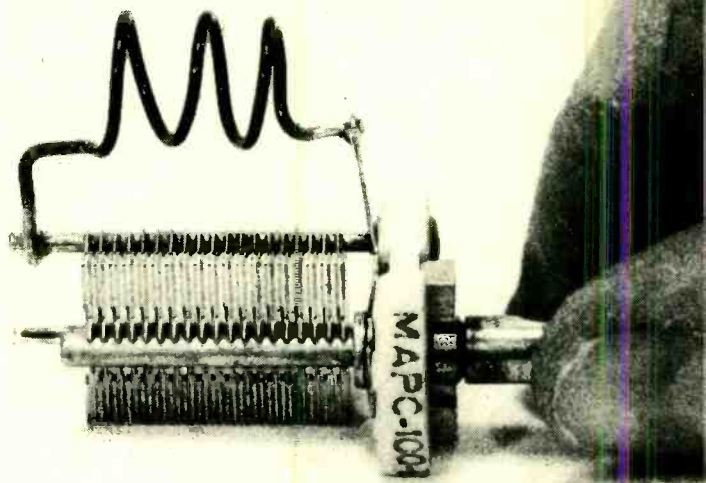

The only critical part is the tuning coil, which is affixed to the tuning capacitor before installation. Your version should look just like this. If the coil isn't formed properly, the meter will not tune both 6 and 2 meters and you'll have a one bander!

jack, try this: First, cut the head off a 3/8-inch 6-32 screw and jam-fit the cut end unto the antenna. It will catch the first few threads, which is all that's really needed. Then secure the banana plug on the few threads of the screw that stick out of the antenna. It will thread on easily because the threads match. A twist with pliers and the jack will be permanently secured to the antenna.

Using the 6-N-2

Apply power by rotating GAIN control R1 about halfway. Switch S1 is part of R1. Note the meter reading. If it isn't exactly on zero adjust BALANCE control R2 for a zero reading. Then key the 6- or 2-meter transmitter and adjust tuning-control C1 slowly until the meter "kicks" to a high reading (it might literally be a kick). Reduce the sensitivity by backing off R1 until the meter reading is "on scale" and then adjust C1 for maximum meter reading. You can then use R1 to set the meter to a convenient "reference" reading.

If capacitor C1 does not cover both bands, coil L1 is spaced either too wide or too close. Make the necessary adjustment to L1 with your fingers: spreading or closing the spacing. But keep in mind that a small adjustment to L1 results in a large change in tuning range. **SP**

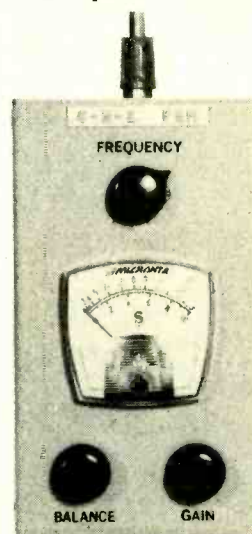

The 6-N-2 field strength meter looks like a store-bought unit even though it is made from salvaged parts. Try to match control knobs for classy look. Press-on type was used to identify the controls. Use a bright red binding post for good looks. If the potentiometer you use does not have a switch activated by the control shaft, install a slide switch on the front panel.

FIRE ALARM MODULE

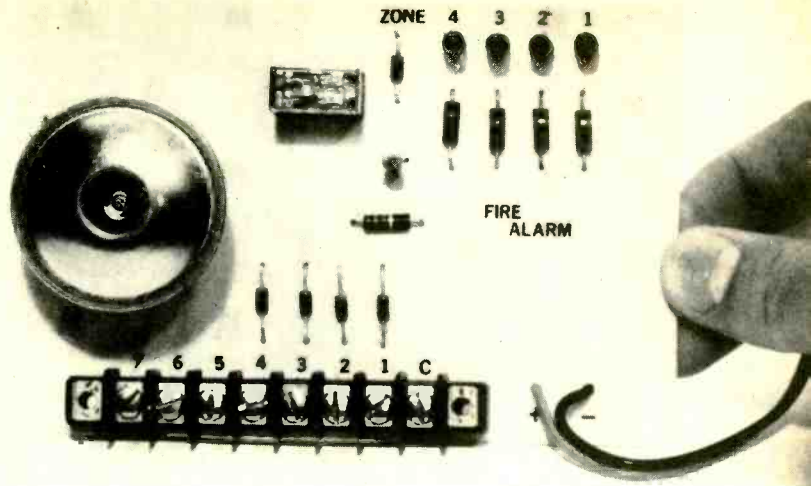

**Your fire alarm sounds off!
Is it upstairs? Downstairs?
Maybe the kids' room? Maybe not?
This easy-to-build project saves
precious seconds and lives!**

HERB FRIEDMAN

AS A GENERAL RULE OF THUMB, THE BEST FIRE ALARM FOR anything—particularly the home—is a U.L.-listed commercially-built alarm. But if you can't afford one, you can build an effective Fire Alarm Module that uses U.L.-listed detectors.

The Fire Alarm Module is complete on a single printed-circuit board, except for the 6-volt lantern battery that serves as the power supply for both the module, and (if desired) as the power source for a standard 6-volt alarm bell. Extra features include a rather raucous alarm horn mounted on the module, and up to four zone LED indicators that show which group of heat detectors has been triggered by excessive heat or a fire. Now you know where the problem is located: upstairs, downstairs, front, or rear.

The circuit

Two options are provided for signalling a fire—or more precisely, that a heat detector has been triggered. The relay used, K1, has two independent double-throw contact sets. One is used to sound the module's own alarm horn. The remaining set of SPDT contacts is brought out to a terminal strip, and can be used to activate a standard internal or external

6-volt alarm bell (which can be powered by the lantern battery—modify the PC foils accordingly); or, the contacts can be used for triggering a 120-volt signal device, or a telephone dialer. Since the SPDT switch contacts have no normal connection to any of the module components you can wire them any way you want. The only limitation is the 120-volt/1-ampere rating of the relay's contacts.

The module uses normally-open heat detectors. Excessive

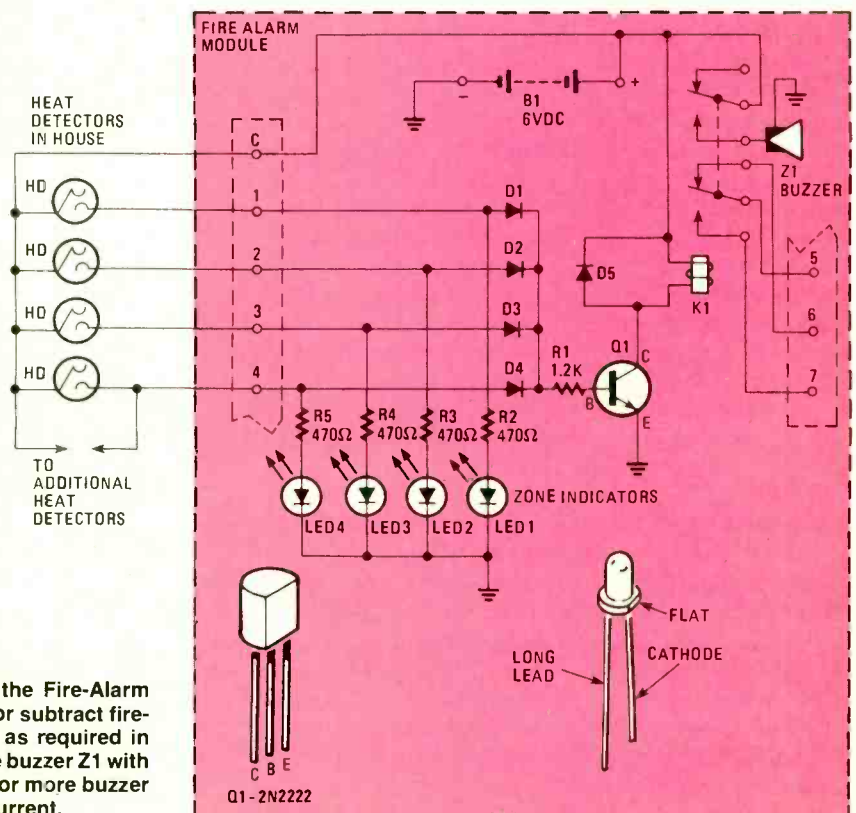
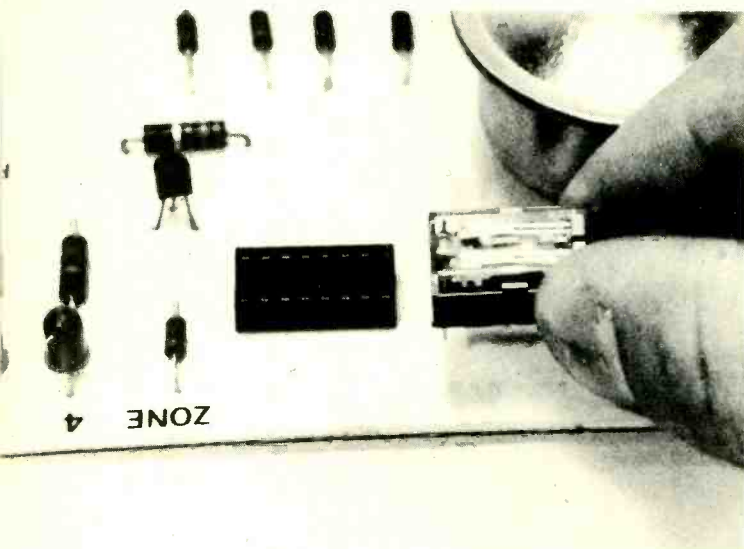

FIG. 1. COMPLETE SCHEMATIC DIAGRAM for the Fire-Alarm Module shows circuit's simplicity. You can add or subtract fire-zone indicator LED's and their series resistors as required in your home. Possibly, you may want to replace the buzzer Z1 with a 6-volt DC relay which, in turn, will activate one or more buzzer or bell alarms requiring higher voltage and/or current.



THE DIP RELAY plugs into a standard 16-terminal, integrated-circuit DIP socket. The relay can be soldered directly to the copper foils, but a socket makes things a lot simpler should you have to remove the relay for any reason.

heat causes a bi-metal strip in the detector to close, activating both the associated LED—which indicates the protective zone of the tripped detector—and transistor Q1. The transistor's collector-emitter current causes relay K1 to "pull in", thereby closing the relay's contacts, which applies the power source to alarm horn Z1.

The alarm will sound as long as any of the heat detectors—in any zone—are closed. The alarm is turned off when the detector's contacts open, which occurs a few seconds to a few minutes after the excess heat is removed from the detector. The usual way a detector is checked is to hold a special test lamp fixture near the detector; the heat from the lamp causes the detector to close. Since the average homeowner or apartment-dweller does not have the special test lamp, the heat of a match can be substituted. The alarm will turn itself off a few moments after the heat of the match is removed.

In the final analysis, the system is dependent on the heat detectors, and no compromise should be made; use only *listed* heat detectors that are specifically intended for fire alarms. For some unknown reason there are many heat-detector elements floating around the surplus market, and those elements are often touted as "excess heat" or "fire" detectors. Their use is specifically *not* recommended because their original purpose and design are unknown. And even if they are fire detectors, how can you tell whether they are first quality, "seconds" or rejects, or whatever? *You can't.*

Hookup

The standard fire detector comes pre-mounted on a plastic fixture which is pre-notched for wiring. You simply push out the plastic "knockouts" with a screwdriver or pliers. (The knockouts insure that you don't accidentally squeeze the wire between the detector and ceiling, possibly cutting through the wire when installing the fixture.) It is available in two heat ranges: 135 degrees (F) for living areas, and 190 to 200 degrees (F) for high-heat areas—such as above a furnace, though 135-degree detectors usually are adequate for home furnace rooms.

As a general rule of thumb, a heat detector (HD) covers

PARTS LIST

RESISTORS

All resistors ½-watt, 10%

R1—1200-ohms

R2-R5—470-ohms

SEMICONDUCTORS

D1-D5—Silicon rectifier diode, 1N4000 series, see text

LED1-LED4—High-brightness light-emitting diode

Q1—2N2222 transistor (Radio Shack 276-009, or equivalent)

ADDITIONAL PARTS AND MATERIALS

B1—6-volt lantern battery

E1—8-tie-point terminal strip

HD—Normally-open heat detectors, quantity determined during installation, see text

K1—5-VDC, DPDT DIP relay (Radio Shack 275-215)

Z1—6-VDC alarm buzzer (Radio Shack 273-049, or equivalent)

Printed circuit materials, wire, solder, metal alarm-box, etc.

Normally-open U.L. listed heat detectors can be ordered from Specialty Parts, Box 22, West Hempstead, NY 11552. Price is \$5.00 for 135°F detectors; \$5.50 for 200°F detectors. Add \$2.50 per total order for postage and handling. NY State residents must add local sales tax.

approximately 400 square feet, essentially 20 × 20 feet with the detector in the center. Now the coverage of the detector does not expand to compensate for walls; that is, if the detector is located 5 feet from a wall the effective range of the opposite side of the detector remains 10 feet. That is why detectors are usually placed in the approximate center of the ceiling; or if it's a long room, two detectors are used, but they are never close to a wall because coverage stops at the wall. Where there are rather long rooms, special detectors with 900 foot coverage—30 × 30 feet—can be used. While it is common to speak of fire protection in terms of a "square" area such as 20 × 20 or 30 × 30 feet, in actual fact the coverage is circular, and the 20 × 20 detector actually covers a 20-foot diameter, while the 30 × 30 covers a 30-foot diameter. We "square" the measurement because rooms are normally rectangular. Square vs. round is usually an unimportant consideration, but keep it in mind if you're protecting a rather large room or hallway. When in doubt, use two detectors.

Good quality detectors have metal straps within the plastic housing that provide two terminals for each of the two connections so you can avoid building a rat's nest of wires within the detector. Two terminals are used for the outgoing wire pair; the remaining two are used for branching connections to another detector. Since the detectors are usually normally open (N.O.), all detectors in each fire-detection zone are connected in parallel. For example, you might have all basement detectors on one zone, all bedrooms on another, and the garage on yet a third zone. The detectors within the same assigned fire-detection zone would be connected in parallel.

Take note that there are some N.C. (normally closed) detectors in the marketplace. These are for "supervised" circuits and are generally used with special, and somewhat expensive, control modules that have a "monitor" current flowing in them, which tends eventually to wear out a battery power supply. The normally-open alarm circuit uses no standby or "monitor" current, so the battery will be useful for its full shelf life (usually at least two years for lantern batteries). As a general rule of thumb, for maximum reliabil-

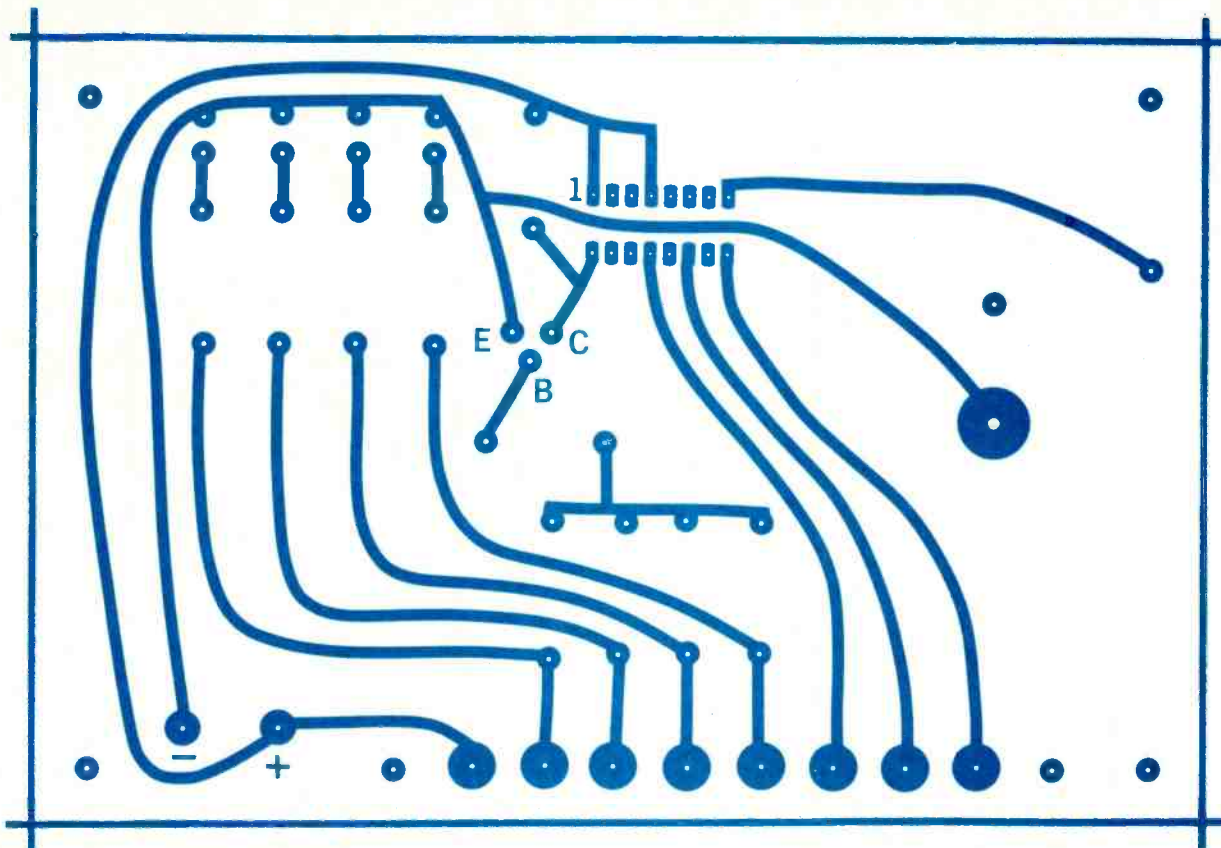

FIG. 2. FOIL PATTERN for the Fire-Alarm Module is like the prairie—lots of open spaces. If you wish duplicate this pattern mechanically on a perfboard using hard wiring or wire-wrap technique.

batteries). As a general rule of thumb, for maximum reliability affix a dated label to the battery and change it every year regardless of whether it has been used or not. Use the removed battery to power your flashlight or model rockets, or anything else, but put a fresh battery in the alarm *every year*.

If you're going to install a fire alarm we strongly recommend you use U.L. "listed" detectors. Depending on the size and type of stores in your particular town they will be available from hardware stores that sell burglar and fire-alarm devices, electrical parts distributors, and some electronic parts stores. If you can't obtain heat detectors locally they can be ordered directly from Specialty Parts. Refer to the Parts List.

Building the module

The Fire Alarm Module shown in the photographs is assembled on a 4 × 6-inch printed-circuit board. The board is oversize to allow for relatively broad foil traces, which are considerably more reliable than "hair thin" foils. We recommend a foil width of at least 1/16 inch.

The alarm horn, Z1, is a standard six-volt buzzer that's adjusted to allow for a slightly

lower battery voltage (caused by aging on the shelf). If possible, temporarily power the buzzer by three AA cells; if the buzzer doesn't sound off, adjust the screw on the back of the buzzer clockwise for no more than 1/4 turn until the buzzer sounds. The screw is cemented in place so use a good Philips screwdriver—one that "seats" snugly—and be prepared to use a goodly amount of force. The ground connection to the horn is made by the mounting screw that seats against a

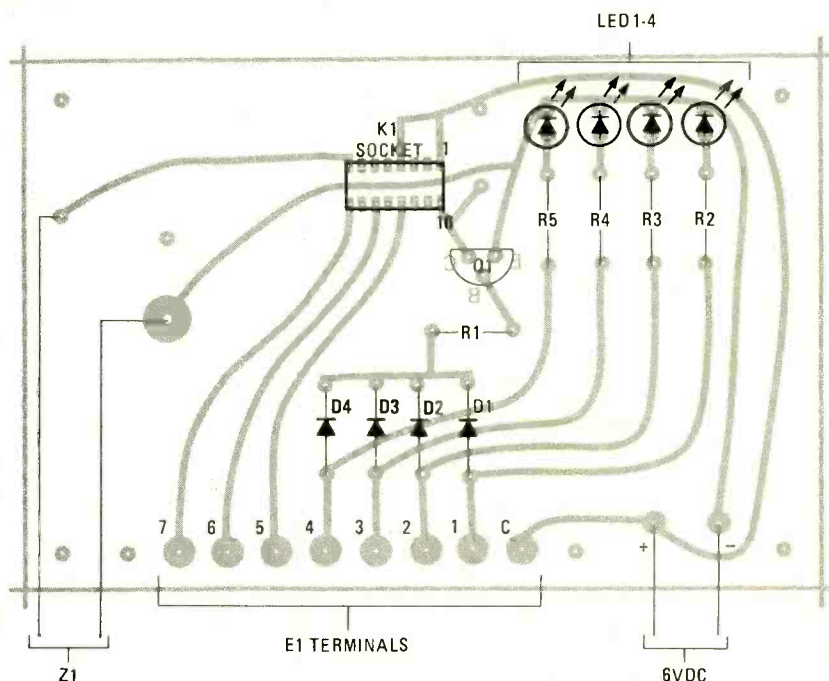
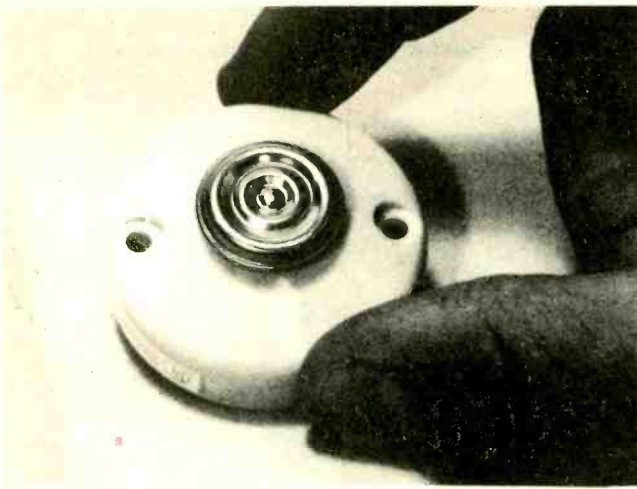
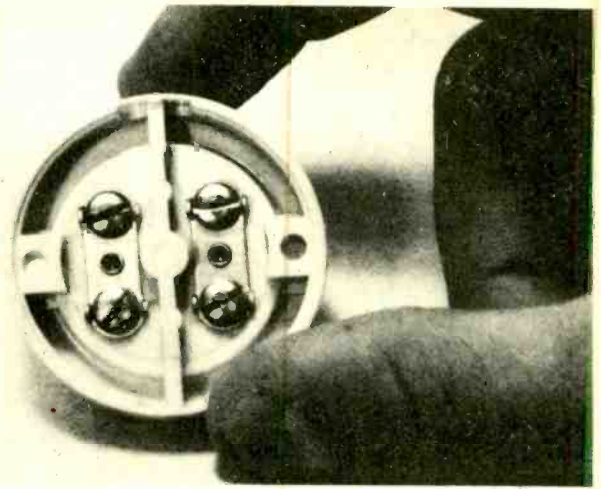

FIG. 3. X-RAY VIEW OF THE PRINTED-CIRCUIT BOARD with component parts in place. Circuit board can be easily redesigned to customize your home's special fire-zone needs.



THE HEART OF THE SYSTEM is the U.L. *listed* heat detector. This model covers 900 square feet, rather than the more common 400 square feet. The detector itself is the small metal "button." The plastic fixture only serves to hold the heat detector element.



A HIGH QUALITY DETECTOR will provide two screw terminals for each contact. One is for the outgoing wire, the other for branching to other detectors. Note the knockout indents in the plastic fixture directly under the thumb and forefinger.

PC-board foil pad. To prevent the horn from working loose, use an internal-starwasher between the horn and the PC board, and under the head of the mounting screw.

Relay K1 is somewhat unusual in that it is a DIP relay, meaning that it mounts just like a 16-pin DIP integrated circuit. In fact, you can even use a DIP IC socket for the relay; we suggest that because if you install the relay incorrectly it's a lot easier to lift it out of a socket than it is to unsolder it from the PC board. We have used the dip relay only because it's easier to obtain and install, and considerably less expensive than a "standard" (large) relay. If you happen to have a 6-VDC standard relay in your stock by all means use it; simply modify the PC template accordingly.

Diodes D1 through D5 are from the 1N4000 family because they are an inexpensive and very reliable type. Use any of the family, such as the 1N4001, 1N4002, 1N4004, etc., as long as it's rated at 25 PIV or higher.

Virtually any LED can be used for the zone indicators. However, for that application the high-brightness type which produces a bright pinpoint of light is preferred to the diffused-lens type, which produces a soft "glow" across the entire face of the LED. The bright pinpoint light is somewhat easier to see when you're excited, or where there is high ambient illumination.

The terminal strip is a standard 8-connection type from Radio Shack. Though we have marked the PC template for the strip's mounting screws they really aren't necessary: It is rather secure when all 8 terminals have been soldered to the foils. The connection labeled "C" is the common power source for all the heat detectors and zones. Terminals 1 through 4 correspond to the four protective zones.

The Fire Alarm Module can be installed in any type of cabinet, although a standard burglar-alarm bell box available from electrical supply stores is recommended because it has sufficient depth to accommodate a lantern battery. Whatever you use for an enclosure, make certain that there are slots or cutouts in the front panel so that the alarm horn can be heard locally. If desired, the zone indicator LED's can be moved to the cabinet's panel. Simply extend the LED's connections with hook-up wire.

AFTER YOU DO THE LIVING QUARTERS don't forget the furnace room. You should install a heat detector above the furnace, as well as in all other basement and garage areas. There is no such having too many. You could have one too few.

Connect a 6-volt lantern battery to the PC board's "+" and "-" terminals. Nothing should happen. If an LED(s) lights, or the horn sounds, you have made an error in assembly. Shorting terminal strip connections C and 1 should sound the horn and cause the #1 LED to light. Same thing when you short C to terminals 2, 3, and 4; the horn will sound and the appropriate LED will light. If that doesn't happen you have made a wiring error.

Installation

After the Fire Alarm Module is mounted in a cabinet and connected to the heat detectors, and possibly an alarm bell, you can check the detectors by heating them with the flame from a match. Be careful not to mar the ceiling. Every detector should individually trip the module, sounding the horn and the bell. As stated earlier, the detectors will reset themselves when the heat is removed. If you have a smoke detector in your home with "dry" normally open alarm contacts (meaning they are not connected to any voltage source in the smoke detector—they are simply a switch closure), you can connect the smoke detector into any of the zone protective-circuit wiring. **SP**

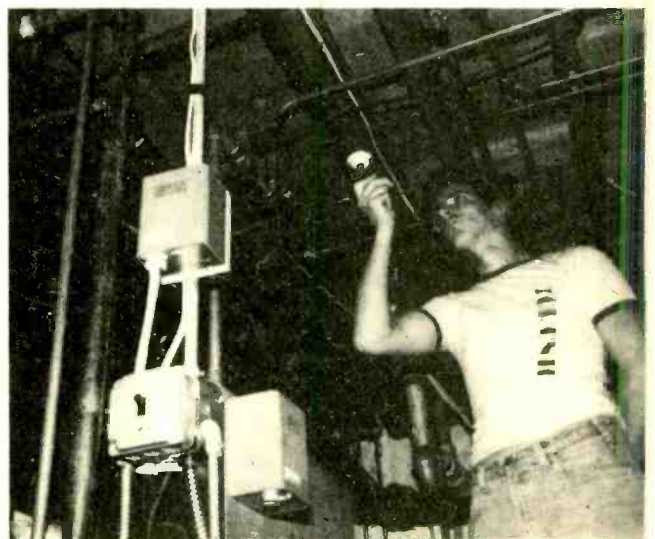

AUDIO SUBCARRIER RECEIVER

***Is your satellite transponder
producing silent movies?
Then pull in the audio with this
television-receive-only project.***

MIKE WALLER

HAVE YOU BEEN AVOIDING THOSE SATELLITE TRANSPONDERS that have no apparent audio? Tired of reading lips? Then the Audio Subcarrier Receiver for satellite TVRO (television receive only) is for you. Here is a story that tells how to build the Subcarrier Receiver that, with a spin of a knob, will allow you to listen to all those subcarriers between 5.4- and 8.2-MHz. Also on the same board is a 5-KHz low-pass filter that will greatly improve listening on the *Anik* series birds (satellites). Power-supply requirements are minimal: +10 volts DC at about 30 mA. Varactor diodes are used for electronic tuning, thereby reducing problems with remote location operation.

The circuit

As you can see from the schematic diagram (Fig. 1), the Audio Subcarrier Receiver circuit is straightforward using conventional IC's. The high-side range of the local oscillator is well above video, with its second harmonic well below 60- and 70-MHz IF frequencies. Even if the unit is left unshielded, it won't cause video interference. FM demodulation is taken care of by IC1, the CA3065 chip. That device, while designed for 4.5-MHz operation in TV receivers, works well at 10.7 MHz. Varactor diodes D1 and D2 are Motorola MV840's, but any 100-pF, 3.0-tuning-ratio varactors will work. Make sure that both diodes are from the same manufacturer (and box, if possible) to maintain accurate tracking.

Tuning voltage is controlled by R11, a 10-turn helical potentiometer. The potentiometer may be remotely located for ease of tuning. A single-turn pot could be used in a pinch, but would make tuning quite critical. For a wider tuning range, jumper wire JU2 could be removed and a higher regulated voltage used, but do not exceed 30 volts. With a regulated power supply connected to V_{CC} stability is very good. You could add remote tuning or frequency sweeping via switch S1. If neither option is needed, replace S1 with a jumper, JU4 as shown in Fig. 1. Inductors L1, L2, and L3 are from a Radio Shack assortment. They may also be hand wound—see information in the Parts List.

Switch S2 selects between standard audio from the American satellites, and the not-so-standard audio from *Anik*. With *Anik*, the low-pass filter greatly reduces background high-frequency chatter caused by the audio channel-two subcarrier. It has unity gain at 1 KHz, and is 12 db down at 5 kHz. **Needless to say, 5% components should be used here.** Higher supply voltages may be accommodated by replacing jumper JU3 with an appropriate value resistor. Its value should be chosen to limit the supply current to about 45 mA. Operation would then be from the internal Zener regulator in the CA3065 (IC1) at about 11 volts. With 10 volts, operation is just below the Zener knee in the CA3065, preventing Zener current from being drawn.

The IF transformer is a J.W. Miller 8851-A. It is double tuned and limits the 6-dB bandwidth to about

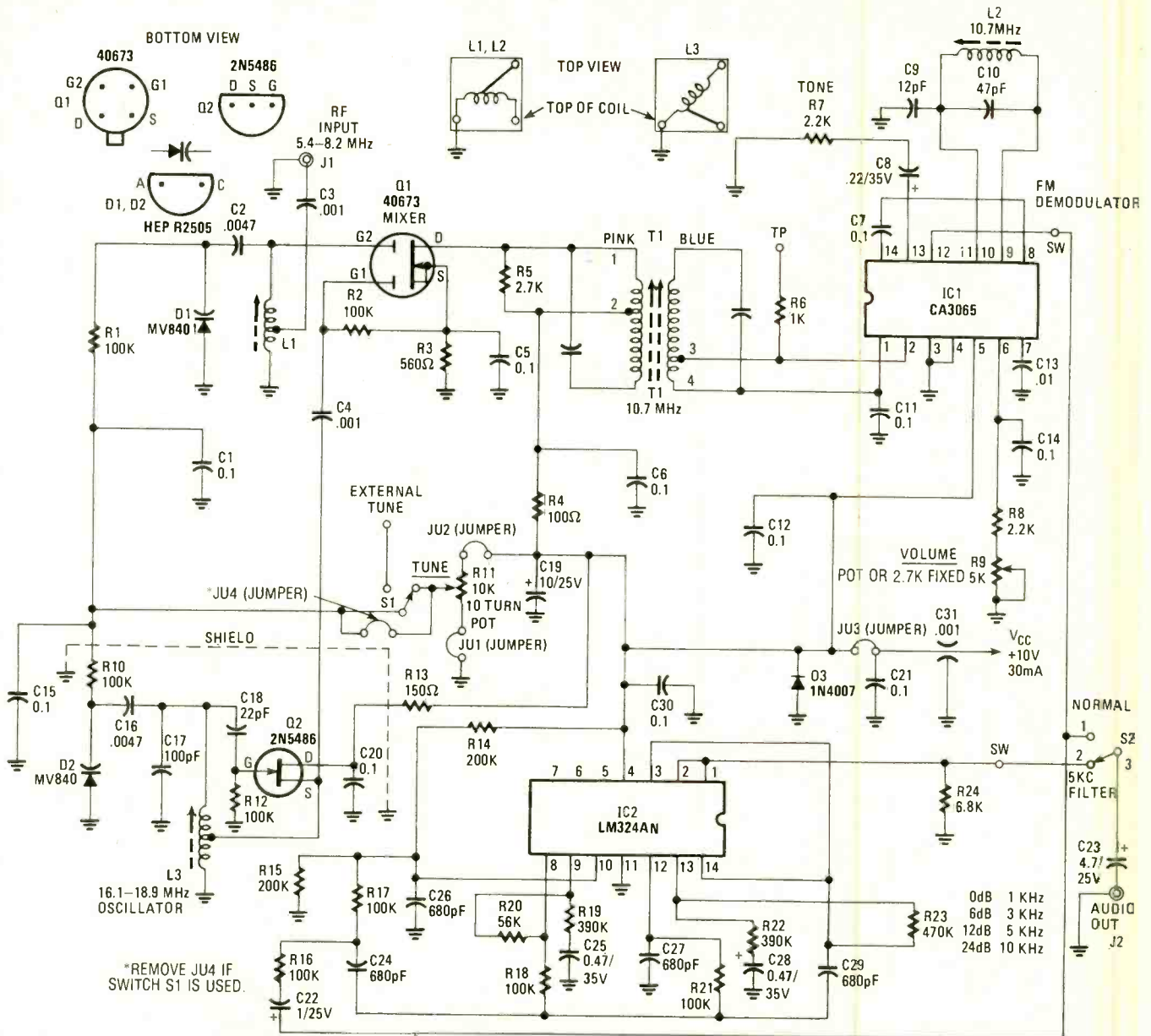

FIG. 1—SCHEMATIC DIAGRAM for the Audio Subcarrier Receiver that will add sound to your satellite receiver's silent movies. The unidentified capacitors near 10.7 MHz transformer, T1, are part of the transformer's assembly.

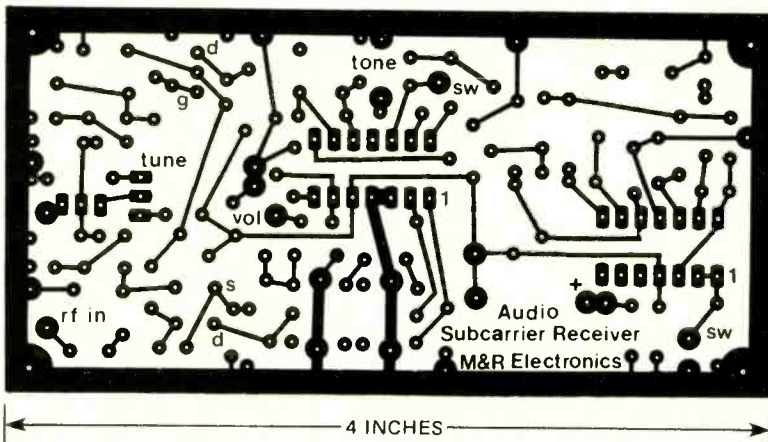

FIG. 2—CIRCUIT-BOARD LAYOUT for the copper foil side of the printed-circuit board. Experimenters new at building projects at 10.7 MHz are urged to follow the layout exactly. There will be some unused tie points on the printed-circuit board because the author made modifications after the board design was completed.

PRINTED CIRCUIT BOARD AVAILABLE

Etched, solder-plated, and drilled printed-circuit boards available from:

DigiCom Engineering, Inc.
 P.O. Box 1656
 Kodiak, Alaska 99615
 Tel: 907/486-5118

COD orders accepted. Prices are \$14.95 per printed-circuit board; \$4.00 for 2 varactors; and \$1.00 per order for postage.

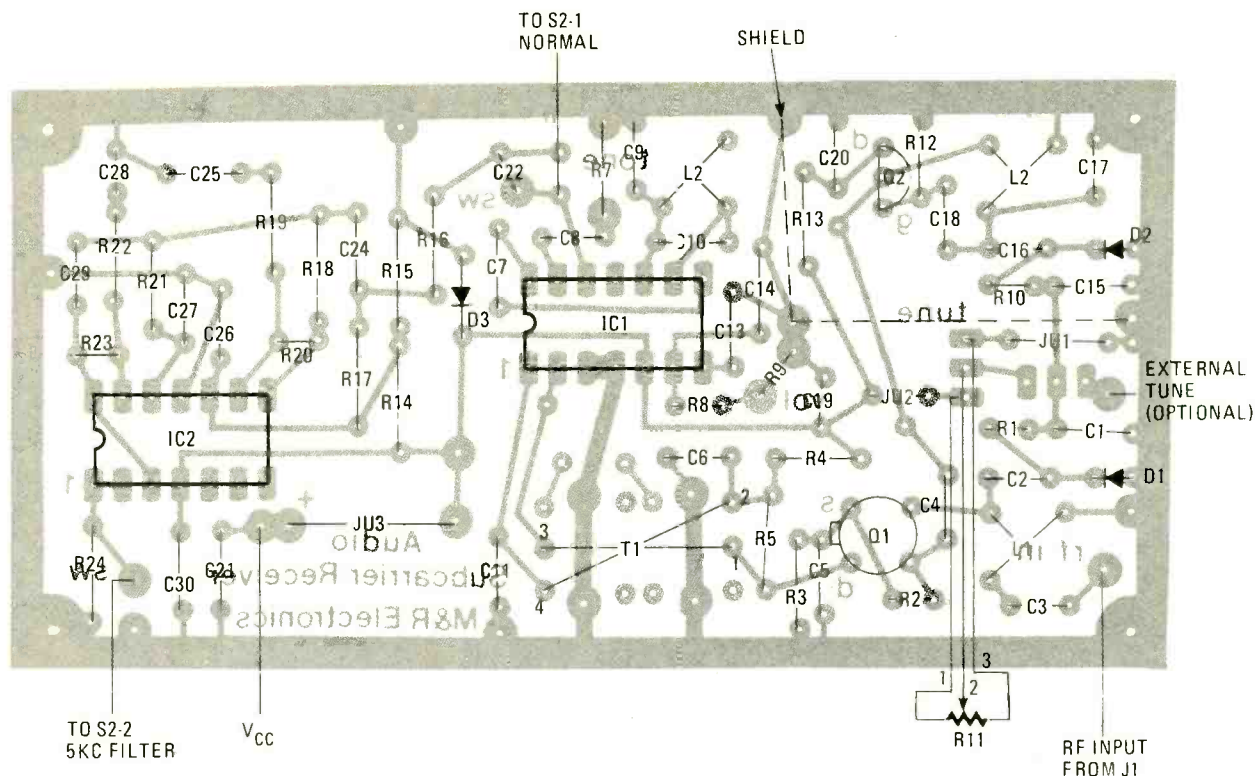

FIG. 3—PARTS LAYOUT FOR THE PRINTED-CIRCUIT BOARD is straightforward. Be sure to hard solder the copper shield to ground the points it passes over. Parts S2, C23 and R11 do not mount on the printed-circuit board.

PARTS LIST

RESISTORS

All resistors 1/4 watt, 5% unless otherwise noted

- R1, R2, R10, R12, R16-R18, R21—100,000 ohms
- R3—560 ohms
- R4—100 ohms
- R5—2700 ohms
- R6—1000 ohms
- R7, R8—2200 ohms
- R9—5000 ohms potentiometer or 2700 ohms (fixed), see text
- R11—10,000 ohms, 10-turn potentiometer
- R13—150 ohms
- R14, R15—200,000 ohms
- R19, R22—390,000 ohms
- R20—56,000 ohms
- R23—470,000 ohms
- R24—6800 ohms

CAPACITORS

- C1, C5-C7, C11, C12, C14, C15, C20, C21, C30—.1 μ F disc
- C2, C16—.0047 μ F disc
- C3, C4—.001 μ F disc
- C8—.22 μ F, 35-volt tantalum
- C9—12 pF silver mica, 5%
- C10—47 pF silver mica 5%
- C13—.01 μ F disc
- C17—100 pF silver mica, 5%
- C18—22 pF silver mica, 5%
- C19—10 μ F, 25-volt electrolytic
- C22—1 μ F, 35-volt tantalum
- C23—4.7 μ F, 25-volt electrolytic
- C24, C26, C27, C29—680 pF silver mica, 5%
- C25, C28—.47 μ F, 35-volt tantalum

C31—1000 pF feed-through

SEMICONDUCTORS

- D1, D2—100 pF TR = 3.0 varactor Motorola MV840, MV2115 or R2505, see text
- D3—1N4007
- IC1—CA3065, SK3072, ECG 712 or MC1358, combination IF amplifier-Limiter, FM detector, electronic attenuator and audio op-amp chip
- IC2—LM324AN low power quad op-amp chip
- Q1—40673
- Q2—2N5486 or MPF107

INDUCTORS

- Note: refer to Fig. 1 for coil form terminal locations
- L1—28½ turns on .225-in. dia., tap 3 turns from bottom, #32 wire (5.75 μ H), use J.W. Miller 25A014-3 coil form or equiv., see text
 - L2—28½ turns on .225-in. dia., no tap, #32 wire (4.5 μ H), use J.W. Miller 25A014-3 coil form or equiv., see text
 - L3—8½ turns on .225-in. dia., tap 1.3 turns from top, #28 wire (.46 μ H), use J.W. Miller 25A014-3 coil form or equiv., see text
 - T1—10.7 MHz IF transformer, J.W. Miller 8851A

MISCELLANEOUS

- JU1-JU4—Solid wire jumpers
 - J1—BNC male connector
 - J2—RCA phono jack
 - S1—SPDT slide switch, if used, otherwise use jumper JU-4, see text
 - S2—SPDT toggle switch
- Cabinet, solder, cable, hardware, etc.

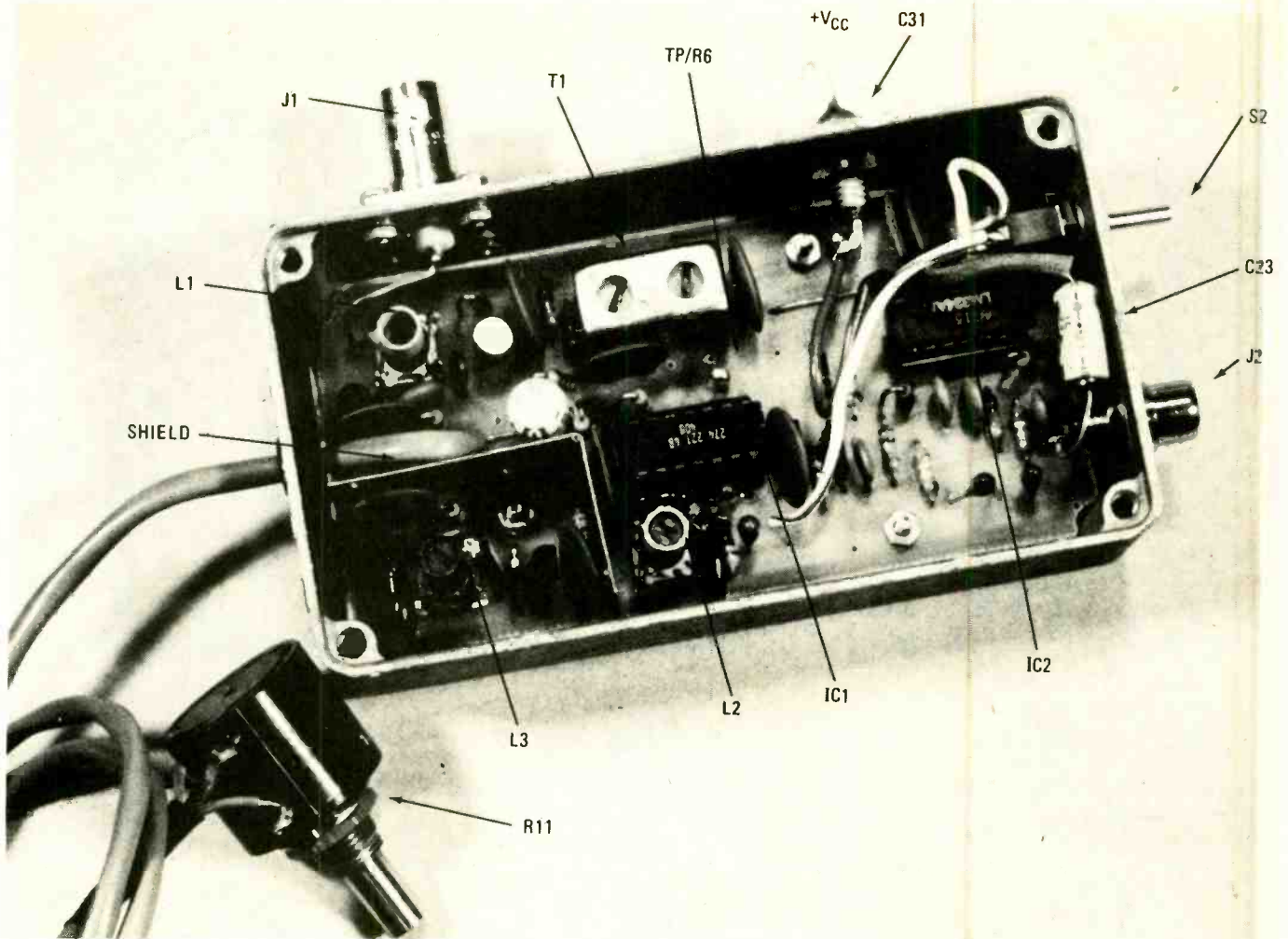

HERE'S THE AUDIO SUBCARRIER RECEIVER completed and ready for installing into a satellite-receiver installation. If a metal box is used, be sure to use standoffs to clear printed-circuit board foil side from metal case.

200 kHz. Take note of R5. There is a considerable amount of conversion gain in the 40673 mixer, Q1. If anything close to the proper bandwidth is to be maintained, the input to IC1 (CA3065) must be kept down to a few mV. Resistor R5 is a quick way to lose about 20 dB of signal. You might have an older commercial satellite receiver that doesn't have direct access to the demodulator. In that case, R5 would be left out and the input tapped from the video baseband output. The extra gain would then be needed to make up for signal loss in the video low pass and CCIR de-emphasis circuitry.

To be sure that your version of the Audio Subcarrier Receiver works the first time out, copy the printed-circuit layout (foil side up) in Fig. 2 exactly without modification. If you're a hot-shot builder in the 10.7 MHz range, then lay out the board your way, using standard design practices. Fig. 3 illustrates parts location on the component side (foil down) of the printed-circuit board.

Set it up to go

The best way to tune-up the Audio Subcarrier Receiver is with a sweep-alignment generator and scope. If you don't own that type of test equipment, you will need at least a signal generator or GDO, and a voltmeter with an RF probe. If you use the latter equipment,

leave fixed resistor R5 out until alignment is completed.

First, set your signal source for 10.7 MHz, connect the RF probe to test point TP at the end of R6, and peak both cores in the IF transformer. Reset your signal source to 6.85 MHz, and the 10-turn potentiometer, R11, five turns from either end. Now adjust L3 for a signal, then peak L1. That takes care of the LO and input tracking. Next, plug the Audio Subcarrier Receiver into the demodulator or baseband output of your satellite receiver, and turn R11 slightly counterclockwise to peak a 6.8-MHz subcarrier. Disconnect the RF probe from test point TP, and adjust L2 for the best sounding audio. That completes the receiver's tune-up.

Shielding and mounting are left up to the builder. The circuit board could be mounted inside your satellite receiver, or inside an enclosure and operated externally. The photograph shows just one example of mounting in a CU-124 Bud Econobox.

Should you want to use a remote volume control, a potentiometer might be used for R9, instead of a PCB-mounted fixed value transistor. Also, the true audiophile might want to experiment with the values of R7, C8, and C13. Those components determine the audio de-emphasis.

SP

You're in the gunner's seat and a boggy is headed your way—Zap 'em silently with the....

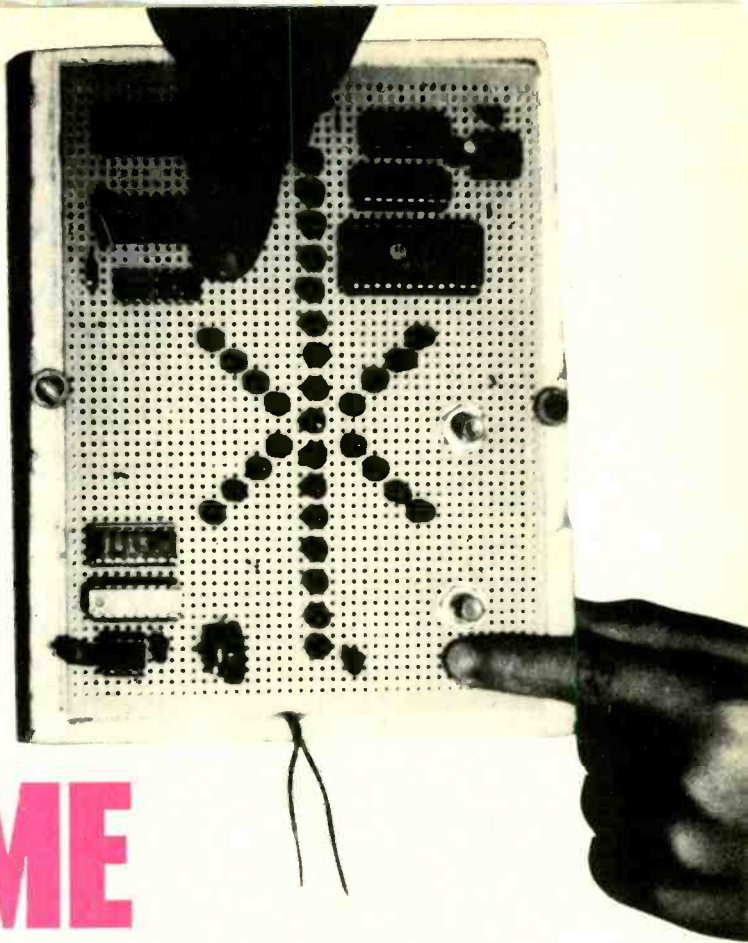

AMAZING LASER GAME

BOB MOSTAFAPOUR

DIGITAL GAMES ARE EVERYWHERE NOW. ARCADES across the country are full of them, and hand-held versions of these games are selling like hot cakes. Here is a chance for anyone with a little experience in circuit building to assemble the Amazing Laser Game.

The game is based on how accurately you can shoot at and hit a moving target. You have a converging "laser" which comes to a center from four points. In the middle of the board are 16 LED's in a series. Those LED's flash back and forth regardless of what you do (although you can vary the speed). An "X" of 16

LED's (which converge on the middle LED of the moving series) is your "radar" and means of attack. When you fire, and your laser converges on the moving LED exactly, your score is increased by one.

That is not as easy as it seems; it will be a challenge for the players of the game to hit the moving target because timing must be exact. You must calculate when to fire your laser to intercept the moving light just in time. If that still isn't enough, for "pros," variable speeds on both the laser firing, and moving target are provided. That will achieve different skill levels, for different players.

The Amazing Laser Game circuit is easy to construct and test, because it is split up into three main sections, each of which can be tested independently. The first portion is the target generator. That is the most difficult section, you should build this part first. Next is the laser shooting generator. That section is easier, and should be done second. Last, but not least, is the all-vital scoring circuit to see how well — or in some cases, how badly — you did. For advanced players there is an option to put more digits in the score display. See Fig. 1 for the block diagram.

Moving target generator

Circuit operation starts with the pulsating output of the 555 timer chip, IC1. See Fig. 2. That output is made

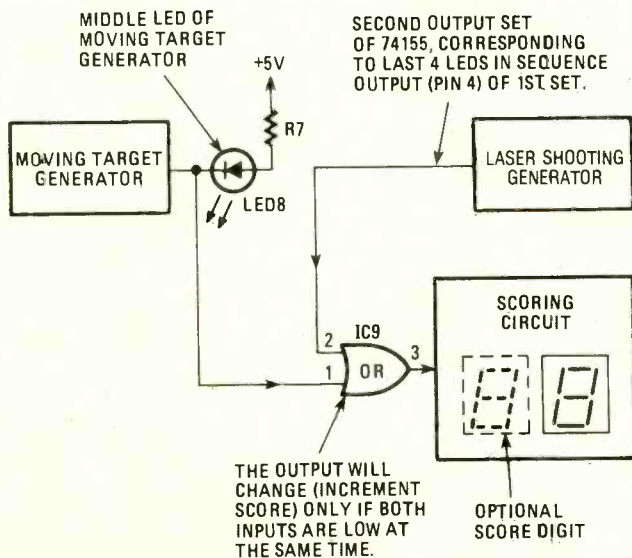

FIG. 1. FUNCTIONAL BLOCK DIAGRAM for the Amazing Laser Game serves to inform readers on the basic circuit sections and points out primary assembly sequence—see text.

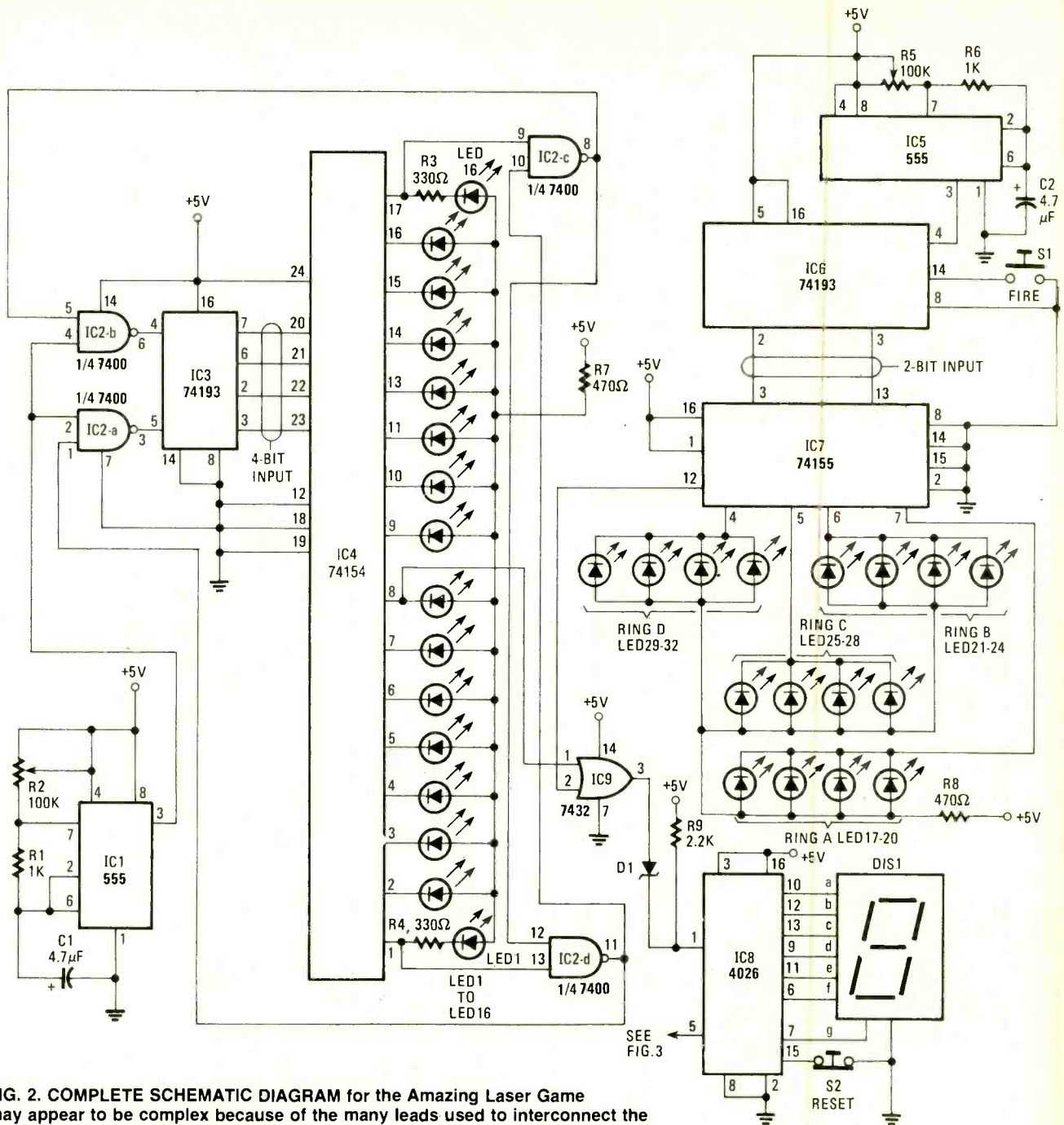

FIG. 2. COMPLETE SCHEMATIC DIAGRAM for the Amazing Laser Game may appear to be complex because of the many leads used to interconnect the 32 light emitting diodes. Lay some strips of paper over the area used by the LED's and notice how simple the remaining control circuits now appear to be.

variable by setting of R2 for different skill levels. Four NAND gates control the 74193 package in IC2. The 74193 chip, IC3, is an up/down counter, with two inputs (one up, one down). While it is counting up, the down input must be high, and vice versa. That is accomplished by the four NAND gates in this section. The two NAND gates, IC2-c and IC2-d, closest to the 74154, IC4, tell the first two NAND gates, IC2-a and IC2-b, when to switch the 74193 to count up, or down. NAND gates IC2-c and IC2-d are hooked up to the ends of the string of 16 LED's. Thus, when the moving sequence of LED illuminated lights reaches either end of the string, the NAND gates will detect that, and reverse the 74193 action to count backwards so that the light will start moving in the opposite direction, and so on. The 74193, IC3, is a 4-bit binary counter, which

cannot be substituted by a BCD counter such as the 74192. Although they are practically twins, the 74193 counts from 0-F (hex) and the '192 only from 0-9.

The 74193 feeds IC4, which is the popular 74154 4-to 16-line decoder de-multiplexer. Enable and data inputs (pin 19 and 18, respectively) on IC4 are brought low so that the selected output will go low. The two resistors, R3 and R4, on the output lines are there so that the NAND inputs will have enough signal to detect a logic change. The last resistor, R7, is for current limiting for the LED array.

The 74154's outputs are selected from a 4-bit input provided by the 74193. For every combination of 1's and 0's the 74193 puts out, the 74154 has a unique output which goes low. That lights one of the 16 LED's connected to the output pins of IC4.

FIG. 3. TO TALLY HIGHER SCORES on your Amazing Laser Game you may want to add additional LED display indicators to count out units, tens and hundreds—if you can play the game that long.

Laser shooting generator

This circuit section, just as the previous one, starts out with a variable clock, which is comprised of a 555 timer, IC5, and several discrete components. The clock timing is made variable by R5. The 555 feeds another 74193 4-bit, up/down counter, IC6. You will see that this 74193 is forever in the up mode, because the down input (pin 4) is fixed high. As with all TTL integrated circuits, a free-floating input is in the high state. That is the case with the clear input of the 74193 in conjunction with normally open FIRE switch S1. The 74193 counts only when its clear input is low. When you press and keep S1 down, you have “fired.” The low state enables the 74193 to start counting. That starts the “laser” sequence.

The next major part of the laser shooting generator is IC7, the 74155, a dual 2-to-4 decoder/de-multiplexer. The 74155 (IC7) is in effect a small cousin of the 74154 (IC8). The 74154 is a 4 bit-16 output device, the 74155 is a 2 bit-4 output device, with one added feature—a dual output. That means that for the 2-bit binary input, the 74155 drives 2 sets of outputs. That is an important part of this circuit.

Only one of the outputs from the second set of the 74155 outputs is used (pin 12). That output goes to the OR gate, IC9. The reasoning behind this is that four LED's are already on each of the outputs of the first set, and if another current drainer, is connected—the output will overload. That is where the dual outputs come in handy; they eliminate loading or brightness problems on the chip and LED's.

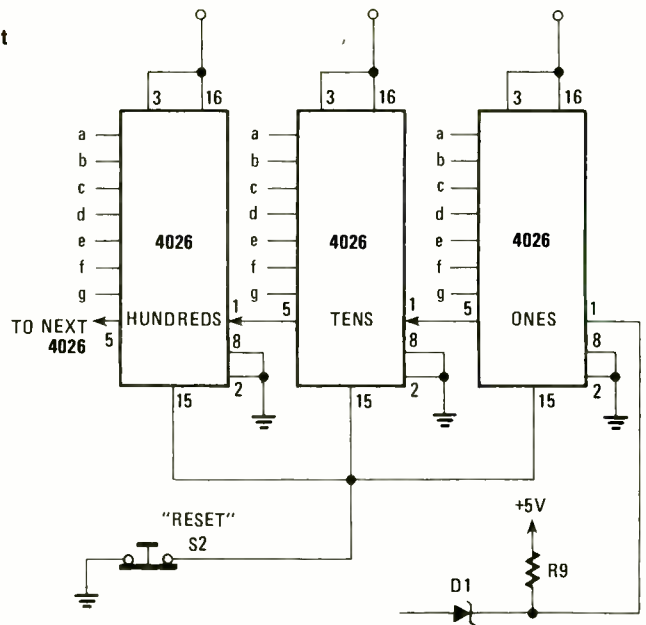

The 74155 (IC7) accepts half of the 74193 (IC6) binary outputs since it is only a 2-bit device, and sequentially flashes them to provide the shooting simulation. When placing the 16 LED's for that, make sure that they converge on the middle LED of the 74154's 16 LED's as in Fig. 4.

Score Circuit

The scoring circuit section uses a CMOS chip. It is the 4026 decade counter/divider (IC8) with a 7-segment output. It is fed by the 7432 OR gate (IC9)

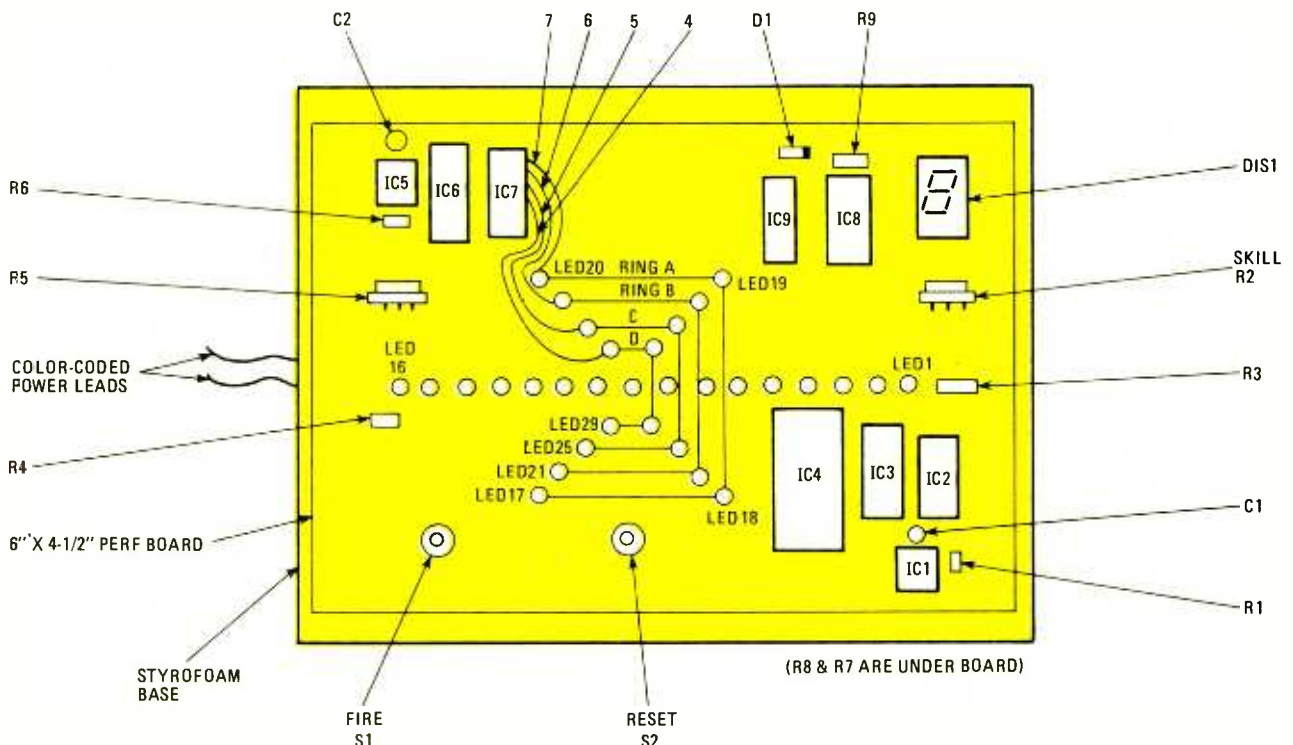

FIG. 4. THE AUTHOR DID NOT GENERATE a PC board for this project. He preferred a perf-board, or you may want to go to a surplus mother board—up to you. Style and neatness counts because you want the game to look attractive to the players.

which is debounced and brought to CMOS levels by D1 and R9. The 4026 drives a 7-segment, common-cathode .3-in. LED display, DIS1. For every hit you get, your score is incremented by one. A normally-closed reset switch, S2, is provided so that random numbers generate on the display (when power is just turned on) can be eliminated, or for new games to be started.

A method of increasing the number of LED displays for larger numerals in scoring is provided (see Fig. 3). All you have to do is connect pin 5 of the original 4026 (IC8) to the clock input of the next added 4026 (pin 1), and so on. The 4026 has internal current limiting for its outputs, so no resistors are necessary. Use CMOS precautions when handling this device.

Build it on perfboard

Take the 6 × 4½ in. piece of integrated-circuit perfboard (hole spacing is 0.1 inch) and insert the components as shown in Fig. 4. Do not insert the IC's just yet. Start with the moving target generator. You can use point-to-point soldering (beware of shorts in the sockets) or wire wrap. Once you have completed the section, power it up (insert the IC's of this section before you power up). Either the displayed light will move back and forth (that would indicate a successful circuit), or only one LED lights, and stays in one place. Several things could be wrong. Turn R2 and see if it starts moving. If it still does not, check pin 3 of IC1 (555) and see if it is pulsing. If it is, fine; if not, your problem is with the 555. Check the circuitry around the IC1. If the 555 is pulsing, fine; check IC3 (74193). Make sure the clear input is connected to ground (pin 14), that pin *must* be low. Do not omit R3 and R4 because those are vital to the circuit's back-and-forth operation.

PARTS LIST

RESISTORS

½ watt, 10%, unless otherwise noted

R1, R6—1000 ohms
R2, R5—100,000 ohms trimmer potentiometer, PC-mount
R3, R4—330 ohms
R7, R8—470 ohms
R9—2200 ohms

SEMICONDUCTORS

DIS1—1 Common-cathode 0.3-inch 7-segment LED numerical display
IC1-IC5—555 timer
IC2—7400 quad 2-input NAND gate
IC3, IC6—74193 synchronous up/down counter with down/up mode control
IC4—74154 1-of-16 data distributor
IC7—74155 dual 1-of-4 data distributor
IC8—4026 CMOS decade counter with 7-segment decoded output
IC9—7432 quad 2-input OR gate
LED1 to LED32—Jumbo LED's

MISCELLANEOUS

C1, C2—4.7 μF electrolytic, 10 volts
S1—Normally-open momentary pushbutton switch—SPST
S2—Normally-closed momentary pushbutton switch—SPST
Perfboard, sockets, Styrofoam, solder, wire, etc.

Now that the moving target generator is operating, go on to the laser shooting generator. The critical point on the circuit is IC7 (74155). Make sure the proper pins are connected to ground and +5V.

An important part of connecting the LED's to IC7 (74155) is that you must remember the sequence; which pin it starts from, and which it ends at. In the shooting section, when you press the FIRE switch S1 (and keep it down), the LED illumination sequence starts from pin 7, and ends at pin 4. Look at Fig. 4. As you can see the radar/shooting LED's form an X. The outer rings circles (the LED's at the ends of the X) correspond to pin 7's LED's as shown in the schematic diagram, since they begin the sequence. The inner ring LED's are connected to pin 4, because they are the last in the series. That is the way the LED's must be connected.

In diagnosing the circuit, insert appropriate IC's and connect the power. Press the FIRE switch S1 and hold it down. The "laser" display should start a sequence from the outermost LED's toward the inner ones. If that does not occur, make sure the proper pins on the 74155 are connected to ground and +5V. The rest of the circuit is identical to the pulsing and counting portion of the moving light section. Go back and repeat the same circuit checking procedure for the circuit.

The last, and easiest section is the scoring circuit. Now is the time to decide whether or not to expand the number of digit displays on the score board. Decide how many digits you want. If it is more than one, go back to the corresponding circuit description, check out Fig. 4, and read through the procedure for adding extra digits. Also be sure to make room on the board for the extra components. Connect the circuit including IC9. There is little here to botch up because it is straightforward. Do not exclude Zener diode D1 or R9 because they are there to debounce the signal and convert to CMOS logic levels. They are important for accurate scoring. If you have added more digits, be sure to line up the units, tens, etc., in their proper readout sequence.

Packaging

Now that the major circuitry is finished, you must provide a suitable enclosure. Take a piece of high-strength styrofoam, dig the inside out a bit, and put the wired side of the perfboard down on it with securing screws holding the board in place. Leave two long color-coded wires hanging out for the power supply connection. If you don't have a 5-volt power supply, you can use four D cells in series with a 7805 voltage regulator. Make sure all IC's are in their proper place and properly aligned.

Put it to the test—try it out

Connect power to the Amazing Laser Game. The moving display should be working. Adjust R2 until you get your desired speed. If the score has some value other than 0, reset the display (via RESET switch S2). Now the fun begins: Try to calculate *when* the moving target will reach the center. Press and hold down "FIRE" to shoot the target. If you got it, the score will increment by one. Don't be disappointed if you miss the first few times. Adjust R5 for faster, or slower shooting. It becomes more challenging when you slow down your shooting. Have fun! **SP**

If you like to make things work...and then find out why they work—

you could be getting paid for doing something you really enjoy!

Learn electronics...right on up to an Associate Degree...in your own home without giving up your present job or income.

People who really like their work get ahead faster. And, when your natural abilities match the job requirements, you have an extra advantage. When you use practical training to sharpen your skills, your odds are better for keeping your job even if others are losing theirs. So, if you find satisfaction and interest in making things work, a career in electronics may be for you.

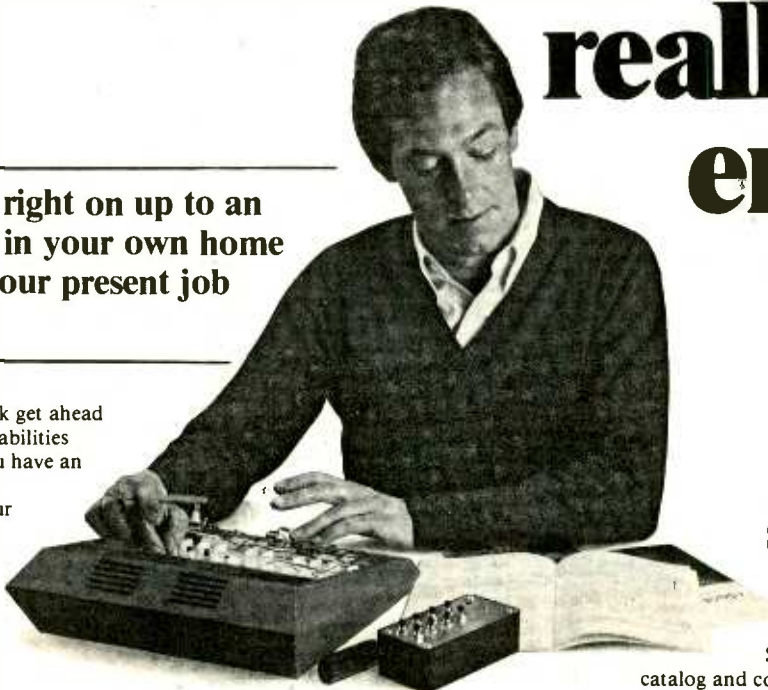

WHY ELECTRONICS IN THE 80's

Opportunity.

The field of electronics simply offers more career opportunities — and more job security — than most other fields today. Take digital technology, for example. Much of the new telecommunications, data processing, and production equipment depends upon sophisticated microprocessors to receive, sort, and send digital signals in microseconds. Two of CIE's newest home study courses combine digital electronics theory with actual experience on digital equipment. Successful completion of either one of those courses is creditable toward CIE's Associate Degree program. That's right...you can earn an Associate Degree without attending a single class session.

MAKING THINGS WORK

Many of CIE's Career Courses stress "hands-on" training. We believe textbook knowledge is important — but it's just as important to know how to apply your book learning in practical situations. From basic circuitry in CIE's Personal Training Laboratory in several Career Courses, through the Microprocessor Training Laboratory in the Associate Degree program, CIE helps channel your desire to "make things work" into skills you can sell.

IN A CLASS BY YOURSELF

One of the great benefits of home study is the independence it gives you. You study where and when you want to. You move as fast as you can handle it. There's no classroom to go to because with CIE, the classroom comes to you! But, you're never alone. When you request help, the CIE electronics expert best qualified will personally respond in writing.

SET YOUR OWN GOALS

CIE's wide selection of courses gives you many options. You start with a Career Course that suits your talents. Then, since more than half of CIE's courses include a series of optional lessons to prepare you to pass the government-administered FCC License exam, you can get an FCC License...a requirement for *some* electronics jobs and a credential for *all* electronics jobs. You may then go on and earn an Associate in Applied Science Degree in Electronics Engineering Technology. It's all up to you!

START MAKING THINGS WORK FOR YOU

Send today for the CIE school catalog and complete package of career information. It's all FREE, and it will help you decide where you want to start and how far you want to go. For your convenience, we'll try to have a school representative contact you to review the various educational programs and assist in course selection. Just mail the postage-paid card or write, mentioning the name and date of this magazine. We want to help you make things work, so send for your FREE school catalog today!

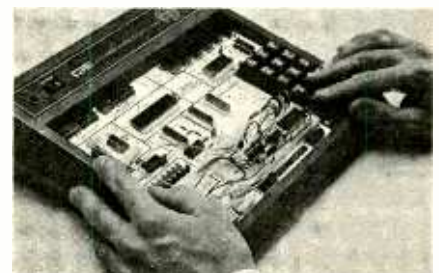

CIE's Microprocessor Training Laboratory, an integral part of the Associate Degree program, lets the advanced student apply digital technology in many of the same ways electronics professionals do.

CIE **Cleveland Institute of Electronics, Inc.**

1776 East 17th Street, Cleveland, Ohio 44114

Accredited Member National Home Study Council

Gain full control of your model train's motion down the track with this...

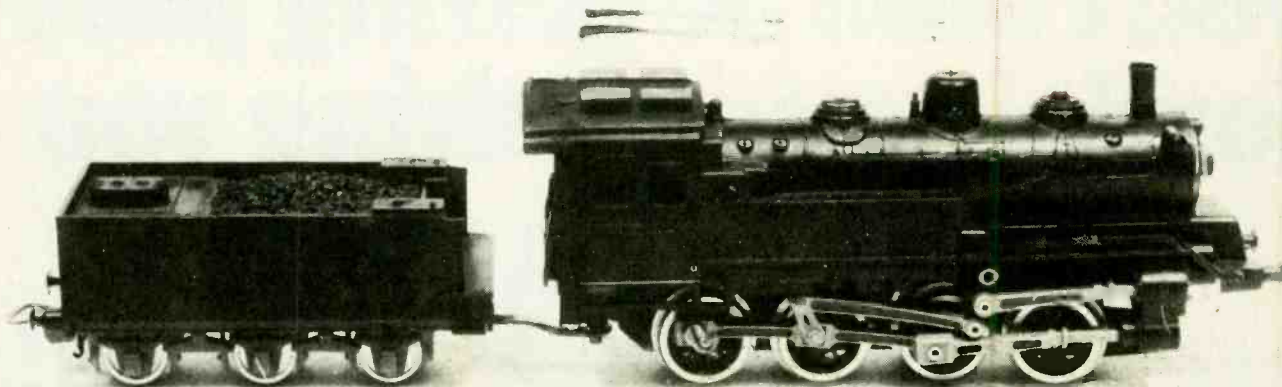

BIPOLAR TRAIN CONTROLLER

JOHN CLARKE

CHRISTMAS HAS PAST AND AGAIN, THERE ARE QUITE A NUMBER of new model-train sets in action. Most will suffer from one major disadvantage—a low-cost rheostat control unit that provides barely adequate performance. Worse still, many of the simpler sets will be powered by batteries alone with just a simple reversing switch.

A rheostat controller consists of a variable resistor in series with the supply voltage. That provides continuous control of the armature current in the locomotive, and hence, control of motor torque. The main advantage of this scheme is that it is the easiest and cheapest method of control, which is precisely why it is used for low- to medium-cost train sets. Admittedly, a rheostat controller provides acceptable control at high running speeds, because the circuit resistance, consisting of the armature resistance and the control resistance, is quite small. In that situation, the back (counter) EMF of the motor is the major factor determining armature current, and the speed of the train will be substantially independent of load variations.

Problems occur at low speed settings, however. Here, the large amount of series resistance in the supply circuit makes the rheostat controller behave as a “constant current” source, negating the beneficial effect of reduced-back EMF. Normally, when a motor slows down, the back EMF generated by the motor falls and armature current rises, increasing the torque; conversely, when a motor speeds up, the back

EMF rises and armature current falls, reducing the torque.

With the rheostat controller, however, the armature current (and hence the torque) is limited at low-speed settings by the large amount of resistance in circuit. What's more, because the supply has a constant-current characteristic, the ability of the motor to vary its torque according to back EMF is quite limited, and the model locomotive becomes quite sensitive to load variations. The locomotive will slow down

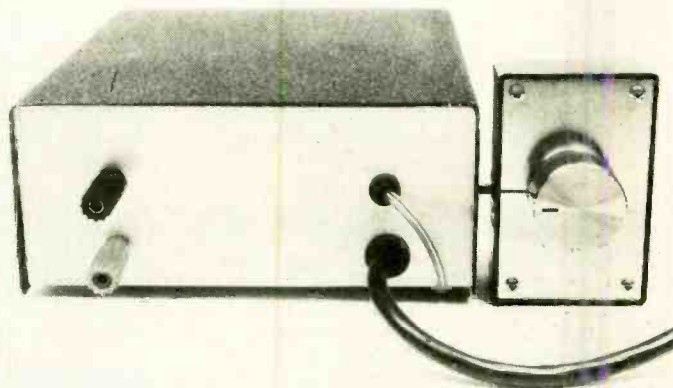

HERE'S WHAT THE BIPOLAR TRAIN CONTROLLER looks like when the control potentiometer is located externally from the main cabinet. Allow for sufficient rainbow-cable length for hand-held operation by children, who tend to be a bit over active.

*Original project appeared in *Electronics Australia*, November, 1980 Edition, and reappears here by permission.

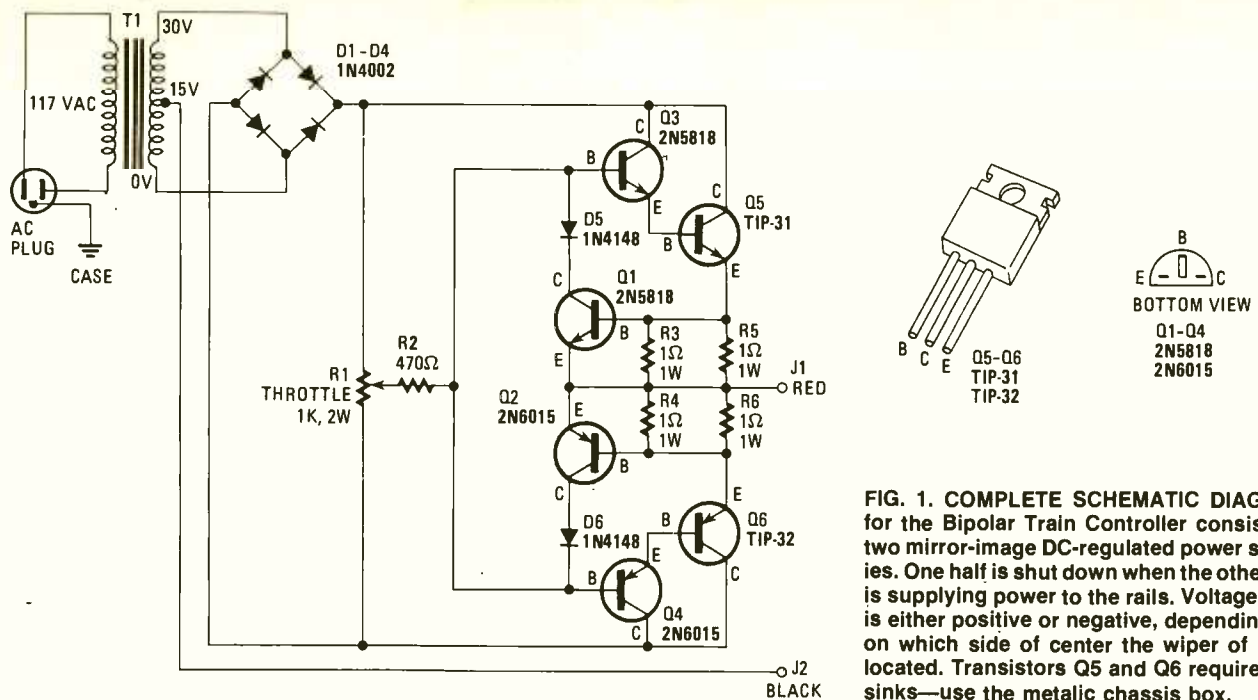

FIG. 1. COMPLETE SCHEMATIC DIAGRAM for the Bipolar Train Controller consists of two mirror-image DC-regulated power supplies. One half is shut down when the other half is supplying power to the rails. Voltage at J1 is either positive or negative, depending upon which side of center the wiper of R1 is located. Transistors Q5 and Q6 require heat sinks—use the metallic chassis box.

noticeably on gradients and curves, and in some instances may even stall.

In addition, the supply voltage to the model train is poorly regulated with a rheostat controller. Whenever additional current is drawn to cope with an increased load, the voltage drop across the resistance increases and the track voltage falls. Again, that has an adverse affect on low-speed performance and the locomotive's ability to cope with load variations.

Another objectionable feature of the simple rheostat controller is its poor starting characteristics. It's almost impossible to start a model train without having it take off like a rocket, no matter how skillfully the control knob is handled. The reason for that is that a very much larger armature current (torque) is needed to start the motor than to keep it running.

So, in order to provide enough current to start the motor, the control knob must be advanced well up the scale. The result is inevitable: Once the motor does start it quickly gathers speed and the train "blasts off."

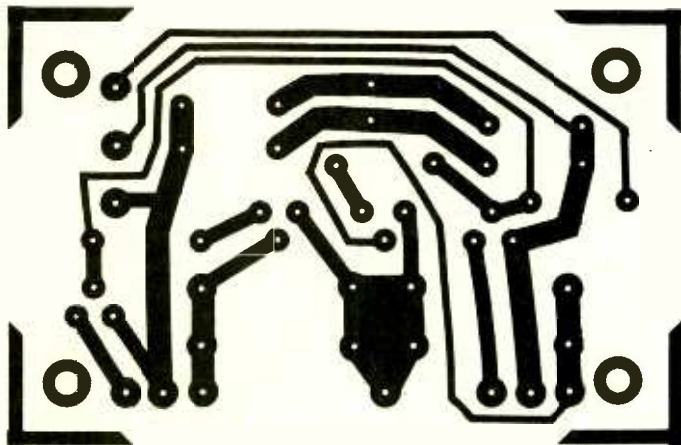

FIG. 2. PRINTED-CIRCUIT FOIL DIAGRAM can either be photocopied from this page or traced directly onto a piece of copper-clad board $3\frac{3}{16} \times 2\frac{1}{8}$ -in. minimum dimensions. Or, place Xerox copy of drawing over a perf-board and insert flea clips at terminal points. Large round holes in corners of board are for screws.

The winning way

This is where the low-cost Bipolar Train Controller* described here scores. Basically, it is a variable power supply with a low-output impedance. At any given setting, it behaves as a constant-voltage source, allowing the current to vary according to the motor's requirements and as dictated by the back EMF. As a result, low-speed torque is considerably improved, leading in turn to much improved starting and low-speed running characteristics.

Other features of the Bipolar Train Controller include overload protection and bi-directional control using a single control potentiometer. The unit can supply positive and negative output voltages variable from 0 volts to 20 volts peak (or around 13.5 volts average), and it is easy to operate, with the control potentiometer mounted in a small hand-held plastic case. An approximate size may be $3\frac{1}{4} \times 4\frac{1}{2} \times 2$ -inches.

The circuit

The circuit is based on complementary Darlington transistor-pair output stages, to which we have added protection circuitry. See Fig. 1. Transistors Q3 and Q5 make up one Darlington transistor pair, while Q4 and Q6 form the other pair. The output voltage is determined by the setting of the 1000-ohm, 2-watt potentiometer, R1, which forms the speed and direction control. When R1 is centered, there is no output voltage, and the locomotive remains stationary. When it is rotated clockwise, the output voltage increases, driving the train in one direction, while anti-clockwise rotation produces the movement in the opposite direction.

Operation of the circuit in Fig. 1 is as follows: The voltage at the wiper of potentiometer R1 is passed to the bases of the Darlington transistor pairs, Q3 and Q4, via 470-ohm resistor, R2. Depending upon the setting of the potentiometer R1, that will forward-bias one Darlington pair, and reverse-bias the other.

The forward-biased stage operates as an emitter follower and supplies current to the load via two parallel 1-ohm emitter resistors, R3/R5 or R4/R6. The emitter-follower action applies local negative feedback, and tends to keep the

PARTS LIST

RESISTORS

R1—1000-ohms, wire-wound, 2-watt potentiometer
 R2—470-ohms, 1/2-watt
 R3-R6—1-ohm, 1-watt composition-type

SEMICONDUCTORS

D1-D4—1N4002; 200-PIV, 1-A diode
 D5, D6—1N4148; 75-PIV, .01-A diode
 Q1, Q3—2N5818, BC547, or equivalent NPN transistor
 Q2, Q4—2N6015, BC557, or equivalent PNP transistor
 Q5—TIP-31 NPN transistor
 Q6—TIP-32 PNP transistor

ADDITIONAL PARTS AND MATERIALS

J1, J2—Banana jack/binding post; one red, one black
 T1—Transformer: 117-VAC primary winding; 30-VCT, 3-A secondary winding
 Metal case—7 × 3 × 6-in., PC board or perfboard materials, cable clamp, AC line terminal block, #18 3-wire rainbow cable, line cord with case ground lead, 1/4-in. spacers, optional plastic case for control—3 1/4 × 4 1/4 × 2-in., hardware, solder, wire, etc.

voltage applied to the train constant, irrespective of the load current. So the locomotive tends to have improved pulling power, even at low speeds. Overload protection is provided by transistors Q1 and Q2 which reduce the drive to the output stages under conditions of excessive loading. That will happen when there is a short across the tracks. In normal operation, the voltage drop across the two parallel 1-ohm resistors, R3/R5 or R4/R6, in the relevant (conducting) stage is less than 0.5 volt, so the protection transistor, Q1 or Q2, does not operate.

In the overload situation, however, the voltage drop across the 1-ohm resistors increases, thus turning on the protection transistor and reducing the drive to the output stage. For example, if R1 biased Q3-Q5 to conduct providing drive power to J1 and J2, the voltage drop across R3-R5 would increase excessively when a short is across the track (J1, J2). Thus, Q1 would conduct heavily reducing the positive bias on Q3 and prevent overheating in a possible current run-away situation. The greater the current flow through the paired 1-ohm emitter resistors (R3/R5 and R4/R6 of Fig. 1), the more the protection transistor (Q1 or Q2) turns on to reduce the voltage drive to the output stage. That self-regulating feedback situation keeps the maximum load current to about 1 ampere.

The diodes, D5 and D6, connected in series with the protection transistors (R3/R5 and R4/R6) prevent them from bypassing the drive signal during normal operation. The 470-ohm resistor, R2, connected in series with the wiper of the potentiometer, limits the bias current to transistors Q3 and Q4 to a safe value.

Positive and negative supply rails for the circuit are derived from a 30-volt, center-tapped transformer, T1, feeding a bridge rectifier consisting of four diodes, D1-D4. The supply rails are left unfiltered, as ripple on the output is actually beneficial to the operation of the locomotive. Pulsed DC is more capable of breaking down contact resistance (static friction) than a smooth DC supply.

Construction

The Bipolar Train Controller was built into a metal case 7 × 3 × 6-inches approximately. Construction is straightforward, with most components mounted on a small printed-circuit board measuring 3 7/8 × 2 1/8-inches. See Fig. 2 for foil diagram.

Start construction by planning the layout and drilling the metal case. It is easier to mark out the mounting holes for the PC board before the components are soldered into place. Mount transformer T1, AC line terminal block and output terminals, J1 and J2, in position and then complete the AC line wiring. See photo. The line cord should be passed through a grommeted hole in the front of the chassis and anchored securely with a plastic clamp. Terminate the AC hot and neutral (black and white) leads to the terminal block and run the ground wire (green) to an adjacent solder lug. It is a good idea to leave sufficient slack in the ground lead so that it will be the last to break in the event of undue strain on the line cord.

Assembly of the PC board can be tackled next. If you choose not to make a PC board, a perfboard with flea clips will do just as well. Make sure that the transistors and diodes are correctly oriented, and use PC stakes (pins) to facilitate external wiring to the board. See Fig. 3. That done, the PC board can be mounted in the case using 3/8-in plastic support spacers, and the wiring completed. If you used a perfboard, be sure the flea clips do not touch the metal case.

Note that heavy-duty hook-up wire should be used for all

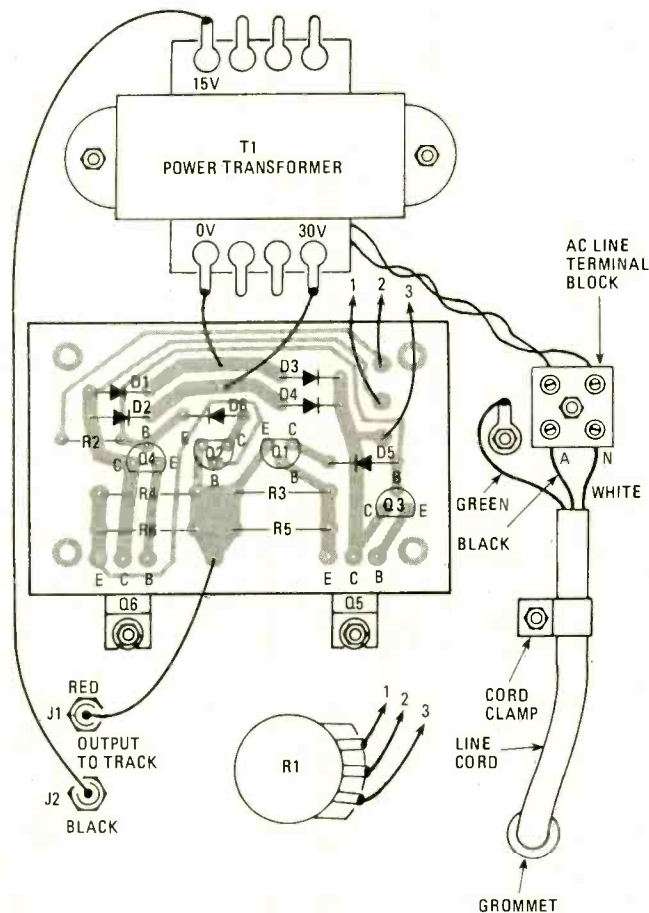
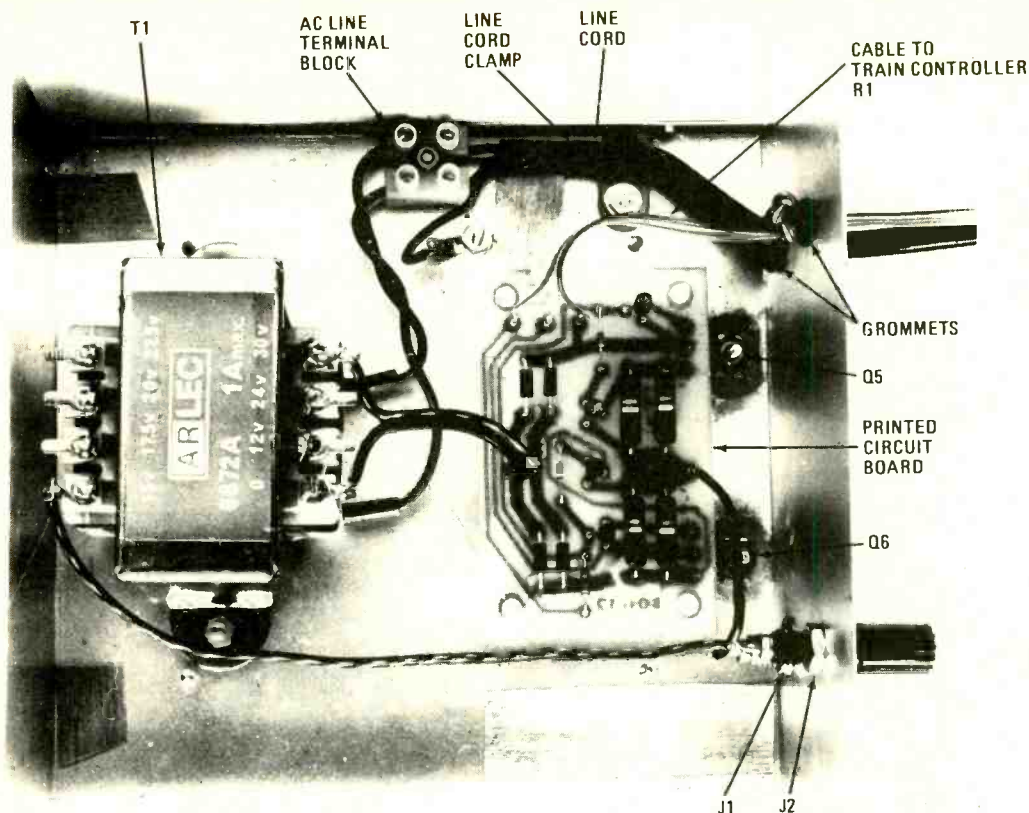

FIG. 3. COMPLETE HOOKUP DETAILS are illustrated here. Transistors Q5 and Q6 are connected from the foil side of the board and the leads are bent carefully so that the transistor heat-sink mating surface is parallel to the board and chassis. Those transistors must be electrically isolated from the chassis when mounted. See text.



HERE'S WHAT YOU GET should you follow the author's layout carefully when building the Bi-Polar Train Controller. The text suggests the addition of a fuse with fuse holder and an on/off switch. The latter may not be necessary should you install a master power switch for your model train set-up.

connections to the transformer and to the output terminals. No. 18 AWG is sufficient. A 3-wire length of rainbow cable will suffice for linking the hand-held train control unit to the PC board.

The T1P-31 and T1P-32 power transistors, Q5 and Q6, are bolted to the base of the chassis and their leads soldered to the underside of the PC board. It is necessary to insulate the metal heatsink tab on each transistor from the chassis using a mica washer and an insulating washer. A smear of heatsink compound on each mating surface is recommended to aid heat transfer. Check the electrical insulation with an ohmmeter after the securing hardware for each transistor has been tightened.

Some builders may prefer to dispense with the separate hand-held controller and mount the potentiometer on the lid of the power-supply case. It's up to you.

Once you have completed the controller, double-check all wiring, and then plug in the AC line cord. Use a voltmeter to make sure that the output voltage can be controlled by the

knob on R1, and that both positive and negative output voltages can be obtained. Note that the voltmeter will give the average value of the output voltage. If all is OK, connect up to a train, and give the unit a practical test. If you have a suitable ammeter, connect it directly across the output, and make sure that the maximum output current is about 1 A, in both directions.

Finally, it is quite normal for control potentiometer, R1 to become warm during operation. That is because the pot is connected directly across the supply rails and continuously dissipates around 0.9 watt. Do not substitute a carbon potentiometer for the 2-watt wire-wound type specified.

There is no need for a power on/off switch or fusing. However, those circuit parts are easy to add, and the metal case has ample space to house them. A fuse holder and SPST switch can be added along side the output jacks, J1 and J2. Electrically wire the fuse in the hot (white or silver) lead in the line cord. Use a 1/2-ampere fuse. The power switch is connected to the protected side of the fuse holder. **SP**

POWER your favorite locomotive by getting on track right now. The Bipolar Train Controller offers the hobbyist the opportunity for realism in train motion never before experienced. You may want to build two or more units to keep a busy schedule going.

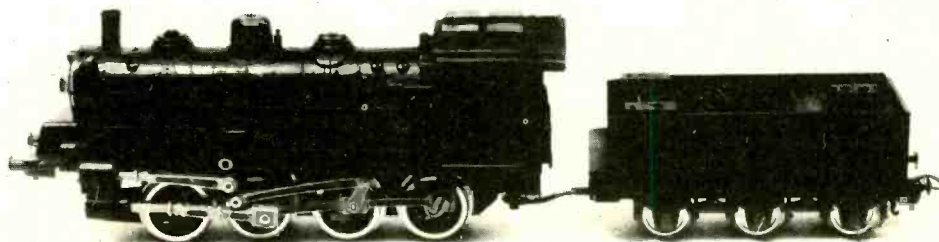

VOLTAGE CALIBRATOR



Economy-class test instrument vies for lab-standard accuracy with miniscule temperature drift and rock-stable output!

USING ONLY THREE IC'S, YOU CAN BUILD A PORTABLE LAB-quality 1-to-10 volt, 10-step voltage calibrator, with two additional preset or variable outputs and an accuracy up to 0.1%. To save bucks, you can build it out of junk box $\pm 5\%$ or $\pm 10\%$ parts, on a piece of perf board, for very little green stuff. Should you want to take the sure fire path to success, a kit of parts and a printed-circuit board are available.

Also, if desired, you can invest a few bucks to upgrade the voltage-reference calibrator for super stability over time and temperature, by adding a precision diode and/or a super IC chip. However, there are many relatively inexpensive configurations we'll be getting into, where some can be used as stand-alone references, or standard cells, with as little as ± 5 ppm of drift over temperature range.

The beauty of the circuit design lies in the fact that there are no expensive resistors or DAC's. Besides, the circuitry is more than adequate for most users who only own a $\pm 1\%$ tolerance DVM.

Taking a closer look

The circuit in Fig. 1 provides calibrated voltage outputs by chopping a 10-volt reference voltage, used as the V_{DD} supply

voltage for a CMOS oscillator, Johnson Counter and set-reset (RS) flip-flop, then integrating selected duty cycles back into an exact voltage. A 10-volt adjustable reference, made up of Op-Amp IC1-d, R1, R2, R3, C1, and Zener diode D1, acts as the V_{DD} supply for IC2 (quad 4001 NOR) and IC3 (4017 Johnson Counter).

IC2-c and IC2-d are configured as a 500-kHz astable oscillator, feeding the clock input of the counter, IC3-pin 14. The clock's frequency or duty cycle have no effect on the precise duty cycles established by IC3, whose outputs are decoded 0-to-9 sequence. So, we can see that the clock's frequency can arbitrarily be any value we choose, albeit the frequency value selected should be as high as feasible, as we'll see in a moment.

Switch S1 selects one of IC3's counter outputs, which is in turn fed to IC2-b, pin 6, where IC2-b and IC2-a are configured as a RS flip-flop, and the counter's 0 output (IC3, pin 3) feeds the other side of the RS at IC2-a, pin 1. Thus, the RS flip-flop is set by the counter's 0 output going active high and reset by one of the selected outputs of S1, going active high. Therefore, the output of the RS flip-flop will be a pulse train of approximately 500-kHz/10 or 50-kHz pulses, with a duty

D.E. PATRICK

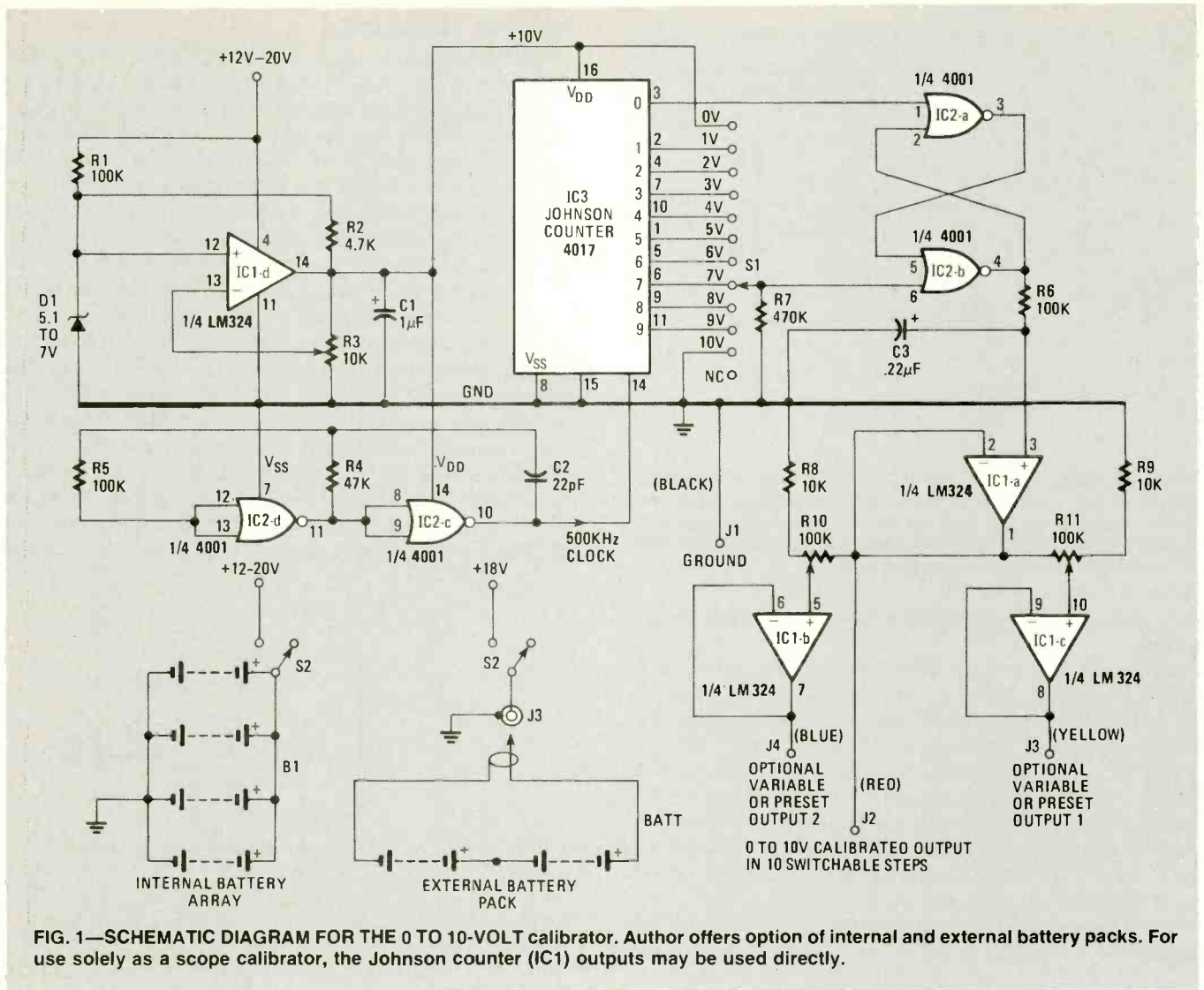

FIG. 1—SCHEMATIC DIAGRAM FOR THE 0 TO 10-VOLT calibrator. Author offers option of internal and external battery packs. For use solely as a scope calibrator, the Johnson counter (IC1) outputs may be used directly.

cycle varying from 0% (S1 set to the 0-volt position) to 100% (S1 set to the 10-volt position) in 10% steps.

The output of the RS flip-flop (IC2-a and IC2-b) feeds a low-pass filter, or integrator, composed of R6 and C3, with its output buffered by op-amp IC1-a. So the output of IC1-a will be a DC level selected by integrating signals, whose duty cycles are determined by S1's position, with a ripple component determined by filter R6/C3. With a good low-leakage capacitor for C3, like a tantalum or polycarbonate rated at .22 μF or thereabout, the ripple voltage will be around 0.5 mV or less, with a response time around 100 ms. Now, that

represents a ripple on the order of 5 parts per 10,000, with a 1-V output and around 5 parts per 100,000 with a 10-V output, which is usually insignificant. However, you can improve even on those numbers by increasing C3's value, adding a better low-pass filter, or increasing the clock frequency. But there are always trade-offs, where increasing C3 also increases response time. We could push things a little, however, by operating the two-gate oscillator (IC2-d and IC2-c) above 500 kHz. You could easily get up to 1 MHz, with the two-gate unit or use a three-gate oscillator and delays through the gates to get above 10 MHz. But, then you



POWER AS YOU LIKE IT is the option open to the experimenter. To keep the unit truly portable, either an internal battery supply is used, or, as shown at left, an external, plug-in battery supply powers the unit. For workbench use, an external regulated supply may be used. Note the two PRESET ADJ settings in the lower right corner of the unit. Here, the two preset outputs may be adjusted to desire levels.

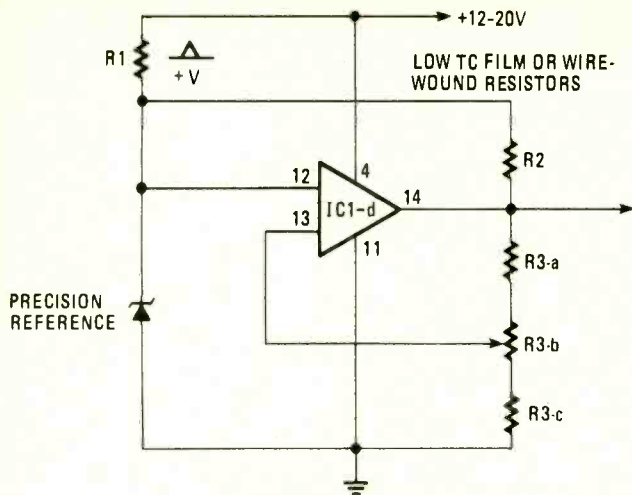
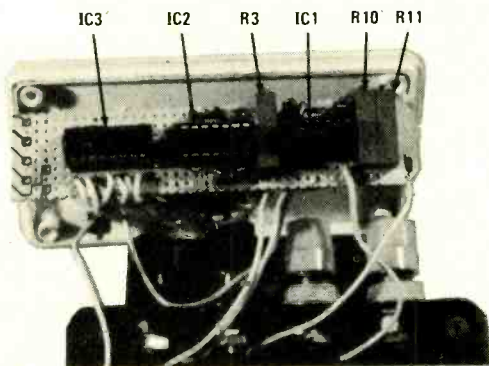

FIG. 2—A VARIATION OF THE BASIC VOLTAGE REFERENCE generator with precision components to limit voltage drive over time and temperature change. An alternate trimmer arrangement is given. Low TC film or wirewound resistors should be used with the precision reference diode—see text.

have to consider the operation of the 4017 (IC1) at higher speeds.

No matter how you decide to handle it, R3 in the 10-V reference circuit is used to adjust IC1-a's output to 1 volt with S1 in the 1-volt position. Op-Amps IC1-b and IC1-c may be superfluous to your application, if you only need 1 through 10-volt steps, but they can be used to provide either a variable voltage between steps, or used as presets. I opted for the latter case, where R3, R10, and R11 were all made 15-turn circuit board trimmers. But, again that was an arbitrary choice. Also, R8, R9, R10, and R11's resistance values may be changed to limit the preset voltages' ranges. That is, the R8 to R10 and R9 to R11 ratio is 10 to 1 or 100K to 10K, respectively; thus, the preset voltage output can be adjusted from 10% to 100% of the calibrated voltage output, determined by S1. Therefore, since S1 can select any voltage from 0% to 100% of full scale, if one of the presets was set to 10% of that, its output would effectively divide by 10. So, if S1 was set to 1 volt, the calibrated output would be 1 volt, while a preset output would be 0.1 volt, and when S1 was switched to 2 volt, the preset output would track it and have a 0.2-volt output, etc.



THE ELECTRONICS IS MOUNTED DIRECTLY TO the front cover of the plastic box used by the author. The bulk of the components and chips are mounted on some scrap perf board material in the original project. Now, a PC board is available to builders. An internal battery pack may cause problems when the cells begin to leak. Use the external battery pack to avoid any possible headaches.

Notes on construction

The low cost LM324 quad op-amp (IC1) used in Fig. 1 was selected on two criteria: First, the current output capabilities of the op-amp selected will determine usable drive, albeit, a transistor included in a op-amp's feedback loop could also have been used. LM324's will handle about 40 mA per quad section, which will give you about 30 mA of usable drive output. Second, the op-amp you use should be able to go to 0 volts or swing within a few millivolts of their negative rail, otherwise, you'll never get 0 volt when S1 is set to 0 volt.

The circuit in Fig. 1 was originally built into a Radio Shack plastic box, with banana jack (J1-J4) outputs. But, if you're going to use one of the presets to derive say 0.1 volt or less, you will be better off using a metal box, which will give you shielding from stray pickup. Use BNC output connectors. That way there is a noticeable decrease in stray pickup from 60-cycle and low-frequency stuff, covering up what you're after when using a 1 mV oscilloscope. So, go with the metal box. Also, you'll be better off using a low-impedance probe for this, not a 10-Meg input probe, which acts like a high impedance invitation to stray pickup at low voltages. If you wish,

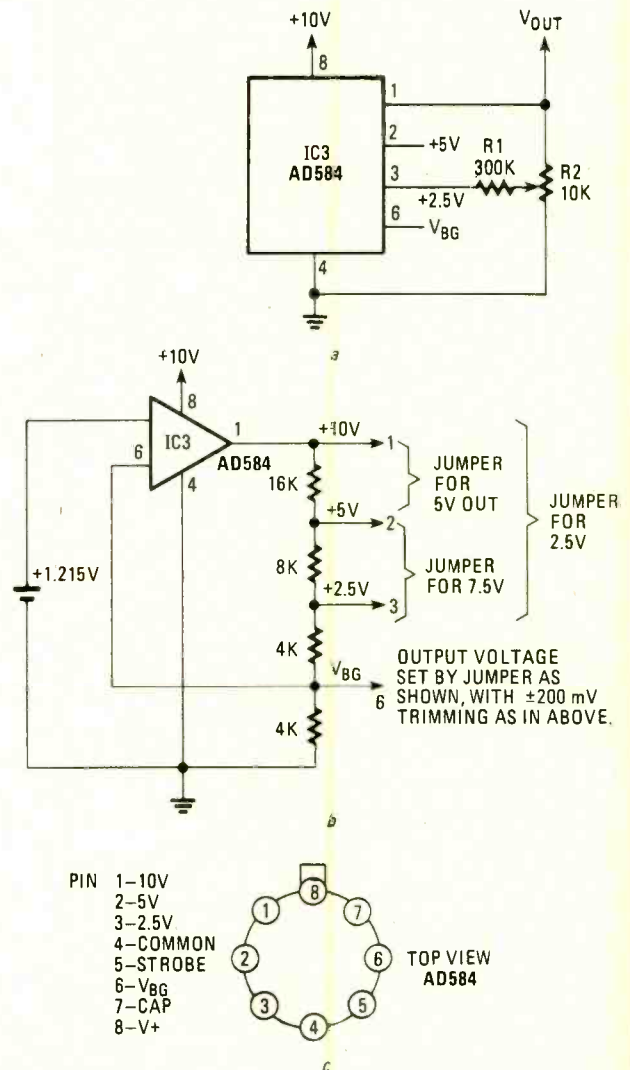

FIG. 3—USING THE AD584 FOR IC1 IN FIG. 1. Typical output trimming is shown in A. Equivalent circuit with variable output options are shown in B. The AD584 does not provide decade stepping as does the 4017 Johnson counter. The AD584 pin location guide is shown in C. For more information on the AD584 refer to the Analog Device's Data Acquisition Components and Data Subsystems book.

TABLE 1. AD581 and AD584 Tolerance Data

MODEL	AD581J	AD581K	AD581L	AD581S	AD581T	AD581U
OUTPUT VOLTAGE TOLERANCE (Error from 10.000V output)	± 30mV max	+ 10mV max	± 5mV max	+ 30mV max	± 10mV max	± 5mV max
OUTPUT VOLTAGE CHANGE Value T _{min} to T _{max}	± 13.5mV	+ 6.75mV	± 2.25mV	+ 30mV	± 15mV	± 10mV
MODEL	AD584JH	AD584KH	AD584LH	AD584SH	AD584TH	AD584UH
OUTPUT VOLTAGE TOLERANCE Outputs of						
10.000V	± 30mV	± 10mV	± 5mV	± 30mV	± 10mV	± 5mV
7.500V	± 22mV	± 8mV	± 4mV	± 22mV	± 8mV	± 4mV
5.000V	± 15mV	± 6mV	± 3mV	± 15mV	± 6mV	± 3mV
2.500V	± 7.5mV	± 3.5mV	± 2.5mV	± 7.5mV	± 3.5mV	± 2.5mV
OUTPUT VOLTAGE CHANGE Maximum Deviation from +25°C						
10.000, 7.500, 5.000V Outputs	30ppm/°C	15ppm/°C	5ppm/°C	30ppm/°C	15ppm/°C	10ppm/°C
2.500V Output	30ppm/°C	15ppm/°C	10ppm/°C	30ppm/°C	20ppm/°C	15ppm/°C

low-frequency stuff can be filtered or notched out. And, if you determine you've got too much ripple for a given application, the simplest solution is to add more capacitance at C3, where filter-response time isn't really important, anyway. You could either use a 12-20-volt DC internal battery supply, or an 18-volt DC supply. See Fig. 1 and photos.

Going further

Now, in many cases, accuracy drift over time and temperature is a more important specification than absolute accuracy. Or, to put it another way, while an instrument might be said to have an absolute accuracy of ±0.1, ±0.01%, or ±0.0001%, those specs could be made meaningless by drift over time and temperature, beyond certain specified limits. However, you can improve drift in

Fig. 1 by using a precision diode or reference in place of the Zener and/or Zener/op-amp configuration, or for that matter build an even more accurate reference approximating a standard cell.

For example, the circuit in Fig. 2 is basically the same as the voltage reference in Fig. 1. But, consider subbing in a precision reference with a temperature coefficient (TC) in the range of ±50 ppm to ±3.5 ppm, using low TC film or wirewound resistors, and a precision op-amp or instrumentation amp. Now, depending on how much money you want to spend, you could build anything from a simple stabilized reference to a stand-alone single-voltage calibrator, to a stand-alone standard cell replacement, with some modifications.

Fig. 2 illustrates an alternate trimmer arrangement which substitutes three resistors for R3 in Fig. 1. Now you can "fine tune" R3-b to limit drift within a finite voltage range. However, precision references, like Analog Devices' programmable AD584 and AD581, using band-gap technology, can be quite inexpensive, while having extremely good specifications. The reference voltages produced by the band-gap method are more temperature-stable than the best of temperature-stabilized Zeners, where temperature coefficients below 5 ppm/°C can be achieved. This technique makes use of the constant potential that exists between adjacent electron energy levels in the integrated circuit's semiconductor material. See Fig. 3.

Now, consider the AD584J/K/L/S/T/U series of devices (see Table 1) with 10, 7.5, 5 and 2.5-volt programmable outputs. In the case of the L series, the maximum error of the

PARTS LIST

RESISTORS

- All fixed resistors are 5%, ¼ watt
- R1, R5, R6—100,000 ohms
- R2, R4—4700 ohms
- R3, R10, R11—10,000 ohms, 15-turn trimmer
- R7—470,000 ohms
- R8, R9—10,000 ohms

CAPACITORS

- C1—1 µF, 20 volts, tantalum
- C2—22 pF ceramic disc
- C3—.22 µF, 20 volts, tantalum

SEMICONDUCTORS

- D1—5.1 to 7.0 volt Zener diode
- IC1—LM324 quad Op Amp integrated circuit
- IC2—4001 CMOS quad NOR gate integrated circuit
- IC3—4017 Johnson counter integrated circuit

ADDITIONAL PARTS AND MATERIALS

- S1—10PST rotary switch
- S2—SPST toggle switch
- J1, J2, J3, J4—banana jacks (one each black, red, blue, yellow)
- BATT1—12-20 volts, 3 required in parallel, use smoke alarm, photo/lighter types of penlight (AA) size, see text
- BATT2—18 volts (2 9-volt transistor) battery, optional for external battery pack. If used, a battery box and matching jack and plug are required.
- Perf board, battery holder, case, knob, wire, etc.

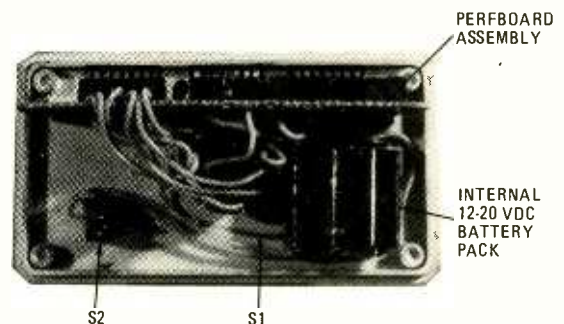

HERE'S ANOTHER PEEK inside the author's unit showing the perfboard assembly packed with circuit parts neatly tucked away. Internal battery pack is soldered together avoiding the need for a battery holder.

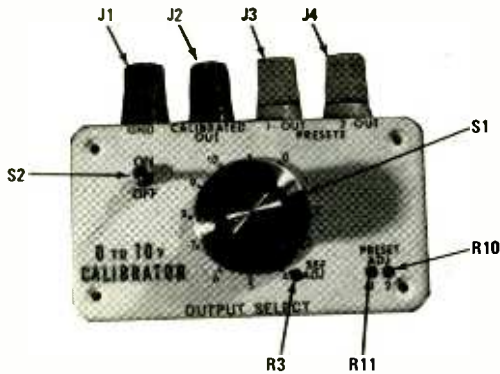

FRONT-PANEL VIEW OF THE 0 TO 10-VOLT CALIBRATOR with operating controls, calibration preset trimmers potentiometers and connecting banana jacks identified.

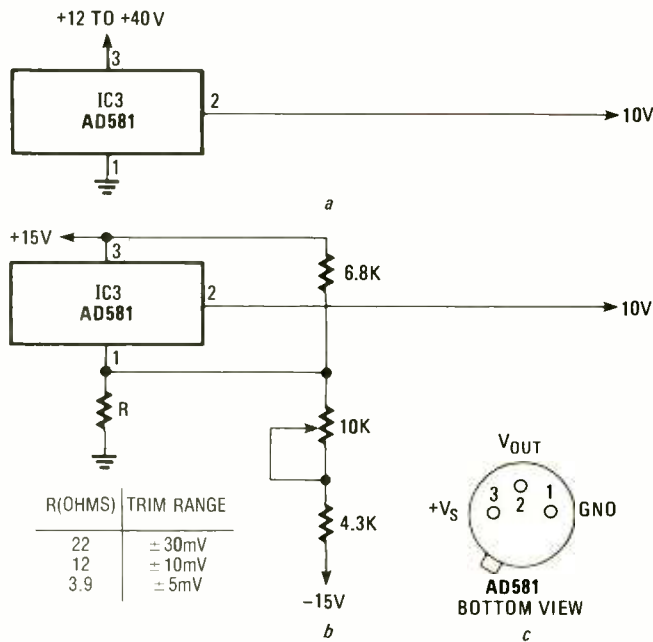

FIG. 4—THE PRECISION AD581 OPTIONS ARE SHOWN HERE. In A, the diagram indicates that no external components are required for a 10-volt output. An optional trim circuit is shown in B for various output trim ranges listed in drawing. Pin-location diagram for the AD581 is shown in C.

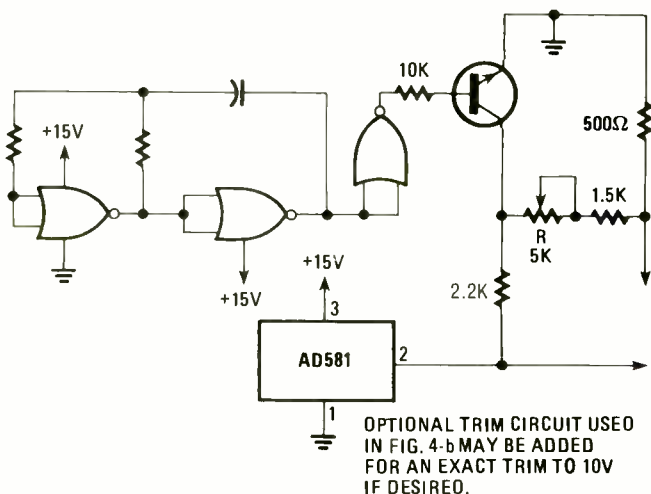

FIG. 5—THE AD581 PRECISION REFERENCE OUTPUT is chopped by CMOS oscillator like that in Fig. 1, to provide both a DC and square wave outputs. Resistor R is adjusted for 1-volt peak-to-peak output.

respective voltages shown, without external trim or components is ± 5 mV, ± 4 mV, ± 3 mV, and ± 2.5 mV. However, those laser-trimmed devices all have pre-trimmed outputs which are pretty close. And we can trim them to the desired output by using a few external components, as shown in Fig. 3A. Multiple-output voltages are available at each pin by buffering each voltage with a non-inverting op-amp, voltage follower, or buffer. And a stabilized 10 mA output is available at pin 1, using the output pin programming in Fig. 3B, or by the addition of one or more external resistors, as shown in Figure 3A.

Next, consider the AD581J/K/L/S/T/U monolithic references listed in Table 1 and shown in Fig. 4. Again we have a laser-trimmed device, with a 10.000-V ± 5 -mV output at 10 mA in the L and U versions, with TCs down to 5 ppm/°C. The trimming arrangement in Fig. 4B allows adjustment to an exact voltage.

Finally, the circuit in Fig. 5 offers both a square wave 1-volt peak-to-peak output and a 10-volt DC reference output, where a transistor, 581 voltage reference, and CMOS oscillator, like that in Fig. 1 or combined. Other peak-to-peak outputs can also be obtained, by adjusting the trimmer and/or changing resistance and/or reference values. However, the circuit in Fig. 1 can also be used as a pretty good square-wave calibrator, by using a output of the Johnson counter. Therefore, you might consider using one of the optional preset amps for that purpose or adding a voltage follower, buffer, and/or another switch to Fig. 1, as opposed to the circuit in Fig. 5, which is self explanatory.

Some final notes

Using any of the circuits shown, or combinations of same, you can create the monster of your choice, using something on the order of a 5 ppm/°C voltage reference, if desired. But, as far as some of the high-accuracy, low-drift circuits are concerned, the main problem comes in calibrating them. Since many experimenters and technicians don't have access to something on the order of a 5½ to 6-digit NBS traceable DVM or equivalent, there are four ways to go: (1) You can calibrate your reference against existing equipment, in which case your calibrator will only be as accurate as the equipment on hand. (2) You can get a friend to handle it if you know somebody with either the equipment or access to same. (3) You can pay a calibration lab to do it, usually for a nominal cost. And, (4) you can get it done on the sly.

Now, if you're one of those people with no scruples, when it comes to laying your hands on some of the best test equipment available, especially when it won't cost you anything, you picked (4) above. So, here's how to go about it: (1) Locate your nearest friendly Fluke, Hewlett Packard, et al, instrument dealer and beat a path over there. (2) Ask the sales rep to look at a few pieces of equipment, and while you're at it, take a look at something like HP's 3455A or 3456A, costing around \$4000 or Fluke's 8400 A, costing around \$3000. (3) While you're looking at these beauties or those of equally enviable specs, it probably wouldn't hurt to try your calibrator out on them. (4) And if you find that HP's, Fluke's, et al, expensive lab equipment don't quite jibe with your calibrator, you might give some thought to adjusting one or the other. (5) If you make the right choice of which one is off a tad, then your calibrator will probably be a very accurate instrument, when you're finished screwdriving it. On the other hand, if you make the wrong choice and take a screwdriver to somebody's expensive \$4000 DVM or DMM, run like hell, before the sales rep can shoot you! **SP**

The Amazing....

PHOTON TORPEDO

***The alien crosses your sights!
A high-pitch whine tells you
your system is energized!
You fire at the alien.
It's a hit and the alien groans!
Get ready for the next alien.***

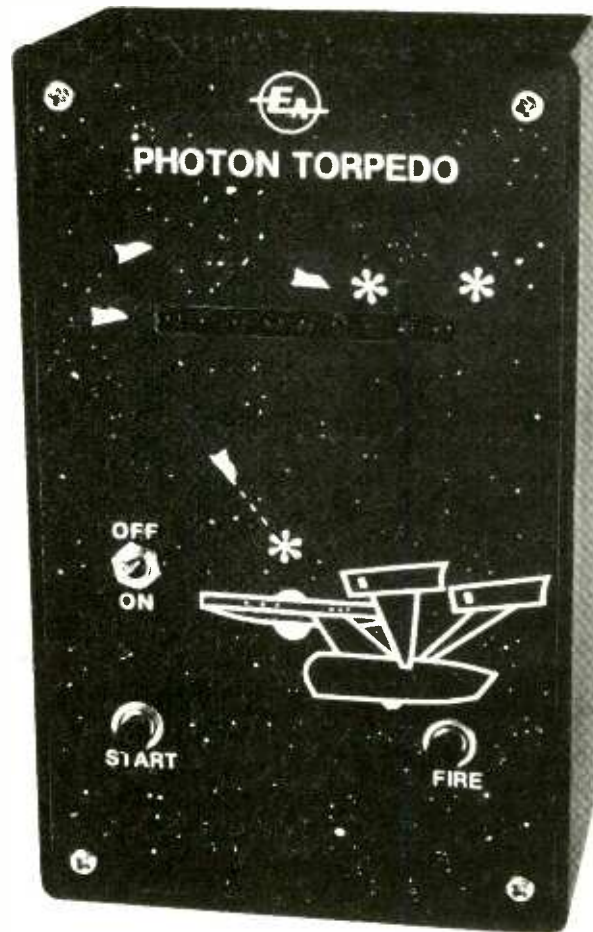

JOHN CLARKE

FOR THOSE WHO HAVEN'T ALREADY GUESSED, PHOTON TORPEDO is an electronics game. It has all the ingredients necessary for a thriller—a space theme, a starship, hostile aliens, and a means of destroying the aliens with an exotic light beam. Add to that the realistic sound effects and you will almost be able to smell the smoke from the battle!

The Photon Torpedo will prove quite popular with those who cannot afford one of those fancy "computerised on-screen" games with its multi-colored aliens. Or maybe you are tired of pouring money into the slot of an arcade-game machine, only to be quickly wiped out by a barrage of bombs and sundry missiles. With spare parts from your junkbox, the cost won't break the bank and, best of all, the aliens don't shoot back.

In fact, it's more like a turkey shoot. The aliens simply fly past and you try to zap them!

However, you don't have things *all* your own way. The alien craft are very quiet and sneaky so no sound effects have been provided for them. All the sound effects are generated when the Photon Torpedo is fired and when an alien craft is

hit. The Photon Torpedo has a high-pitched whine when charging (FIRE button pressed) which dies away in frequency when fired (FIRE button released). When an alien craft is hit, a low frequency "groan" is produced to indicate destruction. The sound effects really add interest to the otherwise visual-only game.

To enhance the game even further, you could add artwork depicting a deep space background on the unit's front panel. A horizontal row of nine circular red LED's is used to depict the position of the alien craft, while the Photon Torpedo is represented by a vertical row of eight rectangular red LED's. You may want to change colors of one or both. The fact that the rectangular LED's are physically butted together produces a good visual traveling torpedo effect.

At the heart of the circuit (refer to Fig. 1) are two 4017 decade counter/divider chips, IC1 and IC2, which drive the LED arrays. Those chip devices have 10 outputs, labelled "0" to "9" and step in that sequence and then back to "0"

Original project appeared in *Electronics Australia*, November, 1980 Edition, and reappears here by permission.

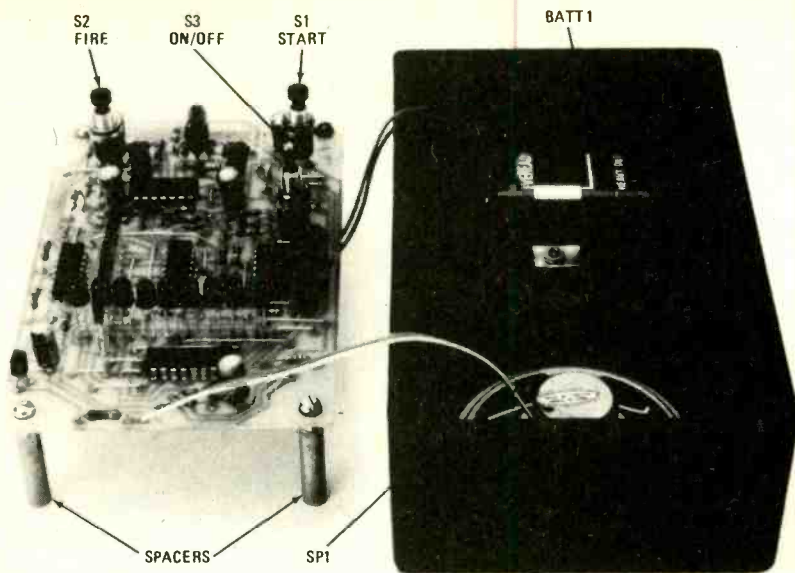

THE PHOTON TORPEDO is shown all wired and ready for final test. Check text for suggestions on changing speed and frequency of aliens and Photon Torpedo. Now would be a good time to modify the unit to your speed.

and so on. They also have a reset input which can be used to reset the counter to "0" at any point in the sequence.

IC1 drives the nine horizontal-row invading LED's (LED1-LED9) via outputs "0" to "8" to represent the position of the alien craft. Those LED's are arranged on the PC board so that the eighth LED (LED8) is intersected by the vertical column LED's (the Photon Torpedo) driven by IC2. In both cases, there is a single extra LED immediately following the intersection. At the intersection, it is the row LED (LED8) which is activated by output "7" (pin 6) of IC1. Since we cannot have two LED's at the same point; the corresponding column LED for the Photon Torpedo is "ghosted" by LED8. Instead of actually driving an LED, output "7" of IC2 (pin 6) is connected to one input of NAND gate IC5-c. IC5 is a 4011 quad 2-input NAND gate. The other input to IC5-c is taken from output "7" (pin 6) of IC1 (in parallel with LED8) and, when both inputs go high, the output of IC5-c, pin 10, goes low.

Note that a single 1000-ohm resistor, R34, limits the current through all the LED's, the cathodes of which are tied together. When one LED is on, the remainder are reverse-biased. When a Photon Torpedo is fired, a maximum of two LED's are illuminated.

Clock pulses for IC2 are derived from IC3-c, one section of a 4136 quad op-amp wired as a Schmitt trigger oscillator. A 10 μ F electrolytic capacitor, C10, connected to the inverting input of IC5-c is charged via resistor, R31, toward the positive hysteresis point of the Schmitt trigger, IC3-c, whenever the output (pin 10) is high. When that voltage is reached, the output of IC3-c goes low and discharges capacitor C10 to the lower hysteresis point. The output then switches high again and the cycle is repeated.

The hysteresis voltages are set by feedback resistor R30 between the non-inverting input and output, and by two 10,000-ohm resistors, R28 and R29, which hold the noninverting input at half supply voltage.

The Photon Torpedo

When FIRE button S2 (see Fig. 1) is pressed the reset bus (pin 15) of IC2 is forced high, activating the "0" LED (LED10). Upon release of the FIRE button there follows a 100-millisecond switch-debounce period, after which the reset bus goes low and the LED's "fire" rapidly up to the

final LED on output "8", LED9. When the "9" output (pin 11 on IC2) subsequently goes high, the clock enable input (pin 13, IC2) also goes high, stopping the counter action of IC2.

In other words, IC2 remains latched with output "9" high until the reset bus of IC1 is again forced high by pressing FIRE button S2. None of the LED's (LED10-LED17) making up the Photon Torpedo will be illuminated during that standby condition.

Here come the aliens!

The clock circuit used to drive IC1 is rather more elaborate than that used for IC2. In particular, extra circuitry has been added to achieve a random sweep speed for the horizontal LED's—the alien spaceship.

IC3-b is a high-frequency Schmitt trigger oscillator, the output of which is gated by NAND gate IC5-d. When START button S1 is pressed, pin 12 of IC5-d is forced high and clock signals from IC3-b are gated through to the clock input of IC4. The reset bus (pin 15) of IC1 is also forced high via diode D4, thus preventing the row LED's from traversing and keeping the "0" LED (LED1) alight.

IC4 is a 4520 dual synchronous divide-by-16 counter wired to operate as a 4-bit binary up-counter which continually counts while there is a clock input at pin 9. The binary outputs Q1 to Q4 are connected to an R-2R ladder resistive network to give a discrete voltage output representative of the binary count number—in other words, a digital-to-analog converter (DAC) network. The output of the DAC network is attenuated and biased to half the supply voltage by two 100,000-ohm resistors, R14 and R15.

Normally, Q1 to Q4 outputs from pins 11 to 14, IC4, are the reverse order to that used in our circuit, so that a linear ramp, or "staircase", with 16 discrete voltage steps is produced. In our circuit, however, a linear ramp is not produced. By reversing Q1 to Q4, as we have done, the voltage levels produced by the DAC are out of sequence although all 16 distinct voltage levels are still represented. That has been done deliberately to make the output of the DAC network more random.

IC3-d is also a Schmitt trigger oscillator, the hysteresis level of which is determined by the voltage set by the DAC network. With a normal Schmitt oscillator, without diode D5

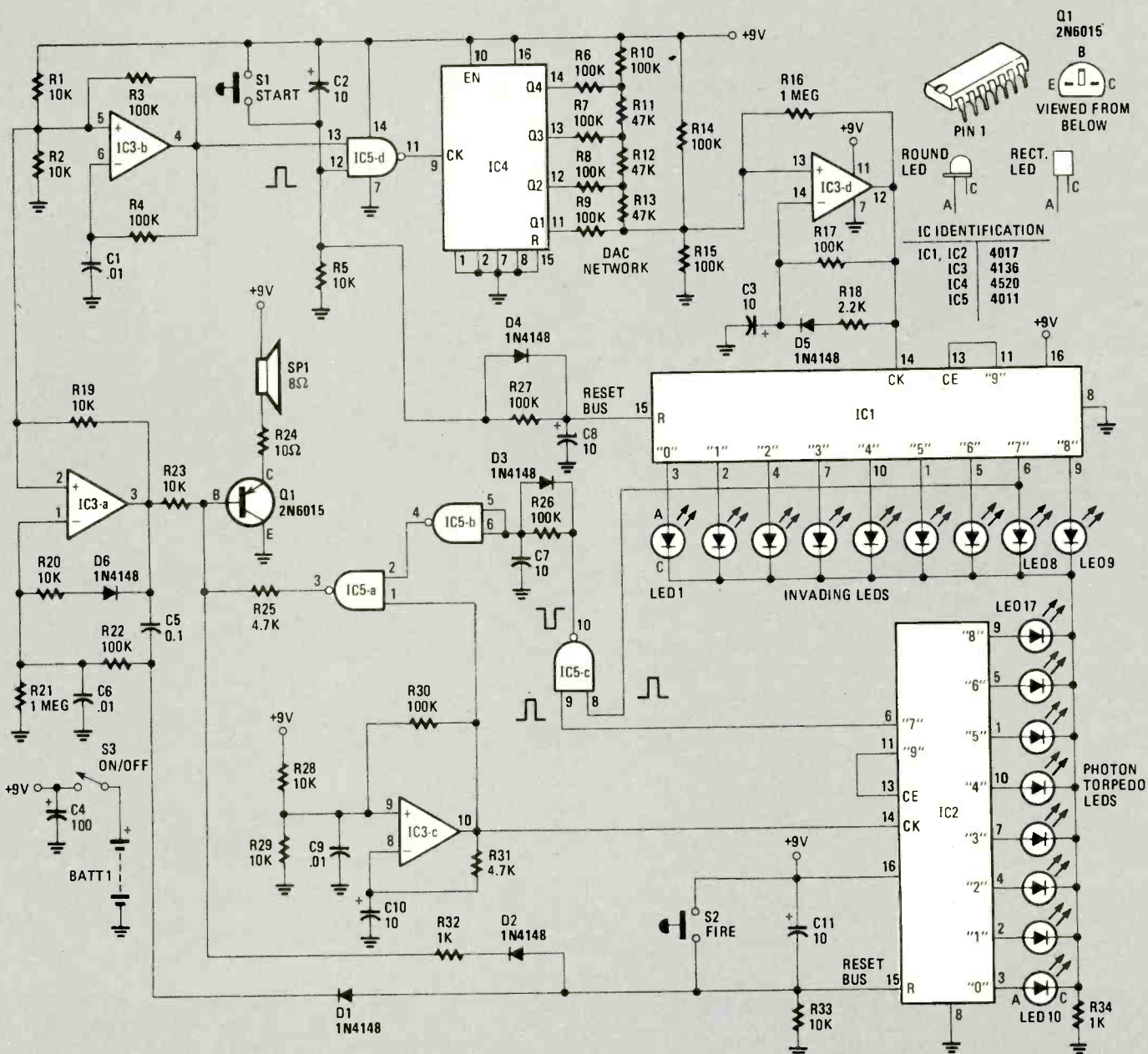

FIG. 1. COMPLETE SCHEMATIC DIAGRAM for the Photon Torpedo. At a glance it looks very complex considering the five IC's (some with multi-sections), 17 light-emitting diodes, 6 diodes, and one transistor. The text explains each section and sub-section of the diagram in detail so that one careful reading will eliminate most of the circuit unknowns. A second reading of this article will have you designing new features into Photon Torpedo.

and resistor R18 in the negative feed-back path, an overall shift in the hysteresis points simply varies the duty cycle. An increase in the hysteresis level would result in longer positive clock pulses and shorter negative pulses—and vice versa—but the actual clock frequency does *not* change appreciably. However, we want the clock frequency to change so that the row LED's will scan at random speed. By adding diode D5 and series resistors, R18, the 10 μ F timing capacitor, C3, will charge rapidly when the output of the Schmitt is high to give a brief positive pulse. Although that is still affected by changes in hysteresis level, it is too short to have much affect on the overall period and hence the frequency of the oscillator. The discharge time continues to vary as before since D5 is reverse

biased when the output of IC3-d goes low.

The output of IC3-d thus consists of short positive pulses and negative pulses of varying widths, depending upon the hysteresis level. IC3-d is, in fact, a voltage-controlled oscillator (VCO) that constantly changes frequency while START button S1 is pressed. Clock pulses from IC3-d are fed directly to the clock input (pin 14) of IC1.

When START button S1 is released, pin 12 of IC5-b is pulled low and no further clock pulses are passed from IC3-b to IC4. Depending on just when IC4 is stopped, the output of the DAC network will remain at a certain fixed voltage and IC3-d will produce a corresponding fixed frequency. At the same time, capacitor C8 on the reset bus will begin to

discharge via resistors R27 and R5. After a delay of about one second, the reset bus to IC1 goes low and the counter is clocked by IC3-d. The LED's representing the alien craft will now light in sequence, the actual scan speed depending upon which of the 16 possible frequencies are generated by the VCO (corresponding to the 16 DAC network output levels). A difference of a few milliseconds in releasing START button S1 makes all the difference, so the scan speed of the LED's will be *completely* random.

Note that diode D4 in parallel with the resistor R26 is to allow an instantaneous reset when the START button S1 is pressed. When START button S1 is released, diode D4 is reverse biased. As with IC2, IC1 is latched when the "9" output goes high at the end of the scan and remains that way until the counter is reset. That is made possible by means of the jumper connecting pins 11 and 13 of IC1 together.

Sound effects

Let's now look at the sound-effects circuitry. IC3-a produces the Photon Torpedo sound, while oscillator IC3-c is tapped off to provide the sound effect when the alien craft is hit. Refer to Fig. 1.

Operation of IC3-a is as follows: When the FIRE button S2 is pressed, capacitor C5 is charged via diode D1, the inverting input is pulled high, and the output goes low. Capacitor C6 on the inverting input then discharges through the resistor R20 and diode D6, and the output switches high again.

That cycle is repeated, with capacitor C6 continually charging via diode D1 and resistor R22 and discharging via resistor R20 and D6. IC3-a thus generates a constant output frequency whenever FIRE button S2 is pressed and that provides the "charging" sound for the Photon Torpedo.

Upon release of FIRE button S2, diode D1 is reverse biased and has no further affect on the circuit. Capacitor C6 now charges through the 100,000-ohm resistor, R22 and 0.1 μ F capacitor, C5, and discharges through the 10,000 ohm resistor, R20 and diode, D6. Because of the mismatch between the 100,000-ohm and 10,000-ohm resistors, the 0.1 μ F capacitor will eventually discharge and become positive at the output side of the op amp, IC3-a. As capacitor C5 discharges, the charging current supplied to capacitor C6 decreases and so the frequency of the oscillator decays.

FIG. 2. SAME-SIZE foil pattern shown here may be used to generate your printed-circuit board. A hand-wired device will look like a rat's nest and it will be nearly impossible to troubleshoot or even make small repairs.

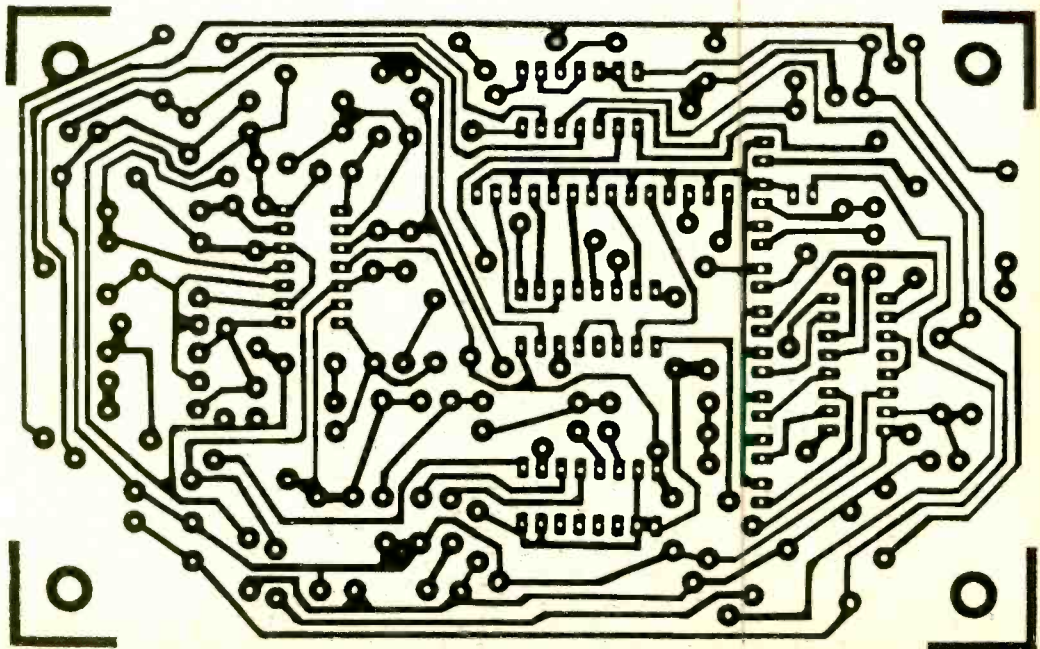

PARTS LIST

SEMICONDUCTORS

- D1-6—1N4148 small signal diode
- IC1-2—4017 CMOS synchronous divide-by-10 counter with 1-of-10 outputs chip
- IC3—4136 quad operational amplifiers chip
- IC4—4520 CMOS dual synchronous divide-by-16 counter chip
- IC5—4011 CMOS quad 2-input NAND gate chip
- LED1-9—Red, round, light-emitting diode
- LED10-17—Red rectangular, light-emitting diode
- Q1—2N6015, BC557 or equivalent 600-mW, audio-type silicon PNP transistor

RESISTORS

- All resistors 1/4-watt, 5% fixed values
- R1-2, R5, R19-20, R23, R28-29, R33—10,000-ohms
- R3-4, R6-10, R14-15, R17, R22, R26-27, R30—100,000 ohms
- R11-13—47,000-ohms
- R16, R21—1-Megohm
- R18—2200-ohms
- R24—10-ohms
- R25, R31—4700-ohms
- R32, R34—1000-ohms

CAPACITORS

- C1, C6, C9—.01- μ F Mylar
- C2-3, C7-8, C10-11—10- μ F, 10-WVDC electrolytic
- C4—100- μ F, 10-WVDC electrolytic
- C5—.1- μ F Mylar

ADDITIONAL PARTS AND MATERIALS

- BATT1—9-volt transistor-radio battery
- S1-2—SPST miniature, momentary-contact, pushbutton switch
- S3—SPST miniature toggle switch
- SP1—2-inch diameter PM loudspeaker
- Plastic utility box with aluminum panel/cover—6 1/4 x 4 x 2 inches, one-side, copper-clad board, 5 1/4 x 3 1/4 inches, etchant materials, spacers, wires, solder, hardware, rubber feet, etc.

The decaying frequency produces the sound when the Photon Torpedo is fired and is designed to stop when the last LED lights.

It's a hit!

Refer back now to IC5-c in Fig. 1. Its output goes low when the row LED (LED8) is "hit" by the Photon Torpedo (pin 6 of IC1 and IC2 both high) and this low is inverted by IC5-b to give a logic high on pin 2 of NAND gate IC5-a. Now, IC5-a now gates through pulses from oscillator IC3 to give the "hit" sound.

That hit sound lasts for about one second and is held on by the C7-R26 delay circuit on the output of IC5-c. The output of IC5-c goes high again immediately after the hit. Diode D3 is included so that capacitor C7 discharges rapidly when the output of IC5-c swings low.

A PNP transistor, Q1, is used to drive the loudspeaker via a current-limiting resistor, R10. The base of Q1 is driven from three sources: IC3-a, IC5-a and from FIRE button S2 via diode D2 and a 1000-ohm resistor, R32. IC3-a drives the transistor when FIRE button S2 is pressed. However, because D2 is forward-biased, the signal drive is attenuated by the resistor R32 between the base of Q1 and D2. Then FIRE button S2 is released, diode D2 is reverse-biased, the sound momentarily becomes louder, and the decaying Photon Torpedo sound is produced.

If a hit is made, IC5-a drives the transistor via resistor, R25. Virtually no mixing of the IC3-a and IC5-a outputs occurs since IC3-a stops soon after the hit.

Power for the circuit (see Fig. 1) is derived from a single 9-volt transistor-radio battery and is decoupled with a 100 μ F electrolytic capacitor, C4. Battery life should be quite good. Four of the IC's are CMOS devices (and thus have low current drain), while the potentially "current-hungry" LED's are only pulsed on for very short periods of time.

Construction

Despite the rather tricky operation of the circuit, the construction is simple. All components, with the exception of the battery and the loudspeaker are mounted on a printed-circuit (PC) board measuring 5 \times 3 $\frac{1}{4}$ -inch. The same-size, foil-up diagram for the PC board is shown in Fig. 2.

Begin construction by mounting the various components on the PC board according to the component overlay diagram shown in Fig. 3. Solder in the wire jumpers, resistors, and

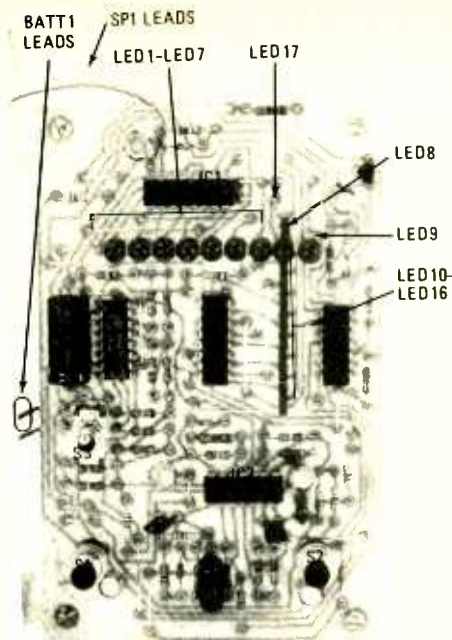

The PC BOARD IS ALL WIRED UP and ready for final assembly. Compare it to Fig. 3. Holes for spacers and mounting screws in bottom of plastic box must be accurately located before drilling. Possibly, you may want to epoxy the bottom of the spacers into place—there's no drilling mistakes that way.

capacitors first, followed by the diodes and the transistor. Note that the wire jumper below the rectangular LED-10 must be curved (or insulated) to prevent it shorting to the LED's cathode.

The two pushbutton switches, S1 and S2, and ON/OFF switch S3 are soldered directly to the PC board. As shown in Fig. 4, they should be mounted so that the top thread of the switch stands off the board by about $\frac{3}{4}$ inch. Note that the solder lugs on the switches may have to be narrowed with a file so that they will fit neatly into the holes you drill into the board. That can be avoided and wire leads used provided you use a deeper box.

The LED'S are best soldered in place with the aid of a template. Cut a piece of stiff cardboard about 3-inches long and $\frac{3}{8}$ -inch wide. Now solder the LED'S in position, one at a time, making sure that the top of each LED polarity is $\frac{3}{4}$ -inch

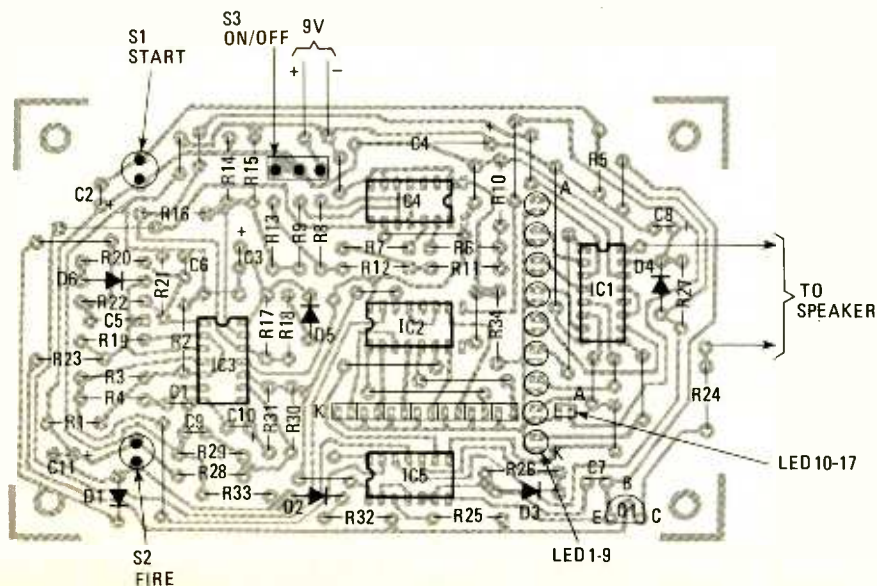

FIG. 3. PARTS-LOCATION diagram pinpoints all the parts in the Photon Torpedo except the loudspeaker and 9-volt battery which are mounted in the bottom of the device's plastic box. Check and re-check polarity of electrolytic capacitors, diodes, LED's, IC's, and transistor before soldering them in place.

above the PC board (use the template) and that the LED polarity is correct. When all LED's are in place, they should be at an even height with no gaps between them.

That done, the IC's can be soldered into place and connections made for the battery and loudspeaker leads. Observe the usual precautions when soldering the CMOS devices to protect them against damage from static electricity. Connect the barrel of your soldering iron to the ground track on the PC board (use a clip lead) and solder the ground and supply pins first to enable the internal protection circuitry.

With the PC board completed, go back over your work, carefully checking for possible wiring errors. In particular, make sure that all polarised components have been correctly oriented. Those components include the IC's, the transistor, LED's, diodes, and electrolytic capacitors.

The assembled PC board is mounted inside a plastic box measuring $6\frac{1}{4} \times 4 \times 2$ inches. A suggested art layout for the aluminium lid (Fig. 5) provides an attractive front panel for the game. You may want to dress up your unit.

The slots in the panel are best made by first drilling along marked lines with a small drill and then filing to shape so that the LED's are a neat fit. That done, place the aluminum lid in position and screw on the nuts for the switches. Provided you've done the job neatly, the PC board, will just fit within the box with the lid in place.

Although not strictly necessary, provide additional support for the PC board by attaching it to the base of the box using four 1.0 and 0.1-inch spacers. Fig. 4 shows the general idea. Note that the 0.1-inch spacers are made up using machine nuts (two per spacer).

As shown in the photograph, the loudspeaker is held in position with stiff wire strapped across it and looped through holes in the bottom of the box. You will also have to drill additional holes in the box to provide a sound grille for the loudspeaker (before mounting the loudspeaker of course). The 9-volt battery is held in place with a piece of scrap aluminium fashioned into a bracket.

With the wiring completed; mount the PC-board assembly inside the plastic box, screw down the lid, and attach the four rubber mounting feet (see Fig. 4). You are now ready to

shoot down the attacking alien craft.

Finally, there are a few adjustments which can be made to the circuit to suit your own personal requirements. To make the Photon Torpedo travel faster, reduce the value of the 4700-ohm resistor, R31, between pins 8 and 10 of IC3-c; to reduce the time of the torpedo sounds, decrease the value of the 0.1 μ F capacitor, C5 connected to pin 3 of IC3-a.

The length of time the "hit" sound lasts can be adjusted by varying the 100,000-ohm resistor, R26, between IC5-b and IC5-c, while the maximum speed for the row LED's is adjusted by varying the 100,000-ohm resistor, R16 in the negative feedback path of IC3-d.

Have fun

Now fire your Photon Torpedos at the alien crafts—zap them away! In the event that you want to enlarge your unit for more excitement, attach a counter circuit to the output of IC5-c to count hits in a *unit* time. The game time period can then be determined by a 555 chip that starts ticking when the START button is pressed and interrupts the counter circuit after a predetermined time to stop the hit count. You may want a rasping buzzer sound to tell you the game is over. There's lots you can do to snap-up the play action of your home-made Photon Torpedo.

SP

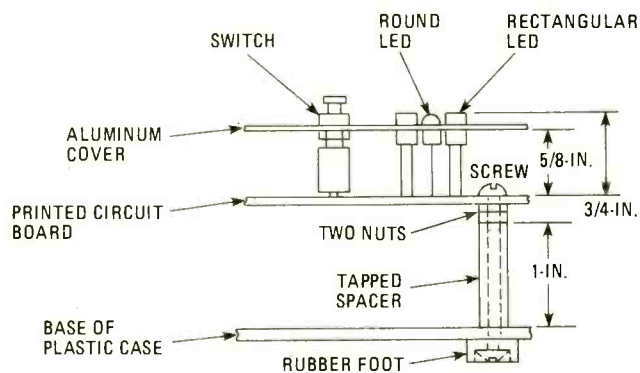
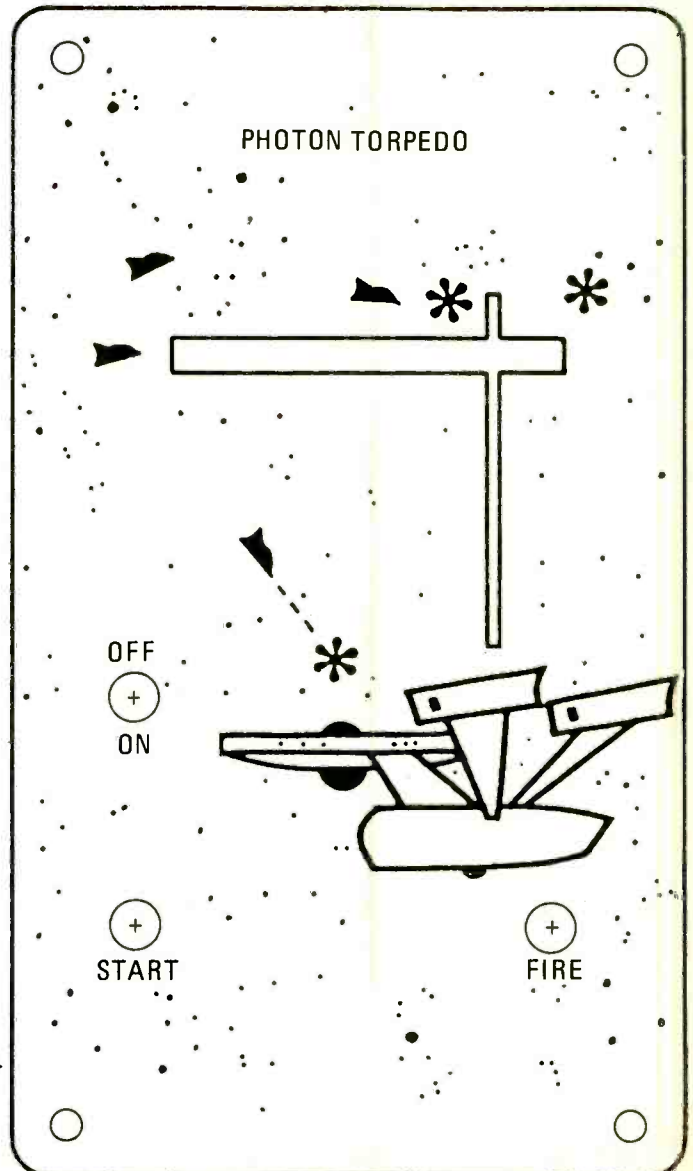

FIG. 4. MOUNTING INFORMATION is provided in the diagram. Dimensions will change should you use a plastic case that differs from that used by the author. Spacers' total height may vary from installation to installation without harm, provided that sufficient room has been left under the printed-circuit board for the loudspeaker and the 9-volt battery stored in the plastic case.

FIG. 5. ALUMINUM-PANEL DECORATIVE ART, switch holes, and slot details are presented above in a same-size illustration. The slot for the LED's is too narrow for a nibbling tool to be used. Drill closely spaced holes, preferably on a drill press, and file edges smooth. Shaft holes for switches are sized during assembly.



Now! Learn on the latest... NRI training includes 25" Heath/Zenith color TV with state-of-the-art features

- 6-function infrared remote control
- space phone lets you answer or call from your chair
- microprocessor-controlled PLL varactor tuner
- 82 VHF/UHF, 35 cable channels
- 24-hour programmable channel selection
- electronic time display
- 4-speaker FM sound system
- choice of three cabinets at student discount

We've taken the finest, most advanced, most complete TV/Audio/Video course available and made it even better. Now NRI brings your training up to and even beyond today's technology with the exciting, advanced performance Heath/Zenith Model 2501 TV. Now you can learn how to service even the latest circuitry on the most expensive TV sets as you assemble and perform experiments on your Heathkit/Zenith. Only NRI combines such complete training with such up-to-date equipment.

Choice of Three Specialties

And only NRI gives you the opportunity to specialize in any of three areas. You get the same complete training covering TV, audio systems, and video recorders, but you select your own specialty for practical, hands-on training.

You can choose to build the Heath/Zenith color TV; specialize in audio systems and build your own AM/FM stereo system; or take your bench



Choice of specialty training on TV, stereo, or VCR



training with remote-controlled videocassette recorder featuring NRI training on videotape. No matter which specialty you elect, your practical training also includes experiments and demonstrations with the exclusive NRI Discovery Lab[®] and your own professional digital multimeter. All equipment is yours to use and keep.

Learn in Your Spare Time

No need to quit your job or tie up your evenings with night school... no classroom competition or rigid schedules. NRI trains you in your own home at your convenience. You're a class of one with complete course materials, practical training on the latest equipment, and the backing of a full staff of professional electronics educators. NRI brings it all to you.

The Professional's Choice

A million and a half students have already chosen the NRI way. And over half the practicing TV service technicians in the U.S. have advanced their careers with convenient home training. Among them, it's NRI 3 to 1 over any other school (summary of national survey on request).

Free Catalog... No Salesman Will Call

Get all the facts on complete, convenient NRI training. See all the equipment, look over complete lesson plans, check out our convenient time payment plans. And see the many other opportunities in fields like Microcomputers, Electronic Design, Communications Electronics, and more. Send postage-paid card and see what advanced training is all about. If card has been removed, please write to us.

Practical training on a real state-of-the-art TV using professional equipment



NRI Schools
McGraw-Hill Continuing
Education Center
3939 Wisconsin Ave.
Washington, D.C. 20016

We'll give you to **tomorrow.**

Build this light dimmer that can be programmed to dim lights at a predetermined rate and level

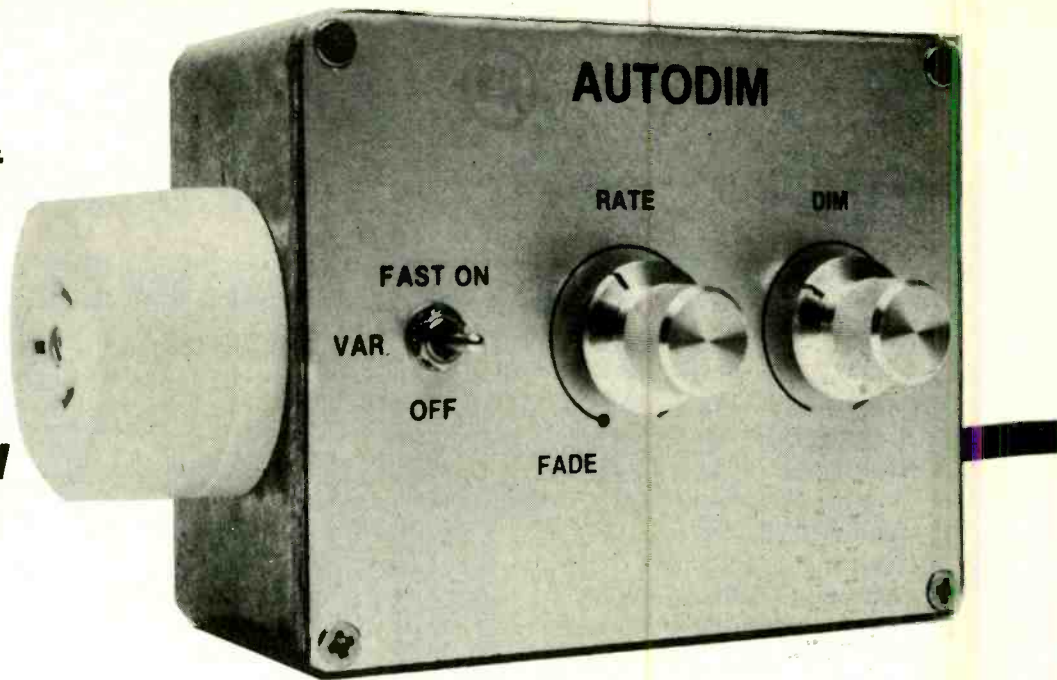

AUTODIM

RON De JONG

LIGHT DIMMERS ARE VERY POPULAR THESE DAYS. BUT ONE function that those simple dimmers cannot perform is *automatic dimming*. The Autodim, a device you can build, functions as a normal light dimmer. It can provide soft lighting for parties, watching television, listening to music, and more private activities upon which the Editor will not allow me to elaborate. With the "autodimming" feature as well, the Autodim can dim lights automatically at an adjustable rate and to an adjustable level, all at the flick of a switch.

In fact, the automatic dimming feature makes the Autodim ideal for use as a night light for young children, where the almost imperceptible dimming provided by the fade function creates a relaxing "sunset" effect while the child is falling asleep. The steady and controlled dimming rate could also be used to advantage in theatrical work, where slow *fade up* and *fade down* can make for a really professional performance.

Other possible applications are in photographic studios for producing special lighting effects; in industrial applications where heat or light must be applied at a controlled rate; and in applications where expensive, high-power lamps, such as projector lights, must be operated on a "soft start" basis to minimize surge failure and prolong bulb life.

One very important feature of the Autodim is that, unlike many commercial dimmers, it provides electromagnetic interference (EMI) suppression. EMI can be particularly annoying in city areas, so effective suppression is a worthwhile feature. In addition, the dim control on the Autodim has no *snap-on* effect as found in some commercial dimmers. *Snap-on* is an effect whereby the dimmer control has to be turned

through (typically) 30-40% of its rotation before the lamp begins to glow. At the initial setting the lamp will be quite bright, although it can be dimmed by now rotating the control back in the opposite direction. The Autodim eliminates that problem completely.

Controls

Three controls are provided on the Autodim. RATE, DIM and a function toggle switch which has three settings: FAST ON, VAR (variable), or OFF. When the function switch is in the VAR position the dimming level is set by the DIM control, just as in a normal dimmer. The rate at which the dimming level changes is controlled by the RATE control, which provides a range in dimming time from around two seconds to three minutes.

The FAST-ON and OFF positions of the function selector are provided for extra convenience. In the FAST-ON position the light dimmer turns full on immediately while in the OFF position the dimmer will dim down to off from a set dimming level at a rate set by the RATE control.

Just to round things out we also have a FADE function which is selected by turning the RATE control to the off position. The FADE function causes the light to dim down very slowly with a fixed dimming time of 30 minutes from full brightness.

All of the features described above are achieved with just one standard CMOS 4070B integrated chip at the heart of a triac power control circuit. (Note: The 4070B and 4030B are electronically identical except for pin connectors. If a substitution is made the PC layout in this article must be altered.) A triac is a bidirectional switching device which is uni-

*Original project appeared in *Electronics Australia*, January, 1981 Edition, and reappears here by permission.

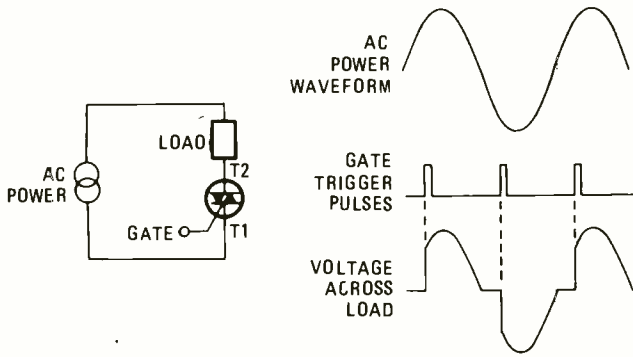

FIG. 1—BASIC CIRCUIT AND WAVEFORMS for a bidirectional switching device called a triac. As gate-trigger pulses shift along AC power waveform, triac is fired and conducts for remainder of half cycle. When AC power waveform drops to zero, triac shuts off and awaits next gate-trigger pulse to fire again.

versally used in AC power-control applications such as dimmers, motor-speed controllers, heat controllers, etc. Since it is bidirectional, it has no anode or cathode as such, but has two terminals (called T1 and T2) plus a control terminal called a gate. When a brief trigger pulse is applied to the gate, the triac turns fully on and remains on until the load current drops to zero at the end of each half cycle of the alternating voltage.

Power control can thus be achieved by "firing" the triac at a set time or *firing angle* after the start of each AC half cycle. That is referred to as phase control and is illustrated in Fig. 1, which shows a triac connected to a load, together with typical trigger and "load" voltage waveforms. Note that power is delivered to the load only after the triac has fired, and can be varied simply by altering the firing angle of the trigger pulses.

The circuit

The first step is to derive a suitable synchronization signal so that the trigger pulses will remain *in phase* with the AC line voltage. In the circuit shown in Fig. 2, sync is obtained from the power supply, which consists of resistor R8, diodes

D1 and D3, 12-volt Zener diode D2, and capacitor C1. That produces a nominal 12 volts across capacitor C1 (which is actually 0.6 volt less than the Zener clipping voltage, due to the voltage drop across D1 when it conducts).

The sync signal is taken from the junction of diodes D2 and D3 where the signal is a square wave version of the line voltage, clipped to 0 volt by the Zener diode on negative half cycles and to +12 volts by the Zener and pull-up resistor R7 across D1 on positive half cycles. The positive transitions of the square wave mark the zero crossing points for the negative half cycles. What we now need to do is convert that square wave signal to a series of brief pulses marking each transition.

The way in which that is achieved is best understood by reference to the waveforms of Fig. 3. First, the square wave signal is fed to one input of IC1-a, an exclusive-OR (XOR) gate, and to the other input via a simple RC delay network consisting of resistor R9 and capacitor C3. Since the output of an XOR gate is high only when its two inputs are at different logic levels, brief pulses will be generated at the zero-crossing points with a pulse width equal to the time delay introduced by the RC circuit (ie: about 1 millisecond).

So far, we have a synchronization signal consisting of brief pulses generated at each zero crossing. Now we have to provide variable delay of those sync pulses so as to obtain variable firing angle and hence controlled light dimming.

If we wanted a simple light dimmer, that could be readily achieved with another RC delay circuit, consisting of a potentiometer and a capacitor. However, because we want the delay to increase or decrease automatically, we need a voltage-controlled delay circuit. A potentiometer and a capacitor can then be used to provide a gradually increasing or decreasing control-voltage to provide the automatic dimming function.

The voltage-controlled delay circuit used consists of IC1-b and IC1-c plus associated components. See Fig. 2. IC1-b is connected as an inverter and drives an RC circuit consisting of a resistor R10 and capacitor C4, together with diode D4. The output of IC1-b is an inverted version of the sync signal, so it is low for 1 millisecond at the beginning of each half

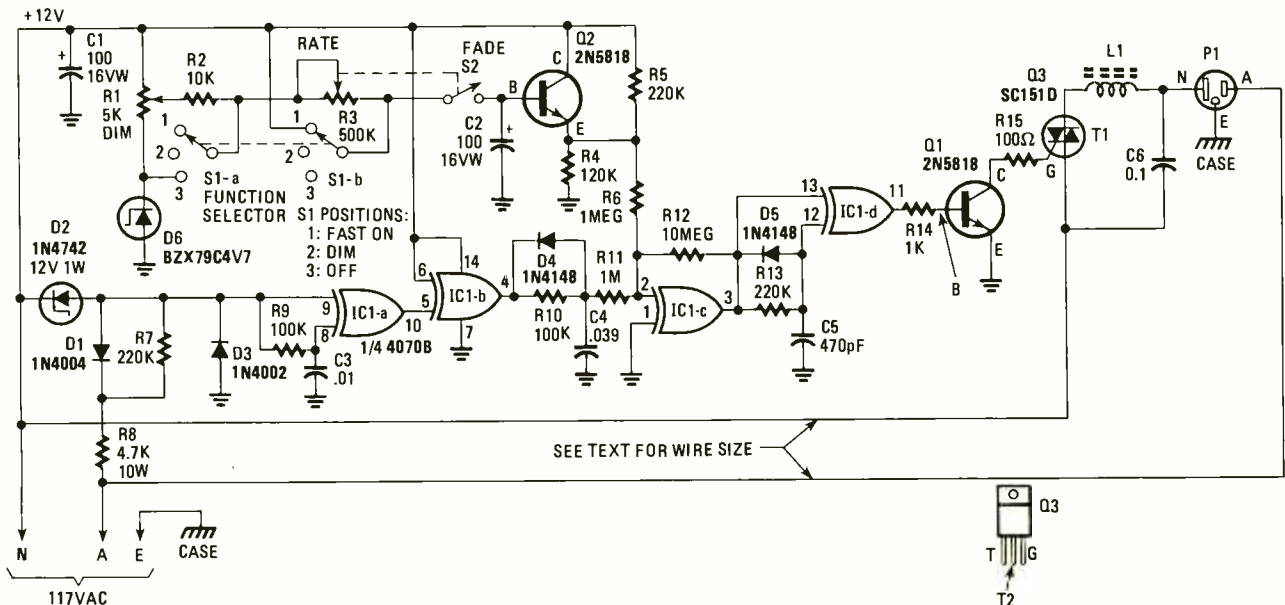

FIG. 2—AUTODIM SCHEMATIC DIAGRAM illustrates how variable light dimming is achieved by means of a phase-controlled triac power-control circuit. IC1 consists of four XOR gates in a 4070B DIP package. C1 and L1 comprise the AC hash-elimination circuit filtering out the RF trash that jams AM receivers.

cycle and high for the remainder or last half cycle.

Thus, at the beginning of each half cycle, diode D4 is forward biased and the capacitor C4 is discharged. Following the pulse, the voltage across the capacitor rises slowly as it is charged via the resistor R10, generating the rounded

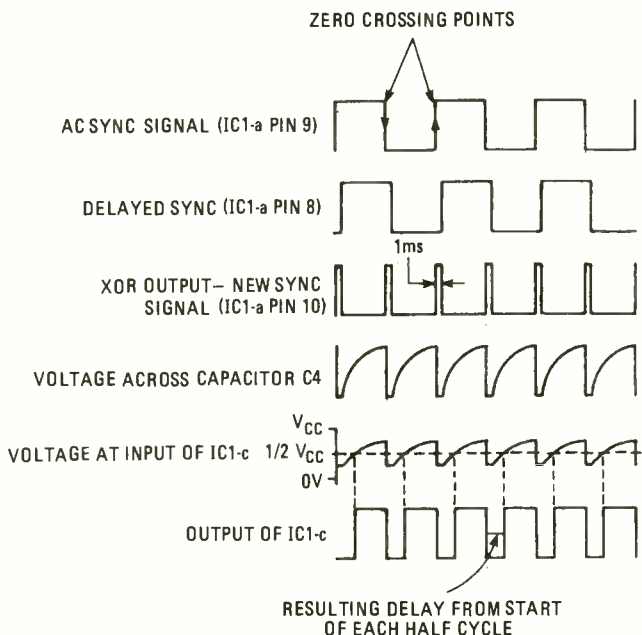
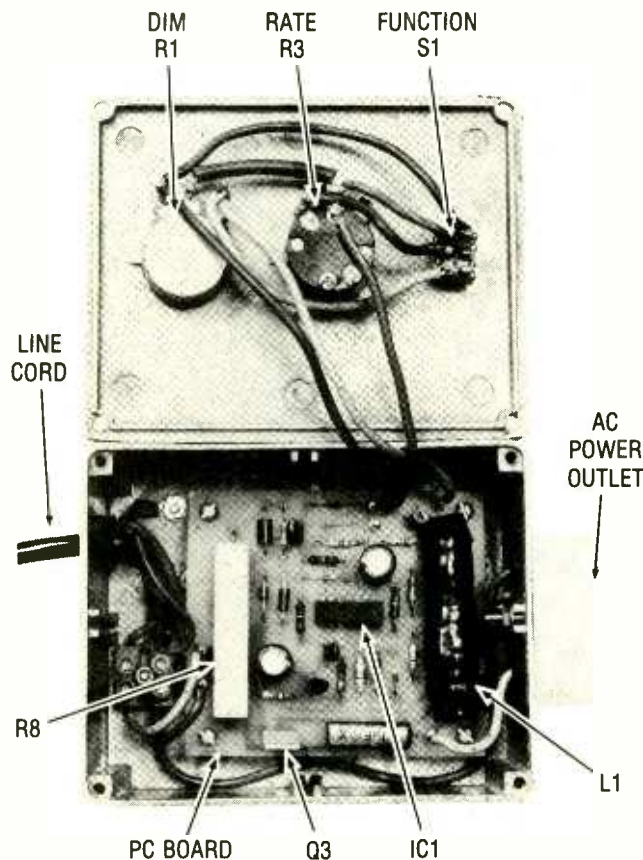

FIG. 3—AUTODIM TIMING WAVEFORMS generated to adjust dimming level of triac output. Triac will not trigger at its crossover point, or at a very low voltage. Thus, about 5 percent or less of the available power is not delivered to the load by the triac at the maximum output setting.



COMPLETED ASSEMBLY OF THE AUTODIM is very neat. PC board is mounted on spacers to avoid shorts to metal case. Keep leads to control panel just long enough to open unit and lay face down, as in photo.

sawtooth waveform shown in Fig. 3. That voltage is then applied to one input of IC1-c via resistor R11. See Fig. 2. Resistor R6 is also connected to this point and supplies what is in effect a bias voltage from transistor Q2. Since the transition voltage for CMOS is $\frac{1}{2} V_{CC}$, (that is, below $\frac{1}{2} V_{CC}$ is logic low and above it is high) the output of IC1-c will go high the instant that the voltages summed together at that input reaches $\frac{1}{2} V_{CC}$. See Fig. 3.

By varying the bias voltage from Q2, the transition point can be varied during each charging cycle, and the output of IC1-c will go high sooner or later as required. Resistor R12 is included between output and input of IC1-c to provide positive feedback to ensure reliable comparator action. That is necessary because at the transition point, the gate functions as a high gain amplifier and would otherwise become quite unstable with a slowly rising input signal.

Now, as mentioned earlier, we require an RC circuit to provide us with a slowly changing voltage. The RC circuit used consists of capacitor C2 and potentiometer R3 connected to the basis of Q2. See Fig. 2. Disregarding switches S1 and S2 for the moment the pot, R3, acts as a RATE control since, by changing its resistance, we can vary the rate at which capacitor C2 charges and hence the rate at which the light dims (or brightens).

The other side of the RATE control goes to a voltage divider consisting of linear pot R1 and Zener diode D6. Since capacitor C2 will eventually charge to the voltage set by R1, and hence to a set dimming level, the pot is called the DIM control. Zener D6 sets a convenient lower limit to the voltage range of the pot.

Three functions

Function-selector switch S1 also controls the operation of the circuit, and has three positions, labelled FAST ON, DIM and OFF. In the DIM position, the circuit functions as described above, while in the FAST ON position S1-b pulls capacitor C2 straight up to the supply voltage, immediately turning the lamp on to full brilliance. In the OFF position, S1-a switches the charging circuit to the minimum voltage, and capacitor C2 slowly discharges to that voltage (ie: the lamp fades to off) at a rate set by the RATE control.

The FADE function is obtained by switching S2, the switch on the back of the RATE controls off. Capacitor C2 is then disconnected from the charging circuit and will discharge very slowly via the base of transistor Q2, resulting in a dimming time from full on to off in 30 minutes.

To remove any loading effects on the RC charging circuit, a buffering stage is connected between it and the voltage-controlled delay stage. The buffer consists of transistor Q2 connected as an emitter follower with a R4/R5 voltage divider as the load. See Fig. 2. The purpose of the voltage divider is to set the minimum bias voltage, and hence maximum delay, in the firing angle: If the minimum bias is too high, the lamp will not completely extinguish; if it's too low, the trigger pulses will be delayed right into the next half cycle, causing the light to flicker.

Due to component variations the minimum bias value may have to be adjusted by altering the values of R4 and R5. The bias level must be set so as not to cause flicker when the lamp is almost completely dimmed out. If the resistors are altered, resistor R4 should not be changed to less than 100,000 ohms.

The XOR gate IC1-d and transistor Q1 form a simple mono-stable which generates the actual triggering pulse used to fire triac, Q3. That pulse is obtained as follows: when the output of IC1-c goes low, both inputs of IC1-d will pull down

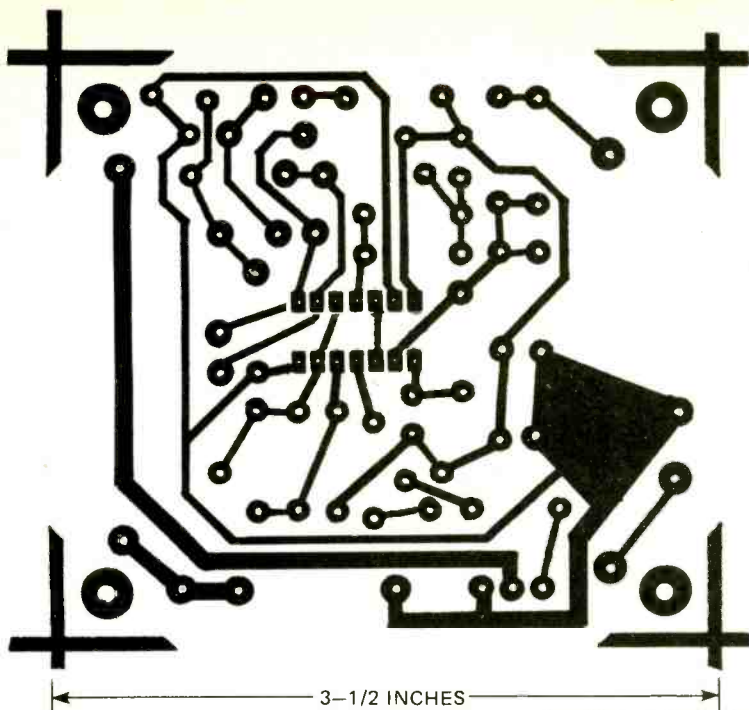
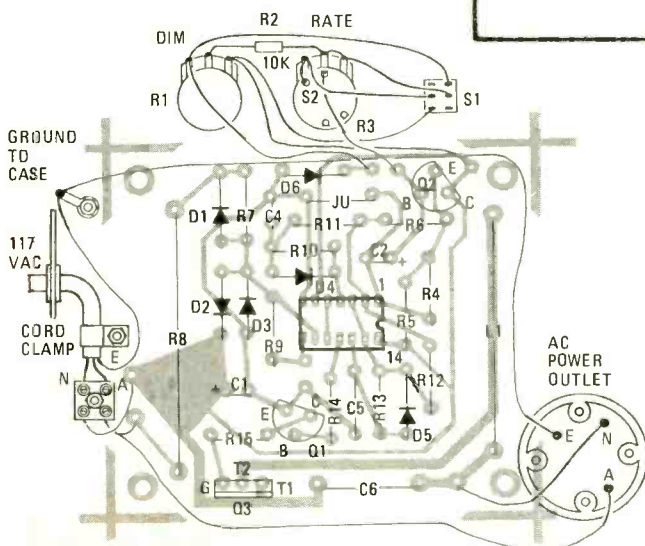

FIG. 4—FOIL-SIDE-UP VIEW of the printed-circuit pattern. Circuit layout is not critical; however, an etched printed-circuit board is desirable, because it physically isolates "AC-hot" components on a sturdy surface than can be electrically isolated from the cabinet ground.

FIG. 5—WIRING DIAGRAM FOR AUTODIM shows how easy it is to hook up the complete unit. PC-board foil side is shown face down. Cut leads close to board after soldering to avoid AC shorting to the aluminum case.

FIG. 6—FRONT-PANEL DETAILS assist the builder in locating drill holes and front-panel nomenclature. If your metal case has different dimensions, layout parts location, safety and sure fit. Parts location is not critical.



simultaneously and so its output will also be low. However, when the output of IC1-c goes high, one signal to IC1-d will be delayed by the RC circuit comprised of resistor R13 and capacitor C5. The resulting short positive pulse on the output of IC1-d turns on transistor Q1, which in turn fires triac Q3.

The duration of the trigger pulse is about 100 microseconds (μ S), which is quite long enough to trigger the triac reliably. Resistor R14 between IC1-d and Q1 limits the current drawn from the gate, while resistor R15 between the gate of the triac and the collector of Q1 limits the trigger current to 100 mA.

The only item not discussed so far is the EMI suppression circuit. That consists of RF choke L1 and capacitor C6 acting together as an LC filter to effectively damp the rapid turn-on currents generated by triac, Q3.

Construction

We assembled our Autodim in a standard diecast aluminum case measuring $2\frac{1}{4} \times 3\frac{3}{4} \times 4\frac{3}{4}$ -inches (D \times H \times W). Of course it is not necessary to use exactly the same box. Note: Autodim must be housed in a metal case which is

AUTODIM

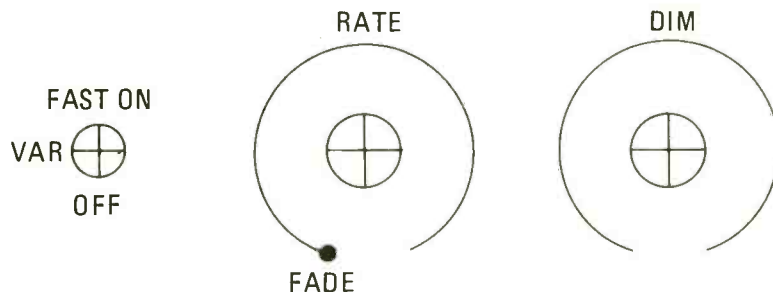

securely grounded, to guard against the possibility of electric shock.

Most of the components are mounted on a small PC board measuring $3\frac{1}{8} \times 3$ -inches. A same-size template for the PC board is given in Figs. 4 and 5.

Construction is best started by fitting all the hardware to the case. As can be seen from the accompanying photographs, the PC board, line-cord clamp, and AC-line terminal block are all mounted on the base of the case, while the two control pots and the toggle switch are mounted on the case lid. The AC output socket is mounted on one end of the case, nearest the toggle switch. Drill centers for the front panel can be obtained from the same-size artwork (see Fig. 5).

Use a grommet for the power cord entry hole and secure the power cord with a clamp. The AC active and neutral conductors are terminated to the insulated terminal block, while the ground wire connects to a solder lug bolted securely

to the base of the metal case. Don't forget to run an additional ground wire from the solder lug to the ground terminal on the AC output socket.

Next, mount the various components on the PC board, following the diagram provided Fig. 4. Pay particular attention to the orientation of polarised components and mount the 10-watt resistor, R8, slightly above the board to allow air to circulate under it. Observe the usual precautions when soldering in the CMOS IC: Do not handle the pins, connect the barrel of your soldering iron to the printed-circuit board foil pattern (to the ground and AC buses), and solder in the two supply pins (pins 7 & 14) first.

The triac is mounted close to one edge of the board and should use the case as a heatsink if large loads are to be driven. Given that heatsinking, the Autodim can drive loads up to about 2 kW, while loads up to about 300 W can be handled without heatsinking. Important note: the metal tab of the triac is at line potential and must be fully isolated from the case using mica washers and a plastic insulating bushing. If you do decide to heatsink the triac, we strongly recommend that you use two mica insulation washers (together with heatsink compound) to increase the break-down voltage, and that you mount the device using a nylon screw and nut. A metal screw passing through the case will be a "hot" terminal that can kill.

Inductor L1 is not available commercially but is quite easily made. A 50-mm (2-inch) length of 10-mm (.4-inch) diameter ferrite rod is required, though if a longer length has been obtained it can be readily cut to size by filing a groove around the circumference and then snapping the rod as if it were glass.

Wind a layer or two of plastic insulation tape around the rod first, then close-wind a layer of #20 enamelled copper wire over the tape. The actual number of turns is not critical; use as many as will fit comfortably.

Next wind another layer or two of plastic insulation tape around the coil making sure that the tape is wound firmly. If that is not done, the inductor will emit a buzzing sound due to the currents being switched by the triac. If you prefer, epoxy the turns solid.

Now mount the PC board using 1/8-inch or 1/4-inch spacers and complete the wiring to the PC board and to the front panel controls. Because the circuit operates at 117-VAC potential, all wiring between the line cords, AC outlet P1 and triac Q3 should be rated at equal to or better than the line cord size. No. 18 wire should do the job.

The front panel for our prototype was made using "Scotchcal" photosensitive aluminum. Use the artwork provided in Fig. 6 to make your own front panel.

Testing

Before switching on, make a final check of all wiring and the PC-board assembly. (See Fig. 5) When you're sure that all is correct, plug a 117-volt lamp into the unit, apply power, rotate the rate control to minimum, and test the various functions. First switch the function switch to FAST ON to see if the lamp comes on at full brilliance. Now switch to the VAR position and rotate the DIM control—the unit should behave just like a normal light dimmer. Next, advance the RATE control and check on whether it controls the rate at which dimming levels change. The automatic slow fade function is checked by switching the RATE control to the FADE position.

Safety first

Finally, a few words are in order concerning troubleshoot-

PARTS LIST

RESISTORS

1/4-watt, 5% unless noted otherwise

R1—5000 ohm linear potentiometer (DIM)

R2—10,000 ohms

R3—500,000 ohm linear potentiometer (RATE) with SPST switch attached

R4—120,000 ohms

R5, R7, R13—220,000 ohms

R6, R11—1 megohm

R8—4700 ohms, 10 watts

R9, R10—100,000 ohms

R12—10 megohms

R14—1000 ohms

R15—100 ohms

CAPACITORS

C1, C2—100 μ F, 16 VDC electrolytic

C3—.01 μ F, 16 VDC or better, ceramic disc

C4—.039 μ F, 16 VDC or better, ceramic disc

C5—470 pF, 16 VDC or better, ceramic disc

C6—.1 μ F, 250 VDC Mylar

SEMICONDUCTORS

D1—1N4004

D2—1N4742 or 12 V, 1-watt Zener

D3—1N4002

D4, D5—1N4148

D6—4.7-V, 1-watt Zener (substitute 5.1-V if only unit available)

IC1—4070B CMOS quad XOR gate

Q1, Q2—2N5818 NPN transistor or Radio Shack 276-2009

Q3—SC151D Triac for 15 amps, SC149D-12 amps, SC146D-10 amps, SC143D-8 amps, SC141D-6 amps

MISCELLANEOUS

S1—DPDT toggle switch with center-off position with no spring return

S2—SPST switch—part of R3

L1—made from #20 enamelec copperwire on 2-in. long, .4-in. diameter ferrite rod, see text.

P1—AC receptacle, three prong type, single unit only.

Aluminum box 2 1/4 x 3 3/4 x 4 3/4-in. (D x H x W), PC board and fabrication material, 3-prong AC plug on heavy duty power cord, cable clamps, grommets, AC terminal strip, spacers, knobs, triac insulating mounting kit, hardware, wire, optional heat sink, solder, lug, etc.

ing the Autodim. Because there is no isolation transformer, and because the circuit operates directly from the mains, most of the circuit can be at active potential. That means that servicing will be quite hazardous, so be very careful if you have any long-term plans for staying alive!

If you do have to service the Autodim, we strongly recommend the use of an isolating transformer to minimize the danger of a fatal shock. You don't even have to use a transformer with a 120 volts AC secondary winding. A transformer with a secondary voltage down to 50 volts would be ideal for servicing although, naturally, the lamp brightness will be markedly reduced.

Note that where a low-voltage isolation transformer is used, resistor R8 should be reduced accordingly. For example, if the transformer secondary is 50 volts, then the resistor value should be halved to 2.2K (the nearest preferred value). An easy way to do that is to tack-solder a 5-watt (or better) 4.7K resistor across R8 during the test. **SP**

DIGITAL CLOCK THERMOMETER



Without squinting you can eyeball time and temperature readings from this home-brew device

LET'S FACE IT. MERCURY OR ALCOHOL THERMOMETERS ARE NOT easy to read or use. A digital thermometer with its big, bright, easy-to-see readout has quite a few applications in the home, workshop and laboratory.

In the home, our Digital Clock/Thermometer (DC/T) can be used to keep a check on inside and outside temperatures, on your freezer and refrigerator and the temperature of tropical fish tanks. In the photographic darkroom, DC/T can keep track of temperatures in developing tanks while in the laboratory and workshop the applications become wider still—measure heatsink or motor temperatures, etching baths, and so on. In fact, the only limit is the number of temperature sensors you use and the overall permissible temperature range of -40°C to $+89^{\circ}\text{C}$ (-40°C to 194°F).

You can build DC/T in a variety of forms. You can "go the whole hog" as the author did and end up with a handsome but quite expensive unit which really looks the part and provides a lot of functions. Or, you can forego some of the functions, put it in a less expensive case and save quite a lot of money.

The circuit

Heart of the circuit is the MA1026 digital LED alarm clock/thermometer module released by National Semiconductor. It requires only a handful of external components to produce a finished, working project: in particular, a power supply, function and time-setting switches and temperature sensors.

The MA1026 is a hybrid PC board-cum-integrated circuit we labeled ICM1. The ICM1 board measures just $3\frac{3}{4} \times 1\frac{3}{4}$ -in. approximately. On one side it has two dual-digit LED displays while on the other it has components for the power

supply, a number of transistors plus a few capacitors and resistors. It also has two IC chips which are bonded and terminated directly to the PC tracks. The main chip is roughly 4 mm square and covered with a blob of encapsulating gook under which a maze of leads can be seen terminating to the chip. There are 58 leads in all, which would make a large IC if housed in a conventional in-line package.

Like most clock chips, the MA1026 provides a list of optional features as long as your arm and which would take a great deal of space to describe in full. We will describe those which are featured in our design and briefly allude to some of the others which may be of interest to readers.

The main chip on the MA1026 module (ICM1) is a conventional clock chip with some extra internal circuitry allowing it to display temperature values. Thirty-one of the chip pins provide normal clock features with each pin pulled low to enable that particular feature. The controls are listed as follows: colon control (low to stop 1 Hz flashing), 50/60 Hz select (low for 50 Hz), 12/24 hour select (low for 24 Hr which disables PM indication), alarm off, time set enable, fast set, slow set, display seconds, display alarm, snooze and brightness.

Two control pins provide the temperature display facility: display temp and Fahrenheit/Celsius select (low for Celsius). The remaining pins on the clock chip are for connection of supplies, temperature interface circuitry and the three control outputs: alarm, sleep and 24 hour. Additional circuitry on the MA1026 module provides temperature input data from external sensors.

Temperature sensor

The temperature sensor used is the LM334, made by National Semiconductor, who describe it as a three-terminal adjustable current source. For the LM334, the output current

*Original project appeared in *Electronics Australia*, September, 1981 Edition, and reappears here by permission.

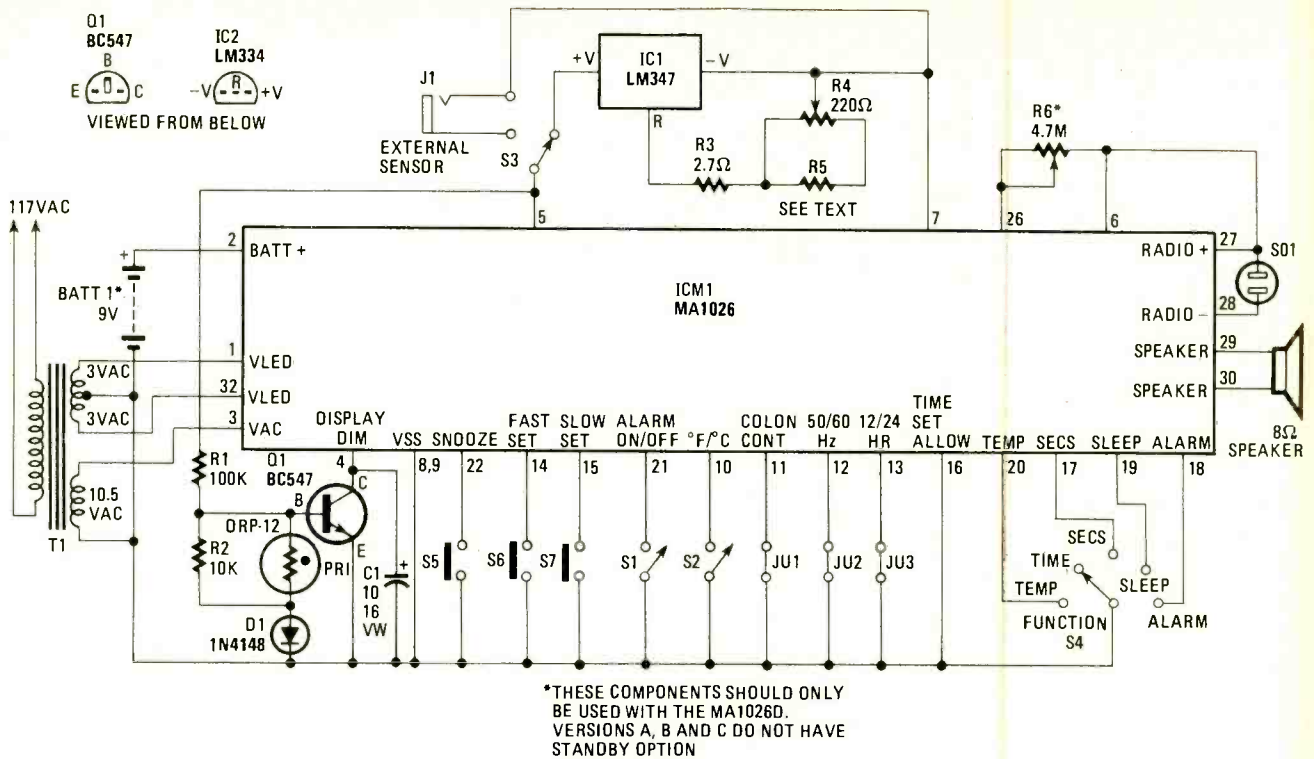

FIG. 1. THE CIRCUIT FOR DIGITAL CLOCK THERMOMETER may be modified to suit reader's needs. For example, S3 could be replaced with a multi-position switch to accommodate several temperature sensors. Note that each temperature sensor needs its own resistor trimming network, and each network must be adjusted against a reference thermometer. The common bus at the bottom of the drawing which interconnects two windings of T1, the rotor terminal of S4, the emitter of Q1 plus a host of switches and other components is referred to as X Bus in Fig. 3.

increases by one microamp for every one Celsius degree rise in temperature. When the current from the LM334 is applied to a 10,000-ohm resistor (on the module) the resulting voltage increases by 10 millivolts for every one Celsius degree rise in temperature. This is converted to a frequency signal which can be displayed by the clock chip counters in degrees Fahrenheit or Celsius.

The LM334 is guaranteed for accuracy only over the range from 0° C to 70° C. In order to guarantee accuracy and reliable operation over the full measurement range of the MA1026, we would have had to specify the more expensive LM134 which has an operating range of -55° C to +125° C or the LM234 which has an operating range of -25° C to 100° C (which would reduce the measurement range for very low temperatures). As it is, we feel that the LM334 (IC1) will be satisfactory for most likely applications.

Plus features

We have added several features to make the MA1026 (ICM1) even more attractive as a clock. First, we have added a back-up power supply (see Fig. 1) which keeps the clock counters going in the event of a AC line power failure—very handy in view of frequent blackouts and power interruptions. The back-up supply takes the form of a 9-volt battery, BATT1, which is isolated by a diode on the module. Some MA1026 modules may not have this diode and a capacitor necessary to run a standby back-up oscillator which drives the counters. We will talk about this aspect later.

The other feature we have added is a dimmer circuit for the display. Many digital clocks with "fixed brilliance" displays are too bright at night (in darkness) or not sufficiently bright in rooms where there is a high level of ambient light-

ing. We have added a Light Dependent Transistor (LDR) circuit (see Fig. 1) which automatically dims the display in darkness.

The LDR circuit consists of photo-resistor PR1, two fixed resistors, R2-R3, diode D1, capacitor C1 and transistor Q1. A look at Fig. 1 will show how the circuit is connected. Photo-resistor PR1 is shunted by a 10,000-ohm resistor, R2, and then connected to ground via diode D1. The other end of the PR1/R2 combination is connected to the base of an NPN transistor, Q1, and one end of a 100,000-ohm resistor, R1, the other end of which is connected to the positive DC supply from the module, ICM1, pin 5. Diode D1 is used to keep the voltage at the base of transistor Q1 in the region of the base-emitter conduction voltage, 0.6 volts. The collector of the transistor is connected directly to the dimmer input (pin 4) on the clock module. A 4300-ohm pullup resistor on the ICM1 normally maintains the display at full brightness. If the dimmer input is not taken low the display will dim. This is exactly what happens when little or no light falls on the PR1. Under bright lighting conditions, the resistance of the PR1 will be very low relatively to the 100,000-ohm resistor at the base. This will result in the transistor being turned off and the dimmer input rising to full supply voltage (due to the on-board pull-up resistor) to give full display brightness.

If the light level happens to fall, the resistance of the PR1 will increase, resulting in a positive bias being applied to the base of transistor Q1. This will result in a collector current flowing, pulling the dimmer input down to a lower voltage. When PR1 has no light falling on it, Q1 will be turned on and the display will dim down to 25% of full brightness. The 10,000-ohm resistor in parallel with PR1 is used to linearize the response of PR1 to changing light conditions. Capacitor

C1 connected between the collector and ground is used to smooth the half-wave DC present at the dimmer input.

Our prototype

Our prototype unit was constructed in an attractive plastic case manufactured by Pac Tec. If you have trouble obtaining it, any case you select will do.

The function select switch, S4, the ALARM on/off switch, S1 and the TEMP selection switch are mounted on the front panel of the DC/T together with the clock module itself. The time-setting push buttons, S6 and S7, temperature sensor changeover switch, S2, and remote sensor jack, J1, are all mounted on the rear panel. Five display modes are selected by function switch S4: TIME (hours and minutes) SEC (seconds), ALARM time, SLEEP timer and TEMP. Toggle switch S2 is used to select between the two temperature scales while switch S1 is used for the alarm disable. A third toggle switch, S3, located on the back panel, is used to select between the internal (rear-mounted) and an external temperature sensor.

The sleep function allows an external transistor radio to be used with the digital clock. The radio can be switched on as the alarm device at the alarm set time and can also be enabled by the sleep timer. The sleep timer is a counter that starts counting down from 59 minutes. When the sleep timer reaches zero, the radio is switched off. The output for this function is in the form of an open-collector output, the emitter of the switching transistor being connected to the positive side of the clock DC supply. The positive of the

clock supply is used as the common between the clock unit and an external radio, instead of the zero volts line. If the DC/T is wired into an existing radio, there is not need for S01—a polarized socket or jack.

The MA1026 module, ICM1 has a time-set enable input but we decided not to make use of the feature and enabled it permanently instead. If desired, a switch could be incorporated to disable the time setting mode. This is handy if you have inquisitive kids about who like to fiddle with pushbuttons.

The photo resistor, PR1, for the dimmer circuit and the snooze button, S5, have been mounted on the top of the case; thus, PR1 gets maximum exposure to ambient light, and pushbutton S5 can be easily pressed to disable the alarm on a blue Monday morning.

Module ICM1 is powered from a small transformer, T1 (see Fig. 1) which has two secondary windings, one at 6 VAC with a center tap and the other at 10.5 VAC. The 10.5-volt winding is used to power the clock chip and ancillary circuitry while the six-volt CT winding is used for powering the LED display and the alarm loudspeaker.

A printed circuit board has been designed on which all of the remaining components are mounted, including the power transformer. The board measures $6\frac{1}{8} \times 4\frac{3}{4}$ -in. approximately. The board is larger in area than it really needs to be, but it was made this particular size to take advantage of the mounting locations in the base of the Pac Tec enclosure. This means that we have no screws showing through the bottom of

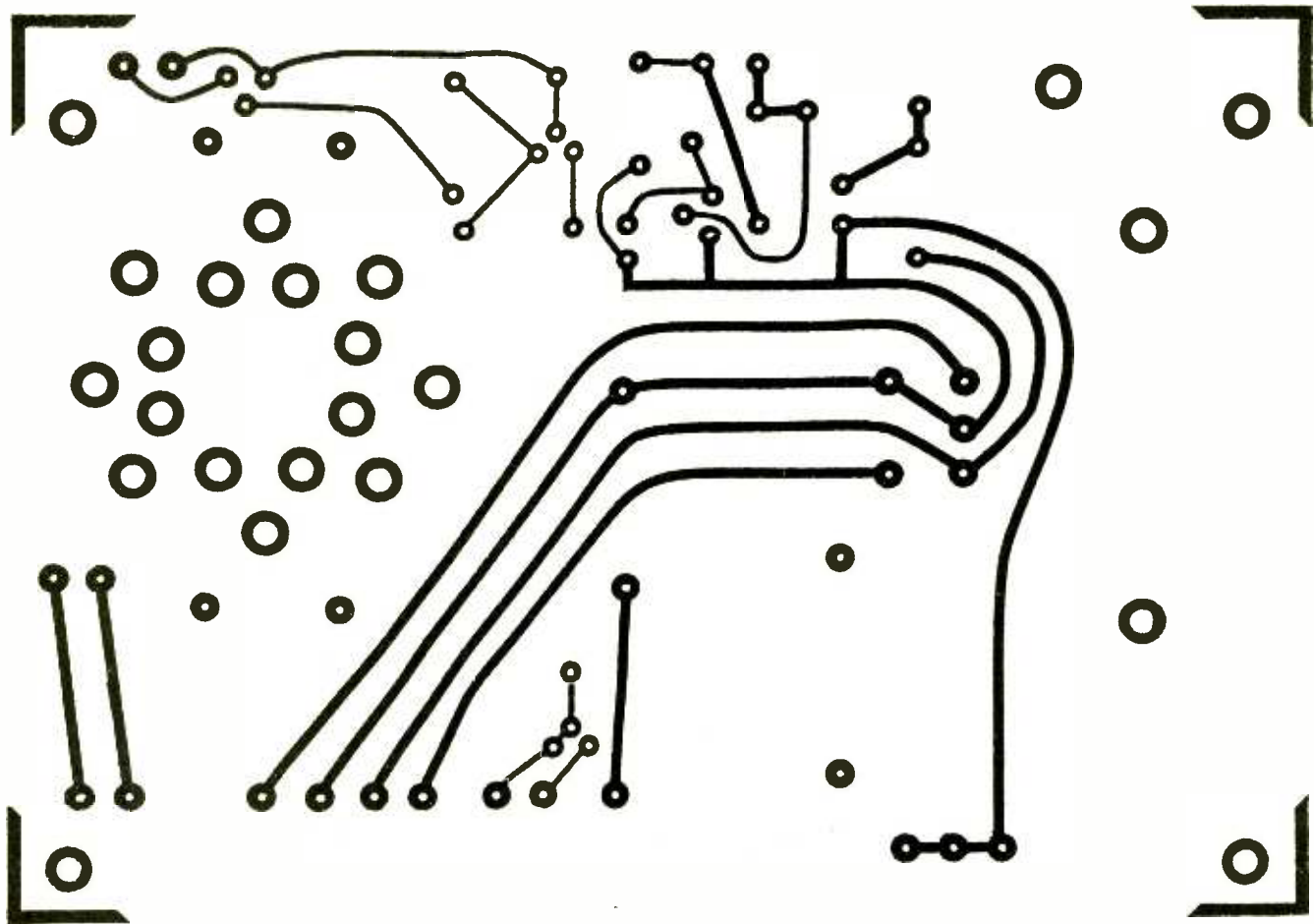

FIG. 2. FOIL SIDE UP VIEW of the made-at-home printed circuit board for the DC/T. Layout is not critical. In fact, since some experimenters will have to use two transformers to obtain the necessary secondary AC voltages of T1, the board may take some drastic, but not difficult, design changes. Parts layout is not critical in this project.

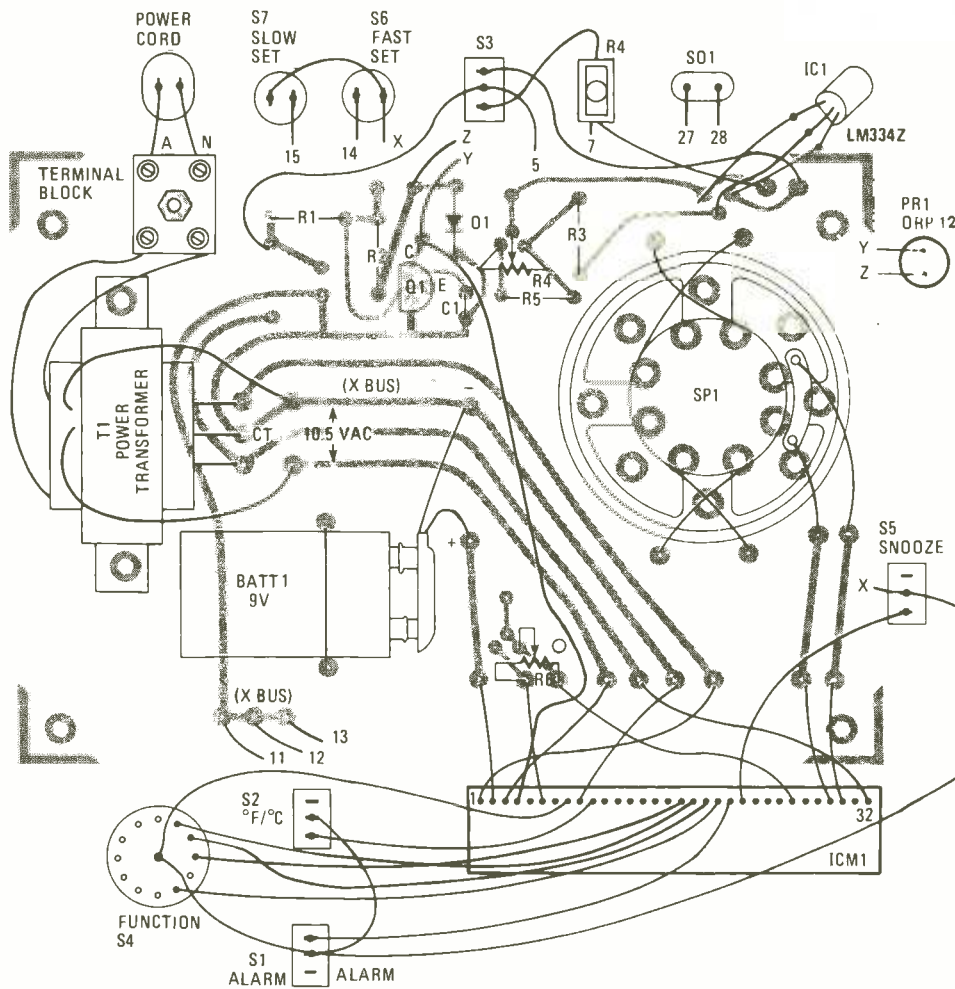

FIG. 3. TO THE WEAK-AT-HEART this wiring diagram looks like a maze. But, take some time out to compare it to the schematic diagram in Fig. 1 and it will become clear and logical. The X Bus is a common tie line to many circuit points in the unit. Not all X Bus connections are shown for clarity sake. After wiring unit completely, check that all components tied to the X Bus are in agreement with those connected in the diagram.

the case—an advantage aesthetically and from a safety point of view.

Variations

As mentioned at the beginning of this article it is possible to build this project in a variety of forms. If you build it with all the features we have included and use the Pac Tec case, the resulting unit will be relatively expensive, and it should give a lot of satisfaction as a *complete* project. On the other hand if you decide to make do without the Pac Tec case, front panel and dimmer facility, you could also dispense with the PC board and save a substantial amount of cash. For example, you may wish to build a version of the unit which can display just the time and temperatures at five separate locations. This would require five LM334 sensors and their

associated resistor network in each case plus a six-position, two-pole switch to perform the selection. The only other components required would be the MA1026 module itself, the transformer and two pushbutton switches for time-setting. Even the Fahrenheit/Celsius switch, S2, could be eliminated from such a basic version—just wire

in a link if you want Celsius only.

Alternatively, another possible version could provide just the time and alarm functions with, say, four temperature sensors. You would then require the parts mentioned previously plus a small speaker to sound the 800 Hz alarm.

Construction

Construction of the DC/T will take time since there is a lot of preparatory work to be done on the enclosure, and then quite a lot of wiring. The first step is to mount the components onto the printed circuit board. The foil pattern is shown in Fig. 2 and parts location, in Fig. 3. Note that these include the mains terminal block.

Once the PCB has been assembled, put it aside and

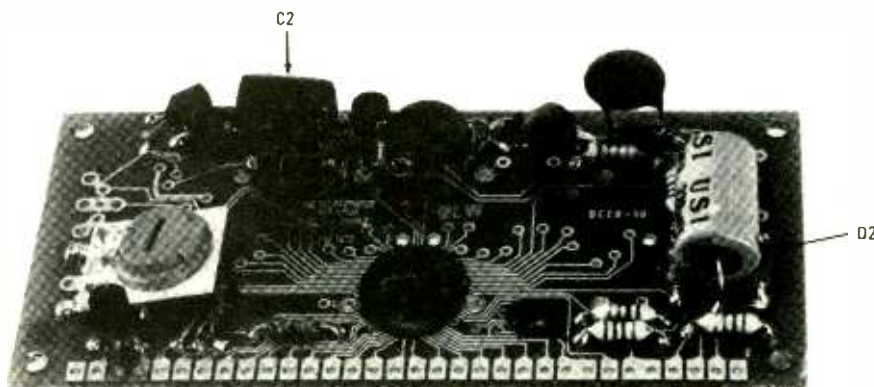

CLOCK/THERMOMETER MODULE ICM1, variations A, B and C, require the addition of C2 and D2 to the circuit board. The photo shows the location of each. These added parts plus the addition of BATT1 and R6 permit the clock to continue counting time during power failures by use of an internal 20 Hertz oscillator as the timing source. Should the clock run for a long time on the battery, the time accuracy should be checked, and corrected if necessary.

BIRD'S EYE VIEW OF THE DIGITAL clock/thermometer. There is more than enough room in the box to position the hookup cables. A smaller box could be used but clock may tip over when setting switches.

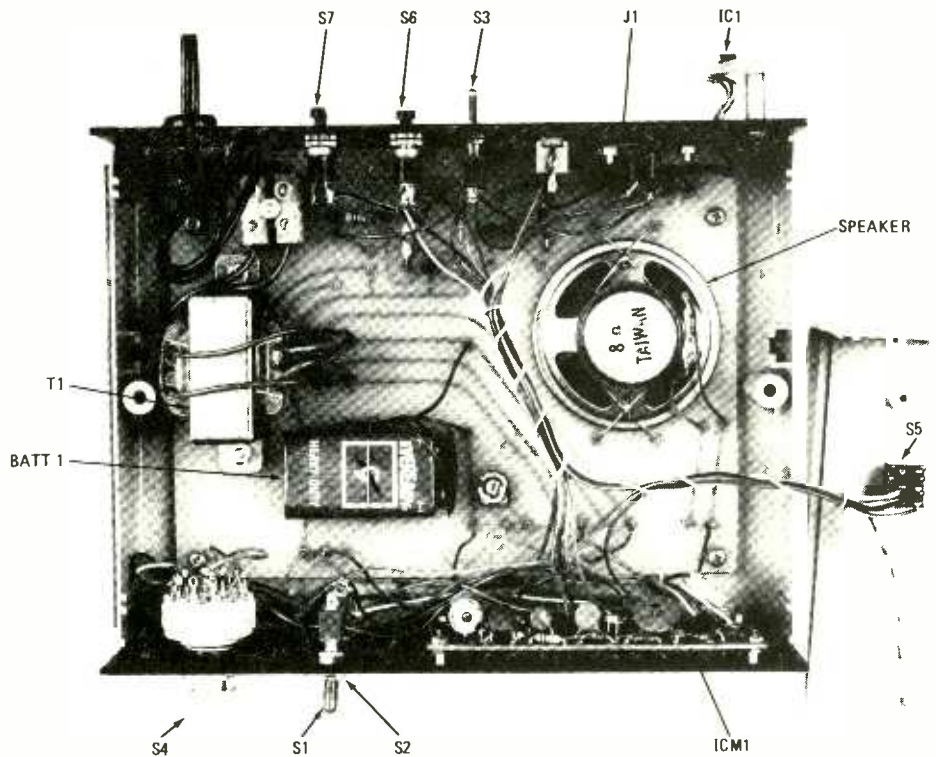

start preparing the enclosure. This will involve cutting the opening for the LED displays of the clock module; drilling and countersinking the four screw holes for the module mounting screws; and drilling the other holes for the switches, pushbuttons and sockets. The slot for the LED displays should be cut out next.

Now mount rotary switch S4 and the two toggle switches, S1 and S2. The next step involves wiring up the connections that have to be made between clock module ICM1 and the switches mounted on the front panel. Once this part of the job has been done, put the front panel assembly aside and start work on the rear panel.

Mount the two pushbuttons, S6 and S7, the double-pole, single-throw toggle switch, S3, and the two sockets J1 and SO2, onto the rear panel. The temperature sensor IC1, is mounted on the rear, but external to the case. A drawing showing a suggested mounting method appears in Fig. 4.

Once the components have been mounted onto the rear panel turn your attention to the mounting photoresistor PR1 and the snooze button, S5, in the lid of the DC/T. Mount PR1 by drilling a hole in the lid, and carefully enlarge the hole by filing until the body of PR1 is a tight fit in the hole. Place a bit of epoxy glue on the back of PR1. Just a little drop will do it. Snooze button S5 is mounted in the right hand top corner of the lid, an easily accessible place for the half awake.

If you elect to use a metal case instead of the Pac Tec case,

the AC line terminal block should be mounted on the chassis rather than on the PC board and the green ground wire in the line cord should be terminated to a solder lug secured by a screw and nut to the base of the case.

Once all of the mechanical work has been done (at least in terms of bolting things to panels), proceed with the remainder of the wiring. The line cord used in the prototype was clamped in place by using a cord grip clamp. With all of the internal wiring completed (the temperature sensors should not have been hooked up at this stage) and checked, apply power to the unit and note that regardless of the display mode selected, the display should be flashing on and off at one second intervals. This flashing is an AC power line failure indicator, and will occur after every power failure to the clock. The flashing can be stopped by setting function switch S4 to the time position and then pressing either of the two time-setting buttons, S6 or S7, on the rear panel.

Primary checkout

Go through each of the mode selections on switch S4 and make sure that the display comes up with the correct information corresponding to the selected mode. If not, then chances

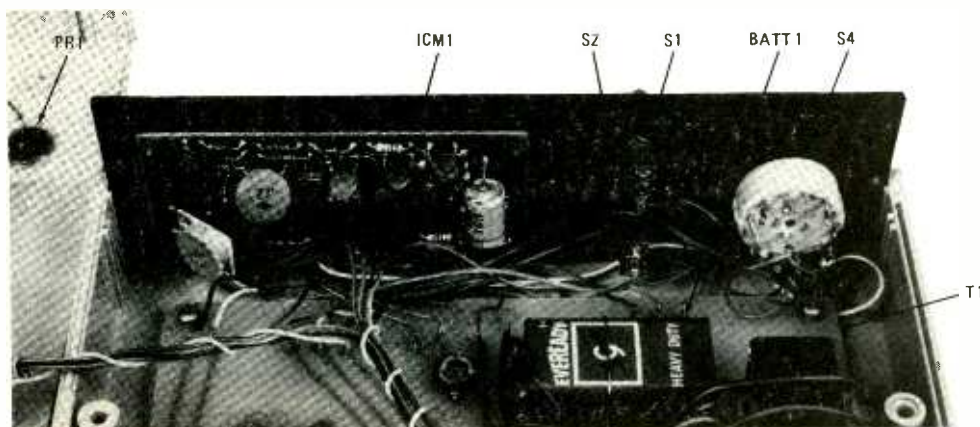

PARTS MOUNTED on the front panel are clearly shown above. ICM1 is positioned over a panel cutout so that the LED display is visible. Printed circuit board holding external components is mounted in the bottom of the box.

are that two of the mode selection wires have been transposed at the switch connections. The only setting that will give a nonsensical reading at this stage will be the temperature mode. It should read -40° in either F or C modes. It is interesting to note that when you convert -40° F to $^{\circ}$ C, the result will be -40 , and contrarywise.

Now check that the dimmer circuit is functioning correctly. This can be done by exposing the PR1 to bright light and noting that the display is bright. Now cover the PR1 with your hand and note that the display dims. Make a note of the external circuit of PR1 and file it away for future applications in special projects you design.

ICM1 modification

Connecting the battery will prevent the display from flashing when the power is interrupted. If your ICM1 module is an MA1026A, B or C type you will have to add the diode and $0.1\mu\text{F}$ metallized polyester capacitor (in place of a jumper) shown arrowed in a photograph. It is necessary to set trimpot R6 for exactly 20 Hz from the backup oscillator. This frequency can be measured at pin 26 of ICM1 using a frequency meter or oscilloscope, or it can be set by trial-and-error.

If all of these tests prove positive, remove the plug from the wall, and mount and connect the temperature sensor, IC1.

Calibration

To calibrate temperature sensor IC1 you will require an accurate thermometer and a fan. Place the thermometer and temperature sensor so that they both receive the same draft from the fan and then adjust trimpot R4 to obtain a reading on the display which agrees with the thermometer. This will involve a number of trial-and-error steps because of the slow update time of the temperature display.

If you find that R4 does not give enough range for adjustment (this is possible as no two current sources have absolutely identical characteristics) then place a 1800-ohm resistor in the position on the board labelled R5. This will reduce the overall value of the trimmer resistance. If on the other hand, the value of the resistance R_p needs to be increased, then substitute a 10-ohms resistor for the 2.7 ohms resistor

R3. Any adjustment of value for R4 required should be quite small.

Finding ICM1

You may have some difficulty in finding one of the variations of the MA1026 clock/thermometer module we specify in this article. One possible source is Digi-Key Corporation, Highway 22 South, Thief River Falls, Minnesota 56701—or dial 1-800-346-5144. Should they not have the exact item specified in the article, Digi-Key sells many other National Semiconductor clock/thermometer modules very

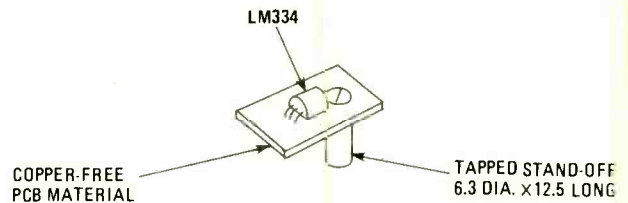

FIG. 4. THE PURPOSE FOR MOUNTING the LM334 as shown in the drawing is to isolate it from heat sources and position the IC in the air away from the rear panel of the DC/T. The technique is our suggested idea—you may have others that are better.

similar to the MA1026 module. Also available from Digi-Key are the transformer and pushbuttons required for the unit.

There are other parts sources that from time to time market modules like that used in this project. The editor suggests that you investigate the classified and display advertisements that appear in the back of **RADIO-ELECTRONICS** magazine. Many good buys are available, and all you have to do is find them.

Last item

An external transistor radio can be controlled by the clock using the sleep timer output socket, SO1. Here, the positive supply from the battery in the radio would be switched by the transistor on board the clock module. The positive of the radio supply and the positive of the clock supply are connected together to form the common connection. **SP**

PARTS LIST

RESISTORS

All resistors are $\frac{1}{4}$ -watt, 5% fixed values unless otherwise noted

- R1—100,000-ohms
- R2—10,000-ohms
- R3—2.7-ohms
- R4—200-ohms miniature trimpot
- R5—See text—Calibration
- R6—4.7-Megohm miniature trimpot (for use with ICM1-MA1026D only. See text—ICM1 Modification.)

CAPACITORS

- C1—10- μF , 16-WVDC aluminum electrolytic
- C2—0.1- μF , 16-WVDC metallized polyester (see text—ICM1 Modification)

SEMICONDUCTORS

- IC1—LM334 programmable current source
- ICM1—Clock/thermometer module, National Semiconductor type MA1026A, B, C, D, L, R
- D1—1N4148 diode

D2—1N4001 diode (see text—ICM1 Modification)

PR1—ORP-12 light dependent resistor

Q1—BC547, 2N2222, or Radio Shack 276-2009 NPN transistor

SWITCHES

- S1, S2—SPST miniature toggle
- S3—SPDT miniature toggle
- S4—ST6T rotary (one position not used)
- S5-7—Momentary contact, normally-open pushbutton

MISCELLANEOUS

- BATT1—9-volt transistor battery
- J1—Polarized open-circuit jack, any available type will do
- SO1—Polarized socket to power external radio
- SP1—2-2 $\frac{1}{2}$ -in., 8-ohm loudspeaker
- T1—Stepdown transformer: 117-VAC pri. winding; 10.5-VAC Sec. winding, 6-VAC center-tapped sec. winding
- Pac Tec plastic enclosure 8-in. W \times 2 $\frac{1}{4}$ -in. H \times 6 $\frac{5}{8}$ -in. D, printed circuit board 6 $\frac{3}{4}$ -in. \times 4 $\frac{3}{4}$ -in., PC etchant materials, battery clip connector, AC power cord, terminal block for AC line, power cord locking grommet, hookup wire, solder, hardware, etc.

SPACE AGE

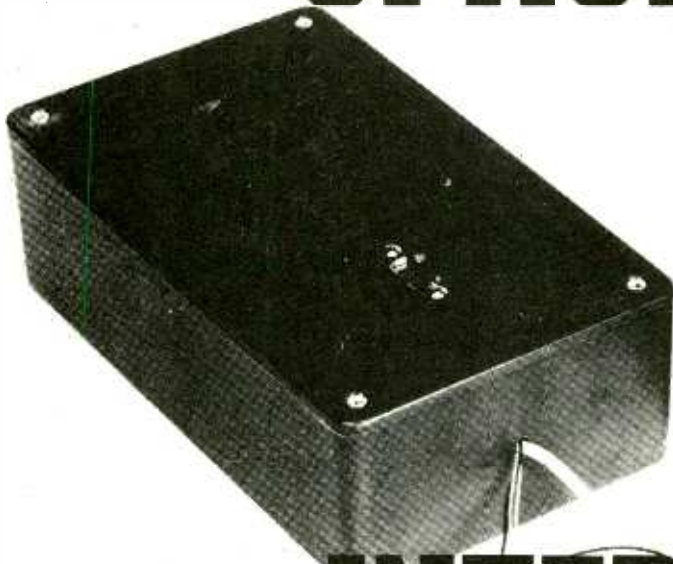

INTERCOM

MICHAEL J. ANDREWS

HOME-BREW INTERCOMS HAVE BEEN A DRAG TO MOST EXPERIMENTER and project builders, and they almost never make the "10 Most Wanted List." Amplitude modulation (AM) intercoms are child's play to design and build, and frequency-modulated (FM) carrier intercoms available on the marketplace are cheaper and better than what the builder can assemble. But, along comes the 9400 voltage-to-frequency/frequency-to-voltage converter chip and we have the root of a new intercom project that's inexpensive and exhibits super-high performance, using pulse modulation theory. Now, what you will hear is not someone speaking into a tin trumpet, and gone are the "Break, break!" signals from that CB linear 'cross the road.

A two-wire, one-way version of an intercom is offered here; however, your imagination should be able to conger up a light-beam communications setup and other exotic communication networks. For the meantime, here is our Space Age Intercom.

The Space Age Intercom consists of two separate units, the

9400 Modulator and the 565 Demodulator.

The 9400 Modulator generates a center frequency of approximately 25 kHz depending upon the setting of the frequency-control potentiometer. It will accept a low-voltage audio signal and cause the center-frequency signal to deviate off frequency. The amount of deviation is dependent upon the amplitude of the audio signal, and the direction of deviation, above or below center frequency, is dependent upon the polarity of the input audio.

The 565 Demodulator, on the other hand, responds to the pulse frequency of the signal at its input. The 565 Demodulator is set to the same center frequency as the 9400 Modulator and generates zero-volt output when the two coincide and are at rest. However, when the incoming pulse train deviates off center frequency, the 565 Demodulator generates a voltage which is proportional to the amount of deviation from center. The polarity of the voltage thus generated is dependent upon the direction of deviation either above or below center frequency. Since the 565 Demodulator is not

***This project is a basic course in pulse-modulation transmission and reception—
and an audio gadget as well!***

PARTS LIST

SEMICONDUCTORS

D1, D2—1N914 silicon switching diode, or 1N4149

IC1—9400 frequency-to-voltage/voltage-to-frequency comparator integrated circuit (Radio Shack 276,1790, or equivalent)

IC2—565 phase-lock-loop integrated circuit (Radio Shack 276-1720, or equivalent)

RESISTORS

R1—5000-ohm printed-circuit potentiometer

R2—1-Megohm, 10%, 1/4-watt

R3—100,000-ohm printed-circuit potentiometer

R4—100,000-ohm, 10%, 1/4-watt

R5, R6—10,000-ohm, 10%, 1/4-watt

R7, R8—560-ohm, 10%, 1/4-watt

R9—5,000-ohm, 5%, 1/4-watt (or two 10,000-ohm, 10%, 1/4-watt resistors connected in parallel)

R10—10,000-ohm printed-circuit potentiometer

CAPACITORS

C1, C6—.01- μ F ceramic disk or epoxy coated, 50-WVDC

C2, C4, C5—.022- μ F ceramic disk or epoxy coated, 50-WVDC

C3—470-pF ceramic disk, 50-WVDC

C7, C8—.1- μ F ceramic disk or epoxy coated, 50-WVDC

ADDITIONAL PARTS AND MATERIALS

B1, B2—6-VDC battery No. 510

MIC1—Dynamic microphone (Radio Shack 33-1054, or equivalent)

2—14-pin DIP sockets for PC board or wire-wrap hook-up

1—Audio amplifier, see text

Note: All required parts are available at Radio Shack stores, or a complete kit is available from M.J. Andrews, Rt. 7, Box 389, Lake City, Fla. 32055 for \$53.42 (includes all parts necessary for one 9400 Modulator and one 565 Demodulator, less perf-board). The following partial kits are also available;

1. All parts less batteries and perf-board, for one 9400 Modulator and one 565 Demodulator, for \$37.18,

2. All parts for one 9400 Modulator and one 565 Demodulator, less batteries, perf-board and audio amplifier for \$22.68,

3. One 9400 V-to-F/F-to-V converter IC plus one 565 PLL IC for \$7.39.

Also, many of the parts can be purchased from the companies that advertise in Radio-Electronics classified section. Check your most recent issue.

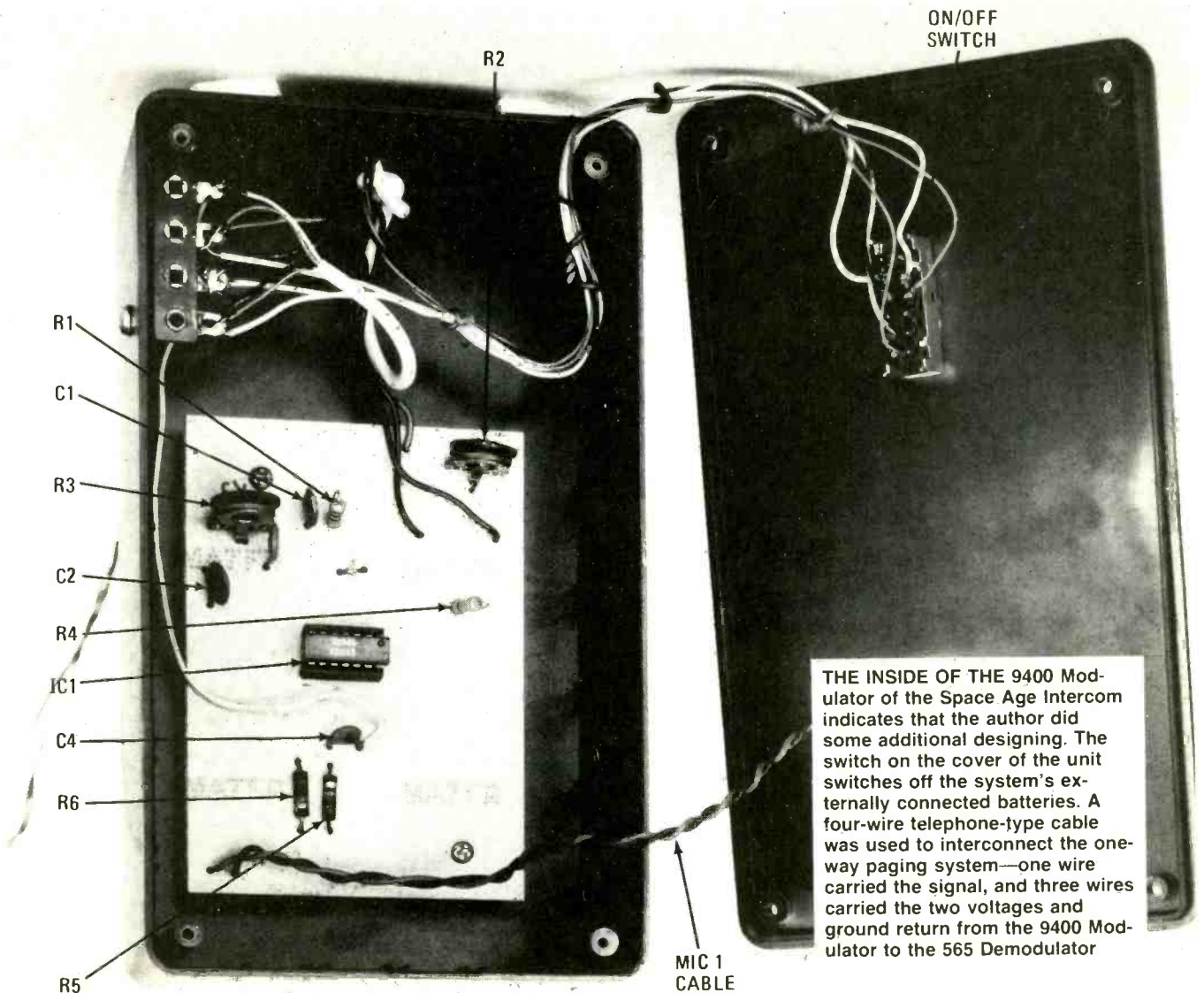

THE INSIDE OF THE 9400 Modulator of the Space Age Intercom indicates that the author did some additional designing. The switch on the cover of the unit switches off the system's externally connected batteries. A four-wire telephone-type cable was used to interconnect the one-way paging system—one wire carried the signal, and three wires carried the two voltages and ground return from the 9400 Modulator to the 565 Demodulator

Construction

Parts placement is not critical nor is the method of construction. Perf board and point-to-point wiring are suitable, although printed circuitry gives a neater appearance. The use of IC sockets is a must because the 9400 uses CMOS circuitry and should not be handled until the circuit is complete. After completion of the wiring, check your work carefully then insert your 9400 chip, IC1, *before* applying power. The microphone can be almost any impedance, dynamic or magnetic type.

After applying power to the 9400 Modulator, check the 9400 for a pulse train on pin 10, IC1 with your oscilloscope input referenced to ground. If a pulse train is not present on the screen, adjust R1 toward the positive side until pulses appear. Then adjust R1 for approximately 25 kHz, making a note of the exact frequency found on pin 10. If you do not have a frequency counter, compare the pulses to a signal-generator output. Temporarily adjust R3 for maximum resistance/minimum audio input.

The 565 Demodulator with no FM signal input should have a free-running center frequency equal to the center frequency of the 9400 (IC1). To obtain that, check the frequency of the waveform at pin 9, IC2. Adjust R10 until you have the same center frequency for IC2 as that of the 9400 Modulator, IC1. Using the appropriate length of intercom cable, connect the modulated signal out of the 9400 Modulator (pins 10, 9, IC1) to the FM signal in terminals of the 565 Demodulator. Connect an audio amplifier to the de-

modulated audio output of the 565 Demodulator (Radio Shacks Mini Amplifier, 277-1008, or their portable phone listener, 43-231, will do well for that application). Adjust R3 to the 9400 Modulator for maximum clean audio sound while speaking quietly into the microphone, MIC1. Be sure to keep the audio amplifier fairly low to avoid feedback while the modulator and microphone MIC1 are in the vicinity of the 9400 Demodulator and audio amplifier. Another method of adjusting the audio-input level is to observe the audio output on an oscilloscope while speaking the letter "I" into microphone, MIC1. That vowel seems to have the greatest peaks in its waveform. While observing the oscilloscope screen, adjust potentiometer R3 on the 9400 Modulator for maximum clean audio at the demodulated audio output (pin 7 of IC2) of the 565 Demodulator.

As a final test, thump the microphone with your finger to make sure the phase-locked-loop chip will not lose its phase lock on strong audio peaks. If it does, readjust the two separate units to the *same* center frequency as previously discussed. If the PLL still loses its phase lock when you thump the microphone, decrease the audio-input level on the 9400 Modulator by adjusting R3.

You now have a Space Age Intercom which can be used in your home for almost anything which requires you to be in two places at one time. By constructing another 9400 Modulator and 565 Demodulator you will have a full duplex intercom with an audio quality approaching that of some of the best commercially available intercoms and at a price you can afford.

SP

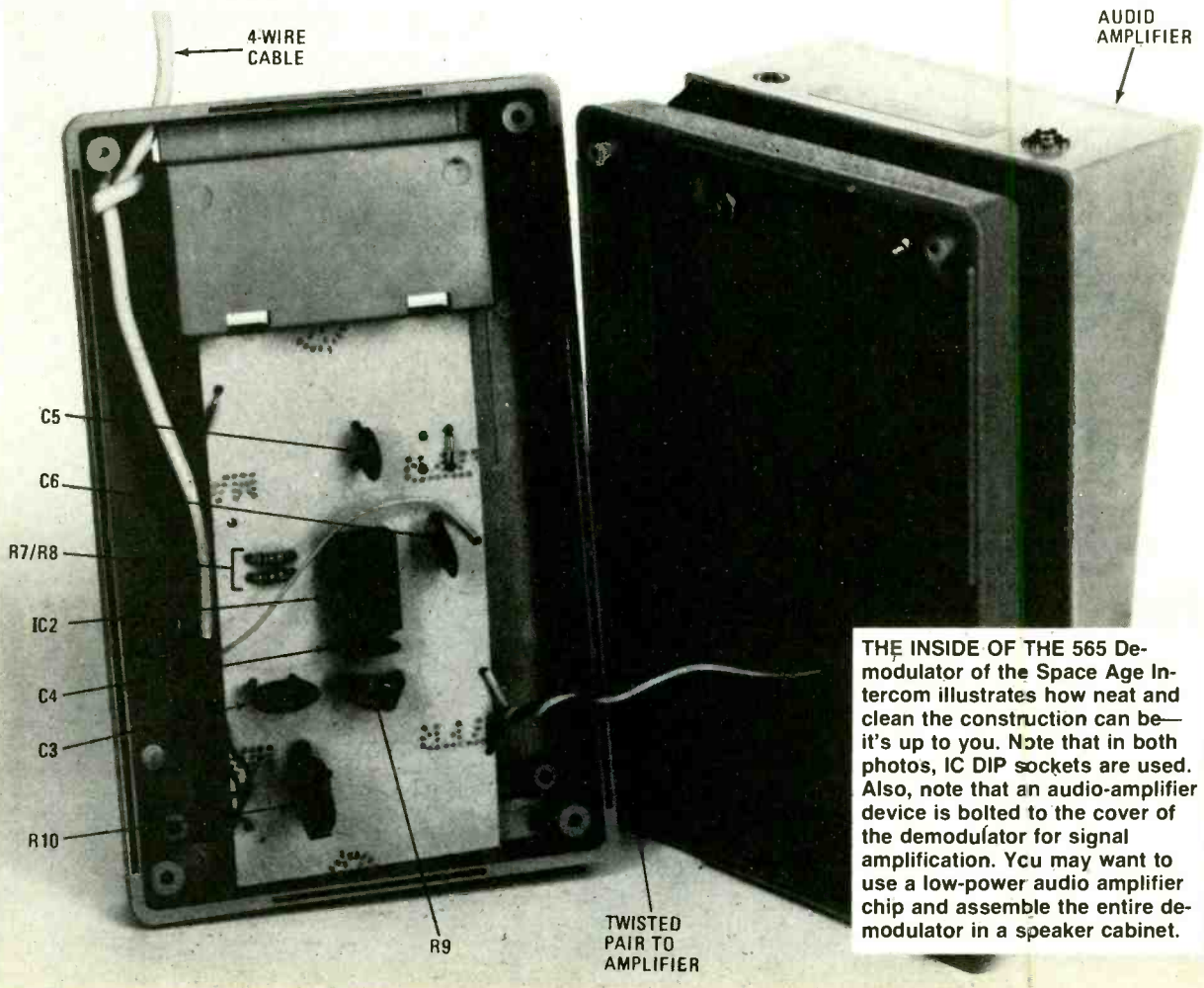

THE INSIDE OF THE 565 Demodulator of the Space Age Intercom illustrates how neat and clean the construction can be—it's up to you. Note that in both photos, IC DIP sockets are used. Also, note that an audio-amplifier device is bolted to the cover of the demodulator for signal amplification. You may want to use a low-power audio amplifier chip and assemble the entire demodulator in a speaker cabinet.

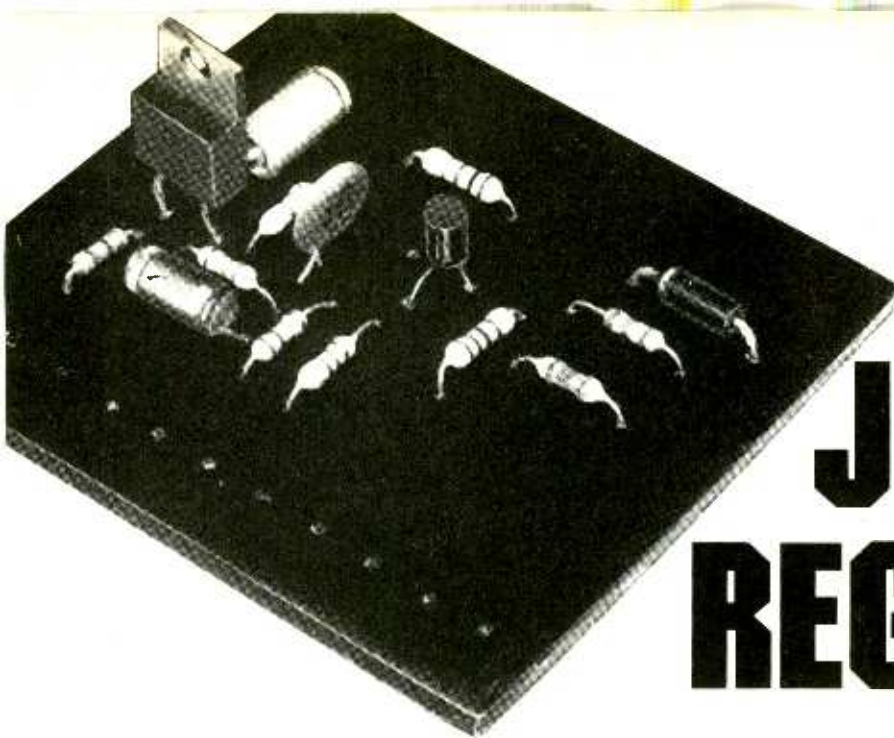

JUNKBOX REGULATOR

Why spend bundles of cash when you can build a replacement regulator for your car's alternator and do a better job than the auto manufacturer?

ROBERT GROSSBLATT

OWNING AN OLD, EXOTIC CAR HAS ITS UPS AND DOWNS. THE pleasures that come from driving it are mixed with the annoyance of having to fix it. If you're the sort of person who likes to do his own work, that means removing a broken part and making a trip to the local automotive transplant shop to find a replacement. A few skinned knuckles and a bit of bargaining are usually part of the replacement price.

Recently my voltage regulator went and I thought that for once I would be able to fix the broken part rather than having to replace it. The regulator turned out to be one of those solid-state units that *couldn't* be repaired—it was in effect, one oversized integrated circuit. When I found out that a replacement would cost substantially more than sixty dollars, I decided to design my own. The design criteria were straightforward. The home brew unit had to be *repairable*, *reliable*, and *adjustable*, and the *parts* had to come from my *junkbox*. I wanted the ultimate inflation fighter.

In order to understand how the Junkbox Regulator works, take a look at Fig. 1, a block diagram of a typical automotive electrical system. The regulator's job is to control the amount of power being fed into the system by the alternator. How much is needed depends on the state of charge of the battery and the electrical demand of the system. In older cars with generators, the output of the generator was a direct function of the engine's rpm. The regulator would then work as a brute-force make-and-break switch at the output. The major advantage of the alternator was the increased degree of control that was possible. The output of the alternator depends on two things—engine rpm and the amount of current being supplied to the alternator's field windings. Since the former is a function of the weight of your right foot, the regulator controls the latter.

At constant rpm, the output of the alternator is a direct function of the strength of the magnetic field in its field windings. The Junkbox Regulator monitors the voltage at the

battery and controls the voltage across the alternator's field windings.

When the ignition switch is turned on, the alternator relay (see Fig. 1) is energized and the battery is connected to the charging system. Without that relay, the battery would always be free to discharge through the field windings of the alternator. Since the windings usually have an effective DC resistance of about four ohms, a simple application of Ohm's Law tells us that there would be a constant battery drain of about three amperes. That would be a definite hinderance to easy morning starting.

Inside the circuit

When power is applied to the Junkbox Regulator (see Fig. 2), the system voltage appears across R5 and the base-emitter junction of Darlington pair Q2 and Q3. Those turn on and current flows through the collector-emitter junction, causing power to be applied to the field windings of the alternator. The increasing alternator output is sampled by Q1 through the resistive divider composed of R1 and R10. At a certain voltage level, Q1 begins to conduct and its collector-emitter voltage begins to decrease, shunting the current from the base of the Darlington pair, and a point is finally reached where they turn off. That reduces the current supplied to the field windings and the alternator output drops off. When the system voltage has dropped far enough, Q1 stops conducting and the voltage at the base of the Darlington pair (Q2-Q3) starts to increase. That turns the pair on again and the whole regenerative business starts all over again.

The oscillation is helped along by the positive feedback provided by C3 and R6. As the Darlington pair (Q2-Q3) starts to turn off, the voltage at its collector increases—causing current to flow through C3 and R6. That helps lower the voltage at the base of Q1 to the point where Q1 turns on completely causing the Darlington pair to turn off. C3 then

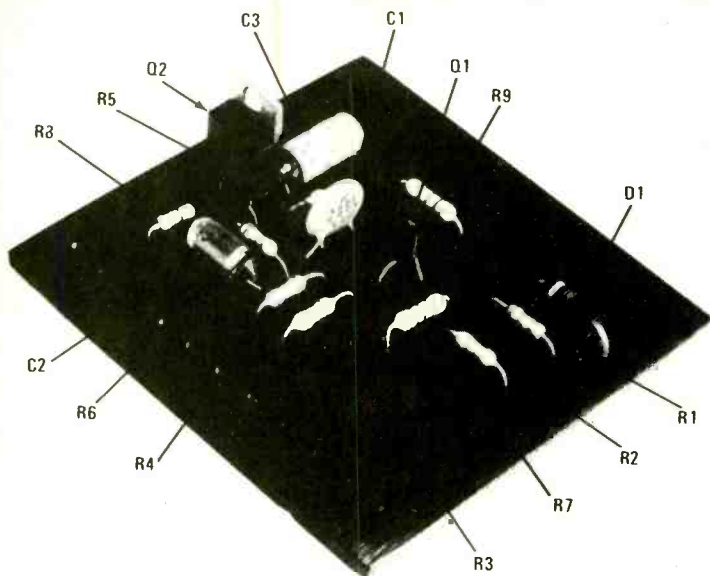

HERE'S THE AUTHOR'S VERSION of the printed-circuit board. It is a very simple layout that any novice can hook-up without any trouble. Transistor Q3 should be heat-sinked. See text.

discharges through R8 and the system voltage drops. Without the current supplied by C3, and because of the reduced system voltage, Q1 begins to turn off again and the voltage at its collector starts to increase. When the voltage at the collector of the Darlington pair drops below the voltage at Q1's base, current flows through C3 in the opposite direction—making Q1 turn off even faster. That causes the Darlington pair to turn *on* even faster and provide current to the alternator field. Diode D1 protects the Darlington pair (Q2-Q3) from being damaged by the induced voltage generated by the

PARTS LIST

RESISTORS

All fixed resistors are ¼-watt, 5% tolerance

- R1—3300 ohms
- R2 4700 ohms
- R3, R5—10,000 ohms
- R4—22,000 ohms
- R6—56,000 ohms
- R7—220 ohms or 100 ohms (See Figs. 2 and 3)
- R8—470 ohms
- R9—1000 ohms
- R10—500-ohm potentiometer

CAPACITORS

- C1—100-pF disc
- C2—50-pf disc
- C3—22- μ F, 35-WVDC electrolytic

SEMICONDUCTORS

- D1—1N4003 diode
 - LED1—red jumbo light-emitting diode
 - Q1—2N2222 NPN silicon transistor
 - Q2—TIP31 NPN silicon transistor
 - Q3—2N3055 NPN silicon transistor
- Suitable enclosure for under-hood mounting, heat sink for Q3, lengths of 12- and 14-gauge wire automotive, heat shrink, hookup wire, hardware, solder, printed-circuit board materials, etc.

Complete set of parts and printed-circuit board available from Hal-Tronix, for \$19.95 postpaid. Be sure to specify whether your car has a "pulled-up field" or "grounded-field" circuit. Send orders to Hal-Tronix, Post Office Box 1101, Southgate, Michigan 48195. Allow 6-8 weeks for delivery.

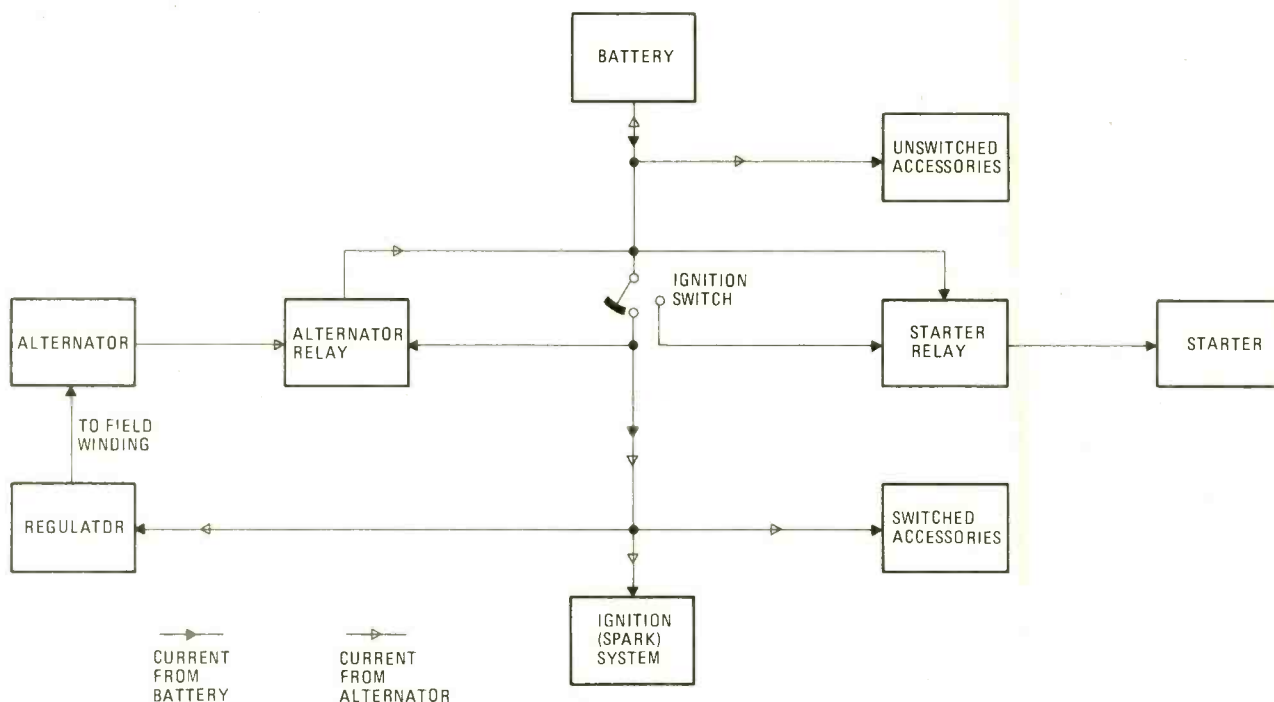

FIG. 1. SIMPLIFIED BLOCK DIAGRAM of a car's electrical system. Solid arrows indicate current supplied by the battery when alternator output is zero. Open arrow indicates power supplied by alternator when its output is charging the battery and supplying some of the power to the car's accessories.

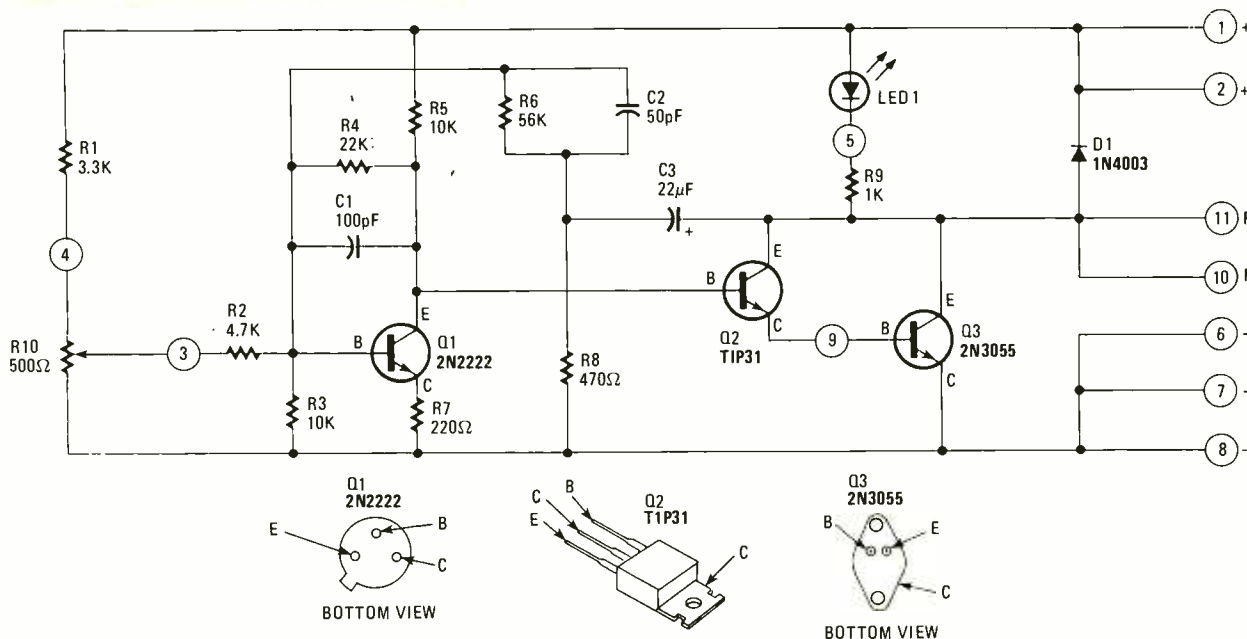

FIG. 2. PULLED-UP FIELD VERSION of the Junkbox Regulator is diagrammed here. The open circles with numbers inside denote printed-circuit board terminals. Potentiometer R10 and LED1 are mounted inside the car's passenger compartment and Q3 is heat-sinked on the cabinet or box used to house the Junkbox Regulator. Q3 must be electrically isolated from ground.

collapse of the alternator field.

Light-emitting diode LED1 gives a visual indication of the amount of power being supplied to the alternator field. Capacitors C1 and C2 help eliminate the effects of radio interference and smooth out the glitches caused by high voltage spikes generated in the electrical system by the ignition (spark) system.

The switching action of the Junkbox Regulator centers around a voltage determined by the setting of R10 and operates over a range of about four volts. If the trip point of the circuit is set to be 13 volts, the output will track along with the input until the trip point is reached. When the input begins

to exceed 13 volts, the output will start to decrease. When the input reaches 17 volts, the output of the regulator will be zero.

A word should be said about C3. During the operation of the regulator current flows through it in both directions. That would seem to indicate that a non-polarized capacitor should be used. I didn't have one when I was building the regulator, so I used a regular electrolytic capacitor instead. It's been in there and working since the regulator was built—more than two years ago. The choice is up to you. You can use a regular electrolytic capacitor as shown in the schematic diagram or replace it with a non-polarized capacitor of the same value.

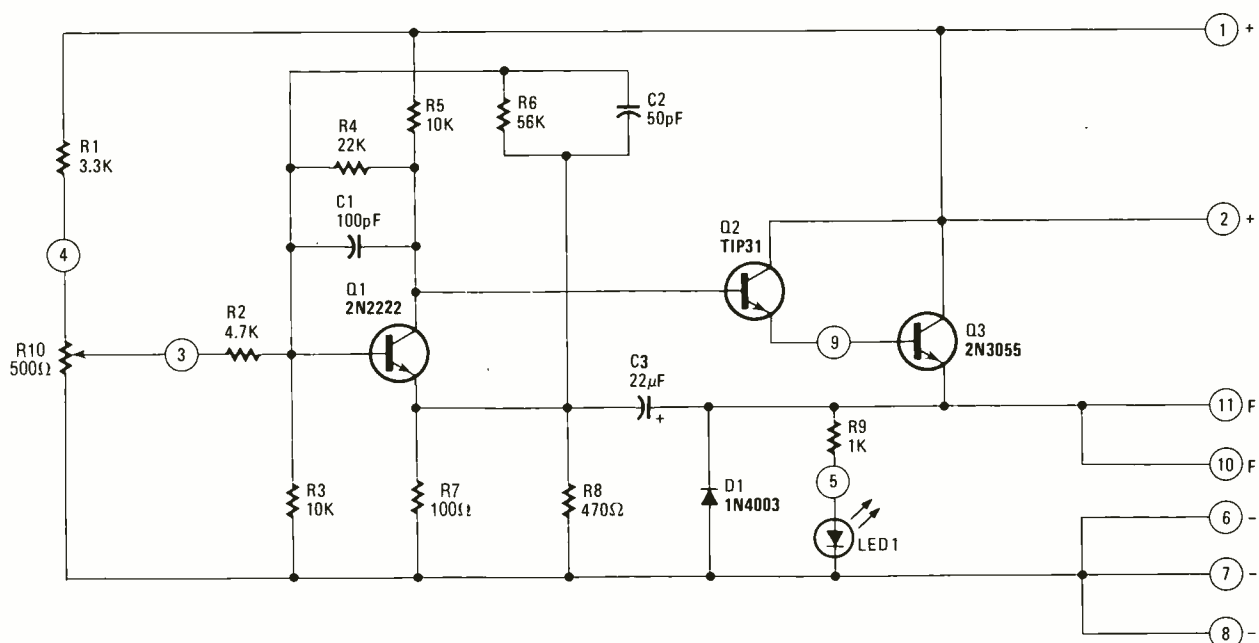

FIG. 3. GROUNDED-FIELD VERSION of the Junkbox Regulator is basically the same circuit as Fig. 2. The printed-circuit approach to construction of the unit is preferred because of its physical strength once properly mounted inside the protective case.

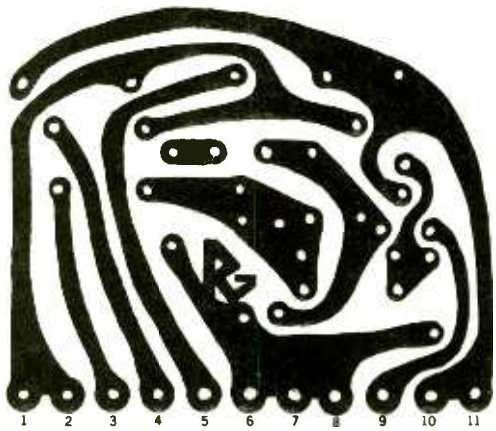

FIG. 4. HERE'S THE FOIL PATTERN for the "pulled-up" version of the Junkbox Regulator. The circuit is simple enough to lay out and etch on a copper-clad board. However, board and parts are offered by a supplier. See Parts List.

Although there should be some difference, there doesn't seem to be.

Now nothing would make me happier than being able to tell you to install the Junkbox Regulator in your car and drive merrily away, thumbing your nose at the parts supplier. Unfortunately, as with most other things, there's a catch. It has to do with the manufacturers, though, and not with the regulator. In a word, although all alternators are pretty much the same, different manufacturers make the field connections differently. Some tie one end of the coil to ground, some tie it to the alternator output, and others make both sides available

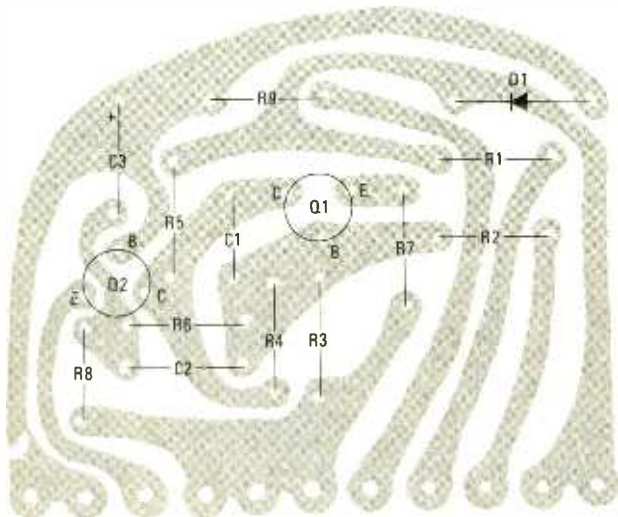

FIG. 5. PARTS PLACEMENT ON THE CIRCUIT BOARD are shown here for the pulled-up field Junkbox Regulator. It should take about one-half hour to solder the board completely and check it.

and do the termination outside the case of the alternator. The Junkbox Regulator was designed to be used in a system in which one side of the field is tied to the alternator output—the so-called pulled-up field. If your car has one side of the field tied to ground—the grounded field system—the junkbox regulator can still be used but *five* modifications have to be made.

The field connection on the regulator has to be made to the emitter of Q3 rather than the Darlington's collector. The collector then has to be connected to the system voltage. Diode D1 has to be moved to straddle the new field connec-

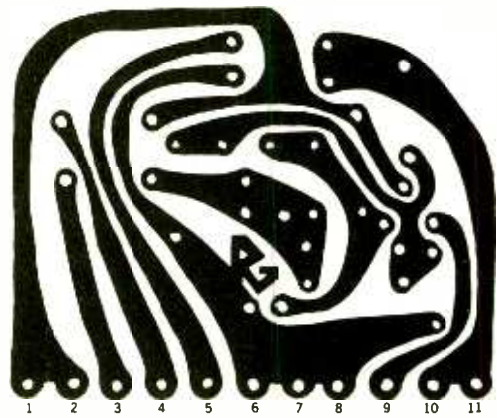

FIG. 6. FOIL PATTERN FOR the printed-circuit board used with the "grounded-field" version of the Junkbox Regulator. Don't get this version of the board confused with Fig. 4, which is almost identical. See text for details on checking your alternator.

tion from ground to the emitter of Q3. Resistor R7 has to be changed to 100 ohms and a jumper has to be installed from the C3/R8 junction to the emitter of Q1. Finally, LED1 and resistor R9 have to be put in parallel with D1 from ground to the emitter to Q3. All those changes are shown in the modified schematic diagram of Fig. 3. If your alternator has both sides of the field coil available externally, the easiest approach is to tie one end to the alternator output terminal, using at least 12-gauge wire. The field connection to the regulator should be made using at least 14-gauge wire, because more than three amps will be flowing through it.

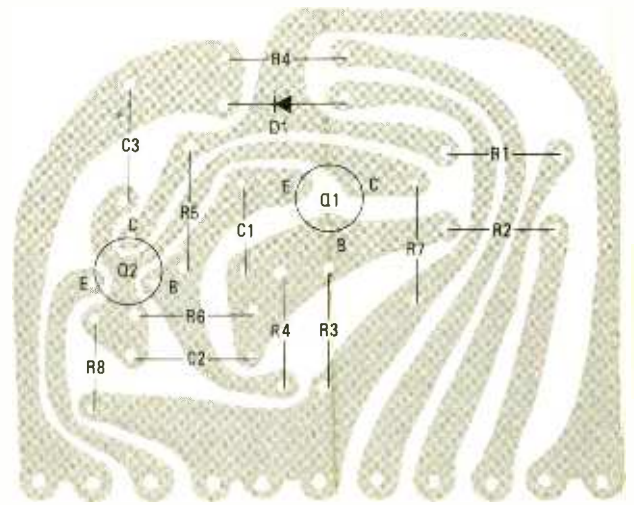

FIG. 7. PARTS-LAYOUT DIAGRAM for the "grounded-field" version of the printed-circuit board. Circuit board is shown with foil side down with the parts mounted on top.

Check out the car

The first thing to do is to check your car and see what the manufacturer has done with the field leads. That is simple to do and requires nothing more exotic than a voltmeter. With the ignition switched on but the engine *not* running, clip the negative lead of the meter to the terminal marked "F" on your existing regulator. Connect the other lead to the positive terminal of the battery. If you get a reading of about 12½ volts, (the battery voltage), your car has a pulled-up field and the original circuit for the Junkbox Regulator should be used. You can check that farther and make sure by measuring the

voltage from the "F" terminal to ground, remembering to reverse the leads. You should read close to zero volts.

If you read zero volts from the "F" terminal to the positive side of the battery, your car has a grounded field. Check that by reading the voltage from the "F" terminal to ground. You should see close to the battery voltage.

Construction and mounting

There is absolutely nothing critical about the construction of the Junkbox Regulator. You can use wire wrap or a printed-circuit board. Figs. 4 and 6 show the foil patterns for both configurations of the regulator. Transistor Q3 should be thermally secured to the heat sink, using thermal grease, and should be mounted outside the case in the air-stream.

If you're one of those poor unfortunates whose voltage regulator is an integral part of the alternator, things will be a little more difficult. You'll have to open the regulator and locate the field and alternator output connections. Determine which field-terminating system is being used in your car and then run wires of the correct gauge from the alternator to wherever you decide to locate the Junkbox Regulator.

Although R10 and LED1 *can* be mounted on the outside of the regulator case, it's much more practical to run wires and locate them on the dashboard. There are few things more

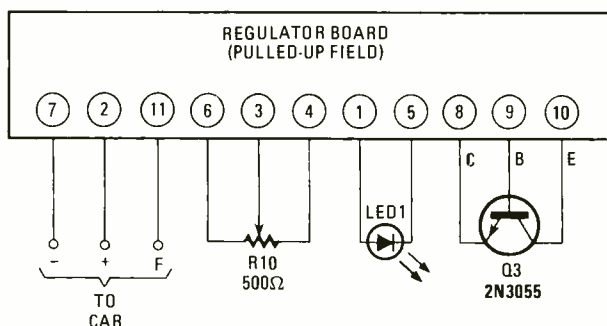

FIG. 8. INSTALLATION GUIDE FOR PULLED-UP FIELD Junkbox Regulator. Refer to text for wire-gauge sizes. Wires can either be soldered directly to the printed-circuit board or to screw-post terminals on the case housing the unit. In either situation, be sure that the external leads are taped to existing cables for a neat run through the engine compartment and under the dash.

comforting than watching the LED indicator light modulate in step with the field current. It tells you what the regulator is doing and shows the state of your car's entire charging system. If the LED is on full and your car's voltmeter indicates that the system voltage is still hovering at the battery voltage, it's an indication that something is wrong with the electrical system. In that case it could be a broken alternator lead, a loose fanbelt, or, heaven help your bankbook, a defective alternator.

By having R10 and LED1 on the dashboard, you can easily regulate the charging rate of your battery. On a rainy summer's night, with all of your car's electrical accessories running full blast, it's a pleasure to be able to increase the charging rate. That is especially true when you're stuck in bumper-to-bumper traffic and your temperature is rising along with the car's.

There are 11 terminals on the PC board. Three of them are for the connections to Q3 on the case. Figs. 8 and 9 show the installation of the Junkbox Regulator for the pulled-up and the grounded field configuration. The eight leads to the car can be made with a barrier strip attached to the case. Whatever method you use, **make sure to use the correct gauge**

wire! If you use a metal case, make sure you insulate the board and the connections to Q3. Check to see that there are no burrs on the holes through which you've routed the wires. It's a good idea to use heat shrink on all the leads in the case.

Calibration

Once the regulator is installed in the car, calibration is simple and only requires a voltmeter. Connect the leads across the battery and start the car. Adjust R10 to make the system voltage about 13½ volts. Accelerate and watch the LED. It will start to flicker and go out as engine rpm increases. The system voltage will rise as well and should then drop off when the LED goes out. Make sure that the system voltage is not allowed to exceed 17 volts. If it does, readjust R10 so that the LED goes out slightly before that.

If the 4-volt range of the Junkbox Regulator doesn't suit the particulars of your car, you can affect it by changing the value of C3. Raising the value will increase the range, and

FIG. 9. INSTALLATION GUIDE FOR GROUNDED-FIELD Junkbox Regulator. Mount the finished unit on the fire wall of the car or on a bracket where cool air will pass over it. Be sure not to mount the unit over the engine where excessive heat will rise up without a cooling blast of air when the motor is off.

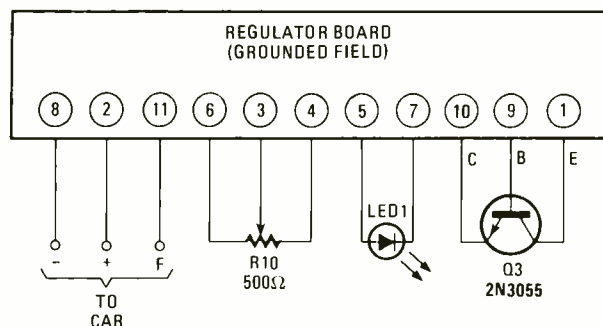

lowering the value will decrease it. You can try that on your workbench by connecting a tail-light bulb in place of the field windings and using a variable power supply. As you increase the applied voltage, the bulb will get brighter and brighter. When the trip point is reached, the bulb will start to flicker and then go out as the voltage is raised still farther. The only comment I can make, as far as the range of the Junkbox Regulator is concerned, is to check your owner's manual and see if a maximum system voltage is given. More than likely it won't be there and you'll have to use trial and error with the unit actually installed in your car. The rule of thumb here is that it is *never* a good idea to let the voltage in the electrical system get much past 17 volts.

A regular Darlington can be used in place of the Q2-Q3 combination but that would have violated one of the design criteria—namely that all the parts had to come from the junkbox. There is nothing more annoying than finding the plans for a project that is exactly what you need and then discovering that the key parts are only available in quantities of a thousand and have to be mail-ordered from a box number located twelve-point-seven miles from nowhere.

The Junkbox Regulator has been working in my car for over two years and I do a lot of driving. As someone once said, it's taken a licking and keeps on ticking. Being able to monitor and control the charging rate while I'm driving has been extremely useful and has also retarded the rate of proliferation of gray hairs on my head. It's done the same thing for my wife—and that's really something to think about!

SP

BENCH-TOP POWER SUPPLY

J. A. HOUSER

Power up CB's, auto radios and cassette decks, stereos, B&W color TV's, VCR's, and other consumer-electronics gadgets on your test bench when troubleshooting, modifying, and fixing them!

THE REQUIREMENTS FOR A UNIVERSAL BENCH TOP POWER SUPPLY for shop use today are far more stringent than those that would have been satisfactory only a few years ago. A brief review of the present situation indicates that the following voltages should be available:

1. **AC voltages** from below 90 volts to at least 130 volts.
2. **DC voltages** such as 12 volts at 5 amperes minimum; 17, 19, 20, 30, 50, 70, 120, and 170 volts at 2 amperes minimum; and variations between the above voltage ranges at the specified current.
3. **Reasonably accurate metering** (within about 2%) for all voltages and currents.

The Bench Top Power Supply described in this article will meet all the above requirements, unlike the mass-produced commercial power supplies on the market today. Those supplies that are being offered often meet only some of the specs, and are extremely expensive to boot.

What you need

The Bench Top Power Supply was built mainly out of junk-box parts. About the only new items used were the 10-ampere rectifiers. Even the variac was a used one that had been through three or four hands before the author found it.

Almost any kind of meter can be used, from a 1-mA DC movement to a 10-mA DC movement. In a pinch, if all you have is a 50-mA meter, you can get by with that, also. Of course, the design and calibration will have to be altered somewhat to fit the type of meter you are going to use. But the method of calibration described here should be sufficient to allow you to calibrate any type of meter that you are going to use. There is only one caution: If you use a 50- μ A meter, be extra careful when you start to calibrate it, so that you don't burn it out. If in doubt, always use higher series resistances to start. You can always reduce the resistances to the required value, but if you start with too-low resistance, the meter might pop on you.

Don't skimp on the DC rectifiers. Don't use less than 10-A stud type. It's cheaper to blow a fuse than to burn up the rectifiers.

About the specs

The Bench Top Power Supply was specifically designed for operating CB's, audio radios, stereos, B&W and color TV's, VCR's, and almost any other type of consumer-electronics equipment. The voltage and current ranges are adequate. You can use the power supply as a substitute 12-volt or 20-volt supply for the start-up circuits in color TV's when the fail-safe circuit is shutting the set down, until you find the reason. You can also use one of the higher voltage ranges out of the DC supply with the variac cranked up to 130-volts AC limit. You will find that you will get about 160 to 170-volts DC for powering TV-set voltage to operate the flyback transistor if that voltage has failed from the built-in power supply.

A 5-times expansion switch was added for reading the DC (or AC) low voltages so that you can read lower voltages with more accuracy. On the higher voltage scales, the accuracy may not be too important, but it certainly is when you wish to get 12 or 20 volts. That way, you can get within 1-volt accuracy without any difficulty.

You probably want to know why an AC and DC ammeter was incorporated in the instrument. That is because more and more TV, CB, and other device manufacturers are starting to specify the current that the device should draw under normal operating conditions, and also advising the repair shops about some of the repair factors to be considered if the device draws less, or more current than the norm specified. Sometimes that is a valuable aid to the serviceman working on the unit.

In color TV's, sometimes the manufacturer will even give the service shops the normal current which the scan-derived power source should draw to power other parts of the set. Thus, when the serviceman is troubleshooting the unit, he can know whether the current drain is excessive enough to actuate the shutdown circuit (which will disable the entire horizontal sweep and flyback, and high-voltage circuits).

It is difficult to estimate how much a power supply like this will cost any individual builder. The author's power supply cost less than \$100. The used variac cost \$15, the most expensive item. The used meters cost \$5 each. The 10-A

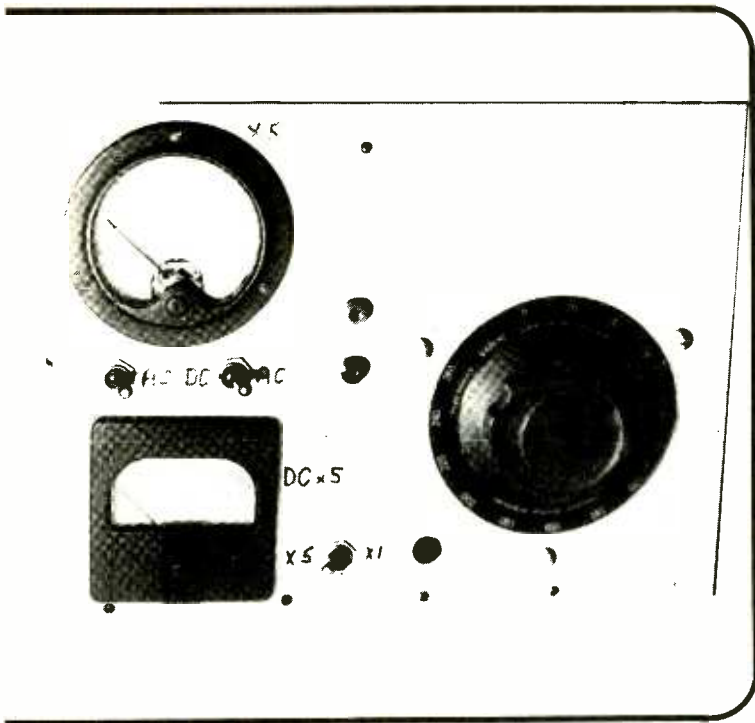

The front panel of the Bench Top Power Supply may not look very professional at first glance; but when it supplies the power to test and repair a defective radio or television set, its true value is immediately discovered.

furnish up to 5 amperes at low voltages without overheating.

The two DPDT (AC/DC and AC/DC METER) switches between the two meters are for changing from DC to AC, or vice versa. See Fig. 1. The lower (multiplier current switch) switch to the right of the ammeter in the photo is for changing the ammeter from X1 to X5 range, i.e., from 1-A full scale to 5-A full scale reading. That switch is a SPST bat handle. It accomplishes the X1 to X5 range merely by opening or closing the switch. The meter shunt consists merely of two pieces of #24 wire, one 6 inches long from one switch terminal to an ammeter terminal, and one 4 inches long from the other switch terminal to the other ammeter terminal. Of course, those lengths were determined experimentally, to obtain a 5X shunt for the meter, but it wasn't difficult, starting with longer pieces and then shortening them until the desired length was obtained. The range of any DC ammeter can be changed by this method with a little experimentation: You set a load across the supply to give full-scale reading; then if you want a 5X shunt, connect a length of wire across the meter terminals until the meter reads 1/5th of full scale.

rectifiers (four are used) and heat sinks cost \$5 from a surplus house.

A word of caution: Be super-careful! Use instruments, like the Bench Top Power Supply with a 1:1 isolation transformer in addition to the isolation transformer used with the set under service. That way you will not be subject to unexpected sparks or shock at any time, as neither the set being worked on nor instrument are directly connected to the AC mains with a common ground at any time.

Metering the output

The Bench Top Power Supply uses a 100-volt DC GE Meter Type DO-41 Model VCB for the voltmeter. It has a GE 0-1 ampere meter Model ABL-221 Type DO-53 ammeter and a General Radio Type 200 CH variac rated at 230 volts maximums, 50/60 cycle at 2 amp maximum, but it will

Some construction tips

The two banana jacks are used for plugging in leads as required; for DC they are polarized—red (J1) for positive, and black (J2) for negative. See Fig. 1. For AC, use a twisted 2-lead cord terminating in a 3-way AC socket. There is no

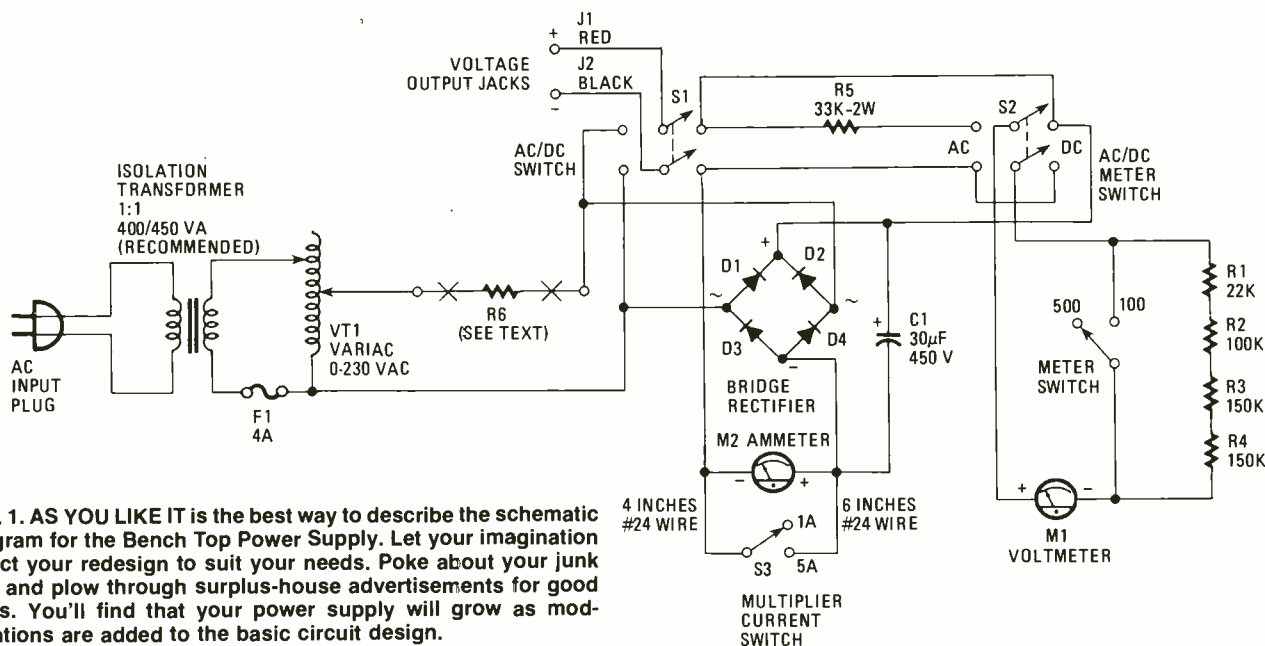

FIG. 1. AS YOU LIKE IT is the best way to describe the schematic diagram for the Bench Top Power Supply. Let your imagination direct your redesign to suit your needs. Poke about your junk box and plow through surplus-house advertisements for good buys. You'll find that your power supply will grow as modifications are added to the basic circuit design.

PARTS LIST

Note: Parts listed here are suggested items that will vary in your installation due to parts availability in your junk box and surplus items that you can obtain inexpensively. Also, your redesign of the unit to your bench-top needs may require a complete redrafting of the schematic diagram shown in Fig. 1.

- VT1—Variac-type autotransformer, 0-130-VAC, 400-VA or better
- F1—4-A with fuse holder—select rating for lowest permissible primary current flow in transformer used with the power supply
- M1—Voltmeter, see text
- M2—Ammeter, see text
- D1-D4—10-A stud-type diode rectifiers mounted on heat sinks, see text
- C1—30- μ F, 450 WVDC electrolytic capacitor
- R1-R6—Selected resistance values to match meters used with power supply, see text
- J1-J2—5-way terminal-type jacks with fitting for banana plug, one red and one black
- S1-S2—DPDT heavy duty power switches rated at 250-VAC at 15-A
- S3, S4—SPST toggle switch rated at 125 VAC at 15 A
- Isolation transformer, 1:1, 400/500 VA or better

need of a grounding conductor. For DC you can use two plugs terminating two lead wires with clip leads, or any other means you prefer.

Looking at the back-view photo of the power supply, the AC-supply cord (with switch in the cord) comes in one side to a 4-A fuse, F1, and then to the variac, VT1. From the variac, the leads go to the 2-way switches, and then to the meters and output jacks for AC.

For DC output, the variac, VT1, leads go the bridge rectifiers, R1-R4, (10 amp. stud type) on a heat sink, then to the filter capacitor, C1, which is a 30 μ F at 450/500 volts, and then to the two meters and switches, through which the output gets to the output jacks.

Two of the rectifiers, D3 and D4, are mounted directly to the heat sink which forms the minus (–) DC terminal. The other two diodes, D3 and D4, must both be insulated from the heat sink.

To make the 100-volt meter read 500 volts full scale, four resistors (R1-R4) in series are used (for this meter), a 22,000, a 100,000, and two 150,000 ohms, all 1-watt resistors. See Fig. 1. It is easier to use four low-wattage, high-ohmage

resistors in an application such as this, instead of trying to get a higher wattage resistor (single) of the exact value you might want. That holds true for multiplying the voltage range of any voltmeter. Of course, those resistors are always connected in series with one leg of the voltmeter, not across the terminals.

The circuit diagram (Fig. 1) for the Bench Top Power Supply is self-explanatory. When you build a supply like this, you can, of course, use your own discretion and preferences as to parts, as long as you do not use under-rated components which are likely to short, burn out, or otherwise give trouble. In an instrument like this, as no other, quality of parts pays off in the long run.

The Bench Top Power Supply does not provide for alternating-current measurement, which to many service people and amateur repairmen is unnecessary. However, if you wish to incorporate alternating-current metering when building the Bench Top Power Supply, here are the details.

Connected to the variac wiper arm, VT1, are two points marked X and X (see Fig. 1). To incorporate alternating current measurement, break the shorted lead between the two X's and insert resistor R6. That resistive device, R6, can be 10 turns of #16 or #18 wire wound around 1/2-inch-diameter form. From points X and X, two leads can be run to an ammeter circuit of your choosing. Insert a series ON/OFF switch to isolate the ammeter circuit when not in use.

If you wish, you can also put an ON/OFF power switch on the front panel, and a neon indicator light to tell if the unit is on or off. Although the variac shown is a 230-volt model, it is used only as a 110-volt type which gives AC variation to 130 volts and DC to 170 volts.

If you use other types of meters, consult any good text on basic electricity and it will tell you how to adapt about any meter to any range of AC or DC voltage or current.

Now, power up your Bench Top Power Supply the next time you go to work on an appliance that needs fixing—you now have the volts and the amps you need. **SP**

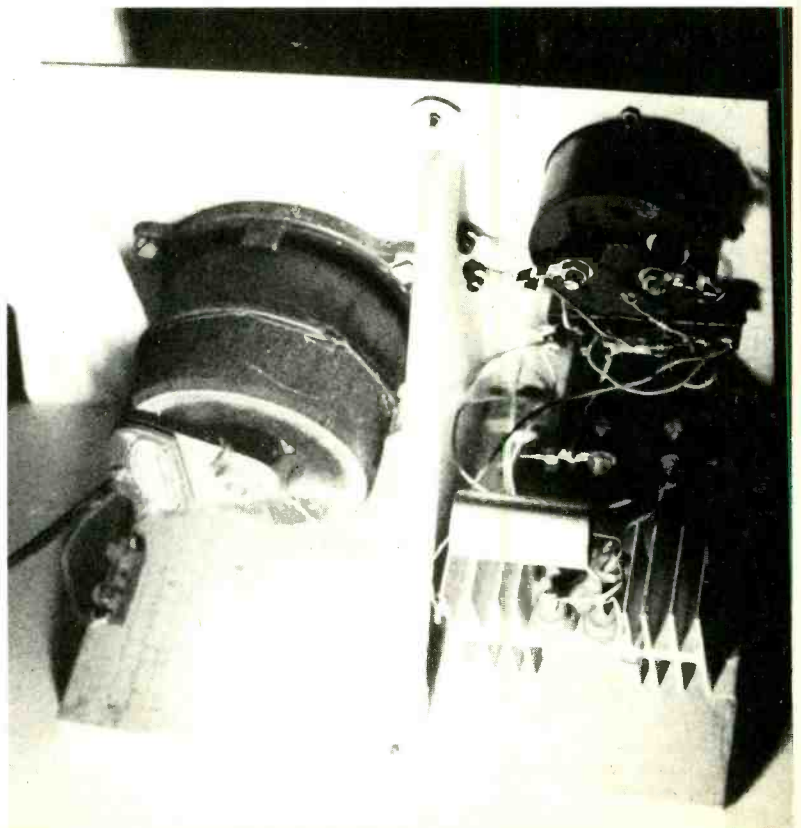

REAR VIEW of the author's Bench Top Power Supply. Construction is similar to the original "bread-board" technique used years ago when solderless gadgets were unknown and wood was still cheap. You may want to enclose the rear deck with a box surface of peg-board Masonite. Note that there is plenty of room for circuit additions for your particular needs.

Rapping on...

WIRE WRAP

HERB FRIEDMAN

ALMOST ALL PROJECTS BEGIN ON A BREADBOARD, A WIRING device that allows components and interconnections to be assembled and changed in their design stage with ease. While some hobbyists utilize the finalized breadboard as a working project, most will transfer the design to a permanent assembly, using either point-to-point wiring on a perfboard or an etched printed-circuit board.

There is, however, a method of breadboard construction—called *wire wrap*—that permits almost instantaneous changes to the circuit and wiring; yet it ends up as a permanent working device, having as much reliability as point-to-point or printed-circuit assembly.

The technique of wire wrapping originated as a means to speed up factory assembly of consumer-electronics equipment such as television receivers. It was back in the era of vacuum tubes, before there were machines to insert components into a printed-circuit board automatically, that manufacturers looked for ways to reduce the damage caused by excess soldering heat and reduce the labor required to mechanically secure and solder each connecting wire. It was discovered that a wire *tightly wrapped* many times around a square terminal pin resulted in a connection as secure and reliable as a solder connection. The corners of the pin “bit” into the wire at the corners of the mounting post and actually “welded” the wire to the post. The connection was “solid”—often more so than soldered connections because there was no longer the possibility of a cold solder joint.

Wire-wrap assembly proved to be particularly advantageous for hobbyists and experimenters building solid-state projects because it permitted easy modification to the circuits without the possibility of soldering-heat damage. Because the wire-wrap connection method was originally an industrial technique, early hobbyists and experimenters using wire wrap had to scrounge the parts and tools from industrial dealers at industrial prices. Today there’s a broad selection of

wire-wrap products specifically intended for the hobbyist and experimenter.

Tools and parts

As a general rule, except for some industrial-surplus component-mounting hardware such as IC sockets and terminal pins, most of the wire-wrap equipment available to hobbyists is provided by the OK Machine & Tool Corporation, even when it’s sold under some other brand name; so we will illustrate wire-wrap techniques specifically with the OK products that are generally available through electronic parts stores and distributors nationwide.

To start, we need wire-wrap wire. The usual hobbyist grade is solid #30 Kynar insulated, available in rolls, and in precut/prestripped lengths. It’s usually available in four colors: red, blue, white, yellow. The rolls are available three ways: as a 50-foot open roll, as a 50-foot roll installed in a plastic dispenser that contains a built-in cutter and a device for stripping away the insulation, and in *tri-packs*, which consist of three compact 50-foot rolls of wire—each a different color—in a single dispenser.

Wire to wrap

Then, we need something to wrap the wire around the terminals, and here the sky is the limit. For industrial use there are air-driven and electric-driven wire-wrap “guns” that cost upwards of \$200. While they might be needed to produce a wrap tight enough for military and space equipment, hobbyists and experimenters can get by with less expensive equipment.

In gun-type wire wrappers, there is the OK *model BW-630* moderately priced hobbyist-grade, battery driven, wire-wrap gun (uses two “C” NiCad or alkaline cells) for those who must rush like the hammers of hell. The gun only wraps, it does not unwrap. For those in less of a hurry, or with a more



THE WIRE-WRAP GUN spins the wires on fast, but that’s all it does, at considerably greater cost than the small hand tool that wraps, unwraps, and strips the insulation.



THIS WIRE WRAPPING STARTER KIT contains the hand tool, a PC board, some sockets, and a roll of Kynar wire—all the newcomer needs for his next electronics project.

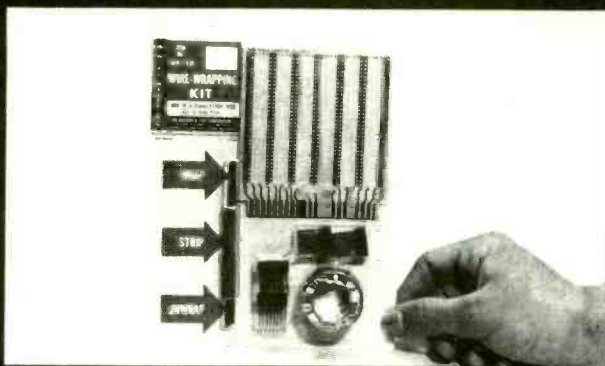

WIRE IS AVAILABLE FOUR WAYS—The bare roll (foreground), or left to right, the roll in a plastic dispenser, three different color rolls in a dispenser, or precut/prestripped.

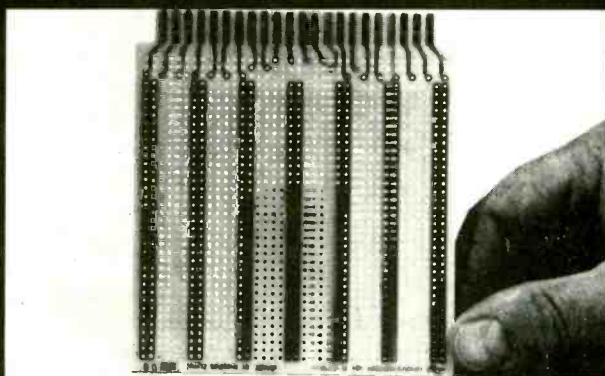

THIS IS THE "TOP" SIDE of the recommended printed-circuit board, the one supplied in a wire-wrap starter kit. The bus strips are only used if needed.

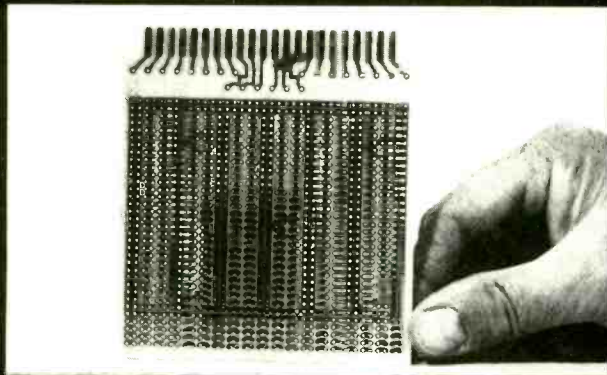

THE FLIP SIDE of the board shows the foil pads. The purpose of these pads near the holes is to permit the sockets and terminals to be tack-soldered in place.

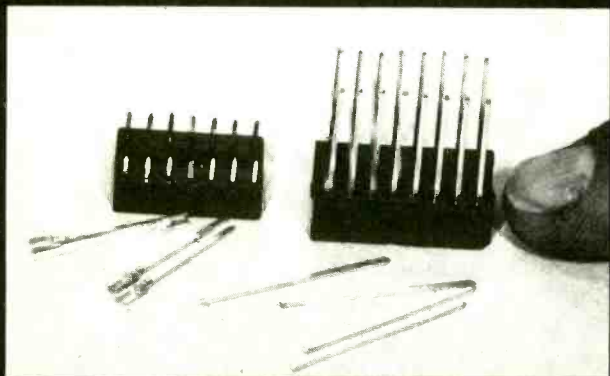

THE WIRE-WRAP IC SOCKET compared with the standard printed-circuit type on the left. The obvious difference is the extra-length terminals made of sturdier material.

restrictive budget, there's the under-\$10 OK model WSU-30 hand tool that can both wrap and unwrap wire, as well as strip the insulation. The reversible ratchet action comes from your wrist! In fact, the wire stripper built into the tool is better than all the other gizmos and gadgets used to strip insulation from Kynar wire: It does the job with the least fuss and the least damage to the wire itself—no nicks means no breaks.

Sockets and stuff

So we have the wire and wrapping tool; next we need something to wrap the wire around. Every size DIP IC socket from 8 to 96 pins is available in a wire-wrap version, with a terminal-pin length sufficient for at least three, possibly four wire-wrap connections per pin. The sockets are secured to some form of wiring board (which we'll get to a little later). For non-IC components such as resistors, capacitors, transistors, and wire connections there are terminal pins that pass through the wiring board. Some pins have slotted heads into which component leads can be placed, others have round heads, and some have no heads—wires can be wrapped around either end. Some pins are what is known as an IC socket terminal. One end of the pin is hollow for IC or transistor leads. If installed on the board in two in-line rows they can serve as an IC socket.

We have the wire, the wrap/unwrap/strip tool, the sockets and the terminals; now all we need is something—a board—to hold the sockets and terminals and we're ready to wire our next project. Among the earliest board products used by experimenters for wire-wrap assembly was ordinary matrix perfboard, matrix meaning that the holes in the board were punched in a grid formation of rows and columns. Usually, socket terminals were passed through the perforations and the socket was cemented to the board with a drop of adhesive.

Terminal pins were something else. If the perforations were narrower than that of pins, the pins were forced through the board, kept in place by the fact they were force-fit. If the holes were larger than the pins, the experimenter had to figure out some way to wrap the wires before the pins fell out of the board. It was a sloppy, difficult way to do things but it was cheap, and many hobbyists have had good success using perfboard.

Using boards

A far easier way to do wire-wrap assembly is with a form of perfboard having solder pads. For some reason that is often called PC (printed-circuit) board. (It sure *isn't* printed circuit but we're stuck with the nomenclature, so we'll also call it PC board—but remember that the board has perforations in rows and columns spaced on-tenth of an inch apart.)

PC board with pads has just what the name implies: On one side each hole has at least one ring of tinned copper around each hole. Some boards have the holes as well as strips, which connect some rows of holes together so they can be used conveniently as a bus, such as a ground bus. The user slips the socket leads through the holes and then solders one or two corner leads to a pad to hold the socket in place. It's the same thing with a pin. The pin is passed through a hole and then tack-soldered to the pad to hold it in place. You can even pass a component lead (from resistor, capacitor, etc) directly through a hole, solder it in place, and then fold the lead across several other holes to form a bus, or the lead can be bent and soldered to a pin terminal. The solder pads make the system much more flexible.

The special PC boards for wire wrap come in several sizes

and pad configurations, though only one is easy to get from local stores. One style is a square PC board with corner mounting holes; another is somewhat similar but it has contacts along one edge for installation in a multicontact socket.

The board intended for a socket is the type most easily obtained. If you don't need the contact edge you can cut it off. In fact, any wire-wrap PC board can be cut down to the desired size. One board in particular, the OK model H-PCB-1, is specifically intended for hobbyists and is the easiest to use: it's the one shown in the photographs. It has dual solder pads arranged in rows on one side and pads, strips, and buses on the other. By careful positioning of the sockets and pins the board's own bus structure can provide many of the connections, sharply reducing the project's assembly time.

Kits make it easier to buy

You can purchase the necessary wire-wrap supplies individually or you can get a starter kit, which consists of a generous quantity of the items you'll need to get started with wire wrap. For example, one kit contains a wrap/unwrap/strip tool, a socket-type PC board, several sockets, and a roll of Kynar wire. Another readily available kit contains the tool, a roll of wire, and a very generous assortment of pre-cut/prestripped wire in four sizes. Finally, there's a kit that contains a PC board, a board socket, IC sockets, the tool, and both an IC puller and an IC inserter.

Wrap up

Keep in mind when you're preparing the component layout, that wire wrap allows for a lot of easy experimentation. For example, if you think you'll be experimenting with different values of resistance and capacitance, provide an extra pair of pin terminals across which you can clip or solder different component values. And provide an extra pin if you think you'll be moving a connection, or make certain it's the last one wrapped on the pin so it can be unwrapped without disturbing the other connections. A wire that's been unwrapped cannot be easily wrapped again because the deformation interferes with its placement in the wrapping tool. Discard an unwrapped wire and substitute a completely new wire. The few extra seconds can save a lot of hassle.

Once you have decided on the general layout and mounted the hardware on the board, there's not much to wire-wrap assembly. About the only precaution is not to stretch the wires tightly; a wire that's bent tightly around a square pin might cause the edge of the pin to cut through the insulation, thereby causing a short circuit.

Wire-wrapped connections do not have to be soldered for reinforcement. As flimsy as you might think they appear, they are tight. However, if your project uses more than one board, and connections between the boards are through direct wires rather than by sockets, it is suggested a heavier insulated hookup wire such as #24 or #22 be used to interconnect the boards. The ends of those wires should be soldered to the pins.

The photographs illustrate many of the different kinds of wire-wrap accessories generally available to hobbyists and experimenters. Sockets and terminal pins are often available at very good prices from the surplus dealers. Tools and boards are rarely found as surplus. If you can't find some version of them at your local store they can be ordered direct from OK Machine & Tool Corporation. In fact, you should send for OK's catalog and price list—there's no charge. Write to OK Machine & Tool Corporation, 3455 Conner St., Bronx, NY 10475.

SP

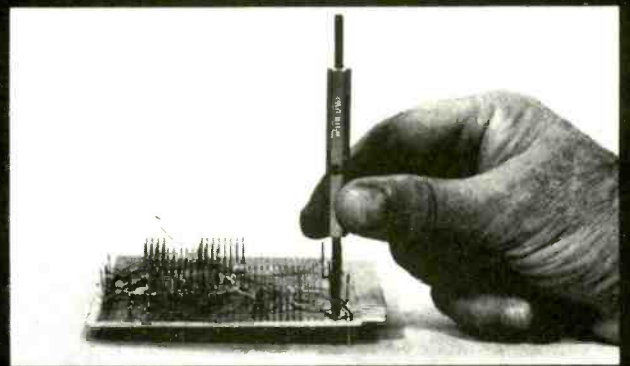

TO APPLY THE WIRE-WRAP WIRES, place an end in the tool, place the tool over a terminal, and twist. When you lift the tool clear, the wire remains secured on the terminal.

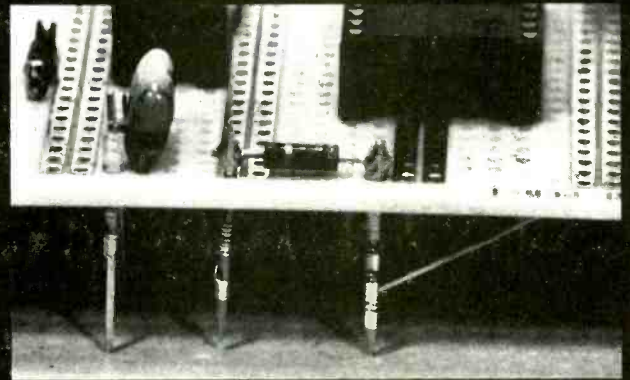

THIS FIXED RESISTOR is connected across two slotted pins. Note that the right resistor pin has three wires connected on the underside of the printed-circuit board.

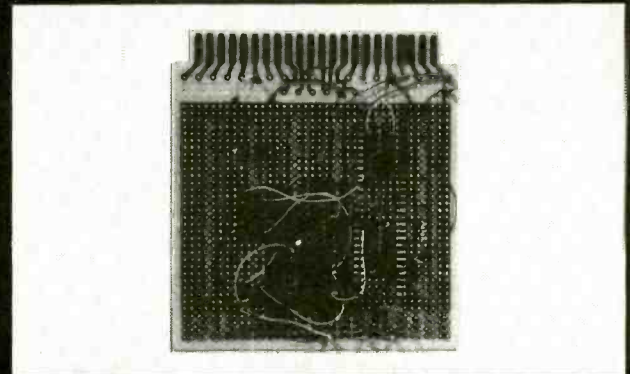

THE UNDERSIDE of the board looks like a rat's nest, but by using multi-color wiring it's easy to trace the circuit for tests, troubleshooting and modifications.

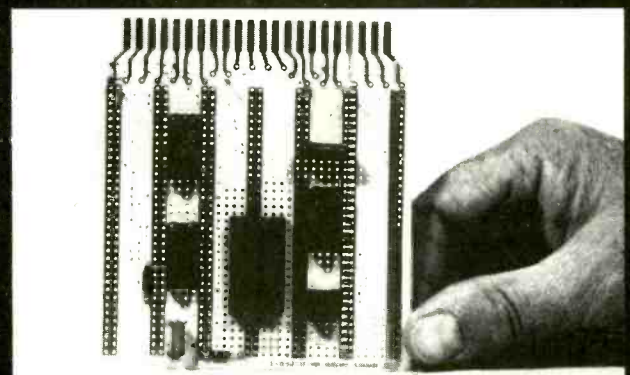

UNLIKE THE UNDERSIDE of the printed-circuit board, the top of the board is clean. It resembles an ordinary perforated printed-circuit board commonly used.

**That miserable buzzer in you car—
replace it with the....**

ELECTRONIC CHIME

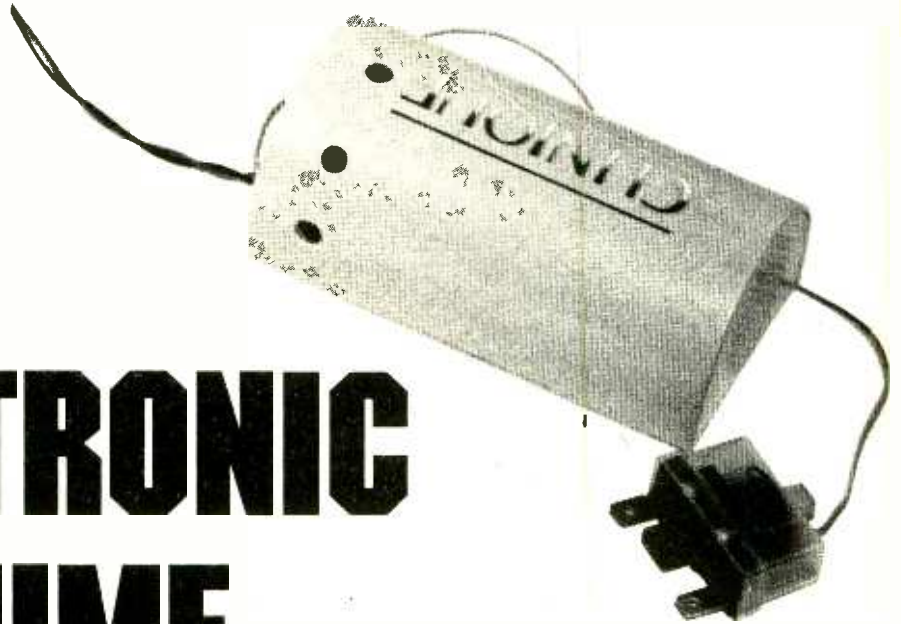

LES SVOBODA

DID IT EVER GET TO YOU...AS IT DID TO ME? THAT AWFUL sounding buzzer in your car? Leave the keys in the ignition and open the door...there it is! You drop the groceries off at home before running your next errand, open the door, two sacks of groceries in your hands, take them in, come back for more and the beast of a noisemaker is still at it!

Gritting my teeth while looking for its hiding place, (it's easier to find while it is buzzing away)...there it was! A small rectangular loud-mouth. It pulled out like a plug since it is constructed as a plug. Peace and quiet at last...until the day I locked my keys in the car. Then I got all those "I-told-you-so's" from my wife, as I often do, so once more the buzzer was back in the circuit!

I guess the day I finally decided to do something practical in solving the problem was the day that Scott, a friend of mine, was showing me all of the neat features of his brand new super automobile. Digital this, digital that, fluorescent readouts here, bar graphs there and then, suddenly I heard...chimes? "What on earth are those chimes for?" I asked. "Oh, those replace that cheap-car buzzer, like the one you have in *your* car!"...That did it!

I hadn't considered replacing my car just to get chimes and assumed that the schematic diagram of the chimes as used in Scott's car would be difficult to obtain, or that the circuitry probably would contain only house numbers. Purchasing the chime unit alone could be expensive, because it might be on a board containing many other elaborate circuits. Hearing a digital electronic door chime at the local electronics hobby store, I felt that hitting a plastic bucket with a hammer would sound better.

Since none of the above seemed the way to go, I decided to design my own, to keep the cost minimal, and to use readily available parts. The sound would have to be reproduced electronically and it had to sound very real and clear, like a

nice sounding home-mechanical type of chime. Well, the end results were pleasing. Not only did I replace the buzzers in both of our cars, but also one in the house alarm which used a "screamer", my own definition for a solid-state piezo-electric sounder. I also can see no reason why, instead of feeding the input of amplifier IC3 on the schematic diagram (Fig. 1), you feed a high-impedance input of a P.A. system at a place of business, if some alarm or alert signal is needed.

The total cost of building the Electronic Chime for your car will be in the neighborhood of \$15. All parts are readily available from local hobby-electronics centers, parts stores and/or various suppliers such as those that advertise in the back of **Radio-Electronics** magazine. I used a surplus scrap of Veroboard to wire-up my unit. You may find it easier to construct the Electronic Chime on a solderless breadboard and then transfer it to a perfboard or home-brew PC board.

The unit will operate satisfactorily in the range of 7½- to 15-volts DC, although some reduction of volume is sacrificed at lower voltages.

How it works

IC1, a 566 function-generator chip, was chosen as the main oscillator to produce the audio tones. It provides a from-the-chip triangle-wave or saw-tooth output allowing for a more economical method of eventual processing the signal into the desired pure sounding wave.

The frequency determining components on the input side of IC1 allow one to vary the frequency of the chime by simply adjusting potentiometer R1. The triangle wave at the output is then processed into a tone wave by R5, C3, D1, D2, R6, and finally by potentiometer R2, which also serves as a volume control.

Chip IC2, an LM555 timer, is set up to produce the pulses

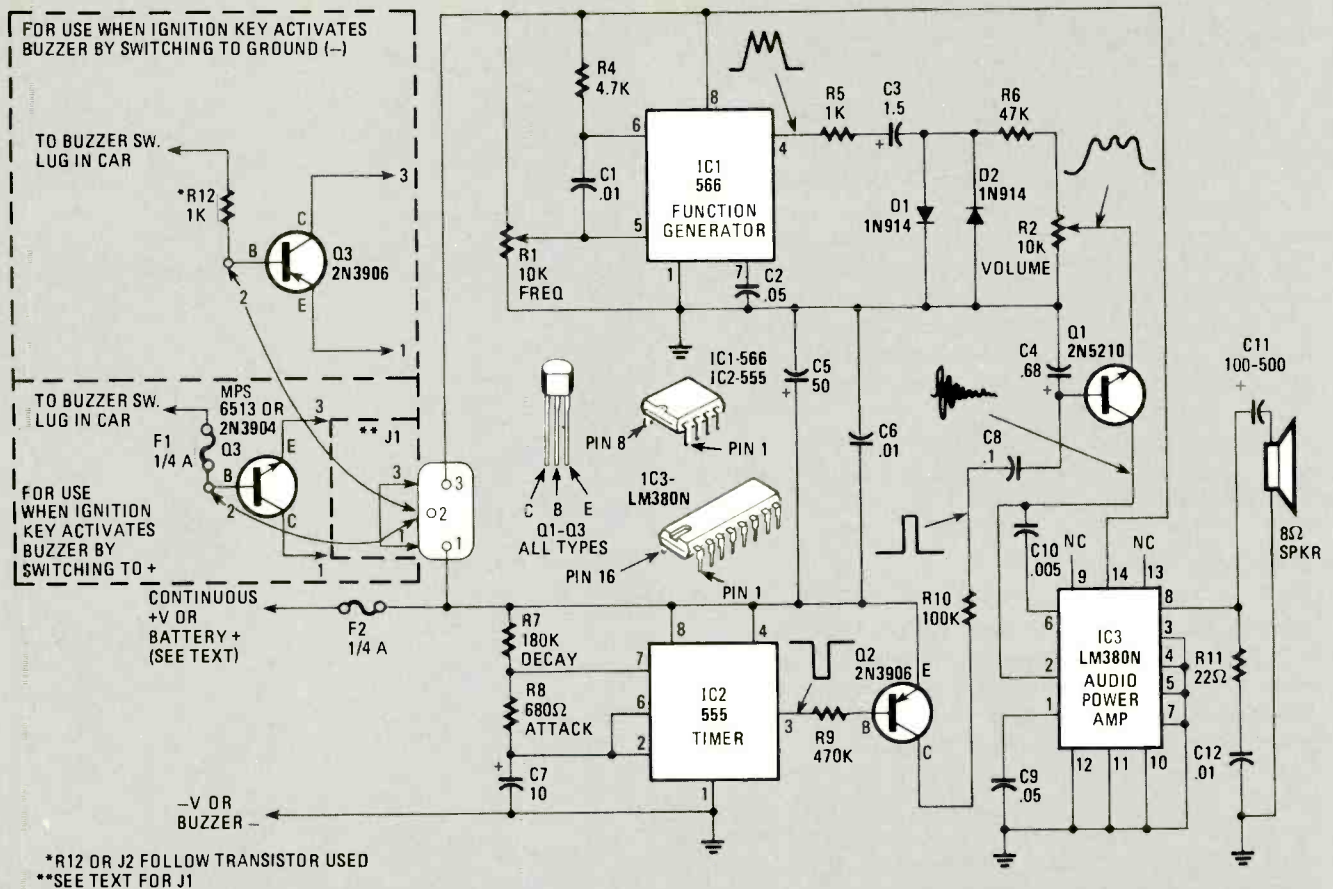

FIG. 1—THE SCHEMATIC DIAGRAM for the Electronic Chime uses two chips and one transistor to develop the chime sound, and one transistor and one chip to step up the audio level so it can drive a small loudspeaker. The use of Q3 or J1 is explained in detail within the text. Due to the many circuit design modifications by the author right up to the last minute to develop the unit fully, resistor R3 was eliminated and will not be found in the diagram or the project.

necessary to control the attack and decay timing of a proper sounding chime. Resistor R8 sets the short ATTACK time while R7 sets the relatively long time lapse necessary for the much slower DECAY time of the chime to take place before the next attack pulse is presented. Those ATTACK and DECAY pulses output on pin 3 of IC2 and then are inverted by Q2. The inverted pulses are then "tinted" through R10 and C8 and fed to the base of Q-1. (Note that C8 must be a disceramic capacitor.)

Parts Q1, R2, and C4 then complete the proper *envelope* shaping of the tone frequency into a proper chime envelope at the collector of Q1. The electronic reproduction of a realistic chime sound is now complete. At that point, however, the audio level is very low and requires further amplification.

Chip IC3, a LM-380N amplifier, the 14-pin DIP version, produces ample audio gain to be fed into a miniature 8-ohm speaker. Components R11 and C12 eliminate self-oscillation or distortion problems which can occur when the amplifier is operated with high impedance inputs and maximum gain. The value of R11 can be between 10 and 22 ohms. A speaker with 8-ohms impedance *must* be used, or undesired degrading of the sound will occur. The 10-ohm imports also work. Two 8-ohm speakers in series may still perform satisfactorily. Heatsinking of IC3 has been provided on the Veroboard or PC board that you may use. Also note that heatsink pins 3, 4, 5, and 10, 11, 12 are directly across from each other and all can be tied together. Also, that IC, has thermal-overload self-protection for durability.

Matching the car

Transistor Q3 is either a NPN 2N3904 or PNP 2N3906 switching transistor. Which transistor to use will be indicated after you locate the mounting location of the old car buzzer and determine with a voltmeter which polarity is switched as the car key is inserted into the ignition. If that switch switches the negative lead, use the PNP transistor version. If the positive lead is switched, use the NPN transistor version. Configurations are shown on the schematic diagram.

Upon study of the schematic diagram in Fig. 1, IC2 remains in a continuous power-up condition while the rest of the circuitry is unpowered because of Q3's base not being

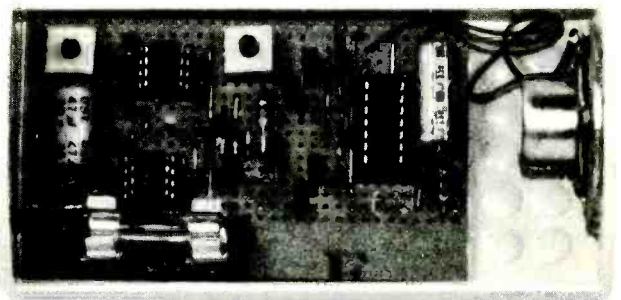

THIS IS HOW THE AUTHOR put together his Electronic Chime project. Entire project was assembled on a Veroboard which is difficult to obtain in many areas. Point-to-point or wire-wrap wiring may be used. Plastic box is a surplus container from a popular facial soap.

energized. Upon activating Q3's base by the old buzzer switch, battery power is immediately applied to the remaining circuits through Q3 and produces chimes immediately when activating power is applied. Although IC2 is constantly on, even with the car's ignition off, that should cause no concerning problems for the car's battery, since the drain is only about 5 mA. Should it be felt that it is a problem, here is the action you should take: Replace Q3 with jumper J1 as shown on the schematic diagram (Fig. 1) and attach the positive lead of the chime unit to the positive lead of the removed buzzer's socket and the negative lead to the negative portion of the socket. Now, however, when power is applied, you must accept a 3- to 4-second delay before the Electronic Chime sounds off. The reason for that is that Capacitor C4 needs this much charging time from the short pulses delivered to it from IC2. Altering the circuit will alter the proper shaping desired for the true chime sound that this circuitry produces.

Mounting the speaker

The small speaker can be mounted in the case which contains the Electronic Chime circuitry, in a separate small case or baffle, or upon a flat sounding board of about 20 square inches; but it must be mounted—otherwise, a lot of the volume will be lost. Be sure that you drill a series of small holes or one large hole slightly smaller than the cone area in front of the speaker cone. A plastic box about 3 × 6 inches and about 1½-inches deep works out very nicely to contain both the speaker and the circuitry. The author used a Clinique plastic case with holes drilled for speaker grille.

Since small speakers, such as is recommended for use here, usually provide no mounting holes, mount it as follows: After the holes are completed for the speaker's cone area, place the speaker face down in the desired position. While firmly holding the speaker in position, run a bead of silicone bathtub sealer around the speaker's outer rim, contacting both the speaker rim and the enclosure surface. Be careful not to let the speaker shift until the sealant is cured. Should you ever desire to remove the speaker, the sealant can be cut away with a sharp blade and used again.

Some comments

You might want to be a bit more clever than the author because your installation may be a bit trickier. One suggestion is to use an opto-coupler to replace the buzzer element in the car and connect the switching output terminals across terminals 1 and 3 in Fig. 1 in place of jumper J1. Or, you may want to use a simple 12-volt, low-current relay to do the same job. In fact, you may want to parallel several other switching devices to sound the alarm when the oil light, or any other idiot light, goes on.

The author used the common Veroboard material to mount and interconnect his project. However, he continued to upgrade the project on the same board, so that if you were to duplicate it from his layout there would be far too many wire

SELF CONTAINED in its plastic box, Electronic Chime is ready to go!

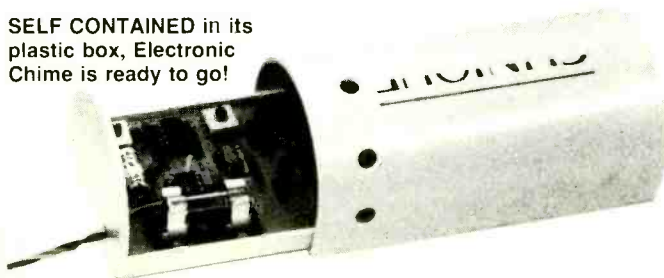

PARTS LIST

SEMICONDUCTORS

D1, D2—1N914 diodes
 IC1—LM566 function-generator DIP integrated circuit
 IC2—LM555 timer DIP integrated circuit
 IC3—LM380N audio, power-amplifier DIP integrated circuit
 Q1—2N5210 or SK3122 NFN transistor
 Q2—2N3906 PNP transistor
 Q3—NPN type 2N3904 or MPS5613 or PNP type 2N3906 (see text)

RESISTORS

All resistors are ½-watt, 5% unless otherwise noted. R3 does not exist.

R1, R2—10,000-ohm, ¼-watt subminiature 1-turn potentiometer
 R4—4700 ohms
 R5—1000-ohms
 R6—47,000-ohms
 R7—180,000-ohms
 R8—680-ohms
 R9—470,000-ohms
 R10—100,000-ohms
 R11—22-ohms
 R12—1000-ohms (see text)

CAPACITORS

C1, C6, C12—.01-μF, 25-WVDC ceramic disk
 C2, C9—.05-μF, 25-WVDC ceramic disk
 C3—1.5-μF, 25-WVDC tantalum
 C4—.68-μF, 25-WVDC tantalum
 C5—5-50-μF, 35-WVDC electrolytic
 C7—10-μF, 15-WVDC electrolytic
 C8—.1-μF, 15-WVDC ceramic disk
 C10—.005-μF, 15-WVDC ceramic disk
 C11—100-500-μF, 25-WVDC electrolytic

ADDITIONAL PARTS AND MATERIALS

F1—¼-A, 3AG fuse
 SPK—8-10-ohm miniature loudspeaker
 Fuse holder (for circuit-board or front-panel mount); IC sockets, wire, hardware, circuit board material for either wire-wrap, point-to-point, or etched techniques, solder, etc.

jumpers. So, the Editor did not supply the reader with a PC-board layout with this project. However, should you come up with a snappy layout, send the Editor a copy of the foil layout.

Conclusion

If you plan to replace another sounder in the home directly with this chime unit, note that the applied regulated power should not be much lower than 9 volts DC and must not exceed 15 volts DC. It should be accepted that certain IC's are more tolerant to excessive voltages or operation under certain lower voltages than others, even though they are of the same type.

Fusing the unit, especially if used in a car, is quite essential. If the leads are long, it is best to place an in-line fuse very near the point of connection. If the leads are short and there is little danger that the leads themselves will short, then the fuse holder can be contained within the Electronic Chime mounting box. Always use proper electronic construction and electronic protection techniques.

Oh, that "I-told-you-so" woman I mentioned earlier...well, she has been a bit quieter lately!

SP

ULTRALINEAR OHMMETER



EVERT FRUITMAN

Throw away that crunched-up ohmmeter scale for one that's rule-stick true with decade switching!

THE ULTRALINEAR OHMMETER GIVES FINE ACCURACY AND resolution from one end of the meter scale to the other—and without crunching the scale, either. This ohmmeter will read from less than 1 ohm to more than 10,000 Megohms. It is assembled from standard parts, many of which may be in your junkbox. The calibration of the Ultralinear Ohmmeter is simple and requires nothing more than a single precision resistor of known value.

The main parts needed to assemble the unit are a 0-1 DC milliamperere meter, op amp, Zener diode, and potentiometer. The 741 op amp works reasonably well, but limits the potential upper range of the instrument. The CA3140 BiFET op amp *must* be used for maximum linear range in the high Megohms. The meter movement may be anything rated from 50 μ A to 0-1 mA DC with a 2½- to 3-inch scale.

Fig. 1 shows the basic circuit from which the Ultralinear Ohmmeter was conceived and designed. The unknown resistor R_X is connected between the output of the op amp and its inverting input, pins 2 and 6. The ratio of the external standard to the unknown, (R_S/R_X), is read on the meter in ohms. If the external standard resistor is 100,000 ohms and the test resistor is 100,000 ohms, the meter will read 100, which is full scale. If the test resistor, R_X is 27,000 ohms, the meter will read 27 (%). Remarkably enough, if the test resistor is just 1000 ohms, (that's 1 % of the standard), the meter will read 1. Try that on your presently owned ohmmeter.

The beginning

The basic circuit in Fig. 1 described by V. Ramprapash, in *Electronics* November 1976, looked as if it could be made more practical. At first glance, it appears that a meter of known internal resistance and an odd-value precision resistor

are required for the metering circuit. It also seemed to be a lot of work for just a single-range instrument. One other somewhat troubling thing came to light after putting the circuit together—the meter was pinned hard, despite the diode clamp, when the input terminals were open (equivalent to multi-Megohms). Once those three problems could be cleaned up, a practical instrument would be the result.

The potential destruction of meter movement M1 was the first thing to be resolved. The simplest protection circuit would have been a short circuit directly across the input terminals, J1 and J2. But a more practical method took the form of a pushbutton switch, S4, across a current limiting resistor, R10, in series with the meter, M1. See Fig. 2.

The need for a precision resistor for R10 was eliminated in favor of an inexpensive 5% type from the junkbox, by use of two inexpensive potentiometers, R11 and R12, and a switch, S3 (see Fig. 2). Actually, what was done here presented the opportunity to eliminate the precision resistor for R10 and, at the same time, add a divide-by-ten scale at the flip of a switch. Now, for example, should the scale offer a reading of 3 (3 out of a possible 100) flipping S3 to the other position (X 0.1) will enable the user to determine whether it is 2.9, 3.0, or 3.1 from a new scale reading of 29, 30, or 31—near the middle of the scale where the meter's inherent accuracy is greatly improved.

Then, there was the matter of just one meter range. It seemed that a rotary switch, S1, and several range resistors should give added ranges, and that proved to be the case. See Fig. 2. A couple of simple tests revealed that there was no problem in going down to 1000 ohms or up to 10 Megohms, full scale, with the 741 op amp. But, of course, it is desirable to go farther in both directions.

As it turns out, the CA3140 op amp chip gives repeatable readings up to 10,000 Megohms and down to 100 ohms, full scale. With the divide-by-ten feature previously discussed, it is possible to go down to 10-ohms full scale.

That means that you can read the DC resistance of loud-speaker voice coils, earphones, meter shunts, etc., on the low end of the spectrum, and TV focus resistors on the high end. That made the instrument *practical*. For the price of two more binding posts, J3 and J4, an external resistive standard may be used. See Fig. 2. That allows direct comparison with precision standards, or more exact matching of resistors for balanced circuits. The divide-by-ten feature works there, too!

Switch S1 is the resistance RANGE selector switch. It picks your choice of internal-standard resistors for full-scale read-

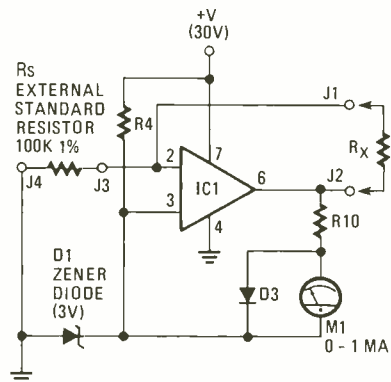

FIG. 1. THE BASIC CIRCUIT for the Ultralinear Ohmmeter is shown here with its advantages and disadvantages discussed in text. Part symbols relate to identical parts in Fig. 2. Should you wire this circuit up for tests, be very careful—the meter may pin with permanent damage.

FIG. 2. THE WORKING CIRCUIT is shown here complete with power source, range switch, and adjustment potentiometers. The external standard resistor terminals, J3 and J4, permit the user to match resistors accurately for those special circuits.

ing. Pushbutton switch S4 shorts out meter-protection resistor R10 when you are ready for readings. With the R_X terminals at J1/J2 open, the meter, M1, tends to hit the high-scale pin rather hard. That can be hard on the meter if it isn't protected. Diode D3 is part of the protection circuit and tends to limit the voltage across the meter to a more or less safe value. Diode D2 protects the op amp chip, IC1, from accidental reversed power-supply connections. Potentiometer R11 is a calibration control and adjusts meter M1 for full-scale deflection, when a known standard is across the input terminals. Zener diode D3 supplies the reference voltage, and is the reason that any power-supply voltage from 12 to 30 may be used without any other voltage regulation. Zeners rated at 2½ to 5 volts may be used for D3.

It needs power

The power supply should be about 12–30 volts DC. A pair of 9-volt batteries in series works well and will give good life if most of the Ultralinear Ohmmeter usage is on the higher ranges. The battery drain is about 15-20 mA on the lower ranges, particularly in the divide-by-ten mode. The drain is about 3-5 mA the remainder of the time.

A plug-in power supply commonly used to power pocket calculators and games could be used at some additional expense. Fig. 3 is an example of such a DC supply. It will deliver close to 20 volts when it is lightly loaded. It does not need to be regulated. However, install a 25-30-volt Zener diode across its output for spike protection. If the air conditioner or the washing machine kicks on and throws a spike (high-voltage transient) into the line, the op amp chip without the Zener diode protection could show how well it doesn't tolerate overvoltage for even a short time. Diode D2 (Fig. 2) will take care of the spikes that get by Zener diode D4 (Fig. 3) since they would be of the opposite polarity.

Assembly

The whole project should go together in about one evening, after the cabinet drilling and cutting is completed. Make the hole for the meter first, but install it last. The switches, binding posts, and meter mount on the unit's front panel. Place all the other components on a piece of perforated board. You may wish to put holes in the panel so that calibration potentiometers R11 and R12 (Fig. 2) may be adjusted without taking the unit out of the case. Once the pots are set they seldom need readjusting. A drop of clear nail polish will lock the setting. Use a socket for IC1, because it can save a lot of unnecessary

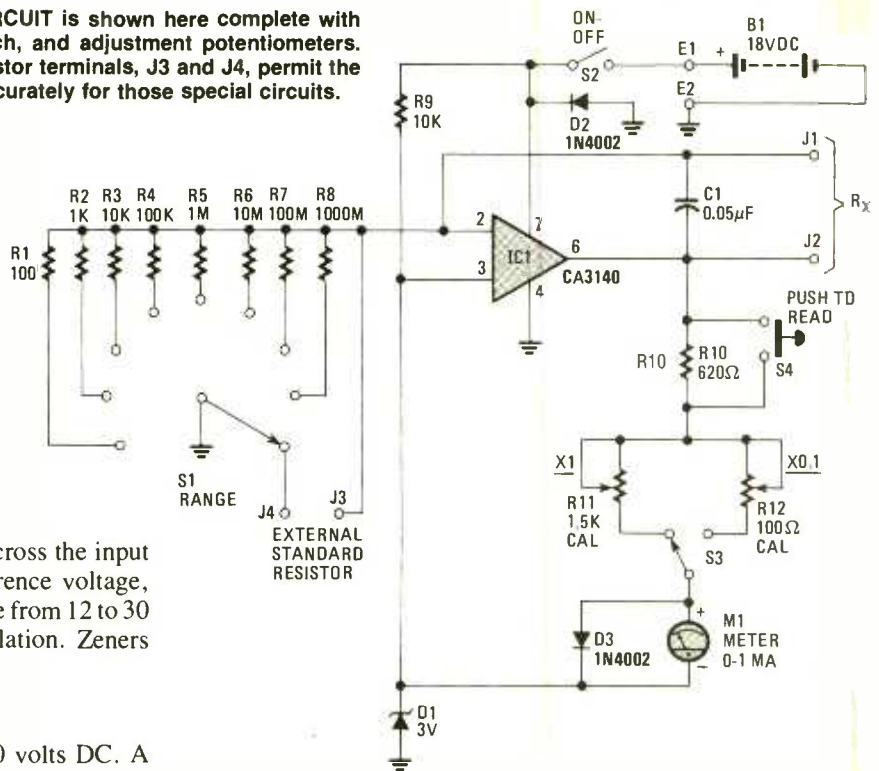

soldering time in the unlikely event of an accident.

RANGE selector switch, S1, is a nine-position, single-pole rotary type. If you don't want as many ranges, use a smaller switch or leave some of the positions blank.

The layout is not super critical, but keep the wiring to pin 3 away from the wiring to pin 6. There might be a tendency toward oscillation when that precaution is not observed. Capacitor C1 connected across R_X terminals J1 and J2 seemed to reduce the oscillation problem.

When the wiring is completed, and you are ready to check the Linear Ohmmeter out, go back and make certain that pin 7 of IC1 goes to the plus battery terminal, and that pin 4 goes to the minus. Be sure that D2 is installed as shown.

A word on parts

The Parts List suggests metal-film, 1% resistors for range

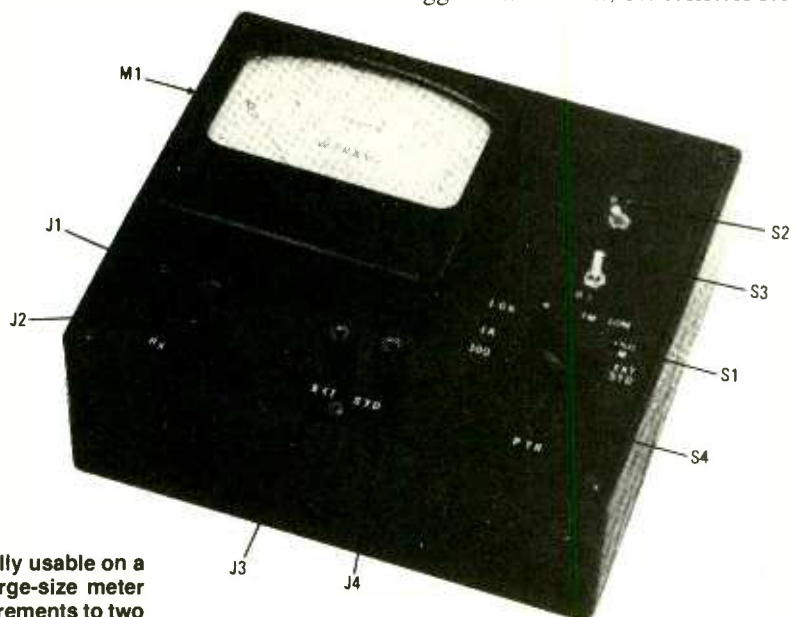

THE COMPLETED UNIT looks as if it will be equally usable on a workbench or laboratory table. Note that the large-size meter scale makes possible accurate resistance measurements to two significant figures without eye strain.

PARTS LIST

SEMICONDUCTORS

D1—3-V, 100-400 mW Zener diode
 D2, D3—1N4002 silicon diode
 IC1—CA3140 biFET operation-amplifier chip

RESISTORS

All fixed resistors are 1/4 watt unless 2 or more are combined in parallel to make usable value—then use 1/2 watt

R1—100-ohm, 1%, metal-film
 R2—1000-ohm, 1%, metal-film
 R3—10,000-ohm, 1%, metal-film
 R4—100,000-ohm, 1% metal-film
 R5—1-Megohm, 1%, metal-film
 R6—10-Megohm, 1%, metal-film
 R7—100-Megohm, (see text)
 R8—1000-Megohm, (see text)
 R9—10,000-ohm, 5%
 R10—620-ohms, 5%

R11—1500-ohm potentiometer (see text)

R12—100-ohm potentiometer (see text)

SWITCHES

S1—9-position, single-pole rotary switch
 S2—SPST, miniature, toggle switch
 S3—SPST, miniature, spring-return (optional), toggle switch
 S4—SPST, normally-open, momentary-contact, pushbutton switch

ADDITIONAL PARTS AND MATERIALS

E1, E2—Tie points on terminal strip
 J1-J4—Binding posts, multi-way connection, any color
 M1—Panel meter, 2½-3-in., 0-1 mA, scale divided into 100 units (see text)
 C1—.05-μF Mylar capacitor
 Battery clips (if required), chassis box or meter case, perforboard, wire, 8-pin DIP socket, flea clips, solder, knob, etc.

FIG. 3. THE ADDITION of an AC power supply is easy when you use the parts from a standard plug-in power supply used to power pocket calculators and games. Be sure that the raw DC before modification is about 20-volts DC under a (5 mA) load.

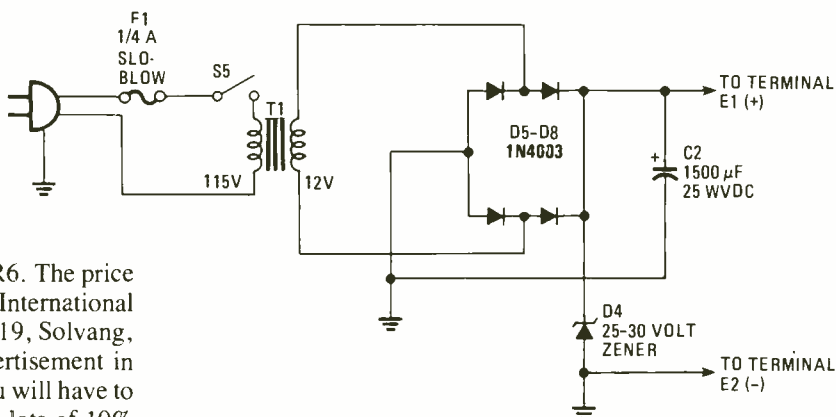

switching—in particular, resistors R1 through R6. The price of those units is about 25¢ each (or less) from International Electronics Unlimited, 435 First Avenue, Suite 19, Solvang, CA 93463 (tel: 805-688-2747). See their advertisement in **Radio-Electronics**. For resistors R7 and R8 you will have to settle for 15% values unless you want to string lots of 10% and/or 5% resistors in a series. Potentiometers R11 and R12 should be multi-turn units, such as 15-turn pots commonly found in the marketplace.

The meter is the largest expense. See if you can salvage a suitable 0-1 mA DC meter from somewhere at a greatly reduced cost. Get the largest type for the panel that you can find, for ease in reading values. Of course, the scale should be divided into units of 100. Should you find a meter divided by 150 units, then substitute 150 ohms for R1, 1500 ohms for R2, etc., for the range resistors.

Should you be able to bring your unit into a basic electrical physics lab, pre-adjust the unit at home so that it is operational to within 10% accuracy or less. Then fine-adjust the unit in the lab right down to the cat's whisker for ultimate accuracy.

Calibration

The next few steps will help you check out and calibrate meter M1. First, set potentiometers R11 and R12 to their maximum resistance settings. Place ON/OFF switch S2 in the OFF position. Set S3 to the 1 position. Select a resistor of your choice, say 10,000 ohms, and connect it to the R_X terminal, J1 and J2. Set RANGE selector switch S1 to the next higher value, 100,000 in this case. Install the batteries, and set S2 to ON and observe the meter. It should read below 10 (%). If it does, hold down the PTR (PUSH TO READ) button S4 and adjust calibration potentiometer R11 for a reading of exactly 10. Move RANGE switch S1, down to the same value as the calibration resistor in this case 10,000. Fine-adjust R11 for a reading of exactly 100 (%). Upscale RANGE switch S1 to the

100,000 position again, and move switch S3, the divide-by-ten switch to the 0.1 position. Now, adjust calibration potentiometer R12 for a reading of 10. That's it! If you used 1% or hand-picked resistors for your range resistors, you will have excellent correlation between scales. Remember: Always start with the higher ranges and work your way down, whether calibrating or checking unknown resistors.

Diodes may be tested as well as resistors. Both forward conduction, (relative to other diodes), and reverse leakage may be checked. You'll find the Ultralinear Ohmmeter a welcome addition to your workbench. **SP**



THE AUTHOR had access to a standard resistance box, providing him with practically unlimited selection of precision resistance values to adjust and test each resistance range at many points. You can do it with as few as one precision resistor.

AUTOMATIC COUNTDOWN TIMER

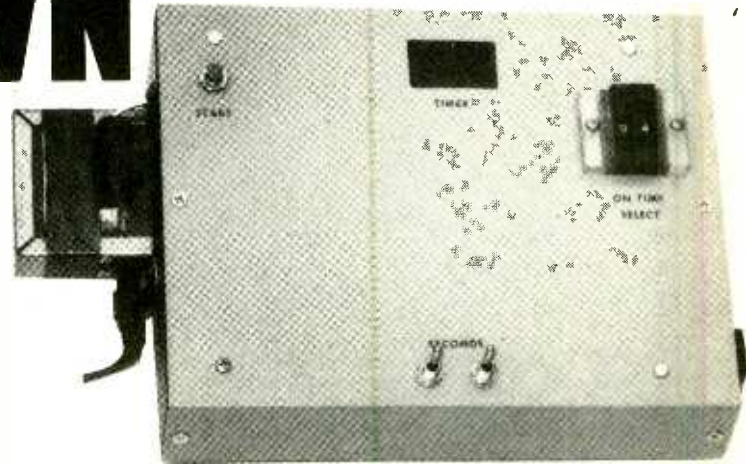

Accurate to the second, this project provides time for darkroom applications as well as PC board fabrications

ROBERT N. BEABER

DO YOU NEED A COUNTDOWN TIMER TO TURN ON A DEVICE FOR A predetermined time? How about a visual display of the time remaining, and an accuracy to within 1 second? The timers found in hardware stores and some electronics shops only provide a circular control dial that is difficult to read, as well as difficult to adjust to an accurate elapsed time. The Adjustable Countdown Timer that the author designed can be useful for darkroom photography work, for the photo-processing of PC boards, or for setting the "on" time for household appliances. The external power requirement will determine the power-control relay to be used. The relay selected by the

author can control 3 amperes of 117-volt AC power. That rating is adequate for turning on and off lamps that dissipate power up to 300 watts.

The application for which the author used the Adjustable Countdown Timer was to photo-process PC boards; it provided the accurate time for the exposure lamp. The timer was inexpensive to build. Many of the parts may be in your junkbox, and the others are readily available from electronics-parts supply houses at moderate cost.

The timer provides either a selectable time from 1 to 99 seconds or from 1 to 99 minutes. The time can be extended by

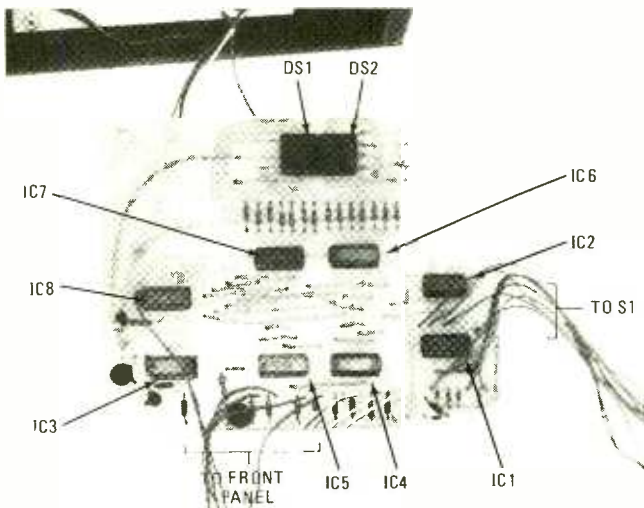

THE TIMER-CIRCUIT BOARD shown here is all wired up and ready for installation in the cabinet. Leads are extra long to play it safe during final hook-up.

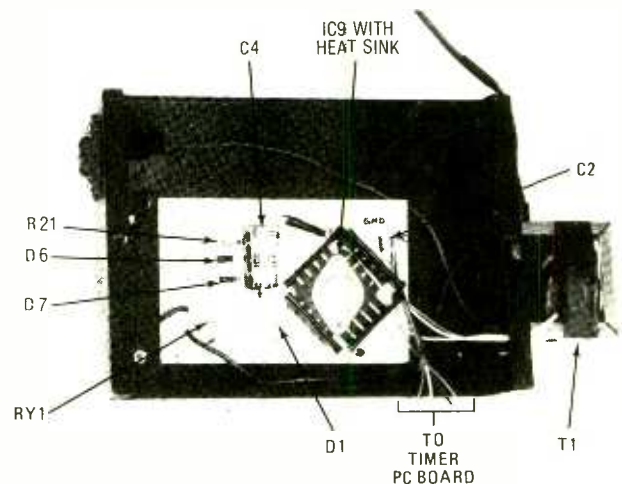

POWER-SUPPLY CIRCUIT BOARD is located on the bottom of the case used to house the adjustable countdown timer. Note that author used a case so small to house transformer T1. Relay RY1 is mounted on the PC board.

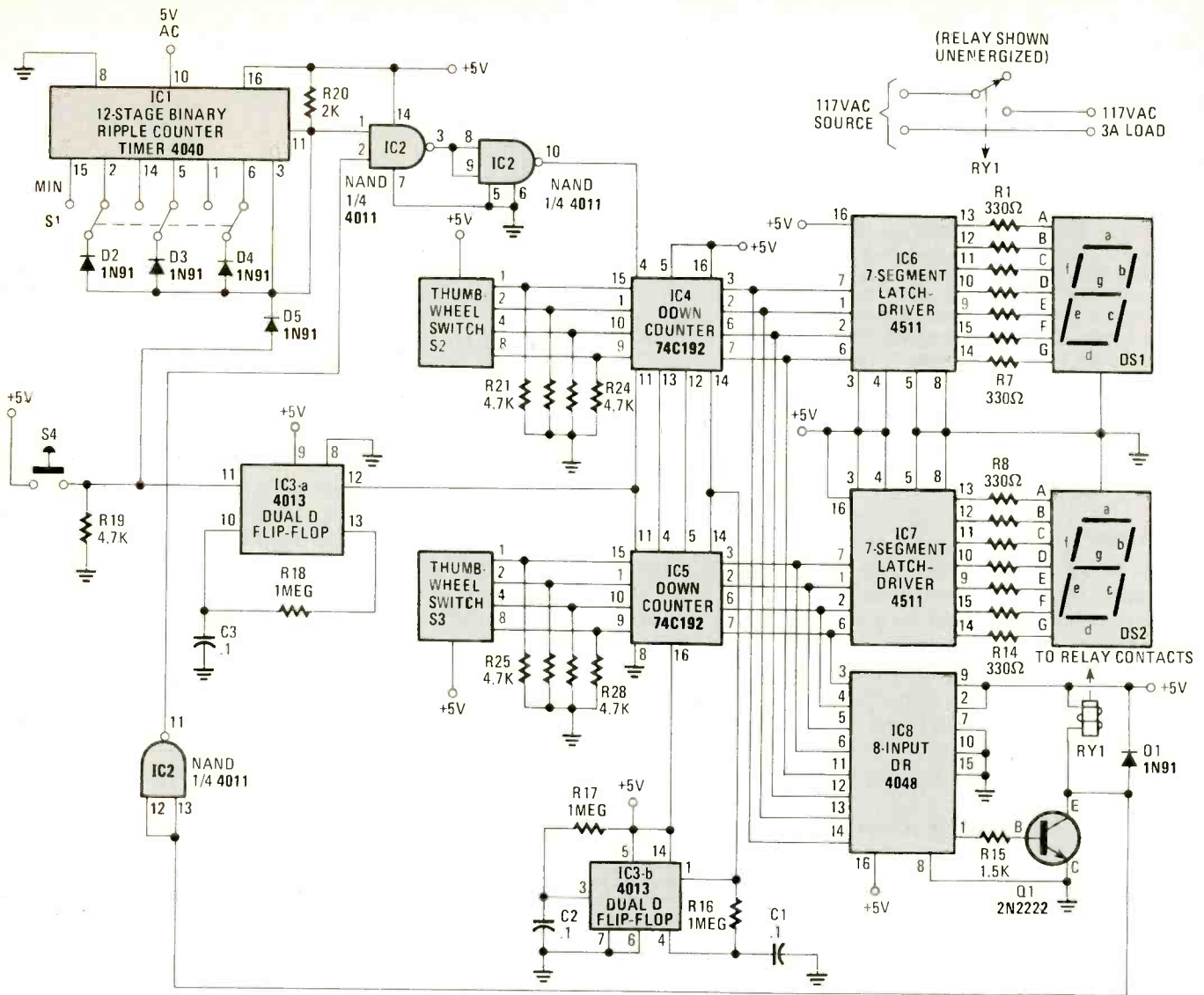

PARTS LIST

SEMICONDUCTORS

- D1-D5—1N91 diode
- DS1, DS2—LED 7-segment common-anode display
- IC1—4040 12-stage binary counter integrated circuit
- IC2—4011 quad two-input NAND integrated circuit
- IC3—4013 dual flip-flop integrated circuit
- IC4, IC5—74C192 up/down decimal counter integrated circuit
- IC6, IC7—4511 decimal-decoder to 7-segment-display integrated circuit
- IC8—4048 multifunction expandable 8-input gate integrated circuit
- Q1—2N2222 NPN transistor

RESISTOR

All resistors 1/4-watt unless otherwise noted

- R1-R14—4330 ohms
- R15—1500 ohms
- R6-R18—1 Megohm
- R19, R21-R28—4700 ohms
- R20—2000 ohms

SWITCHES

- S1—3PDT toggle switch, GC Electronics 35-024 or equivalent
- S2, S3—thumbwheel switch, 10-position to BCD code,

Jameco Electric SF-21

S4—SPST normally-open pushbutton switch

ADDITIONAL PARTS AND MATERIALS

- C1-C3—0.1- μ F disk capacitor, 25-WVDC
 - RY1—5-VDC relay, SPDT contacts, 440-ohm coil, Digi-Key 153C
- Cabinet, hardware, line cord, wire, PC board, solder, etc.

PARTS LIST FOR POWER SUPPLY

SEMICONDUCTORS

- D6, D7—1N4001, 1-A, 50-PIV silicon rectifier diode, or equivalent
- D8—1N751A, 5.1-V, 500-mW Zener diode, or equivalent
- D9—1N91 diode
- IC9— μ A7805CK, 5-V, 1.5-A voltage regulator integrated chip, or equivalent

ADDITIONAL PARTS

- C4—1000- μ F, 25-WVDC electrolytic capacitor
 - C4—0.1- μ F, 25-WVDC disk capacitor
 - R21—2000-ohms, 1/2-watt resistor
 - T1—117-VAC primary winding, 12.6-VDC secondary winding with center-tap, 1-A power transformer
- Printed-circuit board, wire, solder, hardware, etc.

◀ FIG. 1. SCHEMATIC DIAGRAM OF THE TIMING CIRCUIT for the Adjustable Countdown Timer may at first appear too complex to build. However, the bulk of the interconnecting leads are on a printed-circuit board. LED displays can be almost any type of 7-segment LED common-anode display without connection to decimal point if display has one.

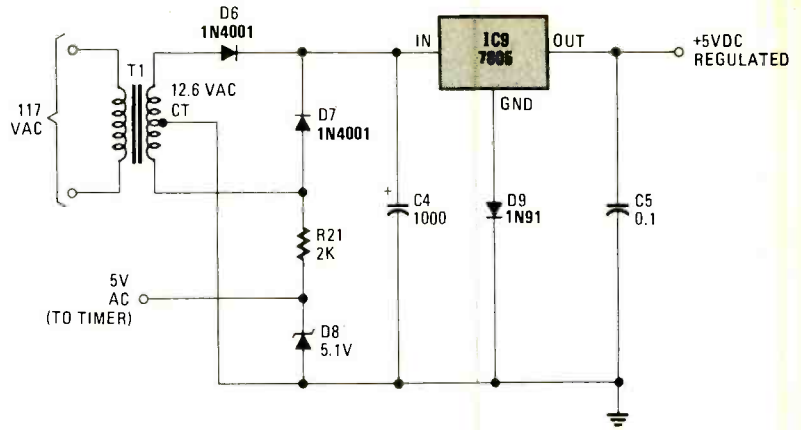

▶ FIG. 2. SCHEMATIC DIAGRAM OF THE POWER-supply circuit used to power-up the Automatic Adjustable Timer. What is unique about the power supply is the 5-VAC tap-off to provide clock pulses for the timer circuit. If elements R1 and D3 can be added to an existing 5-VDC regulated supply, then you may want to use it in place of the power supply designed by the author.

the builder (once he becomes familiar with how the timer functions) by adding another counter stage or by using hexadecimal counters.

Operation

The Adjustable Countdown Timer operates first by storing the required elapsed time in two down counters, IC4 and IC5, displaying the selected time on display DS1 and DS2, and determining if the count is at zero. Displays DS1 and DS2 are 7-segment common-anode LED devices that can be directly driven by 4511 integrated chips. If the count is not at zero, then relay RY1 is energized and the count down of time begins when S4 is depressed.

The above can be explained in detail by examining the

timer schematic diagram shown in Fig. 1. A typical timed sequence begins by the user selecting the desired elapsed time in either seconds or minutes with switch S1. The actual count is selected using the two thumbwheel switches S2 and S3 providing all the usable digits between 01 and 99. Next, pushbutton switch S4, is depressed. That action loads the desired time count into down counters IC4 and IC5, and also displays the time on readouts DS1 and DS2. At this time if the selected time is not zero, IC8, which is connected as an "8-input OR" device, will turn on transistor Q1. When Q1 is on, it energizes the relay coil of RY1 and activates the NAND gate IC2 at pin 2, (follow the signal from the junction of Q1, D1, and RY1 to IC2, pin 2). That allows a clock signal from the 12-stage ($\div 4096$) binary ripple counter IC1, pin 11

FIG. 3. TIMER-CIRCUIT FOIL PATTERN used by the author to make the printed-circuit board shown in the photo.

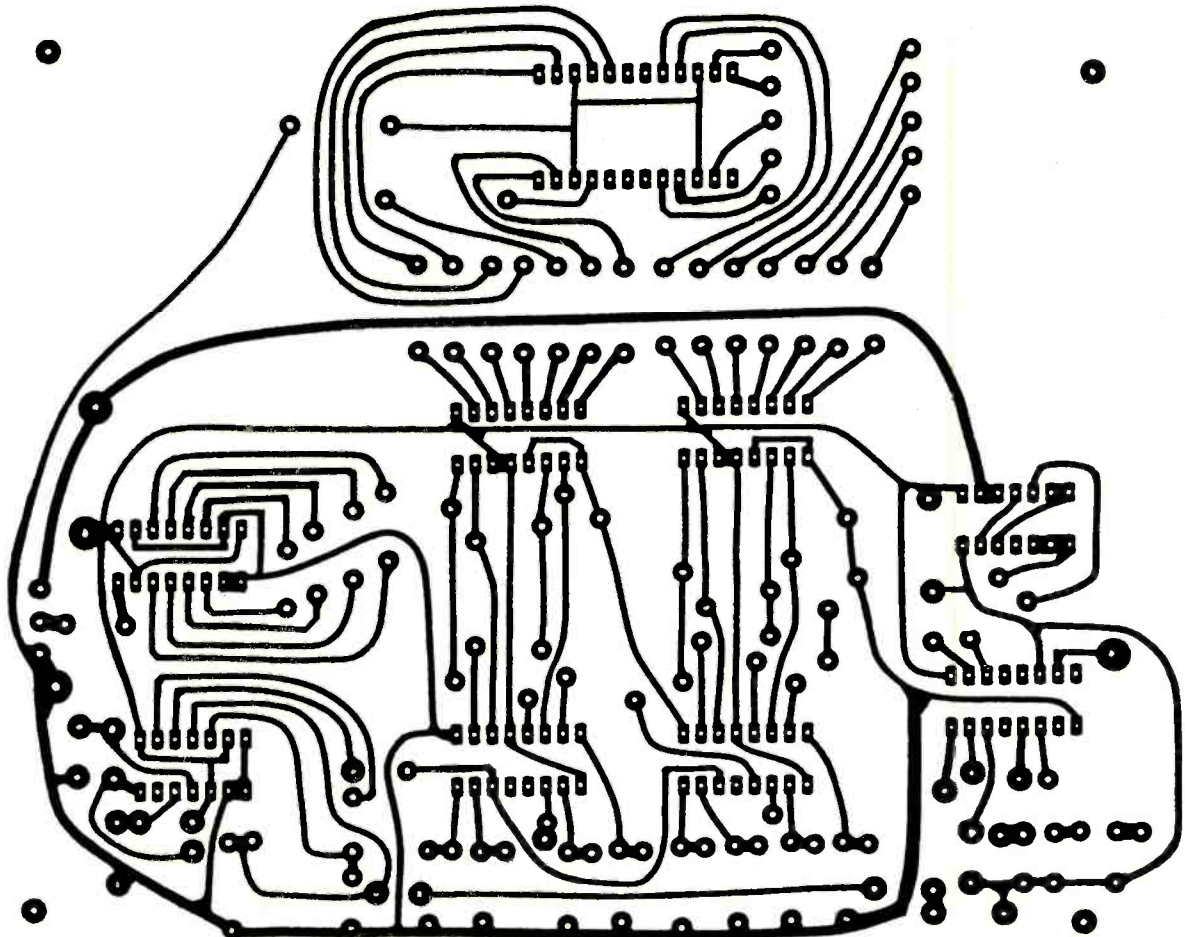

FIG. 4. PARTS-LOCATION DIAGRAM shows details with the foil-side down for the timer circuit. Be sure to use stranded wire for interconnecting power-supply PC board and switches mounted on the front panel.

to go through the IC2 NAND gate to the clock line of counter IC4 at pin 4. With each clock pulse the counters are counted down one count. That can be seen on the readouts DS1 and DS2. When the count reaches zero, IC8 shuts off transistor Q1; and Q1 shuts off the relay and opens the NAND gate IC2. The display readout will read zero, and power to the controlled device will be shut off. That is one complete elapsed time

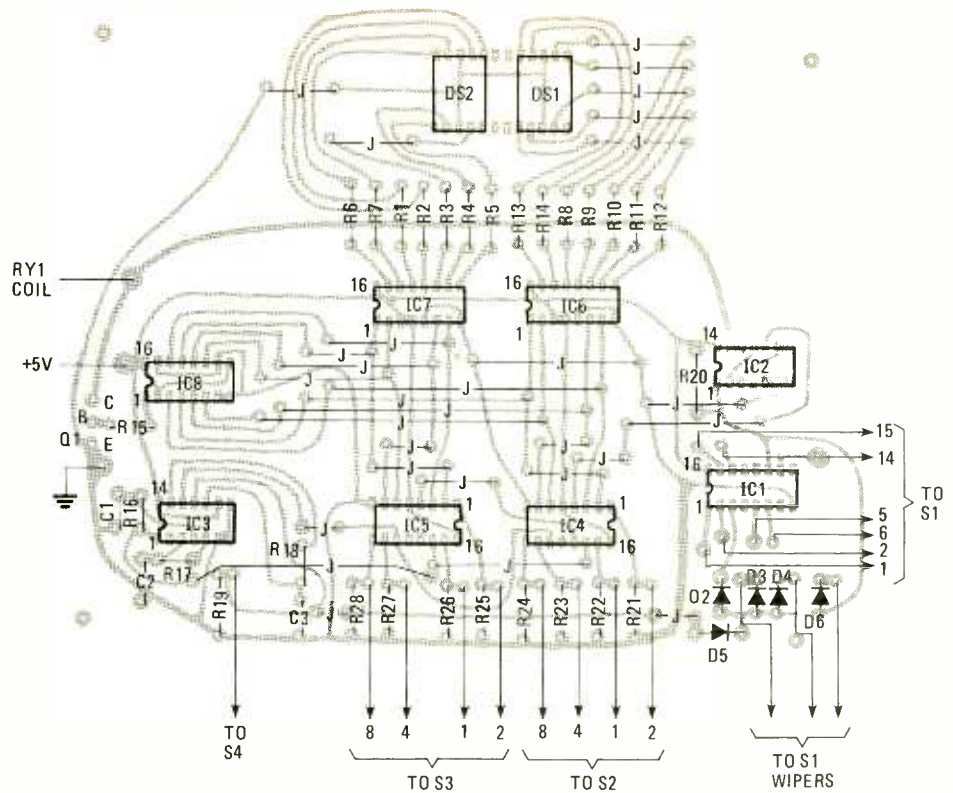

FIG. 5. POWER-SUPPLY FOIL PATTERN for the simple 5-VDC regulated power supply and 5-VAC clock pulses for the timer circuit.

cycle; it can be repeated by depressing pushbutton switch S4 again.

The necessary clock frequency is obtained from the 60-Hz power line and is brought into IC1, pin 10 as a 5-volt AC signal from the power supply. IC1 is a 12-stage binary counter that is gated with diodes D2, D3, D4, and D5 through switch S1 to provide either 1 pulse-per-second or 1 pulse-per-minute at its output pin 11.

The power supply, (Fig. 2) is transformer operated with a center-tapped secondary winding of T1 and two diodes, D6 and D7, connected to provide full-wave DC rectification. That is filtered with a 1000 μ F capacitor, C4, and then regulated to provide 5-volts DC by IC9 for all of the control and excitation power for the timer circuitry. The 5-VAC 60-Hz signal is derived from transformer T1 secondary winding through a current limiting resistor R21 and Zenner diode D8.

Construction

The timer and associated power supply can be breadboarded on perfboard by using wire-wrap sockets for the IC's, or it can be constructed by using printed-circuit boards. A suggested layout for PC construction is shown for both the

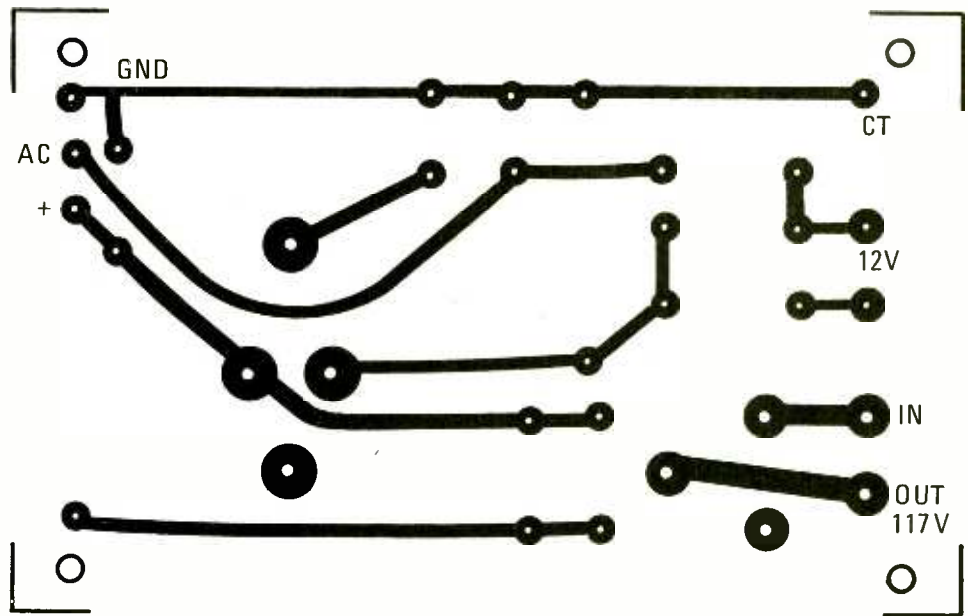

power supply and the timer circuit. Refer to Figs. 3 and 4 for the timer-circuit board.

The simplest way to make the PC boards is to lay out and drill each of the holes on a single-sided copper-clad board. For the IC DIP's, used a #64 twist drill. That is an extremely small drill in diameter; and to prevent breakage, place the drill bit as far into the drill chuck as possible. Drill slowly.

After the board has been etched, insert the IC sockets and components; then solder. Mount the relay on the power-supply board. A suitable cabinet to house the finished timer must be selected; it will contain the two PC boards, the transformer, the switches, the AC receptacle, and wiring. A cabinet 7½ wide, 6¼ high and 4-in. deep provides adequate space. Connections between the two boards for power and AC 60-Hz signal was made using small-gauge wire. Follow the schematic diagram in Figs. 1 and 2, use the parts specified in the Parts List, and use good techniques. **SP**

MAKE YOUR OWN RF COILS



TO PREVENT A COIL from unwinding tensilize the wire by stretching it gently until it goes "dead slack". Clamp one end of the wire in a vise, unroll slightly more wire than you'll need, and then pull on the spool until you feel a slight "give" or "stretch".

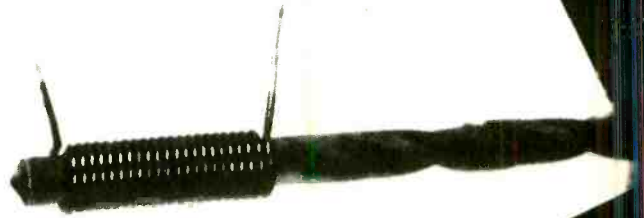

The shank end of a standard drill bit makes an excellent winding form for coils made of moderate to heavy wire. You can stretch the coil to the required overall length while it's on the bit without deforming the turns and providing equal space per turn.

Electronics and car racing are alike in that it's how you make the turn that determines the success of your effort. This is especially true when winding radio-frequency coils!

H. DAVID HERMAN

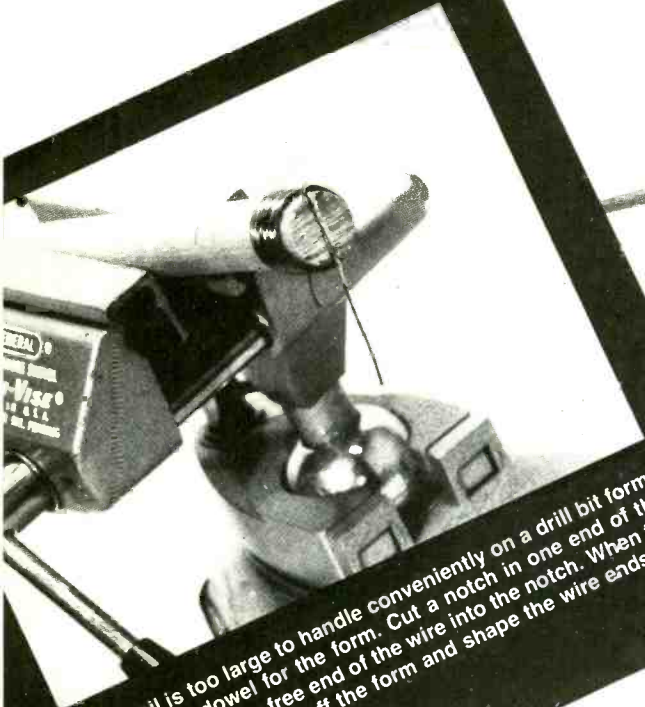

If the coil is too large to handle conveniently on a drill bit form, use a wood dowel for the form. Cut a notch in one end of the dowel and slip the free end of the wire into the notch. When the coil is finished slip it off the form and shape the wire ends.



High-value resistors make excellent supporting forms for small coils. Use resistances of 1 or more Megohms. Solder the ends of the coil to the resistor's leads and use the leads at the coil's connections. This type of radio-frequency coil is very sturdy.

AMONG THE MOST DIFFICULT PARTS TO LOCATE FOR HOMEBREW construction projects are RF (radio-frequency) coils. Fact is, it's usually impossible to locate the exact coil that's needed—or even a reasonable substitute—because virtually no manufacturers presently make coils available for the general electronics hobbyist and experimenter; and even fewer stores sell what little is available. It's more likely that if you need an RF coil you'll probably have to do as the early radio experimenters did—wind your own. Actually, it's a lot easier to do than you might think if you've never homebrewed a coil before.

As a general rule, if the coil is part of a magazine construction project, the author probably gives all the necessary construction details for a homebrew coil. Unfortunately, in this day and age it's a safe bet that the wire and possibly the forms he used aren't available in your neck of the woods. Then again, there's a good possibility the author used a commercial coil that your local parts distributor "...ain't seen since the 1950s" (we've all heard that one). Either way, you'll probably end up winding your own coil(s). Theoretically, it's very easy to design a coil. Simply open the ARRL's *Radio Amateur Handbook* to the section on coils, whip out your calculator, punch in a few equations from the handbook, and in the blink of an eye the calculator will give you the proper coil dimensions and possibly a selection of wire sizes for a particular inductance value.

The problems

Unfortunately, real life isn't all that simple. Most likely, should you need a coil form from your local parts distributor, he: A) won't know what you're talking about (particularly if he's under 30 years old); B) hasn't stocked them since before

Allied and Lafayette Radio stopped selling hobbyist parts through a mail-order catalog; C) can't get them because no one sells small quantities of "experimenter" coil forms other than GC (General Cement) distributors, and not all dealers stock the complete line; coil hardware is one of the first things they don't stock. (It's not the greatest seller). Then there's the problem of wire. Most coil formulas and charts allow for wire sizes from #8 through #40, in Litz, enameled (insulated), single and double silk covered, double cotton-covered (shown in the tables as D.C.C.), and bare. Litz is a special, highly flexible wire consisting of several strands of foil-type wire wrapped around silk and encased in a fabric insulation. It was very popular back in the days of Methuselah for winding coils; the stuff hasn't been seen in stores for better than 20 years, so Litz wire calculations are worthless. The same with D.C.C. wire; the stuff floating around the surplus stores is usually older than the store. Bare wire? That's called "bus bar" (though it isn't really bar shaped); some bus wire in #12 or #16 sizes might be available to the hobbyist is solid enameled (insulated) copper wire (also called "magnet wire", though it's not exactly the same thing). Unfortunately, if you can locate three sizes you're lucky. Radio Shack sells sizes 22, 26, and 30, and that's about the only sizes you're likely to locate easily. Other sizes are few and far between, though some of the surplus distributors might still have a selection of all standard sizes down to "invisible wire", the stuff so thin it can't be seen from five feet away (makes a great

“invisible” antenna—one the landlord can’t see easily from the street).

So if you’re going to make your own RF coils you must work with what’s available in the real world, fudging a little here, making do there, and making an intelligent substitute or two. Whatever, the hardest part will be locating the supplies; making the coils isn’t all that difficult.

If it will work—use it!

When shopping for materials don’t overlook ordinary solid hook-up wire, which is generally available in the #20 and #22 sizes. The plastic (vinyl) insulated stuff is good into the VHF region, and the cloth covered hook-up wire is good for the VHF frequencies to at least to 30 MHz. Ordinary solid copper electrical wire cut from BX or Romex cable is also good. Common electrical wire sizes are #12, #14, and #16. Another common size, #18, is often available as “bell wire”. The problem with electrical wire is it’s usually too soft to be self-supporting, but if you can wind the coil around some type of supporting form it doesn’t make any difference whether the wire is soft or hard.

Almost anything is a form

A coil has very specific dimensions, so some type of winding form must be used. The form can be a wood dowel, a broom handle, a drill bit, a potentiometer’s shaft, a plastic rod or a metal rod, or a high value carbon resistor; in fact, anything that’s round. Unless there’s some reason to provide support for the coil the form is removed after winding the coil. Low inductance RF coils made with wire size #18, or heavier, are usually self-supporting, and no form is necessary. If support is required for heavy wire coils, either wood or plastic dowel is used for the form and the coil is cemented to the form with coil “dope” or *Duco* cement.

When very fine wire is used to make the coil the form *must* be left in place to support the coil. One of the best forms for coils made of fine wire is the ordinary carbon resistor. You can usually modify the coil design to utilize the body-dimensions of the resistor as the form. The ends of the coil can be soldered to the resistor’s leads, which are a lot easier to handle than the coil’s own leads. To prevent the resistor from affecting the circuit, select a value that will not reflect into the associated circuit or the coil: 1-Megohm, or higher, is a safe value.

Non-support

A permanent iron or ferrite core sharply increases the inductance of a coil. An adjustable iron core allows the user to *tweak* the inductance value. At one time adjustable iron-core coil forms in the ¼-inch to ¾-inch sizes were generally available to hobbyists. Today, you’d be lucky to locate any, though ⅜-inch adjustable forms are sometimes available at local parts distributors.

A special type of form that resembles a doughnut, known as a “toroid” core, not only increases the inductance of a coil, it concentrates the field so that little energy radiates beyond the coil. (All these various types are covered in the ARRL handbook). Toroid core assortments are often found in stores catering to the Ham operator. You can also order them direct in small quantities from a manufacturer, the Amidon Associates, 12033 Otsego St., North Hollywood, CA 91607.

Winding the coil

Unless you’re using soft-copper electrical wire you will



If you use a resistor as the form for a coil wound with very fine wire you must encapsulate the coil to prevent the turns of wiring from being displaced, or damaged in handling. A coat of RTV Silicon adhesive is even superior to “coil cement”.

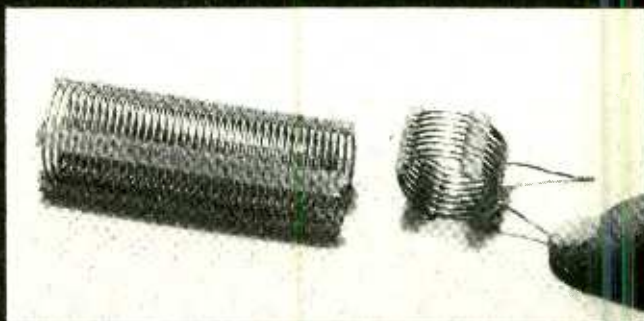

ONCE UPON A TIME the average hobbyist could purchase stock sizes of B & W (Barker and Williamson) or Air-Dux “Miniductors” air-wound coils that could be easily cut down to the desired size. The small transmitter coil on the right was cut from the stock Miniductor on the left. These coils were available in sizes from ½-inch to 6-inch diameter, up to 10-inches in length. They’re just about “surplus” now, but last time we checked there was a good, complete supply available from RADIOKIT, Box 429, Hollis, NH 03049. Send for their detailed catalog.

have to “tensilize” the wire before you wind the coil. Wire might not look like a “spring” when wound on a spool, but, when you wind a coil, the coil will tend to unwind slightly when you let go of the wire; a tight winding on a ½-inch form can end up as a loose-wound coil with a ⅝-inch diameter. Tensilizing the wire removes the “spring” and the wire coil will not unwind when you let go of the ends.

Whether you’re using #8 or #40 wire, to tensilize the wire clamp one end in a vise, unwind a little more than you estimate or calculate you’ll need, and then pull gently on the free end until the wire stretches very, very slightly and goes “dead slack.” You will actually feel a “give” when your pull causes the wire to stretch. Naturally, you’ll probably have to pull on #8 to #18 wire with pliers; use your hand to pull #20 through #40. When working with thin wire, take extra care you use a gentle pull because the wire easily breaks. Also, just give the wire the slightest stretch. An overstretch will cause the enamel coating on enamel-insulated wire to crack and flake off; and you don’t want that, particularly if the turns will touch.

Prepare the ends

To avoid problems after the coil is wound, prepare one end of wire before you wind the coil by stripping away the insulation and then tinning about 3-inch of the free end of the wire—the start of the coil. You will cut the end down to the needed size when you install the coil. If the coil will be secured to a form, or a resistor used as a form, about 1-inch of tinning should be more than sufficient. If you're using bare solid tinned wire, it's already prepared. If you're using electrical wire, lightly scrape the copper oxide off one end with a knife—or use fine sandpaper—and then tin the end with solder. If you're using enameled wire, you must remove the enamel insulation. If the wire is #20 gauge, or heavier, you can scrape away the insulation with a sharp knife or razor blade, or use sandpaper. If the wire is #22 or finer, a knife will most likely cut through the wire as you scrape. Sandpaper will remove the insulation without breaking the wire.

Use a 1-inch or 2-inch square of *fine*, or #0, or #00 sandpaper for removing cleaning copper wire or enamel.

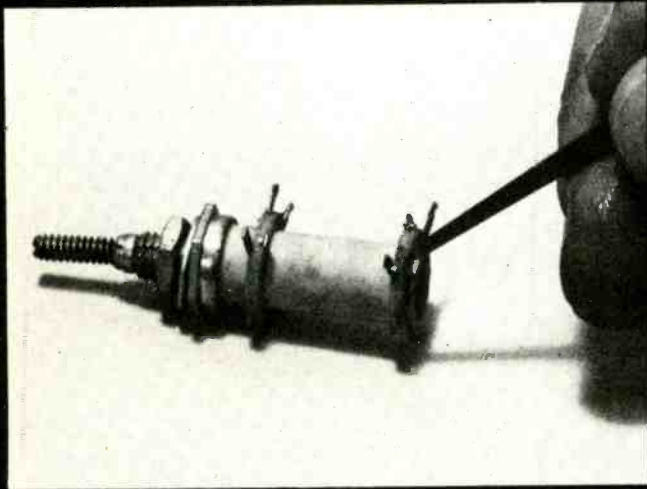

IF YOU NEED a slug-tuned coil you'll probably have to wind your own, but finding the form won't be easy. Again, you'll probably locate forms at a surplus distributor, or one that caters to the radio amateurs. This high-quality form, generally available to experimenters in "the good old days," has the *tie* (connecting) terminals moulded into the form. This is an excellent choice for radio-frequency coils wound with very-fine wire.

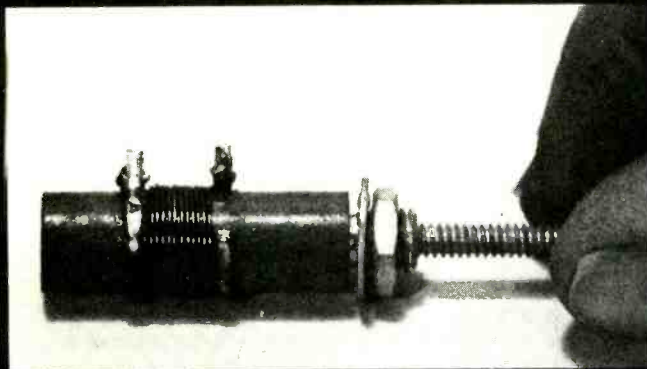

THIS IS THE TYPE OF FORM you're more likely to run across. The ties are slip rings. You position one ring, solder the free end of the wire, wind the coil, and then slip the second ring up against the winding. Don't squeeze the slip rings together too tightly or else some of the coils may lift up or accidentally short out.

Fold the sandpaper square in half, position it where you want the cleaning to start, squeeze firmly but not tightly, and pull the sandpaper towards the free end of the wire. Three or four passes is all it usually takes to clean both heavy and fine wire.

The form

If you don't hold the coil firmly in place it will tend to unwind and change the diameter—and possibly the spacing, or end-to-end dimension—when you let go of either end. So if at all possible, clamp the free end before you start winding. If you're using a wooden dowel for a form, cut a notch in one end deep enough to hold the wire; then wind the coil. When you get to the end, bend the wire at the final turn so it's parallel with the secured end. When you slide the wire off the form it will hold its dimensions. There is always a very slight unwinding—the exact amount depends on how well you tensilized the wire. If you need the form to hold the coil in position—perhaps it's a very long coil used as a powerline filter—cut the dowel slightly longer than the coil and then cement the coil to the form.

If you're using a resistor as a form for very fine wire, wrap several turns of tinned wire around the resistor lead right up against the body and solder it to the lead with a spot of solder. Then run the wire straight out along the body of the resistor to the point where you want the coil to start and bend the wire at a sharp right angle. Wind the coil; and when you finish, secure it in position with tape, bend the free end of the wire parallel to the body of the resistor and run the wire out to the remaining resistor lead. Solder the free end, remove the tape, and then cement the coil to the resistor with coil tape dope or Duco. You can also use G.E. RTV Silicon Rubber Adhesive or a similar product to secure and even protect the coil. But, be careful of "bathtub caulks" that resemble RTV adhesive. Some work, but others contain a chemical or product that seriously affects the coil's inductance. Best bet is to stick with G.E.'s RTV—we know it works.

For heavy wire coils—#18 or larger, 1/4-inch diameter or larger, you might not have to go to the slotted dowel if the coil has medium to wide spaced turns. Usually, such a coil isn't all that critical and it's self supporting, so a drill bit can be used as the form. Use the solid body of the bit as the form, not the flutes. Hold one end of the wire as tight as possible against the bit and wind your turns, counter-rotating both bands as you go along to wrap the coil around the bit. When you're finished, simply push the coil back into the desired shape. The reason you usually can't do this when many close spaced turns are involved is because coil slippage around the bit causes overlapped or relatively wide-spaced turns. Since your coil will be medium to wide spaced you can push the turns around even if they slip.

Slug tuned forms

If your project requires a slug-tuned coil, you'll need a little extra help because you really can't calculate the coil. The charts and tables usually available to hobbyists cover air core and toroid coils. You're usually on your own for slug-tuned forms. Normally, the slug should be "rated" for the operating frequency range but there's little chance many of you will be able to get anything other than a 3/8-inch form, which more often than not will work well in hobbyist projects to at least 30 MHz.

You usually can get a homebrew slug-tuned coil inside the ballpark by calculating the coil for the form without the slug, allowing for the fact that the slug will increase the inductance. Then, beg or borrow a "dip meter" and fudge the

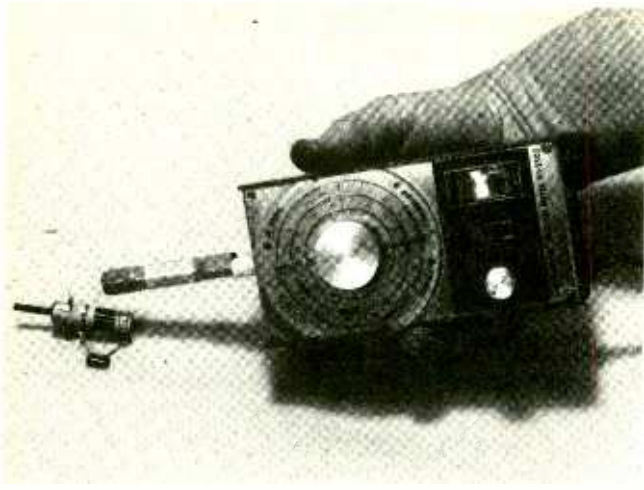

IF YOU'RE NOT CERTAIN of the coil's inductance, solder a known precision capacitor across the coil and measure the resonant (tuned) frequency of the L/C parallel resonant circuit with a "dip meter". Knowing the frequency and capacity, use a standard formula or chart to determine the coil's inductance.

coil to the desired value with the slug set to its mid-position...half in and half out of the coil itself (not the form). The dip meter is a special (not necessarily expensive) meter

usually used by amateurs that indicates the resonant frequency of a parallel resonant circuit. It only needs to be positioned near the coil or a resonant circuit to indicate the resonant frequency.

To use the dip meter to determine the inductance value of your homebrew coil you first connect a precision or silver mica capacitor across the coil to form a parallel resonant circuit whose resonant frequency will be somewhere near what the required inductance will create in combination with the capacitor. You calculate exact resonant frequency that the required inductance will create and then measure the resonant frequency of the coil and capacitor. If it's lower than the required frequency remove some turns (a turn at a time) until the dip-meter indicates the desired resonant frequency. If the dip meter indicates higher than the desired resonant frequency, run the slug in (increasing the inductance) and measure again. If the full slug doesn't drop the tuned frequency far enough you'll have to add some turns to the coil.

Using a dip meter is a simple routine, and the same procedure can be used to trim or *tweak* an air core coil to the desired value.

The photographs illustrate many of the techniques and procedures we're talking about. So next time a project calls for a coil you can't buy, just take some hints from the photos and wind your own. It's a lot easier than it sounds, and you can't break anything if you make a mistake. **SP**

ELECTRICAL SAFETY

DONALD K. ROEBER

WHEN DESIGNING AND BUILDING HOME ELECTRONICS PROJECTS, important safety factors should not be overlooked. If the project is powered by the 117-volt AC line, it is a good idea to have the chassis grounded and the circuit properly fused.

If you are using a metal project box, purchase a three-conductor line cord instead of the usual two conductor. After the line cord has been fastened to the box with a suitable strain-relief clamp, attach an eyelet to the end of the green ground wire. Next, place a lock washer on the ground screw of the box, push the eyelet onto the screw, and secure it tightly with a nut. If there is no ground screw in the chassis, one can easily be drilled and inserted. For those project boxes that have a separate cover and base, you may want to connect the ground circuit to the cover, also. That is done by inserting an insulated jumper wire between the ground screw of the base and the ground screw of the cover. Leave enough slack so that the case and cover can be pulled apart for servicing.

Lastly, check for good continuity by placing the test leads of an ohmmeter between the center ground prong of the line-cord plug and the metal box. The reading should be zero. Proper grounding will protect the user of the project from electric shocks in the event that the unit shorts out.

To avoid dangerous current flow during a short circuit, the unit should be fused. If the schematic diagram of the circuit you are using does not specify the type of fuse to use, the total current flow of the project can be measured by using an AC ammeter as shown in Fig. 1. Note the meter reading and select a fuse which is slightly larger. For example, if your

circuit draws .420 amperes, install a fuse rated at .500 amperes in the black lead circuit. Likewise, if your circuit draws 3.1 amperes, install a 4.0 ampere fuse. The "normal-blo" fuses are adequate for most digital circuits. If your circuit involves magnets, solenoids, motors, or lamps, the "slo-blo" type fuses are recommended because they are designed to withstand momentary high-current surges but still break down quickly if a short occurs.

With proper soldering and insulation, most home projects are reliable and quite safe. The addition of those safety measures, though, will add an extra feeling of security when you or someone else uses your project. **SP**

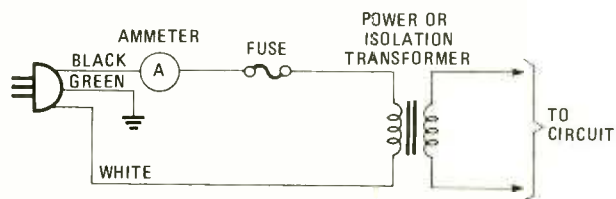
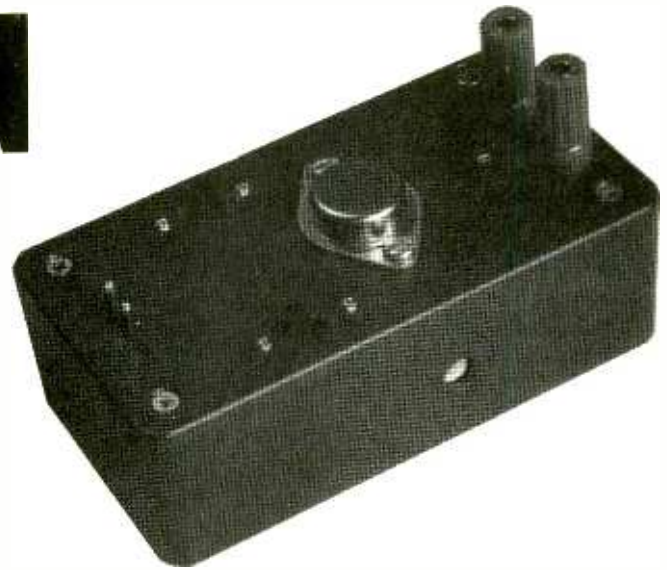

FIG. 1—Ammeter and fuse are shown in series with black lead of line cord. After fuse-size determination is made, remove the ammeter and jumper the circuit so that the fuse is the only circuit element between the black lead of the line cord and the primary winding of the power or isolation transformer in the project. Be sure to ground the green lead to the case of the project. Resistance between the line cord plug and the case should be somewhere between .001 and .01 ohm—too small to indicate on the ohmmeter as other than zero ohms. That's good enough!

CHAMELEON

This LM317 project offers switchable selection for power needs

RALPH TENNY



VERY OFTEN IT IS CONVENIENT TO HAVE AN ADJUSTABLE POWER supply that isn't dedicated to any other purpose except for a first trial of our latest bright idea. Here is a quickly built and very inexpensive power supply which has either voltage or current output. When 2.0 volts to 15 volts at up to 300 milliamps will do the job, the voltage output of *Chameleon* is ready at the flick of the power switch. If you need to charge a NiCad battery pack, form a capacitor, test LED's or any other job for a current source, just switch the leads to Chameleon's current output and go to it.

The LM317 is the heart of the power supply. It is an adjustable voltage regulator from National Semiconductor, and in spite of its somewhat higher cost, it has a number of advantages over the usual three-terminal regulators we have come to know and love. Fig. 1 shows the basic diagram of the regulator. It consists of the normal series regulator and voltage reference, but the LM317 uses a 1.25-volt reference instead of the usual 5 volts. Thus, when you use it like a normal three-terminal regulator (Fig. 2) its output is only 1.25 volts. Resistor R1 is necessary for proper operation.

So, to get the more useful voltages from 5 volts up,

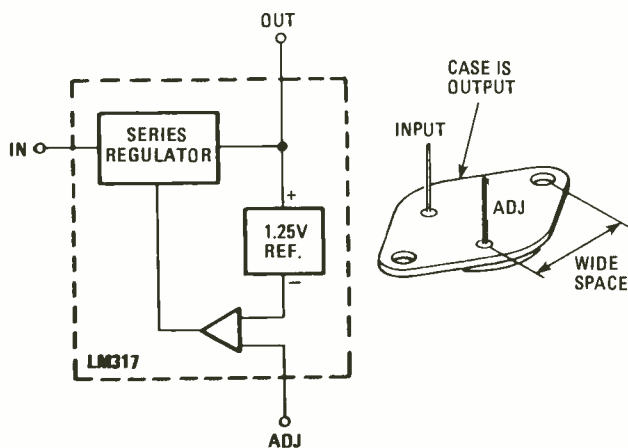

FIG. 1—THE LM317 IS A THREE-TERMINAL adjustable regulator with 1.25 volts internal reference. The chip is capable of 1.5 amperes over a 1.2- to 37-volt range according to the manufacturer's specifications.

connect two resistors, or a potentiometer and a resistor, to the basic regulator as shown in Fig. 3. Now, it may not seem like an advantage to use three parts instead of one, but you'll like the versatility that the LM317 offers. In the first place, only one type of regulator is needed for a number of purposes. And, when you need a variable voltage, as with Chameleon, it should be possible to get as low as 1.25 volts (instead of the usual 5-volts minimum with other regulators) with this basic circuit. However, due to a design compromise discussed later, Chameleon's low end is about 2 volts.

One major advantage of the low reference voltage of the LM317 is that a very efficient current source is possible. The current-source circuit is shown in Fig. 4. Figure 4a shows a 7805 regulator, which requires 5-volt drop across the current shunt, because the older regulator design uses a 5-volt reference. In Fig. 4b, the LM317 requires only 1.25 volts, which means that the energy lost in the regulator and circuitry is about one-fourth that of the older circuit. Note that in Fig. 4b, the variable resistance must not be allowed to go to zero; that would imply infinite output current. (See R3 in Fig. 6.)

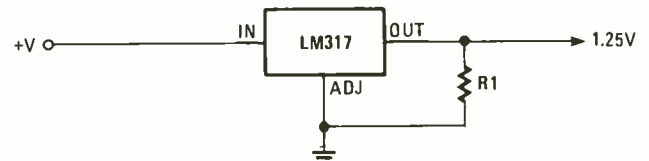

FIG. 2—MINIMUM OUTPUT VOLTAGE for the LM317 is 1.25 volts. Resistor R1 is necessary for proper circuit operation. Maximum rated power dissipation is 20 watts for the TO-3 package, but Chameleon needs only half, or less, of that.

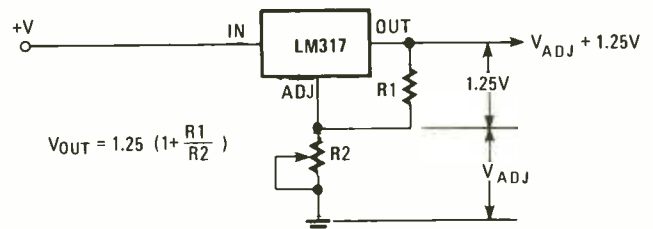

FIG. 3—ADD A POTENTIOMETER to the circuit in Fig. 2, and the LM317 makes a wide-range adjustable voltage regulator. Minimum voltage output is about 2 volts.

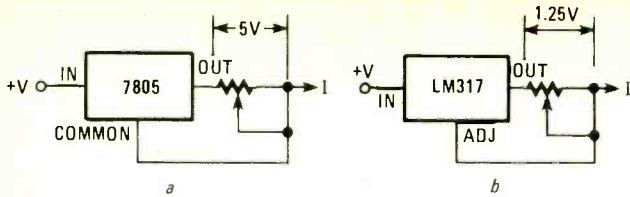

FIG. 4—ALL THREE-TERMINAL REGULATORS can be used as current generators. The 7805 regulator (a) has a 5-volt reference and, therefore, wastes power in the sense resistor. The LM317 (b) with its internal 1.25 voltage reference is more power-efficient and has a wider adjustment range.

Design considerations

In designing Chameleon, it was apparent that only a few additional parts would give either voltage or current output capability. Therefore, in Fig. 5 a circuit is shown which can give either voltage or current output by flipping a switch. The voltage-output terminal *should not be used* with current mode selected; any load between the current-output terminal and common will reduce the output voltage if Chameleon is being used in voltage mode. So, disconnect all loads before

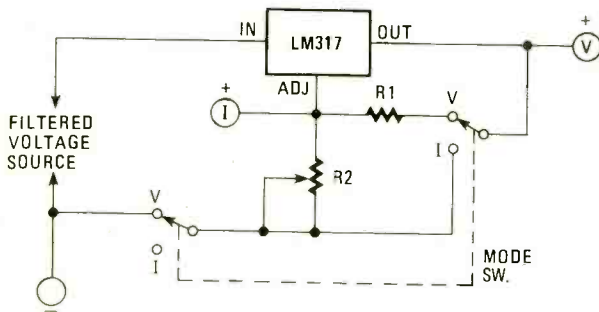

FIG. 5—A FEW ADDED COMPONENTS makes the LM317 into both a voltage and current regulator, switch-selectable. As a precaution, external circuits should not be connected during switch interval. More details in text.

switching and then connect a load to Chameleon before switching it on.

All the previous illustrations have omitted two important parts from the schematics. Those are the input (C2) and output (C3) capacitors in the complete Chameleon schematic diagram shown in Fig. 6. Capacitor C2 can be omitted unless the leads from the filtered DC supply are over five inches long. Capacitor C3 makes a big improvement in the recovery time of the regulator if a sudden change in the load current occurs. No special layout precautions are needed for Chameleon, and, except for good soldering and construction practice, nothing is critical about the circuit layout. In the version shown in the photos, C2 was omitted due to the small box and short leads.

Watts and ohms

One more component was added to the final schematic diagram (Fig. 6); R3 sets an upper limit on the output current furnished to the load. The limiting factor is the power rating of R2; the part specified in the Parts List is a ¼-watt potentiometer. That simply means that there is a maximum current which any part of R2 can handle, and maximum-load current occurs when R2 is set to the lowest resistance. That can be computed using Ohm's law:

$$\text{Power (watts)} = I^2 (\text{amps}) \times R (\text{ohms})$$

From the formula, we can compute that about 22 mA current in R2 would be the maximum. Since the wattage rating on

PARTS LIST (Refer to Fig. 6)

RESISTORS

¼-watt, 5% unless otherwise noted

R1—100 ohms

R2—1000 ohm potentiometer

R3—27 ohms

R4—50,000 ohm potentiometer (see Fig. 7)

CAPACITORS

C1—1000 µF, 35-volt electrolytic

C2, C3—1 µF, 35-volt tantalum

SEMICONDUCTORS

IC1—LM317 adjustable voltage regulator

DB1—Diode bridge rectifier, Radio Shack 276-1151

Q1—NPN silicon transistor, Radio Shack 276-2013

(See Fig. 7)

ADDITIONAL PARTS AND MATERIALS

S1—DPDT slide switch

T1—line primary to 25.2 VAC secondary, 200 mA transformer, Radio Shack 273-1386

Delux plastic project case, line cord, binding post, perf board, solder, wire, etc.

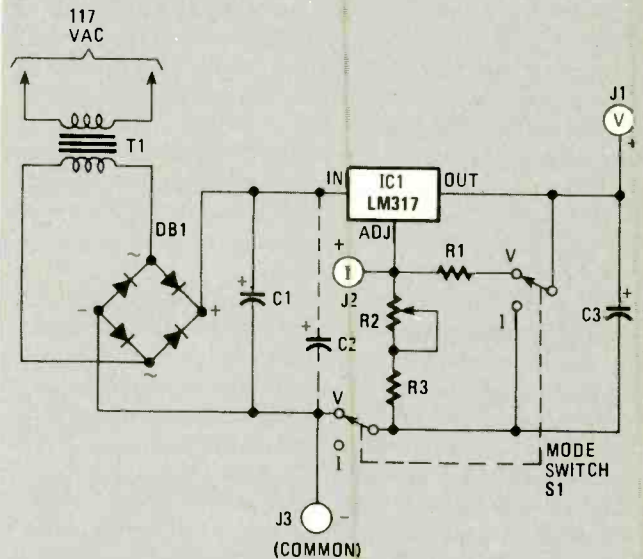

FIG. 6—SCHEMATIC DIAGRAM FOR CHAMELEON presents no parts problem at all. Except for the LM317, all parts may be in your junkbox now.

components is for continuous use, we can fudge some and assume that about 50 mA load current is acceptable for short-time applications.

Potentiometer R2 was chosen for its availability, even though a potentiometer with a shaft would have been preferable. The lack of shaft is solved by mounting R2 so that a hole in the side of the box (see photos) allows screwdriver adjustment of the output. If a larger value of current is needed from Chameleon, you should substitute a 100-ohm, one-watt potentiometer, and use a 10-ohm resistor for R3. That combination will give you a maximum current of 300 mA, which is more than the LM317 should be called on to deliver without a heat sink. With the high current configuration installed, Chameleon will deliver about 3-volts maximum in the voltage mode, unless R1 is much smaller. However, with R1 preselected to be 27 ohms, the maximum output will be about 6 volts. At 6-volts output, the R1-R2-R3 resistive

string will pull over 40 milliamperes of current. Therefore, if a heavy current source is needed, it should be a separate unit.

Low current

When you test Chameleon's current mode (using the schematic diagram of Fig. 6), you will note that about 3 mA is the lower limit of adjustment. That is due to the current used by the circuitry inside the LM317. However, Fig. 7 shows an alternate hookup which can give an arbitrarily small current (down to 100 microA or less, if Q1 is a low-leakage transistor). What happens is that the LM317 serves as a voltage reference for Q1 and R4. The accuracy of that current source is directly dependent upon the current gain (h_{FE}) of Q1 at any collector current. That is, if the h_{FE} is only 10 at a collector current of 100 microamps, the actual load current will be 110 microamps, or a 10% error. For a h_{FE} of 250, the error is only 0.4%. Of course, the error is pro-

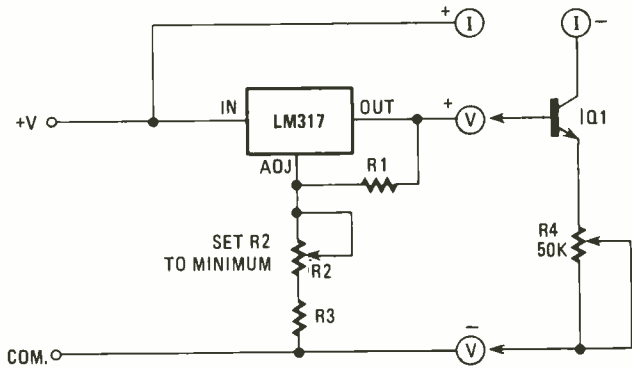

FIG. 7—TWO OUTBOARD COMPONENTS added to Chameleon makes a very low current generator when R2 is set for minimum voltage output.

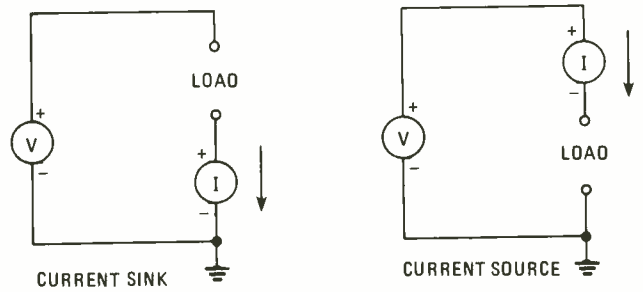

FIG. 8—A TWO-TERMINAL CURRENT GENERATOR can be used as either a current source (feeding a ground load) or a current sink (taking current from a floating load).

portional to the h_{FE} at any collector current, instead of just at low currents as in the example chosen.

Just looking at the circuits in Fig. 4 and 7, it would seem that Fig. 4 shows a current source; and Fig. 7, a current sink. Actually, Fig. 8 shows the same two-terminal current generator connected as both a current source and a current sink. The difference is in which terminal is referenced to which terminal of the main circuit. All you need to remember in applying Chameleon as a current generator is that the (+) current terminal is a current source and the (-) terminal is a current sink, and to reference the appropriate terminal to the desired place in the circuit under test.

Chameleon is constructed entirely from Radio Shack parts for convenience, using the parts shown in the Parts List. If you choose the same chassis box as the author, the photos will show one way to assemble the parts. You'll find bench testing of new circuits with a variable voltage source is a lot quicker when you have Chameleon around. And as a plus, you now own an often-needed current source. **SP**

Putting Chameleon Together

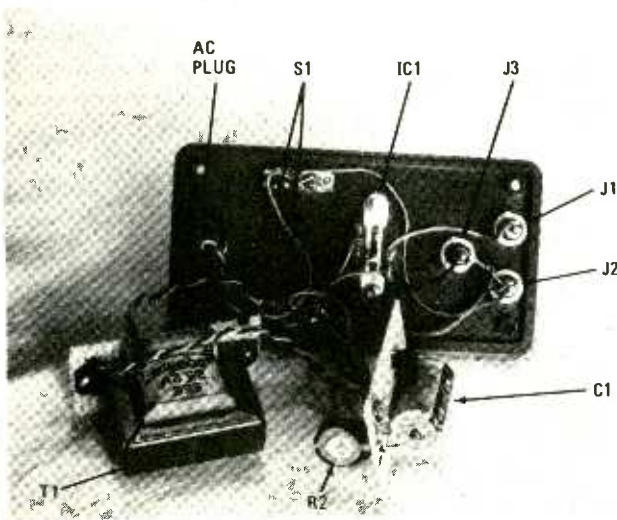

TEST CHAMELEON, after it is all wired up, but before putting it into the chassis. That way you can see any smoke and feel things get hot if you goofed! In this version of Chameleon two SPST switches performed the function of S1 in Fig. 1. The editor finds it wiser and cheaper to use one DPDT switch in your version.

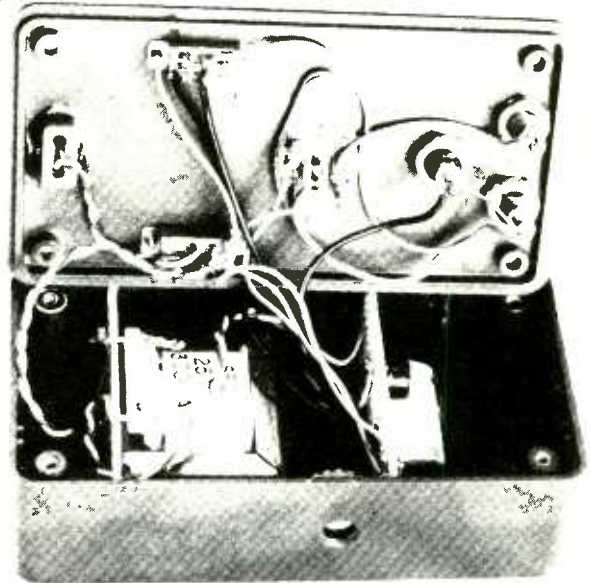

HERE IS THE FINISHED CHAMELEON, showing off the internal arrangement of parts. Tuck wires carefully out of the way as you close the lid—don't pinch any of them. Note hole on side of box permitting adjustment of potentiometer.

Radio-Electronics

BUILD FOR LESS THAN \$10
DIGITAL LOGIC PROBE

51.25 AUG. 1980

6 audio test accessories to build
Tuning in worldwide SW
Step-by-step TV W/align.

**AVAILABLE — COMPLETE
for the FIRST TIME!**

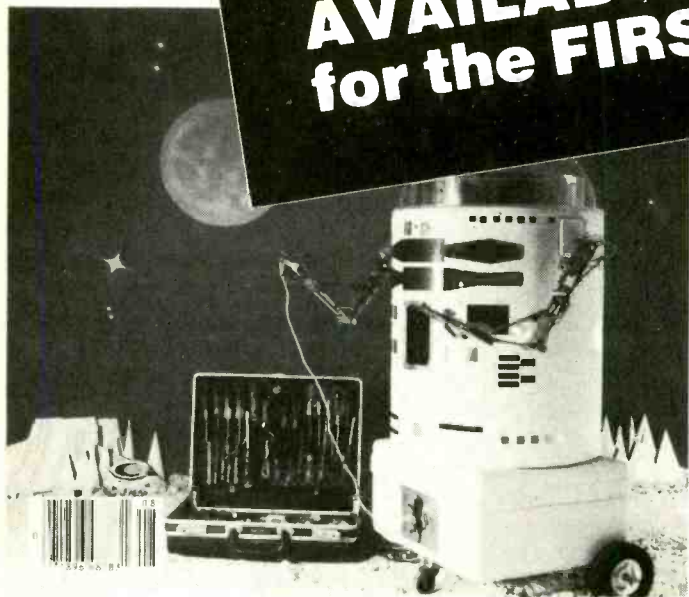

BUILD YOUR OWN ROBOT!

Send today for your 52-page (8½ × 11") booklet containing complete reprints of all eleven articles in the Build Your Own Robot series by Jim Gupton.

This all-inclusive reprint gives you all the data you need to build your own Robot.

■ TELLS EVERYTHING YOU NEED TO KNOW to build the Unicorn-1 Robot without the need for an engineering degree or special equipment.

The robot is fully mobile with manipulator arms to grasp, lift and carry.

■ MANIPULATOR ARMS and end-effectors (hands) are what enable the robot to perform useful tasks. Details of construction techniques and considerations are fully explored.

■ MOBILITY BASE is not a lunar space station. It is the drive system that permits the robot to move from here to there. Full construction details along with a discussion of power sources is included.

■ THE BODY—FRAME AND ROTATION MECHANISM. This is the part that makes Unicorn-1 look like a robot. Wood and Formica are the materials for the body. Motors and gears are what make it function.

■ COMMUNICATIONS. How you can tell your robot what to do. Preprogramming techniques....radio controlcomputer control are all detailed.

■ SENSORS. How to add sensors so your robot doesn't bump into things.

Radio-Electronics

Robot Reprints
200 Park Ave. South
New York, N.Y. 10003

SPF1

Please print

(Name)

(Street address)

(City)

(State)

(Zip)

I want to order _____ reprints @\$12.00 plus \$1.00 postage and handling for U.S., Canada and Mexico. Add 96c sales tax for New York State residents only. U.S. Funds only.

I want to order _____ reprints @\$12.00 plus \$3.00 Air Postage and handling for all other countries. U.S. Funds only.

Allow 6-8 weeks for delivery.

We do not bill, check must be enclosed.

NEW PRODUCTS

(Continued from page 6)

SATELLITE VIDEO RECEIVER, model *RCV-650*, is an antenna-mount receiver with remote-control capability, digital channel select, and a self-contained LNA power supply.

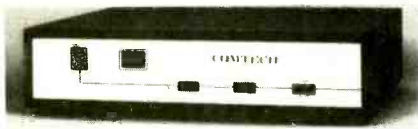

CIRCLE 712 ON FREE INFORMATION CARD

The channel select allows the user to set the channel and read it on the LED readout. The MGC/AGC switch, control and test-point allows the user to align the antenna to insure the best antenna position. The model *RCV-650* is priced at \$2275.00.—Comtech Data Corporation, 613 South Rockford Drive, Tempe, AZ 85281.

AMPLIFIERS, Model *BA-3082* (shown), and Model *BA-7082*, are back-of-the-set TV amplifiers designed to improve reception where signal levels are low and pictures are snowy. They are also valuable for reception problems caused by adding couplers, splitters, and switches to systems, combining signals from several sources, or operating more than one set or receiver. They also provide sharp pictures for high VCR recording quality.

The Model *BA-3082* has a 300-ohm input and output, while the Model *BA-7082* has a

75-ohm input and output; either can be used with any outdoor or indoor antenna. Both are CATV compatible and amplify all VHF, mid, and super band channels, FM, and UHF channels 14 through 83.

There is also an FM version—Model *FM-3000*—that cleans up fading distant FM stations and provides excellent stereo reception. It features 300-ohm input and output and amplifies 88-108 MHz. All three models attach out of sight, behind the TV set or FM



CIRCLE 713 ON FREE INFORMATION CARD

tuner, and feature a UL-approved, calculator-type power supply, which plugs directly into an AC receptacle.

The suggested retail price for Model *BA-3082* and Model *BA-7082* is \$29.95. Model *FM-3000* lists for \$34.95.—Winegard Com-

pany, 3000 Kirkwood Street, PO Box 1007, Burlington, IA 52601.

WIRE DISPENSER, model *WD-30-TRI*, holds three colors of wire and features built-in cutting and stripping mechanism. The refill-

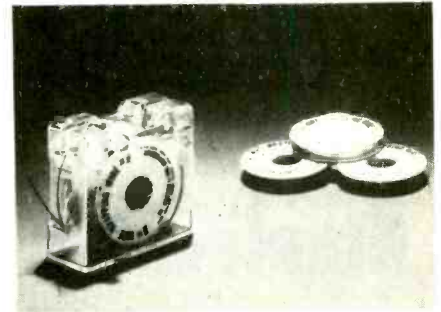

CIRCLE 714 ON FREE INFORMATION CARD

able dispenser holds 50 feet each of red, white, and blue Kynar insulated, silver-plated, solid copper wire. To operate the cut-strip mechanism, the wire is first drawn out to desired length; then a built-in plunger cuts the length free from the roll, while a gentle pull through the stripping blade removes the insulation. The model *WD-30-TRI* is priced at \$9.17; the three-color refill, model *R-30-TRI*, is priced at \$7.01.—OK Machine and Tool Corporation, 3455 Conner Street, Bronx, NY 10475.

(Continued on page 102)

2 NEW OPTO DESIGN KITS!

Now you can have 36 different options for easy LED design right at your finger tips!

Opto Designer I 180 T-1 and T-1½ Red, Green, Yellow, Orange and Red-Orange LED Lamps **\$19.95**

Opto Designer II 180 Round, Square, Triangular, Rectangular and Cylindrical LED Lamps **\$24.95**

Send for **FREE LED BROCHURE**:
 • 3 mm (T-1) 5mm (T-1½) • Round • Square
 • Cylindrical • Triangular • Rectangular • High Intensity • Custom • Arrays • Two-color Round, Rectangular • Level meter panel displays.



FREE 100 CB-50 T-1½ mounting Clips if you order within 7 days

ETRONIX 14803 NE 40th Street, Dept. SP-6 Redmond, WA 98052

YES, I would like to take advantage of your offer.

- Send me — Opto Designer I @ \$19.95 plus \$3.00 shipping and handling
- Send me — Opto Designer II @ \$24.95 plus \$3.00 shipping and handling.

Name _____

Address _____

Company _____

City _____ St. _____ Zip _____

Signature _____

Please charge my Mastercard Visa

No _____ Exp. _____

CALL TOLL FREE 1-800-426-1044

CIRCLE 716 ON FREE INFORMATION CARD

FREE
 A \$2.19 VALUE Socket Sample Pak

You can now receive nine phosphor bronze IC sockets absolutely **FREE**. It is our way of introducing you to the quality parts we offer.

Sample Pak 3 ea. S-247013-14 (14 pin)
 Includes: 3 ea. S-247013-16 (16 pin)
 3 ea. S-247040-40 (40 pin)

YES, please send me a **FREE SOCKET SAMPLE PAK**, plus your brochure on additional products available.

Please include \$1.00 to help cover postage and handling

Name _____

Address _____

City _____

State _____ Zip _____

ETRONIX

14803 N.E. 40th Dept. SP-6 Redmond, WA 98052

CIRCLE 717 ON FREE INFORMATION CARD

MICRO-PROFESSOR
 MPF-1 USER'S AND EXPERIMENTAL

Dear Electronic Enthusiast:
 Now Let the Micro-Professor usher you into the microcomputer revolution.

"The Micro-Professor" is the first really low-cost learning system designed for personal use. It will truly become your Personal Computer.

Sincerely,
 Chris Johnson
 Chris Johnson, Customer Service

only **\$129.95**

Z-80 BASED MICROCOMPUTER

A superb learning tool for students, instructors, hobbyists.

Nothing else needed. Just plug in and start learning! Complete experimenters manual, easy instructions. 18 experiments. Fully expandable for Z80-CTC, Z80-PIO, EPROM, Breadboarding and prototyping. Invest with confidence. Now only \$129.95, two for only \$239.95. Full BASIC interpreter now available, only \$19.00. 2KB money back guarantee!

Plus-FREE GIFT

Check this box for **FREE Z-80 Microprocessor Programming and Interfacing** textbook when you order within 7 days. \$12.95 value.

ETRONIX For immediate action call TOLL FREE: **1-800-426-1044**

Dept. SP-6 14803 N.E. 40th Redmond, WA 98052

NAME _____
 ADDRESS _____
 CITY _____ ST _____ ZIP _____
 VISA MSTCRD EXP _____
 ACCT. NO. _____

CIRCLE 718 ON FREE INFORMATION CARD

Radio-Electronics



Radio-Electronics

This will be coming to you when you subscribe to **RADIO-ELECTRONICS:**

- HELPFUL CONSTRUCTION ARTICLES ...
- NEWS ON NEW TECHNOLOGY ...
- FASCINATING "HOW TO DO IT" ARTICLES
- HOW YOU AND THE COMPUTER CAN BE FRIENDS ...
- NEW AUDIO DIMENSIONS FOR YOUR PLEASURE ...
- TV WONDERS FOR YOUR FUTURE ...

Get it all! Subscribe today to Radio-Electronics. Don't miss a single issue. Save up to \$10.03 off the newsstand price.

When you select one of the subscription offers listed below you'll be assured of having your copy of Radio-Electronics reserved each month even if it sells out on the newsstand.

Fill in and mail this coupon today.

SAVE MONEY—enclose payment now and receive ONE EXTRA ISSUE per year.

Get the Best—Every Month! Mail Today!

7HB38

YES! please send me

- | | |
|---|---|
| <input type="checkbox"/> Payment enclosed, 13 issues \$14.97
(You save \$4.53 off newsstand price.)
Canada \$17.97 - U.S. funds only | <input type="checkbox"/> Bill me - 12 issues \$14.97
(You save \$3.03 off newsstand price.)
Canada \$17.97 - U.S. funds only |
| <input type="checkbox"/> Payment enclosed, 26 issues \$28.97
(Save More! \$10.03 off newsstand price)
Canada \$34.97 - U.S. funds only | <input type="checkbox"/> Bill me - 24 issues \$28.97
(Save More! \$7.03 off newsstand price.)
Canada \$34.97 - U.S. funds only |

Name _____ (please print)

Address _____

City _____ State _____ Zip Code _____

Mail to: RADIO-ELECTRONICS
P.O. Box 2520
Boulder, Colorado 80322

Offer valid in U.S. and Canada only
Allow 6-8 weeks for delivery of first issue.

LETTERS

(Continued from page 4)

tures of both Designers, yours and mine for a super Designer. You know, I'm all excited, and the only reason I am writing to you and not working on a project is because I have to wait for some parts to be shipped in.

DAN ROSS
Montebello, California

Thanks for the nice note, Dan. We like to hear that our readers are not copying our projects exactly. A little imagination and circuit modification makes for a more interesting hobby. And, to be honest with you, the only reason I'm answering your letter so soon is because I have some free time—because I am waiting for some parts to come in the next UPS delivery.

SAVING SPACE

Dear Editor:

The #5 issue of **Special Projects** was a real winner. However, I'd like to make a suggestion. Why don't you reduce by half the size of those big printed-circuit diagrams and use the extra space to illustrate the project with additional

diagrams and photos.
KAL DANSE
Islin, New Jersey

Thanks for the tip, but reducing the diagrams would make problems. We'd have to tell the readers that they were looking at 50% reductions. That's OK, but what if one of our readers wanted to trace the printed-circuit board directly, or use a home-type photo-transfer technique? He (or she—the ladies are joining our ranks) must then get a blowup of the diagram—at a cost of \$2.50-5.00. Thus, for a majority of our project builders there would be an added cost to those projects with large printed-circuit boards.

But that isn't all of it. Even for those who have the money or means to enlarge the drawing, there would be additional troubles. A clean photostat enlarged produces a clean enlarged picture. However, the fine lines of a drawing printed on paper by a high-speed press may seem to be very sharp as seen in the issue, but, when enlarged, the edges look hairy with breaks and the like. In fact, should a small wood splinter in the paper appear in the diagram, a copper bridge might be added to the final product—and destroy the project.

Sorry, Kal, your suggestion is not the answer, but keep on thinking; we are, too. We welcome tips on methods for improving our magazine. **SP**

NEW PRODUCTS

(Continued from page 101)

BOARD, model 4S/2P-ASM, is a four-serial/two parallel port board. The four RS-232 serial input/output ports use four 8251's. The I/O ports use eight consecutive 8080 ports. Features include full handshaking capability and four dip-switch controlled baud-rate generators.

Two 8-bit parallel I/O ports include four 8-bit latches (74LS373's) and use four consecutive 8080 ports. There are separate handshaking lines, outputs that will drive up to 30 mA, and inputs that present less than a .4-mA load.

The board is S-100 compatible; all cables are included; it comes completely assembled and thoroughly tested, and there is a six-month, no-fault full warranty.

The model 4S/2P-ASM is priced at \$395.00.—**Tarbell Electronics**, 950 Dovlen Place, Suite B, Carson, CA 90746.

CIRCLE 715 ON FREE INFORMATION CARD

ADVERTISING INDEX

R-E SPECIAL PROJECTS does not assume any responsibility for errors that may appear in the index below.

Free Information Number	Page
--	Advance Electronics Cover 3
719	A P Products Incorporated 6
--	Cleveland Institute of Electronics, CIE 37
716	Electronix 101
717	Electronix 101
718	Electronix 101
--	McGraw-Hill Continuing Education Center 16
--	NRI Schools 55
--	Windjammer Cover 4

HITACHI

NLS Non-Linear Systems

HICKOK

WESTON

DATA PRECISION

KEITHLEY

FLUKE

PHILIPS

BK PRECISION

VIZ RCA

DORIC

TRIPLETT

Simpson

LEADER

BK PRECISION 15 MHz TRIGGERED SWEEP SCOPE

MODEL 1477

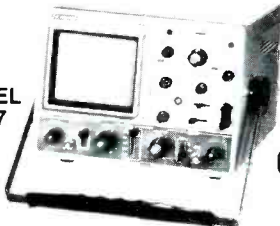

CALL FOR PRICE

- Mode automatically shifts between CHOP and ALTERNATE
- Bright P31 blue phosphor
- Front-panel X-Y operation
- Differential input capability
- 19 calibrated sweeps—.5 μ SEC/cm to .5SEC/cm
- Sweep to .1 μ SEC/cm with 5x; 1.5SEC/cm with uncalibrated vernier

PRICE DOES NOT INCLUDE PROBES

BK PRECISION 30 MHz TRIGGERED SCOPE

MODEL 1479B

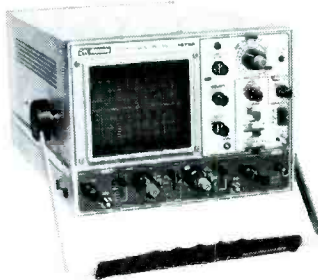

CALL FOR PRICE

- Built-in signal delay line permits view of leading edge of high frequency pulse rise time.
- Triggers on signals up to 50MHz
- Rectangular CRT with P31 phosphor
- Mode automatically shifts between CHOP and ALTERNATE

PRICE DOES NOT INCLUDE PROBES

BK PRECISION 70 MHz. Dual Time BASE SCOPE

MODEL 1570

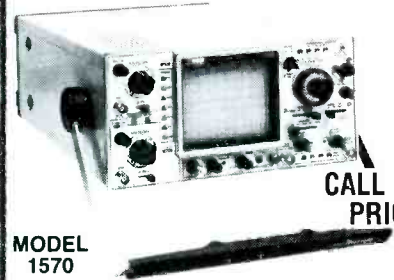

CALL FOR PRICE

- 1 mV/division sensitivity to 70 MHz
- 500 μ V/division cascade sensitivity
- Four-input operation provides trigger view on 4 separate inputs.
- Alternate time base operation
- Switching power supply delivers best efficiency and regulation at lowest weight

FLUKE 4 1/2 DIGIT MULTIMETERS

MODEL 8060A

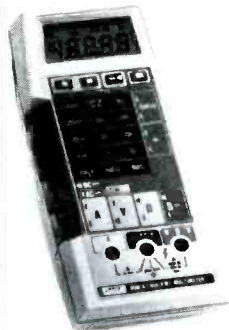

- Frequency measurements to 200KHz
- dB measurements
- Relative measurements
- True RMS
- High-speed Beeper

CALL FOR PRICE

MODEL 8062A

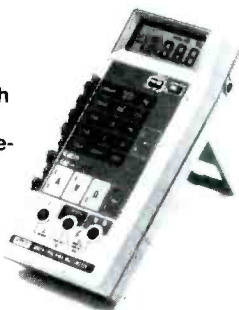

- .05% accuracy
- True RMS
- 30KHz bandwidth
- Relative measurements
- Beeper

CALL FOR PRICE

BK PRECISION FUNCTION GENERATORS

MODEL 3010
CALL FOR PRICE



- Four instruments in one package—sweep generator, function generator, pulse generator, tone-burst generator
- Covers 0.02Hz-2MHz
- 1000:1 tuning range
- Low-distortion high-accuracy outputs

SWEEP FUNCTION
MODEL 3020
CALL FOR PRICE

- Sine, square and triangle output
- Variable and fixed TTL outputs
- 0.1 Hz to 1MHz in six ranges
- Push button range and function selection
- Typical sine wave distortion under 0.5% from 1 Hz to 100kHz

HITACHI 35MHz DUAL TRACE W/DELAY



CALL FOR PRICE

MODEL 352
HIGH PERFORMANCE LAB SCOPE.
A MINUS B INPUT

PRICE DOES NOT INCLUDE PROBES

AWS
A. W. SPEAR
INSTRUMENTS INC.



CALL FOR PRICE

AWS DIGITAL MULTIMETERS

- Models EZ-6100, 6110, 6200 & 6220
- Autorangeing on volts and ohms
- Self-contained 10 Amp AC/DC ranges (EZ-6110 & 6220)
- Low power ohm ranges—applied voltage \leq 0.3V.
- Continuity buzzer (EZ6100 & 6110), 5 settings
- Range hold (EZ6100 & 6110)
- Large 3 1/2 digit LCD display
- 300 hours continuous operation
- FIVE-YEAR WARRANTY



TOLL FREE HOT LINE
800-223-0474

THE TEST EQUIPMENT SPECIALISTS

ADVANCE ELECTRONICS

26 West 46th Street, New York, N.Y. 10036 212-730-7030

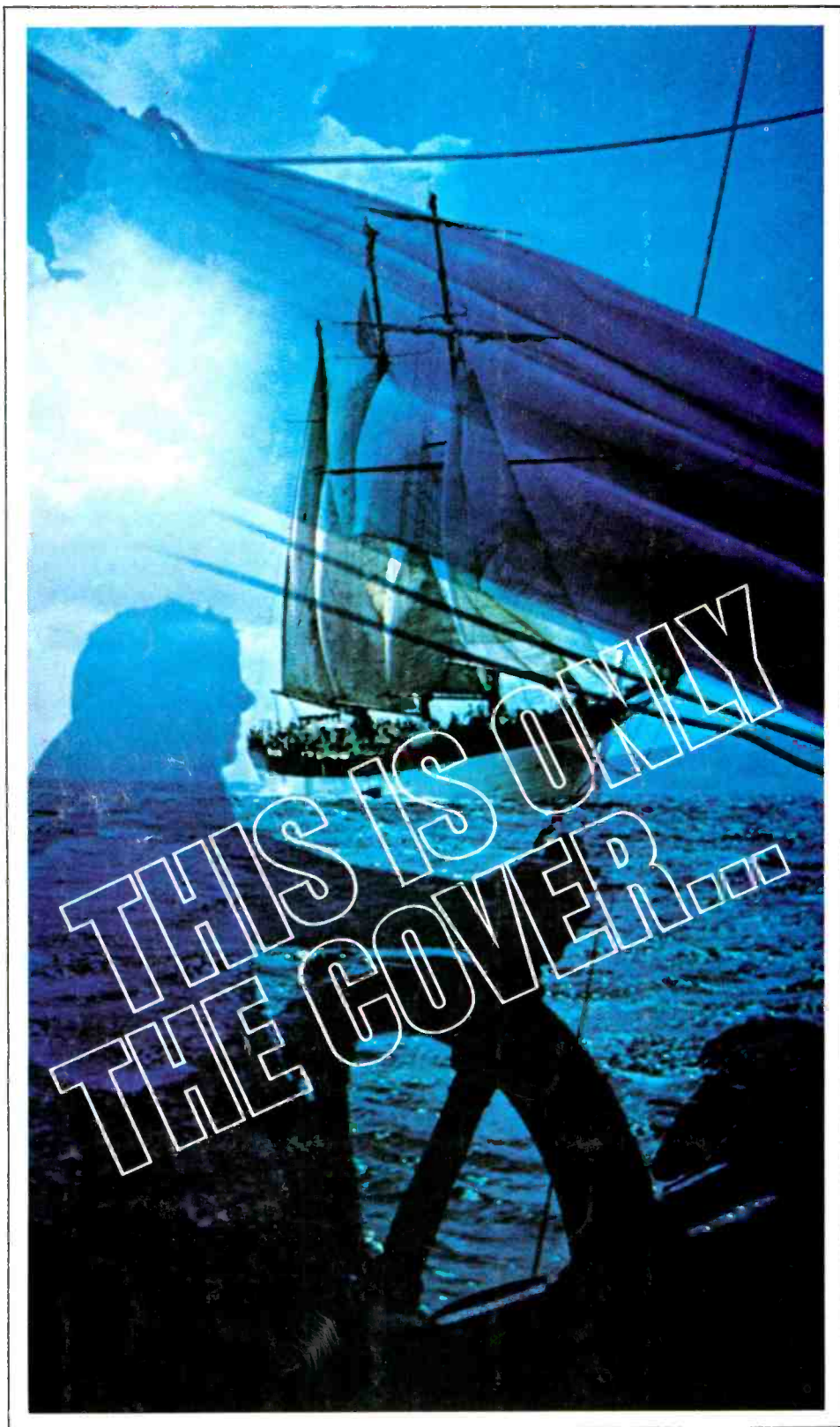

**...you
should
see the
rest!**

It's full of fun, sun,
barefeet & bikinis.

It's runnin' with the wind
to small, tropical islands
and unique ports o' call for
those with itchy feet and
adventure in their soul.

We're not the Love Boat,
but we'll take on anybody
when it comes to beach-
combing, sailing &
exploring the exotic Carib-
bean. It's our backyard
and we know all the great
places in paradise.

And, 6-day cruises start
from \$425.

So send for the rest of the
booklet. It's free!

Look us over & "sea it"
our way!



**Windjammer
Barefoot Cruises, LTD.**

Box 120, Dept. 1642, Miami Beach, FL 33119-0120

or call TOLL FREE and tell us you need the rest of the booklet: 800-327-2600

in FL: 800-432-3364