

1991

Radio
Electronics

ELECTRONICS EXPERIMENTERS handbook™

164 PAGES!

**BUILD THIS
LIGHT-BEAM
COMMUNICATOR**



\$3.50 U.S.
\$3.95 CAN.

BUILD ONE OF THESE!

- ★ SPECTRUM MONITOR
- ★ ALPHA MEDITATION GOGGLES
- ★ REMOTE A/B SWITCH

TECHNOLOGY

- ★ TRACKING DOWN EAVESDROPPING BUGS
- ★ FMX NOISE REDUCTION
- ★ CHOOSING SHORTWAVE ANTENNAS

VIDEO PROJECTS

- ★ AMATEUR TV TRANSMITTER
- ★ SCENE SWITCHER
- ★ REMOTE-CONTROL EXTENDER

ELECTRONIC HOW-TO

- ★ SOLVING VCR TAPE-LOAD PROBLEMS
- ★ SERVICING DIGITALLY TUNED RADIOS
- ★ AUTOMATED TEST EQUIPMENT

COMPUTER PROJECTS

- ★ RGB-TO-NTSC CONVERTER
- ★ 68705 MICROCONTROLLER
- ★ D/A CONVERTER

AUDIO PROJECTS

- ★ ACOUSTIC FIELD GENERATOR
- ★ SUBWOOFER SIMULATOR
- ★ PHONE-ACTIVATED AUDIO MUTE

ELENCO & HITACHI PRODUCTS AT DISCOUNT PRICES

NEW! RSOs (Real-Time & Storage Oscilloscopes) From HITACHI **NEW!**
The RSO - its the new solution
View, Acquire, Test, Transfer and Document Your Waveform Data

4-Channel, 100MS/s Model **Introductory Price**
100MS/s (25MS/s on 4 channels simultaneously), 100MHz, 4kw x 1ch., 2kw x 2ch., 1kw x 4ch. VC-6145 \$4,695.00

Compact, Full Feature Models
40MS/s, 100MHz, 4kw x 1ch., 2kw x 2ch. VC-6045 \$3,049.00
20MS/s, 50MHz, 2kw x 2ch. VC-6025 \$2,295.00

Low Cost/High Value Models
20MS/s, 50MHz, 2kw x 2ch. VC-6024 \$2,049.00
20MS/s, 20MHz, 2kw x 2ch. VC-6023 \$1,749.00

RSOs from Hitachi feature such functions as roll mode, averaging, save memory, smoothing, interpolation, pretriggering, cursor measurements, plotter interface, and RS-232C interface. With the comfort of analog and the power of digital.



V-422 40MHz Dual Trace \$795

Hitachi Portable Scopes
\$435 DC to 50MHz, 2-Channel, DC offset function, Alternate magnifier function
V-525 CRT Readout, Cursor Meas. \$1,025
V-523 Delayed Sweep \$995
V-522 Basic Model \$895

Compact Series Scopes



Delayed Sweep
Lightweight (13lbs)
2mV Sens
3 Yr Warranty

Model V-1065 Shown

This series provides many new functions such as CRT Readout, Cursor measurements (V-1085/1065/665), Frequency Ctr (V-1085), Swepttime Autoranging and Trigger Lock using a 6-inch CRT. You don't feel the compactness in terms of performance and operation.

V-660 60MHz Dual Trace \$1,195
V-665 60MHz Dual Trace w/Cursor \$1,345
V-1060 100MHz Dual Trace \$1,425
V-1065 100MHz Dual Trace w/Cursor \$1,695
V-1085 100MHz Quad Trace w/Cursor \$2,045
V-1100A 100MHz Quad Trace w/Cursor \$2,295
V-1150 150MHz Quad Trace w/Cursor \$2,775

20MHz Elenco Oscilloscope

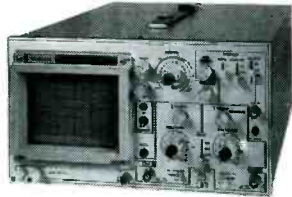

\$375
MO-1251

- Dual Trace
- Component Tester
- 6" CRT
- X-Y Operation
- TV Sync
- 2p-1 Probes

FREE DMM
with purchase of
ANY SCOPE
SCOPE PROBES
P-1 65MHz, 1x, 10x \$19.95
P-2 100MHz, 1x, 10x \$23.95

Elenco 35MHz Dual Trace

Good to 50MHz **\$495**
MO-1252

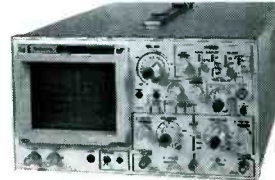

- High luminance 6" CRT
- 1mV Sensitivity
- 6KV Acceleration Voltage
- 10ns Rise Time
- X-Y Operation + Z Axis
- Delayed Triggering Sweep
- Includes 2 P-1 Probes

All scopes include probes, schematics, operators manual, and 3 year (2 yrs for Elenco scopes) world wide warranty on parts & labor. Many accessories available for all Hitachi scopes. Call or write for complete specifications on these and many other fine oscilloscopes.

WE NOW CARRY COMPLETE LINE OF FLUKE MULTIMETERS Models

- 21F 83
- 23F 85
- 25F 87
- 27F 8050A
- 73 8060A
- 75 8062A
- 77F + More

CALL FOR SPECIAL PRICING



True RMS 4 1/2 Digit Multimeter M-7000
\$135
.05% DC Accuracy
.1% Resistance with Freq. Counter and deluxe case



10 Function Multimeter CM-365
\$65
AC + DC Voltage & Amps
Resistance to 2000MΩ
Diode, Logic, & Trans test
Capacitance to 200uF



Digital Capacitance Meter CM-1550
\$58.95
9 Ranges
1pf-20,000ufd
.5% basic acy
Zero control with case



Digital LCR Meter LC-1801
\$125
Measures:
Coils 1uH-200H
Caps .1pf-200uf
Res .01-20M



Function Generator Blox #9600
\$28.95
Provides sine, triangle, square wave from 1Hz to 1MHz
AM or FM capability

Triple Power Supply XP-620



Assembled \$65 Kit \$45
2 to 15V at 1A,
-2 to -15V at 1A
(or 4 to 30V at 1A)
and 5V at 3A
Contains all the desired features for doing experiments.
Features short circuit protection, all supplies.

Wide Band Signal Generators



SG-9000
\$129
RF Freq 100K-450MHz
AM Modulation of 1KHz
Variable RF output
SG-9500 w Digital Display and 150MHz built-in Counter \$249



AC Current Meter ST-1010
\$69.95
1000 Amps
Data & Peak hold
8 Functions
Deluxe Case



Decade Blox #9610 or #9620
\$18.95
#9610 Resistor Blox
47 ohm to 1M & 100K pot
#9620 Capacitor Blox
47pf to 10MFD



Quad Power Supply XP-580
\$59.95
2-20V at 2A
12V at 1A
5V at 3A
-5V at 5A
Fully regulated and short circuit protected
XP-575 without meters \$39.95

LEARN TO BUILD AND PROGRAM COMPUTERS WITH THIS KIT!

INCLUDES: All Parts, Assembly and Lesson Manual



Model MM-8000
\$129.00
Starting from scratch you build a complete system. Our Micro-Master trainer teaches you to write into RAMs, ROMs and run a 8085 microprocessor, which uses similar machine language as IBM PC. You will write the initial instructions to tell the 8085 processor to get started and store these instructions in permanent memory in a 2816 EPROM. Teaches you all about input and output ports, computer timers. Build your own keyboard and learn how to scan keyboard and display. No previous computer knowledge required. Simple easy to understand instruction teaches you to write in machine language.
ROBOTICS KIT FOR ABOVE (MM-8010) \$71.95



Digital Triple Power Supply XP-765
\$249
0-20V at 1A
0-20V at 1A
5V at 5A
Fully regulated, Short circuit protected with 2 limit control, 3 separate supplies
XP-660 with Analog Meters \$175



GF-8016 Function Generator with Freq. Counter
\$249
Sine, Square, Triangle
Pulse, Ramp, .2 to 2MHz
Freq Counter .1 - 10MHz
GF-8015 without Freq. Meter \$179

WE WILL NOT BE UNDERSOLD!
UPS Shipping: 48 States 5%
(\$10 Max) IL Res., 7% Tax

C & S SALES INC.
1245 Rosewood, Deerfield, IL 60015
(800) 292-7711 (708) 541-0710

15 Day Money Back Guarantee
2 Year Warranty Prices subject to change
WRITE FOR FREE CATALOG

1991 Electronics **ELECTRONICS EXPERIMENTERS handbook™**



BUILD ONE OF THESE

- 11 AMATEUR TV TRANSMITTER
- 29 REMOTE-CONTROL EXTENDER
- 37 LIGHT-BEAM COMMUNICATOR
- 45 SPECTRUM MONITOR
- 63 FAX MATE
- 67 ALPHA MEDITATION GOGGLES
- 72 REMOTE A/B SWITCH
- 103 VIDEO SCENE SWITCHER
- 154 CONTROL YOUR HOME BY TELEPHONE



AUDIO PROJECTS

- 9 PHONE-ACTIVATED AUDIO MUTE
- 33 SUBWOOFER SIMULATOR
- 113 ACOUSTIC FIELD GENERATOR
- 127 FET AUDIO AMPLIFIER

TECHNOLOGY

- 24 FMX: IS IT GOOD FOR FM?
- 55 TRACKING DOWN BUGS USING A SPECTRUM ANALYZER
- 77 CHOOSING THE RIGHT SHORTWAVE ANTENNA
- 135 AUTOMATED TEST EQUIPMENT



COMPUTER PROJECTS

- 60 RGB-TO-NTSC CONVERTER
- 83 68705 MICROCONTROLLER
- 91 D/A CONVERTER

ELECTRONIC HOW-TO

- 22 DESIGNING PC BOARDS
- 96 SERVICING DIGITALLY TUNED RADIOS
- 124 SOLVING VCR TAPE-LOADING PROBLEMS
- 140 SECURITY SYSTEM COOKBOOK



AND MUCH MORE

- 164 AD SALES OFFICES
- 164 ADVERTISING INDEX
- 117 FREE INFORMATION CARD
- 146 PC SERVICE
- 161 MARKET CENTER
- 2 EDITORIAL
- 6 NEW LITERATURE
- 4 NEW PRODUCTS

EDITORIAL

Build a project and build your knowledge!

Welcome to a new edition of the **Radio-Electronics Experimenters Handbook!** We've gone back through the last year's issues of *Radio-Electronics Magazine* and picked the stories that we think would be most popular with electronics experimenters.

For beginning experimenters, we have easy-to-build projects. A Remote-Control Extender gives you greater control over your home entertainment system, as does a Remote A/B Switch. A Subwoofer Simulator lets you get pounding base from your stereo system. A Phone-Activated Audio Muting Circuit means you'll never miss a phone call again—no matter how loud you play your stereo!

For advanced experimenters, we have advanced projects. A Spectrum Monitor will allow you to use your oscilloscope to view activity in the electromagnetic spectrum. An Amateur TV Transmitter allows licensed hams to give video broadcasting a try, and our Video Scene Switcher lets amateur videographers add a touch of professionalism to their home video movies. A Light-Beam Communicator lets you use the light of an LED to send messages for more than a half mile. With that kind of range, it has some very practical applications!

For computer experimenters, we have an D/A Converter that lets you use your computer to generate continuous signals. Our RGB-To-NTSC Converter lets you display your computer's output on a TV, and our 68705 Microcontroller lets you learn how to take advantage of single-chip computers in the design of your own projects.

For those who don't like building projects as much as they enjoy reading about technology, we show how spectrum analyzers can be used to track down eavesdropping bugs. And we look at a noise-reduction system for FM radio and its potential for expanding the range for good stereo listening.

So what are you waiting for? Pick a project and let it spark your imagination! Start experimenting, and have fun as you build.

—The Editors

1991 **ELECTRONICS EXPERIMENTERS handbook**

Hugo Gernsback (1884-1967) founder

Larry Steckler, EHF, CET,
editor-in-chief and publisher

EDITORIAL DEPARTMENT

Brian C. Fenton, editor

Marc Spiwak, associate editor

Daniel Goodman, technical editor

Kim Dunleavy,
assistant technical editor

Teri Scaduto, assistant editor

Jeffrey K. Holtzman
computer editor

Robert A. Young, assistant editor

Robert Grossblatt, circuits editor

Larry Klein, audio editor

David Lachenbruch
contributing editor

Don Lancaster
contributing editor

Richard D. Fitch
contributing editor

Kathy Campbell, editorial assistant

Andre Duzant, technical illustrator

Injae Lee, assistant illustrator

PRODUCTION DEPARTMENT

Ruby M. Yee, production director

Robert A. W. Lowndes
editorial production

Karen Tucker, advertising production

Marcella Amoroso, production traffic

CIRCULATION DEPARTMENT

Jacqueline P. Cheeseboro,
circulation director

Wendy Alanko,
circulation analyst

Theresa Lombardo,
circulation assistant

Typography by Mates Graphics

Cover photo by Diversified Photo

**Advertising Sales Offices listed
on page 164.**

**Gernsback Publications, Inc.,
500-B Bi-County Blvd., Farm-
ingdale, NY 11735. 516-293-3000**

As a service to readers, *Radio-Electronics Electronics Experimenter's Handbook* publishes available plans or information relating to newsworthy products, techniques and scientific and technological developments. Because of possible variances in the quality and condition of materials and workmanship used by readers, we disclaim any responsibility for the safe and proper functioning of reader-built projects based upon or from plans or information published in this magazine.

Since some of the equipment and circuitry described in *Radio-Electronics Electronics Experimenter's Handbook* may relate to or be covered by U.S. patents, we disclaim any liability for the infringement of such patents by the making, using, or selling of any such equipment or circuitry, and suggests that anyone interested in such projects consult a patent attorney.

Radio-Electronics Electronics Experimenter's Handbook is published annually by Gernsback Publications Inc. All rights reserved. Printed in U.S.A. Single copy price \$3.50, Canada \$3.95. ©Copyright Gernsback Publications Inc., 1990.

No other training—in school, on the job, anywhere—shows you how to troubleshoot and service computers like NRI

DIGITAL MULTIMETER

Professional test instrument for quick and easy measurements.

LESSONS

Clearcut, illustrated texts build your understanding of computers step by step.

SOFTWARE

Including MS-DOS, GW BASIC, word processing, database and spreadsheet programs.

HARD DISK

20 megabyte hard disk drive you install internally for greater data storage capacity and data access speed.

NEW! AT-COMPATIBLE COMPUTER

High-speed 80286 CPU (12 MHz clock, 0 wait states), 1 meg RAM, 1.2 meg, 5 1/4" high-density floppy disk drive.

MONITOR

High-resolution, non-glare, 12" TTL monochrome monitor with tilt and swivel base.

TECHNICAL MANUALS

With professional programs and complete specs on your computer.

DIGITAL LOGIC PROBE

Simplifies analyzing digital circuit operation.

DISCOVERY LAB

Complete breadboarding system to let you design and modify circuits, diagnose and repair faults.

Only NRI walks you through the step-by-step assembly of a powerful AT-compatible computer system you keep—giving you the hands-on experience you need to work with, troubleshoot, and service all of today's most widely used computer systems. You get all it takes to start a money-making career, even a business of your own in computer service.

No doubt about it: The best way to learn to service computers is to actually build a state-of-the-art computer from the keyboard on up. As you put the machine together, performing key tests and demonstrations at each stage of assembly, you see for yourself how each part of it works, what can go wrong, and how you can fix it.

Only NRI—the leader in career-building, at-home electronics training for more than 75 years—gives you such practical, real-world computer servicing experience. Indeed, no other training—in school, on the job, *anywhere*—shows you how to troubleshoot and service computers like NRI.

You get in-demand computer servicing skills as you train with your own AT-compatible system—now with 20 meg hard drive

With NRI's exclusive hands-on training, you actually build and keep the powerful new AT-compatible West Coast 1010 ES computer, complete with 1 meg RAM and 20 meg hard disk drive.

You start by assembling and testing the 101-key "intelligent" keyboard, move on to test the circuitry on the main logic board, install the power supply and 1.2 meg 5 1/4" floppy disk drive, then interface your high-resolution monitor. But that's not all.

Only NRI gives you a top-rated micro with complete training built into the assembly process

Your NRI hands-on training continues as you install the powerful 20 megabyte hard disk drive—today's most wanted computer peripheral—included in your course to dramatically increase your computer's storage capacity while giving you lightning-quick data access.

Having fully assembled your West Coast 1010 ES, you take it through a complete series of diagnostic tests, mastering professional computer servicing techniques as you take command of the full power of your computer's high-speed 80286 microprocessor.

In no time at all, you have the confidence and the know-how to work with, troubleshoot, and service every computer on the market today. Indeed you have what it takes to step into a full-time, money-making career as an industry technician, even start a computer service business of your own.

No experience needed, NRI builds it in

You need no previous experience in computers or electronics to succeed with NRI. You start with the basics, following easy-to-read instructions and diagrams, quickly

moving from the fundamentals to sophisticated computer servicing techniques. Step by easy step, you get the kind of practical hands-on experience that makes you uniquely prepared to take advantage of every opportunity in today's top-growth field of computer service.

What's more—you learn at your own pace in your own home. No classroom pressures, no night school, no need to quit your present

job until you're ready to make your move. And all throughout your training, you have the full support of your personal NRI instructor and the NRI technical staff always ready to answer your questions and give you help whenever you need it.

Your FREE NRI catalog tells more

Send today for your free full-color catalog describing every aspect of NRI's innovative computer training, as well as hands-on training in robotics, video/ audio servicing, electronic music technology, security electronics, telecommunications, and other growing high-tech career fields.

If the coupon is missing, write to NRI School of Electronics, McGraw-Hill Continuing Education Center, 4401 Connecticut Avenue, Washington, DC 20008.

AT is a registered trademark of International Business Machines Corporation

NRI

School of Electronics

McGraw-Hill Continuing Education Center
4401 Connecticut Avenue, Washington, DC 20008

For career courses approved under GI bill
 check for details

Check one FREE catalog only

<input type="checkbox"/> Computers and Microprocessors	<input type="checkbox"/> Security Electronics
<input type="checkbox"/> Robotics	<input type="checkbox"/> Electronic Music Technology
<input type="checkbox"/> TV/Video/Audio Servicing	<input type="checkbox"/> Basic Electronics
<input type="checkbox"/> Computer Programming	<input type="checkbox"/> Telecommunications

Name _____ (please print) Age _____

Address _____

City/State/Zip _____

Accredited Member, National Home Study Council

9-110

NEW PRODUCTS

FET-INPUT OP AMP. Requiring no external compensation to achieve 135-ns settle time of 10-volt steps to within $\pm 0.01\%$, Analog Devices' AD843 is the industry's fastest FET-input monolithic operational amplifier. Drawing 13-mA maximum quiescent current, the internally compensated monolithic AD843 dissipates less than one-third the power of high-speed devices (high-power hybrids requiring external compensation) with similar specifications. Operating from ± 15 -volt supplies, the op-amp is available in five performance grades. J and K grades are specified for the 0 to $+70^\circ\text{C}$ commercial temperature range, A and B grades for the -40 to $+85^\circ\text{C}$ extended industrial temperature range, and S grade for the -55 to $+125^\circ\text{C}$ military operating temperature range. The AD843 is also available processed to MIL-STD-883B, Rev. C. Packaging options include an 8-pin plastic DIP, an 8-pin hermetic ceramic

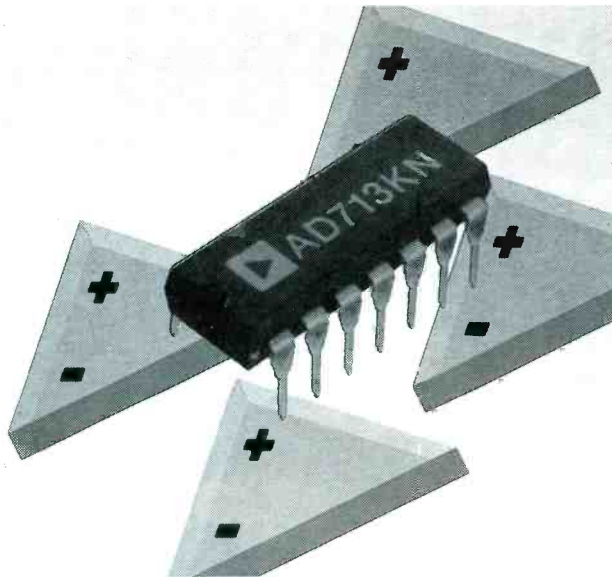

CIRCLE 20 ON FREE INFORMATION CARD

DIP, and 12-pin metal cans are also available.

With a 34-MHz gain-bandwidth product, the unity-gain AD843K also benefits high-precision applications. Its guaranteed maximum 1-nA input bias current and 1-mV input offset voltage maintain low error in filtering

and integrator applications. It also exhibits low droop rates in sample-and-hold designs.

Prices for the AD843 FET-input monolithic op-amps begin at \$8.80 (100's).—Analog Devices, Inc., Literature Center, 70 Shawmut Road, Canton, MA 02021.

as little as three hours. A lifetime replacement guarantee against failure to accept a charge is included on all power cells. The rechargeable power packs come in ten different models, and they can be used with most models of video camcorders.



CIRCLE 22 ON FREE INFORMATION CARD

For information on pricing and availability of the Millennium rechargeable battery line contact—Gates Energy Products, Inc., P.O. Box 861, Gainesville, FL 32602.

ADAPTER KIT. A selection of popular adapters to convert BNC connectors to double-banana plugs or jacks is available as kit 5510 from Pomona Electronics. Included in the kit are BNC male- and BNC female-to-double-banana plugs, BNC male- and BNC female-to-double-binding posts, BNC male-to-male, and BNC female-to-female adapters. A sturdy plastic case is fitted with a contoured foam interior liner to separate and protect the six adapters from damage. The case is conveniently sized for lab and field use.

The 5510 adapter kit costs \$37.75.—ITT Pomona Elec-



CIRCLE 21 ON FREE INFORMATION CARD

tronics, 1500 East Ninth Street, Pomona, CA 91766.

RECHARGEABLE POWER CELLS. Gates Energy Products is introducing the Millennium line of re-

chargeable batteries in January 1990. The line includes AA, C, D, 9-volt, and AA round cells with two- and four-position RapidChargers. Several camcorder power-pack models for use with VHS, VHS-C, and 8mm camcorders complete the line.

The Millennium products aim to overcome three problems common to the rechargeable battery market: initial cost, length of charge time, and length of run time. The AA, C, and D power cells run 33% longer than traditional rechargeable batteries, and Millennium AA, C, D, 9-volt, and AAA power cells charge in

STEREO ACTIVEWEAR. For those situations where headphones are unacceptable due to safety or social considerations, Sport Electronics offers an alternative listening experience. The Safe & Sound Stereo Jacket has a removable stereo module in its collar that provides joggers, cyclists, and walkers with a "surround sound" stereo effect, from any portable stereo radio or cassette player. The patented position of the speakers on the users' shoulders creates a "natural crossover." The Stereo Jacket also allows users to hear outside sounds, such as potentially dangerous traffic noises, and to converse with others

continued on page 8

SELECT 5 BOOKS for only \$4.95

(values to \$123.70)
and get a **FREE Gift!**

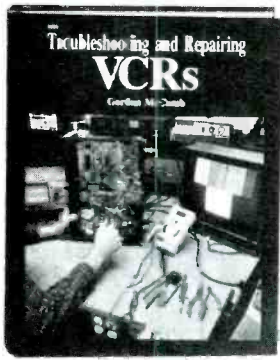
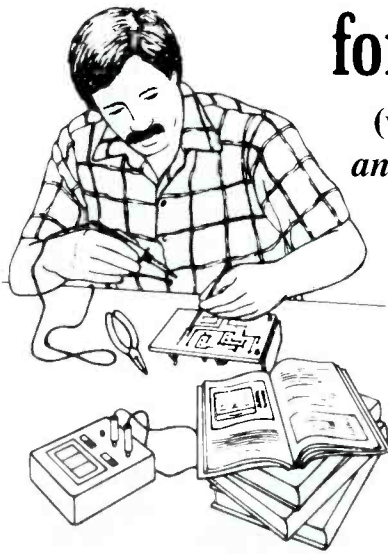

2960 \$27.95
Counts as 2



3258 \$27.95
Counts as 2



3031P \$17.95



2613P \$17.95



1367P \$24.95



2867P \$18.95



804P \$21.95
Counts as 2

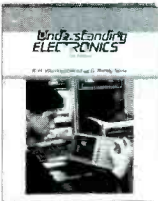

3044P \$11.95



2800P \$15.95

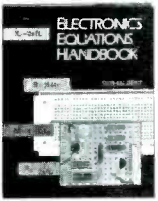

3241P \$16.95



1604P \$17.95



1599P \$17.95

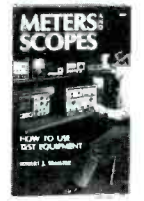

2826P \$16.95

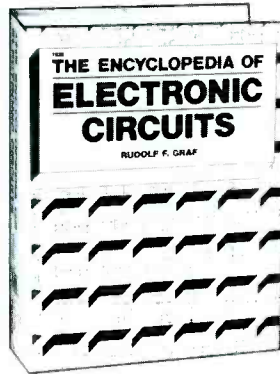

1938 \$60.00
Counts as 3



2790P \$13.95

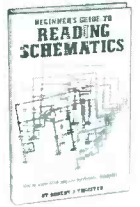

1536P \$11.95

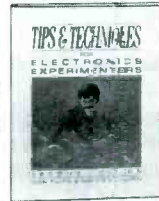

3145 \$19.55



1625P \$22.95

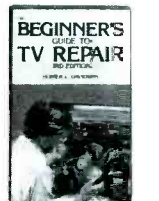

1897P \$14.95



2325P \$9.95

For over 25 years, your most complete source for electronics books.

Membership Benefits • Big Savings. In addition to this introductory offer, you keep saving substantially with members' prices of up to 50% off the publishers' prices. • **Eonus Books.** Starting immediately, you will be eligible for our Bonus Book Plan, with savings of up to 80% off publishers' prices. • **Club News Bulletins.** 15 times per year you will receive the Book Club News, describing all the current selections—mains, alternates, extras—plus bonus offers and special sales, with scores of titles to choose from. • **Automatic Order.** If you want the Main Selection, do nothing and it will be sent to you automatically. If you prefer another selection, or no book at all, simply indicate your choice on the reply form provided. You will have at least 10 days to decide. As a member, you agree to purchase at least 3 books within the next 12 months and may resign at any time thereafter. • **Ironclad No-Risk Guarantee.** If not satisfied with your books, return them within 10 days without obligation! • **Exceptional Quality.** All books are quality publishers' editions especially selected by our Editorial Board.

All books are hardcover unless number is followed by a "P" for paperback. (Publishers' Prices Shown)

©1990 ELECTRONICS BOOK CLUB, Blue Ridge Summit, PA 17294-0810

FREE when you join!

15 Easy Electronic Projects From Delton T. Horn

Projects you can build—some unique, some old favorites—from the author's vast treasury of electronics know-how.

A \$7.95 Value!

Delton T. Horn's All-Time Favorite Electronic Projects

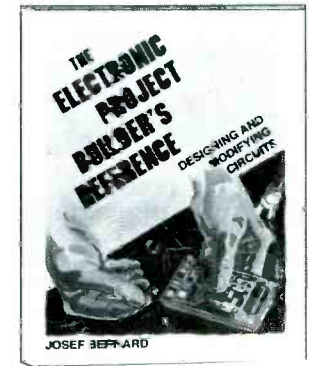

3260 \$22.95

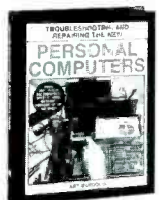

2809 \$29.95
Counts as 2



3374 \$24.95



ELECTRONICS BOOK CLUBSM

Blue Ridge Summit, PA 17294-0810

Please accept my membership in the Electronics Book Club and send the 5 volumes listed below, plus my FREE copy of Delton T. Horn's All-Time Favorite Electronic Projects (3105P), billing me \$4.95. If not satisfied, I may return the books within ten days without obligation and have my membership cancelled. I agree to purchase at least 3 books at regular Club prices during the next 12 months and may resign any time thereafter. A shipping/handling charge and sales tax will be added to all orders.

Name _____
Address _____
City _____
State _____ Zip _____ Phone _____
Signature _____

Valid for new members only. Foreign applicants will receive special ordering instructions. Canada must remit in U.S. currency. This order subject to acceptance by the Electronics Book Club. REX990

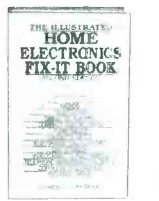

2883P \$17.95



3157 \$25.95
Counts as 2



3270 \$32.95
Counts as 2

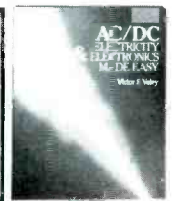

2285 \$25.95
Counts as 2

NEW LITERATURE

TEST EQUIPMENT. Although its emphasis is on test instruments—including bench-top and portable digital multimeters, function generators, frequency counters, probes, transistor testers, capacitance meters, oscilloscopes, power supplies, and waveform monitors—*Fordham's 1991 Catalog* offers still more. Also featured are



CIRCLE 10 ON FREE INFORMATION CARD

electronic robot kits, special-effect lights, CB's, scanners and transceivers, telephones and answering machines, soldering equipment, tool kits, automotive accessories, audio and video equipment, and home-office supplies. The 68-page catalog costs \$2.00.—**Fordham Radio**, 260 Motor Parkway, Hauppauge, NY 11788-5134; Tel. 800-645-9518 (in NY, 800-832-1446).

LEARN-AT-HOME COURSES.

For electronics professionals who want to brush up on the latest technology, enthusiasts who want to broaden their knowledge and skills, and beginners looking for a way to learn about electronics at their own pace, the *Homeworks by Heathkit* catalog is the place to turn. Featured in the free 36-page booklet are courses on basic and advanced electronics, robotic theory, digital processing, PC programming, amateur-radio operation, and more. An assortment of

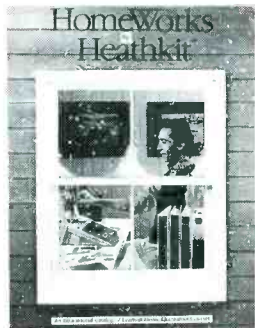

CIRCLE 11 ON FREE INFORMATION CARD

trainers and trainer accessories, which are used to perform the course experiments, are offered in both kit and preassembled form. Several of the Heathkit courses also have optional video or audio tapes that supplement the workbooks.

The programs are accredited by the National Home Study Council and the Council on the Continuing Education Unit. By successfully completing the optional final exams, users earn Continuing Education Units (CEU's). A growing number of professional and technical organizations, as well as many companies, recognize CEU's as certified job-related training.—**Heath Company**, Department 350-048, Benton Harbor, MI 49022.

COMPUTER PARTS AND SUPPLIES. Designed to serve as a complete resource for the computer enthusiast,

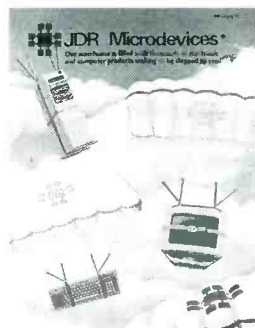

CIRCLE 12 ON FREE INFORMATION CARD

JDR Microdevices 1991 Catalog #8 contains 100 pages of popular items including mini-386 and 80386SX motherboards, high-density hard drives and controllers, software, laptops, and computer cases. The new edition also includes "Derick's High Tech Corner," a series of columns covering computer topics ranging from upgrading an XT to working with programmable logic devices. The catalog presents JDR's full line of computer accessories and peripherals, including keyboards, modems, monitors, printers, full systems in kit form or preassembled, cables, interface cards, diskettes, and power supplies. The catalog is free upon request.—**JDR Microdevices**, 2233 Branham Lane, San Jose, CA 95124; Tel. 800-438-5001.

COMPUTER/OFFICE FURNITURE. Two catalogs of computer/home-office accessories and furnishings, as well as two informational brochures, are being offered by Curtis Manufacturing. All



CIRCLE 13 ON FREE INFORMATION CARD

are designed to help computer users set up comfortable, efficient work stations. One catalog features space-saving products such as swing-away monitor arms, printer "legs," clip-on copy holders, and a universal system stand, along with surge protectors, outlet strips, cables, and maintenance products. The other catalog

illustrates an attractive line of oak office accessories, including diskette files, computer and peripheral stands, letter trays, desk pads, calendars, and memo holders. *Tips to Computing More Comfortably* shows how work-station design can increase computing comfort, and *Surge Protection & the UL 1449 Standard* explains how surge protectors work and the new UL procedure for testing levels of protection. All of the booklets are free upon request.—**Curtis Manufacturing Company**, 30 Fitzgerald Drive, Jaffrey, NH 03452; Tel. 603-432-4123.

KNOB CATALOG. The fully-illustrated 1990 catalog from *Rogan Corporation* describes all their available



CIRCLE 14 ON FREE INFORMATION CARD

knob styles, markings, colors, decorative options, and mountings. Material specification and mechanical-tolerance standards are depicted for each style of knob. The catalog features a series of control knobs that meet the requirements for MIL Spec 91528, the "Pure Touch Knobs" series with soft thermoplastic outer shells, an extended line of clamping knobs, and a new series of ball knobs. The catalog is free.—**Rogan Corporation**, 3455 Woodhead Drive, Northbrook, IL 60062; Tel. 800-423-1543 (in IL, 708-498-2300).

Discover Your Career Potential In The Fast Growing Field Of High-Tech Electronics!

CIE Gives You The Training You Need to Succeed...
At Your Own Pace...& In Your Own Home!

If you're anxious to get ahead...and build a *real* career...you owe it to yourself to find out about the Cleveland Institute of Electronics!

CIE can help you discover your career potential in the fast growing field of high-tech electronics. A career that will challenge and excite you every day...reward you with a powerful feeling of personal accomplishment...and deliver a level of financial security you may have only dreamed of before!

As the leading school in home-study electronics, CIE has helped over 150,000 students in the U.S.A. and over 70 foreign countries get started in this exciting field. To find out how CIE could be helping you...read on...then send for a CIE catalog TODAY!

A Growing Need For Trained Professionals!

The career opportunities shown here are only a few of the challenging, high-paying careers you could enjoy as an electronics technician.

You could be the "brains" behind the scenes of an exciting TV broadcast...trouble-shoot life-saving medical equipment...design exotic new aeronautics systems...CIE's job-oriented programs offer you the quickest possible path to the career of your dreams! And CIE also features military and union re-training, to build on what you already know.

Dozens Of Fascinating Careers To Choose From!

Even if you aren't sure which career is best for you, CIE can get you started with core lessons applicable to *all* areas of electronics. As you advance, CIE makes job opportunities available to you through the bimonthly school paper, *The Electron*.



Data Communications



Automotive Electronics



Avionics

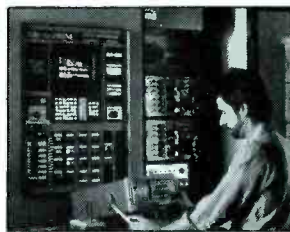

Computer-Assisted Manufacturing

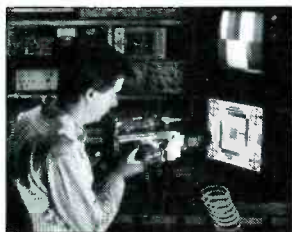

Consumer Electronics



Military Electronics

Personal Training From A Renowned Faculty.

Unlike the impersonal approach of large classroom study, CIE offers you one-on-one instructional help 6 days a week, toll-free. Each CIE lesson is authored by an independent specialist, backed by CIE instructors who work directly with you to answer your questions and provide technical assistance when you need it.

Practical Training... At Your Own Pace.

Through CIE, you can train for your new career while you keep your present job. Each course allows a generous completion time, and there are no limitations on how fast you can study. Should you already have some electronics experience, CIE offers several courses which start at the intermediate level.

"State-Of-The-Art" Facilities & Equipment.

In 1969, CIE pioneered the first electronics laboratory course, and in 1984, the first Microprocessor Laboratory. Today, no other home study school can match CIE's state-of-the-art equipment. And all your laboratory equipment is included in your tuition cost. There is no extra charge—it's yours to use while you study at home and on the job after you complete your course!

Earn Your Degree To Become A Professional In Electronics!

Every CIE course you take earns you credit towards the completion of your Associate in Applied Science Degree, so you can work towards your degree in

stages. And CIE is the only school that awards you for fast study, which can save you thousands of dollars in obtaining the same electronics education found in four-year Bachelor's Degree programs! Write for details today!

Send For Your Catalog Today!



CIE World Headquarters

Cleveland Institute of Electronics, Inc.
1773 East 17th St., Cleveland, Ohio 44114

AEH-05

YES! Please send me your independent study catalog (For your convenience, CIE will have a representative contact you—there is no obligation.)

Print Name _____

Address _____ Apt # _____

City/State/Zip _____

Age _____ Area Code/Phone No. _____

Check box for G.I. Bill bulletin on educational benefits: Veteran Active Duty

Mail This Coupon Today!

AEH-05

NEW PRODUCTS

continued from page 4

while listening to music. As a bonus, listeners are freed from troublesome headphone cords; the only cord is threaded through the jacket's lining from the collar to the pocket where the radio plugs in.



CIRCLE 23 ON FREE INFORMATION CARD

The light-weight, black windbreaker features royal-blue racing stripes down the sides and a gray reflective stripe (which conceals a strip of ventilating mesh) across the back. The sound system zips into the collar and is easily removable for cleaning—or to use the system on its own, on a beach blanket, for instance. *Stereo Sweats* are also available.

The *Safe & Sound Stereo Jacket* costs \$34.00; an AM/FM radio costs \$9.00.—**Sport Electronics, Inc.**, P.O. Box 1412, Northbrook, IL 60065; Tel. 312-564-5575.

HAND-HELD MULTI-TESTER.

A pocket-sized test instrument from **B&K-Precision**, called the *Test Bench Jr.* (model 377), has the capabilities of five separate instruments. The 39-range voltmeter/ammeter/ohmmeter/frequency counter/capacitance tester/logic tester/transistor tester/diode tester/continuity tester comes in a case the size of a compact digital multimeter. It measures just $5 \times 2\frac{7}{8} \times 1\frac{1}{8}$ inches, making it ideal for field-service applications. For durability, the *Test Bench Jr.* features the triple protection of reverse-polarity protection, high-energy fusing, and overload protection.

DC accuracy is within 0.5%; AC accuracy is within 1.25% from 50 to 500 Hz. Input impedance on DC and AC is 10 megohms. DC and AC current measurement capabilities extend to 10 amps, with resistance measurement to 2,000 megohms. Five capacitance ranges extend to 20 microfarads, and the frequency-counter capability range to 200 kHz with resolution of up to 1 Hz. Diode junctions are tested with a maximum test current of 1.0 mA and a maximum open circuit of 3.2 volts, with test results appearing on the LCD. An audible signal is used for quick continuity tests. Bipolar transistors can be tested for hFE gain from 0 to 1000.



CIRCLE 24 ON FREE INFORMATION CARD

The logic tester indicates a logic 1 or 0 state in TTL-level digital circuits.

The model 377 *Test Bench Jr.* has a suggested list price of \$109.00.—**B&K-Precision**, Maxtec International Corp., 6470 West Cortland Street, Chicago, IL 60635; Tel. 312-889-9087.

QUASI-MICROWAVE SPECTRUM ANALYZER.

Offering 10-Hz resolution bandwidth as a standard feature, the upgraded 497P is the industry's narrowest resolution, widest frequency range quasi-microwave spectrum analyzer, according to **Tektronix**. The newly added capability provides a 10-dB improvement in sensitivity, dynamic range, and close-in sideband analysis, and makes the instrument suitable for testing various digitally encoded communications systems, such as digital microwave, cellular-radio, and UHF/VHF-

radio systems. The 497P now provides the narrow resolution bandwidth needed to observe the frequency modulation characteristics produced by low-frequency signals including close-in phase-noise characteristics, line-related sidebands, and activating signaling tones. Its key features include 100-Hz to 71-GHz frequency coverage for 906-MHz, 2-GHz, and 6-GHz analog and digital microwave systems; 0.0001% frequency-measurement accuracy; 0.90-dB dynamic range; ≤ 105 -dBc/Hz noise sidebands at 30-kHz offset; and 5-Hz peak-to-peak residual FM.

"Signal-processing intelligence" lets the unit search, sort, and mark CW, pulse, or spurious signals. A bandwidth mode gives hands-off convenience for measuring the bandwidth of filters, amplifiers, and channelized spectrum occupancy. Automatic-noise-normalization and automatic-conversion features eliminate tedious, time-consuming calculations. Front-panel controls are ergonomically placed, and major measurement parameters can be directly input via the keypad. An IEEE-48 interface is built in, and complete automated packages with software are

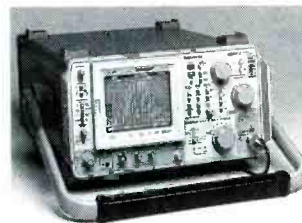

CIRCLE 25 ON FREE INFORMATION CARD

available.

The 497P portable quasi-microwave spectrum analyzer is base priced at \$26,250.—**Tektronix, Inc.**, Microwave & RF Instruments Division, P.O. Box 500, M/S 58-183, Beaverton, OR 97077; Tel. 1-800-TEK-SPEC (in OR, 503-235-7315).

RIGHT-ANGLE D-SUB CONNECTORS. 3M's line of right-angle D-sub connectors increases printed-circuit board design options with a wide

range of styles for computer and peripheral board-mount applications. The connectors are available in four product families: 0.318-inch-footprint sockets and plugs in 9, 15, 25, and 37 positions, 10- and 30-microinch gold plated; 0.590-inch-footprint sockets and plugs in 9, 15, 25, and 37 positions, 10- and 30-micro-

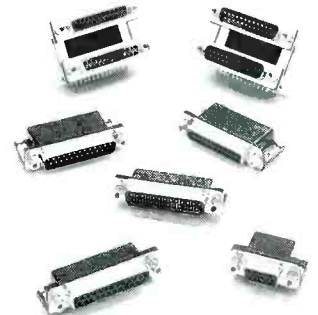

CIRCLE 26 ON FREE INFORMATION CARD

inch gold plated; high-density socket only, 15 positions in 9-position size; and stacked, with two 9, 15, or 25 positions, or 9 over 25 positions, socket/plug, socket/socket, plug/plug, or plug/socket.

To ensure reliable electrical contact, all have sealed backs to protect against solder and flux entrapment. Each connwCvor has a tin-plated metal shell for high-quality shielding. In addition, friction dimples on the male connector's metal face provide ground continuity with the mating connector for effective EMI shielding. The dual-wipe, clover-leaf contact design assures a good connection, and rigid tin-plated solder tails eliminate bending and aid in alignment with PC board hole patterns. Optional features include inside or outside ground straps, board locks to hold the connector securely in place during wave soldering, and 4-40 inserts to offer still more design options.

The 25-position right-angle female connector with metal face and 10-microinch gold plating costs \$1.80 each in quantities of 5,000. (Contact 3M for pricing details on other styles and quantities.)—**3M Electronic Products Division**, P.O. Box 2963, Austin, TX 78769-2963; Tel: 800-225-5375.

BUILD THIS

PHONE-ACTIVATED AUDIO-MUTING CIRCUIT

MARK A. VAUGHT

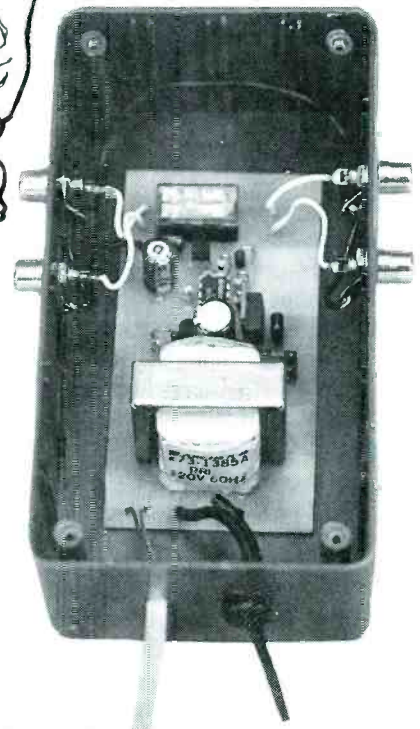

Automatically silence your stereo or TV as soon as your telephone rings.

IF YOU'RE USING A TELEPHONE, THE SOUND from a radio, stereo, or TV can be annoying. To avoid that nuisance, build this phone-activated audio-muting circuit. It cuts off the audio from a radio, stereo, or TV when your phone rings, or when the handset is picked up to make an outgoing call. About five seconds after a phone is hung up or stops ringing, the audio resumes.

To use the audio-muting circuit, just connect it anywhere prior to the speaker(s) of your radio, stereo, or TV. That applies to low-power mono or stereo audio, whether from a radio, stereo system, or TV. For use with high-power audio (above 20 watts), place it between preamp and power amplifier. Most recent stereo gear has a rear-panel jack for audio-signal pro-

cessing like enhancement or compression prior to power amplification. If your equipment doesn't have such a jack, and if you're not using a separate preamp and power amp, you might want to install the audio-muting circuit in the tape loop.

Circuit description

The schematic of the audio-muting circuit is shown in Fig. 1. A standard phone line has about 48-volts DC on it when open (on hook), and about 5-volts DC when in use (off hook). The ring signal is a low-frequency AC voltage superimposed on the DC. Rotary phones dial by intermittently making and breaking the phone-line connection, toggling it from 5 to 48 volts and back. That is, the number of make/break pulses in a single rotation

of the dial represents the number being dialed. About five seconds after the phone is hung up or stops ringing, the audio resumes.

The reason for that delay is that rotary-dial phones operate by making and breaking a phone line connection, and the central-office equipment would count the number of pulses for each digit of a phone number. If the delay weren't present, the audio would be cut off when the phone handset is lifted up, but when a number is dialed, the user would hear the pulses of the dial intermittently

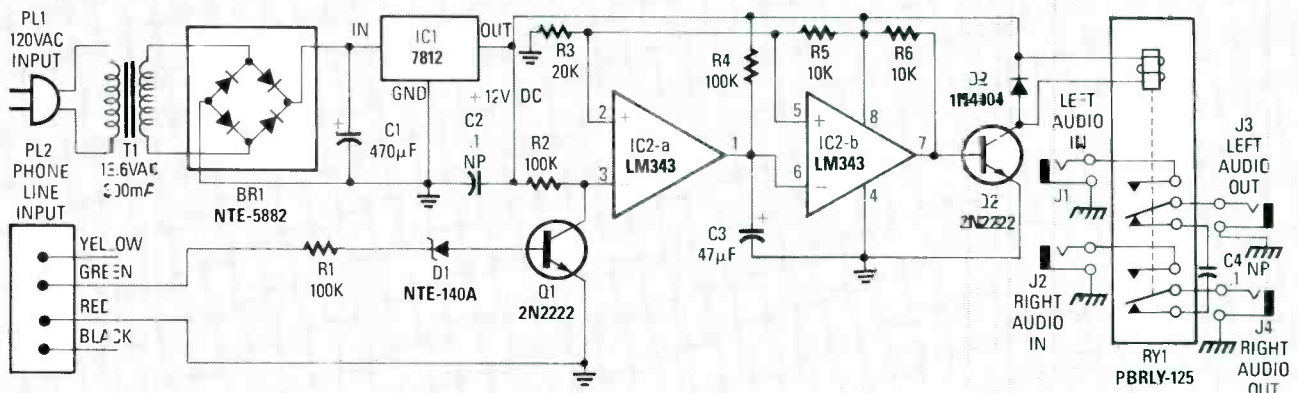

FIG. 1—SCHEMATIC OF THE AUDIO-MUTING CIRCUIT; RY1 switches audio inputs J1 and J2 through J3 and J4, respectively, or shorts J3 and J4 when the phone on PL2 rings or is picked up. That continues for about five seconds after the phone stops ringing or is picked up.

between the audio.

The input stage, composed of R1, 10-volt Zener D1, and the base-emitter junction of Q1, places a high-impedance loop across the green (tip) and red (ring) phone-line wires. The current through the phone line should be:

$$I_{\text{phone}} = (V_{\text{tip}} - V_{\text{DI}} - V_{\text{BE1}}) / R1, \\ = (48 \text{ V} - 10 \text{ V} - 0.7 \text{ V}) / 100\text{K}, \\ = 373 \mu\text{A}.$$

That causes about a 1-volt drop from the 48-volt level, that drives Q1 into saturation at about 200 millivolts. If the phone rings or is picked up, Q1 cuts off and the inverting input of IC2-a goes to 12 volts. Next, voltage divider R3-R5 biases the noninverting input of IC2-a and the inverting input of IC2-b at:

$$V_{\text{BIAS}} = V_{\text{CC}} \times [R3 / (R3 + R5)], \\ = 12 \text{ V} \times [20\text{K} / (20\text{K} + 10\text{K})], \\ = 8 \text{ V}.$$

At that point, the output of IC2-a goes low, discharging C3. The output of IC2-b goes high, turning Q2 on and driving it into saturation via R6, and activating relay RY1, breaking the audio path between J1 and J2, and J3 and J4. After the phone stops ringing, or is hung up, the output of IC2-a goes high, charging C3 through R4, with a time constant of:

$$\tau = R4 \times C3 \\ = 100\text{K} \times 47 \mu\text{F} \\ = 4.7 \text{ seconds}.$$

If the phone rings before C3 reaches 8 volts as set by R3 and R5, C3 discharges and the timing cycle restarts. After a certain exponential charging interval, the potential across C3 reaches 8 volts, and the output of IC2-b goes low, turning off Q2 and RY1 and reconnecting the audio. The final charging voltage in that case is $V_f = V_{\text{CC}} = 12 \text{ V}$, and the target voltage is $V_t = 8 \text{ V}$. Since τ is known, the charging interval is:

$$T = -2.303 \times \tau \times \log_{10}[1 - (V_f / V_t)], \\ = -2.303 \times 4.7 \text{ seconds} \\ \times \log_{10}[1 - (8 \text{ V} / 12 \text{ V})], \\ = 5.164 \text{ seconds}.$$

When RY1 energizes and the audio is cut off, audio output terminals J3 and J4 are shorted through C4 to prevent any hum introduced when the audio-muting circuit switches line-level audio. Here, D2 prevents reverse-bias spikes, generated by switching RY1, from destroying Q2.

PARTS LIST

All resistors are 1/4-watt, 5%, unless otherwise indicated.

R1, R2, R4—100,000 ohms
R3—20,000 ohms
R5, R6—10,000 ohms

Capacitors

C1—47 μF , 16 volts, electrolytic
C2, C4—0.1 μF , 50 volts, non-polarized (NP) ceramic disc
C3—47 μF , 10 volts, electrolytic

Semiconductors

BR1—NTE-5332 1-amp, 600-volt PIV 4-pin DIP bridge rectifier
D1—NTE-140A 10-volt Zener diode
D2—IN4004 rectifier
Q1, Q2—2N2222 NPN transistor
IC1—7812 12-volt regulator
IC2—LM393N DIP dual voltage comparator

Other components

T1—120-volt/12.6-volt, 300-mA transformer
RY1—12-volt, DPDT, 8-pin DIP Relay
PL1—AC line cord with plug
PL2—four-conductor modular tele-

phone cord with plug
J1—J4—RCA phono jack

Miscellaneous: Case, AC line cord grommet, two straight-line TO-3 transistor sockets, an 8-pin DIP IC socket, wire, solder, and drill with bits.

NOTE: A kit of parts is available for \$19.95 from Applitron Electronics, 2721 Creswell Road, Bel-Air, MD 21014. It includes an etched and drilled PC board, but excludes the AC line plug and cord PL1 with grommet, modular telephone plug and cord PL2, and the case. The PC board alone is \$15.00, should you wish to obtain the parts locally. Please enclose \$1.95 postage and handling; allow 4-6 weeks for delivery. Relay RY1 can be obtained separately from All-Electronics Corp., P.O. Box 567, Van Nuys, CA 91408, (800) 826-5432, for \$2.50.

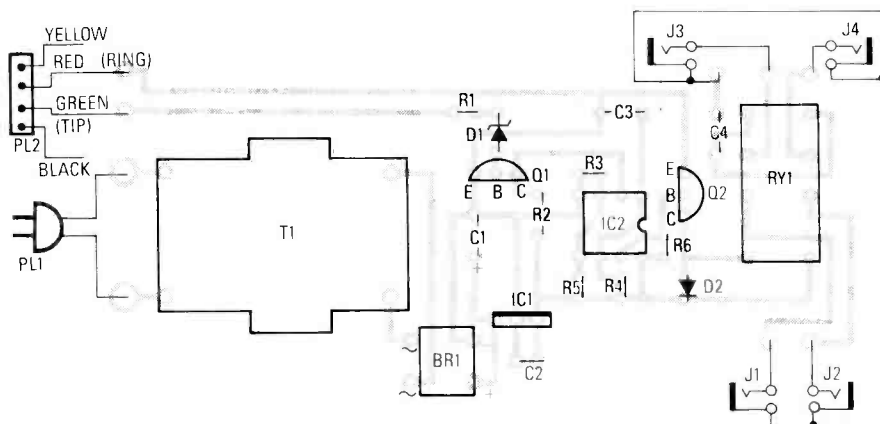

FIG. 2—PARTS-PLACEMENT DIAGRAM for the audio-muting circuit. Note the spacing of the pins of RY1, for orientation purposes.

Finally, the grounds for J1–J4 in Fig. 1 are separate from those of the rest of the circuit. The ground symbol for the main part of the audio-muting circuit is the normal downward-pointing, three-line, triangular arrow, whereas the ground symbol for J1–J4 is a downward-pointing open triangle. The reason is that the radio, stereo, or TV, shouldn't share a common ground with the rest of the audio-muting circuit.

Also, the ground terminals aren't connected J1-to-J3 and J2-to-J4, to attempt to separate the channels and avoid crosstalk. The radio, stereo, or TV will have one common ground for all four terminals within its own cabinet, so joining all four ground termi-

nals of J1–J4 shouldn't make any difference. Similarly, you wouldn't connect J1-to-J2 and J3-to-J4, since that would isolate input and output, preventing the speakers from being properly grounded, and might damage whatever audio source is connected to J1 and J2.

You can also use the audio-muting circuit with two mono sources, like two TV's, instead of one stereo source, but you have to isolate the grounds for the two channels. In that case, *don't connect all four grounds for J1–J4 together*, or you might get one really nasty shock, and/or some pretty spectacular fireworks. You can connect the grounds of J1 and J3 and

continued on page 112

BUILD THIS

AMATEUR TV TRANSMITTER

Add TV transmission to your radio shack.

**RUDOLF F. GRAF and
WILLIAM SHEETS**

HOW WOULD YOU LIKE TO TRANSMIT COMPLETE VIDEO, EITHER COLOR OR BLACK-AND-WHITE, with accompanying audio, either through coaxial cable, or to a remote receiver? Hold your breath, because it's all possible with our video-link transmitter, an inexpensive way to get involved in all the following applications:

1. Amateur TV transmission.
2. Video installations where cable hookups are not possible, like robotics.
3. Security and industrial work.
4. Simultaneous viewing of several remote TV receivers.
5. Remote sensing application, like wildlife viewing.
6. Cable transmission.
7. Wireless camera/TV receiver, or VCR link.

Our video-link transmitter is available in two levels of RF power. For low-power wireless video like in a house or office, where simultaneous monitoring of program material is desirable without cumbersome hookups, 1-30 mW is available. For longer ranges up to several miles, as in amateur (ham) TV, security, and surveillance purposes, 2 watts into a 50-ohm load is available.

The video-link transmitter will accept color and B/W video, and audio inputs from VCR's, camcorders, small TV cameras, and microphones. The unit runs on a nominal 12-volts DC and draws 100 mA in the low-power version, or 500 mA in the 2-watt version.

The PC board is quite small (2¼ inches × 4 inches), and contains everything needed except a power supply and connectors. We used both



subminiature and surface-mount components because they perform well at RF, requiring simple tuneup without complex test equipment. In fact, a good tuneup can be achieved with only a VOM and a TV receiver.

Readers may be familiar with the author's previous article on an RF video-link (February, 1986, **Radio-Electronics**). Since then, many improvements have been made. The new transmitter is easier to tune, uses three slug-tuned coils instead of air-wound, and has a double-sided PC board for better shielding and grounding. Additionally, better transistors were substituted in the new design, which also has an integral power amplifier, and audio/video gain controls for easier interfacing. Linearity control was added to optimize video quality.

Liability

Be warned: The 2-watt version is intended for educational purposes, legitimate TV broadcasting, amateur TV, and industrial, and scientific purposes. It can transmit several miles, so those intending to use our design must have a Technician-class amateur-radio license.

Carrier frequency

As Fig. 1 shows, transistor Q1 and the surrounding circuitry is a crystal-controlled oscillator operating at $\frac{1}{8}$ the video frequency, from 52.5 to 62.5 MHz. After being multiplied by

four through frequency-doublers Q2 and Q3, the output covers 420–500 MHz, overlapping the 430-MHz ham TV band and the lower UHF (300 MHz–3 GHz) TV channels.

First, the frequency is doubled to 105–125 MHz by Q2, and then to 210–240 MHz by Q3. With some modifications, higher or lower frequencies are possible, but with lower power above 500 MHz, and higher power below 420 MHz. Double-tuned interstage networks suppress unwanted harmonics. Then, Q4 doubles Q3's output to the final carrier frequency, which is injected into transistor Q5.

In the low-power version, Q5 modulates the carrier by V_{cc} . The RF (1–30 mW, depending on coupling) is taken from Q5's collector and fed to either a cable or a 6-inch whip antenna. In the high-power version, Q6 and Q7 form a high-gain RF power amplifier, and adjustable matching networks are used in the circuit for optimum tuneup.

Instead of matching networks, a tuned strip-line design was contemplated, but at 420–500 MHz, it would have occupied too much PC-board area. Broadband RF chokes, surface-mount (tantalum chip) capacitors, and careful design strategy avoided possible low-frequency spurious oscillations. We ended up with a very stable, efficient, reproducible circuit having no UHF "horrors."

Modulator

The audio input at J1 will accept a wide range of voltage levels; 10 mV (typical microphone output) to 1 V (line input) is fed to audio-amplifier Q8. The audio-gain control adjusts for optimum modulation of Q9, a Colpitts Variable Control Oscillator (VCO) producing 4.5-MHz FM audio subcarrier, which is fed to video amplifier Q10, where it is then combined with the video from J3.

The video input at J3 may be 0.5– to 1.5-volts peak-to-peak, negative sync, while the video-gain control prevents Q10 and Q11 from video overload. Current-source Q10 and amplifier Q11 feed modulator Q12, which is capable of producing video having a 12-volt swing, and can drive a load up to 1 amp. Its bandwidth at –3 dB is in excess of 10 MHz, assuring crisp picture detail.

In the high-power version, Q12 is a power supply to Q6 and Q7, effectively amplitude modulating the RF carrier. In the low-power version, Q5 is modulated in the same manner. A linearity control adjusts Q12's operating point for optimum modulation linearity. The Q-point must be properly set; otherwise, video clipping will occur, producing "burned-out" picture highlights (white areas) and loss of detail. Other Q-point problems could include sync "buzz" in the audio, and loss of picture stability in extreme cases.

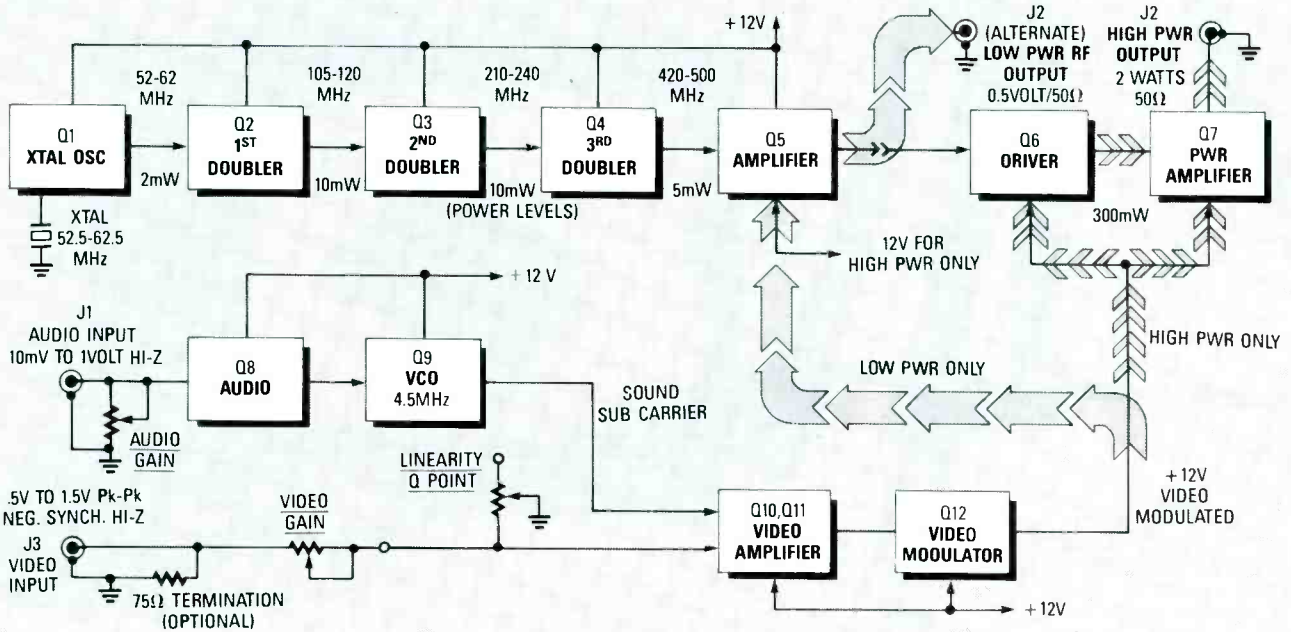

FIG. 1—VIDEO-LINK TRANSMITTER CAN BE CONFIGURED for either low-power, or high-power operation.

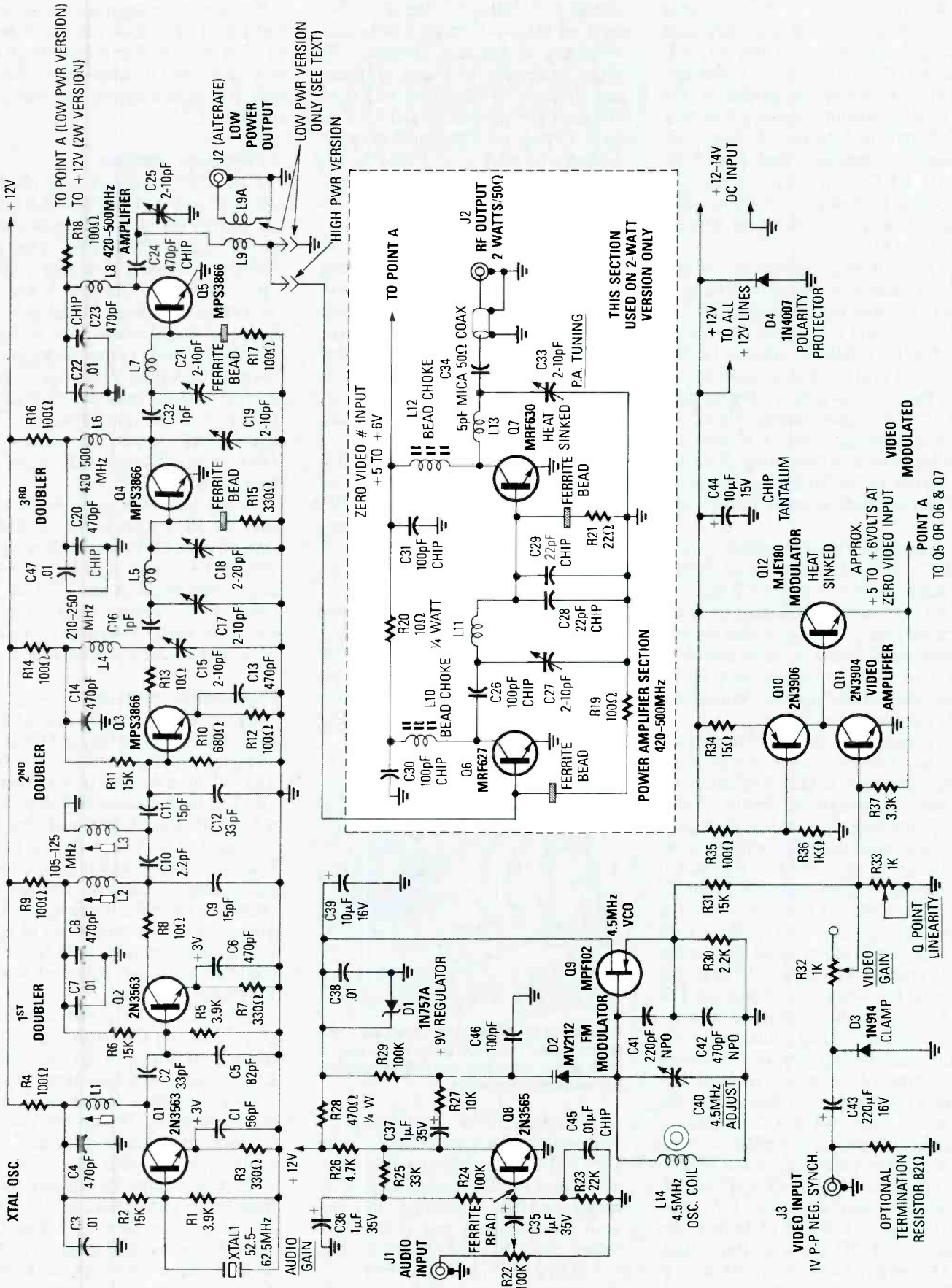

FIG. 2—HIGH POWER, 2-WATT Video-link Transmitter.

Frequency doublers

Referring to Fig. 2, VHF transistor Q1 is biased at 10 volts and 5 mA, with the Q-point set by resistors R1, R2, and R3. Crystal XTAL1 is series-resonant, "bypassed" to ground. At the crystal's resonant frequency (between 52.5 and 62.5 MHz), Q1 is a common-base amplifier. Tank (tuned circuit) L1/C2, in series with C5, together with about 1–2 pF of stray capacitance, form a load for the collector of Q1.

Once Q1 starts oscillating, its collector current is typically 5–10 mA, and depends on the tuning of L1. Here, C3 and C4 bypass the "cold" end of L1 solidly to ground for AC. Internal collector-to-emitter (C-E) feedback occurs in Q1 via the intrinsic 2-pF C-E capacitance. Here, C1 forms a voltage divider to feed the collector back to the emitter. Note that C1 is not for emitter bypass, but is part of the feedback network of oscillator Q1.

A portion of the voltage across tank L1/C2, and C5, is fed to Q2 by the voltage division between C2 and C5. Next, Q2 and its associated circuitry is a frequency doubler, where a large drive signal from Q1 causes rectification in Q2's emitter-to-base (E-B) junction, which produces considerable harmonic generation.

At twice the oscillator frequency, C5 has low impedance; keeping the impedance low in Q2's E-B circuit by using a large value (82 pF) for C5 also helps produce efficient harmonic generation. Biasing for Q2 is the same as Q1, via R5, R6, and R7. Bypass C6 adds stabilization, as does C7 and C8.

Tank L2/C9 is tuned to twice the crystal frequency. R9 supplies DC to Q2. A slug in L2 tunes the tank, while C10 couples RF energy at 2 times the crystal frequency to a second tank L3/C11/C12, also tuned to twice the crystal frequency. Using dual tanks assures good selectivity, and improved rejection of unwanted frequencies; that's important for a clean transmitter signal. Next, R8 in Q2's collector suppresses any self-oscillation tendencies at unwanted, parasitic UHF.

Frequency doubler Q3 (MPS3866, 400-MHz, medium power, 1-W, plastic) is fed at 105–125 MHz from the junction of C11 and C12. Here, R10, R11, and R12 bias Q3. The RF level at Q3's base is quite high, and that affects Q3's biasing, while the collector current runs at 10–15 mA.

Note that Q3 offers better performance at 250 MHz than the 2N3563's used for Q1 and Q2; Q3 doubles the frequency to between 210 and 250 MHz. Except for frequency, Q3 operates similarly to Q2. Then, R13 suppresses UHF parasitics, and L4/C15 form a bandpass filter tuned to twice the input frequency. At 250 MHz, C1 (for Q1) and C3 (for Q2) are ineffective, whereas C14 is sufficient. Finally, R14 feeds DC to Q3.

Note in tank L4/C15 that C15 is variable and L4 is fixed. Slug tuning is no longer practical because L4 has too few turns. Energy is coupled through C16 to tank L5/C17/C18, which forms a double-tuned bandpass filter at 210–250 MHz. Then, C17 is for RF tuning, while C18 will optimize matching into Q4, the last (third) doubler.

Figure 3 shows how a ferrite bead is slipped over one lead of R15, which causes a high series-impedance at RF, yet passes DC without attenuation, thereby completing the base circuit DC path for Q4. The bias is now supplied entirely by the drive signal; no extra DC bias is applied. The emitter of frequency-doubler Q4 is directly grounded, because bypassing emitter circuits at 420–500 MHz is difficult without some loss of RF gain; however, a low value of R15 keeps DC stability adequate.

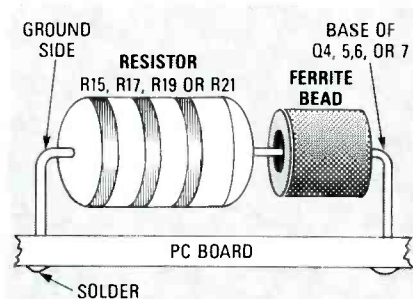

FIG. 3—SLIP RESISTOR LEAD through ferrite bead. The bead inductor causes a high series impedance at RF, yet passes DC without attenuation.

Tank L6/C19 (a short length of wire) operates at 420–500 MHz. Both C19 and C20 provide low-frequency video and RF bypassing, while C29 bypasses UHF; they also stop any stray low-frequency gain in Q4. Tantalum-chip C20 is the only type effective at 420 MHz, and provides a solid RF ground for the "cold" end of L6.

The 420–500-MHz at Q4's collector is fed to tank L7/C21, via C32,

which matches Q4's collector circuit to Q5's low base impedance; together with L6/C19 they form a double-tuned UHF circuit. The ferrite bead and R17 provide a low DC impedance, but a high RF impedance to the base of amplifier Q5.

Low-power version

The UHF signal is amplified to about 30 mW by Q5. Choke L8 keeps RF energy out of the DC power supply. C22 and C23 bypass video and UHF, respectively. Note that if Q5 is video modulated (the low-power version) then C22 must be deleted, because it would cause loss of high-frequency video components; moreover, R18, which limits the supply current to Q5, must be returned to Q12's emitter. Tantalum-chip C24 couples RF output, yet blocks DC (and video, if applicable) from the tank circuit L9/C25.

In the 1–30-mW version, L9 couples the RF output to the secondary link of wire L9A, which then transfers the RF to output jack J2A (Alternate). Note that J2A and L9A are not used in the 2-watt version. Output power is limited depending on the proximity of the link L9A to L9.

High-power version

In the 2-watt version, L9 matches to the base of driver Q6, and Q5 is fed straight, unmodulated +12-V DC. The full 30-mW drive from Q5 drives Q6. The ferrite bead and R19 provide a high RF impedance, and low DC resistance at Q6's base. Since a ferrite bead looks more like a high resistance rather than a reactance at high frequencies, the effective Q is very low. That prevents the possibility of parasitic oscillations that could occur if a conventional-type solenoid-wound RF choke were used.

Here, C27, L11, and tantalum-chips C28 and C29 match Q6's collector impedance to Q7. RF-choke L10 is made with three turns of wire wound through a ferrite bead, in a toroidal fashion. That results in a low Q, about 1000 ohms resistance, and again avoids possible parasitics.

Tantalum-chip C26 is used to minimize stray inductance, and couples RF energy from Q6 to Q7. Now, C30 and C31 bypass UHF to ground while looking like a high impedance at 20 MHz or lower, so the video component of the modulating power supply voltage is relatively unaffected. Note

PARTS LIST

Resistors all are 1/8 or 1/10-W, 5%

R1, R5—3900 ohms
 R2, R6, R11, R31—15,000 ohms
 R3, R7, R15—330 ohms
 R4, R9, R 2, R14, R16—R19, R35—100 ohms
 R8, R13—10 ohms
 R10—680 ohms
 R20—10 ohms, 1/4-W
 R21—22 ohms
 R22—100K-ohms potentiometer
 R23—22,000 ohms
 R24, R29—100K ohms
 R25—33,000 ohms
 R26—470 ohms
 R28—470 ohms, 1/4-W
 R30—220 ohms
 R32, R33—1000-ohm potentiometer
 R34—15 ohm
 R36—100 ohms
 R37—330 ohms

Capacitors

C1—56 pF, NPO, ceramic disc
 C2, C12—33 pF, NPO, ceramic disc
 C3, C7, C19, C22, C38, C47—0.01 μ F, ceramic disc
 C4, C6, C8, C13, C14—470 pF, NPO, ceramic disc
 C5—82 pF, NPO, ceramic disc
 C9, C11—15 pF, NPO, ceramic disc
 C10—2.2 nF, NPO, ceramic disc
 C15, C17, C19, C21, C25, C27, C33—2-10-pF, trimmer
 C16, C32—1 pF, NPO, ceramic disc
 C18—2-18 pF, or 2-20-pF-trimmer
 C20, C23, C24, C45—470 pF, ceramic chip
 C26, C30, C31—100 pF, ceramic chip
 C28, C29—22 pF, ceramic chip
 C34—5 pF, silver mica
 C35—C37—1 μ F, 50 V, electrolytic
 C39—10 μ F, 16 V, electrolytic
 C40—3-4 pF trimmer
 C41—220 pF, NPO, ceramic disc
 C42—470 pF, NPO, ceramic disc
 C43—220 μ F, 16 V, electrolytic
 C44—10 μ F, 16 V, tantalum chip
 C45—0.01 μ F, ceramic chip
 C46—100 pF, NPO, ceramic disk

Semiconductors

Q1, Q2—2N3563, transistor
 Q3—Q5—MPS3866, transistor
 Q6—MRF 559, or MRF627 transistor
 Q7—MRF 630, transistor

Q8—2N3565, transistor
 Q9—MPF102, transistor
 Q10—2N3906, transistor
 Q11—2N3904, transistor
 Q12—MJE180, transistor
 D1—1N757A, diode
 D2—MV2112, varactor diode
 D3—1N914, diode
 D4—1N4007, diode

Inductors

L1—L14—See table 1.

Other components

XTAL—52.5-62.5 MHz

Note: Kits for this project are available from North Country Radio, PO Box 53, Wykagyl Station, New Rochelle, NY 10804. Two different kits are available; one is a low-power, the other is a high-power version. Those kits include the PC board and everything on it, except jacks, connectors, batteries, power-supply components, and case. Those are not included, because individual hobbyists may have their own preferences and interface requirements. The author recommends that those components be obtained at another supplier.

The Low-Power Kit w/ATV crystal for operation on 439.25 MHz costs \$79.95, plus \$2.50 for shipping and handling; the 2-W Kit w/ATV crystal for operation on 439.25 MHz costs \$104.95, plus \$2.50 for shipping and handling. Extra crystals for CH14/CH15 operation are \$6.50, plus \$1.50 for shipping and handling. The PC board only, plus cores, chip capacitors, and D2 (a partial kit) cost \$49.95, plus \$2.50 shipping and handling. The Video-Link transmitter, Radio-Electronics, February, 1986, plus a reprint of the article, costs \$69.95, plus \$2.50 shipping and handling. Crystals can be purchased separately from Crystek Corporation, PO Box 06135, Fort Myers, FL 33906.

that Q6 draws about 130 mA at modulation peaks (sync tips).

Also, Q6 supplies between 300- and 500-mW drive to Q7, an MRF630 (Q6 and Q7 are similar in their operation). RF-choke L12 functions exactly the same as L10. Collector matching-network L13/C33, together with mica C34 match the 50-ohm load impedance to the optimum collector load-impedance needed by Q7. Note that a 50-ohm load must always be present at J2, otherwise Q7

may be damaged. A tolerance of $\pm 50\%$ (25–100 ohms) is permissible here; however, optimum performance is obtained with a 50-ohm load.

Suitable 50-ohm coax must be connected from C34 (on the PC board) and J2, with short connections (a 1/4-inch or so). Any length of coax can be used, but for the best results, keep it short. We used RG174/V PVC type, but teflon coax (RG188/U) would be better. From J2, a standard coax (RG8U, RG58/U, etc.) will do. Re-

member, feedline loss must be avoided as it can be very high at 420 MHz and up.

Video feed

Input video from J3 (standard 1-V p-p negative sync.) is fed through C43 to clamp-diode D3. Note that C43 is apparently incorrectly polarized; that is to allow for video equipment that may have a DC component of up to 16 volts at the video output. If you do not expect to encounter that, you can reverse the polarity of C43—if you wish. When turned around, the low reverse voltage (0.6 V) appearing across it doesn't seem to do any harm. Diode D3 clamps the maximum negative input level to -0.7 V, and avoids serious over-modulation at the sync tip levels. If you wish, you can DC couple from J3 directly into R32, the video-gain control, if your equipment interface permits. Also, note the optional 82-ohm termination (R32A) is not on the PC board, but is soldered across J2. Use it unless you're in a situation where loop-through (several other video loads in parallel) is required. It was not placed on the PC board so that possibility would not be compromised.

Video-gain control R32 feeds the base of video-amplifier Q11. Video-amplifier Q11's collector is fed by current-source Q10, which is biased by R34, R35, and R36 to about 50-mA of collector current. That permits Q11's collector to supply plenty of drive to modulator Q12, and eliminates the need for a low-value decoupling resistor from Q11's collector to the power-supply rail (+12V); therefore, Q12's base can approach V_{cc} , and allows a higher positive swing of Q12's emitter than a resistor from Q11 to +12V would permit, due to Q12's base-drive needs.

Modulator Q12, an MJE180, is configured as an emitter follower. It must supply all the current to Q6, Q7 (or Q5), have a low supply impedance, and high slew rate. The low impedance is necessary for both full RF power output, and to control the parasitic-oscillation tendencies in power amplifiers Q6 and Q7. The load tends to be capacitive due to the bypassing from C26 (somewhat), C30, and C31.

In tests, Q12 can supply nearly 12 volts of video into a 10-ohm load, at 1.2 amps; therefore, Q12 must be heat sunk. To establish both Q-point,

video gain, and bandwidth, R37 provides feedback around the modulator; however, R33 sets the exact Q-point (voltage seen at point A, Q12's emitter), under zero-drive conditions at about 5- to 6-volts DC, to Q6 and Q7. R33 is adjusted for maximum undistorted symmetrical video at point A, while R32 controls video drive to Q11. Supply bypassing must be effective at Q12's collector due to the high current and fast waveforms handled. The main supply bypass, C44, a 10- μ F, 15-volt, tantalum chip was used because standard electrolytics are somewhat less effective.

Power feed

DC power is fed to the transmitter at J4. Diode D4, a 1N4007, is provided to serve as reverse-polarity protection. It's cheap insurance against inadvertent damage to Q6, Q7, Q10, Q11, and Q12, should the negative and positive leads of the power supply be reversed by accident. Diode D1 is connected directly across J4. The 12-volt supply (11-14 V is OK) may come from Nickel-Cadmium batteries, an auto's electrical system, or any kind of AC-operated power supply.

Audio feed

Audio is fed to gain control R22 from jack J3. Input level should be between 10 mV and 1 volt at high impedance, allowing direct interfacing with most microphones, or other audio sources. From R22 the audio is coupled through C35 to Q8, which is biased from R23, R24, and R25. Bypass C36 will prevent audio degenerative feedback, and loss of gain. Collector-load R26 supplies DC to Q8, while C37 blocks DC and couples audio through R27 to the frequency modulator.

Note that no pre-emphasis (high-frequency boost) has been used. If you want to use it, for better high-frequency audio response, change C37 to 0.001 μ F, and set the gain-control R22 up higher to compensate for loss. The author found that pre-emphasis was unnecessary for most applications.

Audio is coupled to the varactor-diode D2, an MV2112, where R29 biases D2 at 9 V. The varactor diode varies its capacitance at an audio rate from 56 pF at 4 V, to about 33 pF at 9 V. The capacitance of D2 appears across 4.5-MHz oscillator coil L14.

Then, Q9, an MPF102 FET, together with C41, C42, C40, and L14 form a Colpitts RF oscillator operating at 4.5 MHz. Trimmer C40 is used to set the frequency to exactly 4.5 MHz, while toroidal coil L14 is used to minimize stray magnetic field generation.

The audio voltage on the DC bias causes D2 to change capacitance, which shifts the oscillator frequency causing frequency modulation (FM) of the 4.5-MHz generated in Q9, the Colpitts oscillator. Bias for Q9 is provided by R30, while R31 couples the audio subcarrier (4.5-MHz FM) into the video amplifier, which modulates it and the video onto the RF.

Zener-diode D1, R28, and C38 and C39 (which provide bypass) supply a regulated 9-V DC voltage to Q9, and varactor D2. The regulation prevents oscillator drift if the supply voltage were to vary. A frequency counter can be connected to point A to set C40 to exactly the value needed for 4.5-MHz audio subcarrier.

Assembly hints

As long as the author's design is exactly duplicated, you shouldn't encounter any *off the wall* UHF prob-

TABLE 1—COIL DESCRIPTIONS L1-L14

COIL	FREQ. RANGE MHz	NO. TURNS & LENGTH	WINDING FORM	NOTES
L1	420-450 (HAM TV) 450-500 (VIDEO LINK)	9½ 8½	8-32 SCREW THREAD	NO. 22 ENAMEL WIRE
L2	420-450 450-500	4½ 3½		
L3	420-450 450-500	5½ 3½		
L4	ALL	3 TURNS ¼" LONG	NO. 27 DRILL (0.144" DIA) SPACE TURNS	MADE WITH NO. 22 TINNED COPPER
L5	ALL	4 TURNS ¼" LONG		
L7	ALL	1½ TURNS ⅛" LONG		
L8	ALL	2½ TURNS ⅛" LONG		
L6, L9, L11, L13	ALL	PER FIG. 1	NONE (PC BOARD)	
L10, L12	ALL	PER FIG. 1	FERRITE BEAD	NO. 32 ENAMEL WIRE
L14	4.5 MHz (NTSC SOUND SUBCARRIER)	8 TURNS NO. 22 ENAMEL	TOROID	NO. 22 ENAMEL WIRE

NOTE: Due to individual winding technique and normal circuit tolerances, L1, L2, L3 and L14 may require one turn more or less than shown in Table 1. L4, L5, L7 and L8 may have to be squeezed or spread lengthwise. All dimensions are taken from average of several working units. Individual units vary somewhat from given dimensions due to tolerances, winding techniques, and installation.

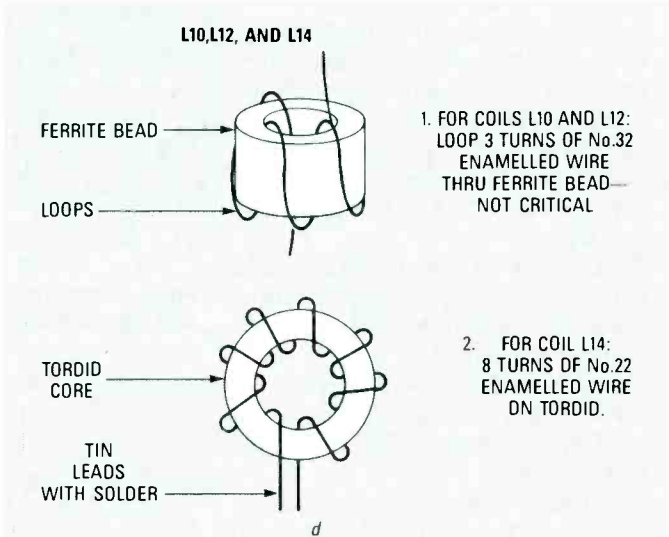
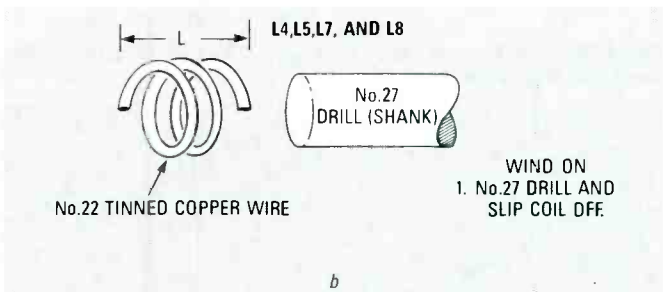
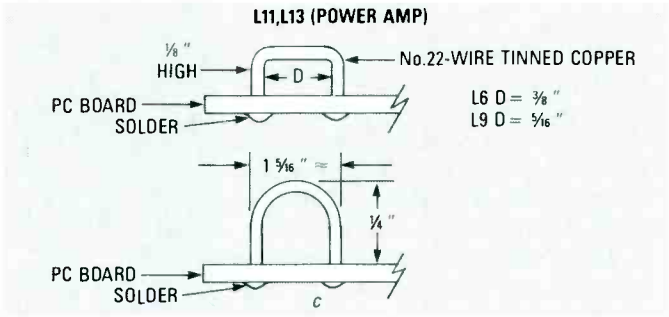
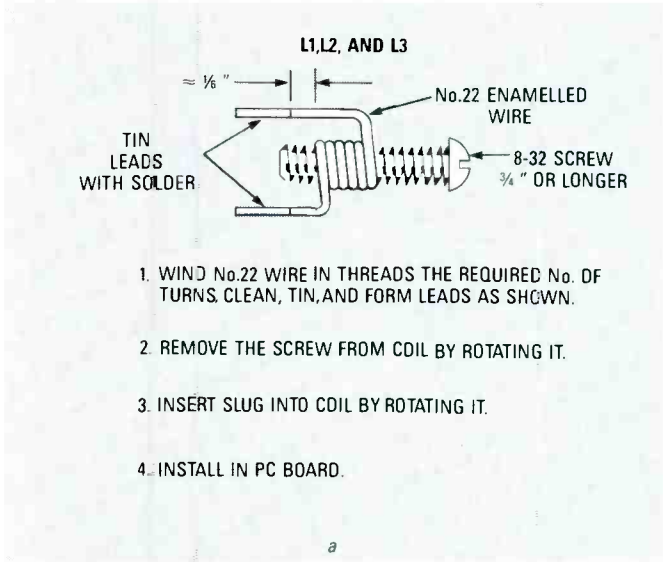

FIG. 1—IF YOU WANT TO CONSTRUCT THE COILS BY HAND, you have to wind them on the threads of a screw (a), the shank of a drill bit (b), using measured bends (c), or around a ferrite bead (d).

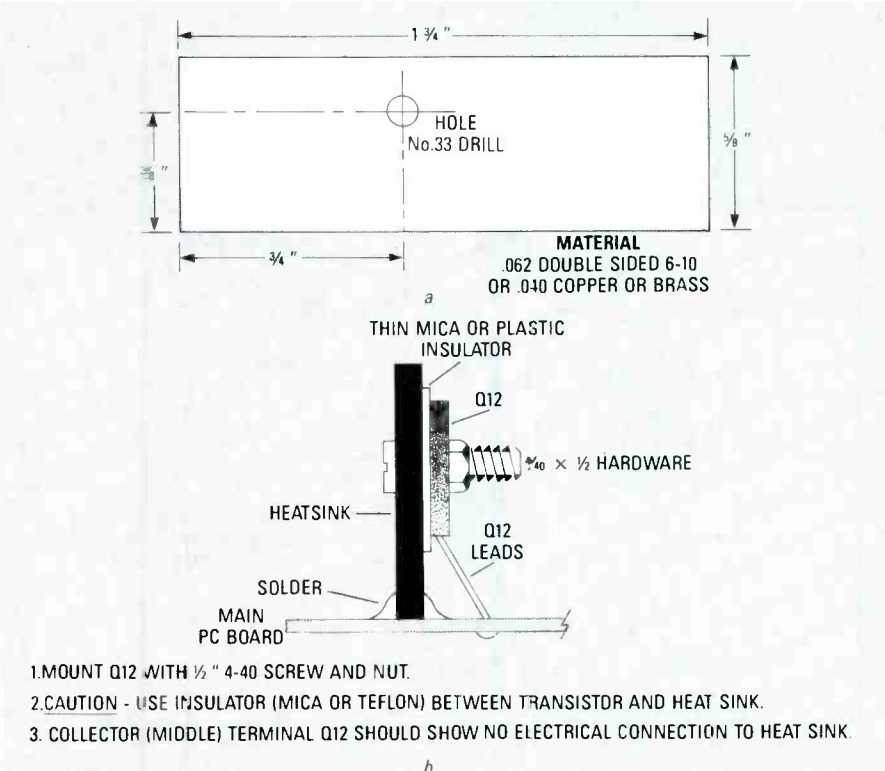

FIG. 2—THE ALUMINUM PLATE THAT IS USED AS A HEAT SINK FOR Q12 also functions as an RF shield for transistors Q6 and Q7.

lems, so follow these suggestions without compromise:

1. As you assemble this project, use only the parts specified in the Parts List because ultra-high frequency circuits are sensitive to changes in component type and value. Also follow the author's parts placement as closely as possible.
2. Lead lengths should be kept short. Handle the surface-mount components and ferrite beads with extra care. The 1/10-watt resistors and miniature NPO ceramics should have short leads, and close component spacing.
3. Wind your own slug-tuned coils with available materials, rather than using commercial, hard-to-get factory-made types. That gets rid of the coil headaches. If the dimensions are followed, no problems should result. As shown in Fig 1, you'll find that the coils are easy to wind, and the largest ones have only eight or nine turns of wire. In fact, several are only loops or pieces of wire because the inductors required at 420–500 MHz are usually in the 0.01 to 0.1-microhenry range. Complete technical data is compiled in Table 1.

4. Pay particular attention to supply bypassing. We have incorporated a tantalum chip capacitor to guarantee good bypassing. By keeping everything compact, and by using a shielded, double-sided PC board with good RF bypassing, all the possible "horrors" associated with VHF and UHF circuitry can be done away with.
5. The PC board is compact and parts are small, so a small iron with a pointed tip is recommended, especially for soldering the chip capacitors.
6. Use only 0.062-inch thick epoxy-fiberglass PC-board materials. Other materials and thicknesses could be used, but may result in different tuning conditions, and stray capacitances. Don't use paper-base phenolic materials; they're too lossy at UHF frequencies.
7. Transistor Q12 must be heat-sinked because it must dissipate up to 3 watts. The method shown in Fig. 2 has proven adequate if at least 1-ounce copper is used. On the other hand, Q7 is adequately heat-sinked if the metal case is soldered to the PC-board ground plane.
8. Solder as many component leads as possible (that pass through the ground plane) to the top and bottom of the board. In particular, the ground lugs on all trimmer capacitors should be soldered on both sides, and also the resistors that have one side connected to ground. The idea is to ground as much of the ground plane to the ground foil on the component side, in as many places as possible; that's especially important around Q4-Q7.
9. Use chip capacitors where specified. Do not substitute ordinary leaded capacitors.
10. Keep all component leads as short as possible, and as close to the board as possible.
11. Take care to make coils as accurately as possible. While some errors can be tolerated, accurate work will make tuneup easier.

Parts installation

Figure 3 shows the Parts-Placement diagram for the TV transmitter. First install all resistors and then diodes D1 and D3. Don't forget the ferrite beads on R15, R17, R19, and R21. Next install all disc ceramics (0.01 μ F and 470 pF), and then the NPO capacitors. Now install potentiometers R22, R32, and R33, soldering the grounded side of R22 and R33 to both

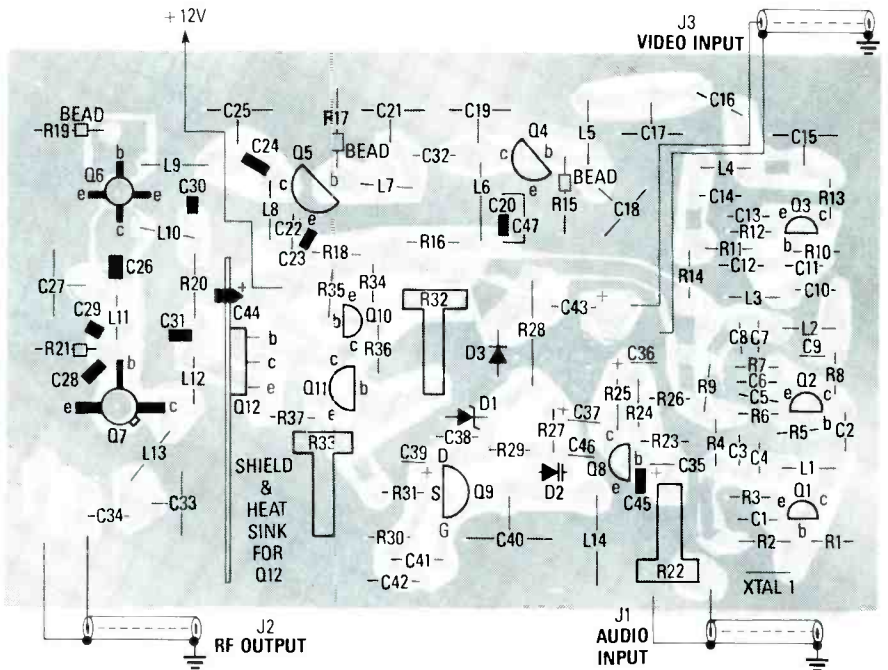

FIG. 3—PARTS PLACEMENT DIAGRAM shows capacitor chips (C20, C23, C24, C26, C28, C29, C30, C31, C45) mounted on the solder side, as is Q6.

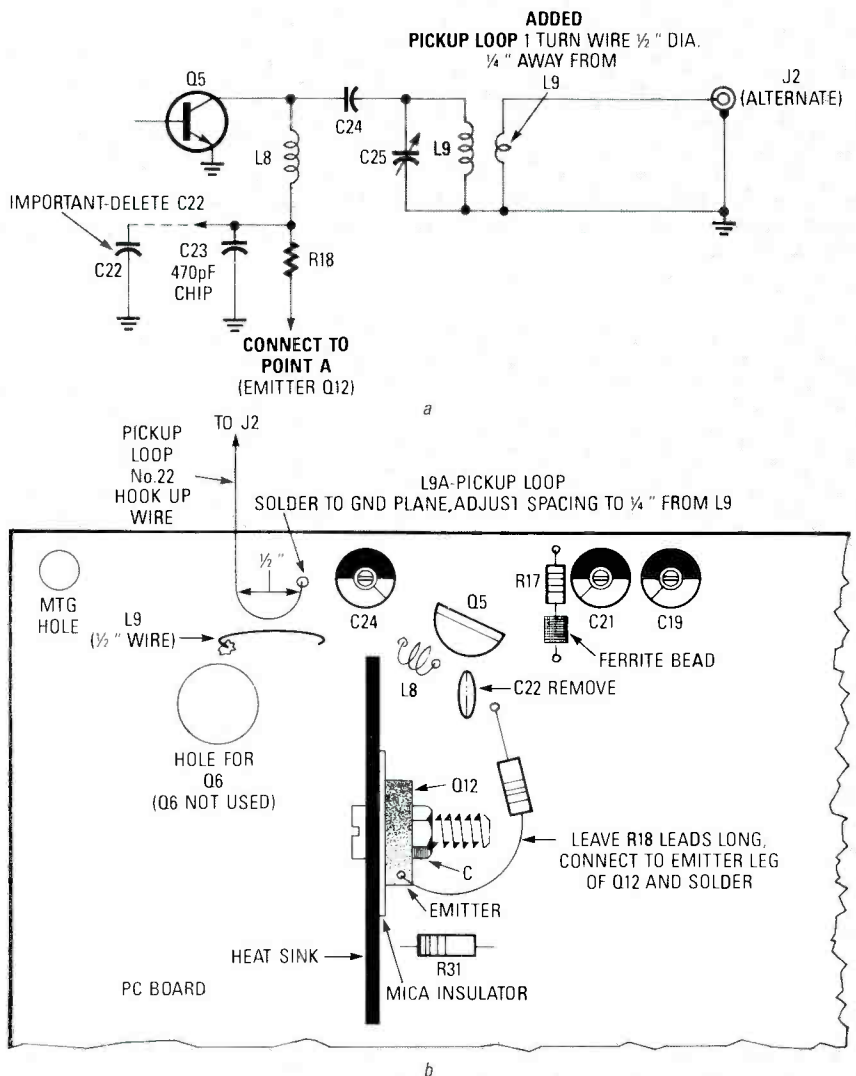

FIG. 4—TO OPERATE THE UNIT AT LOW POWER you should follow schematic (a) and assembly modification (b).

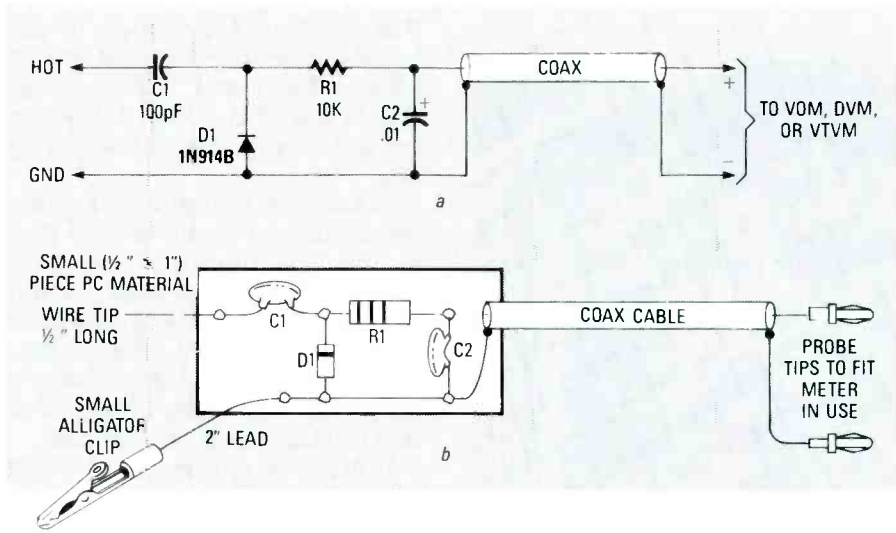

FIG. 5—HERE'S AN RF PROBE YOU CAN BUILD for your DMM, VOM, or scope. It's helpful in adjusting the transmitter for peak power.

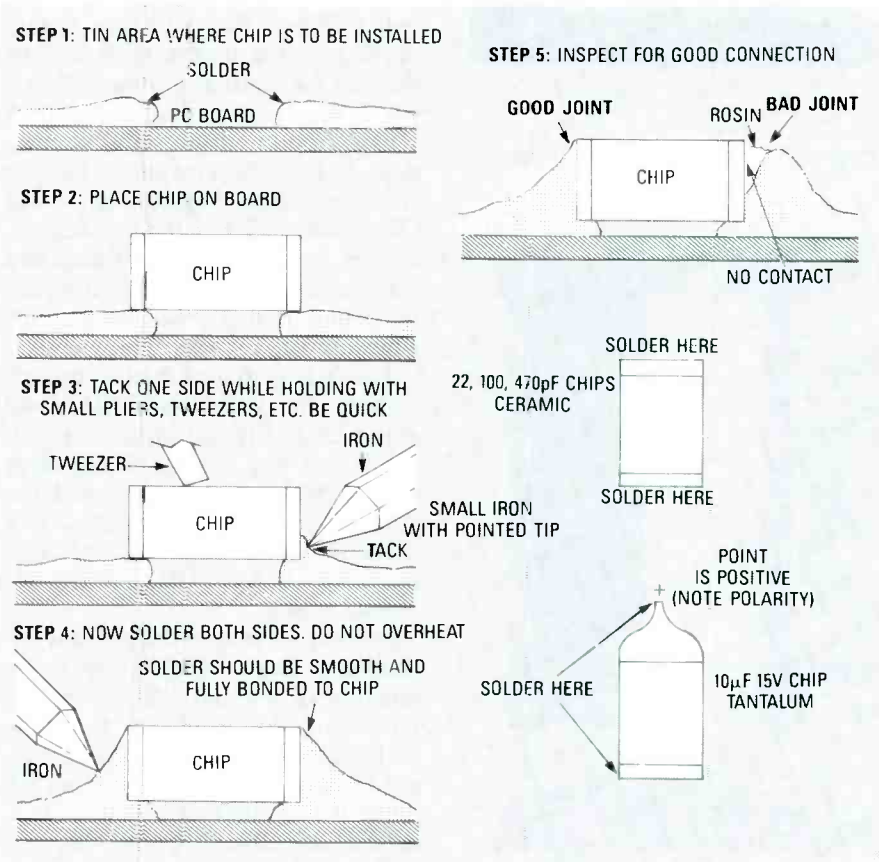

FIG. 6—IF YOU FOLLOW THESE STEPS when soldering the chip components to the PC board, you'll have no problems with them.

sides of the PC board. Install all trimmer capacitors. Note that C18 and C40 are different from the rest. Solder ground tabs of all trimmers to both top and bottom of the PC board. Install transistors Q1 through Q5, and Q8 through Q11, but don't install Q6, Q7, or Q12 yet.

Wind and install L1 through L9, and L14. If you're building the low-

power version, leave out any components associated with Q6 and Q7, except L9; go ahead with the modification shown in Fig. 4, and be sure to omit C22. Install chip capacitors C22, C24, C44, and C20.

Check the PC board for shorts, solder bridges, and trim away any excess foil with a sharp knife (*X-acto* type or equal). Make sure that excess foil on

the top side is not touching any component leads that are not intended to be grounded. Slight mis-registration of the top foil during PC fabrication may cause that.

Now install Q12 and its heat sink. Note that the heat sink also serves as an RF shield for Q6 and Q7 (if used). Be sure to solder the heat sink where it butts against the PC board. Note that Q12's case should be insulated from the heat sink. Use a TO-220 insulator (cut to size), or a scrap of mica, mylar, polyethylene, or teflon tape used in plumbing work.

You are now ready to test the main part of the board. If you're constructing the 2-watt version, Q6, Q7, and any associated components will be installed only after the rest of the PC board is tested.

Testing

After checking your work, measure the DC resistance between V_{CC} and ground; it should be greater than 200 ohms. If it's lower than that, check your work again for the cause before proceeding any further.

Next, install the slugs in L1, L2, and L3 if you haven't already done so. The slugs should be initially set fully inside the coils. Set R22, R32, and R33 about halfway between extremes of rotation. Set trimmer C40 and all other trimmer capacitors to half mesh. Final settings will depend on the operating frequency, coil-construction technique, and application.

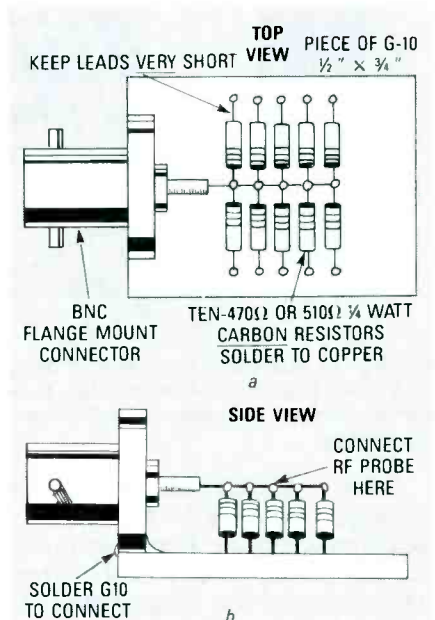

FIG. 7—A DUMMY LOAD SHOULD BE USED while adjusting the power output.

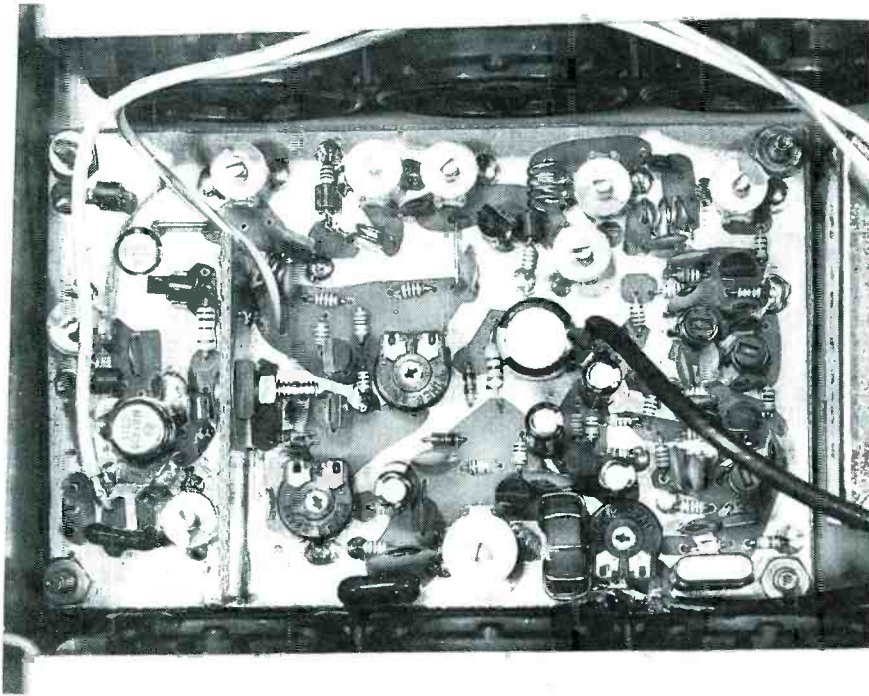

FIG. 8—THE FINISHED PC BOARD has a neat, clean appearance. Sloppy workmanship can not be tolerated on this circuit layout.

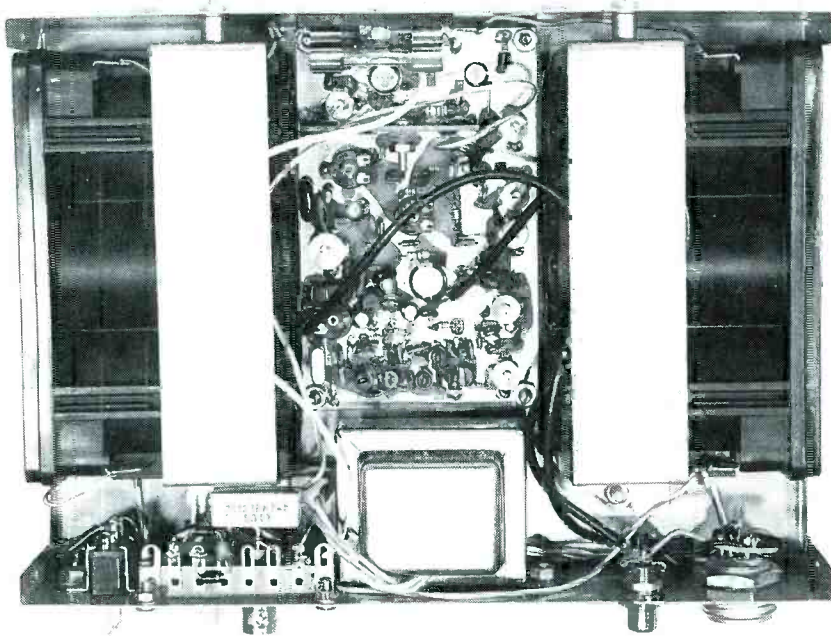

FIG. 9—The AUTHOR'S PROTOTYPE USED 2-Ni-Cd BATTERY PACKS, one on either side of the PC board, which makes the transmitter portable. You'll also notice a power transformer and associated circuitry used for running the transmitter off household AC-line voltage.

Apply +12 volts after connecting the negative-supply lead to the PC-board ground plane. Immediately observe power-supply current; if it's over 130 mA, there may be a problem. If anything smokes or gets too hot, immediately remove the power and find the problem before proceeding.

If all seems OK, connect a VOM (preferably an analog meter) across R3, and then R7. You should read between 1.5 and 3-volts DC. Next connect the VOM across resistor R12 Q3; you should read 1 volt or less. Now connect the VOM between point A (emitter of Q12) and ground. Verify

that adjusting R33 through its full range will vary the voltage at point-A between less than 5 volts to greater than 11 volts. Set R3 for full voltage (greater than 11 volts) at point A for now.

Measure the voltage at Q8's collector; about 4 to 7 volts is OK. Next measure the voltage across D1; it should be between 8- and 10-volts DC. If it is more or less, that indicates a problem in Q8, Q9, or the associated circuitry. Check for 8- to 10-volts across D2. If it reads 1 volt, D2 is installed backwards or is shorted.

If all is good up to this point, install crystal XTAL1, connect a VOM across R7, and apply power. Tuning the oscillator is done as follows: Slowly back L1's slug out of the winding. You'll find that the voltage across R7 will suddenly increase, then slowly decrease as the slug is tuned. Adjust the slug for maximum voltage (3 to 5 volts), then back out the slug for about a 10% drop to ensure stable oscillation. As a check, a frequency counter connected to the junction of C2 and C5 should indicate the crystal frequency. An unstable reading indicates that the crystal is not controlling the frequency. If that's the case, try re-adjusting L1.

Here's how to tune the 1st doubler. Connect the VOM across R12, and adjust L2 and L3 for maximum voltage (about 1 to 2 volts). If adjusting the L1 and L2 slugs doesn't peak the voltage, then add or subtract a turn from the coil as required, after first checking C9, C10, C11, and C12 for correct values.

Here's how to tune the 2nd and 3rd doublers. Connect an RF probe to the junction of L9 and R19, or to the junction of C25 and L9 if you're building the low-power version. Figure 5 shows you how to build an RF probe if you don't already have one. Adjust C15, C17, C18, C19, C21, and C25 for a maximum reading. You should be able to obtain at least 1.5 volts of RF energy at the junction of R19 and L9 for the high-power version, and about 2 volts at the junction of C25 and L9 for the low-power version. If everything looks good, that checks out stages Q1 through Q5.

To adjust the RF output for the low-power version connect a 47-ohm resistor to J2A (Alternate). Adjust C25 and the position of L9A (Alternate) with respect to L9 for maximum out-

Continued on page 163

Electronics Paperback Books

GREAT PAPERBACKS AT SPECIAL PRICES

BP248—TEST EQUIPMENT CONSTRUCTION \$5.95. Details construction of simple, inexpensive, but extremely useful test equipment. AF Gen, Test Bench Ampl, Audio Millivoltmeter, Transistor Tester and six more.



BP267—HOW TO USE OSCILLOSCOPES AND OTHER TEST EQUIPMENT \$6.95. Mastering the oscilloscope is not really too difficult. This book explains all the standard controls and functions. Other equipment is also described.

BP265—MORE ADVANCED USES OF THE MULTIMETER \$5.95. Use these techniques to test and analyze the performance of a variety of components. Also see how to build add-ons to extend multimeter capabilities.



BP256—INTRO TO LOUDSPEAKERS AND ENCLOSURE DESIGN \$5.95. We explore the variety of enclosure and speaker designs in use today so the reader can understand the principles involved.

BP263—A CONCISE INTRO TO dBASE \$6.95. The dBASE series of programs are probably the best known database programs for microcomputers. This book is designed to help you get started working with them.



BP260—CONCISE INTRO TO OS/2 \$5.95. If you are a multitasking PC user and want to get the most out of your computer, then you must learn its OS/2 operating system. This book shows you just how to do that, quickly and easily.



BP249—MORE ADVANCED TEST EQUIPMENT CONSTRUCTION \$6.95. Eleven more test equipment construction projects. They include a digital voltmeter, capacitance meter, current tracer and more.



Digital Audio Projects

BP245—DIGITAL AUDIO PROJECTS \$5.95. Practical circuits to build and experiment with. Includes A/D converter, input amplifier, digital delay line, compander, echo effect and more.



BP247—MORE ADVANCED MIDI PROJECTS \$5.95. Circuits included are a MIDI indicator, THRU box, merge unit, code generator, pedal, programmer, channelizer, and analyzer.



BP257—INTRO TO AMATEUR RADIO \$6.95. Amateur is a unique and fascinating hobby. This book gives the newcomer a comprehensive and easy to understand guide to the subject.



PCP102—INTRODUCING DIGITAL AUDIO \$9.95. Covers all kinds of digital recording methods—CD, DAT and Sampling Bridges the gap between the technician and the enthusiast. Principles and methods are explained.

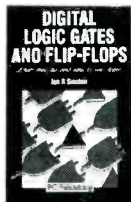

PCP107—DIGITAL LOGIC GATES AND FLIP-FLOPS \$10.00. Thorough treatment of gates and flip-flops for enthusiasts, student and technicians. Only a basic knowledge of electronics is needed.

BP251—COMPUTER HOBBYISTS HANDBOOK \$8.95. A wrapup of everything the computer hobbyist needs to know in one easy to use volume. Provides a range of useful reference material in a single source.

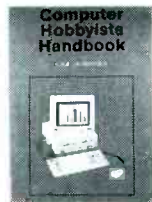

PCP108—COMPUTERS AND MUSIC \$9.95. Explains the basics of computers and music with no previous knowledge of computers needed. Covers types of music software and explains how to set up your own computer music studio.

- BP195—INTRODUCTION TO SATELLITE TV** \$9.95. A definitive introduction to the subject written for the professional engineer, electronics enthusiast, or others who want to know more before they buy 8 x 10 in.
- BP190—ADVANCED ELECTRONIC SECURITY PROJECTS** \$5.95. Includes a passive infra-red detector, a fiber-optic loop alarm, computer-based alarms and an unusual form of ultrasonic intruder detector.
- BP235—POWER SELECTOR GUIDE** \$10.00. Complete guide to semiconductor power devices. More than 1000 power handling devices are included. They are tabulated in alpha-numeric sequence, by technical specs. Includes power diodes, Thyristors, Triacs, Power Transistors and FETs.
- BP234—TRANSISTOR SELECTOR GUIDE** \$10.00. Companion volume to BP235. Book covers more than 1400 JEDEC, JIS, and brand-specific devices. Also contains listing by case type, and electronic parameters. Includes Darlingtons transistors, high-voltage devices, high-current devices, high power devices.
- BP99—MINI-MATRIX BOARD PROJECTS** \$5.50. Here are 20 useful circuits that can be built on a mini-matrix board that is just 24 holes by ten copper-foil strips.
- BP82—ELECTRONIC PROJECTS USING SOLAR CELLS** \$5.50. Circuits with applications around the home that are powered by the energy of the sun. Everything from radio receivers, to a bicycle speedometer, to timers, audio projects and more.
- BP117—PRACTICAL ELECTRONIC BUILDING BLOCKS—Book 1** \$5.75. Oscillators, Timers, Noise Generators, Rectifiers, Comparators, Triggers and more.
- BP184—INTRO TO 68000 ASSEMBLY LANGUAGE** \$6.95. The 68000 is a great new breed of microprocessor. Programming in assembly language increases the running speed of your programs. Here's what you need to know.

BP179—ELECTRONIC CIRCUITS FOR THE COMPUTER CONTROL OF ROBOTS \$7.50. Data and circuits for interfacing the computer to the robot's motors and sensors.

- BP239—GETTING THE MOST FROM YOUR MULTIMETER** \$5.95. Covers basics of analog and digital meters. Methods of component testing includes transistors, thyristors, resistors, capacitors and other active and passive devices.
- BP97—IC PROJECTS FOR BEGINNERS** \$5.50. Power supplies, radio and audio circuits, oscillators, timers, switches, and more. If you can use a soldering iron you can build these devices.
- BP37—50 PROJECTS USING RELAYS, SCR'S & TRIACS** \$5.50. Build priority indicators, light modulators, warning devices, light dimmers and more.
- RADIO—100 RADIO HOOKUPS** \$3.00. Reprint of 1924 booklet presents radio circuits of the era including regenerative, neutrodyne, reflex & more.
- BP42—SIMPLE LED CIRCUITS** \$5.50. A large selection of simple applications for this simple electronic component.
- BP127—HOW TO DESIGN ELECTRONIC PROJECTS** \$5.75. Helps the reader to put projects together from standard circuit blocks with a minimum of trial and error.
- BP122—AUDIO AMPLIFIER CONSTRUCTION** \$5.75. Construction details for preamps and power amplifiers up through a 100-watt DC-coupled FED amplifier.
- BP92—CRYSTAL SET CONSTRUCTION** \$5.50. Everything you need to know about building crystal radio receivers
- BP45—PROJECTS IN OPTOELECTRONICS** \$5.50. Includes infra-red detectors, transmitters, modulated light transmission and photographic applications.

BP185—ELECTRONIC SYNTHESIZER CONSTRUCTION \$5.95. Use this book to learn how to build a reasonably low cost, yet worthwhile monophonic synthesizer and learn a lot about electronic music synthesis in the process.

CHECK OFF THE BOOKS YOU WANT

ELECTRONIC TECHNOLOGY TODAY INC.
P.O. Box 240, Massapequa Park, NY 11762-0240

SHIPPING CHARGES IN USA AND CANADA

\$0.01 to \$5.00	... \$1.25
\$5.01 to 10.00	... \$2.00
\$10.01 to \$20.00	... \$3.00
\$20.01 to \$30.00	... \$4.00
\$30.01 to \$40.00	... \$5.00
\$40.01 to \$50.00	... \$6.00
\$50.01 and above	... \$7.50

SORRY No orders accepted outside of USA & Canada

Number of books ordered

Name _____
Address _____
City _____ State _____ Zip _____

Total price of merchandise \$ _____
Sales Tax (New York State Residents only) \$ _____
Shipping (see chart) \$ _____

All payments must be in U.S. funds

Total Enclosed \$ _____

EEHB

PC BOARD BASICS

IN LOOKING THROUGH THE COLUMNS that have appeared in the past couple of years, I realized that we've developed some fairly complex circuits. But we've never talked about putting the final touch on a circuit—that is, of course, generating printed-circuit boards.

PC boards can be anything from simple single-sided ones for small projects to complex multi-layer affairs for digital designs. And, unfortunately, while there's really no limit to the complexity of a circuit that you can develop on your bench, the same isn't true of PC boards. I've been making PC boards for years, and despite some really creative (and occasionally off-the-wall) attempts, I've never managed to do more than two layers (a double-sided board), produce plated-through holes, or route more than one trace between IC pins.

The bright side to all that, however, is that there's always more than one way to do a job, and we'll be spending the next few columns on the methods you can use to produce PC boards on your own.

To start with, all PC-board production can be broken into three basic jobs:

1. Designing the layout.
2. Producing the artwork.
3. Fabricating the board.

Each of those areas has its own set of hassles, and just how painless each one will be depends on how you go about doing it. The last couple of years has seen the appearance of computer software that makes a lot of the work much easier—if you've got the necessary hardware and the bucks.

Computer Aided Design (CAD) is great stuff but the software will only do what you tell it to do. How successful you'll be using CAD depends (to a large degree) on how much experience you've had producing boards by hand. Some things can be learned only by manually producing a PC board. But the basic principles are the same whether you're doing it by hand or if you're lucky enough to have the required CAD equipment.

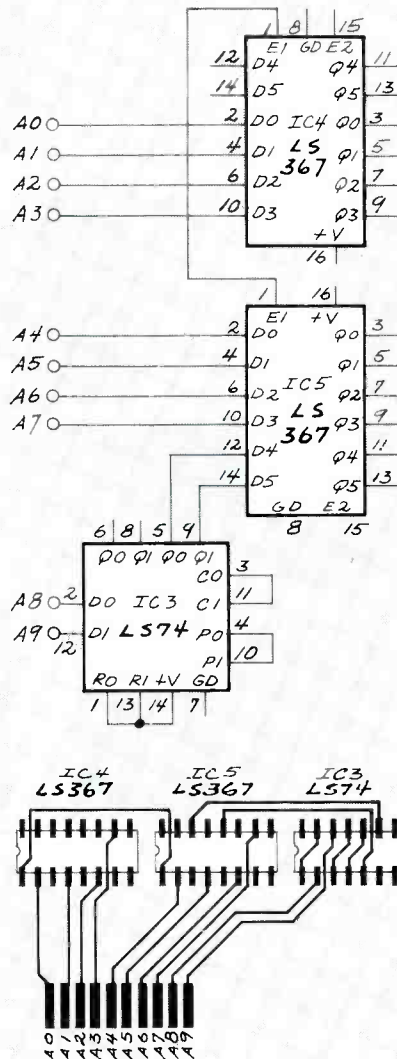

FIG. 1

Designing the layout

This first step must never be started until you're sure that the circuit design is finished. After all, there's a lot less brain damage involved in moving wires on a breadboard than adding and removing traces on a PC board.

Don't even think about starting a layout unless you have an up-to-the-minute set of schematics for the circuit. (Few things are worse than producing a board that's a faithful reproduction of an incorrect schematic.)

Once you're ready to lay out the board, make sure that you have these supplies:

Designing a PC-board layout is not as difficult as you might think it is.

ROBERT GROSSBLATT,
CIRCUITS EDITOR

1. A non-repro-blue pencil.
2. A pad of ten-to-the-inch graph paper.
3. A ruler (ideally marked in tenths of an inch).
4. A pair of dividers.
5. An eraser (because nobody's perfect).

Graph paper marked with a ten-to-the-inch grid is an ideal background for laying out a board, since most standard components are designed around that measurement. Make sure that the paper is at least four times larger than the board you're planning to lay out, because it's always a good idea to work at twice the actual size (and by the time you're ready to lay out your board you should have *some* idea of its size and shape). Working double size is not so important for simple layouts; but complex layouts require routing traces between IC pins, which is just about impossible to do on a one-to-one scale.

The first things to put on a board are those that require certain locations—such as edge connectors or headers. The placement of the rest of the components is usually dictated by the placement of those first components. Figure 1-a shows how the edge connectors are connected directly to a series of buffers. It follows, therefore, that the buffers have to be located close to the edge connectors (Fig. 1-b). The chances are that you'll be moving things around the board as the layout develops but at least it gives you a starting point.

Component placement can also be made a bit easier by examining the schematic and breaking the circuit into component groups -

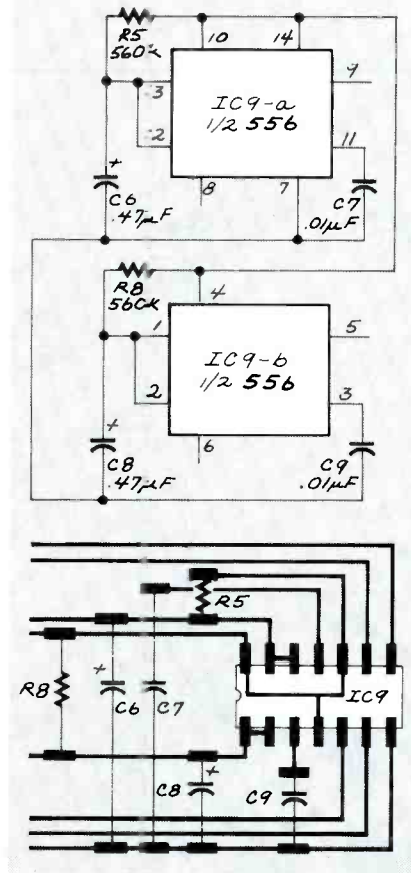

FIG. 2

those that share common connections, components that hang on a particular bus, and so on.

Translating lines on a schematic to traces on a board is a slow and tedious process. You get better at it as you gain more experience, but it's still going to take a lot of trial and erasure to get everything connected on the board. Every board layout is unique, but there are standard ways of handling certain designs that can make life much easier.

If you have an IC with lots of passive components hanging off the pins, the board layout can be considerably simplified by using what I've officially designated the "ladder" approach, as illustrated in Fig. 2. We're looking at a pair of monostables built from the two timers in a 556 (Fig. 2-a). In order to connect the passive components, the IC pins have been connected to a series of parallel traces that are straddled by the passive components (Fig. 2-b).

That's a really simple way to get the job done, and just about the only time you'll run into trouble is

when you're limited in board space or if you have to keep the traces as short as possible. You can see in the illustration that the more IC pins, the wider the collection of traces, so you may have to move the traces closer to the IC if you have to conserve trace length.

During the initial layout stages, you're drawing the traces with the blue pencil and there's really no consideration of the final width of the copper trace on the board. But trace-width is not usually a major factor in most layouts, because a 1/16-inch trace on one-ounce copper board (the most common material) can carry as much as 5 amps. If you do want a wider trace, just leave room for it as you do the layout. You won't be putting any actual traces on the graph paper until you've finished the layout

And you'll wear down a lot of the eraser before that happens.

As you continue adding traces with the blue pencil, there will come a time when you're faced with the untraceable trace—you just won't be able to make the connection. That's when you have to decide whether to use jumpers or make the board double-sided. It's a major decision, because producing a double-sided board is a real pain in the neck. Jumpers may be slightly less than elegant, but the brain damage involved in doing double-sided boards at home is considerable; and generating a double-sided layout just to avoid a handful of jumpers is not what you would call a wise decision.

If the density of the board is such that you *have* to make it double-sided, you're going to have to keep track of both sides of the board on the same piece of graph paper.

To do that, draw a horizontal line

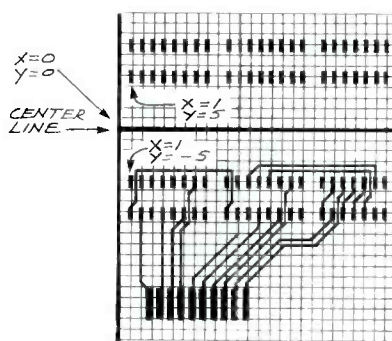

FIG. 3

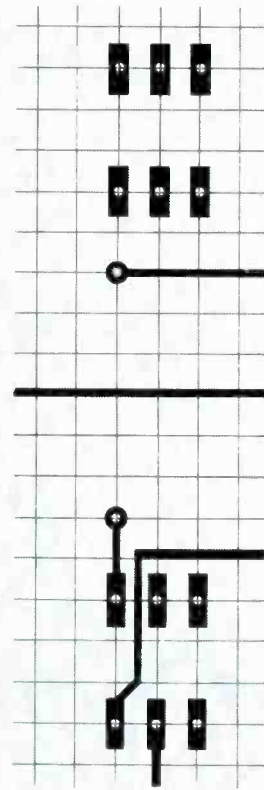

FIG. 4

down the middle of the graph paper and use the dividers to copy the component pads to the other half of the paper as shown in Fig. 3. What you're really doing is unfolding the board using the horizontal line as the center point. It's really important to transfer the pad locations exactly, and it's much easier to do that if you've put all the pad centers on intersection points of the graph paper.

Once you've made the decision to go double-sided, every time you put a component on the foil side (the first one we started), you should mark its location on the component side of the board as well. The horizontal line you've drawn is the zero baseline for your layout. As you can see in Fig. 3, each pair of pads has very similar coordinates—the only difference between them is in the sign of the Y coordinate.

When you jump a trace from one side of the board to the other, you should try to make the side-to-side connection on the leg of a component, since it will save you some work when you get to the drilling and soldering stage.

continued on page 161

ALL ABOUT

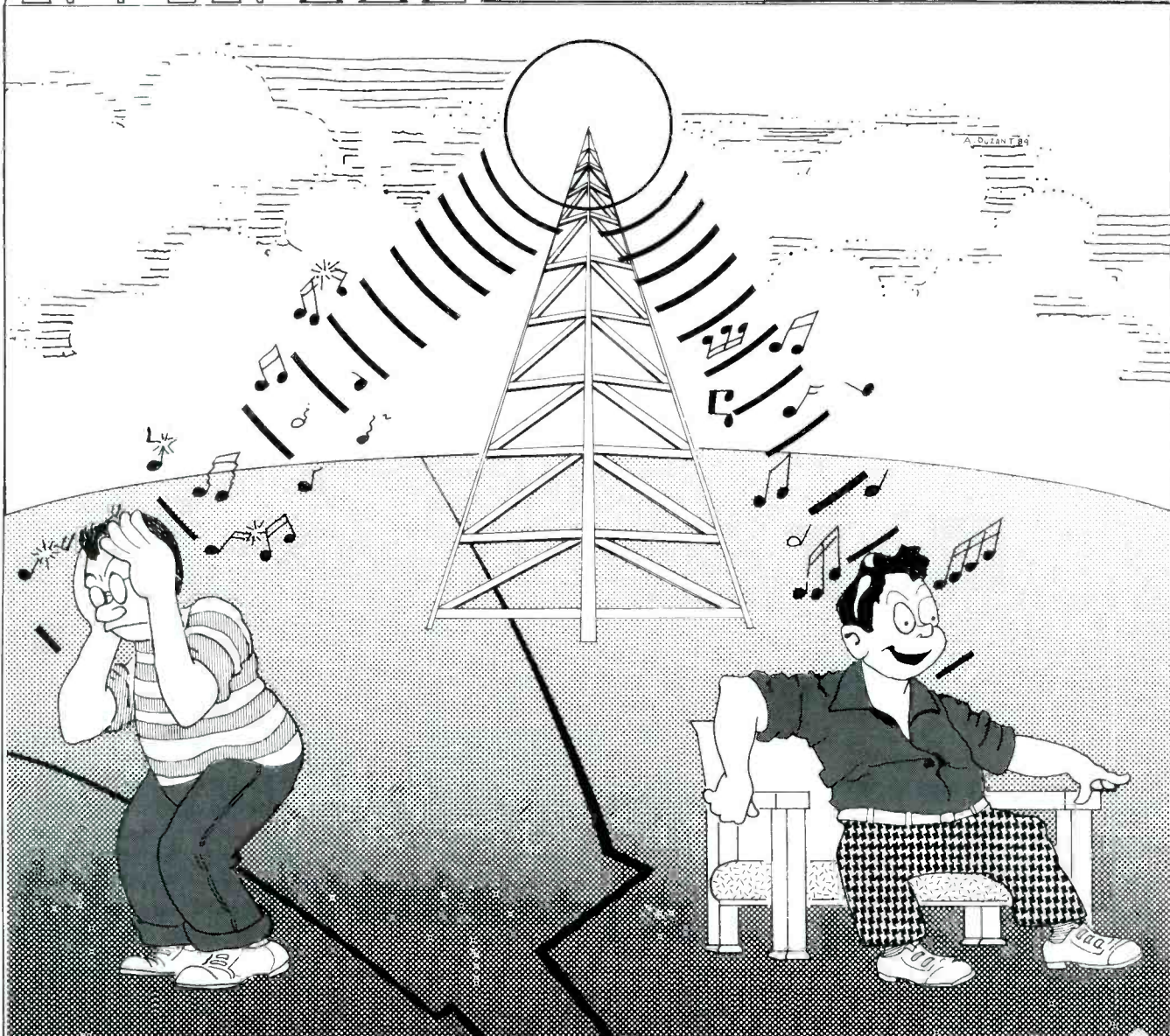

FMX: IS IT GOOD FOR FM?

Can FMX improve stereo FM reception?

LEN FELDMAN

THERE'S A BATTLE BREWING IN THE broadcast industry, and it's one that could affect the way in which we listen to FM radio and, more specifically, FM stereo radio broadcasts. On one side is a company called Broadcast Technology Partners. Its president, Mr. Emil Torick, is a distinguished engineer who spent many years at the CBS Technology Center in Connecticut before it was shut down a few years ago.

During his last years at CBS, Mr. Torick worked out a system that he maintains will decrease the background noise commonly encountered when listening to FM stereo stations whose transmitters are at a considerable distance from the FM tuner or receiver. Torick calls his system FMX. As anyone who has ever listened to stereo FM under fringe-area conditions knows only too well, programs whose background noise levels

are perfectly acceptable in mono can become unlistenable when you switch to stereo. The increase in noise level can be as much as 23 dB or, in arithmetic terms, there's a 200-to-1 increase in noise power!

If FMX can make stereo FM almost as noise-free as mono FM, the number of listeners in any given area who could enjoy noise-free stereo reception would increase. From a commercial standpoint, stations could

then charge higher rates to sponsors based upon a greater audience potential. It's easy to understand why many stations jumped on the bandwagon and converted to FMX. Today, some 50 to 70 FM stations are actually transmitting signals in the FMX format, even though, other than some experimental tuners, there are no home FM tuners or receivers equipped to receive FMX signals. Several manufacturers are said to be ready to produce such sets, especially car-stereo systems where noise has always been a big problem. (Many car radios already use a form of "blend-

ing," that gradually switches reception to mono, when stereo reception is weak.)

If FMX sounds like a panacea for FM listeners and broadcasters alike, hold on a moment! In a press conference held at the Massachusetts Institute of Technology, Dr. Amar Bose, a Professor of Electrical Engineering at MIT (who also happens to be Chairman of The Board of the Bose Corporation, the well-known manufacturer of loudspeakers and other audio components), and Dr. William Short, a researcher at Bose Corporation, presented their findings

about the operation and limitations of FMX. The revelations from Dr. Bose and Dr. Short can best be summarized as:

- Broadcast station coverage, instead of being increased as originally hoped, is actually decreased by the FMX system.
- FMX transmissions degrade reception even on existing FM stereo receivers.
- Receivers designed specifically for FMX reception are inferior to existing FM stereo receivers, even for receiving FMX transmissions.

Such claims, of course, were not made without a substantial amount of backup. Those in attendance received a massive document detailing the mathematical modeling, computer simulation of the effects produced by FMX, and a summary of results obtained from actual broadcasting experiments that led to those startling conclusions. Since the MIT event took place, the full report has become available as an MIT Technical Research Report. Readers interested in the complete report (which goes into far more detail than is possible in this article) can obtain a copy for \$7.50 (shipping and handling costs included) by writing to the Research Lab of Electronics, Room 36-412, Massachusetts Institute of Technology, Cambridge, MA 02139, and requesting a copy of Technical Report #540, entitled *A Theoretical and Experimental Study of Noise and Distortion in the Reception of FM Signals*.

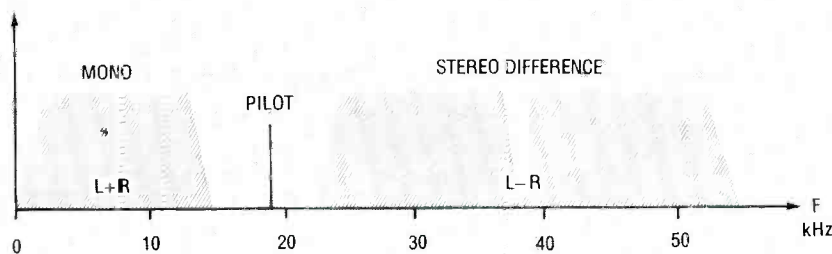

FIG. 1—SPECTRUM OF FM STEREO composite audio signal. Ordinary FM stereo signals consist of a monophonic signal, a stereo difference signal, and a pilot signal.

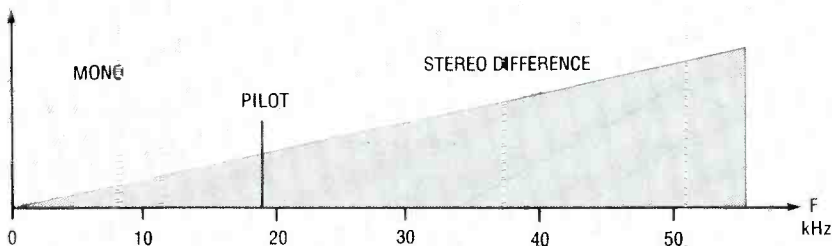

FIG. 2—IN STEREO FM TRANSMISSION, noise is added to the signals, and the amplitude of the noise increases with frequency.

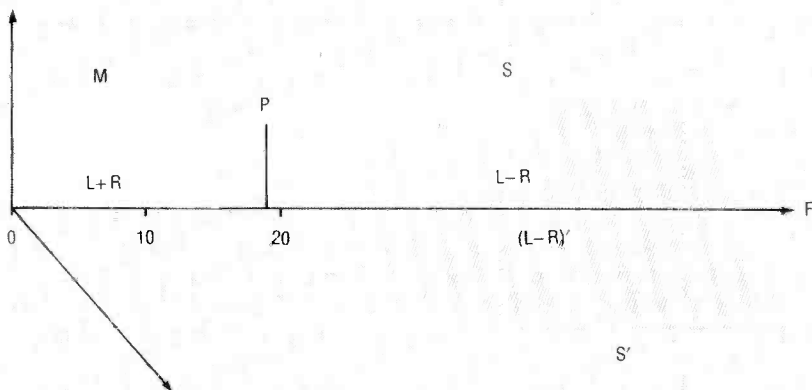

FIG. 3—FMX ATTEMPTS TO REDUCE NOISE during weak-signal stereo FM reception by adding another subcarrier signal that is 90 degrees out of phase with respect to the regular L - R signal.

FM stereo and FMX stereo

To understand the issues raised by Bose and the counter arguments put forth by Torick, it's helpful to review how FM stereo works, and how FMX is supposed to work. Ordinary FM stereo signals consist of three parts (see Fig. 1). A monophonic signal, consisting of the sum of the left and right stereo signals is transmitted as the main channel, and received on both mono and stereo FM sets. A difference signal, created by subtracting the right signal from the left ($L - R$) is used to modulate a 38-kHz subcarrier. The subcarrier itself is suppressed, but the modulation products ride along in what has best been described as "piggyback" on the main RF carrier. In addition, a pilot signal, at a frequency of 19 kHz, or half the suppressed subcarrier frequency, is transmitted at a low 10%

modulation level. That's so that the receiver can recreate the 38-kHz subcarrier for subsequent demodulation or detection of the L-R signal. The original left (L) and right (R) signals are then recovered by adding L+R to L-R and, in a separate signal path, by subtracting L-R from L+R.

As illustrated in Fig. 2, random noise is added to those signals along the way from the transmitter to the receiver and by the circuits in the receiver as well. The amplitude of that noise, when recovered by the detector in the receiver, increases with frequency. Since, in the case of stereo, more information is being inserted at higher baseband frequencies, signal-to-noise (S/N) ratios are poorer than during mono reception. The difference in the S/N ratio can be as great as 23 dB!

Figure 3 shows how FMX attempts to reduce noise during weak-signal stereo FM reception by adding yet another subcarrier signal that is 90 degrees out of phase with respect to the regular L-R. The audio used to modulate the second subcarrier is a *compressed* version of the difference signal. At low modulation levels, the audio level is raised by about 14 dB, as shown in Fig. 4. Compression is reduced for audio levels that are approximately 20 dB below 100% modulation (for louder audio signals).

Expansion at the receiver end is the converse of the compression, so that low-level signals are made even quieter and, along with them, noise is reduced as well. At or near maximum modulation levels, the secondary L-R signal nearly vanishes, allowing maximum modulation levels to be as high with FMX as they are with conventional stereo FM transmissions. An ordinary receiver is supposed to ignore the presence of the quadrature-related extra "difference" subcarrier, while a specially built FMX receiver would use the expanded, new difference signal to recover the proper L-R components. The conventional L-R signal, though present in such receivers, would act only as a level guide, ensuring that the correct amount of expansion takes place.

Under ideal conditions, the scheme appears to be a good one, as evidenced by the fact that many stations are using it and are, in fact, experiencing increased coverage with reduced noise. Bose conceded that in his re-

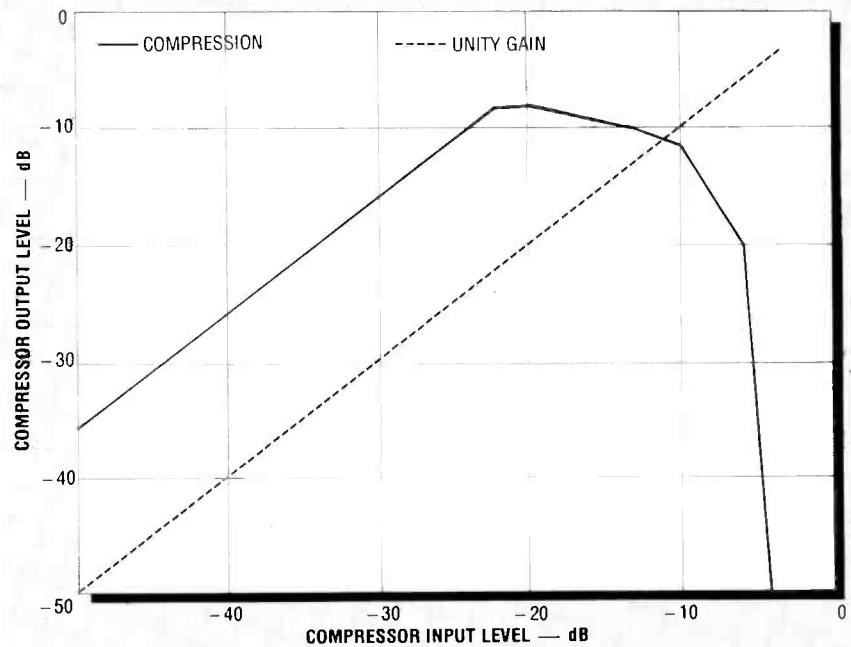

FIG. 4—AT LOW MODULATION LEVELS, the audio level is raised by about 14 dB. Compression is reduced for audio levels that are approximately 20 dB below 100% modulation.

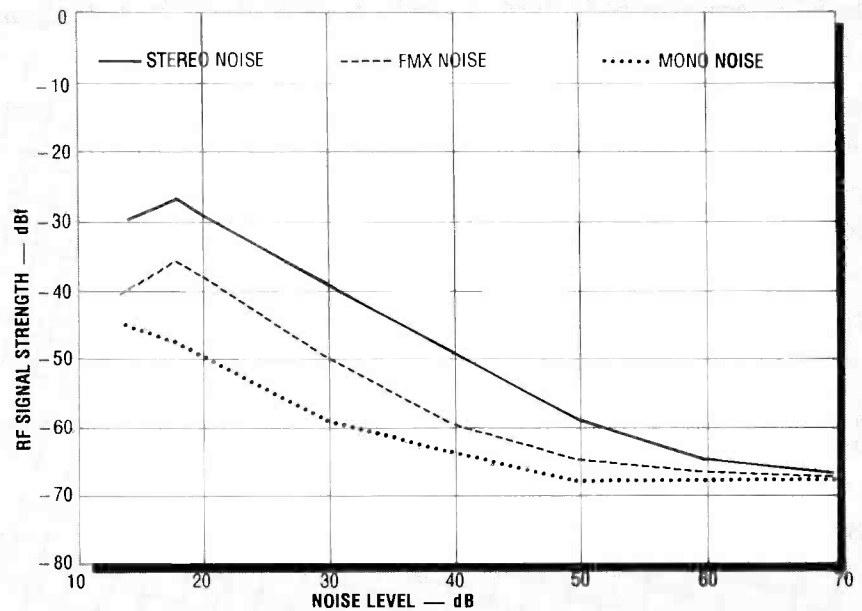

FIG. 5—AT WEAK SIGNAL LEVELS of 30 dBf, FMX stereo S/N ratios are some 12 dB better than for ordinary stereo FM.

port. In fact, the report even contains a diagram comparing the S/N ratios of mono FM, conventional FM stereo, and FMX stereo as a function of signal strength. As shown in Fig. 5, at weak signal levels of 30 dBf (a measure of relative RF signal levels and, in this case, 30 dBf is about 17.4 microvolts across a 300 ohm antenna input), FMX stereo S/N ratios are some 12 dB better than the S/N ratios

for ordinary stereo FM. Bose's contention is that in the presence of multipath, or signal reflections, the gain in S/N ratio afforded by FMX is more than offset by the increased amount of distortion, added noise, and reduced stereo separation.

A mathematical model developed by Dr. Bose and Dr. Short was used to create an audible computer simulation of how normal stereo FM suffers

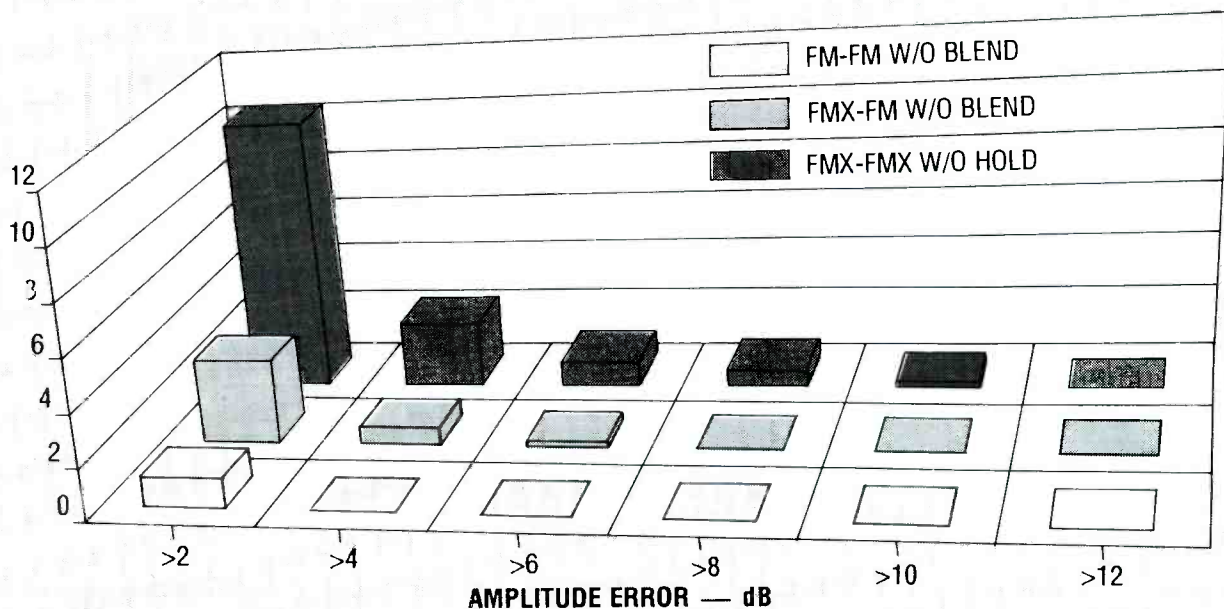

FIG. 6—GREATER AMPLITUDE ERRORS OCCURRED when FMX stereo signals were received. Results are shown from ordinary FM transmitted and ordinary FM received, FMX transmissions received on an ordinary FM set, and FMX transmitted and received on an FMX receiver. The worst degradation occurred when FMX was transmitted and received by an FMX receiver.

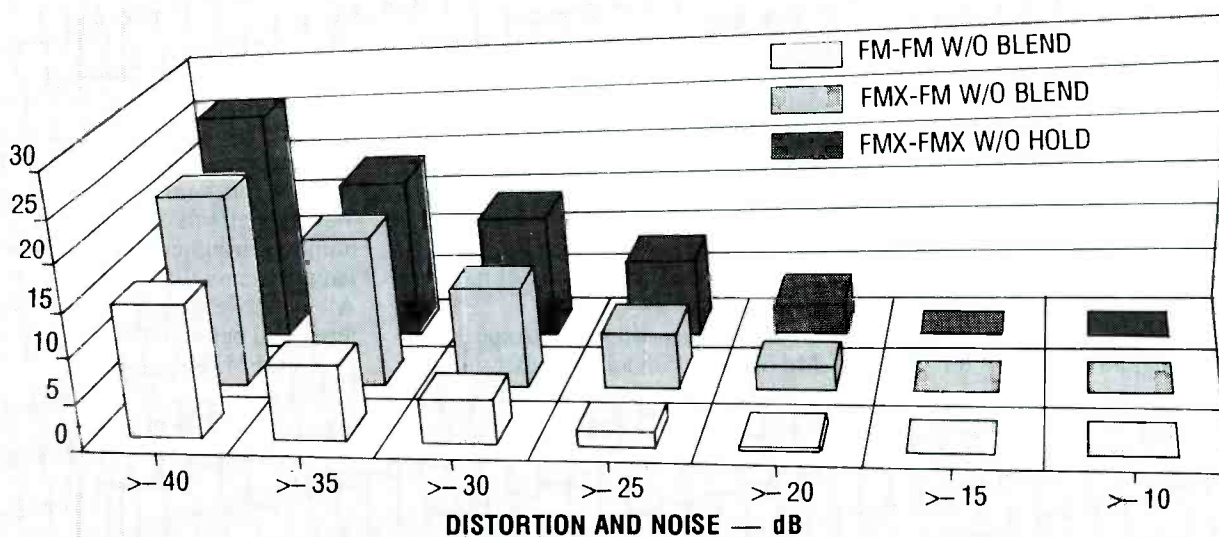

FIG. 7—DISTORTION AND NOISE LEVELS also increased when FMX signals were received.

when multipath conditions exist. The mathematical model, say its developers, reveals three factors that cause increased multipath effects: high-level modulation, the addition of modulation at higher frequencies in the composite "baseband" signal, and long distances between the direct and reflected signals.

According to Bose, since FMX injects more energy at high frequencies with its added quadrature-related sub-

carrier, that fact alone will increase multipath problems. But in addition, the effect of phase error between the 19-kHz pilot and the subcarrier is to attenuate the recovered L-R signal, thereby decreasing stereo separation. And because multipath may cause varying amounts of the conventional L-R signal to mix with the FMX L-R signal, overall volume changes and an upset of tonal balance can occur. Furthermore, since the FMX re-

ceiver uses the regular L-R signal to adjust the level of the expander circuit, any relative phase error between the pilot signal and the subcarrier that occurs in the presence of multipath will cause the expander to operate on a mixture of normal and compressed signals, introducing more audible problems.

To further substantiate their findings, Dr. Bose and Dr. Short installed a car-stereo receiver, modified to in-

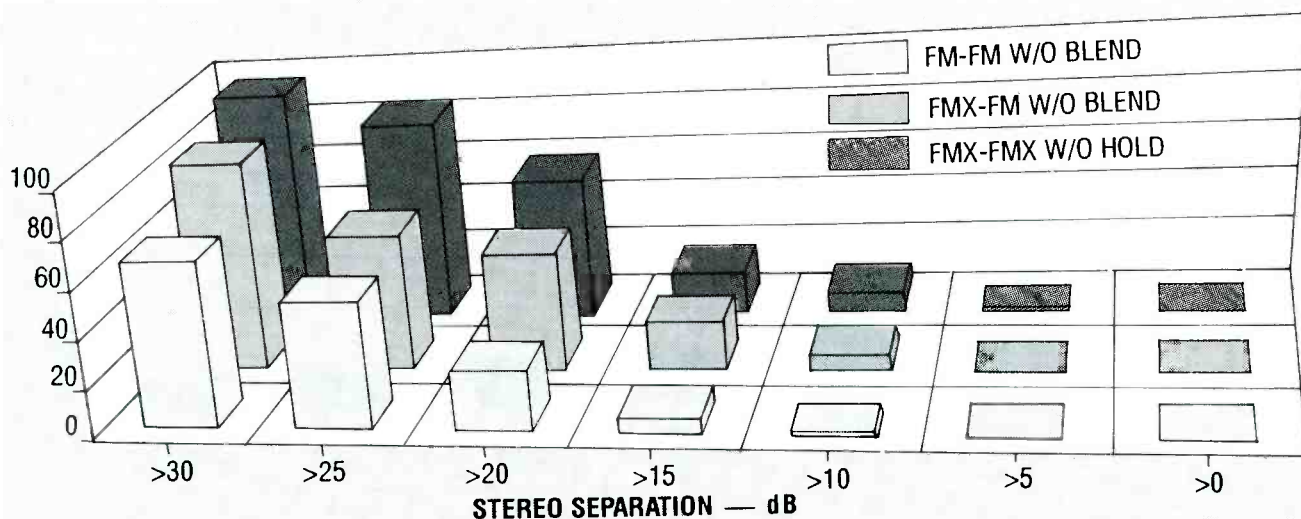

FIG. 8—STEREO SEPARATION also suffered when FMX signals were received.

clude FMX, in an automobile and drove the car over a considerable distance while recordings were made of transmissions by the local MIT FM radio station, which had installed an FMX system that could be switched in and out. The automobile radio was also capable of being switched from conventional FM to FMX. Later, by processing the resulting tape recordings, it was possible to analyze three types of reception conditions for the equivalent of 1500 separate locations or "samples" along the car's route.

Figures 6, 7 and 8 show what happened to amplitude errors, distortion, and separation, respectively, for the following three conditions: ordinary FM transmitted and ordinary FM received, FMX transmissions received on an ordinary FM set, and FMX transmitted and received on a set

modified to receive FMX. The bar graphs clearly show that greater amplitude errors, reduced separation, and higher distortion levels occurred when FMX signals were received, even on a conventional FM set. The worst degradation occurred when FMX was transmitted and received by an FMX receiver.

Mr. Emil Torick of Broadcast Technology Partners was present at the MIT session, but because much of the data presented was new to him, his response during the question and answer period following the presentation was limited. Since then, Mr. Torick and his associates have had a chance to examine the report in full and have questioned many of its findings.

Rather than attempt to speak for Mr. Torick, I understand that the edi-

tors of **Radio-Electronics** have asked Broadcast Technology Partners to respond to the Bose findings. (See box below.)

It seems clear that the debate between the Bose/MIT people and Broadcast Technology Partners concerning the relative merits or demerits of FMX can only be resolved, in time, by more experience with this new type of transmission. Do the benefits of noise reduction outweigh the disadvantages introduced when multipath is present? How often will severe multipath cause the type of signal degradation demonstrated by Bose? Will the effects be as obvious in a home environment, where the FM antenna is generally in a fixed position? All of those questions must still be answered before the final verdict concerning FMX is rendered. **R-E**

FMX: Is it bad for FM?

Broadcast Technology Partners (BTP) and Mr. Emil Torick believe that the Bose-Short presentation was misleading in many aspects, that their tests were improperly done, and that the intent of the presentation was to manipulate the press and denigrate the FMX system.

BTP claims that the tests were seriously flawed. For example, they believe that WMBR's transmission equipment (a 200-watt college station) used for the over-the-air tests was not adjusted properly. BTP offered to help align the transmitter and adjust the FMX compression levels, but their offer wasn't accepted. As a result, the tests showed clear evidence of compressor misadjustment and synchronous amplitude modulation. BTP engineers have been able to correct

similar effects in other FMX installations.

Another test using a modified car radio to test for off-the-air compatibility resulted in misleading stereo-FMX comparisons. The Bose-Short tests were done with a radio without stereo-blend and high-frequency-cut circuitry (which is common to all modern car radios). The car was then taken to a fringe-reception area for the tests—exactly the kind of area where such circuitry is normally activated.

BTP also pointed out that an experimental FMX-equipped Bose radio using an unapproved prototype version of the Sanyo LA-3440 FMX decoder IC was used in vehicle tests. BTP permitted the use of the chip for preliminary design purposes, but specifically rejected it as inadequate for vehicular use.

The Short-Bose bi-path laboratory simulation was also flawed according to BTP. The equipment used permitted the simulation of a direct signal from a transmitter and a reflection from a building or a mountain.

The equipment also allowed the mountain to be "moved" to a position that apparently created the most disruptive interference. Had the "mountain" been misplaced by a few inches, there would have been no audible differences between FMX and stereo transmission. Also, BTP engineers have calculated that the chances of encountering the effects simulated by Short and Bose are 1 in 6.7 million. Besides, as any listener knows, when a multipath condition occurs in a stationary or slow-moving vehicle, it is corrected after moving only a few inches. **R-E**

BUILD THIS

REMOTE CONTROL

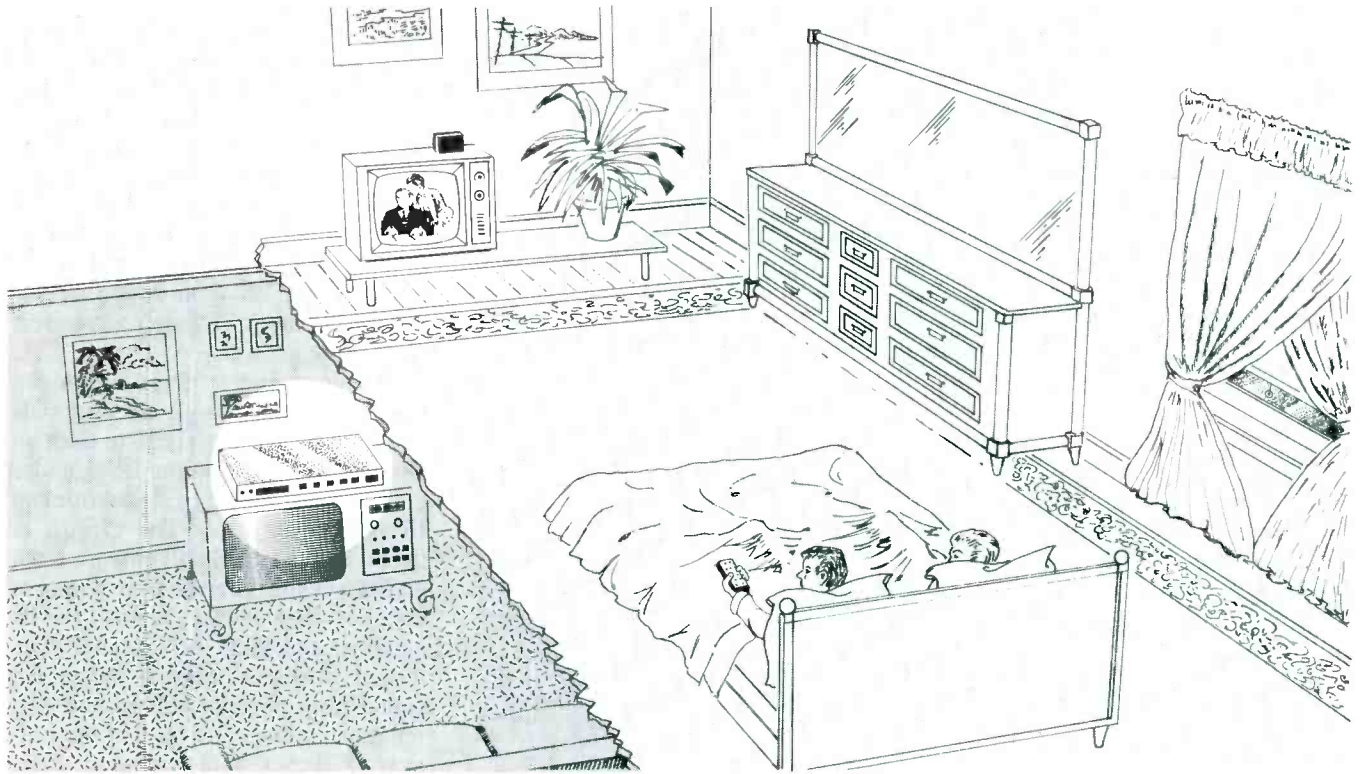

EXTENDER

Control your VCR and watch video tapes from any room in your home with our VCR extender!

ROBERT A. HEIL

WHILE THE NUMBER OF FAMILIES THAT have two VCR's in their home is steadily increasing, owning two VCR's is still considered an expensive luxury for most. But now you can get the benefits of having two VCR's for a fraction of the cost with our VCR extender. Our easy-to-build device will let you watch your VCR from *any* room in your home and still maintain full remote-control capabilities. And the extender is not limited only to VCR's—it will relay *any* IR-transmitted signal. So even if you have an old manually controlled TV in your bedroom, you'll be able to use all the remote-control features of the VCR in your living room!

The extender mounts next to your TV set and can be operated via your

IR remote control from a distance of 20–30 feet depending on ambient light conditions. The unit uses inexpensive, easy-to-get parts, and does not require RFI or IR shielding. Also, several extenders can be connected in parallel, so that you can extend your VCR to as many locations as you like.

Using the extender unit, remote-control signals can be sent to the VCR via the existing coaxial cable (if you have cable television), as shown in Fig. 1, or by using ordinary two-conductor speaker wire or zip cord. The latter will eliminate the need for the two additional filters that are required for the coaxial-cable system but, of course, will require two lines—one for the out-going IR signals, and a second for the returning video or RF.

Circuitry

Refer to the schematic in Fig. 2 for the description of the basic circuit. A signal from an IR remote control enters phototransistor Q1, where it is converted from IR radiation to a frequency pulse and then passed to decoupling-capacitor C1. Resistor R1 keeps Q1 from saturating too quickly from visible light. Because the IR signals from a remote control are not that strong, Q1 is kept constantly conducting, via IR-LED2, which was added to increase the range during extreme low-light conditions. IR-LED2 is positioned directly behind Q1 and aimed at the base, where it emits a small amount of IR radiation, ensuring that Q1 will continue to conduct without IR or visible light.

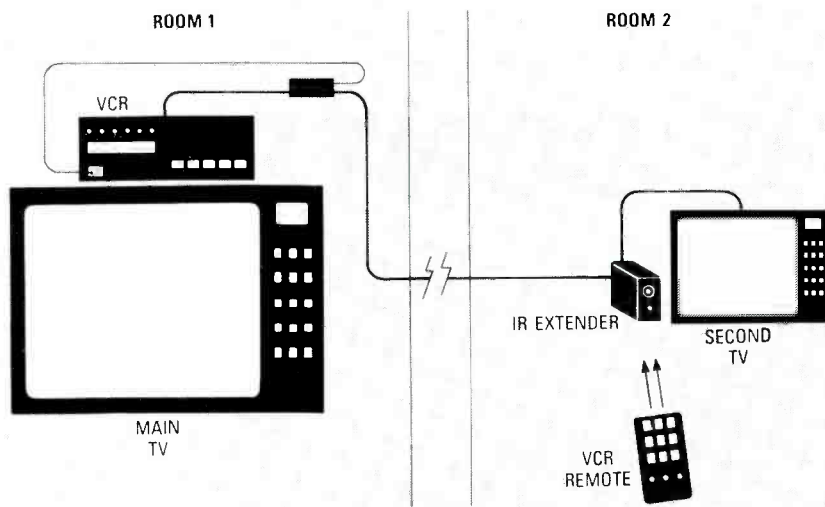

FIG. 1—YOU CAN CONTROL YOUR VCR from any TV set with an extender unit. Signals can be sent to the VCR via the existing coaxial cable or by using ordinary two-conductor speaker wire or zip cord.

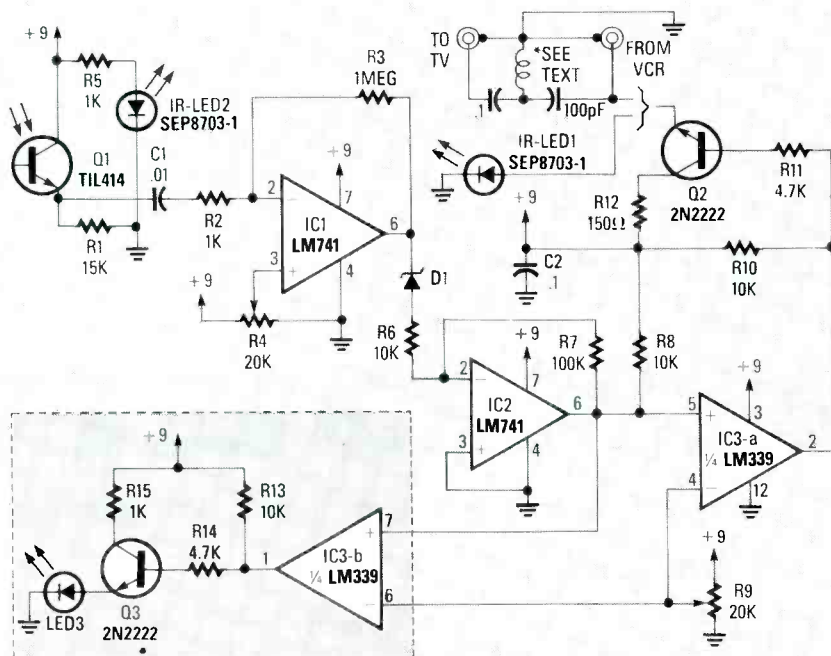

FIG. 2—A SIGNAL FROM AN IR REMOTE CONTROL is converted from IR radiation to a frequency pulse that can be transmitted through coaxial TV cable or any other two-conductor wire to another room, where it's converted back into an IR signal.

The signal from C1 is amplified by a factor of 1000 by IC1, with gain set by R2 and R3. It is then passed to D1, a 5.1-volt Zener diode, which is used as a voltage shifter. The anode stays low until the input voltage at pin 2 of IC1 rises higher than the reference voltage at pin 3, which is set by R4. When that happens, the output of IC1 goes high and avalanches D1, producing a voltage rise at the anode along with the signal. The signal is then passed to IC2 where it is amplified by a factor of 10. Pin 3 of IC2 is tied to

ground. That allows any signal higher than ground to be amplified and sent to pin 5 of IC3 via pull-up resistor R8. IC3 is a comparator, in which the output goes high when the reference voltage at pin 4 (set via R9) is exceeded by the smallest amount.

IC1 and IC2 are independent 741 op-amps. Separate op-amps were used because IC1 is referenced at pin 3 while IC2 is tied to the ground rail at pin 3. Dual or quad op-amps share a common bias network and power-supply leads—that produces noise at the

reference point, so very small signals could not be detected. But by using two independent op-amps, the noise level is reduced and the circuit sensitivity is increased.

The output of IC3 (pin 2) is pulled up by R10 and sent through R11 to the base of Q2, which then passes the signal to IR-LED1 at the VCR by one of two methods. The first method passes the signal directly to IR-LED1 via a suitable length of two-conductor speaker wire or zip cord. The second method passes the signal, via a high-pass filter, right onto the existing coaxial TV cable, to IR-LED1 at the other end. R12 sets the maximum current through IR-LED1, which retransmits the IR signal to the receiving unit's (the VCR, stereo receiver, etc.) IR window.

The components enclosed in the dashed lines in Fig. 2 are optional. That circuit causes an LED to flash on and off rapidly when the IR-extender circuit is activated by a signal from an IR remote control. The circuit is useful in that LED3 will only flash if a signal is being received from a remote control—that way you know if the IR signal is reaching the extender. The circuit works as follows: When the signal from pin 6 of IC2 exceeds the reference voltage set by R9, the output of IC3 causes Q3 to conduct, driving LED3. That can be either a red or green non-IR LED, and R15 sets its current (brightness level).

Construction

A foil pattern is provided in PC Service, and is available separately. (See Parts List.) If you wish to hard-wire the circuit, place the external components as close together as possible to keep stray capacitance to a minimum.

The Parts-Placement diagram is shown in Fig. 3. Be sure that pin 1 on all three IC's faces Q1, and mount Q1 with enough lead length (approximately 3/4-inch) so that it will be able to protrude through a hole in the project box. The flat side of Q1 (the collector) is connected to +9-volts DC. Mount IR-LED2 so that it can be positioned directly behind Q1 (that way it can emit a small amount of IR into the base of Q1 during low-light conditions), as shown in Fig. 4. The flat sides (the cathode) of D1, D2, and D3 are attached to ground.

If you are going to use the existing coaxial cable in your home to transmit

PARTS LIST

All resistors ¼-watt, 5%.

- R1—15,000 ohms
- R2, R5, R15—1000 ohms
- R3—1 megohm
- R4, R9—20,000 ohms, 20-turn potentiometer
- R6, R8, R10, R13—10,000 ohms
- R7—100,000 ohms
- R11, R14—4700 ohms
- R12—150 ohms

Capacitors

- C1—0.01 μ F, disc capacitor
- C2—0.1 μ F, disc capacitor

Semiconductors

- IR-LED1, IR-LED2—SEP 8703-1, infra-red light-emitting diode
- LED3—light-emitting diode, red or green

- Q1—TIL 414 phototransistor
- Q2, Q3—2N2222, NPN transistor
- D1—5.1-volt Zener diode
- IC1, IC2—LM741 op amp
- IC3—LM339 comparator

Other components

- T1—120-volts AC/9-volts DC, wall transformer

Miscellaneous: 4-40 hardware, standoffs, tape, speaker wire, etc.

Note: The following two filters are needed only for transmitting through coaxial TV cable (see text).

Parts for the first filter

- 1 0.1- μ F disc capacitor, 1 100-pF disc capacitor, 1 inductor (see text), 1 chassis-mount F connector, 1 cable-mount F connector, a piece of coaxial TV cable, cardboard, 2 washers, copper tape or aluminum foil.

Parts for the second filter

- 1 0.1 μ F disc capacitor, 1 100-pF disc capacitor, 1 inductor (see text), 2 chassis-mount F connectors.

Note: An etched and drilled PC board is available postpaid for \$7.50 in U.S. funds from Fen-Tek, P.O. Box 5012, Babylon, NY 11707-0012. NY residents must add sales tax.

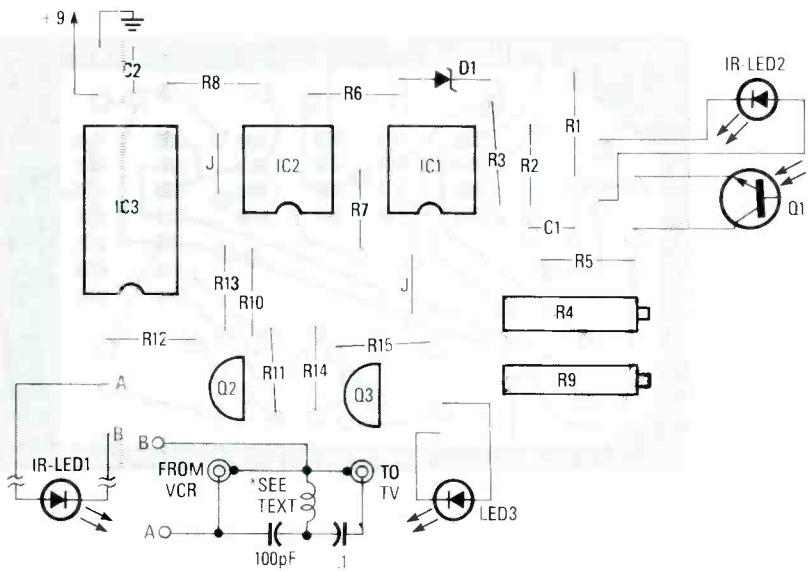

FIG. 3—PARTS-PLACEMENT DIAGRAM. Mount Q1 so that it can protrude through the project box. Either IR-LED1 or the filter circuit attaches to pads A and B.

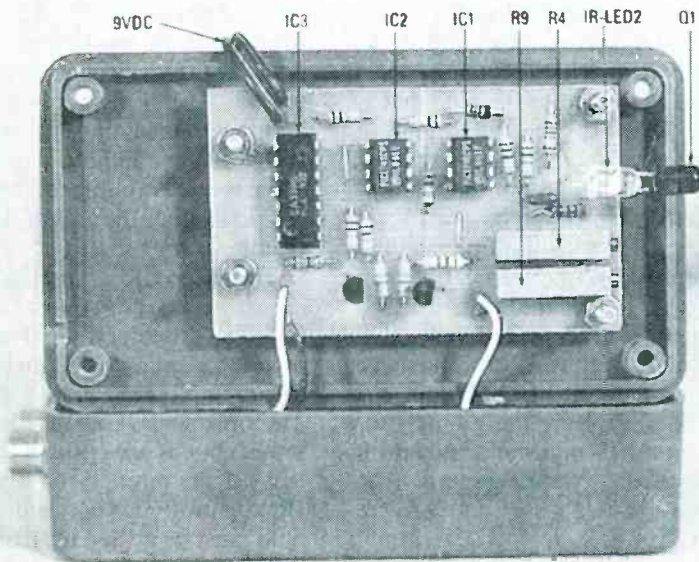

FIG. 4—MOUNT IR-LED2 so that it can be positioned directly behind Q1 as shown. That way it can emit a small amount of IR into the base of Q1 during low-light conditions.

the signals, then two filters are required to decouple the DC voltage and to attenuate the transmitted signal. That keeps the TV tuner or VCR from receiving any harmful DC voltages. The only consequence of doing it that way is that there is an interchanging between the control signal and the video signal that takes place in the coaxial cable when the extender is activated; that results in a small amount of interference that is visible on the TV screen when a command is being sent.

Both filters must be installed be-

tween the last output stage and the tuner of your second TV, as shown in Fig. 5. (If you have an amplifier to boost your VCR output, then the amplifier becomes the last output stage.)

The first filter, located after the last output stage, can be constructed in two ways: The first way—and also the easiest—is to purchase a Radio Shack high-pass filter (PN 15-579). Remove the rubber gromet and slide back the case, as shown in Fig. 6. Take a 4- to 5-foot length of small-gauge two-conductor speaker wire or zip cord, and scrape away enough potting material

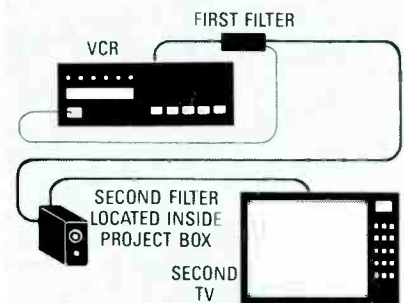

FIG. 5—TWO FILTERS are required if you want to use your current coaxial cable.

at the filter's F connector to attach one wire to the center pin and the other to the ground side (see Fig. 6). Run the

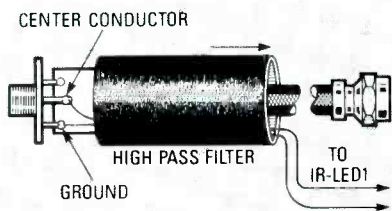

FIG. 6—A RADIO SHACK HIGH-PASS FILTER (PN 15-579) can be used for the first filter if you don't want to make your own.

wire through the case and then slide the case back over the filter. Use RTV silicone to reseal the area where you removed the grommet. Attach IR-LED1 to the other end of the wire. Remember that the wire that you attached to the center pin of the F connector is positive for IR-LED1.

For those true do-it-yourselfers, the other way is shown in Fig. 7. Because solder will not easily adhere to metal plating, file or sand away a small amount of the metal plating on the F connector and washer before soldering. When the filter is finished, wrap a piece of cardboard around it and tape in place. (The cardboard found on a blister pack works well.) The filter should then be wrapped with copper tape or aluminum foil for RF shielding. Make sure that a small piece of copper tape or aluminum foil is in contact with the washers at both ends of the filter to effectively complete the ground shield. You can also build the filter in a small metal case.

The inductors can be obtained in an inductor assortment from Radio Shack (PN 273-1601), or by making your own. If you purchase the induc-

tor assortment, the 1/2-inch enameled wire-wound inductors have a value of 10 μ H. Combined with a 100-pF capacitor, the filter should have a cutoff frequency of about 5 MHz.

If you wind your own inductor, use 22-gauge enameled copper wire, and wind 6 1/2 turns on an 8-32 screw. Remove the screw and coat the outside of the windings with non-conductive RTV silicone. That will keep the windings from deforming during assembly. Scrape and tin both ends of the inductor. The value of the inductor should be approximately 100–200 nH. (It is much more difficult to make a 10- μ H coil by hand, and because a 100- to 200-nH coil will do the job, that's what we'll make.) When that is combined with a 100-pF capacitor, the cutoff frequency should be about 35–50 MHz. The formula used for calculating the cutoff frequency is:

$$F = 1/2\pi\sqrt{LC}$$

The second filter is located inside the extender box as shown in Fig. 8. Be sure to attach the output wires from the PC board to the side that is coming from the other filter and not the one to the TV set. Label the two F connectors as in and out to make installation easier. If you have a TV set that uses a 75- to 300-ohm matching transformer, then the second filter can be omitted. In that case, just solder a bus wire from the center pins of both F connectors, and attach the positive output lead for IR-LED1 to that bus wire. Then bus-wire the grounds together on the F connectors and attach them to the PC board's ground.

If you decide to use the two-wire system, you can install a terminal

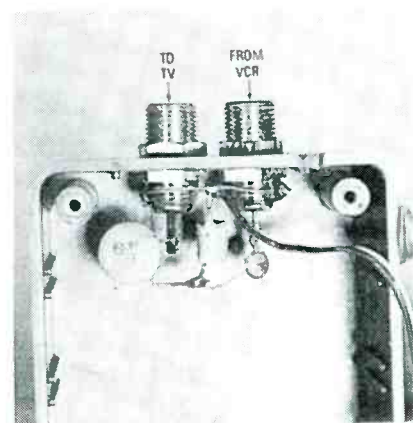

FIG. 8—THE SECOND FILTER, if required, is installed inside the project box across the two F connectors.

block inside the project case, or you can solder the wire directly to the PC board. Just make sure that the grounded lead gets soldered to the cathode of IR-LED1.

The easiest way to mount IR-LED1 on an appliance is to position it so that it covers 1/4 of the IR receiving window on the device that you wish to control. Use a piece of clear tape to secure it to the unit. That way you can still use your remote control in the same room as your receiving unit. Be sure to insulate the legs of IR-LED1 so that they don't short out.

The PC board is installed inside a small plastic project box, and mounted on 1/4-inch stand-offs. If you do not have stand-offs, then 3 nuts on top of each other can be used instead. The hole for Q1 in the front of the project box is not critical. Just be sure that Q1 fits through the opening and slightly protrudes outward. A smaller hole must be drilled for LED3, if you decide to use it.

Calibration

Apply power and make sure that nothing gets too hot. If anything does, then recheck your connections. Then, connect a voltmeter across IR-LED1. Adjust R9 until the output drops to approximately 0.004 volts. Then attach the voltmeter to pin 3 of IC1. Adjust R4 for 4.55 ± 0.05 volts. Remove the test lead and reconnect it across IR-LED1. Again, adjust R9 until the output goes high, and then back off slowly until it drops to approximately 0.004 volts. If you used the optional LED circuit, then there is no need to connect a voltmeter across IR-LED1, because LED3 will light when the output of IR-LED1 is high, and it goes out when it's low. **R-E**

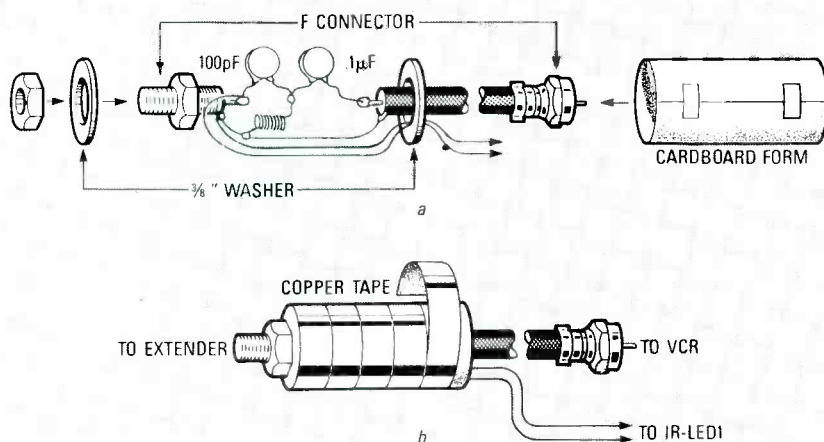
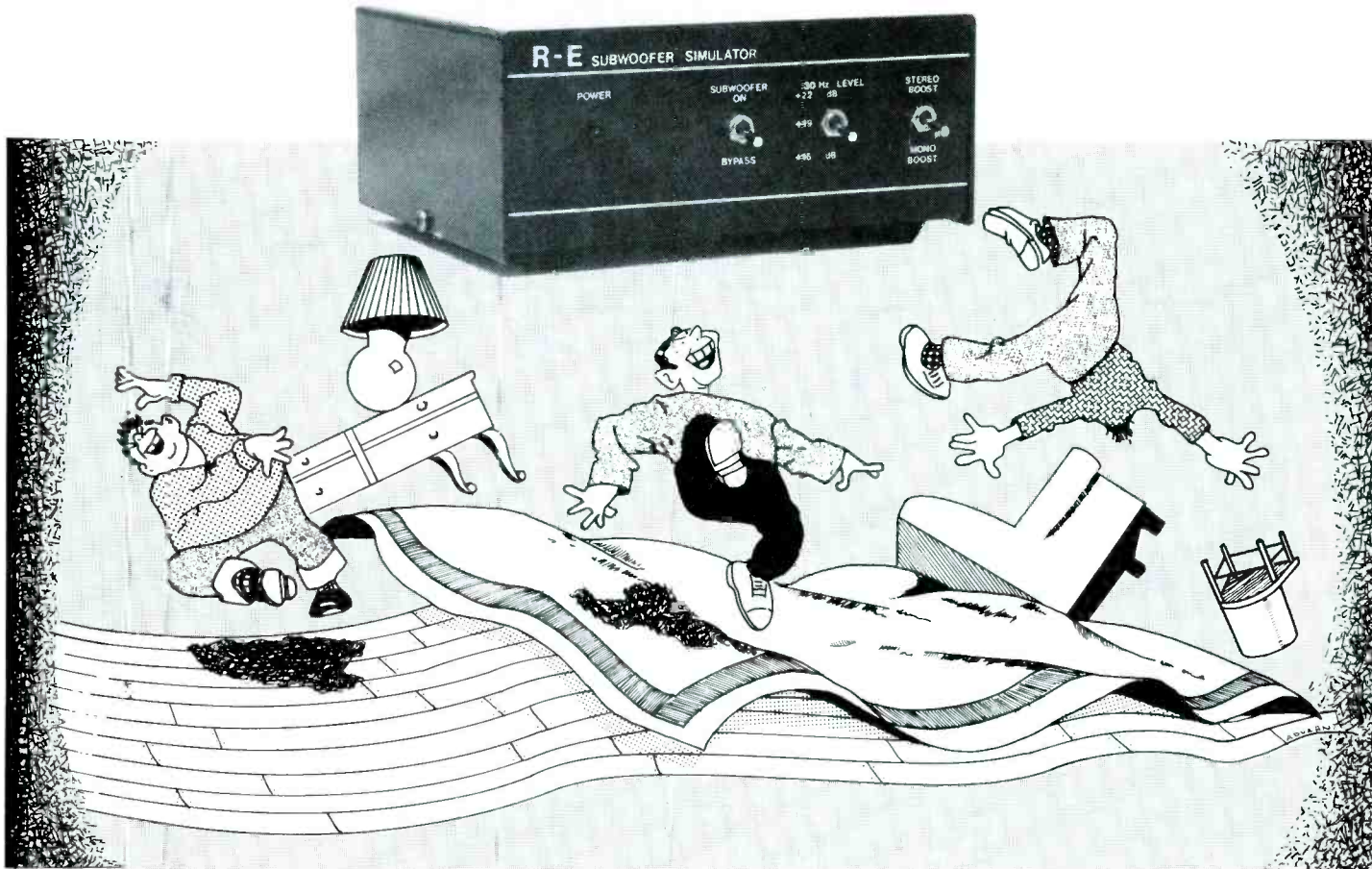

FIG. 7—YOU CAN MAKE YOUR OWN FILTER by first building the assembly shown in (a), and then wrapping it with copper tape or aluminum foil (b).

BUILD THIS

SUBWOOFER SIMULATOR

NORM HILL



Build a subwoofer simulator and fill your living room with movie-theater sound you can actually feel.

A MOVIE THEATER CREATES REALISM BY projecting a large picture, using surround sound, and by extending the sound's low-frequency response with subwoofers so that the viewer can actually feel the special-effects. When a movie contains explosions, jet rumble, thunder, galloping horses, or other heavy-duty action, the subwoofer adds realism by literally shaking the floor.

Although it is generally accepted that a healthy ear can hear a frequency range of 20 Hz to 20 kHz, in fact, some of that range is not so much heard, but sensed. For example, many people cannot hear frequencies higher than 15 kHz, although they can sense that they exist. It's the same

thing for frequencies in the deep-bass range of 20–50 Hz; many persons cannot hear frequencies within that range, although they can feel and sense them as vibrations.

In a theater, special effects are often exploited by enhancing the deep-bass frequencies, so that when the jets rumble, they rumble so powerfully that you can actually feel the runway vibrating under your feet. (And a flat frequency response ceases to be desirable once your feet become the listening transducers.) Below 20 Hz, sound is neither felt nor heard; at best there is a strange sensation of changing air pressure.

But although most people can perceive sounds in the 20–50 Hz range,

because conventional woofers, even 12-inch and larger, roll off below 50 Hz, deep bass sounds are rarely heard unless some kind of deep-bass compensation is provided. The usual solution to providing deep bass in both theaters and the home is to add a monaural subwoofer that is driven off the front channels by an active filter and a separate amplifier.

Not that perfect

Unfortunately, there are some drawbacks to using a monaural subwoofer. It is commonly assumed that deep-bass information has such a long wavelength that it will be summed by the room to a mono signal, and that therefore a single transducer can be

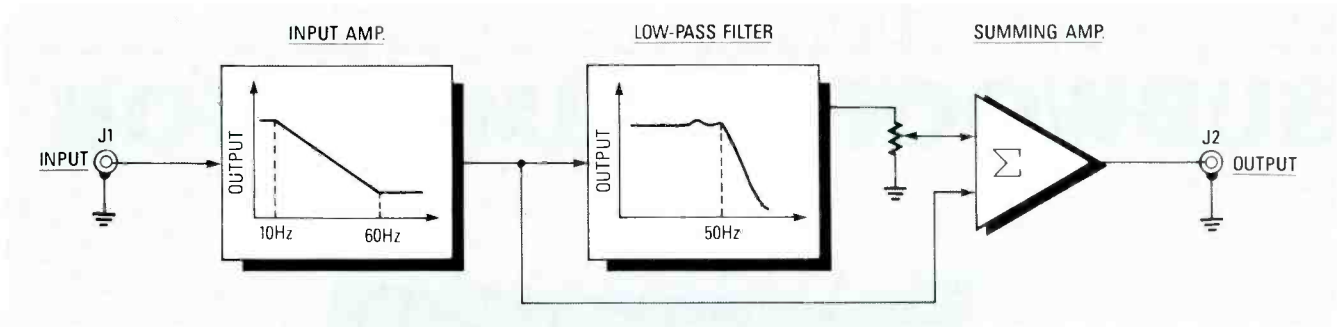

FIG. 1—TO ENSURE THAT ONLY THE DEEP-BASS FREQUENCIES are enhanced, the simulator's first stage amplifies the frequencies below 60 Hz before the low-pass filter attenuates all signals above 50 Hz.

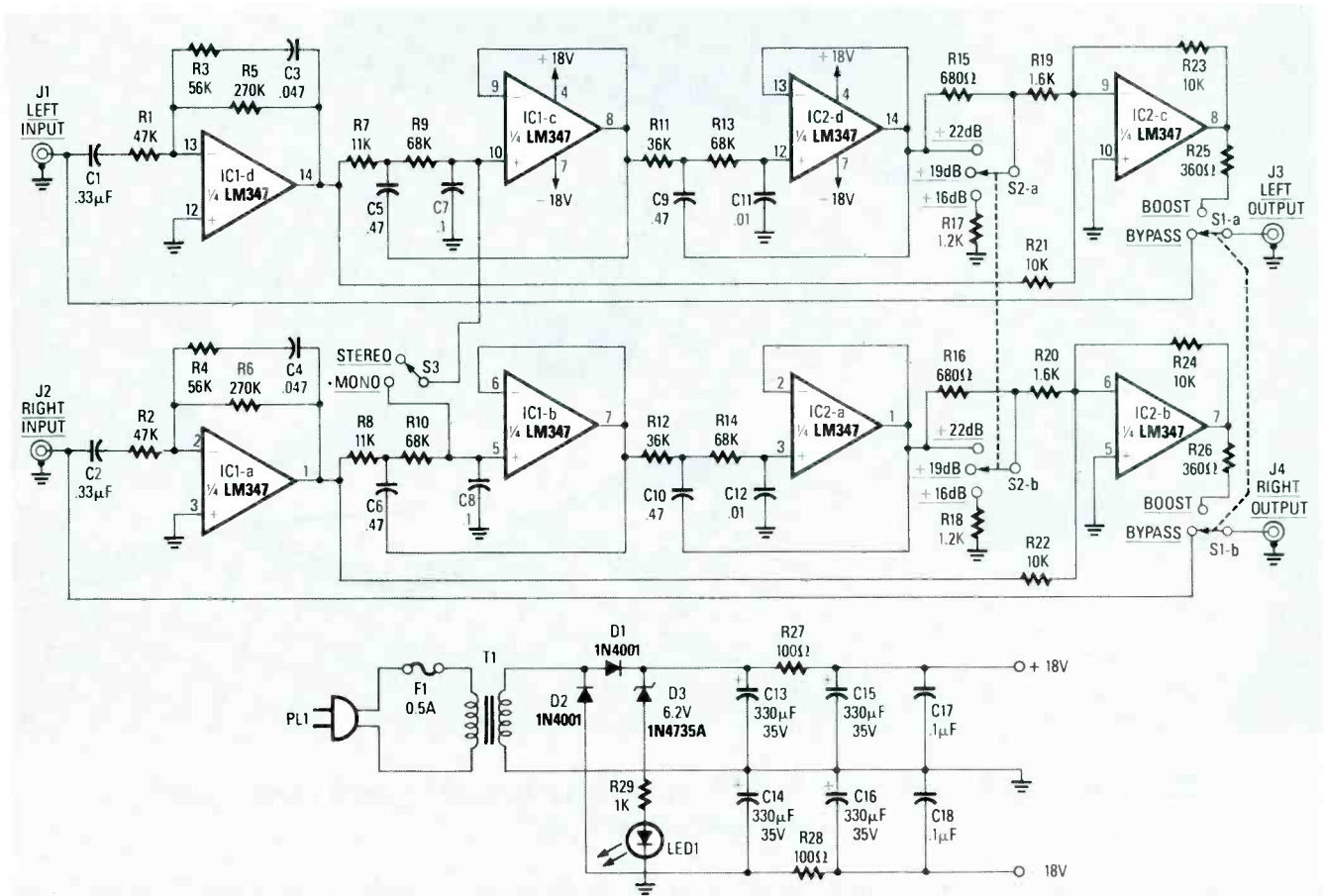

FIG. 2—THE LEFT AND RIGHT CHANNELS ARE IDENTICAL. Switch S3 blends the two channels when only mono deep-bass sounds are wanted. Switch S2 provides three levels of deep-bass amplification.

used. A simple comparison of mono and stereo bass-boosting calls that into question. Jet rumble, such as in the movie *Top Gun*, takes on a flatter, quieter, less spacious sound when boosted monaurally instead of stereophonically. A quick check of the low-frequency information (measured using a dual-trace scope and active 50-Hz stereo filters) shows that the two channels have little in common during jet rumble or numerous other situations. Only in music are the two channels similar.

Another concern is the type of filter used to feed the subwoofer. All filters have substantial phase shift at the roll-off frequencies. It can easily turn out that the high-band and low-band speaker cones will end up out of phase during the transition region, causing a loss of response over, say 60–90 Hz, which will produce a peculiar bass quality. It is likely that many subwoofer systems suffer that problem, especially those using simple passive crossovers for which 180° is a common roll-off phase angle.

Price is another objection to a mono-subwoofer system that includes a filter and separate amplifier: You'll have to spend a lot before your floor starts to shake, rattle, and roll.

A cheaper way

A less expensive way to simulate the "feelie" effect of the movie theater's deep-bass system is to simply boost the bass signal delivered to your existing front speakers. (Most home-stereo systems are overbuilt, at least when listening to a video movie at the

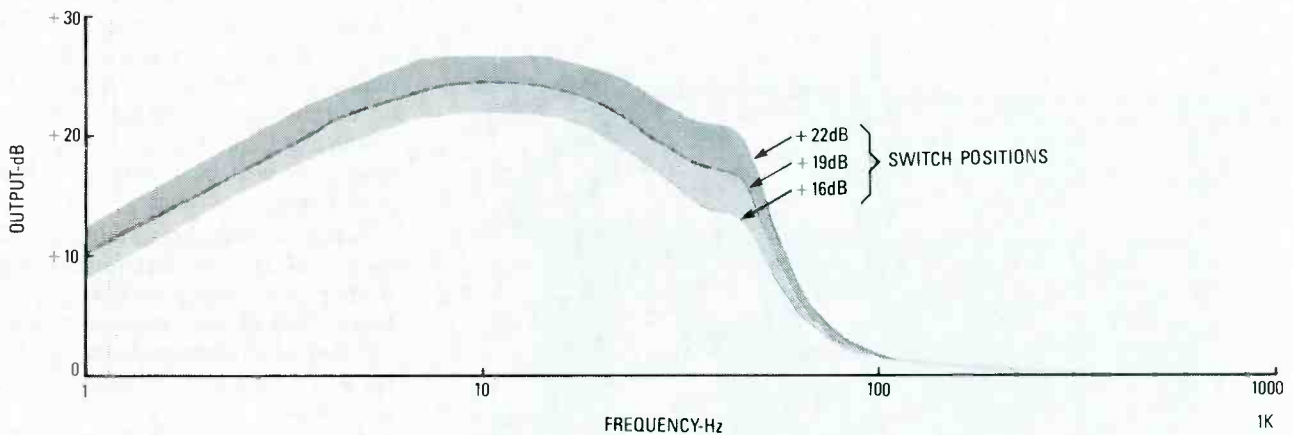

FIG. 3—MAXIMUM DEEP-BASS BOOST IS ATTAINED AT approximately 12 Hz. Note that the curves shown are unattainable with conventional tone controls.

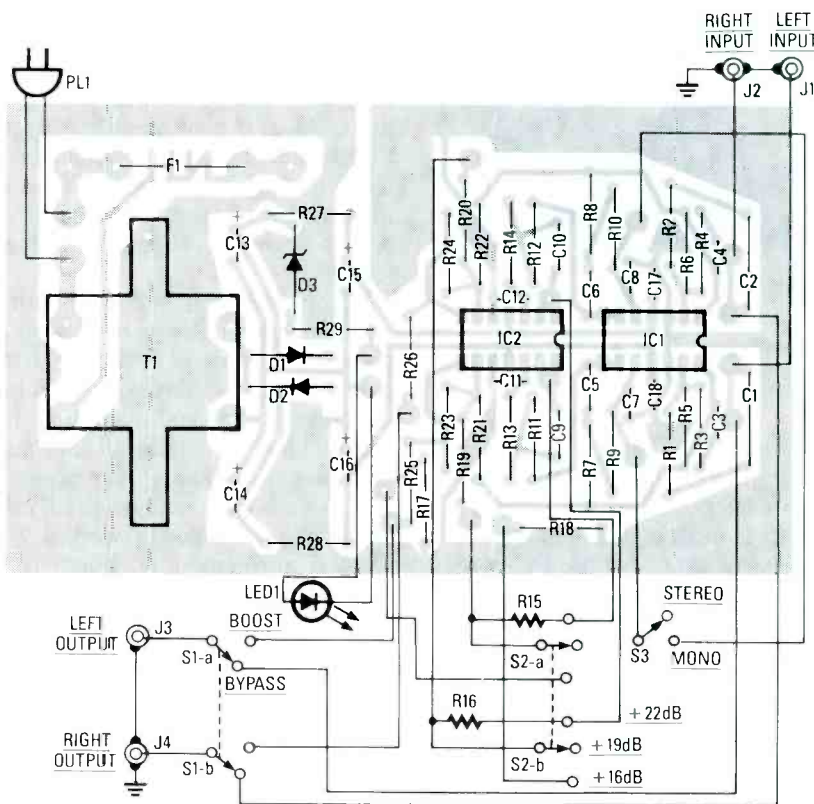

FIG. 4—THIS IS THE PARTS LAYOUT for the printed-circuit board. Take note that resistors R15 and R16 are mounted on switch S2, not on the board.

usual living-room volume level.) Although home-speaker systems having a 10- or 12-inch woofer may be rolling off between 20-50-Hz, that doesn't mean that they can't radiate energy in that range. We merely need to provide compensation so that they get more power in the deep-bass frequency range. An analogy is hitting the loudness switch or turning up the bass, except that the boost must be more selective to create the illusion of a subwoofer's sound & feel.

Figure 1 shows the block diagram of a subwoofer simulator that can be used for either the left or right channel. The first stage is a buffer-amplifier that provides gain below 60 Hz to compensate for the fact that most speakers roll off in that range. The buffer is followed by an active low-pass filter that removes everything except the deep-bass frequencies. The output from the filter is summed with its input so that the total bandwidth is at a substantially higher level than it

PARTS LIST

All resistors are ¼-watt, 5%.

- R1, R2—47,000 ohms
- R3, R4—56,000 ohms
- R5, R6—270,000 ohms
- R7, R8—11,000 ohms
- R9, R10, R13, R14—68,000 ohms
- R11, R12—36,000 ohms
- R15, R16—680 ohms
- R17, R18—1200 ohms
- R19, R20—1600 ohms
- R21-R24—10,000 ohms
- R26, R26—360 ohms
- R27, R28—100 ohms
- R29—1000 ohms

Capacitors

- C1, C2—0.33 μ F, 100 volts
- C3, C4—0.047 μ F, 50 volts
- C5, C6, C9, C10—0.47 μ F, 50 volts
- C7, C8, C17, C18—0.1 μ F, 50 volts
- C11, C12—0.01 μ F, 50 volts
- C13-C16—330 μ F, 35 volts, electrolytic

Semiconductors

- IC1, IC2—LF347N, Quad JFET op-amp
- D1, D2—1N4001 rectifier diode
- D3—1N4735A, Zener diode, 6.2 volts,

LED1—Light-emitting diode

Other components

- F1—½-amp slo-blo fuse
- J1-J4—Phono jack
- S1—Switch, DPDT
- S2—Switch, DPDT, center off
- S3—Switch, SPST
- T1—Power transformer, 117 volt primary; 12.6-volt, 300-mA secondary.

Miscellaneous: PC-board materials, fuse clips, wire, linecord, solder, enclosure, etc.

An etched and drilled PC board is available for \$10.25 postpaid from Fen-Tek, P.O. Box 5012, Babylon, NY 11702-0012. NY residents must add appropriate sales tax.

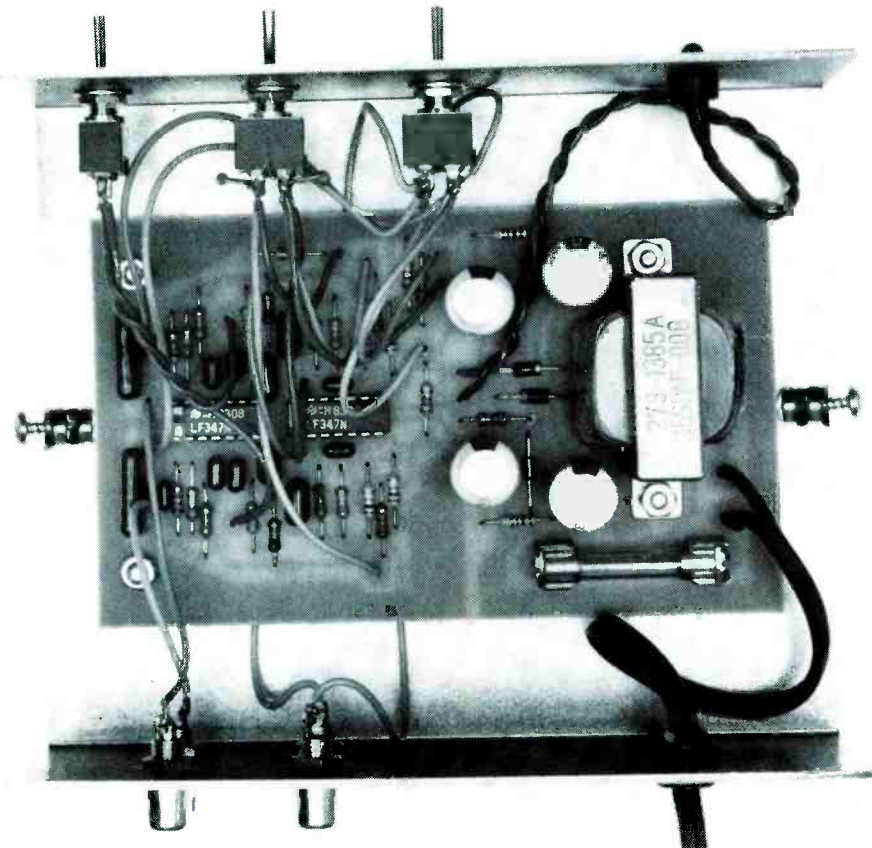

FIG. 5—TO AVOID NOISE PICKUP the simulator should be enclosed in a metal cabinet. Cabinets that are partially metal and partially plastic aren't suitable.

would be if only the deep-bass frequencies were filtered.

Figure 2 shows how the block diagram becomes the schematic for our stereo-subwoofer simulator.

How it works

Both channels are identical. Buffer amplifier IC1-a has unity gain above 60 Hz, and a rising gain characteristic below 60 Hz to compensate for the speaker's deficiency in the deep-bass range. Active low-pass filters, IC1-b and IC2-a, pass the frequency components below 50 Hz. Amplifier IC2-b sums the input and output signals of the filters. Switch S2-a provides three levels of bass summation—a fancy way of saying “bass boost.” The subwoofer simulator's frequency-response curves for the three switch positions are shown in Fig. 3.

Construction

The project should use printed-circuit assembly to avoid introducing noise. A foil template for the PC board is provided in PC Service. You'll find that the template has holes

to accommodate either a pigtail-lead fuse (F1), or individual fuse clips (which take two holes per clip) Use whatever is most convenient for you.

The parts layout for the PC-board and the connections for the panel-mounted components are shown in Fig. 4. For simplicity, an on/off power switch was not included so that the unit would be switched on and off by the master power switch for the entire system. If you want separate power control for the subwoofer simulator, simply install a SPST switch in series with one leg of the power cord.

Although the circuit will accept conventional part tolerances for the resistors and capacitors, for best results we suggest you use 5% capacitors for the active-filter components. As shown in Fig. 5, the prototype is mounted in a metal enclosure; do not use a cabinet that is part metal and part plastic.

Hookup

If your sound system has a separate pre-amp and power-amp, the subwoofer simulator connects imme-

diately before your front power amplifier—after any surround-sound decoder. If you have a receiver, your only option is to connect the simulator before the receiver's AUX input, or within the tape-monitor loop—which isn't quite ideal because the simulator will be receiving a line-level 1-volt rms signal

Since the bass boost can exceed a factor of 10, the subwoofer simulator may occasionally output more than 10-volts rms, so to avoid blowing out your speakers, be careful when first trying the subwoofer simulator.

Increase the amplifier's gain slowly. Back off the amplifier's output power if you hear distortion. The author developed the circuit using a 200-watt-per-channel amplifier and speakers rated for 250 watts. If your system is more modestly powered, you may not want to use S2's higher boost positions. Also, if your amplifier is rated for less than 60 watts per channel, or if your woofers are smaller than 10-inches, you may not attain sufficient deep-bass output to create the sense of feeling.

Clipping within the simulator is possible, although we have seen no problems because of the device's relatively high DC supply voltage. A bigger concern is an audio amplifier that wasn't built to handle an unusually large deep-bass signal. For example, one time we absent-mindedly installed the simulator between a VCR and a *Trinitron* monitor, which has an audio switching function. It took quite a while to figure out that the sound's distortion was caused by the *Trinitron* monitor's inability to handle more than a few volts of input. Moving the simulator so that it was installed after the monitor, between the TV and preamplifier, completely resolved the problem.

The payoff

Once your system is wired for surround sound you'll discover that some movies have effects that you can literally feel, while others don't. There is a wide variation in the quality of the effects, usually from one studio to the next, not from one movie to the next. Some outfits put in plenty of enjoyable, surround-sound and “feelie” effects, while others put in few sound effects. Unfortunately, the only way to find which is which is through trial and error.

R-E

LIGHT BEAM COMMUNICATOR

Now, using our top-secret device, you and your partner can communicate across a void at the speed of light—on a beam of light!

ROGER SONNTAG

IF YOU'RE LOOKING FOR A purely *fun* project, then this light beam communciator is for you. It not only contains the usual electronics, it also has an ingenious mechanical assembly whose operation is interesting in its own right. You're sure to find it a refreshing change from the usual board-in-a-box project. But don't think that this light-beam communicator is just for fun. The powerful transmitter and extremely sensitive receiver take this project out of the realm of toys—you can do some pretty serious work with our device!

A complete Light-Beam Communicator (LBC) consists of a transmitter and a receiver, installed inside 2 tube-like assemblies, along with various optical components. Two complete LBC's are required for two-way communication, but you will need only one transmitter and one receiver for one-way communication. Full-duplex operation is provided, meaning that you can talk and

listen at the same time—there is no transmit/receive switch.

Figure 1 shows the block diagram of the transmitter. The transmitter houses a high-intensity LED, powered from a constant-current source, a self-contained circuitry necessary to modulate an audio signal from a microphone onto the LED's light output. Using the optics, the modulated light from the LED is focused into an intense, narrow beam.

That narrow light beam travels a surprisingly long distance. The standard unit has about a ¼-mile range. The high-power unit has an amazing range of better than ½-mile! (When testing the range of the units, we used small "toy" 100-mW walkie talkies to assist with setup and aiming—the walkie talkies "ran out of gas" long before the LBC did!) At the end of its travel, the beam is received by another identical LBC that turns the modulated

light beam back into the original audio signal. The receiver's block diagram is shown in Fig. 2. For more information on the individual components, see the sections more closely.

The difference between the standard LBC and the high-power LBC is the LED that is used. The standard unit has a high-intensity 3-candela-power (3,000 milli-candela or mcd) LED manufactured by Hewlett Packard (a *candela*, formerly *candle*, is a measure of luminous intensity). The high-power unit has a very-high-intensity 12-candela (12,000 mcd) LED, also manufactured by Hewlett Packard. Both of those LED's are much brighter than a normal LED, and they have a focusing rather than a diffusing lens. However, *any* LED will work but the useful-range of the LBC will be greatly reduced if a high intensity LED is not used.



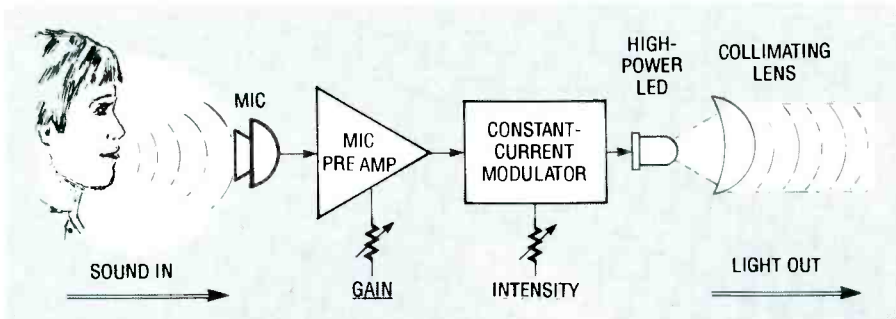

FIG. 1—BLOCK DIAGRAM OF THE TRANSMITTER. This circuit contains a high-intensity LED, powered from a constant-current source, and the circuitry necessary to modulate an audio signal onto the LED's light output.

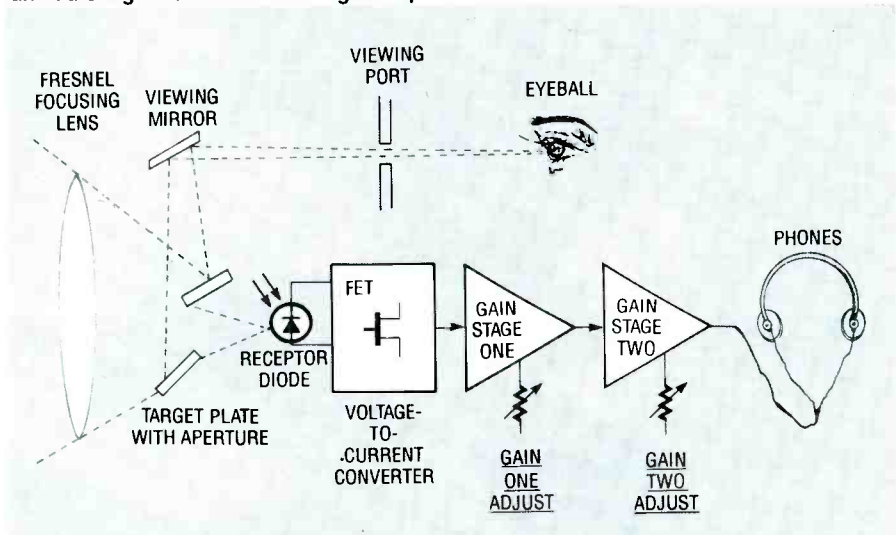

FIG. 2—RECEIVER BLOCK DIAGRAM. This circuit turns the modulated light beam back into the original audio signal.

The transmitter

There are two stages in the transmitter: a microphone preamplifier and a constant-current modulator (see Fig. 3). Each stage uses half of a 5532, which is an internally compensated, dual low-noise op-amp. After the microphone output is pre-amplified by IC1-a, the output signal from pin 1 is fed through C6 to pin 5 of IC1 where it is further amplified.

An adjustable constant-current source is fed to Q1, an NPN transistor capable of handling at least 3 amps. The audio signal at pin 7 of IC1 drives the base of Q1, modulating the signal onto the LED's light output. (An infrared LED can be used for this project, and will, in fact, increase the range. Unfortunately IR light is invisible, so it is not easy to work with. However, among the interesting things you can "hear" with the LBC are IR remote controls and IR burglar-alarm sensors.) Basically, the AC signal either adds or subtracts from the average DC level. Transistor Q1 and LED1 are in the feedback loop of the op-amp, and the DC current flowing

through the LED remains constant due to the setting of R9. The DC current can be adjusted via R9 through a range from 1 to 50 mA.

The transmitter assembly, shown in Fig. 4, is fitted inside one end of a

rugged cardboard tube that has a collimating lens at the other end. That lens focuses the light beam into a very narrow, intense beam, giving the light from an LED such an unusually long range.

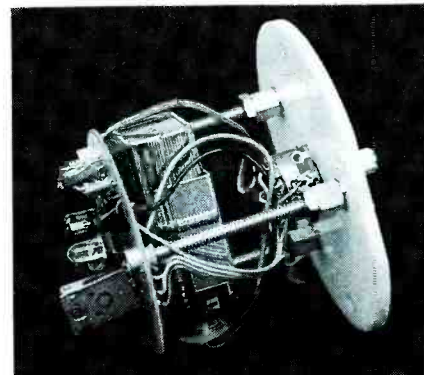

FIG. 4—THE TRANSMITTER ASSEMBLY. It is fitted inside one end of a rugged cardboard tube that has a collimating lens at the other end.

The receiver

The schematic for the receiver section of the LBC is shown in Fig. 5, and the receiver assembly is shown in Fig. 6. The receiver assembly is mounted inside one end of a large tube, which has a fresnel lens at the other end. The fresnel lens concentrates the light beam, and directs it to the photodiode, D1. The photodiode provided in the kit is actually a Kodak part, and not available to the general public. That part is well suited for this application, and it is more sensitive to infrared light than most photodiodes; but if you don't buy the kit, any silicon photodiode or phototransistor

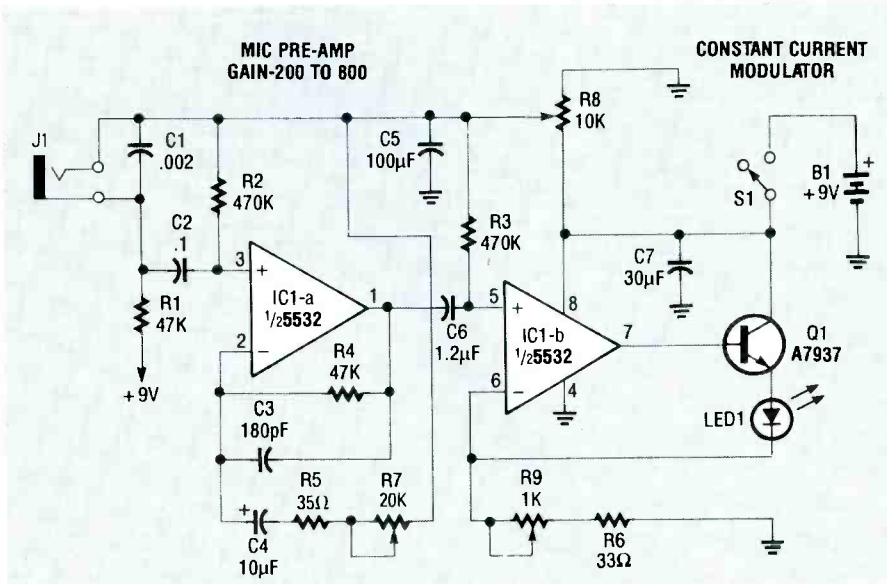

FIG. 3—THE TRANSMITTER CONTAINS TWO STAGES: a microphone preamplifier and a constant-current modulator. Each stage uses half of a 5532 op-amp.

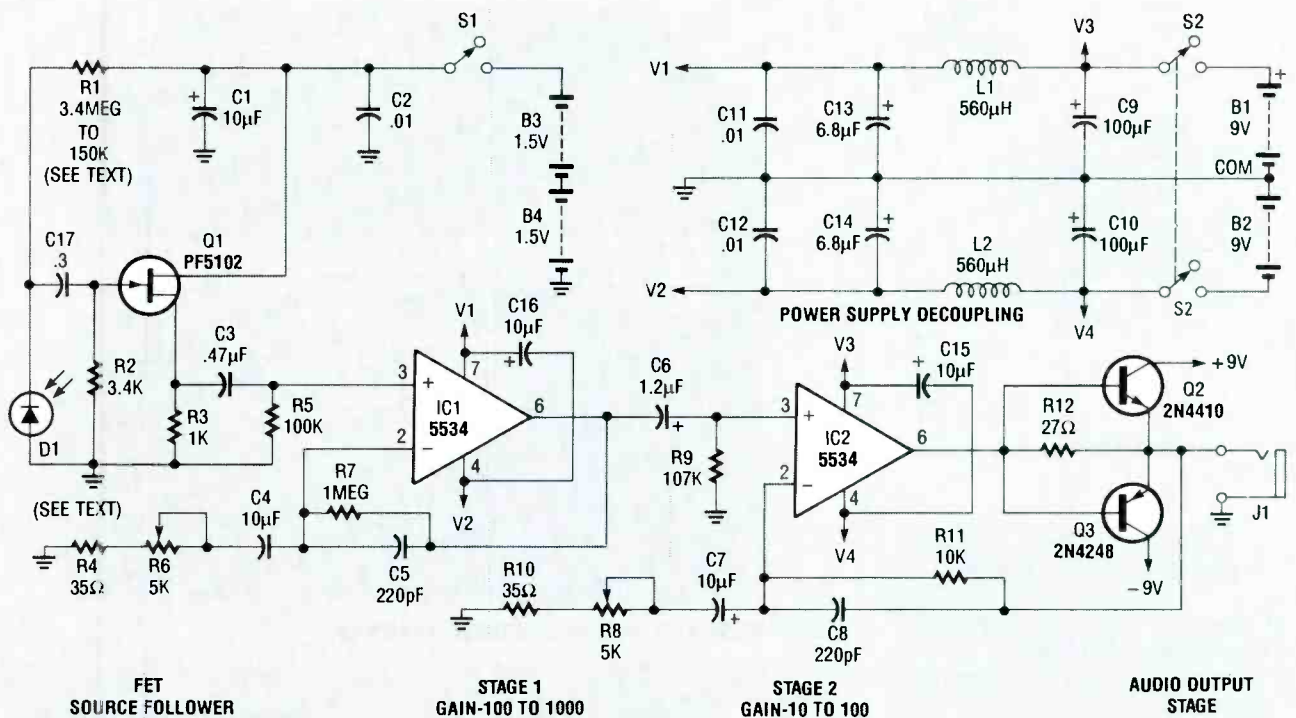

FIG. 5—THE RECEIVER SCHEMATIC.

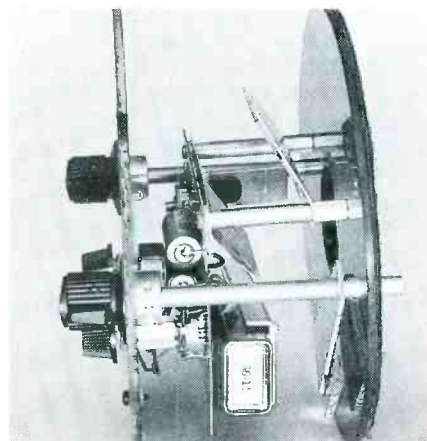

FIG. 6—THE RECEIVER ASSEMBLY. It is mounted inside one end of a large tube, which has a fresnel lens at the other end.

should do. The small signal that is generated by D1 is fed to pin 3 of IC1 via FET Q1.

Op-amp IC1 is the first gain stage in the receiver, and it amplifies the signal from Q1 100 to 1000 times, depending on the setting of gain-control potentiometer R6. The signal from pin 6 of IC1 is then fed through C6 to pin 3 of IC2, which is the second gain stage; the gain of the second stage is variable from approximately 10 to 100 via gain-control potentiometer R8. Two gain-control potentiometers are used to help improve stability, because stray oscillation is hard to avoid in a circuit with so much gain.

The signal at pin 6 of IC2 is then fed to R12, which is connected across the base-emitter junction of both Q2 and Q3. The voltage across R12 turns Q2 and Q3 on and off; those transistors are capable of driving a pair of low-impedance headphones.

Note that R1 is listed as being 3.4 megohms or 150 kilohms. That's because, if you use a value near 3.4 megohms, the receiver will be extremely sensitive, resulting in the greatest possible range. On the other hand, a value near 150K will decrease the sensitivity while providing a wide bandwidth, giving the unit higher fidelity. You can use any value between 3.4 megohms and 150 kilohms, but do not use a potentiometer, as it will be a source of noise in the circuit.

Construction

Let's start by building the transmitter board. Foil patterns for both boards are provided in PC Service. Figure 7 is the Parts-Placement diagram for the transmitter. First install the resistors, then the capacitors (bend the leads, solder, and then trim), and then the potentiometers. Cut some ribbon cable into 6 2-conductor pieces (3 for now and 3 for later), 1/2-inches long, and then separate and strip the ends. (Any thin, stranded wire will do if you don't have ribbon cable.) Then use one piece to

PARTS LIST—TRANSMITTER

All resistors are 1/4-watt, 5%, unless otherwise noted.

- R1, R4—47,000 ohms
- R2, R3—470,000 ohms
- R5—35 ohms
- R6—33 ohms
- R7—20,000 ohms, PC-mount potentiometer
- R8—10,000 ohms, PC-mount potentiometer
- R9—1000 ohms, combination potentiometer/switch (incorporates S1)

Capacitors

- C1—0.002 µF, 50 volts, ceramic
- C2—0.1 µF, 50 volts, ceramic
- C3—180 pF, 100 volts, ceramic
- C4—10 µF, 10 volts, electrolytic
- C5—100 µF, 10-25 volts, electrolytic
- C6—1.2 µF, 20 volts, electrolytic
- C7—30 µF, 20 volts, electrolytic

Semiconductors

- IC1—NE5532 dual low-noise op-amp
- Q1—7937 3-amp NPN transistor
- LED1—high-intensity light-emitting diode, can be Hewlett Packard HLMP-8103 (3000 mcd) or HLMP-8150 (12,000 mcd), or any other high-intensity LED.

Other components

- B1—9-volt battery
- S1—SPST switch (part of R9)
- J1—mono phone jack
- Miscellaneous: 9-volt-battery clip, 8-pin DIP socket, wire, solder, etc.

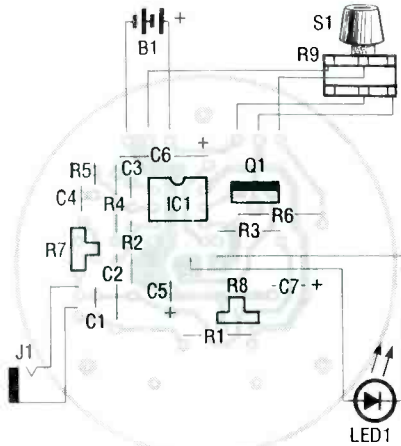

FIG. 7—TRANSMITTER parts-placement diagram.

PARTS LIST—RECEIVER

All resistors are 1/4-watt, 5%, unless otherwise noted.

- R1—between 3.4 megohms and 150 kilohms (see text)
- R2—3.4 ohms
- R3—1000 ohms
- R4—35 ohms
- R5—100,000 ohms
- R6, R8—5000 ohms, potentiometer
- R7—1 megohm
- R9—107,000 ohms
- R10—35 ohms
- R11—10,000 ohms
- R12—27 ohms

Capacitors

- C1—10 μ F, 50 volts electrolytic
- C2, C11, C12—0.01 μ F, 10 volts, ceramic
- C3—0.47 μ F, 20 volts, ceramic
- C4, C7—10 μ F, 10 volts, electrolytic
- C5, C8—220 pF, 100 volts, ceramic
- C6—1.2 μ F, 20 volts, electrolytic
- C9, C10—100 μ F, 15 volts, electrolytic
- C13, C14—6.8 μ F, 20 volts, electrolytic
- C15, C16—10 μ F, 25 volts, electrolytic
- C17—0.3 μ F, 50 volts, ceramic

Semiconductors

- IC1, IC2—NE5534 single low-noise op-amp
- D1—Siemens BPW-33 silicon photodiode (see text)
- Q1—PF5102 field-effect transistor
- Q2—2N4410 NPN transistor
- Q3—2N4248 PNP transistor

Other components

- L1, L2—560 μ H
- S1—SPST switch
- S2—DPDT switch
- B1, B2—9-volt battery
- B3, B4—1.5-volt N-size battery

Miscellaneous: 2 9-volt-battery clips, DIP sockets, wire, solder, etc.

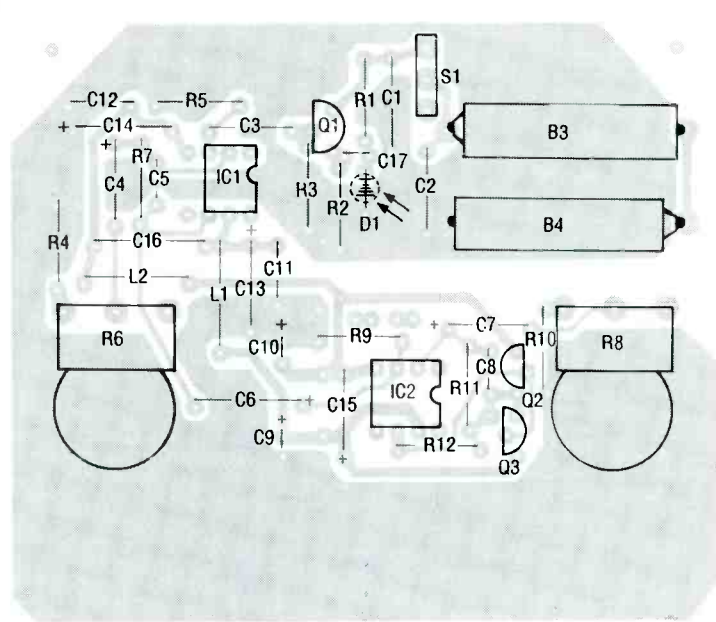

FIG. 8—RECEIVER PARTS-PLACEMENT DIAGRAM.

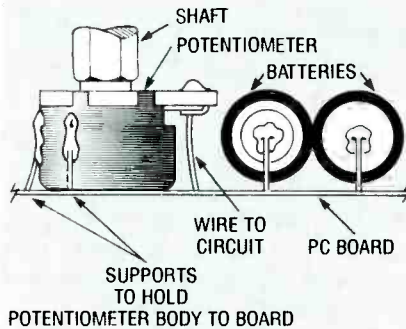

FIG. 9—YOU MUST USE PIECES of bus wire to attach potentiometers R4 and R6 securely to the PC board.

connect the microphone jack, J1, to the pads indicated in Fig. 7, and two more to connect R8/S1.

Connect a 9-volt battery clip to the appropriate pads on the board, and then install IC1. (It's a good idea to use a socket for IC1.) Last, position LED1 (observe its polarity) so that it is standing perfectly straight off the PC board, then solder it in place.

For the assembly of the receiver board, see Fig. 8. First install resistors R1-R12, and then install the capacitors observing polarity where indicated. Then install L1 and L2, and sockets for IC1 and IC2. Using pieces of bus wire, attach potentiometers R4 and R6 securely to the PC board as shown in Fig. 9. Prepare B3 and B4 by soldering a short length of bus wire to each terminal (see Fig. 9) so that each battery can be PC mounted. PC-mount S2 and solder it in place. Now turn the board over, and solder D1 (the

ORDERING INFORMATION

The following are available from General Science and Engineering, P.O. Box 447, Rochester, NY 14603 (716-338-7001): Kit of all parts, including all electronic and mechanical components, \$98; Set of two PC boards, \$12.00; 6-inch Fresnel lens, \$15.00; A headset with built-in microphone, \$12.00; Telephone-type handset, \$5.00; Siemens BPW-33 photodiode, \$3.50; HLMP-8150 12-cd LED price to be determined (call GSE for information); Assembled and tested communicator, \$240. Note: the spotting scope is not available from GSE.

photodiode) in place observing its polarity indicated by a painted dot on its anode.

Take two 9-volt-battery clips and, on one of them, clip the red lead down to 1 inch and the black one to 2 1/2 inches; on the other battery clip, cut the black lead down to 1 inch and the red to 2 1/2 inches. Solder the leads to the PC board as shown. Using three more pairs of leads (as was shown in Fig. 8), connect J1, the headphone jack, and S2.

The transmitter, as you may recall, consists of a high-intensity LED whose light output is modulated by an audio signal. Connect a microphone to the jack on the transmitter, and turn the transmitter on. Turn up the gain control, and speak into or tap the mi-

crophone. You should be able to see the light flicker somewhat. An even better test is to connect an oscilloscope across the LED, and observe the signal there. It should "follow" your voice as you speak into the microphone. If you're not getting a signal at the LED, start at the input to the first op-amp (IC1-a from Fig. 3 in the July issue), and trace until you can find where you lose the signal.

The receiver can be quickly tested by connecting a pair of headphones to the output jack, and powering up the circuit. If you hear some hissing, the circuit is probably functioning correctly. Reduce the receiver gain and position the two completed boards about a foot or so apart, so that the light from the transmitter's LED strikes the receiver's photodiode. You should be able to transmit an audio signal to the receiver. Without the

proper optics, the quality will be poor, but it will serve to verify that the system is operating.

Assembly

Let's start our mechanical assembly with the transmitter. As shown in Fig. 1, take the completed PC board (1) and install the three rivet-like threaded inserts (2). That is normally done by first inserting the narrow end of an insert through each of the three holes on the edge of the PC board. (The narrow end should now be protruding on the solder side of the board.) By resting the wide end of the insert on a *solid* surface, the narrow end is spread apart, by giving it a whack with a tapered punch. Otherwise, you can use some *Krazy Glue* or RTV silicone to secure them to the board.

Next, take two 3/8-inch-long screws

(3), insert them in the proper holes, and secure them with a nut (4). Then place the battery holder (5) over the ends of those screws as shown in Fig. 1, and secure the battery holder with two 3/8-inch long threaded spacers (6). (The battery is held down by tightening those spacers with the battery in place. Just be sure that the battery has some foam-rubber tape or other insulating material on the side to be pressed against the PC board. That will prevent any of the component leads from being short-circuited.)

The next thing to prepare is the plastic end piece (7). The end piece is held in place by three long adjusting screws (8). Just make sure that the heads of the adjusting screws are on the side of the end piece that has two countersunk holes, and be sure to use the washers (9) where needed. (The countersunk holes are for the two

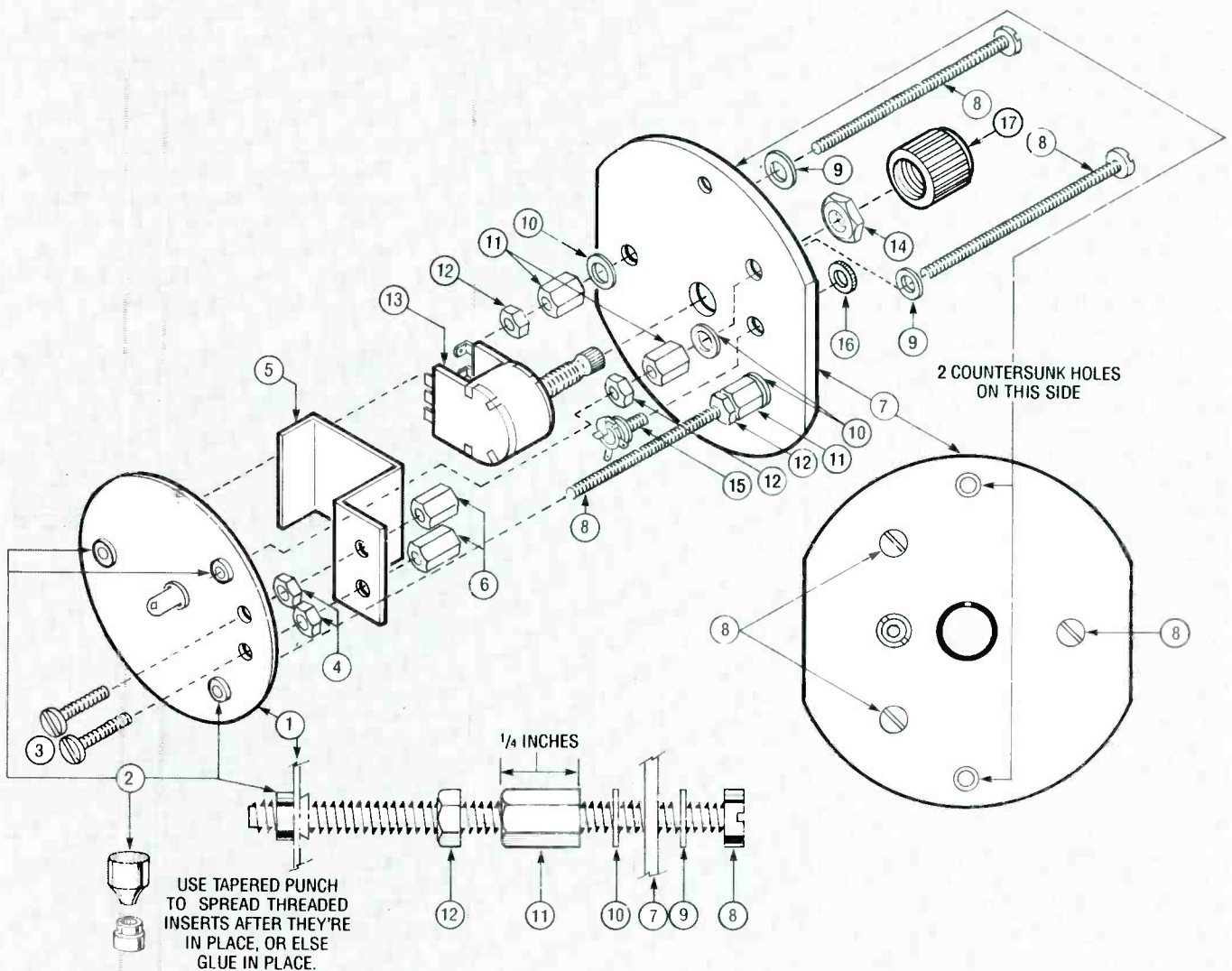

FIG. 1—THE TRANSMITTER is assembled as shown. Look over the assembly instructions carefully before starting the project.

PARTS LIST FOR THE TRANSMITTER (FIG. 1)

Part #	Quantity	Description
1	1	PC BOARD
2	3	THREADED INSERTS
3	2	SCREWS, 1/40 x 3/8"
4	2	NUTS, 1/40
5	1	BATTERY HOLDER
6	2	THREADED SPACER, 1/40 x 1/4"
7	1	PLASTIC END PIECE
8	3	SCREWS, 5/32 x 2 1/8"
9, 10	6	WASHERS, 5/32
11	3	THREADED SPACER, 5/32 x 1/4"
12	3	NUT, 5/32
13, 14	1, 1	POTENTIOMETER & MOUNTING NUT
15, 16	1, 1	MICROPHONE JACK & MOUNTING NUT
17	1	POTENTIOMETER KNOB

screws that hold the entire assembly to the cardboard tube, but we'll worry about that later.) Place another washer (10) over each screw so that the end piece has a washer on both sides of each adjusting screw. Now screw a 1/4-inch long threaded spacer (11) onto each adjusting screw and tighten to the point of snugness—the screws should be able to rotate without wobbling. Put a nut (12) over each screw and tighten each one against the threaded spacers to permanently set the screw's tightness.

The potentiometer (13—the one that should be wired to the PC board) has a shaft with a nut (14) on it. First remove the nut; then you must break off the potentiometer's anti-rotation tab, or else it won't properly connect to the plastic end piece. Put the shaft through the center hole in the end piece, and then replace the nut. Install the microphone jack (15—it, too, should be wired to the PC board) in the proper hole in the end piece (7), and secure it with its screw-on collar (16) in the same manner as you secured the potentiometer shaft. For now, line up the three adjusting screws with the three PC-board inserts (2), and screw each one in a few turns, just to hold the assembly together. Also push on the potentiometer knob (17). Place the transmitter assembly aside for now, as we get started on the receiver.

The receiver

For the receiver assembly, use Fig. 2 as a guide. The PC board (1) should already have the headphone jack, the on/off switch, and the potentiometers attached. Put a 1/2-inch long Phillips-head screw (2) in both of the PC-board's holes. Put a 1/4-inch spacer (3) over each screw, put the viewing

ORDERING INFORMATION

The following are available from General Science and Engineering, P.O. Box 447, Rochester, NY 14603 (716-338-7001): Kit of all parts, including all electronic and mechanical components, \$98; Set of two PC boards, \$12.00; 6-inch Fresnel lens, \$15.00; A headset with built-in microphone, \$12.00; Telephone-type handset, \$5.00; Siemens BPW-33 photodiode, \$3.50; HLMP-8150 12-cd LED price to be determined (call GSE for information); Assembled and tested communicator, \$240. Note: The spotting scope is not available from GSE.

bracket (4) in place, and a 1/4-inch long threaded spacer (5) onto the end of each screw.

The headphone jack and the on/off switch (parts (6) and (7) respectively) have threaded collars. Remove their collar nuts and push the jack and the switch through their appropriate mounting holes in the plastic end panel (8). Replace the collar nuts. Now take the two 1/2-inch long spacers (9) with the large holes in them, and fit them over the threaded shafts of the two potentiometers. Fit the threaded ends of those shafts through the holes in the plastic end panel (8), and tighten a nut (10) on each one.

If you purchase the kit, you'll find that the pivoting-mirror bracket (11) comes with the mirror glued to the bracket. You will, however, have to attach it to the two-piece shaft as follows: Screw the threaded stud (12) into the long end of the 3-inch shaft (13), put the mirror bracket over it with the mirror facing as shown, and tighten a 3/4-inch threaded spacer (14) onto the end of the stud.

In a manner similar to the mirror bracket, you can assemble the bracket that locks the receiver assembly in place inside the tube. The locking bracket is made up of the threaded stud (15), 3-inch shaft (16), 3/4-inch threaded spacer (17), the L-shaped bracket (18) with its rubber gripper

PARTS LIST FOR THE RECEIVER (FIG. 2)

Part #	Quantity	Description
1	1	PC BOARD
2, 24	4	SCREWS, 1/40 x 5/8"
3	2	SPACER, 1/4"
4	1	VIEWING PLATE
5	2	THREADED SPACER, 1/40 x 1 1/4"
6	1	HEADPHONE JACK MOUNTING RING
7	1	ON/OFF SWITCH MOUNTING NUT
8	1	PLASTIC END PANEL, FRONT
9	2	SPACER, 1/4" HOLE, 1/2" LONG
10	2	POTENTIOMETER MOUNTING NUT
11	1	PIVOTING MIRROR BRACKET
12, 15	2	THREADED STUD, 5/32 x 7/8"
13, 16	2	THREADED SPACER, 5/32 x 3"
14, 17	2	THREADED SPACER, 5/32 x 3/4"
18	1	L-BRACKET
19	1	RUBBER GRIPPER
20	2	LOCK WASHERS, 5/32
21	1	MIRROR BRACKET
22	2	SPACER, 3/8"
23	1	PLASTIC END PANEL, REAR
25	1	BATTERY HOLDER
26	1	SCREW, 1/40 x 1"
27	1	NUT, 1/40
28	1	THREADED SPACER, 1/40 x 1/4"
29	1	THREADED SPACER, 5/32 x 2 7/8"
30	2	SCREWS, 5/32 x 1/2"

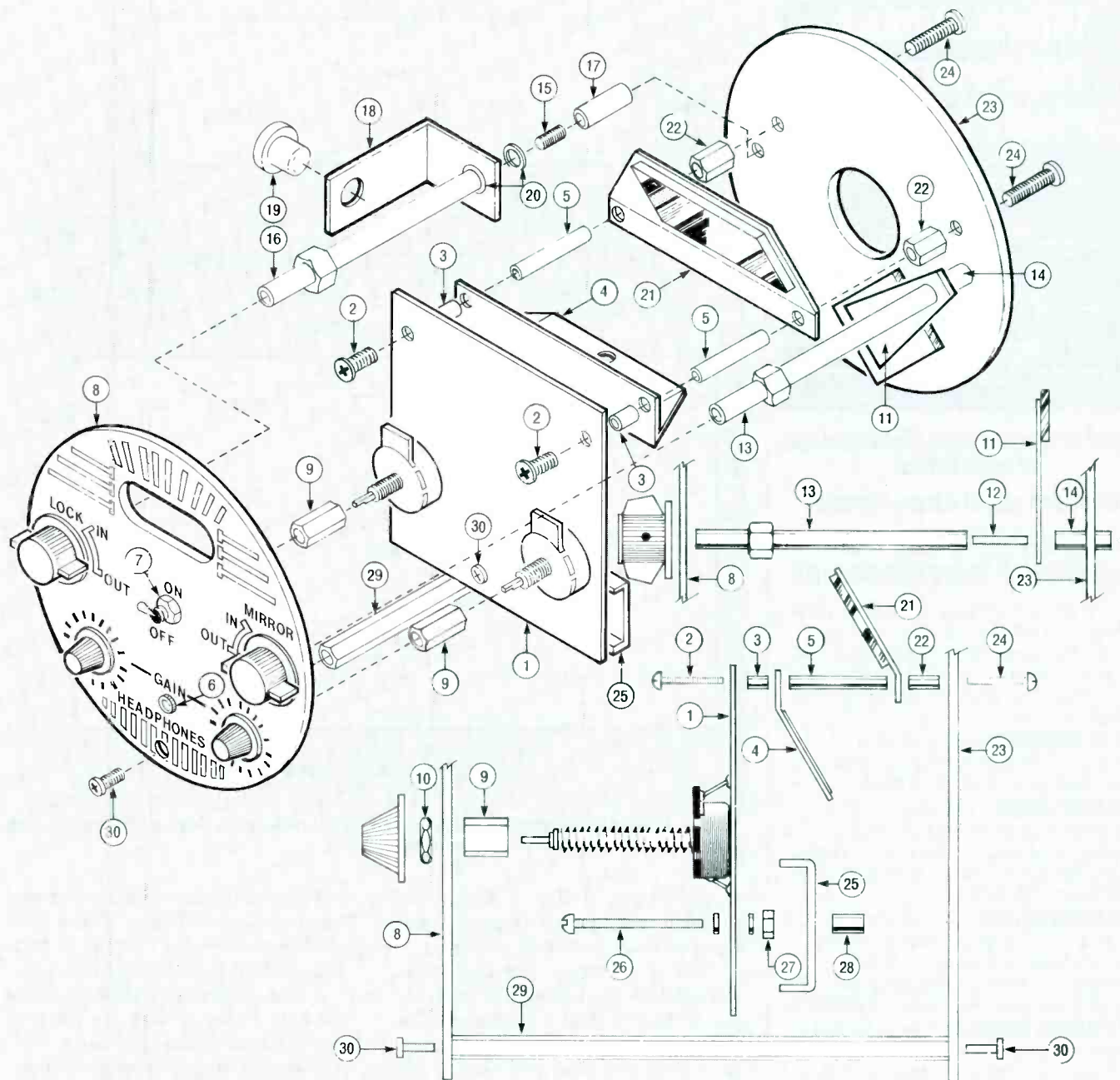

FIG. 2—THE RECEIVER is a little more complicated than the transmitter. Identify all parts before assembling them.

(19), and the two locking washers (20). Those two assemblies now fit through the two appropriate holes in the plastic end panel (8), and a knob should be put on the end of each shaft, so that the two shafts can turn, but with some resistance.

Before continuing, the rear plastic end panel (23) requires a layer of black felt-like material glued onto the side that faces the lens side of the tube. That material cuts down on reflections inside the tube, and it is included in the kit. Use part number (23) as a template to cut the felt piece to the right shape, and to mark the

holes for the metal shafts and screws to pass through. Then, using any kind of suitable glue, affix the felt.

With that out of the way, position the mirror bracket (21), the two $\frac{3}{8}$ -inch spacers (22), and the rear plastic end panel (23), and secure everything with the two $\frac{5}{8}$ -inch long Phillips-head screws (24). (Note that the ends of the two rotating shafts merely pass through the holes in rear panel (23), and are not held on in any way. The battery holder (25) is held in place by the screw (26) and nut (27) that are secured to the PC board as shown. The battery-holder bracket fits over

the end of screw (26), and the $\frac{1}{4}$ -inch threaded spacer (28) is screwed on to hold it in place. The last part to install is the $2\frac{7}{8}$ -inch long threaded spacer (29), and the two $\frac{1}{2}$ -inch long Phillips-head screws (30).

Tube assemblies

Before you prepare the tube assemblies, spray-paint the inside and both ends of both tubes flat black. Then, following Fig. 3 as a guide, mount the two brackets that hold the two tubes together. Basically they are L-brackets that are secured to the cardboard tubes using T-nuts. (See the

Which symbol represents a variable inductor?

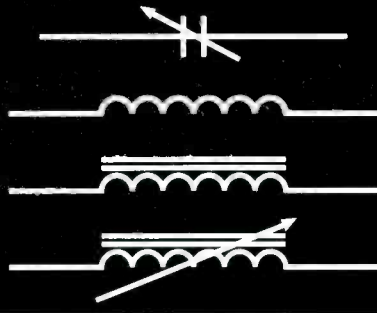

What is the principle disadvantage of neon lights?

What are out-of-phase signals?

Heath Video Courses speed your learning curve!

Learn basic electronics at home at your own pace with four, 60-minute video tapes. Know the variable inductor symbol. Recognize a PN junction. Understand oscillator fundamentals. Clearly SEE what most basic electronic books can only describe.

DC ELECTRONICS. Covers electron movement to troubleshooting and repairing a simple electronic circuit. **EV-3101-A.**

AC ELECTRONICS. Follow-up to DC Electronics. Covers the principles of AC, voltage and electrical measurement. Includes motors, generators and test instrument meter movements. **EV-3102-A.**

SEMICONDUCTORS. Complete the DC/AC videos and you're ready to learn how semiconductor devices are made, plus the principles of discrete devices, integrated circuits & optoelectronic devices. **EV-3103-A.**

ELECTRONIC CIRCUITS. Complete the basic course with amplifier configurations, biasing, coupling, audio amplifiers, closed-loop vs. open-loop operation and more. **EV-3104-A.**

An activity-filled workbook and explanation of how to solve each problem comes with each tape so you learn three ways — video, workbook and hands-on!

Order today!
Call Toll free,
24-hours a day.
1-800-253-0570.

We accept VISA,
MasterCard, American
Express and Heath Revolving
Charge card. Use Order Code 601-047

VIDEO TAPES
\$39.95
EACH

Heath®

Benton Harbor, MI

Call for a FREE catalog 1-800-44-HEATH.

*Price does not include shipping and handling. ©1990, Heath Company. Subsidiary of Bull Data Systems, Inc. or applicable sales tax.

CIRCLE 52 ON FREE INFORMATION CARD

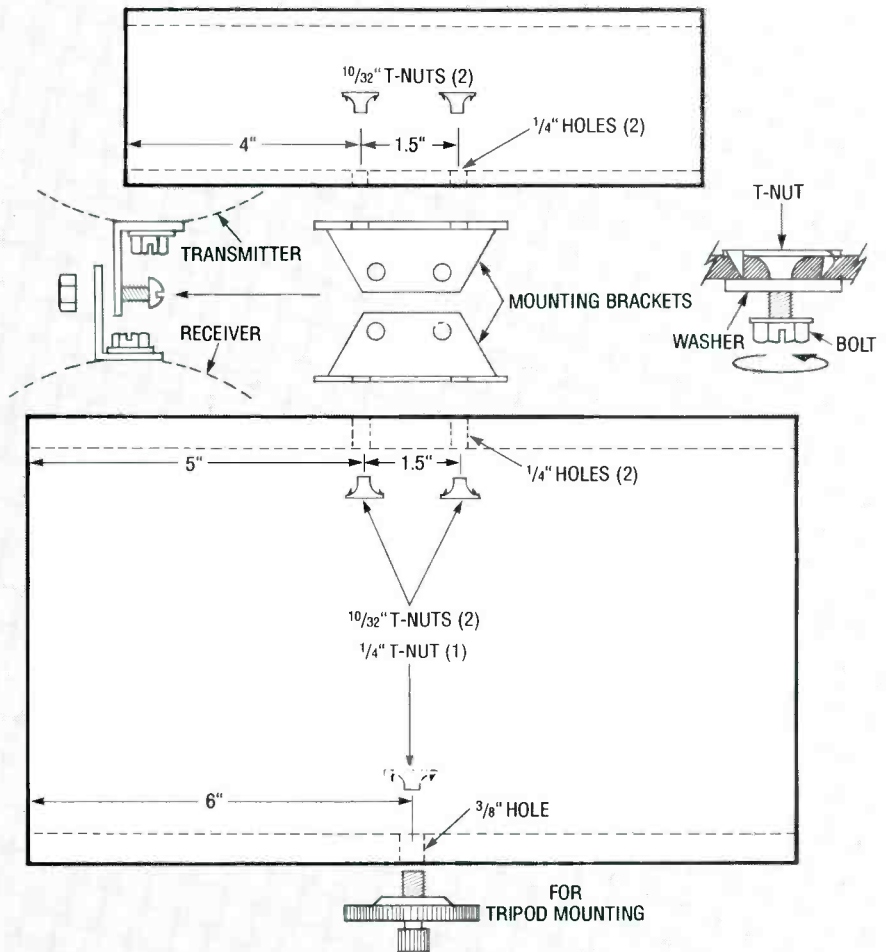

FIG. 3—THE CARDBOARD TUBES go together as shown. Spray paint the inside and both edges of both tubes flat black before assembling.

detailed view in Fig. 3 on how to install T-nuts.) You also have to install a larger T-nut for tripod mounting.

The transmitter assembly is mounted on the end of the tube opposite the lens, and is held in with the two screws as shown. The receiver just sits in the tube and is locked in place with the locking bracket.

After all of the hardware is mounted, you must install the lenses. The receiver uses a 6-inch fresnel lens with a 7½-inch focal length (the ridged side faces out). The transmitter uses a 2.345-inch positive convex lens, with a 6½-inch focal length (the curved side faces out). The lenses are held in place inside the tube with rolled-up paper while the black RTV silicone glue dries.

Alignment

The following procedures will help you align your light-beam communicator so that you can achieve the greatest possible communication range. To align the transmitter's LED,

turn it on and shine it on a white wall at a distance of 10 feet. Set the three adjusting screws so that the light is concentrated in the center of a halo.

As for the receiver, the only thing you have to do is align the pivoting mirror so that when it is in the "in" position, the light beam from a transmitter bounces straight off the mirror back to the transmitter. For long-distance communication, proper alignment is essential. When trying to set up a communication path at ¼ or ½ mile, the light reflected back from the receiver's mirror is a sure sign that everything is set up properly.

You can align the mirror by aiming the transmitter at the receiver with the mirror in place, and the red dot of light reflecting off the mirror should appear in the center of the fresnel lens. (To locate the dot, switch the mirror in and out of position; the extra dot will appear and disappear.) If it needs aligning, just carefully bend the mirror bracket into position.

continued on page 161

BUILD THIS

SPECTRUM MONITOR

WE HAVE ALL, AT ONE TIME OR ANOTHER, needed some of the capabilities that a spectrum analyzer offers. Unfortunately, sophisticated analyzers can cost more than a new car! So most of us have managed to live without the benefits that those instruments offer. After all, a meter, oscilloscope, frequency counter, and RF probe can actually give quite a bit of information about a signal environment. But none of those instruments can depict the total spectral content clearly and unambiguously, and give you information on modulation or spurs.

The solution is the spectrum monitor presented here. It doesn't have the frequency or amplitude resolution of a professional version, but it costs only around \$200, and you'll be able to view the 20-600 MHz range and compare relative levels.

The spectrum monitor has two operating modes; you can use it to either visually display an amplitude spectrum on an oscilloscope, or as a receiver to help identify FM signals.

Spectrum analyzer theory

The function of a spectrum analyzer is to tune across a controlled frequency range and display RF amplitude versus frequency on a CRT. Frequency increases from left to right (the +x-direction), while amplitude increases from bottom to top (the +y-direction). The signal being analyzed is applied to the vertical amplifier of an oscilloscope, and the horizontal amplifier is driven by a linear ramp like a triangle or sawtooth.

The simplest spectrum analyzer requires an oscilloscope and two sine/square/triangle function generators, connected as shown in Fig. 1. The oscilloscope time base is set for external sweep, and the scope's horizontal input is grounded. The beam is positioned at the bottom center of graticule, which will be the origin.

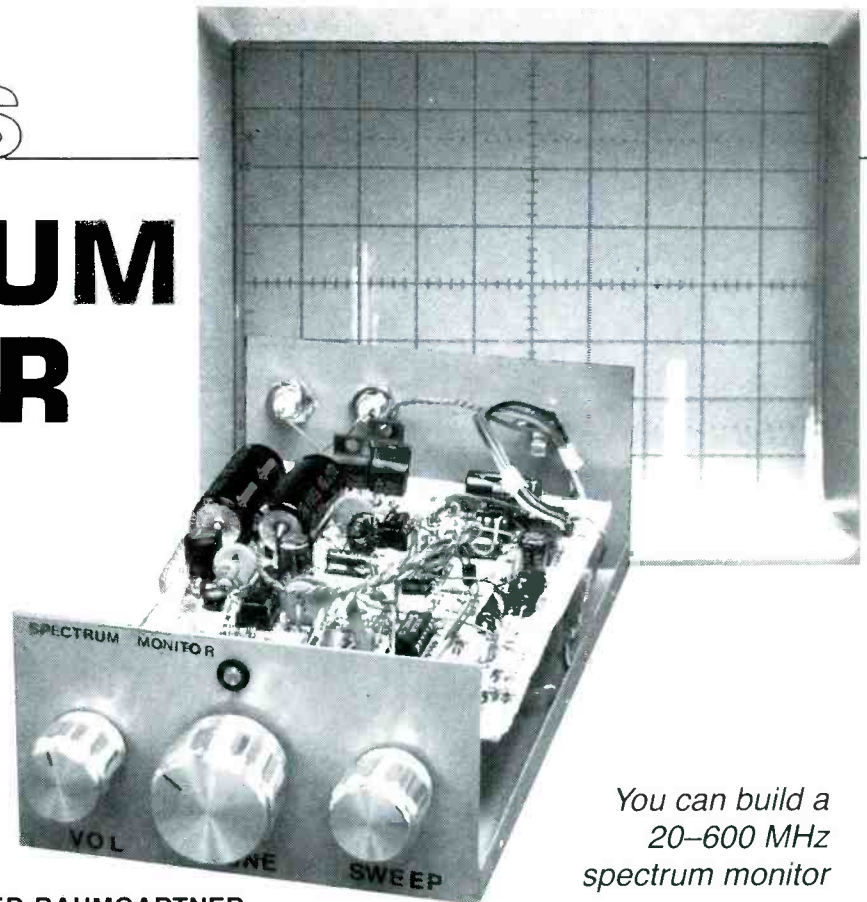

*You can build a
20-600 MHz
spectrum monitor*

FRED BAUMGARTNER

If V_1 , the output of the first function generator, is a 1-kHz triangle wave applied to the FM input of the second function generator, and if V_2 is a 10-kHz sine wave, then V_2 would be an FM sinusoid. Varying the frequency of V_1 varies the rate of change about the carrier frequency, and varying the amplitude of V_1 varies the deviation from that center frequency, or the modulation index. However, while the FM waveform is needed to generate a spectrum, it isn't the spectrum itself.

If the 1-kHz triangle wave is ap-

plied to the horizontal oscilloscope inputs, the CRT beam will sweep out a horizontal line along the x-axis of the graticule. Varying the amplitude of V_1 controls the length of the line on the oscilloscope screen. By making the frequency of V_1 high enough and experimenting with its amplitude, you can make the beam occupy the whole length of the bottom of the graticule, and make its retrace completely invisible.

Now take any audio filter or amplifier, a piece of stereo equipment, for example. If you apply V_2 to this filter

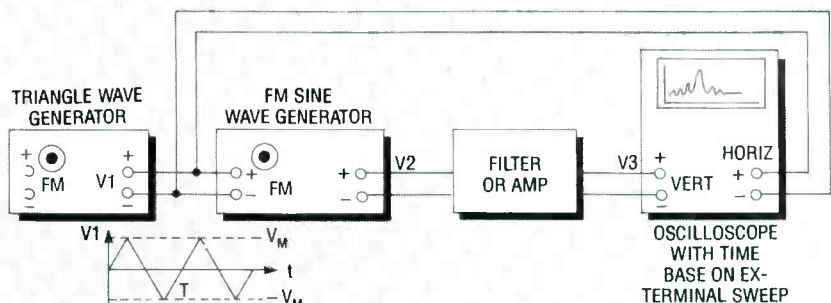

FIG. 1—BASIC SPECTRUM ANALYZER. The first function generator produces a linear ramp waveform (either a triangle or a sawtooth) V_1 . That is applied to the FM input of the second function generator to produce an FM sinusoid, V_2 , which is applied to the inputs of a filter or amplifier. The output, V_3 , is applied to the vertical amplifier of an oscilloscope, the time base of which is set to external sweep. The ramp V_1 is applied to the horizontal amplifier, and the amplitude spectrum appears on the CRT.

ZENITH SX SERIES 175-2292A TUNER/CONVERTER

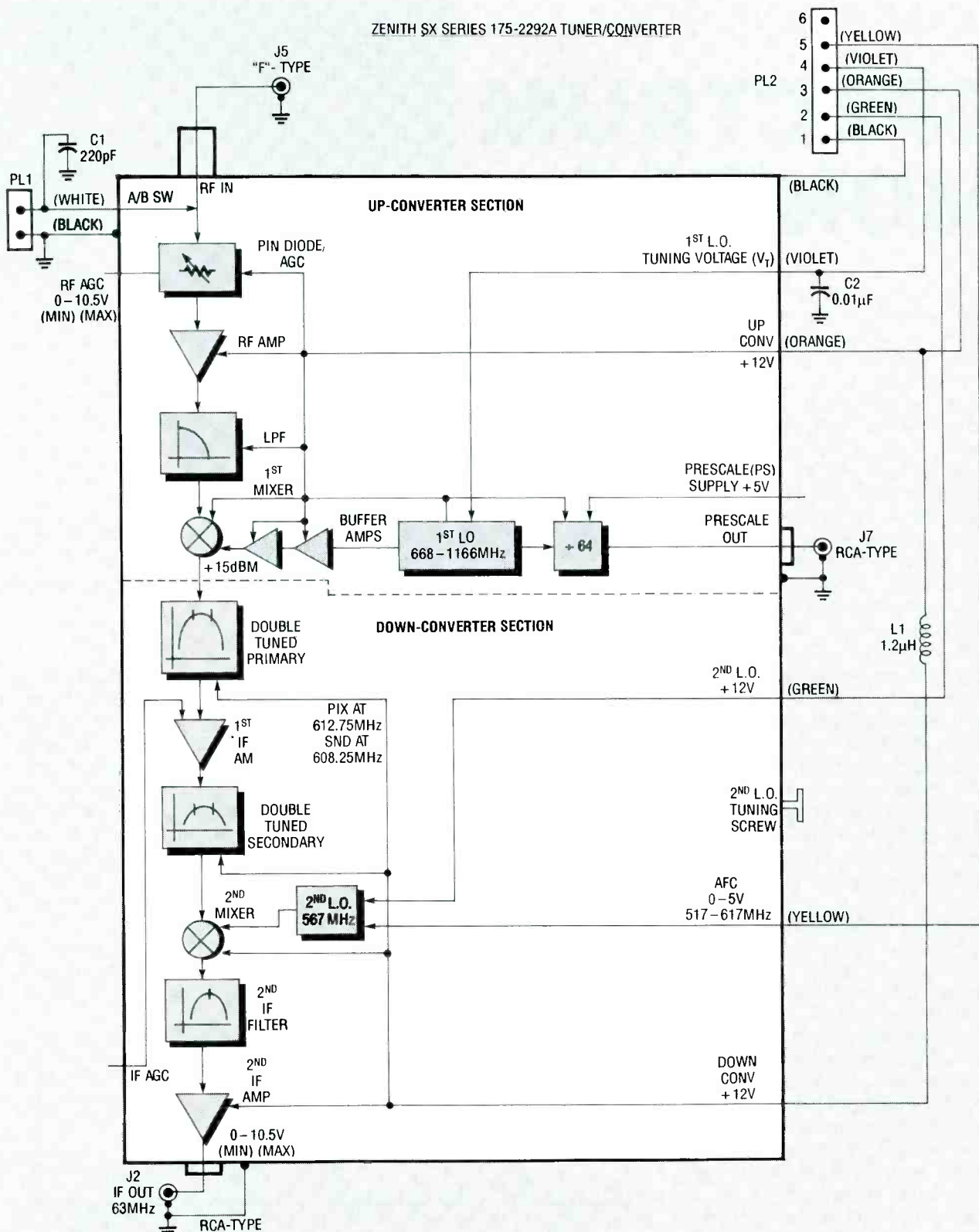

FIG. 2—TUNER/CONVERTER BLOCK DIAGRAM. The Zenith SX Series 175-2292A tuner/converter is the heart of the project. It accepts RF signals from about 55–553 MHz and downconverts them to a standard 63-MHz constant-level IF.

the FM signal coming out as a function of frequency. The voltage gain in decibels (A_{dB}) as a function of frequency is equal to 20 times the base-10 logarithm (\log) of the ratio of V_3 to V_2 . Or:

$$A_{dB} = 20 \times \log_{10}(V_3/V_2).$$

or amplifier, and apply the filter or amplifier's output V_3 to the oscilloscope's vertical amplifier, you should see some smooth continuous

curve with valleys and plateaus in its shape. That is the amplitude frequency-response of the filter or amplifier, a visual depiction of the amplitude of

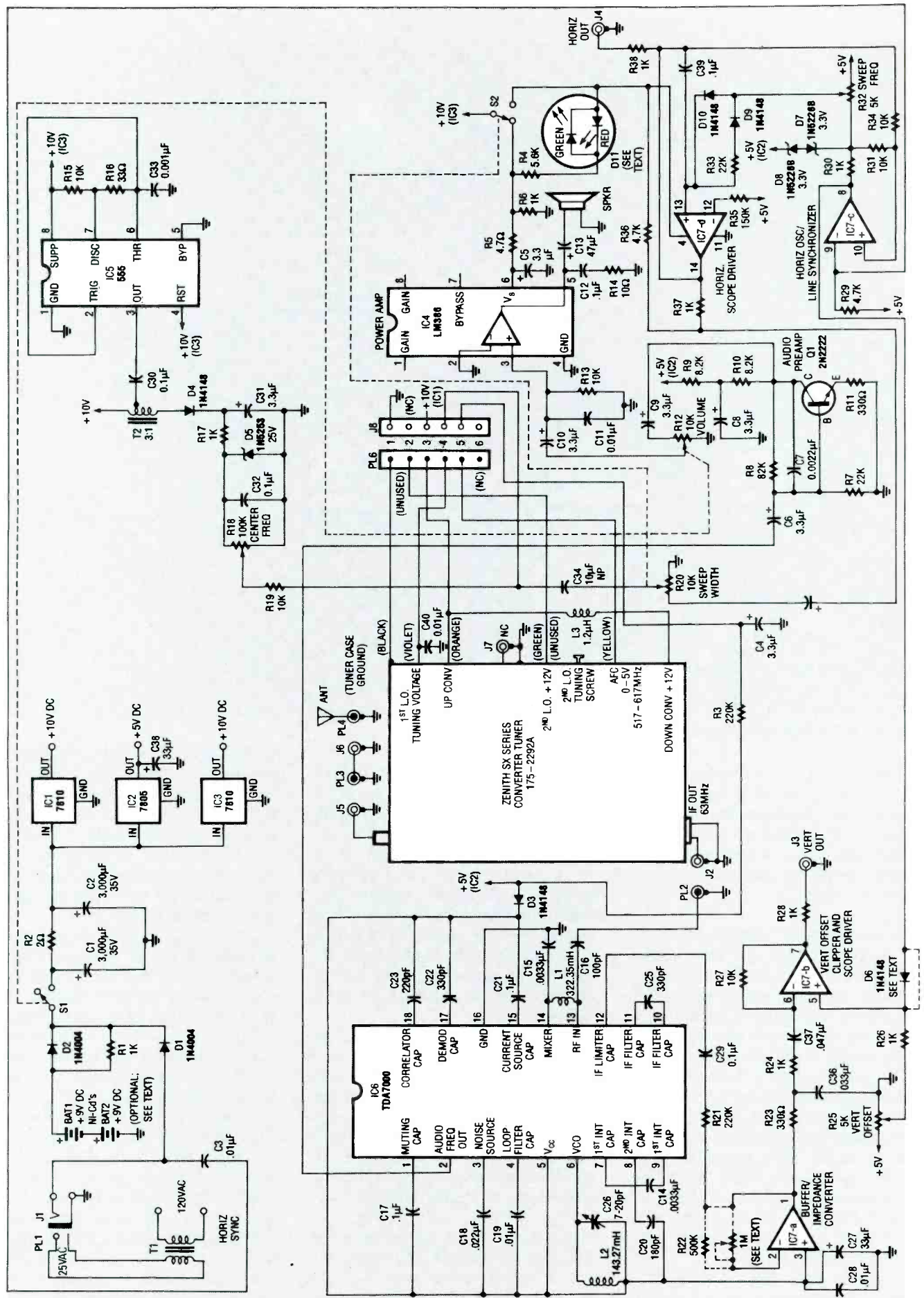

FIG. 4—SCHEMATIC OF THE SPECTRUM MONITOR.

PARTS LIST

All resistors are ¼-watt, 5%, unless otherwise indicated.

R1, R6, R17, R24, R26, R28, R30, R37, R38—1,000 ohms

R2—2 chms

R3, R21—220,000 ohms

R4—5600 ohms

R5—4.7 ohms

R7, R35—22,000 ohms

R8—82 000 ohms

R9, R10—8200 ohms

R11—330 ohms

R12-S1—cabinet-mounted 10,000-ohm potentiometer with SPST switch

R13, R15, R19, R27, R31, R34—10,000 ohms

R14—10 ohms

R16—33 ohms

R18—cabinet-mounted 100,000-ohm 10-turn potentiometer

R20-S2—cabinet-mounted 10,000-ohm potentiometer with SPDT switch

R22—1 megohm

R23—330 ohms

R25, R32—5000-ohm PC-board potentiometer

R29, R36—4700 ohms

R35—150,000 ohms

Capacitors

C1, C2—3300 µF, 35 volts, electrolytic

C3, C11, C19, C28—0.01 µF, 25 volts, ceramic disc

C4-C6, C8-C10—3.3 µF, 25 volts, electrolytic

C7—0.0022 µF, 25 volts, ceramic disc

C12, C-7, C21, C29, C30, C32—0.1 µF, 25 volts, ceramic disc

C13—47 µF, 25 volts, electrolytic

C14, C15, C24—0.0033 µF, 25 volts, ceramic disc

C16—100 pF, 25 volts, ceramic disc

C18—0.022 µF, 25 volts, ceramic disc

C20—180 pF, 25 volts, ceramic disc

C22, C25—330 pF, 25 volts, ceramic disc

C23—220 pF, 25 volts, ceramic disc

C26—7-70-pF PC-board trimmer capacitor

C27, C38—33 µF, 16 volts, electrolytic

C31—3.3 µF, 50 volts, electrolytic

C33—0.001 µF, 25 volts, ceramic disc

C34—10 µF, 50 volts, nonpolarized electrolytic

C35—10 µF, 25 volt, electrolytic

C36—0.033 µF, 25 volts, ceramic disc

C37—0.047 µF, 25 volts, ceramic disc

C39—0.1 µF polystyrene

C40—0.01 µF polystyrene

C41—220 pF ceramic disc

Inductors

L1—12 turns, No. 26 enamel wire on ⅛-inch air core

L2—8 turns, No. 26 enamel wire on ⅛-inch air core

L3—1.2-µH RF choke

Transformers

T1—RODCO Class 2 power transformer, Model DV-1260, 120-volts AC/12-volts AC, 60-Hz, Digi-Key catalog number T201-ND

T2—3:1 toroidal auto-transformer using No. 26 enameled wire on a toroidal core (Mouser Electronics 542-T68-2), with eight turns for the primary and 24 turns for the secondary (see text)

Semiconductors

D1, D2—1N4004 silicon diode

D3, D4, D6, D9, D10—1N4148 germanium diode

D5—1N5253B 25-volt Zener diode

D7, D8—1N5226B 3.3-volt Zener diode

D11—combination red/green LED (Mouser Electronics ME351-261)

Q1—2N2222 NPN transistor

IC1, IC3—7810 10-volt DC regulator

IC2—7805 5-volt DC regulator

IC4—LM386 audio amplifier

IC5—555 timer

IC6—Signetics TDA7000 FM receiver (Radio Shack 276-1304)

IC7—NE5514 quad op-amp

Modules

MODULE1—multipurpose cable TV/VCR tuner/converter (Zenith SX 175-2292A)

Other components

PL1—miniature monophonic plug

PL2—RCA-type monophonic plug connecting to braided-shield coaxial cable

PL4-ANT—folding monopole antenna with BNC plug (optional)

PL5—2-socket PC-board-mounted SIP version, not a separate item, attached to the tuner (MODULE1), intended for AB SWITCH (unused)

PL6—6-socket PC-board-mounted SIP version, not a separate item, attached to the tuner (MODULE1), used for the majority of the tuner pinouts

J1—miniature monophonic jack

J2—RCA-type monophonic jack, not a separate item, built into cabinet of the tuner (MODULE1), used for IF OUT

J3, J4—BNC jack

J5—"F"-type jack, not a separate item, built into cabinet of the tuner (MODULE1), used for IF OUT (63 MHz)

J7—RCA-type monophonic jack, not a separate item, built into cabinet of the tuner (MODULE1), used for PRESCALE OUT

J8—6-pin PC-board-mounted Single-Inline Package (SIP) jack

PL3-J6—adapter with "F"-type plug and BNC jack (optional)

SPKR—8-ohm loudspeaker, 2- × 2-inch

Miscellaneous: Cabinet (minimum size 8- × 4.5- × 2.5-inches), large knob (for R18), small knob (for R25 and R32), four 1-inch standoffs, LED bezel, wire, solder, etc.

NOTE: The following is available from FM Broadcast Services, 7029 Chimney Rock Ct., Indianapolis, IN 46217: A complete spectrum monitor kit with all parts, PC board, hardware, tuner, cabinet, transformer and postage for \$187.00.

Third, you'll want a usable output IF. TV Channel 3 (63 MHz) is popular, but Channel 4 (69 MHz) is suitable and within the range of the project. Also, you'll want relatively stable gain characteristics and few images or spurs.

Some adjustment of the spectrum monitor may be necessary for use with your tuner. Automatic Gain Control (AGC) voltages can be brought out to a front panel control to set RF

gain, or tied to a voltage representing full gain. Measuring the local oscillator output with a frequency counter will enable you to calculate the center frequency.

Zenith SX tuner/converter

The Zenith SX series tuner/converter (part number 175-2292A) used in the prototype is representative of a suitable tuner; a block diagram is shown in Fig. 2. It can be bought with

the kit described in the Parts List, or directly from Zenith Corp. It contains both up- and down-converter sections, and fits into a 4.25- × 2.78- × 1.05-inch aluminum shell with one "F"-type and two RCA-type jacks.

The "F"-type jack (J5) is the RF IN, with a frequency range of 55.25-553.25 MHz. One RCA-type jack (J2) is the 63-MHz IF OUT, and the second (J7) is the PRESCALE output, which isn't used here.

There are two PC-board plugs supplied with the tuner. One is a two-pin version, PL5, used for A/B SWITCH, which along with C1 is unused. The other is a Single-Inline-Pin (SIP) plug, PL6, which connects to most of the pinouts. Pin 1 (black) of PL2 is ground, pin 2 (green) is the SECOND LOCAL OSCILLATOR +12-volt supply (unused), pin 3 (orange) is the UP-CONVERTER +12-volt supply, pin 4 (violet) is the FIRST LOCAL-OSCILLATOR TUNING VOLTAGE, and pin 5 (yellow) is the AUTOMATIC FREQUENCY CONTROL (AFC) voltage for tuning the second local oscillator over the range 517–617 MHz. Pin 6 is not wired.

Even though the up- and down-converter supplies are labeled as nominally needing +12 volts, +10 volts proved to be adequate. The AFC potential on pin 5 of PL2 should nominally be +2.5 volts, to keep the second local oscillator at 567 MHz. Enough information is provided to let you look into suitable replacements if you can't get this version, or want to experiment with others.

Spectrum monitor operation

The block diagram of the spectrum monitor is shown in Fig. 3. It can operate using either 12-volts AC or +12-volts DC, and provision is also made for optional Ni-Cd batteries. An RF signal over the frequency range 55.25–553.25 MHz is applied to the Zenith tuner via J5. The tuner will down-convert to a 63-MHz IF, the center frequency being adjusted using R18, and the sweep width using R20; the IF exits the tuner via J2. It is then fed to an FM receiver IC that acts as detector/demodulator. The input resonant frequency of the IC is adjusted using trimmer capacitor C26.

The output of the detector/demodulator IC is applied simultaneously to a discrete NPN transistor preamplifier and an op-amp buffer/impedance converter. The preamplifier output goes to an IC power amplifier and speaker, the volume being adjusted using R12. This is the FM-receiver audio output, letting you listen to FM broadcast stations, TV audio, two-way FM communications, etc.

The buffer/impedance converter is part of the vertical output section, and is followed by a two-pole low-pass filter which suppresses any signal amplitude overshoots, preventing the spectrum monitor from forcing the oscilloscope beam off the graticule.

That's followed by a vertical offset clipper and oscilloscope driver amplifier, which is adjusted using R4. The output of this amplifier is fed to the VERT OUT jack J3.

Note that S2 feeds power to either the audio amplifier for receiver operation, or IC7 for sweep operation in spectrum monitor mode. The two operating modes are mutually exclusive; you can't use the monitor to simultaneously observe a region of the RF spectrum, and listen to whatever station is at the center frequency of the display. However, it is a simple matter to switch between modes.

The horizontal circuitry begins with a horizontal oscillator, which also acts as a line-voltage synchronizer. When the spectrum monitor is powered by 60-Hz AC, the 12-volts AC from the secondary of T1 is coupled into the horizontal oscillator, locking it to the 60-Hz power-line frequency automatically. When 12-volts DC is applied directly to J1, synchronization to 60 Hz becomes impossible, so the horizontal oscillator will be free running.

The horizontal-oscillator waveform then passes through a network that generates the sawtooth waveform used for horizontal scan/retrace. That sawtooth is amplified by a horizontal driver and appears at HORIZ OUT jack J4. The sweep frequency is adjusted using R32, but the adjustment is effective only when the spectrum monitor is operated using AC.

Circuit description

The complete schematic of the spectrum monitor is shown in Fig. 4. The spectrum monitor uses 12-volts AC or +12-volts DC, allowing operation from a car battery, or a plug-in 12-volt AC adapter. It also can operate off of a Ni-Cd power pack.

Diode D1 is the power rectifier for 12-volts AC, D2 and resistor R1 provide a charging path for the Ni-Cd cells, and S1 is an SPST ON/OFF switch. While a full-wave rectifier would be much easier to filter, it would prevent AC/DC compatibility. The filter is composed of R2 and capacitors C1 and C2. Also, C3 samples AC to synchronize the sweep oscillator to 60 Hz. The three voltage regulators provide +10-volts DC to the tuner, and +5-volts DC to the sweep circuits. The TDA7000 receiver uses +4.5 volts; the drop across D3 provides +4.3 volts.

While the 555 timer (IC5) is configured as an astable, its real purpose is to function as an additional voltage source. It works in conjunction with T2, a 3:1 toroidal auto-transformer, to provide the tuning voltage. Most tuner/converters need 0–25 volts for full-range control. The primary of T2 is supplied by the +10 volts from IC3, and the 143.056-kHz oscillation superposes an additional 20 volts, producing 30 volts across C31. The duty cycle is very low to conserve power. Next, D5, a 25-volt Zener, clamps and regulates the tuning voltage, and R18 controls the tuning voltage for the first local oscillator in the tuner.

For tuners requiring negative or multiple voltages, T2 will have to be modified. For a different maximum amplitude required, change the ratio of T2, and for a negative voltage, reverse D4 and D5 and also the non-tap terminals on the auto-transformer. This will force the auto-transformer to generate negative-going pulses, which will be superposed upon the +10-volts DC. Reversing D4 and D5 allows current to be passed in the reverse direction, and the Zener voltage of D5 could be changed if needed. The horizontal sweep generator produces both sawtooth and pulse waveforms, and can be externally synchronized.

The purpose of D9, D10, and R33 is to allow the negative and positive slopes to be set independently. Note that R33 is in series with D9, but that there's no comparable resistor in series with D10. Thus, R33 extends the duration of the sawtooth waveform up-ramp so the CRT beam fits on the horizontal axis of the graticule. Then, D10 permits a steep, rapid discharge, minimizing the sawtooth waveform fall time and permitting fast horizontal retrace. Sweep-frequency potentiometer R32 allows the time constant to be varied.

Zener-diodes D7 and D8 clamp the output of the oscillations from IC7-c, D7 the negative-going direction, and D8 the positive-going direction. Then, IC7-d buffers the sawtooth generated across C39, and IC7-c switches C39 from charge to discharge based on the feedback through R34. Finally, D6 routes the blanking/sync pulse to the vertical section (IC7-a and IC7-b) for vertical retrace. Note that D6 may need to be shorted or left out for faster vertical retrace,

although some oscilloscopes will experience vertical overshoot as a result. You'll have to experiment with whatever oscilloscope you use, in order to decide.

True "Z"-axis control (blanking or brightness) is difficult to obtain on many oscilloscopes. If yours permits external blanking control, it's available as a positive pulse from pin 8 of IC7-c. This pulse drives the CRT beam vertically off the screen during retrace and turns the vertical amplifier off, preventing retrace from being seen.

The Signetics TDA7000, IC6, is a complete FM receiver on a chip. The tank L1-C26 for the Voltage-Controlled Oscillator (VCO) on pin 6 is the only RF adjustment. Only L2, C15, and C16 are required on IC5 as external components to create the RF input filter and perform matching. If the IF is 45 MHz, the value of L1 may need to be increased. By altering L1, any IF from 30–110 MHz may be used. It's also possible to similarly adapt L2.

The TDA7000 reduces the received signal deviation from ± 75 kHz to ± 15 kHz (suitable for the internal IF of 70 kHz), using an internal Frequency (not phase) Locked Loop (FLL). The TDA7000 greatly simplifies the circuitry for many tuned circuits and filters, and neither needs nor uses AGC. In its place, a sample of IF limiter voltage is fed back to the IF LIMITER CAPACITOR input (pin 12), after being buffered and amplified by IC7-a. The gain of IC7-a is controlled by R22. The prototype used 500 K for R22, but the gain can be varied by using a potentiometer.

The positive signal portion of the IF envelope is amplified by IC7-b to produce the vertical drive. Potentiometer R25 sets the base line to "rectify" the signal from IC7-a. Between IC7-a and IC7-b, a two-pole low-pass filter smoothes DC ripple and reduces vertical overshoots. Also, IC7-a converts the high-impedance receiver section AGC, where the RF level is derived, to something low enough for proper filter design, while also providing some gain. Overall, IC7-a and IC7-b provide a gain of about 40.

The tuner is the heart of the spectrum monitor. It accepts the RF IN (J5) and produces a 63-MHz IF OUT (J2). The FIRST LOCAL-OSCILLATOR TUNING VOLTAGE controls the first local oscillator. Remember that there are two

operating modes, FM receiver and spectrum monitor. In the former, the tuning voltage is steady DC and is determined by center frequency potentiometer R18. In the latter, the tuning voltage is swept.

Sweep-width potentiometer R20 controls the tuner sweep-voltage and how much of the spectrum is displayed. The SPDT switch S2 selects between modes, not merely by selecting between the outputs for each with both sections (IC4 and IC7) operating simultaneously, but actually switches power between them, saving power and avoiding any coupling problems.

Construction

The Parts-Placement diagram is shown in Fig. 5. This project is sufficiently easy to build and align that even those who shy away from RF construction shouldn't have any trouble. Reasonable care, especially in grounding, will allow successful construction on perfboard, protoboard, or the PC board.

If you're using a PC board (a foil pattern is provided in PC Service), use sockets for the IC's and Q1. Install R2 before C1 and C2 so that you'll have room to work, followed by IC1–IC3, IC5, D4, D5, L3, R15–R17, C30–C33, D2 and S1. Plug in IC5; you should now have +5 volts out of IC2, +10 volts out of IC1 and IC3, and +25 volts across D5. Use

either pieces of clipped component leads or other stiff wire to make the pins of J8, the jack used to attach the tuner wires to the PC board. You can replace the tuner wiring-plug PL6 with any other compatible six-pin SIP versions, as long as you can find a matching socket that'll fit on the PC board.

The coils are hand-wound from No. 26 enameled wire. Inductors L1 and L2 are 12 and 8 turns on a 1/8-inch drill bit as the form. Transformer T2 is a 3:1 auto-transformer using a Mouser 542-T68-2 ferrite toroid-core with 3/16-inch inside diameter. Tie a small knot in the wire and wind 8 evenly spaced primary turns, twist in a 1.5-inch center tap, and do the 24 secondary turns. A toroid prevents the cabinet from being flooded with 10-kHz magnetic noise.

The metal cabinet is a 8- × 4.5- × 2.5-inch steel box. All wires between the PC board and the controls and jacks should be twisted in related groups, and made sufficiently long to route them to the side of the PC board with J8 and PL6 so the PC board can be easily removed from its 1-inch standoffs. Use plastic and styrofoam between the PC board and tuner to stabilize both and insulate one from the other, and install the rest of the parts.

Figure 6 shows a photograph of the spectrum monitor with its case open.

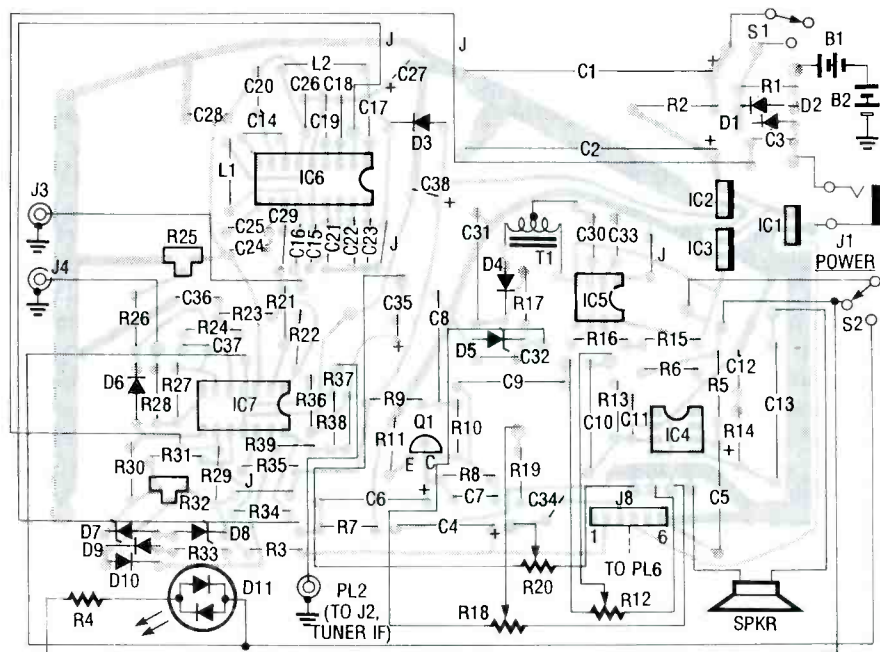

FIG. 5—PARTS-PLACEMENT DIAGRAM for the spectrum monitor. Use sockets for the IC's and Q1. Use plastic or styrofoam between the PC board and tuner to stabilize and insulate both.

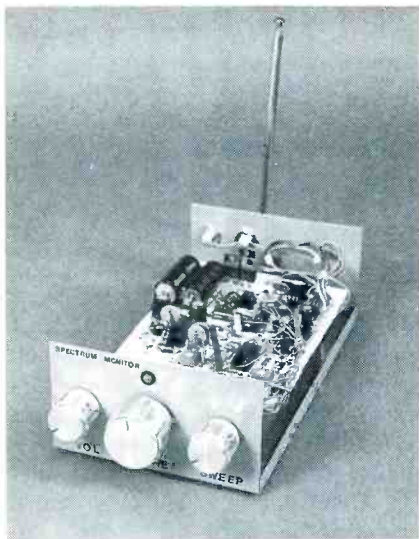

FIG. 6—THE COMPLETED MONITOR. The telescoping antenna is connected to J5 via a BNC-to-“F”-type adapter.

The coaxial cable in the center is the IF OUT from the tuner (J2), and the wiring for the front potentiometers and switches, as well as for the rear jacks is on the right so the PC board can be removed for maintenance. However, proper construction techniques should eliminate the need for maintenance. Note the positions of the IC’s, Q1, and the PC-board-mounted potentiometers. The monopole antenna (ANT) is connected to J5 via a BNC-to-“F”-type adapter (PL3-J6), and gives good reception.

Checkout and setup

After everything is installed and wired, remove the DIP’s and verify that the +5-volt and +10-volt supplies work. Replace the 555 (IC5), and verify the +25 volts from the voltage tripler and clamp. Replace the LM386 (IC4) and verify the audio by turning up the volume with the sweep off. Insert a little audio hum into pin 2 of the TDA7000 (IC6) socket by using a piece of wire to couple to your hand; if you don’t hear anything, something’s wrong.

Replace the NE5514 (IC7), turn on the sweep, and observe the HORIZ OUT (J4) on an oscilloscope. If you see a sawtooth, adjust the sweep frequency potentiometer R32 for a stable waveform. To lock to 60-Hz, use AC. With the oscilloscope sweep on line, adjust R32 for a single sweep waveform per 60-Hz cycle. The vertical output from J3 should be a straight line with a short +5-volt pulse, in sync with the horizontal sweep retrace portion.

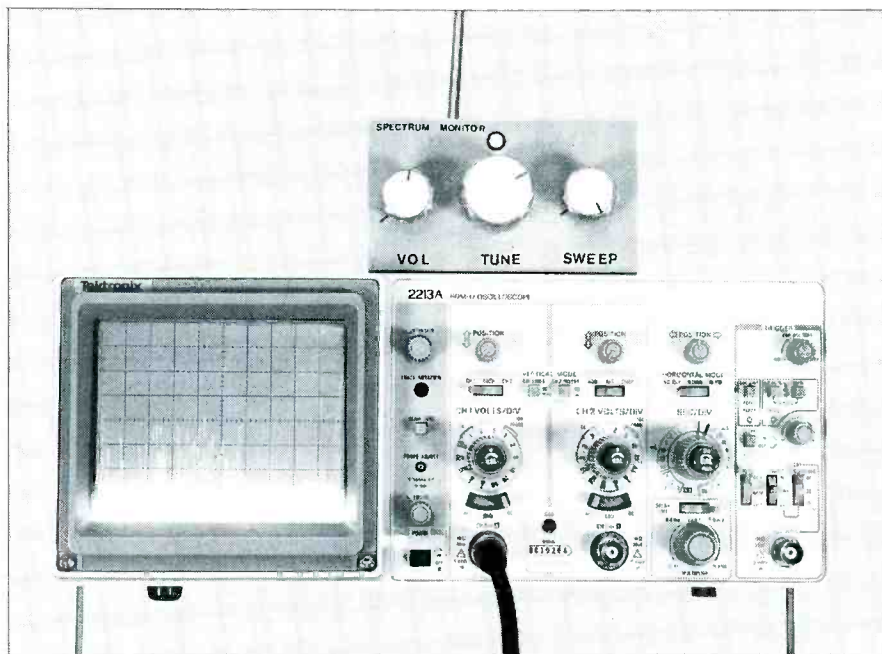

FIG. 7—THE SPECTRUM MONITOR in operation, examining a portion of the New York area spectrum.

Replace the TDA7000 (IC6); with the sweep off and the volume turned up, you should hear white noise. Tune the TDA7000 using C26 to 63 MHz, the middle of TV channel 3. You can tune the converter to a channel-3 TV station if you have one in your area. Disconnect the coaxial cable from IF OUT (J2), and use another cable to connect the IF OUT (J2) to a TV on channel 3, using the fine tuner to pick a station.

Without moving the fine tuner, reconnect the IF OUT to the TDA7000 simultaneously, and tune C26 to match the audio of the selected station. You could also use an RF generator producing a 63-MHz carrier with a modulated FM tone, if you prefer, but keep the level low, as the TDA7000 is quite sensitive.

With the sweep at maximum (fully clockwise), an oscilloscope displaying the VERT OUT (J3), and a small wire in J4, adjust R18 and C26 to produce a display with maximum sensitivity and clarity. Set the baseline, adjusting R25 so the display is as vertically large as possible, with no downward mirror image (lower portion of the signal envelope); some slight noise should show above the baseline. Repeat to maximize performance before closing the cabinet.

The two-color LED (D11) in the front panel should be green for receive/audio and red for sweep; both it and R4 are mounted off the PC board. When you rotate the center-frequency

potentiometer R18, clockwise corresponds to a lower-central frequency, and counter-clockwise to a higher value. That is as if you were looking through a moving window at the spectrum, the window width determined by the sweep-width potentiometer R20.

Using the spectrum monitor

A photograph showing the spectrum monitor in operation, examining a portion of the New York area FM spectrum is shown in Fig. 7. The monitor has quite good RF sensitivity, so use an RF attenuator before J5 when making comparative level measurements, or when handling strong signals. Comparing RF levels is straightforward, with the accuracy limited only by the tuner gain linearity. With the exception of the extreme ends of the tuning range, most converters seem to have a fairly flat response.

The cheapest attenuator pads are the in-line “barrel” type used in cable TV, available in 3-, 6-, 10-, 12-, or 20-dB sizes, with “F”-type jacks. You can also use a switchable gain set as discussed in the Radio Amateur’s Handbook. To connect an oscilloscope to the spectrum monitor, set the vertical amplifier to DC mode at 1 volt/div, and the horizontal sweep to external (x-y mode). Hook the VERT OUT (J3) to the vertical amplifier (the y-axis), and the HORIZ OUT (J4) to the

(Continued on page 82)



TRACKING DOWN BUGS USING A SPECTRUM ANALYZER

*Are you being bugged?
Here's how to find RF
bugging devices that
are invading your privacy.*

RICHARD A. BOWEN

BEING WIRETAPPED IS NO JOKE. TODAY'S micro-miniaturized electronics have made it easy for anyone with a little know-how and willful attitude to tap your phone and invade your privacy. Whether you call it eavesdropping, phone tapping, radio interception, or covert operations, we'll show you how to hunt down those tiny bugs.

Although there are many advertised gadgets that claim to locate clandestine transmitters, licensed private investigators, with few exceptions, have neither the technical expertise nor background to properly use them. Consequently, more and more investigators are turning to radio technicians who are knowledgeable in counter-surveillance technology.

That's why a competent radio technician with an inquisitive mind and the proper equipment can make a supplemental income (perhaps \$100 + per hour) by availing himself, his

equipment, and his expertise to investigators who are trying to locate clandestine transmitters.

Tools of the trade

The first order of business is to have the right tools. But what are the right tools for detecting bugs that are positioned by persons good at hiding them? Bar none, the most invaluable tool is a *spectrum analyzer* (spec-an). The one used by the author is an IFR model A7550, which becomes portable when using its built-in Nickel Cadmium (Ni-Cd) battery—an essential convenience.

You'll also need a good receiver to scan the RF spectrum looking for the bug's frequency. Many spec-ans have radio-scanner options (receivers) that are designed to be hooked up without modification. Now admittedly, \$500 dollars for that option might sound like a lot of money; but when you're

talking about a \$10,000 investment, it's not really that much. After all, you're trying to discern what type of intelligence is contained in a detected signal, you need a good receiver. Of tremendous benefit would be some kind of mixer, down converter, or pre-scaler to extend the receiver's frequency range.

For obvious reasons, it's paramount to tape-record the bugged audio; also, a first-rate direction-finder is necessary so you can track down and locate clandestine, or spurious emissions.

Another option that is extremely useful is a *General Purpose Interface Bus* (GPIB) interface with a plotter, which will allow you to make hard-copy two-color printouts of the suspect frequencies that you have discovered, or wish to document. The GPIB will interface the spec-an's output to the plotter.

There are a lot of gizmos that are advertised on the market as so-called "counter-intelligence devices." The author is compelled to warn you that most of the equipment will not perform as advertised, and the equipment that *will* perform is often unethically sold for 3 to 5 times the list price—*caveat emptor!*

If you think that you're being bugged, you may be desperate for anything that advertises to solve your problem quickly. The false promise of those gizmos seems like a good risk. But wait a minute: That's exactly what those unethical companies are depending on to motivate a sale! Don't fall into their trap. There's no short-cut gizmo that can replace the proper test equipment in the hands of a qualified radio technician.

Sleuthing

Technicians make some of the best detectives in the world—no kidding! They have to investigate why something doesn't work and trace down the fault; that takes an inquisitive mind. And if one has a good sense of business, there's plenty of work in counter-surveillance. That's because private citizens are being illegally bugged every day; not to mention all the industrial and foreign espionage that seems so prevalent in today's world. Yes, indeed, when word gets around that a technician knows how to ferret out phone-taps, that person's skills will be in demand.

Most people just aren't aware of all the inexpensive devices that can be legally purchased to invade their privacy. Figure 1 shows three tiny bugs that can hear everything you say. Although clandestine bugs can come in small packages, a willful intruder will use what's handy and what works. Bugs range from sugar-cube sized "wireless microphones" for \$20, to candy-box sized "wireless intercoms," and handhelds, that will allow anyone within a half-mile radius to listen to every spoken word in your home. And you can bet that there are many more sophisticated and much more expensive devices, too! Let's face it; not just anyone can find one of those cleverly hidden bugs in your home or office. It takes someone like a technician with expert knowledge of radio transmissions, having the skills and equipment needed to track down tiny radio bugs.

Did you know that a perfectly legal

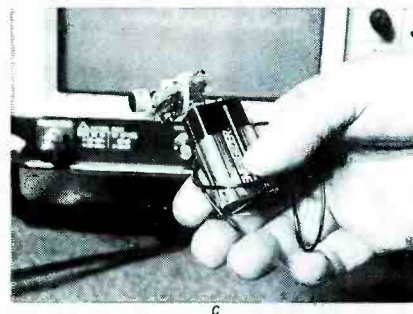
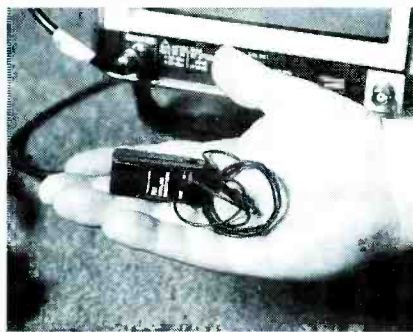
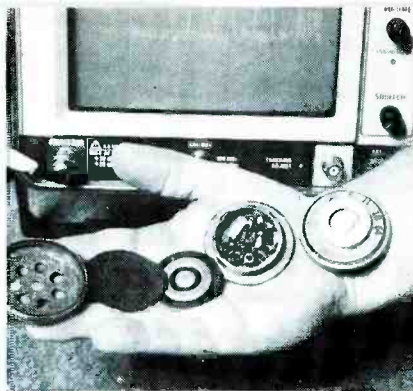

FIG. 1—THESE ARE CLANDESTINE radio bugs. In (a), a parasitic phone-tap is shown disassembled. In (b), a Radio Shack FM-transmitter (part No. 33-1076) can be conveniently dropped behind the cushion of a chair. In (c), this tiny FM transmitter can be hidden in a kitchen cabinet.

(FCC registered) phone tap is available from many companies for only \$25? That's because there's a big market for bugging *your own* phone. Just think for a moment: At one time or another haven't you called some big-time attorney, or doctor, or insurance company, only to hear strange beep-tones or clicks. That's right, you're being recorded—and it's all legal!

Most people are under the impression that intercepting *your own* telephone conversation, or recording the conversation without beep tones, is illegal. That simply isn't true! You don't have to notify anyone that you're tapping *your own* phone. How about that! And if you can buy a simple phone-tap, so can a criminal out to victimize the average Joe.

Bug frequency

Let's suppose a client suspects a

radio bug has been planted in his telephone. However, the client might lack the know-how to either disassemble the phone, or even tell the difference between a wiretap and the normal telephone's circuitry. It's possible that the client has found a wiretap, but doesn't know what to do. A common wiretap is shown in Fig 1-a. It's a "parasitic telephone transmitter" (not to be confused with parasitic or spurious emissions from a legal RF transmitter).

The nomenclature "parasitic" was derived from the fact that the bug steals power (as a parasite feeds on others) from the telephone company and, consequently, needs no external battery or antenna. Those devices use the telephone's own headset coil-cord and associated wiring as the antenna, and the 48-volt central-station battery for power (which drops to about 10 volts when the handset is off hook).

Depending upon how the tiny phone-bug is designed and where it's located, it can be received on an FM radio, or other receiver, up to one-half mile away. The beauty of that bug is that it can't be detected unless it's actually operating, which means the phone must be off-hook. And although able to operate on virtually any frequency, it's common to sandwich the transmissions between high-powered FM-broadcast stations; that's so they won't create radio interference that would tip off the authorities. Besides, an FM transmission can be received by any inexpensive FM car radio—usually sitting in front of, or nearby, the victim's house or business.

Here's a step-by-step procedure using a spec-an to make any bug stand out like a sore thumb:

Step 1: Set scan-width for the 88 MHz to 108 MHz FM broadcast spectrum.

Step 2: Set bandwidth resolution to 3 kHz. You will now have a factual display of all electromagnetic radiations occurring in the 88 MHz to 108 MHz frequency range.

Step 3: Set the "peak hold" to capture and store all legitimate signals that are on the air (see Fig. 2-a).

Step 4: Digitally invert all stored information (see Fig. 2-b).

Step 5: Pick up the suspected telephone (off hook) and you'll notice that the signal previously not present is now displayed (see Fig. 2-c).

What we have accomplished is a digital cancellation of everything that

should be on the air against a brand new signal that was not there prior to our picking up the phone, but which now sticks out like a *sore thumb*.

Incidentally, for evidence in court (and customer records) the plots that are reproduced can be made at the actual scene of the crime with the GPIB option (also known as IEEE-488). One GPIB is available from IFR to connect their spec-an to a Hewlett Packard 7470A Plotter. Whatever spectrum analyzer and plotter you're using, contact the manufacturer's representative for interfacing suggestions.

Bug locating

If you are sharp enough to find a bug, the last thing in the world that you want is the bug to hear itself! (If the bug is active, it is logical to assume that someone is listening.) If you have a receiver tuned to the bug with speaker audio, and you get too close, you'll get audio feedback, which will immediately tip off the spy that you're on to him! No good! Here's what to do.

Once the bug's frequency is found, use headphones with a long, long, extension cord (maybe 50-100 feet or so) to listen to the audio. Now walk around the house tapping the walls, rattling objects, or talking in a normal voice, while listening for an increase in volume level. Make your rattling sounds appear as natural as possible, so that the "bad guys" don't become suspicious. If the bug is in the kitchen, then as you move from the living room into the kitchen, the bug will pick up more audio thereby transmitting a higher-amplitude signal. You'll hear that over your headphones.

The receiver option of your spec-an will undoubtedly have a speaker output. Figure 3 shows how to convert the speaker output to a headphone output only. Although by no means any engineering marvel, the modification is extremely effective and retains the integrity of the receiver! The audio is re-directed (using shielded coaxial-cable) from the speaker to a set of headphones. Figure 4 shows the author's home-built adaptor box. Alternatively, a set of cordless infrared headphones, such as Maxon's model 49-SA can be used, which would not only eliminate the possibility of tripping over a long headphone cord; but they are also useful in detecting infrared bugs—yes, those exist, too!

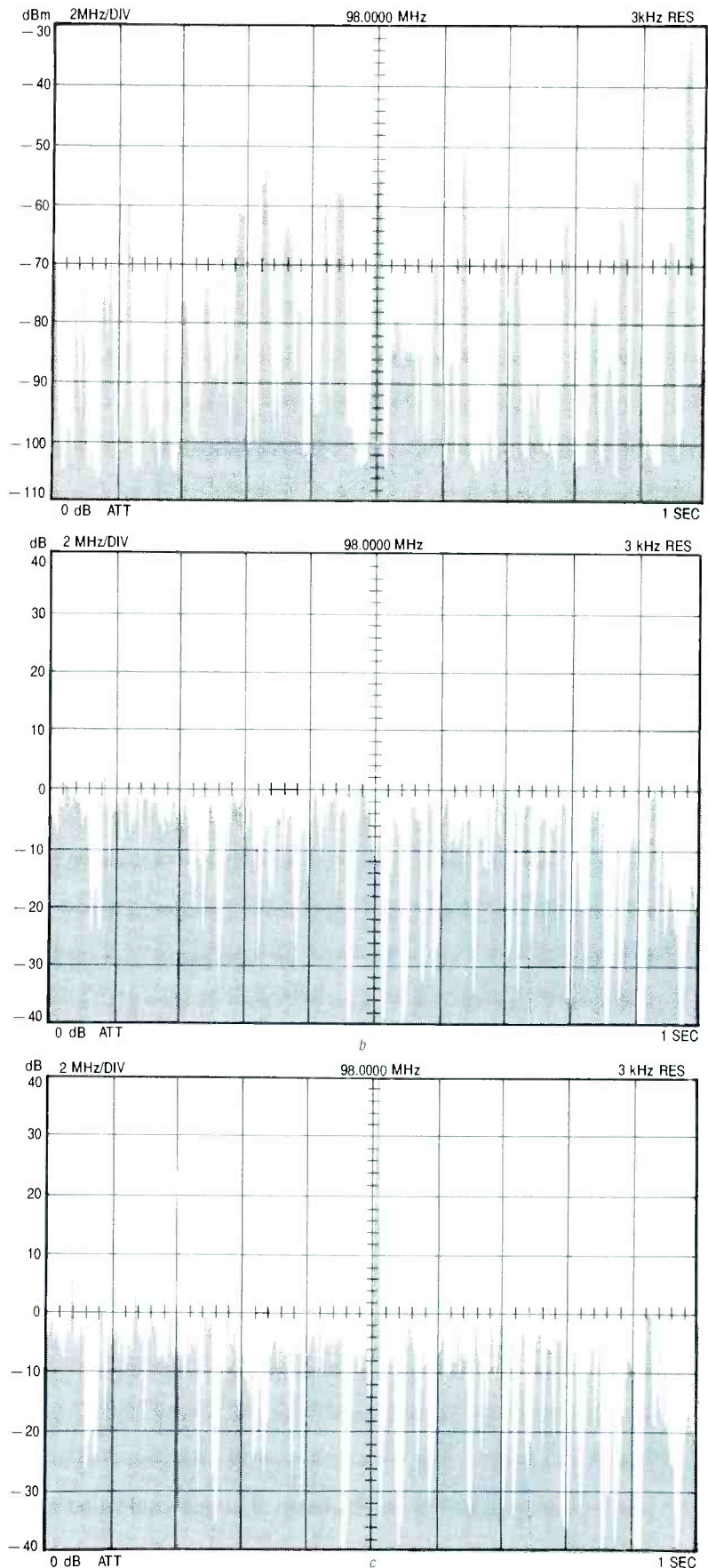

FIG. 2—A SPECTRUM ANALYZER WILL INTERCEPT THE BUGS FREQUENCY. In (a), the broadcast (88-108MHz) FM spectrum is scanned and stored. In (b), the stored spectrum is digitally inverted. In (c), the bugs frequency sticks out like a sore thumb when the phone-tap begins transmitting.

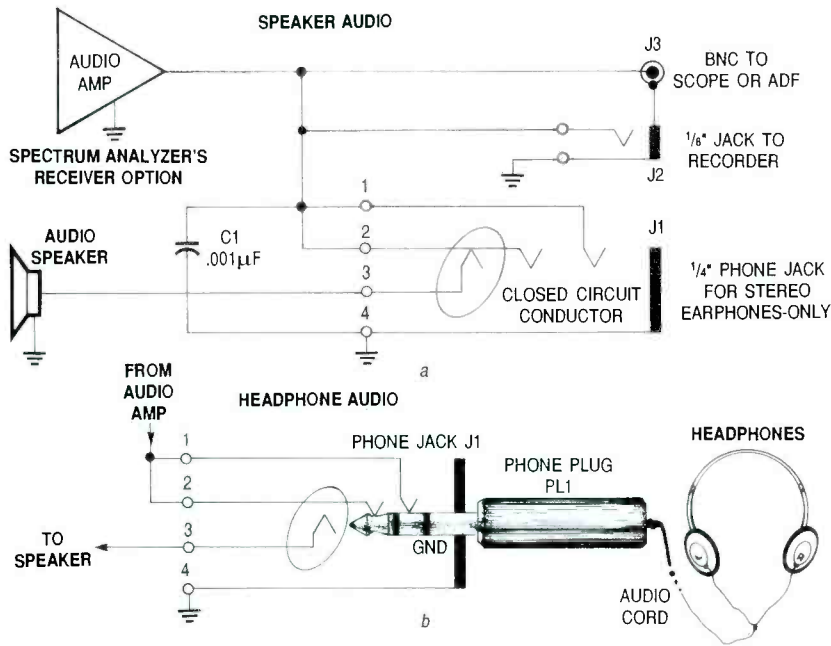

FIG. 3—USE HEADPHONES FOR LISTENING TO THE BUG'S TRANSMISSIONS. In (a), this circuit will modify your receiver's speaker output for headphone use only. As shown in (b), when the phone plug is inserted, the closed-circuit spring opens, thereby cutting off the speakers while re-directing the audio to the headphones.

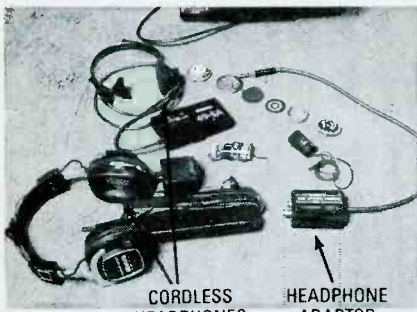

FIG. 4—USE THE AUTHOR'S home-built adaptor box with either a pair of stereo headphones, or a cordless infrared transmitter and receiver.

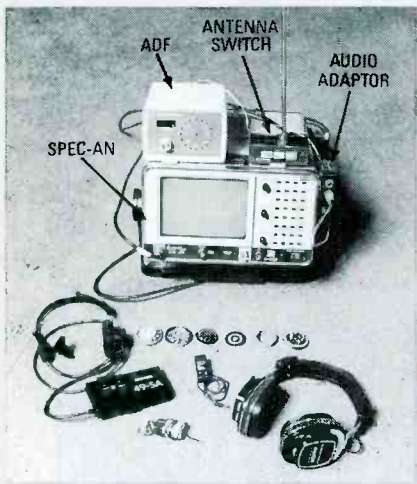

FIG. 5—HERE'S YOUR PERFECT sleuthing setup: a spectrum analyzer, automatic direction-finder, antenna switching box, and headphone audio-adaptor to listen privately to clandestine transmissions.

remove my guardianship?" The husband would then stand to become the trustee to three-million smackers.

The author and out-of-state detective set up a spectrum analyzer, and proceeded to search for a radio signal that shouldn't be there. After an hour or so, an intermittent signal kept popping up in the middle of the FM-broadcast band that didn't correlate with any known or published local radio-stations in the area. Without going into detail, it was established that a *frequency-hopping transmitter* was operating, and was remotely controlled by an AC line-current carrier transmitter.

In other words, that was a bug that selectively transmitted information on numerous frequencies. The purpose was to make it much more difficult for someone, to locate the bug because it would continually "hop" to a new frequency. If such a signal is monitored on a single frequency, all that is heard is gibberish.

The control of that device was discovered to be an AC line-current carrier transmitter that could activate or disable the bug from a convenient location in the neighborhood. Now that you have found something as insidious as that, what do you do? Psychology is always the best weapon. If we were to rip the bug out, the "bad guys" would instantly know that it was found.

The author made a hand-written note, showed it to the parties involved, and instructed them to walk outside onto the patio where their conversation could not be overheard. There he informed the victim that she was neither paranoid nor insane, and she immediately fell into the author's arms, crying in relief. The author advised that if they tore apart the kitchen cabinets, (where the bug was located) that the perpetrator would be aware that the bug had been discovered.

So "what now?" The author suggested that she make a tape recording (at another residence) of the kids screaming and carrying on, as if something terrible was happening. The next step of the plan was to take the children and place them in someone else's custody, whose testimony and verification could not be disputed in a court of law.

Having done that, she should stay in her house alone, play back the tape as loud as possible, grab a few pots and pans and make as much noise as

The headphone adaptor box can be attached with *Velcro* tape to the side of the spec-an. In addition to providing headphone audio, J2 can input to a Voice Operated Transmit (VOX) actuated tape-recorder, J3 can input to an oscilloscope, Automatic Direction Finder (ADF), or whatever else is required. Note: Use only a 1/4" stereo phone-plug for audio-jack J1; that's because if a monophonic phone-plug is inserted, it will short-circuit the audio amplifier.

An actual bust

As a case in point, the author's services were requested by an out-of-state detective agency. They had a client who quite honestly thought she was losing her mind.

Separated from her husband and having their two children in her custody, the children stood to inherit close to three million dollars, which would be administered by their legal guardian as a trustee. (Not a bad situation for the legal guardian.) To her, it seemed that every single word she said inside her home, or over the phone, was somehow being overheard. No one could find any clandestine listening device, and her suspicions seemed to be getting the best of her. She thought, "Is my ex-husband trying to collect evidence to prove that I'm an unfit mother, and then use that as a tactic in court to

possible (portraying a scene of total chaos and child abuse). The whole purpose of that action was to find out who would show up.

Well, it worked! It was the in-laws (outlaws) that showed up, and not the husband, much to the surprise of everyone. I can only presume that they cared more about the three-million dollar inheritance than they did about the welfare of their grandchildren.

Spec-an modifications

Unfortunately, the IFR A7550, along with other spectrum analyzers, has one fault in common: There is an unacceptable amount of leakage from the internal oscillators that cause alarming and inaccurate readings with an antenna placed as far as 20 to 30 feet away. The problem is caused by RF case leakage that can easily be corrected. But if you don't correct it, that leakage will ruin your day!

Spectrum analyzer RF leakage can be cured by making sure that the front and rear mounting bezels make good contact with the case. Dissimilar metals should not be used, because oxides caused by the bi-metallic contact will form a resistive film that isolates the bezel from the chassis. That turns the bezel and aluminum case into an antenna which, in turn, radiates all of the internal RF of the spec-an's circuitry. Also make sure that your plotter is line-filtered so that RF energy emitted by its microprocessor circuitry is not radiated into the power line.

RF direction-finding

Sometimes clandestine, spurious or overbearing emissions can be so powerful that they cause problems many miles from their source. Enter the *automatic direction-finding system* manufactured by Doppler Systems Inc., PO Box 31819, Phoenix, AZ. 85046, (602) 488-9755. Figure 5 shows the Doppler direction-finder attached by *Velcro* to the right top of the spec-an. The circle of LEDs indicates the bearing to the RF source, while a 7-segment LED-display indicates the bearing in large numerals. The Doppler system has a frequency range of 27 MHz to 500 MHz, and can be connected to any standard VHF or UHF FM-receiver. No receiver modifications are required—simply plug the Doppler electronics into the receiver's antenna and external speaker jacks.

As shown in Fig. 6, four ¼-wave

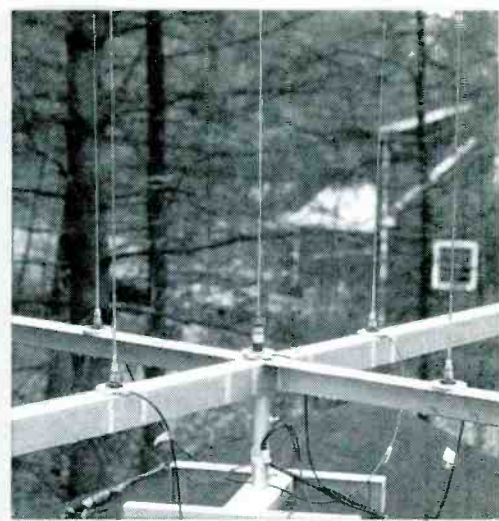

FIG. 6—DIRECTION FINDING using Doppler System's four matched quarter-wave whips, shown in (a), are supported on magnetically mounted bases for mobile operation. In (b), four collapsible antennas are mounted on a sturdy platform, on top of the author's roof.

whip antennas can be mounted on a car's roof for mobile operation, or on the roof of a house. The antennas can electronically simulate a rotating directional-antenna. As the antenna moves toward the RF source, the apparent signal frequency increases; as the antenna moves away from the source, the apparent signal frequency decreases. That up-down (Doppler) frequency shift is detected by the FM receiver as a 300-Hz audio tone. The phase of the tone is related to the bearing angle and is used by the direction-finder electronics to compute and display the bearing.

The purpose of the direction-finding platform is to get an initial bearing to the desired signal, and the relative signal strength. The ¼-wave whip antennas must be tuned to the exact frequency of the clandestine transmissions. You know the exact frequency by using the spectrum analyzer. The antennas are collapsible and will allow tuning by extension-retraction, and spacing the bases by sliding them along the platform. To work properly, the antennas must be spaced approximately ¼-wavelength apart.

One of the capabilities of a spectrum analyzer is the ability to identify the frequency of the offending radio-emission. That includes spurious emissions that are common in areas where multiple transmitters are placed in close proximity with each other. Besides the non-linear mixing that occurs in a transmitter's final-amplifier (called intermodulation) that create strong spurious signals, other far more exotic kinds of heterodyning also occur.

One time the author found a "difference" frequency coming from an oxidized dome of a town hall. There

were two AM-broadcast stations less than a mile away; one was on 1590 kHz and the other on 900 kHz. Within a half mile of the town hall, everyone in town could hear one of the stations at 690 kHz! That was caused by rectification from the dome's copper-oxide layer.

When "DF-ing" a spurious signal in a moving vehicle, it is absolutely imperative that you have an assistant, or navigator to read a road map and give directions, or more important—to prevent you from kissing a telephone pole. Using Doppler System's Automatic Direction Finder (ADF), the author has been able to track down signals to a specific section of a house—from the road out front!

Proximity signals

If you narrow down a suspected transmitter to within a given area, here's one method of determining its proximity. Place three identical antennas having identical lengths (and types) of coaxial cable connected to a coaxial-switch box. Use the best coax, like RG 223-U coaxial cable, which is double-shielded (98% each) silver-plated (both shields and center-conductor) cable to ensure total integrity of the received signal. That may sound like overkill, but if you're going to do something, why not do it right?

Separate the three antennas by about 30 feet. A low-powered bug will show a marked change in signal strength on the spec-an, when antennas are independently selected. The stronger signal will indicate the relative bearing of the transmitter's location. Transmissions from far away will indicate almost identical signal strength.

RGB-to-NTSC CONVERTER

High-quality computer video on your TV—for peanuts!

ROBIN BEK

Have you been searching for a low-cost alternative to a \$300 color monitor? Or would you like to run your flight simulator on a big-screen TV? Great idea, but there are problems. Personal computers deliver digital signals that tell the TV when to turn the red, green, and blue guns in the CRT off and on. But TVs expect an analog signal that is a combination of the three color signals, the audio signal, horizontal and vertical sync pulses, and other things as well.

Even so, there's an easy (i.e., inexpensive) way of cutting your cake and eating it too. Our RGB-to-NTSC color converter is easy to build, costs less than \$30, and is easy to tune using only a color TV and a voltmeter. The circuit was designed specifically for the Atari ST, but it could be used with any computer that delivers standard

RGB video. Also, the circuit could be adapted to RGB-to-PAL operation for use with European PCs.

Theory of operation

The problem with interfacing a computer to a TV is that the two use two totally different types of video systems. Computers typically deliver RGB video, which is composed of separate digital signals corresponding to the red, green, and blue guns in a color TV tube. In an RGB system, each signal is either on or off. Hence there is a certain number of combinations of on and off signals which correspond to colors ranging from white (all signals on) to black (all signals off). Because there are three signals, and each may assume only two values, there are 2^3 possible combinations, or eight colors.

On the other hand, TV's gener-

ally expect a composite NTSC (National Television Standards Committee) video signal, which, as the name suggests, combines the three RGB signals, an audio signal, sync signals (and possibly others as well) into a single composite signal.

The advantage of composite video is that instead of using five wires, you use just one. The disadvantage of a single wire is loss of fidelity and increased circuit complexity. Fortunately, though, converting the two radically different signal systems is relatively easy (and inexpensive), thanks to modern technology.

Our circuit is built around Motorola's single-IC solution to the problem, the MC1377. The circuit is easy to build and tune; you really don't even need a scope unless you run into problems. However, you will need a volt-

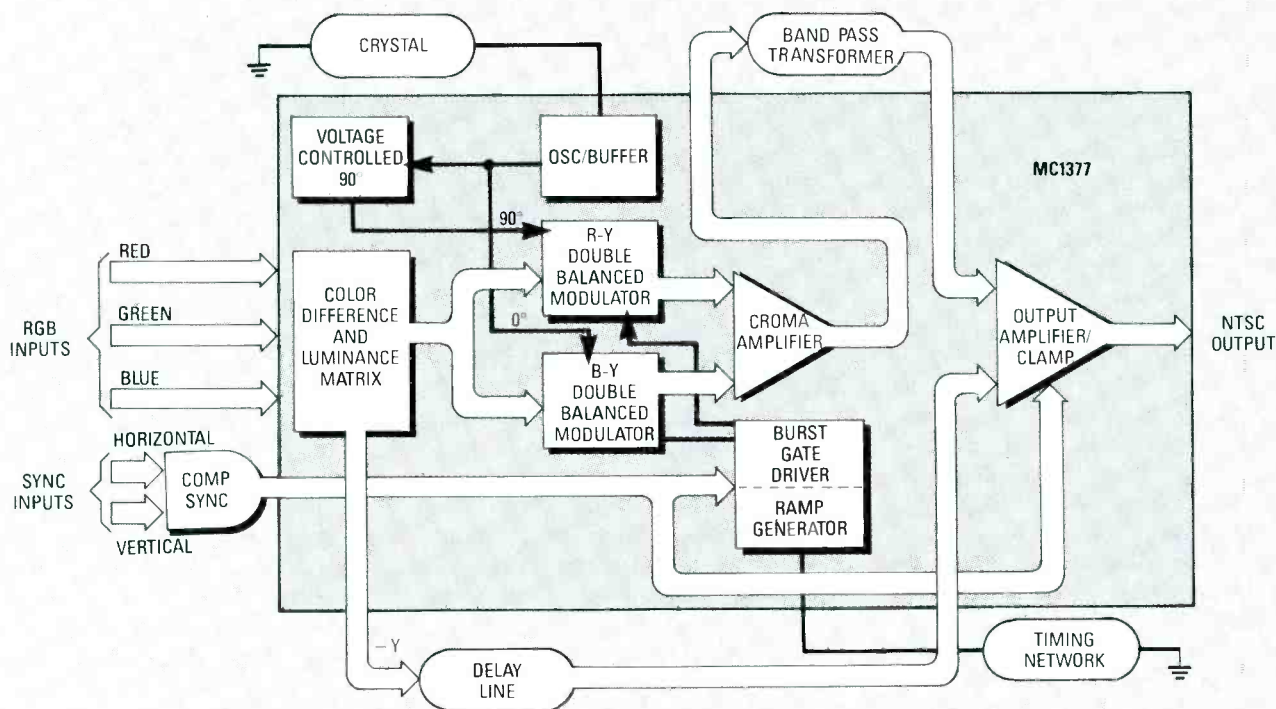

Fig. 1 BLOCK DIAGRAM OF THE CONVERTER IC, a Motorola MC1377.

meter to verify the supply voltage and several test points.

How it works

The MC1377 is a 20-pin IC. As shown in Fig. 1, pins 3, 4, and 5 accept the incoming RGB signals, which are separated into chrominance (color) and luminance (intensity) information. The chrominance (R-Y and B-Y) signals drive two double-balanced modulators that are 90° out of phase. The resulting signals are then combined in a chroma amplifier and bandwidth-reduced by an external bandpass transformer.

The luminance signal (-Y) is fed through an external delay line before being combined with the chrominance signal. A composite sync signal is obtained by combining the horizontal and vertical sync signals before they enter the MC1377. Figure 2 shows the complete schematic diagram of the circuit. The power supply is not critical; the circuit shown in Fig. 3 will suffice.

Construction

Because of the high frequencies involved, we recommend use of a PC board. Patterns are shown in PC Service; a kit is also available, as mentioned in the Parts List. If you use a PC board, Fig. 4 shows where to mount the components.

Whatever your construction method, place the components (especially T1 and IC2) as close as possible to the associated pins of IC1. In addition, make sure that the trimmer capacitor (C3) is mounted firmly and is accessible for adjustments. Mount LED1 so that it is visible when the unit is powered up.

Most of the components are readily available, but C13 and R7 are critical. Those two components set the timing for the color-burst signal at pin 1 of IC1. If they are off by as little as 5%, bye-bye color. Therefore, you should use a 2% polypropylene capacitor for C13 and a 1% metal-film resistor for R7. If you have access to a scope, you can use a potentiometer in series with R7, an inexpensive capacitor for C13, and tune the circuit to the right frequency.

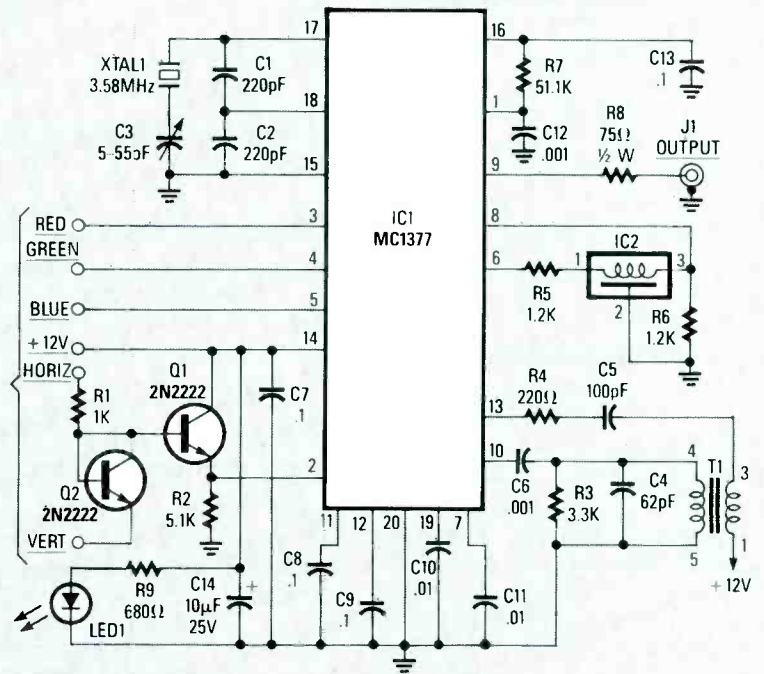

Fig. 2 SCHEMATIC DIAGRAM of the RGB/NTSC converter.

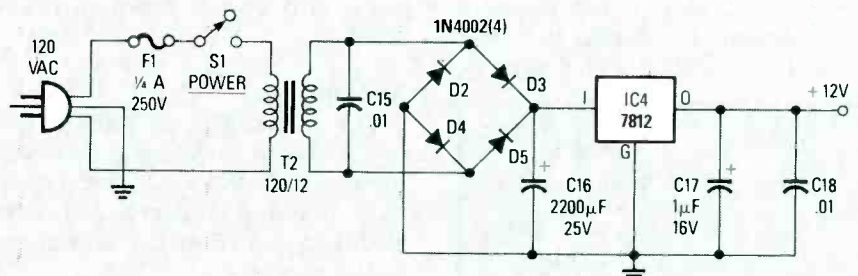

Fig. 3 POWER SUPPLY for the converter.

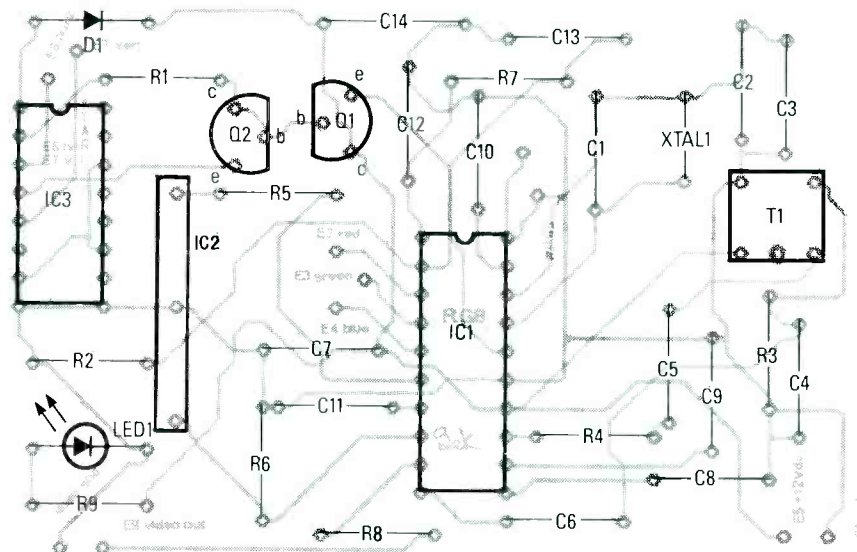

Fig. 4 INSTALL ALL COMPONENTS as shown here.

After soldering all components to the board, check your work carefully and correct any mis-

takes. Then apply power to the circuit, making sure polarity is correct. Upon power-up, LED1

Parts List

Resistors

All resistors are 1/4-watt, 5%, unless otherwise noted.

R1	1000 ohms
R2	5100 ohms
R3	3300 ohms
R4	220 ohms
R5, R6	1200 ohms
R7	51, 100 ohms, metal film, 1%
R8	75 ohms, 1/2-watt
R9	680 ohms

Capacitors

C1, C2	220 pF disc
C3	5-55 pF trimmer
C4	62 pF disc
C5	100 pF disc
C6	0.01 μF disc
C7-C9, C13	0.1 μF disc
C10, C11, C15, C18	0.01 μF disc
C12	0.01 μF polypropylene, 2%
C14	10 μF, 25-volt electrolytic

C16	2200 μF, 25-volt electrolytic
C17	1 μF, 16-volt electrolytic

Semiconductors

IC1	MC1377 RGB to NTSC converter
IC2	DL122401D-1533 delay line (TDK)
IC3	CD4049 inverting hex buffer (optional, see Fig. 7)
IC4	LM7812 12-volt regulator
D1	1N5237 8-volt Zener diode (optional, see Fig. 7)
D2-D5	1N4002 diode
Q1, Q2	2N2222 NPN transistor
LED1	Panel-mount LED

Other components

XTAL1	3.58MHz (for PAL use 4.43 MHz)
T1	166NNF-10264AG bandpass transformer (TOKO)

T2	120/12-volt AC transformer
S1	SPST power switch (120 VAC)
F1	1/4-amp, 250-volt fuse
J1	Video output connector (see text)
J2	Female MIDI connector (optional 5-pin DIN)

Miscellaneous

PC board, cabinet, 59-ohm cable, line cord, RF modulator (optional), etc.

Note:

The following items are available from RGB, 32 Wilson Ave., Trumbull, CT. 06611, (203) 374-7634, leave a message if no answer: Complete kit of parts including Atari video connector, \$29.95; PC board only, \$10.00. All orders add \$2.50 postage and handling. Connecticut residents please include sales tax.

should light. Measure the voltage at pin 9: it should be +3-volts DC, and pin 16 should be +8.2 volts. If the LED doesn't light or

those voltages are incorrect, go back and check your connections.

Hooking up

The most difficult part of the project is the hook-up to the computer. And that's not very difficult. Just don't forget to route the audio signal from the computer to the monitor.

The output of the converter should be routed with RG59 coax cable and terminated with a male RCA connector (depending on your television). If your TV doesn't have audio and video inputs, you can feed the video output of the converter into one of

those cheap (preferably less than \$5) RF modulators, and connect it to your TV's antenna inputs.

Pinout information for the Atari ST is shown in Fig. 5. To connect the circuit to an IBM CGA circuit, you must invert the sync signals. A simple way to do that is shown in Fig. 6-a; the IBM video pinout is shown in Fig. 6-b.

Turn on your computer and the converter, and place your TV in the monitor mode (or on channel 3 if you're using an RF modulator). You should see a computer image on the screen. If you don't, go back and check your connections again, especially the sync circuit (Q1 and Q2).

There are two ways to adjust the converter. If you have a frequency counter, connect it to pin 17 and adjust C3 until the counter reads 3.579545 MHz. Without a counter, use a computer image of known color. For example, the bootup screen of the Atari is a bright green. Adjust C3 till you obtain that color.

Troubleshooting

There are two things to watch out for:

No image. Check the power supply, Q1, Q2, and connectors. If you have a scope, check pin 2 of

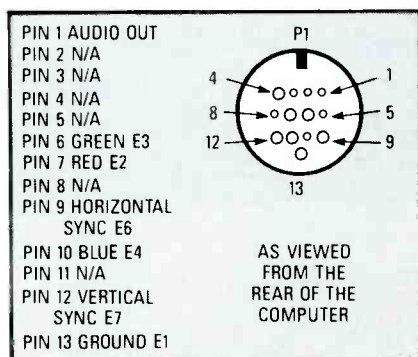

Fig. 5 VIDEO OUTPUT connector of the Atari ST.

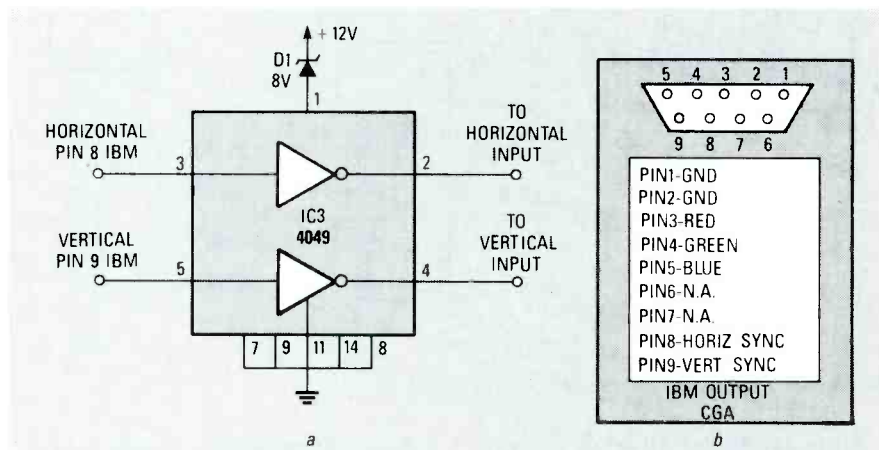

Fig. 6 USE THIS CIRCUIT FOR AN IBM CGA video system. The gates invert the sync lines.

BUILD THIS

THE USE OF FAX MACHINES IS CATCHING ON by storm, and, as fax-machine prices continue to drop down toward the five-hundred-dollar mark, their sales will continue to skyrocket. However, the one continuing problem with using a standard auto-answer fax machine, is that it requires a separate phone line because it answers on the first ring and the modem tones make voice communication impossible. Unfortunately, the monthly cost of a second phone line may be higher than the lease cost of fax equipment! Computer-modem users have been fighting the same problem for years.

Historically, the solution has been to prearrange a fax transmission with a quick phone call, and then call back after the fax machine is connected. While that does work (if someone is there) it's inconvenient for everyone. The solution is to allow the same phone line to receive both voice and digital data, and that's where the Fax-Mate comes in. It will prevent your fax machine from answering a phone call before you get a chance to, allowing you to use one phone line for both of them—but, of course, only one of the two at any given time.

Theory of operation

Voice calls are the majority of telephone contacts; and with a single line, they are usually the most important. That means that the telephone should be answered first. A fax machine will also try to answer first when plugged in, so it must be iso-

lated until needed. The Fax-Mate acts as a switch between the incoming line and the fax machine. It:

- 1) Separates the fax machine from the phone line
- 2) Rings-up the fax machine when commanded
- 3) Connects the equipment to the incoming line

4) Senses the end of the message and resets

Referring to the block diagram in Fig. 1, the incoming telephone line is split into two paths. The top path is the data line that switches the fax equipment on and off, and the lower path continually monitors and waits for a control signal.

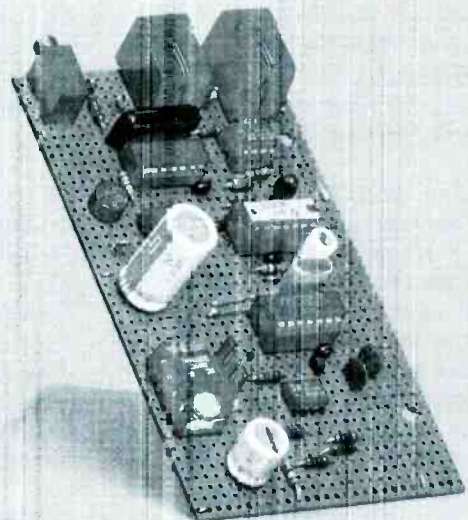

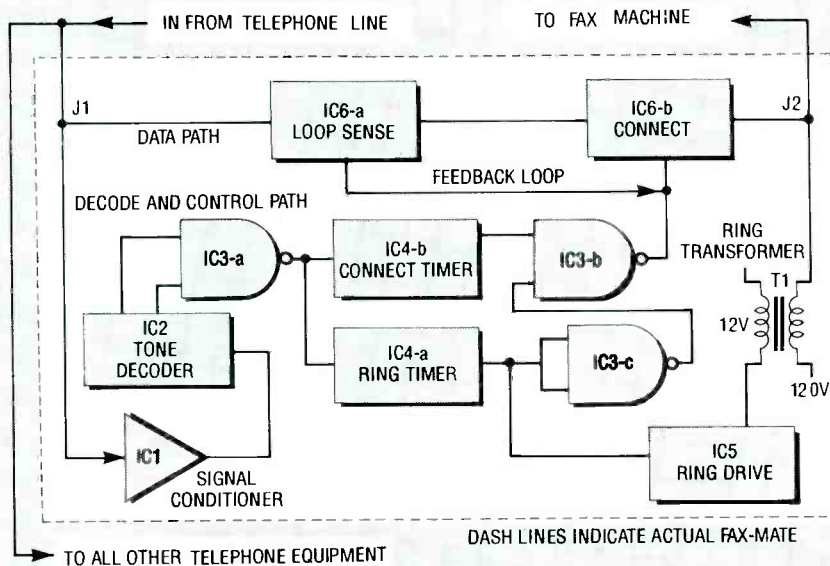

FIG. 1—BLOCK DIAGRAM for the Fax-Mate. The upper path is for data, and the lower one is the decode and control path.

Starting with the lower path, the phone line enters an op-amp. The op-amp, IC1, converts the balanced phone input to a single-ended signal that drives the tone decoder, IC2. It also serves as a buffer to prevent any incoming high-voltage ringing signal from entering the tone decoder.

When the decoder detects a *Touch Tone* representing the “#” key, its BCD output causes NAND-gate IC3-a to go low. The # key was chosen because it is not used in ordinary dialing and is present on most phones. The low from the NAND gate triggers IC4, a dual 556 timer. The 556 has two distinct functions, and both are triggered at the same time by the tone decoder’s NAND gate. Optoisolator IC5 is driven by IC4-a for 1½ seconds. Transformer T1 is actually a 120-to-12-volt AC step-down transformer used in reverse; what’s normally the primary is now the secondary, and vice-versa. Therefore, the *secondary* of T1 is driven by IC5, and a stepped-up 100 volts AC at the *primary* of T1 provides a ring signal to the fax machine through jack J2. IC3-c also receives an input from the ring timer (IC4-a) and, wired as an inverter, serves to inhibit the connect line during the ring cycle.

The other section of the 556, IC4-b, runs for 15 seconds and drives part of the connect IC (IC6-b) through IC3-b, which will not let the connect signal pass through until the ringing phase is completed. At this point the

fax (or modem) has fired up and is sending out a handshake tone. It will do that 6 or 8 times, along with an ASCII message telling its baud rate. The fifteen seconds that the connect driver is turned on allows the handshake time that is necessary to establish contact. The connect IC (IC6) does two things: IC6-b connects the equipment for the initial link-up and,

when that occurs, the loop-current detector (IC6-a) continues to keep the connect section powered. The hookup is broken when the fax machine hangs up and the loop-current detector turns off the connect section. The system is then reset and waits for the next message.

Circuitry

When working with the phone line, it is very important not to put any foreign signals on the line, and equally important not to load the line except when equipment is connected to communicate. Looking at the schematic in Fig. 2, the upper path is the data path and the lower path monitors the incoming line waiting for a # *Touch-Tone*. As designed, the Fax-Mate will not respond to any other voice or data signal. IC1 is the phone-line monitor buffer, and it conditions incoming tones for the decoder, IC2. C1 and C2 prevent the nominal 48-volts DC on the phone line from overloading the op-amp, and resistors R1 and R2 limit the current on an incoming ringing voltage. The ratio of R3/R2 sets the gain of IC1 to unity, and voltage-divider R6/R7 biases IC1 midway between its supply voltage and ground. That allows the op-amp to operate from a single supply.

The tone decoder, IC2, is manufac-

PARTS LIST

All resistors are ¼-watt, 5%, unless otherwise indicated

- R1—R3, R5—330,000 ohms
- R4, R12—1000 ohms
- R6, R7—27,000 ohms
- R8—1 megohm
- R9—270,000 ohms
- R10—27,000 ohms
- R11—100 ohms
- R13, R14—2200 ohms
- R15—27 ohms
- R16—330 ohms

Capacitors

- C1, C2—0.001 µF, ceramic disk
- C3, C6, C9—47 µF, 16 volts, electrolytic
- C4, C5, C7, C8, C10, C13—0.1 µF, ceramic disk
- C11—0.47 µF, 250 volts
- C12—1000 µF, 16 volts, electrolytic

Semiconductors

- IC1—LM741 op-amp
- IC2—SSI 204CP or Sierra 11204 *Touch Tone* decoder
- IC3—74LS00 quad NOR gate
- IC4—LM556 dual timer
- IC5—MOC3010 triac driver

- IC6—Theta-J TS117 telcom switch and loop sense
 - IC7—7805 regulator IC
 - D1—1N4001 silicon diode
 - BR1—50-volt bridge rectifier
 - LED1—red light-emitting diode
 - LED2—green light-emitting diode
- Other components**
- XTAL1—3.58 MHz crystal
 - J1, J2—RJ-11 modular phone jack
 - J3—¼th-inch miniature phone jack
 - T1—12-volt transformer (see text)
 - S1—DPDT switch

Miscellaneous: 1 8–12-volt AC 300-mA wall adapter, modular phone cable, project case, solder, etc.

Note: A kit containing a PC board and all parts except T1, LED1, LED2, S1, the wall adapter, the phone cable, and a project case is available from Benchmark Research, Inc., 2727 W. Manor Pl., Seattle, WA 98199, for \$65.00 plus \$2.50 shipping and handling. WA residents must add 8% state sales tax.

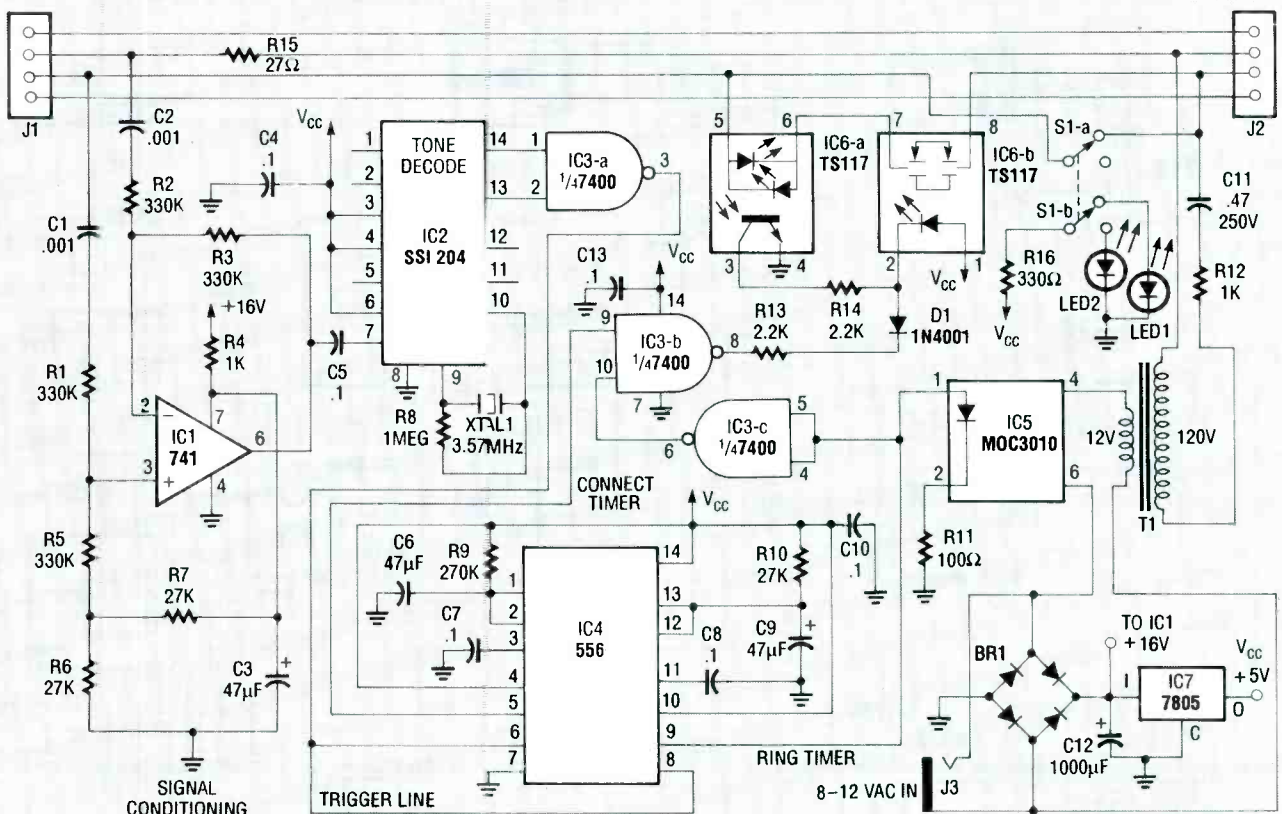

FIG. 2—SCHEMATIC for the Fax-Mate. Notice how it closely resembles the block diagram.

tured by both SSI and Sierra Semiconductor under part numbers 204CP and 11204, respectively. Both work equally well, require no tuning, and show great immunity to false triggering. Furthermore, all they require is an external crystal and a 1-megohm resistor, and they can drive either CMOS or TTL. The output is three-state 4-bit hexadecimal. The decoder can read 16 tone sets, but a typical telephone has only twelve keys. The other keys are for phone-system internal use, as well as certain industrial controls.

The decoder puts a high on pins 13 and 14 when the # tone is decoded; the two high pins drive NAND-gate IC3-a low, which triggers the 556 timer, IC4-a. That section of the timer drives IC5 for 1/2 seconds to generate the ring signal required to activate the fax or modem. The MOC3010 (IC5) is one of a series of triac drivers designed to be optically coupled to 5-volt logic, but is used here to drive the 12-volt secondary of the ring transformer, T1. IC5's drive is current-limited by R11, and the 1/2-second high signal from IC4-a also goes to IC3-c which is wired as an inverter.

At the same time, IC4-b (the 15-second timer) is triggered and sends

its high signal to another NAND gate, IC3-b. That gate also receives the low input from the inverter, IC3-c, and will not let the connect stage conduct until ringing has finished. IC3-b drives the data-connect circuitry through R13 and D1, preventing current from flowing backward when the data line is self-running.

In Fig. 2, one side of the telephone line enters J1 and passes through R15 to the fax jack, J2. Resistor R15 balances that side of the line against the small resistance that IC6 inserts into the lower loop. (By the way, the Fax-Mate is not dependent upon phone-line polarity, but the PC layout does adhere to tip-and-ring standards in and out of the project.)

Incoming data passes through 1/2 of IC6, the current-sensing portion of a TS117 optoisolator. As shown, the telephone-loop current is fed through a bidirectional LED configuration that controls a phototransistor output. That output latches the connect section of the optoisolator, IC6-b.

The project draws 25 mA in its quiescent state from the 5-volt output of IC7, a 7805 regulator IC. From a 12-volt AC supply, the filtered input to the 7805 is 16 volts, yielding a device dissipation of 275 milliwatts.

Switch S1-a connects the data equipment straight through the Fax-Mate for outgoing calls. S1-b is used to switch between two LED's (a red and a green), as a reminder to put the project back into receive. Nothing serious will happen if the device is left in the send mode, except that the fax machine will answer before you do.

Construction

With the exception of T1 and the front-panel components, everything mounts on the printed-circuit board, for which a foil pattern is provided in PC Service. Perfboard construction is also adequate. There is also a kit that is available that includes a drilled and plated PC board and all parts that mount on it. However, you will have to supply your own transformer, front-panel LED's, switch, and cabinet (see Parts List).

The PC board measures 2 3/4 x 4 3/4 inches, and that, alongside Radio Shack's 12-volt transformer (part no. 273-1385) measures 4 1/4 inches across. The required internal height is 1 1/4 inches. The cabinet shown in the photographs is a Pac-Tek model CM 5-125, but any enclosure of the right size will do.

It is helpful to attach leads to the

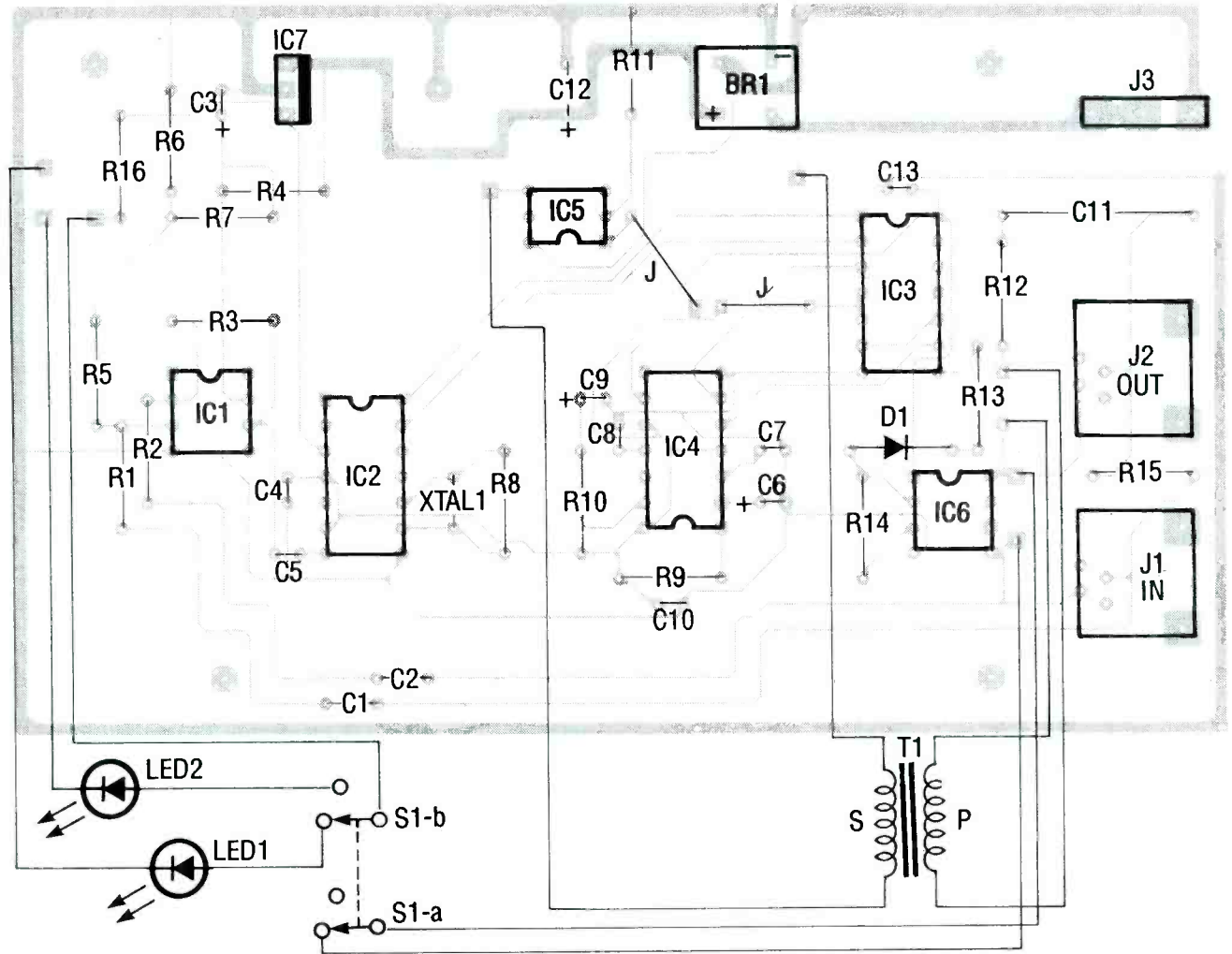

FIG. 3—PARTS-PLACEMENT DIAGRAM. A similar layout can be used if you choose to use perfboard instead of a PC board.

transformer before mounting it, because they will be difficult to attach once T1 is mounted. Also, as in the prototype, T1's pins may be bent sideways to mount the transformer directly to the case. Just be sure that the wiring does not touch the underside of the PC board.

A Parts-Placement diagram is shown in Fig. 3. Some builders prefer to use sockets for the IC's, but they are not necessary for this project. The PC board is laid out for a closed-circuit jack for J3; the third pin is not used, but it adds mechanical strength to the power jack mounted on the PC board, and it costs just a few cents more. The modular jacks, J1 and J2, have protrusions that fit through holes in the circuit board; the protrusions can then be flattened out with a hot soldering iron to secure the jacks in place. (Be sure to clean and re-tin the iron's tip after melting the plastic.)

The prototype uses a red LED for a transmit indicator and a green LED

for receive. That tells you which position the switch was left in—in other words, green is for go. Also, because the two jacks are identical, they should be labeled "Tel In" and "fax Out."

One last thing: the Fax-Mate requires an AC power source of 8–12 volts. Many R-E advertisers offer such wall adapters.

Installation and test

Installation of the Fax-Mate consists of unplugging the fax (or modem) from the incoming phone line and connecting the unit to the Fax-Mate's J2. The Fax-Mate then requires one modular cable to connect it to the incoming telephone line.

As a first test, with the Fax-Mate installed, punch in any variety of digits; nothing should happen. Then enter the # sign; you should hear the fax fire up and transmit the handshake signal. The signal, a steady tone followed with an ASCII burst, will re-

peat for about 30 seconds. The machine will then automatically reset. The second test is equally simple. Have a friend who also has a fax machine send you a fax. Explain to him that once your phone is answered, either by yourself, family, answering service, or answering machine, he should push the # sign and press the send button on his fax machine. The sender (or the originator) will hear the receive tones. The receiver (you, the host) will continue contact until the sending fax finishes. Your fax (or modem) will then hang up and the Fax-Mate will reset and wait for the next incoming call.

Once your Fax-Mate is operating properly, leave it connected to your fax machine and make sure that it is set on "receive." That way you will avoid the inconvenience of having your fax machine answer the phone before you get a chance to. Use the "send" mode only when you wish to send a fax to someone else. R-E

BUILD THIS

ALPHA/THETA MEDITATION GOOGLES

Our alpha/theta meditation goggles can help you relax!



MARK WORLEY

MOST OF US NEED TO LEARN HOW TO RELAX FROM THE EVERY day stress of modern life. Research has shown that while in a relaxed state, our brains are generating alpha waves. For example, practitioners of yoga and transcendental meditation, after months and sometimes years of painstaking practice, can put themselves into a state that produces a preponderance of alpha brain-waves. But because few of us

have the patience to learn yoga, a far simpler technique to achieve relaxation is by using alpha-wave biofeedback.

The Alpha/Meditation Goggles (AMG) will allow you to readily produce those restful alpha waves through a process called photic stimulation. That technique has been used since the 1930's, but, until recently, it required a darkened room with bulky, expensive equipment. Now, solid-state electronics provides an inexpensive, safe, pocket-sized photic stimulator that runs on a 9-volt battery.

Photic stimulation

Alpha waves are a normal rhythm of brain signals, ranging from about 7 Hz to 14 Hz. They are low in amplitude and occur infrequently while you're in an alert awake state. However, they become pronounced when you close your eyes and fall into a cozy, drifty state of physical and mental relaxation.

When a person's particular alpha (or theta) frequency is visually flashed into their eyes, their brain tends to "resonate" with the light flashes. Because each person has their own dominant alpha frequency (or theta frequency), the flashing light has to be adjusted to a rate that nearly matches that frequency for any real effect.

The applications for the AMG range from helping you to get to sleep more easily, to

meditate, or for self-hypnosis training. You'll find that the alpha waves occur while you're in a state of relaxed awareness, which is often called an *alpha state*.

Circuit description

As Fig. 1 shows, a 555 astable oscillator (IC1), and transistor driver (Q2) are used to flash the series-connected LED's over an adjustable range of about 6.5 pps to 14.5 pps (pulses per second), or, optionally, 3.5 pps to 7 pps.

IC1 is configured as a conventional astable oscillator having an output pulse that goes low for 10 ms at the rate set by potentiometer R1. Resistors R4, R5, and R6 allow the oscillator to be fine tuned to correct for $\pm 20\%$ tolerance error in C2 and R1. You can use a frequency counter on pin 3 of IC1 to set R1's range, so that it has about the same overlap at each end of the 7- to 14-Hz band.

Note: Resistors R4-R6 can be omitted from the project, because it may not be necessary to trim the flash rate of your instrument so precisely. If you like, R5 can be a panel-mounted potentiometer for fine-adjusting R1.

Transistor Q1 is normally kept off by R8; Q1, in turn, keeps Q2 off. A low-going pulse from IC1 turns on Q1 for 10 ms, and pulses Q2 to momentarily flash the LED's. Resistor R10 will develop 650 mV across it at 54 mA. That 650 mV will turn on Q3 and limit Q2's current to 54 mA. Having that limiter, a constant current passes through the LED's with each pulse, independent of the supply voltage.

Most LED's are rated for about 20 mA of continuous current, but at a 15% duty-cycle, they can handle over 50 mA without harm. The LED brightness is significantly increased, yet the battery drain is still kept quite low. If you find that the LED's are uncomfortably bright, increase R10 to between 15 and 27 ohms.

The specified LED's are high-efficiency versions that emit a surprisingly intense beam of 30-mcd (millicandles are a measure of light intensity) at 20 mA. Standard LED's frequently have an intensity of 1 to 5 mcd, and a scattered, diffused beam. For the best effect, use the specified LED's because they have lightly tinted lenses, higher output, and a narrow beam.

Commonly, red LED's have a forward voltage drop (V_F) of about 1.7

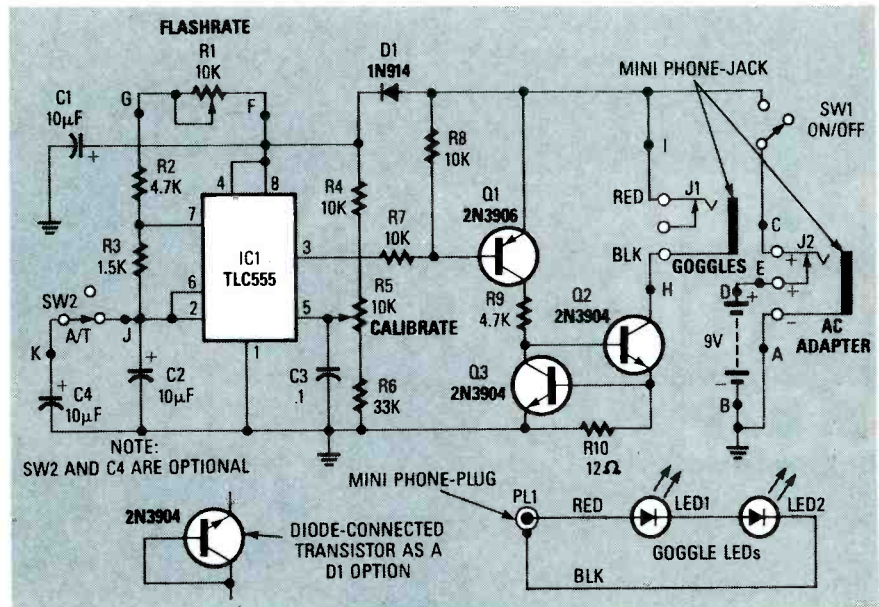

FIG. 1—THE HEART OF THE ALPHA MEDITATION circuit is a simple 555 timer whose pulse frequency is controlled by potentiometer R1. The pulse rate sets the visual flashing rate of the LED's in the goggles.

volts at 20 mA, whereas the brighter ones typically have a V_F of over 2 volts.

Therefore, up to four standard LED's can be used in the circuit. However, the V_F of the brighter LED's prevents using four of them with a 9-volt supply.

Diode D1 and capacitor C1 provide better power-supply filtering and isolation for IC1 than a conventional R/C filter. However, a 100-ohm resistor can be substituted for D1 if you desire. For a very-low voltage loss across D1, you could try using a Schottky diode or a diode-connected transistor, such as a 2N2222 or 2N3904 (see Fig. 1.). That isn't really necessary, but it may keep some purists happier. Without the filter, the high-current pulses through the LED's can adversely affect the 555's operation, particularly with a weakening battery.

A mini phone-jack, J1, provides a convenient way to disconnect the goggles from the control box for storage. Another jack, J2, allows you to power the A/MG from an AC adapter having a 6- to 12-volt DC output. Make sure that the adapter has the proper polarity (a DC output, not AC), and a rating of 50 mA or more. Remember that a 12-volt adapter will not make the LED's any brighter than a 9-volt battery because of the current limiting.

PC-board assembly

The control circuitry does not need special care in assembly or layout, so perfboard should work just as well as

the author's PC-board; the Parts Placement is shown in Fig. 2. For ease of discussion, we'll assume you're using the PC board. Note that the PC board supplied by the author is silk screened with all parts labeled, and solder-pads A through K are identified. All the holes have been drilled to their proper size. The inside of the control box is shown in Fig. 3, while the control box exterior assembly is shown in Fig. 4.

1. To keep the board oriented properly, lay the board on your work surface with the copper side down and S1's mounting holes to your right. Identify the locations of all the component mounting holes, and the mounting pads. Keep IC1 in its anti-static foam until you're ready to install it.

2. Insert the switch into its mounting holes and solder the three leads. The mounting tabs can be soldered to the board, too, but you will have to scrape the black finish from those tabs in order to do that.

3. Install C1, C2, and D1. Those parts are polarized and must be installed as indicated. (C4 should also be installed if it is going to be used.)

4. Install all resistors except R1, and also install C3. There are two ground pads for C3 to accommodate a variety of capacitor styles and sizes. One of C3's leads *must* mount in the hole next to C2's "+" sign.

5. Use a piece of capacitor or resistor lead to jumper the two pads on the 555 (pins 4 and 8). Install the jumper flat

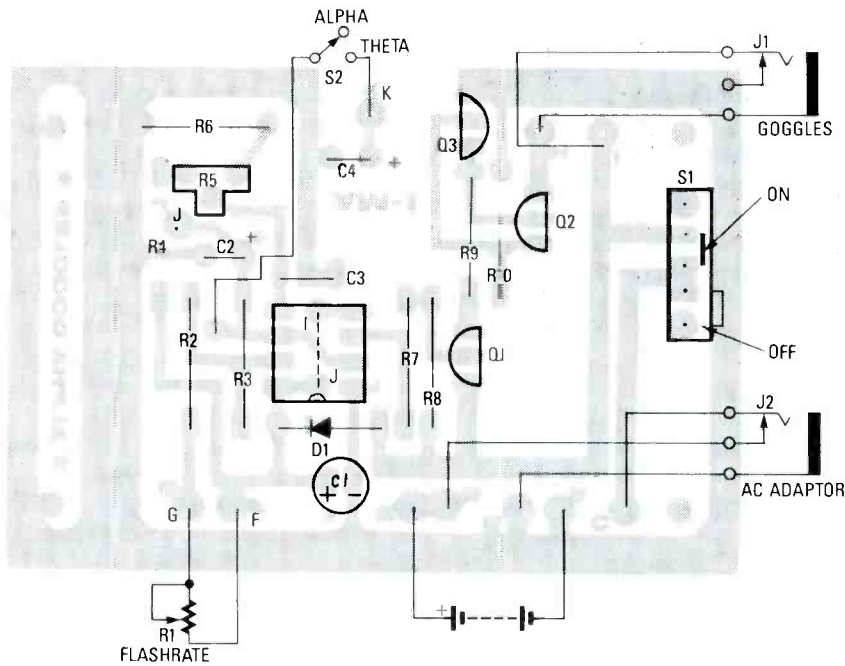

FIG. 2—THE PARTS PLACEMENT for the A/MG PC-board shows switch S1 soldered directly on the board. Notice transistor orientation, and the polarity of capacitors and diode D1.

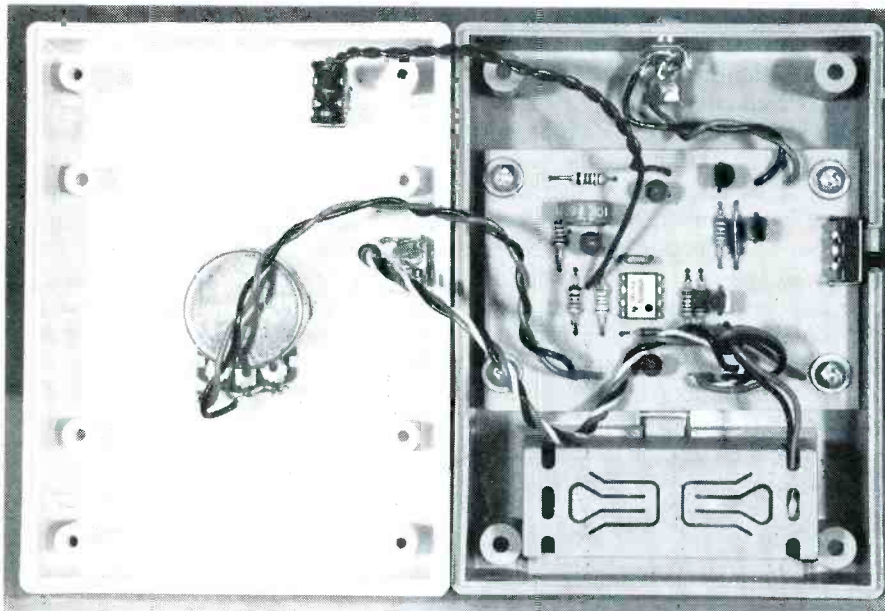

FIG. 3—THE INSIDE VIEW OF THE A/MG control box. Notice the clean layout. A 9-volt-battery compartment is just below PC board.

on the component side of the board. The 555 will be installed on top of that wire.

6. Identify the three transistors, Q1-Q3. Install them with their flat side facing the proper direction, according to the Parts-Placement diagram in Fig. 2.

7. Install IC1 with pin 1 in the lower-right corner near D1. (Pin 1 is also identified on the copper foil.) Be sure the jumper wire has been installed under IC1 before you install IC1 or a

socket. We'll continue with the remaining wires later.

8. Temporarily mount the board loosely in the bottom half of the box on top of the mounting bosses, and mark the hole for the on/off switch. Be sure to slide the switch between its two positions when marking the cut-out. The plastic is easy to cut, so a small, flat file is all that's required. The switch has a low profile, so the top half of the case does not have to be notched.

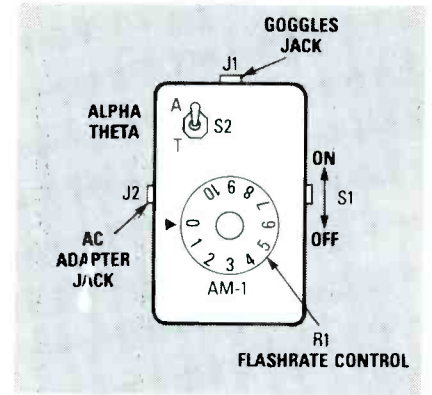

FIG. 4—EXTERIOR DIAGRAM OF THE A/MG control box showing the position of the flashrate control knob, and various jacks and switches.

9. In the bottom half of the case, mount a mini phone-jack (J1) for the goggles. Also, mount a jack for the AC adapter (J2) on the top half of the case. Make sure the jack clears any internal obstructions.

10. Insert the battery-clip leads from inside the battery holder through the slot on the right side. Tie a large knot in the leads to keep them from pulling back through the slot, while leaving 1/4 inch of lead length to solder to the PC board.

11. Solder the black battery-lead to solder pad "A" and the red lead in pad "D." (If you aren't installing an AC-adapter jack at this time, solder the red battery lead to pad "C," and the black lead to pad "A.")

12. Solder a red wire to pad "C" and a black wire to pad "B," then route them to the AC-adapter jack and solder them in place. Make sure that the polarity of the adapter matches the red (+) and black (-) wires. Also, connect a white wire between pad "E" and the switched terminal on the same jack. (That way, the battery will be disconnected when the AC adapter is plugged in.)

13. Solder a black wire between pad "H" and the outer ring terminal of the jack for the goggles, then solder a red wire between pad "I" and the "tip" terminal of the same jack.

14. Drill a hole in the center of the box's cover for the flash-rate potentiometer, R1.

15. If the theta-range option is used, connect a pair of lightly twisted 3-inch wires from pads "J" and "K" and S2, which should be mounted on the instrument's cover. Either wire can go to either pad. When S2 is closed, the A/MG will be operating in

PARTS LIST

All resistors are 1/4-watt, 5%.

R1—10,000 potentiometer
R2, R9—4700 ohms
R3—1500 ohms
R4, R7, R8—10,000 ohms
R5—10,000 trimmer potentiometer
R6—33,000 ohms
R10—12 ohms

Capacitors

C1—10 μ F, 15 volts, electrolytic
C2, C4—10 μ F, 20 volts, 10%, tantalum
C3—0.1 μ F ceramic disk

Semiconductors

IC1—Texas Instruments, TLC555CP oscillator
Q1—2N3906 transistor
Q2, Q3—2N3904, 2N2222, or equivalent transistor
D1—1N4148, 1N914, or equivalent diode
LED1, LED2—Dialight #521-9247, red LED

Other components

S1—slide switch, Mouser #10SP018
J1, J2—mini phone-jack, 2 conductor, closed circuit
PL1, PL2—mini phone-plugs, 2 conductor

Miscellaneous: 9-volt battery clip, Amerex box No. 171, 3/8-inch No. 4 screws, No. 4 washers, knob, PC board, pair of goggles, 1-inch diameter black-vinyl caps for goggles, 4 foot of 22-gauge wire (red and black).

Note: The following is available from Mark C. Worley, P.O. Box 261113, San Diego, CA 92126. Kit #AMG2 complete with all parts for alpha and theta frequencies, including goggles, plain white case, wires, PC board, and article reprint: \$50 plus \$3 shipping and handling per order, \$53 total. California residents add \$3.63 tax per kit (\$56.63 total). A silk-screened PC board is available for \$7.00 plus \$0.75 shipping. CA residents add \$0.51 tax per board. Must be payable to Mark C. Worley on a U.S. bank in U.S. funds. Canadians may use Canadian Postal Money Orders. All items are shipped via ground, First Class mail. No guarantee of delivery outside U.S.A. and Canada. All orders will be shipped within 2-6 weeks, usually sooner. Please include a stamped envelope when making inquiries.

the theta mode, otherwise the A/MG will be in the alpha mode. (The unmarked pad between R2 and R3 can be used in place of pad "J" if you find it more convenient.)

16. Mount the PC board with four No. 4 screws and four No. 4 washers, so that S1 is fixed solidly against the inside edge of the box.

Goggle assembly

As shown in Fig. 5, the goggles are built from modified swimming goggles, which can be bought from a variety of department and sporting-goods stores for \$5 or less. Choose darkly colored goggles if you have a choice.

1. Carefully identify the center of the lenses; that's where the LED's will be mounted. That way you'll get the maximum exposure from the LED's.
2. Some goggles are made from a plastic that can shatter quite easily when drilled, so use sharp drill bits and operate your drill at the lowest practical speed possible.
3. Drill the LED mounting holes 0.2-inch in diameter, or better yet, measure your LED's with calipers and drill the holes slightly undersized. With care, you'll get a good press fit. If the hole is too large, a little epoxy or *Super glue* will fix that. Don't worry about a little glue mess because it will be covered later.
4. Drill a series of 5 holes (1/16-inch in diameter) across the top of the goggles (not the lenses) to allow them to "breathe." Remember, they are watertight, so we'll need to let any perspiration escape.
5. Use minimum heat and a heatsink when soldering wires to the LED's because they are easily destroyed by excessive heat. Solder the following wires about 1/4-inch up from the base

of the LED, then clip the LED leads just above the solder point. Tightly twist a pair of red and black 22-gauge wires to form a flexible cable about 3-foot long to connect the goggles and the control box. Solder a 3-inch wire between the cathode of LED1 to the anode of LED2; solder the red wire of the 3-foot twisted pair to the anode of LED1, then solder the black wire of the twisted pair to the cathode of LED2.

6. Finally, attach a mini phone plug to the end of the cable that matches J1, on the control box.

7. After verifying that the LED's flash properly when plugged into the control box, use epoxy, hot glue, or RTV to glue two plastic bottle caps over the exposed lead ends of the two LED's, and then anchor the twisted-pair cable to the side of the goggles to prevent straining the LED solder connections. The caps can be medicine-vial caps, bottle caps, or anything similar that's about 1 inch in diameter.

8. Complete any final assembly work, attach the two halves of the instrument case, and apply power.

Using the goggles

Seat yourself comfortably where you'll have minimal distractions. Put the goggles on and adjust the straps for a comfortable fit. Place the control box where you can easily adjust the flashrate with minimal arm movement. Now close your eyes and turn the A/MG on. Play with the flashrate control for awhile to get a feel for the instrument. At the two extreme ends of the control's rotation, you should

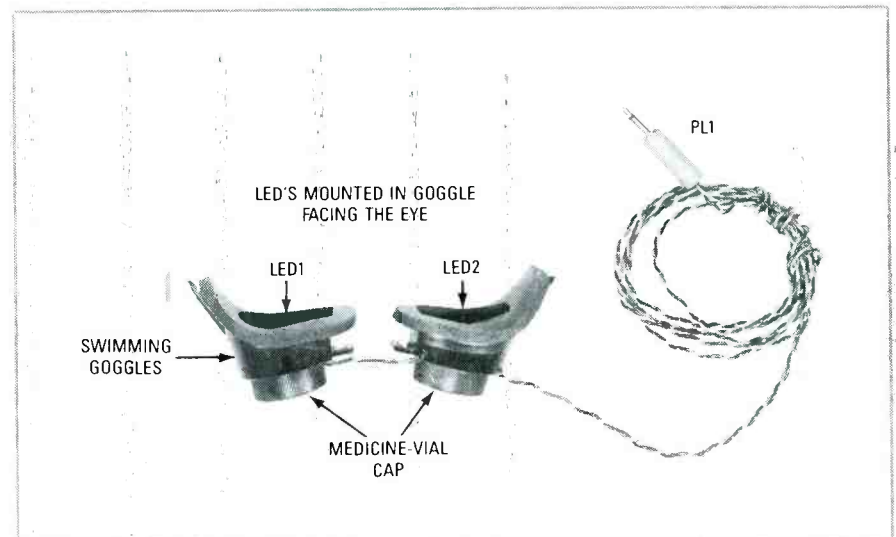

FIG. 5—THE ALPHA-MEDITATION GOGGLES are really common swimming goggles having LED's mounted inside each eye goggle. The LED's are electrically connected in series, and synchronously flash on and off.

feel that the flashrate somehow feels too fast and too slow. Somewhere in between those two extremes is a flashrate that's just right for you.

You should find that even with your eyes closed, there's still a noticeable flashing from the goggles. The LED's aren't bright enough to hurt your eyes, but the best effects are accomplished with your eyes closed. Continue to adjust the control slowly back and forth as you search for your own, personal alpha frequency.

At the correct frequency, you may find that your eyelids tend to flutter slightly in time with the flashes, or the intensity of the LED's may seem to be greater. Also, somehow, the flashrate will feel more comfortable and in tune with you. Don't force the process or worry too much about whether or not the A/MG is working at your frequency. Pick a rate that seems comfortable and try to relax under its effects.

After about 10 minutes, turn the A/MG off. You will almost assuredly find that you are feeling quite relaxed, almost languid, and that the feeling will begin to dissipate with the instrument turned off. That means that you've found the right flashrate for yourself. Make a note of the dial position for future reference. Each person that uses the A/MG will likely have a different setting.

Theta waves

For those wanting to experiment with the theta band, add a switch on the front panel, S2, that will connect a 10 μ F capacitor (C4) in parallel with C2, for the lower frequency range. (Refer to step No. 15 in the PC-board assembly instructions.) There's a space on the PC board for C4 just below the legend "AM-1." Watch the polarity of the new capacitor. Because the timing capacitance is doubled with C4 added, the pulse width of each flash has also doubled, but the duty cycle is the same because the pulse period has also doubled.

Here is a list of the more commonly documented brain frequencies, and when they usually occur. That is not to imply that these frequencies occur only during these states, or that all authorities on brain functions agree to the exact frequencies specified for each band.

- **Beta:** 14–30 Hz, predominant frequencies while awake.
- **Alpha:** 7–14 Hz, predominant when sitting or lying down quietly

with eyes closed and the mind is at ease.

- **Theta:** 3.5–7 Hz, present during problem solving, also present during sleep or deep trance.
- **Delta:** 0.5–3.5 Hz, present during sleep and, sometimes, illness.

Questions & answers

When do alpha brain waves appear? Alpha waves change under differing conditions and may disappear completely. They are most prominent when the subject is sitting or lying down quietly with the eyes closed and the mind at ease. Considerable mental effort tends to depress alpha waves, such as concentration or emotional excitement can cause their complete disappearance.

What are Alpha goggles? The meditation goggles are photic stimulators that synchronize the brain's natural alpha frequency to that of the goggles. When a close match of the flashing rate and the subject's alpha rate is accomplished, the brain naturally begins to "get in step" with the goggles and increases the amplitude of the alpha waves. Simply put, the flash rate forces the brain to generate alpha waves, resulting in relaxation.

How do you adjust for the proper flash rate? That is a difficult and subjective thing to describe. For the most part, you will notice that as you adjust the rate, it will seem too slow at one point and too fast at another. Somewhere in between those points is a frequency that feels right, somehow. Also, at that rate, you may notice that the flashing lights seem brighter and that your eyelids or other related muscles begin to twitch slightly with the

MEDICAL ALERT

If you are an epileptic, do not use the A/MG goggles. Persons suffering from epilepsy can experience a seizure when exposed to alpha-rhythm photic stimulation. For example, one commonplace photic stimulation is the "picket fence effect," which gives the sunlight a strobing effect when viewed through trees from a moving vehicle—such photic stimulation is also caused by the A/MG goggles. If you are not known to be an epileptic, but begin to perceive an odd odor, sound, or other unexpected phenomenon while using the A/MG goggles, shut it off immediately and seek professional advice from your physician.

rhythm of the lights. The rate does not have to be set precisely.

How do you know that it's working? Again, that is quite subjective, but easily proved. Lie back, set the rate for what seems right, and relax for a few minutes under the influence of the goggles. Now, leave the goggles on, but turn the switch off, using a minimum of body movement to do so. There will be a noticeable "coming down" feeling as you lose the high state of alpha that was induced by the goggles. You'll also feel quite lethargic and at ease, something you might not have noticed while the goggles were flashing. You're still producing a good level of alpha waves and are still in a meditative state with the goggles turned off, so why not continue your meditation at that time?

What dangers are there? With one exception, epilepsy, none that we know of. Photic stimulation is not a new idea. What is new is the application of solid-state circuitry and sensory-reducing goggles. The lights are low-powered solid-state devices called LED's, virtually the same as used in many digital clocks and appliances. There are no dangerous, eye-damaging light levels used.

If you are a known epileptic, do not use this instrument. Lights flashing at the alpha rate can cause a seizure: see medical alert side box. If you have undiagnosed epilepsy, you may perceive an odd smell, or other unusual effect immediately prior to a seizure. If that happens, remove the goggles immediately!

What about hypnosis? The goggles are also a useful aid in hypnosis when the subject is overly analytical, or critical of the hypnotic techniques used. Likewise, self-hypnosis is more easily achieved through the relaxation the goggles provide.

Will I lose control of myself? An emphatic NO. Except as noted about epilepsy, the goggles cannot control your mind; they are only a tool. You are always in control. The state that the goggles help induce is usually of heightened awareness, so you're more aware of your surroundings, but, because you're relaxed, they aren't as distracting.

Of course, there is the chance that you'll become so relaxed you'll fall asleep and miss your favorite TV program, or maybe you'll be late for supper—but those usually aren't classified as harmful side effects. **R-E**

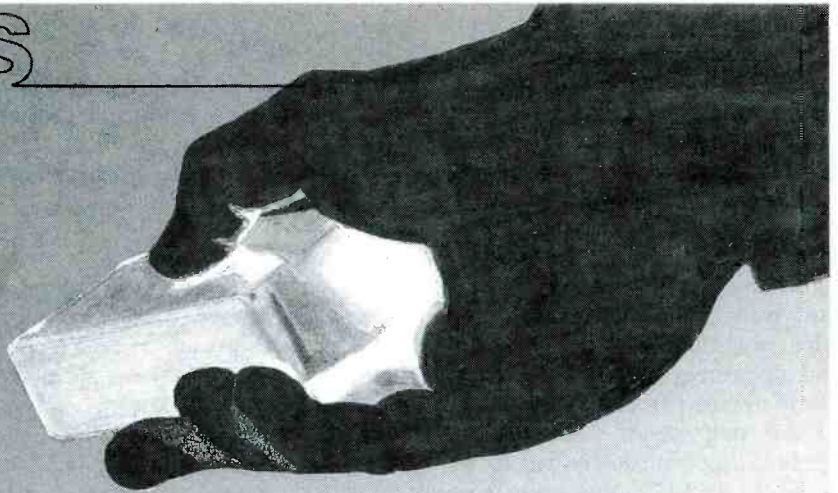

REMOTE A/B SWITCH

With our IR remote control, you can switch cables between your VCR, TV, and outdoor antenna with the same ease as switching channels.

ROBERT A. HEIL

DON'T YOU WISH THAT YOU COULD SWITCH the cables between the outside antenna, VCR, and TV without the hassles of bending over the TV, reaching behind the VCR, and fumbling in dim light to disconnect one cable while connecting others? It doesn't take long before that type of inconvenience forces you to buy a manually operated A/B switch. And for awhile that seems to clear things up. But after going through all that trouble, you still have to get up from your cozy chair to throw the A/B switch by hand. If only you could do the whole thing remotely.

Well that's just what we've done. Our A/B switch operates by an infrared (IR) light beam just like your TV remote control, and that makes it possible to switch TV cables without ever having to leave the comfort of your own chair.

And that's not all! By using a power relay instead of a high-frequency relay, our unit becomes a remote-control power switch for small appliances and lamps. A third module containing a standard relay can be used to remotely turn on and off just about anything else.

A/B switch setup

Here are four tried-and-true setups using our IR remote A/B switch.

- Figure 1 shows a setup in which the incoming television signal is first put through a splitter that outputs two identical signals attenuated between 2–4 dB. (Even though the attenuation is undesirable, it can't be helped.) One signal is fed into the cable box, where it's re-modulated to a TV carrier frequency (usually channel 3), and then routed to the VCR that must be tuned to the same channel. The output of the VCR is then fed to the B input. The other splitter output is fed directly into the A input.

Selecting the B position allows you to watch cable on channel 3. To record a cable program while watching another channel is no problem if your TV is cable-ready. Begin recording your program, then flip the A/B switch to position A. Use your TV remote control to select the desired channels on your TV tuner. If your TV set is not cable-ready, then that setup won't work; but don't despair, maybe the setup in Fig. 2 can help you.

- Figure 2 shows the A/B switch

between the cable box and the VCR. If you have an older TV and a remote-controlled cable-ready VCR, you can use the VCR to tune in the unscrambled cable channels. Position A restores full operation to your VCR tuner including multiple programming features, assuming it's cable-ready. In that setup, the TV must be tuned to Channel 3 at all times.

- Figure 3 shows a setup that allows you to watch unscrambled cable channels (or a tape playback) on the second TV that's cable-ready, while viewing scrambled cable or a VCR tape on the main TV set. If a family member decides to play a tape or record a program, you can retreat to the second TV and watch something else.

- Figure 4 uses two A/B switches. You can watch either the VCR or cable box on channel 3, or unscrambled channels using your cable-ready TV tuner. If you add an IR remote extender as described and featured in the May, 1989 issue of **Radio-Electronics**, the second TV can be anywhere in the house.

As you can see, A/B switches can be used in many ways to contour a system to your liking. If the input

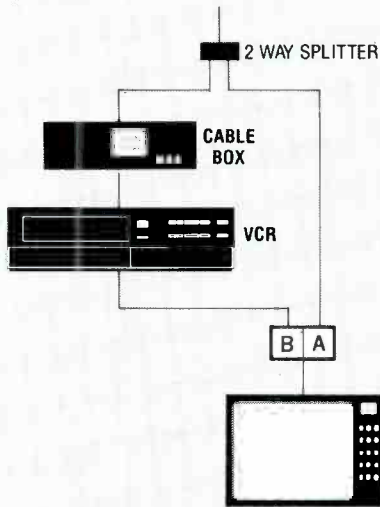

FIG. 1—YOU CAN RECORD a scrambled show while watching an unscrambled one with this setup. Your TV must be cable-ready to do so.

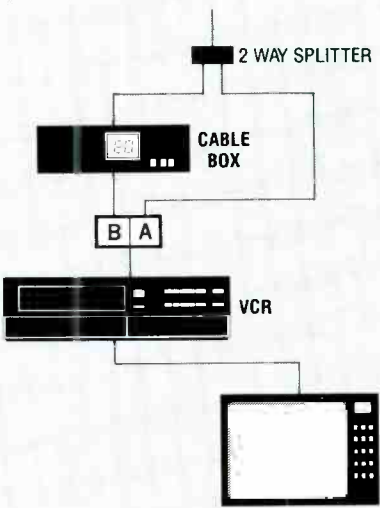

FIG. 2—THOSE WITH OLDER TV SETS and a cable-ready VCR prefer this setup.

signal loses too much strength due to signal splitters, just add a 10-dB signal booster (such as Radio Shack's 15-1118) between the input of the first splitter and the cable trunk line. Besides all the elaborate setups you can create, an A/B switch can also be used to keep an emergency antenna hooked up in case of a cable blackout in your area.

IR transmitter

The IR transmitter is a transistor oscillator that pulses an IR diode at 850 Hz. The IR output is quite strong, even when working off 3 volts. Figure 5-a shows the IR transmitter circuit.

When S1 is depressed, Q4 and Q5 begin oscillating at a frequency determined by R16 and C11; changing C11 to a smaller value increases the frequency. Diode LED4 is an infrared light-emitting diode, while LED3 is a red 2-mA mini light-emitting diode that's connected across LED4 so you can visually monitor the output.

IR receiver

Figure 5-b shows the receiver circuitry. The infrared signal from the IR transmitter passes through a front-end magnifying lens and falls on Q1, a light-sensing phototransistor, where the IR radiation is converted into electrical pulses. The pulses are coupled through C1 and R1 to IC1's inverting input. The biasing of Q1 is set to keep it from saturating too quickly from ambient room light.

Op-amp IC1's gain is set to $\times 1000$ by the R2-R3 feedback network. The reference voltage at IC1's non-inverting input is set at one half the supply

voltage by R5 and R6; that forces the output, pin 6, to one half the supply voltage. Op-amp IC1 is usually powered from a bipolar supply; however, a single-ended supply can be used—as we did—if a midpoint ground is created. The output signal can then vary above and below that (bias) artificial ground.

The output pulses are then passed through R7 and decoupled by C2 before entering pin 3 of IC2, a tone decoder. Here, IC2 compares the pulse's frequency with an internal voltage-controlled oscillator that's set to a specific frequency by potentiometer R17, and C3. The frequency-lock range is set by C5. The delay period, the time between when the pulses are received and when pin 8 of IC2 goes low, is set by C4. Pull-up resistor R9 is needed because pin 8 is an open-collector output. Capacitor C7 shapes up that output, which is then passed to IC4-a where the signal is inverted from low to high.

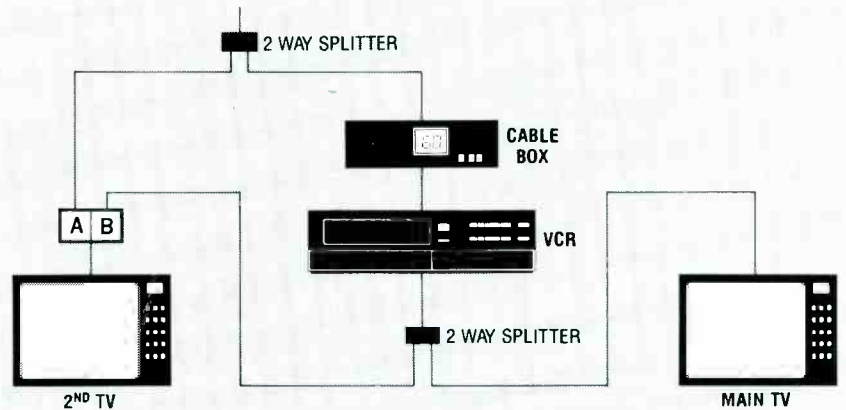

FIG. 3—USE THE A/B SWITCH TO CONNECT A SECOND TV with an option to watch either unscrambled cable via the A input, or scramble cable or a VCR tape via the B input.

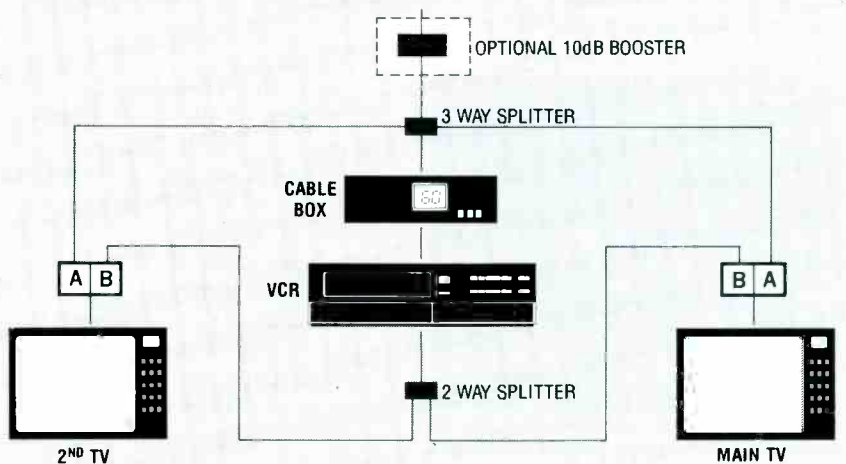

FIG. 4—THIS SETUP USES TWO A/B SWITCHES to provide more viewing options.

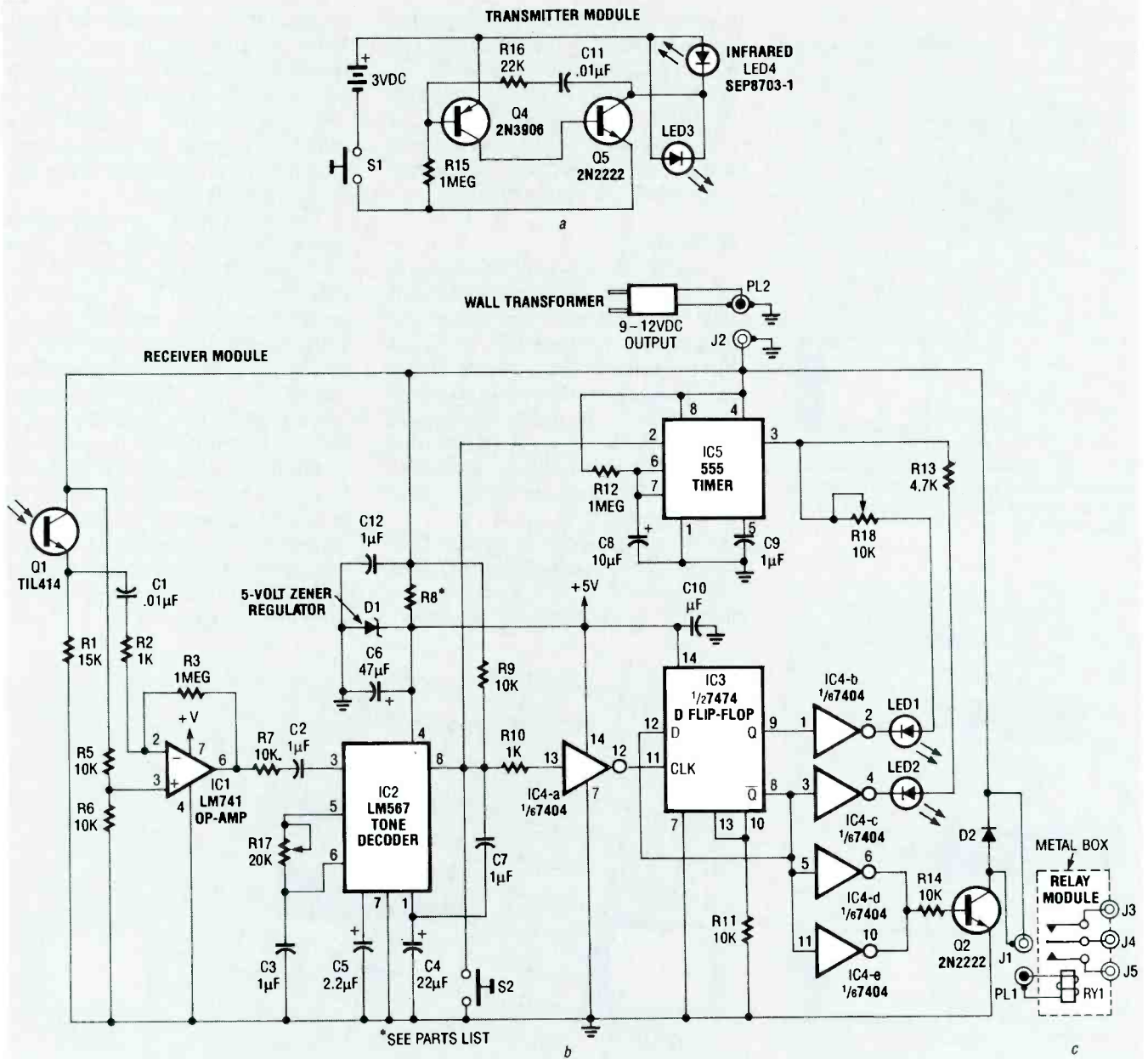

FIG. 5—THE INFRARED TRANSMITTER (a) can't get much simpler than this: two transistors with RC feedback. The infrared receiver (b) uses a number of optional components. For example, IC5 is used to turn the A/B indicator LEDs off after about 15 seconds. The relay module (c) is simple in design, although a bit complicated to construct. Do not attach the ground side of J1 to the board ground. If using a metal case be sure to isolate J1.

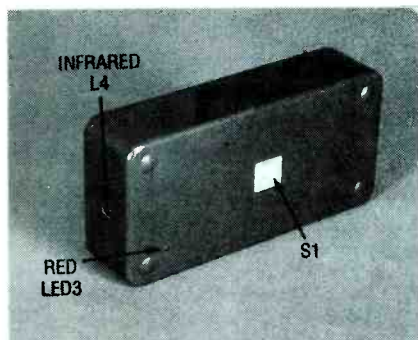

FIG. 6—YOU CAN ASSEMBLE THIS IR transmitter even smaller than the author's model. This project case is about the same size as a regular remote control.

The Q and \bar{Q} outputs of D flip-flop IC3 toggle on the rising edge of the output from IC4-a. The two inverters IC4-d and IC4-e are connected in parallel to double the available driving current to Q2. When IC3's \bar{Q} output goes high, inverters IC4-d and -e go low, and that turns on Q2. The bottom side of relay RY1 is grounded by Q2, which energizes the relay coil, so the contacts throw to the opposite position. Diode D3 protects the collector of Q2 by suppressing negative voltage spikes that occur when the relay coil is de-energized.

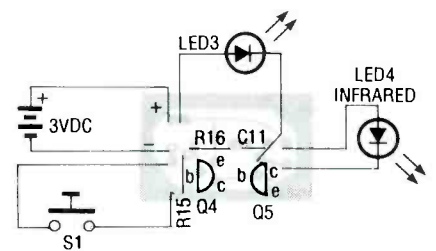

FIG. 7—THE IR-TRANSMITTER PC board should take you about 5 minutes to stuff. Instead of using LED3 as an indicator, try a low-voltage buzzer.

When IR-light pulses of the correct frequency are received, pin 8 of IC2

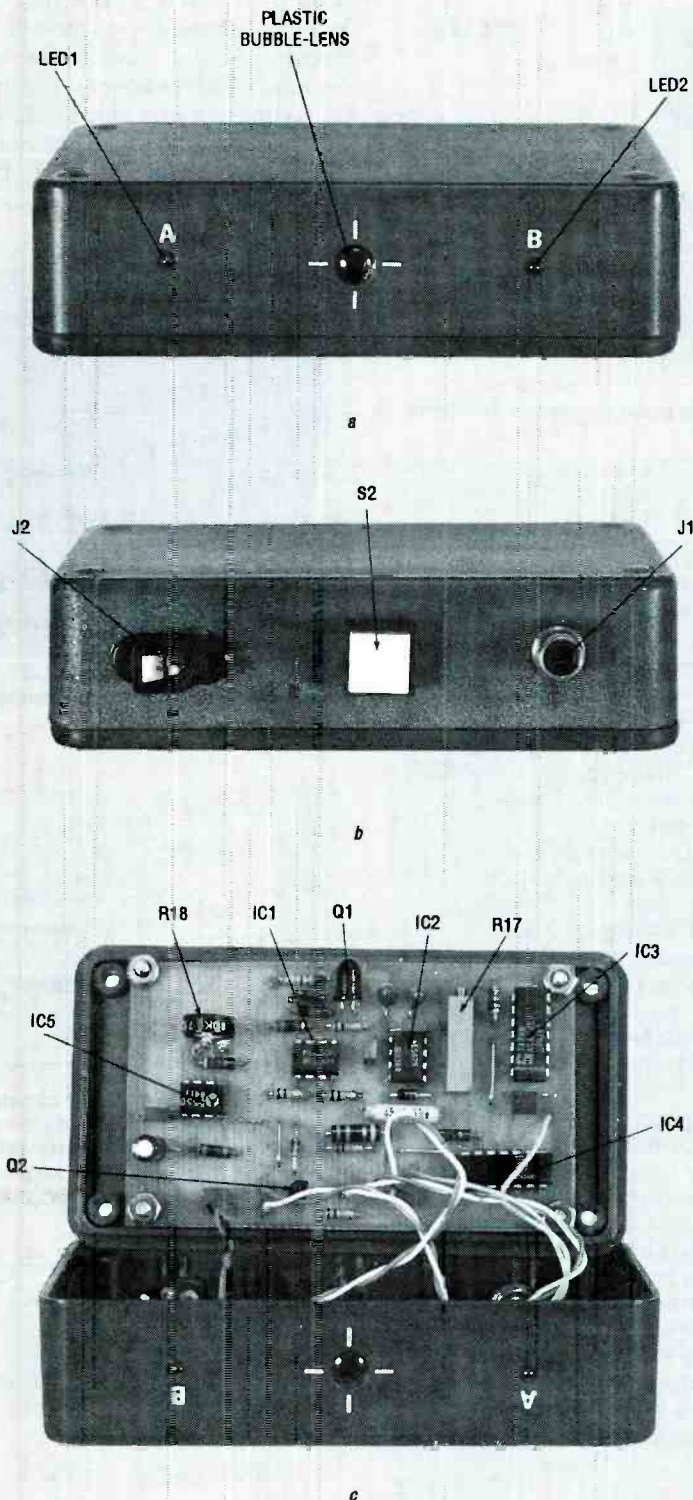

FIG. 8—THE AUTHOR HAS JAZZED UP the front panel (a) with rub-on-letting and decals. The rear panel (b) shows J1, the DC current path for energizing the relay's coil, S2, which manually toggles the A/B switch, and J2, the DC-input jack. The opened IR receiver (c) reveals the author's handy work.

goes low; that forces pin 2 of IC5 low, which starts the timer. Pin 3 goes high for about 20 seconds, supplying voltage to LED1 and LED2. The timing cycle is set by R12 and C8. Resistor

R13 limits the current through LED2. Potentiometer R18 is used to match the current through LED1 to that of LED2, so that both LED's glow with equal brightness.

When the \bar{Q} output of IC3 is low, the output of IC4-c is high, which keeps LED2 off. When \bar{Q} is low, then Q is high, and the output of IC4-b is low, which means LED1 turns on. When Q and \bar{Q} outputs toggle, then the reverse happens, LED2 turns on and LED1 turns off. The 20-second timing circuit is added to keep either LED1 and LED2 from constantly conducting.

Power to the receiver and relay module is supplied by any 9-volt DC, 200-mA wall transformer. Zener regulation (D1, C12, C6 and R8) is used to provide IC2, IC3, and IC4 with a well-regulated and filtered 5-volt supply. Power to the unit can also be supplied by a 12-volt DC supply; however, it will be necessary to change R8 to a 110-ohm, 1/2-watt resistor.

Relay module

The high-frequency relay module shown in Fig. 5-c is simple in design, though a bit touchy to construct because of the necessary RFI shielding. It's capable of switching signals up to 800 MHz with 68-dB isolation.

Construction

For those of you who etch your own PC boards, the transmitter, receiver, and relay-module PC-board artwork is provided in PC Service; however, etched and drilled PC boards can be purchased from the source in the Parts List. Even though a PC board produces a neat-looking product, don't hesitate to hardwire everything on perfboard.

1. Figure 6 shows what the IR transmitter should look like. Its assembly is uncomplicated, and any small project box can be used to house the transmitter. Drill a hole in the box's front just large enough for IR LED4 to peek through; then mount the circuit board, shown in Fig. 7, and position LED4 in the hole you just drilled. The flat side of LED4 is connected to C11. The optional indicator LED5 is located in the corner, and can be fixed securely in place with a small drop of *Krazy Glue*.

2. Figure 8 shows what the IR receiver should look like. The PC board should be mounted on 1/4-inch standoffs. If you don't have standoffs, then use three nuts on top of each other. The large hole for the lens of Q1 in the front of the project box is made with a 5/16 drill bit. Bevel the inside of the hole to give the lens more mounting surface.

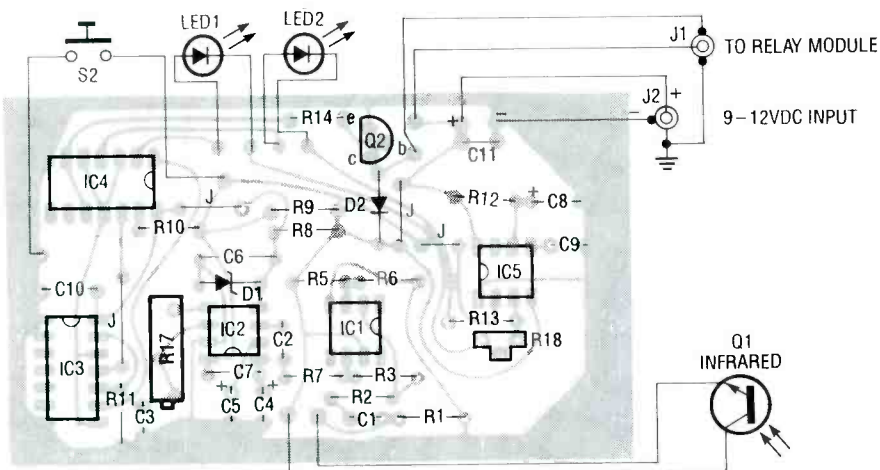

FIG. 9—STUFFING THE IR-RECEIVER PC BOARD should present no special problems.

PARTS LIST

All resistors are 1/4-watt, 5%, unless otherwise noted.

- R1—15,000 ohms
- R2, R10—1000 ohms
- R3, R12, R15—1 megohm
- R5, R6, R7, R9, R11, R14—10,000 ohms
- R8—68 ohms, 1/2-watt for 9-volts DC
- R8—110 ohm 1/2-watt for 12-volt DC
- R13—4700 ohms
- R16—22,000 ohms
- R17—20,000-ohms, 20-turn trimmer potentiometer
- R18—10,000-ohms, 1-turn trimmer potentiometer

Capacitors

- C1, C11—.01 μ F, ceramic disc
- C2, C3, C7, C9, C10, C12—.01 μ F, ceramic disc
- C4—22 μ F, 16 volts, tantalum
- C5—2.2 μ F, 35 volts, tantalum
- C6—47 μ F, 35 volts, electrolytic
- C8—10 μ F, 35 volts, electrolytic

Semiconductors

- LED1, LED2—Mini red LED's
- LED3—micro red LED
- LED4—SEP8703-1 Infrared LED
- D1—5.1-volt DC, 1-watt Zener
- D2—IN914 switching diode
- Q1—TIL414, NPN infrared phototransistor
- Q2, Q5—2N2222, NPN transistor
- Q4—2N3906, pNP transistor
- IC1—LM741 op-amp

- IC2—LM567 tone decoder
- IC3—7474 D flip-flop
- IC4—7404 hex inverter
- IC5—LM555 timer

Other components

- T1—9-12-volt DC, 200 mA, wall transformer
- S1, S2—SPST momentary switch
- RY1—SPDT (Digi-Key PN Z701-ND) high-frequency relay, Omron
- J1—phono jack
- J2—5-mm DC power jack
- J3-J5—coax F-connector jacks
- PL1—phono plug
- PL2—5-mm DC power plug

Miscellaneous

- Two 1.5 N(size) cell batteries, shielded wire, hookup wire, hardware, plastic and metal enclosures, RFI shield tape.

Notes: The Omron high-frequency relay Z701-ND is available from Digi-Key Corporation for \$6.96 plus shipping (800-344-4539). Etched and drilled PC boards are available from RAH, 16 Heritage, Irvine, CA 92714. The transmitter PC board is \$4.00. The receiver PC board is \$8.00. The relay PC board is \$4.50. The three-board kit is \$15.00. All prices are in US funds only. California residents must add sales tax.

The lens is made out of a clear-plastic bubble foot (Radio Shack, 64-2365), which has a natural magnifying ability. The sticky glue on the lens' back surface must be removed. Rubbing a little isopropyl alcohol across the surface with your finger tip should do the job. Apply a small amount of *Krazy Glue* to the bevel

side of the mounting hole, then carefully install the lens so that the bubble faces outward, and the flat side faces Q1. Make sure that the lens is not angled.

Indicators LED1 and LED2 are located on both sides of the lens, and can be mounted in two ways. If you have miniature LED holders, then

drill the prescribed hole size and mount them in the holders. The other way is to drill holes just large enough—a snug fit—to push the LED through. Find a washer that will fit over the LED but not past the lip, and use a drop of *Krazy glue* to anchor the LED to the washer; then place another drop on the washer and slide the assembly through the LED mounting

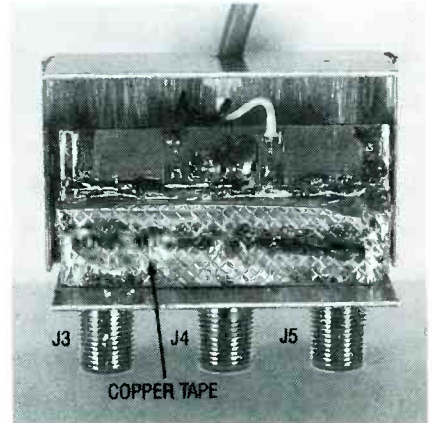

FIG. 10—LOOK AT THE DELICATE WORK needed to construct an RFI shield out of copper tape.

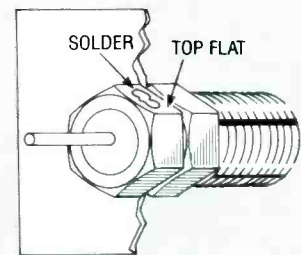

FIG. 11—HERE'S A TIP FOR constructing a RFI shield. Before soldering the copper tape to the nut flats, tin the flats with a little solder first. The relay is on the underside of the PC board as viewed from this angle.

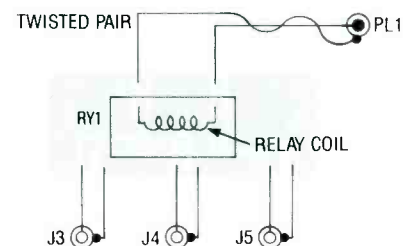

FIG. 12—THE RELAY MODULE'S PC board uses a large ground plane; that helps to shield the relay from stray RF-signals that could cause interference.

hole, anchoring it to the project box. The washer acts as a spacer to stop the LED from protruding outward too far.

If you hardwire the receiver circuit,
(Continued on page 82)

CHOOSING THE RIGHT SHORTWAVE ANTENNA

Boost your shortwave reception using a wire antenna—and a little know-how.

JOSEPH J. CARR

MOST ARTICLES ON HIGH-FREQUENCY ANTENNAS are about transmitting, but there's also a body of knowledge purely about receiving antennas. Who can benefit from knowing about receiving antennas? On top of the list is the shortwave listener (SWL); a close second is the amateur radio operator who wants a separate receiving antenna to pull in those weak DX (distant) stations.

Reciprocity

Antennas possess a property called *reciprocity*. That's a fancy way of saying that antennas work as well on receive as they do on transmit; that's usually taken for granted. For example, many hams use transceivers, which commonly use the same antenna for both transmitting and receiving. A half-wavelength dipole that works well as a transmitting antenna on 20 meters works equally well as a receiving antenna on 20 meters. Antenna properties like directivity, gain, angle of radiation, and polarization do not vary between transmit and receive at a given frequency. (Bear in mind, however, that simple wire an-

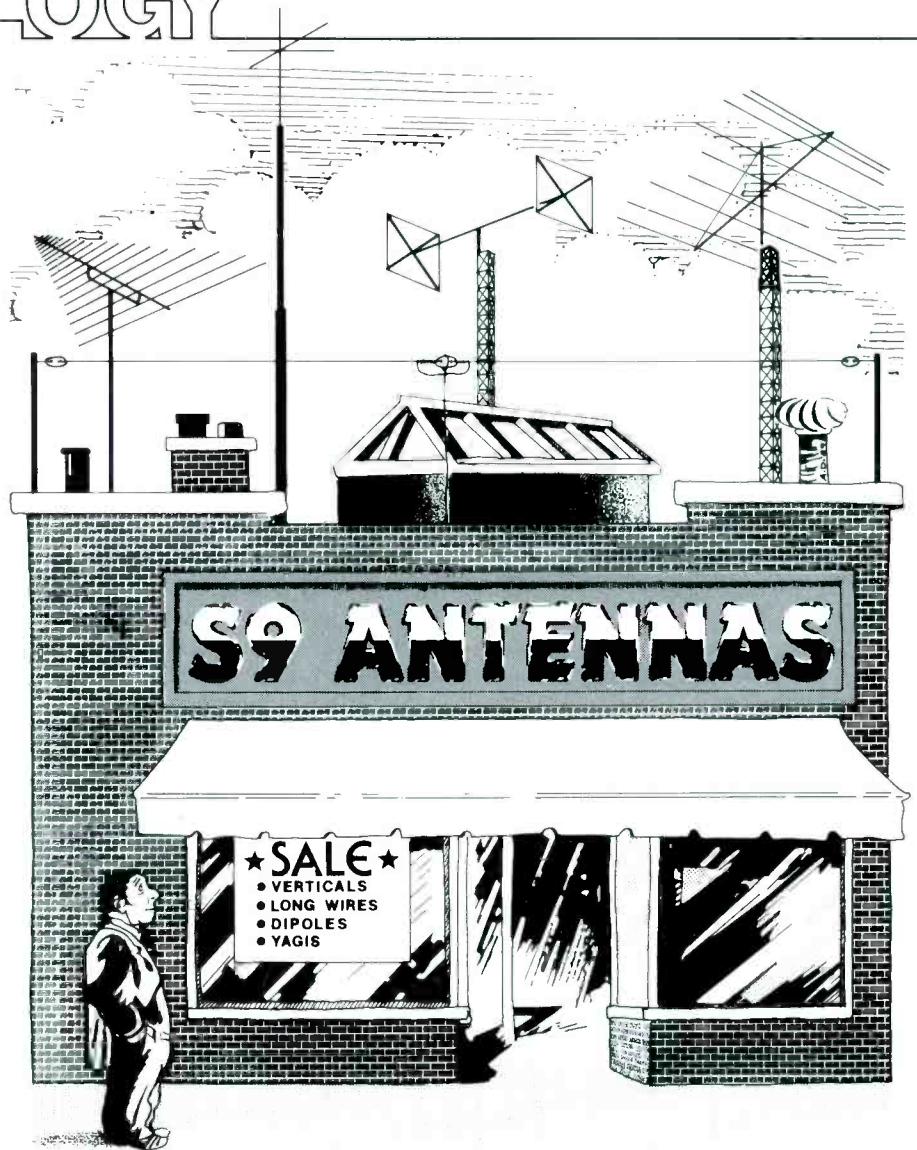

tennas suitable for reception of shortwave signals are not necessarily suitable for transmitting.)

Antenna properties

Assuming that you want more than a simple longwire antenna (which will be discussed shortly), you will want to explore the antenna properties best suited to your monitoring application. Is the antenna to be fixed or rotatable? Do you want omnidirectional or directional reception? In which polarized plane? What about gain?

Because receiving antennas exhibit the same properties as transmitting antennas, any directional transmitting antennas are directional while receiving, too. Therefore, any specifications given for an antenna's transmitting characteristics can be applied

toward receiving characteristics. The common terms you'll come up against when reading antenna specifications are gain, directivity, and angle of radiation. Let's look at each.

Antenna gain stems from the fact that the directional antenna can focus energy. Gain is expressed as the ratio in decibels of the power radiated in a given direction by a test antenna to the power radiated in the same direction by a reference. The two commonly used reference antennas are a dipole (which has a figure-8 radiation pattern) and a spherical point source (which is an isotropic radiator that has an omnidirectional radiation pattern). If an antenna gain is listed as 8 dB over isotropic then, in the direction specified, the radiated signal is 8 dB higher than that radiated by an isotropic antenna.

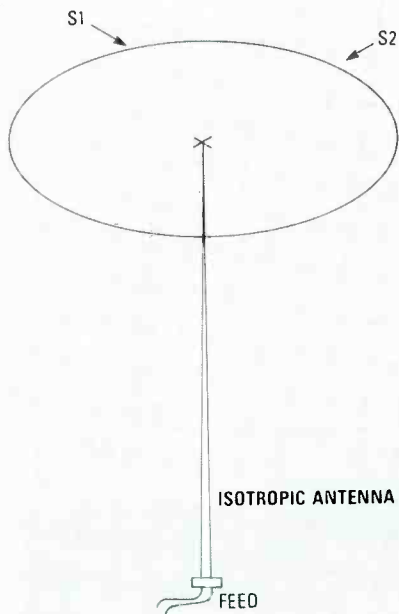

FIG. 1—AN ISOTROPIC ANTENNA is a theoretical construct that receives equally well in all directions.

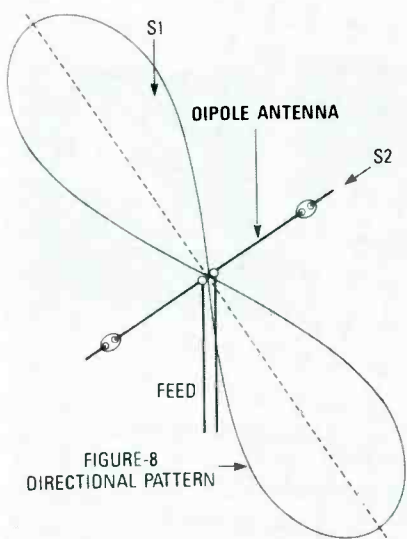

FIG. 2—A DIPOLE ANTENNA has a figure-8 directivity pattern.

So what good is antenna gain? By accumulating more signal, the apparent receiver sensitivity is increased. Note that the antenna gain does not create a higher powered signal, but merely increases the *apparent* signal power by focusing energy—like an electromagnetic lens—from a given direction. Note that antenna gain implies directivity.

Directivity is often taken to mean horizontal directivity. But all antennas radiate in three dimensions, so both azimuth and elevation angle of

radiation are important. Certain VHF/UHF vertical antennas are listed as “gain antennas”, yet the pattern in the horizontal direction is 360 degrees, implying omnidirectional behavior. In the vertical plane, however, lost energy is compressed into a smaller range of elevation angles, so gain occurs by refocusing energy that would have been radiated at a higher-than-useful angle.

A second application of directivity is to suppress interfering signals. On the regular AM- and FM-broadcast bands, each station is allowed a channel (called channelization), permitting receiver selectivity to overcome adjacent channel interference. But in the high frequency (HF) amateur radio and international broadcast bands, channelization is either nonexistent, poorly defined, or ignored altogether. In those cases, interference from adjacent channel signals can wipe out a weaker desired station.

A similar circumstance occurs in co-channel interference when both stations are on the same frequency. In Fig. 1, two 9540-kHz signals, S1 and S2, arrive at the same omnidirectional vertical antenna; both will be heard, or the stronger will drown out the weaker. In Fig. 2, a dipole is used as the receive antenna, so a little directivity is obtained. The main lobes of the dipole are wide enough to provide decent reception of S1 even though the antenna is positioned in such a way that S1 is not along the maxima line (dotted). Better yet, the position-

ing places interfering co-channel S2 in the null (off the ends of the dipole), weakening response to S2. The result is enhanced S1 reception.

The idea is not to exploit the antenna's gain to increase the response to S1, but rather to place the unwanted signal S2 into the null. Note that the notch is sharper than the peak of the main lobe. If the dipole is placed on a mast with an antenna rotator, the ability to place undesired signals in the null is increased even more.

Another antenna parameter of considerable interest is angle of radiation, which also means angle of reception. Because long-distance HF propagation is caused by skip, the angle of incidence for the signal with the ionosphere becomes extremely important. Figure 3 shows two skip conditions from the same transmitting station. Here S1 has a high angle of incidence a_1 , so skip distance D1 is relatively short. For S2, however, the angle incidence a_2 is low, so the skip distance D2 is much longer than D1.

The angular range of effective radiation of an antenna is fixed by its design. The angle of refraction in the ionosphere is a function of ionospheric properties at the time and frequency of interest. For that reason, some well-equipped radio hobbyists use several different antennas. The radiation angle can vary with antenna height as well.

Receiver connection

It's rather naive to state, I suppose,

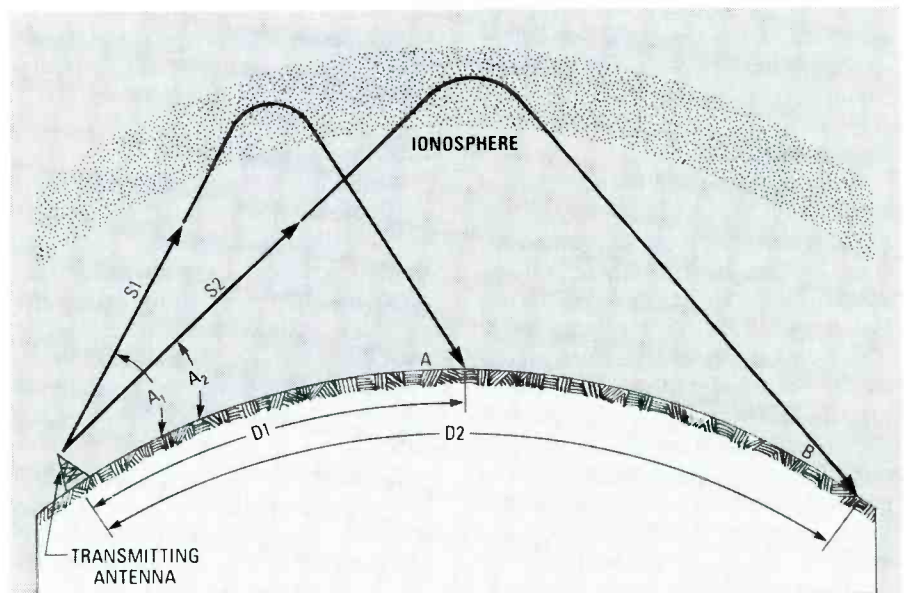

FIG. 3—THE SKIP DISTANCE OF A RADIO WAVE depends upon the angle of elevation at which it's transmitted.

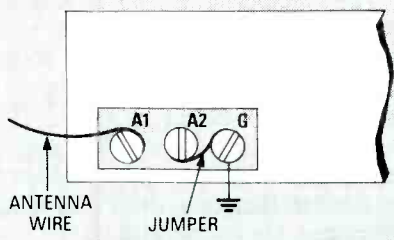

FIG. 4—A RECEIVER'S BALANCED antenna input can be converted to an unbalanced input by connecting A2 and G (ground) together.

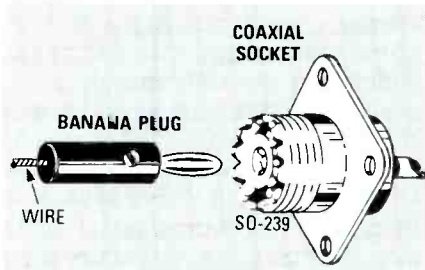

FIG. 5—USE A MINIATURE banana plug to connect your antenna's downlead wire to a standard SO-239 coaxial connector.

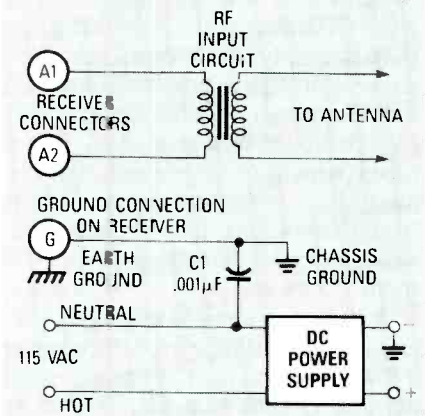

FIG. 6—MANY OLDER VACUUM-TUBE receivers use power supplies that are not isolated from the AC power line. When working on such units, *always* use a 1:1 isolation transformer—for safety.

but let's do it anyway: An antenna must be properly connected to a receiver to be effective. If your antenna uses coax, and the receiver accepts coax, simply attach the proper connector; however, in other cases, non-coaxial cable antennas are used.

There are two major forms of antenna connectors used on shortwave receivers. One uses two or three screws for wrapped wire leads or spade lugs, while the other uses some type of coaxial connector. Consider first the screw-type connector (Fig. 4).

If only two screws are found, then one is for the antenna and the other is for the ground. Those screws will be marked something like "A/G" or "ANT/GND," or with the schematic symbols for antenna and ground.

Three-screw designs are intended to accommodate balanced transmission lines such as twin-lead or ladder line. When balanced parallel lines are used, connect one lead to A1 and the other to A2. Of course, the ground terminal G is connected to Earth ground. On the other hand, for single-lead antennas, connect a jumper wire or bar (a short piece of bare No.22

also serves as the RF common. However, on older AC/DC models the neutral AC power-line wire serves as both DC common and RF-signal ground. In Fig. 6, C1 sets the chassis at RF ground potential, while isolating the DC common from the 60-Hz AC. A danger exists if either the AC plug is installed backwards, or someone wired the socket in the wall incorrectly (which often happens)!

Even if C1 is intact, you can get a nasty shock by touching the antenna ground (G or GND) terminal. The capacitive reactance of C1 is about 2.7 megohms for 60-Hz AC, so you'll get

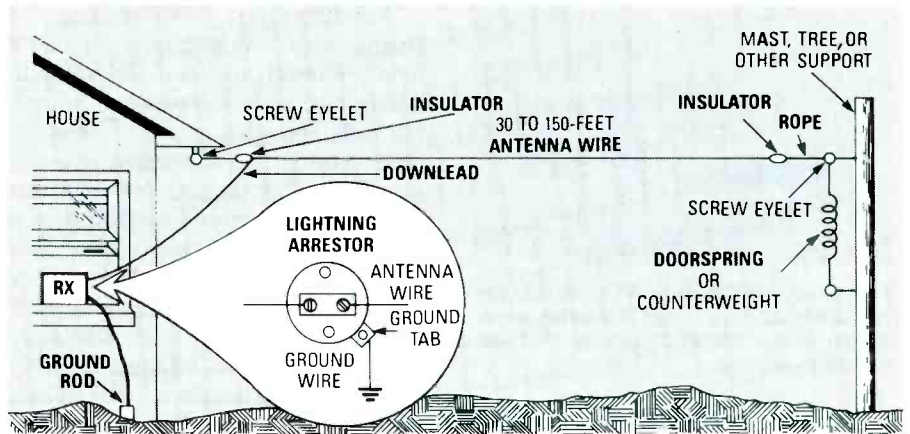

FIG. 7—HERE'S A TYPICAL LONG-WIRE INSTALLATION. Notice the insulator, rope, and spring mechanism, which helps holds the antenna steady when the wind is blowing.

solid hook-up wire) between A2 and G to convert a balanced input to unbalanced. As an interesting aside, shortwave listeners sometimes use ordinary AC-line cord (called zipcord) as a twin-lead transmission line. Zipcord has an impedance that approximates the 75-ohm impedance of a dipole.

On receivers that use an SO-239 coaxial connector, there are two techniques to connect a single-lead antenna. First, using a PL-259 mating plug, solder the antenna lead to the center conductor pin, and then screw the connectors together. An alternative that's easy enough, as shown in Fig. 5, is to attach a (miniature) banana plug to the downlead wire, and then firmly to insert that banana plug into the SO-239 receptacle.

Grounds that bite

Danger! Certain low-cost receivers, especially older vacuum-tube models, have a so called AC/DC (transformerless) internal DC power supply. On most modern receivers the DC common is the chassis, which

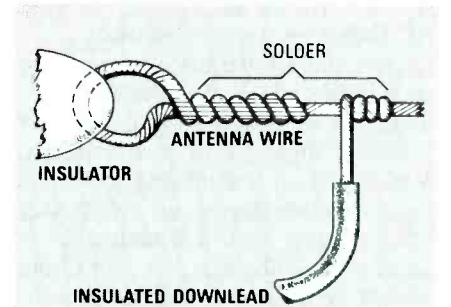

FIG. 8—A GOOD MECHANICAL connection will keep your antenna from falling down prematurely. Solder will keep the electrical connection from corroding too quickly.

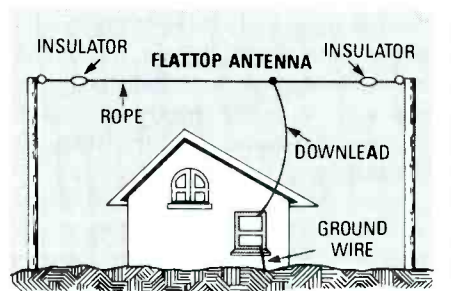

FIG. 9—A FLATTOP ANTENNA is a long wire tapped in the center.

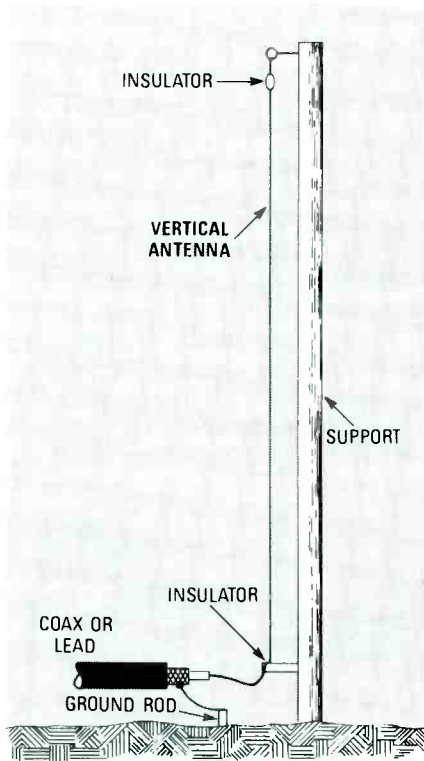

FIG. 10—A VERTICALLY POLARIZED antenna should be at least a quarter-wavelength of the lowest frequency that you expect to receive.

a “bite.” But if that capacitor is shorted, as is likely on older receivers, then the bite might prove *fatal*. The problem is that a reversed polarity AC-line will set the hot line from the AC socket on the ground lead.

The usual advice given to owners of such radios is to make sure that C1 is intact before using the radio. A better solution might be to use a 110:110 VAC isolation transformer to isolate your receiver from the AC power lines. Using such a transformer is standard practice in repair shops, and should be standard practice in your house, too.

Wire antennas

Figure 7 shows the common receiving longwire. The antenna element should be 150 to 300-foot long. Although most texts show it horizontal to the ground and, indeed, a case can be made that performance is better that way—it is not strictly necessary. If you must slope the wire, then it’s doubtful that you will notice any reception problems. The far end of the wire is attached to a supporting structure—a building, tree, or mast—through an insulator and rope.

Wind will cause motion in the antenna wire, and its supporting struc-

ture. Over time, the wind movement will fatigue the antenna wire and cause it to break. Also, if a big enough gust or a sustained storm comes along, then even a new antenna will either sag badly or break altogether. You can do either of two things to reduce the problem. First, as in Fig. 7, a door spring can be used to provide some variable wire slack. The spring tension is selected to be only partially expanded under normal conditions. When the wind begins to blow, the wire’s tension will increase, thereby stretching the spring. Make sure that the spring does not become over-stretched, or it won’t work.

Another tactic is to replace the spring with a counterweight that’s heavy enough to keep the antenna nearly taut under normal conditions, but light enough to move in wind. In other words, antenna tension should exactly balance the counterweight under normal conditions, and not stretch the antenna wire excessively.

The antenna wire should be either No.12 or No.14 hard-drawn copper, or stranded wire. The latter is actually steel-core wire with a copper coating. Because of “skin effect,” RF signals only flow in the outer copper coating. Soft drawn copper wire will stretch and break prematurely, and should be avoided.

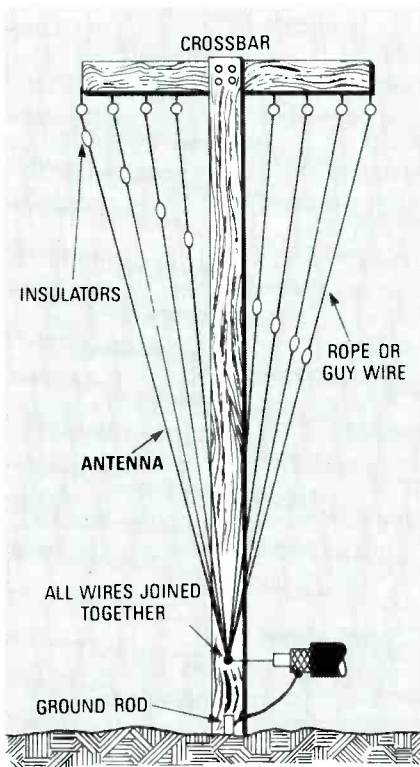

FIG. 11—TUNE IN THE WORLD with eight antennas in one.

The antenna downlead should be insulated and stranded; stranded wire breaks less easily than solid wire. Again, use No.12 or No.14 wire, although No.16 could be used. The point where the downlead and antenna wire are joined should be soldered to prevent the joint from corroding over time. Do not depend on the solder for mechanical strength, for it has very little. Instead, as shown in Fig 8, mechanical strength is provided by proper splicing technique.

There are several ways to bring a downlead into a building. If you can tolerate a slight crack in the junction of the sash and sill, then run a wire underneath the sash and close the window. However, the job looks mechanically nicer with a flat strap connector that passes under the window. Of course, you can always drill a hole in the wall, slip the coaxial cable through, then putty around the seam for a snug fit.

Grounding

The ground lead should be a heavy conductor, such as heavy wire, braid, or the shield stripped from RG-8 or RG-11 coaxial cable. For reception purposes only, the ground may be a cold-water pipe inside the house. Do not use either the hot-water pipes (which are not well grounded), or gas pipes (which are dangerous). Also, be aware that residential air-conditioner liquid lines look like copper cold-water pipes in some cases—don’t use them.

A lightning arrester is a safety precaution, and *must* be used. It provides a low resistance path to ground in the event of a lightning strike. Don’t consider the arrester optional—it isn’t. Besides the obvious safety reasons (which are reason enough), there may be legal and economic reasons for using the arrester. Your local government building and fire codes may require one. Also, your insurance company may not honor your homeowner’s policy if the lightning arrester required by local code is not used.

Warning! Do not ever attempt to install an antenna by crossing a power line! No matter what you believe or what your friends tell you, it’s never safe—and it may very well kill you.

What about antennas other than the receiver longwire? The flattop antenna is shown in Fig. 9. That antenna is a close relative of the longwire, with

the exception that the downlead is in the approximate center of the antenna section. The flattop antenna should be at least a half wavelength ($492/f$ MHz) at the lowest operating frequency. The advantage of the flattop antenna over other designs is that it allows maximum use of available space in the configuration shown.

It is also possible to build vertically polarized shortwave receiving antennas; Fig. 10 shows one such version. The support structure (a tree or building) should be at least a quarter-wavelength high on the lowest operating frequency. The vertically polarized antenna is fed at the base with coaxial cable. The center conductor goes to the antenna element, while the coaxial cable's shield gets connected to the ground rod at the base of the support structure.

It's possible to install the wire (or

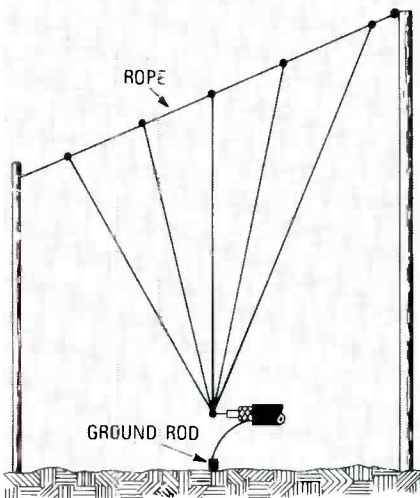

FIG. 12—BY USING A SLANTED ROPE, you can tie together any number of antennas tuned to different wavelengths.

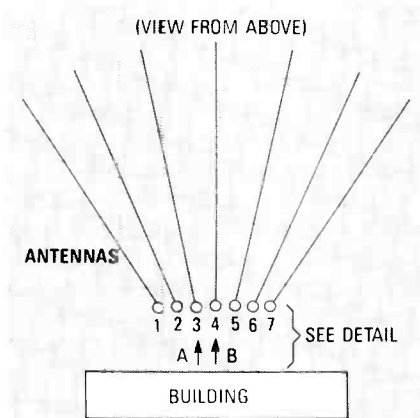

FIG. 13—SELECT THE DIRECTIONAL pattern of the antenna system by interchanging antenna elements of different wavelengths and position.

multiple wires of different lengths) inside a length of PVC plumbing pipe. The pipe serves as the support, and the conductors go inside. If you use a heavy pipe gauges of PVC, then the antenna support can be disguised as a flag pole (townhouse dwellers take note)!

Different conductor lengths ($L = 246/f$ MHz) are required for different operating bands. In Fig. 11, several bands are accommodated from the same feedline using the same support. In fact, eight different antenna elements are supported from the same tee-bar. Be sure that you insulate them from each other, as well as from the support; again, PVC piping can be used for the support structure. Figure 12 shows a method for accommodating several bands by tying the upper ends of each antenna wire to a sloping rope.

Directional wire antenna

A directional antenna has the ability to enhance reception of desired signals, while rejecting undesired signals arriving from slightly different directions. Although directivity normally means a yagi beam, a wire-quad beam, or at least a rotatable dipole, certain designs and techniques allow fixed antennas to be more or less directive. One crude but effective approach uses pin plugs or a rotary switch to select the direction of the antenna's reception.

Figure 13 shows a number of quarter-wavelength radiators fanned out from a common feedpoint at various angles from a building. At the near end of each element is a female banana-jack. A pair of balanced feedlines from the receiver (300-ohm twin-lead, or similar) are brought to where the antenna elements terminate. Each wire in the twin-lead has a banana plug attached. By selecting which banana jack is mated to which banana plug, you can select the directional pattern. If the receiver has a balanced antenna input, then connect the other end of the twin-lead directly to the receiver; for receivers with unbalanced inputs, you will have to use a balanced-to-unbalanced (balun) antenna coupler.

Figure 14-a shows a balun antenna coupler tuned to the receiving frequency. The coil is resonantly tuned by the interaction of the inductor and capacitor. Antenna impedance is matched by selecting the inductor

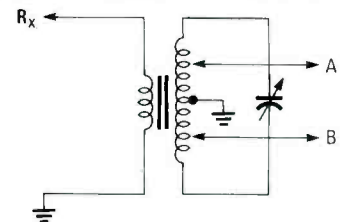

a

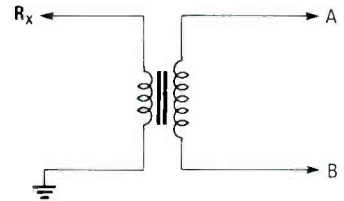

b

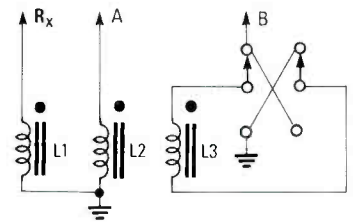

c

FIG. 14—MATCH A BALANCED ANTENNA with an unbalanced receiver input using any of three methods, (a), (b), or (c).

taps to which the feedline is attached. A simple RF broadband coupler is shown in Fig. 14-b. The transformer is wound over a ferrite core using 12 to 24 turns of No.26 enameled wire, with more turns for lower frequencies, and fewer turns for the higher frequencies. Experiment with the number of turns to determine the correct value.

By combining the right antenna and matching network, the best of both worlds can be had. For example, the antenna in Fig. 13 works by phasing the elements so as to null or enhance the reception in certain directions.

The nulling operation becomes a little more flexible if you build a phasing transformer, like the one in Fig. 14-c. Windings L1, L2, and L3 are wound trifilar style on a ferrite toroidal core using 14 turns of No.26 enameled wire. The idea is to feed one element from coil L2 (the A port), the same way all the time; that port becomes the 0-degrees phase reference. Port B is fed from a reversible winding, so it can either be in-phase, or 180-degrees out-of-phase with port A.

R-E

SPECTRUM MONITOR

continued from page 54

horizontal amplifier (the y-axis). The spectrum monitor outputs have +5-volts DC bias and 5-volts AC maximum swing. If the oscilloscope can't be offset enough in the DC mode, use AC coupling.

If the oscilloscope has no x-y mode, use the VERT OUT (J3) alone. It contains the positive blanking pulse mentioned earlier, and the oscilloscope can then use that as the trigger in a free sweep. If you're running the spectrum monitor off an AC line, it'll synchronize with the 60-Hz line voltage, so line triggering will suffice. Don't overload the RF input, otherwise the display will tend to clip on strong signals, and the front end of the tuner will then either generate modulation products which will appear on the oscilloscope, or it'll be damaged. The spectrum monitor can be used with either a marker or RF generator of known output frequency to mark a specific value.

To use the spectrum monitor as a continuously tuned FM receiver, turn-off sweep potentiometer R20. The signal in the center of the oscilloscope screen will then be demodulated, which is often very useful in identifying an offending carrier, or in hearing FM noise. You'll then be able to listen to signal levels that even some really good consumer FM receivers would have trouble with.

Some modifications

A couple of changes can make the tuned-receiver approach more useful. The first is to extend the frequency range downward. Converters typically contain high-pass filters to remove frequencies below 50 MHz, which can be shorted out with a piece of jumper wire and cutting the relevant foils on the board.

Tapping the IF OUT (J2) lets you use the spectrum monitor as a cable converter. Use two 50-ohm resistors and a switch as a "Y" to feed both the TDA7000 (IC6) and a back-panel "F"-type jack. One way to find the center frequency is to tap pin 4 of the tuner (the FIRST LOCAL-OSCILLATOR TUNING VOLTAGE) to an outside pin jack for a high-impedance VOM or DMM. That lets you graph known frequencies and voltages to find unknown ones.

R-E

REMOTE A/B SWITCH

continued from page 76

remember to place the components as close together as possible to keep stray capacitance low. If you use the PC board, follow the parts placement in Fig. 9, making sure that the IC's and components that are polarity-sensitive are correctly orientated. Mount Q1 with enough lead length to be positioned directly behind the bubble lens. The collector (flat side) of Q1 is connected to the positive supply. The cathodes of LED1 and LED2 (flat side) are connected to IC4-b and IC4-c, respectively.

3. Figure 10 shows what the relay module should look like. If you choose to hard wire the relay module, use a double-sided copper board, and a shielded enclosure such as a LMB box chassis, Model No. M00. Another RFI shield should be constructed out of copper tape, and should enclose jacks J3, J4, and J5. Constructing that RFI shield isn't easy. With a small file, remove the plating from the top flat of the nuts securing the coax jacks in place. Figure 11 shows you how that's done. Apply some solder to the flats, and secure a piece of copper-shield tape at a 90-degree angle across the flats, then heat the tape so that the solder melts and adheres to the tape. Be sure to leave enough tape at the ends to bend down and solder to the copper-tape ground shield created earlier.

Now drill and mount the three coax jacks, J3-J5. One in the center and the other two 3/4-inch to the right and left of center. Label the center jack "To TV" and the other jacks "A" and "B." Drill a hole in the opposite panel for the relay's DC supply line.

If you use a single-sided PC board, Fig 12, it may be necessary to shield the non-copper side with 1/2-inch copper tape to hold down the RFI. Apply two copper-tape strips across the board's length; however, be sure to scrape the copper tape—using an *Exacto* knife—so that the relay pins don't get shorted out. Drill feed-through holes for the relay pins and the DC voltage line. The ground pin on the relay remains grounded to the shield. Install RY1 on the tape side of the board. Be sure that the relay is properly orientated before soldering into place.

The DC line to the relay can be

made out of any two-conductor wire. Be sure to leave enough wire length to place the relay module behind the TV set. The positive wire to the relay is connected to the center conductor of PL1.

Calibration

Apply power to the receiver and make sure that nothing gets hot. If something does, that indicates trouble, so immediately turn the power off and check the board for incorrectly placed parts such as diodes, capacitors, and IC's.

Calibration should be made with RY1 connected to the circuit. Attach a DC voltmeter or oscilloscope to IC2 pin 8. Hold the transmitter approximately one foot from the receiver, aiming it directly at the lens. While depressing the transmitter switch, adjust R17 until IC2 pin 8 drops low. Release the switch and IC2 pin 8 should return high. If you don't have a meter handy, then watch the indicators LED1 and LED2. If the circuit is working properly, the indicators will light alternately each time S1 is pressed. After 10 seconds or so, both indicators should turn off. Place your finger on the relay module and you should feel a click each time S1 is pressed. Vary the adjustment of R17 to find the limits at which IC2 will respond, then center the adjustment between the two limits. Adjust R18 to match the brightness of LED1 to LED2. If more brightness is needed, lower the value of R13 and then readjust R18. The timing cycle of IC5 can be made longer or shorter by varying R12 and C8.

Other relays

A power relay can be used instead of an RF relay (RY1). Although the power relay won't require shielding, a metal enclosure is recommended to provide a proper chassis ground. Make sure that the power relay has a high enough rating for your appliance; contacts rated at 10 amps are usually sufficient. If the relay coil requires more current than Q2 can deliver, replace Q2 with a 2N3053 or TIP 31, which can handle the extra load current and dissipate the heat generated by the power requirement. A general-purpose relay module can be hardwired in an unshielded plastic enclosure. Q2 should be able to energize the relay coil.

R-E

68705 MICROCONTROLLER

How to build a single-IC microprocessor system

Sophisticated burglar alarms, stage-lighting controllers, digital music synthesizers, frequency counters, and other test instruments—they all have one thing in common. Designing each of those circuits (and others) using microprocessors is fast and easy if you use the right technology.

That technology needn't consist of expensive ICE's (In-Circuit Emulators) and the like. In fact, by using a single-chip Motorola microcontroller and building a low-cost (well under \$100) programmer, you can create custom designs as fast as you can think them up!

The MC68705P3 is a complete microcomputer on a chip. It contains CPU, ROM, EPROM, RAM, timer, interrupt input, clock, and twenty bidirectional I/O lines. Magically, it's all contained in a 28-pin package, which means that the data and address buses are completely hidden from the designer, so circuit-board layout becomes trivial.

In this article we'll discuss the 68705's architecture, its register structure, and programming considerations. Then we'll go on to build a programmer that burns your software into the 68705's internal EPROM. Next time, we'll put theory into practice when we design a two-IC digital alarm clock.

Hardware overview

To use the 68705 in your own projects, you must understand both its hardware and its software capabilities. Let's examine the hardware first. Figure 1 shows a block diagram of the main subsystems that comprise the 68705. First, note the CPU, which is itself composed of an ALU (Arithmetic Logic Unit) and a controller. Every instruction that the 68705 can execute (addition, subtraction, etc.) is performed by the ALU under

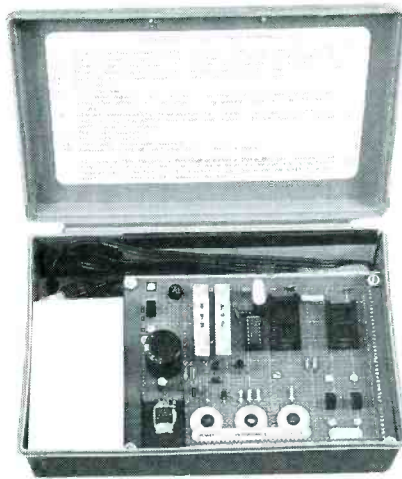

THOMAS HENRY

direction of the controller. The controller provides the timing necessary to carry out the microinstructions (even basic operations such as addition are composed of smaller steps called "microinstructions"), and ensure that they are performed in the correct order.

The 68705 has several types of memory. For starters, there are 112 bytes of RAM. That may not sound like much, but keep in mind that it is used only for storing variables and the stack; the application program itself is stored elsewhere. Typical microcontrollers seldom use even 30 or 40 variables, so the 68705 has plenty of RAM to handle almost all situations.

The 68705 also contains ROM. Actually, it has both ROM (Read Only Memory) and EPROM (Erasable Programmable Read Only Memory). The ROM, comprising 115 bytes, contains the EPROM burner program, which Motorola calls the "bootstrap." That means that the means for programming the EPROM is built right into the chip itself!

The EPROM itself consists of 1804 bytes; it is used to hold your application program and con-

stant data. Since EPROM is non-volatile memory, even if you interrupt power to the IC and later re-apply it, your program is still there ready to be executed.

In addition, many I/O lines are available. Logically they are grouped into three ports (parallel groupings of I/O lines). Port A and Port B are each eight bits wide; Port C is four bits wide. To send a message to the outside world, you simply store a byte in the desired port register, and the associated lines will reflect what was written. In an analogous way, the outside world can talk back; a byte placed on the lines of a port may be read by the CPU. I/O in the 68705 is memory-mapped, unlike the case in the Intel family, which has a separate address space and separate instructions for reading I/O ports.

Electrically speaking, the three ports are easy to use. They're all TTL compatible for both input and output. Also, Port B can sink as much as 10 mA, so it can drive LED's directly.

Associated with each port is a DDR (Data Direction Register). It is the duty of the DDR to configure the associated I/O lines for either input or output operations. The DDR itself is programmed by writing to special memory locations.

Referring to Fig. 1 again, note that there is an external interrupt line (\overline{INT}). Normally, the 68705 executes some sort of program. But there may be times when you wish to temporarily halt execution of the main program and then continue execution in a subsidiary program. An external signal (a fire sensor or burglar alarm) applied to \overline{INT} might cause such a change. Most microprocessors and microcontrollers have interrupt inputs, but what makes \overline{INT} especially useful is the fact that it can accept both digital and analog inputs!

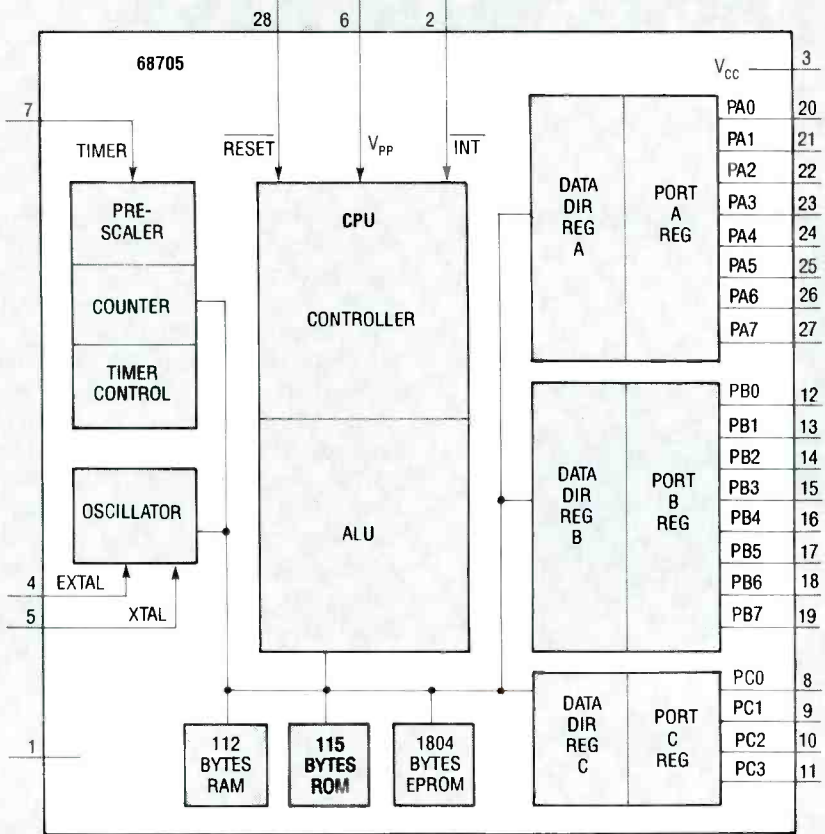

Fig. 1. THE 68705 IS A 28-PIN MICROCONTROLLER with RAM, ROM, EPROM, and 20 bytes of I/O.

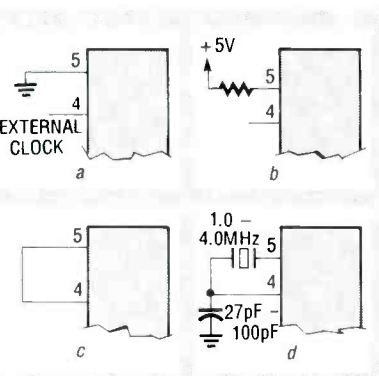

Fig. 2. CLOCKING THE 68705: (a) using an external clock, (b) using a resistor, (c) using the default clock, and (d) by crystal control.

The reason is that the 68705 has an internal Schmitt trigger, which means that it can detect zero-crossings of an analog signal. That capability might be useful in frequency-counter applications, in which a timebase is derived from a 60-Hz AC signal.

The 68705 also contains a timer with an optional prescaler. The timer, which is actually an 8-bit countdown register, can be

loaded with a number. The register will then proceed to decrement at the processor's internal clock rate; when the register hits zero, an interrupt is generated that causes the processor to continue execution at a special program location. The prescaler allows for longer periods between timeouts. The timer can also be clocked from an external source, if desired.

Of course, all computers must have some sort of clock to synchronize activities (access I/O ports, execute the microinstructions in the CPU, etc.) The 68705 has quite versatile clocking options. In fact, as shown in Fig. 2, it can be clocked in four distinct ways.

In Fig. 2-a we see how the 68705 can be clocked by an external source; you would use that method when a master clock is present in existing circuitry with which the microcontroller must interface. Figure 2-b shows how an external resistor can be used to set up the internal clock, and

Fig. 2-c shows how installing a jumper will allow the internal clock to run at a default rate. Last, in Fig. 2-d, a crystal is used for best accuracy and reliability.

Software overview

Now let's change focus and consider the software side of the 68705. If you've any experience with the 6800 or other 8-bit microprocessors, the 68705 will appear quite similar. Figure 3 shows the programming model. Both the accumulator and the index register are eight bits wide. As the name suggests, the results of most arithmetic and logical instructions "accumulate" in the accumulator. The index register, on the other hand, is typically used to access individual elements of tables and lists; it does so using special address modes discussed shortly.

The program counter is 11 bits wide, giving the 68705 a total address range of 2048 (\$0800) locations. Those locations include all the RAM, ROM, EPROM, DDR's, and I/O ports.

Also included in the programming model is the stack pointer. The stack is a LIFO (Last In, First Out) type; it's maintained in the user area of RAM, and its pointer always aims at the next usable

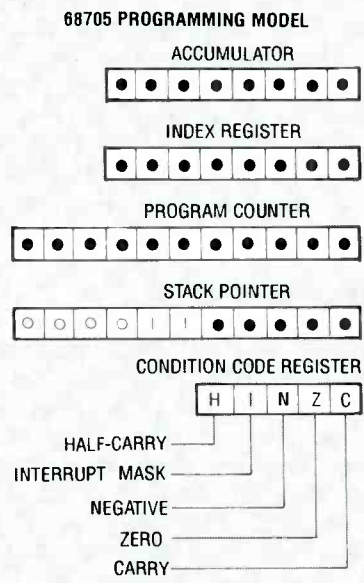

Fig. 3. THE 68705 consists of an eight-bit accumulator and index register, an 11-bit program counter and stack pointer, and a condition-code register.

TABLE 1—68705 MEMORY MAP

\$000	Port A
\$001	Port B
\$002	Port C (low order nibble only)
\$003	Not used
\$004	Data direction register, Port A
\$005	Data direction register, Port B
\$006	Data direction register, Port C (low order nibble only)
\$007	Not used
\$008	Timer data register
\$009	Timer control register
\$00A	Not used
\$00B	Program control register
\$00C - \$00F	Not used
\$010 - \$07F	RAM
\$080 - \$783	EPROM
\$784	Mask options register
\$785 - \$7F7	Bootstrap ROM (EPROM burner program)
\$7F8 - \$7F9	Timer interrupt vector
\$7FA - \$7FB	External interrupt vector
\$7FC - \$7FD	SWI interrupt vector
\$7FE - \$7FF	Reset vector

location. The stack pointer is shown in the model to be 11-bits wide, but the highest six bits are fixed in such a way that the stack pointer always points into the RAM area. The maximum depth of the stack is 32 bytes, which may not seem like much, but which should suffice for most controller applications.

Also, a condition-code register keeps track of the results of various operations. For example, one bit of the register is set whenever a negative number appears in the accumulator; another is set whenever a value of zero appears in the accumulator. Another bit informs us if a carry or borrow was required to complete an arithmetic operation (addition or subtraction, respectively). The half-carry flag is set if a carry results from adding two BCD (Binary Coded Decimal) numbers. The interrupt mask lets us tell the 68705 to ignore interrupt signals applied to \overline{INT} .

The 68705's memory map is shown in Table 1. Note that all of RAM sits in page zero, while EPROM addresses start in page zero and continue to higher addresses. The I/O ports and DDR's are also located in page zero, as are the timer's control registers.

At the highest memory locations you will find a set of vectors (pointers) that tell the microprocessor where to continue pro-

gram execution in the event of an interrupt. It is the designer's responsibility to program the correct values into the EPROM.

Interrupts in the 68705 can take one of four forms: (1) \overline{RESET} is generated at power up; it is used to start the processor from a known condition. (2) \overline{INT} (external interrupt) occurs when there is activity on pin 2 of the 68705, as discussed earlier. (3) An SWI, or Software Interrupt, happens when the CPU executes an SWI instruction, which is typically used for debugging purposes. (4) The last type of interrupt is triggered when the internal timer times out.

One additional location in the memory map is interesting; the mask options register (\$784), which is a location in EPROM that allows the designer to determine how the 68705 operates. For example, by burning various bits in the location low or high, you can specify what type of clock you're using, how the timer is used, whether the prescaler is used, etc.

Address modes

The 68705 has ten address modes; many instructions are functional in several address modes. Unfortunately, we haven't space to discuss operation of each instruction in detail; consult the appropriate Motorola

data sheets for more information. We will, however, discuss the basic address modes and several unusual instructions.

The immediate addressing mode is concerned with constants. For example, LDA #20 says to load the accumulator with the decimal constant 20. The pound sign is what indicates immediate mode.

Contrast that with the direct-address mode instruction LDA 20, which says to load the accumulator with the number contained in memory location 20. Here the accumulator loads a variable, not a constant. The direct mode can only access locations in page zero, because the operand (the address) is specified by a single byte.

The extended-address mode overcomes that liability by allowing two-byte operands. For example, LDA 450 says to load the accumulator with the contents of location 450. Of course, extended-mode instructions take more space and execute slower than direct-mode instructions.

The relative-address mode is used in branching instructions. Rather than specifying a precise location to branch to, the relative mode allows the programmer (or the assembler program) to designate an address relative to the current address at which execution should continue. For example, BRA 10 would move execution to the tenth location following completion of the current instruction.

There are three types of indexed addressing modes available. The no-offset indexed mode takes its argument from the index register. For example, LDA (X) says to load the accumulator with the contents of the location pointed to by the index register.

The one-byte indexed mode extends that concept. For example, LDA 20,X1 tells the processor to add the number 20 to the contents of the index register and then access the resulting location. If the index register contained the number 35, say, then the contents of location 55 would be fetched (20 + 35 = 55).

The two-byte indexed mode extends the concept even further by

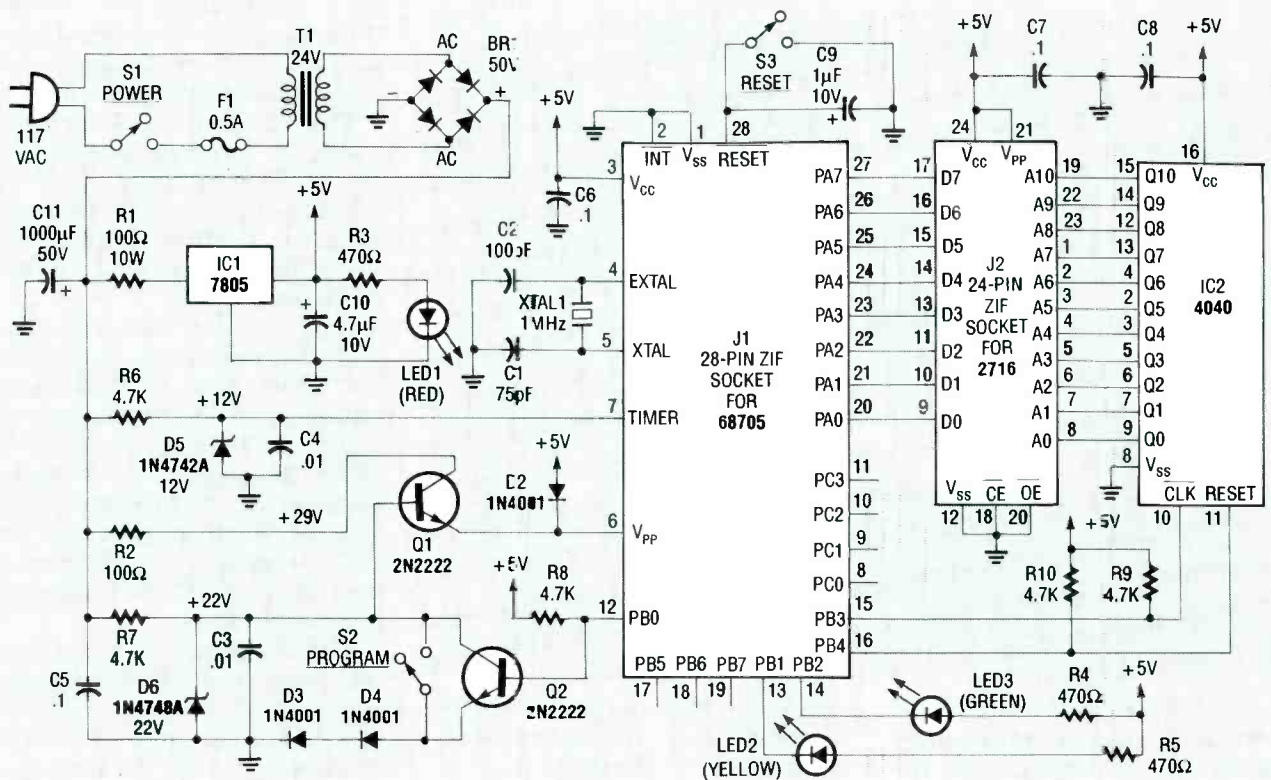

Fig. 4. EPROM BURNER FOR THE 68705: IC2 decodes sequential memory locations in the EPROM (J2), whose outputs are applied to Port A of the 68705 (J1).

allowing a larger number to be used. For example, LDA 450.X2 adds the two-byte number 450 to the contents of the index register and then accesses the location specified by that sum.

The inherent addressing mode covers one-byte instructions whose operand is implied in the nature of the instruction. For example, CLR A says to clear (reset to zero) the accumulator; obviously, no external memory locations are involved. Unusually, the 68705 also allows the inherent mode with the index register. So, for example, CLR X would clear the index register.

Bit twiddling

Although we don't have space to discuss the entire instruction set, it's worthwhile mentioning several special instructions. With most microprocessors, to access individual bits within a byte, you must "mask" that byte; AND and OR it with constants. The 68705 has four special instructions that allow you to get at bits directly. BRSET allows your program to branch if a bit is set, and BRCLR allows your program to branch if

a bit is clear. For example, BRSET 7,20,46 says to test bit 7 of location 20. If that bit is set, then branch forward 46 locations and resume program execution there.

BSET and BCLR allow you to set and clear bits individually. For example, BSET 4,20 sets the fourth bit of location 20, and BCLR 4,20 clears that bit.

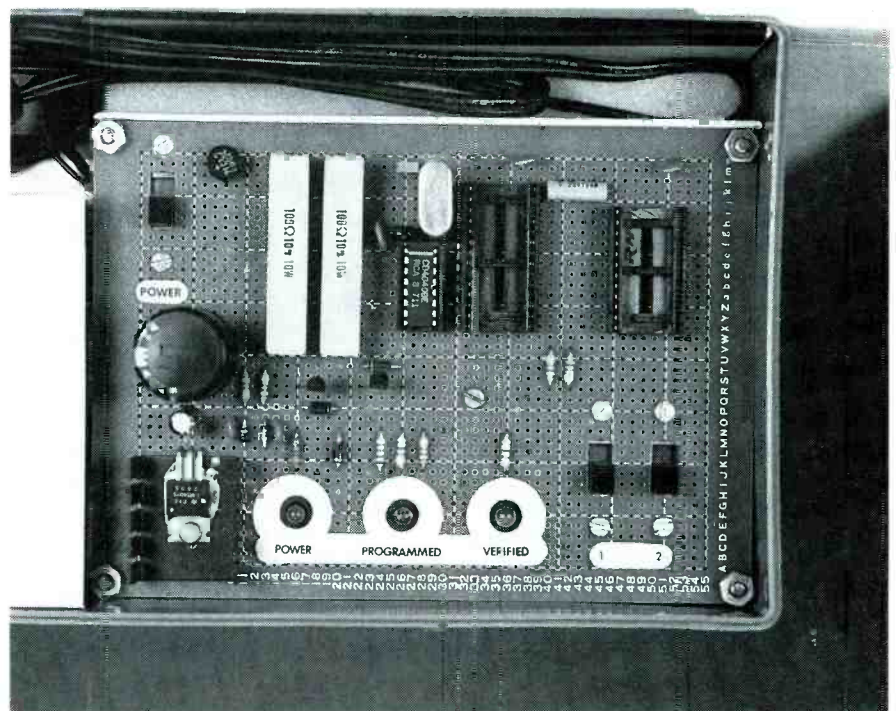

Fig. 5. PROTOTYPE OF THE EPROM BURNER. The author used wirewrap and point-to-point wiring techniques.

Parts List

Resistors

All resistors are 1/4-watt, 5% unless otherwise noted.

R1	100 ohms, 10 watts
R2	100 ohms
R3-R5	470 ohms
R6-R10	4700 ohms

Capacitors

C1	75 pf, silver dipped mica
C2	100 pf, silver dipped mica
C3, C4	0.01 μ F disk
C5-C8	0.1 μ F disk
C9	1 μ F, 10 volts, electrolytic
C10	4.7 μ F, 10 volts, electrolytic
C11	1000 μ F, 50 volts, electrolytic

Semiconductors

BR1	50-volt bridge rectifier
D1	not used
D2-D4	1N4001
D5	1N4742A 12-volt Zener
D6	1N4748A 22-volt Zener
LED1	red
LED2	yellow
LED3	green
Q1, Q2	2N2222 NPN, general purpose
IC1	7805 5-volt regulator
IC2	4040 CMOS counter

Other components

F1	0.5-amp fuse
J1	28-pin ZIF socket
J2	24-pin ZIF socket
S1-S3	SPST switch

Designing with the 68705

The question now is how to get a program into the 68705's internal EPROM. The process is actually quite simple. First, you need to write the desired program. If it is a short program, you can hand-assemble it (that is, look up the instructions and find the appropriate opcodes). Of course, it's faster and more accurate to use a cross-assembler, a translator that runs on one computer, say a PC, and converts the ASCII source code into 68705-compatible

object code (hex bytes). You can either buy a commercial cross-assembler or write one yourself in BASIC or PASCAL.

After writing and assembling the program, it takes two steps to burn the program into the 68705. First you must burn the code into a 2716 EPROM (a common device for which burners are likewise commonplace). Then the program is transferred from the 2716 to the 68705 using the bootstrap program in the latter. A circuit for doing that is shown in Fig. 4. The basic idea is that under direction of the bootstrap program, the bytes in the 2716 are sent one at a time to I/O Port A, where the 68705 reads them and then burns them into the appropriate locations of its EPROM.

In the schematic, J1 and J2 are Zero Insertion Force (ZIF) IC sockets for the 68705 to be burned and the 2716 containing the program, respectively. The 4040, IC2, is a counter that is clocked by PB3 of the 68705. The 4040's outputs allow locations in the EPROM to be accessed sequentially. The data outputs of the EPROM are then read by Port A of the 68705.

How does the 68705 know to execute the bootstrap program? Note that the TIMER input (pin 7) of the 68705 is tied to +12 volts. Pin 7 normally acts like a standard TTL input, but if the voltage on this pin rises to +12V, the CPU halts all other activity and starts executing the bootstrap program.

How to burn

To understand the remaining circuitry, let's trace through the sequence of steps involved in actually burning a 68705. Start by assuming that S1 is open (no power applied), and that S2 and S3 are closed. After inserting a 68705 and a 2716, close S1, which powers up the device. Now +12V is applied to the timer input, so the CPU knows that it must execute the bootstrap program. However, since S3 is still closed, the microprocessor is stuck in a reset condition, so nothing happens yet. In addition, since S2 is closed, Q1 is off, so only +5 volts is applied to the

V_{PP} input, rather than the +22-volt programming voltage. Also, both programming indicators (LED2 and LED3) are extinguished.

Now open switch S2. That allows Q1 to turn on, which allows it to pass the regulated +22V. Thus the programming voltage, not +5V, appears at V_{PP}. Now open S3; that brings the CPU out of the reset condition and allows it to execute the bootstrap program. After all bytes have been transferred, LED2 lights up, indicating that the internal EPROM has been burned.

However, the bootstrap isn't done yet. As a check, it goes back and compares each byte in its internal EPROM with the associated byte in the 2716. If they match successfully all the way down the line, then LED3 lights up, indicating that verification is complete. At this point, you would close S3, close S2, and then open S1. At this point the 68705 is ready for use.

Construction

The 68705 programmer uses only garden-variety components and is easy to build. Figure 5 shows the author's prototype; it was built ordinary wirewrap techniques; the entire unit is housed in a plastic pencil box.

Now we'll put our theory to work and build a digital alarm clock. The project is not just an educational exercise; you'll find that it is useful and that it incorporates several features not found in commercial units. By studying the example, you'll find numerous hints for designing with the 68705.

Design goals

We want a four-digit readout for hours and minutes, a blinking colon to indicate seconds, fast and slow display-set buttons, clock- and alarm-set buttons, an AM/PM indicator, an enable switch and a volume control for the alarm, the ability to show either hours and minutes or minutes and seconds, a power-outage warning, and the ability to display either a 12- or a 24-hour clock.

Those may seem like am-

bitious design goals. As it turns out, however, the 68705's versatility lets us build the project using only two IC's. And one of them is a dedicated sound generator, which means that the clock really requires only the 68705!

The basic plan of attack is to derive the 60-Hz timebase from the 117-VAC power lines. In most communities, that frequency is accurate to 0.02 Hz, or 3 parts in 10,000. By using the AC lines (which are more than accurate enough for a clock), we can simplify the design tremendously, and even eliminate the need for a crystal oscillator. (See part one of this story for more information on clocking the 68705.)

To simplify things even further, we multiplex the four seven-seg-

ment LED displays. Doing so means we need no latches or decoders, reducing the number of passive components as well. Port B of the 68705 can sink 10 mA of current directly, so no display drivers are needed either. Decoding is handled by means of a look-up table burned into the internal EPROM. Since we don't use a commercial display decoder, we can create our own alphanumeric characters and display textual messages.

The clock uses the interrupt capabilities of the 68705 to keep track of the passage of time. Normally, the CPU runs a program that updates the display LED's, scans for switch closures, and checks to see if the alarm time has been met. But while all that

is happening, the 60-Hz AC signal interrupts the main program every 1/60th of a second. After 60 such interrupts, a memory location in RAM is incremented to indicate that another second has elapsed. In a similar fashion, other RAM locations keep track of passing minutes and hours. Generally speaking, the two-program approach (a main program used in conjunction with an interrupt program) is a powerful technique with many applications in modern electronics.

Hardware

Now let's examine the schematic and see how the hardware works. As shown in Fig. 1, only two IC's are used (or three if you count the voltage regulator). First

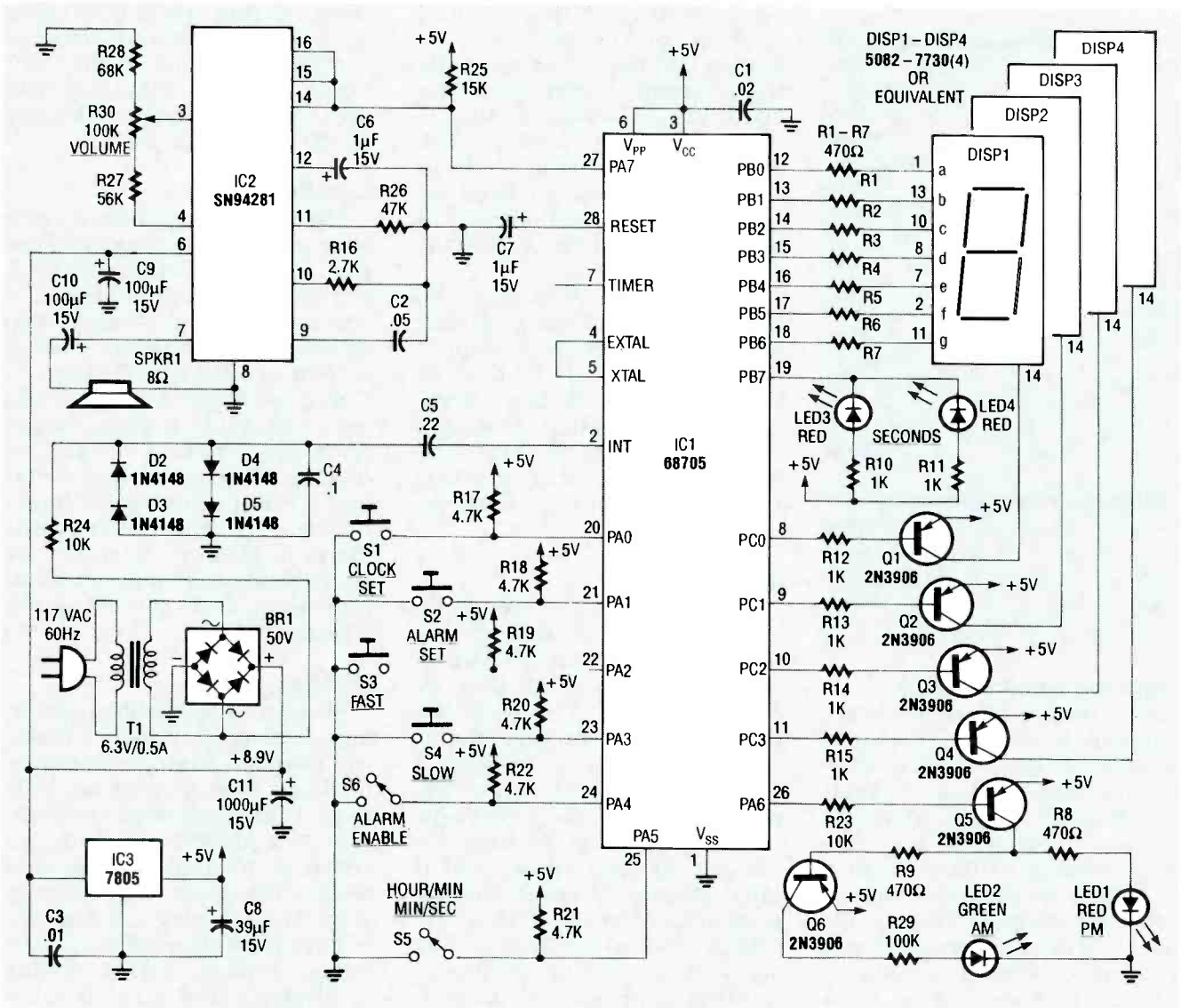

FIG. 1—THE ALARM CLOCK USES THREE IC'S: The microcontroller, a sound generator, and a voltage regulator.

is IC1, the 68705. Second is a 94281 sound generator, which is used to create the alarm signal. Although it would probably be possible for IC1 to generate the

alarm signal by itself, it seemed simpler to use a dedicated IC. Last is the voltage regular, IC3, a 7805.

Actually, the clock uses two voltages: an unregulated +8.9 volts for the sound generator, and the regulated +5 volts for the microcontroller and display circuitry. Note that we tap one leg of the transformer to derive the timebase. To keep the voltage to a safe level, the AC signal is clipped by diodes D2–D5, and then filtered by C4 to remove any remaining cusps. The resultant signal is then capacitively coupled to the \overline{INT} input (pin 2 of IC1) by C5. A Schmitt trigger, internal to the 68705, squares up the signal.

Now let's consider the display. The secret of a multiplexed display is the concept of rows and columns. We define one set of output lines as rows and another as columns. We can supply voltage to a particular segment in a particular display by enabling specific row and column outputs of the microcontroller; the LED at the intersection thus lights up.

Transistors Q1 through Q4 function as the columns; they're enabled by four lines from Port C. Those lines can't source much current, which is why we need the transistors. However, because of its current-carrying capacity, Port B drives the row outputs (i.e., the display segments) directly.

Each segment in a display is labeled with a letter from *a* through *g*. All four *a*'s are connected to each other, and then to PBO, via R1, which limits current. Similarly, the *b* segments are tied together and connected to PB1 via R2, and so on, through PB6, which drives the *g* segment.

As for the columns, we must use common-anode displays, because of the current-sinking logic. (Incidentally, we specified Hewlett-Packard types in the schematic and Parts List, but you can substitute just about any common-anode type.) Note in Fig. 1 that the anode of each display is supplied current through a transistor (Q1–Q4). The software ensures that only one transistor is on at a time, thus only one display is enabled at a time.

By successively turning on Q1, Q2, Q3, Q4, and then Q1 again (and so on), each display shows its current segment pattern. If that rotational multiplexing happens fast enough, then persistence of vision leads to the optical illusion that all four displays are illuminated continuously. And it's all handled in software, without any external logic!

We generate the blinking colon using two discrete LED's (D8 and D9), which are driven from PB7. Two other discrete LED's (D6 and D7) provide an AM/PM indicator. When PA6 goes low, Q5 turns on, so D6 (PM) lights up. However, Q6 turns off, so D7 (AM) turns off. On the other hand, when PA6 goes high, Q5 and D6 are off, and Q6 and D7 are on.

PA7 fires up the sound generator when an alarm must be sounded. The operation of IC2, the SN94281, is beyond the scope of this article, but suffice it to say, when PA7 of the 68705 goes low, IC2 emits a mighty "whooping" burst sufficient to arouse the soundest of sleepers. Alarm volume may be adjusted by potentiometer R30. However, that may be a dangerous control to leave in the hands of a confirmed late sleeper!

All the I/O lines examined so far (all of ports B and C, as well as PA6 and PA7) are used for output operations. Of course an alarm clock needs information from the user in order to be useful; S1–S6 provide that information.

For example, SPST pushbutton S1 acts as the CLOCK SET button. Pressing it along with either S3 (FAST) or S4 (SLOW) allows the user to set the proper time. The ALARM SET button (S2) works in a similar manner with S3 and S4 to set the alarm time.

Notice how simple the switch interfaces are. A pullup resistor ties a port line high until a switch pulls it to ground. Through software, the 68705 senses the change and can then take appropriate action. Note further that the switches needn't provide "clean" make/break operations; the 68705 handles the contact debouncing through software, thus eliminating yet more out-

Parts List

Resistors

All resistors are 1/4-watt, 5%, unless otherwise noted.

R1–R9	470 ohms
R10–R15	1000 ohms
R16	2700 ohms
R17–R22	4700 ohms
R23, R24	10,000 ohms
R25	15,000 ohms
R26	47,000 ohms
R27	56,000 ohms
R28	68,000 ohms
R29	100,000 ohms
R30	100,000 ohms, audio potentiometer

Capacitors

C1, C2	0.02 μ F, disk
C3	0.01 μ F, disk
C4	0.1 μ F, disk
C5	0.22 μ F, disk
C6, C7	1 μ F, 15 volts, electrolytic
C8	39 μ F, 15 volts, electrolytic
C9, C10	100 μ F, 15 volts, electrolytic
C11	1000 μ F, 15 volts, electrolytic

Semiconductors

IC1	68705 microcontroller
IC2	SN94281 sound generator
IC3	7805 5-volt regulator
BR1	50 volt bridge rectifier
D1	not used
D2–D4	1N4148 switching diode
DISP1–DISP4	4082-7730 common-anode 7-segment display, or equivalent
LED1, LED3, LED4	red light-emitting diode
LED2	green light emitting diode
Q1–Q6	2N3906 PNP switching transistor

Other components

SPKR1	8 ohms
S1–S4	SPST pushbutton
S5, S6	SPST slide or toggle
T1	6.3 volts

Computers are digital devices. In a computer, all information can ultimately be resolved into bits that are either on or off. The real world, however, is analog. The sun rises gradually, not suddenly. Temperature changes smoothly. Water flows. All human sensory inputs receive data in analog format.

However, it's difficult to represent analog values digitally. When people began to design thinking machines, they quickly discovered that devices that operated on analog principles were complicated, sensitive, and unreliable. The problem needed simplification: what greater simplification than to allow no more than two states, on and off?

The problem, of course, is that operation on digital principles erects a fundamental barrier between the computer and the world outside the box. How can the computer, which is essentially a yes/no device, sense, much less control, analog phenomena in the real world?

Two complementary devices make both sensing and control possible: the Analog-to-Digital Converter (ADC) and the Digital-to-Analog Converter (DAC), respectively. As the name suggests, an ADC is a device that converts real-world analog quantities into digital terms that the computer can deal with. Conversely, a DAC is a device that converts the computer's digital data to analog form, and it is usually current or voltage.

In this article we'll show what a DAC is, how it works, and how it can be used. To illustrate those ideas, we'll present construction details for building a low-cost (\$35), high-speed DAC, with as many as eight independent channels. You can connect the DAC to any standard parallel printer port. We'll also discuss the software that controls the DAC, but space precludes printing full listings. However, the software (DAC.ARC) is available on the R-E BBS (516-293-2283). A special feature of the software is an interactive full-screen editor/compiler that functions much like Borland's Turbo and Microsoft's Quick languages.

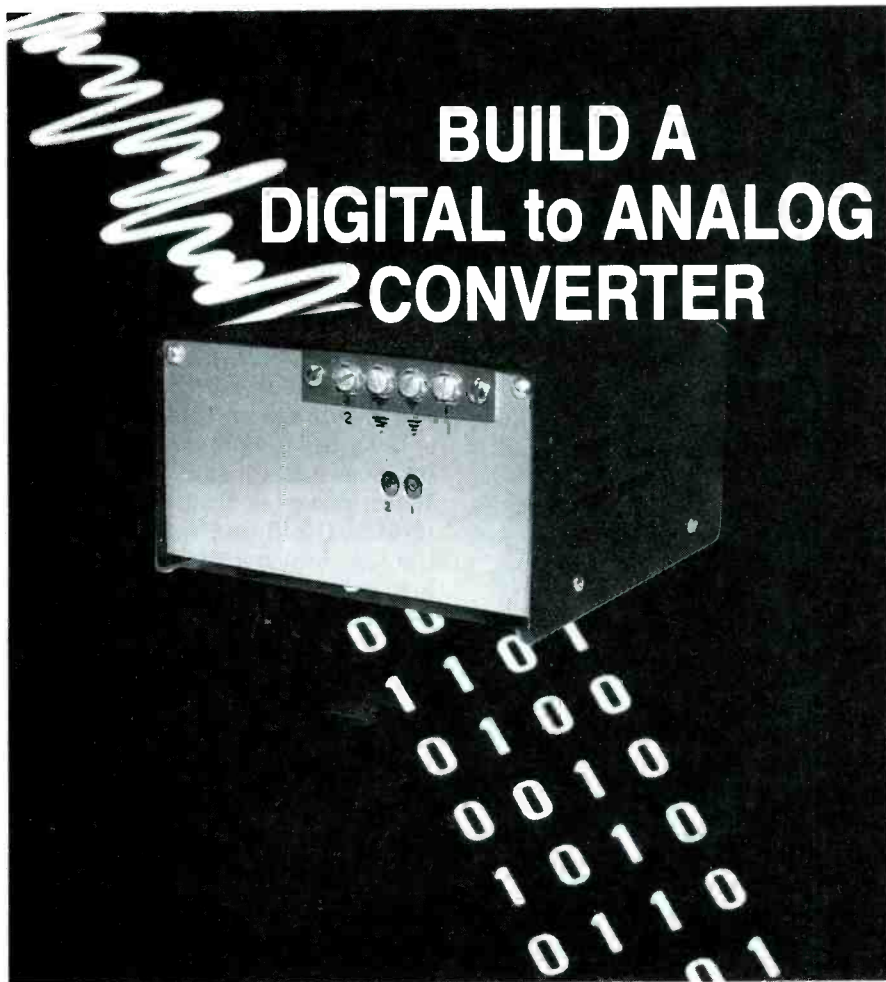

BUILD A DIGITAL to ANALOG CONVERTER

DAVID WEBER

DAC basics

The most common technique for making an analog signal from a digital value is the R-2R resistor ladder: an eight-stage ladder is shown in Fig. 1. A precision reference voltage (V_{REF}) is applied to the top of the ladder; current then passes through the R-2R resistor network to ground. The strength of the output current (I_{OUT}) is determined by which of the S1 through S8 switches are open or closed.

The maximum I_{OUT} occurs when all the switches are closed, which places one end of all the 2R resistors at ground potential (disregarding the low resistance of ammeter M1). Solving for the equivalent resistance we get R, so the maximum full-scale current is V_{REF}/R . On the other hand, if only S1 is closed (S2-S8 open), then the maximum current is $V_{REF}/2R$. The current is now one-

half the original full-scale current.

It should be obvious to you now that closing any combination of switches will yield a specific fraction of the full-scale current. By rapidly changing the digital word that closes and opens switches S1 through S8, a changing current will be present at I_{OUT} and that's digital-to-analog conversion.

The precision of I_{OUT} depends on the precision of V_{REF} on the precision of the resistors in the ladder, and on the precision with which they are matched. In addition, the number of stages in the ladder determines the fineness with which I_{OUT} can be adjusted. Commercially, eight-bit DAC's are inexpensive and readily available; sixteen-bit DAC's are available at higher cost for high-precision applications.

The DAC0808

The hardware described in this article is built around an eight-

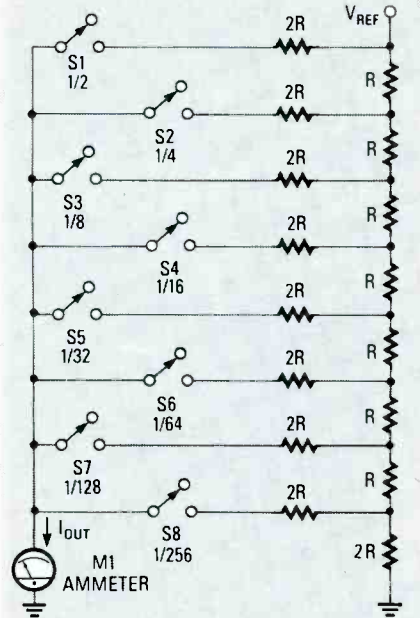

Fig. 1. THE SIMPLEST DAC: An $R/2R$ resistor ladder. Each switch that is closed increases the amount of current at I_{OUT} .

bit DAC, the DAC0808 (also known as the LM1408). It has been around for some time, is a stable design, is widely available, and is inexpensive. Eight bits give a precision of 0.39%, which is more than adequate for many uses. The typical settling time for the DAC0808 is 150 ns; that translates to a switching speed better than 5 MHz. In fact, a standard PC cannot come close to driving the converter at that speed. (A 35-kHz square wave was generated using a hand-optimized assembly-language loop on a 4-MHz CPM machine directly driving an 8255 port.)

The internal construction of the DAC0808 differs somewhat from the idealized resistor ladder discussed here. Output is provided on two pins as complementary currents, rather than on a single output as shown in Fig. 1. Also, the lower four stages of the ladder are driven separately from the upper four, because the lower stages are more sensitive to error. The fundamental operating principles, however, are the same.

The circuit

The schematic for the circuit is shown in two parts. The first section (shown in Fig. 2) details the digital interface to the PC's parallel port. One analog section is

shown in Fig. 3; bear in mind that the digital section can drive eight analog sections.

An eight-bit parallel printer port is an ideal interface for a DAC, because it is typically the fastest standard interface on a PC. The Centronics parallel port has a 36-pin connector, of which the IBM PC family uses 25; our DAC uses only 16 of those. Eight lines are for data, one is for ground, and the remaining seven are for status and handshaking.

Let's discuss the status lines (PE, BUSY, SELECT, and ERROR) first. When power is applied to the interface, the signal levels on the PE (paper empty) and BUSY lines are low, and the levels on the ERROR and SELECT lines are pulled high by R1 and R2. Those levels prevent the computer from hanging up, thinking that a printer was out of paper, or busy, or in an error condition. We're able to ignore the busy line because the DAC is so much faster than the computer.

When power is off, ERROR and SELECT go low, thereby indicating to the computer that the DAC is in an error state and not selected. In that way the computer can sense whether or not the DAC is powered and ready for data.

There are three handshaking signals: RESET, STROBE, and ACK. RESET is normally used to reset a printer. In our circuit, however, RESET is used to load the value that defines which of the eight converters will receive the data that follows.

The STROBE and the ACK lines handshake data through the parallel port pretty much as they would for a printer. The computer puts a byte of data on D0-D7 and pulses STROBE to tell the parallel device that data is ready. The parallel device reads the data and responds with ACK to signal that everything is fine. To understand what happens in detail, let's walk through a typical data-transfer sequence. Assume that one analog section has already been selected (we'll show how that's done momentarily).

A byte of data enters the circuit and is buffered by IC1, an octal data buffer; IC1 cleans up the signals after their long journey

Parts List

Resistors

All resistors are 1/4-watt, 5% unless otherwise noted.

R1, R5, R6	10,000 ohms
R2	2200 ohms
R3, R7, R8	3300 ohms
R4	220 ohms
R9	1000 ohms (for two DAC's; see text)
R10	5000 ohms, ten-turn potentiometer
R11	200 ohms
RP1	3300 ohms, 8 positions, common ground

Capacitors

C1	0.001 μ F ceramic capacitor
C2	10 pf ceramic capacitor
C3	100 pf ceramic capacitor
C4	0.1 μ F ceramic capacitor
C5-C7	2.2 μ F, 15 volts, tantalum bypass capacitor

Semiconductors

IC1	74LS244 octal buffer
IC2	74LS374 octal latch
IC3	74LS74 dual D flip-flop
IC4	74LS221 dual monostable multivibrator
IC5-IC7	74LS373 octal latch
IC8-IC13	74LS373 octal latch (optional)
IC14	74LS14 hex Schmitt trigger
IC15	DAC0808 8-bit D/A converter
IC16	LF353 high-speed op-amp
D1	ECG177 clamping diode
D2	LM329 6.9-volt precision Zener

Miscellaneous

Perf board, power supply, IC sockets, wire, solder, etc.

down the cable. The data then proceeds to IC2, an octal data latch; IC2 will latch the data when it gets STROBE from the computer. As for STROBE, it is conditioned by a pair of 74LS14 inverters, IC14-a and IC14-b. It is the rising edge of STROBE that latches the data in IC2.

The output of IC2 is presented to latches IC6-IC13; the latter are

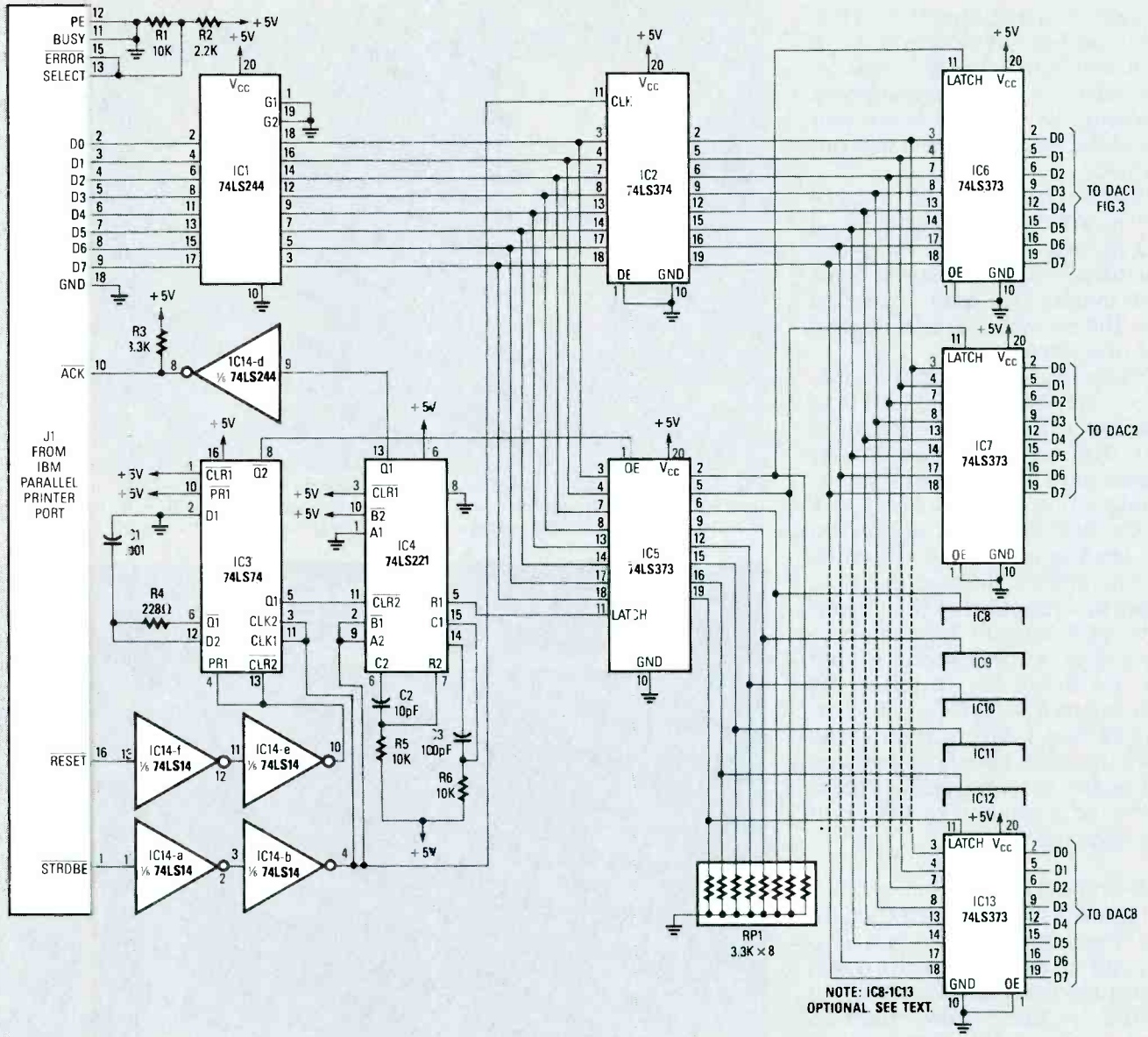

Fig. 2. DIGITAL SECTION: A standard parallel printer port can control eight digital latches, for a total of 64 bits of digital I/O.

what drive the eight converters. Which latch picks up the data depends on the mask stored in IC5, but we'll get to that in a moment. For now, let's look a little closer at what **STROBE** does.

In addition to latching the data into IC2, **STROBE** drives a dual one-shot multivibrator, IC4, a 74LS221, which generates a pulse of precisely controlled width—1 μ s. in this case. After buffering by IC14-d, that pulse becomes the **ACK** signal that tells the computer the transaction is complete.

Now let's see how the data latches (IC6-IC13) are selected by IC5, also a 74LS373. When one of

IC5's outputs is high, the associated latch will be selected and its outputs will follow the data stream presented to the device. When an output is low, the latch ignores the data stream. In addition, the last value sent (when the latch enable signal was high) is retained in IC5's outputs.

Because of that arrangement, the same data may be written to several latches simultaneously. For example, a mask of 0Ch (0000 1100) would enable latches three and four and disable the remaining latches. Subsequently, any data written to the device would put the same data in both latches three and four.

How is the selection mask loaded into IC5? Via the PC's **RESET** line. When **RESET** goes low, section two of IC3, a 74LS74 dual flip-flop, is cleared, and that causes IC5's output enable (\overline{OE}) line to go high. That in turn causes IC5's outputs to go into a high-impedance state, so the latch buffers (IC6-IC13) retain their current contents on their outputs. Also, those latches will ignore the next byte of data (which will be the latch-selection mask) from the PC.

Now the PC sends that selection byte; the **STROBE** line is pulsed, and that toggles the other half of flip-flop IC3 and also

causes IC4 to send a 100-ns pulse to selection register IC5. That pulse latches the selection mask data into the selection register. The selection mask is now where it should be and has been kept out of the places where it was not wanted.

When the next data byte comes, STROBE is toggled again, so IC3 returns control of the selection lines to IC5, which now has a new mask. The data is loaded into the converter(s) specified by the new mask.

The purpose of R4 and C1 (between the two halves of IC3) is to guarantee that the second gate is not flipped until two STROBE pulses have been sensed. The RC combination delays the response to the first STROBE for about 100 ns, leaving it ready to sense the second STROBE. Because the time delay is a function of the output drive of $\overline{Q1}$ and the input impedance of D2, substitutions should not be made for functionally equivalent IC's (74HC74, 74S74, 74F74, etc.) without verifying that the time constant remains the same, or using a different resistor or capacitor to maintain the time constant.

The analog circuit

Figure 3 shows one DAC channel. The digital circuitry can handle as many as eight DAC channels, but there's no need, of course, to build more channels than you need. However, because the analog amplifiers (IC16, an LF353) contains two amplifiers per package, it makes sense to add DAC's and associated components in pairs.

In the diagram, there are three fundamental components: the DAC, a voltage reference, and an amplifier. The DAC takes the digital number from the latch and the reference voltage from the LM329, and generates a proportional output current that drives the amplifier. Let's look at the job of each individual component in detail.

The LM329 is a precision temperature-compensated Zener voltage reference. It creates a 6.9-volt source with a long-term stability of 0.002% and a temperature sensitivity of 0.01% per

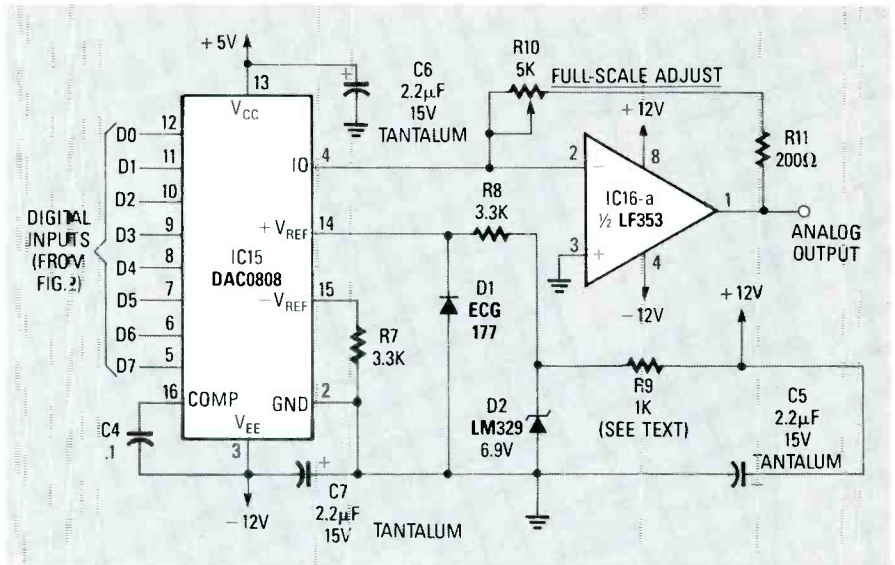

Fig. 3. ANALOG SECTION: A single channel consists of a DAC0808 (IC15) and half an op-amp (IC16-a). The voltage reference (D2) is common to all channels, but the value of the dropping resistor (R9) varies as the number of DAC's installed in the system.

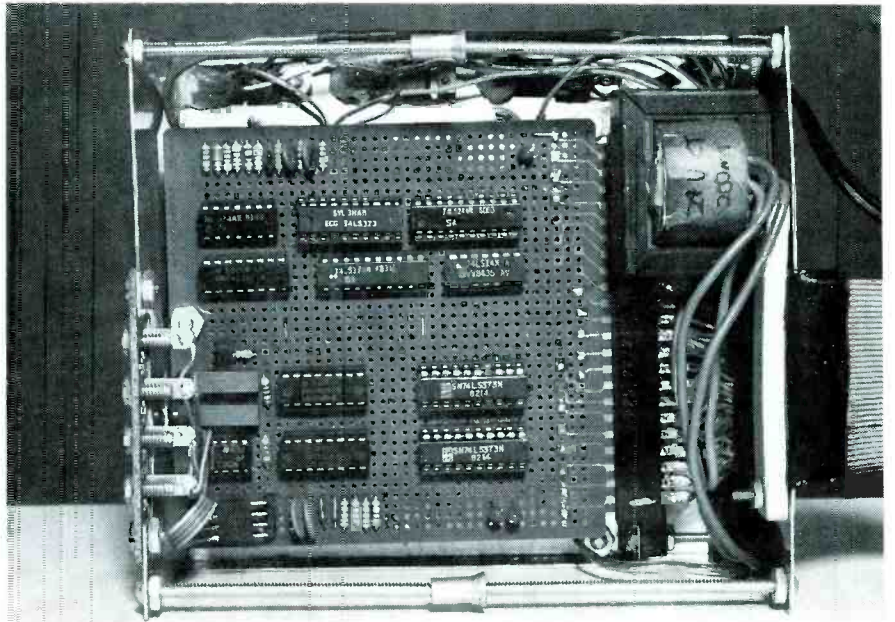

Fig. 4. SEPARATE THE ANALOG AND DIGITAL SECTIONS of the circuit. The author used point-to-point wiring.

degree Centigrade. Only one LM329 is needed, regardless of the number of converters. However, the dropping resistor (R9) between the LM329 and the +12-volt power supply should be adjusted for various loads. With two DAC's it should be 1000 ohms, with four it should be 510 ohms, with six, 330 ohms, and with eight, 240 ohms. In addition, even though only one dropping resistor and LM329 reference are needed for all eight converters, the 3.3K resistor (R8) and clamping diode (D1) must be duplicated in the circuit for each of the con-

verters.

The op-amp is a high-speed, high input-impedance, low power consumption model. It does not have a lot of output drive, but it can produce 10.0 volts across a 2K load. Its strong points are that it is very precise, that it has no offset voltage, and that it can change voltage at the maximum speed of the DAC. The feedback potentiometer (R10) on the amplifier allows you to adjust the full-scale output from 0.5 to 10.0 volts. You'll want to use a 15-turn potentiometer to make fine adjustments easily.

TABLE 1—DACL PROGRAM STATEMENTS

Statement	Meaning
' or ;	The rest of the line is a comment.
use [1pt]p	Use parallel port 'p' for the converter.
reset	Reset the converters on the current port to 0.00
scale, n, val	Use 'val' as a full scale value for converter 'n'
set n, exp	Set value of converter 'n' to expression.
wait t [msec, sec, min, hr]	If no units given, milliseconds assumed
wait until hh[:mm[:ss]]	Wait until 24 hour time.
do index = start, stop, step	Loop on index from start to stop by step.
do forever	Do forever or until user presses ESC
enddo	Close innermost do loop
nop	Do nothing except update display.

Attach a voltmeter to the output terminals of the first DAC, and adjust it for the desired full-scale value. Repeat the adjustments on the second DAC and continue until all have been set.

Use

It's easy to send data and selection masks to the converter. Loading a selection mask takes three steps: First, pulse the **RESET** line low, then high. Second, load the selection mask on the data lines. Last, pulse the **STROBE** line low then high. Sending data to the converter is a two-step process. First, load the data on the lines. Second, pulse the **STROBE** line low, then high.

Unfortunately, we don't have space to present program listings here. However, sample driver programs are included in DAC.ARC, which is available on the R-E BBS (516-293-2283). Two drivers are provided; DACGEN.ASM and DACPAR.ASM. DACPAR.ASM controls the parallel port directly. It is the fastest method, but requires close compatibility with the IBM standard. The other driver, DACGEN.ASM, uses the BIOS to control the parallel port. DACGEN.ASM should run on any IBM compatible, but it will transfer data at a slower rate.

Functionally, the drivers are identical. Each provides three function calls: one to obtain the status of the DAC; one to send a selection mask to the DAC; and one to send data to the DAC.

In addition, the author has developed a special programming language called DACL (Digital to Analog Control Language), and an integrated programming environment that allows you to experiment with programming the hardware. DACL's program statements are listed in Table 1.

The environment is illustrated in Fig. 5. With it, program development is as easy as in an interpreted language like BASIC; but run-time speed rivals that of a compiler. As shown, a full-screen editor is on the left, and current DAC status is shown on the right. The compiler produces plain English error messages, and leaves the editor pointing to the offending line.

R-E

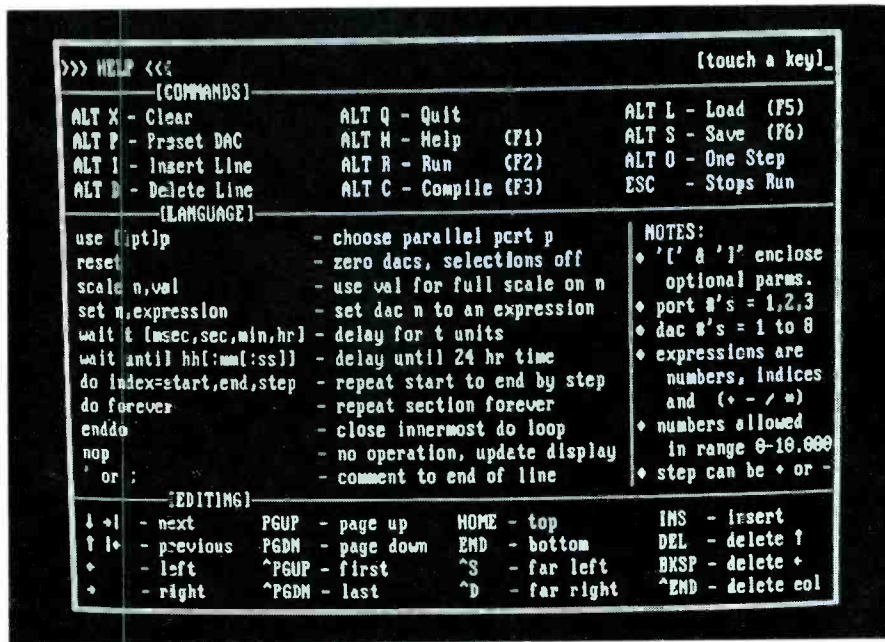

Fig. 5. THE DACL EDITOR/COMPILER. Compilation is nearly instantaneous; programs may be single-stepped.

Construction

Unlike some projects, construction details are important. One of the most common failings of mixed analog/digital designs is noisy digital signals corrupting sensitive analog devices. So keep the analog section physically separate from the digital section, as shown in Fig. 4. In addition, keep the analog lead lines short, and make sure that the feedback resistor on the LF353 amplifier is placed close to the IC and far from the digital parts.

Some components can be substituted. A 74LS123 can replace IC4, the 74LS221. Except for IC3, each of the other digital parts can use the corresponding member

of another family. For example, 74373, 74C373, 74S373, 74F373, 74HC373, 74HCT373, 74ALS373. Also, an LM1408-8 is a direct replacement for the DAC0808.

The maximum power required when driving eight DAC's into full loads is +5 volts at 250 mA, +12 volts at 100 mA, and -12 volts at 100 mA. Of course, the supply voltages must be regulated too. Power-supply bypassing is also a must. Put a 2.2-µF tantalum capacitor (C5-C7) between ground and each of the three power supplies.

Now calibrate the system. Unplug the device from the computer's parallel port and turn it on.

SERVICING

REPAIRING SICK AM/FM receivers is generally an easy, straightforward job; that can all change when tackling the newer digitally tuned models. It's bad enough having to work with densely packed circuitry sprouting unfamiliar components, no product documentation, and a matchbook-size schematic; now you have to cope with fixing digitally tuned (synthesized) radios, too.

But don't despair; we'll get you started in servicing those radios. You'll learn about synthesizer circuitry and the most commonly used IC's. We'll also take a look at some troubleshooting techniques that might be new to you.

Synthesizer blues

A lot of technicians have sung the synthesizer blues. Here are some real-life reasons why: One receiver had an annoying whine in the audio on AM. The sound got louder when a station was tuned in. Power-supply problem? Not quite; it turned out to be an open capacitor in the loop filter. Another radio worked on AM but not on FM. Bad FM circuitry? Nope, a dead prescaler IC. And finally a third receiver was dead except for a rushing noise on both AM and FM. Bad power supply or any part in the synthesizer circuitry? You're getting close. That radio had a bad voltage regulator, which powered the synthesizer's controller IC. Let's examine the parts just mentioned a little closer, along with their typical

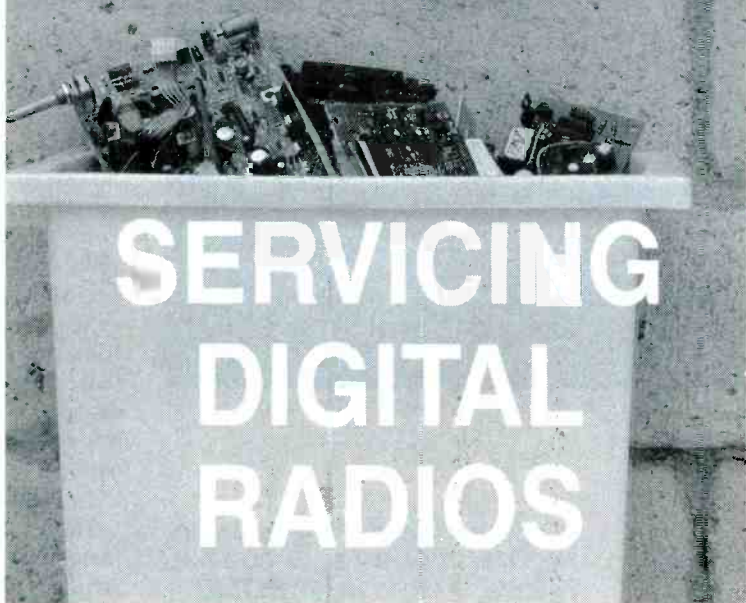

SERVICING DIGITAL RADIOS

*Stop! Don't throw out that radio.
We'll show you how to fix the new
digitally tuned receivers.*

GARY McCLELLAN

symptoms when they fail.

Actually, the toughest symptom to troubleshoot is the "receives no AM or FM stations," because that fault could be in the synthesizer, the tuner, or even the power supply. Good news! Since the early 1970's, synthesizer ra-

dios have gone from PC boards loaded with IC's to a four-IC set. That means that troubleshooting today's circuits will be a lot easier than with the earlier monsters, although the broken-radio symptoms remain the same.

Radio circuitry

Digital tuning offers the advantage of drift-free reception along with such features as station presets and signal-seeking tuning. That makes radios easier for consumers to use, and highly profitable for the manufacturers. Modern car radios are a perfect example of synthesizer radios using presets; that's when you just push a button and the station you preset is automatically tuned in. Of course, the old-fashion pushbutton car radios worked fine, but the manufacturer had the added costs of manually installing the mechanical pushbuttons along with its pulleys and sliding pointer. Quality control then depended on how the assembler felt that day. Now a machine just picks up an IC and solders it in place.

Figure 1 shows a typical synthesized AM/FM stereo receiver. Notice that the AM/FM front end uses conventional super-hetodyne circuitry—but with a few modifications. Instead of the familiar mechanical tuning capacitor, a set of varactor (variable capacitor) diodes control the tuning frequency. Varactors change their capacitance in direct proportion to the driving voltage. The

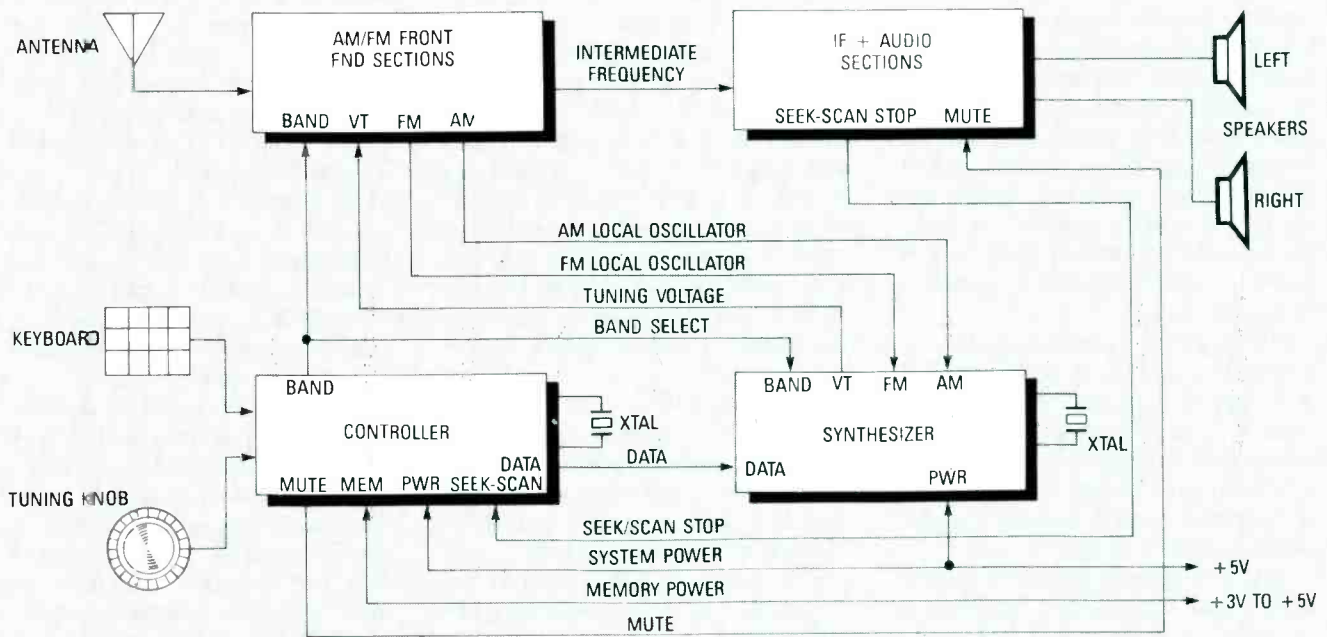

FIG. 1—DIGITALLY TUNED RADIO showing the control lines between the AM/FM front end, controller, prescaler, synthesizer, IF and audio sections, LED display, and keyboard.

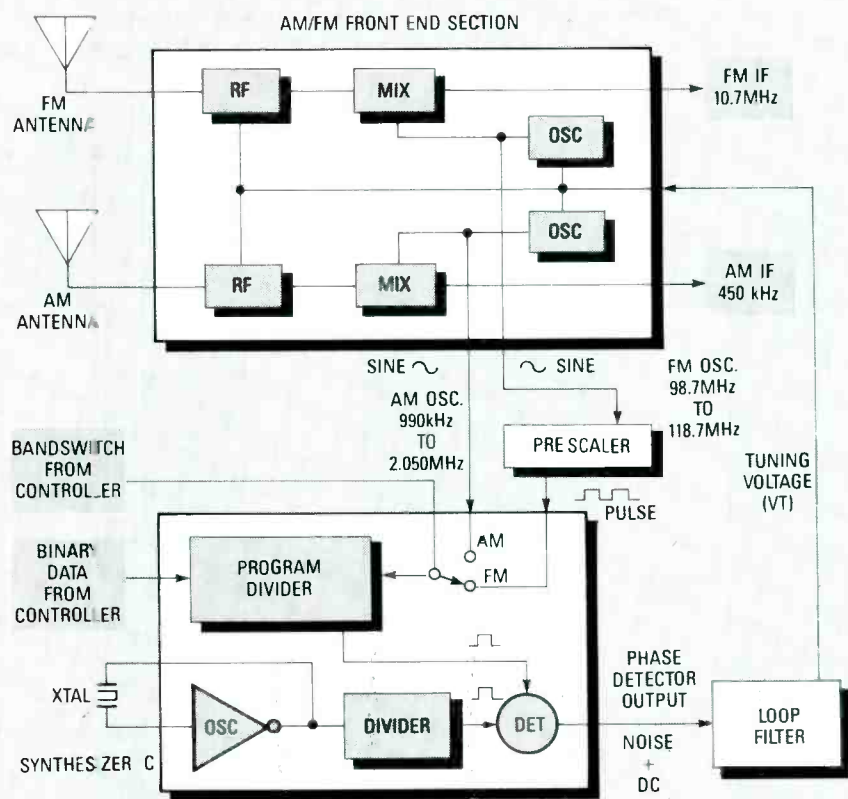

FIG. 2—THE RADIO'S SYNTHESIZER works closely with the AM/FM front end.

synthesizer monitors the AM- or FM-local oscillator and varies V_T , the tuning voltage that drives the varactor diodes, thereby controlling the receiver frequency.

Unique to digitally tuned receivers is the controller, which accepts inputs from the keyboard (presets, AM, FM,

Seek, Scan) or the tuner switch. The inputs are converted into a binary code that drives the synthesizer IC via the data lines—essentially, it tells the synthesizer what to do. Notice that the DATA output from the controller drives the synthesizer, and is also decoded for the digital display. Under-

stand that the digital display does *not* read the frequency that the receiver is tuned to; it is the frequency entered into the controller. That's an important fact to know when it comes to radio-tuning problems. The BAND-SELECT output selects AM or FM operation. Incidentally, if the receiver contains a clock, that function is also performed by the controller. Last, the controller also includes a MUTE output, which silences the radio during the tuning interval.

Deluxe receivers may contain an additional pushbutton called seek/scan stop tuning; when depressed, the controller forces the receiver to scan the radio band until a station is found. The radio's IF section then drives the SEEK/SCAN STOP line low, which stops the controller at the received station.

Two power sources are used to run the controller. Memory power is derived from batteries, or a large-value capacitor charged by receiver operation. System power (usually a 5-volt supply) runs the rest of the controller circuitry while the receiver is operating, including the display.

As shown in Fig. 2, the synthesizer IC accepts AM and FM local-oscillator signals from the front end. After receiving a divided-down signal from either local oscillator, a phase detector compares it with a signal derived from a crystal oscillator whose frequency is typically 10 kHz. The phase-detector output is an analog

tuning voltage that varies with the difference between local-oscillator and crystal-oscillator frequencies. If the local-oscillator frequency is too low, the tuning voltage rises to a maximum; if the frequency is too high, the tuning voltage drops to zero. When the two frequencies are exactly the same, the voltage reaches an equilibrium and the desired frequency is tuned in. That condition is known as being "in lock."

Although all synthesizers directly accept the AM local oscillator, few work at FM local-oscillator frequencies. So, you'll find a prescaler IC nearby that divides the 98.7-MHz to 118.7-MHz FM local-oscillator frequency down to a frequency that the synthesizer IC can handle.

The analog tuning voltage from the synthesizer output must be filtered, and possibly level shifted (scaled) to suit the AM/FM front end. The filtering is simply a low-pass filter (dubbed a loop filter) that removes noise pulses generated by the phase detector for a clean DC output. Often, several transistors or an op-amp is used to improve filter performance.

Typical tuning voltages for AM reception range from 1.5 volts (540 kHz) to 6.9 volts (1600 kHz) in car radios. Home receivers may increase that range from 3.0 to 21 volts, especially in older models. On the other hand, FM-tuning voltages tend to be a little less than the AM tuning voltages. Note that the received frequency increases with tuning voltage; that information is sometimes useful.

Typical tuning voltages for AM reception range from 1.5 volts (540 kHz) to 6.9 volts (1600 kHz) in car radios. Home receivers may increase that range from 3.0 to 21 volts, especially in older models. On the other hand, FM-tuning voltages tend to be a little less than the AM tuning voltages. Note that the received frequency increases with tuning voltage; that information is sometimes useful.

Sought after IC's

Figure 3 is a typical synthesizer radio that features AM/FM digital-tuning along with seek/scan modes, and five station presets per band. There is also a clock feature.

The heart of the radio is the UPD1701 (IC1), manufactured by NEC of Japan. That device sports nearly all of the controller and synthesizer functions in one 28-pin DIP package. It is widely used in both home and car receivers; you'll find it in expensive receivers from Japan and

in the "no name" specials from Hong Kong. Another popular IC is the UPD1703, which is like the UPD1701, but without the clock.

A popular FM prescaler is the UPB553 (IC2). It accepts the FM local-oscillator signal on pin 2, divides it by either 15 or 16, and outputs on pin 5 to the synthesizer. One interesting feature is the "divide by" pins 6, 7, and 8, that are controlled by IC1. The division ratio depends upon the frequency programmed by the controller and other factors.

The TD6250 (IC3) drives the display segments, and the UPA53 (IC4) drives the display cathodes. Note that the common-cathode LED display has four digits, plus LED indicators for functions like preset number, AM, FM, and memory. Sometimes you'll find individual transistors replacing the TD6250, and five transistors substituting for the UPA53.

When the keyboard is used, the synthesizer (IC1) internally decodes the key pressed and performs the desired function. Incidentally, the knob-

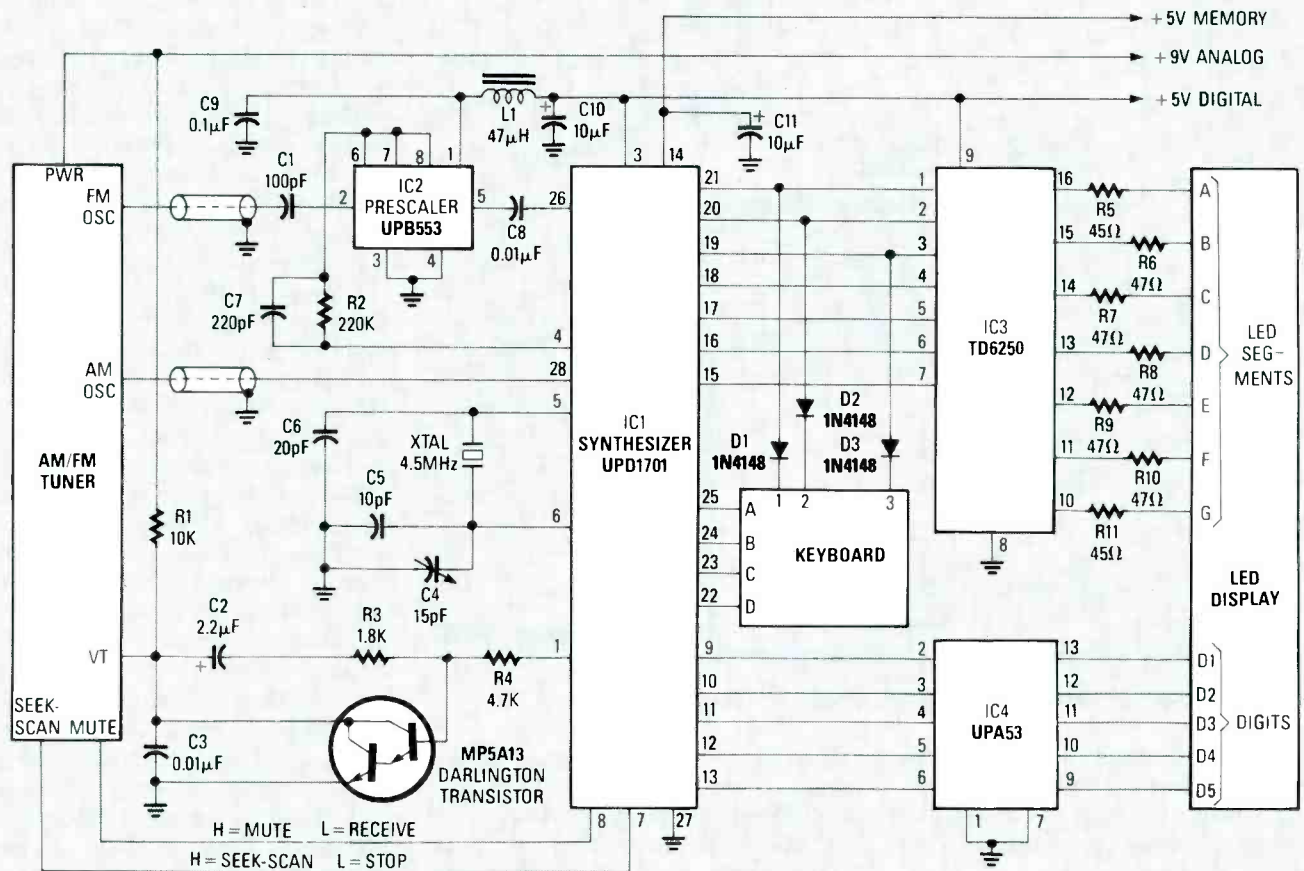

FIG. 3—THIS DIGITALLY TUNED RADIO uses custom IC's that perform complex functions. To fully understand each IC's operation, you really need the manufacturer's service manual.

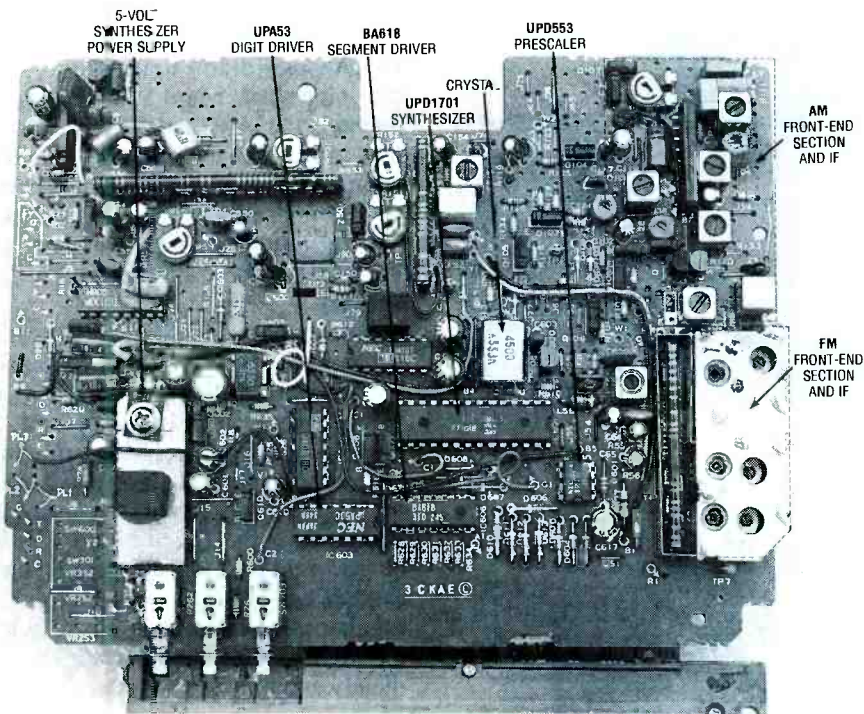

FIG. 4—THIS IS WHAT THE INSIDE of a digitally tuned radio looks like.

tuning feature found in car radios connects exactly like the keyboard. The tuning assembly uses two cam-driven SPST switches. One switch closes momentarily to tune down, and the other closes momentarily to tune up—a simple, but clever device.

The phase-detector output is taken from pin 1 of IC1, through a loop filter consisting of a Darlington transistor, and a few capacitors and resistors. Sometimes you'll find a FET transistor combination used instead. Some high-end receivers substitute op-amps, in their loop filters, for supposedly better results.

The AM/FM tuner may be a collection of discrete components on the board, or more likely a module from Alps or Mitsumi Corporation. It provides buffered local-oscillator outputs on the order of 100–400 mV, and accepts the tuning voltage. Some tuner modules also include IF circuitry; in that case, they can have a seek/scan stop output, and audio-muting provisions.

The increased desire for more presets has forced receiver manufacturers to return to separate controller and synthesizer IC combinations. Chrysler, for example, uses a National COP-series controller and a DS8908 synthesizer-IC set in their recent-model car radios. Headphone portables use a single IC for controller, synthesizer, and display driver

functions—available from Sharp or NEC. Should one of those parts fail, you can buy it *only* from the receiver manufacturer, and that often makes repairs uneconomical.

Troubleshooting techniques

Now let's look at some winning troubleshooting procedures. Well, OK, nothing can replace good ol' factory training, full service data, plus five-years experience, but these tips will get you off to a good start. Figure 4 is a typical digitally tuned receiver that you might come across in any repair shop.

Here's the *test* procedure, which is simple enough. Before you do anything else, try all receiver controls and functions to verify and duplicate the customer's complaints. Doing that will help you avoid those problems caused by customers who have trouble using electronic equipment and may simply be confused. Other problems you want to immediately rule out include the obvious: wiring disconnected, blown fuses, and tinkering by Saturday mechanics.

Just trying the controls can uncover digital-tuning defects like stuck keyboards and intermittent switches. Clean or replace the bad part and your work is done. Suffice to say, "Always fix the obvious problems first."

Now let's evaluate receiver problems to isolate a bad power supply or

dead amplifier. Only when everything else is working should you turn your attention to the digital tuner. Many times, you'll find fixing the simple problems clears up over half of the "it won't get any stations" problems.

As you might expect, to service the digital tuner, it helps to obtain the radio's service manual from the manufacturer; at least then you'll know what voltages to expect, and can identify the parts on the board.

To troubleshoot down to the component level in a digital tuner, the following tips should be helpful:

- **The AM/FM front-end** is good if you hear a rushing sound with the volume turned up. That can be verified by connecting an antenna, and listening for any stations near 540-kHz AM or 88.1-MHz FM. If you have no local stations, try a signal generator.

- **The controller** is probably good if all keys work, and it stores the frequencies you enter. If you observe one or more bad keys, the keyboard is likely to be at fault—bridging the connections behind the bad key with a screwdriver blade will show that fault.

- **The display** has common problems like missing segments, and are usually caused by an open connection between the display and driver. Look for an unsoldered connection or broken wire.

- **The synthesizer IC** is good if you can tune in AM or FM stations. If you can't get FM, check the prescaler circuit. If you can't get AM, suspect either the local oscillator output from the AM/FM front end, or the synthesizer IC itself.

- **The loop filter** is good if you can tune in AM stations across the entire band, without a whine in the sound.

- **The prescaler** is good if you can tune in FM stations—either it works or it doesn't.

- **The power supply** is a common trouble spot. Typically that defect is obvious because the display is not lit.

- Test or substitute the major components in the area you isolated. Look out for the little things like broken parts and unsoldered connections.

Ok, roll up your sleeves: We're going to put theory and practice together to fix some digitally tuned radios, and find some of those hard-to-find replacement parts.

Digital clock radio

As shown in Fig. 1, Cola on the



FIG. 1—SPILLED COLA ON A KEYBOARD will ruin any radio.

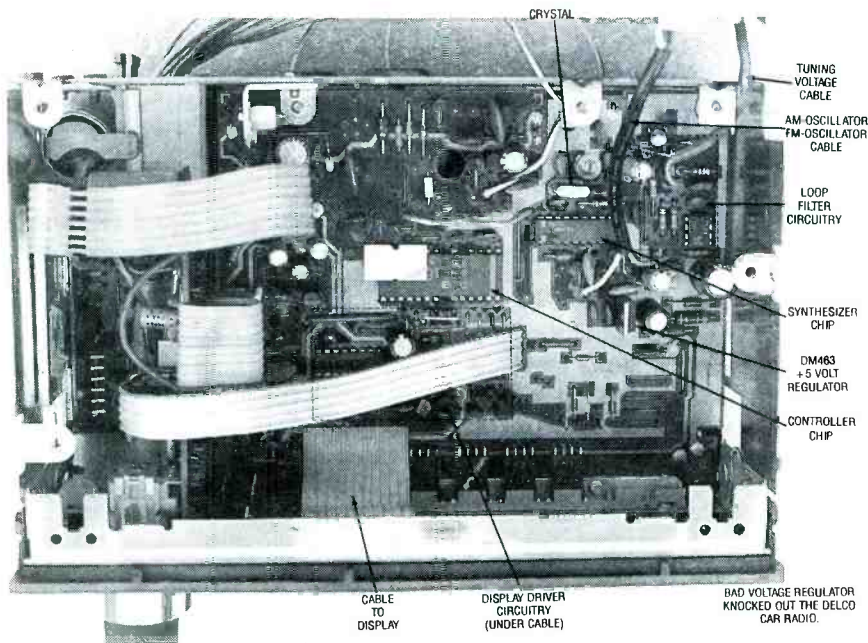

FIG. 2—HERE'S A DELCO CAR-RADIO that doesn't work. Would you know where to look to fix this baby?

keys killed that General Electric model 7-4885A digital-clock radio. That's right; go ahead, spill cola all over your radio's keyboard and let it leak inside—*your* radio won't work, either. So why should cola kill a radio? Let's take a look inside and check it out. We see dried gook and gunk all over the keyboard. Bridging the FM-key contacts with the screwdriver blade turned the music right on. It doesn't take a genius to know that the keyboard contacts need cleaning. OK, that was an easy fix. While we're on the subject, what's a good way to clean that keyboard, anyway?

Cleaning a keyboard just takes some common sense. Luckily, that radio could be disassembled to access the contacts. Unsolder the cable from the keyboard, scrub out the sticky cola with a toothbrush and a pan of warm water, then let it dry. Shoot each

keypad contact with some contact cleaner, rub-a-dub, then re-install the keypad. Success!

Be careful when handling the keyboard wiring, and use Electrostatic Discharge (ESD) precautions. For example, walking across a rug can generate several thousand volts, which (when discharged) can blow a controller IC faster than lightning. Excuse the pun. The cost of a new Texas Instruments TMS-1100 IC can make repairs prohibitive. So please don't say that you weren't warned here first.

Delco car-radio

"I know it's Sunday afternoon, but can you fix my car radio? It doesn't get any stations." Does that sound like your next-door neighbor? The car radio was a Delco model 40JHMAI, typical of the black-faced digital radios found in recent General-Motors

cars.

Figure 2 shows the Delco board. Trying that radio on the bench, the LED display didn't light. Turning up the volume, we heard a rushing noise on both the AM and FM channels; that implied that the audio and RF circuitry were working. Connecting an external antenna verified RF-circuit operation because we heard an 88.1-MHz FM station through the speaker.

At that point, it's best to stop and study the symptoms for a moment. Because the display wasn't lit, that means there's no power, or possibly a open wire somewhere. Measuring the voltages on several IC's revealed zero voltages on every pin of the controller IC. Look at the Delco board a little closer; right next to the controller and synthesizer IC's is a DM463 voltage regulator. Replacing that old IC with an MC7805 from our stock immediately brought the receiver back to life.

Like keyboard problems, power-supply problems are usually repaired quite easily. Here's a tip: If you are working on a car radio, be sure to check the "clock" or "memory" power lead. If that lead gets disconnected, the radio may either play dead or lose time-and-station settings whenever the ignition is turned off.

Toshiba stereo

What about a Toshiba model KT4066 portable headphone-radio developing an intermittent on FM shortly after purchase? It would go dead at infrequent intervals, but the AM band and cassette player worked fine. Until, finally, the headphone jack went completely bad. Opening up that baby revealed surface-mount circuitry. Think of surface-mount technology like a pizza: the crust is the PC board, while the toppings (tomato sauce, cheese, maybe anchovies) represent the parts.

The headphone-jack problem was fixed first. It was nothing more than a cold solder joint that had broken loose, causing intermittent sound in one channel. But that bad solder connection didn't fix the intermittent FM-reception problem. Unfortunately, the radio wouldn't fail for a long enough time to isolate the problem. In fact, just bringing the radio near the bench was enough to make it work perfectly!

The solution was to inspect the synthesizer board mounted in the lid. Figure 3 shows a bird's eye view of the

radio's guts. Under a magnifying glass, several solder connections looked suspicious; one connection next to what appeared to be a pre-scaler IC looked unsoldered! Using a grounded soldering pencil and 0.031-inch solder, each poor connection was resoldered. Jackpot! The receiver works perfectly to this day.

Incidentally, be careful when taking apart and re-assembling headphone stereos. The tiny plastic parts used are easy to break and hard to replace. On some models you must remove the switch knobs first or you'll break them.

Exotic-car radio

An automobile importer had a minor problem with some radios. It seemed that he received a shipment of cars from Europe with radios that would not receive AM stations. Could the problem be a switch? While his mechanics made the cars conform to USA emissions standards, they were stumped when it came to digital radios. The receivers supplied were the Fujitsu-Ten model *EP821*, which has

some unusual AM/FM reception capabilities, plus a cassette deck, clock, and equalizer.

The problem with foreign radios is that they are set to tune in the broadcast frequencies of a particular country. For example, the AM-broadcast band (535–1605 kHz) was set to 9-kHz tuning steps, instead of the 10-kHz tuning standard in North America. Because the radio was tuning in 9-kHz steps, it missed most AM stations! The FM reception was unaffected because the *EP821* tuned in 0.05 MHz steps, making it possible to receive either European or USA stations. Understand that Europe uses even-numbered 0.2 MHz steps (100.2, 100.4...), while in the USA we use odd-numbered steps (100.1, 100.3...).

Inspecting the chassis for a switch to select either 9-kHz or 10-kHz tuning steps revealed nothing. So the only alternative was to contact the Fujitsu service department to buy a service manual for the *EP821* model. To our surprise, they didn't know that model number, but they could supply

a manual on the *EP820* model, which fit the set's description exactly.

Immediately upon receiving the service manual, we found that the schematic page showed a diode marked "USA" connected across two pins of the MB8851-110 controller IC. After installing the diode, the radio still did not work on AM. The only solution was to obtain the MB8851-101C controller called out in the parts list and try a replacement. Sure enough, the AM section worked fine when a new IC was plugged in.

Nothing works right

From all appearances the Sansui model *R707* had many problems; yet the cause was a single part that was fixed at no cost. Turning on the power, everything was working except for the AM and FM tuner section. On FM, the display would scan frequencies and it would store ones chosen at random. The only sound was a soft rushing noise. On AM, the display read typical AM frequencies, but the decimal point remained lit and the display said MHz instead of kHz. There was no sound, so it appeared that the AM front end was dead. Unusual symptoms to be sure; but that particular repair project would get stranger as we continued!

Analyzing the problems showed that the controller was basically working because all controls worked and it stored stations. But there was some sort of controller defect that caused the display to read frequencies like 160.0 MHz on AM. So controller troubleshooting was called for. The receiver wouldn't pick up any stations; in fact, it wouldn't respond to the output from a signal generator, either! So, for those reasons, troubleshooting of the AM/FM front end was necessary.

The question was where to start troubleshooting. The controller was a good beginning because of the display faults—but the voltages were good and there was no sign of any problems. Short of substituting the controller IC, there was nothing else to check in that area; therefore, looking at the synthesizer might prove worthwhile. A quick way to check synthesizer operation is to locate the vt (tuning-voltage) line and measure it with a high-impedance voltmeter. For stations around 88 MHz or 540 kHz the voltage will be low, typically a few volts or less. For stations around 108 MHz or 1600 kHz the voltage will be

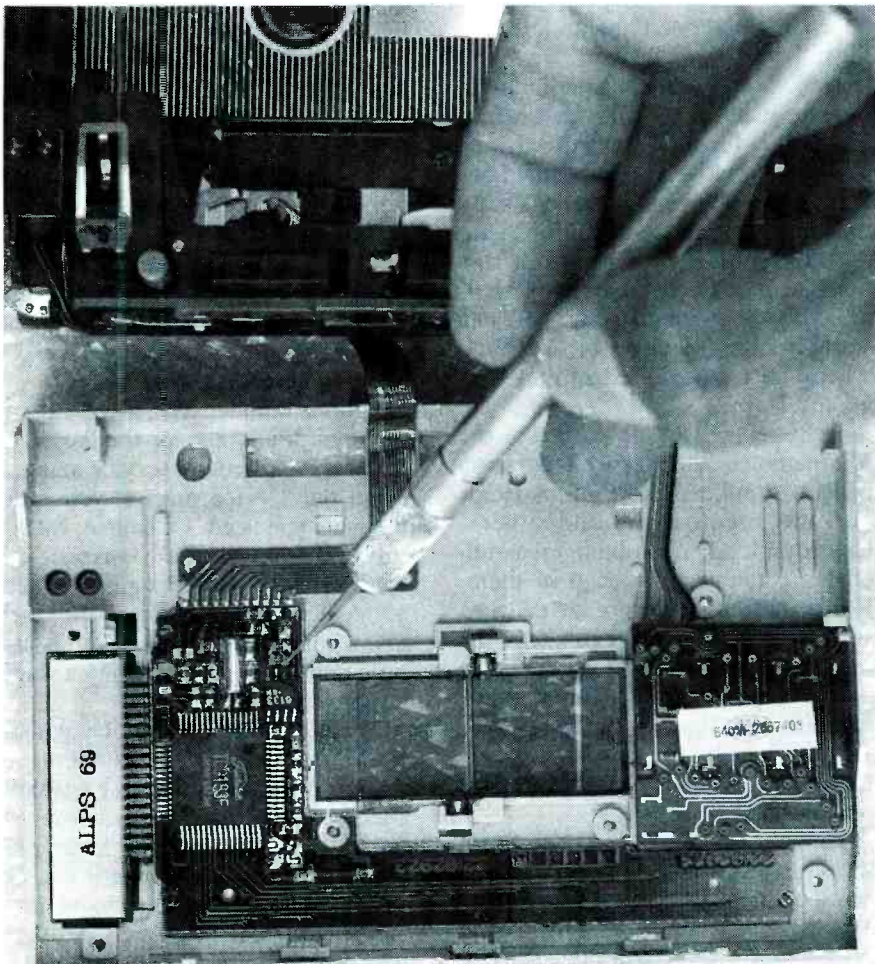

FIG. 3—THIS TOSHIBA PORTABLE HEADPHONE-RADIO uses Surface Mount Technology (SMT) components.

nearing maximum, or roughly 6 to 24 volts, depending upon the model. If the voltage is far below or above that range, the synthesizer is out-of-lock and needs attention or servicing of some kind.

Measuring the tuning voltage showed that it was stuck at maximum; the synthesizer was out-of-lock. From past experience that indicated a failure in the loop filter, synthesizer IC, or local oscillator in the front end. In other words, the bad part could be almost anywhere! After substituting the synthesizer IC, and finding no obvious defects in the loop filter, a scope check of the AM local-oscillator confirmed there was no signal; neither was there any signal from the FM prescaler. So what was going on here?

It looked as if the front-end wasn't getting any power because both local oscillators were out; yet 13 volts was measured to the tuner board earlier. Something on the tuner board was preventing the voltage from getting to the radio's front end. With the receiver still in the FM mode, checking for power on the IF board revealed nothing wrong—12 volts was present at several points. But when we moved to the terminals of the shielded front-end, we struck luck like gold. For the only value above a volt was the (tuning voltage) vt pin. There was no power anywhere else! Tracing the B+ pin from the tuner module to a nearby choke, L1, there was 12 volts on one side of L1, and nothing on the other side. L1 was open, thus disabling the unit!

Inspecting the choke revealed a broken coil-wire. Not the heavier coil-winding itself, but the slender connecting wire extending from the choke body. Soldering a new piece of wire to the choke body repaired that problem. Re-installing the repaired choke restored all functions to the Sansui R707.

Getting parts

Let's face it: Obtaining replacement parts can be as difficult as servicing the receivers themselves. That's especially true if you're an individual seeking a single component rather than a factory's authorized-service center receiving weekly scheduled parts deliveries. Here are some insider tips to help you play the parts game and win.

For general troubleshooting,

nothing beats a supply of modules and assorted parts. One way to get parts is to collect cast-off radios from owners who have decided that their sets weren't worth fixing. Test each throw-out and determine the radio's general condition, such as no left channel, no FM, and so on. Parts that seem to be good can be pulled as needed for substitution into other radios. If the substitution of a certain part works, an authorized replacement part can be ordered to complete the repair.

Good sources of cast-off electronics components include flea markets, friends, and ham-radio swap-meets; keep your eyes open for local radio clubs that hold swap-meets regularly. Other sources are various auctions. Sometimes you can get current-model receivers dirt cheap at bankruptcy auctions, so don't shy away. Some radios might be new and can be resold below the regular cost; others might be damaged, but can be broken up for parts—an ideal situation. Don't shy away from new-but-damaged goods, which can be scavenged for parts at unbelievable savings. Try it!

Understand that there are limitations to using parts from cast-off receivers and you'll do well. Using those parts is low-cost and sometimes convenient, but you must spend extra time removing and re-installing them. Also, you must be reasonably sure that the part removed is good. It is amazing how much time you can waste troubleshooting a broken radio when you replace one bad part with another!

A better source of parts are the Maintenance and Repair Operation (MRO) suppliers like Phillips-ECG, NuTone Electronics, and others. Check their ads and obtain cross-reference catalogs from each of them. While MRO suppliers offer convenience, they tend to carry only the more popular parts that are found in older equipment. So if you have a sick receiver less than a few years old, which is usually the case for digitally tuned radios, you're out of luck for certain parts.

Another good source for parts are the suppliers who advertise Japanese semiconductors. Typically, they offer exact replacements at reasonable prices. Also, they have other special parts, like flame-proof resistors, VCR belts, and so on. Dig through the ads,

call them up and request a catalog. A drawback from ordering from suppliers is the 1–2 week wait for UPS delivery and a minimum-order amount. Many times you'll have to order several more parts than you need, just to attain a \$10 to \$20 minimum. You can beat minimum-order requirements by combining parts from several repair projects into one order.

One ideal way to obtain parts is directly from the manufacturer. Because most radios are imported, you must contact the radio company's regional office, which is usually on the East or West Coast. Those offices seem to work best for factory-authorized service centers. The service center calls the regional office, orders by part number, and receives it in their weekly (or monthly) scheduled shipment. Billing is done on an account held by the service center; once a month the bill is paid. Simple for service centers. The rub is that many regional offices are warehouses; they have no facilities for walk-in customers who don't have part numbers. To be fair, some regional offices like Sanyo have walk-in centers where you can look up part numbers and get parts, but places like that are extremely rare, so consider yourself lucky if you find such a place.

Dealing with regional offices can be frustrating, but this procedure is typical: First you determine the location of the regional office. Often that information will be printed on the receiver's identification label. Then you dial for Directory Assistance to get the phone number. When you call the regional office, ask for the Parts Department and order a service manual. From the service manual you order the parts you need. Of course, by that time six months have passed. It's therefore best to avoid regional offices altogether if you can get the parts elsewhere—the paperwork is too time-consuming for repairing a single out-of-order unit!

Some regional offices play games: If they find out that you're not one of their dealers, they demand cashier's checks for the manual and parts. A few dealers resort to the letter ploy where they won't take your calls. Instead, you must write to them for a service-manual price and delivery, then again to order parts. Try to avoid outfits like those at all costs when you run into one!

R-E

IF YOU'RE LIKE MOST VIDEO-CAMERA owners, you've built up an inventory of hours and hours of home video movies. If you like to show your movies to others, you've undoubtedly found that even your best friends won't sit through an hour-long video of your son's first birthday. The solution is to edit your tapes into groups of short scenes. The trick is to do it with professional results.

The problem that arises is how to make the transitions between scenes or sources as smoothly as possible, without visually or aesthetically disturbing transitions. Our Video Scene Switcher is the key to smooth transitions.

In order to switch between video channels with a minimum of disturbance, several technical requirements must be met:

- Sources must be identical in polarity and type (for example, both NTSC with negative sync)
- Sources must have the same levels. That requirement can be met using gain adjustments.
- Color-burst phase must match in order to reduce color shifts between scenes.
- Terminations and impedance matching must be considered in order to reduce reflections and "ghosting."
- The time phases of the sources must be constant and have a fixed relationship. The sync pulses must coincide both in time of occurrence and frequency, both vertical and horizontal.

Most of the time there is no problem in meeting the first four requirements, as they are under direct control of the system operator. However, the last requirement, that the video sources have sync pulses in phase, does present a problem. That's because, when using two separate VCR's, a VCR and a camera, or a VCR and an over-the-air source, there is generally no relationship between sync phases.

The term "genlock" is used to describe the act of using a master syn-

VIDEO SCENE SWITCHER

Make your next transition a smooth one!

WILLIAM SHEETS and RUDOLF F. GRAF

chronization source to control the sync phase of other sources. Some video equipment has genlock inputs but, most of the time, the availability of two genlocked sources cannot be relied on.

When the signal source to a video monitor, TV receiver, or VCR is suddenly switched, the synchronizing circuits of the video device experience a discontinuity of input, in frequency, phase, or both, depending on

"amateur" look to a program, and should be eliminated.

A common way to deal with the problem is to fade to black, or some other level. During this interval, switching takes place, and since the screen is black, no transient effects are noticed. After a predetermined time, the new video is switched in and then the fade from black to program is performed.

There are other methods that can be

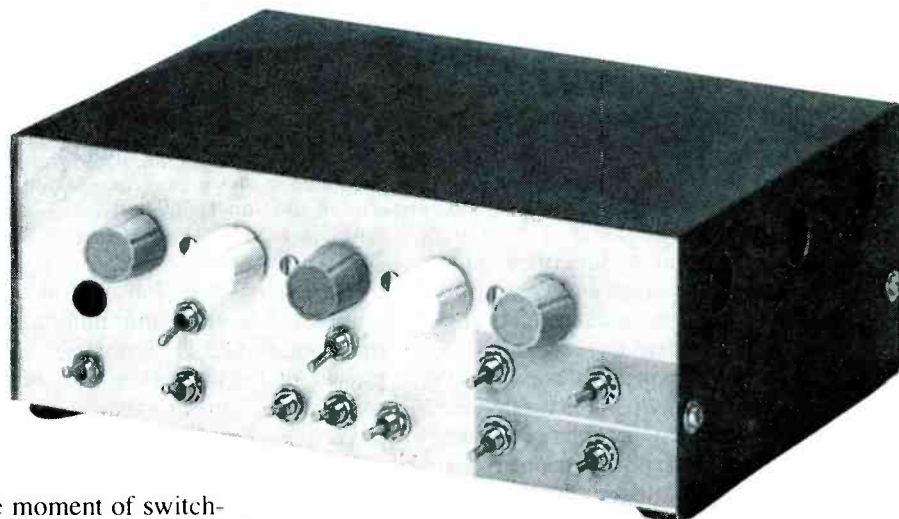

the moment of switching in most instances. If, by chance, the vertical and horizontal sync pulses of both sources are coincident in time (in phase) at the moment of switching, there will be no noticeable disturbance. If, however, they are not (the usual case), a momentary loss of synchronization will occur. Depending on the characteristics of the sync system in the video device in use, a momentary flicker, jump, tear, or roll will occur in the picture—it's objectionable, esthetically unpleasant, gives an

used. A black-over can be "keyed" into the picture; for example, a black over can be wiped across the picture, much like a curtain, either horizontally or vertically, or both (diagonally). A black-over can also be broken up like a series of vertical or horizontal strips that gradually enlarge, covering the picture with the effect of a Venetian blind. By doing that vertically and horizontally at the same time, black

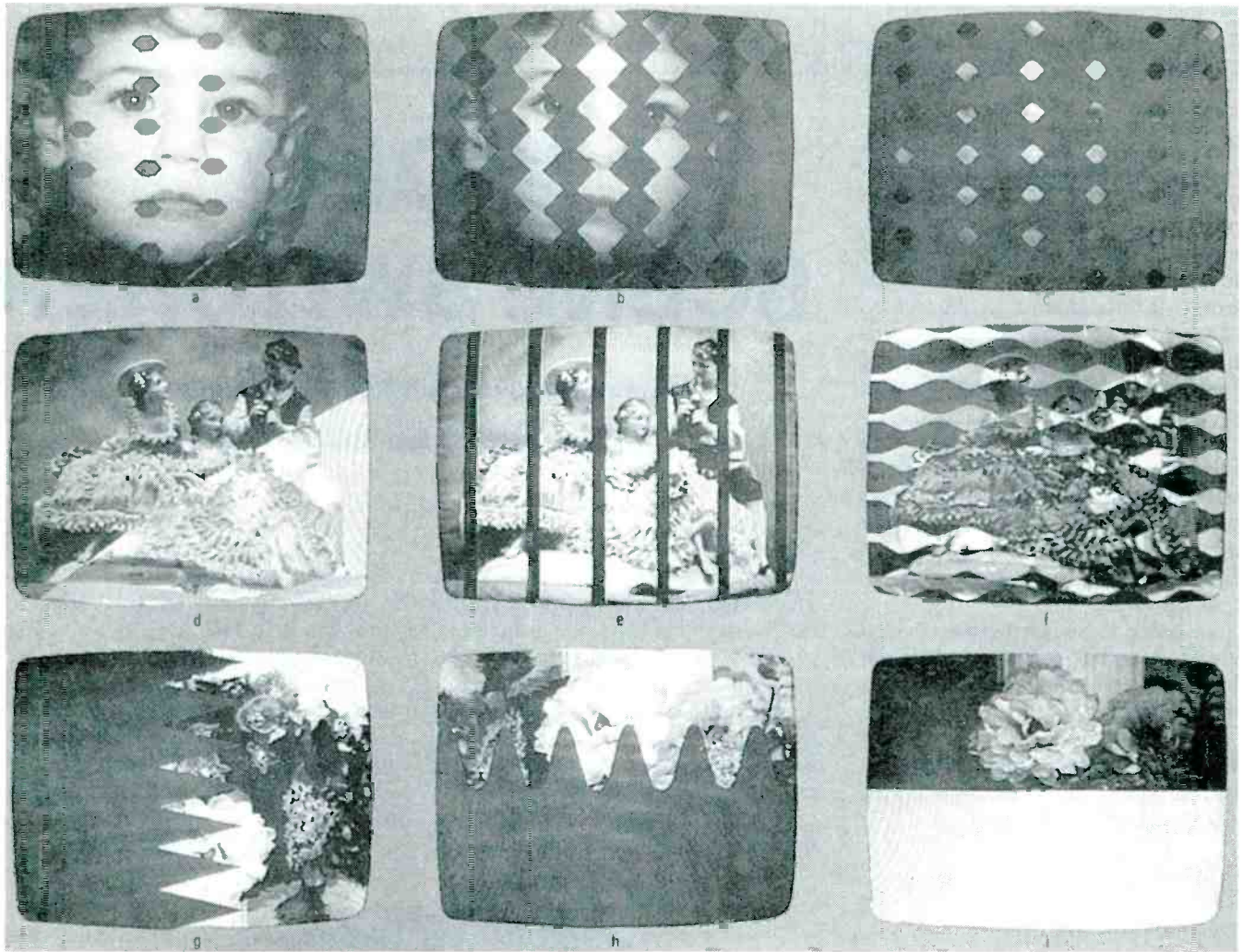

FIG. 1—VARIOUS FADES, WIPES, AND EFFECTS can be keyed into the picture. You don't have to stick to simple horizontal or vertical fades, as complex fades are also possible; see how Danny disappears in *a*, *b*, and *c*. A diagonal wipe from regular video to effects video is shown in *d*, expanding vertical bars "consume" the picture in *e*, expanding diamond-like patterns in *f*, and *g*, *h*, and *i* show three additional wipe patterns.

dots appear in the picture that expand in size to first overlap and then completely obscure the picture. Figure 1 shows those patterns.

The act of "keying" is actually video switching using waveforms that are tied to the sync pulses or other picture elements, such as the luminance level (luminance keying) or chroma level (chrominance keying). By producing such waveforms, a great variety of switching and special effects can be produced. Note that the effects are performed steadily on the video, and that the sync pulses must remain unaltered during the switching process.

For wipes, keying, or other switching between two sources without an intermediate fade, the two sources must be genlocked or synchronous. There is no easy way around that, save for a large video buffer memory, or

some form of synchronizing storage system. However, that shouldn't be considered a serious limitation, since many fade-to-black techniques have a pleasing effect, and they provide a more defined differentiation between scenes.

Basic operation

The Scene Switcher basically consists of two parts, as shown in the block diagram in Fig. 2. A video switching system is used to switch in various video effects, fade levels, and to select channel 1 (CH1) or channel 2 (CH2), and a waveform generator is used to generate keying waveforms to drive the analog switches at precisely timed intervals.

There are two video channels (CH1 and CH2), but we will describe the operation of only CH1, because the

two are identical. Each channel has two switch-selected inputs, main or auxiliary, and each channel is fed to a splitter circuit that separates the video and sync components. That way, the video can be processed separately from the sync. The sync is not processed in any way.

The video from CH1 first passes through an analog switch (NORMAL/EFFECTS) that either passes it or selects CH1 video that has been altered by an external special-effects unit (for example, the Video Palette described in the September and October 1987 issues of **Radio-Electronics**). Since the video from the special-effects unit is inherently synchronous with the CH1 video, direct switching is possible, and you can wipe the altered scene over the original one.

Next, the video is fed to another

analog switch, the *FADE SELECTOR*. The output of that switch is either unaltered video or a DC background level from the *fade level generator*, which is variable between black (about zero volts) and white (1 to 1.5 volts). That is determined by the setting of the *FADE LEVEL* control, which gets its switch signals from the control panel and the *keying generator*. During a line-scan interval, several switching actions may take place, causing various pattern configurations to be generated on the monitor screen.

Next, the video goes to a switch network that routes it to either side of the *FADER* control, or selects CH1 or CH2. Both analog switches are driven by the keying waveform from the keying generator and control panel; switching may take place several times during a line scan, depending on the effects desired. The output from the *FADER* control is fed to a

summing amplifier, and mixed with appropriate sync. The system output is composite video.

The keying generator consists of a set of sawtooth-wave generators. Sync from CH1 or CH2 is fed to a phase-locked loop, where constant outputs of 15.74 kHz and 60 Hz are generated, phase locked to the video input waveform. Those outputs are fed to the horizontal and vertical sawtooth generators.

The generators each produce two waveforms; a sawtooth at eight times the input frequency and a sawtooth at the input frequency. The sawtooth waveforms are fed to a comparator, whose "trip" level is adjustable. The sawtooth is compared to the trip level from the keying control, which may be manual, or automatic.

When the sawtooth exceeds the trip level, the comparator switches. Since the sawtooth level varies synchronously with the horizontal, or

vertical, or both sweeps, varying the trip level causes the comparator to switch at varying points in either the horizontal or vertical scan. Therefore, since the comparator output is the keying waveform, we can control the position of the switching at any desired point in either the horizontal or vertical scan cycle.

The switching waveform is fed to the control panel and then to the correct analog switches in the video channels. Several switching patterns can be generated, using the $\times 1$ or $\times 8$ vertical, the $\times 1$ or $\times 8$ horizontal, or various combinations.

The circuit features external access capability to the switch signals and sync outputs via emitter followers. That permits using an external computer or microprocessor to generate other switching patterns than we have here, if desired. That is left as a project for the experimenter or computer hobbyist.

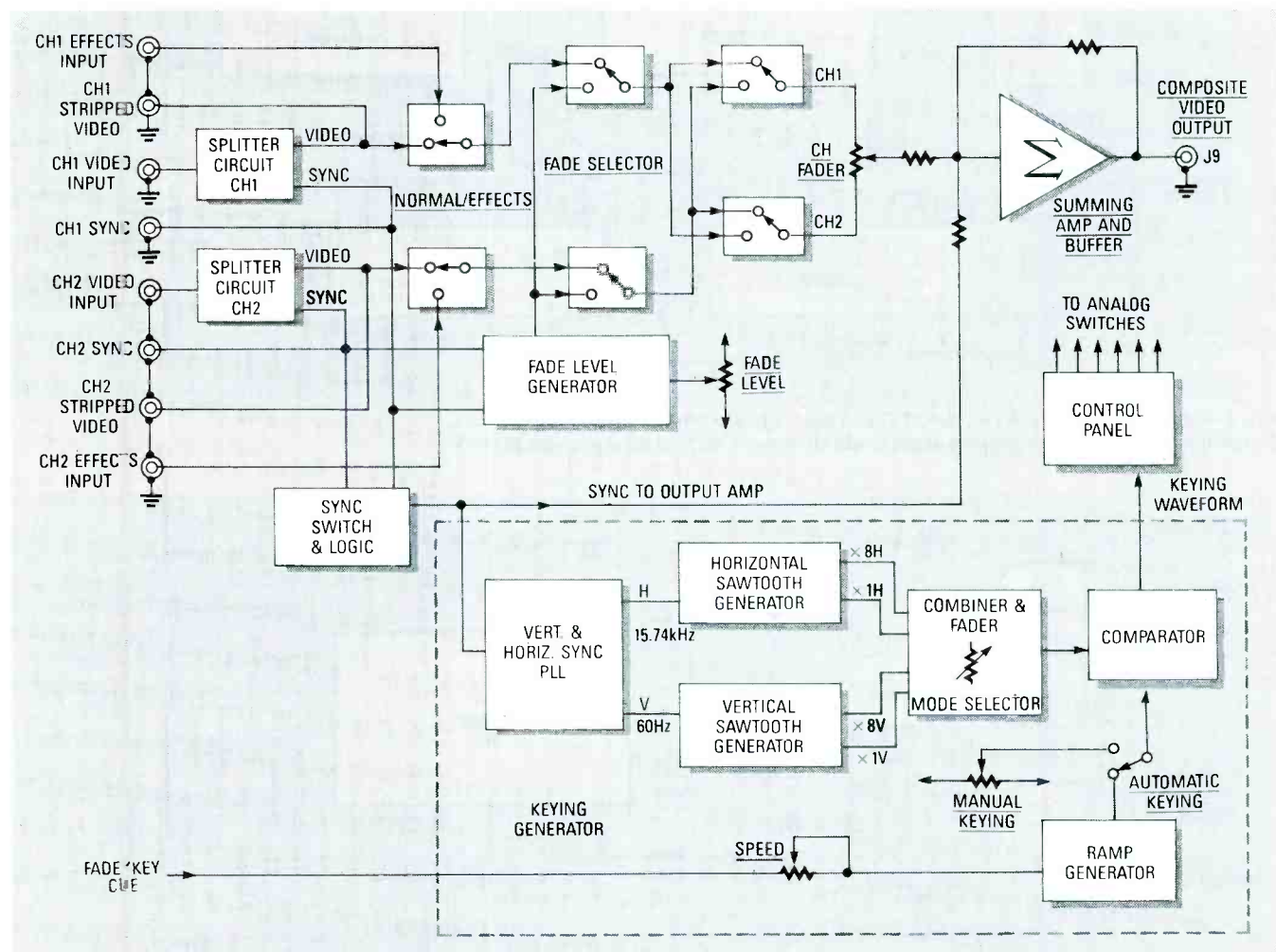

FIG. 2—THE SCENE SWITCHER BASICALLY CONSISTS OF TWO PARTS, as shown in this block diagram. A video switching system is used to switch in various video effects, fade levels, and to select channel 1 (CH1) or channel 2 (CH2). A waveform generator is used to generate keying waveforms to drive the analog switches at precisely timed intervals.

Circuitry

Due to the large amount of circuitry, very detailed descriptions of every circuit will not be given. Only a single example of each essential block will be described in detail, since much of the circuitry is repetitive.

Referring to Fig. 3, video is fed through C1 and filter R1-C2 (to remove excess noise) to sync-separator IC1, an LM1881N; it separates the horizontal and vertical sync from the video. Composite horizontal sync (negative-going pulses) appears at pin 1, and is then fed to IC2-a, the hori-

zontal-delay multivibrator, in which R5, R6 and C6 determine the period.

The multivibrator produces an 8-microsecond pulse triggered by the leading edge of the sync pulse. The 8-microsecond pulse is used to initiate another pulse generated by IC2-b, which is active only during the line-scan portion (the video) of the video waveform. The IC2-b pulse is used to gate the video-only component from the composite video waveform (R7, R8, and C7 set the width of the pulse at 53 microseconds).

IC3-a and IC3-b perform a similar

function on the vertical sync pulses from pin 3 of IC1; IC3-a is the delay and IC3-b generates a 16-microsecond pulse which is active during individual fields of the TV signal. During vertical-retrace intervals, it is desirable *not* to gate on the composite video, so horizontal multivibrator IC2-b is locked out during the vertical-blanking interval, when pin 10 is low.

Figure 4 shows the sync selector and PLL block. When SYNC SELECT (pin 2) of IC4 is high SYNC 1 is selected, and when it's low SYNC 2 is selected.

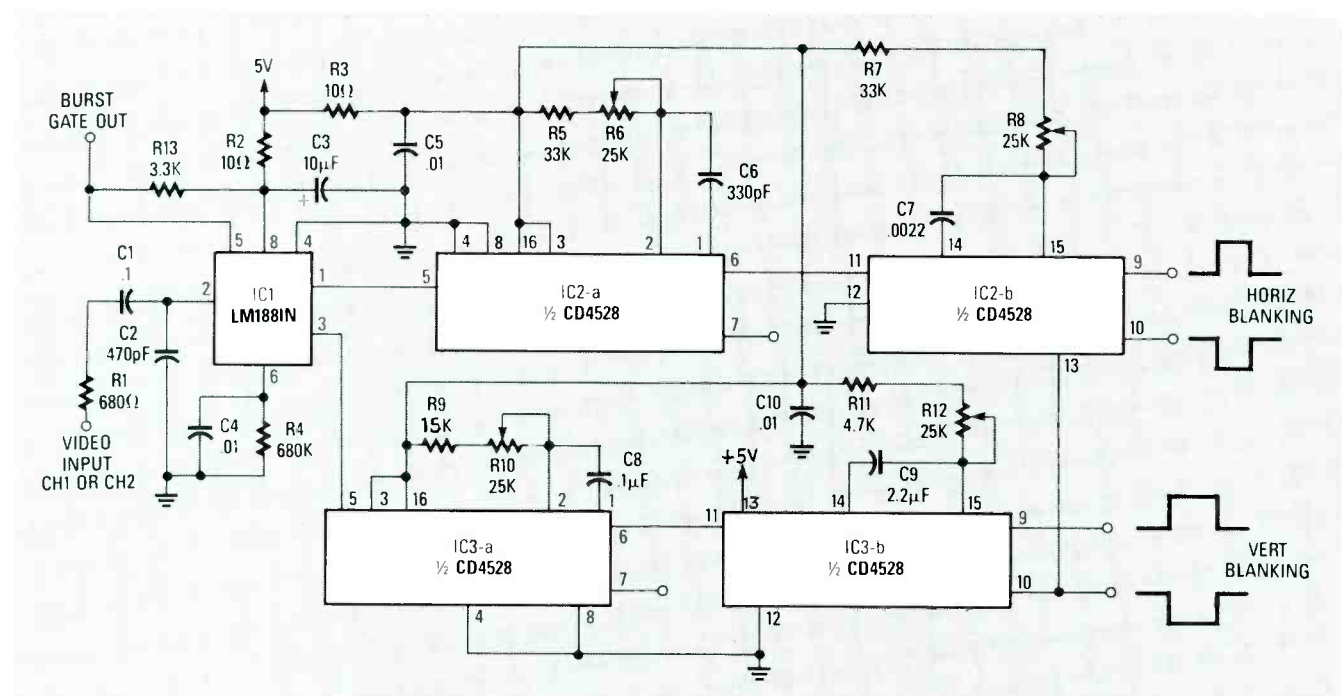

FIG. 3—SHOWN HERE IS A SYNC SPLITTER. Video is fed to pin 1 of sync-separator IC1. Composite horizontal sync appears at pin 1, and composite vertical sync appears at pin 3.

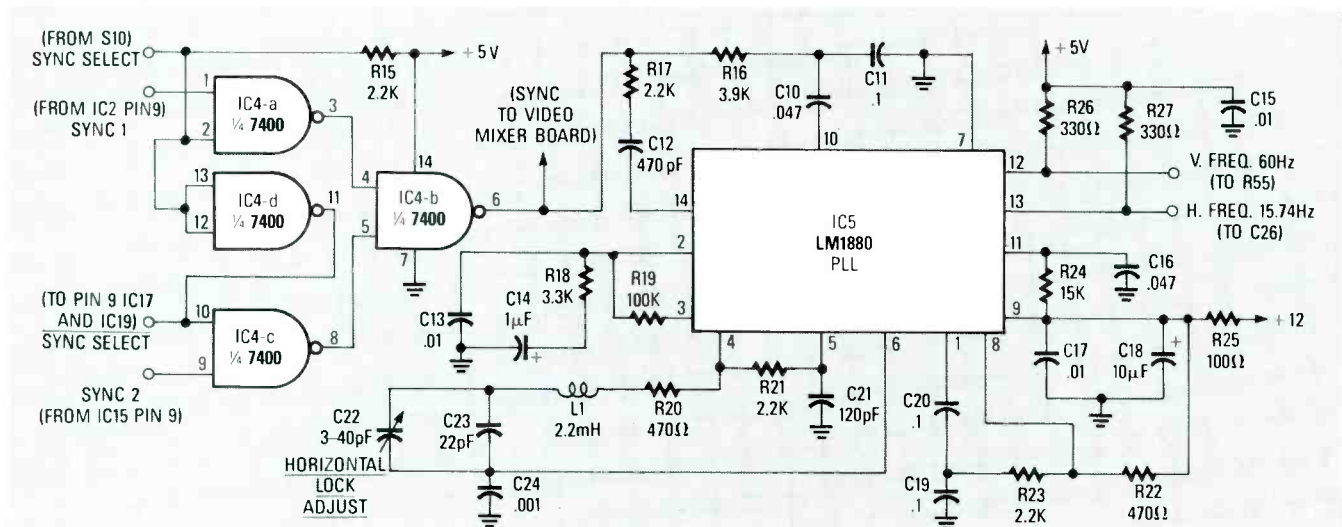

FIG. 4—SYNC SELECTOR AND PLL BLOCK. When pin 2 (SYNC SELECT) of IC4 is high, SYNC 1 is selected, and when it's low SYNC 2 is selected.

PARTS LIST

All resistors are ¼-watt, 10%, unless otherwise indicated

R1, R201—680 ohms
 R2, R3, R29, R62–R64, R134, R135, R127, R128, R140, R141, R143–R150, R202, R203—10 ohms
 R4, R204—680,000 ohms
 R5, R7, R205, R207—33,000 ohms
 R6, R8, R10, R12, R42, R45, R47, R49, R206, R208, R210, R212—25,000 ohms, potentiometer
 R11, R32, R33, R36–R40, R52, R53, R58, R59, R130, R209—4700 ohms
 R15, R17, R21, R23, R28, R30, R31, R34, R41, R54–R56, R61, R100, R101, R104, R105, R112, R114, R118, R123, R124, R138a–R138f—2200 ohms
 R16—3900 ohms
 R13, R18, R213—3300 ohms
 R19, R102, R103, R106, R111, R120–R122, R136—100,000 ohms
 R20, R22—470 ohms
 R25—100 ohms
 R26, R27, R139a–R139f—330 ohms
 R35, R57—5000 ohms, potentiometer
 R43, R50, R51—1000 ohms
 R44—1 megohm
 R46, R48, R113, R116, R119, R126, R129, R131, R142—10,000 ohms
 R60—47,000 ohms
 R132—68 ohms
 R108, R133—82 ohms
 R115, R125—2000 ohms, potentiometer
 R110, R117, R137—22,000 ohms
 R9, R24—15,000 ohms
Capacitors
 C1, C8, C11, C19, C20, C33, C34,

C40, C101, C208—0.1 µF, Mylar
 C2, C12, C202—470 pF, ceramic disc
 C3, C18, C27, C30, C35, C36, C37, C38, C41, C47, C50, C203, C307, C309, C311—10 µF, 16 volts, electrolytic
 C4, C5, C13, C15, C17, C32, C43–C45, C48, C49, C101, C102, C105, C106, C109–C116, C204, C205, C302, C303, C305, C306, C308, C310—0.01 µF, ceramic disc
 C6, C206—330 pF, NPO
 C7, C207—0.0022 µF, Mylar
 C9, C209—2.2 µF, tantalum
 C10, C16, C26, C28—0.047 µF, Mylar
 C14, C42—1 µF, 35 volts, electrolytic
 C21—120 pF, ± 5%, NPO
 C22—3–40 pF, trimmer
 C23—22 pF, NPO
 C24, C25, C29, C39—0.001 µF, Mylar
 C31—470 pF, NPO
 C103—5 pF, NPO
 C104, C107—2–18 pF, trimmer
 C301—4700 µF, 25 volts, electrolytic
 C304—2200 µF, 25 volts, electrolytic
Semiconductors
 IC1, IC14—LM1881N video sync separator
 IC2, IC3, IC15, IC16—CD4528B dual monostable multivibrator
 IC4—7400N quad 2-input NAND gate
 IC5—LM1800N PLL FM stereo demodulator
 IC6, IC9—LM565N PLL IC
 IC7, IC10—74C93 4-bit binary counter
 IC8, IC11, IC12—TLO81 wide-bandwidth JFET-input op-amp

IC13, IC21, IC22—LM318N op-amp
 IC17–IC20—CD4053B analog multiplexer/demultiplexer
 IC301—LM7812 12-volt regulator
 IC302—LM7805 5-volt regulator
 IC303—LM7905 –5-volt regulator
 D1, D100—1N914B diode
 D301–D303—1N4007 rectifier diode
 Q1–Q3, Q5, Q6, Q101, Q103a–f, Q105—2N3904 NPN transistor
 Q4, Q102, Q104a–f—2N3906 PNP transistor

Other components

L1—2.2 mH coil
 T1—120VAC/24VAC, 500 mA transformer
 J1–J10—RCA jack
 S1–S3—SPDT switch
 S4, S10, S11—SPST switch
 S5–S9—SPDT with center off
Miscellaneous: project case, wire, line cord, solder, etc.

Note: A kit consisting of the two PC boards, the parts that mount on them, and the front-panel potentiometers is available from North Country Radio, PO Box 53, Wykagyl Station, New Rochelle, NY 10804, for \$137.50. The kit does *not* contain other parts that mount off the board, such as the switches, RCA jacks, power supply components, project case, etc. A set of two PC boards is available separately for \$27.50. Add \$2.50 to either order for postage and handling. New York residents must include sales tax.

Sync from pin 4 of IC4 is fed to a filter network (R16, R17, C10, C11, C12) and then to IC5, an LM1880 PLL. Components C13, C14, R18, and R19 help determine loop parameters; R20, R21, C22–C24, and L1 are for the internal oscillator of IC5 operating at 503 kHz; and C19, C20, R22, and R23 are feedback components.

R24 and C16 are vertical-timing components necessary for correct operation of IC5, and R25, C17, and C18 are supply decoupling components. A signal at the horizontal frequency appears across R26. Capacitor C22 is adjusted for lockup with the SYNC 1 or SYNC 2 input. The outputs (pins 12 and 13) are fed to sawtooth generator circuits for vertical and horizontal frequencies, respectively.

The keying circuits are shown in

Fig. 5. There are four circuits—two for horizontal and two for vertical. Horizontal square-wave pulses at the junction of C25 and C26 are differentiated by C25 and R28. Therefore, Q1 is momentarily forward biased during sync intervals, and C33 is thus discharged through R29. When Q1 is cut off, C33 charges toward +5 volts through R30 until discharging again at the next sync pulse. Q2 and R31 form an emitter follower to interface the waveform, which is a sawtooth of about 1–2 volts at the horizontal frequency, to HORIZONTAL PATTERN SELECT switch, S1.

Vertical sync pulses (very short and negative-going) are directly integrated by R60 and C42, and D1 provides a discharge path. Emitter-follower Q6 and R61 feed S2, the

VERTICAL PATTERN SELECT switch.

The triangle waves needed to produce keying waveforms are obtained from PLL circuits IC6, IC7, and IC8 for horizontal, and IC9, IC10, and IC11 for vertical. Only the horizontal circuitry will be discussed, as the two are similar except for component values, and their operation is identical.

Horizontal sync is fed through C26 to an LM565 PLL, which is biased by R32 and R33, and supply bypassed by C27 and C30 for the ±5V lines. C28 is a loop filter capacitor and C29 suppresses spurious responses. The VCO frequency at pin 8 is nominally 126 kHz (480 Hz for the vertical circuit). It is set by R34, R35, and C31. The VCO output at pin 4 of IC6 is fed to the pin-8 input of IC7, a 74C93 four-stage counter. Only three stages

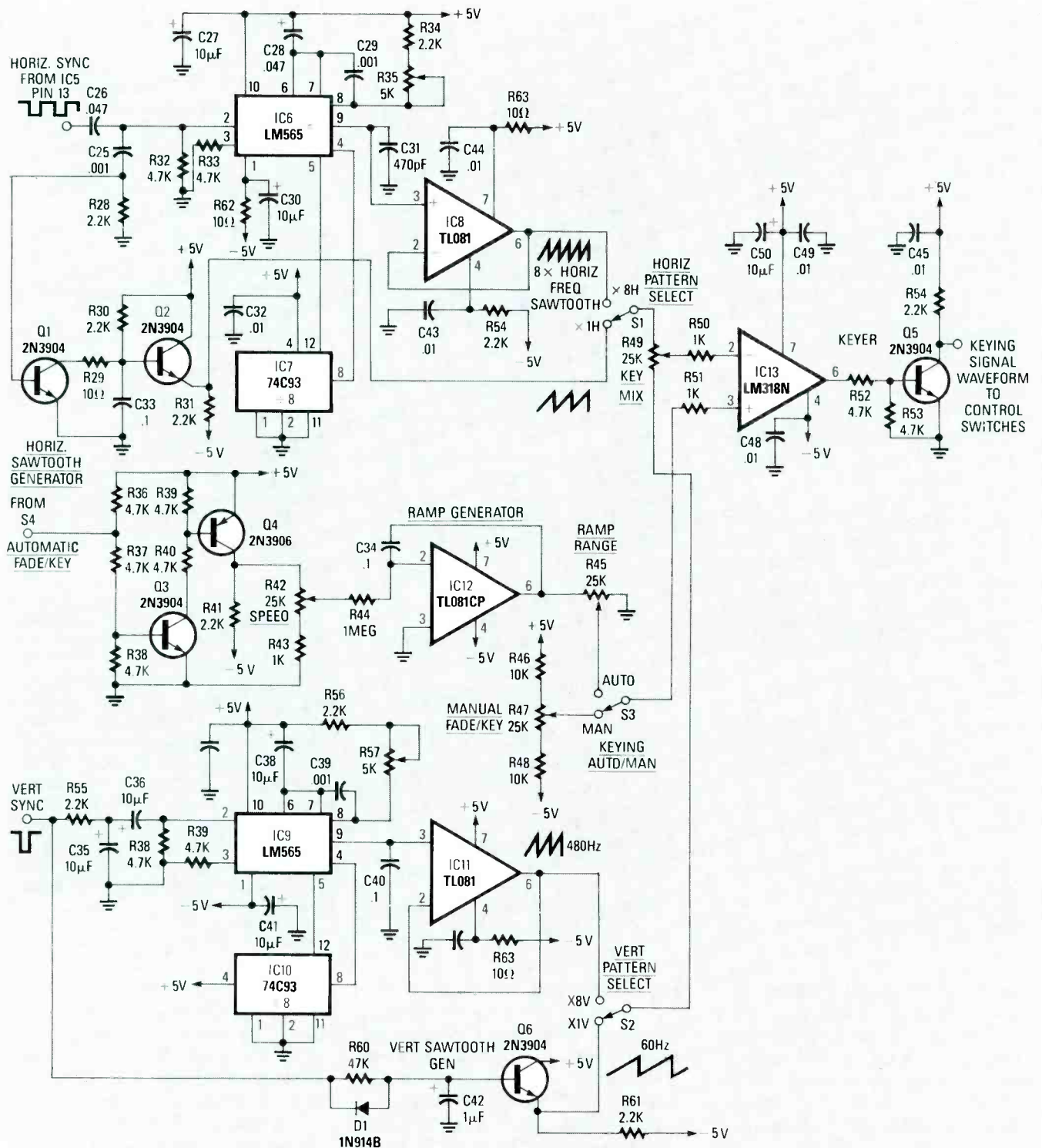

FIG. 5—THERE ARE FOUR KEYING CIRCUITS; two for horizontal and two for vertical.

are used to get a divide-by-8. The divide-by-8 output (IC7 pin 12) is fed back to IC6 pin 5, the phase detector input. Therefore, under lock conditions, the VCO frequency at pin 9 will be 126 kHz (8×15.74) and will be a triangle wave. IC8 is a buffer amplifier and delivers the triangle wave to S1.

Potentiometer R49 is a mixer control that taps any combination of two

out of the four available waveforms (V, 8V, H, and 8H). The resultant proportion can be varied to achieve various key patterns. The resulting waveforms are fed to comparator IC13 via R50.

IC13 is biased to a threshold by a DC voltage from S3 and voltage divider R46-RR48, or by a slowly varying DC voltage from pin 6 of IC12, as selected by S3. The output of IC13

feeds Q5 via R52 and R53. The output Q5 is a square wave whose duty cycle depends on the signals for S3 and R49. It is used to drive the keying switches in the video mixer circuit.

Ramp-generator IC12 is used to generate a slowly varying DC voltage for slow fades, wipes, or key-ins. It is fed either positive or negative signals through R44. The speed (rate) of the ramp depends on the setting of the

speed control R42. By varying R42, either a slow or fast key transition can be obtained. R47 is used where manual control of key transition is desired. Q3 or Q4 feed either +5 or -5V DC to R42, depending on the logic level at the junction of R37 and R36.

Figure 6 shows the video switching circuits; IC17-IC20 are CMOS analog SPDT switches. Each has three sections that can be switched at over

1-MHz and can handle signals up to 5 MHz with 50 dB isolation. They are controlled by a logic level at the input. All switches are in "up" positions (N.C.) when logic level is zero, and "down" (N.O.) when logic level is high.

Channel-1 video is input to pin 15 of IC17 (IC1 is fed from that point as well), where it is split into video and sync. IC17 is driven by IC2 in the

keying section. Sync and video are available separately at J2 and J7. In Fig. 6, an "EF" followed by a letter represents an emitter-follower circuit: one is shown in detail inside dashed lines in Fig. 6. IC18-a selects either input video or effects video (derived externally from video 1). IC18 selects either CH1 or a DC level between -0.5 and +1.5 volts from R115 used in a fadeout; it is blanked during sync

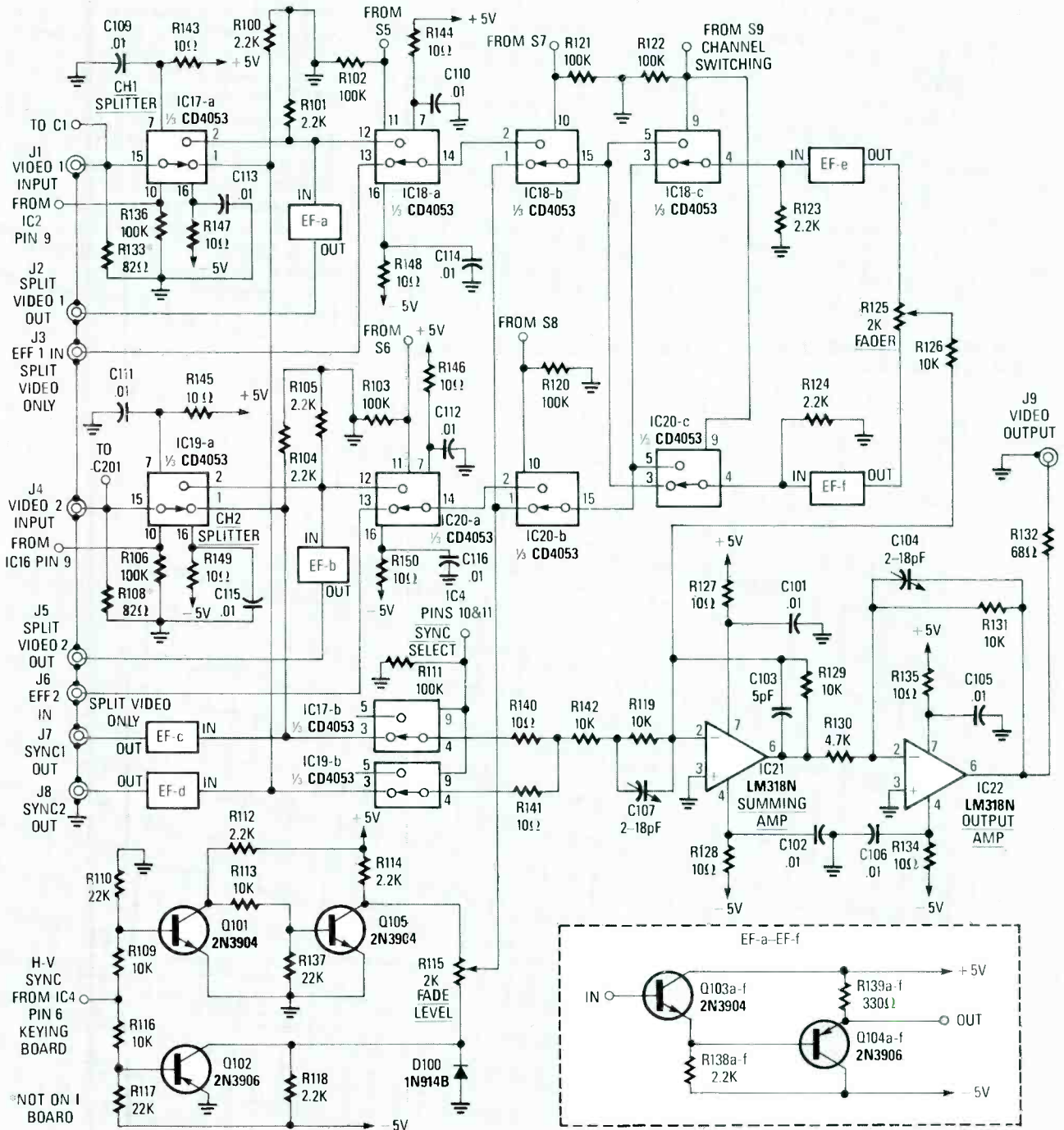

FIG. 6—THE VIDEO SWITCHING CIRCUITS. Each analog switch (a CD4053) has three sections that can be switched at over a 1-MHz rate, controlled by a logic level at the input. An "EF" followed by a letter represents an emitter follower circuit; one is shown in detail inside the dashed lines.

intervals so as to not upset sync levels. Transistors Q100-Q102, D100, and R112-R118 generate the required waveform.

IC18-c and IC20-c are configured as a DPDT switch to switch between CH1 and CH2 for direct fades, wipes, or key-ins (genlock sources are required). Switched video from both channels is fed to fader R125. The

output of R125 is taken to summing amplifier IC21, together with sync from IC17-b and IC19-b (sync is selected for the channel in use). Frequency-compensation components R119 and C107 maintain correct burst phase. The output of IC21 is a complete inverted video signal. It's fed to IC22 for re-inversion and then to J9 via termination-resistor R132.

The unit requires ± 5 , and $+12$ -volts DC. The ± 5 -volt supplies must be at least 500 mA. Two IC regulators, an LM7805 for $+5$ and an LM7905 for -5 , together with a 12-volt AC transformer and bridge rectifier can be used. The $+12$ volts for the PLL on the keyer board (IC5) need be only 50 mA, but it should be well filtered. A suitable power-supply is

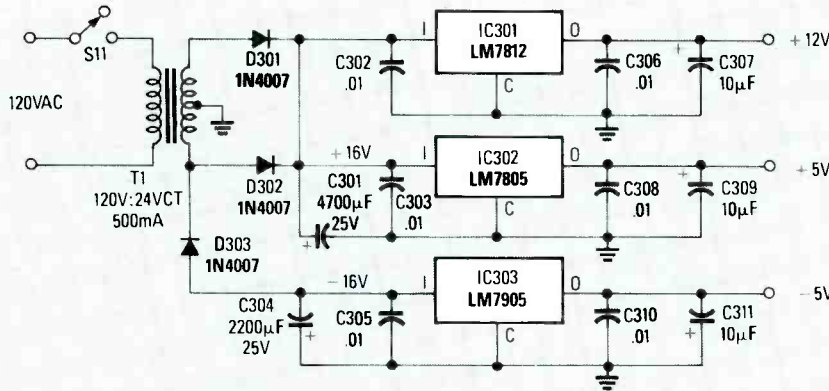

FIG. 7—THE SCENE SWITCHER REQUIRES ± 5 AND $+12$ -VOLTS DC. The prototype's power supply is shown here.

Note: A kit consisting of the two PC boards, the parts that mount on them, and the front-panel potentiometers is available from North Country Radio, PO Box 53, Wykagyl Station, New Rochelle, NY 10804, for \$137.50. The kit does *not* contain other parts that mount off the board, such as the switches, RCA jacks, power supply components, project case, etc. A set of two PC boards is available separately for \$27.50. Add \$2.50 to either order for postage and handling. New York residents must include sales tax.

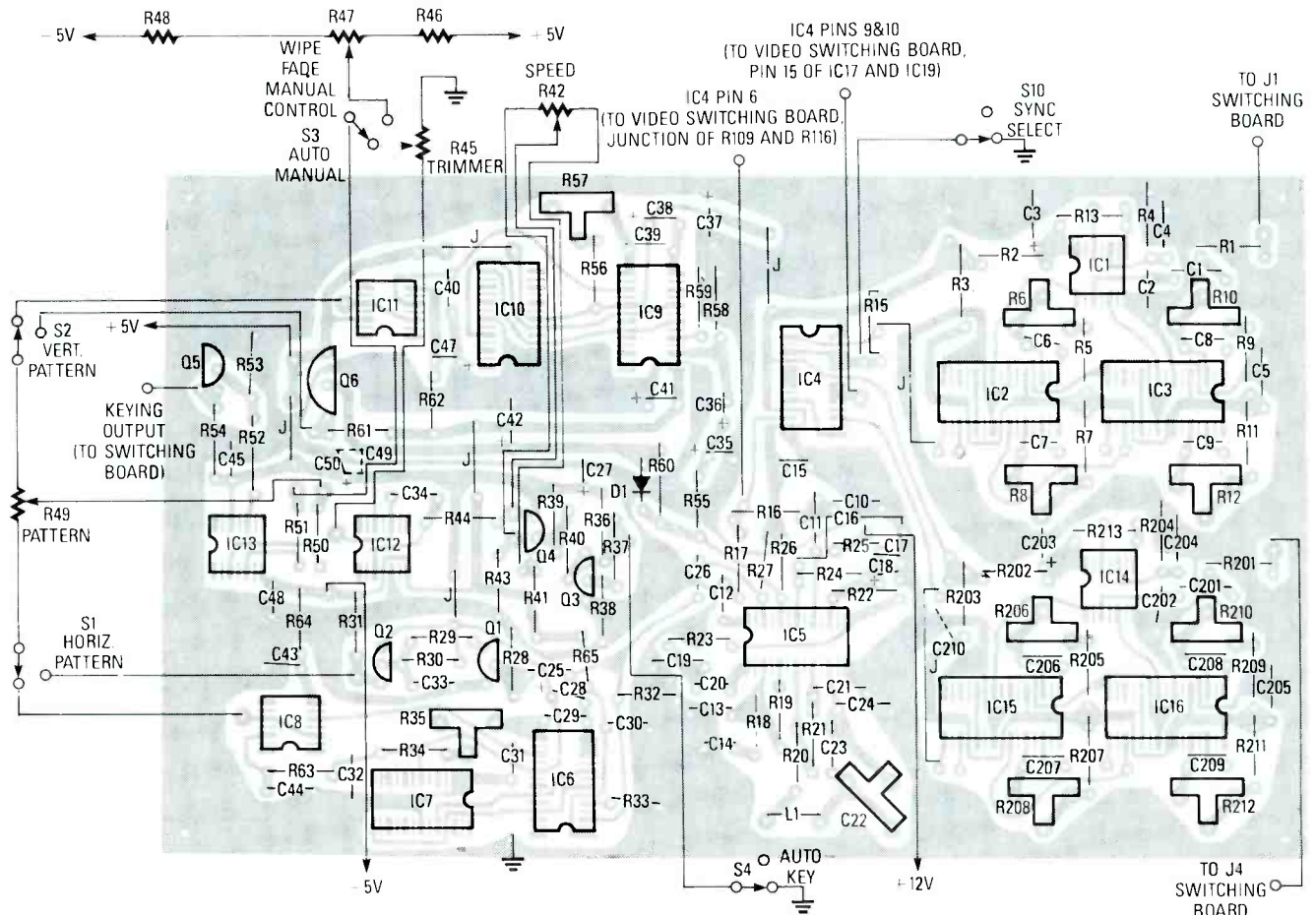

FIG. 8—VIDEO-KEYING BOARD parts-placement diagram. Solder the resistors and capacitors first, and then the IC's.

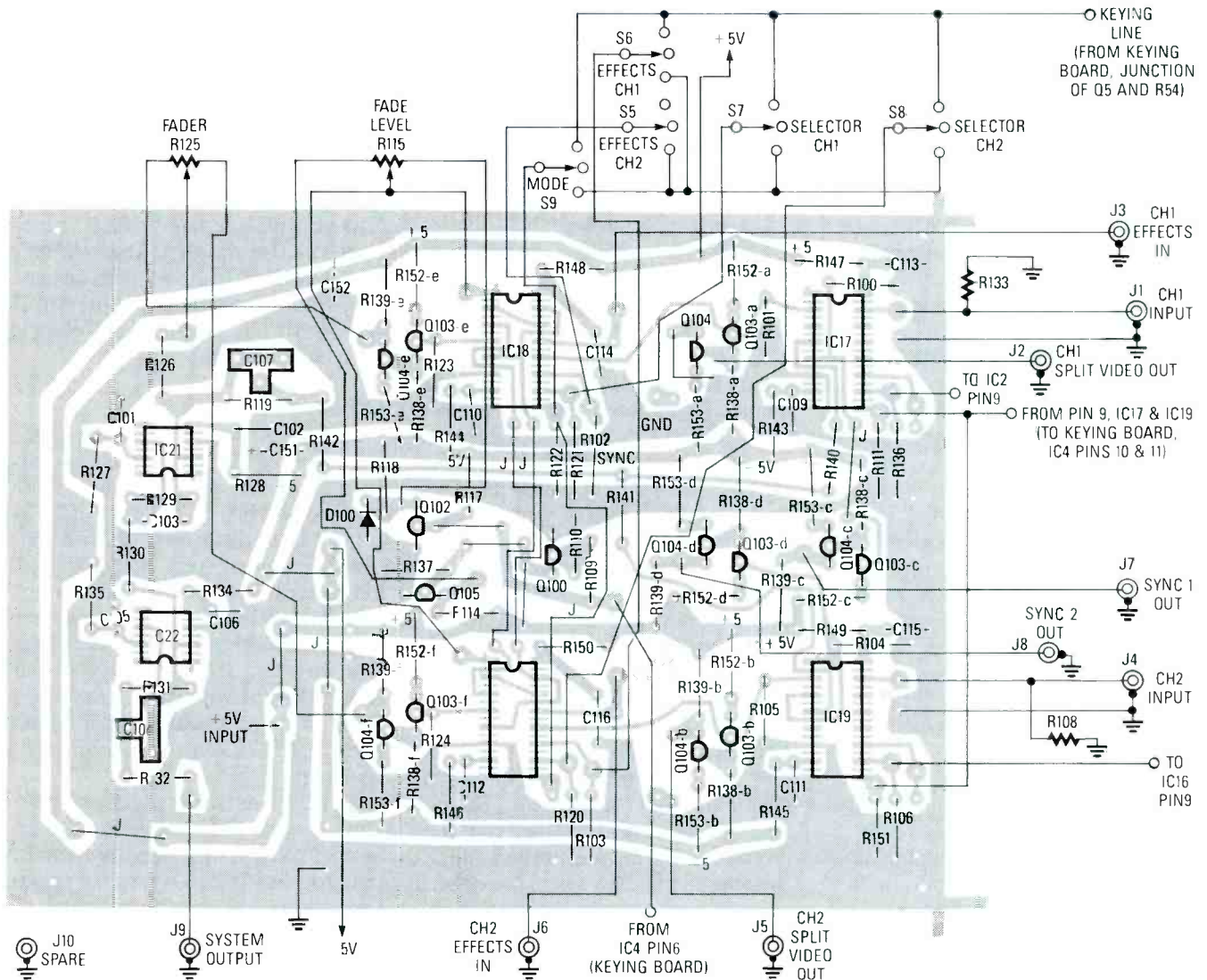

FIG. 9—VIDEO-SWITCHING BOARD parts-placement diagram. Check your work as you go along, to lessen the likelihood of any problems.

shown in Fig. 7.

The two PC boards can be constructed using the Parts-Placement diagrams of Figs. 8 and 9. Foil patterns for the two PC boards are provided in PC Service. Just be very careful when soldering, so that you don't create any problems for yourself when you go to calibrate the unit. Check off each part as you install it, and inspect your work as you go along to minimize headaches later on.

After you've assembled and checked out the two boards, you must wire them along with the switches, RCA jacks, control potentiometers, and power supply as shown in Fig. 10. There are a lot of connections to be made, so be patient, take your time, and do a careful job.

Any suitable control-panel layout can be used. Just make sure that leads are kept as short as possible and sepa-

rated from each other to minimize crosstalk. The prototype that you see pictured in this article is mounted inside a metal cabinet. While a metal cabinet is preferred for its shielding, any other kind will do, as long as everything fits inside.

Checkout and alignment

After the unit is all together, and you've inspected the boards for soldering defects, turn the unit on and make sure that none of the IC's get hot. Then check all points for proper voltages—+5, -5, and +12. You will need an oscilloscope for the following checks, and we will go over the procedures for CH1 only, but the procedures are identical for CH1 and CH2.

Apply a 1-volt p-p negative-sync NTSC video signal to J1, and verify negative sync pulses at about 5-volts

p-p at IC1 pin 1. Adjust R6 so that IC2 pin 6 (IC2-a) shows an 8- μ s pulse and adjust R8 so that pin 9 (IC2-b) shows a 53 μ s-pulse. Check for a 60-Hz vertical-sync pulse at IC1 pin 3. Adjust R10 for 0.5–0.6-ms pulses at IC3-a pin 6, and adjust R12 for a 16-ms pulse at IC3-b pin 9. (Start out with R12 at its minimum-resistance setting). Make sure that S10 (SYNC SELECTING) is in the CH1 position, and then check for sync pulses at pin 6 of IC4. Connect the scope to IC5 pin 13 and, using a non-metallic tool, adjust C22 so that the pulses are synchronized to the video signal. Check for 60-Hz pulses at IC5 pin 12.

Connect the scope to IC8 pin 4, and adjust R35 for a 126-kHz sawtooth wave. Now connect the scope to IC11 pin 6, and adjust R57 for a 480-Hz sawtooth. Verify a 15.7-kHz horizontal sawtooth at the junction of R31 and

the emitter of Q2, and a 60-Hz vertical sawtooth across C42. Now check the waveform at the wiper of R49; it should be a mixture of two of the four previous waveforms, depending on the settings of S1, S2, and R49.

Check for ± 2.5 volts at the wiper of R47, and also for between +4 and -4 volts at IC12 pin 6. When you activate S4, the voltage should slowly change, and R42 should vary the rate of change. Set R45 at the center of its range, and set S3 to manual.

Place the scope at the collector of Q5; you should see the keying waveform. The waveform will disappear if you rotate R49 to its extremes, and you will see either 0 or +5 volts at either extreme.

Place S5-S9 in the "normal" position; you should get video at J9 that you can check with a monitor. Adjust C104 for optimum sharpness. Adjust C107 for correct burst phase, as indicated by proper flesh tones on a video image. Place S8 in the "fixed" position, and vary R125. You should be able to fade to a level set by R115.

Using the switcher

Switches S5-S9 determine exactly what signal is applied to each side of the fader control. For example, suppose a fade to black is desired. In that case, FADE SELECT (S7) would be set so that CH1 video passes directly to one side of FADER CONTROL (R125). S8

would be placed in the fixed position, which applies a fixed DC level (set via the FADE LEVEL CONTROL) to the opposite side of the FADER CONTROL. By rotating the FADER CONTROL, a mix of CH1 video and the DC fade level is sent to the output amplifier, and manual fading is performed.

If a fade from CH1 to CH2 is desired, both CH1 and CH2 fade selectors must be placed in the normal position. If a fade from CH2 to CH1 is desired, S7 and S8 must be placed in the fixed and normal position. S9 swaps CH1 and CH2, reversing the connections to each side of the fader control. If the fader control is set at one extreme, and CH1 is coming through, then moving S9 to the "reverse" position instantly routes CH2 into the output amplifier.

In the "keyed" positions, S5-S9 apply a waveform to electronically switch the video for wipes, transitions, and fades. Switches S1 and S2, in combination with R49 determine the particular pattern. Switch S3 selects the manual fade/key mode where R47 manually controls the effect, or the auto-key mode where the ramp generator produces the effect; S4 initiates the transition or effect, but has no effect in the manual position of S3. Switches S5 and S6 select the effects channel or other video inputs that are synchronized to CH1 or CH2. **R-E**

AUDIO MUTE

continued from page 10

the grounds of J2 and J4, but leave both pairs separate.

That isolates the two channels, but make certain that there's no accidental short between the two channels, like a solder splash. Thus, only in the case of two mono sources, should there be three separate grounds; the main one for the audio-muting circuit, the one for the J1-J3 channel, and a separate one for the J2-J4 channel. (Figs. 1-3 show the two grounds that would normally be present for stereo audio.)

Construction

This is a very simple project to build. The parts-placement diagram is shown in Fig. 2, and the foil pattern is shown below. You might, however, want to build the circuit on either breadboard or perfboard. You can stuff the PC board in any order, and you might want to use sockets for Q1, Q2, and IC2, even though they weren't used in the prototype. When you're finished building the circuit, check for mistakes like solder splashes, or diodes, transistors, or IC's inserted backwards. The completed board can be installed in any suitable case. **R-E**

MICROCONTROLLER

continued from page 90

After connecting everything, check for wiring errors, clipped wires, shorts, and opens. If everything seems OK, apply power. You should see the "HELP" message on the display. Turn S6 on and R30 (VOLUME) to maximum, and you should hear the alarm. If not, remove power and check your work again.

Other ideas

Now that you've gotten your feet wet with the 68705, you might want to consider other projects that can exploit its power. Here are a few suggestions.

Astronomers use a clock that keeps track of "sidereal time," which is related to the apparent motion of the stars, rather than the sun. A sidereal day is 23 hours, 56 minutes and 4 seconds long. Can you modify the clock as presented to keep track of sidereal time?

Another astronomical application is telescope control. A telescope mounting has two axes; can you figure out a way for servo motors to control the rotation of those axes under control of the 68705?

How about a programmable light show? With suitable optoisolators (for electrical safety) and high-current semiconductor relays, that should be a straightforward task. What about designing a scanning keyboard using the 68705?

Another project is a frequency counter. You could use the multiplexed display in the alarm clock as is, and likewise derive the time base from the power-supply's AC source. Then, determining the frequency of an input signal is no harder than counting how many zero crossings occur per time-base period. The alarm clock's software and hardware are a good starting point.

As you can see, designing with the 68705 is quite simple—and fun! So consider designing your next project around the 68705 and reap the rewards that the microcomputer revolution makes possible! **R-E**

BUILD THIS

IF YOU'VE SEEN A RECENTLY PRODUCED motion picture presented in a modern theater, then you are undoubtedly aware of the stunning realism and dramatic impact created by the use of the Dolby-stereo surround-sound audio process. The system was developed by Dolby Laboratories for the motion-picture industry to literally surround viewers with sound and place them in the very midst of the action.

For anyone unfamiliar with the concept, the Dolby-stereo surround-sound process works to increase the sensation of "being there" by reproducing distinct sounds toward the front, sides, and rear of the viewer. In practice, it is accomplished by feeding the primary stereo soundtrack to speakers located behind the screen on the left, the center, and the right side of the theater.

Simultaneously, an additional audio channel, decoded from within the primary channels, is sent to a system of smaller speakers located to the sides and to the rear of the audience. That additional surround channel is used to re-create ambient sounds like wind noise or "on location" street sounds as well as special sound effects intended to travel past the audience from front to rear, or even to seem to circle overhead.

Since the mid 1970's, over 1100 motion pictures have been produced with surround-sound tracks. Because the process encodes the surround information into a 2-channel stereo signal, when the movies are transferred to video tapes and laser discs, the encoded information remains intact. However, in order to enjoy surround sound at home, at the very minimum, a stereo VCR; some type of decoder, and additional surround speakers are required.

The basic principle of all surround-sound decoders, from the simplest to the most expensive, is the same. They all reproduce the surround information by recovering the (L - R) difference signal which is encoded into the left and right channels of the movie soundtrack. The decoder presented here goes beyond the capabilities of a simple surround-sound decoder. Besides the surround decoder circuit, additional circuitry is

ACOUSTIC FIELD GENERATOR

Our AFG will turn any livingroom into a full-sized movie theater or concert hall.

TOD T. TEMPLIN



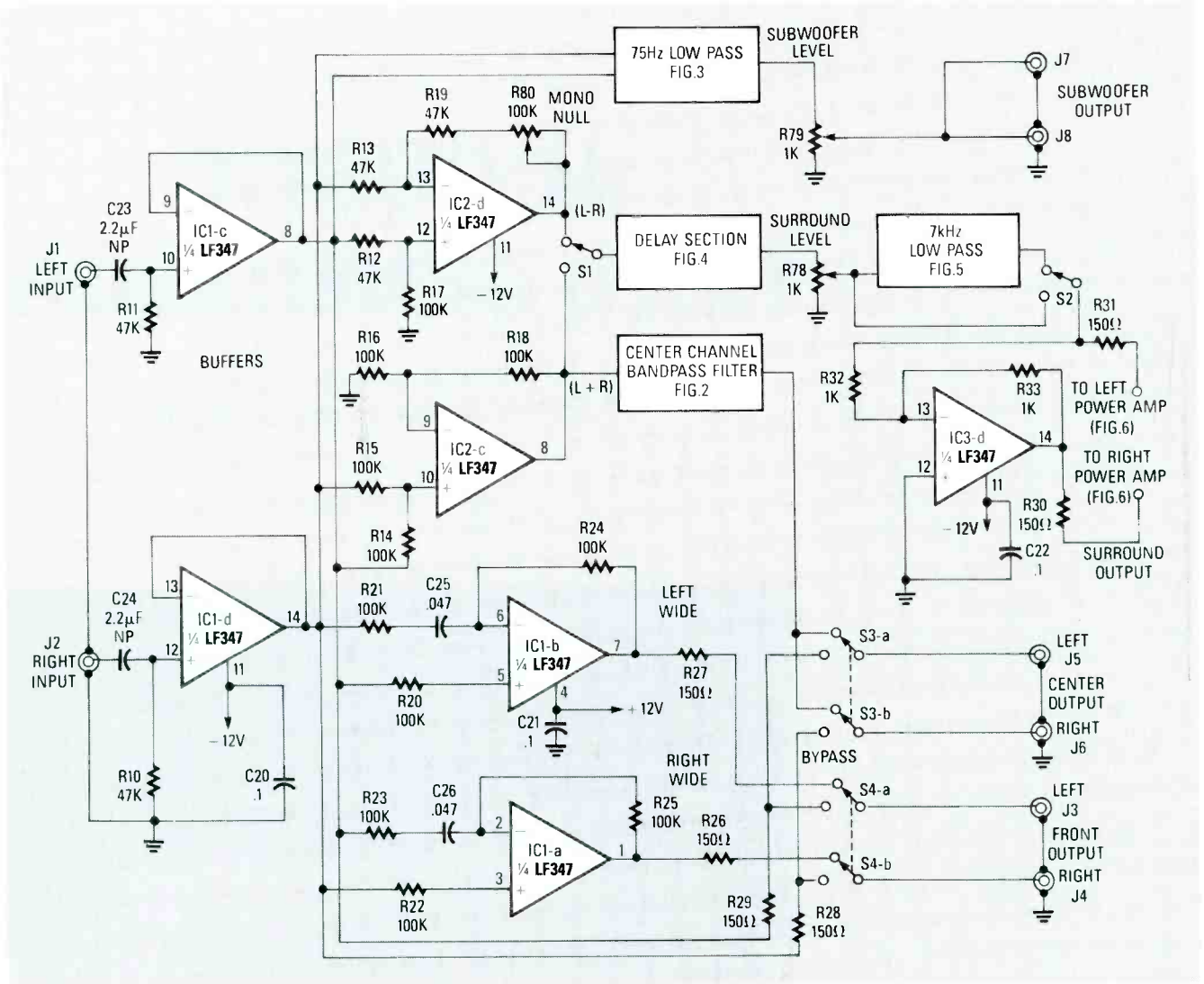

FIG. 1—THE AFG IS MADE UP OF 10 relatively simple circuit elements.

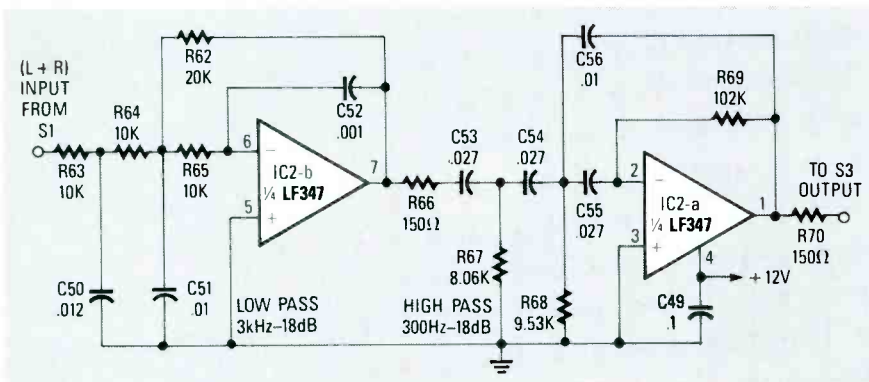

FIG. 2—THE CENTER-CHANNEL SPEECH FILTER is built by cascading a 3-kHz low-pass filter with a 300-Hz high-pass filter to form a band-pass filter.

used to create wide-left, center-dialogue, wide-right, and subwoofer signals. Presenting those signals through six properly arranged speakers results in the acoustical illusion of a large, almost boundless, three-dimensional listening environment, even in a small room; hence the name,

“Acoustic Field Generator,” but we’ll call it the AFG for short. This article is not intended to provide an in-depth tutorial or technical description of the surround-sound system. Rather, it is intended to show you how to construct and install a high-quality, multichannel sound decoder for use in

your home.

The AFG offers two different modes of operation; “matrix” and “concert.” In the matrix mode, the (L - R) difference signal is recovered from surround-encoded source material and is then passed through a 2048-stage bucket-brigade delay line. The delay is continuously adjustable from about 5 to 35 milliseconds, and has a bandpass of 50 Hz to 15 kHz. That enables the accurate decoding and presentation of the surround-channel information present within the source material. The (L + R) sum signal is also recovered to be sent through the delay section of the AFG when the concert mode is selected. That imparts the ambience and realism of a live concert-hall performance to musical material played through the AFG. In either mode, the output of the decoder/delay section is sent to a pair of 10-watt-per-channel power

amplifiers, included on the main circuit board, for driving a pair of surround-channel speakers.

The AFG also provides a means of greatly increasing the apparent separation or "width" of the stereo image presented by the front speakers. In an ordinary decoder, the left- and right-channel signals are sent to the front speakers unaltered, and the center channel, if present at all, is fed a simple sum of the left and right signals. Although that technique provides a very solid front soundstage, it severely limits the system's ability to convincingly present extreme-left or right sound effects. And, because the screen in most home-video systems is relatively small, especially when compared to the screen in a movie theater, dialogue which should be confined to the screen, tends to appear off screen in the left and right speakers—particularly for viewers seated off center.

The AFG uses frequency-selective circuitry to cancel some of the dialogue from the left and right channels, but that creates a phantom "hole" in the center of the soundstage. So, the AFG also creates a center dialogue channel to fill that hole by summing the left and right channels and passing them through a band-pass filter with a response curve which favors the range of frequencies covered by the human voice. Feeding the voice-only "dialogue" signal directly to the speakers in the video monitor locates the dialogue firmly on the screen without destroying the spatial effects of the front soundstage.

Finally, the AFG includes a 75-Hz active low-pass filter for driving a subwoofer setup. If you are not currently using a subwoofer as part of your system, you are missing out on the dynamic impact and heightened level of excitement which is imparted by the extreme low-frequency sounds used in motion pictures, primarily as a special audio effect. The subwoofer output of the AFG has that sonic information isolated and ready to feed to a power amplifier and speaker of your choice. You may wish to consult with a local audio dealer for advice on selecting a proper subwoofer and power amplifier. Suffice it to say, that a relatively high-power amplifier and large subwoofer will be required if you intend to fill your room with earth-shaking bass that goes far beyond the capabilities of most "full-

range" speakers. It is preferable to place the subwoofer toward the front of the soundstage, although the exact position is not critical, due to the ear's inability to accurately locate very low-frequency sound. Thus, many subwoofers are designed to physically resemble an end table or other piece of furniture, so that they can aesthetically blend into the other room decor.

The AFG was designed to be connected into the pre-amp/power-amp loop of your regular home entertain-

PARTS LIST

All resistors ¼-watt, 5%, except as noted.

R1—1500 ohms
 R2, R3, R54—22,000 ohms
 R4, R5, R32, R33—1000 ohms
 R6, R7, R61, R62, R74—20,000 ohms
 R8, R9—1 ohm, ½-watt, 5%
 R10—R13, R19, R34, R35—47,000 ohms
 R14—R18, R20—R25, R47—R49, R55, R56—100,000 ohms
 R57—330,000 ohms
 R26—R31, R66, R70—150 ohms
 R36—R43, R67—8060 ohms, 1%
 R44—R46—16,000 ohms
 R50, R51—5600 ohms
 R52—2400 ohms
 R53—8200 ohms
 R58—R60, R63—R65, R71—R73—10,000 ohms
 R68—9530 ohms, ¼-watt, 1%
 R69—102,000 ohms, ¼-watt, 1%
 R75, R80—100,000 ohms, potentiometer
 R76—10,000 ohms, potentiometer
 R77—50,000 ohms, PC-mount potentiometer
 R78, R79—1000 ohms, PC-mount potentiometer

Capacitors

C1—C4—2200 µF, 25 volts, electrolytic
 C5, C6—10 µF, 35 volts, radial electrolytic
 C7—C12, C19—C22, C27, C28, C30, C31, C45, C49—0.1 µF, 50 volts, metal film
 C13, C14, C23, C24, C43—2.2 µF, 50 volts, bi-polar radial electrolytic
 C15, C16—22 µF, 16 volts, bi-polar radial electrolytic
 C17, C18—0.22 µF, metal film
 C25, C26—0.047 µF, metal film
 C32—C34—3300 pF, polyester
 C35—C37—2700 pF, polyester
 C38—C41—270 pF, 5% ceramic disc
 C42, C47—0.47 µF, metal film
 C44—120 pF, 5% ceramic disc
 C46—0.56 µF, metal film

C48—0.039 µF, metal film
 C50—0.012 µF, metal film
 C51, C56—0.01 µF, metal film
 C52—1000 pF, 5% polyester
 C53—C55—0.027 µF, metal film
 C57—5600 pF, 5% polyester
 C58—4700 pF, 5% polyester
 C59—470 pF, 5% ceramic disc

Semiconductors

D1, D2—1N5400 50 PIV 3-amp diode
 IC1—IC4—LF347 quad JFET
 IC5—MN3008 2048-stage bucket brigade device
 IC6—MN3101 2-phase clock
 IC7—7812T +12-volt regulator
 IC8—7912T -12-volt regulator
 IC9, IC10—LM1875T audio amp
 LED1—light emitting diode pilot lamp

Other components

T1—Power Transformer 25.2 Volt Center Tapped 2 Amp.
 F1—F3—1-amp fuse
 J1—J8—8-pin RCA-style jack panel
 J9—J12—4-position pushbutton speaker-terminal panel
 S1, S2, S5—SPDT switch
 S3, S4—DPDT switch

Miscellaneous: speakers of your choice, 5 14-pin IC sockets, 1 8-pin IC socket, 1 heat sink (2 × 2 × 5¼-inch aluminum angle stock), 2 T0-220 mica insulators with mounting hardware, silicone grease, 3 in-line fuse holders, 3 knobs, chassis, linecord, solder, etc.

Note: The following items are available from T3 Research, Inc., 5329 N. Navajo Ave., Glendale, Wisconsin 53217-5036: An etched, drilled, and plated PC board, \$15.00; a basic parts kit consisting of all semiconductors, resistors, and capacitors, \$60.00; a piece of aluminum stock for the heat sink, \$3.00. Please include \$2.50 for postage and handling with your order. Wisconsin residents please include appropriate sales tax.

ment system. Consequently, all the functions of the AFG may be switched to bypass and unity gain to effectively remove it from the system, if required. We believe, however, that once you experience the added sonic dimension that the AFG adds to music as well as movies, you'll never want to switch it off.

About the circuit

When viewed as a whole, the AFG circuitry is quite complex. However,

referring to the simplified schematic in Fig. 1, you can see that the AFG is really made up of 10 relatively simple circuit elements. IC1-c and IC1-d are configured as unity-gain non-inverting buffer amplifiers. They transform the 47-kilohm input impedance, which is set by R10 and R11, to a low-impedance source which drives all of the AFG amplifiers, filters, and bypass outputs.

The summing (L + R) amplifier, IC2-c, combines equal amounts of the left and right signals, via R14 and R15, to develop a total composite signal. Left- and right-channel signals are applied equally through R13 and R12 to IC2-d, the difference (L - R) decoder. Any signal that's common to both channels is canceled by IC2-d, thus forming one signal which contains none of the common "mono" information present in the original stereo signal. Potentiometer R80 provides a means of exactly balancing the inverting and non-inverting gains of the amplifier for a perfect null.

The stereo width-enhancement circuit is made up from IC1-a and IC1-b. It works similarly to the (L - R) decoder, except that C25 and C26 have been added in the inverting inputs of each op-amp. Consider, for the moment, just the "right wide" circuit of IC1-a; C26 and R23 form a gently sloping high-pass filter for the left-channel signal only. Thus, the amount of signal cancellation is dependent on frequency and the relative amplitude between the two channels. In other words, the more a signal is the *same* in both channels, the more it is removed from the output of the circuit; the effect increases as the signal's frequency rises. If, however, the input signal appears only in the right channel, no matter what its frequency or amplitude, it does not cancel in the difference amplifier and appears at the output unaffected.

IC1-b functions in the same way to develop the "left wide" signal because its inverting and non-inverting inputs are connected to the left and right channels in a manner opposite that of IC1-a. The net effect of all that is to increase the apparent separation between the left and right channels by eliminating some of the material common between them. The output of the width-enhancement circuit is routed to S4, which selects either the "wide" or the bypass signal for feeding the front-channel amplifier.

The center-channel dialogue filter, or speech filter if you prefer (see Fig. 2), is built by cascading a 3-kHz low-pass filter with a 300-Hz high-pass filter to form a band-pass filter. The frequency characteristics of the human voice fall predominantly within that range. As with all of the other filters used in the AFG, those are of the 3rd order Butterworth design. That design was chosen because it offers minimum peaking within the passband. It has a sharp -18 dB/octave cutoff, a flat voltage and power frequency response, and minimum phase change within the passband. The output of the bandpass filter is routed to the high side of S3. That switch allows the center-channel output of the AFG to be switched between the dialogue filter and the bypass mode.

As shown in Fig. 3, IC3-a and IC3-b form an active crossover network for driving a subwoofer. IC3-a sums signals from the left- and right-channel buffer amps, it inverts the summed signal 180 degrees, and it provides a low driving impedance for the following filter stage. IC3-b and its associated RC network form a 75-Hz, 3rd-order low-pass filter. Because the filter inverts the signal another 180 degrees, the signal that appears across R79 (which is the output-level control) is back in phase with the original input signal.

The delay section of the AFG, shown in Fig. 4, is built around the MN3008 *Bucket Brigade Device* (BBD), made by Matsushita (Panasonic), and the MN3101 two-phase variable-frequency clock generator. The BBD is a P-channel silicon-gate MOS LSI circuit comprised of 2048 bucket-brigade stages fabricated on a single chip. Each stage consists of a small capacitor that stores an electric charge and a tetrode transistor for

switching purposes. Electrical charges corresponding to analog signals are transferred from one stage to the next by a two-phase clock drive, in the same manner that a fireman's bucket brigade transfers a pail of water from one man to the next. A signal presented at the input is transferred down the line of buckets toward the output at a speed controlled by the clock frequency. The more slowly the clock runs, the longer it takes for the signal to travel through the circuit. (See discussion of BBD theory in the October 1986 **Radio-Electronics**.)

The amount of delay required in our system varies between approximately 5 and 35 milliseconds, so our first consideration must be to select the proper range of clock frequency. The delay time of a BBD is equal to the number of stages divided by twice the clock frequency. So, based on manufacturer's data for the MN3101 clock-generator IC, values were chosen for R53, R54, R77, and C44, to produce a clock frequency, adjustable via R77, which varies from about 30 kHz to 130 kHz.

Our next consideration deals with the property of delay lines known as aliasing. If the frequency of the signal applied to the input of a delay line becomes higher than one half of the clock frequency, the time available to store the sample of that signal in the capacitor becomes too short. The amplitude of that signal's frequency has a value which changes during the time of the sample, so the charge stored in the capacitor is not an accurate representation of that instant of time. To avoid the problem and the resulting distortion, a filter is placed ahead of the BBD which limits the input frequency to one half of the lowest clock frequency used. Given that we'd like to run the clock at speeds as slow as 30 kHz, we must limit the maximum fre-

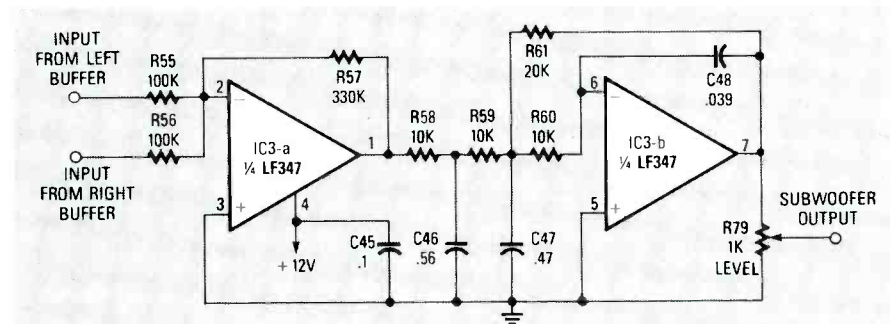

FIG. 3—AN ACTIVE CROSSOVER NETWORK for driving a high-power subwoofer system is made from IC3-a and IC3-b.

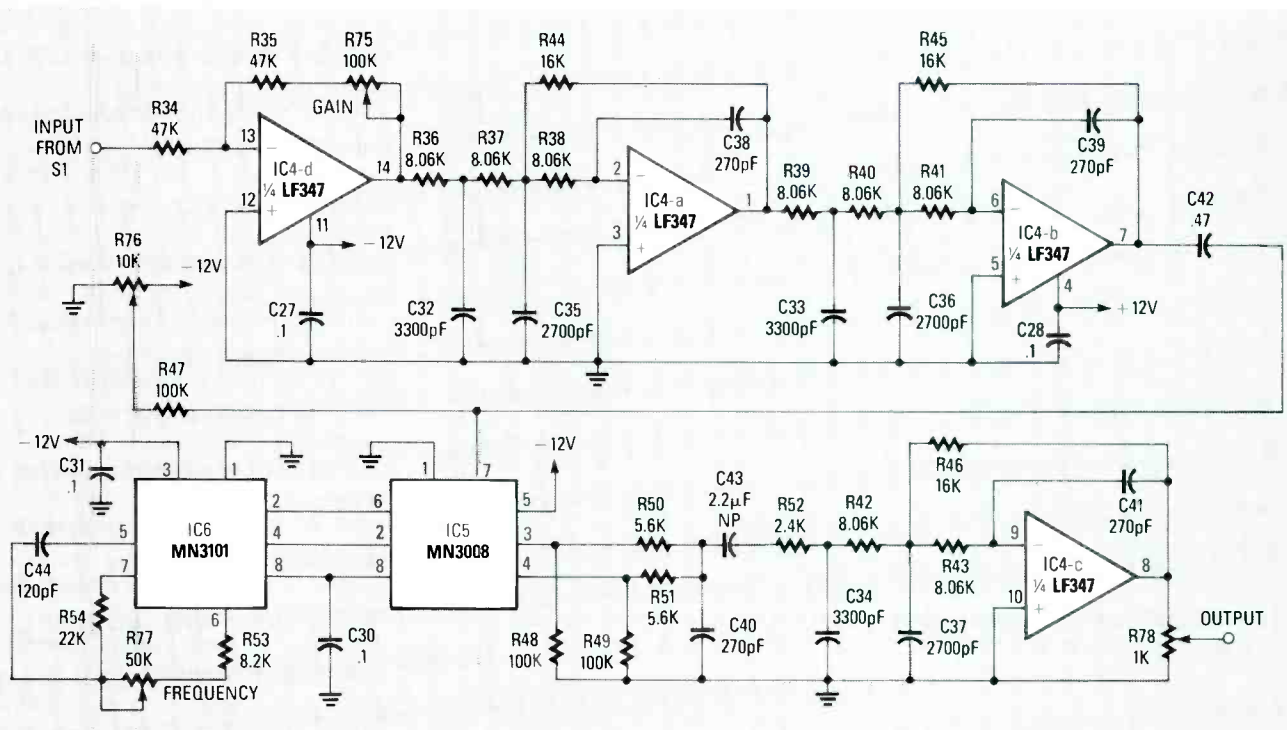

FIG. 4—THE DELAY SECTION OF THE AFG is built around the MN3008 bucket-brigade device and the MN3101 two-phase variable-frequency clock generator.

quency that we apply to the BBD to 15 kHz.

If you refer back to Fig. 1, S1 selects the signal to be delayed; either the difference signal (L - R) from IC2-d in the matrix mode or the sum signal (L + R) from IC2-c in the concert mode. The selected signal is fed from S1 to the delay section (Fig. 4) where IC4-d is configured as an inverting amplifier; R75 adjusts the gain between unity and $\times 3$. Integrated circuits IC4-a and IC4-b, along with their associated RC networks, are identical 3rd-order 15-kHz low-pass filters. Cascading two filters produces a very sharp cut off (-36 dB per octave), which is convenient, as it eliminates any problems that may arise with aliasing, while maintaining a respectable 15-kHz bandwidth for the section. Potentiometer R76 is used to adjust the bias voltage required by the BBD to exactly one half the supply voltage; a requirement of the device. Notice that both the BBD and the clock IC run off of the negative power-supply rail.

Another property of a BBD is that clock phase 1 drives all the odd-number stages of the device and clock phase 2 drives all the even stages. When the signal reaches the end of the line, the output of the last odd stage must be combined with the output of

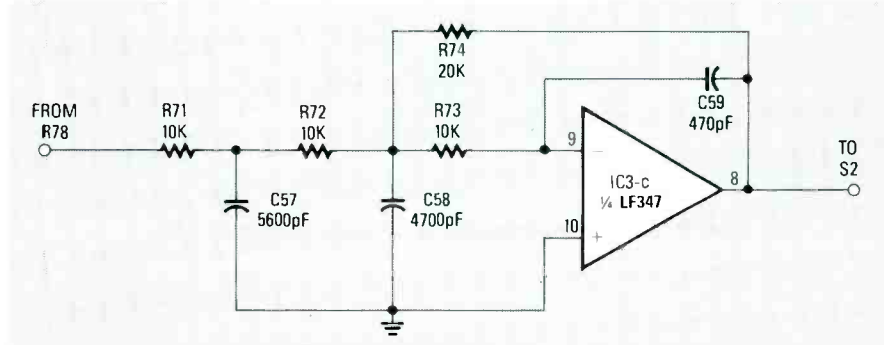

FIG. 5—A 3rd-ORDER 7-kHz LOW-PASS FILTER is made from IC3-c and its associated RC network.

the last even stage to reconstruct an exact replica of the input signal. The purpose for doing that is to self-cancel any of the clock signal from the output of the device; R48 and R49 are the source-load resistors for the last two BBD stages and R50 and R51 sum the two outputs. The delayed signal is next applied to another 3rd-order 15-kHz low-pass filter comprising IC4-c and its associated RC network. That last filter is required to stop any remaining clock signal from reaching the output of the circuit. Potentiometer R78 is there to serve as the volume control for the surround channels by controlling the amount of delayed signal that is applied to the power amplifiers.

To provide for increased high-fre-

quency noise reduction in the surround channel and to more closely comply with the Dolby Laboratories standards for surround sound, a 3rd-order 7-kHz low-pass filter is included in the AFG design. As shown in Fig. 5, IC3-c and its associated RC network forms the filter; S2 then selects between the output of that filter and the bypass mode. If you refer back to Fig. 1, notice that the wiper of S2 is directly connected to the left surround power amplifier via R31, and to IC3-d, a unity-gain inverting amplifier, via R32. The output of IC3-d drives the right surround power amplifier via R30. The reason for driving the power amplifiers out of phase will be explained shortly.

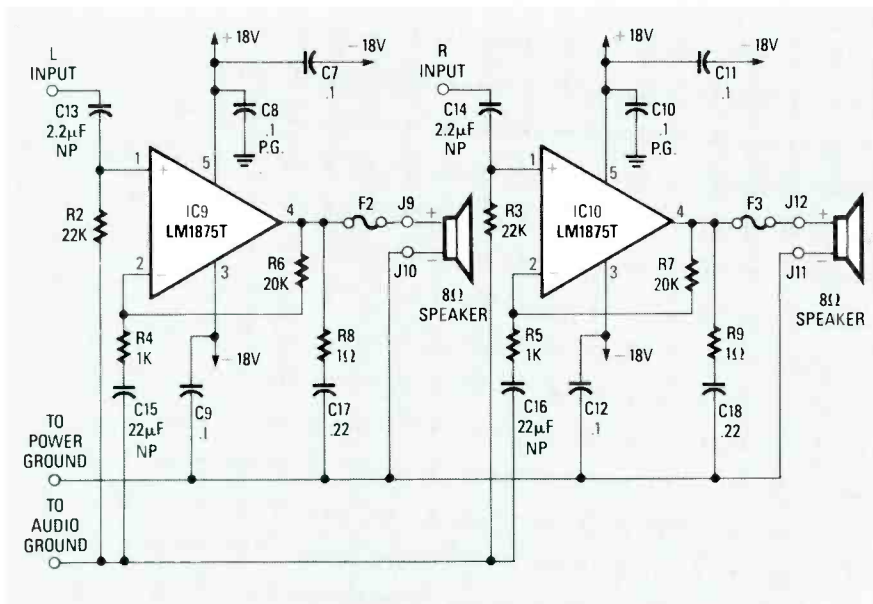

FIG. 6—THE SURROUND CHANNEL POWER AMPLIFIERS are designed around a pair of LM1875 monolithic power-amplifier IC's.

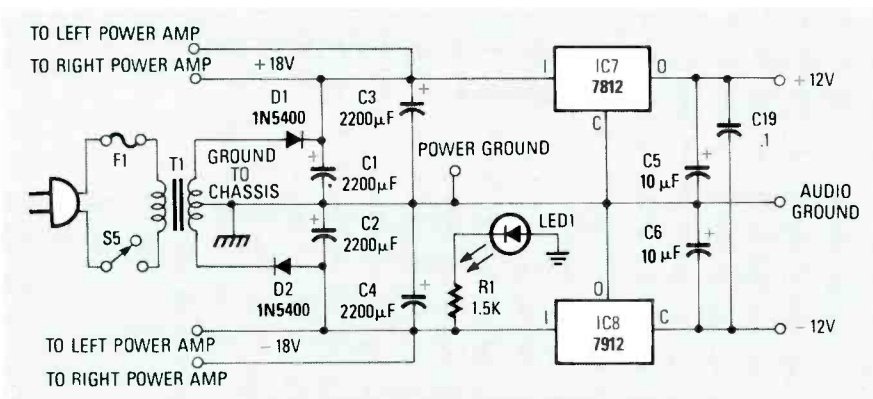

FIG. 7—THE POWER SUPPLY produces about ± 18 -volts unregulated DC.

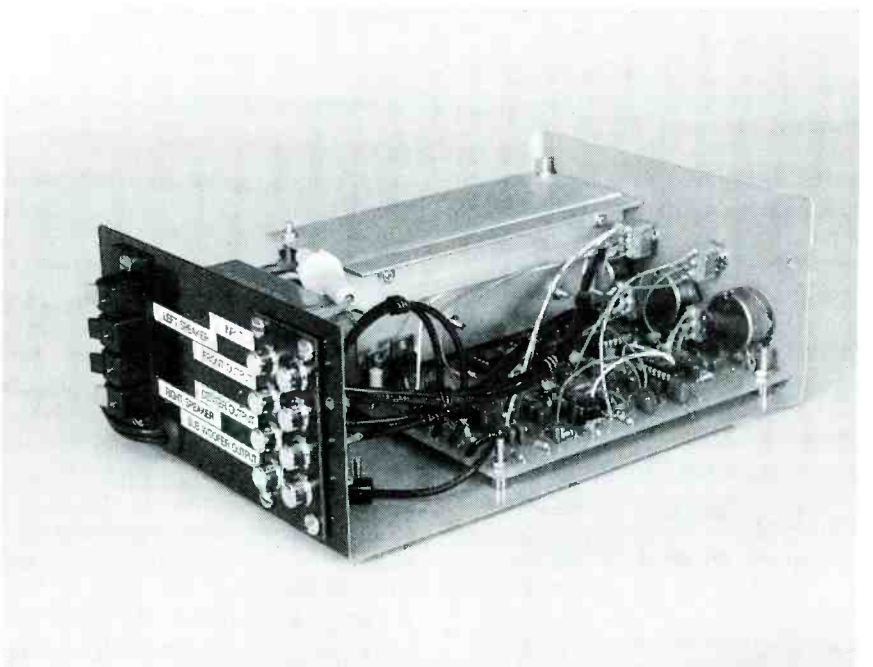

FIG. 8—THE PROTOTYPE ACOUSTIC FIELD GENERATOR. It's a tight fit in this cabinet, but it makes for a neater finished unit.

The surround channel power amplifiers of the AFG, shown in Fig. 6, are designed around a pair of LM1875 monolithic power-amplifier IC's. Chosen primarily because they require very few external parts to implement, and they also offer very low distortion, fast slew rate, wide power bandwidth, and the ability to deliver up to 20 watts into an 8-ohm load; all in a 5-pin TO-220 package. Because of limited heat-sink space in the AFG, we are running the LM1875 at about half of its power capability. The circuit configuration of the power amp is essentially the same as that of any ordinary op-amp operating in the inverting mode. Notice however, that there are two separate ground-return lines to the power supply. That is necessary because high currents flow through the output ground-return line. If a common ground-return line were used for both the input and output signal, those currents could develop enough voltage across the resistance of the return line itself to effectively act as an input signal to the amplifier, thus causing problems such as high-frequency oscillations or distortion.

The power supply of the AFG, shown in Fig. 7, is of conventional design. A 25 volt center-tapped transformer, along with diodes D1 and D2, produces about ± 18 -volts unregulated DC. Two 2200- μ F filter capacitors are used in each leg of the supply to provide ample energy storage to meet the high-current demands of the audio output amplifier IC's during high output peaks. Integrated circuits IC7 and IC8 regulate the positive and negative supply rails to plus and minus 12 volts for use in the low signal level circuits. The plus and minus 12 and 18 volt rails are bypassed to ground by 0.1 μ F capacitors distributed throughout the entire AFG circuitry. That keeps the impedance of the supply rails at audio frequencies as low as possible, thus reducing the interaction between circuits.

Construction

All of the electronic components are mounted on a single PC board as shown in Fig. 9. The board can be made using the foil pattern provided in PC Service or purchased from the source mentioned in the parts list. Only the power transformer, the input and output jacks, and the function switches are mounted off-board.

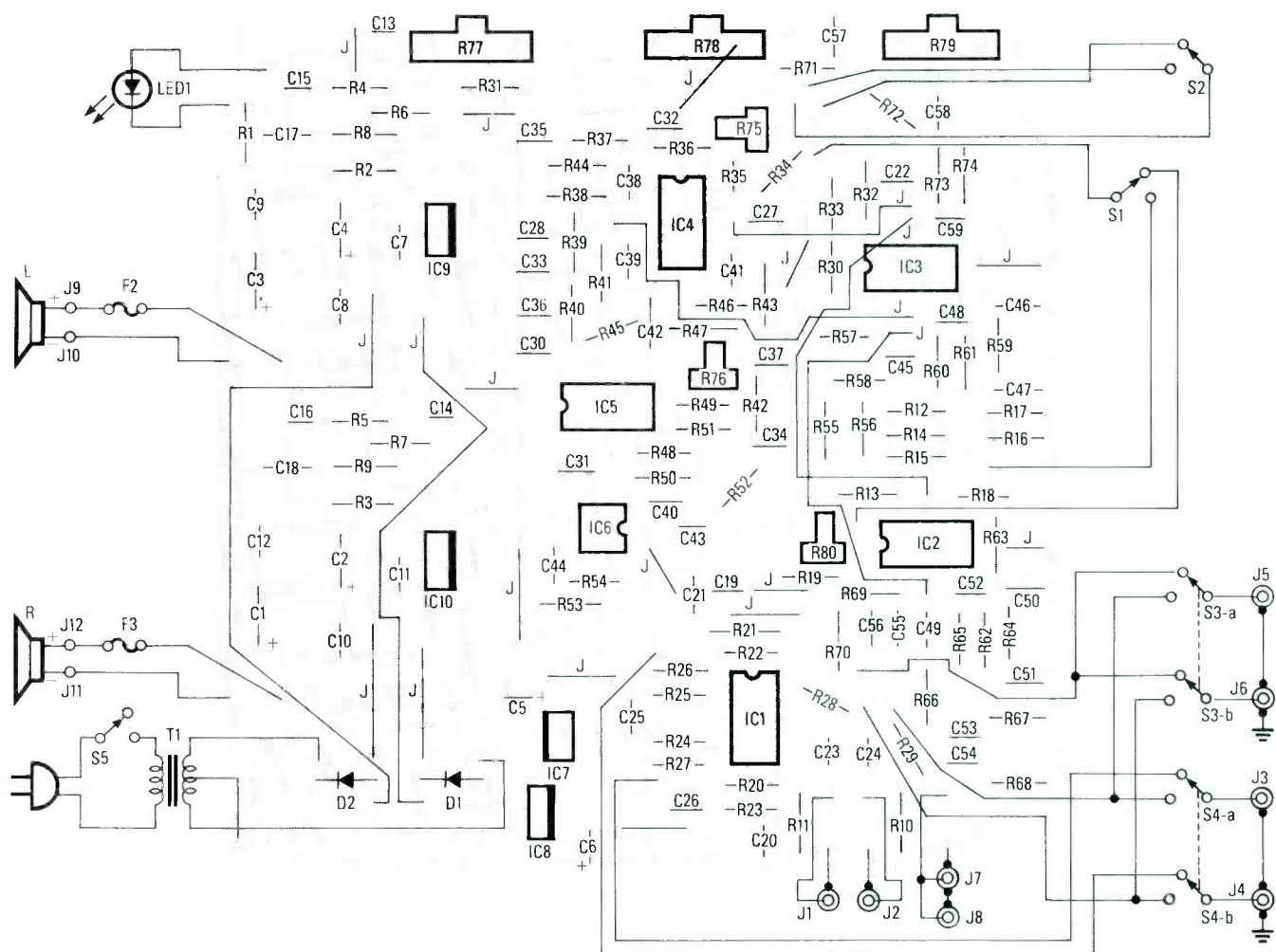

9—ALL OF THE COMPONENTS mount on a single PC board as shown.

The chassis shown is readily available, but it makes for a rather tight fit. If you plan to use a similar chassis, study the pictures of the prototype carefully before drilling. If you choose a different chassis, keep all the leads between jacks, switches, and the circuit board as short as possible. Locate the power transformer as far away from the circuit board as possible to avoid 60-Hz hum. If you must mount the transformer near the circuit board, wait until your unit is operational before you choose a final position for the transformer. Then, while listening, you can try the transformer in different positions until you find a location where there's no hum.

Begin stuffing the board by mounting all of the fixed resistors and the small potentiometers. Note that R35 and R69 are mounted upright. Next mount the IC sockets. Position each socket's pin 1 identifier so that it matches the small dot indicating pin 1 on the circuit board (do not insert the IC's into their sockets at this time). Next mount the capacitors. Please

note where polyester and metal-film capacitors are called for in the parts list. *Do not* substitute ceramic capacitors; they perform poorly in audio circuits and their use will destroy the performance of the AFG. Also, don't substitute polarized electrolytic capacitors where bi-polar units are specified in the parts list.

Using some of the excess leads clipped from the capacitors, install bare jumpers where indicated, except for the six long jumpers. The two long jumpers in the audio power amplifier should be made from insulated heavy-gauge wire, as they carry relatively high current—no. 18 will do. The other four long jumpers in the decoder section should be made from lighter gauge insulated hookup wire.

Finish stuffing the circuit board by installing D1, D2, IC7–IC10, and the three large potentiometers, R77, R78, and R79. You can plug in the IC's now, but you should take static-electricity precautions with them.

Finish up the wiring between the PC-board pads and the switches, the

input/output jack panel, the speaker terminal jacks, the power transformer, and the pilot LED. Use shielded cables for the leads to the input/output jacks. Try to keep all wiring as short and direct as possible to avoid crosstalk and hum. Use no. 18 or heavier wire for the speaker connections. To simplify construction, the prototype used inline fuse holders in the positive speaker leads and the power transformer primary circuit, as indicated in the schematics.

The power-supply regulator IC's are being operated very conservatively and thus do not require heat sinks. However, the LM1875T audio power amplifiers must *always* be operated with a heat sink. Failure to use a proper heat sink will cause the IC's to quickly overheat and possibly destroy themselves. Although they contain on-board circuitry to shut them down in case of overheating under normal operating conditions, it is best to leave fate untempted and refrain from operating the AFG until after the heat sink has been installed.

The heat sink used on the prototype was homemade from a 2- × 2- × 1/16-inch thick piece of aluminum angle stock cut 5/4-inches long and notched out in the front to fit over R77. If you use a commercially made heat sink, be sure that it provides about 8 to 10 square inches of surface area for each IC. Assuming that you are using a homemade heat sink like the one shown, temporarily position it so that the bottom edge is even with the bottom of the IC cases, or about 3/8" above the circuit board. Be sure that it does not touch D1. Mark the heat sink where the holes in the IC tabs fall and drill mounting holes at those points. In order to provide additional support, holes were also added at the top corners of the heat sink in line with the PC-board mounting holes. 3-inch screws with double sets of nuts were then used to mount the PC board as well as to hold the heat sink in place. Carefully examine the photographs that are shown in Fig. 10 to see how that was accomplished.

Because the metal tab of the LM1875T is not at ground potential, mica insulators and plastic shoulder washers must be used between the cases of the IC's and the heat sink. Use a small amount of silicone grease between the IC's and the heat sink to increase thermal conductivity. Make sure that the tabs of the IC's are actually insulated from the heat sink before operating the unit. Although adequate, the heat sink becomes moderately warm during operation, so be sure to provide good ventilation in your chassis.

Setup and operation

Figure 11 shows one method of integrating the AFG into a home audio-video system. As mentioned earlier, a separate power amplifier is required for the subwoofer channel, in addition to the subwoofer speaker itself. In the setup in Fig. 11, the center channel is connected to the audio inputs of a monitor-style television receiver which has provisions for amplifying external line-level audio signals. If your TV set doesn't have audio inputs, or if you use the AFG in a music-only system, you'll have to provide a separate amplifier and speaker for the center channel as well. Please note that although the subwoofer-channel and center-channel speakers are a desirable part of any audio system, they are not absolutely

necessary. The AFG may still be used as an excellent surround-channel decoder simply by adding a pair of small speakers for the surround channels.

The best place to patch the AFG into your system is between the pre-amplifier outputs and the power-amplifier inputs of your receiver or amplifier. Most component receiver/amplifiers allow for that connection by providing removable jumpers between the appropriate phono jacks on their rear panels. By placing the AFG in that loop, all the audio signals selected by the amplifier will also pass through the AFG. Furthermore, the volume and tone controls of the main amplifier will have control over all the levels in the system simultaneously; i.e. the subwoofer, surround speakers, and the center channel, as well as the regular left and right speakers. If your amplifier doesn't provide pre-amp out/main input jacks, you may still use the AFG by connecting it into a tape-monitor loop, or even more simply, to the audio output of a stereo VCR; but then you will have to adjust the levels of the subwoofer and surround channels independently of the main amplifier via the level controls on the AFG.

Calibration of the AFG is easy. Begin by setting, R75, R76, and R80 to their center positions. Now feed a

mono signal into the AFG from some source in your system (an FM tuner switched to mono operation is a good choice). Set the balance control on your amplifier to its exact center mark. With the AFG switched to the matrix position (L-R), adjust R80 for the minimum output from the surround speakers. Now switch the receiver back to stereo and the AFG to concert (L+R). Adjust R76 for minimum distortion. R75 provides a means for matching the drive level of the AFG delay section to your system's normal audio levels. The BBD delay line has a maximum recommended input-signal level of 1.5 volts. To maximize the signal-to-noise ratio of the delay amplifier, the signal going into the delay line should be as high as possible without driving it into distortion. While using the highest normal level you are likely to feed the AFG, adjust R75 to obtain the maximum level that does not cause distortion.

The speakers you choose for the surround channels don't have to match your front-channel speakers in sonic characteristics. The frequency response of the surround channel is limited at the time of encoding to a bandwidth from approximately 100 Hz to 7 kHz by the Dolby process. Small bookshelf-style speakers

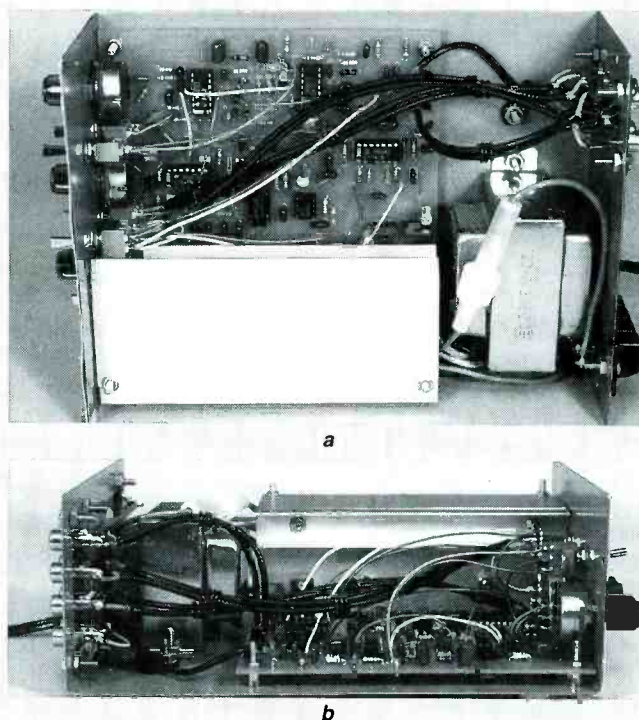

FIG. 10—THE HEAT SINK AND PC BOARD are installed as shown. Two 3-inch screws with double sets of nuts are used to mount the PC board on one side and hold the top of the heat sink in place (a). Two shorter screws hold down the other side of the board (b). Be sure to use spacers to prevent the board from touching the metal cabinet.

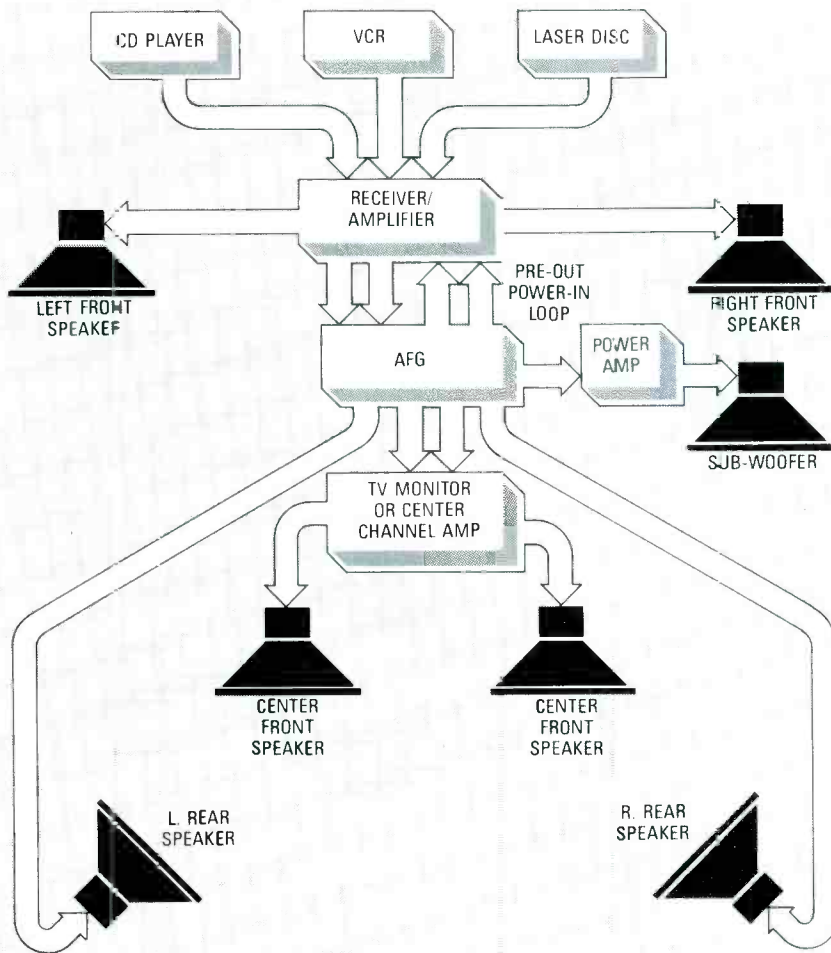

FIG. 11—HERE'S ONE METHOD OF INTEGRATING THE AFG into a home audio-video system. A separate power amplifier is required for the subwoofer channel, in addition to the subwoofer speaker itself.

mounted toward the rear of the room at ear level or slightly above are adequate. Although it is customary to use two speakers for the surround channel, one placed to the right rear and one to the left rear of the listening position, the surround channel signal that feeds those speakers is really monaural. The internal power amplifiers in the AFG drive the signal to the two rear speakers 180 degrees out of phase. That tends to spread apart the sound field created between the rear speakers. However, that may or may not sound well in your listening environment, depending on such things as speaker placement and actual listening position. You may restore the speakers to in-phase operation by simply reversing the leads connected to one of the speakers. Try setting up both ways to find which sounds better to you. Note that phase integrity is maintained through the AFG for the left, right, center, and subwoofer channels.

Actual level adjustment of the sur-

round channels, center channel, and subwoofer is a subjective process. The source material itself, the listening area, and personal preferences for tonal balance must be taken into account. Use the AFG in the matrix and wide modes for surround-encoded movies. Use the concert mode to add ambience and depth to musical performances. Generally speaking, don't set the level of the surround channel so high as to make it overwhelming. The surround signal is intended to supplement the main channel, not to be a separate channel that is always equal in level to the front channel. That is particularly true for surround-encoded movies.

The delay of the surround signal can be adjusted via R77 from about 5 to 35 milliseconds. In matrix operation, delaying the surround signal tends to acoustically mask any leakage of front channel information into the surround channel. Setting R77 to the center provides a delay of approximately 20 milliseconds. R-E

SPECIAL FROM ETT

PCP101—PRACTICAL DIGITAL ELECTRONICS HANDBOOK ... \$9.95. Introduces digital circuits, logic gates, bistables and timers, as well as microprocessors, memory and input/output devices. Special section on digital test gear projects.



PCP102—INTRODUCING DIGITAL AUDIO ... \$9.95 Shows what is involved in the digital part of audio signals, particularly in the newest devices such as CD, DAT and sampling. Bridges the gap of understanding for the technician and enthusiast.



PCP103—PRACTICAL MIDI HANDBOOK ... \$9.95. Covers all MIDI based equipment you can use—keyboards, drum machines, sequencers, effects units, mixers, drum pads and guitars. Also a section on computer music that covers software and more.



PCP104—ELECTRONICS BUILD & LEARN, Second Edition ... \$9.95. You start by assembling a circuit demonstrator that is then used to build and investigate a variety of useful circuits including oscillators, multivibrators, bistables and logic circuits.



PCP105—MAKE MONEY FROM HOME RECORDING ... \$10.00. Now that you've spent all that money on all that recording gear, wouldn't it be nice to get some of it back? Well here's the book that can show you how.



PCP106—SYNTHESIZERS FOR MUSICIANS ... \$10.00. All current popular forms of synthesis explained: LA, additive, phase distortion, FM and sampling. Get the sounds you want from your synth. Written especially for musicians.

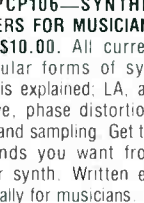

MAIL TO: Electronic Technology Today, Inc.
P.O. Box 240
Massapequa Park, NY 11762-0240

SHIPPING CHARGES IN USA AND CANADA

\$0.01 to \$5.00	\$1.25	\$30.01 to \$40.00	\$5.00
\$5.01 to 10.00	\$2.00	\$40.01 to \$50.00	\$6.00
\$10.01 to \$20.00	\$3.00	\$50.01 and above	\$7.50
\$20.01 to \$30.00	\$4.00		

SORRY. No orders accepted outside of USA and Canada

Total price of merchandise \$ _____
Shipping (see chart) \$ _____
Subtotal \$ _____
Sales Tax (NYS only) \$ _____
Total Enclosed \$ _____

Name _____
Address _____
City _____ State _____ Zip _____

E E H B

KEEP YOUR VCR HEALTHY

Troubleshooting VCR tape-loading problems

PETER M. HANSEN

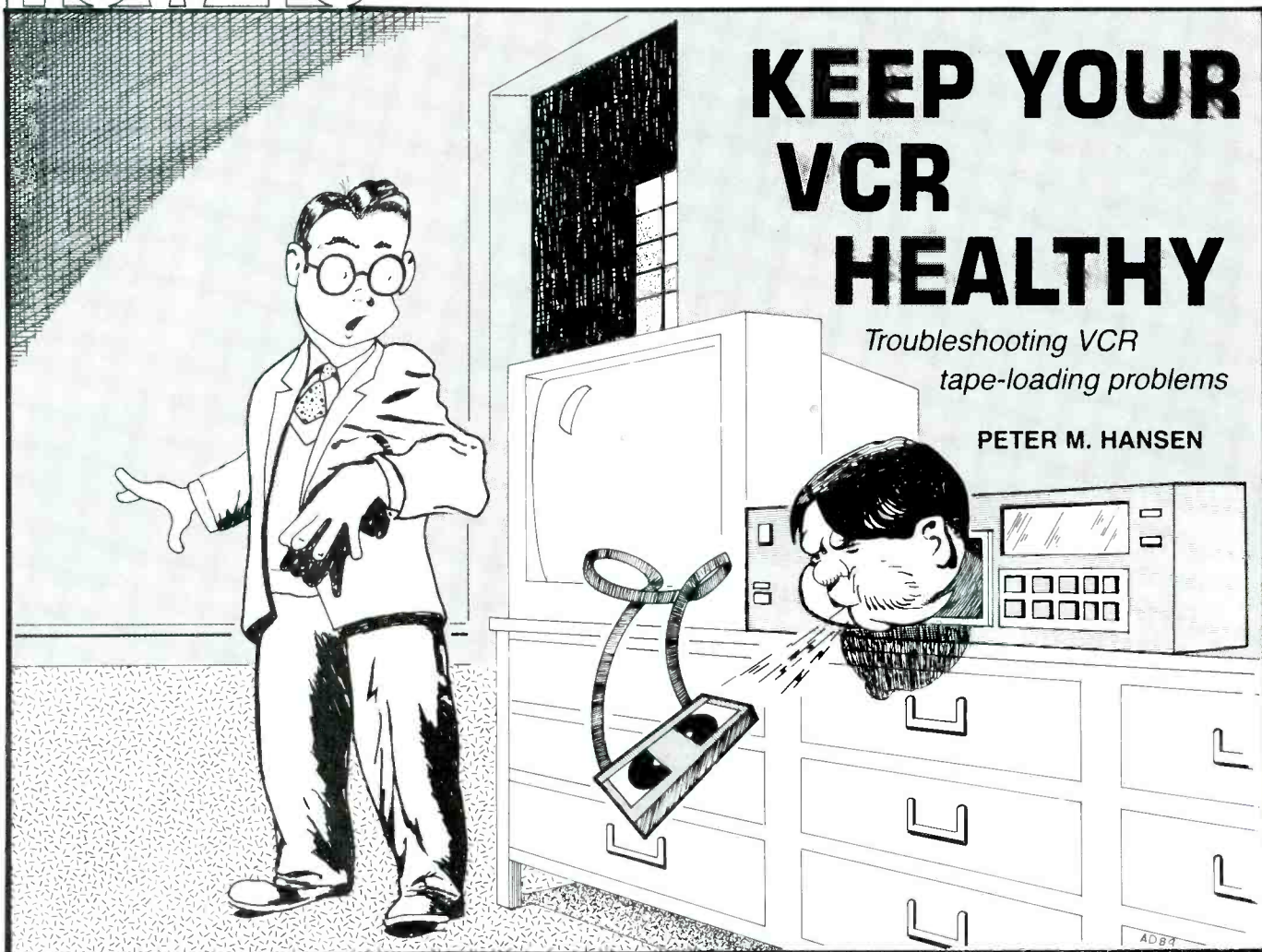

ONE OF THE MOST COMMON PROBLEMS found in VCR's is the inability to properly load a tape. Before you try to fix any VCR, though, you should be somewhat familiar with basic VCR disassembly skills and simple servicing precautions. You can learn about the various components inside a VCR by reading our last article on VCR maintenance (**Radio-Electronics**, March 1989). That article covered basic VCR mechanism identification, cleaning techniques, and the necessary hand tools.

Tape-load problems

It is important that you clearly understand the difference between cassette-loading problems and tape-loading problems. A cassette-loading problem is where the cassette carriage assembly does not properly accept the cassette (the shell) into the VCR. A tape-loading problem is when the tape is not properly extracted from the

cassette once the cassette is fully seated inside the VCR.

Figure 1 shows the basic VCR components. You should be somewhat familiar with them before attempting any servicing, but right now our main concern is the tape-loading process. To be able to see the internal components, you first have to remove the VCR's top cover and head shield. You may also have to remove the cassette carriage in order to fully access the components involved in the tape-loading process. Figure 2 shows the cassette carriage being removed from a VCR—there are usually four Phillips-head screws on the top of the assembly that secure it to the VCR chassis. Figure 3 shows the cassette carriage assembly by itself. The gear block and motor assembly on the right side of the carriage is the drive system that is used in front-loading VCR's to load the cassette into the VCR when it is first inserted.

The VCR's guide rollers and slant poles are what actually extract the tape from the cassette and guide it across the video head/drum assembly. After you select play or record, you will see the two guide posts start the tape-extraction process; the video drum starts to spin counterclockwise (it reaches 30 rpm in about 3 seconds), and the pinch roller starts its short movement toward the capstan shaft. It is the action of the pinch roller "pinching" the rotating capstan shaft that actually pulls the tape through the machine during play or record.

Most recent VHS VCR's use a dedicated DC motor to load the tape across the video-drum assembly. The motor is located either above or below the mechanism, and is usually driven by an integrated circuit that receives the motor load and unload signals from the VCR's main microprocessor. Figure 4 shows a typical tape-load

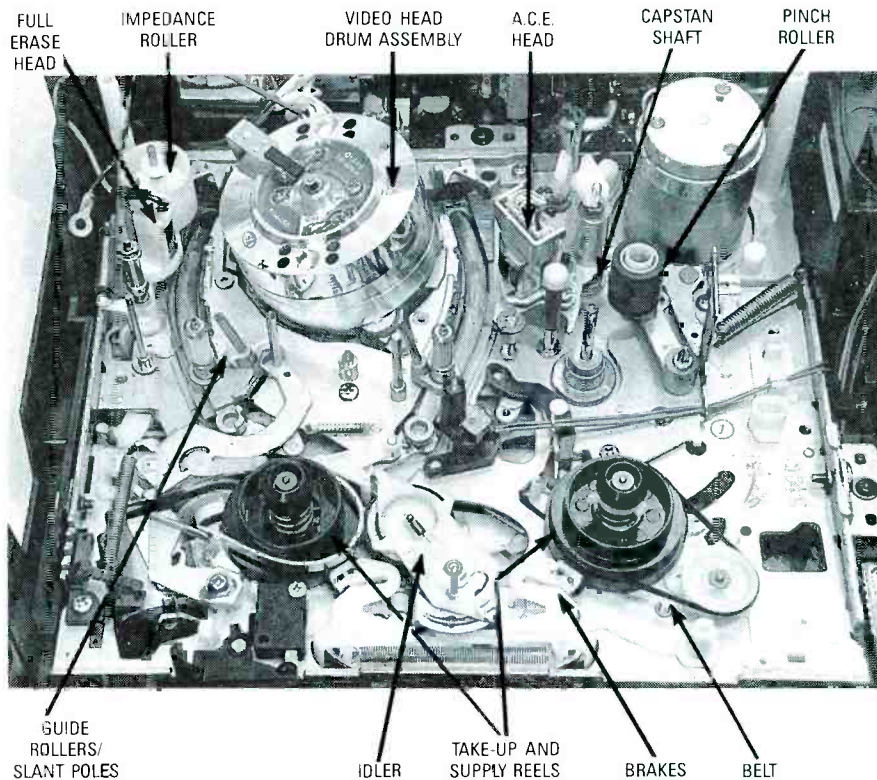

FIG. 1—MAJOR VCR COMPONENTS. You should be able to identify these basic mechanisms found in all VCR's.

board to the chassis. Many times there will be identifying arrows printed on the PC board indicating which screws must be removed. If you remove the wrong ones, you may be dismantling the wrong thing.

In some VCR's, you must remove the front panel in order to release the PC board. Many times the front-panel assembly (which contains the switches, display, etc.) is secured to the chassis by small (fragile) plastic retaining tabs—give the unit a close visual inspection *before* attempting to remove it so that you don't crack anything! Remember that any mistake can cause you much grief—not to mention the added expense.

With the VCR placed in its service position (see Fig. 7), you can closely observe the loading components during a tape load. To do that, plug in the unit, insert an inexpensive test tape, and hit the play button. As soon as you hit play, you should see movement of the loading gear train as well as the the guide posts. On many units, you'll also see the cam gear as it shifts position from "stop" to "fully loaded." Sometimes a mirror placed on your workbench surface can help you see both sides of the VCR's loading mechanism simultaneously.

Diagnosing malfunctions

A very common malfunction in VCR's is cracked, dirty, or worn (slippery) load belts. The major symptom of that is that when the operator se-

tom side of the chassis.

To get at components on the underside of the chassis, first make sure that power is off and the unit is unplugged, and then remove the VCR's bottom plate. There are usually several Phillips screws securing the bottom plate to the chassis. Next, you have to identify the screws that secure the PC

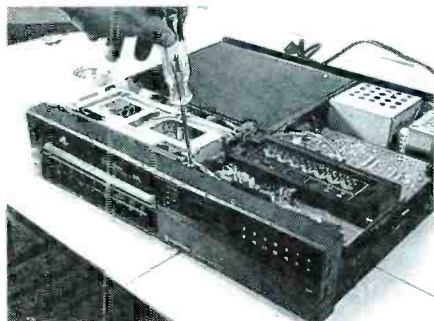

FIG. 2—THE CASSETTE CARRIAGE assembly is usually secured to the VCR chassis by four Phillips-head screws.

motor located on the bottom of the VCR's chassis; in this case, the unit is a later model Fisher VCR. In Fig. 5 we see a load motor that is located on the top of the mechanism, with the video drum behind it.

Tape-loading components

The load gear train is located (almost always) on the VCR's bottom side chassis. The load gear train is connected to the load motor via the load belt (or worm gear) and associated linkage rods and connectors. The load-gear assemblies are made out of hard plastic, and have one and sometimes two cam gears with grooves that contain a lubricant. Figure 6 shows a typical loading-gear train on the bot-

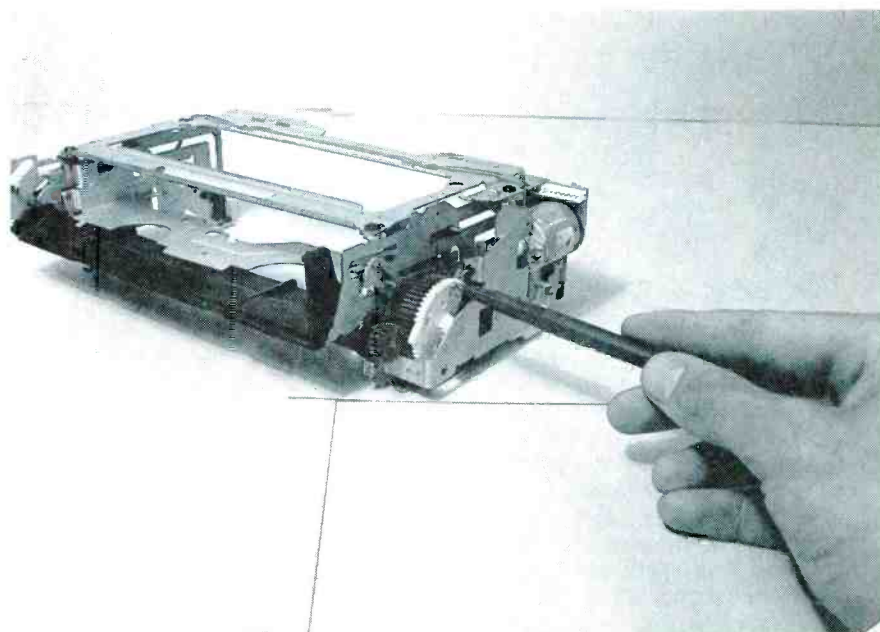

FIG. 3—THE GEAR BLOCK AND MOTOR ASSEMBLY on the right side of the carriage is the drive system that accepts the cassette into a front-loading VCR.

lects play or record, the guide posts will start their path toward the "V" stoppers (the metal brackets situated at the end of the loading grooves), but they will not reach the end of their path. Many times they will appear to have completed the load process, but closer inspection reveals that they only completed about 90% or 95% of the load process. The loading posts will then start retracting back toward the stop position and the video drum will stop spinning. Most of the time, that type of failure is due to a bad load belt.

Because the slipping load belt prevented the load posts from traveling their full distance, the microprocessor did not receive what's called the "load complete," the "after load," or, more simply, the "AL" signal. Some of the older units have a small microswitch embedded in the load gear train that is activated when the load posts are fully extended. However, most newer VCR's have infrared sensors built into the cam-gear assembly that transmit the various mechanical load stages during the tape-load mode to the microprocessor.

In an aborted tape-load attempt, you will also be able to see that the pinch roller does not come in contact with the capstan shaft. The pinch roller will come in contact with the capstan shaft only when the system microprocessor receives a load-complete signal.

A simple test for a malfunctioning load belt is to "assist" the load pro-

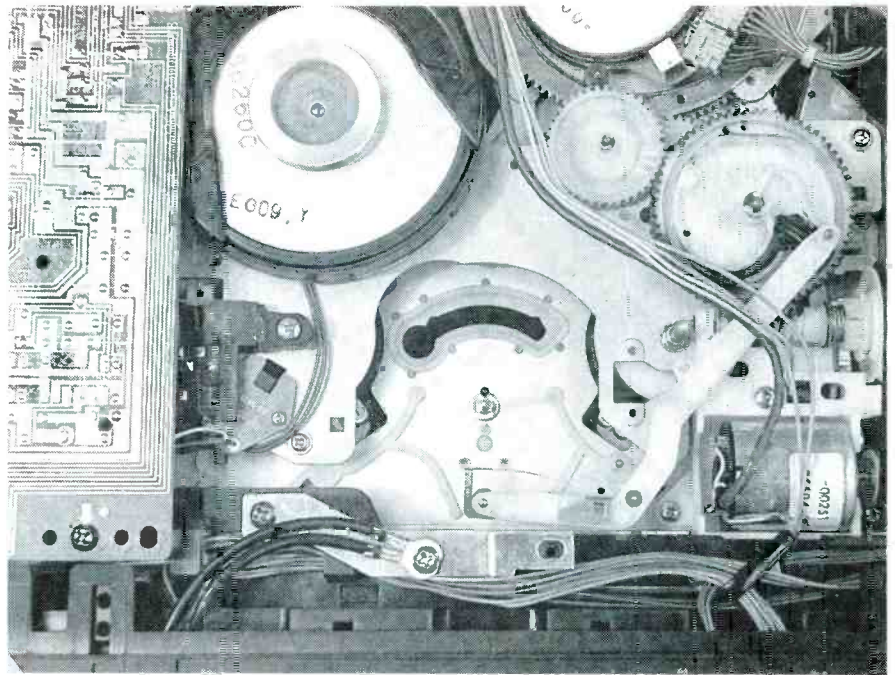

FIG. 4—A TYPICAL LOAD MOTOR is located on the bottom side of the VCR's chassis.

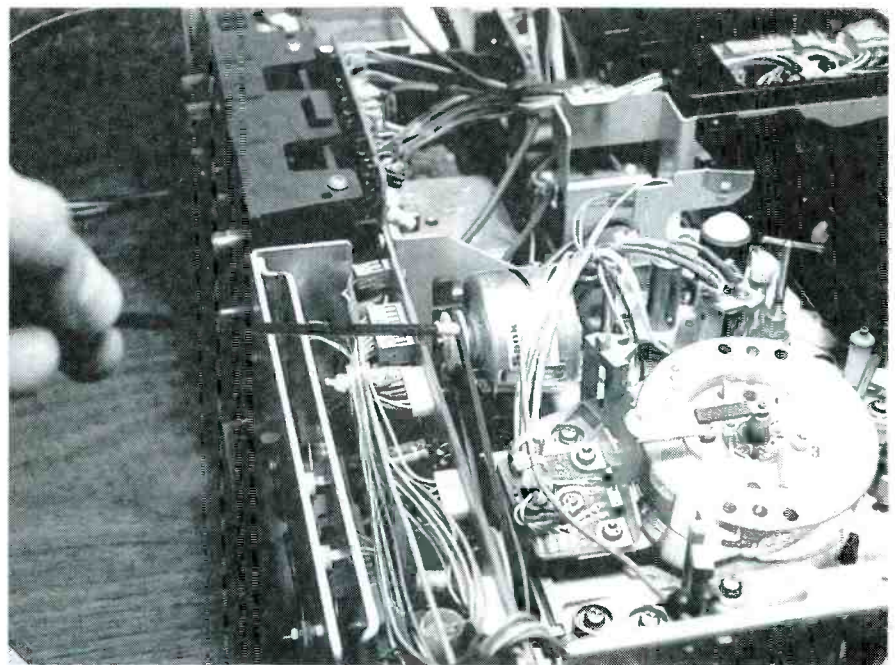

FIG. 5—THIS LOAD MOTOR is located on top of the mechanism, with the video drum directly behind it.



Peter M. Hansen is the author of the *Viejo Method of VCR Maintenance and Repair* and president of Viejo Publications. The manual is available with or without the VCR-maintenance kit and training video. The kit contains VCR cleaning materials and an assortment of replacement belts, tires, idlers, etc. Contact Viejo Publications, 3540 Wilshire Blvd., Suite 310, Los Angeles, CA 90010. 1-800-537-0589.

cess with your finger (see Fig. 8). With the VCR in its service position, and a tape inside the machine, select the play mode; you should have your index finger or thumb placed gently on the load-motor shaft. You will feel the rotation of the load motor shaft against your finger. Wait for the load process to be completed (when the load posts appear to have reached the end of their travel), and then "assist" the load process by manually turning

the load motor shaft in the same direction as it was turning by itself. If the belt is bad, the action of your finger will most likely complete the load. The load-complete signal will now be received by the microprocessor, which will issue the signal to activate the pinch roller. A bad belt should be replaced, but sometimes you can extend its life a bit by cleaning the belt and applying some rubber revitalizer.

continued on page 164

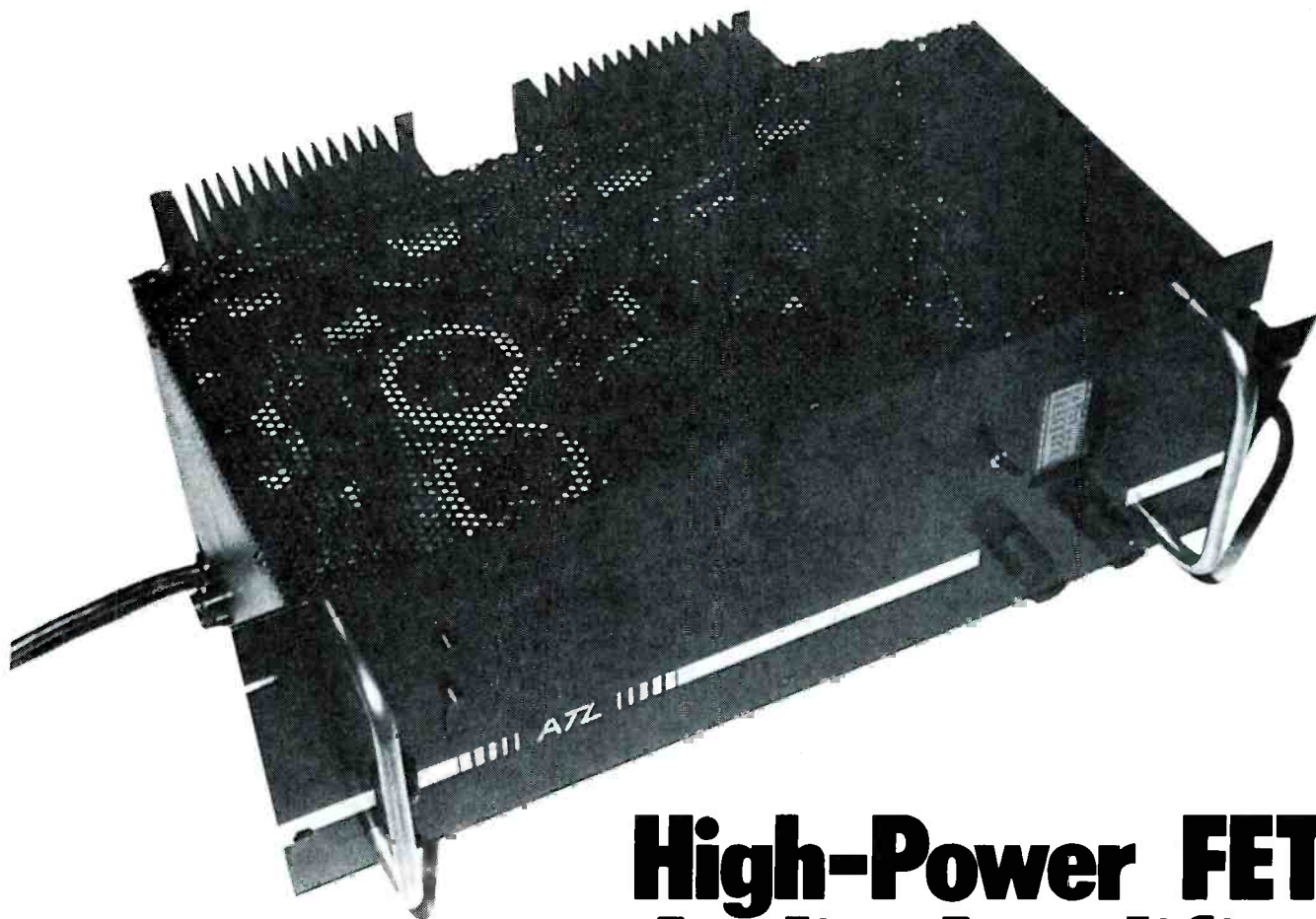

High-Power FET Audio Amplifier

REINHARD METZ

YOU'VE PROBABLY ALWAYS WANTED TO own a high-performance, high-power stereo amplifier. If you don't have one, there are two likely reasons why: You are not sure you need that much power and you are deterred by the cost. But these days, with the increasing popularity of digital audio disc players, there is a new motivation for owning a high-power amplifier that can faithfully reproduce a wide dynamic range without distortion. And while the cost of commercial high-power amplifiers is still high, we'll describe a very high-performance design that you can build at a reasonable cost. Just what do we mean by "high performance?" Table 1 summarizes the characteristics of our design.

One of the most important features of the design is the use of power MOSFET output transistors in a complementary configuration. Those transistors, by themselves, eliminate a number of the problems usually associated with their bipolar counterparts.

The highly desirable characteristics of power MOSFET's for audio amplifiers have been recognized for a few years. However, for many years only N-channel devices were available—only recently

have their P-channel counterparts appeared at reasonable prices, making it possible to design amplifiers with remarkable performance but little complexity.

As we'll see shortly, MOSFET's aren't the only transistors used in the amplifier. Ahead of the output stage, a fully complementary bipolar design combines simplicity with high performance.

Why MOSFET's?

Although the evolution of power MOSFET's has primarily been (and still is) fueled by power-supply applications, there are a couple of reasons why MOSFET's make ideal devices for audio-amplifier output stages. First, they allow the design of amplifiers with very wide bandwidths, high slew rates, low distortion, and straightforward simplicity. Also, MOSFET's lack a secondary-breakdown mechanism. (Secondary breakdown in bipolar devices is a localized heating effect

in which "hot spots" develop under high-current conditions. A hot spot then conducts even more current, creating more heat, which, in a positive-feedback manner, may lead to a catastrophic destruction of the device.)

Because of secondary breakdown, bipolar devices must be operated within a "safe" area that often falls far short of the device's stated static current and power-dissipation characteristics. Safe-operation-area limiter circuits (whose misoperation has often been notorious) must be used in bipolar circuits. Because MOSFET's do not exhibit secondary breakdown, simpler and more reliable designs can be used.

The characteristics of the MOSFET's used in this amplifier are shown in Fig. 1. They are, of course, voltage-controlled devices. When the gate-to-source voltage, V_{GS} , drops below about 3.5 volts, the drain-to-source current, I_D , quickly drops

Get high performance and high fidelity from this FET stereo amplifier. It feels equally at home in your living room or in a disco!

TABLE 1—SPECIFICATIONS

Power output:

250 watts/channel into
a 4- or 8-ohm load

Frequency response (-3dB):

5 Hz to 1.1 MHz @ 1 watt
5 Hz to 330 kHz @ 250 watts

Distortion:

< 0.05% IM to 250 watts
< 0.05% THD 20 Hz-20 kHz

Signal-to-noise ratio:

> 100 dB

Damping factor:

> 500 to 1 kHz with 8-ohm load

Risetime:

< 0.5 μ s @ 80 volts P-P

Slew rate:

> 160 volts/ μ s

to zero. That is called the *gate threshold voltage*, V_T . Above V_T , the *transconductance* (or transfer admittance) builds up to an asymptotic value, averaging about 3 amps of drain current per volt increase in gate-to-source voltage, V_{GS} . (Measured with V_{DS} constant, $\Delta I_D / \Delta V_{GS} = 3$ siemens)

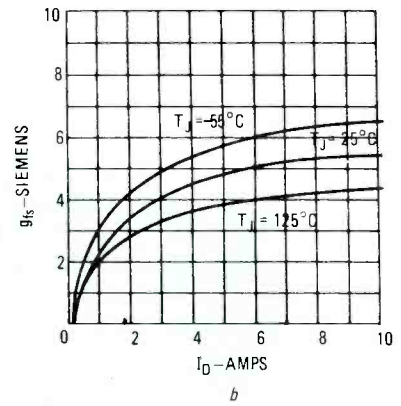
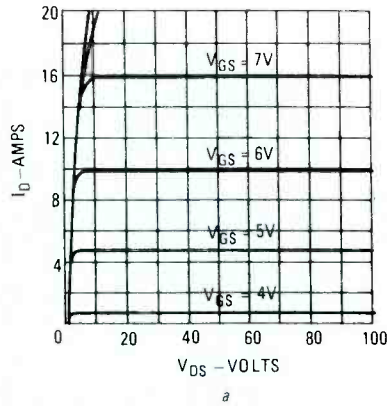

FIG. 1—MOSFET CHARACTERISTICS. Shown in a are the typical output characteristics of the IRF630. Shown in b is the typical transconductance as a function of drain current for the same device.

A look at the circuit

The stereo power amplifier consists of four main stages: input, voltage-amplifier, inverter/driver, and output. Since the MOSFET outputs are the center of attraction, we'll begin there and work our way backward. The amplifier schematic (for one amplifier channel) is shown in Fig. 2.

Transistors Q21 through Q28 are the N- and P-channel MOSFET power output transistors. Each one is capable of contributing a minimum of 6 amps of the output current for peak current requirements. Since the output transistors are in a common-source configuration, the output

stage can have voltage gain, and the transistors must be biased with respect to the supply rails. The major advantage of that approach is that the bipolar driver-stage does not have to swing very much voltage, but the outputs may swing from rail to rail. (A common-drain output stage would require the driver to swing the entire output-voltage range which, with bias, would mean that either a pair of separate higher-voltage supplies would be required for the drivers, or that the output would not swing from rail to rail. That would make the stage operate far less efficiently.) The relatively high gate-capaciti-

PARTS LIST

All resistors 1/4-watt, 1% unless otherwise indicated. (5% types—values shown in parenthesis—can be substituted)

- R1—10,000 ohms, audio-taper potentiometer
- R2—2050 (2000) ohms
- R3, R4, R13, R14—10,500 (10,000) ohms
- R5, R6, R11, R12, R22—100 ohms
- R7—2490 (2400) ohms
- R8—500 ohms, potentiometer
- R9—2470 (2700) ohms
- R10, R29—100,000 ohms
- R15, R16—1000 ohms, 2 watts
- R17, R18—1000 ohms
- R19—5000 ohms, 10-turn potentiometer
- R20—8660 (8200) ohms
- R21—1500 ohms, 2 watts
- R23—R26—511 (510) ohms
- R27, R28—2000 ohms, 5 watts
- R30—50 (47) ohms
- R31—R38—24.9 (24) ohms
- R39—162 (160) ohms
- R40—5110 (5100) ohms, 1/2 watt
- R41—4.64 (4.7) ohms
- R42—4.64 (4.7 or 5) ohms, 10 watts

Capacitors

- C1—10 μ F, Mylar film
- C2—220 pF, ceramic disc
- C3, C4, C11—150 pF, ceramic disc
- C5—220 μ F, 63 volts, electrolytic

- C6—8 pF, ceramic disc
- C7—0.1 μ F, 50 volts ceramic disc
- C8, C9—0.1 μ F, 100 volts, ceramic disc
- C10—1500 pF, 50 volts, ceramic disc
- C12—C15—100 μ F, 100 volts, electrolytic
- C16, C17—25,000 μ F, 75 volts, electrolytic (Sprague 253G075CF2A or similar)

Semiconductors

- Q1—Q4—2N5210
- Q5—Q8—2N5087
- Q9—ECG289A or NTE289A
- Q10—ECG290A or NTE290A
- Q11, Q12, Q17, Q18—ECG129 or NTE129
- Q13—Q16—ECG128 or NTE128
- Q19—ECG373 or NTE373
- Q20—ECG374 or NTE374
- Q21—Q24—IRF9630
- Q25—Q28—IRF630
- Q29—ECG123AP or NTE123AP
- BR1—25 amps, 400 PIV bridge rectifier
- D1, D2—1N4148
- D3—D5—1N4002
- D6, D7, D21—1N4735A 6.2 volts, 1 watt, Zener
- D8—D11, D23—1N4750A 27 volts, 1 watt, Zener
- D12, D13—1N4737A, 7.5 volts, 1 watt Zener
- D14, D15—1N4738A 8.2 volts, 1 watt Zener

- D16—1N4728A 3.3 volts, 1 watt Zener

Other components

- L1—1 μ H (15 turns of No. 16 wire wound on R42—see text)
 - NE1, NE2—Neon bulbs with 100K series resistors.
 - F1—5 amps, fast-blow fuse
 - F2—F5—6 amps, fast-blow fuse
 - F6—10 amps, fast-blow fuse
 - T1—106 volts, center-tapped power transformer
 - S1—SPST power switch
 - J1—Phono jack for input
- Miscellaneous**
Heat Sinks, Wakefield 512 series, 2 x 7 inches or equivalent; TO-5 heat sinks for Q12, Q13, Q15, and Q18; chassis; handles; fuse holders; capacitor clamps; power cord; input jacks; binding posts; wire; hardware; insulators, etc.

The following items are available from **A&T Labs, Box 552, Warrenville, Illinois, 60555: Etched, drilled, plated-through PC boards, \$25 each; Power transformer, \$74 each; Set of 8 matched power FET's, \$48, Drilled heatsink (type 512), \$42. Add 5% shipping and handling, 12% for transformer. Illinois residents include 6.75% sales tax. Outside of U.S.A., add 5% extra for shipping.**

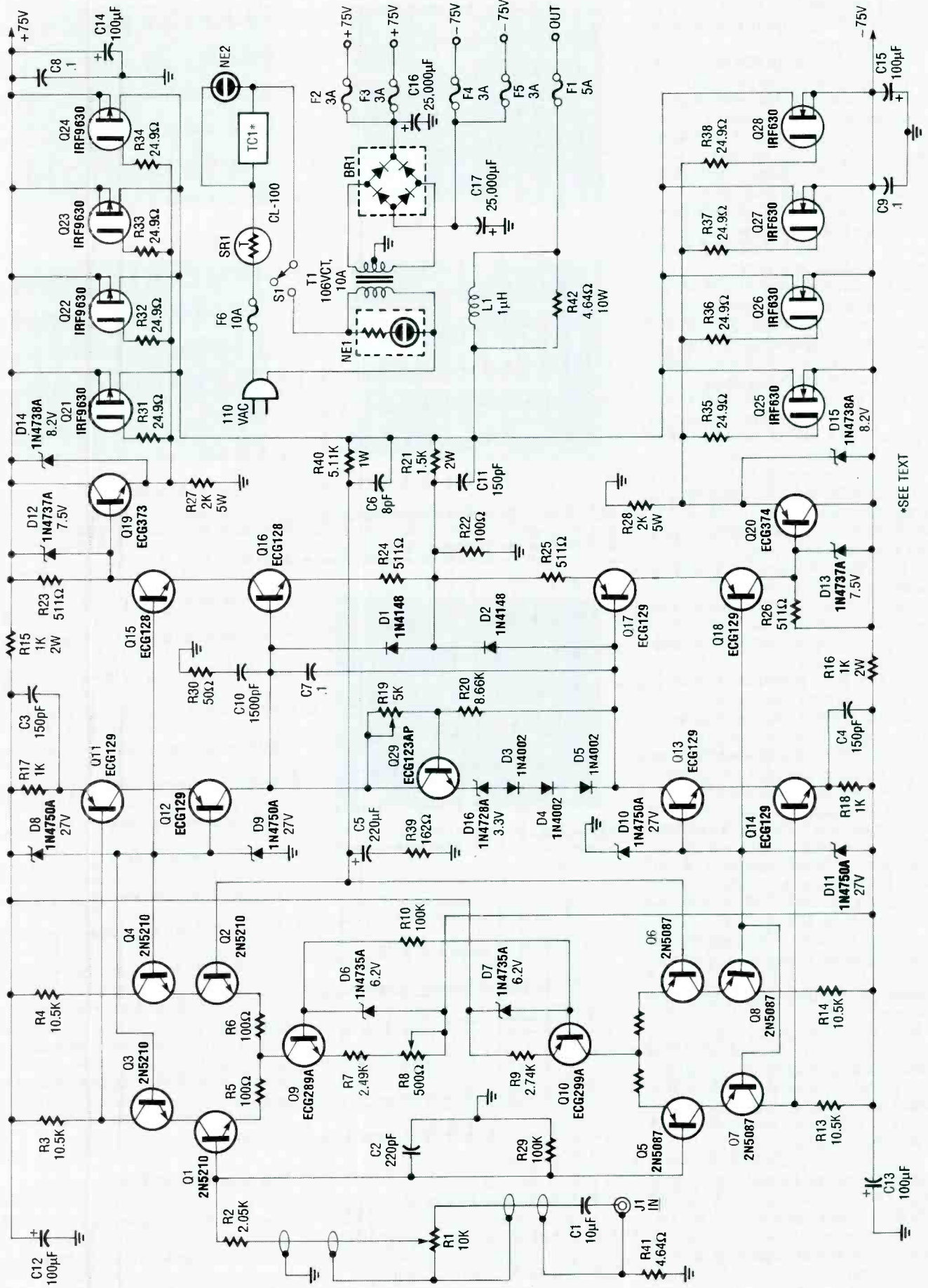

*SEE TEXT

tance of the power MOSFET's is also somewhat easier to drive in the common-source configuration.

Resistors R31 through R38 help to suppress the parasitic oscillations that might otherwise occur with the extremely fast transistors used. Zener diodes D14 and D15 limit the amount of drive available to the output. Finally, L1 and R42 serve to isolate the amplifier output from capacitive loads at very high frequencies.

The inverter/driver stage consists of Q15 through Q20. Its purpose is to deliver bias and drive signals to the FET output stage. Their basic requirement is to sit at about 3.5 volts with respect to the source, increasing about .3 volt per ampere of output current. Transistor Q29 forms a conventional voltage multiplier, which, in this case, multiplies the voltage across D3, D4, and D5 and D16 to about 7 volts. The 7-volt bias is presented to the bases of Q16 and Q17, which form the bottom transistors of a pair of complementary cascode amplifiers.

An output-stage gain of 10 is set by R21, R22, R25, and R26. Therefore, the voltage generated by Q29 is split in half and reflected up against the two supply rails as a pair of bias voltages across R23 and R26. Those voltages, along with the AC drive-signals from the previous stage, are passed along to emitter followers Q19 and Q20, which have the high-current drive capacity required by the gate capacitance of the output devices. Using cascode stages here, as well as in the input and voltage-gain sections, serves the dual purpose of splitting the emitter-collector voltage and power drops among two transistors per rail, while increasing the open-loop frequency response of the amplifier.

The voltage-gain stage consists of transistors Q11 through Q14, again configured as complementary cascode amplifiers. The collector loads for Q12 and Q13 are essentially the input impedance of Q16 and Q17. That is in the neighborhood of 50K, leading to a stage gain of about 50 (the quotient of 50K and R17 or R18). Capacitors C3 and C4 increase the frequency response of the stage. Zener diodes D8, D9, D10 and D11 set the base voltages for the upper transistors in the cascodes.

Now we'll look at the input stage, which consists of Q1 through Q8. Those transistors are connected as complementary-cascode differential amplifiers, supplied by current-sources Q9 and Q10. The gain is set at about 100 by the ratios of R3 to R5 and R13 to R11.

Resistor R8 is used to zero the output voltage by varying the collector currents of Q1-Q4, compensating for any V_{BE} offsets that may exist in Q1, Q2, Q5, and Q6. That is important, because with an extremely low output-impedance such as this amplifier has, even very low output offsets (in the tens of millivolts) can deliv-

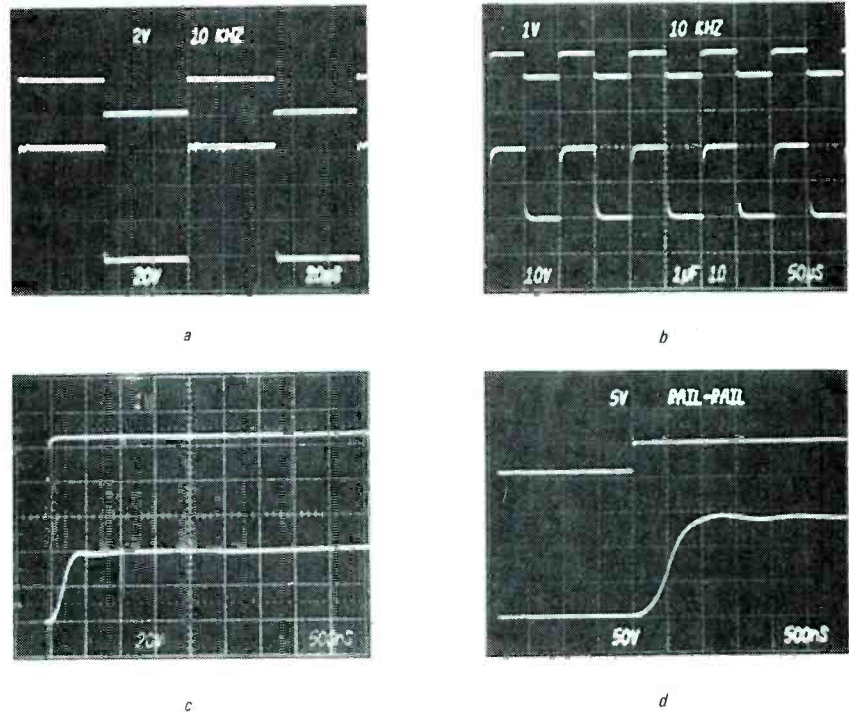

FIG. 3—AMPLIFIER RESPONSE CHARACTERISTICS. A shows the response to a 10-kHz squarewave input at 150 watts into an 8-ohm load, while b shows the response into a 1-ohm, 1- μ F load. Shown in c and d are the step responses at 50 watts and full output, respectively (both with input filter C2 removed). Note the excellent slew-rate and risetime capabilities.

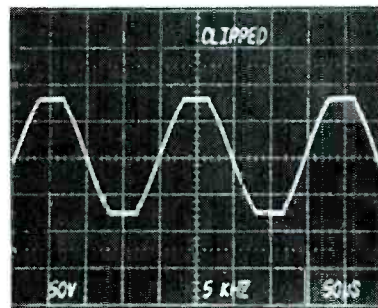

FIG. 4—FULL-POWER OUTPUT with a 5-kHz sinewave input. Note the clipping level is about ± 75 volts.

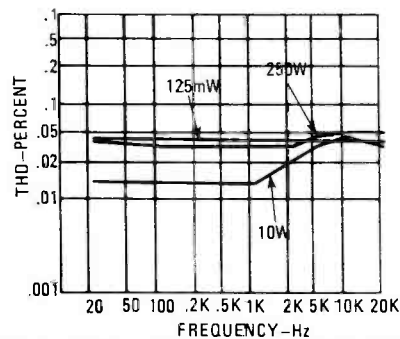

FIG. 5—TOTAL HARMONIC DISTORTION (THD) at 1 kHz.

er many amps into a short.

The overall voltage-gain of the amplifier is set at about 30 by the ratio of R40 to R39. A 3-dB rolloff is set at about 3 Hz by C5. High-frequency compensation is provided by C10, R30, C6, and C11.

Some optional components are shown

in the schematic, notably in the power-supply section. First, there is TC1, the thermal cutout made by Elmwood sensors (1655 Elmwood Ave., Cranston, RI 02907). It is normally closed, and opens at 70°C. Another optional component is SR1, an inrush limiter made by Keystone (Thermistor Div., St Marys, PA 15857). For home applications, those shouldn't be necessary. However, if you plan to run the amplifier continuously at high power (in a disco, for example), you should include all the protection you can.

Amplifier performance

Some of the response characteristics of the amplifier are shown in the oscilloscope photographs in Fig. 3. For example, in Fig. 3-a we see the response to a 10-kHz squarewave at 150 watts into 8 ohms. Figure 3-b shows the response with a 1-ohm, 1- μ F load. Figures 3-c and 3-d show the step response at 50 watts and full output, respectively. (Those two risetime tests were made with input-filter capacitor C2 removed.) Figure 4 shows the full-power output with a 5-kHz sinewave input. Figure 5 shows the total harmonic distortion from less than 1 watt to 250 watts at 1 kHz.

Building the amplifier

It is essential that a printed-circuit board be used for the amplifier. Figures 6 and 7 show foil patterns for the component and solder side respectively. Note that one board is required for each channel. If you don't want to etch your own boards,

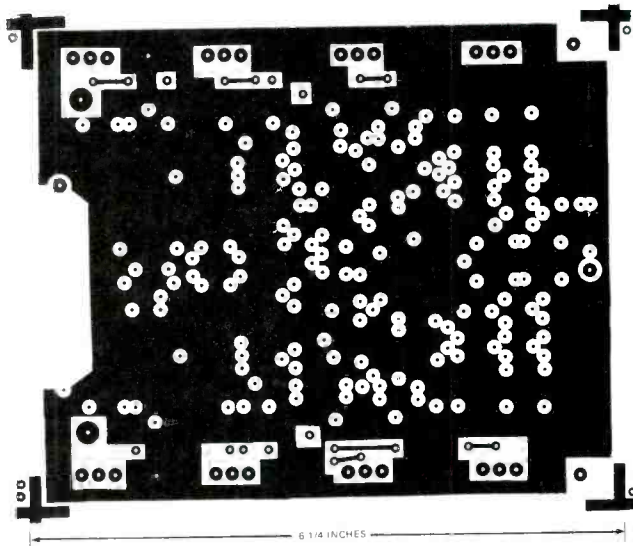

FIG. 6—THE COMPONENT SIDE of the amplifier board is mainly used as a ground plane.

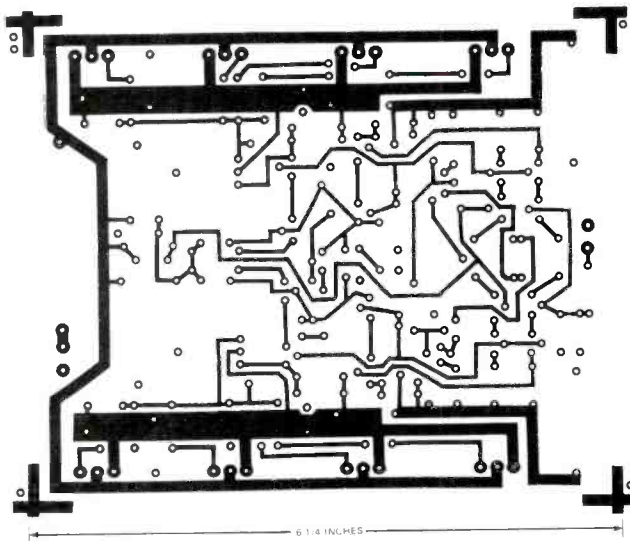

FIG. 7—THE SOLDER SIDE of the amplifier board. Remember that you need one board for each channel.

etched, pre-drilled, and plated-through boards are available; see the Parts List for information. If you *do* want to etch your own boards from the patterns shown, keep in mind that the board uses plated-through holes. You can, of course, get around that by soldering some of the components, including the output transistors, on both sides of the board. Note that the wiring to the output transistors is incorporated in the PC-board layout. That keeps the wire lengths to the output devices to a minimum. (It also simplifies construction by eliminating 48 wires, reducing the chance of error in that particularly critical area!)

Before we begin with the construction details, we should point out that the values shown in the schematic are for 1%-tolerance resistors. For most applications, it is not essential that you use such parts. Thus, the parts list also shows acceptable values for 5%-tolerance resistors. (One source for 1% resistors is Digi-Key Corpo-

ration, Highway 32 South, P.O. Box 667, Thief River Falls, MN 56701.)

Once you have your boards and components, you can begin construction by referring to the parts-placement diagram in Fig. 8 and by installing the fixed resistors. Check the values with an ohmmeter as you go, and be sure that the leads are sufficiently far from the ground plane!

Next, install capacitors, carefully checking values and ensuring that the polarized electrolytic types are properly oriented. Follow by installing the diodes, except for D3–D5. (Those three diodes mount on the output-transistor heat sink, and should not be installed yet.) Again, be careful of the polarity—the diode band indicates the cathode. Next, install the transistors (except for the output transistors Q21–Q28). Transistors Q19 and Q20 should be mounted with insulators and heatsink compound. (If you look closely at Fig. 9, you'll see some heatsink

compound around those transistors.) Transistors Q12, Q13, Q15, and Q18 use TO-5-type heat sinks.

Adjust potentiometers R8 and R19 to their middle positions and install. (For R19, which is a multiturn potentiometer, you will need to use an ohmmeter.) You will have to make L1: Wind 15 turns of 16-gauge magnet wire on R42. Solder to the leads of R42, and install the assembly. The PC boards are now complete.

Preparing the heat sink

The Wakefield heat sinks that are used for the output transistors (see Fig. 10) were not chosen arbitrarily. Their design is almost 100% more efficient for natural convection applications than conventional designs of equivalent volume.

You can use other heat sinks but a minimum surface area of 800 square inches per channel is required. A flat-backed heat sink is desirable for the TO-220 package, but is not essential.

The Wakefield type 512 is available in a 14-inch long extrusion, which needs to be cut in half to yield the two 7-inch pieces called for. After you cut it, drill holes for the output transistors according to the layout shown in Fig. 11. To keep the transistor-mounting hardware to a minimum, you might want to drill and tap the heat sink. However, screws with nuts may also be used. The optional over-temperature sensor and thermal-compensating diodes D3–D5 should also be glued to the heat sink as shown in Fig. 11.

If you have a confined-space application, you can mount the two heat sinks back to back; they will then readily accept a muffin fan for forced convection. For home applications, however, we recommend natural convection—to eliminate the noise, filter, and/or temperature-sensing aspects typically associated with fans. We should make a final note that wiring length should be kept to a minimum, with less than 2 inches from transistor to PC board. Even with that length, a ferrite bead is necessary on each gate lead, and using coaxial cable is recommended.

Preparing the chassis

The design and construction of a chassis for the amplifier is not critical. The author's prototype was built with rack mounting in mind. It consists of an 8 × 17 inch bottom plate with 1 inch turned up at the front and back. The front plate is 19 × 17 inches. As shown in Fig. 10, the two heat sinks mount on the back of the unit, leaving a 2½ × 7-inch strip for a small plate where the input and output jacks and fuses are mounted. Finally, an 8¼ × 31-inch U-shaped piece of perforated metal makes up the cover.

Begin mounting the components with the transformer, bridge rectifier, filter capacitors, and fuse-holders. Then, mount the power switch, pilot lights, and level

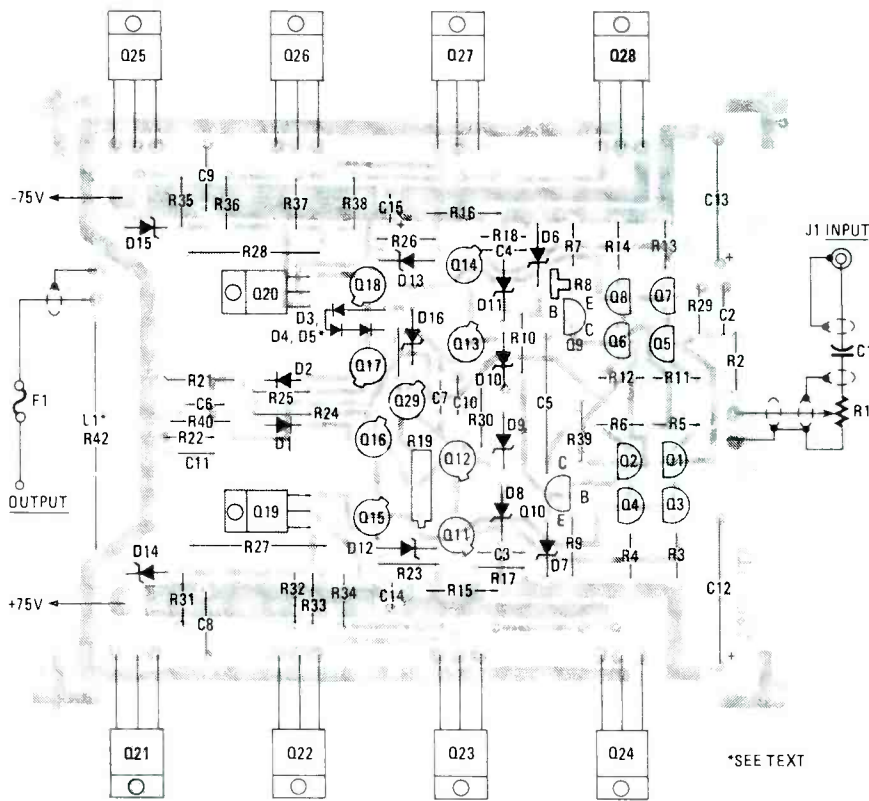

FIG. 8—PARTS-PLACEMENT DIAGRAM for the amplifier board. Refer to the text for information on mounting the output transistors (Q21-Q28) on a heat sink. Note that the pin labels for Q9 and Q10 are correct, but do not correspond to the package outlines shown. Be careful when installing them.

during subsequent tests.

Locate a suitable single-point ground, such as a screw through the bottom of the chassis near the power supply, and attach the filter capacitors' common power-supply ground to it. If you use a 3-wire power cord, do not ground or terminate the cord's ground lead.

Checkout procedures

The amplifier checkout is by far the most important part of building this amplifier, so, shift into low gear and **proceed with great care through the following steps!**

First we strongly advise you to make a final visual check of all parts placements on the circuit boards and the power-supply wiring. Then, before applying any power, measure each supply terminal with an ohmmeter to ground. An initial low reading should slowly move up to high resistance as the capacitors charge. Install the main power fuse and, with the DC fuses F2-F5 not installed, apply power. Check the two supplies for ± 75 volts. Remove power, and discharge the filter capacitors through a 1K resistor.

Next, install a pair of ¼-amp fuses for F2 and F4. Measure the resistance from each power-supply input to ground on

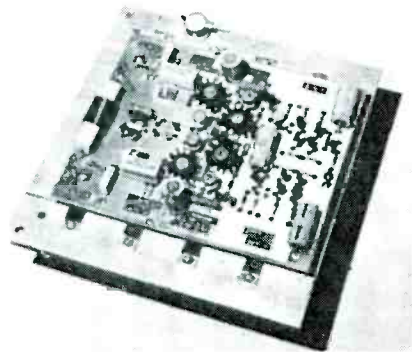

FIG. 9—AMPLIFIER BOARD is shown here mounted on heat sink. Note that Q12, Q13, Q15, and Q18 use TO-5 type heat sinks.

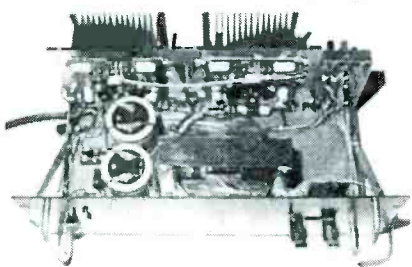

FIG. 10—COMPLETE STEREO AMPLIFIER with cover removed. The chassis configuration is not at all critical.

controls on the front panel.

Next you'll have to make up a suitable mounting plate and install output jacks that are insulated from their mountings. Install the input-fuse holder and the power cord with a strain relief. Then wire the

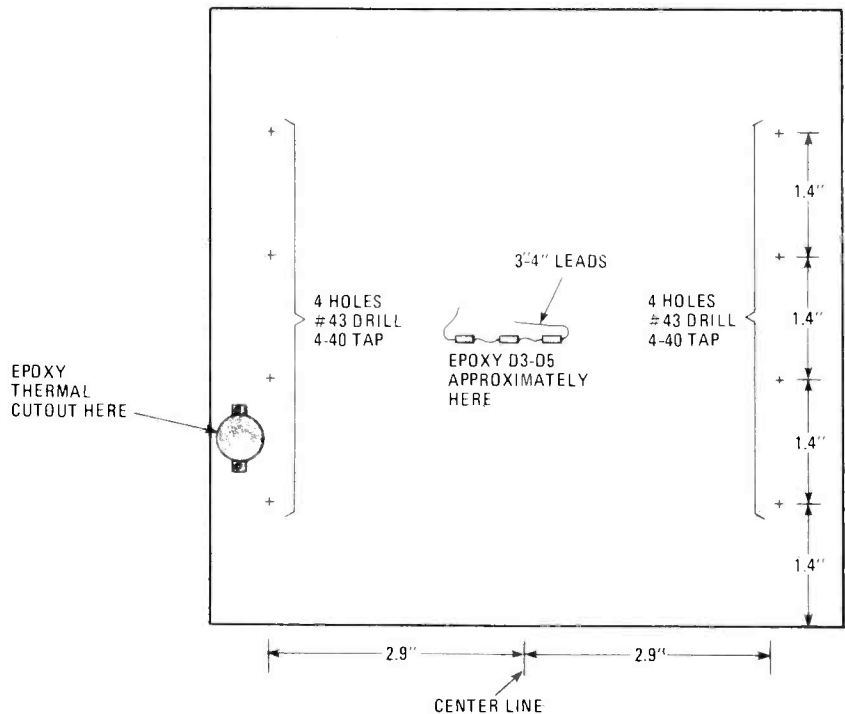

FIG. 11—HEAT-SINK DRILLING GUIDE. Note that some parts are fastened with epoxy to the heat sink.

transformer primary and secondary as shown in the schematic. If you plan to use the optional thermal cutouts, leave a pair of wires to go to the heat-sink area. Use 18-gauge (minimum!) wire in the power supply. We recommend that you use some simple color code for the DC wiring—it will help reduce the possibility of errors

both driver boards. The reading should be greater than 100K. If it is, temporarily connect one board to F2, F4 and ground. Connect a clip-lead from the collector of Q4 to the collector of Q3. Connect another clip-lead from the collector of Q7 to the collector of Q8. Temporarily clip-lead D3, D4, and D5 into the circuit. Apply

power, and measure the voltage between the bases of Q16 and Q17. It should be near 7 volts. Adjust R19, and observe this voltage changing. Leave it at 6.8 volts. Measure the voltage from the emitter of Q19 to the +75-volt supply, and the voltage from the emitter of Q20 to the -75-volt supply. The sum of the two voltages should be about 6.5 volts. Remove power, discharge the filter capacitors, remove clip leads, and repeat with the other driver board.

Next, solder the output transistors to the driver board. Note that it is important that the transistors be matched (within each particular type) so that they will share the output current equally. A simple circuit for checking the matching is shown

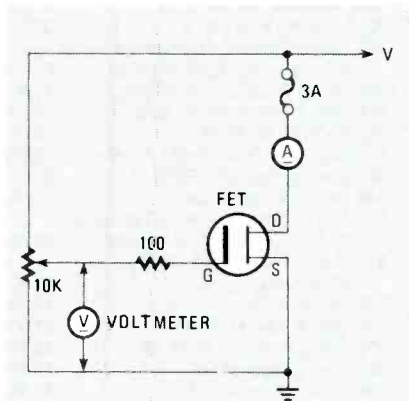

FIG. 12—TO CHECK THE MATCHING OF TRANSISTORS, you might want to use this simple circuit. Start by setting the potentiometer's wiper voltage to zero. Then turn it up to the desired drain current and measure the voltage as shown. For N-channel devices (IRF630), V should be +5 volts. For P-channel devices (IRF9630), V should be -5 volts.

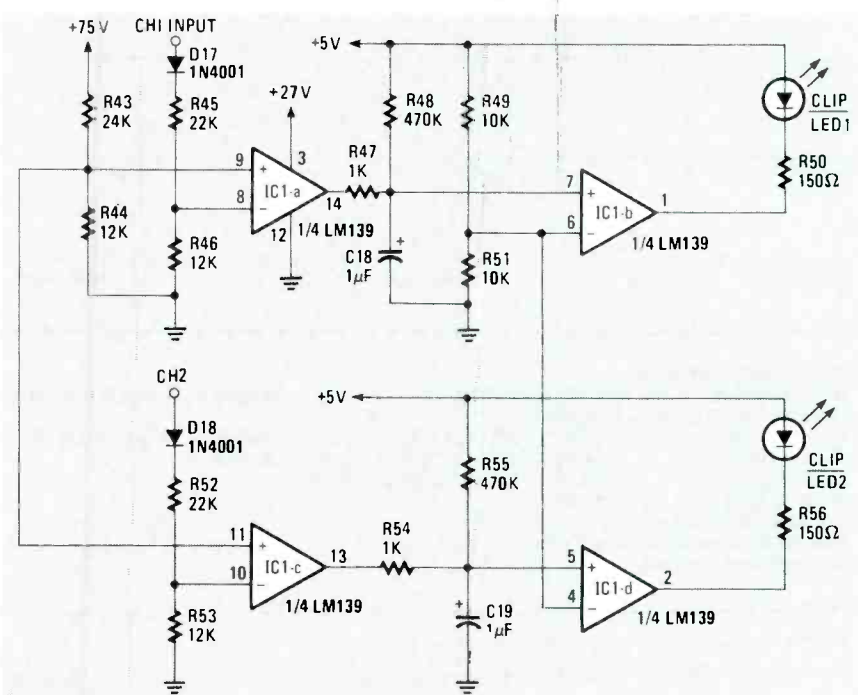

FIG. 13—CLIPPING INDICATORS can be added to your amplifier, if desired.

PARTS LIST—BARGRAPH DISPLAY and CLIPPING INDICATORS

All resistors are 1/4 watt, 5%, unless otherwise specified.

- R43—24,000 ohms
- R44, R46, R53—12,000 ohms
- R45, R52, R70—22,000 ohms
- R47, R54—1000 ohms
- R48, R55—470,000 ohms
- R49, R51, R58, R59, R61, R62—10,000 ohms
- R50, R56—150 ohms
- R57, R60—53,000 ohms
- R63, R65—1200 ohms
- R64, R66—7500 ohms
- R67—350 ohms, 20 watts
- R68—15,000 ohms
- R69—2200 ohms, 5 watts

Capacitors

- C18, C19—1 μ F, 10 volts, electrolytic
- C20—2.2 μ F, 10 volts, electrolytic

Semiconductors

- IC1—LM139 Quad op-amp
- Q30—ECG291
- D17, D18—1N4001
- D19, D20—1N4741A 11 volts, 1-watt, Zener
- D21—1N4735A 6.2 volts, 1 watt, Zener
- D22—1N4744A 15 volts, 1 watt Zener
- D23—1N4750A 27 volts, 1 watt, Zener
- LED1, LED2—Standard red LED
- DISP1, DISP2—NSM39158 logarithmic bargraph display with driver (National)

Other components

- S2, S3—SPDT

The following items are available from A&T Labs, Box 552, Warrenville, Illinois, 60555: Etched, drilled, plated-through PC boards, \$25 each; Power transformer, \$74 each; Set of 8 matched power FET's, \$48; Drilled heatsink (Type 512), \$27. Add 5% shipping and handling, 12% for transformer. Illinois residents include 6.75% sales tax. Shipping 5% higher in Canada and outside U.S.A.

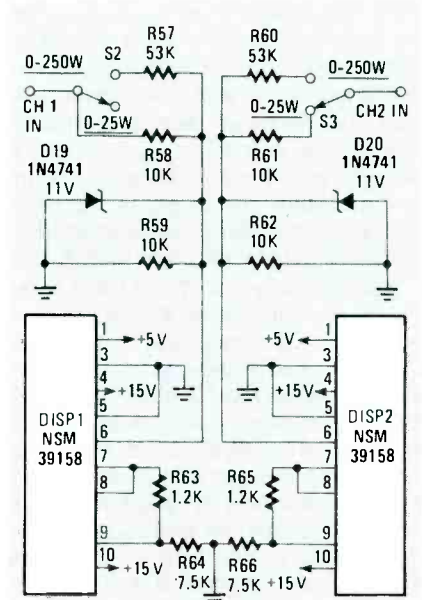

FIG. 14—BAR-GRAPH POWER METERS will certainly make a nice addition to any stereo amplifier.

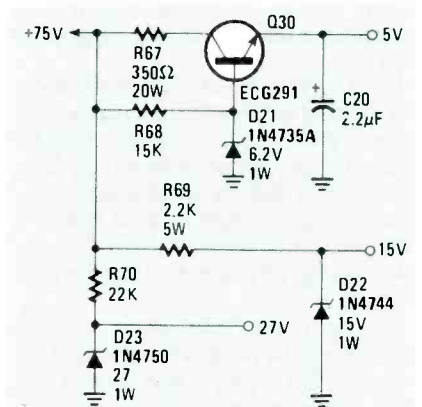

FIG. 15—THIS POWER SUPPLY is needed if the clipping indicators and bar-graph power meters are added. Note that Q30 requires a 10-watt heat sink.

in Fig. 12. They should be matched to be within 100 millivolts of gate voltage at 50 mA of drain current and 200 millivolts of gate voltage at 2 amps of drain current. Make the 2-amp measurement quickly, or with the transistor heat-sinked.

To mount the transistors, first bend the leads up at a 90-degree angle right at the point where their width changes. Spread the leads a bit and insert in board. Solder carefully while aligning the transistors as much as possible in a common plane. (They may temporarily be screwed to the heat sink as a holding fixture for this operation.) Solder short leads from D3-D5 to the bottom of the driver board, carefully observing polarity. Apply heat-sink compound and insulators to the transistors, and screw the driver and output-transistor assembly to the heat sink, using insulating shoulder washers. Tighten carefully.

Measure each transistor's tab (or case, if you are using TO-3's) to the heatsink. The readings should all be infinite, indicating no insulator shorts. (If you are using

TO-3 output parts, it will be necessary to run individual leads to each transistor. When doing that, be extremely cautious: Double-check all your connections and keep your leads as short as possible. Don't forget to install a ferrite bead on each gate lead if you are using TO-3's. In no case should the wiring to the transistors be more than 2 inches in length.) Install the heatsink and driver assemblies.

Wire on channel to F2 and F4 with 18-gauge (minimum) wire. Connect a wire from the circuit board ground, near the output, to the chassis single-point ground. Install a 1/2-amp fuse for F2, and a milliammeter for F4. Apply power, and check for a current through F3 of less than 500 mA. Also check that the output voltage at L1 is between ± 1 volt. If either of those tests fail, immediately turn off power, and look for the source of the problem before proceeding. Adjust R19 to set the current to about 200 mA, corresponding to an output idle current of about 150mA. Next, adjust R8 carefully to bring the output voltage at L1 as close as possible to zero. Turn off the power, and repeat for the second channel, using fuse positions F4 and F5.

Upon completion of those initial tests, finish wiring the remainder of the chassis. Run at least 18-gauge wire from each driver-board output, along with a ground from the board to the output binding posts. Shielded cable should be used from the level controls to the input jacks. The input-coupling capacitors mount at the level controls.

For continuous full-power applications, it will be necessary to use 5-amp fuses for F2-F5, and 8-amp output fuses for F1. However, for normal, or even loud general listening situations, it is advisable to use much smaller fuses to protect the speakers. It is usually sufficient to use 2-amp supply and 1- or 2-amp output fuses, and work up from there if necessary.

You may want to add clipping indicators and/or bar-graph power meters to your amplifier. The clipping indicator is shown in Fig. 13, the power meter, in Fig. 14, and the power supply needed for the two additions is shown in Fig. 15. **R-E**

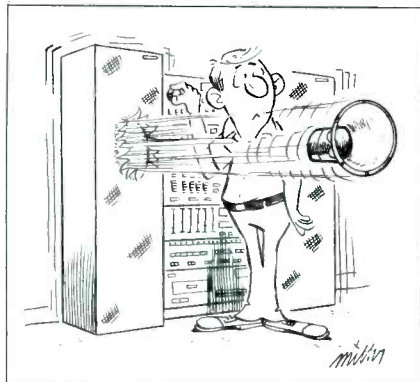

- | | |
|--|--|
| <input type="checkbox"/> 126 Radio-Electronics Annual 1986 \$6.00 | <input type="checkbox"/> SP8 Special Projects #8 \$6.00 |
| <input type="checkbox"/> 125 Radio-Electronics Annual 1985 \$6.00 | <input type="checkbox"/> SP6 Special Projects #6 \$6.00 |
| <input type="checkbox"/> 210 Radio-Electronics (1990 back issues) .. \$3.50 | <input type="checkbox"/> SP5 Special Projects #5 \$6.00 |
| <input type="checkbox"/> 109 Radio-Electronics (1989 back issues) .. \$3.75
(April not available)
Write in issues desired _____ | <input type="checkbox"/> SP4 Special Projects #4 \$6.00 |
| <input type="checkbox"/> 108 Radio-Electronics (1988 back issues) .. \$4.00
Write in issues desired _____ | <input type="checkbox"/> SP1 Special Projects #1 \$7.00 |
| <input type="checkbox"/> 107 Radio-Electronics (1987 back issues) .. \$4.50
(January, February not available)
Write in issues desired _____ | <input type="checkbox"/> EH90 Experimenters Handbook (1990) .. \$4.00 |
| <input type="checkbox"/> 106 Radio-Electronics (1986 back issues) .. \$5.00
Write in issues desired _____ | <input type="checkbox"/> EH87 Experimenters Handbook (1987) .. \$5.00 |
| <input type="checkbox"/> 105 Radio-Electronics (1985 back issues) .. \$5.50
(January, February not available)
Write in issues desired _____ | <input type="checkbox"/> HH89 Popular Electronics Hobbyist Handbook \$4.50 |
| <input type="checkbox"/> 104 Radio-Electronics (1984 back issues) .. \$5.75
(December, February not available)
Write in issues desired _____ | <input type="checkbox"/> EH88 Experimenters Handbook (1988-89) \$4.50 |
| <input type="checkbox"/> 220 Popular Electronics (1990 back issues) \$3.50 | |
| <input type="checkbox"/> 119 Popular Electronics (1989 back issues) \$3.75
Write in issues desired _____ | |
| <input type="checkbox"/> 118 Hands-On Electronics (1988 back issues) \$4.00
Write in issues desired _____ | |
| <input type="checkbox"/> 117 Hands-On Electronics (1987 back issues) \$4.50
Write in issues desired _____ | |
| <input type="checkbox"/> 116 Hands-On Electronics (1986 back issues) \$5.00
Write in issues desired _____ | |
| <input type="checkbox"/> 115A Hands-On Electronics #6 \$5.50 | |
| <input type="checkbox"/> 115 Hands-On Electronics #5 \$5.50 | |
| <input type="checkbox"/> 114 Hands-On Electronics #4 \$5.50 | |
| <input type="checkbox"/> 113 Hands-On Electronics #3 \$5.50 | |
| <input type="checkbox"/> 112 Hands-On Electronics #2 \$5.50 | |
| <input type="checkbox"/> 111 Hands-On Electronics #1 \$6.00 | |
| <input type="checkbox"/> SP10 Special Projects #10 \$6.00 | |

- | | | |
|--|-----------------|-----------------|
| | REPRINTS | REPRINTS |
| <input type="checkbox"/> 169 Think Tank (133 Circuits) | \$3.50 | |
| <input type="checkbox"/> 169A Think Tank Vol. 2 | \$3.00 | |
| <input type="checkbox"/> 168 Fact Cards (#34-66) | \$4.00 | |
| <input type="checkbox"/> 168C Fact Cards (#67-99) | \$3.50 | |
| <input type="checkbox"/> 168D Fact Cards (#100-132) | \$3.50 | |
| <input type="checkbox"/> 167 Designing With IC's | \$4.00 | |
| <input type="checkbox"/> 166 Collected Works of Mohammed Ulyses Fips
(62 pages, April Fools Collection) | \$7.50 | |
| <input type="checkbox"/> 165 How to Repair CD Disc Players | \$5.00 | |
| <input type="checkbox"/> 164 Modern Electrics (April 1908) | \$3.00 | |
| <input type="checkbox"/> 163 Receiving Satellite TV | \$5.00 | |
| <input type="checkbox"/> 162 Build Your Own Satellite TV Receiver | \$5.00 | |
| <input type="checkbox"/> 161 Descrambling (Feb., 1984) | \$3.00 | |
| <input type="checkbox"/> 160 New Ideas - 42 Circuits | \$3.50 | |
| <input type="checkbox"/> 159 Low Frequency Receiving Techniques
Building and using VLF Antennas | \$5.00 | |
| <input type="checkbox"/> 158 Electro Importing Co. Catalog
(Circa 1918) | \$5.95 | |
| <input type="checkbox"/> 157 All About Kits | \$2.00 | |
| <input type="checkbox"/> 156 How To Make PC Boards | \$2.00 | |
| <input type="checkbox"/> 155 IBM Typewriter To Computer | \$2.00 | |
| <input type="checkbox"/> 154 How To Repair VCR's | \$3.50 | |
| <input type="checkbox"/> 150 Pay TV Decoder (1981) | \$3.00 | |

To order any of the items indicated above, check off the ones you want. Complete the order form below, include your payment, check or money order (DO NOT SEND CASH), and mail to **Radio-Electronics**, Reprint Department, P.O. Box 4079, Farmingdale, NY 11735. Please allow 4-6 weeks for delivery.

If you need a copy of an article that is in an issue we indicate is unavailable you can order it directly from us. We charge 50¢ per page. Indicate the issue (month & year), pages and article desired. Include payment in full, plus shipping and handling charge. Make checks payable to Gernsback Publications, Inc.

ARTICLE _____		
PAGES _____	MONTH _____	YEAR _____
TOTAL PAGES _____	@50¢ each	TOTAL PRICE _____

MAIL TO: **Radio-Electronics**
Reprint Bookstore, P.O. Box 4079, Farmingdale NY 11735

SHIPPING CHARGES IN USA & CANADA

\$0.01 to \$5.00	\$1.25	\$30.01 to 40.00	\$5.00
\$5.01 to \$10.00	\$2.00	\$40.01 to 50.00	\$6.00
\$10.01 to 20.00	\$3.00	\$50.01 and above	\$7.50
\$20.01 to 30.00	\$4.00		

Total price of merchandise \$ _____
Sales Tax (New York State Residents only) \$ _____
Shipping Charge (see chart) \$ _____

Name _____ Total Enclosed \$ _____
Address _____
City _____ State _____ Zip _____

All payments must be in U.S. funds
SORRY — We only ship to USA & Canada



WHERE TECHNICIANS AND ENGINEERS once tested products on work benches surrounded by test equipment and a maze of cables and wires, they now connect the product to Automatic Test Equipment (ATE), press a button, and have a cup of coffee. Companies build ATE in all sizes and complexities, in both off-the-shelf and customized versions. The advent of ATE has revolutionized electronics troubleshooting.

A typical ATE approach

Figure 1 is a block diagram of a typical piece of ATE. It contains:

- A computer to control the test cycle, which can be a micro, mini, mainframe, or dedicated processor. The computer controls ATE over a bus, most often the *General Purpose Interface Bus (GPIB)*, although *RS-232C*

A T E AUTOMATIC TEST EQUIPMENT

ALLAN C. STOVER

Automatic test equipment is revolutionizing electronic testing and troubleshooting

and others are sometimes used. Some HP computers use a 16-bit parallel version called *GPIO*, very useful for in-house test panels. (See *Radio-Elec-*

tronics, July 1988, "General-Purpose Interface Bus".)

- A controller to sequence through test steps, control test equipment and the

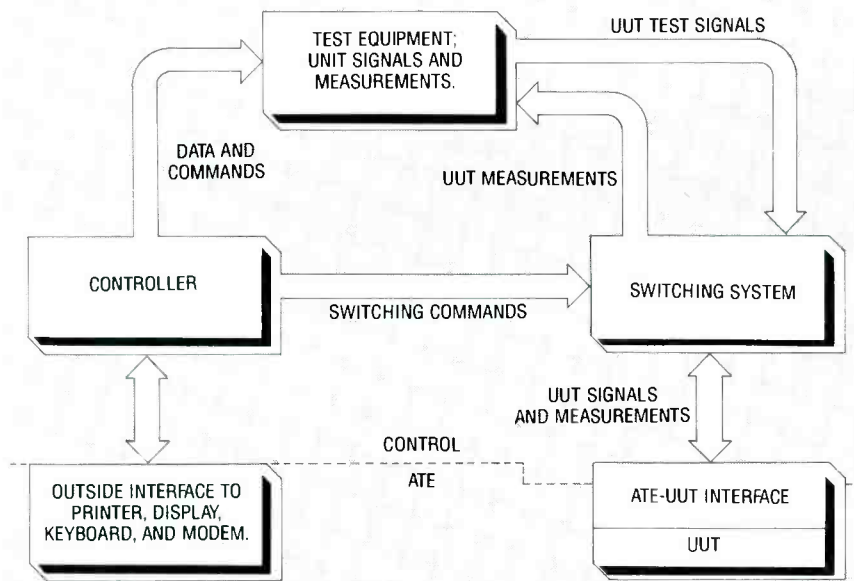

FIG. 1—A TYPICAL ATE BLOCK DIAGRAM. The test equipment provides test signals to the UUT through the switching system and interface, and the results are routed through to the test equipment for measurement. The controller sequences through the test cycle, and controls the test equipment, switching system, and interfaces.

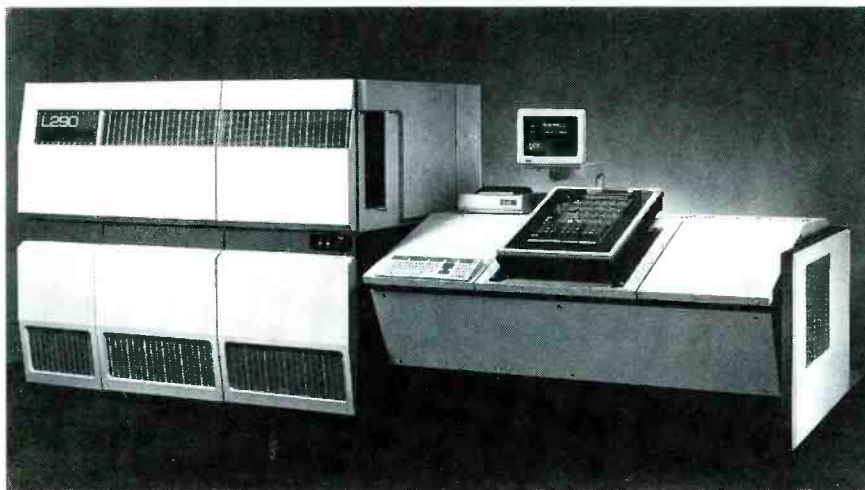

FIG. 2—TERADYNE L290 VLSI MODULE TEST SYSTEM. The test fixture with a UUT mounted on it is in the center of the operator console on the right. The console also contains a monitor, keyboard, printer, and analog and digital channel cards. The left console contains system and user power supplies, the DEC MicroVAX II, and analog instruments.

bus, read measurement results, perform calculations, and send results to a display or printer. Most "smart instruments" have memory and micro-processor control so an ATE controller can communicate via a bus, downloading computer programs to a smart instrument for use. While a controller is busy, a smart instrument can perform computations, and the controller can read the results later.

- A switching system to route signals between the *Unit-Under-Test* (UUT) and the rest of the ATE. The switching system might route UUT digital signals to an ATE panel, and video to a fre-

quency counter. Also, RF switches may route signals from a frequency synthesizer to the UUT input, then route UUT RF responses to a spectrum analyzer or power meter for measurement.

- Test equipment or circuitry to provide signals to the UUT and make measurements of UUT parameters. Most test equipment with GPIB capability can be used with ATE. Logic analyzers can analyze digital signals and provide results via GPIB, while spectrum analyzers and digital oscilloscopes can do the same for RF and analog signals. Also, RF generators and the function and pulse generators that modulate

them can also be controlled via GPIB.

- An operator interface like a keyboard, display, printer, host computer over a network, or switch array.
- An interface between the UUT and the ATE, like a cable, a test fixture with pins to touch test points on a PC board, a fixture with cooling air and UUT connector, component sockets, or some combination. The interface type depends on what's tested; in some ATE, drivers and sensors handle signals to and from the UUT. They often have *Random Access Memory* (RAM) to store the test patterns and UUT responses.

Types of ATE

There are versions available today for almost any electronic device. Some varieties may overlap two or more categories, while some may not fit any. The following types cover most versions:

- *In-Circuit Test* (ICT): This category can test PC boards for shorts, opens, continuity, and defective components. Some test only for shorts and opens, some only digital, and others both digital and analog. Most ICT memories have a component-characteristic library. The board is positioned on a "bed-of-nails" fixture, with an array of spring-loaded probes or pins connecting to test points on the board to test equipment, and the board is held down pneumatically, manually, or by vacuum. Sharp pins can penetrate coatings, while blunt pins make contact without damage. Drivers provide test signals, sensors measure responses, and RAM stores test patterns.

- *Functional test*: This variety tests signals at UUT inputs and checks for a correct response. Functional testers can test boards, assemblies, even entire systems. To test a board, the functional tester might input test signals at an edge connector, then check the response at the output pins on the same connector or a different one.

- *Hot mockup, or known-good system*: This incorporates an entire system known to be good (called a "gold" system). In testing a UUT subsystem, the known good one is removed, a questionable version is substituted, and the whole system is tested. If it passes, the UUT should be good because it operates as well as known good one. Hot mockup is most often built in-house, and can test only gold-system components. Since the

UUT may be far removed from system Input/Output (I/O), subtle faults may be missed, but it's economical and tests a UUT operationally.

- **Comparison test:** This compares a UUT and a gold unit of the same type, applying the same signals to both and comparing responses. If the UUT responses differ from those of the gold version, the UUT fails. A comparison test is economical because it avoids the need for large reference memory. The gold unit represents the correct response.

- **Component test:** This tests components ranging from VLSI and memory chips to resistors and capacitors. It's especially useful for digital devices, which use a myriad of high-speed test patterns.

A battle has been raging over functional versus ICT approaches. Functional supporters claim that a board can be tested only if signals are applied to simulate actual operating conditions, while ICT supporters claim that only individual components and subsections need be tested. Fortunately, many testers use both methods.

ATE software

Since ATE controllers manage test cycles, software is as important as hardware. Subtle software errors can result in passing defective UUT's. Since ATE uses computer-controlled hardware, a programmer must know the ATE, the UUT, and the commands and idiosyncrasies of the bus involved. An ATE processor uses the same instructions as in most computers for calculation, branching, and display. However, instructions that control hardware interfaces and bus devices, and that communicate with test equipment to read results are unique.

Many ATE manufacturers offer packages like component-characteristic libraries to keep prices competitive, since ATE software costs can exceed those of hardware. Interactive packages are also available to produce test programs from circuit data and test requirements provided by an engineer. Diagnostic software to locate UUT faults is also available. Many ATE systems have menu-driven hardware and software. Sometimes, ATE uses a "guided-probe" technique, where software guides a technician step by step, showing him which measurements to make.

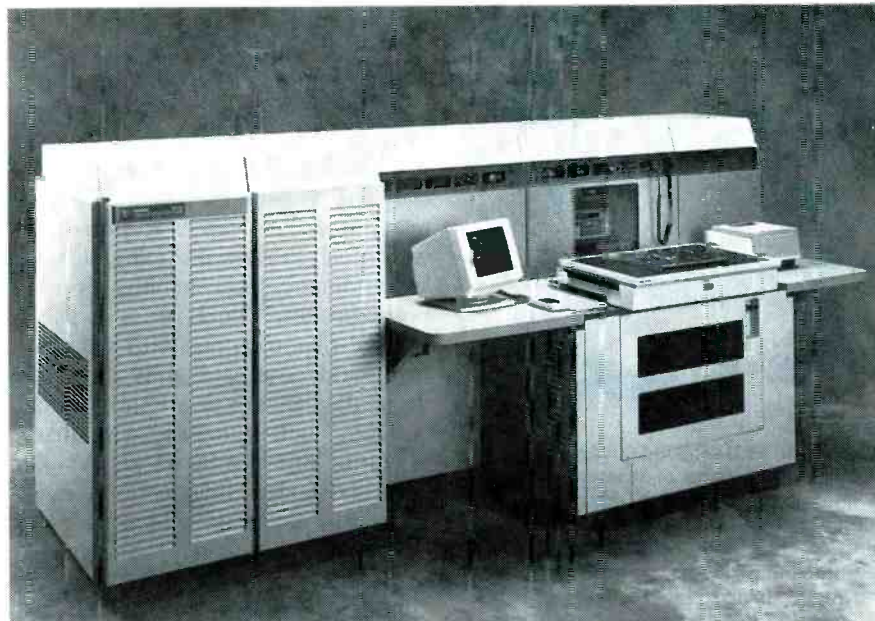

FIG. 3—GENRAD GR2282 BOARD TEST SYSTEM. The operator console with the UUT fixture is at left. The GR2282 performs ICT and functional testing of digital boards.

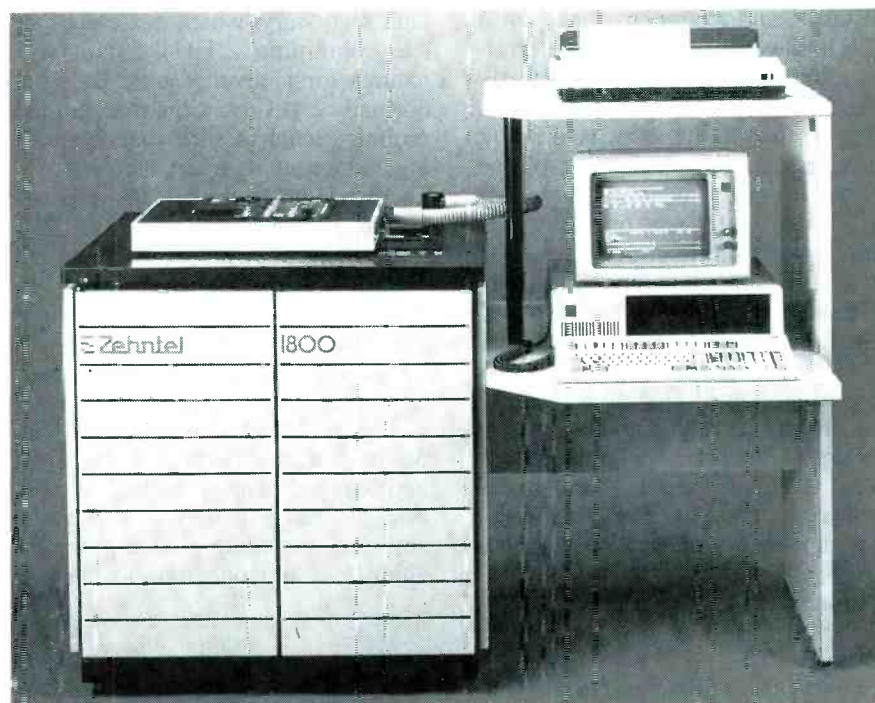

FIG. 4—ZEHNTEL 1800 BOARD TESTER. A PC serves as controller, and the UUT fixture is on the console at left. Note the vacuum hose to the right. The 1800 is prewired for 640 analog/digital test points.

While technicians may balk at taking orders from a computer, they'll find it operates more methodically and rapidly for routine problems. Computers fail when problems are no longer routine and require human judgment. Even that may no longer hold true when ATE successfully incorporates Artificial Intelligence (AI) for fault isolation. With AI, ATE hardware can learn from its own mistakes.

ATE pro and con

Any discussion of ATE must include justifications before spending money for it. Here are some common favorable arguments:

- **Speed:** ATE gives a significant increase in test speed, until the number and complexity of the tests tax it enough to slow it down. Also, speed is limited by test-equipment performance, which may operate slowly via a bus or require settling/setup time.



FIG.5—THE FLUKE 900 DYNAMIC TROUBLESHOOTER uses comparison testing as a low-cost alternative to isolate faults to the component level without programming or knowledge of a board. The 900 captures timing errors, intermittent faults, and static device failures, and performs dynamic ICT tests on each IC while operating.

- Quality: We're all human, make mistakes, and are inconsistent. Once ATE hardware and software are error-free, they can operate almost perfectly without many human errors. However, getting it that way is difficult because of the complexity and volume of the software, involving thousands of lines of code, any one of which may conceal subtle errors.
- Lifetime operating cost: Installing ATE may be expensive, but if it operates faster, makes fewer errors, and requires less operator experience, it'll be cost-effective. That doesn't mean that an organization doesn't need experienced technicians. Someone has to fix UUT's when ATE can't find a fault, or fix the ATE itself. The work, then, should be more interesting, because ATE has done most of the repetitious testing.

Today's ATE

Let's look at some current off-the-shelf ATE. Figure 2 shows the Teradyne L290 VLSI Module Test System. The UUT test fixture is in the middle of the console at right, and can use bed-of-nails, edge-connector, or test-socket interface modes. The console contains analog and digital cards. The L290 has room for up to 1152 bidirectional test channels. The console at left contains analog instruments, voltage references, power supplies, and any user-supplied test equipment. A DEC MicroVAX II computer is the system controller, operating dedicated processors on its Q-bus. All L290 test programs are writ-

ten in a variant of PASCAL.

A color monitor, keyboard, dot-matrix printer, and control console provide for human interaction, and an optional DECnet/Ethernet interface can link the L290 with other computers. The test-station console can rotate from 22.5 degrees to horizontal or vertical, to allow it to integrate with an automatic UUT handler or test-point prober. The L290 can use a guided-probe approach, where a hand-held, automatic probe examines the nodes leading to a failing output using a "fault signature" dictionary, operating at up to 80 MHz. When a fault is detected, diagnostic software is used to determine which nodes to probe in what order. The expected responses to the nodes can come from simulation software, or learned by the tester beforehand by probing good nodes manually.

Fault-simulation software uses a fault dictionary, which is a computer file containing a UUT's fault signatures for a given cause. Using it normally takes less time than guided probing, which requires manual probing and rerunning a test at each node. The two methods are often combined. Figure 3 shows a GenRad GR2282 Board Test System, which performs both ICT and functional testing on complex digital boards, also using a DEC MicroVAX II as system controller. Its software has a library of over 6,000 devices.

The GR2282 can handle up to 3,840 pins, each with 16K of driver and sensor memory behind it. The GR2282 has a variety of diagnostic software, including guided-probe diagnostics, and one routine that the

manufacturer calls BusBust automatically identifies a failing bus component without operator intervention. The GR2282 uses a device known as a Scratchprobe to allow an operator to distinguish between defective components and assembly failures (like broken foils, poorly soldered joints, and bent leads).

Figure 4 shows a Zehntel 1800 board tester, with 640 pins; this is a small, low-cost piece of ATE. The controller is a PC, using an MS-DOS spreadsheet environment. Test programs can be executed automatically; either a list of inputs to a given board is read in as a file of components and interconnections, or the configuration of a board is specified interactively. Both approaches generate a debugged test program and board input list. The 1800 has an expandable library of over 3,500 digital devices, tests for opens and shorts, and performs ICT of active and passive analog and digital devices. All of that adds up to a very thorough test.

Figure 5 shows the Fluke 900 Dynamic Troubleshooter, a low-cost alternative using comparison testing to isolate faults to the component level without programming or knowledge of a board. The 900 captures timing errors, intermittent faults, and static device failures, and performs dynamic tests on each IC while in-circuit and operating at speed.

Figure 6 shows a Locost 106 from Julie Research Laboratories, used for automatic calibration of test equipment and calibration standards like meters, precision dividers, resistance standards, platinum thermometers, and power supplies. The Locost 106 has precision DC/LF calibration standards under GPIB control of a PC or Hewlett-Packard 9826S desktop micro, reducing calibration times by 80% and minimizing operator error and the need for calibration experts to be present.

A variety of ATE is available to test almost anything. Each has hardware and software to test UUT's and perform diagnostics. It's worthwhile even for small companies, has revolutionized testing and troubleshooting, and is here to stay. You should understand that ATE, like most other things, isn't a panacea. However, it's a very powerful tool when used carefully by experienced technicians and engineers, and frees them to use their time more productively. R-E



FIG.6—THE JULIE RESEARCH LABORATORIES LOCOST 106. This version automatically calibrates test equipment and calibration standards. The desktop-computer controller is at top right.

Welcome to. . .

SCIENCE PROBE!®

The Amateur Scientist's Journal

Embark on an irresistible new journey into the realm of mystery, challenge, and exploration! The perfect magazine for the budding scientist, the serious amateur, the professional who would like to relax, and those who simply want to gaze at the stars.

Articles to appear in early issues of **SCIENCE PROBE!** are:

LIGHTNING—CAPTURE IT ON FILM
MONITORING ULTRAVIOLET FROM THE SUN
MOBILE-MOUNT EXPERIMENTAL WIND TUNNEL
CHECKING OUT ACID RAIN
AERIAL PHOTOGRAPHY FROM KITES AND BALLOONS
MINIATURE TRACKING TRANSMITTER
KILLER BEE IDENTIFICATION
HOW TO OBTAIN ANIMAL EYESHINE PHOTOGRAPHS

If you're fascinated by science in all its many forms, if you are compelled to experiment and explore, then **SCIENCE PROBE!** is your kind of magazine!

SCIENCE PROBE!

500-B Bi-County Boulevard
Farmingdale, NY 11735

EEHB

Please forward my Premier Edition of **SCIENCE PROBE!** as soon as it comes off the press. I am enclosing \$3.50-U.S.A. (\$3.95-Canada) plus \$1.00 for shipping and handling. Better still, please enroll me as a charter-member subscriber and send the next four (4) quarterly issues of *Science Probe*. I am enclosing \$9.95-U.S.A. (Canada: \$14.95 U.S.A. Funds)

Premier Edition only First Four Issues (1 Year)

Offers valid in the U.S.A. and Canada only. No foreign orders.

Name _____

Address _____

City _____

State _____

ZIP _____

All Orders payable in U.S.A. Funds only.

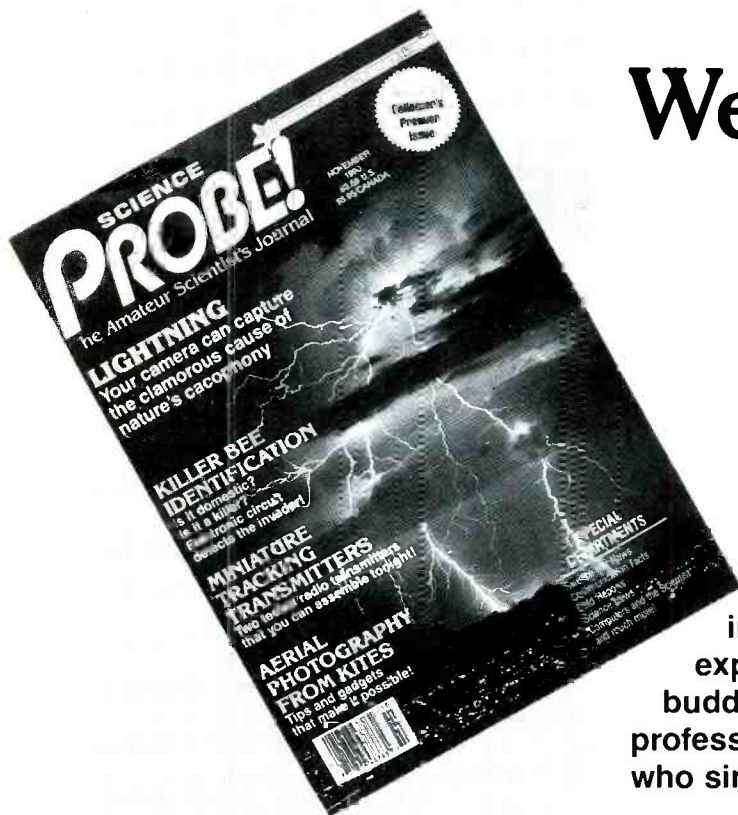

SCIENCE PROBE! — the *only* magazine devoted entirely to Amateur Scientists! If you are fascinated by science in all its many forms . . . if you can't stay away from a microscope, telescope, calipers, or test tube — we invite you to share the wonders in every issue of **SCIENCE PROBE!** You will join a community of Amateur and Student Scientists who enthusiastically seek scientific knowledge or follow scientific pursuits for their own sakes and not merely as a profession.

Obtain your personal *premier* edition of **SCIENCE PROBE!** by visiting a quality Newsstand, Convenience Store, or Supermarket this Fall or by reserving your personal copy through the mail by completing the coupon below.

From the very first issue of **SCIENCE PROBE!** you will be involved in a world of scientific facts, experiments, and studies pursued by amateur scientists who are university students, inventors, academicians, engineers, or office workers, salesmen, farmers—whose *quest* is to probe into the mysteries of science and reveal them to all.

Plan to become a **SCIENCE PROBE!** reader!

**ON SALE AT QUALITY NEWSSTANDS, CONVENIENCE STORES AND SUPERMARKETS
STARTING SEPTEMBER 13, 1990 — \$3.50-U.S.A. — \$3.95-Canada**

WHEN YOU THINK ABOUT HOME-SECURITY and alarm systems, probably the first things you think about are guarding windows, doors, and the perimeter of your property. That kind of protection is usually provided by opening or closing some kind of switch or breaking a light beam. However, sensors that are triggered by heat or light can be just as important to your personal safety. In this article we'll take a look at temperature-activated and light-activated alarms for the home, as well as burglar-alarm systems and immobilizer switches for cars or other kinds of vehicles.

HOME-SECURITY COOKBOOK

In this survey of electronic security and alarm systems we take a look at miscellaneous circuits for use in the home or car.

RAY MARSTON

Temperature alarms

Electronic temperature alarms can be used to indicate any one of the following conditions: over-temperature, under-temperature, temperature-deviation, or excessive temperature-differential. Some applications for electronic over-temperature alarms include using them as fire alarms, in a greenhouse, or a car or other vehicle. Electronic under-temperature alarms are used to indicate either a heating system failure, or the presence of frost and ice.

Temperature-deviation alarms are specialized devices that can sound an alarm whenever a temperature being monitored either exceeds or falls beneath some preset limit. Some useful domestic applications for this type of circuit include monitoring the temperature of tropical fish tanks or greenhouses.

Temperature-differential types of alarms are also specialized devices that are activated whenever the *absolute value* of the *difference* between two temperatures being monitored exceeds some preset limit. In this case, the actual individual values of the two temperatures are not involved in the circuit operation, only the magnitude of their difference. Temperature-differential alarms can be used in applications ranging from liquid level control and altimeters to solar heating systems.

Practical electronic temperature alarms can be built using a variety of different types of thermal sensors, including electromechanical thermostats, thermistors, or silicon diodes. Figure 1 shows a practical example of a simple, relay-aided fire or over-temperature alarm that is built using two electromechanical thermostats as temperature sensors.

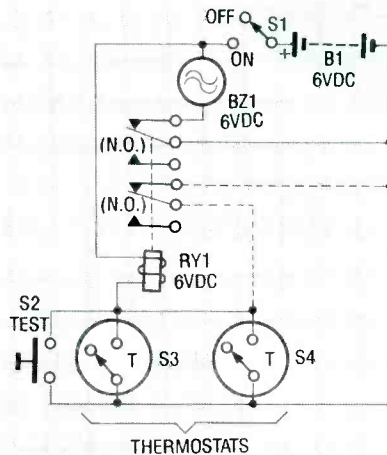

FIG. 1—A SIMPLE RELAY-AIDED fire or over-temperature alarm using thermostats S3 and S4 as temperature sensors.

Thermostats are typically Normally-Open (N.O.) temperature sensitive, SPST switches that are activated only when the temperature

of their internal bimetallic element exceeds some preset limit. Whenever both thermostats are less than the preset temperature limit, their switches remain open, in which case both relay RY1 and buzzer BZ1 are turned off, and no current flows.

When the temperature of either or both of the thermostats exceeds their preset trip values, RY1 and BZ1 are turned on, sounding an alarm. Any number of thermostats can go in parallel, and the circuit can be checked by closing S2. This type of circuit is normally made to be non-latching, but can be made self-latching by using a second set of contacts for RY1, connected as indicated by the dashed lines.

If the thermostats to be used with the temperature alarm are intended to go in normal living areas, they should

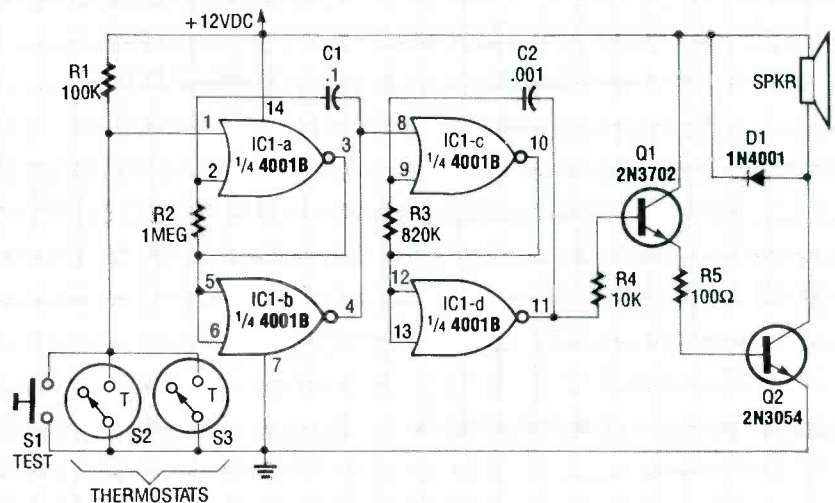

FIG. 2—AN 800-Hz PULSED-TONE FIRE alarm using thermostats S2 and S3 as temperature sensors.

be set to close at about 60–70°C (140–158°F). If the thermostats are supposed to go in fairly warm areas like furnace rooms or attics, they should be set to close at approximately 90°C (194°F).

Figure 2 shows an electronic fire or over-temperature alarm that generates an 800-Hz tone that's pulsed or gated on and off at 6-Hz. IC1-c and IC1-d are used as an 800-Hz astable multivibrator that is gated by IC1-b, and IC1-a and IC1-b are used as a 6-Hz astable multivibrator gated by the thermostats.

When both thermostats are open, the astable multivibrators are turned off, and approximately one microamp will flow in the circuit. When either or both thermostats close, the 6-Hz astable multivibrator made from IC1-a and IC1-b turns the 800-Hz astable multivibrator made from IC1-c and IC1-d on and off at 6 Hz. The operation is normally non-latching, and the pulsed tone stops whenever the thermostats re-open due to decreasing ambient temperature.

Thermistor-activated alarms

As a rule, thermostats respond rather imprecisely. A less expensive and more precise alternative is the thermistor, a semiconductor resistor with a Negative-Temperature-Coefficient (NTC). In an NTC component, resistance decreases with increasing temperature, implying a relatively high resistance at low temperatures, and a relatively low resistance at high temperatures.

Figures 3 and 4 show two practical versions of thermistor-controlled electronic temperature alarms. In each case, R6 can be any thermistor with a nominal value of approximately 5K and a variable range of approximately 1K–10K, at the desired operating temperature.

Figure 3 shows a precision thermistor-controlled electronic over-temperature alarm. The thermistor R6 controls IC1, a 741 op-amp, and transistor-driven relay RY1. In that case, IC1 is used as a voltage comparator, creating a temperature-dependent variable voltage on the non-inverting input (pin 3), which is compared with a fixed +6 volts DC on the inverting input (pin 2). The voltage on pin 3 is set to approximately equal to that of pin 2, which will rise as the temperature falls and fall as the temperature rises.

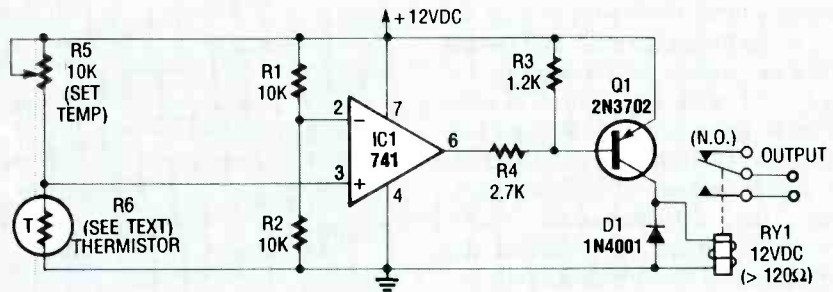

FIG. 3—A PRECISION OVER-TEMPERATURE alarm using thermistor R6 as a temperature sensor. To use that version as an under-temperature alarm, reverse the connections of pins 2 and 3 of IC1.

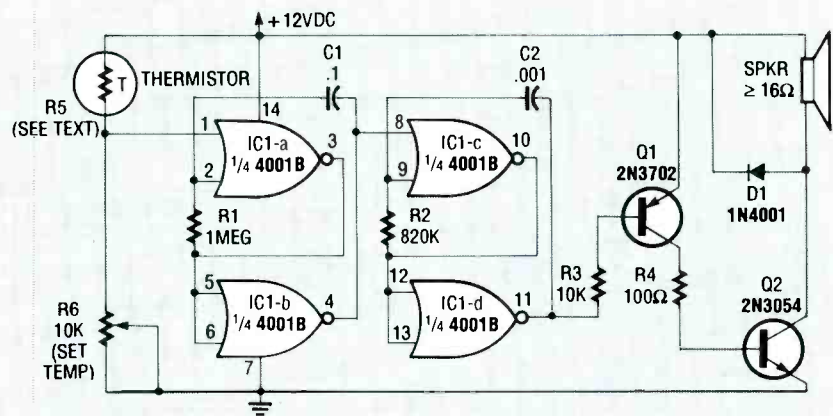

FIG. 4—AN 800-HZ PULSED-TONE under-temperature alarm using thermistor R5 as the temperature sensor.

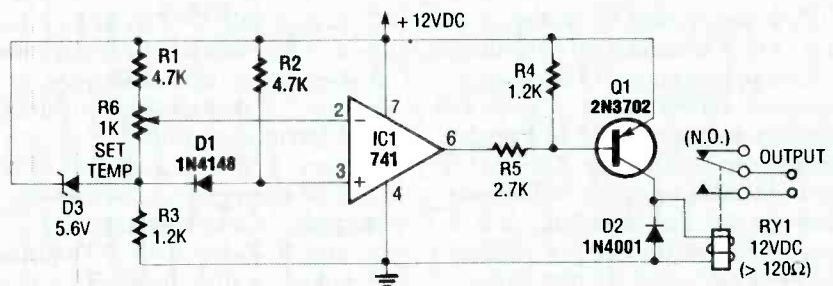

FIG. 5—AN OVER-TEMPERATURE ALARM WITH silicon diode D1 as the temperature sensor. To use that version as an under-temperature alarm, reverse the connections of pins 2 and 3 of IC1.

Whenever the temperature of R6 is beneath the alarm threshold temperature, the voltage on pin 3 exceeds the voltage on pin 2, and so the output, pin 6, saturates in the positive direction, going to +12 volts DC. As a result, both the base and emitter of Q1 are at approximately the same potential, and Q1 stays turned off, which keeps RY1 turned off.

As the temperature of R6 rises, the voltage on pin 3 falls, decreasing to the point where it's less than that of pin 2 at the threshold value. The output of IC1 then saturates in the negative direction, going to ground, which

turns on Q1 and RY1 in succession, sounding an alarm. Because IC1 has high voltage gain, RY1 can either be turned on or off by temperature variations of a fraction of a degree around the threshold, as set with R5. This action can be reversed to create a precision electronic under-temperature alarm by transposing the connections of pins 2 and 3 of IC1.

Figure 4 shows a thermistor-controlled 800-Hz pulsed-tone electronic under-temperature alarm. It is similar to the over-temperature version shown in Fig. 2. Again, IC1 is used as a dual-astable multivibrator pulsed-tone

generator turned on by the voltage on pin 1 going toward ground, and turned off by the voltage on pin 1 going toward +12 volts DC. Pin 1 is connected to the junction of R5 and R6, with a low voltage at low temperatures and a high voltage at high temperatures. Thus, the dual-astable multivibrator is turned on whenever the temperature of thermistor R5 falls beneath a value preset by R6, generating a pulsed tone.

In practice, the precise gating point

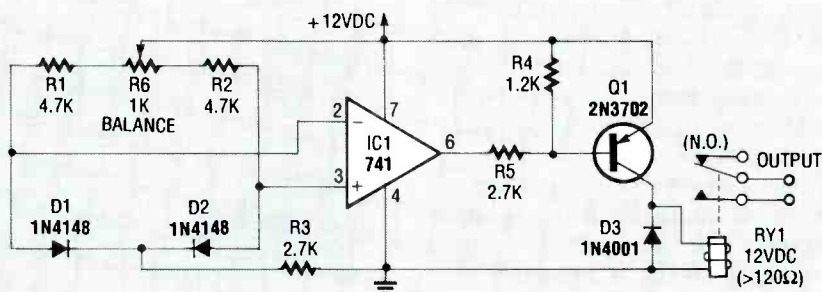

FIG. 6—DIFFERENTIAL-TEMPERATURE alarm using silicon diodes D1 and D2 as temperature sensors.

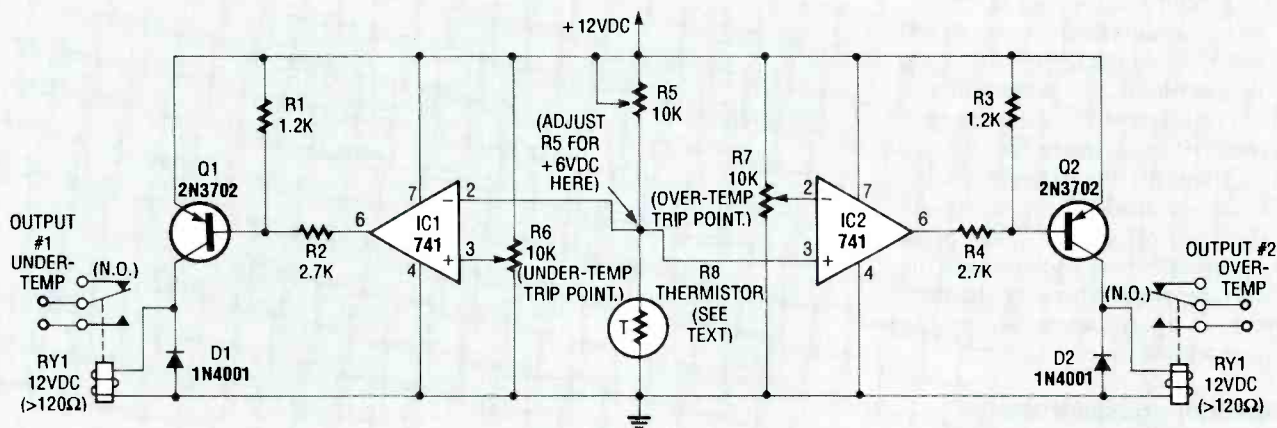

FIG. 7—TEMPERATURE-DEVIATION ALARM WITH independent over-temperature and under-temperature relay outputs, and thermistor R8 as the temperature sensor.

of IC1 is determined by its threshold value, which is some fixed percentage of the supply voltage. Consequently, the circuit shown in Fig. 4 turns on whenever the ratio of R5 to R6 goes beneath some exact value. The ratio of threshold value to supply voltage depends on the individual IC, but is independent of the supply voltage. The nominal value of that ratio is 50%, but it can range between approximately 30–70% for different IC's.

The circuit shown in Fig. 4 has excellent stability, and a sensitivity of approximately 0.5°C. The under-temperature trip point is preset by R6, and the circuit can also be used as an electronic over-temperature alarm by transposing the connections of pins 2 and 3 of IC1.

Diode-activated alarms

Silicon diodes make quite accurate and inexpensive sensors for electronic temperature alarms. They have a typical forward voltage drop of approximately 600 millivolts DC at 1 milliamp. If their current is constant, their forward voltage drop has an NTC

of -2 millivolts DC/°C. Most silicon diodes have similar thermal characteristics, while their small mass, as in the case of the 1N4148, ensures a rapid thermal response.

Figure 5 shows a 1N4148 diode used as a temperature sensor in an electronic over-temperature alarm. In this circuit, Zener diode D3 regulates the voltage across the R1-R6 voltage divider to 5.6 volts DC. A constant reference voltage is presented to pin 2 of IC1. A temperature-dependent voltage with an NTC of -2 millivolts DC/°C occurs across D1—for every degree C in that D1 increases, its forward voltage drop will be reduced by 2 millivolts DC. A differential voltage will then appear between pins 2 and 3 of IC1.

If the temperature dependent voltage across D1 exceeds the trip level set by R6, then RY1 turns on. Under that condition, a differential of 1 millivolt appears between pins 2 and 3, and both Q1 and RY1 turn on. Whenever the temperature of D1 goes beneath the trip level, the voltage on pin 3 goes above that of pin 2, driving the output of IC1 to positive saturation, turning

Q1 and RY1 off.

The circuit in Fig. 5 has a sensitivity of approximately 0.5°C, and can be used as an electronic over-temperature alarm from below zero to above the boiling point of water. Conversely, to use it as an electronic under-temperature alarm, simply transpose the connections of pins 2 and 3 of IC1 as before.

Finally, the circuit shown in Fig. 6 shows a pair of 1N4148 silicon diodes D1 and D2 used as temperature sensors in an electronic differential-temperature alarm. It turns on only when the temperature of D1 exceeds that of D2 by greater than some preset amount, and is not influenced by the absolute temperature of either diode.

Bias currents are fed to D1 and D2, setting up a differential voltage between pins 2 and 3 of IC1. A differential trip temperature of the circuit is then established. Once the trip temperature is set, the differential voltage is influenced only by the difference in temperatures between D1 and D2. The circuit has a sensitivity of approximately 0.5°C, and can handle temperature differentials of up to 10°C.

Temperature-deviation alarms

Electronic temperature-deviation alarms activate whenever a temperature being monitored deviates from a preset value by more than a specific amount. They are useful for tasks such as monitoring the temperatures of tropical fish tanks or greenhouses. The temperature-deviation alarms discussed here combine both over-temperature and under-temperature circuits, sharing one or two common relays.

Fig. 7 shows a temperature-deviation alarm using two independent relay outputs, RY1 and RY2. Thermistor R8 is a temperature sensing component with a resistance that varies from 1K–10K, and is nominally 5K at its middle trip-range temperature. In order to calibrate the under-temperature and over-temperature trip points, first adjust R5 so that +6 volts DC appears across R8, when the thermistor is at its nominal mid-range temperature. The next step is to decrease the temperature of R8 to the required lower-temperature trip value, and adjust R6 so that RY1 just turns on. Finally, increase the temperature of R8 to the desired upper trip value, and adjust R7 so that RY2 just turns on.

Fig. 8 shows a different version of a temperature-deviation alarm, which uses a single relay output RY1, and temperature sensing thermistor R6. Under-temperature and over-temperature trip points are calibrated by first adjusting R3 so that +6 volts appears across thermistor R6, when this component is at its nominal mid-range temperature. Then, decrease the temperature of R6 to the required lower-temperature trip value, and adjust R4 so that RY1 just turns on. The last step is to increase the temperature of R6 to the desired upper trip value, and then to adjust R5 so that relay RY1 just turns on.

Light-activated alarms

Electronic light alarms are designed to sound an alarm when light enters a darkened area such as the inside of a storeroom or wall safe, or when smoke interferes with the passage of light into a photocell. Several useful versions of electronic light alarms are shown in Figs. 9–12, all of them using a Light Dependent Resistor (LDR) as the sensor.

An LDR is a photocell that offers a relatively high resistance on the order

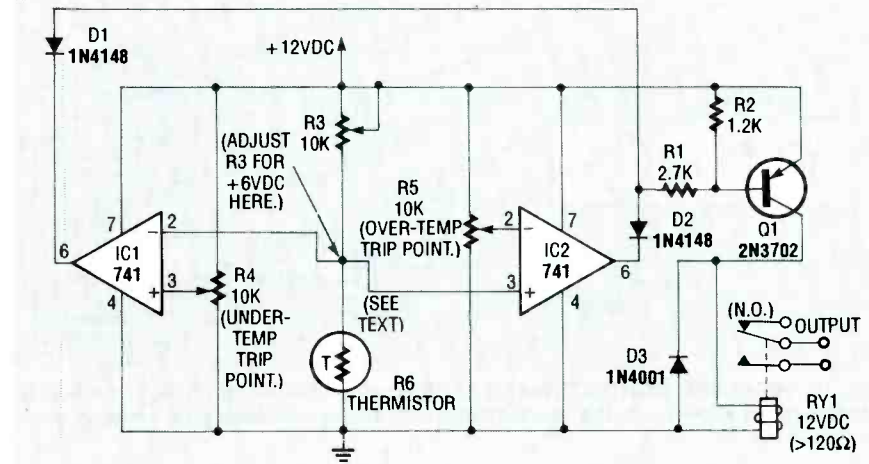

FIG. 8—TEMPERATURE-DEVIATION ALARM WITH single relay output, and the thermistor R6 as the temperature sensor.

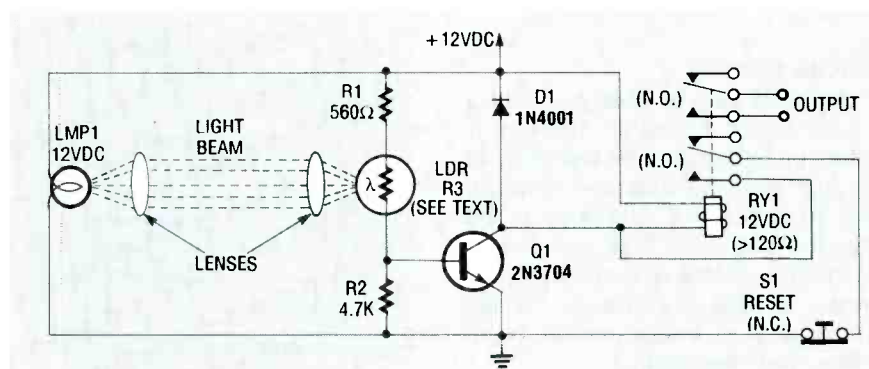

FIG. 9—SIMPLE SELF-LATCHING light-activated alarm, using Light Dependent Resistor (LDR) R3 as the light sensor.

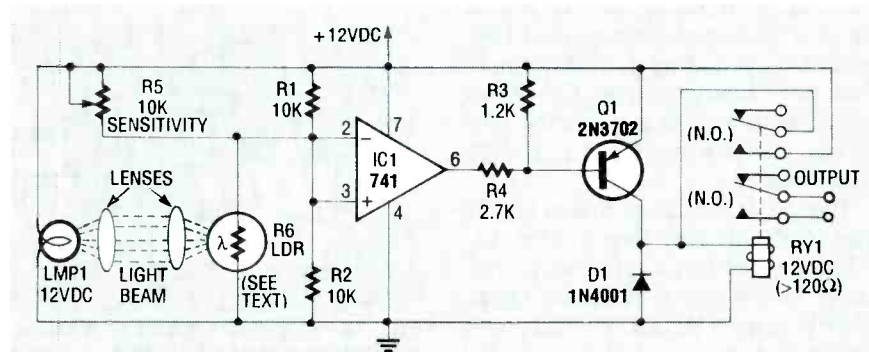

FIG. 10—LIGHT-BEAM SMOKE ALARM, using LDR R6 as the light sensor.

of hundreds of kilohms when in darkness, and a low resistance on the order of hundreds of ohms when illuminated. The several different types of electronic light-alarm circuits discussed here can use any general-purpose LDR with a face diameter of 3–12 mm.

Figure 9 shows one method to use an LDR in a simple, self-latching type of light-activated alarm. When the LDR R3 is in darkness, it has a very high resistance, resulting in Q1 and

RY1 being turned off. When the LDR is illuminated, its resistance significantly decreases, turning on Q1 which activates RY1 and sounds an alarm. The series combination of R3–R1–R2 acts as a voltage divider to bias Q1, with R3–R1 as the upper half, and R2 as the lower half.

One defect with that type of circuit is that it has a fairly low fixed sensitivity. Figure 11 shows an improved version of a light-activated alarm. Better temperature sensitivity and

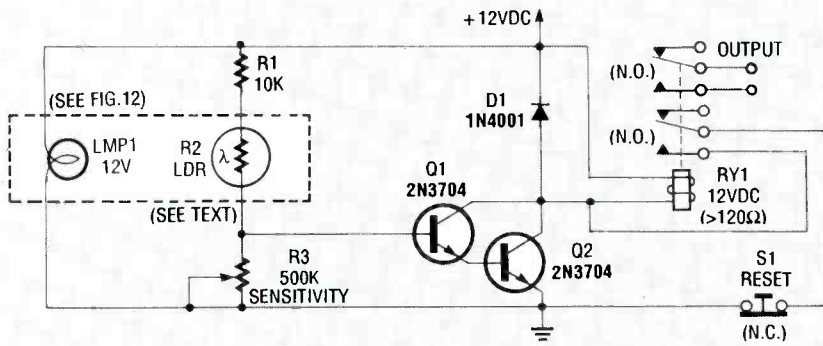

FIG. 11—IMPROVED LIGHT-ACTIVATED ALARM using LDR R2 as the light sensor. The modifications shown with the dashed lines refer to the reflection-type smoke detector shown in Fig. 12.

user adjustability is achieved in this circuit by replacing Q1 with a Darlington pair and using a variable 500K resistor R3 in place of R2.

Smoke alarms

An LDR can be used to build a smoke alarm by either light-projection or light-reflection methods. In the light-projection method shown in Fig. 10, a beam of light is projected onto the face of the LDR and its sensitivity is adjusted so that a small decrease in light level caused by the introduction of smoke into the beam will activate the alarm.

A somewhat more satisfactory and sensitive method is to use the reflective approach shown in Fig. 11. The presence of smoke actually *increases* the total light level reaching the LDR, instead of decreasing it. This example uses the Darlington pair Q1-Q2 as mentioned above to increase the sensitivity, and provides R3 to adjust the sensitivity.

The box in the dotted line in Fig. 11 refers to the drawing shown in Fig. 12. When the reflection-type smoke detector box is used, both the lamp, LMP1, and the LDR, R2, are mounted in an open-ended, light-excluding box, with an internal screen that prevents the light from LMP1 from falling onto R2. The heat from LMP1 convects air into the bottom of the box, and expels it from the top. The inside of the box is painted matte black; its construction permits air to pass through, but excludes external light.

If the convected air currents are smoke-free, no light will fall on R2, and its resistance will remain very high. If the air currents do contain smoke, the smoke reflects the light from LMP1 back onto R2, resulting in

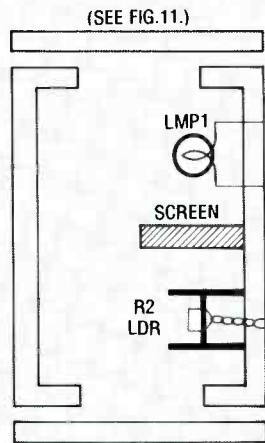

FIG. 12—SECTIONAL VIEW OF reflection-type smoke detector.

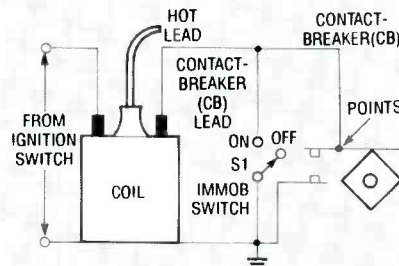

FIG. 13—CONTACT-BREAKER immobilizer switch in parallel with the contact-breaker points.

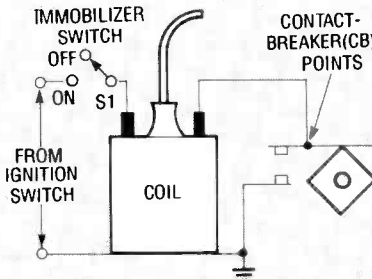

FIG. 14—IGNITION IMMOBILIZER switch wired in series with the contact-breaker points.

a decrease in resistance which is then detected. To use that version of electronic light alarm, simply replace the LDR with the assembly shown in Fig. 12, and add LMP1 as is indicated. All three versions of electronic light or smoke detector alarms shown in Figs. 9-11 can be made non-latching, if you prefer, by the use of a single-contact relay for RY1.

Car immobilizers

There are two basic types of electronic anti-theft devices for cars or other vehicles, the immobilizer switch and the burglar alarm. In this section, we'll discuss the advantages and disadvantages of different versions of car immobilizer alarms.

In the immobilizer version shown in Fig. 13, the immobilizer switch is wired in parallel across the contact-breaker points, thus it will work on any cars without electronic ignition. The switch disables the vehicle when it is closed, and provides excellent protection, especially if the wiring is well-concealed at the end of the switch that goes to the contact-breaker points.

Figure 14 shows an immobilizer switch in series with the ignition switch. The engine operates only when the switch is closed. More reliable protection is provided by the parallel switch connection because a skilled thief can bypass the immobilizer switch and ignition switch by connecting or "hot wiring" a jumper lead from the battery to the S1 terminal of the coil.

An immobilizer switch can be wired in series with the starter solenoid, as shown in Fig. 15, or in series with an electric fuel pump, as shown in Fig. 16. When the immobilizer switch is wired in series with an electric fuel pump, the thief can start the engine, but will only be able to drive it a short distance until the fuel pump stops operating. The only disadvantage to the method shown in Fig. 16 is that it works only for cars with electrical fuel pumps.

The flaw in the circuits shown in Figs. 13-16 is that they are manually operated, and will work only if the owner or operator of the car remembers to use it. By contrast, the immobilizer circuit shown in Fig. 17 turns on automatically when the engine is started using the ignition switch, but can be turned off by pressing a hidden push-button switch S1.

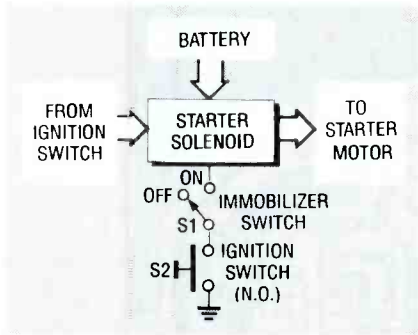

FIG. 15—STARTER-MOTOR immobilizer switch wired in series with the ignition switch.

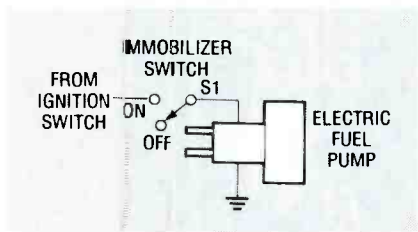

FIG. 16—FUEL-PUMP immobilizer switch wired in series with the electric fuel pump.

Car burglar alarms

An electronic burglar alarm for a car or other vehicle should sound an alarm and possibly immobilize the engine during or after a break-in. The electronic alarm system needs an ON/OFF switch which can be either internal or external to the car. However, if you make the switch internal, you will need a time delay to enable you to get in and out of the vehicle without sounding an alarm.

Electronic burglar-alarm circuits for cars that use internal ON/OFF switches tend to be complex, expensive, fairly unreliable, and give only poor protection at best, since thieves will usually have 15 seconds or more before an alarm will sound. The use of an external ON/OFF switch in an electronic burglar alarm is more efficient than an internal switch and provides excellent protection because it sounds an alarm the instant a door is opened.

One disadvantage of a common type of burglar alarm is that when it is activated, the horn and lights continue to operate until they are either turned off by the owner, or the battery goes dead. That limitation is overcome by using the type of burglar alarm shown in Fig. 18. Relay RY2 turns off automatically after approximately four minutes, as determined by the time constant $R1 \times C1$.

Finally, the version of vehicular

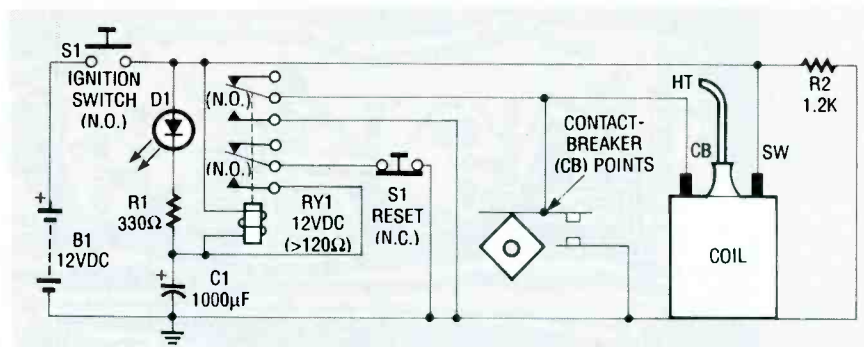

FIG. 17—SELF-ACTIVATING IMMOBILIZER switch circuit, for use with the contact-breaker points in a car.

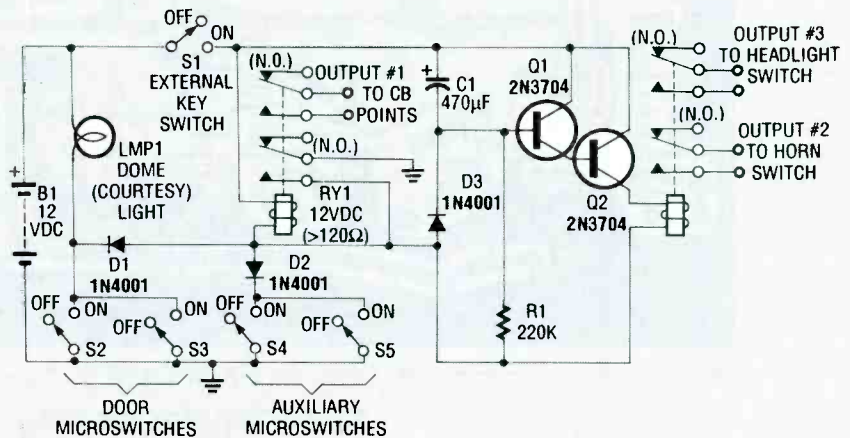

FIG. 18—MICROSITCH-ACTIVATED ANTI-THEFT burglar alarm system and immobilizer switch that turns the horn and lights on to sound an alarm, and then automatically turns them off after four minutes.

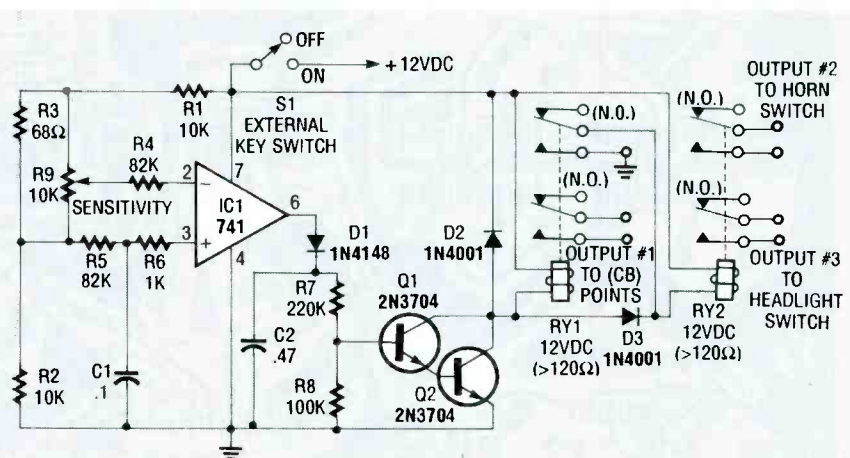
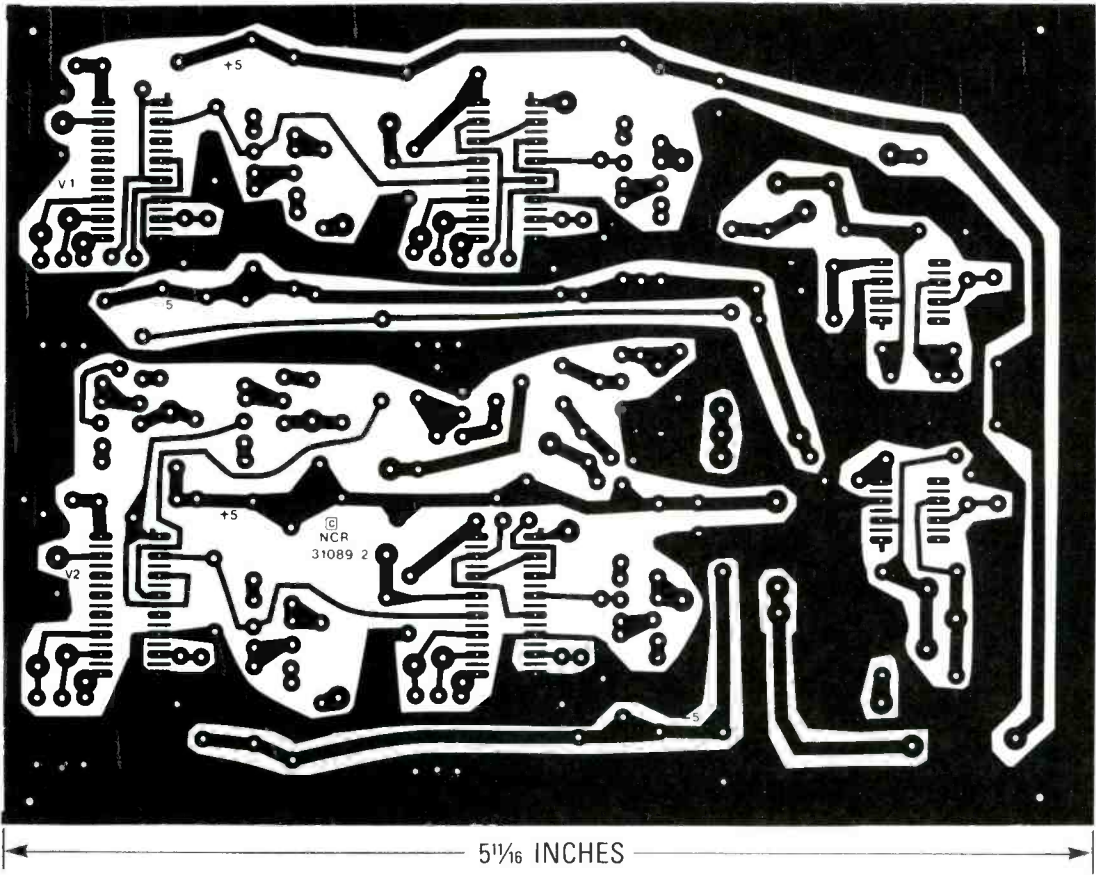

FIG. 19—VOLTAGE-SENSING ANTI-THEFT burglar alarm system and immobilizer switch for cars and other vehicles.

electronic burglar alarm shown in Fig. 19 detects a small decrease in battery voltage that occurs when a light or the ignition switch is turned on, which will cause a load on the battery.

Instead of using microswitches, C1 will "remember" the mean battery

voltage and apply it to pin 3 of IC1, while the instantaneous battery voltage is applied to pin 2. If the battery voltage falls beneath its mean value, the output of IC1 goes high, turning on RY1 via Q1-Q2. The contacts for both RY1 and RY2 work as shown in Fig. 18.



5 1/16 INCHES
VIDEO SCENE SWITCHER BOARD.

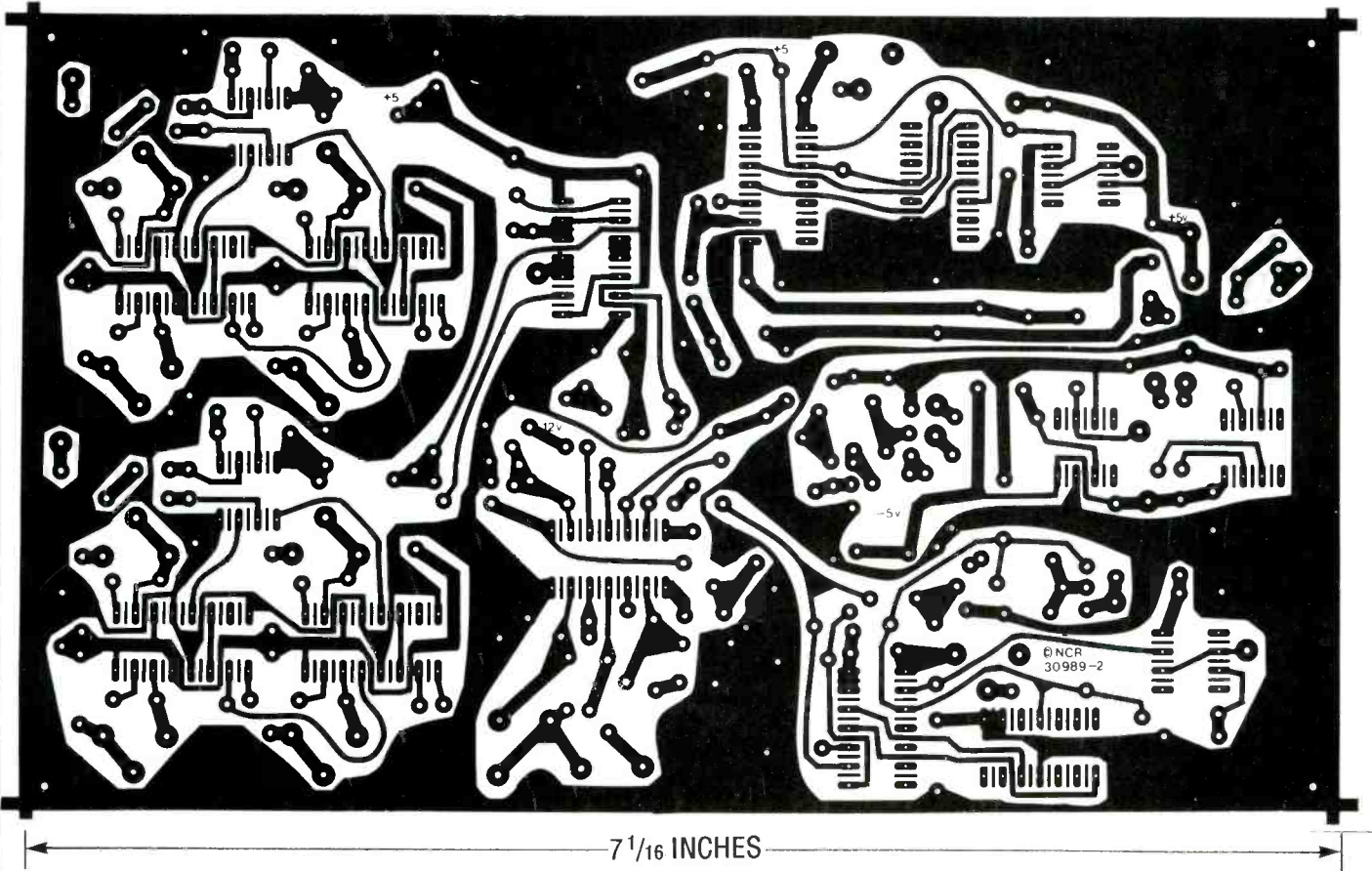

7 1/16 INCHES
VIDEO SCENE SWITCHER BOARD.

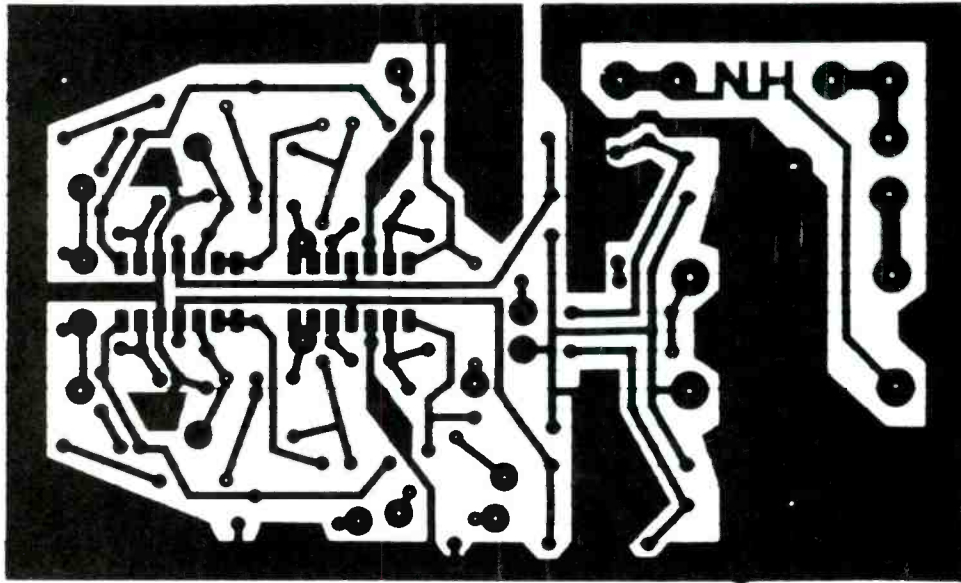

5 INCHES

BUILD THE SUBWOOFER SIMULATOR using this board.

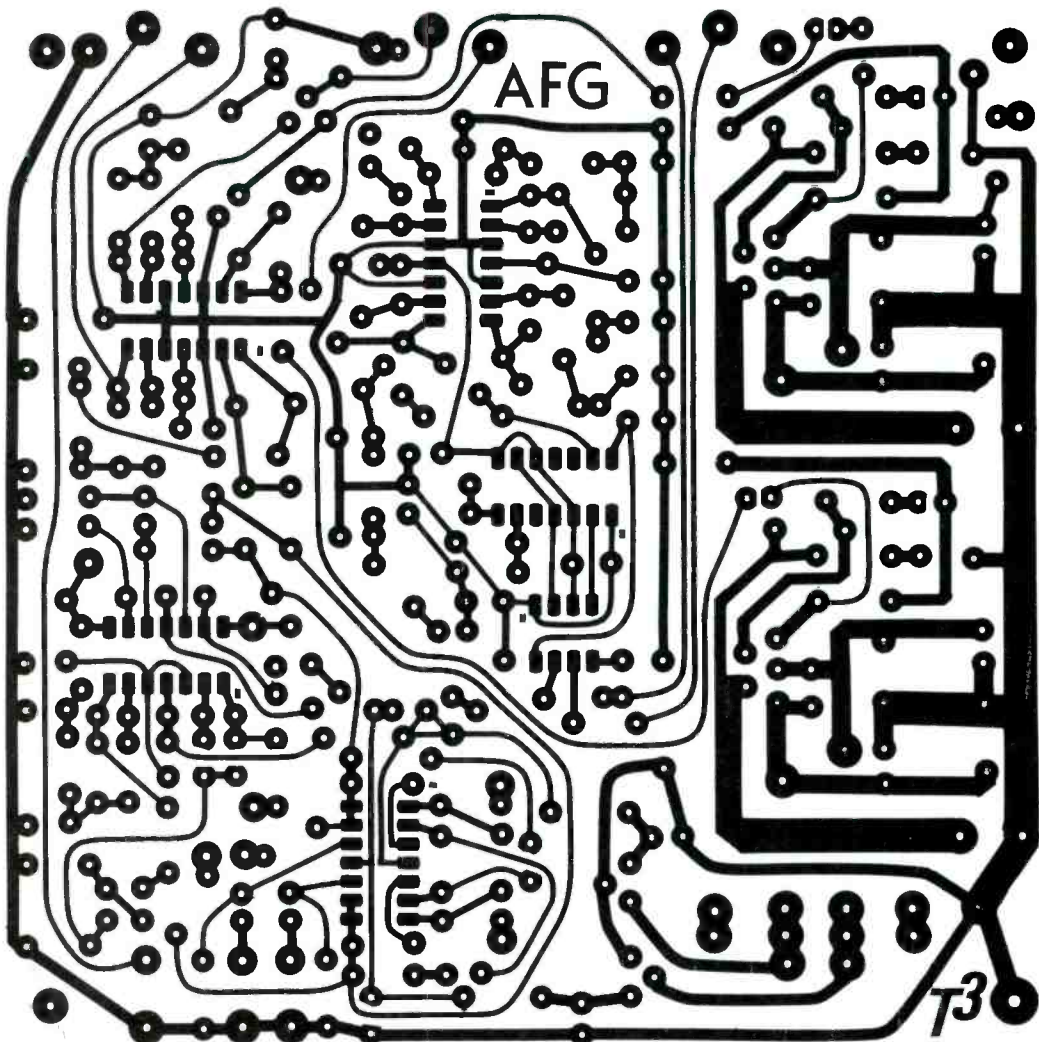

5 1/2 INCHES

ACOUSTIC FIELD GENERATOR foil pattern.

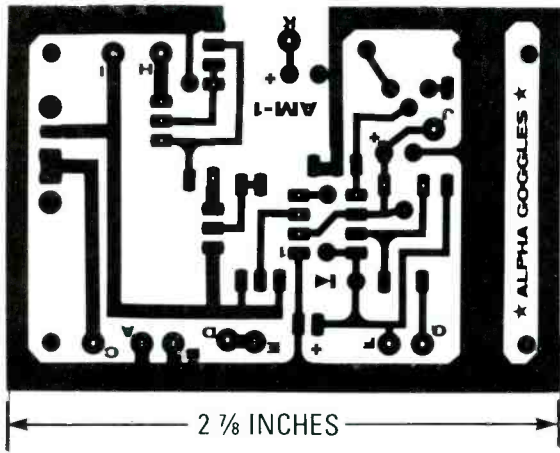

ALPHA MEDITATION GOGGLES foil pattern.

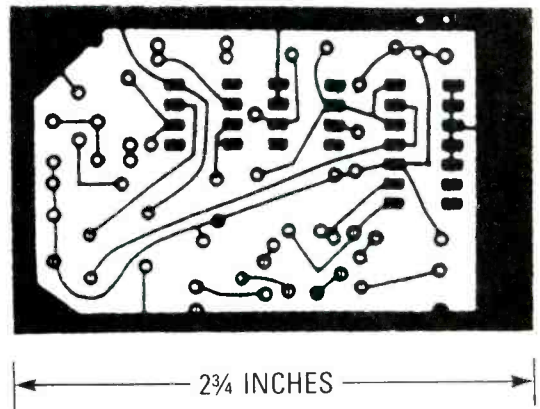

THE IR EXTENDER foil pattern.

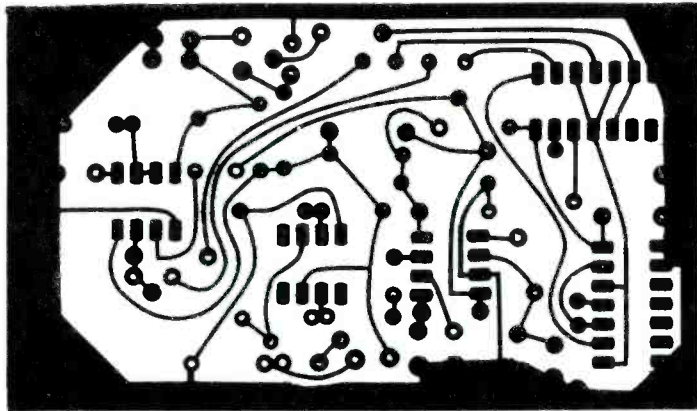

3 5/8 INCHES
A/B RECEIVER.

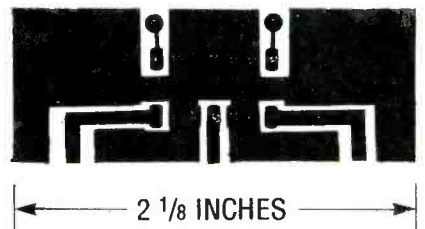

2 1/8 INCHES
A/B RELAY MODULE.

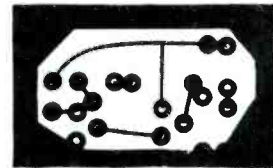

1 3/8 INCHES
A/B TRANSMITTER.

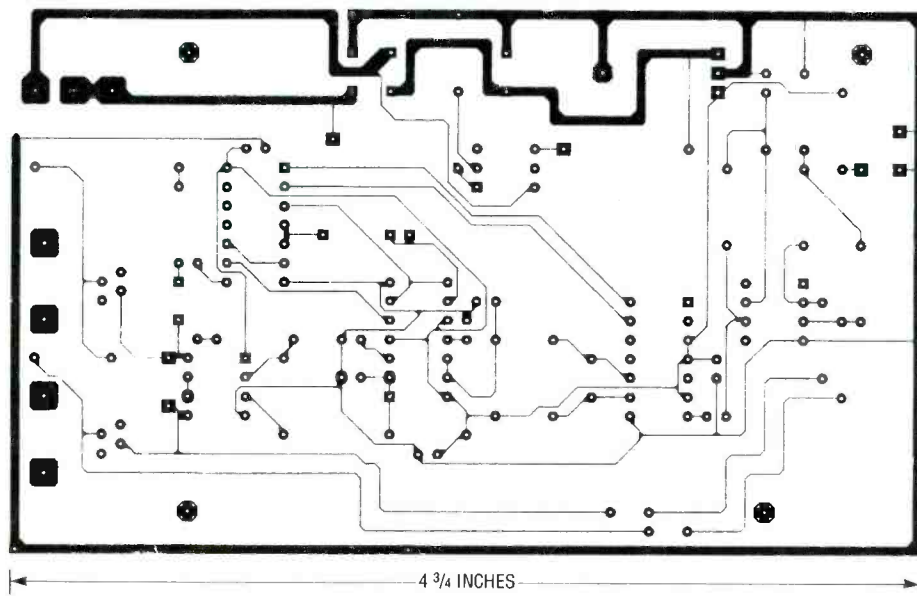

4 3/4 INCHES
FAXMATE FOIL PATTERN.

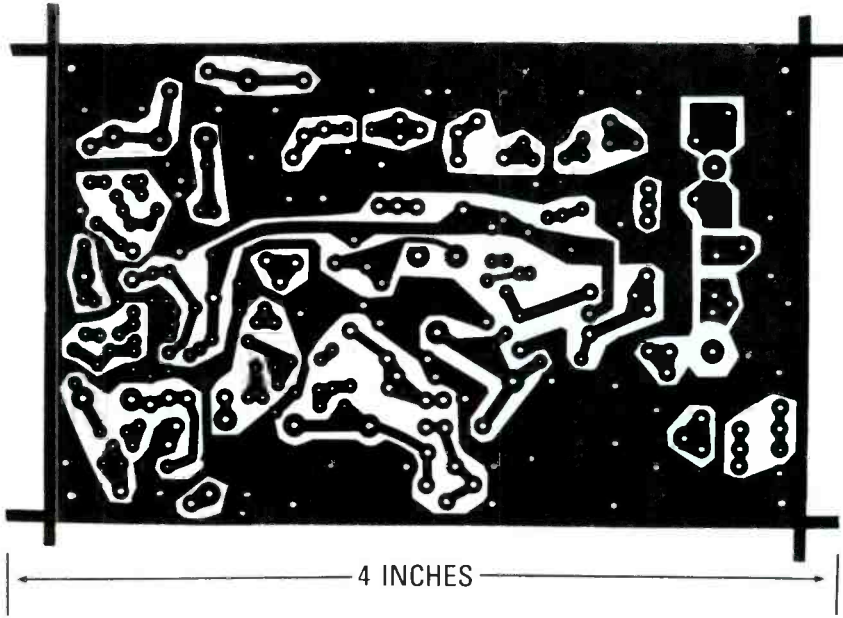

FOIL SIDE OF TV TRANSMITTER.

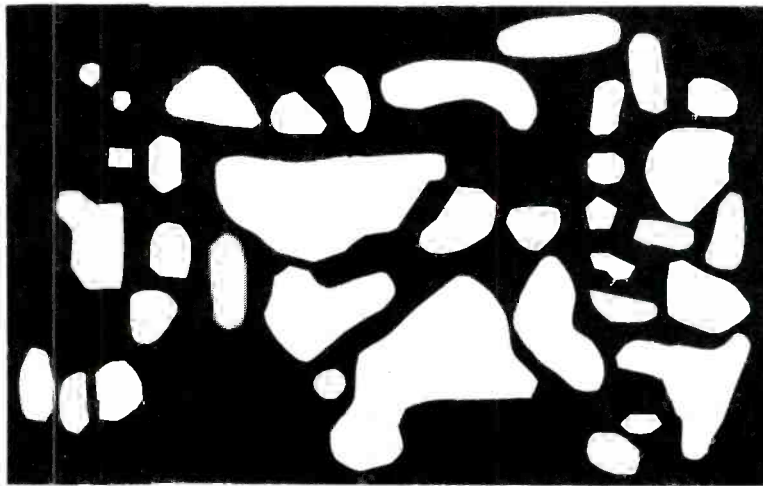

COMPONENT SIDE OF TV TRANSMITTER.

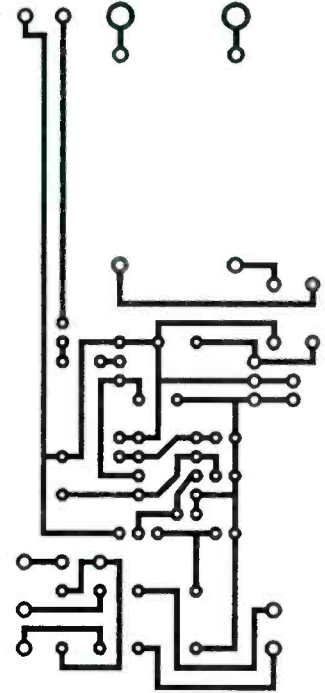

Audio-muting circuit's solder-side foil pattern

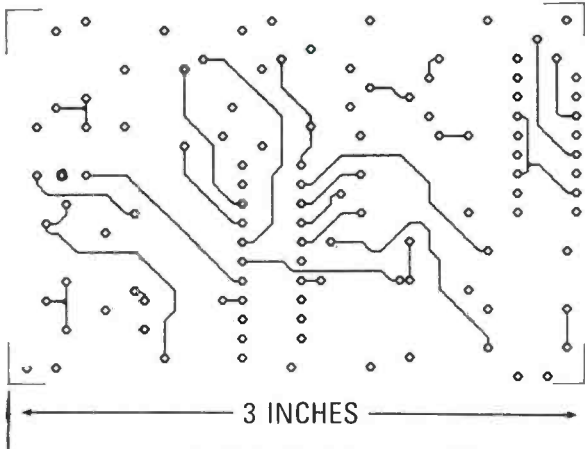

COLOR CONVERTER SOLDER SIDE.

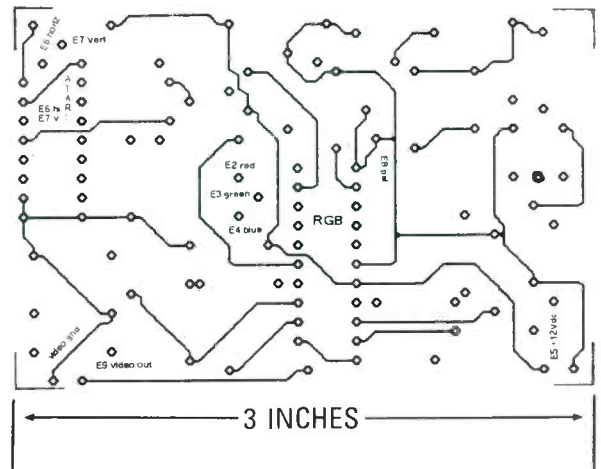

COLOR CONVERTER COMPONENT SIDE.

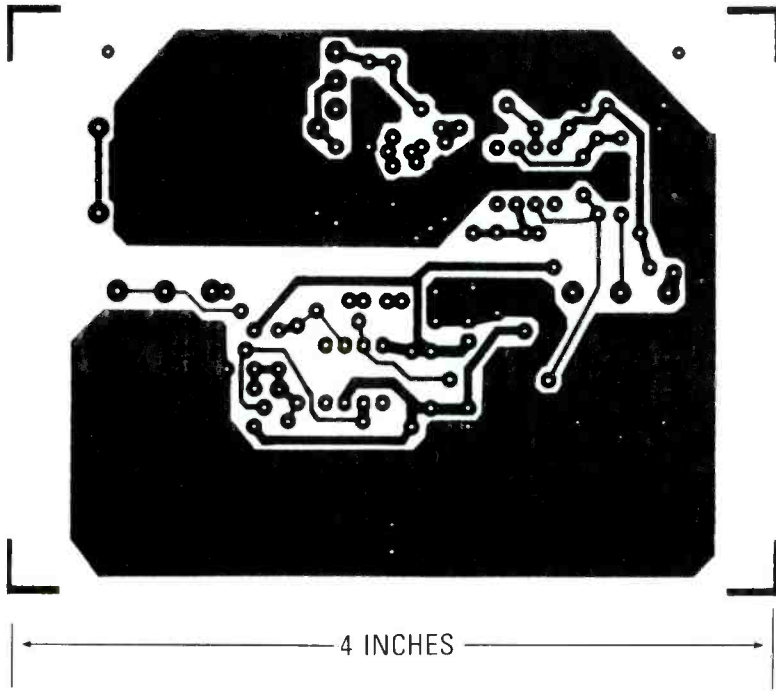

THE LBC'S RECEIVER BOARD.

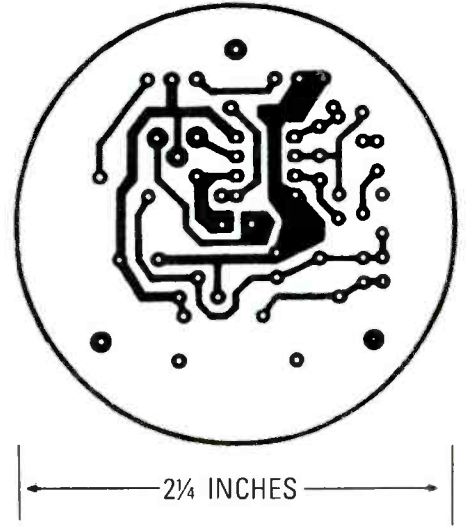

THE LBC'S TRANSMITTER BOARD.

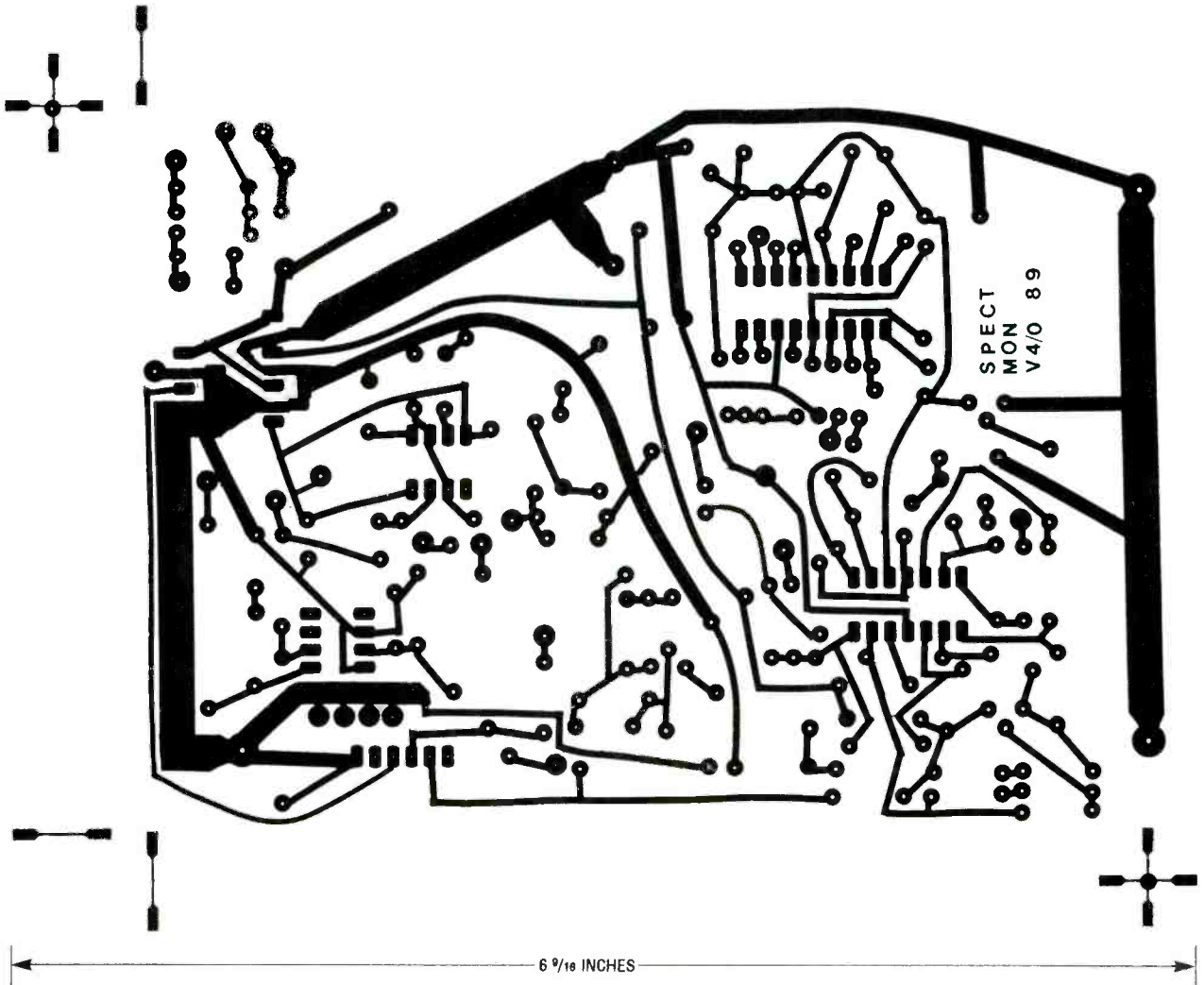

SPECTRUM MONITOR FOIL PATTERN.

Control Your Home Through Your Telephone

Build this X-10 compatible controller system and let every telephone in your home control lights and appliances.

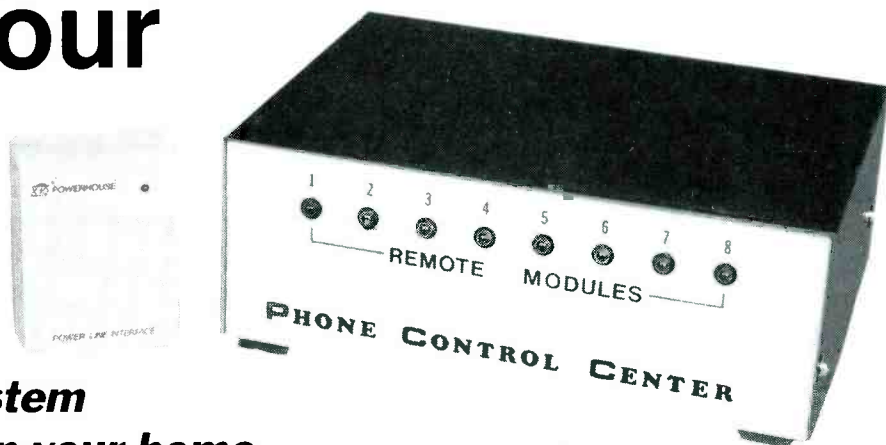

RONALD J. DALEY

WHETHER YOU'RE A REMOTE-CONTROL fanatic, or just an average home owner, you may be interested in our innovative X-10 compatible telephone controller. Imagine the convenience of coming home to stereo music and air-conditioning, or the secure feeling of a lived-in home while you're away, all controlled by any Touch-Tone phone! This can also be a useful device for the visually impaired or the handicapped.

The phone control center (PCC) is compatible with the popular and easily available X-10 system. The PCC can control any remote X-10 module via a Touch-Tone phone. The X-10 Powerhouse control console transmits coded signals to remote plug-in modules over your existing house wiring via carrier-current modulation techniques. The coded signals determine which remote modules turn on and which turn off. With the PCC, you can control up to eight modules with any home or business phone. Any new extension phone, even if it's cordless, automatically becomes a controller—one unit does it all!

Not only can you control remote modules with your cordless phone from several hundred feet away, but the PCC has a home security connection to command "ALL LIGHTS ON" when an on-premise alarm system is activated. If an alarm system is not used, the input can be wired to a

remote switch for manual operation of that security feature. Another option available in the PCC is a status monitor with eight light-emitting diodes (LED's) that indicate which of the remote modules are on or off.

You may wonder if your PCC will interfere with another PCC unit in a different house—you don't want to get a call from your neighbor complaining that his lights keep flashing on and off when you're operating your PCC! There's no need to worry about that because the PCC software uses specialized codes to prevent inter-system interference. Up to 16 PCC controllers can be used on the same power line.

Circuit theory

At the heart of the system is the 8035, an 8-bit microcomputer with an on-board RAM, programmable timer, and 24 I/O ports, 11 of which are reserved for the databus that interfaces with the RAM and the dual-tone multi-frequency (DTMF) receiver IC. Two hardware interrupts are used, one to recognize a valid tone, and the second to control a 4-second timer. Figure 1 shows a block diagram of the system.

Besides the microcomputer circuitry shown in Fig. 2, the PCC has three other sections; the telephone interface, power-supply/RF oscillator, and optional status indicator. The telephone

interface shown in Fig. 3 provides a high-impedance differential connection to the phone line to reduce line loading and noise susceptibility. The output signal from pin 6 of IC7 is amplified and capacitively coupled to IC8, a DTMF receiver.

A 3.58-MHz TV color-burst crystal is used in IC8, which contains all the necessary on-board circuitry (discriminators, filters, clocks, timers, and decoders) to detect and validate individual Touch-Tone signals. Once a tone has been validated, the processor is interrupted and IC8 immediately resets for the next tone pair.

The power-supply is shown in Fig. 4; a full-wave rectifier, D2 and D3, is filtered by C9 and regulated by IC5 to provide +5 volts DC to the PCC. A heat sink for IC5 is built into the PC board. The +12 volts DC unregulated input to IC5 is also needed to power IC7.

The status indicator shown in Fig. 5 has eight LED's in series with 860-ohm line dropping resistors going to IC6, a 74LS164 8-bit parallel-output serial shift register. The 8035 provides the necessary clocking and data levels to control the interface. The 74LS164 in turn provides the necessary output voltages for the LED's on the front panel.

The RF oscillator, zero-crossing detector, and AC house wiring in-

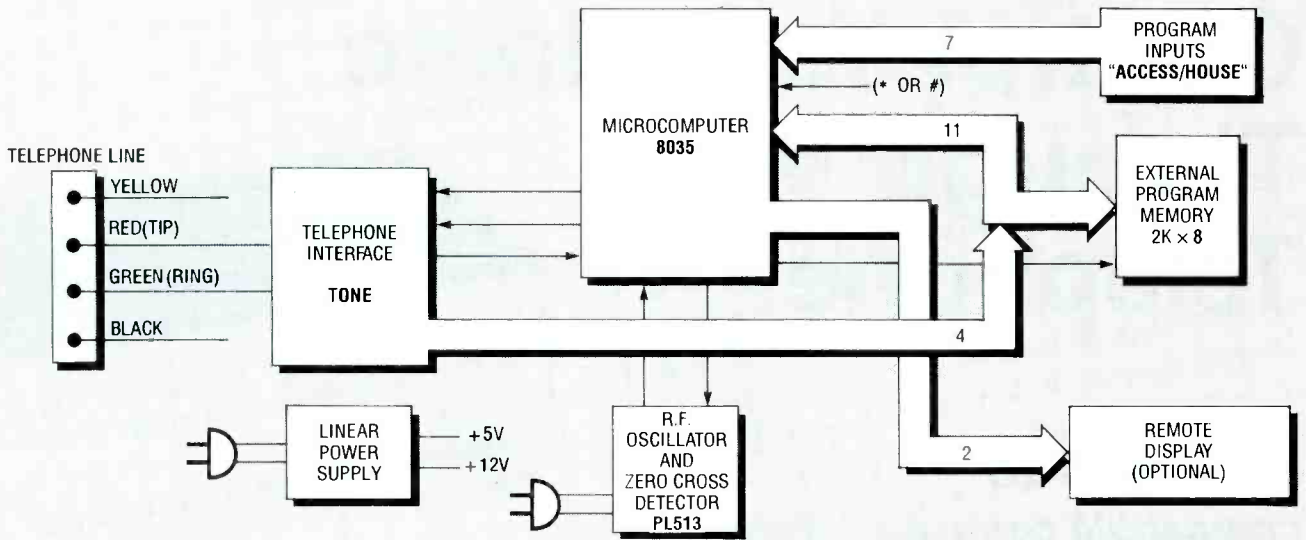

FIG. 1—BLOCK DIAGRAM OF THE PCC. The heart of the system is the 8035, an 8-bit microcomputer which interfaces with the program memory and the telephone tone decoder circuit.

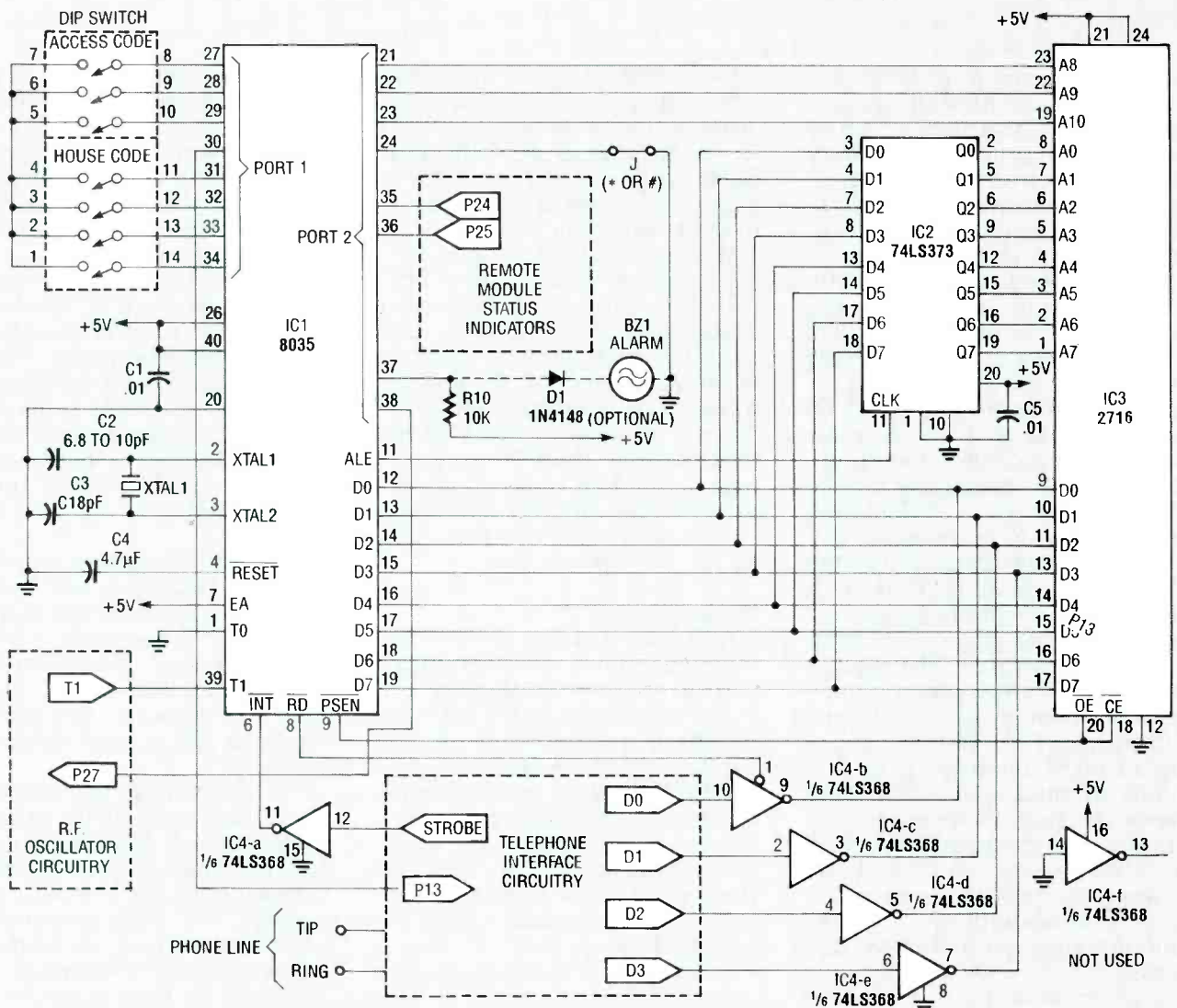

FIG. 2—MICROCOMPUTER INTERFACE CIRCUITRY. An on-premise alarm can be connected between the cathode of D1 and ground, which will turn "ALL LIGHTS ON" when activated.

GET THE LATEST ADVANCES IN ELECTRONICS

WITH A SUBSCRIPTION TO

Radio Electronics®



ENJOY THE WORLD OF ELECTRONICS EACH MONTH!

Now you can subscribe to the best electronics magazine. The only one that brings you articles on—electronics projects, technology, circuit design, communications, new products and much more.

Radio-Electronics looks to the future and shows you what new video, audio and computer products are on the horizon. What's more you'll find helpful, monthly departments such as Video News, Equipment Reports, Hardware Hacker, Audio Update, Drawing Board, Communications Corner. All designed to give you instruction, tips, and fun.

Radio-Electronics gives you exciting articles like:

- ISDN: The Telephone Network of Tomorrow
- The Facts on FAX
- A Digital Phone Lock
- How To Design Switching Circuits
- EIA-232 A real standard for serial interfacing?
- Build a synergy card for your PC
- '386 Power at a '286 price
- Build a biofeedback monitor
- More on Multiplexing



FOR FASTER SERVICE CALL TODAY
1-800-999-7139

DON'T DELAY SUBSCRIBE TODAY!

Just fill out the order card in this magazine and mail it in today.

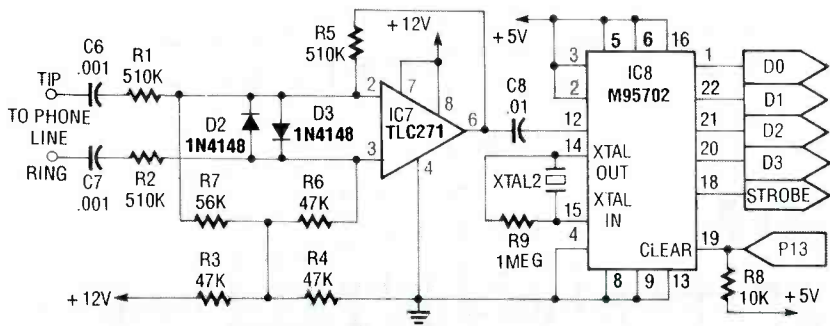

FIG. 3—THE TELEPHONE INTERFACE CIRCUITRY provides a high impedance, differential connection to the phone line. The amplified signal from pin 6 of IC7 is capacitively coupled to IC8, a DTMF receiver.

a start code, followed by a house code, and either a number or function code. With the exception of the start code, the remaining codes are all four or five bits, transmitted during the first half of the AC cycle, followed by their complement during the second half. Table 1 contains the PCC house codes, and Table 2 lists the module number and transmission codes. A binary "1" is transmitted as a 120-kHz burst lasting 1 millisecond, and a binary "0" is no burst. The start code "1110" consists of three 1-millisecond bursts in each of the first three half-cycles, followed by a binary "0" (no burst) in the fourth cycle. The start code synchronizes the remote modules in receiving and decoding messages that are transmitted from the PCC. To increase system reliability, each command block is transmitted twice, lasting eleven AC cycles each.

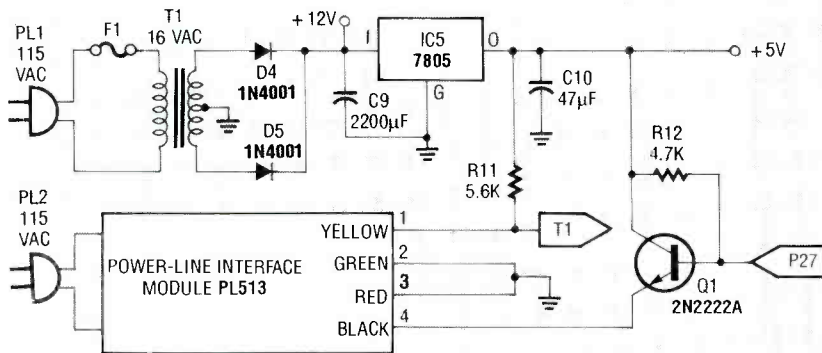
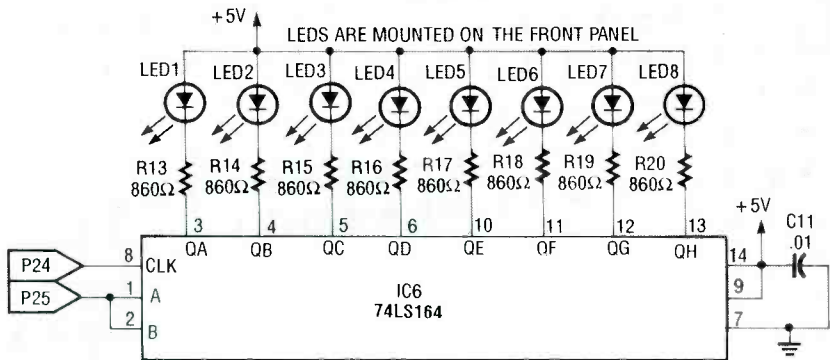

FIG. 4—THE POWER-SUPPLY AND RF OSCILLATOR circuitry; this is a basic linear type power-supply. The +5 volts DC from IC5 provides power to the PCC.

Software

The PCC software is available from the source in the parts list as a separate item. Anyone having access to the necessary software tools can easily modify the program as needed.

The main PCC control loop is shown in Fig. 7. The program starts with the initialization of all software control variables, and then reads the microswitch settings (both house and access codes) that were previously programmed by the user. The program waits about seven seconds for the user to define the remote light modules then runs the system diagnostic check. If the PCC is working, the diagnostics will



5—THE STATUS INDICATOR circuitry centers around IC6, an 8-bit parallel output, serial shift register.

interface are all contained in the PL513 power-line interface developed by X-10 to let others interface with the vast variety of remote modules. Since the X-10 code is patented, licensing is automatically granted to the purchasers of the power-line interface. The user must provide the necessary interface and control to the PL513.

The remote modules are controlled by pulse-width modulating (PWM) your AC power lines at 120-kHz. The ON cycle lasts for 1 millisecond, and the OFF cycle for 1.6 milliseconds. The exact

timing is crucial for proper operation of the PWM transmission: Fig. 6 shows a typical waveform of that transmission line.

Synchronization of the remote modules is established when the coded signal is transmitted within 200 microseconds of the AC zero-crossing point. The encoded message is then transmitted to either operate the remote modules individually, or to address a specific group all at one time. The latter occurs when you command "ALL LIGHTS ON" or "ALL LIGHTS OFF."

The transmission begins with

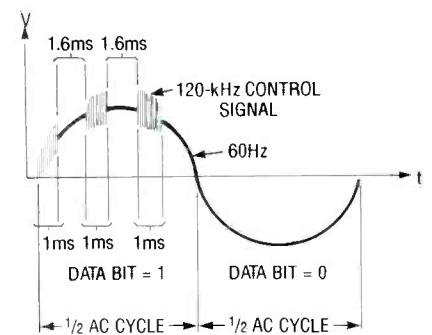

FIG. 6—A TYPICAL 60-Hz AC transmission consists of a pulse-width modulated waveform. A 120-KHz frequency is superimposed on the sine-wave during the 1-millisecond ON pulse, according to the specific code that is transmitted (see Tables 1 and 2.)

TABLE 1—HOUSE CODES
House Code Transmission Code

A	0	1	1	0
B	1	1	1	0
C	0	0	1	0
D	1	0	1	0
E	0	0	0	1
F	1	0	0	1
G	0	1	0	1
H	1	1	0	1
I	0	1	1	1
J	1	1	1	1
K	0	0	1	1
L	1	0	1	1
M	0	0	0	0
N	1	0	0	0
O	0	1	0	0
P	1	1	0	0

turn all lamp modules on for about one second then turn them all off. The status indicator is updated for one second, then it will display blanks.

The program spends most of its time in control loop 1 waiting for activity. If an alarm is enabled, the software enters control loop 2 to turn on all the light modules, followed by control loop 3 until the alarm has been disabled, at which time control loop 4 turns off all the light modules, then the cycle repeats. During that interval, the two interrupt routines, shown connected by dotted lines, are enabled.

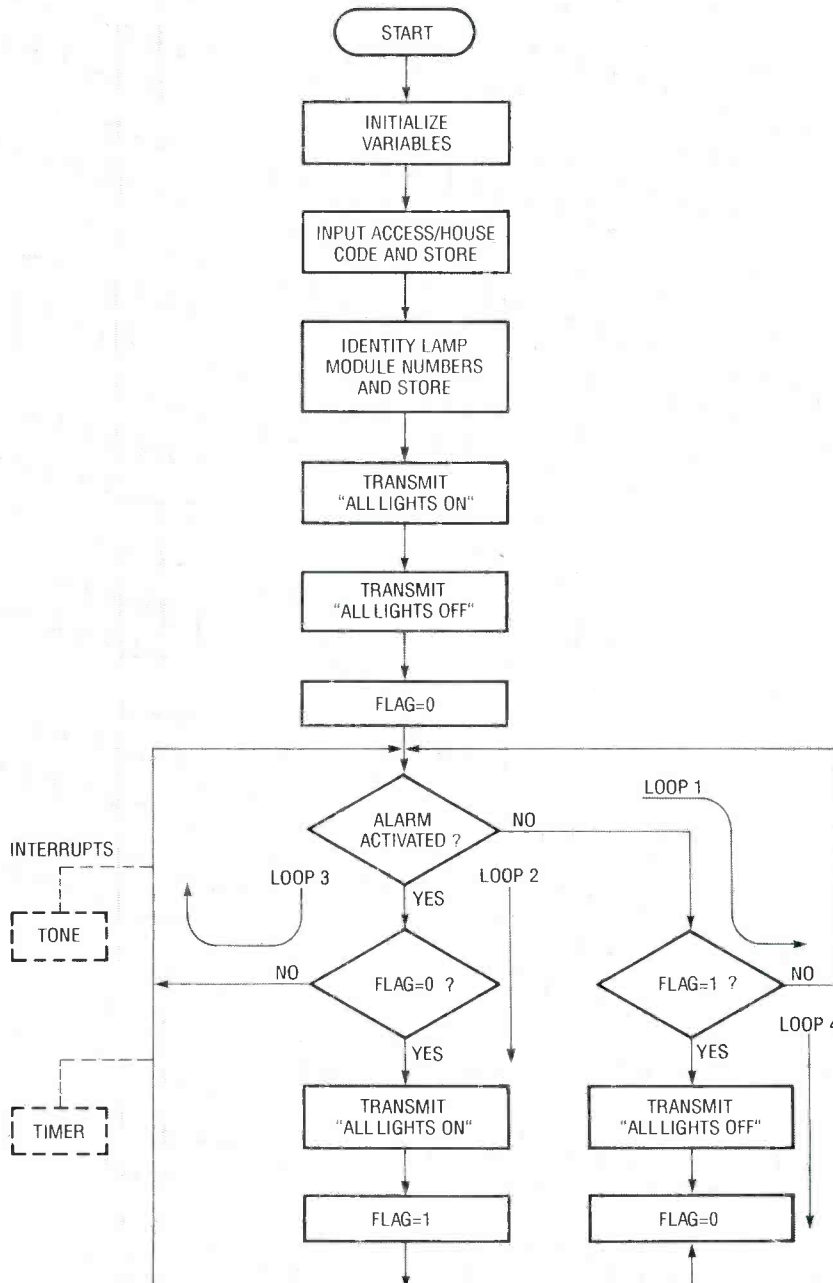

7—A FLOW CHART OF THE controllers main loop.

ELECTRONICS WAREHOUSE CORP.

• Over 20,000 Electronic Items in stock
• Same day order processing & shipping

REMOTE CONTROLS

Zenith Multi-Access Remote Control...
Now you can use just one wireless controller for your TV, VCR & Cable box... **\$39.95**



Gemini MAC-20 Advance Multi-Access Control with Instant Learning Mode for unlimited commands or direct entry programming. Full VCR control plus on/off, volume & channel selection... **\$54.95**

VIDEO ACCESSORIES

Camcorder & Video Light Batteries, Rewinders from **\$9.95**
VCR Head Cleaners from **\$2.95**
Repair Parts Including Heads, Belts & Idler Assemblies, in Stock for all Popular Brands.



AUTO STEREO, ALARM SYSTEMS

SPEAKERS & ACCESSORIES

Monstrous selection at largest discounts.

INTERCOM & SOUND EQUIPMENT

Large and small systems for every application; Office, Residential, and Institutional.

CLOSED-CIRCUIT VIDEO SURVEILLANCE EQUIPMENT

Individual Components as well as complete package deals for the do-it-yourselfer.



Send \$1. Postage & Handling for FREE 173 Page Catalog



-- ORDER DEPT. ONLY --

TOLL FREE (800) 221-0424

Other Business (718) 375-2700

Fax: 718-375-2796

1910 CONEY ISLAND AVENUE
BROOKLYN, NEW YORK 11230
VISA & MASTERCARD ACCEPTED

CIRCLE 55 ON FREE INFORMATION CARD

Be an FCC LICENSED ELECTRONIC TECHNICIAN!



Learn at home in spare time. No previous experience needed!

No costly school. No commuting to class. The Original Home-Study course prepares you for the "FCC Commercial Radiotelephone License." This valuable license is your professional "ticket" to thousands of exciting jobs in Communications, Radio-TV, Microwave, Maritime, Radar, Avionics and more...even start your own business! You don't need a college degree to qualify, but you do need an FCC License.

No Need to Quit Your Job or Go To School
This proven course is easy, fast and low cost! **GUARANTEED PASS**—You get your FCC License or money refunded. **Send for FREE facts now. MAIL COUPON TODAY!**

COMMAND PRODUCTIONS

FCC LICENSE TRAINING, Dept. 205
P.O. Box 2824, San Francisco, CA 94126
Please rush FREE details immediately!

NAME _____
ADDRESS _____
CITY _____ STATE _____ ZIP _____

The tone-interrupt routine shown in Fig. 8 is entered any time a valid DTMF signal is detected by the telephone interface circuit. That routine is primarily made up of six control loops identified as 5–10. The routine is activated during start-up when the user enters the remote light module information. During that time, the software variable "MODE COMPLETE" is set equal to 2, and control loop 5 is entered each time a light module identification is entered. When the user enters the access code, control passes to loop 8 if the codes are valid, otherwise control is passed to loop 7. In loop 7, the software variable "MODE COMPLETE" is set equal to 1. Any further tone information is ignored by the PCC and software control is channeled to loop 10 until the "TIMER" interrupt routine re-initializes the software variables, taking about four seconds. If the access code is entered correctly, loop 9 remains active until the PCC is inactive for four seconds, or the user terminates the PCC by entering "*" or "#".

The second "TIMER" interrupt, shown in Fig. 9, is enabled by the "TONE" routine. It increments a 4-second hardware/software timer that suspends PCC operation when it's inactive for at least four seconds.

The 8035 has an internal 8-bit counter under program control. The clock input, T1, is derived from the AC zero-crossing detector incorporated in the PL513, which increments the counter every 8.3 milliseconds when enabled. Since the maximum time obtained before overflow is 2.1 seconds (256×8.3 milliseconds), the 4-second timer gets the job done by accumulating multiple overflows in a register under software control.

Construction

The PCC is built on a double-sided PC board, the foil patterns of the component side and solder side are shown in this article. An etched and drilled PC board is available from the source in the parts list.

Install all components according to the parts placement diagram shown in Fig. 10, a view of the inside of a completed PCC is shown in Fig. 11. Use DIP sockets

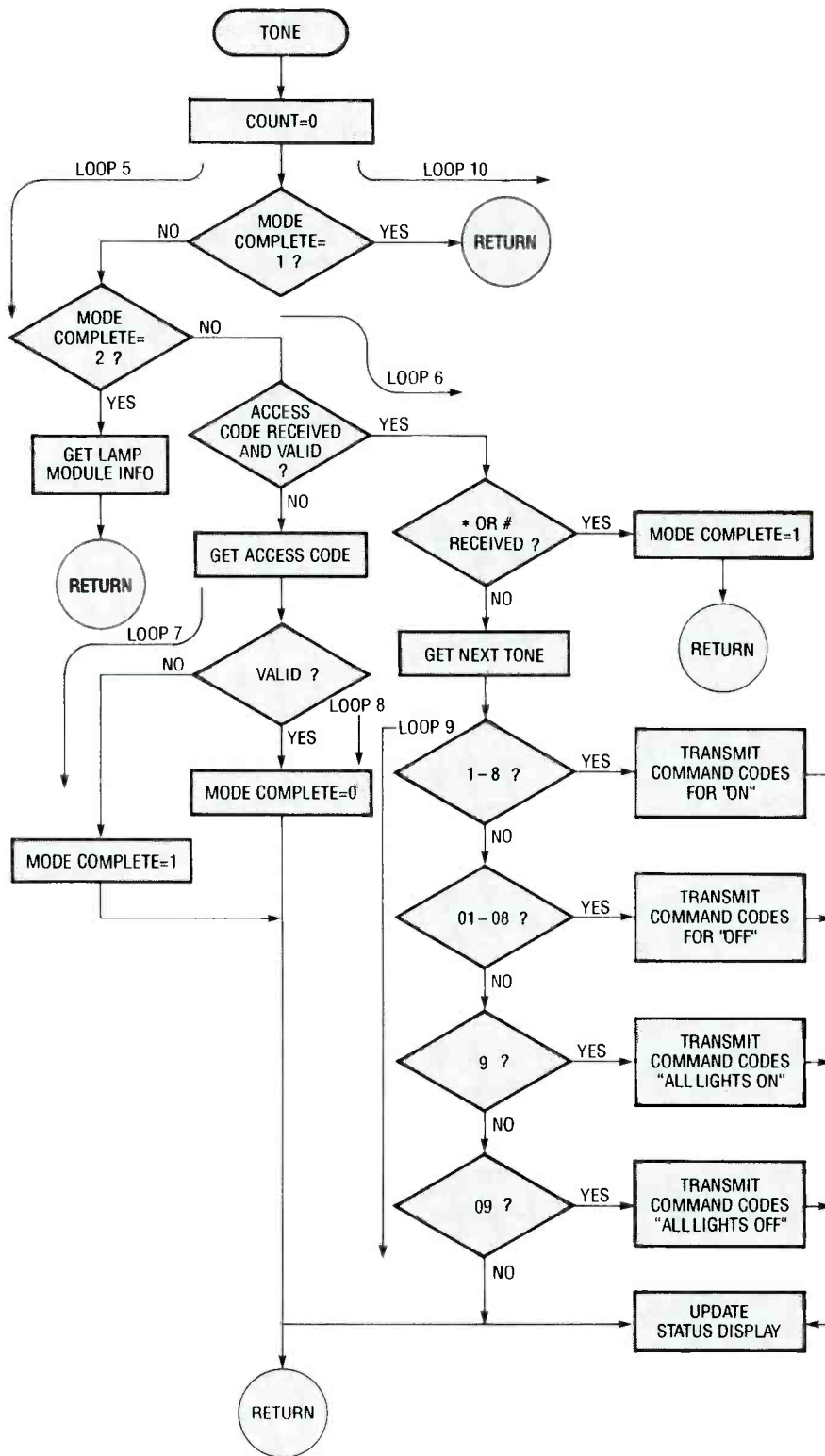

8—A FLOW CHART OF THE TONE interrupt service routine.

for all IC's, and make sure they're correctly positioned. When installing T1, the dot on the transformer should match that of pin 1 on the parts placement diagram, which is the primary AC side connected to F1. When connecting the PL513 to the PCC, match the

pin numbers with the correct wire color code as shown in Fig. 4.

The AC power cord goes to the PC board at the locations shown in Fig. 10 after one side is connected to the fuse holder. If the alarm function is used, install

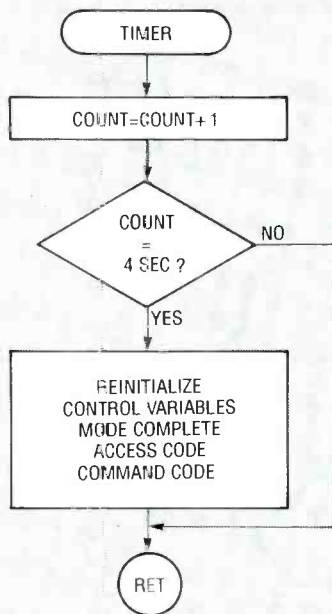

FIG. 9—THIS IS A FLOW CHART timer routine.

two wires at the locations shown in the parts placement diagram to an alarm system with a normally open contact. Connect the status LED's as shown in Fig. 10, and mount them on the front panel with grommets, or other suitable hardware.

Connect the phone-line tip (green) and ring (red) connections as indicated. If you buy the complete PCC kit, two 6-foot modular phone extension cords are included with modular phone jacks attached. Since the PL513 uses the same modular phone connector as the local phone company, label the two cords at the end of the plug to avoid wrong connections.

Any connection to the phone line is controlled by the Federal Communications Commission (FCC), Part 68, and your local telephone company. Since each telephone company may have its own regulations, we suggest you contact yours before making any connections to the phone line. In general, the FCC is concerned that no disturbances of any type occur on a phone line; all connections to it must be made through standard plugs or jacks so the device can easily be disconnected if suspected of causing interference. The PCC has been designed to meet those requirements. Let's see how easy it is to program and checkout the PCC.

All resistors are 1/4-watt, 5%, unless otherwise indicated.

- R1, R2, R5—510,000 ohms
- R3, R4, R6—47,000 ohms
- R7—56,000 ohms
- R8, R10—10,000 ohms
- R9—1 megohm
- R11—5600 ohms
- R12—4700 ohms
- R13-R20—860 ohms

Capacitors

- C1, C5, C8, C11—.01 μ F, ceramic disc
- C2—6.8 to 10 pF, ceramic disc
- C3—18 pF, ceramic disc
- C4—4.7 μ F, electrolytic
- C6, C7—.001 μ F, ceramic disc
- C9—2200 μ F, electrolytic
- C10—47 μ F, electrolytic

Semiconductors

- D1, D2, D3—1N4148 switching diode
- D4, D5—1N4001 rectifying diode
- Q1—2N2222A NPN transistor
- IC1—8035 microprocessor
- IC2—74LS373, 8-bit latch
- IC3—2716, 2K \times 8 EPROM
- IC4—74LS368, hex bus drivers
- IC5—LM7805, +5-volt regulator
- IC6—74LS164, 8-bit parallel output serial shift register
- IC7—TLC271, op-amp
- IC8—M95702, DTMF receiver

Other components

- S1—SPST microswitches 1-7
- T1—16 volts AC, 260-mA center-tapped secondary winding transformer
- XTAL1—6-MHz crystal
- XTAL2—3.58-MHz crystal
- PL513—X-10 power-line interface module, available from X-10 (USA) Inc., Anova Electronics, Leviton, General Electric, Pittway Corporation or Radio Shack.

Miscellaneous: AC line cord, PC board, LED's, LED mounting hardware, 1/4-amp fuse, fuse holder, 2 modular phone extension cords, and 3 strain reliefs.

NOTE: The following items are available from Master Control Systems, P.O. Box 504, Ellington, CT 06029: A kit of all parts including a programmed EPROM, an etched, drilled and plated-through PC board, and miscellaneous items, \$135.00; a programmed EPROM, \$20.00; an etched, drilled and plated through PC board, \$35.00; program listing, \$10.00. Please add 5% for postage and handling in the U.S., 10% for foreign orders. Connecticut residents include 7.5% sales tax. Allow 2 to 4 weeks for delivery.

Programming the PCC

The first step in programming the PCC is to enter the house code and access code into the PCC via the seven slide switches on S1. The house codes, identified as letters A-P, allow independent operation of up to 16 PCC controllers. Table 3 shows the switch settings for the 16 house codes. Select one house code and set switches S1-S4 to their ap-

AMAZING SCIENTIFIC & ELECTRONIC PRODUCTS

PARTS ARE IN STOCK	PLANS	PRICE
GRA1 — ANTI GRAVITY GENERATOR		\$1000
LC7 — 40 WATT BURNING CUTTING LASER		\$2000
RUB4 — HI POWER PULSED DRILLING LASER		\$2000
BTC5 — 1 MILLION VOLT TESLA COIL		\$2000
MCPI — HI VELOCITY COIL GUN		\$1500
LLS1 — LASER LIGHT SHOW 3 METHODS		\$2000
EHI — ELECTRONIC HYPNOTISM TECHNIQUES		\$800
EML1 — LOWER POWERED COIL GUN LAUNCHER		\$800
JL3 — JACOB LADDER 3 MODELS		\$1000
SD5 — SEE IN THE DARK		\$1000
LEV1 — LEVITATION DEVICE		\$1000

ASSISTANCE PROGRAM AVAILABLE	KITS	PRICE
FMV1K — 3 MILE FM VOICE TRANSMITTER		\$34.50
PFS1K — HAND CONTROLLED PLASMA FIRE SABER		\$49.50
NIG7K — HI FLUX NEGATIVE ION GENERATOR		\$34.50
PG5K — PLASMA LIGHTNING GLOBE		\$49.50
LHC2K — VISIBLE SIMULATED 3 COLOR LASER		\$44.50
HOD1K — HOMING/TRACKING BEEPER TRANSMITTER		\$44.50
LGU6K — 2.5 MW HAND-HELD VISIBLE LASER GUN		\$249.50
BTC3K — 250,000 VOLT TABLE TOP TESLA COIL		\$249.50
IOG2K — ION RAY GUN, project energy without wires		\$129.95
TKE1K — TELEKINETIC ENHANCER/ELECTRIC MAN		\$79.50
VWPM7K — 3 MILE AUTO TELEPHONE TRANSMITTER		\$49.50

ASSEMBLED	ASSEMBLED IN OUR LABS	PRICE
LIST10 — INFINITY XMTR Listen in via phone lines		\$199.50
IPG70 — INVISIBLE PAIN FIEL D BLAST WAVE GENERATOR		\$74.50
ITM10 — 100,000 VOLT INTIMIDATOR UP TO 20"		\$39.50
JAT30 — AUTOMATIC TELEPHONE RECORDING DEVICE		\$24.50
PSP40 — PHASOR SDNIC BLAST WAVE PISTOL		\$89.50
DNE10 — ALL NEW 26" VIVID COLORED NEON STICK		\$74.50
LGU20 — 5 TO 1MW VISIBLE RED HeNe LASER GUN		\$199.50
BLS10 — 100,000 WATT BLASTER DEFENSE WAND		\$89.50

EASY ORDERING PROCEDURE · TOLL FREE 1-800-221-1705 or 24 HRS ON 1-603-673-4730 or FAX IT TO 1-603-672-5406
VISA, MC, CHECK, MOIN US FUNDS. INCLUDE 10% SHIPPING. ORDERS \$100.00 & UP ONLY ADD \$10.00. CATALOG \$1.00 OR FREE WITH ORDER.

INFORMATION UNLIMITED
P.O. BOX 716, DEPT. R2, AMHERST, NH 03031

CIRCLE 57 ON FREE INFORMATION CARD

QUALITY PARTS • DISCOUNT PRICES

ALL ELECTRONICS CORP.

We Stock Over 4,000 Items.

Call Or Write For Our

Free 60 Page Catalog

Of Parts For All Your Projects...

Resistors • Capacitors • Diodes • Cables • Bridge Rectifiers • Lamps • Choke Coils • Crystals • Relays • I.C.'s • Heat Sinks • Motors • Sub Miniature D Connectors • Transistors • Power Supplies • Jacks • Plugs • Switches • Fans • Perf Boards • Shrink Tubing • Tie Wraps • Tools • Keypads • Video Accessories • S.C.R.'s • Transformers • Telephone Accessories • Ribbon Cable • Circuit Breakers • Voltage Regulators • Crimp Connectors •

And Many Other Items...

CALL TOLL FREE
1-800-826-5432

Call Toll Free, or clip this coupon
For a **FREE** 60 Page Catalog
ALL ELECTRONICS CORP.
P.O. Box 567 • Van Nuys, CA • 91408

Name _____

Address _____

City _____ State _____ Zip _____

SEE90

CIRCLE 58 ON FREE INFORMATION CARD

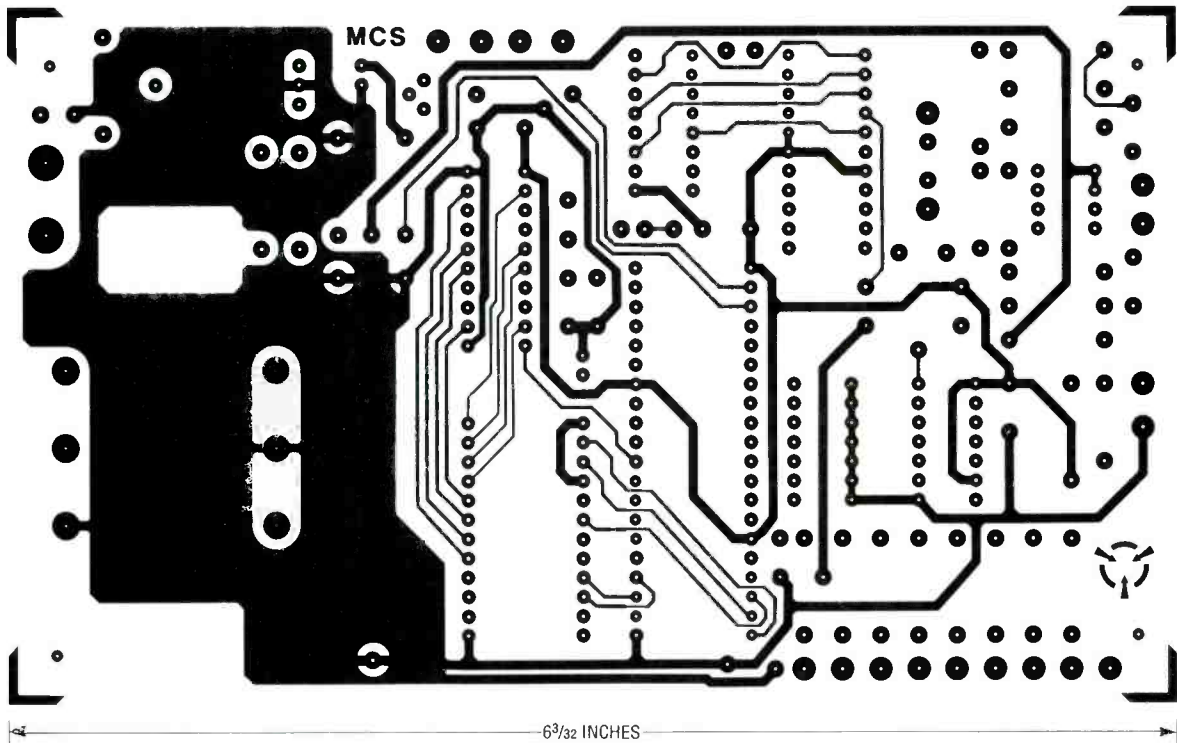

SOLDER SIDE OF THE PCC BOARD.

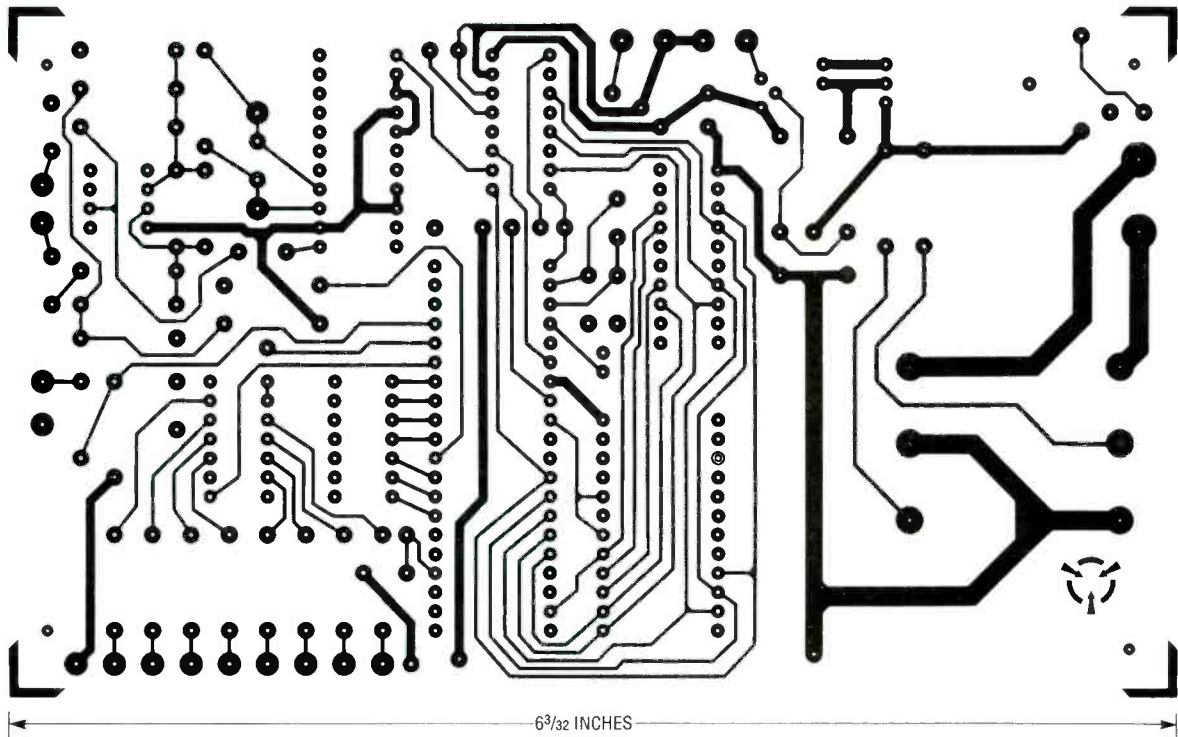

COMPONENT SIDE OF THE PCC BOARD.

appropriate positions. Select an arbitrary access code (1-8) from Table 4, and set switches S5-S7 as indicated. The house code and access code is set only once, although you may wish to change the access code occasionally for security reasons.

The remote X-10 modules you're using have both a unit

code and a house code, which must be properly set. The house code (A-P) on *all* modules should be set to the specific house code you chose. Each module should be assigned its own unit code (1-8), corresponding to the power outlet locations used with them.

The PCC has the capability of

commanding "ALL LIGHTS ON" to the remote modules. A problem that arises with that command, as you might imagine, is that you may want to turn on *only* the light modules, not the modules that control other appliances. To circumvent that problem, you can program only the light modules you wish to turn

TABLE 2—MODULE NUMBER AND TRANSMISSION CODES

Module Number Code	Transmission Code
1	0 1 1 0 0
2	1 1 1 0 0
3	0 0 1 0 0
4	1 0 1 0 0
5	0 0 0 1 0
6	1 0 0 1 0
7	0 1 0 1 0
8	1 1 0 1 0
"ALL LIGHTS ON"=9	0 0 0 1 1
"ALL LIGHTS OFF"=09	0 0 0 0 1

on with the "ALL LIGHTS ON" command. That task is accomplished the first time the PCC is plugged into an AC outlet. First, enter the access code as previously discussed, then enter "9" ("ALL LIGHTS ON"), and finally, enter the *light* module numbers. This is a one-time operation that is optional.

After the last module number is entered, the PCC delays for four seconds, then transmits "ALL LIGHTS ON" followed by "ALL LIGHTS OFF," while updating the status indicators. The status indicators let the user

TABLE 3—HOUSE CODE SWITCH SETTINGS

House Code	Switch Settings			
	S1	S2	S3	S4
A	ON	ON	ON	ON
B	ON	ON	ON	OFF
C	ON	ON	OFF	ON
D	ON	ON	OFF	OFF
E	ON	OFF	ON	ON
F	ON	OFF	ON	OFF
G	ON	OFF	OFF	ON
H	ON	OFF	OFF	OFF
I	OFF	ON	ON	ON
J	OFF	ON	ON	OFF
K	OFF	ON	OFF	ON
L	OFF	ON	OFF	OFF
M	OFF	OFF	ON	ON
N	OFF	OFF	ON	OFF
O	OFF	OFF	OFF	ON
P	OFF	OFF	OFF	OFF

know if the lamp module information was entered correctly, and are also a useful diagnostic tool.

Checkout

After you've programmed the house code and access code you intend to use with the PCC, connect the telephone-interface modular phone jack (tip and ring conductors) into any modular

phone jack in your house. Now connect the other modular phone cord (PL513 pins 1-4) into the PL513. First plug the PL513 into an AC outlet, *then* plug in the PCC.

If you buy the PCC kit, the built-in diagnostic program will assist you in the checkout. The diagnostic program is divided into two parts; it checks the operation of the power-supply, processor, and status display, and verifies the user's programming and interfacing with the PL513.

Immediately after applying power, the eight status LED's will light for about one second, then go blank. About four seconds later, the PCC will transmit "ALL LIGHTS ON," then one second later will transmit "ALL LIGHTS OFF." At that time, all the X-10 modules with the same house code as the PCC will go on, then off. If they do not, verify the house code you programmed is the same one used on the remote modules. If the diagnostic program has run successfully, then only the telephone interface needs to be checked. Assume, for checkout purposes, that your

Motorless Motion!

Robotics! Engines! Inventions! Thin Shape Memory Alloy wires contract like living muscle when electrically activated.

Space Wings - Sleek silver wings flap silently using only 5 cm of SMA wire. Assemble this futuristic kit in under an hour. Stands 15 cm high. Perches on your PC or desk lamp. Annoys cats. With printed circuit board, parts, info on SMAs, and complete instructions. Runs on two AA batteries (not included).

3-001 Space Wings Kit \$19.95

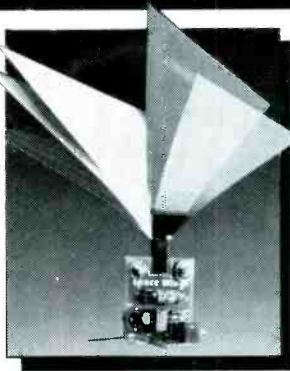

Send a business size Self-Addressed Stamped Envelope for latest catalog.

Order Today - Send check or money order (sorry no credit cards). CA orders add 7.25% tax. All orders add \$4 P&H (\$8 to Canada).

Mondo•tronics • 2476 Verna Ct. San Leandro, CA 94577 • USA

CIRCLE 59 ON FREE INFORMATION CARD

REALMAGIC!

An ETCHED circuit board from a Printed PAGE in just 3 Hours

The ER-4 PHOTO ETCH KIT gives you the tools, materials and chemicals to make your own printed circuit boards. The patented Pos-Neg™ process copies artwork from magazines like this one without damaging the page. Use the circuit patterns, tapes and drafting film to make your own 1X artwork. Or try the Direct Etch™ system (also included), to make single circuit boards without artwork. The ER-4 is stocked by many electronic parts distributors, or order direct, postpaid.

ER-4 PHOTO ETCH KIT (NJ and CA residents add sales tax) ... \$38.00
DATAK'S COMPLETE CATALOG lists hundreds of printed circuit products and art patterns. Also contains dry transfer letter sheets and electronic title sets for professional looking control panels. **WRITE FOR IT NOW!**

DATAK Corporation • 55 Freeport Blvd, Unit 23 • Sparks, NV 89431

CIRCLE 53 ON FREE INFORMATION CARD

Give.

American Heart Association



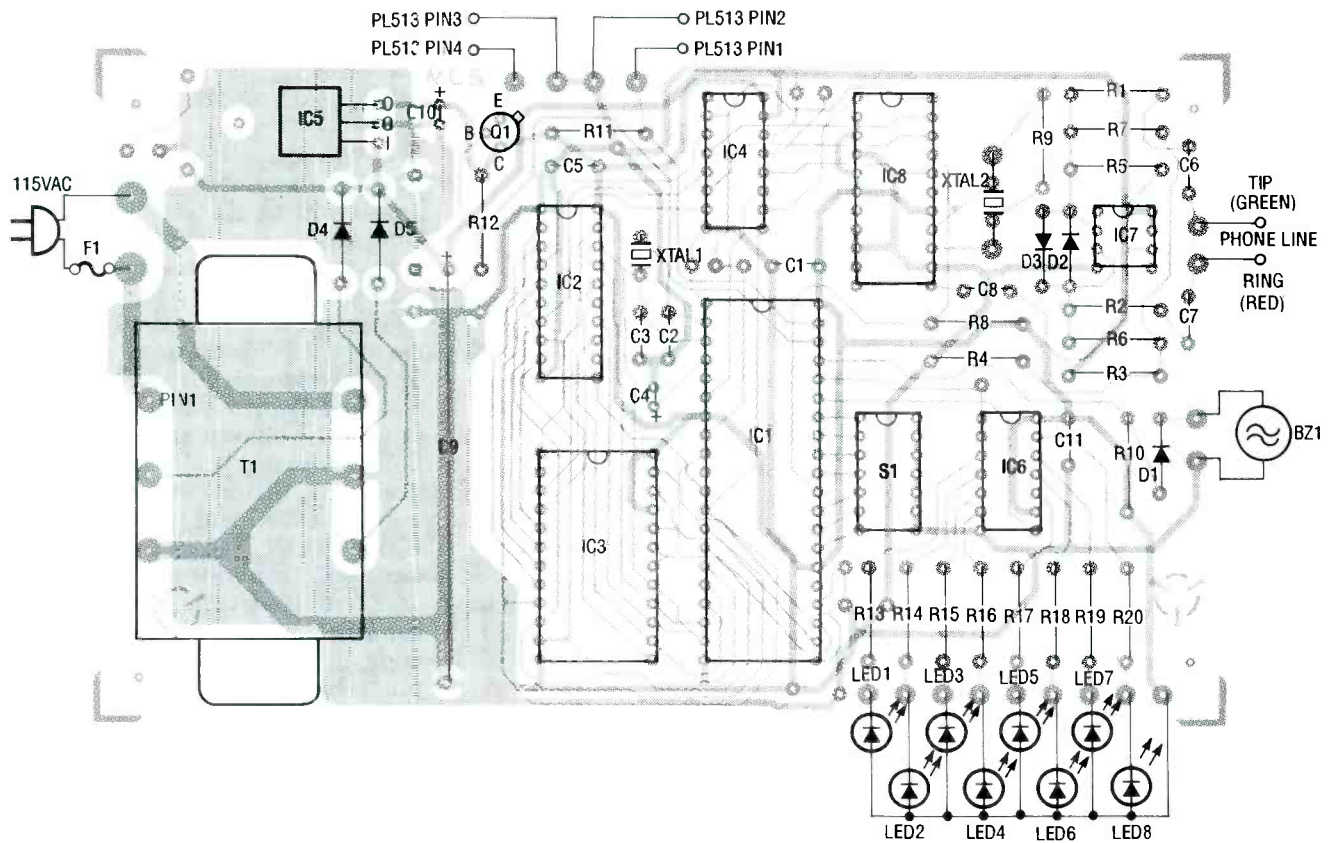

FIG. 10—THIS IS THE PARTS PLACEMENT DIAGRAM of the PCC. The LED's are mounted on the front panel, and the fuse is mounted on the bottom enclosure.

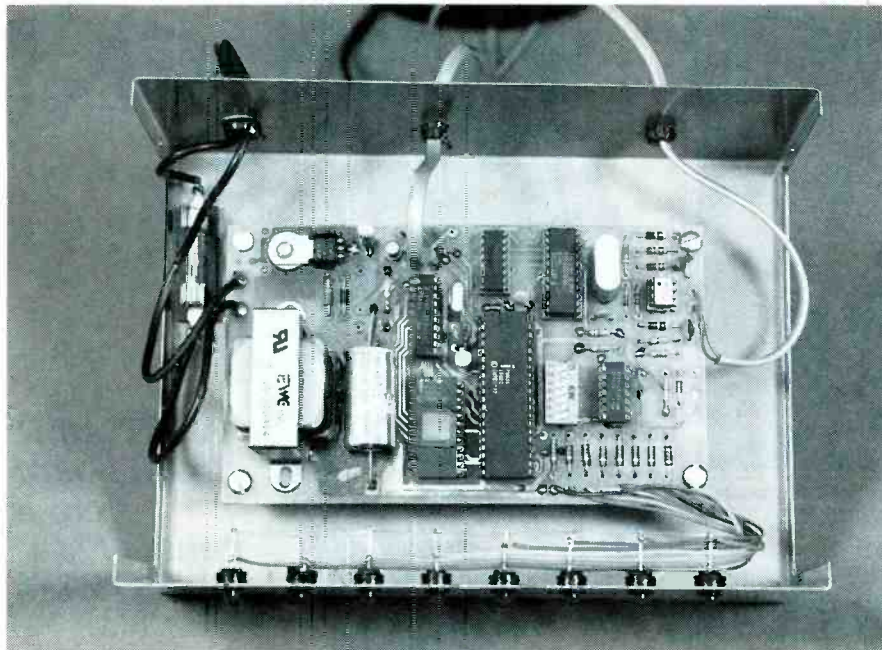

FIG. 11—THIS IS AN INTERNAL VIEW of the PCC. Be sure you make the proper connections to the phone line and the PL513 unit.

system has a remote module number "3" with an assigned access code of "5." Remove the handset from the phone cradle and dial "2," "5," "*", or "#." Within four seconds dial "3," then "0," "3." Verify that remote

module "3" went on, and then off, as did the status indicator position 3. If you haven't already done so, remember that you can identify specific *light* modules to the PCC after the unit is plugged in.

Operation

The PCC is easy to operate and doesn't interfere with normal telephone use. To address a remote module, just lift the handset, dial the access code, then the remote module number. The PCC uses a three digit access code: the first digit is always "2," the second is "1"–"8" (the access code you programmed in S5–S7), and

TABLE 4—ACCESS CODE SWITCH SETTINGS

S5	Switch Setting		Access Code
	S6	S7	
ON	ON	ON	1
ON	ON	OFF	2
ON	OFF	ON	3
ON	OFF	OFF	4
OFF	ON	ON	5
OFF	ON	OFF	6
OFF	OFF	ON	7
OFF	OFF	OFF	8

the third is "*" or "#."

To turn a module off, simply precede the module number with a "0." For example, if the assigned access code is "6," and you want to turn modules 1 and 3 on

MARKET CENTER

FOR SALE

BOOKS! Catalog of most exciting electronic and science books, **FREE!**, Box 596-J, Logan, Utah 84321. (800) 359-0466.

IS it true...Jeeps for \$44.00 through the U.S. government? Call for facts! (504) 649-5745 Ext. S-2677.

PLANS AND KITS

UNIQUE projects. Build an infrared motion detector, ultrasonic distance meter, digital rain gauge. Complete plans, PCB layout, \$4.00 each. Others available. **K. KEMP**, 13772 Goldenwest Street., #549, Westminster, CA 92683.

BUSINESS OPPORTUNITIES

LET the Government finance your small business. Grants/loans to \$500,000 yearly. Free recorded message: (707) 449-8600. (KS2)

WANTED

EASY work! Excellent pay! Assemble products at home. Call for information. (504) 641-8003. Ext. 2677.

EDUCATION/INSTRUCTION

MAGIC! Four illustrated lessons plus inside information shows you how. We provide almost 50 tricks including equipment for four professional effects. You get a binder to keep the materials in, and a one-year membership in the International Performing Magicians with a plastic membership card that has your name gold-embossed. You get a one-year subscription to our quarterly newsletter, "IT'S MAGIC!" Order now! \$29.95 for each course plus \$3.50 postage and handling. (New York residents add applicable state and local sales tax.) **THE MAGIC COURSE**, 500-B BiCounty B'ld., Farmingdale, NY 11735.

PC BOARD BASICS

continued from page 23

The only exception to that rule has to do with IC legs. Since all the IC's are going to be socketed (soldering IC's to the board is a really bad idea), and since the socket should sit flush against the surface of the board, it will be hard to solder the socket's pins on both sides of the board. You can use a wire-wrap socket and leave the socket slightly above the board, but the legs on a wire-wrap socket are thicker than normal, so you'll have

CABLE TV DESCRAMBLERS! BARGAIN HEADQUARTERS!



- JERROLD™ •TOCOM •HAMLIN
- OAK •ZENITH
- SCIENTIFIC ATLANTA

6 month warranty! We ship C.O.D.!
Lowest retail/wholesale prices!

FREE CATALOG:

Global Cable Network
1032 Irving St. Suite 109
S.F., CA 94122

NO CALIFORNIA SALES!!!

ORDER TODAY! 800-327-8544

Surface Mount Chip Component Prototyping Kits— Only \$49⁹⁵



CC-1 Capacitor Kit contains 365 pieces, 5 ea. of every 10% value from 1pf to 33µf. CR-1 Resistor Kit contains 1540 pieces; 10 ea. of every 5% value from 10Ω to 10 megΩ. Sizes are 0805 and 1206. Each kit is ONLY \$49.95 and available for Immediate One Day Delivery!

Order by toll-free phone, FAX, or mail. We accept VISA, MC, AMEX, COD, or Pre-paid orders. Company P.O.'s accepted with approved credit. Call for free detailed brochure.

COMMUNICATIONS SPECIALISTS, INC.
426 West Talt Ave. • Orange, CA 92665-4296
Local (714) 998-3021 • FAX (714) 974-3420

Entire USA 1-800-854-0547



TUBES - 2000 TYPES DISCOUNT PRICES!

Early, hard-to-find, and modern tubes. Also transformers, capacitors and parts for tube equipment. Send \$2.00 for 28 page wholesale catalog.

ANTIQUE ELECTRONIC SUPPLY
6221 S. Maple Ave. • Tempe, AZ 85283 • 602-820-5411

LASERS	
 New Laser Diodes \$15	 New Visible Diode Modules
Helium-Neon Laser Tubes from \$25	
FREE CATALOG CALL OR WRITE TODAY! COMPLETE HELIUM-NEON LASERS FROM \$110 ⁰⁰	
MEREDITH INSTRUMENTS PO Box 1724/Glendale, AZ 85311/(602)934-9387	

Cable TV Descramblers

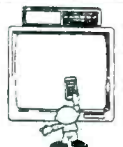

If you find a better deal, we'll better our deal.

*Jerrold *Tocom *Hamlin *Oak
*Scientific Atlanta *Zenith
Ask about our extended warranty program.

COD, Visa, M/C welcome.
Free Call — Free Catalog.

Video Tech **800-562-6884**

3702 S. Virginia St., Ste. 160-304
Reno, NV 89502.

to use larger pads to accommodate the larger holes. You could also use the more-expensive machined sockets.

Another alternative is to add a

LIGHT BEAM

continued from page 44

A completed light-beam communicator should also have both its transmitter and receiver aligned with one another. Just aim the communicator at a nearby wall, and you should see the light spot in the viewfinder of the re-

ceiver. Adjust if necessary. There are a lot of other "fun" uses for the light-beam communicator besides two-way communication. You can "listen" to an airplane flying overhead, or to waterfalls, waves, and sprinkler systems. Car headlights going past you also have their own sound. If an insect flies through another unit's light beam, you can actually hear its wings beating.

R-E

R-E

FREE CATALOG!

- Hard-to-find tools
- Tool kits ● Test equipment
- Soldering supplies
- Wire & cable testers
- Strippers ● Crimpers
- Computer & PCB accessories ● Cases
- Shipping containers

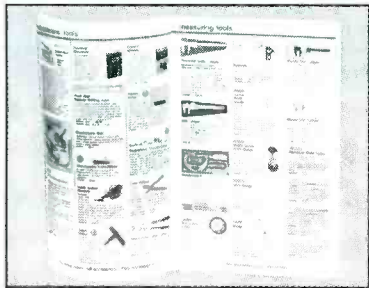

Attention electronic hobbyists, students, professional electrical/ electronic technicians! The new Jensen Catalog is your most complete source of tools, tool kits, and test equipment for all kinds of electrical and electronic projects.

As a valued Jensen customer, you will enjoy quality products and service, free technical support and rapid, no-charge delivery anywhere in the USA. For a free copy, write or call today.

JENSEN TOOLS INC. 7815 S. 46th Street
Phoenix, AZ 85044
(602) 968-6231
FAX (602) 438-1690

CIRCLE 54 ON FREE INFORMATION CARD

ATTENTION! ELECTRONICS TECHNICIANS

EARN YOUR
**B.S.E.E.
DEGREE**

THROUGH HOME STUDY

Our New and Highly Effective Advanced-Placement Program for experienced Electronic Technicians grants credit for previous Schooling and Professional Experience, and can greatly reduce the time required to complete Program and reach graduation. No residence schooling required for qualified Electronic Technicians. Through this Special Program you can pull all of the loose ends of your electronics background together and earn your B.S.E.E. Degree. Upgrade your status and pay to the Engineering Level. Advance Rapidly! Many finish in 12 months or less. Students and graduates in all 50 States and throughout the World. Established Over 40 Years! Write for free Descriptive Literature.

**COOK'S INSTITUTE
OF ELECTRONICS ENGINEERING**

4251 CYPRESS DRIVE
JACKSON, MISSISSIPPI 39212

CIRCLE 56 ON FREE INFORMATION CARD

and module 5 off, the sequence would be

- access code: "2," "6," "*" , or "#"
- address modules: "1," "3," "0," "5"

The PCC also works after a call has been placed or an incoming call is received. That way, if you hear a strange noise while talking on the phone, just activate the system as previously described. If you have an answering machine, you control the PCC the same way as if you were home. When the answering machine finishes its recorded message, enter the access code, then address the remote modules.

As a safeguard to the system, an internal timer monitors PCC activity. If PCC activity is suspended over four seconds, or the phone is being used to make an outside call, the PCC is temporarily inhibited and the access code must be reentered to enable it.

The PCC can indicate the remote module ON/OFF status for single remote module commands as well as when the "ALL LIGHTS ON" or "ALL LIGHTS OFF" function is addressed. For instance, if you program the controller to turn on modules 1, 2, and 5, LED's 1, 2, and 5 would light on the front panel. If the "ALL LIGHTS ON" command is used (function code 9), all eight LED's would light, unless you previously programmed only the light modules to turn on with that command. In that case, only the LED's corresponding to the light modules would light on the status indicator.

That's all there is to building and operating the PCC. We think you'll find this to be a handy addition to your electronic repertoire.

R-E

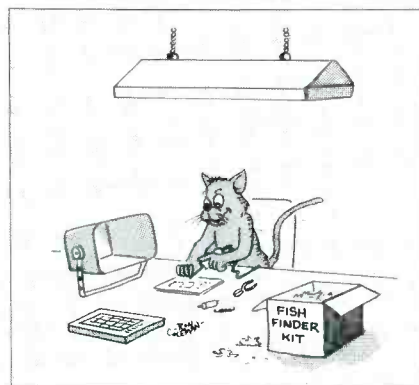

RGB to NTSC

continued from page 62

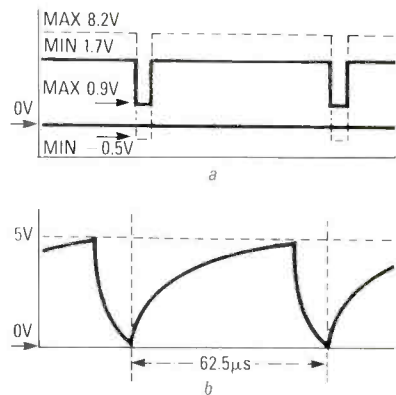

Fig. 7 WAVEFORMS OF A PROPERLY OPERATING CONVERTER. At (a) is the signal at pin 2; at (b), the signal at pin 1.

IC1 for the waveform shown in Fig. 7-a.

Image but no color. Check pins 3, 4, and 5 of IC1 to make sure that all three of the RGB signals are getting through. Check pin 1 of IC1 for the waveform shown in Fig. 7-b. If adjusting C1 has no effect, then the RC network R7/C13 is out of tolerance. Either replace C13 with a more accurate capacitor or place a trimmer potentiometer in series with R7, and adjust the trimmer until the waveform is correct.

Good luck and enjoy your new computer-TV screen. ♦CD♦



"It keeps spitting out the tapes? Maybe it just has better taste in movies."

TV TRANSMITTER

continued from page 20

put. Don't couple L9A too close to L9—just enough for about 1 volt across the 47-ohm resistor.

Final assembly

If you're building the 2-watt version, now is the time to install Q6 and Q7, and then L10 through L13. You may now install the chip capacitors C26, C28, C29, C30, and C31, but don't overheat them! Make sure that the PC board is tinned in the areas where chips are installed. The best way to install them is to first tack-solder one side to hold it down, solder the other side, and then go back and resolder the first (tack-soldered) side.

Figure 6 shows you how to solder chip components. Use a 25-watt iron with a pointed tip. Fine-point needle-nose pliers or tweezers should be used to manipulate the chip capacitors.

Finally, install C34 and a suitable length of small-diameter 50-ohm coax to J2. Check all joints for solder bridges. Make sure that the metal case of Q7 is soldered to the ground plane (top side), and connect its leads to the

PC-board underside using as little lead length as possible.

Apply power and quickly adjust C25, C27, and C33 for maximum power into a 50-ohm load connected to J2. You can use a 47-ohm, 2-watt carbon resistor, or the dummy load which can be assembled as shown in Fig. 7. An RF probe can be connected to the hot side of the resistors (center conductor of connector) to read the RF voltage, but an RF power meter is nice to have.

You should get at least 1.5 watts (about 8.5-volts RMS) into the 50-ohm load, which should become warm when operating. Power-supply current will be about 500 mA. Now adjust R33 for an output voltage about half that, or a quarter the power as read on the power meter, if used. Leave the RF load connected as you proceed to the next step.

For either the low- or high-power unit, adjust R33 for about +6 volts at point A (emitter of Q12). Connect a frequency counter to point A, and adjust C40 for exactly 4.500 MHz. Now apply video and audio signals to J3 and J1, respectively. Watch the transmitted image on a TV receiver tuned to the transmitter frequency; adjust the video gain (R32) for best picture

contrast and stability, then adjust the audio level (R22) until its level is comparable to a commercial station. Now alternately adjust R32 and R33 for maximum video contrast without seeing any side effects such as instability, audio buzz, or other evidence of clipping. You may also wish to go over all tuning adjustments again for best results. The finished PC board is shown in Fig. 8

Enclosure

Mount the PC board in a shielded metal-case, as shown in Fig. 9, and connect leads from the board to suitable jacks for J1, J2, or J2A, and J3. Also provide a suitable connector for the 12-volt supply, if desired. The transmitter case can house an AC supply, or batteries for portable operation. Use the right size *Ni-Cd* batteries to handle the 100-mA drain (low power), or 500-mA drain (2-watt unit). Use a BNC-type fitting for the antenna jack, J2.

A suitable antenna would be a 6-inch whip or a center-fed dipole, 12-inches long. For amateur TV, a linear amplifier may be installed between J2 and the antenna for greater power output. For the low-power version, use the 6-inch whip antenna. **R-E**

UNICORN - YOUR I.C. SOURCE!

EPROMS

COLLIMATOR PEN (INFRA-RED)



- Output: 2.5 mW (max.)
- Current: 90-150 mA
- Operating Voltage: 2.2-2.5V
- Wavelength: 820nm
- Collimation: .18mrad (typ.)
- Size: 11mm diameter

STOCK # PRICE
SB1052 \$39.99

LASER DIODE (INFRA-RED)



- Output: 10 mW (max.)
- Current: 90-150 mA
- Operating Voltage: 2.2-2.5V
- Wavelength: 820nm

STOCK # PRICE
SB1053 \$9.99

LASER DIODE (VISIBLE-RED)



- Output: 5 mW (max.)
- Current: 65-100 mA
- Operating Voltage: 1.75-2.2V
- Wavelength: 780nm

STOCK # PRICE
LS022 \$19.99

LASER DIODE (VISIBLE-RED)

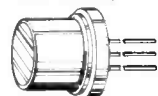

- Output: 4 mW (max.)
- Current: 20 mA
- Operating Voltage: 2.2-3.0V
- Wavelength: 665nm

STOCK # PRICE
LS3200 \$129.99

POWER SUPPLY

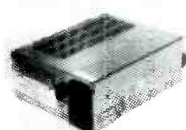

- Input: 115/230v
- Size 7" L x 5 1/4" W x 2 1/2" H
- Output: +5 volts @ 3.75 amps
- Output: +12 volts @ 1.5 amps
- Output: -12 volts @ .4 amps

STOCK # PRICE
PS1003 \$19.99

STOCK #	PINS	DESCRIPTION	1-24	25-99	100+
1702	24	256 x 4 1us	3.99	3.79	3.41
2708	24	1024 x 8 45ns	6.49	6.17	5.55
2716	24	2048 x 8 450ns (25v)	3.29	3.13	2.82
2716-1	24	2048 x 8 350ns (25v)	3.79	3.60	3.24
TMS2716	24	2048 x 8 450ns	6.29	5.98	5.38
27C16	24	2048 x 8 450ns (25v-CMOS)	3.99	3.79	3.41
2732	24	4096 x 8 450ns (25v)	3.79	3.60	3.24
2732A-2	24	4096 x 8 200ns (21v)	3.79	3.60	3.24
2732A	24	4096 x 8 250ns (21v)	3.69	3.51	3.16
2732A-4	24	4096 x 8 450ns (21v)	3.19	3.03	2.73
TMS2532	24	4096 x 8 450ns (25v)	5.79	5.50	4.95
TMS2532P	24	4096 x 8 450ns (25v-One Time Programmable)	1.99	1.89	1.70
27C32	24	4096 x 8 450ns (25v-CMOS)	4.19	3.98	3.58
2764-20	28	8192 x 8 200ns (21v)	3.99	3.79	3.41
2764	28	8192 x 8 250ns (21v)	3.79	3.60	3.24
2764A-20	28	8192 x 8 200ns (12.5v)	3.99	3.79	3.41
2764A	28	8192 x 8 250ns (12.5v)	3.29	3.13	2.82
TMS2564	28	8192 x 8 250ns (25v)	6.79	6.45	5.81
27C64	28	8192 x 8 250ns (21v-CMOS)	4.19	3.98	3.58
27128-20	28	16,384 x 8 200ns (21v)	5.79	5.50	4.95
27128	28	16,384 x 8 250ns (21v)	5.09	4.84	4.35
27128A	28	16,384 x 8 250ns (21v)	5.79	5.50	4.95
27C128	28	16,384 x 8 250ns (21v)	5.79	5.50	4.95
27256-20	28	32,768 x 8 200ns (12.5v)	5.29	5.03	4.53
27256	28	32,768 x 8 250ns (12.5v)	4.79	4.55	4.09
27C256	28	32,768 x 8 250ns (12.5v)	5.29	5.03	4.53
27512-20	28	65,536 x 8 200ns (12.5v)	7.49	7.12	6.41
27512	28	65,536 x 8 250ns (12.5v)	6.99	6.64	5.98
27C512	28	65,536 x 8 250ns (12.5v-CMOS)	6.99	6.64	5.98
27C1024	32	131,072 x 8 200ns (12.5v-CMOS)	17.99	17.09	15.38
68764	24	8192 x 8 450ns	13.99	13.29	11.96
68766	24	8192 x 8 450ns	14.99	14.24	12.82



10010 Canoga Ave., Unit B-8 • Chatsworth, CA 91311
 OUTSIDE CALIFORNIA: (800) 824-3432 (Orders Only)
 IN CALIFORNIA: (818) 341-8833
 ORDER BY FAX: (818) 998-7975

Minimum Order \$15.00

ADVERTISING INDEX

RADIO-ELECTRONICS Experimenter's Handbook does not assume any responsibility for errors that may appear in the index below.

Free Information Number		Page
58	All Electronics Corp.	157
—	CIE	7
50	C&S Sales, Inc.	C2
—	Command Productions	155
56	Cook's Institute	162
53	Datak Corporation	159
—	Electronics Book Club	5
—	Electronic Tech. Today	21
55	Electronic Warehouse Corp.	155
52	Heath	44
57	Information Unlimited	157
54	Jensen Tools	162
59	Mondotronics	159
—	NRI	3
51	Unicorn Electronics	163
—	Windjammer	C3

ADVERTISING SALES OFFICE

Gernsback Publications, Inc.
 500-B Bi-County Blvd.
 Farmingdale, NY 11735
 1-(516) 293-3000
 President: **Larry Steckler**
 Vice President: **Cathy Steckler**

For Advertising ONLY
 516-293-3000
 Fax 1-516-293-3115
Larry Steckler
 publisher

Arline Fishman
 advertising director
Denise Haven
 advertising assistant
Christina Estrada
 advertising associate
Kelly McQuade
 credit manager

Subscriber Customer Service
 1-800-288-0652
Order Entry for New Subscribers
 1-800-999-7139
 7:00 AM - 6:00 PM M-F MST

SALES OFFICES

EAST/SOUTHEAST
Stanley Levitan, Eastern Sales Manager
 Radio-Electronics
 259-23 57th Avenue
 Little Neck, NY 11362
 1-718-428-6037, 1-516-293-3000
 Fax 1-718-225-8594

MIDWEST/Texas/Arkansas/Okla.
Ralph Bergen, Midwest Sales Manager
 Radio-Electronics
 540 Frontage Road—Suite 339
 Northfield, IL 60093
 1-708-446-1444
 Fax 1-708-446-8451

PACIFIC COAST/ Mountain States
Marvin Green, Pacific Sales Manager
 Radio-Electronics
 5430 Van Nuys Blvd, Suite 316
 Van Nuys, CA 91401
 1-818-986-2001
 Fax 1-818-986-2009

VCR REPAIR

continued from page 126



FIG. 6—A TYPICAL LOADING GEAR train is usually covered by a protective plastic guard that must be removed for servicing. This gear train is on the bottom of the chassis.

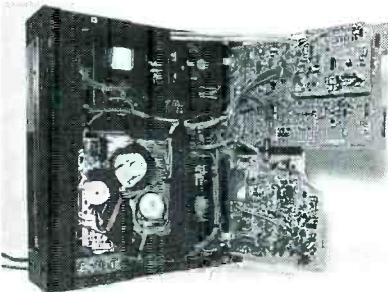

FIG. 7—A VCR IN ITS SERVICE POSITION. A mirror on your workbench surface will allow you to see both sides of the VCR simultaneously.

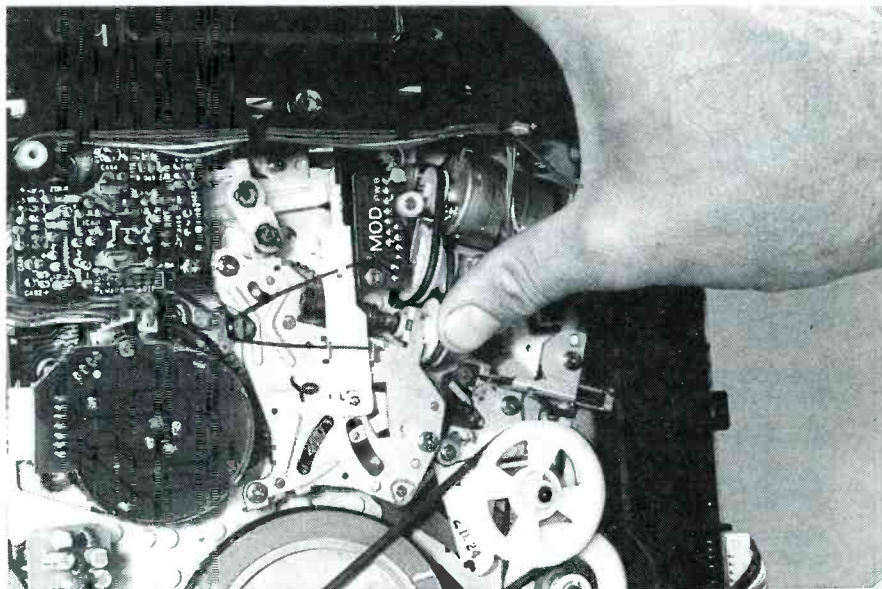

FIG. 8—A MALFUNCTIONING LOAD BELT is can be tested by "assisting" the load process with your finger.

cause the load to be aborted. If that's the case, you have to dismantle the assembly, clean off the dried-up lubricant, and apply a fresh coat. It is best to use a cleaner like acetone for removing the old lubricant. It is also a good idea to first take a photo or make a quick sketch of an assembly before dismantling it for cleaning, so that everything goes back correctly. Many times there will be small alignment arrows imprinted on the gears themselves—pay careful attention to any arrows, as they must be exactly aligned during reassembly.

If the load belt appears to be good, and there is no dried-up lubricant, then you have to inspect the load gears for any signs of cracking—especially hairline cracks. Any gears that show signs of cracking must be replaced. Note that load motors do not usually go bad, but if there is excess freedom of shaft movement, or any signs of excessive friction in the motor, it may have to be replaced.

Another quick test of the load system is to perform a tape "load" by hand, with the unit unplugged and no tape inserted. That will provide an unobstructed view of the loading mechanisms as they operate. Also, the loading process will be greatly slowed down, so you'll be able to see—and perhaps even feel—exactly

Sometimes the lubricant that is applied in sliding tracks and to various components dries up and hardens. That can cause much added friction for the load components, and may

when a problem occurs. Then you can determine which part might be causing it to happen. To perform the test, turn the load-motor shaft by hand and observe the unit's operation. **R-E**

Countersurveillance

Never before has so much professional information on the art of detecting and eliminating electronic snooping devices—and how to defend against experienced information thieves—been placed in one VHS video. If you are a Fortune 500 CEO, an executive in any hi-tech industry, or a novice seeking entry into an honorable, rewarding field of work in countersurveillance, you must view this video presentation again and again.

Wake up! You may be the victim of stolen words—precious ideas that would have made you very wealthy! Yes, professionals, even rank amateurs, may be listening to your most private conversations.

Wake up! If you are not the victim, then you are surrounded by countless victims who need your help if you know how to discover telephone taps, locate bugs, or “sweep” a room clean.

There is a thriving professional service steeped in high-tech techniques that you can become a part of! But first, you must know and understand Countersurveillance Technology. Your very first insight into this highly rewarding field is made possible by a video VHS presentation that you cannot view on broadcast television, satellite, or cable. It presents an informative program prepared by professionals in the field who know their industry, its techniques, kinks and loopholes. Men who can tell you more in 45 minutes in a straightforward, exclusive talk than was ever attempted before.

Foiling Information Thieves

Discover the targets professional snoopers seek out! The prey are stock brokers, arbitrage firms, manufacturers, high-tech companies, any competitive industry, or even small businesses in the same community. The valuable information they filch may be marketing strategies, customer lists, product formulas, manufacturing techniques, even advertising plans. Information thieves eavesdrop on court decisions, bidding information, financial data. The list is unlimited in the mind of man—especially if he is a thief!

You know that the Russians secretly installed countless microphones in the concrete work of the American Embassy building in Moscow. They converted

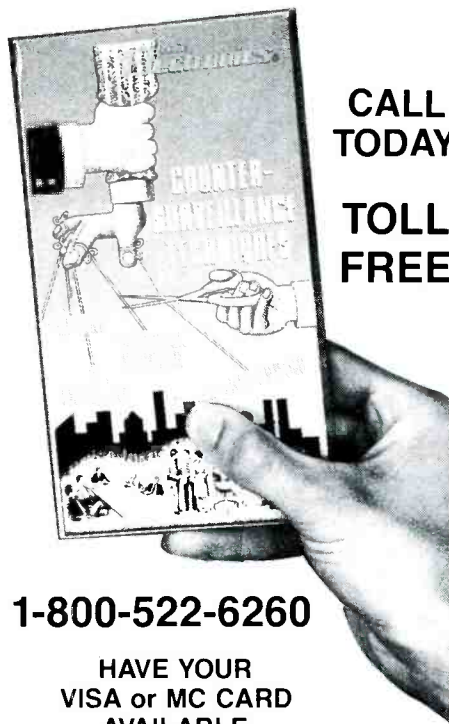

1-800-522-6260

**HAVE YOUR
VISA or MC CARD
AVAILABLE**

what was to be an embassy and private residence into the most sophisticated recording studio the world had ever known. The building had to be torn down in order to remove all the bugs.

Stolen Information

The open taps from where the information pours out may be from FAX's, computer communications, telephone calls, and everyday business meetings and lunchtime encounters. Businessmen need counselling on how to eliminate this information drain. Basic telephone use coupled with the user's understanding that someone may be listening or recording vital data and information greatly reduces the opportunity for others to purloin meaningful information.

RADIO-ELECTRONICS VIDEO OFFER

EEHB

500-B Bi-County Blvd.
Farmingdale, NY 11735

Please rush my copy of the Countersurveillance Techniques Video VHS Cassette for \$49.95 plus \$4.00 for postage and handling.

No. of Cassettes ordered _____

Amount of payment \$ _____

Bill my VISA MasterCard

Card No. _____

Expire Date _____ / _____

Signature _____

Name _____

Address _____

City _____ State _____ ZIP _____

All payments in U.S.A. funds. Canadians add \$4.00 per VHS cassette. No foreign orders. New York State residents add applicable sales tax.

The professional discussions seen on the TV screen in your home reveals how to detect and disable wiretaps, midget radio-frequency transmitters, and other bugs, plus when to use disinformation to confuse the unwanted listener, and the technique of voice scrambling telephone communications. In fact, do you know how to look for a bug, where to look for a bug, and what to do when you find it?

Bugs of a very small size are easy to build and they can be placed quickly in a matter of seconds, in any object or room. Today you may have used a telephone handset that was bugged. It probably contained three bugs. One was a phony bug to fool you into believing you found a bug and secured the telephone. The second bug placates the investigator when he finds the real thing! And the third bug is found only by the professional, who continued to search just in case there were more bugs.

The professional is not without his tools. Special equipment has been designed so that the professional can sweep a room so that he can detect voice-activated (VOX) and remote-activated bugs. Some of this equipment can be operated by novices, others require a trained countersurveillance professional.

The professionals viewed on your television screen reveal information on the latest technological advances like laser-beam snoopers that are installed hundreds of feet away from the room they snoop on. The professionals disclose that computers yield information too easily.

This advertisement was not written by a countersurveillance professional, but by a beginner whose only experience came from viewing the video tape in the privacy of his home. After you review the video carefully and understand its contents, you have taken the first important step in either acquiring professional help with your surveillance problems, or you may very well consider a career as a countersurveillance professional.

The Dollars You Save

To obtain the information contained in the video VHS cassette, you would attend a professional seminar costing \$350-750 and possibly pay hundreds of dollars more if you had to travel to a distant city to attend. Now, for only \$49.95 (plus \$4.00 P&H) you can view *Countersurveillance Techniques* at home and take refresher views often. To obtain your copy, complete the coupon below or call toll free.

East of the sun. West of the moon. Windjammer.



A place to live your fantasies.
A place to free your soul.

To cozy up to the Caribbean sun.
To dance among a thousand stars
to the rhythms of steel drums.
To play on sparkling white and
pink sand beaches.
To discover the underwater
paradise of the reefs.
To find a new friend and share the
intimacies of a sensuous night.

To come alive and live.
To remember for a lifetime.
6 days and 6 nights. From \$675.

Reservations toll free
1-800-327-2600
In Florida 305/373-2090.

**Windjammer
Barefoot Cruises**

Post Office Box 120.
Miami Beach, Florida 33119.



Cap'n Mike, rush me my free, full color 'Great Adventure' booklet and show
me the way to Paradise for 6 days and 6 nights from \$675.
Windjammer 'Barefoot' Cruises.
P.O. Box 120, Dept. 1642 Miami Beach, Fla. 33119.

Name _____
Address _____
City _____
State/Zip _____