

Electronics NOW

NEW SECTION!
Prototype
A Look At Tomorrow's Technology



Build a Multichannel Oscilloscope Trigger

Troubleshoot and debug even the most complex digital circuits with a standard scope and this accessory

A Precision Voltage/Current Reference

Build one and perform lab-grade measurements on your own workbench

Build a POCSAG Encoder

Create your own pager messages

The Great Compression

MPEG is what makes today's high-capacity multimedia possible; here's how it works

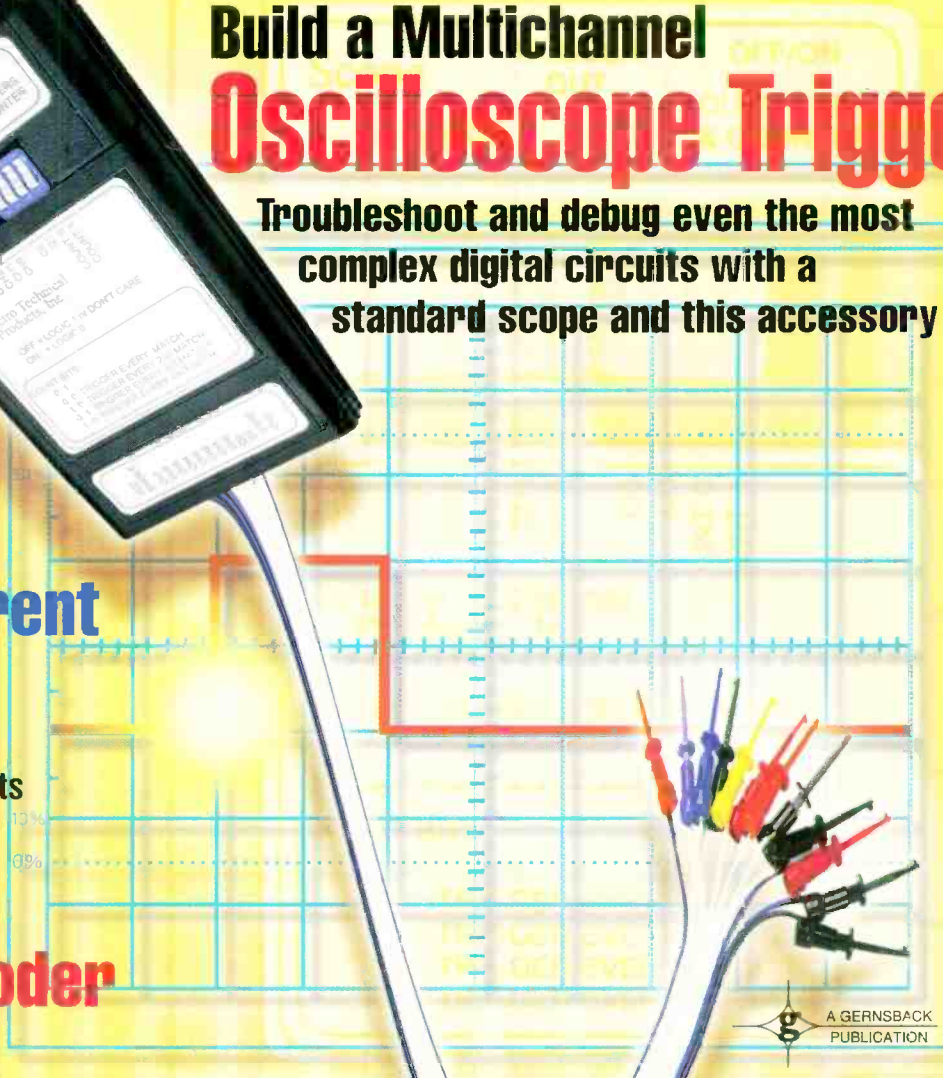

\$4.50 U.S.
\$4.99 CAN.

A GERNSBACH PUBLICATION

#BXNBQMF***** 5-DIGIT 21046
#DHM951SR093 7#460734
OAS12
APR 98
91EN
ROBERT DAHM
9515 RED RAIN PATH
COLUMBIA MD
21046-2073

Professional Power

at a hobbyist price.

That has been our philosophy at MicroCode Engineering since 1987. So it's no surprise that **CircuitMaker** and **TraxMaker** are the leading software tools for affordable, easy-to-use circuit design, simulation and PCB layout.

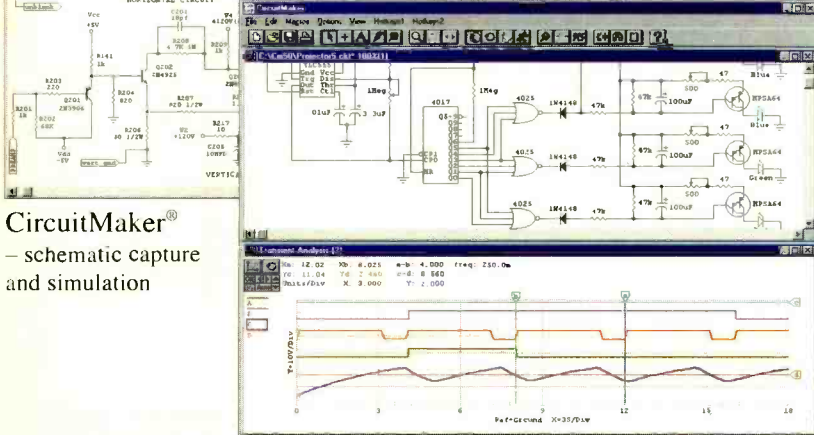
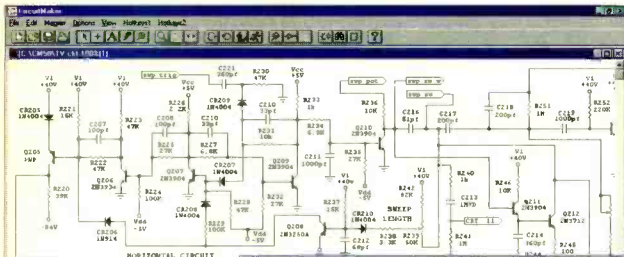

CircuitMaker®
– schematic capture
and simulation

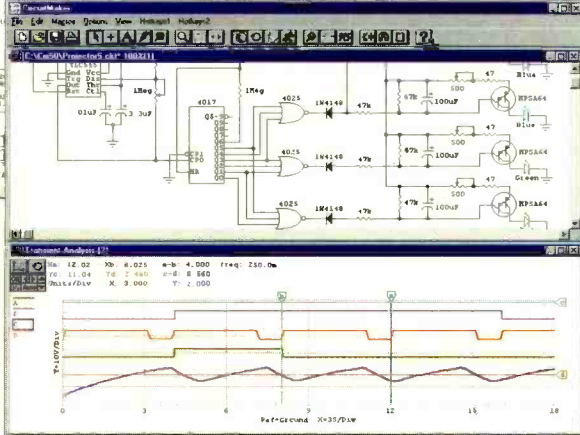

QUICKLY DESIGN analog, digital or mixed analog/digital circuits with CircuitMaker's advanced schematic features. You fully control the wiring, device placement, annotation and colors. And the Symbol Editor and macro features let you create unlimited custom devices and symbols.

SIMULATE and **ANALYZE** what you create – try all the “what if” scenarios with:

- Fast, proven 32-bit SPICE 3f5/XSpice simulator
- True mixed analog/digital simulation
- Fully interactive digital logic simulation
- 4,000-device library
- AC Frequency Analysis
- DC Operating Point Analysis
- DC Transfer Function
- Transient Analysis
- Step Function – step component values and sources over a user-definable range

TraxMaker® – PCB layout and autorouting

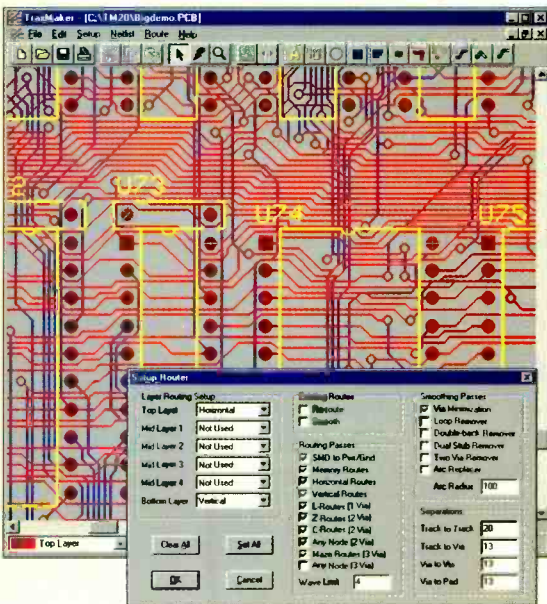

TAKE MEASUREMENTS at any point in the circuit with a click of the Probe tool. Results appear immediately on virtual instruments like the Digital Oscilloscope, Curve Tracer, Digital Multimeter and Bode Plotter. No other simulator lets you take measurements as quickly and easily as CircuitMaker.

COMPLETE the design process with TraxMaker, a professional printed circuit board layout program with built-in autorouter. Import netlists from CircuitMaker and other schematic programs, or design boards from scratch.

- Includes autorouter, auto component placement and Design Rules Check
- Supports up to 8 copper layers, board sizes up to 32 x 32 inches
- Surface mount and through-hole components from a customizable library
- Outputs your PCB as a Gerber file, Excellon N/C drill file, and prints to any Windows-selectable printer or plotter

RELY ON free technical support from qualified engineers. And every MicroCode product is backed by our **30-day Money-Back Guarantee** if it does not live up to your expectations.

Call 800-419-4242 for more information and free demos

(or download from www.microcode.com)

CIRCLE 171 ON FREE INFORMATION CARD

CircuitMaker Version 5 \$299

TraxMaker Version 2 \$299

CircuitMaker Design Suite™ \$549

(CircuitMaker and TraxMaker)

CONTENTS

FEBRUARY 1998

ON THE COVER**33 BUILD A MULTICHANNEL OSCILLOSCOPE TRIGGER**

While an oscilloscope is among the most useful pieces of test gear one could own, there are times it falls short of our needs, such as when troubleshooting a computer or another complex digital circuit. For example, have you ever tried to confirm that data was being written to the correct address or that the correct bit is being set during a memory operation, using just a standard, two-channel scope? Impossible, you say? Well, not anymore—thanks to this month's cover story. If you troubleshoot digital electronics, this is one accessory that you just can't do without.

— *Thomas Peterick*

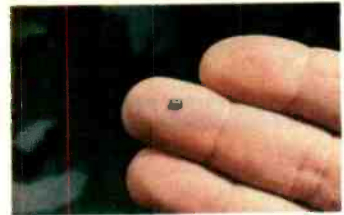
**TECHNOLOGY****13 PROTOTYPE**

Tiny medical sensors, 50-inch high-definition plasma TVs, using space technology to treat tumors, and more.

37 THE GREAT COMPRESSION
MPEG is what makes many of today's high-capacity multimedia technologies possible; here's how it works.
— *Yasuda Hiroshi*

46 RESTORING A "REEL" RECORDER



Bring those marvelous open-reel recorders of yesteryear back to life. — *Phil Van Praag*

As a service to readers, ELECTRONICS NOW publishes available plans or information relating to newsworthy products, techniques and scientific and technological developments. Because of possible variances in the quality and condition of materials and workmanship used by readers, ELECTRONICS NOW disclaims any responsibility for the safe and proper functioning of reader-built projects based upon or from plans or information published in this magazine.

Since some of the equipment and circuitry in ELECTRONICS NOW may relate to or be covered by U.S. patents, ELECTRONICS NOW disclaims any liability for the infringement of such patents by the making, using, or selling of any such equipment or circuitry, and suggests that anyone interested in such projects consult a patent attorney.

ELECTRONICS NOW, (ISSN 1067-9294) February 1998. Published monthly by Gernsback Publications, Inc., 500 Bi-County Boulevard, Farmingdale, NY 11735-3931. Periodicals Postage paid at Farmingdale, NY and additional mailing offices. Canada Post IPM Agreement No. 334103, authorized at Mississauga, Canada. One-year subscription rate U.S.A. and possessions \$19.97, Canada \$27.79 (includes G.S.T. Canadian Goods and Services Tax, Registration No. R125166280), all other countries \$28.97. All subscription orders payable in U.S.A. funds only, via International postal money order or check drawn on a U.S.A. bank. Single copies \$4.50. © 1997 by Gernsback Publications, Inc. All rights reserved. Printed in U.S.A.

POSTMASTER: Please send address changes to ELECTRONICS NOW, Subscription Dept., Box 55115, Boulder, CO 80328-5115.

A stamped self-address envelope must accompany all submitted manuscripts and/or artwork or photographs if their return is desired should they be rejected. We disclaim any responsibility for the loss or damage of manuscripts and/or artwork or photographs while in our possession or otherwise.

BUILD THIS

42 BUILD THIS POCSAG ENCODER

Generate your own pager signals with your computer and this simple interface.

— *Robert B. Whitaker*

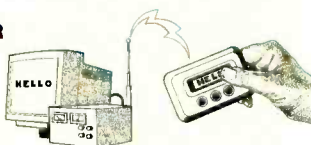

51 BUILD THIS PRECISION VOLTAGE/CURRENT REFERENCE

Perform laboratory-grade measurements on your own workbench.

— *Skip Campisi*

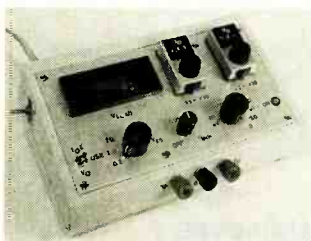

DEPARTMENTS

11 EQUIPMENT REPORT

Nomai 750.c portable SCSI hard drive.



12 COMPUTER CONNECTIONS

Pilot port I/O.

— *Jeff Holtzman*

22 TECH MUSINGS

A tiny TV test generator, investigating Brown's Gas, and more.

— *Don Lancaster*



63 SERVICE CLINIC

How printers and copiers work.

— *Sam Goldwasser*

66 AUDIO UPDATE

Build a capacitance-substitution box. — *Franklin J. Miller*

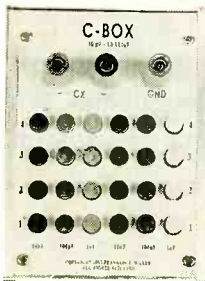

AND MORE

4 EDITORIAL

5 Q&A

8 LETTERS

28 NEW PRODUCTS

60 NEW LITERATURE

106 ADVERTISING INDEX

106 ADVERTISING SALES OFFICE

Electronics NOW®

Hugo Gernsback (1884-1967) founder

LARRY STECKLER, EHF, CET,
Editor-in-chief and publisher
ADRIA COREN, Vice-President
KEN COREN, Vice-President

EDITORIAL DEPARTMENT

CARL LARON, editor
JOSEPH J. SUDA, technical editor
JULIAN S. MARTIN, associate editor
EVELYN ROSE, assistant editor
TERI SCADUTO, assistant editor
MICHAEL A. COVINGTON, N4TMI
contributing editor
SAM GOLDWASSER, service editor
JEFFREY K. HOLTZMAN,
computer editor
FRANKLIN J. MILLER,
audio editor
DON LANCASTER,
contributing editor
DEBBIE CYBULA, editorial assistant

ART DEPARTMENT

ANDRE DUZANT, art director
RUSSELL C. TRUELSON, illustrator

PRODUCTION DEPARTMENT

RUBY M. YEE, production director
KATHRYN R. CAMPBELL,
production assistant
KEN COREN,
desktop production director
LISA BAYNON, desktop production
MELISSA GIORDANO, desktop production

CIRCULATION DEPARTMENT

THERESA LOMBARDO,
circulation manager
GINA GALLO,
circulation assistant

REPRINT DEPARTMENT

MARIE FALCON, reprint bookstore

Typography by Mates Graphics

Electronics Now is indexed in *Applied Science & Technology Index*, and *Readers Guide to Periodical Literature*, *Academic Abstracts*, and *Magazine Article Summaries*.

Microfilm & Microfiche editions are available. Contact reprint bookstore for details.

Advertising Sales Offices listed on page 106.

Electronics Now Executive and Administrative Offices
1-516-293-3000.

Subscriber Customer Service:
1-800-999-7139.

7:00 AM-6:00 PM Monday-Friday MST

VISIT US ON THE INTERNET AT:
www.gernsback.com



Audit Bureau of Circulations
Member

JAMECO - Your One Stop Component & Computer Source

Special Prices for Electronics Now Readers. Please mention VIP #2R8!

JAMECO 75MHz Barebones Pentium® System



Monitor, video card and hard drive not included

- 16MB of RAM upgradeable to 128MB
- 256KB cache RAM, upgradeable to 512K
- Hard disk and floppy I/O controller card
- Four exposed bays (two 5.25", two 3.5"); one internal 3.5" bay
- Includes keyboard, mouse and cables
- 3.5" floppy drive
- Four PCI slots and three ISA slots

Part No.	Description	Price
146499	75MHz Pentium® Sys. [Special]	\$299.95

Component Cabinet Kits

Kits include the most popular components with extra space for your customized expansion. Each kit includes a 20 drawer component cabinet.



More kits available - call for details!

Part No.	Description	Price
84953	330 pc. 7400 series IC kit	\$152.95
84961	420 pc. 74LS series IC kit	119.95
84970	300 pc. CD4000 series IC kit	84.95
84988	385 pc. Linear series IC kit	159.95
108329	540 pc. 1/8 watt Resistor kit	29.95
81832	540 pc. 1/4 watt Resistor kit	28.95
107879	540 pc. 1/2 watt Resistor kit	32.95
108433	2200 pc. Electr. Hardware kit	39.95
81867	110 pc. Radial Capacitor kit	34.95
81859	320 pc. Ceramic Capacitor kit	29.95
81883	160 pc. Mylar Capacitor kit	34.95
81841	129 pc. Tantalum Capac. kit	49.95
82587	270 pc. Diode kit	39.95
82595	180 pc. Transistor kit	49.95

PCI I/O Card

- PCI bus
- PnP ready
- Software support for DOS, Windows® 95
- One-year warranty

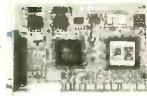

Part No.	Description	Price
146675	1 parallel, 2 serial ports	\$139.95

Linear IC Tester

Identify and test op amps, comparators, optocouplers, transistor arrays, analog switches and voltage regulators.



Part No.	Description	Price
130147	Linear IC tester	\$699.95 \$649.95

Digital Display Soldering Station

- Electronic temperature control from 200°F to 878°F
- Zero-voltage thyristor switching protects voltage and current sensitive devices such as CMOS ICs against voltage spikes
- Power consumption: 60 watts
- UL listed • Includes one 1/16" tip



Part No.	Description	Price
35351	Soldering Stat.	\$129.95 \$116.95

METEX® 4 1/2-Digit Multimeter with Computer Interface

- 4 1/2-digit LCD (5 1/2 high digits)
- AC voltage/resolution: 200mV/10µV to 750V/100mV
- DC voltage/resolution: 200mV/10µV to 1000V/100mV
- AC & DC current/resolution: 2mA/100mA to 20A/1mA
- Measures hFE, diode/continuity, capacitance and frequency
- One-year warranty



Part No.	Description	Price
144872	4 1/2-digit meter	\$169.95 \$152.95

JKL Single Lead Tipless Type Fluorescent & Ultra Violet Lamps



- 142244 Fluorescent:
- Starting Volt.: 390 (Vrms)
 - Intensity: 3500 (nt)
 - Lamp Current: 5mA (12 max.)
 - Size (L x Dia.): 2.0" x 25"

- 142965 Ultra Violet:
- Starting Volt.: 900 (Vrms)
 - Total Output Flux: .25mW/cm²@1"
 - Lamp Current: 2.5mA
 - Size (L x Dia.): 2.0" x 12"

Part No.	Description	1-9	10-49	25-49
142244	Fluorescent lamp	\$12.95	\$11.49	\$9.95
142965	Ultra violet lamp	12.95	11.49	9.95
142252	12VDC lamp power supply	19.95	17.95	15.95

OMI One Touch Selectable Gear Box Kit

- One touch slide switch with 6 gear ratio possibilities: 6.8:1 to 807.93:1



Part No.	Description	1-4	5-9
145509	Selectable gear box	\$14.95	\$13.49

DATA I/O Universal 8KB-8MB EPROM Programmer

Parallel Port, DOS/Win 3.1/Win® 95

- Operating voltage: 100/110/220/240VAC
- Programs 8 and 16-bit EPROMs up to 8MB, paged EPROMs, EEPROMs, serial EEPROMs (including 8-pin), flash devices, NVRAMs, bi-polar PROMs, PALs, GALs, PEELs, PALCes, EPLDs
- Package supports DIPs up to 48-pin
- Robust memory and logic editing features



Part No.	Description	Price
145365	EPROM programmer	\$999.95

JAMECO IC Function Tester/Emulator

- Any DIP type IC up to 40-pins can be inserted into the universal TEST TOOL socket for function emulation
- A 360 tie point solderless bread-board provides free wiring space for any additional circuits
- Size: 10.0"L x 6.5"W x 1.5"H
- Weight: 1.5 lbs. • One-year warranty



Part No.	Description	Price
111907	Tester/emulator	\$39.95

ECG® Master Replacement Guide and Software (1996)

The Guide features approx. 294,000 crosses and over 390 new devices.

New Instant Cross software gives ECG® replacement, description, case style, and special notes. Over 4,000 ECG® products • Wt. (Guide): 2.5 lbs.



Part No.	Description	Price
146819	ECG Master Replacement Guide	\$9.95
146801	ECG Instant Cross software	9.95

PIC-SERVO Motor Control Chip Set

A Complete Motion Control System on a Chip

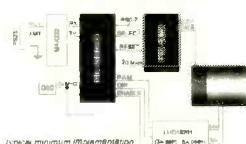

- P.I.D. servo control for DC motors with incremental encoders
- Position, velocity and PWM control modes
- 32-bit resolution acceleration and velocity profiling
- Standard serial interface supports multi-drop networking
- Full documentation, test software and technical support available from the J.R. KERR PROTOTYPE DEVELOPMENT web site: "www.jrkerr.com"

Part No.	Description	Price
146472	PIC-SERVO Chip Set	\$34.95

Jameco 66 Piece Tool Kit

A comprehensive set of tools for field technicians, engineers and lab personnel. Aluminum case features removable pallets, surface-type locks, a black plastic handle, side buckles and strap.



Part No.	Description	Price
105646	66 piece tool kit	\$169.95

OMI Spider Advanced Kit

A robot that moves about avoiding obstacles by infrared ray sensing system. The infrared ray sensing system, composed of infrared ray emitter and infrared ray receiver, finds obstacles to go around and changes its direction.



Part No.	Description	1-4	5-9
140821	Spider advanced kit	\$59.95	\$53.95

Robotics 14.4kbps Data/Fax Internal Modem

- Supports 14.4 down to 300 bps of data
- Compatible with ITU-T standard
- System requirements: 139871 486 or Pentium®, Windows® 3.xx to Win® 95, 4MB RAM, 2MB hard disk space
- One-year warranty



Part No.	Description	Price
139871	14.4 int. modem	\$34.95
145015	33.6 int. modem	59.95
146587	Compat. X2 int. modem	Special 99.95
145023	K56 Flex int. modem	Special 99.95
145031	K56 Flex ext. modem	Special 119.95
137998	14.4 int. modem (w/voice)	44.95
141292	28.8 ext. modem	79.95
136864	33.6 int. modem (SAVD)	79.95
136872	33.6 ext. modem (SAVD)	119.95

Jameco Solderless Breadboards

- Low static plastic body - CMOS safe
- Nickel plated clips designed to withstand up to 5,000 insertion cycles



Part Number	Contact Points	Size L x W	1-9	10-49
94457	100	6.5 x 0.4	\$2.49	\$2.25
20600	400	3.3 x 2.1	4.95	4.49
136901	1,600	5.5 x 2.3	21.95	19.95
20669	630	6.5 x 1.4	5.49	4.95
20722	830	6.5 x 2.1	7.95	6.95
20757	1,360	6.5 x 3.1	11.95	10.95
20773	1,660	6.5 x 4.3	17.95	15.95
20790	2,390	6.9 x 5.8	22.95	20.49
20811	3,220	7.3 x 7.5	30.95	27.95

Jameco Powered Project Board

- DC power: +5V@1A, variable power 0-15V @ 500mA
- Input power: 120VAC @ 60Hz
- Back panel has ground terminal
- Outputs are short circuit protected
- Solderless breadboard with 2420 tie points
- Breadboard size: 7.4"L x 6.8"W
- Box size: 9.8"L x 8.0"W x 2.6"H
- Weight: 6.8 lbs. • One-year warranty



Part No.	Description	Price
136258	Powered breadbrd	\$99.95 \$89.95

Roadrunner External 16X CD-ROM

- 486SX or better compatibles
- Can daisychain up to 8 compatible devices plus a printer via pass-through connector
- Includes power adapter and parallel cable



Part No.	Description	Price
145322	Ext. 16X CD-ROM	Special \$229.95

JAMECO ELECTRONIC COMPONENTS COMPUTER PRODUCTS

© 1998 Jameco 2/98
Order Toll Free 24-Hours 7-Days a Week!

1355 Shoreway Road Belmont, CA 94002-4100
FAX: 1-800-237-6948 (Domestic)
FAX: 650-592-2503 (International)
E-mail: info@jameco.com
http://www.jameco.com



Mention V.I.P.# 2R8

Call 1-800-831-4242 day or night!

Accredited B.S. Degree in Computers or Electronics

by studying at Home

Grantham College of Engineering
offers 3 distance education programs:

- B.S.E.T. emphasis in Electronics
- B.S.E.T. emphasis in Computers
- B.S. in Computer Science

NEW!
-Electronics Workbench Professional 5.0
included in our B.S.E.T. curriculums
-Approved by more than 200 Companies,
VA and Dantes, (tuition assistance avail.)

For your free catalog of our programs dial
1-800-955-2527

<http://www.grantham.edu>

GCE

Your first step
to help yourself
better your future!



Grantham College of Engineering
34641 Grantham College Road
Slidell, LA 70460-6815

ANTIQUÉ RADIO CLASSIFIED Free Sample!

Antique Radio's
Largest Circulation Monthly.
Articles, Ads & Classifieds.



6-Month Trial: \$19.95 1-Yr: \$38.95 (\$55.95-1st Class).
A.R.C., P.O. Box 802-L19, Carlisle, MA 01741
Phone:(508) 371-0512 VISA/MC Fax:(508) 371-7129

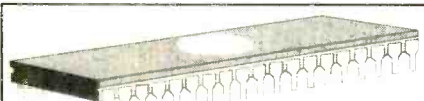

CABLE CONVERTER DIAGNOSTIC TEST CHIP

LOAD FULL ACTIVATION OF CABLE CONVERTER

**WE STOCK A COMPLETE LINE OF CHIPS, TOOLS,
WIRELESS QUICK INSTALL TEST BOARDS AND
DIAGNOSTIC CUBES FOR ALL CONVERTERS!**

*****ANYONE IMPLYING ILLEGAL USE WILL BE ***
DENIED SALE. WE SELL PRODUCTS ONLY!! TO
TECHNICIANS OR CABLE REPAIR FACILITIES!!**

#1 IN CUSTOMER SERVICE & TECH. SUPPORT!

***ALL ORDERS SHIP WITHIN 24HRS, UPS/ FED-X.**

***PRIORITY NEXT DAY SHIPPING AVAILABLE!**

***SALE= BUY 5 TEST BOARDS AND GET 1 FREE.**

***MON-FRI - 8AM-7PM - SAT 10AM-2PM EST.**

***WEB PAGE [HTTP://WWW.800-GOCABLE.COM](http://www.800-gocable.com)**



VISUAL

COMMUNICATIONS INC.

**ORDERS/CATALOG 1-800-GO-CABLE
TOLL FREE TECH. DEPT. 1-888-519-TECH EST. 1976**

EDITORIAL

Unanswerable FAQs

In the nearly 17 years I've been associated with Gernsback Publications, I've fielded hundreds, if not thousands, of reader questions. Most can be answered quickly and efficiently. Others simply can't be answered. Of course, as you might expect, it's the unanswerable ones that seem to come up time after time. Here are some examples of the frequently-asked questions (FAQs) we can't answer:

I need a circuit to . . . We get a few of these a week, sometimes with detailed specifications and notes on the intended applications. If we answered them all, this page and all the ones that follow would be blank. The time demands of putting out **Electronics Now** just don't allow us to do the research and design work required. Even so, when we know of a circuit that will approach the reader's needs, we'll take the time to send it and often even add comments or hints to help things along. Further, the circuit requests we feel would benefit the greatest number of readers are printed and answered in our monthly "Q&A" department. One further suggestion here: Why not ask your fellow hobbyists for help? Posting a circuit request on the Forums at our www.gernsback.com Web site might just get you exactly what you are looking for.

How can I modify project XYZ? The projects that appear in these pages have undergone days, weeks, months, and sometimes years of development and testing by the author. Without duplicating that work, we have no way of knowing what the impact of any proposed modifications might be; in some cases, they could easily render a project dangerous to use. Therefore, any modifications are solely up to you. If you like, you could contact the author for help, but any response or help is solely up to him or her. Which brings us to . . .

How can I contact the author? Actually, this is one we CAN answer. Almost always, our authors are independent contractors who do not work for the magazine. As such, our policy is to not give out mailing addresses or telephone numbers without their permission. In most cases, where authors are willing to be contacted directly, contact information is provided in the article. In all other cases, you must write the author in care of **Electronics Now**, and we will forward your letter. In a similar vein . . .

What's the kit supplier's telephone number? Often there is none. That's because many of the companies doing kits for our authors are part-time "kitchen-table" operations that simply do not have the resources to handle telephone orders or other calls. In any case, all available contact information for any kit supplier is always provided in the article.

There you have it—our short list of unanswerable FAQs. We wish we could answer them all, but, alas, it's not a perfect world.

Carl Laron
Editor



Q & A

READERS' QUESTIONS, EDITORS' ANSWERS

BNC: The Answer?

Readers wrote from as far away as Australia to tell us what "BNC" stands for. The trouble is, they didn't agree! "Bayonet Navy Connector" was one of the most popular answers, sanctioned by a Hewlett-Packard catalog. Others include "British Navy Connector" and "Baby 'N' Connector."

The most authoritative source was an article in *Electronic Packaging and Production*, 1980, which cites a "legend" that BNC stands for "Bayonet Neill-Concelman." Paul Neill and Carl Concelman definitely did invent the earlier N connector and C connector respectively. It's certainly plausible that the B stands for bayonet, because a TNC connector is the same thing, with threads instead of a bayonet attachment.

We thank everyone who wrote.

Pulley Correction

Your answer to the question on slowing down a tape recorder ("Q&A," September 1997, page 11) is incorrect. A larger pulley on the motor shaft will cause the recorder to speed up. You need a smaller pulley on the motor shaft to slow it down. — Robert Blum, Huntington Station, NY

Oops! You are correct. We also thank Vincent Sullivan, for pointing out that the *torque*, not the *power*, is what changes when you change the pulley or gear ratio. He also points out that gears are not used in good tape recorders, though we've seen them in talking toys.

Power-On Sequence

Q I need to turn on the components of my audio system in a particular sequence, about five seconds apart, to prevent loud transients in the speakers. Can you suggest a circuit that would automate the process, and

would also turn off the equipment in the opposite order? — T. M., Pleasant Grove, UT

A Power-on and power-off sequences are a classic problem in industrial electronics; old-fashioned solutions involve thermal-delay relays and other awkward circuits.

Figure 1 shows a thoroughly modern solution using an LED bargraph chip. In effect, the chip displays the gradual charging and discharging of a capacitor. But instead of turning on a set of LEDs, it drives a set of solid-state relays (up to ten) which can control AC loads. Adjust C1 until the timing suits you; you may need to make it as large as 220 μ F. The power-down sequence will be slower than the power-up sequence.

will smooth out the vibrations? I would use my vibrator to speak into the device which would remove some of the buzz, making the speech sound closer to normal. — E. C., Las Vegas, NV

A That's a very interesting idea. As you've found out the hard way, intonation (tone of voice) is the hardest part of speech synthesis. The human voice box varies in pitch and loudness, and even turns its vibrations on and off many times during the articulation of a single word. Your artificial larynx can't do anything but buzz continuously at a fixed frequency.

It would probably require digital signal processing, but it ought to be possible to filter your speech to remove some of the buzz and amplify the harmonics added by your vocal tract. Even then, your speech would be far from natural, but it ought to be easier to understand.

Thinking even more futuristically, why not pick up the nerve impulses that would have gone to your larynx if it were still there and use them to control the artificial larynx? Then you might be able to achieve much more natural speech.

Artificial Voice Box

Q I am a laryngectomee; my larynx has been removed surgically. In order to speak, I use a vibrating device that I hold against my throat. Unfortunately, it makes me sound like an alien from outer space. I hate it!

Is there a device I can build or buy that

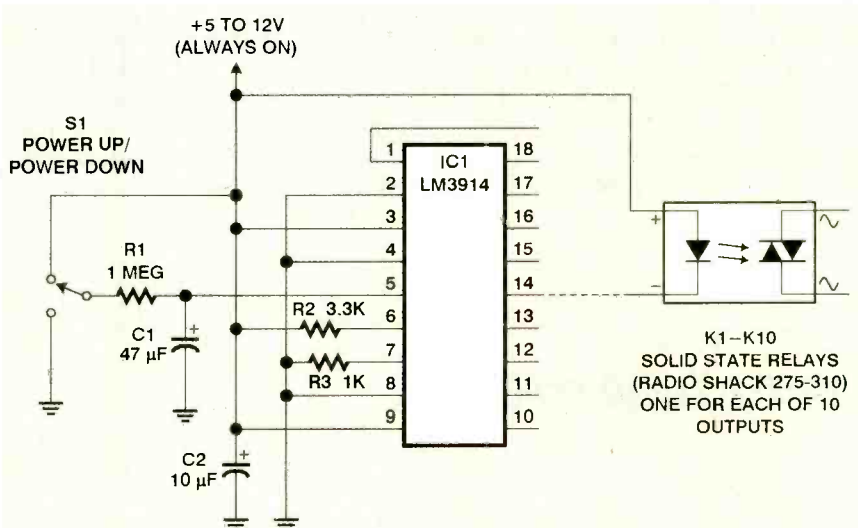

FIG. 1—A MODERN SOLUTION TO A CLASSIC PROBLEM—here an LED bargraph-driver IC is used as the heart of a circuit to turn equipment on and off in sequence.

HOW TO GET INFORMATION ABOUT ELECTRONICS

On the Internet: See our Web site at <http://www.gernsback.com> for information and files relating to our magazines (**Electronics Now** and **Popular Electronics**) and links to other useful sites.

To discuss electronics with your fellow enthusiasts, visit the newsgroups sci.electronics.repair, sci.electronics.components, sci.electronics.design, and rec.radio.amateur.homebrew. "For sale" messages are permitted only in rec.radio.swap and misc.industry.electronics.marketplace.

Many electronic component manufacturers have Web pages; see the directory at <http://www.hitex.com/chipdir/>, or try addresses such as <http://www.ti.com> and <http://www.motorola.com> (substituting any company's name or abbreviation as appropriate). Many IC data sheets can be viewed online.

Books: Several good introductory electronics books are available at RadioShack, including one on building power supplies.

An excellent general electronics textbook is *The Art of Electronics*, by Paul Horowitz and Winfield Hill, available from the publisher (Cambridge University Press, 1-800-872-7423) or on special order through any bookstore. Its 1125 pages are full of information on how to build working circuits, with a minimum of mathematics.

Also indispensable is *The ARRL Handbook for Radio Amateurs*, comprising 1000 pages of theory, radio circuits, and ready-to-build projects, available from the American Radio Relay League, Newington, CT 06111, and from ham-radio equipment dealers.

Copies of past articles: Copies of past articles in **Electronics Now** and **Popular Electronics** (post 1993 only) are available from our Claggg, Inc., Reprint Department, P.O. Box 4099, Farmingdale, NY 11735; Tel: 516-293-3751.

Electronics Now and many other magazines are indexed in the *Reader's Guide to*

Periodical Literature, available at your public library. Copies of articles in other magazines can be obtained through your public library's interlibrary loan service; expect to pay about 30 cents a page.

Service manuals: Manuals for radios, TVs, VCRs, audio equipment, and some computers are available from Howard W. Sams & Co., Indianapolis, IN 46214 (1-800-428-7267). The free Sams catalog also lists addresses of manufacturers and parts dealers. Even if an item isn't listed in the catalog, it pays to call Sams; they may have a schematic on file which they can copy for you.

Manuals for older test equipment and ham radio gear are available from Hi Manuals, PO Box 802, Council Bluffs, IA 51502, and Manuals Plus, PO Box 549 Tooele, UT 84074.

Replacement semiconductors: Replacement transistors, ICs, and other semiconductors, marketed by Philips ECG, NTE, and Thomson (SK), are available through most parts dealers (including RadioShack on special order). The ECG, NTE, and SK lines contain a few hundred parts that substitute for many thousands of others; a directory (supplied as a large book and on diskette) tells you which one to use. NTE numbers usually match ECG; SK numbers are different.

Remember that the "2S" in a Japanese type number is usually omitted; a transistor marked D945 is actually a 2SD945.

Hamfests (swap meets) and local organizations: These can be located by writing to the American Radio Relay League (Newington, CT 06111; <http://www.arrl.org>). A hamfest is an excellent place to pick up used test equipment, older parts, and other items at bargain prices, as well as to meet your fellow electronics enthusiasts—both amateur and professional.

voltage increase and operate an alarm whose power supply is independent of the garage door opener. — E. U., Northfield, OH

A circuit that should do the job is shown in Fig. 2. It uses a Zener diode to subtract 12 volts from the voltage going to the coil of a miniature relay. Thus, at 11 volts, no current flows, but at 20 volts, the relay gets 8 volts, which is more than sufficient to pull it in, even though it's nominally a 12-volt relay.

Be sure to use a relay with a high coil

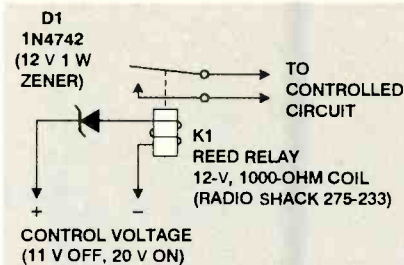

FIG. 2—HERE'S A CIRCUIT that can be used to detect an increase in voltage: The relay pulls in when the voltage exceeds about 17 volts.

resistance (500 ohms or more) so the diode doesn't overheat.

Back-Up For Car Alarm

Q My car, like most, has an alarm installed on it. Could you suggest a circuit for a 12-volt battery backup for the alarm that would also charge the back-up batteries as the car is being driven? — W. S., Phoenix, AZ

A Without knowing the power requirements of your alarm, it's hard to be specific, but Fig. 3 shows a simple way to charge a 12-volt lead-acid gel cell from your car's power supply. Then the alarm will still work even if the main battery runs down.

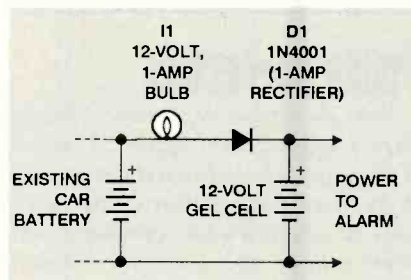

FIG. 3—THE CAR'S ELECTRICAL SYSTEM charges the 12-volt gel-cell back-up battery, but, thanks to diode D1, only the car's alarm is able to take power from it.

The diode acts as a one-way valve so that only the alarm can take power from the alarm battery. The light bulb limits charging current to 1 amp; under normal conditions it will never light up.

XT Memory In PC AT?

Q I have an old 286 AT clone to which I would like to add more memory. Can I use an old memory card for an XT? — J. W. B., Warren, MI

Maybe this will be the next research project at a major lab somewhere.

Detecting Voltage Increase

Q I have an overhead garage door with a safety beam across the opening. I would like to sound an alarm in the house when someone breaks the beam. When the door is up or down, the control voltage is 11-volts DC, and when the beam is broken the voltage rises to 20 volts. I need a circuit to detect that

A Yes, possibly, but only up to a total of 640K (the memory limit of the XT). Addresses from 640K to 1Meg are reserved, and on the XT bus, higher addresses don't exist—the bus doesn't have address lines for them. There may also be timing problems. In any case, it won't hurt to try; you will not damage your computer.

At the heart of any multimeter is a big multi-contact switch; that's the part that would be hardest to make for yourself. If you're building meters for yourself, it's easier to put fewer functions in each instrument, so you don't need complicated switching. See the *ARRL Handbook for Radio Amateurs* for some circuits and advice.

at 2275 Hz, which is within the audio range. Newer ones operate on 475 kHz, just below the AM-broadcast band. Low frequencies are used so the signals won't reflect off objects or the atmosphere. Range is limited to a few hundred yards, but the higher frequency gives somewhat better range than the lower one.

We'd like to hear from readers with more information to share. Because it's a critical safety device, you probably wouldn't want to build your own avalanche transmitter, but homebuilt direction-finding receivers might make for some interesting experimentation. Also, some good multi-band radios cover 475 kHz, so all you'd need is a directional antenna.

Build A Multimeter?

Q I am new at electronics and find it difficult to spend a lot of money on equipment I could probably build myself. I've been looking for plans for a good multimeter to no avail. Could you provide me with a design for a multimeter that measures ohms, capacitance, and AC/DC volts and amps? — G. G., Bradenton, FL

A Believe it or not, it's generally cheaper to buy a multimeter than to build one. If you want a real bargain, find a partly defective multimeter that you can repair; many of the parts are replaceable. The main digital IC in a DMM, and the meter movement in an analog meter, are not easy to replace.

Avalanche!

Q I'm having a difficult time finding out about skier avalanche communication. I wrote to you in July of 1996 requesting this information, have scanned every issue, but so far have found nothing. — R. G., Gig Harbor, WA

A Unfortunately, space does not permit us to answer all the questions we receive, and this one has been particularly hard to research. Here's what we've found out so far.

Avalanche transmitters are carried by skiers so they can be located by radio direction finding even if they are buried in snow. Originally, they were very-low-frequency transmitters, operating

Electronic Ignition

Q My brother has a 1953 6-cylinder Chevy. He lives in a country where gasoline is expensive and of bad quality. Since I am an electrical engineer he has asked me for electronic help. Would a capacitive-discharge ignition help? Can you suggest a (Continued on page 18)

ProtoLab 4.0

Easy-to-use circuit simulation package from the leader in electronic prototyping.

- Designed for use with Windows®95
- Low Cost - \$49.95
- Design circuits instantly while choosing from a complete list of active and passive components
- Analyze circuits using built-in test instruments.

The screenshot shows the ProtoLab 4.0 software interface. At the top, there's a title bar with the file name 'ProtoLab 4.0 - C:\PLAB\RMP_BIP.WPF'. Below the title bar is a toolbar with icons for various functions like 'Close', 'Insert', and 'Print'. The main window displays a schematic diagram of a circuit with various components like resistors, capacitors, and a transistor. On the left side, there's a panel with icons for a Voltmeter (displaying '888'), an Oscilloscope, and other test instruments. A starburst graphic in the top right corner of the screenshot contains the text: 'Create and Analyze Circuits INSTANTLY for only \$49.95!'. At the bottom of the screenshot, there's a status bar with the text 'ProtoLab 4.0 - C:\PLAB\RMP_BIP.WPF'.



GLOBAL SPECIALTIES
SOFTWARE

INNOVATIVE PRODUCTS. UNSURPASSED QUALITY.
1-800-572-1028 • For a demonstration, visit:
www.globalspecialties.com

Windows®95 is a U.S. registered trademark of Microsoft Corporation.

CIRCLE 122 ON FREE INFORMATION CARD



LETTERS

SEND YOUR COMMENTS TO THE EDITORS OF ELECTRONICS NOW MAGAZINE

Telephone Number Updated

Thanks for reviewing the TriField Natural EM Meter in "New Products" (*Electronics Now*, November 1997). However, our telephone number has since changed. Our current number is (808) 874-9126 (Phone/Fax). We can also be reached via e-mail at emfmeter@webtv.net or at our Web site: <http://www.maui.net/~emf>.

DAVID FAGGIOLI
ALPHALAB, Inc.

Code Readers Revisited

The article by Thomas Fox, "Reading Automobile Computer-Service Codes" (*Electronics Now*, December 1997), is a good one. I, too, have found *Sure You Can Work on Electronic Ignition*, Wells Mfg. Corp., to be quite useful. Mr. Fox did not mention that this book can be purchased, at a low price, at many auto parts stores and in the auto department of some discount stores.

As he did say, a service manual for the car is also needed, such as *Chilton*, *Haynes*, or *Motor's* manuals—available at the same stores. Another option is a manual from the car's manufacturer, which is the best source of service codes. However, a few manuals don't have codes. In that case, the general codes in the Wells' book can be used.

However, I have found that not all "code readers" are as useless as Mr. Fox's description. Since neither my 1993 edition of the Wells' book nor the manual of the Ford I was repairing had complete information about entering the diagnostic mode in a Ford product, I purchased a Sunpro CP9015 Ford Code Scanner for about \$30. I found it to be much more than a simple code reader.

Besides reading the codes stored in memory, it also activates diagnostic routines in the car's computer. The "Key On-Engine Off" tests evaluate most of the sensors, relays, and solenoids; and there's also a "wiggle" test for finding loose con-

nections (with a buzzer indicator). The "Key On-Engine Running" tests indicate current problems, which may not be stored in memory, and change various settings to see if the car responds properly.

On cars with separate fuel injectors for each cylinder (as opposed to "throttle-body" injectors), it will test for "weak," "very weak," or "dead" cylinders. This testing is done by turning off the injector for that cylinder and measuring the change in engine rpm. Codes are read out by a flashing LED, since many Ford products do not have a "Check Engine" light.
BILL STILES
Hillsboro, MO

"Does Not Compute!"

I am a free-lance journalist, who has written for *Electronics Now* and other technical magazines. I'm also a dinosaur—I balance my checkbook in my head, use a wall switch to turn on the lights, and use a four-legged security system to guard my house.

I still don't own a personal computer. From the look of things, I never will. My friends have given me all of the arguments. However, I still do all of my work on a word processor that costs only about 10% of the PC system I would need to replace it. Although I'd love to own a PC, I've never been able to justify the cost.

I draw my schematics by hand, knowing that a CAD software package can do it easier and faster. However, it would probably take me even longer to enter the unusual circuit elements I use into

Write To:
Letters,
Electronics Now Magazine,
500 Bi-County Blvd.,
Farmingdale, NY 11735

Due to the volume of mail we receive, not all letters can be answered personally. All letters are subject to editing for clarity and length.

the program library. A PC-board design package might be handy, but most of my designs are too complex for a single-sided board—long traces are NOT the best solution.

Surfing the Net looks like fun, but after reading Michael A. Covington's nicely-done article "Ethics and the Internet" (*Electronics Now*, September 1997), I *definitely* would *never* send any personal information over the Net.

For years, I've used a RadioShack pocket-scientific computer (16K of RAM), running my own BASIC programs to handle all of the heavy math in my designs. Scoff if you like, but doing the most difficult problems still left me memory to spare!

SKIP CAMPISI
S. Bound Brook, NJ

Screen Savers or Pretty Pictures?

From your article "All About Monitors" (*Electronics Now*, July 1997), I learned that their technology differs little from the TV sets that I repaired in the mid-1970s on board the USS Forrester. A common fault on the scores of picture tubes I replaced was that their cathodes were no longer capable of emitting enough electrons to yield a good picture.

Usually, the green cathode wore out first, resulting in a purple image. All those sets had high voltage between 25 and 30 kV. Even though many of them displayed color bars for hours, I never saw one with an image burned into its phosphors. But as long as electrons flow through the cathodes, those cathodes are wearing out. Screen savers do nothing to inhibit that flow.

Anyone who really wants to watch tropical fish swimming back and forth could install a fish bowl near his computer. And, when he goes to lunch, he could switch the monitor off.

RONALD D. LINDOW
Pittsburgh, PA



EQUIPMENT REPORT

NOMAI 750.C PORTABLE SCSI HARD DRIVE

This portable SCSI hard drive can move more than a CD-ROM's worth of data between computers.

CIRCLE 15 ON FREE INFORMATION CARD



If you regularly deal with large computer files, some type of removable media is a must. After all, floppy disks are useful for transferring a few kilobytes or even a few megabytes, and Zip and similar drives become necessary for moving 100 megabytes or so. But even that's not much, not with people dabbling in CD-R, making movies, and so on with their PC. And hard drives inevitably fill up no matter how large they are; so being able to add storage is a plus.

A Solution

One practical solution is the Nomai 750.c portable SCSI hard drive. That unit packs 750 megabytes of data on to removable cartridges that cost about \$69 each—that's only 9 cents per megabyte. The Nomai 750.c is available in internal and external PC and Mac versions, and there are parallel-port and docking-bay options for the external models. The external PC version we tested costs about \$359, which includes one 750-megabyte data cartridge pre-formatted for a PC, an AC power supply, a SCSI card, and all necessary cables.

The Nomai 750.c removable hard-disk drive is fully compatible with SyQuest cartridges. It can read and write Nomai 750- and 540-megabyte cartridges, or any SyQuest-compatible disks. The drive uses Winchester technology and achieves an average seek time of 10.5 milliseconds and sustains a data transfer rate of 3.46 megabytes per second.

SCSI is a popular option on many

PCs these days, and a PC that doesn't have SCSI is just a few dollars away from having it. SCSI is inexpensive and fast, so it makes sense to use it for a 750-megabyte portable drive. An entire CD-R's worth of data can be gathered from different PCs and brought to the CD-R system for recording. Or 750 megabytes of storage space can be added to a PC with each new \$69 cartridge.

The Nomai 750.c is small and extremely rugged. It measures 7-inches deep by 4¼-inches wide by 1¼-inches high and weighs less than two pounds. It's small enough to be easy to carry around with you. The drive has a thick steel enclosure that could easily support a person, so it's not likely to get damaged simply by being bumped around. The enclosure has a modern looking matte-black finish. An AC power adapter supplies the +5 and +12 volts DC required by the drive. An eject button and power/activity indicator are located on the front panel.

Installing the Nomai 750.c

Installing and using the Nomai 750.c is very easy. The external model we tested comes with a SCSI card, and installing it is the most difficult step, though even that is a piece of cake. That's because it's a plug-and-play PCI card—Windows 95 instantly recognizes it and installs the drivers for it automatically. (What's more, if your PC already has a SCSI card in it, you don't even have to install the one included with the

drive.) After that, one simply plugs the Nomai's power supply into an AC outlet and pops in a PC-formatted cartridge—when the system boots, the removable drive becomes part of the operating system.

Having 750 megabytes of free disk space to play with is a good thing, especially if your original hard drive is getting clogged. And the speed of the Nomai 750.c is equal to most conventional hard drives, so there's no penalty in performance whether you are archiving data or running applications off it. In benchmark tests, the Nomai drive had a cached speed of 716 MB/s and an uncached speed of 0.77 MB/s. We tested the real-world speed of the drive by copying a 427 MB file; the job took exactly 4 minutes—a transfer rate of 1.78 MB/s when writing data to disk, which is always slower than reading data from disk into RAM.

The Nomai 750.c package includes Adaptec EZ SCSI 4.0 software on CD-ROM and SCSISelect on diskette. Those utilities let you prepare cartridges, format for PC or Mac, change a configuration, update firmware, change the SCSI ID via software, manage read/write cache options, test and re-format disks, verify the disk surface and reallocate bad blocks, low-level format disks, control the cartridge lock on the drive, and eject cartridges by software.

Some Final Thoughts

The Nomai 750.c is very handy and very fast compared to MO and PD drives. It's also very affordable. If you've been waiting for the right removable media drive to come along before buying one, then the wait is over. Now is the time to get a Nomai 750.c. For more information contact the manufacturer directly (Nomai; 592 Weddell Street, Suite 5/6; Sunnyvale, CA 94089; Tel: 408-542-5900; Sales Hotline: 888-99NOMAI; Web: <http://www.nomai.com>), or circle 15 on the Free Information Card. **EN**

Pilot Port I/O

ONCE UPON A TIME THE VALLEY BEGAT A LITTLE COMPANY CALLED PALM COMPUTING, AND THAT WAS GOOD. SO GOOD, IN FACT, THAT MEDIUM-SIZE U.S. ROBOTICS SWALLOWED IT WHOLE, AND THAT WAS FINE. SO FINE, IN FACT, THAT

big ole 3Com Corp. gobbled it, and that was COOL. SO COOL, in fact, that when a USR/Palm manager presented 3Com president Eric Benhamou with a Pilot, he said, "Thanks, but I already have one. We all do." In fact, 3Com is said to be the largest installed corporate site for Pilots.

Anyway, it's a cool and useful thing. Not only can it help you get and stay organized, but you can also have fun with it. You can buy and download games for the Pilot, of course, but I'm talking about a different kind of fun. Like making it do things that are both interesting and unusual. Like making it talk to the outside world.

This month we'll examine a little data-logging application I wrote that allows the Pilot to track the minimum, maximum, and running average of a series of byte-size inputs. The program is called HiLo. HiLo is illustrated in Fig. 1. When you click the Go button, the program opens the serial port at 9600n81 and waits for input. Each time something arrives, the program recalculates and displays the values shown at the top of the screen. That process continues until you click the Exit button, at which time the program closes the serial port and exits.

CoPilot

The illustration was created using a freeware program called CoPilot. CoPilot runs on Win95/NT, and I believe ports are in progress to other platforms. CoPilot provides a fairly accurate and complete emulation of the Pilot. You

can load, execute, and even debug Pilot programs using CoPilot. To run CoPilot, you need a copy of a Pilot ROM. The CoPilot package comes with a utility that allows you to upload your Pilot's ROM to your PC. The ROM is needed because there is actually a 68000 CPU emulator running beneath the hood. The bad news is that you can't use CoPilot to develop and debug serial I/O programs. Programs run, but serial I/O just doesn't occur.

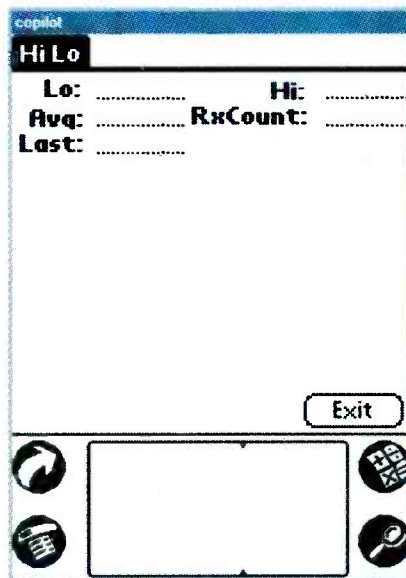

FIG.1—COPILOT IS A FAIRLY COMPLETE EMULATOR for the Win95/NT environment. An independent DLL implements a complete, virtual 68000 CPU, which can run the actual code uploaded from a Pilot ROM. CoPilot doesn't do serial I/O.

Setup and Use

Using HiLo is easy. First download the program to your Pilot using the Pilot Install Tool. Then close the HotSync manager, so it will relinquish the (PC's) serial port. Run a telecommunications program, such as HyperTerminal on the PC, with a setting of 9600 bps, 8 data bits, no parity, and 1 stop bit. Next, with the Pilot in the cradle, run HiLo, and click the Go button; any characters typed on your PC's keyboard will end up in HiLo's queue. Remember that you're sending ASCII characters so for a Ctrl-A, you'll see a value of 1; for 'A' (uppercase) you'll see 65; and for 'a' (lowercase), you'll see 97.

The complete program is over 300 lines of C code, not to mention the resource and header files, so we can't print the whole thing here. What I will do is discuss overall program flow, and present details of key routines. You can pick up the complete source, along with the executable, at the new Engineering web site, www.ingininc.com. Look for HiLo.Zip, and unzip with the -d option if you want to recreate the build directory structure. I created the program in MetroWerks CodeWarrior DR3 running on NT4, but it should be easy to port to GCC.

PilotMain and The Event Loop

Analogous to the 'main' routine in a normal C program, the entry point for a Pilot program is called PilotMain, shown in Listing 1. When the user launches an application, the operating system calls the corresponding PilotMain, passing it a command code and a set of launch flags. The command code and flags provide a clever way to implement system-wide behavior. For example, the Pilot's built-in Find procedure doesn't search the Address Book, the Memo Pads, and everything else. Instead, it calls each

(Continued on page 17)

Prototype

The Doctor Will Sense You Now

BY DOUGLAS PAGE

Using a tiny, wireless electronic device that can be attached like a band-aid or imbedded in a fingertip or earlobe, tomorrow's doctors and paramedics will be able to remotely monitor the vital signs of high-risk patients or permit neo-natal babies to be liberated from sensor wires so they can be held and stroked.

These medical telesensors—miniature integrated circuits that can measure blood pressure, blood oxygen, pulse, and temperature, and then transmit data to remote receivers—are being developed for the military by government researchers at Oak Ridge National Laboratory (ORNL), which is located at Oak Ridge, TN.

Civilian and Military Applications

While the work at ORNL is for the military, there are also countless civilian applications for these tiny marvels. For example, doctors can use them to monitor vital signs from miles away, paramedics can be more prepared for emergencies that await their arrival, and fire-battalion chiefs can track the respiratory and safety status of firefighters and "hazmat" crews working in smoke or toxic clouds. In that last application, built-in alarms will notify firefighters, for instance, when blood oxygen levels indicate danger. The sensor chips can also automatically telephone emergency services when triggered by a patient's deteriorating vital signs.

The military's interest in the sensors is for remote battlefield triage. "Military leaders need a way to find out quickly which soldiers have been wounded and what their conditions are," said ORNL's Thomas L. Ferrell, lead researcher on the project. "Then, medics will be able to decide whom to treat first and whom to remove from the battlefields for treat-

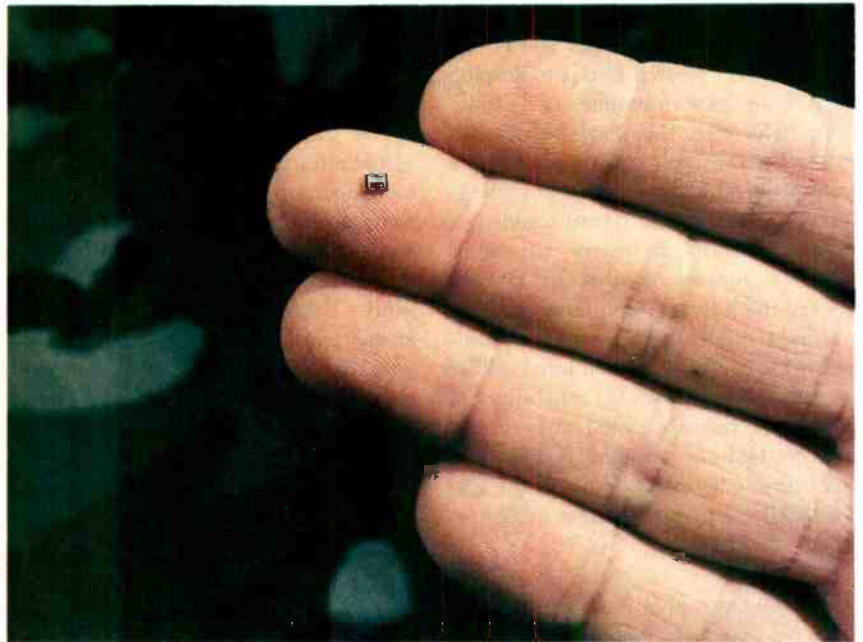

THIS MEDICAL TELESSENSOR CHIP can measure and transmit data on body temperature. It is the first of several remote sensors under development at the Oak Ridge National Laboratory. (Photo by Tom Cerniglio, ORNL)

ment." Of course, the same would also apply in civilian emergency or disaster situations. Also, if the soldier (or firefighter) were a fatality, that information would be transmitted, preventing the unnecessary endangerment of rescue personnel.

While there are many situations where these sensors could prove invaluable, civilian firefighters will especially benefit in several ways. "Our pulse-oximeter telesensor finger-ring or earlobe device will monitor the oxygen in the blood," said Ferrell. "If there's too much smoke or fume inhalation, an alarm will sound and an alert will be transmitted via a belt-worn radio device." Blood oxygen level is a reliable indicator of a wide variety of respiration problems. It is expected that later versions of the system will incorporate

pulse-sensor and blood-pressure technology, in addition to an instrument that measures electrical conductivity in the skin, which is often used as an indicator of stress.

The pulse-oximetry sensor will measure the pulse on the wrist or neck using a pressure sensor. Blood oxygen changes are measured by detecting changes in hemoglobin, the iron-containing pigment in red blood cells. Hemoglobin's color changes when there is an alteration in oxygen level. "The sensor chip will have an infrared light source and detector that can measure changes in the light absorption of the hemoglobin when it is excited by light of specific frequencies," said Ferrell.

"Measurements of pulse rate are important to the military," he continued "because this information helps medics

determine quickly which wounded soldiers are alive and which are not. Also, blood pressure can be determined by measuring and comparing times of pulse arrival at various points on the body. Measurement of a drop in blood pressure is important because that may indicate a soldier is bleeding." In a civilian setting, measurement of erratic pulse rate can warn that a patient has cardiac arrhythmia.

Eventually the system will be capable of providing diagnostic information on such conditions as shock and injury. The ultimate research goal is to develop an array of chips to monitor body functions collectively. They will be attached to the body, using methods similar to a waterproof bandage, sending physiological data via wireless transmission to a remote monitor. In rescue situations, whether military combat or civilian search-and-rescue, the data will be transmitted directly to paramedics, indicating the condition of an injured soldier or firefighter. Homing capability, in which the monitor could also receive global-satellite-positioning (GPS) data, will one day be incorporated in the system, allowing precise location of all fire-

fighters, soldiers, etc. at all times. The value of commanders or rescuers having access to that information can not be overstated.

Progress To Date

So far the research group has produced a temperature sensor 2.3 millimeters square—about one-eighth the size of standard postage stamp. The chip can be attached to a fingertip or earlobe where it can measure body temperature and transmit a reading when queried by a remote receiver. Ferrell said the chip contains a temperature sensor that measures absolute temperature to within one-tenth degree Celsius using bipolar transistors whose electronic properties are sensitive to temperature. The chips also contain some analog signal-processing circuitry and a short-range (about 1.5 meters) digital transmitter designed to transmit to a nearby helmet- or belt-worn transceiver/microprocessor unit. That unit analyzes the trauma situation, compresses the data, and if indicated, sends an alert to the appropriate medical professional via a longer-range transmitter.

"Each chip," said Ferrell, "will have a unique identifier—a characteristic

radio-signal pattern . . . in which the frequency spectrum changes every few microseconds. Such spread-spectrum transmission allows the monitor to know which individual soldier, firefighter, etc. needs immediate medical care."

The pulse-oximeter chip is expected to be near production status as soon as early this year (1998), Ferrell said. "At present, only the body temperature telesensor chip has been constructed, and it will require two further iterations at a chip foundry before its final form. Each cycle of fabrication takes several months. The master-control unit is only partially designed, and a full range of telesensor chips will not be ready for several years—unless a large increase in the funding of this project is obtained. We have, however, put in place all of the basics needed to show that this technology is within our grasp without further requirement of extraordinary scientific breakthroughs."

Clinical trials will be done in association with cardiac surgeons as they cool patients during surgery and need to monitor brain temperature, Ferrell said. Also, patients undergoing chemotherapy, and those who lose their ability to regulate their body temperature, must sometimes be packed in ice if a fever sets in. With early intervention, in which the onset of a fever may be reported by one of the telesensors, simple aspirin often is sufficient.

"We will soon begin work on the skin-conductivity telesensor chip for measuring pulse, respiration, and ion-level on the skin (a measure of stress)," Ferrell said. "Blood pressure we hope can be done accurately by passive monitoring of pulse velocity."

The Oak Ridge National Laboratory research, funded by the Defense Sciences Office of the Defense Advanced Research Projects Agency (DARPA), is expected to become so important in civilian settings ORNL is seeking additional funding from the private sector to speed up the research.

"Wireless monitors attached to the skin," said Ferrell, "could provide valuable information on the physiological conditions of intensive-care patients in hospitals, high-risk outpatients (aiding paramedics responding to the scene), or infants at risk of suffering sudden infant-death syndrome (SIDS)." EN

➤ Interoperable Cable Set-Top Boxes

Cable Television Laboratories, Inc. and its members have established OpenCable, a project aimed at developing a new generation of set-top boxes that are interoperable. These devices will enable a range of interactive services to be provided to cable customers. The OpenCable effort will include an intellectual property (IP) pool and a certification process for testing vendor compliance.

The first task of OpenCable is to evaluate responses to a request for information (RFI) that was sent to leading computer and consumer-electronics companies. The RFI seeks their input into the creation of a draft specification for advanced set-top boxes. CableLabs executives and board members have held meetings with CEOs of companies in these industries. This research was overseen by MediaOne President and COO William T. Schleyer, who is a member of the CableLabs Board of Directors.

"Our meetings with other industries have shown us that microprocessor and semiconductor technology are advanced to the point where a set-top box can become a digital set-top computer very soon," according to President and CEO of CableLabs, Dr. Richard R. Green.

CableLabs is a research and development consortium of cable television system operators representing more than 85% of the cable subscribers in the US, 75% of subscribers in Canada, and 12% of subscribers in Mexico. For more information, check their Web sites at <http://www.cablelabs.com>, <http://www.cablemodem.com>, and <http://www.cablenet.org>. EN

Space Research Spotlights Tumors

Special lighting technology—developed for NASA Space-Shuttle plant-growth experiments—may soon help treat cancer and save lives on Earth. A treatment technique called Photodynamic Therapy uses tiny pin-head-size LEDs to activate light-sensitive, tumor-treating drugs.

Experiments indicate that when special tumor-fighting drugs are illuminated with LEDs, the tumors are more effectively destroyed than with conventional surgery. The light source, consisting of 144 tiny diodes, is compact (about ½-inch in diameter), and mechanically more reliable than lasers and other light sources used to treat cancer. The entire light source and cooling system is only the size of a medium suitcase.

Through the Small Business Innovation Research Program, NASA funded contracts to demonstrate the feasibility of using LEDs in cancer treatment. The program is managed by the Technology Transfer Office at Marshall Space Flight Center, Huntsville, AL. In this application, the LED forms the tip of a new nine-inch neural probe. The LED probe can be used for hours at a time, remains cool to the touch, and is a fraction of the price of a laser.

"This new probe illuminates through all nearby tissue," said Dr. Harry Whelan, pediatric neurologist at the Medical College of Milwaukee, WI. "We've used lasers too," he added, "but they are often unreliable and limited in color spectrum. Lasers are also very expensive and lose power in their fiberoptic cables."

The technique used by Dr. Whelan involves injecting the patient's bloodstream with a drug called Photofrin II. The drug attaches itself to the unwanted tissues and permeates them, leaving the surrounding tissues unaffected. The doctor then places the solid-state LED probe near the affected tissue to illuminate the tumor and activate the Photofrin II drug. Once activated by the light, the drug destroys the tumor's cells, leaving the tender brain stems virtually untouched.

The FDA has approved using the



THIS SIMULATION shows how LED probe would be used, in conjunction with special drugs, to destroy brain-cancer tumors.

LED probe on a trial basis in the removal of children's brain tumors. After the clinical trials are concluded, Dr. Whelan anticipates full approval of what could be the operating technique of the future. Further research combining LEDs and promising new drugs is yielding the possibility of deeper tumor penetration with the probe, faster reaction times, and shortened patient sensitivities to sunlight.

"We're very happy to be a part of this innovative procedure," said Rose Allen, manager of the Space Product Development Office at the Marshall Center. "It is exciting to see how NASA's commercial space research results in benefits on Earth. Who would have thought that experiments searching for ways to improve agricultural products would lead to a medical procedure that saves children's lives?"

The LEDs, developed for Marshall Center by Quantum Devices, Inc., (Barneveld, WI), were first intended for use in food-growth experiments in outer space. They were used as low-energy light sources on NASA's second US Microgravity Laboratory Spacelab mission in October 1995, as part of the Astroculture Plant Growth Facility. The experiment was led by Dr. Raymond J. Bula of the Wisconsin Center for Space

Automation and Robotics (Madison, WI), a NASA Commercial Space Center.

"The LED technology developed by NASA offers new hope to children with cancer," stated Dr. Whelan. "Every one of our cases will be a critical case with no hopeful alternatives. We think this new probe will help give children with tumors a chance to live healthy, happy lives."

Low-Altitude Vertical Flights in Urban Areas

A research and development project conducted in Atlanta during last year's Olympic games could have a long-term impact on improving transportation in crowded cities. Supported by the FAA, Operation Heli-STAR (Helicopter Short-Haul Transportation and Aviation Research) showed that communications, navigation, and surveillance (CNS) equipment based on the Global Positioning System (GPS) could reliably track helicopters operating in large metropolitan areas.

Air-traffic-control radar now pro-

vides the primary means of monitoring aircraft in flight. However, ground clutter caused by obstructions such as tall buildings prevents tracking low-altitude flights in urban areas. This problem restricts helicopter transportation in cities where clogged highways would otherwise make vertical flight an attractive alternative to ground transportation.

On the busiest day, the project processed 83,000 aircraft position reports between 6 AM and 10 PM, tracking more than 60 aircraft engaged in a wide range of cargo delivery and public safety missions—including critical security requirements. Heli-STAR used 12 heliports strategically located around Atlanta. Routes were established to min-

Speaking of the Olympics

The NEC Corporation announced that it will sell, beginning in Japan, the world's first high-definition 50-inch plasma television, the *Hi-Vision Plasma X*. Sales will begin in February to coincide with the start of the Winter Olympic Games in Nagano, Japan. The 50-inch Hi-Vision Plasma X (PX-50V2) offers 1.4 times the screen size of its 42-inch predecessor.

The use of a panel production process specifically for manufacturing large-sized high-resolution screens permits pixel pitch to be reduced to 0.81mm from 1.08mm. This process produces a 1365×768 pixel screen (or PDP—plasma display panel) capable of displaying over one million pixels. Integrated circuits that endure high pressure allowed NEC to achieve a very slim television at 97mm.

New versions of NEC's 42-inch PlasmaX television and the 33-inch plasma display unit (PX-33M2) share in the design concepts of the 50-inch model. These new models, which have been on sale since December, are slimmer than the previous ones: 89mm instead of 99mm. The PX-33M2 is compatible with NTSC, PAL, and SECAM broadcast signal standards. Worldwide sale of these TVs is expected to start in Spring 1998.

Both the 50- and 42-inch plasma TVs use NEC's capsulated color-filter (CCF) technology. This technology applies a black stripe to non-discharging plasma cells for more vivid contrast in bright-light conditions at a ratio of 40:1. CCF offers colors purer than those of any Braun tube TV. Both models feature display, tuner/selector, and speaker units in a component-style set, and use only one cable to connect the display and the tuner.

NEC sees the new PDPs as meeting the demands for thinner, larger, and clearer TVs. They anticipate that the combined demand from consumer and business users will result in the shipment of 30,000 NEC sets in 1998. That figure is expected to rise to 300,000 per year by the year 2000. The price in US dollars is about \$22,500 for the 50-inch display and \$12,083 for the 42-inch set.



A SPECIALLY-EQUIPPED Operation Heli-STAR helicopter is shown here landing at GIT's research facility.

“Operation Heli-STAR showed that the technology is here now to do low-altitude traffic control in urban areas,” according to Charles M. Stancil, manager of the Georgia Tech Research Institute (GTRI). “Everything that we planned and designed for the system worked. We could track the aircraft, communicate with them, send weather information, and even change the mission just by using digitized messages.”

Some 88 aircraft equipped with this technology participated in Heli-STAR during the Games in Atlanta. The aircraft used on-board GPS systems to determine their own positions, then reported that information every few seconds to a central ground station through a very high-frequency (VHF) data link. Heli-STAR also sent data about all project aircraft operating in the area to multi-function displays that were installed aboard many of the helicopters. On the ground, sophisticated equipment used bar-coding and an extensive computer network to track cargo as it moved to its final destination.

imize noise and avoid the restricted air-space set up around Olympic venues.

Development of Heli-STAR began in 1994. The Heli-STAR program was the result of cooperation among numerous government and industry groups who shared the \$10 million cost. Among the government agencies involved were the FAA, NASA, Department of Defense, and GEMA (Georgia Emergency Management Agency). Businesses and organizations, among others, were ARNAV Systems, the Harris Corporation, Helicopter Association International (HAI), and the Atlanta Vertical Flight Association (AVFA). The Project Operations Center was established at Georgia Institute of Technology's (GIT's) Cobb County Research Facility, near Dobbins Air Force Base.

The project was intended both to demonstrate the feasibility of the GPS-based equipment and to gather information for development of future large-scale helicopter and low-altitude operations.

EN

EN

COMPUTER CONNECTIONS

continued from page 12

application with a special launch code. The app in turn knows that it should search its database and return results to the calling app. We don't need that functionality, so the only launch code HiLo responds to is the one for normal program launch.

When it receives that code, it calls a startup routine, which draws the main form and obtains a reference to the serial port. It then goes into an event loop, in which various processes in turn get a chance to handle events. The Palm OS is not multitasking, so the term processes must be taken loosely, in the sense of a block of code that belongs to a separate logical entity.

Events include things like detecting pen motion on the screen, hardware button presses, serial I/O, alarms, and so forth. Applications can add their own events to the event queue. For example, in HiLo, when the user clicks the Exit button, the program enqueues an "appStopEvent." When the event loop terminates, control returns to PilotMain, where the StopApplication routine performs any required clean-up. In our case, that primarily means closing the serial port.

Within the event loop, the system gets first crack at handling events. That allows it to do things like, for example, translating raw pen strokes into ASCII characters, which in turn get enqueued as keyDown events. Typically, if a process handles an event, it returns a value of True, so that subsequent (higher-level) processes skip over it.

After the system, the menu handler gets next crack at events. For simplicity, HiLo has no menu, so I commented out the corresponding code. I didn't simply remove it, because I want to show the default event-processing hierarchy. Next, the application's main form gets a try, and finally, the active form. Again, for simplicity, this application has only one form, so the latter call is redundant. And again, I didn't remove it, for the same reason.

So after the user starts an application, the Palm OS settles into the event loop. The event loop itself is nothing but a large, possible nested switch statement, with cases for different types of events, and subcases for instances of each type. Typically there are cases for system events, form events, control events, and

```
LISTING 1—SERIAL I/O ROUTINE

static void SerIOReceive(void) {
    ULong          RcvCount = 0;
    Err            error;
    Byte          BufIn[17];

    if (!SerIORef || !SerIOConnected)
        return;

    error = SerReceiveCheck(SerIORef, &RcvCount);
    if (error) {
        SerClearErr(SerIORef);
        FrmCustomAlert (AlertGenericAlert, strErrRcvChk, StrBlank, StrBlank);
        return;
    }

    if ((RcvCount <= 0))
        return;

    if (RcvCount > 1)
        RcvCount = 1;

    // Palm OS1, OS2 compatible
    error = SerReceive10(SerIORef, BufIn, 1, 10);

    // Palm OS2 compatible only
    //error = 0;
    //RcvCount = SerReceive(SerIORef, BufIn, 1, 0, &error);

    if (error) {
        SerClearErr(SerIORef);
        FrmCustomAlert (AlertGenericAlert, strErrRcvErr, StrBlank, StrBlank);
        return;
    }

    SerIOCnt++;
    SerIOCur = BufIn[0];
    SerIOSum += SerIOCur;
    if (SerIOCnt > 0)
        SerIOAvg = SerIOSum / SerIOCnt;
    if (SerIOCur < SerIOMin)
        SerIOMin = SerIOCur;
    if (SerIOCur > SerIOMax)
        SerIOMax = SerIOCur;

    // display results
    ShowNumResultFld (HiLoMainFldAvgField, SerIOAvg);
    ShowNumResultFld (HiLoMainFldRxCountField, SerIOCnt);
    ShowNumResultFld (HiLoMainFldLoField, SerIOMin);
    ShowNumResultFld (HiLoMainFldHiField, SerIOMax);
    ShowNumResultFld (HiLoMainFldLastField, SerIOCur);
}
}
```

so on. Then, where it makes sense, nested switch statements perform code (or launch subroutines) that depend on the subtype. For example, the event dispatcher for control events would have a case for each control for which an application

needed to respond to an event, and a sub-sub handler for each event type it needed to respond to. An application does not have to respond to every possible event for every control.

The Palm OS is not object-oriented, 17

PILOT DEVELOPER RESOURCES

www.wademan.com/Pilot/Program/FAQ.htm
www.massena.com/darrin/pilot/index.html
www.sls.lcs.mit.edu/raylau/pilot/
www.usr.com/palm/pilotlinks.html
www.roadcoders.com/pilot/index.html
www.shoppersmart.com/jlehett/gccwin32.html
www.usr.com/palm/dresources.html
www.metrowerks.com (general info)
www.metrowerks.com/db/updates.qry?function=list&sw=CWPP3 (patches)

Newsgroups:

alt.comp.sys.palmtops.pilot
comp.sys.palmtops.pilot
news.massena.com/pilot.programmer
news.massena.com/pilot.programmer.codewarrior
news.massena.com/pilot.programmer.gcc
news.massena.com/pilot.programmer.jump
news.massena.com/pilot.programmer.pila

nor is the development language. Thus, the API presents parallel clusters of functions with similar names that perform similar duties on similar types of controls. For example, there are separate functions to set controls (buttons) and fields (entry fields) usable (visible and “clickable”). Conversely, some functions do not have parallels across controls and fields. In the absence of overridable methods with identical names and behaviors across different classes of objects, I wish the API were more consistent. On the other hand, the overall API is small enough that such inconsistencies are not intolerable.

Something Happened

The Palm OS user-interface philosophy gives high priority to UI (user interface) events, so those are handled first. (In a performance-critical application, that probably wouldn't be the case.) HiLo's event loop lets all other events get processed first, and then only for nil events does it attempt to read serial I/O. (A nil event is just the OS's way of keeping the system active when there is a lack of other stimuli. After so much time consisting only of nil events, the system powers itself down.)

Whenever a nil event occurs, HiLo calls the routine SerIOReceive, shown in Listing 1. SerIOReceive simply returns if the port hasn't been opened, if no characters have been received, or if an error has occurred. Otherwise, it reads a single character, updates the internal statistics (count, min, max, avg), and displays the results.

The routine that actually reads bytes

from the UART is called SerReceive10. The routine was originally called SerReceive. The latter is now the OS rev. 2 version, and the former the original. By using SerReceive10, you can write code that will run on both versions. The new routine provides more and better status information, which we don't need for our application.

For Next Time

There are several ways we can proceed. Right now all we can do is read data; it might be nice to be able to write it as well. Another limitation is the user interface, which is pretty boring. It might be nice to see a histogram or a chart-recorder type of display. Peripheral to the Pilot itself, but nonetheless important, is the data input. Connecting the Pilot to an (emulated) ASCII terminal is OK, but there are an awful lot of interesting analog quantities out there.

Stay in touch; you can reach me via e-mail at jkh@acm.org. EN

POPTRONIX
Online Edition
We're on the web **FREE**
<http://www.poptronix.com>

Q & A

continued from page 7

source or publish a circuit? — R. F., Rochelle Park, NJ

A There are two things you can do: route the primary current through a transistor rather than directly through the points, and generate a primary voltage higher than 12 volts (perhaps more like 250). Almost all modern cars have transistor ignition, which does the first of the two. The second one is what you're asking about, and it ensures a really high spark voltage at all times.

Because you need high reliability and special parts, and because it's not going into your own car, it's probably best to use a commercial unit. Write to J. C. Whitney and Company, P.O. Box 8410, Chicago, IL 60680, and ask for a catalog. They have add-on electronic ignitions for American cars made since 1947.

Darts and Transistors

Q *I'm looking to build an electronic dart board out of an old computer. Are there any plans available for this project?*

Also, I have an old receiver for which I need two transistors, a 2SA765 and a 2SC1445. What can I use as replacements? — J. Z., Waukesha, WI

A We don't recall an electronic dart board project, but we'd like to hear from any reader who has designed and built one. Constructing the board itself, with digital sensors embedded, is the hard part.

The transistors are easier. Any parts jobber should have ECG, NTE, and SK reference books in which you can look up transistor substitutes. Those you ask about are silicon audio power output transistors, equivalent to ECG197 and ECG196 respective

Writing to Q&A

As always, we welcome your questions; please write to Q&A, **Electronics Now Magazine**, 500 Bi-County, Blvd., Farmingdale, NY 11735. The most interesting ones are answered in print. Due to the volume of mail we receive, we regret that we cannot give personal replies. EN

GET HERE.

LEARN A SKILL YOU ENJOY... ...THEN FIND A JOB THAT HAS A FUTURE.

New Web Site!
Visit our new web site at
www.cie-wc.edu
• Preview a sample from one of our lessons, detailed course descriptions, visit the bookstore, order a free catalog & much more!

Everyone has to start somewhere.

As 150,000 CIE graduates have discovered, independent-study from The Cleveland Institute of Electronics can get you where you want to be. *In a secure, financially rewarding, exciting career field of your choice.*



Industrial Robotics

Since 1934, CIE has been on the forefront of an ever expanding technological revolution.

CIE's curriculum is unique from other independent-study schools in the respect that we not only provide hands-on training utilizing today's technology we also instill the knowledge and understanding of why technology works the way it does. This is the foundation upon which every CIE graduate can trace their success back to and in which CIE's reputation as a quality learning facility is based on.



Project Engineer

Independent study is not for everyone. But, if you have the desire, the basic intellect and the motivation to succeed, CIE can make it happen. Our learning program is patented and each lesson is designed for independent study while our instructors are available to assist you whenever you feel you need help. In fact, CIE's curriculum is so well respected many Fortune 1000 companies utilize it for their own employees.



Telecommunications

CIE offers personalized training to match your background with over ten career courses, an Associate Degree Program and a Bachelor Degree Program through our affiliation with World College. And every CIE graduate got started in a

successful career the same way you can...by sending for your free CIE course catalog and judging for yourself if CIE's for you.



Computer Programming

START HERE...

YES! Please send me more information on:

- CIE's Associate Degree Program
- CIE's Computer Programming Course
- CIE's 12 Career Courses
- World College's Bachelor Degree Program

AE114

Name _____

Address _____

City _____

State _____ Zip _____

Phone: _____

Check for G.I. Bill Details
Active Duty Veteran



*It's More Than Just Training...
...It's an Education.*

1776 East 17th Street
Cleveland, OH 44114
(216) 781-9400 • 1-800-243-6446



Electronics

Back then it was radio and TV, today it's computer technology, programming and the electronics that make it all possible. Today and yesterday's similarities are uncanny... *Employers are looking for qualified applicants to hire and having a hard time finding them.*

Students at CIE receive the training and the education needed to get hired and to succeed in challenging fields such as computer programming, robotics, broadcast engineering, and information systems manage-

Investigating Brown's Gas, A Tiny TV Generator, and More

THIS MONTH, WE AGAIN HAVE A FASCINATING MIXTURE OF PSEUDOSCIENCE AND REAL SCIENCE TOPICS. INTERESTINGLY, HOWEVER, THIS TIME "THEY" ALMOST (BUT NOT QUITE) GOT THE PSEUDOSCIENCE RIGHT. BEFORE WE GET TO THAT, LET'S

see if we can kick things off with a little dose of reality.

The PIC Calibar

Tim Jenison of NewTek just sent me one of his new *Calibar* television test generators. That \$349 pen-sized instrument, shown in Fig. 1, can replace an entire studio full of professional NTSC TV test gear. The device generates the 24 precision test patterns shown, and it can also double as a station master sync generator. It can be used in the field, drawing power from a two-hour internal battery, or on the bench, using a standard wall-transformer AC supply.

The ergonomics here provide new meaning to my search for elegant simplicity. The user interface consists of a pushbutton! You briefly hit the button twice to turn it on. If you don't like the current pattern, keep hitting the button until the one you want comes around. Hold the button down to turn power off. A single red LED lights if the Calibar is active.

Internal 10-bit digital accuracy is used for highest waveform precision. Baseband video is output from a male BNC connector. Phono plug, phono jack, and female BNC adaptors are also included. There's also a "magic" set of blue glasses you wear for chroma balance.

Before we get too much further, let's review some NTSC TV basics. The crucial frequency is called a chroma reference or color subcarrier, and it is always

a precise 3.579545 MHz, though it is usually quoted as 3.58 MHz. When that signal's phase is zero, it corresponds to a color very slightly on the purple side of blue. As you shift the phase of the signal, the color produced varies as shown in the "color wheel" or "vectorscope display" of Fig. 2. Thus, the phase of the 3.58-MHz signal sets the color, while its amplitude sets the saturation. Actually, a color-difference amplitude scheme is used so that very little subcarrier is needed with whites or pastels. Chroma shift adjustments are also made to favor facial and skin tones.

The chroma reference is divided by 227.5 to produce a horizontal-scan frequency of 15,735 Hz, providing 63.55 microseconds for each horizontal scan line. They are further divided by 262.5 to produce a vertical field frequency of 59.94 Hz. Two fields are combined into a single, interlaced scan, giving you a frame rate of a tad under thirty frames per second.

Back to our horizontal scan line: The line is separated into a live scan time of around 55 microseconds and a blanking time, called the horizontal-blanking interval, of slightly over 8 microseconds. Blanking gives a classic CRT "picture-tube" electron beam enough time to reset from the right side of the screen back to the left.

Baseband video is normally set so that one volt is white, a tad over a quarter volt is black, and zero volts are the "blacker than black" sync tips. The horizontal-blanking interval includes a five-microsecond wide horizontal-sync pulse and an eight-cycle long chroma reference burst on its "back porch". Those are used to synchronize or lock the transmitter to the receiver.

The vertical-blanking interval is more complex. Vertical blanking is needed to give the electron beam time to get back to the top of the screen. Various "hidden" services are also provided in that interval, including closed captioning, test signals, and timing standards. The vertical blanking also provides a vertical sync pulse as the third locking signal. Some fancy equalizing "teeth" are also placed in the vertical-sync pulse to preserve horizontal-sync extraction and to take care of the half line offset between even and odd fields.

Inner Details

Figure 3 shows a rough block diagram of the Calibar. The PIC 16C57 microprocessor used is not quite fast enough to directly generate the highest speed video timing, but it does all of the slower tasks such as a partial pattern timing, horizontal scan-line generation, pattern picking, pushbutton housekeeping, sync, and the frame-rate timing. The usual 4× chroma frequency of 14.318

NEED HELP?

Phone or write all your US Tech Musings questions to:

Don Lancaster
Synergetics
Box 809-EN
Thatcher AZ, 85552
Tel: 520-428-4073

US e-mail: don@tinaja.com
Web page: <http://www.tinaja.com>

**new from
DON LANCASTER**

ACTIVE FILTER COOKBOOK

The sixteenth (!) printing of Don's bible on analog op-amp lowpass, bandpass, and highpass active filters. De-mystified instant designs. **\$28.50**

RESEARCH INFOPACKS

Don's instant cash-and-carry flat rate consulting service. Ask any reasonable technical question for a detailed analysis and complete report. See www.tinaja.com/info01 for specifics. **\$75.00**

CMOS AND TTL COOKBOOKS

Millions of copies in print worldwide. THE two books for digital integrated circuit fundamentals. About as hands-on as you can get. **\$28.50 each.**

INCREDIBLE SECRET MONEY MACHINE II

Updated 2nd edition of Don's classic on setting up your own technical or craft venture. **\$18.50**

LANCASTER CLASSICS LIBRARY

Don's best early stuff at a bargain price. Includes the CMOS Cookbook, The TTL Cookbook, Active Filter Cookbook, PostScript video, Case Against Patents, Incredible Secret Money Machine II, and Hardware Hacker II reprints. **\$119.50**

LOTS OF OTHER GOODIES

Tech Musings V or VI	\$24.50
Ask the Guru I or II or III	\$24.50
Hardware Hacker II, III or IV	\$24.50
Micro Cookbook I	\$19.50
PostScript Beginner Stuff	\$29.50
PostScript Show and Tell	\$29.50
PostScript Video & secrets	\$29.50
PostScript Reference I	\$34.50
PostScript Tutorial/Cookbook	\$22.50
PostScript by Example	\$32.50
Understanding PS Programming	\$29.50
PostScript: A Visual Approach	\$22.50
PostScript Program Design	\$24.50
Thinking in PostScript	\$22.50
LaserWriter Reference	\$19.50
Type 1 Font Format	\$16.50
Acrobat Reference	\$24.50
Whole works (all PostScript)	\$380.00
Technical Insider Secrets	FREE

BOOK-ON-DEMAND PUB KIT

Ongoing details on Book-on-demand publishing, a new method of producing books only when and as ordered. Reprints, sources, samples. **\$39.50**

THE CASE AGAINST PATENTS

For most individuals, patents are virtually certain to result in a net loss of sanity, energy, time, and money. This reprint set shows you Don's tested and proven real-world alternatives. **28.50**

BLATANT OPPORTUNIST I

The reprints from all Don's Midnight Engineering columns. Includes a broad range of real world, proven coverage on small scale technical startup ventures. Stuff you can use right now. **\$24.50**

RESOURCE BIN I

A complete collection of all Don's Nuts & Volts columns to date, including a new index and his master names and numbers list. **\$24.50**

FREE SAMPLES

Check Don's Guru's Lair at <http://www.tinaja.com> for interactive catalogs and online samples of Don's unique products. Searchable reprints and reference resources, too. Tech help, hot links to cool sites, consultants. email: don@tinaja.com
FREE US VOICE HELPLINE VISA/MC

SYNERGETICS
Box 809-EN
Tatcher, AZ 85552
(520) 428-4073

FREE catalog: <http://www.tinaja.com>

MHz is used as a master system clock.

The heart of the circuit is a high-speed, low-power, 10-bit Harris D/A converter, followed by a fast video op-amp driver with a carefully controlled bandwidth. The D/A is driven from a large EPROM pattern generator. Low address bits of that pattern generator are continuously and sequentially accessed when you scan across each horizontal line. Upper address bits pick the pattern for the particular lines being output.

A resettable 4-bit CMOS binary counter does the fastest of the pattern addressing. The PIC does everything else! Their PIC apparently executes one instruction cycle every chroma cycle of 3.58 MHz. My best guess as to how the "half cycle" at the end of each horizontal line is handled is by using horizontal-line-pattern pairs. Again guessing, I suspect that the need for any half or odd horizontal lines is eliminated by generating a full two frames of four fields. Special line-pair sync patterns would be needed for each case of even or odd field and even or odd frame.

Clearly, there is some innovative programming going on here. There's 910 samples of 4X chroma per line, so 10 address bits ($2^{10} = 1024$) should handle the sequential addressing for one horizontal line, or 11 address bits for horizontal-line pairs.

With a 64K word EEPROM, that leaves you with five address lines to access

up to 32 possible line patterns. Many of those will be needed for the exotic synchronization; some others can be reused in several modes.

The nice thing about this scheme is its content independence. You don't have to try and logically define all of the patterns; all you do is stash their values in a lookup table. Not all that many live patterns should be required, because any selected screen-display mode does not change much in the vertical direction. And certain screen modes are simply combinations of earlier ones. All patterns are exact, and as precise as 10-bit samples allow.

I was sort of joking to Tim that he should also offer the classic "indian head" pattern. Done as lookup, that would require a somewhat oversize EPROM; with some folding, around eight megs might do it.

Note that the Calibar is NTSC only. It is not intended for VGA or other computer-monitor uses, due to differences in scan rates and how colors are generated and distributed. However, I'd guess that similar computer monitor testers are in the works.

As an aside, NewTek is not in Kansas anymore (took the dog, but left Aunt Em). Note their new Texas address in the Names and Numbers box elsewhere in this article. Their Website remains www.newtek.com.

I will try to work up some PIC video

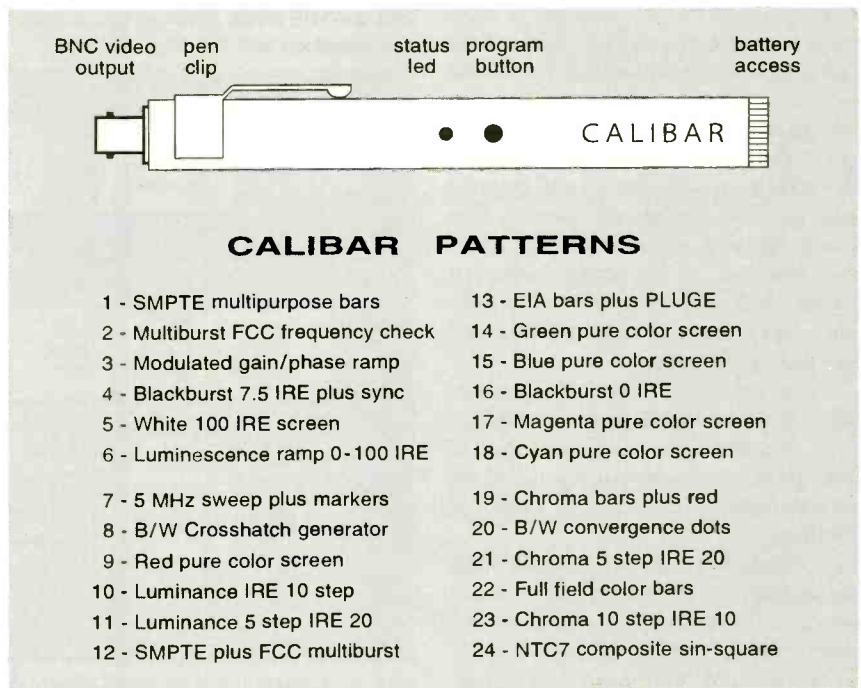

FIG. 1—PEN-SIZED AND PIC-BASED CALIBAR from NewTek replaces a whole studio full of television test instruments. The 24 standard precision test patterns listed can be generated.

demos in a future column. Meanwhile, much more on PIC apps appears on the PIC Library Shelf and the pair of PIC Web Link pages on www.tinaja.com; also look there for ELESIMP.PDF, which contains more on elegant simplicity. Good sources for video in general are the older *Television Engineering Handbook* from McGraw-Hill, and the newer *Video Demystified* from Harris Semiconductor. More TV and video information appears as this month's resource sidebar.

Meta Studies

How can you honestly evaluate a controversial technical concept? One older scientific tool that's seeing new life is called the meta study, in which you simply "study the studies." You objectively and without bias gather together everything you can find on the subject. Both pro and con. Only after everything is gathered do you try to judge both sides for relevance, scientific rigor, timeliness, hidden agendas, vested interests, and overall credibility. From there, you go on to decide whether you want to spend the time and effort to further involve yourself. The argument "But you haven't done the experiment" cuts no ice here. The chances are "the experiment" (or its interpretation) will be dead wrong anyhow.

A meta study usually will clearly tell you whether there is any point in getting further involved. It all comes down to a simple matter of probabilities. A meta study is similar to a civil jury trial, where "preponderance of evidence" is carefully sought, along with the suitable "motive, means, and opportunity." After you have run a few meta studies, obvious "looks like a duck—quacks like a duck" patterns emerge. The big picture patterns that easily let you separate science from pseudoscience, or the scams, "not even wrong" bad labwork, and "thuzzy finking" from the real opportunities and genuine breakthroughs.

The web sure makes doing meta-study searches simple and easy. I've got lots of brand-new search tools at www.tinaja.com/webwb01.html. But my favorite search tool remains good old Hotbot.

Meta studies work in nearly any field. As one practice non-electronic example, punch L-Carnitine into Medline and you'll probably reach the same conclusions that I did: This nutritional supplement does seem highly useful and effective for certain cardiovascular problems,

but does not normally provide stamina or energy benefits for fitness jocks. More on this can be found on my site in DONTICK.PDF. Free Medline links are at www.tinaja.com/beewb01.html. A custom meta-study service is at www.tinaja.com/info01.html.

It's a Gas

I decided to apply a meta study to Brown's Gas, one currently popular web

pseudoscience topic. I found a fascinating mixture of legit science, highly unexpected though apparently valid "gee whiz" results, along with outrageously unsupported claims. The bottom line is that I spotted nothing here to get personally excited about, although a PostScript and PIC-controlled flutterwumping precision torch just might make for a rather interesting project.

First off, note that any decent torch

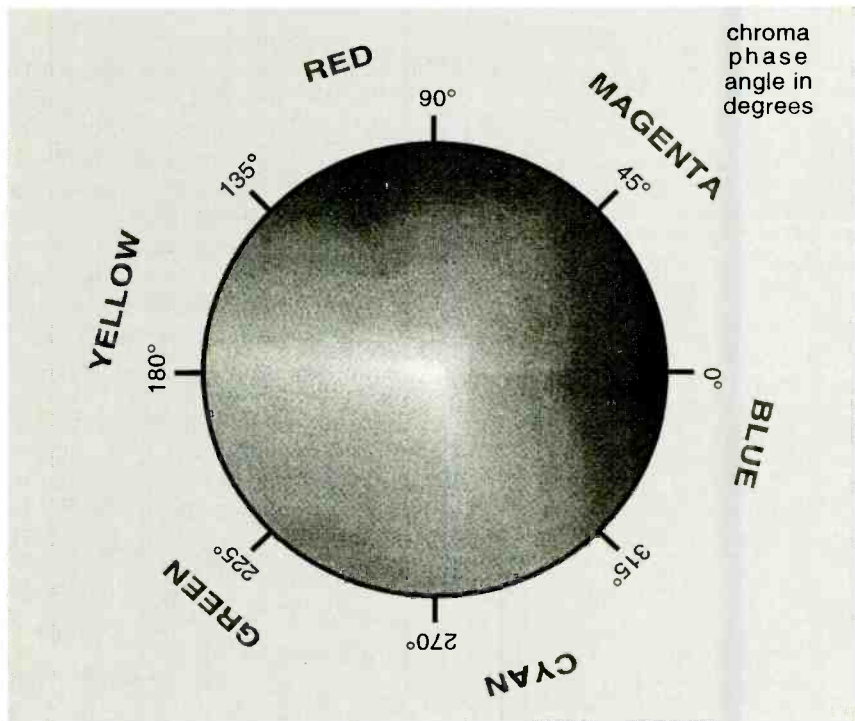

FIG. 2—THE NTSC CHROMA SUBCARRIER PHASE determines the hue, while its relative amplitude sets the color saturation.

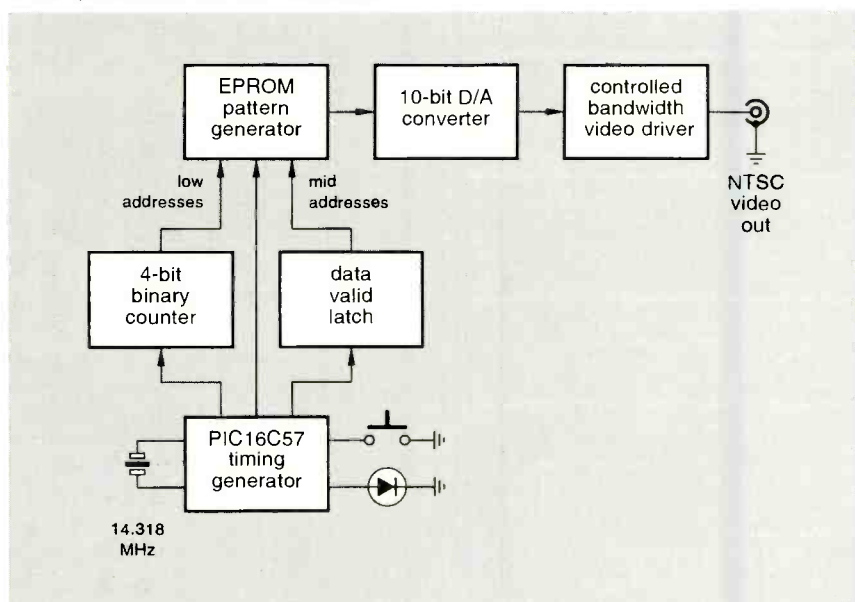

FIG. 3—A SIMPLIFIED BLOCK DIAGRAM of the Calibar. Table lookup of 43 chroma samples is provided to 10-bit accuracy. The PIC controls most table access and does all the synchronization and low-frequency timing.

SOME TELEVISION BROADCASTING RESOURCES

Bacon's TV Directory

332 S Michigan Ave.
Chicago, IL 60604
(312) 922-2400

Broadcast Engineering

9800 Metcalf Ave.
Overland Park, KS 66212
(913) 967-1737

Broadcasting & Cable

245 W 17th St.
New York, NY 10011
(212) 337-6942

Cable Vision

825 7th Ave.
New York, NY 10019
(212) 887-8400

College Broadcaster

71 George St.
Providence, RI 02912
(401) 863-2225

Electronic Media

740 N Rush St.
Chicago, IL 60611
(312) 649-5293

HDTV Report

1201 Seven Locks #300
Rockville, MD 20854
(800) 777-5006

IEEE Communications Journal

445 Hoes Lane
Piscataway, NJ 08855
(908) 981-0060

Multichannel News

825 7th Ave.
New York, NY 10019
(212) 887-8400

National Association of Broadcasters

1771 N Street NW
Washington, DC 20036
(202) 429-3931

Response TV

201 Sandpointe Ave.
Santa Ana, CA 92707
(714) 513-8400

Satellite Orbit

8330 Boone Blvd.
Vienna, VA 22182
(703) 827-0511

SMPTE Journal

595 W Hartsdale Rd.
White Plains, NY 10607
(914) 761-1100

Television Broadcast

460 Park Ave. S 9th Flr.
New York, NY 10016
(212) 378-0400

Television Quarterly

111 W 57th St.
New York, NY 10019
(212) 586-8424

TV Technology

5827 Columbia Pike #310
Falls Church, VA 22041
(703) 998-7600

person can pull off all sorts of magic tricks. At Thatcher Fire Department, we have a Broco oxy-iron torch we use as the "master key" to vaporize anything between where we are and where we want to go. I've personally used a Broco to cut through cement blocks and to burn the bottom out of a bucket full of water—from the inside.

Let's start with the re-mixed gas a chemist would get from the classic electrolysis of water. That will be a stoichiometric mixture of very nearly two parts of hydrogen and one part of oxygen by volume. For semantics, let's call this one stokegas on the off chance that Brown's Gas might really be something else. Stokegas is one of the most highly com-

bustible substances known to man. For that reason, stokegas gets normally generated and used only as it is needed. Storage is a big time no-no. Specialized torches seem to be a good on-demand match here.

Stokegas burns with an extremely hot, but remarkably low-energy flame; the degrees are there but the BTUs are not. For instance, gasoline offers 9000 watt hours of energy per liter. Stokegas at normal temperature and pressure delivers only 2.4 watt hours per liter. Stokegas theoretically burns at 5120 degrees F, or 3100 degrees C. Hydrogen in air theoretically burns at 3860 degrees F, or 2400 degrees C. By contrast, acetylene in air burns at a hotter 4770 F, or 2670 C.

Claims that you can briefly place your hand near a stokegas flame do appear true. But do not try it! The reason is that despite the extreme temperature, there is not enough heat energy present to briefly do you any significant harm.

A claim that stokegas "adjusts" its temperature to suit the task at hand is apparently rotten labwork. Infrared thermometers are based on emissivity, and there is darn little to emiss. The correct method to make an accurate reading is to place an object in the flame and heat it. Then measure the object's emitted radiation. Even then, interpretation can get rather tricky.

Is a hydrogen flame invisible? Hazmat folks think so—especially during that hot summer afternoon tanker rollover in the Phoenix desert when they had to "joust" with a rag on a pike pole to find the flame front. However, in the lab you can in fact see the flame, albeit it a rather weak one. Reasons for the near invisibility include an emission primarily in the ultraviolet, the lack of carbon particles, and the low total energy involved.

Valid hydrogen proponents are taking steps to make their flames more visible. Their efforts are similar to placing methyl mercapan odorant in natural gas, which otherwise has no smell whatsoever. Interestingly, it seems that when they first tried natural gas odorants, they used a chemical that smelled good, rather than bad, which made people purposely leave their gas jets open to act as room air fresheners!

Does stokegas implode rather than explode? Not really. However, if the container walls are cool enough, the generated steam will condense and will provide you with an amazingly reduced final pressure, perhaps down around 1 PSI or so, giving you an explosion rapidly followed by condensation.

There are two rather distinct, but overlapping processes here. After demonstrating that effect several times in a row, the container walls and the accumulated water usually seem to heat up enough that positive pressures result. The claims that an "implosion" can lead to any "sub-vacuum" pressures or pressures below the vapor pressure of liquid water have no apparent basis in fact. "T'ain't likely McGee."

Could a reduced-pressure engine be developed? Possibly. Would it be useful or efficient? Almost certainly not. Why? Because of inherent and fundamental thermodynamic-cycle limitations. More

NAMES AND NUMBERS

Adobe Systems

PO Box 7900
Mountain View, CA 94039
(800) 833-6687

Amazon.com Books

Box 80387
Seattle, WA 98108
(800) 201-7575

BioCard International

7500 Old Oak Blvd.
Cleveland, OH 44130
(440) 243-1800

Broco

2824 N Locust Ave.
Rialto, CA 92377
(909) 350-0580

Dallas Semiconductor

4401 Beltwood Pkwy. S
Dallas, TX 75244
(972) 371-4448

Harris Semiconductor

Box 883
Melbourne, FL 32902
(407) 724-7000

Lindsay Publications

PO Box 538
Bradley, IL 60915
(815) 935-5353

McGraw-Hill, Inc.

11 West 19th St.
New York, NY 10011
(212) 512-2000

NewTek

8200 IH 10 W, Suite 900
San Antonio, TX 78230
(800) TOASTER

Science/AAAS

1333 H St. NW
Washington, DC 20005
(202) 326-6400

SenSym

18404 McCarthy Blvd.
Milpitas, CA 95035
(408) 954-1100

Synergetics

Box 809
Thatcher, AZ 85552
(520) 428-4073

Weighing Technology

301 Gibraltar Dr.
Morris Plains, NJ 07950
(201) 292-5100

John Wiley and Sons, Inc.

605 Third Ave.
New York, NY 10158
(212) 850-6088

happens only at low production rates and is usually swamped by other cell losses.

There is also classic EE student lab blunder #01-A, where you'll fail to accurately measure rms power when dealing with any unusual waveforms. More on this in MUSE112.PDF.

Claims that any electrolysis cell "stays cool" are easily explained by staying in the endothermic generation region between 1.23 and 1.47 volts. More details in Peavey's ineptly misnamed *Fuel From Water*, stocked by Lindsay Publications.

In short, I've found nothing whatsoever to convince me that Brown's gas is in any way, shape, or form any different from stokegas. But the simple mass spectrographic proof apparently has never been done. Other Web proponents claim to be able to somehow "resonate" a water molecule, aiding its dissociation in some vaguely over-unity manner. The problem is that the frequencies they are using seem ten million times too low. And even if resonance worked, I personally see absolutely no way that any energy gain could possibly result in the process.

Claims that a hydrogen-powered car can be run with "a few watts of electricity" are usually demonstrated by running the few watts for a long time, dangerously accumulating the gas, and then idling the car for a brief instant—otherwise known as using a piggy bank effect. Unless such extraordinary claims can be solidly backed up by lots of independent tests and extraordinary evidence, those on-board "miracle" hydrogen-electrolysis generators will remain totally useless for cars. Why? Because you'd be ridiculously better off sending the electricity directly to wheel motors in the first place.

Lots more about Brown's Gas is on the Net. Be sure to remember that Net clearly stands for Not Entirely True. There is no Brown's Gas torch or information supplier that I can honestly recommend. First, because of highly questionable claims and endemic bad lab-work. And second, because I strongly feel the Broco is a vastly better choice for any

on thermodynamic cycles can be found in HACK64.PDF.

Certain Brown's gas proponents claim they are generating something that's different than stokegas. Yet the schematics I looked at seemed to be sending more-or-less plain old current through more-or-less plain old water.

Brown's gas proponents claim to melt tungsten. That is believed to be impossible with stokegas. However, reversible tungsten side reactions that can involve oxidation, ablation, or a sublimation appear to be credible mainstream explanations for the observed effects.

Proponents also claim significant generation and long-term storage of monoatomic oxygen and hydrogen, which I find highly unlikely, and a chemist finds so hilarious he won't even talk about it. As far as anyone knows, monoatomic hydrogen and oxygen very rapidly recombine into their diatomic forms, or quickly enter into other reactions at most realistic tem-

peratures and pressures.

Certain Brown's gas proponents also claim over-unity generation and the ability to neutralize radioactivity. The strongest evidence for these last three extraordinary claims so far is a GIF image of a large orange box, which clearly is radiating at 590 nanometers. Uh, nice try.

As to doing over-unity hydrogen generation, it does turn out that up to one sixth of electrolysis energy can sometimes in fact come from waste heat rather than input electricity. But this modest "gain"

Gasoline	9000 Wh/l	13,500 Wh/Kg
Lithium	350 Wh/l	150 Wh/Kg
Flywheel	210 Wh/l	120 Wh/Kg
Lead Acid	40 Wh/l	25 Wh/Kg
Hydrogen	3.5 Wh/l	39,000 Wh/Kg

FIG. 4—COMPARE THE ENERGY DENSITIES shown here and draw your own conclusions as to the worth of each as a fuel or a means.

hazmat, rescue, underwater, or maintenance. More on hydrogen can be found in MUSE115.PDF.

An Energy-Density Summary

It never ceases to amaze me how figures that people do not want you to see sometimes are extremely hard to pin down. One example is a simple and direct comparison of energy density. Another is the fact that the currently highly touted electric car has a theoretical maximum energy-storage equivalent of less than six pints of gasoline (less than your lawn mower).

As a review, a fuel is something (such as gasoline) that is capable of delivering net BTU's worth of "on the books" energy. The fact that the sun and some swamp labored eons to pre-concentrate the energy does not seem to count. What does count by today's economics is just how much energy you get back for the energy and "energy equivalents" you put in, using today's dollars.

By contrast, any energy transport means (such as hydrogen or lead acid) does not deliver any net "on the books" BTUs or watt hours. Those are simply ways of moving already existing energy to a more convenient time or place, but always at an efficiency and energy loss.

At any rate, two very important measures of "how good" either a fuel or an energy transport means are: How heavy is it? How much room does it take up? A useful measure of "how heavy" is in watt hours per kilogram (Wh/Kg). The "how much room" can be measured in watt hours per liter (Wh/l). Figure 4 gives you the direct comparisons for conventional and alternate energy densities. Form your own conclusions.

New Tech Lit

What just might be the long-sought inside secret to photosynthesis may have appeared in the September 26, 1997 issue of *Science*. Check out "A Metalloradical Mechanism for the Generation of Oxygen from Water in Photosynthesis" by Hoganson and Babcock, on pages 1953-1956. Their key process may involve a manganese compound that goes through five reaction states. The first state accepts water and solar energy and kicks off both an electron and a hydrogen ion. The second, third, and fourth stage also kick off an electron and a hydrogen ion. The fifth state burps out a new diatomic oxygen molecule as a "waste product," and reverts itself back to state one.

From SenSym comes an update on their fine *Solid State Pressure Sensors Handbook*. Dallas Semiconductor has their latest *Short Form Catalog* on clock, temperature, digital pot, and other unique chips.

Our two featured trade journals this month are *Biocard International* on hand print and related security, and *Weighing Technology* on scales.

The Secrets of Building a Plastic Injection Molding Machine forms the latest title from Lindsay Publications. It shows you how to recycle ordinary plastics into custom items. Vince and Dave Gingery are the authors. It lists for \$15.95. Lindsay's Website is www.keynet.net/~lindsay.

One Internet marketing book I am rather impressed with is *Increasing Hits and Selling More from your Web Site*. It is authored by Greg Helmstetter and published by Wiley. Amazon Books sells it at \$19.96. While largely non-technical, it seems to nicely complement some of the ideas and concepts you'll find in the Webmaster Library Shelf files of my www.tinaja.com.

Free and detailed specs on new PostScript Level III are now available from www.adobe.com. Level III is more

about "formalizing" high-end publishing and networking options, rather than about adding new low level features, although there is a unique curve tracing feature (spline interpolation of sampled data), that I will be looking at closely. Sadly, the transparency options you'll need for video apps still seem to be either lacking or well hidden.

Brand new opportunities in PIC PostScript robotics can be found in POSTFLUT.PDF My ongoing Blatant Opportunist columns are now in e-zine format at www.tinaja.com/blat01.html. The latest two include BANNYEAR.PDF on profiting from Internet advertising banners; and TRIMODE.PDF about tri-mode paper, electrons, and plastic publishing options. For details on starting up your own tech venture, take a gander at my *Incredible Secret Money Machine II* as per my nearby Synergetics ad or at www.tinaja.com/ismm01.html.

As usual, most of the mentioned items should appear in the Names & Numbers or the Television Resources sidebars. Always check there before you phone our U.S. technical help line shown in the Need Help? box you'll find nearby. Let's hear from you. **EN**

One Touch Auto Set-Up

100MHz and 200MHz Analog Oscilloscopes

±2% Accuracy
Save & Recall Up To 32 Panel Settings
3 Year Product Warranty



Model SS-7821, 200 MHz Bandwidth - \$2,995.
Model SS-7811, 100 MHz Bandwidth - \$1,795.

Featuring... 3-CH, 8 Traces • 2m V/div Sensitivity • Full TV Trigger with Field and Line Select
• 5 Digit Frequency Counter • Cursor Measurements with CRT Readouts • Fine Adjustment Modes
• Auto Probe Readout, CH-2 Output • Z-Axis Input • Bright, Sharp, 6" Meshless CRT • Built-in Diagnostics.

Also available: 400 MHz & 470 MHz models. Send for Complete Catalog

IWATSU AMERICA, Inc.
TEST & MEASUREMENT EQUIPMENT DIVISION
430 Commerce Blvd. Carlstadt, NJ 07072 • Tel: (201) 935-8486 • Fax: (201) 935-8533
WebSite: <http://www.iwatsu.com> • e-mail: iwatsu@access.digex.net

CIRCLE 134 ON FREE INFORMATION CARD

February 1998, Electronics Now



NEW PRODUCTS

USE THE FREE INFORMATION CARD FOR FAST RESPONSE

Digital Multimeters

FLUKE CORPORATION'S 70/20 Series III Digital Multimeters (DMMs) is ergonomically designed. Its tapered shape provides stable results in harsh, industrial environments. The Series III DMMs can be used in a variety of electronic and electrical applications by technicians in field service, facilities maintenance, and/or production equipment maintenance and installation; in bench service and repair, and in manufacturing environments.

The DMMs feature a large, high-contrast screen and segmented bargraph for

easy reading. With the meter's Touch Hold function that automatically freezes the reading and beeps when the measurement is captured, technicians are able to focus their attention on the test probes without having to touch any button. The user-interface has been improved to provide easier access to the Range and Hold buttons. In addition, the battery and fuses can be replaced without breaking the calibration seal, thus eliminating unnecessary calibration.

The top-of-the-line models, the 79 and 26 Series III DMMs, offer true rms,

capacitance, frequency, and low-ohms capabilities. These meters measure volts, millivolts, DC, AC/DC volts, ohms, and amps. All the models in the Series III family perform diode and continuity tests.

Complying with the International Electrochemical Commission (IEC) 1010-1 safety category ratings, based upon the ability of meters to withstand power surges and high voltage transients, the Series III has protection up to 6 kV. Input ranges and functions are protected up to the meter's rated voltage. They have dual IEC 1010 ratings for Overvoltage Category III 600 V and Overvoltage Category II 1000 V. These DMMs will not blow a fuse or be destroyed if accidentally connected to a live circuit while in the resistance mode.

The Series III meters are rugged and durable; their integrated, overmolded cases are meant to withstand falling, being dropped, or being tossed into a tool box. List prices for the 70 Series Model III DMMs are \$199 (Model 79 III), \$179 (Model 77 III), \$159 (Model 75 III), \$129 (Model 73 III), and \$99 (Model 70 III). For the 20 Series Model III DMMs, the list prices are \$219 (Model 26 III), \$199 (Model 23 III), and \$179 (Model 21 III).

Fluke Corporation

P.O. Box 9090

Everett, WA 98206

Tel: 800-44FLUKE or 206-356-6600

Fax: 800-FLUKE-FAX or 206-356-5116

E-mail: fluke-info@tc.fluke.com

Web: www.fluke.com



CIRCLE 20 ON FREE INFORMATION CARD

Low-Cost EPROM Emulator

The SR256, Socket Rocket, from Wisch Communications is a low-cost EPROM emulator with the ability to emulate 8K × 8, 16K × 8, or 32K × 8 EPROMs. Designed as a productivity tool, the SR256 features a sophisticated command-line loader utility, jumperless operation, and single-device bus loading. It has 90-120ns access times, dual-polarity reset outputs, and an LED status indi-

cator. Its small outline accommodates dense component areas.

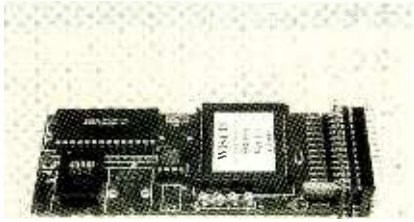

CIRCLE 21 ON FREE INFORMATION CARD

The command-line loader utility allows users to load Hex, S-Record, or Binary files into the emulator. It also enables them to set the EPROM size of the emulator, to fill unused locations in the emulator with a data byte, to locate code anywhere using offsets, to verify that the data loaded is correct, and to run a self-test diagnostic on the emulator.

Cables and software, as well as a shareware table-driven assembler, are included with the SR256, as is the manual and step-by-step instruction for installation and use. The SR256 is priced at \$99, plus shipping and handling.

Wisich Communications

2550 Trinity Mills Road, Suite 132B

Carrollton, TX 75006

Tel: 972-417-3533

Fax: 972-417-3821

E-mail: wisichcom@cyberramp.net

Schematic Capture Tool

CircuitMaker Version 5 has recently been released by MicroCode Engineering. The Windows-based schematic capture and simulation tool now features fast, accurate, mixed-signal simulation previously only available on higher-cost EDA software. Aimed at engineers, this software can simulate any combination of analog and digital components—without manually inserting A/D or D/A translators. Version 5 makes mixed-signal simulation as easy as analog-only simulation.

Along with the expanded simulation capability, the new release features a larger device library of over 4000 devices, easier SPICE model import, and no limit on the number of pins for an individual device. Version 5 offers a proven, accurate, 32-bit SPICE-based simulator for analog and mixed-signal circuits. It also provides fully interactive digital logic mode when only logic simulation is needed.

CircuitMaker is an EDA software tool

that seamlessly integrates schematic capture and simulation in one complete program. Professional schematic capabilities include a built-in symbol editor, a macro feature for hierarchical devices, and SmartWires automatic wire routing. These features allow users to quickly create high-quality schematics. Designers can also export CircuitMaker schematics as PCB netlists for use in MicroCode's TraxMaker or other printed-circuit-board layout products.

A wealth of analyses in the software allows designers to test and troubleshoot circuits in a virtual lab environment, without worrying about bad parts or faulty connections that often plague traditional prototyping. With a click of the free-floating Probe tool, users can instantly see waveforms and measurements on virtual instruments, like the digital oscilloscope, curve tracer, bode

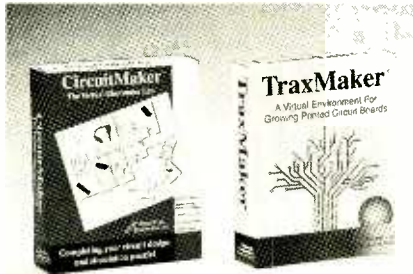

CIRCLE 22 ON FREE INFORMATION CARD

plotter, or digital multimeter. Simulation tools like CircuitMaker give engineers the freedom to try all scenarios, changing parts or component values to see how changes affect the circuit's operation and performance.

The software operates on the Windows 3.1x, 95, and NT platforms. Single-use copies are priced at \$299. Special upgrade offers are available for current registered users.

MicroCode Engineering Inc.

927 West Center Street

Orem, UT 84057

Tel: 800-419-4242 or 801-226-4470

Fax: 801-226-6532

E-mail: sales@microcode.com

Web: www.microcode.com

Serial Data Acquisition Module

B&B Electronics has introduced an RS-232 serial-port data-acquisition module. It amplifies and conditions the very low-voltage signals coming from sensors, so that they can be monitored and recorded on a PC. Two digital I/O lines

and six A/D channels are provided.

An optical fiber link in each line provides a minimum of 2500V DC isolation against electrical ground loops, surges,



CIRCLE 23 ON FREE INFORMATION CARD

and spikes. The 2320PSDA is port-powered on the RS-232 side of the device. An external isolated power supply is needed to power the I/O side of the device, which has terminal blocks. The host RS-232 serial port is a DB-25 (female) connector.

Demonstration software and a data-logging utility on a 3.5-inch disk are included. The 2320PSDA is priced at \$109.95. The optional power supply is \$14.95.

B&B Electronics Manufacturing Co.

707 Dayton Road

Ottawa, IL 61350

Tel: 815-433-5100

Fax: 815-434-7094

Web: www.bb-elec.com

Coax LAN Test Accessory Kits

Two Coaxial LAN Test Accessory Kits from ITT Pomona provide the network technician with everything needed for



CIRCLE 24 ON FREE INFORMATION CARD

coax-cable LAN troubleshooting, installation, and repair. The Model 6201, a general-use LAN test kit, includes a flexible assortment of cables, breakouts, termination plugs, and adapters. The Model 6202 LAN test kit is designed specifically

(Continued on page 62)

RETAILERS THAT SELL OUR MAGAZINE MONTHLY

Arkansas

Telephone Store
P.O. Box 804
Searcy, AR 72145

California

California Electronics
221 N. Johnson Ave.
El Cajon, CA 90202

Ford Electronics
8431 Commonwealth Avenue
Buena Park, CA 90621

All Electronics
14928 Oxnard Street
Van Nuys, CA 91411

Gateway Electronics of CA
9222 Chesapeake Drive
San Diego, CA 92123

Mac's Electronics
191 South "E" Street
San Bernardino, CA 92401

Electronics Warehouse
2691 Main Street
Riverside, CA 92501

Orvac Electronics
1645 E Orangethorpe Ave.
Fullerton, CA 92631

Sav-On Electronics
13225 Harbor Blvd.
Garden Grove, CA 92643

JK Electronics
6395 Westminster Blvd.
Westminster, CA 92683

Marvac Dow Electronics
980 S. A Street
Oxnard, CA 93030

Kandarian Electronics
1101 19th Street
Bakersfield, CA 93301

Whitcomm Electronics
105 W. Dakota #106
Clovis, CA 93612

Marvac Dow Electronics
265-B Reservation Road
Marina, CA 93933

Minuteman Electronics
37111 Post St., Suite 1
Fremont, CA 94536

HCS Electronics
6819 S. Redwood Drive
Cotati, CA 94931

Halted Specialties Co.
3500 Ryder Street
Santa Clara, CA 95051

Metro Electronics
1831 J Street
Sacramento, CA 95814

HSC Electronics
4837 Amber Lane
Sacramento, CA 95841

Colorado

Gateway Electronics of CO
2525 Federal Blvd.
Denver, CO 80211

Centennial Electronics
2324 E. Bijou
Colorado Sps., CO 80909

Connecticut

Cables & Connectors
2198 Berlin Turnpike
Newington, CT 06111

Electronic Service Prod.
437 Washington Avenue
North Haven, CT 06473

Georgia

Norman's Electronics, Inc.
3653 Clairmont Road
Chamblee, GA 30341

Illinois

Tri State Elex
200 W. Northwest Hwy.
Mt. Prospect, IL 60056

Kansas

Electronic Hobby Shop
309 E. McKay
Frontenac, KS 66763

Maryland

Mark Elec. Supply Inc.
5015 Herzel Place
Beltsville, MD 20705

Amateur Radio Center
1117 West 36th Street
Baltimore, MD 21211

Massachusetts

U-Do-It Electronics
40 Franklin Street
Needham, MA 02194

Michigan

Purchase Radio Supply
327 East Hoover Avenue
Ann Arbor, MI 48104

Norwest Electronics
33760 Plymouth Road
Livonia, MI 48150

The Elec. Connection
37387 Ford Road
Westland, MI 48185

Elec. Parts Specialists
711 Kelso Street
Flint, MI 48506

Minnesota

Acme Electronics
224 Washington Avenue N.
Minneapolis, MN 55401

Missouri

Gateway Electronics Of MO
8123-25 Page Blvd.
St. Louis, MO 63130

New Jersey

Lashen Electronics Inc.
21 Broadway
Denville, NJ 07834

New York

R&E Electronics
4991 Rt. 209
Accord, NY 12404

Unicorn Electronics
Valley Plaza
Johnson City, NY 13790

Ohio

Philcap Electronic Suppliers
275 E. Market Street
Akron, OH 44308

Oregon

Norvac Electronics
7940 SW Nimbus Avenue
Beaverton, OR 97005

Taztronics
257 N. Wasson St.
Coos Bay, OR 97420

Pennsylvania

Business & Computer Bookstore
213 N. Easton Road
Willow Grove, PA 19090

Texas

Mouser Electronics
958 N. Main Street
Mansfield, TX 76063

Tanner Electronics
1301 W Beltline
Carrollton, TX 75006

Electronic Parts Outlet
3753 B Fondren
Houston, TX 77063

GMD Electronics
2625 S. Loop Hwy.
Alvin, TX 77511

Electronic Parts Outlet
17318 Highway 3
Webster, TX 77598

Washington

Amateur Radio Supply Co.
5963 Corson Ave., Ste 140
Seattle, WA 98108

Wisconsin

T.V.-VCR Repair
1306 W. Madison St.
P.O. Box 64257
Milwaukee, WI 53204

**If you'd like to sell our magazine in your store,
please circle 210 on Free Information Card.**

Build A MULTICHANNEL Oscilloscope TRIGGER

Trigger an oscilloscope sweep on a combination of input signals!

THOMAS PETERICK

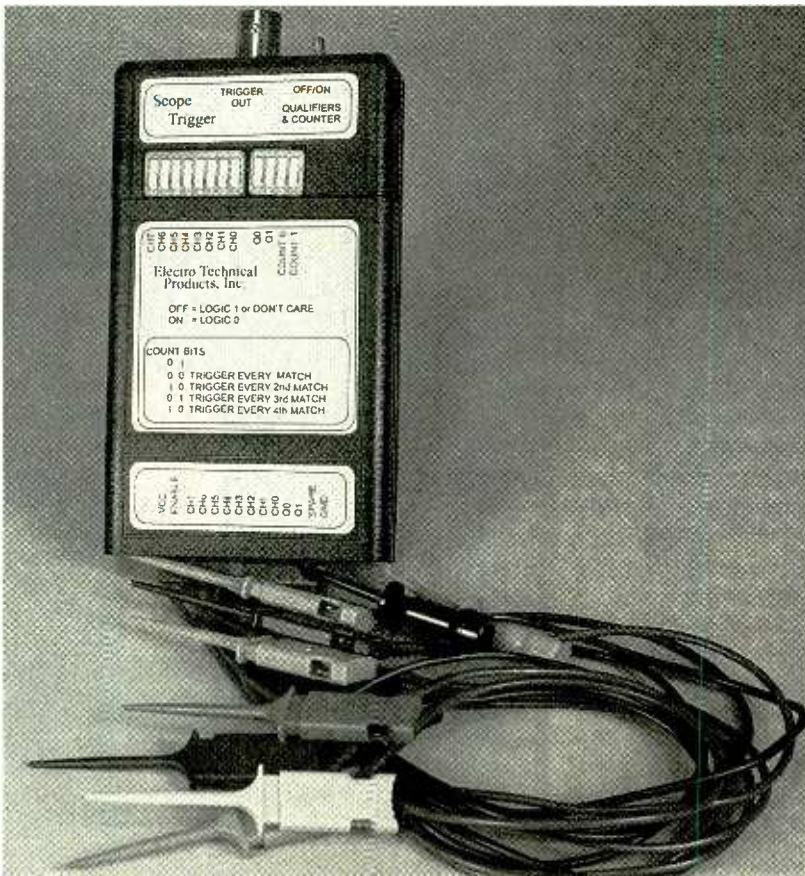

If you have ever experimented with your PC's hardware, you have probably figured out that a two-channel oscilloscope isn't exactly the best tool for debugging or troubleshooting computers. Generally, when digging around in any computer-based circuit, you want to look at the resulting output of several input signals. A two-channel scope doesn't provide that capability. With the Multichannel Oscilloscope Trigger presented here, you can examine one or two signals with a triggering circuit based upon as many as ten other inputs. Such a capability can be very handy when you want to be sure that data is written to the correct I/O address or the correct bit is set when a memory operation takes place.

The Multichannel Oscilloscope Trigger can assist in providing faithful and reliable information when probing digital circuits. The scope trigger

is a ten-bit comparator with a built-in counter feature. It generates an output pulse when the inputs match the value set into the selector switches or on some multiple of matches. The counter feature allows the scope trigger to provide an output pulse on every second, third or fourth count. The output pulse can be fed into the trigger of a standard oscilloscope causing the scope to trigger only when the digital signals present at the monitored inputs match the switch settings on the trigger unit.

Circuit Description. The schematic for the scope trigger is shown in Fig. 1. It consists of two integrated circuits, three resistor packs, and some support circuitry. The monitoring portion of the circuit is built around IC1, a 74AC520 eight-bit comparator. It compares the inputs that are connected to pins 5-12 of J1 to the switch settings on S2. Pin 13 of J1 is

an enable control that must be at a low logic level (or grounded) for IC1 to operate.

When the inputs match the switch settings, a negative-going pulse appears on pin 19 of IC1 and is passed on to IC2, a GAL16V8 Programmable Logic Array (PLA). The programming for IC2 is set so that it acts as both a 2-bit comparator and a counter. Inside IC2, the inputs from pins 3 and 4 of J1 are compared to S1-c and S1-d. If the inputs match the switches and there is a negative pulse from IC1, the logic inside IC2 decodes a data match and outputs that condition on pin 17. In other words, S1-c and S1-d act like a ninth and tenth comparator bit, extending the range of IC1.

The count process is also controlled by IC2. If both S1-a and S1-b are on, every match is passed out of IC2 on pin 19. If S1-b is turned off and S1-a is turned on, every other match is passed out of pin 19 of IC2. The full set of combinations for S1-a and S1-b is shown in Table 1. The counter feature gives the Multichannel Oscilloscope Trigger greater flexibility for whatever type of triggering is needed.

Resistor packs R1, R2, and diode D1 provide some isolation from the circuit under test as well as protection for the scope trigger, in case the Multichannel Oscilloscope Trigger is not hooked up properly to a circuit. Resistor pack R3 acts as a set of pull-up resistors for S1 as well as for the inputs on J1. That is done in order to have a valid signal on the inputs in case not all of the inputs are needed. Capacitors C1 and C2 are for power decoupling.

The final output to the oscilloscope trigger is selected by S3. If the output from IC1 is to be used directly by the oscilloscope, the final trigger can have up to eight trigger

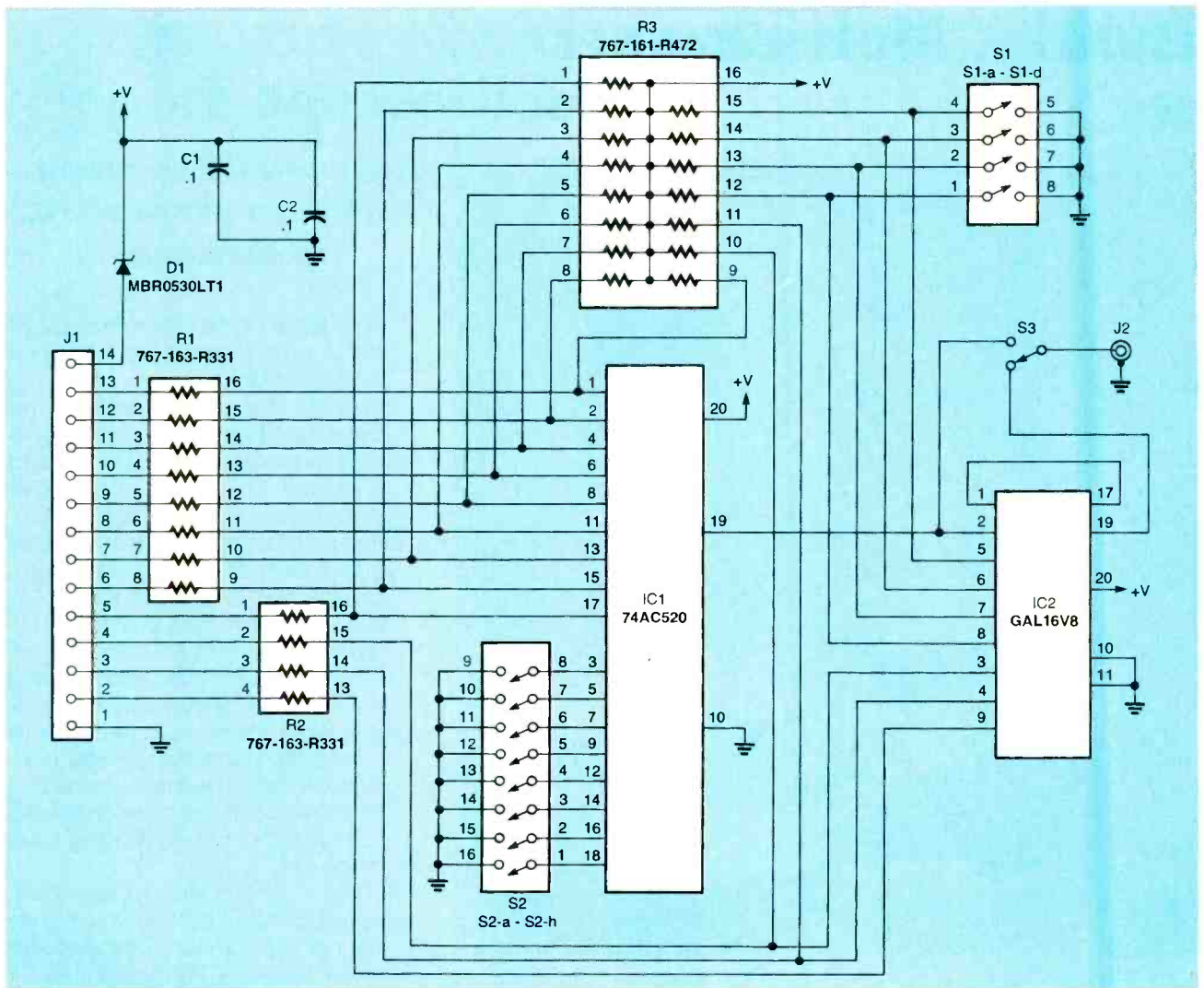

Fig. 1. The Multichannel Oscilloscope Trigger is a simple device that lets you use your oscilloscope to examine complex circuits. You can trigger your oscilloscope on a combination of either eight or ten logic inputs. You can also set the output to trigger on every trigger occurrence up to every fourth trigger occurrence.

inputs at a speed up to 100 MHz. By using the output from IC2, the trigger output can be more sophisticated in operation. However, the speed of the trigger will drop to about 50 MHz.

Building the Multichannel Oscilloscope Trigger. The Multichannel Oscilloscope Trigger uses several surface-mount (SMT) components. Anyone with knowledge of soldering should be able to build the unit without difficulty. If you do not have any experience with surface-mount technology, this project is a good first exposure to the methods used in working with SMTs. The sidebar on soldering SMT components should be reviewed before starting construction.

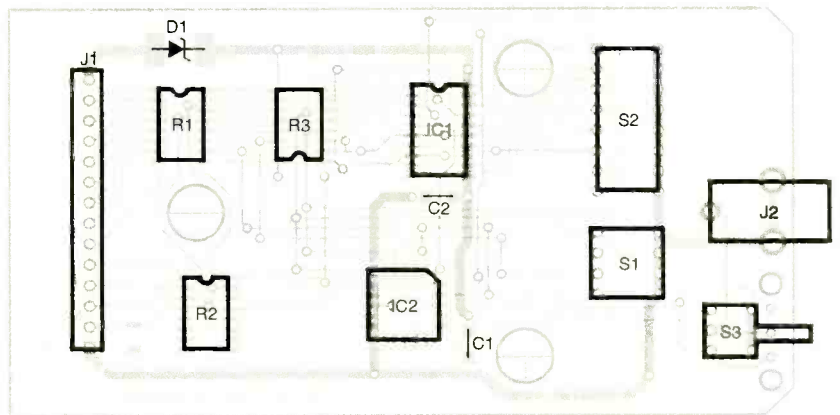

Fig. 2. The Multichannel Oscilloscope Trigger is based on surface-mount components. This project is a good introduction if you've never worked with SMT components before.

IC2, must be programmed before it is installed in the board. If you wish to program your own part, the pro-

gramming data can be downloaded from the Gernsback FTP site (<ftp://ftp.gernsback.com>). The

AN SMT PRIMER

Soldering surface-mount components is no different from any other soldering task. The limited contact area that SMT components have just makes the same job more critical. Dirt or contamination that could be ignored on through-hole components cannot be tolerated on SMT components. Therefore, the first rule of SMT soldering is cleanliness. The least bit of contamination on the PC board or component can drastically change the amount of solderable surface area in a connection.

Use fresh components and PC boards to reduce the chances of contamination. The soldering iron should be tinned and shiny. If there is any flux crust or dark spots on the iron tip, wipe it off with a damp sponge and re-tin the tip. Always use fresh solder.

The second rule is that the equipment should match the job. You don't crack walnuts with a sledgehammer, nor should you solder SMT components with an oversized soldering iron. To do the job right, the soldering-iron tip should match the physical size of the SMT connections. A suggested tip size should be no bigger than $\frac{1}{16}$ inch. It is also a good idea to purchase solder that is appropriate for soldering SMT components. A solder diameter between 0.015 and 0.031 inch is suitable for most SMT tasks.

The third rule is to watch the temperature of the soldering iron. All common electrical solders begin to melt at about 361° F. Applying an iron with a tip temperature over 800° F to the joint could damage the component or the board. If the tip is properly sized to the job, there is no need to heat a component lead and PC board contact to more than 600° F to solder components.

Now that we have the right tools for the job, let's examine how to hand-solder an SMT component to the board. For multi-leaded components, pick a corner lead on the PC board for the component to be soldered. Melt some solder onto that pad. Position the component on the board. Heat the component and wetted pad with the soldering iron. The solder will reflow and the component leg will sink into the solder. Inspect the component's alignment with its footprint. If the alignment is good, solder the diagonally opposite corner from the first connection so that the component cannot move. If the alignment is not correct, reheat the joint and move the component until the alignment is good. With two diagonal corners soldered in place, the other pins can be soldered. Those connections are done the same way you would solder any other connection—heat the component and pad with the soldering iron and apply solder to the component leg. The corner-tack method holds the component in good mechanical alignment.

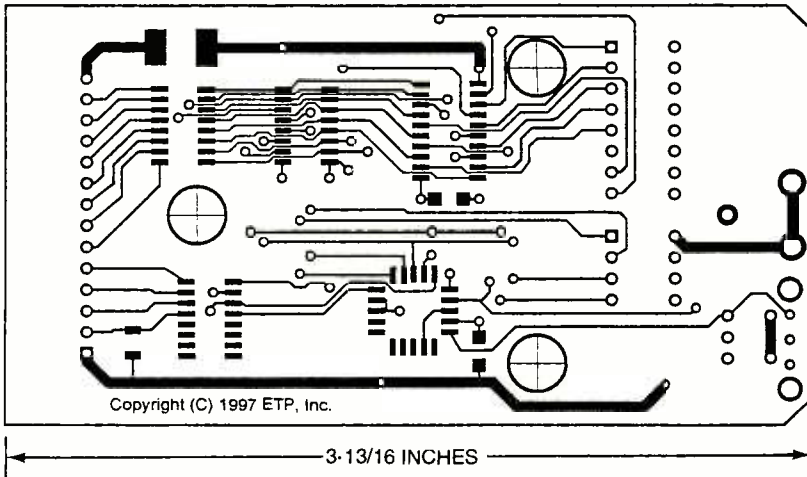

Here's the foil pattern for the component side of the Multichannel Oscilloscope Trigger.

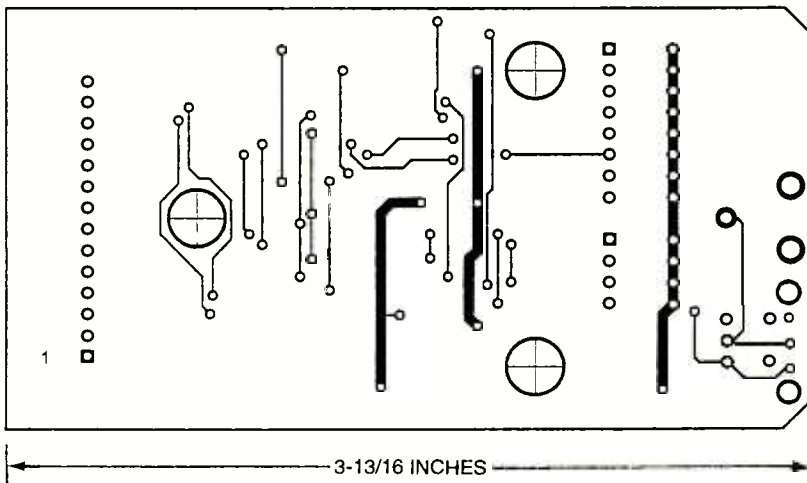

The solder side of the Multichannel Oscilloscope Trigger completes all of the connections needed to the other side of the board. If you're making your own board, don't forget to make the connections between the two sides of the board or the Multichannel Oscilloscope trigger won't work.

name of the file that contains the data is otrigger.dat.

If you are using the PC board from the kit given in the Parts List or you have etched your own board using the foil patterns included here, follow the parts-placement diagram in Fig. 2 for component location. Start by soldering the surface-mount components to the PC board. That approach will make it easy to position the soldering iron and solder the components to the PC board without some of the larger components getting in the way. After C1, C2, D1, R1-R3, IC1, and IC2 are in place, install the through-hole components. If you wish, you could add a jumper wire between pin 13 and pin 1 of J1. That will disable the pin 13 input on J1 and permanently

enable IC1. A disadvantage to that modification is that it will not be possible to cascade several Multichannel Oscilloscope Trigger units together. However, it is not necessary to remember to ground the enable line when using a single unit. The enable input can also be used as an active-low qualifier input for the Trigger—the choice is entirely up to you.

Install sockets for S1 and S2. That will lift the switches off the PC board and project them through the top of the case. The trigger output jack, J2, has a large thermal mass, making it more difficult to solder to the PC board with a small iron. When soldering J2 onto the board, heat the two large pins more than the pads on the PC board. The joint will

PARTS LIST FOR THE MULTICHANNEL OSCILLOSCOPE TRIGGER

SEMICONDUCTORS

IC1—74AC520SC 8-bit comparator, integrated circuit, surface-mount
IC2—GAL16V8 programmable logic array, integrated circuit, surface-mount
D1—MBR0530LT1 Schottky diode, surface-mount

RESISTORS

R1, R2—767-163-R330G resistor network, surface-mount
R3—767-161-R472G resistor network, surface-mount

ADDITIONAL PARTS AND MATERIALS

C1, C2—0.1- μ F capacitor, ceramic surface-mount
J1—14-pin right-angle header (Digi-key A5308 or similar)
J2—BNC connector, right-angle PC-board-mount (AMP 414373-1 or similar)
S1—4-position DIP switch
S2—8-position DIP switch
S3—Single-pole double-throw switch, right-angle PC-board-mount (Digi-key EG1905 or similar)
IC sockets, case (Digi-key SRM6-B or similar), wire, test probe clips, hardware, etc.

Note: The following items are available from Electro Technical Products, Inc., PO Box 16658, West Palm Beach, FL 33416-6658, E-mail: etpinc@pb.seflin.org: Complete kit of parts including pre-programmed IC2, case, PC board, and case labels, \$64.95; Assembled and tested unit, \$84.95; 13-piece test clip set for use with J1, \$29.95. Please add \$3.00 for shipping and handling charges. FL residents add appropriate sales tax.

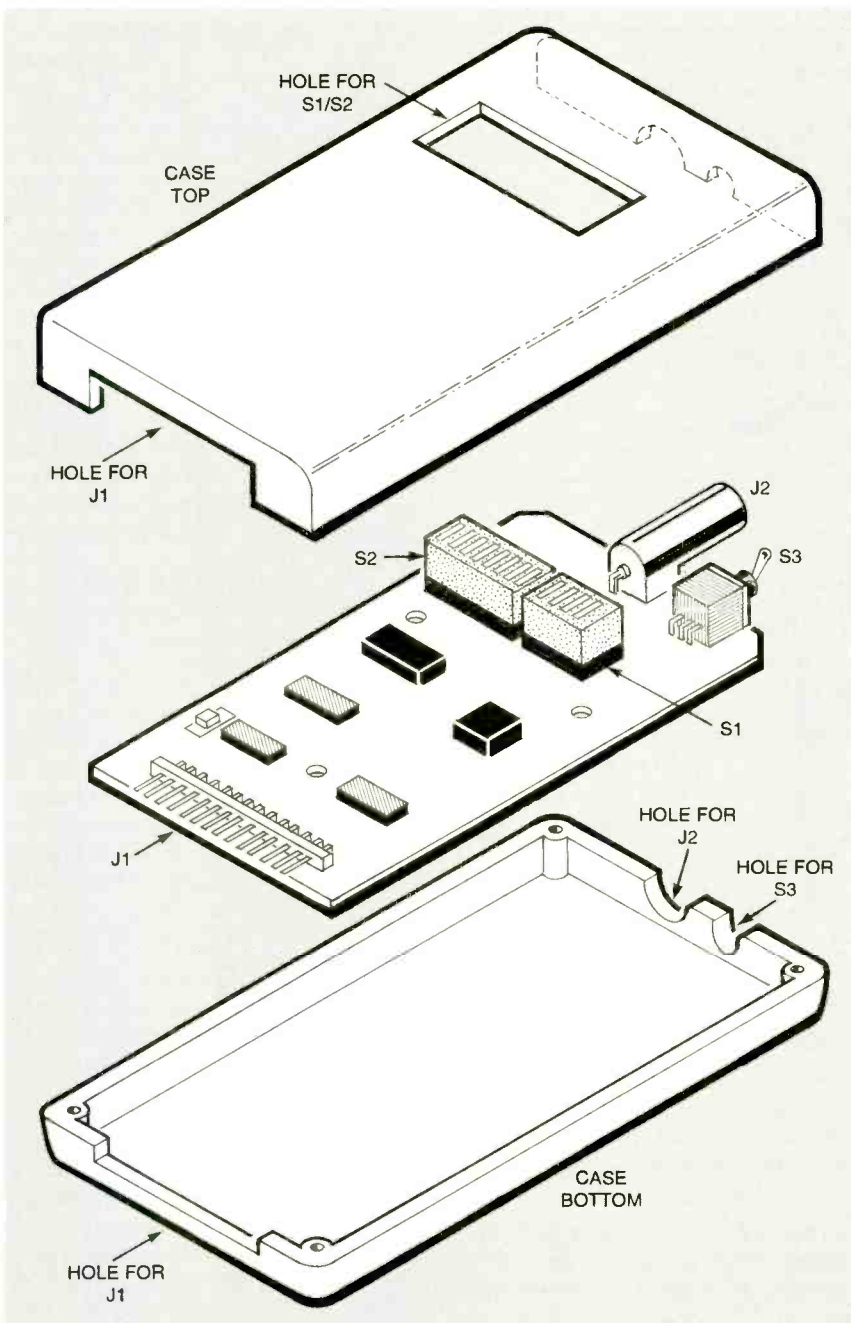

Fig. 3. The Multichannel Oscilloscope Trigger fits nicely into a small hand-held case. Several holes will need to be cut at specific locations in order for the controls to be accessible.

eventually get hot enough for the solder to flow. When installing J1, you could cut off pin 2. That pin is not used, and can be utilized as an orientation key. Filling the hole on the corresponding plug will reduce the risk of installing the input cable backwards.

Once all of the components have been soldered to the board, inspect each solder connection thoroughly. Use a magnifying glass or jewelers loupe, if possible. Look for all the indications of a good sol-

der joint. They should be shiny and even, without either too much solder or too little solder. Joints that have peaks or points have too much solder. If there is too little solder, it will be difficult to tell if the connection is soldered. Solder bridges and excessive solder can be cleaned up by using solder wick to draw the excess solder away from the components.

Drill and cut appropriate holes in a suitable enclosure. Square holes will have to be cut for J1, S1, and

S2. Round holes are needed for J2 and S3. Measure the locations of those components on the PC board to find the locations that need to be cut on the case. Additional holes will be needed in the back of the case for mounting the PC board. Screws, nuts, and spacers can be used. As an alternative, plastic tubes can be glued to the inside of the case and the PC board held in place with self-tapping screws. The general

(Continued on page 56)

THE GREAT COMPRESSION

Most readers of this magazine have likely heard the term "MPEG," and are aware that it is the key technology that has made digital direct-to-home satellite TV, DVD video, DTV (digital TV), and other advances possible. In this article, we will explore what MPEG is, what it does, and some of the history behind it.

Why MPEG? MPEG, which stands for Moving Picture Coding Experts Group, is a technology for compressing the amount of data contained in moving images such as in film and video. It is also the name of the organization that has worked to create international standards for this technology.

But why is compression needed at all? Take a look at Fig. 1, which is a comparison of the volume of data required for a person to spend an hour enjoying various media forms. As you can see from that figure, an hour of music requires 1,000 times as much data space as an hour's worth of text, and an hour of video takes up 1 million times as much data as an hour of text. While high-capacity CDs (compact discs), MO (magnet optical) discs, or DVD (digital video discs) can hold more than previously available technologies, there is still a limit on how much data can be placed on a single disc.

In the broadcasting realm, digital technology coupled with compression would allow a high-definition TV (HDTV) signal to be broadcast using no more spectrum than a standard, analog signal. It would also allow the transmission of multiple channels of standard-definition digital TV in the same spectrum space as a single channel of analog television.

How Compression Works. Technology for the perfect reproduction of moving images has yet to be developed. Television broadcasts and film footage use a series of still photographs to reproduce motion. For television, 30-frames-per-second are used, while 24-frames-per-second are used for film. (Japan and the United States use the same number of shots per second for tele-

*Courtesy LOOK JAPAN, August 1997

MPEG is the key behind many of today's high-capacity multimedia technologies. Here's an overview of what it is and how it works.

vision, while European countries use only 25 shots per second. Consequently, video tapes recorded in Europe cannot be viewed in Japan or the U.S. without special equipment. No such regional differences exist in relation to movies.)

When many photographs are continually transmitted like this, often there are only minute differences between one still image and the next. If there is absolutely no movement on the screen during the $\frac{1}{30}$ th or $\frac{1}{24}$ th of a second between

images, there is no need to send the next photograph as long as the previous image has been stored and can be re-shown in the place of the next photo. In this way, the number of photographs sent (the volume of data) can be reduced.

Figure 2 shows two images of a moving airplane. The entire image other than the moving plane does not change from one image to the next. Thus, that part of the image that has not changed need not be retransmitted. Assuming the moving

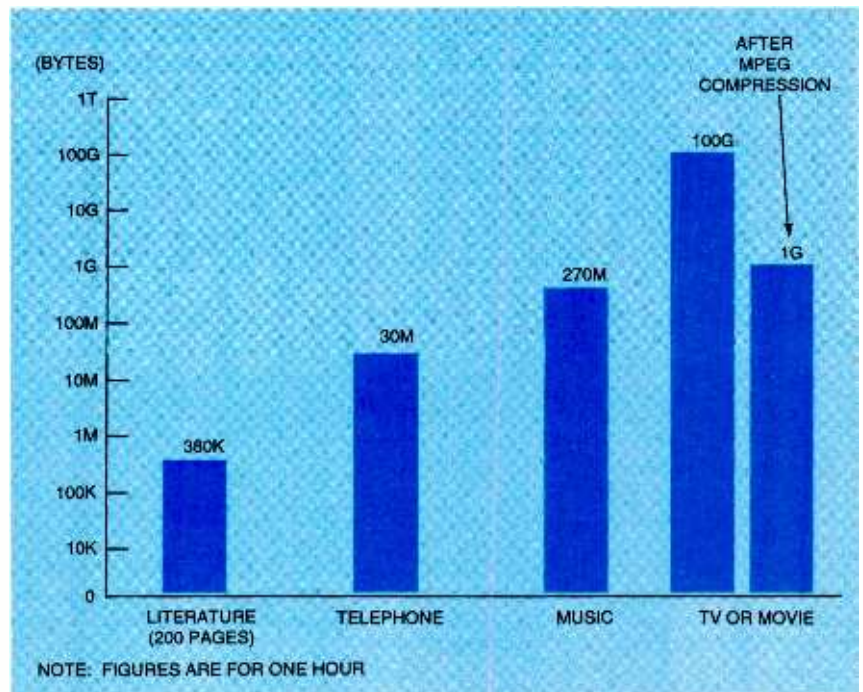

Fig. 1. While moving images (either video or film) require much more storage space than other types of media, MPEG compression can greatly reduce those requirements.

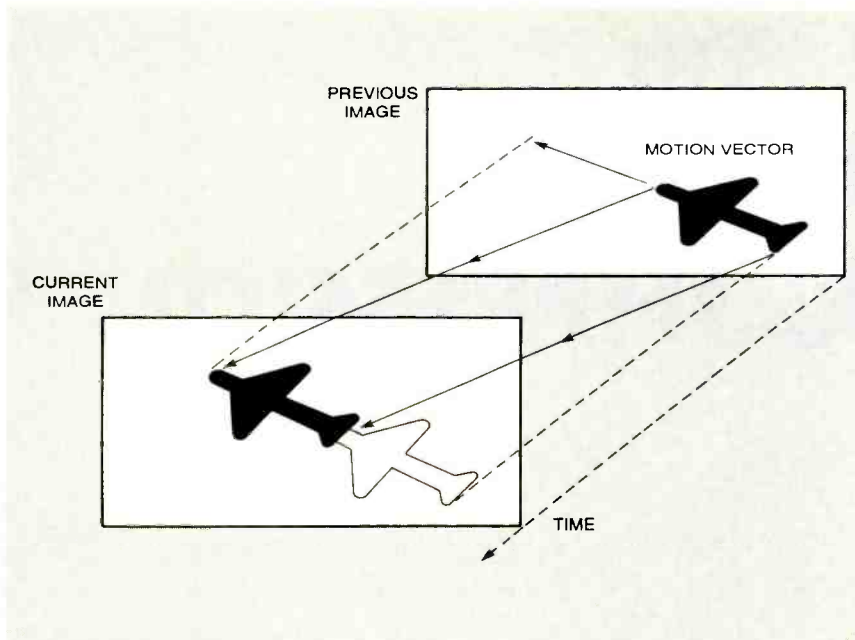

Fig. 2. For an object in motion, such as an airplane, and assuming that all other elements in the image are identical, the only additional information needed to produce the next frame is the object's motion vector and data for the area occupied by the object in the first frame.

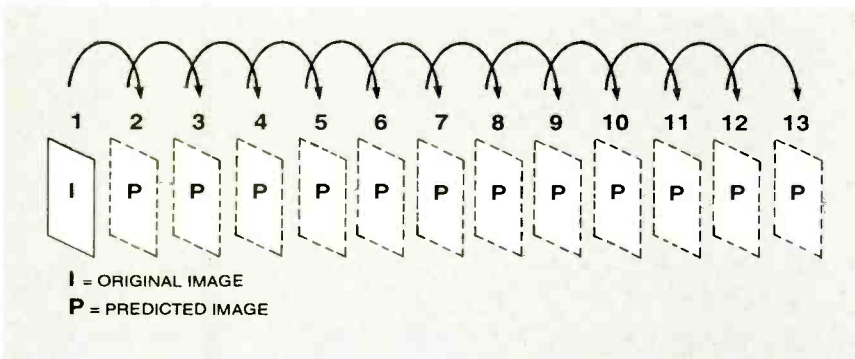

Fig. 3. In motion-compensated interframe coding, all images after the original (I) frame are predicted by combining the initial image and any motion information.

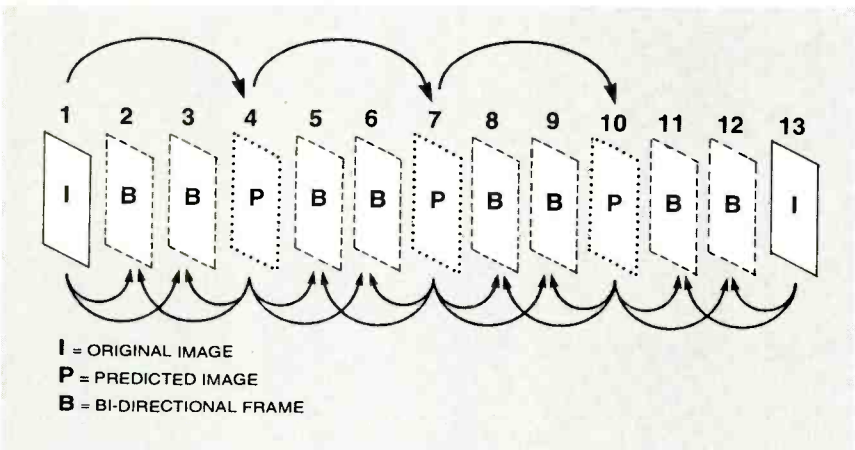

Fig. 4. In MPEG encoding, the frame stream is broken up into GOPs (group of pictures) and motion compensation from past and future images is used. For example, in this GOP the fifth frame is created using information from the fourth and seventh frames.

duce the next image. Furthermore, if the shape of the airplane is known, the only additional information needed is how far and in what direction (known as the vector of movement) the plane moved during the $\frac{1}{30}$ th of a second between the two still images.

In this way, the volume of data can be cut even more by simply moving the known image of the plane along the known vector of movement. (Of course, since it is not known what image will appear in the area occupied by the plane in the first image, the data for that area must be sent as well.) This method of reducing data volume combined with mathematical processing technology is called "motion-compensated interframe coding."

The initial research in that technology was initiated to find a way of making video telephone technology less expensive. MPEG took the motion-compensated-interframe-coding principle and corrected its faults, made it applicable to a wide range of fields, and standardized the technology so it could be used worldwide.

Establishing The Compression Standard.

The history of MPEG standardization began in 1987 with the JPEG (Joint Photographic coding Experts Group). The difference between JPEG and MPEG is that JPEG encodes and compresses still images rather than moving images. By the fall of 1987, specifications for the JPEG international standards had already been settled and all that was left to do was to put them in writing and put them to a final international vote. Once those tasks were achieved, the organization formed to create the international standards would have completed their function. To dissolve the organization after going to all the trouble to create it, however, seemed a pity. In fact, there were calls for setting up a new task for the organization to take on. Then, at a meeting in the United States of JPEG members in November 1987, a discussion developed over the desire to place movies on CD and the possibility of creating compression-coding standards for film and television. Based

(Continued on page 56)

plane accounts for $\frac{1}{20}$ th of the total area of the image, for example, only $\frac{1}{20}$ th of the total volume of data need be transmitted to repro-

The Four-Year Electronics Degree Program That Really Hits Home!

Bring The Technology Home With A Bachelor Of Electronics Engineering Degree. No Hassles. No High Cost!



Now's the time to prepare for a profitable career.

We've lowered the cost of higher education.

It's true! You can earn a four-year Bachelor of Electronics Engineering Technology degree today ... and prepare yourself for a high-paying electronics career ... without quitting your job or ever leaving your home. Because World College, an affiliate of the Cleveland Institute of Electronics, offers you the total flexibility of independent study programs proven effective for people like you who truly want to succeed! World College independent study lessons help you build valuable skills

**Mail/Fax Today
or Call
1-800-696-7532**

step-by-step, and expert instructors are personally available to you with a toll-free call. What a way to earn an education!

A world of opportunity.

Where is your career headed? With a four-year bachelor's degree from World College, you call the shots, choosing from incredible, high-paying opportunities in electronics, telecommunications, computer, electrical power, and many other growing fields.

World College gives you the skills, the knowledge, the power to take advantage of your best opportunity in electronics. And you can do it all at your own pace!

Without leaving home.

World College continually works to provide its students with the most advanced education tools. From the latest equipment and reference books to breakthrough computer-simulated experiments, students are exposed to the latest technological advancements.

All the equipment, parts, and software you need are included in your affordable tuition, including more than 300 hands-on lab experiments you can complete in your home.

Choose your own pace.

Earn your bachelor's degree on your time — and at your pace — because you pay tuition to World College only as you complete the upper-level semesters close to graduation. The faster you make it through, the less you pay. So you have an incentive to make your future happen quickly — yet the freedom to choose your own pace!

Send today for your FREE course catalog — and give yourself that future you've always wanted — with an electronics degree education from World College.



Take charge of your future in electronics.

Four Powerful Reasons To Connect With World College Today:

- 1. Earn your four-year degree!**
- 2. Self-paced training!**
- 3. Independent study in your home!**
- 4. Expert instruction!**

Give Me The Power!

Send me a FREE World College course catalog today!



(Please Print Neatly)

Name _____

Address _____

City _____

State, Zip _____

Phone () _____

Age _____

**For faster service, call
1-800-696-7532,
or call
1-804-464-4600.**

**Or fax this coupon to
1-804-464-3687.**



Lake Shores Plaza
5193 Drive, Suite 113
Virginia Beach, VA 23455-2500



Affiliated with
Cleveland Institute of Electronics
WAE60

BUILD THIS POCSAG SIGNAL GENERATOR

Generate pager signals with this simple interface and computer program.

ROBERT B. WHITAKER, KI5PG



Not too many years ago, personal pagers were mainly used only by people in the business world. Now pagers have become a popular means for almost everyone to keep in touch with one another. These days, even school children have pagers on their belts or in their backpacks so that they can keep in touch with their parents and friends.

The strange-sounding digital signals that activate pagers and encode their messages are not difficult to generate. We'll show you how to build a simple POCSAG pager-signal generator and encoding system using a small interface circuit to connect an IBM-compatible personal computer and an FSK (frequency-shift keyed) FM-radio transmitter or signal generator.

The software for the pager encoder is readily available over the Internet, and it is free. The interface itself can be built for about \$10.00 on a small piece of perfboard.

What is POCSAG? POCSAG is an abbreviation for Post Office Code Standard Advisory Group. It refers to the standard protocol used to send messages to common pocket pagers that many people carry around on their belts or in their purses. As opposed to the radio signals used for voice transmission, POC-

SAG is based on digital signals. Depending upon the type of pager used, different digital signals can be sent. Some *tone-only* pagers activate when they receive a special tone. With tone-only pagers, you generally have to call the pager service in order to find out what the message is. *Numeric* pagers can receive numeric information such as a telephone number to call to talk directly to the person trying to contact them. *Alphanumeric* pagers have the capability of viewing actual text messages; long messages will usually scroll across a viewing screen. Some people even have the capability of directing their Internet e-mail to their alphanumeric pager so that they can read their e-mail directly from it.

The most common baud rates used by pagers are 512 baud, 1200 baud, and 2400 baud. With just a little experience, a person can distinguish different pager baud rates just by listening to the digital signal over a scanner or radio receiver.

What is FSK? POCSAG signals are sent using a method called *Frequency-Shift Keying*, or FSK for short. With that method, the carrier wave is shifted by 4.5 KHz up or down from the center frequency. Those shifts represent the actual

data being sent. For example, a signal sent on 158.100 MHz will shift back and forth between 158.0955 MHz and 158.1045 MHz.

One of the easiest ways to create an FSK signal is to directly control the modulation stage of an FM transmitter. A varactor (a voltage-variable capacitor) is usually used to couple the digital data into the transmitter. The changing voltage fed to the varactor changes its capacitance. That will change the tuning of the transmitter's modulation stage, causing the transmitter to shift its output frequency in direct response to the digital data.

Ham operators who have 9600-baud packet-capable radios can use those radios to generate POCSAG signals. Many other crystal-controlled FM radios can also be used for FSK work when properly modified. Some older radio equipment that uses phase-locked loop circuits might have problems trying to generate FSK signals. A list of known FSK-capable radios is shown in Table 1.

The Software. An excellent program that can be used to generate POCSAG signals and control a radio transmitter has been written by two British ham-radio enthusiasts, Clive Cooper (G8UKN) and Pete Baston (GW0PJA). The pro-

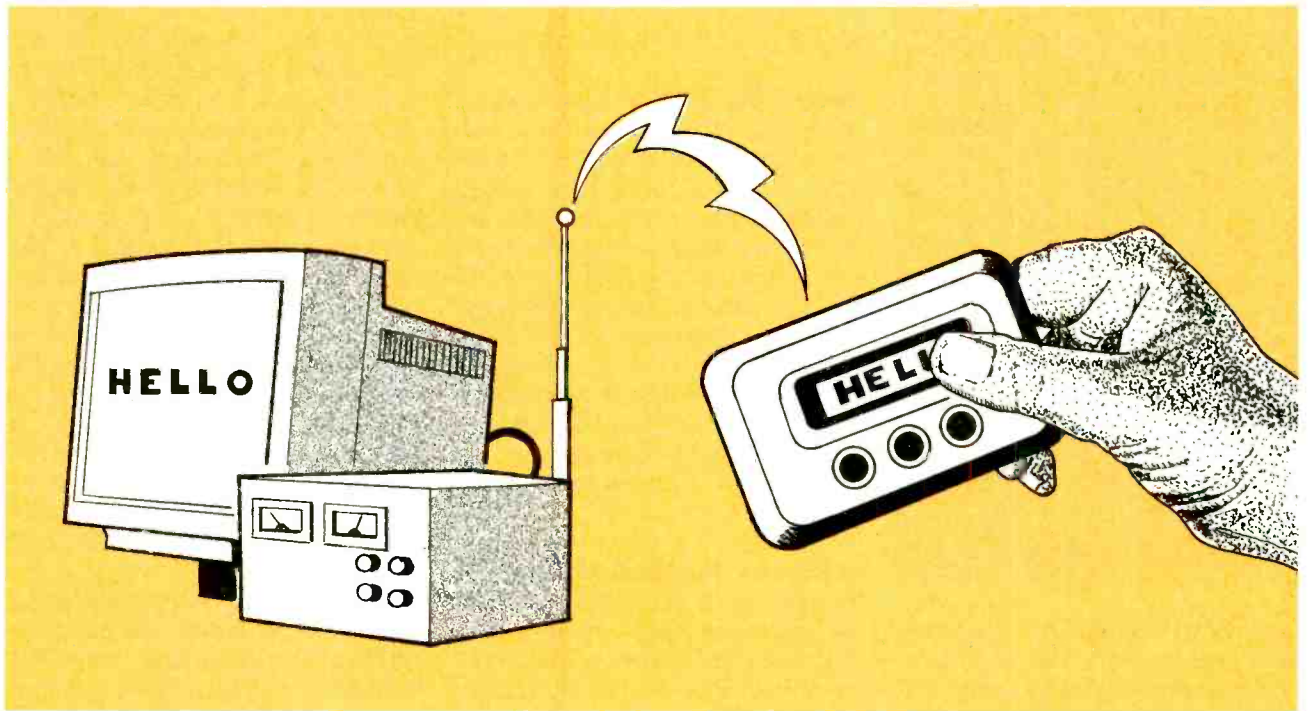

gram, PE.EXE, can be found at several Internet locations, including <http://www.seelect.demon.co.uk/pocsag.html> and <ftp://ftp.demon.co.uk/pub/ham/scanners/pe-204.zip>.

At only 68 kilobytes, PE.EXE is a fairly small DOS-based program that needs only an 80386-based personal computer or better. Text to be sent is typed into the program, which then assembles the data into the POCSAG format and sends that information to an RS-232 port for controlling the radio transmitter. The radio is keyed by shifting the voltage state on the serial port RTS (Request to Send) pin. The POCSAG data is then sent to the transmitter's modulation stage by shifting the voltage state on the DTR (Data Terminal Ready) pin.

When first started, the program asks for the "capcode" of the pager. A capcode is a unique seven-digit identification number that is assigned to each pager. After the capcode is entered, the program asks for the data that will be sent. Once the data is typed in, the program will ask if the data should be sent in the alphanumeric or numeric format. If the data is all numbers, the program will default to numeric format.

The baud rate and serial port can be shifted through the various choic-

es by simply pressing the various control keys. Each press of a certain control key will cycle that individual setting to the next choice. Pages can be sent in normal or inverted mode by keyboard control as well. Different transmitters might invert the digital signal, so try the inverted signal format if the normal mode does not work.

One particularly useful way to use the program is by entering all of the information directly through the DOS command line. That method, which can be used in a "batch" command, is set up as follows:

```
PE (CAPCODE) (TYPE) ("MESSAGE") (N/I) (COMPORT#) (BAUD)
```

The first entry, of course, is the program itself. The pagers seven-digit capcode is entered next. The "type" choices are A, N, 1, or 2, which refers

TABLE 1—RADIOS THAT ARE KNOWN TO BE FSK CAPABLE

Alinco DR-1200 Data Radio
 GE Mastr Executive II, VHF and UHF
 GE Custom MVP, VHF and UHF
 Icom IC series: 25, 38, 228, 271, 290, 471
 Kenwood TM series: 211, 212, 221, 231, 431, TS series 700 and 770
 Motorola Mitrek
 MFJ Model 8621 VHF Data Radio
 Standard C58, C140
 Yaesu FT series: 212, 221, 230

to alphabetic, numeric, signal and tone only function 1, or tone only function 2. The message to be sent must be enclosed in quotation marks. One important limitation of the unregistered version of the software is that the message is limited to a maximum of eight characters and spaces. The registered version of the software allows longer text strings. If the signal must be inverted as described above, type an "I" next. Typing an "N" will not invert the signal. Finally, the serial port and baud rate are specified.

A typical command line might look something like:

```
PE 1281491 N "800 555 1212" I 4 512
```

In that example, the numeric-only message "800 555 1212" will be sent to pager number 1281491. The inverted signal will be sent to serial port 4 at a rate of 512 baud.

The Interface. Any number of different interface designs between the computer serial port and radio transmitter could be used. A suggested circuit is shown in Fig. 1. That circuit uses a small relay powered directly by the voltage from the serial port's RTS line. The relay provides a reliable switch to turn on and off the radio transmitter. The voltage

PAGER SOURCES

The following businesses have agreed to supply refurbished numeric and alphanumeric pagers without signing a commercial pager contract. For a reasonable charge, the pagers can be re-crystaled for a specific frequency.

McManus Communications
400 North Fifth Street
Blytheville, AR 72315
501-763-6250 (voice)
501-763-6533 (fax)

PageCo International, Inc.
2400 E. Commercial Blvd., Suite 630
Ft. Lauderdale, FL 33308-4033
954-491-9501 (voice)
954-491-8834 (fax)
e-mail: info@pageco.com
Web: http://www.pageco.com

level of the POCSAG data, which is delivered through the serial port DTR pin, can be adjusted with R2. A 2.2- μ F non-polarized capacitor (C1) provides DC isolation between the transmitter and the serial port while passing the modulation voltage. A bipolar LED (LED1) is included for a visual indicator of the outgoing modulation data. An additional LED (LED2) shows when the radio is keyed on. That LED also prevents the RTS voltage from closing the relay when the program is idle. Diode D1 is included to sink any possible voltage spikes caused by the collapsing magnetic field when the relay is switched off.

The circuit can easily be built on a small piece of perfboard. For a neater appearance, an etched single-sided PC board can also be used. A foil pattern has been included here for those who wish to use that method for building the interface. A source where you can obtain etched PC boards is given in the Parts List.

If an etched board is used, the parts-placement diagram in Fig. 2 should be followed. Note the polarities of the diodes when assembling the board. The three connections to the computer serial port should be wired to the proper terminals of a suitable connector. The particular pins to be used depend upon the type of connector that will be used. If a 9-pin connector will be used, connect DTR to pin 4, RTS to pin 7, and the ground to pin 5. For a 25-pin

connector, use pin 20 for DTR, pin 4 for RTS, and pin 7 for ground.

Using a Signal Generator. A signal generator can also be used with the program and interface to generate POCSAG signals for testing pagers. In that case, the only circuitry needed is a potentiometer wired between the serial port's DTR line and ground. The potentiometer sets the voltage level of the signal from the serial port. Set the signal generator to external modulation and attach interface's the ground and potentiometer wiper to the generator's external-modulation input.

In Case of Problems. Although the software and hardware interface are relatively simple in operation, diagnosing problems could be a little difficult. The first step in problem solving would be to make sure that the program is operating properly. The best diagnostic tool for that is an

RS-232 tester such as RadioShack catalog No. 276-1401. That device has red and green LEDs that light up to show serial port activity. No LED activity at all probably indicates that the wrong serial port has been picked. The tester's LED for the RTS pin should shift color when the radio is keyed up to send a page. At the same time the RTS line is shifted, the LED on the DTR line should flicker to show that the POCSAG data is being sent to the transmitter. If an RS-232 tester is not available, the voltage on the RTS and DTR pins can be checked with a standard multimeter. The voltage on the serial port's RTS and DTR pins should shift between -10 to -12 volts DC and +10 to +12 volts DC.

If the program and the serial port appear to be working properly, the hardware interface and transmitter should be checked. Make sure that the transmitter is being keyed when pages are being sent. The program will indicate "Transmitting" on the status line at the bottom of the screen, and the RTS pin on the serial line will shift from +12 volts to -12 volts.

Most transmitters are turned on and off by a control line that is switched on and off to ground. The output of the hardware interface should change the resistance from a high resistance state to near ground potential state that should activate the transmitter's push-to-talk (PTT) switch. In case the keying of the radio is reversed, change the polarity of the LED2. If the relay does not work at all, try reversing the

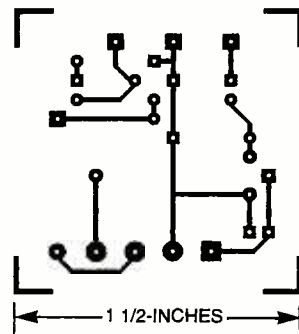

The POCSAG interface is simple enough to be laid out on a single-sided PC board.

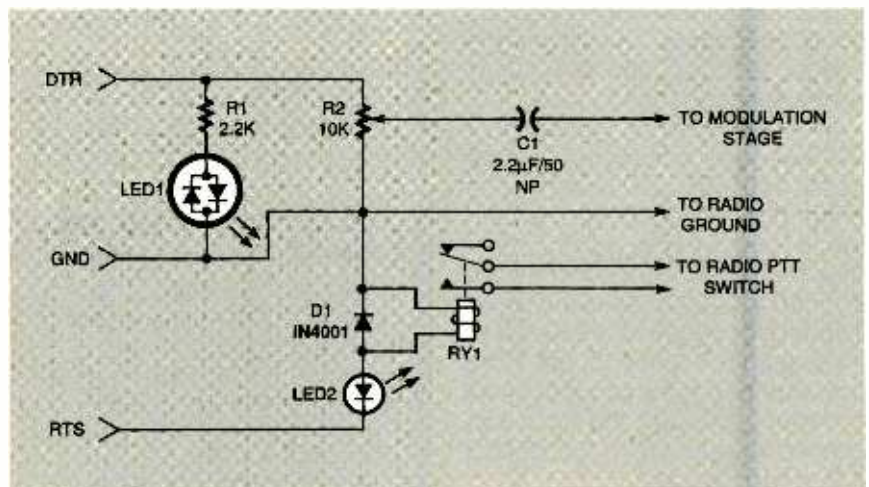

Fig. 1. The interface circuit for the POCSAG encoder is very simple. Light-emitting diodes give a visual indication of activity during transmission.

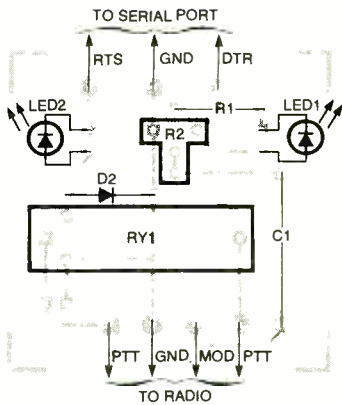

Fig. 2. Use this parts-placement diagram if you build the interface circuit on an etched PC board.

polarity of D1.

If the radio keys up properly, monitor the transmitted signal with a scanner or another radio. POCSAG signals are very distinctive. The easiest way to check your transmitter volume level (deviation) without expensive test equipment is simply by listening to a commercial pager transmission and setting your signal level to about the same level. If a commercial signal is not available for comparison, just set your output level to a sound level comparable with normal voice transmissions. Signals that are cut short or sound especially distorted or garbled are probably at too high a level. Reduce the level of voltage output though R2. Also, some transmitters might work better if you remove capacitor C1.

If you still have problems, your radio might not be FSK capable or you might not be injecting the signal to the proper modulation stage on your radio. Remember, you are sending data by direct frequency shifting. Using the regular transmitter microphone input for this application simply will not work.

What You Can Do With a POCSAG Encoder. This project lends itself to quite a number of useful applications. First, it is quite educational. You can learn about POCSAG signals and how pagers function. The project can be used to demonstrate POCSAG operation to others. Using a second PC with a POCSAG decoder, such as the unit described in the May 1997 issue of **Electronics Now**, allows a complete POCSAG

PARTS LIST FOR THE POCSAG ENCODER

- LED1—Light-emitting diode, bi-polar
 - LED2—Light-emitting diode, green
 - D1—1N4001, silicon diode
 - R1—2200-ohm 1/4-watt, 5% resistor
 - R2—10,000-ohm potentiometer
 - C1—2.2- μ F, 50 WVDC, electrolytic capacitor, non-polarized
 - RY1—12-volt DC relay, single-pole, single-throw (RadioShack 275-233 or similar)
- Wire, PC board, 9- or 25-pin connector, hardware, etc.

The POCSAG encoding program can be found at <http://www.seelect.demon.co.uk/pocsag.html> and <ftp://ftp.demon.co.uk/pub/ham/scanners/pe-204.zip>. United States purchasers can obtain registered copies of PE, the POCSAG encoding program, from Robert B. Whitaker, Trustee, P.O. Box 1266, Victoria, TX 77902-1266. The registered, full-function software costs \$39.95, postage paid. Unregistered software, for those without Internet access, can also be purchased for \$12.50, postage paid.

A high-quality printed circuit board with silkscreen artwork for parts placement is available from FAR Circuits, 18N640 Field Ct., Dundee, IL, 60118-9269 for \$3.75. A fully assembled and tested interface kit is available for \$29.95, plus \$5.05 for shipping and handling, from Robert B. Whitaker, P.O. Box 1266, Victoria, TX, 77902-1266.

transmission and reception system to be demonstrated.

Commercial paging companies and technicians will enjoy using the POCSAG encoder program to test and diagnose pagers without the need to use expensive page-generating equipment. Amateur operators could use the program to set up their own personal- or club-paging system on the ham bands. Using the paging capabilities from the DOS command prompt, pages could even be sent remotely using remote-computer-control programs such as pcAnywhere from Symantec Corporation.

POCSAG encoding is really fairly simple. The software and hardware interface described here can be used to generate POCSAG digital signals for a wide variety of diagnostic, demonstration, and actual applications. Ω

You can Build Gadgets! Here are 3 reasons why!



BP345—GETTING STARTED IN PRACTICAL ELECTRONICS \$5.95

If you are looking into launching an exciting hobby activity, this text provides minimum essentials for the builder and 30 easy-to-build fun projects every experimenter should toy with. Printed-circuit board designs are included to give your project a professional appearance.

BP349—PRACTICAL OPTO-ELECTRONIC PROJECTS \$5.95

If you shun opto-electronic projects for lack of knowledge, this is the book for you. A bit of introductory theory comes first and then a number of practical projects which utilize a range of opto devices, from a filament bulb to modern infrared sensors and emitters—all are easy to build.



BP363—PRACTICAL ELECTRONIC MUSIC PROJECTS \$5.95

The text contains a goodly number of practical music projects most often requested by musicians. All the projects are relatively low-in-cost to build and all use standard, readily-available components that you can buy. The project categories are guitar, general music and MIDI.

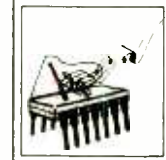

Mail to:
Electronic Technology Today, Inc.
P.O. Box 240
Massapequa Park, NY 11762-0240

Shipping Charges in USA & Canada

\$0.01 to \$5.00.....	\$2.00	\$30.01 to \$40.00.....	\$6.00
\$5.01 to \$10.00.....	\$3.00	\$40.01 to \$50.00.....	\$7.00
\$10.01 to \$20.00.....	\$4.00	\$50.01 and above.....	\$8.50
\$20.01 to \$30.00.....	\$5.00		

Sorry, no orders accepted outside of USA and Canada. All payments must be in U.S. funds only.

Number of books ordered.

Total price of books.....	\$ _____
Shipping (see chart).....	\$ _____
Subtotal.....	\$ _____
Sales Tax (NYS only).....	\$ _____
Total enclosed.....	\$ _____

Name _____
Address _____
City _____ State _____ ZIP _____

Please allow 6-8 weeks for delivery.

This month, we begin a series of articles about repairing and restoring audio tape recorders. Specifically, it focuses on vintage open-reel machines of the 1940s through the early 1970s—a time that saw explosive growth in the field in terms of both features and performance. Just as with the ‘muscle cars’ of the 1950s and ‘60s, the ‘big-iron’ tape recorders—such as the ones shown in the beginning of this article and in Fig. 1—still draw head-turning attention, not only from the ‘Baby-Boomer’ crowd, but from ‘post-Boomers’ as well! In addition, when properly restored and tuned, these machines can still provide countless hours of enjoyment with all the clarity and response they provided when new.

Note: The material presented here and in subsequent articles is taken from the author’s book *Evolution of the Audio Recorder*; details on that book, including ordering information, can be found in the ‘For More Information’ box that is located elsewhere in this article.

The Dilemma. Pity the poor tape-recorder repair person of the 1960s or ‘70s, having to cope with a seemingly endless array of models and maladies, both electronic and mechanical. For the non-manufacturer-specific repair shop, it was especially tough, given the lack of key service manuals and repair bulletins. Even some of the so-called ‘simple’ single-motor machines, such as the 1950s Webcor (an internal view of that machine is shown in Fig. 2), were a real challenge to repair. As if that weren’t bad enough, let’s ‘fast forward’ to the present, where added to this situation is the age of most of these classic analog machines: from 20 to over 40 years old!

That unnerving fact adds a whole new level of difficulty if your goal is to get that old machine

RESTORING A “REEL” RECORDER



Here’s what you need to know and do to bring your open-reel audio tape recorder back to life.

PHIL VAN PRAAG

working again. Not only do you have to repair the original problem (the one that most likely sidelined it in the first place), but now you’re faced with an extreme parts scarcity, deteriorated rubber components, dried up or seized bearings, frequently faulty capacitors, and, in most cases, a total lack of servicing information!

Well, never fear, as the purpose of this article, and the ones that follow, is to prepare you for this challenging task. And it is a task that is

worthwhile as it can be most rewarding personally to breathe life back into these wonderful old ‘talk back’ machines. Plus, when you’re done, you will have both a useful tool and a valued keepsake.

We will explain the differences between repairs and restorations, let you know what test equipment you’ll need, and then get into the restoration process itself. As you can see, we’ve a lot to do, so let’s get started.

Repair vs. Restoration.

All vintage tape recorders—irrespective of complexity or quality when designed and manufactured—require periodic maintenance. Rubber parts wear, harden, and otherwise decompose; vacuum tubes wear out with use; capacitors deteriorate over time; heads and other tape-path components become contaminated and gradually acquire permanent magnetism; grease sloughs off and becomes mixed with dirt; oil dissipates . . . sounds really bleak, doesn’t it! Well, that is all part of the normal

aging process, some of which occurs whether or not the recorder is used. Add to that the consequences of abuse, poor storage conditions, and neglect for long periods of time (certain parts, such as belts and idlers, should be rotated from time to time), and the result is likely to be a candidate for complete restoration.

One major issue here is that, even if you have been lucky enough to obtain the original manufacturer’s service manual, the manual will not address the steps that must be taken to overcome the various aging effects. A number of those steps should be taken even before powering up a machine for the first time after a long period of storage.

There’s actually a very important distinction between ‘repair’ and ‘restoration’—and it’s one that’s often not fully understood. That lack of understanding can wind up being both frustrating and expen-

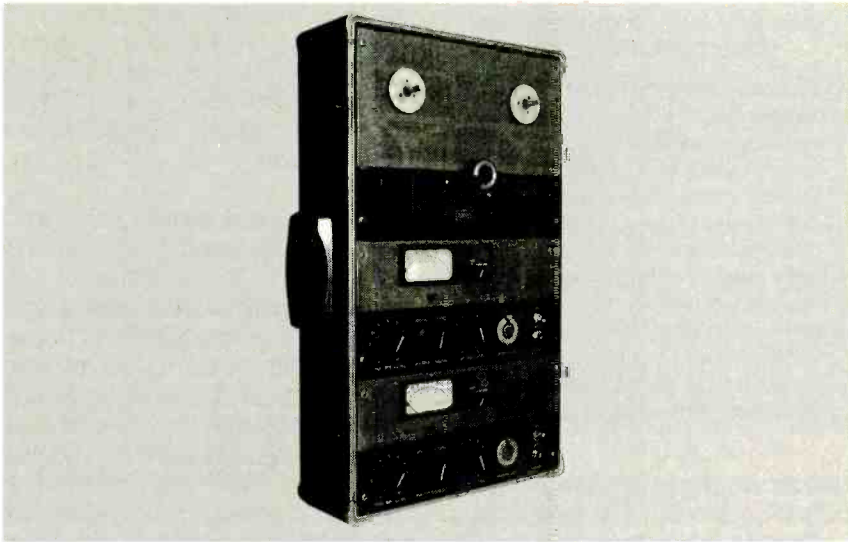

Fig. 1. The Ampex Model 602-2 tape deck is a vintage vacuum-tube machine with professional, timeless styling—and performance to match.

sive. Once you do understand the difference and decide what path you want or are willing to take, you can better determine what to look for before you buy; what questions to ask; and how to evaluate what you already own. Now you can get mentally prepared for the service or restoration process before you dig into the machine.

Repairs, by definition, tightly focus on specifically targeted trouble spots. Typically, those service operations should be clearly identified at the outset—and if you are using the services of a repair shop, thoroughly agreed upon by both yourself and the technician. Note that there may be additional faulty components or alignments needed beyond the identified symptoms; you and the technician need to discuss what to do if such problems are encountered. That will ensure that both parties understand how much work will be done. To do otherwise could easily result in repairs costing more than two times the amount needed to just fix the immediate problem.

Once again, repair means: “fix the following problem(s); eliminate the following symptom(s); and do nothing else, unless specifically agreed upon beforehand by both parties.”

Restoration, on the other hand, means do everything necessary to bring this machine back to original specs, additionally ensuring that all

appropriate manufacturer’s periodic maintenance steps are followed. It might optionally also include complete cosmetic renovation—not simply cleaning, but restoring original finishes and repairing cabinet cracks or separations. While that might seem to be all-inclusive, there are still decisions to be made, such as whether to replace all capacitors, or even just all electrolytic capacitors.

Which Way to Go? Now, you may be thinking: “I don’t want a complete restoration, but I also don’t

want to overlook something that will fail soon, or may wear out prematurely due to lack of lubrication; also, I want it to look nice.” Well, here’s the tough part. A failing component doesn’t always hang out a shingle saying: “Hey, replace me now because I’m going to fail soon.” Further, if you don’t reconcile just how far you want to go with this work, you will probably be disappointed with the results. It might cost too much, take too long, or not look as good or work as well as you would like.

If you take the machine to someone else with a non-specific, non-detailed repair order, that will doom the poor technician no matter what he does. If he scrupulously just repairs the immediate problem—only those components and adjustments directly accounting for the current malady—then there’s a good likelihood the machine will come back soon with some other—or even the same—symptom. If, on the other hand, he or she—just as scrupulously—repairs, replaces, or adjusts all weaknesses associated in any way with the problem . . . well, that can be a much more expensive proposition.

The relevance of all this is that whether or not you decide to have others help you get your machine fixed, you first need to reconcile exactly what it is you want accom-

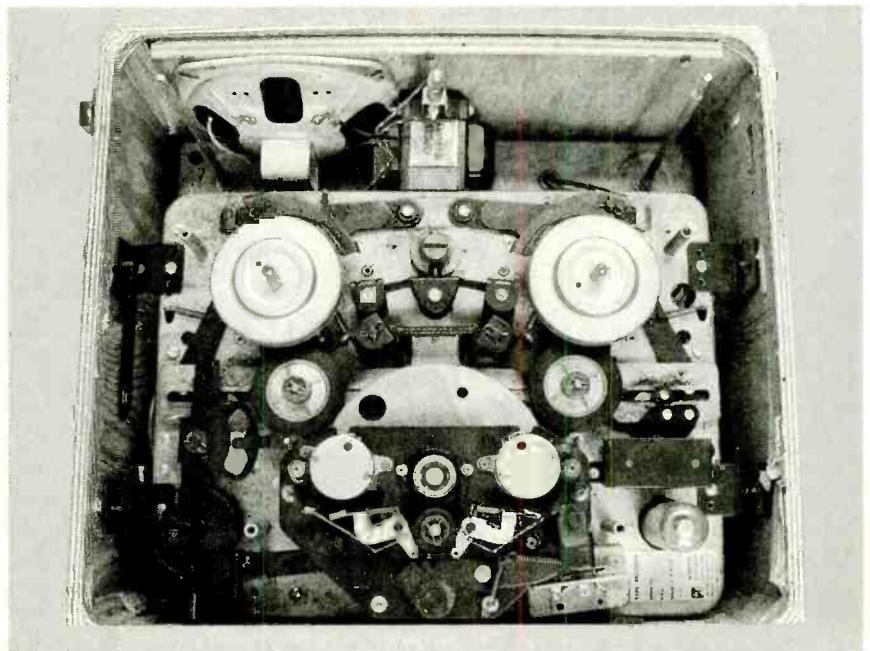

Fig. 2. The internal mechanics of a typical 1950’s single-motor recorder transport.

plished. What is it that you really want this machine to be; what role do you want it to play in your life? Is it to be simply a display item? Is it to provide a means for occasional, recreational recording, where it's "no big deal" if things don't work out during a particular session? Or is it to play a serious role in critical applications, where breakdowns or substandard performance are intolerable?

Once you've thought the above through, it is important to communicate your intentions to your technician. Be realistic about what we've been saying concerning the deterioration that comes with time, use, abuse, and storage. Consider the complexities of the mechanics and electronics, and all of the tests and alignments that must be performed to truly recreate the machine that you may want (but may not be prepared to pay for).

Doing it Yourself. Assuming you have the financial resources, and can find a technician or repair shop willing to accept the challenge of restoring or repairing your machine (note that while some will, most won't), that is a perfectly legitimate way to handle this task. But there is another, potentially more rewarding way to go: doing the work yourself. However, no matter how skilled you are around a test bench, there is plenty of potential frustration attached to this task as well. Before you dive in, we need to

TABLE 1—AUDIO OSCILLATOR RECOMMENDATIONS	
Frequency range:	20 Hz–20,000 Hz
Accuracy:	within $\pm 5\%$
Frequency response:	± 1 dB (although greater amplitude change with frequency is okay as long as you remember to reset level each time you change frequency)
Output level:	1 volt into 600 ohms is usually sufficient
Distortion (THD):	Better than 0.5 % is adequate; also, you can get by if your unit can meet that spec at just a single frequency, either 400 Hz or 1 kHz

discuss what you will need in terms of test gear and other resources.

One of those resources is time. On average, it can easily take a full day or more to completely restore a relatively simple vintage recorder that is cosmetically still in good shape and still at least partially operational. A complex machine that's a basket case can easily take two or three days. If major rebuilding of mechanical components is needed, or major re-wiring or component replacement is required, or extensive cabinet and cosmetic work is specified, this can add another day or two. Note that those time estimates are for experienced technicians, with many similar restorations already completed. Of course, that can translate into huge costs if you have others perform this work.

On the other hand, if you're

ready, willing, and able, read on to find out how you can do most or all of the work yourself. In this way you could save 80% or more of the total cost that usually constitutes the labor portion.

Test Equipment Needs. Let's talk a bit about test equipment. Now, I'm not trying to scare those of you thinking about possibly doing your own repairs or restorations at home, but we do need to be realistic about just what it takes to do the job right. Further, even if you can't do the entire job yourself, there may be aspects of it that you can do, and thus reduce the cost for professional help to finish the repair or restoration task. Finally, once you understand exactly what's needed and where to get it, you may find it surprisingly inexpensive.

The two most basic pieces of gear you need are an audio oscillator and voltmeter that is "audio-capable" (more on that in a moment). If you have both on hand, great. If not, the purchase of those two items could easily set you back about \$250. One way to cut that cost is to look at a local "flea market" or amateur-radio swap meet ("hamfest"). Of course, if you do that you will face the problem of ensuring that they both work properly, and at least come close to meeting their original specs. One compromise would be to purchase older, but guaranteed, instruments from a used-equipment dealer; you can often find ads for those in the back pages of **Electronics Now**. That way you will pay more than at a flea market, but you will at least be sure that the items work.

Two of my own "flea market finds" are shown in Fig. 3: a Hewlett Packard (HP) Model 200 audio oscillator and an HP Model 410 VTVM (vacuum-tube voltmeter). The HP 200 is one of a long-lived series of similar oscillators that were an outstanding success for Hewlett Packard. These were truly "work-horse" machines, rarely requiring service. Many thousands of these were "excessed" by industry when transistorized gear became the standard, but those vacuum-tube units perform about as well as many new designs.



Fig. 3. Two examples of vintage vacuum-tube test equipment from Hewlett Packard: a Model 410 VTVM (left) and a Model 200 audio oscillator.

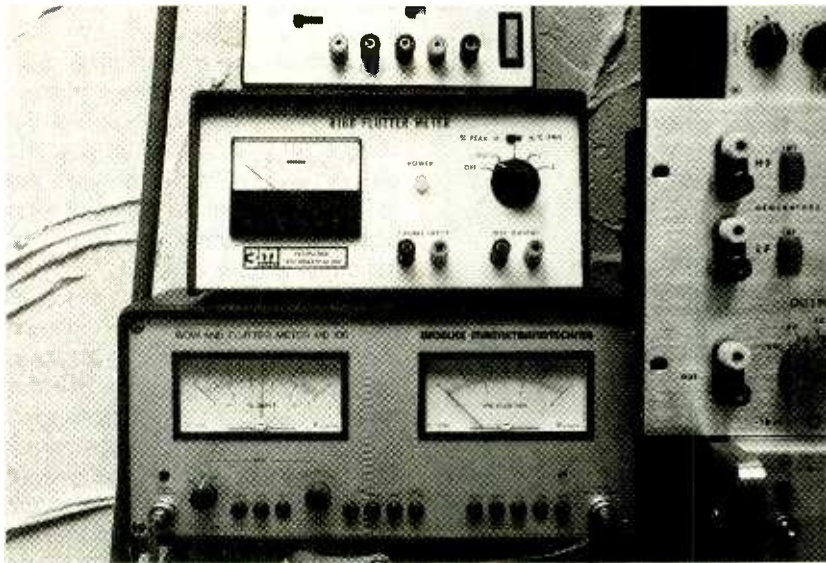

Fig. 4. Two wow/flutter meters: the 3M Model 8160 (top) and the Woelke Model ME-106 (bottom).

That unit meets or exceeds what is needed to service any audio recorder manufactured through at least the 1970s. If you go with another unit, the basic specs you should look for are given in Table 1.

Note that the HP410 shown is not an "audio VTVM". It's important to understand the difference. With most VTVMs, like the 410, the smallest AC-voltage range is 1-volt full scale. Due to reading interpretation, that generally translates to an ability to read voltages as low as about 20 millivolts. That is okay for most troubleshooting and alignments, except S/N. For that, you will need an audio voltmeter with at least a 3-millivolt scale (thereby capable of reading 100 microvolts). One unit that you might find on the surplus/hamfest market is the HP403B. It has a 1 millivolt scale—more than what's needed for tape-recorder work. As an alternative, if you choose to purchase a surplus distortion analyzer (our next topic), you may find that an audio voltmeter is also built in to that instrument.

As a final note on voltmeters, many ordinary VTVMs and VOMs (volt-ohm-meter) do have sufficient frequency response to cover the audio spectrum. An old favorite, the Simpson Model 260 Series 4, for example, has an AC frequency response up to 500 kHz.

Next, let's take a look at distortion analyzers. Harmonic distortion

is the standard distortion test and calibration used by tape-recorder manufacturers. Distortion analyzers can be expensive new, but can also be found from used/surplus/hamfest sources. For example, the modest but adequate Heath Model IM-58 can still be found at hamfests for about \$30 to \$45. While it doesn't have specs as impressive as the HP analyzers, such as the Model 331A (which still sells for about \$150 or more), it can be used quite effectively for all but the most demanding measurements. It also has a built-in audio voltmeter.

An oscilloscope is not absolutely required for most tape-recorder servicing. After all, armed with your oscillator, distortion analyzer, and audio voltmeter, you can perform the necessary checks and alignments on a machine whose electronic components are functioning well. However, if you don't have an oscilloscope, "Murphy's Law" will surely kick in. This will occur in the form of a noisy pre-amp stage, or the inexplicable loss of signal deep within a record or play amp, or any number of other maladies for which the oscilloscope is a worthwhile, if not required, diagnostic tool.

The subject of oscilloscopes usually conjures up notions of the family savings quickly evaporating. True, a new, triggered-sweep, 50-MHz analog scope can set you back at least \$600 or so. The new digital scopes, despite their small size, carry

a hefty price tag—generally exceeding \$1,000. However, a trip to your local flea market (once again, hamfests are particularly good for this), plus a little patience, will likely yield something useful in the \$50 to \$150 range. Because of the relatively modest requirements associated with working in the audio-frequency range (and even considering bias/erase oscillators that operate at, say, 180 kHz), even the lowest-frequency-response scopes are suitable for tape recorder use. I do recommend that you purchase one with a "triggered-sweep" option. However, other than getting a decent probe, that's about it.

And don't necessarily ignore the older vacuum-tube scopes. Although they are not in fashion anymore (translation: they can be had cheap), if you find one that's not rusty and that appears in good cosmetic and functional condition, it may provide you with many years of flawless operation when used judiciously. Just allow adequate warm-up time (around 20 minutes or so), and remember to switch it off when you're done!

A good wow/flutter (W/F) meter is indispensable for mechanical adjustments and alignment. Very briefly, W/F is a measure of short-term speed accuracy; that is, speed variations of less than one second, up to about two seconds (corresponding to a frequency range of about 200 Hz down to about 0.5 Hz). We'll get into this much more in a later installment.

There are many different possible causes for poor W/F. I have seen good technicians virtually pulling their hair out in vain attempts to correct W/F problems. There is literally no way of doing this effectively without the assistance of wow/flutter measurements.

The principal issue for those on a limited budget is that used commercial W/F meters are rather expensive and seldom found. This is probably due to their restricted application, and therefore relatively few being manufactured. When you can find one, prices of \$70 to \$150 are not unusual. Two popular commercial models were the 3M 8160 and the (German) Woelke ME-106, as pictured in Fig.4. Either of



Fig. 5. Here are various measurement tools used to check tensions, speed, and wear.

these will do the job nicely. While a sensitivity of 0.3% full scale is acceptable, both of these particular units exceed that capability.

If budget or availability becomes a problem, and time is not a pressure, here is another alternative: Franklin Miller, as part of the audio test-gear series currently running in his "Audio Update" column in this magazine, is scheduled to do a simple W/F meter in a future installment. In fact, if you are comfortable doing construction work, many of the pieces of equipment outlined above will be appearing in future issues, and an audio oscillator has already appeared (see "Audio Update," **Electronics Now**, July, September, and October 1997).

Other equipment you will need includes tube/transistor testers and power supplies (if you will be performing electronic repairs), a variable voltage AC transformer ("Variat" is a common trade name), a tape-head demagnetizer, a soldering iron with a fine tip, and various hand tools. In addition, to perform mechanical adjustments and to check manufacturer specs in this area, you will need tension gauges such as those pictured in Fig. 5. Also shown in that photo is a play-speed strobe wheel, and an illuminated magnifier (less than \$10 at Radio Shack). Finally, if you will be restoring cabinetry, etc., you will need wood- and metal-working tools, plus strippers, cleaners, polishers, and refinishing coatings.

The only other items needed are tapes for test recordings, plus a music source and playback gear to check out your accomplishments. If you will be testing or adjusting head alignment, equalization, or playback response, then a standard alignment tape is very desirable. More about this tape will be covered in a future installment. If you would like information on obtaining an open-reel alignment tape, write to the author c/o EC Designs at the address given in the "For More Information" box.

FOR MORE INFORMATION

This article is based on the new book, *Evolution of the Audio Recorder* by the author, Phil Van Praag. It contains over 500 pages of history, evolution, restoration, photos, and a price guide. It's available at \$39.95, postpaid, from EC Designs, P.O. Box 33, Genesee Depot, WI 53127.

Cost and Commitment. From a cost standpoint, the equipment described above would total about \$500 or less, if a conservative "used-or build-only" strategy is followed. Perhaps a more difficult decision to be made is whether to invest the time to acquire the knowledge needed to perform the various mechanical and electronic tasks associated with repairs and restorations. Much of this, of course, will have to do with whether you intend to continue doing repairs and

restorations, or whether this is pretty much a one-time event. Of course I'm biased in this matter, but I believe this is an excellent hobby—it's a great way to increase your overall understanding of mechanics and electronics in general, and to gain a heightened appreciation and enjoyment of your tape recorder specifically.

However, if you don't have the time or desire to make a commitment to this, then you're probably better off leaving the work to others. It's possible to do great damage to a tape recorder if improper repairs are performed. In fact, technicians will often charge more to work on a machine if faulty repair efforts have been made. Efficient repairs by professional technicians depend on certain assumptions that are based on previous experience coupled with subtle observations during the troubleshooting process. This process can be seriously impeded if things have been "stirred up" by someone else. Adjustments might have been disturbed, and components that were still okay before the aborted repair attempt might now be defective (bent, broken, shorted out, electrically or mechanically stressed beyond their design limits, etc.). This often complicates subsequent repair attempts. So, read through the repair and restoration descriptions in the upcoming installments carefully, and then decide whether this is something you want to tackle.

In the next installment, we'll begin the actual restoration process! See you then. Ω

**Yours for only
\$3.50**
Prices includes
shipping!



HAVE A THOUSAND YUCKS FOR ONLY THREE AND A HALF BUCKS! That comes to one-third of a cent per laugh. **Electronics Comics** is a compilation of over 125 riotous, outrageous and phenomenal cartoons that appeared in **Popular Electronics** and **Electronics Now**. Only **\$3.50**—price includes shipping. **Clagck, Inc., Reprint Bookstore, P.O. Box 4099, Farmingdale, NY 11735-0793.** All payments in U.S. funds. Sorry, no orders outside U.S.A. and Canada. Check or money order only—send no cash. NY state residents add applicable tax. MA04



BUILD THIS PRECISION VOLTAGE/ CURRENT REFERENCE

Add this easy-to-build and inexpensive accessory to your test bench for lab-quality measurements and calibration.

SKIP CAMPISI

If you enjoy experimenting with both linear and non-linear analog-electronic circuits, you've probably gotten aggravated having to breadboard a precise reference circuit every time one is required. A standard linear power supply with variable voltage and current limiting can sometimes be used if the application is not too critical.

However, those methods leave a lot to be desired when precise, drift-free performance is required. Wouldn't it be great if you had such a piece of test equipment available on your test bench to handle such tasks?

The Precision Reference presented here has a typical stability of better than ± 100 -parts-per-million-per-degree Celsius when assembled with the suggested components. Even better, the cost of the entire project is less than the cost of a standard power supply! The outputs include a voltage output that can range between 1 millivolt and 10 volts, and a current output that can be set anywhere from 1 microamp to 10 milliamps. A range-select switch can set the output range to 0.1, 10, 100, or 1000 millivolts or microamps. Two independent 10-turn precision potentiometers with turn counters let each range be multiplied by 1 through 10 according to the dial setting.

Using the 1% metal-film resistors specified, you can expect an accu-

racy of about 0.2% of the dial setting for the 10, 100, and 1000 range-switch settings. Typically, the accuracy is better than 0.1% overall. The lowest range has an accuracy of 1%, and it typically can be as good as 0.5%. A built-in 3½-digit LCD panel meter can display the load voltage present at either output. It has its own range selector switch.

Fixed current limiting is provided for the voltage-output section of the circuit. That provides a maximum of about 30 milliamps at the 10-volt-output level, increasing to about 80 milliamps at the 1-millivolt-output level. This method has the added benefit of short-circuit protection.

The current output has a variable "compliance" control in order to protect any voltage-sensitive devices being tested. The voltage at the current output is adjustable between about 1.5 volts at the minimum setting and about 11 volts at the maximum position.

Circuit Description. The Precision Voltage/Current Reference design can be divided into four basic sections: the voltage-reference inputs, the voltage-current-reference outputs, the power supply, and the panel-meter display.

The schematic diagram in Fig. 1 shows the simplicity of the circuit. A 1-volt reference is supplied by D1 to the current-reference circuit, with D2 supplying a 1-volt reference to the voltage-reference

section. Both diodes are temperature-stable ICL8069 band-gap reference diodes. The 1-volt reference from D1 appears on the wiper of R3 when R3 is set to its maximum rotation. At the minimum setting of R3, 100 millivolts appears. That voltage is buffered by IC2, an LF356 JFET op-amp. The buffered reference voltage is applied to Q1. Since Q1 is a part of the feedback loop of IC2, the reference voltage is placed across the range resistor (R6-R9) as selected by S1-a.

Due to the high gain of Q1, the output current at its collector is the same as the reference voltage divided by the selected range resistor. That output current is connected to J1. The maximum output voltage at J1 is set with R13 and Q2, which is configured as an emitter follower. The bias on D3 lets the output of IC2 stay in its active-voltage range.

The 1-volt reference from D2 feeds the voltage divider composed of R17-R21. The range from that divider is selected by S1-b and is buffered by IC1, a TLC271 CMOS op-amp. It is configured as a non-inverting amplifier with a variable gain set by R24. High-current capacity for the voltage output is provided by Q3, a 2N2219 NPN transistor. It is a part of IC1's feedback loop. Current limiting and short-circuit protection for Q3 is provided by R26, a 100-ohm, 2-watt resistor.

The power-supply portion of the circuit is shown in Fig. 2. The power

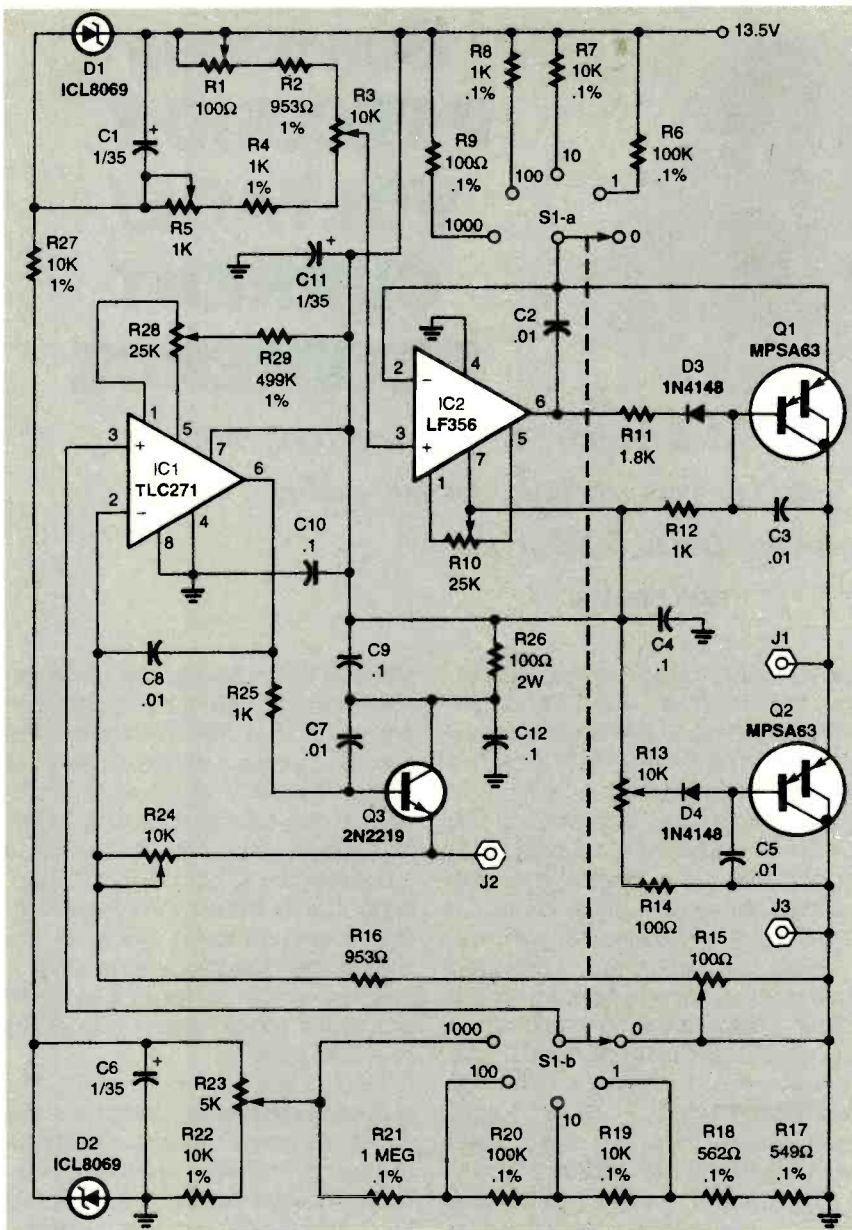

Fig. 1. Although it might look complicated, the Precision Voltage/Current Reference is actually a straightforward circuit that is built around several high-precision op-amps. The circuit is easy to calibrate using only an accurate digital voltmeter.

supply has some unusual design features that are needed for the circuit to work properly. There are two isolated outputs: 13.5 volts for the main circuit and 9 volts for the digital-panel meter, DISP1. Because DISP1 uses an on-board reference, its supply *must* be completely isolated from the rest of the circuit!

The isolated outputs are achieved by choosing a "split-bobbin" transformer for T1. That type of transformer has two separate 120-volt primaries and two separate 12-volt secondaries. In effect, the transformer is two separate transformers that share

a common core.

The input to the display circuit is switched by S4. That lets the input measure the load voltage at J1 (the current reference) or J2 (the voltage reference). The voltage is applied to IC4, a TLC271 CMOS op-amp wired as a unity-gain buffer. The output of IC4 drives another voltage divider consisting of R34 through R37. The output of IC4 is loaded by R38 so that it can approach ground potential if needed.

The range of DISP1 is set by S3. The resistor-divider network lets DISP1 display voltages beyond its

normal 200-millivolt range. One half of S3 selects the range from the divider network, while the other half selects the proper decimal-point location for the display.

Construction Tips. The actual layout and construction of the Precision Current/Voltage Reference is not critical to circuit performance. However, following the guidelines mentioned here will assure success and accuracy with the project.

Choose a suitably-sized cabinet that will be big enough to hold all of the circuitry and all of the controls. The author's prototype was assembled in a sloping plastic cabinet about 7½-inches wide and 4¾-inches deep. The cabinet's aluminum top panel on which most of the controls were installed is an excellent ground plane.

Point-to-point wiring was used on standard 0.1-inch-grid perfboard with copper-foil pads. The power-supply section was mounted on a separate board, supported by DISP1's mounting lugs. The power cord enters the cabinet near the supply with S2 mounted next to it. Be sure to drill several ventilation holes in the cabinet near the transformer.

The references and meter driver were constructed on another board; the voltage-current-output sections are contained on a third board. Both of those boards were mounted away from the power-supply board in order to avoid picking up any 60-cycle "hum". All of the connections between the components on the boards were made with 22-gauge bus wire. Insulated stranded wire was used for any connections between boards or anywhere there was a possibility that the wires could come in contact with another conductor. For the long runs between the boards and the panel components, the insulated wires were twisted together in pairs.

Mount 0.1% metal-film resistors R17-R21 directly onto the appropriate lugs of S1-b. One lead of R17 should be connected to a panel ground lug. Mount R6-R9 from S1-a to the lug on R13 that will be connected to the positive power source. The positive lead of R26 should be connected directly to that lug, also. Note that the 13.5-

volt power leads from all of the boards, including the power supply, should be run to that same lug. That arrangement is called a "star" because all of the connections radiate out from one central point. In that way, there is no accumulated resistance from the individual wires if they were to be run sequentially from point to point in a "daisy-chain" style.

Make a "star" connection for the ground in the same way. Connect each board's ground lead to the panel ground lug connected to R17. The common-output ground terminal, J3, should also be connected to that lug with a short piece of bus wire. For best decoupling, install bypass capacitors C9 and C12 right on the body of R26 with very short leads.

DISP1, a 3½-digit LCD-panel voltmeter, is available from many surplus and overstock sources for less than \$10. Brand new units can be bought from several major mail-order sources, but those sources might charge \$50 and up. The unit that you choose should have a maximum input range of 200 millivolts, and can be powered by an isolated supply of 9 volts, as mentioned

before. You have the option of using a 4½-digit digital-panel meter (DPM) at about twice the cost. If you require further information on DPMs, refer to the excellent article by Bill Stiles in the October 1996 issue of **Popular Electronics** magazine.

Install and wire DISP1 according to its instruction sheet. Although a typical hookup is shown on Fig. 2, you should follow any recommendations for the actual unit that you will be using. Install R34-R37 on the appropriate lugs of S3-a. One lead from R37 is connected to a panel ground lug, as with R17 and S1-b. Wire S3-b to select the decimal point.

Before connecting 10-turn precision potentiometers R3 and R24, the "dead space" at the ends of their rotations must be eliminated. Start by securely mounting R3 and R24 in their holes on the top panel. With a DMM, make a note of the exact resistance between lugs 1 and 3 on R3.

Connect the DMM between lugs 1 and 2. Rotate R3's shaft until you read exactly 10% of the previous resistance. Take one of the 10-turn dial counters, set it for 2.00 (two turns clockwise from 0.00), and lock the setting. Install the counter on R3

without moving the shaft. Check the resistance on R3 once again to be sure that the shaft hasn't moved and lock the set screws securely.

Rotate the counter dial counter-clockwise until it stops. You will note that it now reads a couple of "clicks" below 1.00. That shows that the installation is correct. Rotating the counter nine turns clockwise will give an indication of 0.00, which is to be taken as 10.00. Ten-turn counter dials do not have the number "10" on their dial. Turning the dial an additional clockwise turn will indicate 1.00 again, which is now equal to 11.00.

You can, of course, use a 15-turn counter dial for true indications. However, the Precision Reference might not work correctly beyond the "10.00" setting because of the design of the circuit. Using the same techniques, install the other counter dial on R24, and complete the wiring of the controls.

Double check all of your wiring and interconnections before calibrating the unit. Turn on the power and check the 13.5-volt supply to make sure it is within ±0.5 volt. If it is over 14 volts, add an infra-red LED in parallel with LED1. If it is under 13

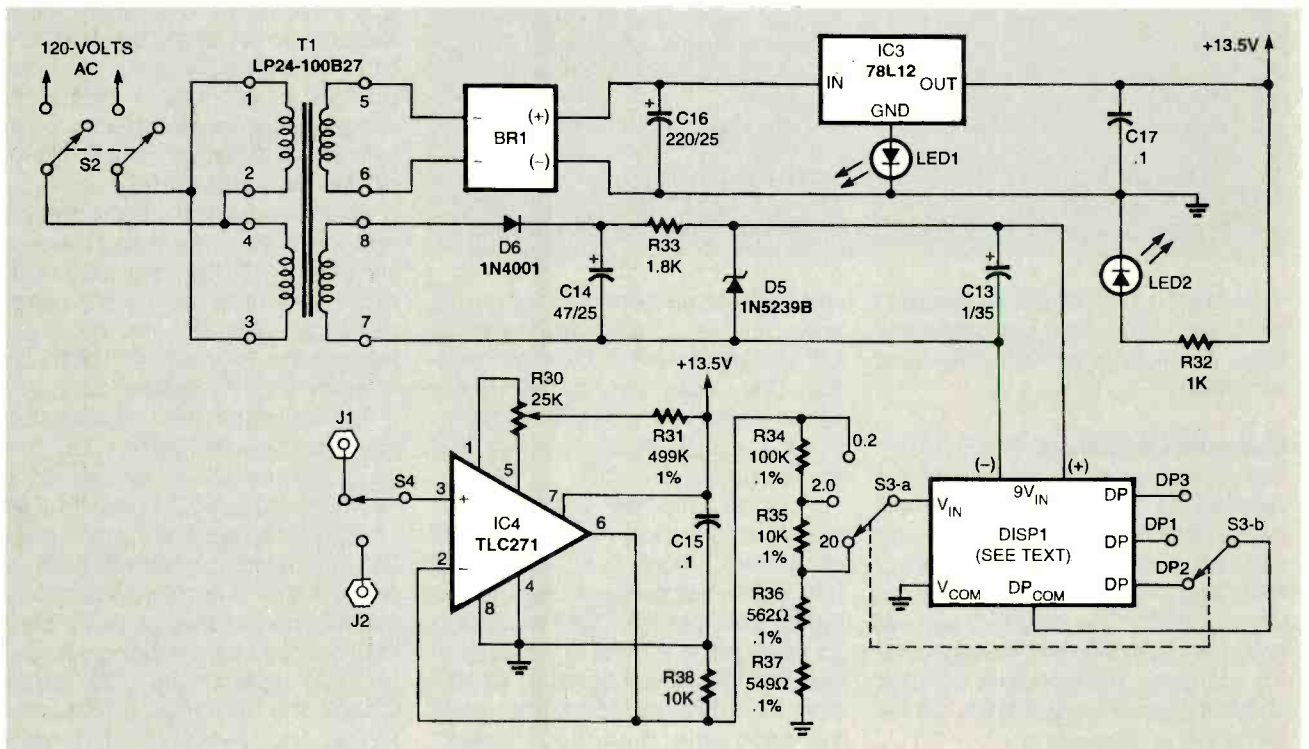

Fig. 2. The Precision Reference's power supply uses a split-secondary transformer in order to have two isolated power sources in a compact size. The digital-panel meter allows for easy monitoring of the outputs.

PARTS LIST FOR THE PRECISION VOLTAGE/CURRENT REFERENCE

SEMICONDUCTORS

IC1, IC4—TLC271 or TL091 CMOS op-amp, integrated circuit
 IC2—LF356 JFET-input op-amp, integrated circuit
 IC3—78L12 voltage regulator, integrated circuit (TO-92 package)
 Q1, Q2—MPSA63 or MPSA64, PNP Darlington transistor
 Q3—2N2219, NPN transistor
 BR1—1 amp, 50-volt bridge rectifier
 LED1—T-1 light-emitting diode, red
 LED2—T-1 ¼ light-emitting diode (any color)
 D1, D2—ICL8069 band-gap reference diode
 D3, D4—1N4148 silicon diode
 D5—1N5239B Zener diode, 9.1-volts
 D6—1N4001 silicon diode

RESISTORS

(All resistors are ¼-watt, 5% units unless otherwise noted.)

R1, R15—100-ohm, single-turn trimmer potentiometer
 R2, R16—953-ohm, ¼-watt, 1% metal-film
 R3, R24—10,000-ohm, 10-turn, panel-mount, precision potentiometer
 R4—1000-ohm, ¼-watt, 1% metal-film
 R5—1000-ohm, multi-turn trimmer potentiometer
 R6, R20, R34—100,000-ohm, ¼-watt, 0.1% metal-film
 R7, R19, R35—10,000-ohm, ¼-watt, 0.1% metal-film
 R8—1000-ohm, ¼-watt, 0.1% metal-film
 R9—100-ohm, ¼-watt, 0.1% metal-film
 R10, R28, R30—25,000-ohm multi-turn trimpot
 R11, R33—1800-ohm
 R12, R25, R32—1000-ohm
 R13—10,000-ohm, panel-mount, single-

turn potentiometer
 R14—100-ohm
 R17, R37—549-ohm, ¼-watt, 0.1% metal-film
 R18, R36—562-ohm, ¼-watt, 0.1% metal-film
 R21—1 megohm, 0.1%, ¼-watt, metal-film
 R22, R27—10,000-ohm, ¼-watt, 1% metal-film
 R23—5000-ohm multi-turn trimpot
 R26—100-ohm, 2-watt, 5%, wire-wound
 R29, R31—499,000-ohm, ¼-watt, 1% metal-film
 R38—10,000-ohm

CAPACITORS

C1, C6, C11, C13—1-µF, 35-WVDC, solid tantalum
 C2, C3, C5, C7, C8—0.01-µF, ceramic-disc
 C4, C9, C10, C12, C15, C17—0.1-µF, ceramic-disc
 C14—47-µF, 25-WVDC, aluminum electrolytic
 C16—220-µF, 25-WVDC, aluminum electrolytic

ADDITIONAL PARTS AND MATERIALS

T1—Dual 12-volt, 100-mA secondary, split-bobbin transformer
 DISP1—3½- or 4½-digit liquid-crystal display panel-mount voltmeter (see text)
 S1, S3—2-pole, 6-position rotary switch, panel-mount, non-shorting
 S2—double-pole, double-throw toggle switch
 S4—single-pole, double-throw toggle switch
 J1—J3—binding posts
 10-turn counting dials for R3 and R24, case, line cord, wire, hardware, etc.

volts, add a 1N4148 silicon diode in series with LED1. That will assure the best operation of the Precision Reference.

Calibration Procedure. The Precision Reference needs to be calibrated properly in order to get the most benefit from the circuit. Although the calibration procedure given here is fairly straightforward, it should be followed exactly. The only tool you will need is a good-quality 4½-digit digital voltmeter. An accurate 3½-digit DVM will also work, but there will be some loss of accuracy.

Turn on the power and allow the unit to warm up for a minute or so. Set S4 to connect J2 to the panel-

display circuit. Range switch S3 should be set to the highest setting (20 volts). Rotate R13 to its "off" position (the wiper connected to the supply voltage) and set S1 to the 1-millivolt range. Both R3 and R24 should be set to "1.00".

To calibrate the voltage-reference section, connect the DVM across pins 2 and 3 on IC1. Adjust R28 for a reading of exactly 0.00 millivolts. Connect the DVM to J2 and J3 and adjust R23 for a reading of exactly 1.00 millivolt. Set S1 to 10, 100, and 1000 millivolts, noting the reading each time. If needed, "tweak" R23 for accuracy over the entire range. With S1 set at 1000 millivolts, set R24 to "10.00" and adjust R15 for

a reading of exactly 10.000 volts. Switch S1 to 1 millivolt and "tweak" R28 for a reading of exactly 10.00 millivolts. Note that that adjustment is very sensitive. Return R24 to the "1.00" setting and re-check your calibration results.

To calibrate the current-reference section, set S1 to 1 microamp. Connect the DVM across pins 2 and 3 of IC2 and adjust R10 for a reading of exactly 0.00 millivolts. If you can't get that setting, replace IC2. Set R3 to "10.00" and connect the DVM between the 13.5-volt "star" connection and the wiper of R3. Adjust R5 for a reading of exactly 1.0000 volts. Reset R3 down to "1.00" and adjust R1 for a reading of exactly 100.00 millivolts. As those last two adjustments interact slightly, reset R3 back to "10.00" and note the reading. "Tweak" R5 again if necessary, and recheck the reading with R3 set at "1.00". Keep repeating the process until you are satisfied.

With S1 set to 1 microamp, connect the DVM across R6 and set R3 to "1.00". The reading should be 100 millivolts. Advance R3 to "10.00" and the reading should advance linearly with the counter dial up to a 1.00-volt reading. If not, replace IC2 with a unit made by a different manufacturer. Some chips are known to have problems working near their positive supply rails. A good chip should not have a problem working with its inputs as high as 100 millivolts above the positive rail.

Finally, connect the DVM in its current-measuring mode to J1 and J3. Set S1 to 1, 10, 100, and 1000 microamps and note the actual current readings with R3 set at "1.00". Repeat the process at "10.00" and re-calibrate, if necessary.

To calibrate the digital-panel-meter section, set R24 to "1.00", S1 to 1000 millivolts, S4 to connect to J2, and S3 to 2.0 volts. Connect the DVM across pins 2 and 3 of IC4 and adjust R30 for a reading of exactly 0.00 millivolts. Adjust the reference-calibration trimmer located on DISP1 as per its data sheet for a reading of exactly 1.000 volts on its LCD display. Check the readings on all other ranges and "tweak" the trimmer as needed for overall accuracy.

If the display refuses to go down low enough to indicate the lower

output ranges, try swapping IC4 with IC1, or replace IC4 altogether. Maximum output swings for the TLC271 can vary from unit to unit, although they will normally go down to within a few hundred microvolts above ground.

Operating Hints. The Precision Voltage/Current Reference is extremely accurate and simple to operate. Aside from the obvious uses such as the calibration of analog circuitry, metering equipment, and the like, the unit has many other applications. Only a few examples will be discussed here—you will surely find many others uses.

If you need to put high current into a low-impedance load, you might want to use "remote sensing" to maintain an accurate load voltage. That is easily done by bringing the lead from lug 1 on R24 out to a separate binding post rather than connecting it to Q3 and J2. Likewise, connect the ground connections of R15 and R17, along with D2, C6, and R22 to another binding post rather than J3.

Run separate leads from J2 and the binding post from R24 to one side of the load, and separate leads from J3 and the other new binding post to the other side of the load. For normal operation with a "light" load, simply short J2 to its companion binding post and J3 to the other binding post with short lengths of solid bus wire. That will restore the original connections and only two leads will be needed for the load.

If long leads are used for "remote sensing", output instability might be a problem. If that is the case, shielded cables should be used. Also, increasing the value of C8 by one or two decades might be quite helpful.

Of course, the Precision Reference makes an excellent oscilloscope calibrator. If you have a dual-trace oscilloscope, you can even use the Precision Reference as a voltage-cursor display! Input a signal into one channel of the oscilloscope and adjust the scope to show a normal display. Set the scope's attenuators to their "calibrated" position. Connect J2 and J3 from the Precision Reference to the scope's second channel. Set S1 to 0.0 millivolts and set the scope to

"alternate" or "chop" so that both traces will be displayed superimposed on each other

The input signal from the first channel will be shown on the scope's display with a straight horizontal line through it. That line represents the "zero"-volt cursor from the Precision Reference. By using the second channel's vertical-position control, the zero cursor can be moved to any position vertically on the trace from which you wish to begin your measurement.

Note the approximate signal voltage being displayed on the first channel and set up the second channel to display a similar voltage available from the Precision Reference. Set S1 on the Precision Reference to the appropriate range required and advance R24 until the cursor reaches the measurement endpoint. Since you already know the approximate voltage from the CRT display, it is a simple matter to read the precise, actual voltage from the Reference controls.

The current reference can be easily used as a precision ohmmeter simply by connecting the resistance to J1 and J3. Leave R3 set at "1.00", set S4 to read current from J1, set S3 to 2.0 volts, and raise compliance control R13 so that there is no "compliance". Advance S1 from 1 to 1000 microamps and find the highest voltage reading that can be displayed on DISP1. Dividing the voltage by the current setting gives the resistance. If you need to read higher or lower resistance readings than normal, set S3 to 200 millivolts or 20 volts and set R3 to "10.00", if required.

The current source output can also be used to precisely forward or reverse bias a semiconductor junction, with the display measuring the resulting voltage drop. Reverse voltages of up to about 11 volts can be measured with R13 in the "off" position. Zener diodes, signal diodes, LEDs, and laser diodes are easily tested. Be sure not to exceed the maximum reverse voltage on the component or it will be destroyed. Light-emitting diodes and laser diodes are especially sensitive to reverse voltages. Keeping the reverse voltage below 3 volts will protect most LEDs.

Laser diodes will not "lase" at very low currents levels when being

tested by the Precision Reference. It is quite easy to identify the package leads in laser diodes, as the PIN photo-diode will have a forward drop of about 0.7 volts, while the laser diode will exhibit a forward drop of about 2.0 volts.

You can also identify the leads on bipolar transistors the same way. As most emitter-base reverse-breakdown voltages on silicon transistors are below 11 volts, the Reference should be used at a setting of about 10 to 100 microamps to locate that junction. The collector-base reverse-breakdown voltages are usually well above 20 volts. Of course, the forward voltages of both junctions are about 0.7 volts.

As you can see, the Precision Reference has unlimited applications. The display is only for showing the load voltages at the current source output—the voltage-source output-control settings have much more resolution than the 3½-digit display. If you're more interested in ultimate display accuracy, it's a good idea to invest in a 4½-digit digital-panel meter which will have higher resolution. Ω



This card can stop a bullet.

It's only a piece of paper, but that little card up there carries a lot of weight. Keeping millions of kids off drugs, out of gangs and in school. To learn how you can help the Boys & Girls Clubs, call: **1-800-854-Club.**

The Positive Place For Kids

MULTICHANNEL TRIGGER

(continued from page 36)

arrangement for fitting the PC board into the enclosure given in the Parts List is shown in Fig. 3. Using a different case will probably need a different arrangement. The only requirement is that the switches and jacks be readily accessible.

Using the Multichannel Oscilloscope Trigger. To use the Multichannel Oscilloscope Trigger, locate a 5-volt source and ground connection on the circuit you will be testing. Attach the 5-volt source to pin 14 of J1, and connect pin 1 to ground. If you didn't permanently ground the enable input (pin 13), that pin should also be either grounded or connected to a signal that is low during the time that you want to trigger your oscilloscope.

As mentioned before, there are three ways to use the Multichannel Oscilloscope Trigger. The mode with the fastest speed is the eight-bit

Count 1 (S1-b)		Count 2 (S1-a)
Trigger Function		
OFF	OFF	Every occurrence
OFF	ON	Every second occurrence
ON	OFF	Every third occurrence
ON	ON	Every fourth occurrence

mode. Operation at speeds over 100 MHz is possible. To use that mode, set the qualifier and counter switch in S1 to the off position and set the S2 switches to the desired pattern of on and off states. The eight settings on S2 will be compared to the inputs on J1. A negative-going pulse will appear at J2 when a match is detected.

Probably the most common mode of operation will be the 10-bit mode. With that mode, you can typically decode a full byte of data on a computer's data bus during a read or write operation along with an enable signal. The 10-bit mode

works the same as the eight-bit mode, except that it will only decode at rates up to 50 MHz. To use the 10-bit mode, the qualifier and counter switch in S1 must be on.

To use the Multichannel Oscilloscope Trigger in the counter mode, simply set the count switches as shown in Table 1. The counter mode lets the trigger output toggle on every second, third, or fourth occurrence of a match on the input pins.

If you want to use the trigger to qualify fewer than 8 or 10 inputs, simply set the S1 switches for the unused inputs to logic ones. The internal pull-up resistors on IC1 will automatically set the unused pins to the same state, making them valid. That will let the Multichannel Oscilloscope Trigger pulse its output based upon the other inputs.

To troubleshoot complex circuits, you might want to have several units available on your bench. Connecting the output of one device into the enable pin of another will let you see the state of some very complex signal combinations. Ω

GREAT COMPRESSION

(continued from page 38)

on this discussion, the MPEG organization was formed in April 1988.

At the time, international compression-coding standards for video telephones were already being discussed. Initially, MPEG members believed that adopting those standards for film and television compression would be a simple matter, but their research turned up problems.

Figure 3 shows a moving image reproduced using the motion-compensated interframe-coding method already described. The P (predicted) images are generated one after another by incorporated data about the portion of image I (the original image) that has experienced motion. Although this is a very good method for compressing data, it has one fatal flaw. That flaw is that compression coding cannot start from a P image, but only from the original I image. (This can be compared to switching television channels in the middle of a broadcast: Without the original I image, the subsequent P images cannot be

generated.) In addition, rewind playback, playing a video or film backwards, is also impossible. This shortcoming in the compression coding of television broadcasts has no place in the current video culture. Thus, MPEG's work began with the search for compression-coding standards under which channel-surfing, fast-forward playback, and rewind playback would be possible.

The eventual solution to this problem is shown in Fig. 4. As seen there, the series of still images are broken down into units of 12 to 15 photographs called a GOP (Group of Pictures). The initial image is always the original I image. As long as there is an I image, all the problems are resolved. However, an original image at the head of each GOP cuts into the degree of compression possible. To solve this problem, the degree of movement from one still image to the next is predicted using not only the previous image but future images as well. That is, the B (bi-directional) frame is an image created with motion compensation from past and future P frames or the I frame. The fifth B frame, for instance, was created with refer-

ence to the fourth and seventh P frames. This technique serves to both improve the accuracy of the predictions and cut back on amount of data required.

Faultless Timing. Despite its technological breakthroughs, MPEG would not have succeeded without the benefits of good luck and good timing. With the participation of many top scientists and researchers and under good, positive leadership, the standards were hammered out in a short period. Due to the swift movement, standardization coincided with the rise in popularity of the Internet and the standards were widely adopted.

MPEG is now firmly entrenched as the compression method of choice for a wide variety of audio/video technologies in the U.S., Japan, and throughout the world. In recognition of its technological achievements and its wide acceptance, particularly in the area of broadcast video, MPEG (including its predecessor, JPEG) were awarded an Emmy by the U.S. National Academy of Television Arts and Science in October 1996. Ω

ELECTRIFY Your Library

when you join EBC

GET **5** Books
FOR ONLY

\$4.95

Values to
\$62.90



0707613 \$27.95



0231193 \$27.95
Hardcover

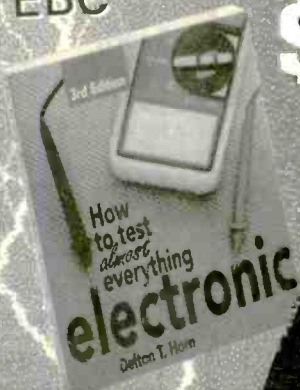

0304068 \$17.95

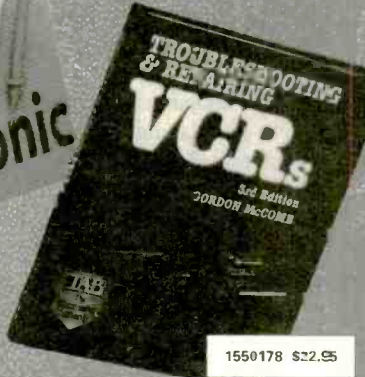

1550178 \$22.95



373092X \$27.95



0850740 \$27.95



0317914 \$63.00



0900247 \$13.95



0535438 \$23.95
Hardcover



0501149 \$26.95



0112733 \$47.95



0852537 \$44.95



0236143 \$24.95



0242054 \$24.95



0350787 \$44.95



3355748 \$19.95



0380767 \$39.95



0044392 \$14.95



1575472 \$29.95

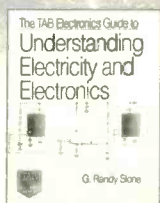

0582165 \$19.95



0331893-CX \$89.50
Hardcover/Counts as 2

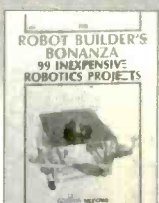

1571469 \$18.95



3483375 \$24.95



0428433 \$60.00
Hardcover

As a member of the ELECTRONICS BOOK CLUB...

You'll enjoy receiving Club bulletins every 3-4 weeks containing exciting offers on the latest books in the field at savings of up to 50% off the regular publishers' prices. If you want the Main selection, do nothing and it will be shipped automatically. If you want another book, or no book at all, simply return the reply form to us by the date specified. You'll have at least 10 days to decide. If you ever receive a book you don't want due to late delivery of the bulletin, you can return it at our expense. Your only obligation is to purchase 2 more books during the next 12 months, after which you may cancel your membership at any time. And you'll be eligible for FREE BOOKS through our EBC's Book Program.

* Shipping/handling charge and sales tax will be added to all orders. All books are paperback unless otherwise noted. Publishers' Prices Shown © 1997 EBC

If card is missing, write to:
Electronics Book Club®

A Division of The McGraw-Hill Companies
P.O. Box 549, Blacklick, OH 43004-0549

PHONE: 1-614-759-3666 (9 a.m. to 5:00 p.m. EST Monday-Friday)

FAX: 1-614-759-3743 (24 hours a day, 7 days a week)

INTERNET: www.bookclubs.mcgraw-hill.com

RPIE298



0053553 \$50.00



9119018 \$32.95



0497060 \$34.95
Hardcover



0365946 \$24.95



0717753 \$19.95



0155593 \$22.95



1574875 \$19.95



1577564 \$24.95



NEW LITERATURE

USE THE FREE INFORMATION CARD FOR FAST RESPONSE

The ARRL Handbook for Radio Amateurs 1998 Edition

edited by Paul Danzer, N111
American Radio Relay League
225 Main Street

Newington, CT 06111-1494

Tel: 860-594-0200 or 888-277-5289

Fax: 860-594-0259

E-mail: pubsales@arrl.org

Web: www.arrl.org

\$32



CIRCLE 338 ON FREE INFORMATION CARD

The 1998 ARRL Handbook, the 75th edition published by the American Radio Relay League, covers the state of Amateur Radio as the 21st century approaches. Over the course of 75 years, this handbook has

meant many things to several generations of hams, engineers, and technicians. It's been an unimpeachable source of reference data, project ideas, and electronics theory. The book has served as an overview of what hams do and how they do it. To the technician and engineer, the guide has been an invaluable supplement to their reference books and data sheets. For newcomers to the hobby, it's provided a primer on the modes and equipment hams use, as well as an introduction to basic theory.

Among the new material in this edition are three items that are shown on the front cover. They are N1TEV's super-regenerative receiver, which readers will enjoy building and using; K9EK's integrated L-band satellite antenna and amplifier; and a high-power antenna tuner by N6BV. In response to reader comments on the last edition, this book has been redesigned to be more user-friendly, with the addition of a mini-table of contents and index tabs at the start of each chapter.

The handbook is divided into 30 chapters grouped under five headings:

Introduction, Fundamental Theory, Practical Design and Projects, Construction Techniques, and Operating Practices. In addition to the ones already mentioned, projects include power supplies, RF power amps, modulators and demodulators, receivers and transmitters, and antennas.

Since bundling a disk with the book increased its cost, the software for the book is now available separately. It can be downloaded from either the ARRL Web site above or from the League's Hiram BBS, or it can be ordered for a nominal cost.

Mouser Electronics Catalog

Mouser Electronics
958 North Main Street
Mansfield, TX 76063

Tel: 800-992-9943 or 817-483-4422

Fax: 817-483-0931

E-mail: catalog@mouser.com

Web: www.mouser.com

Free

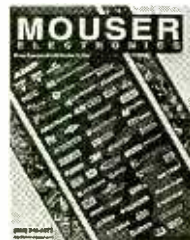

CIRCLE 339 ON FREE INFORMATION CARD

Updated and expanded to 356 pages, the Mouser Electronics Catalog is an excellent guide for anyone who needs electronic components. It offers over 69,000 products from more than 135 of today's leading electronic manufacturers. Free copies of the catalog or CD can be obtained by using either the telephone or fax numbers, or the e-mail or web addresses listed above.

In addition to the paper catalog, a CD-ROM version is also available. This user-friendly disk includes the entire catalog cover-to-cover, a new-products section, product and vendor listings, service options that offer order forms and credit applications, a direct link to the Web site, and over 1850 of their available spec sheets.

Mouser has an established line of quality electronic components from such industry leaders as 3M, AMP, Amphenol, Dale, Mallory, NEC, SGS-Thomson, Spectrol, Sprague, Thomson-Passive, and many more.

Now Hear This! Electronic Eavesdropping Equipment Design

by Winston Arrington
Sheffield Electronics Co.

P.O. Box 377940

Chicago, IL 60637-7940

Tel: 773-324-2196

\$65 plus S&H (\$6 U.S.;
\$8 Canada)



CIRCLE 340 ON FREE INFORMATION CARD

This 126-page revised edition contains explanatory text and 117 schematic diagrams of electronic eavesdropping equipment. Knowledge of electronics, including how to build projects from a schematic, is essential for building this equipment.

In the introduction, the author discusses surveillance techniques and presents an extract from Title III, the law on wiretapping and electronic surveillance. There are plans for 29 crystal-controlled transmitters of all types, 35 room-surveillance transmitters—both battery-powered and plug-in—and 32 telephone devices. Schematics for phantom zero-subcarrier transmitters, infrared units, and high-impedance recorder activators are also included. Each chapter starts with a discussion of the theory behind those devices, and their advantages and disadvantages.

Counter-surveillance techniques and countermeasure-detection equipment are covered in detail. The chapter on counter-surveillance techniques is written by Kevin Murray, an expert in the field.

TechAmerica Catalog

TechAmerica

300 W. Third Street, Suite 300

Ft. Worth, TX 76102-2905

Tel: 800-303-4550 x2151

Fax: 800-813-0087

Web: www.techam.com

Free



CIRCLE 341 ON FREE INFORMATION CARD

The recently published full-color 500-page catalog from TechAmerica is designed to serve the needs of small business and individual purchasers. Readers can easily order individual electronic components, test equipment, and specialized tools from the extensive and comprehensive collection included here.

Seven new categories have been added: home automation, home and auto security, satellite products, computer cables and switch boxes, video, weather equipment, and metal detectors. Also featured is a collection of technical books, do-it-yourself kits, and soldering equipment. Containing color photographs, in-depth descriptions, and useful reference materials, the catalog is a handy resource of parts and components from resistors to cables for hobbyists and electronics professionals.

anticipate, prevent, and solve problems.

Five key steps to successful troubleshooting are presented: collect information, localize the problem, isolate the problem, correct the problem, and verify problem resolution. Each of these steps is explained in detail, and methods of putting them into practice are also illustrated.

Directions on how to use this book suggest that readers designing a new network begin at the beginning with Chapter 1. However, if there is a panic situation, the place to start is Chapter 2. Chapter 3 goes on to give an overview on how to form a network-maintenance strategy. Useful appendices discuss important aspects of networks. It is recommended that people new to the field start by looking at Appendix B: Operation. The guidebook concludes with a glossary of LAN terms.

The Troubleshooting Guide serves both as a reference for networking professionals and an educational text for novices interested in learning more about network operation.

Catalog 97/'98

Elenco Electronics, Inc.

150 W. Carpenter Avenue

Wheeling, IL 60090

Tel: 847-541-3800

Fax: 847-520-0085

E-mail: elenco@elenco.com

Web: www.elenco.com

Free



CIRCLE 343 ON FREE INFORMATION CARD

The 25th anniversary issue of Elenco Electronics' 48-page color catalog is now available. It features trainers, hand tools, oscilloscopes, power supplies, counters, generators,

multimeters, and breadboard accessories. Educational kits of all types are also included, such as robot kits, an electronic keyboard kit, and a remote-control car kit. Two radio kits complete with training courses make excellent projects for the classroom. Elenco specializes in building kits for many of the largest schools in the country.

Among the new products highlighted in the catalog are the XK-700 deluxe digital/analog tester, a complete mini-lab for building, testing, and prototyping analog

and digital circuits; a digital temperature meter; and a function generator kit that includes a training course on working with surface-mount components (surface mount components are used in the generator itself). Photographs and specifications are provided for each product.

HiQ Brochure

National Instruments

6504 Bridge Point Parkway

Austin, TX 78730-5039

Tel: 512-794-0100

Web: <http://www.natinst.com/hiq>

Free

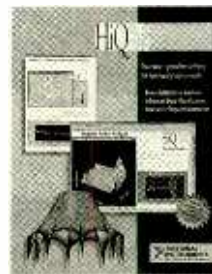

CIRCLE 344 ON FREE INFORMATION CARD

This eight-page brochure describes National Instruments' HiQ interactive problem-solving software for technical professionals. The brochure highlights some of HiQ's hundreds of built-in functions,

including data fitting, geometry, integral equations, numerical integration, and more. Advanced features include powerful built-in analysis, data visualization, and interactive report generation. Scientists and engineers can use HiQ to generate two- and three-dimensional graphs from both data and functions and immediately view the results. Users also can import data from other applications, for example, from Excel and LabVIEW. HiQ is available for Windows NT and 95 and Macintosh. A free evaluation copy can be downloaded from the National Instruments Web site, listed above.

Network Maintenance and Troubleshooting Guide: First Edition

by Neal Allen

Fluke Corporation

P.O. Box 9090

Everett, WA 98206

Tel: 800-44FLUKE or 206-356-6600

Fax: 800-FLUKE-FAX or 206-356-5116

E-mail: fluke-info@tc.fluke.com

Web: www.fluke.com/nettools

\$29.95



CIRCLE 342 ON FREE INFORMATION CARD

Fluke Corporation has published a 176-page reference guide for troubleshooting and maintaining local-area networks (LANs). Written for the network administrator, MIS director, and others responsible for maintaining networks, the guide covers how to operate a healthy network; and how to

The Futuretech Sourcebook

by Larry Ball

Futuretech

P.O. Box 6291

Gulf Breeze, FL 32561

Tel: 850-932-9682

\$11.95 plus \$3 S&H (Florida residents, add 7% sales tax)

Locating parts and equipment is a problem for electronics professionals and hobbyists. This directory of electronics and technical vendors makes that problem easier to handle. The 63-page booklet contains 394 categories, organized in both table and index formats.

Most of the product lines of the mail-order vendors, including transistors,



CIRCLE 345 ON FREE INFORMATION CARD

resistors, capacitors, and oscilloscopes, are listed. There is information on the types of products carried; minimum order requirements, if any; if there are toll-free numbers and Web sites; and if credit cards are accepted. The organization of the tables makes it easy to compare the product lines of various companies, and it can eliminate the need to order from multiple vendors to assemble all the parts needed for one project. In the alphabetical index, there are 147 vendors—most of which were previously cited, as well as over 30 additional specialized suppliers who are only listed there. This index includes address, phone, and web information; a short description of the product lines; and anything of note about the vendor.

This convenient booklet helps you locate various items from air muscles to custom-made crystals. You can even find Van De Graff generators, voice changers, and fog machines in these pages.

Practical Robotics

by Bill Davies
WERD Technology Inc.
Unit 35, Suite 155
10520 Yonge Street
Richmond Hill, Ontario
Canada L4C 3C7

\$69
It is difficult to find information about robotics. When you do find it, it is often bits and pieces in many different places. This book, the first in a projected series on robotics, takes care of that problem with a wealth of material on robotics, both theoretical and practical.

It starts with an introduction to the electronic equipment needed by



CIRCLE 346 ON FREE INFORMATION CARD

the robot builder, such as oscilloscopes, meters, and logic probes. That is followed by a chapter reviewing basic electronics. The rest of the book offers detailed descriptions of the components used in robotics—what they are and how to use them. Power sources, sensors, force transducers, motors, magnetic forces, resistors, and capacitors are thoroughly explained and illustrated.

This 337-page compendium is profusely illustrated with over 250 drawings and photographs. Useful appendices present a bibliography of robotics publications and a list of manufacturers and suppliers. Aimed at students primarily, it will also be a handy reference for hobbyists, teachers, and professionals—anyone interested in robotics. **EN**

NEW PRODUCTS

continued from page 31

for use with Fluke LAN testers.

Accessories in each of the kits include two 50-ohm BNC cables; two BNC-male-to-Grabber breakouts with Minigrabber and Mini-gator test clips; BNC termination plugs for 50-, 75-, and 100-ohm impedances; Type-N termination plugs for 50- and 75-ohm impedances; and eight BNC and Type-N adapters.

All connection interfaces feature gold-plated center contact pins and PTFE dielectrics for high connection integrity and reliability. Insulated in Teflon with a tarnish-resistant brass shell, Pomona 50-ohm coax connectors are typically rated at 500 volts rms.

The Model 6201 and Model 6202 test accessory kits are priced at \$200 each.

ITT POMONA ELECTRONICS

1500 East Ninth Street
Pomona, CA 91766-3835
Tel: 909-469-2900
Fax: 909-629-3317

Desktop FM Transceiver

R.L. Drake has returned to the amateur-radio market with the TR270

FM Transceiver. It is the only desktop FM transceiver dedicated specifically to two meter operation. Two radios in one, the TR270 permits both full two-meter capability (142-150 MHz) and independent dual-band reception (136-174 MHz and 420-470- MHz). This broad range lets listeners hear public service, marine, weather, and amateur bands.



CIRCLE 25 ON FREE INFORMATION CARD

Internal card slots are used for integrating 1200/9600 bps packet-radio, satellite, weather-fax, and data reception. The optional TNC270 Terminal Node Controller and DEMOD270 Demodulator plug-in cards fit neatly inside the TR270. Those cards eliminate the need to jury-rig multiple components together, as well as eliminate the tangled web of cabling that often accompanies multiple pieces of equipment.

Its five modes of operation provide the amateur-radio user with a wider

variety of options than previously found in one transceiver. This transceiver caters to the preferences of the operator and can be customized to meet the individual user's needs. Selecting filters, setting memory scan, or customizing channel lists for both receiver and transmitter can easily be done with setup menus and front-panel inputs. The TR270 boasts 400 total channel memories, and it can remember favorite frequencies in voice, satellite, or data modes.

The unit comes with a built-in 140-watt, 115/230 VAC switching power supply, and has three jacks: external audio-in, external speaker, and telephone. Other features of this unit include an external DC input for mobile or emergency-power operation and a transmit time-out timer. DTMF and CTCSS tone-encoding and decoding ability for both two-meter and wideband receivers is also provided. Among the accessories included with this Drake transceiver is a high-quality dynamic microphone.

The TR270 FM transceiver retails for \$999.

R. L. Drake Company

230 Industrial Drive
Franklin, OH 45005-4496
Tel: 513-746-4556
Fax: 513-746-4510
Web: <http://www.rldrake.com>

Printer and Copier Basics

THIS MONTH, WE ARE GOING TO DO SOMETHING THAT'S A LITTLE DIFFERENT: RATHER THAN DEALING WITH SPECIFIC SERVICING PROBLEMS AND SOLUTIONS, WE ARE GOING TO PRESENT A BRIEF OVERVIEW OF COMPUTER PRINTERS AND HOW THEY

work. Note that some of the following information was sent to my Web site by others; in those cases, I have given credit to the original contributor.

Let's start off by taking a look at dot-matrix printers. In that printer, a set of steel pins—as few as 9 and as many as 24—strike the paper through a fabric or carbon-film ribbon. The pins are activated by solenoids that are controlled by the printer's control logic. Multiple passes are sometimes used to increase the effective number of pins and improve print quality (letter versus draft mode).

For text, an internal character generator (ROM) converts ASCII codes to pin-firing patterns. For arbitrary graphics, the actual bitmap is read out and used to control the pin drive. The paper, carriage, and sometimes ribbon movement are all controlled by stepper motors. Those motors, their drivers, or the interconnect cables, are the most common problem areas. Note that dot-matrix printers are about the only type of impact printers still in wide use, and fewer and fewer are being sold each year.

Ink-Jet Printer Basics

Much of what follows on ink-jet printers comes from Tony Hardman (tony@f54x19.demon.co.uk): There is a US publication called *The Hard Copy OBSERVER* from Lyra Research Inc., Tel: 617-322-0708. It discusses the latest technologies and who does what. It may not cover the print-head technology in

very great detail, but it is still a good read if you are into print technology in general. There are many companies that sell variable print processes. One I have heard of is RALFLATAC. They publish a brochure that presents an excellent brief of most technologies available for print-



DOT-MATRIX PRINTERS are the only type of impact printers widely sold today.

ing. They have locations in the UK (and around Europe) and the US. By telephone, you can reach them in the UK at 01732-583661, and in the US at 704-684-3931. I have no idea if you can get copies of either publication from them, so here is a very brief description:

There are two main types of ink-jet printing—continuous ink jet (CIJ) and drop-on-demand (DOD) impulse printing. Each of those can use either a single jet or an array of jets. CIJ is a continuous jet of ink cycling round a system and occasionally (when required) a drop is

deflected out of the stream onto the paper. The stream is modulated to break it into a consistent drop size. The deflection works like the beam on an oscilloscope. If you charge one drop and pass it between two high-voltage plates, it is deflected. This system also requires cunning mechanics, but the support electronics is much more complex, and probably one of the reasons for its performance limitations; the calculations of the aerodynamics of drops being deflected is no small task, even if look-up tables are used. For the most part, CIJ, as a single jet, is used in high-speed industrial applications, such as product marking (sell-by dates, serial numbers, etc.).

In contrast, DOD most often uses an array of small jets and is the system used in most desk-top printers. In principle, DOD works like a dot-matrix pin printer, but instead of firing a pin at a ribbon, a drop of ink is fired at the paper. The drop is fired by either a piezoelectric crystal squeezing the ink out of a small tube, or by boiling the ink and having the vapor force the ink out of the chamber. The key to both of those processes is in the mechanical design of very small components. The control electronics is a bit cunning, too, but I figure that is the easy bit.

How Many Colors?

I use a Hewlett-Packard DeskJet 680C in the office. It has two cartridges: one for black and one for color. If the printer fires one drop of each ink at a given point, we can have only six different colors (ignoring white and black). If it can fire two or more drops at a given point, maybe we can have more colors, but I suspect that the printer uses this to control the quality of the presentation, not the number of colors (does anybody know for sure?). With dithering it can make more colors, with reduced resolution.

As in most print processes, you only have a limited selection of inks to use. Full color can be derived from three colors, just like a monitor. For monitors, those colors are red, green, and blue because monitors emit light, resulting in an additive color process. Inks, on the other hand, absorb light, so printing is a subtractive process. The resulting inks should then be cyan (blue plus green or blue minus red), magenta (red plus blue or red minus green), and yellow (red plus green or red minus blue). Therefore, the colors used in common ink-jet printers are not really capable of producing true full-spectrum, photo-realistic quality since they are red (not magenta), blue (not cyan), and yellow. Those inks are optimized for nice saturated primary colors when used independently. One of the newest color inkjet printers is the Epson Stylus Photo. It uses a five-color ink cartridge, in addition to black, to create high-quality realistic color images.

From Tony Hardman comes the following: If you can vary the drop size, you can change the drop spread on the paper. That can be done by firing bigger slugs of ink, or multiples of the drop at the same position. As you can understand, the ink will either spread and make a bigger drop, or stay the same size and become denser. Depending on the resolution you want, either technique could improve color density, depending on two key components: the ink, and the paper.

The problems with laying down multiple drops on paper is that if you do a large block, the paper will curl and the overall image becomes worse. That is why you can pay as much as \$1 for a sheet of really high-quality, really white paper.

Another problem with this is speed. Firing two drops in the exact same place is difficult unless the head is stationary, but that is not good either. You may notice that most DOD printers operating in their high-resolution mode do a number of passes over the same place. That allows dithering and other techniques that improve resolution/color enhancement. These printers usually only print while going in one direction for improved mechanical control.

Inks are a problem too. They can dry at different rates because of the different dyes used, or they may not mix the way you expect if you place two colors on top of each other. It's only ink, but to get the best balance of surface tension, drying time, viscosity, color, stability and more is not as straightforward as it might



THE HEWLETT-PACKARD DESKJET 680C has two ink cartridges: One for black ink and one for the three color inks.



THIS COLOR INKJET PRINTER from Epson uses a five-color ink cartridge (plus black) to provide more realistic colors.

seem. I have noticed that the water-based inks are improving, and there are some that do not run if they get wet (after drying on the paper).

Laser Printers

Some of the information in this section was sent to me by Copenhagen Cowboy (cowboy@fastlane.net): Copiers and laser printers have a lot in common. The major difference between them is in how the image is formed on a photosensitive drum. A copier uses a bright light and lens to focus an image of the original (actually, a strip at a time is scanned in most modern low- to medium-performance copiers) onto the drum. Adjusting the lens-to-original and the lens-to-drum distance is used to vary the reduction or magnification.

A laser printer uses a low-power, sharply focused laser beam to scan one line at a time on the drum. Modern laser printers use infrared, solid-state laser diodes similar to those used in CD players and optical disk drives. The digital image is generated from a bit map stored in the printer's memory and modulates the laser beam. Scanning is mechanical—a high-speed motor spins a multifaceted deflection mirror to get the X-axis, and the paper moves to get the Y axis. LED "page printers" use a large array of LEDs as the image source, but are otherwise similar to laser printers. Plain-paper fax

machines also use similar techniques in their printing mechanism.

The only other significant difference between copiers and laser printers is that copiers use a positive process (dark areas in the original result in marks on the paper) and laser printers commonly use a negative process (a spot of light results in a dark mark on the paper).

The photosensitive drum is the heart of the laser printer or copier. In larger machines, it may be a separately replaceable unit. In many laser printers and smaller copiers, it is part of the toner cartridge and is a throw-away (or could be recycled). The drum is coated with a photosensitive material that has an extremely high resistance when in darkness. Its resistance drops to a low value when illuminated.

All of the following takes place as a continuous process as the drum rotates. Note that the actual photosensitive drum in most copiers and laser printers has a circumference that is much smaller than the length of the printed page. Therefore, only a portion fits at any given time; and the charging, exposure, transfer to the paper, cleaning, and erasing is a continuous process.

The drum's surface is charged to a high positive voltage (typically 5 to 6 kilovolts DC) by a set of charging corona wires in close proximity to the drum. The exposure process differs for copiers and laser printers.

For copiers, a swath of the original is focused onto the drum. As the drum turns, a quartz lamp and strip mirror moves along the original, with a second strip mirror moving at half the speed of the first. The result is that the entire original image is kind of "peeled" onto the rotating drum. (Look through the glass platform that supports the original as the machine is copying, and you will see what I mean.) For laser printers, the negative image of the page stored in the printer's buffer memory (the laser is turned on where the print is to be black) is read out and scanned onto the drum one line (e.g., $1/300$ th or $1/600$ th of an inch) at a time. Where the light hits the drum's surface, its resistance drops dramatically and the charge in those areas is dissipated.

Regardless of the machine type, at that point, a swath of the image of your ultimate copied or printed page resides as areas of electrostatic charge on the drum. That is a "latent" image and must be "developed."

As the drum continues to turn, the

latent image rotates past the developer unit, which contains a mixture of developer and toner. For the most part, developer is not really used up during the printing process, but some is lost and may need to be replenished from time to time (depends on the machine's design).

Developer is a material that includes powdered iron or another powder that is attracted by a magnet. Toner is the actual ink and consists of very finely powdered, thermoplastic particles. Those are "fixed" in the fuser by literally melting the image onto the paper. Depending on design, the developer material may be separate or actually combined with the toner. A magnet in the developer unit, which is as long as the page is wide, causes the developer along with trapped toner to stand out, following the lines of force off of its long N-S pole pieces. That forms a kind of brush of toner and developer material that is in contact with the drum as it rotates with its latent image. Normally, the developer-material brush is C-shaped, and toner particles are carried in the C-shape (the back of the "C" is against the drum).

Here is where the developing processes of copiers and laser printers differ. For copiers, the relative charges of the drum and toner are set up so that toner is drawn to the unexposed (dark parts of the original) portions of the drum resulting in a positive image on the paper. For laser printers, the relative charges of the drum and toner are set up so that toner is drawn to the exposed (where the laser beam was turned on) portions of the drum resulting in a negative image on the paper.

The drum continues to rotate around and comes in contact with the paper. Below the paper is another corona, the "transfer corona." Another high voltage is applied to the back of the paper (around 7 or 8 kilovolts DC) to draw the toner from the drum to the paper. Remember, all that is going on in a continual cycle and it is all in motion.

Depending on the manufacturer of the machine, there may or may not be a third corona, the "separation corona". That is needed to separate the paper from the drum, but not disturb the toner on the paper. The separation corona is usually at around 4 or 5 kilovolts AC (if it was DC, you would separate the paper from the drum, but will have very smeared toner all over the page, making it unreadable). The separation corona usually has guides over it to keep the paper from dipping down too far into the corona shell.

Paper is then transported to the fuser, which fixes the toner to the paper via heat (to soften the toner particles) and pressure (to embed them in the paper fiber). There are parts in the fuser that also keep the paper from sticking to the hot rollers. A thermostatically-controlled quartz-tube lamp provides the heat inside the anti-stick (Teflon-coated) fuser roller.

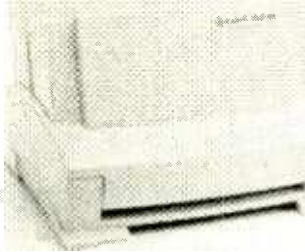

LASER PRINTERS, like this one from Hewlett-Packard, work very much like laser copiers, though there are some significant differences.

Finally, your copy or printed page is ready. However, we are not completely done as there is still some toner on the drum—it is not possible to get it all off electrically—so there is usually a rubber or plastic blade that rubs in direct contact with the drum. That drum blade scrapes the toner off the drum, and the recovery blade catches it to keep it from falling back into the machine. A used-toner auger transports the used toner, which is now changed both physically and electrically, and is also contaminated with paper dust. Don't reuse your used toner, because it will eventually damage the developer unit, cleaning blades, fuser sections, and other parts of the mechanism.

Now that all the toner has been scraped off the drum, there is still some residual charge on the drum from the previous exposure process. You obviously can't scrape the static charge off the drum, so the cleaned drum is now fully exposed to a bright light to discharge the drum surface and prepare it for the next charge.

That is the basic process. Many variations are possible and, depending upon the machine and manufacturer, some of this may be a little different in your printer or copier. Where a toner cartridge is used, many of the components mentioned—typically the drum, the toner and developer (usually combined into a single powder), developer magnet, cleaning blades, and some of the corona wires—

are part of that cartridge and are replaced each time the cartridge is changed.

Wrap Up

Well, I told you that it was going to be different this time. While we did not get to any hard-core servicing information, I felt that, since so little information on printers is readily available, the information I did have was worth presenting.

Anyway, that's all for this month. Between now and my next column, why not visit my sci.electronics.repair FAQ site on the internet at www.repairfaq.org. If you wish, you can reach me directly via e-mail at sam@stdavids.picker.com. See you next time.

EN

Timid about getting on the... World Wide Web?

You've heard about the *Information Superhighway* and all the hype that goes with it! Sort of makes you feel timid about getting on the Web. Put your fears aside! A new book, *The Internet and World Wide Web Explained*, eliminates all the mystery and presents clear, concise information to build your confidence. The jargon used is explained in simple English. Once the tech-talk is understood, and with an hour or two of Web time under your belt, your friends will believe you are an Internet guru!

To order Book #403 send \$6.95 plus \$3.00 for shipping in the U.S. and Canada only to Electronics Technology Today Inc., P.O. Box 240, Massapequa Park, NY 11762-0240. Payment in U.S. funds by U.S. bank check or International Money Order. Please allow 6-8 weeks for delivery.

BUY BONDS

WINDOWS 95 —One Step at a Time

Don't know what to do when confronted with Microsoft's Windows 95 screen? Then you need a copy of *Windows 95—One Step at a Time*. Develop your expertise with the straight-forward presentation of the frequently-used features that make Windows 95 so valuable to the PC user.

To order Book BP399 send \$6.95 plus \$3.00 for shipping in the U.S. and Canada only to Electronics Technology Today Inc., P.O. Box 240, Massapequa Park, NY 11762-0240. Payment in U.S. funds by U.S. bank check or International Money Order. Please allow 6-8 weeks for delivery.



Building a Capacitance-Substitution Box

IF YOU WERE INTERESTED IN THE RESISTANCE SUBSTITUTION BOX WE DESCRIBED IN THE DECEMBER 1997 ISSUE, IT IS LIKELY THAT YOU HAVE BY NOW BUILT IT AND PUT IT TO WORK. THIS MONTH, WE WILL SHOW YOU ANOTHER USEFUL ACCESSORY

for audio testing. It is a capacitance-substitution box, or C box; it is very similar to the R-box, and it too will help make your audio-testing chores easier.

A Capacitor-Substitution Box

Our C Box provides capacitance outputs from 10 pF to 11.1110 μ F just by pushing the appropriate combination of buttons on the front panel. If you decide to build the box, be sure to use only precision components. Particularly, close capacitor tolerances are a must. Ideally, you need 1% components to make a very accurate box. Unfortunately, such tolerances are nearly impossible to find, and what is available is very expensive. To get around this problem, I purchased a large number of readily available 20% tolerance ceramic-disc capacitors. Then I measured them carefully with a capacitance bridge, and I selected sets of capacitors that came closest to the needed values. I also made sure that they all fell to the same side of the optimum value. I know that this is a time-consuming process, but it is the only practical way to get the precise values of capacitance you need if you decide to build the box without the benefit of the available kit (see the Parts List). The parts in my kit are selected in the fashion described, and all of the capacitors swing in the same direction so their actual values track.

A photograph of the finished unit is shown in Fig. 1. Just like the R-box, you select the value you want to use by simply

punching in the capacitance value you need using the pushbutton pad. The selected value then appears across the terminals labeled CX at the top of the unit.

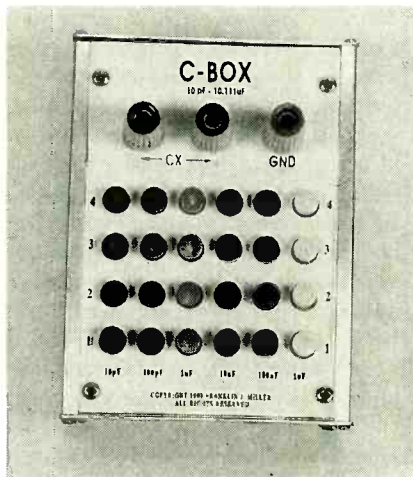

FIG. 1—HERE'S HOW THE C-BOX will look when finished. As you can see, the look is very similar to December's R-Box.

Note that the unit is labeled in nanofarads (nF) rather than the more familiar microfarads (μ F). (Actually, outside of this country, capacitors are often marked in nanofarads rather than microfarads). To make the conversion, just move the decimal point three places to the left. For example, 562 nF is 0.562 μ F.

Now, let's see how we would get the C Box to output that 562 nF. If you built or remember our R Box you have a head start, as the process is pretty much iden-

tical. First, you would push the 4 key and the 1 key in the row above 100 nF—that gives you 500 nF at the terminals. Then you would depress the 4 key in the 10-nF row and the 2 key in the same row. That adds 60 nF to the 500 nF. The switches stay down, and the selected value is available across the CX terminals. For the final 2 nF, push the 2 button in the 1-nF row. It is just that easy.

Putting It Together

The complete schematic for the substitution box is shown in Fig. 2. For easiest construction, a PC board is recommended and is provided elsewhere in this column. The parts-placement diagram for that board is shown in Fig. 3. As indicated there by the dotted lines, the capacitors are all mounted on the foil side of the board; that's done to make the entire assembly as compact as possible. The switches mount on the component side of the board in the usual manner.

Note that both the PC pattern and the schematic show DPDT switches, although only one section of each is used. Those switches are used because they are easier to find than latching SPDT pushbuttons; they are probably less expensive, too.

Construction is straightforward. All 24 switches mount right on the PC board. Make sure that you insert them so that they fit flat and tight against the board. This is important! If you do not get it right, the knobs will not fit properly through the top plate. Note: If you elect not to use the available kit, make sure you select an enclosure that is deep enough to accommodate the switches that you do use. The critical dimension here is the depth of the box; it should be deep enough so that when you mount the PC board inside, the switch buttons pro-

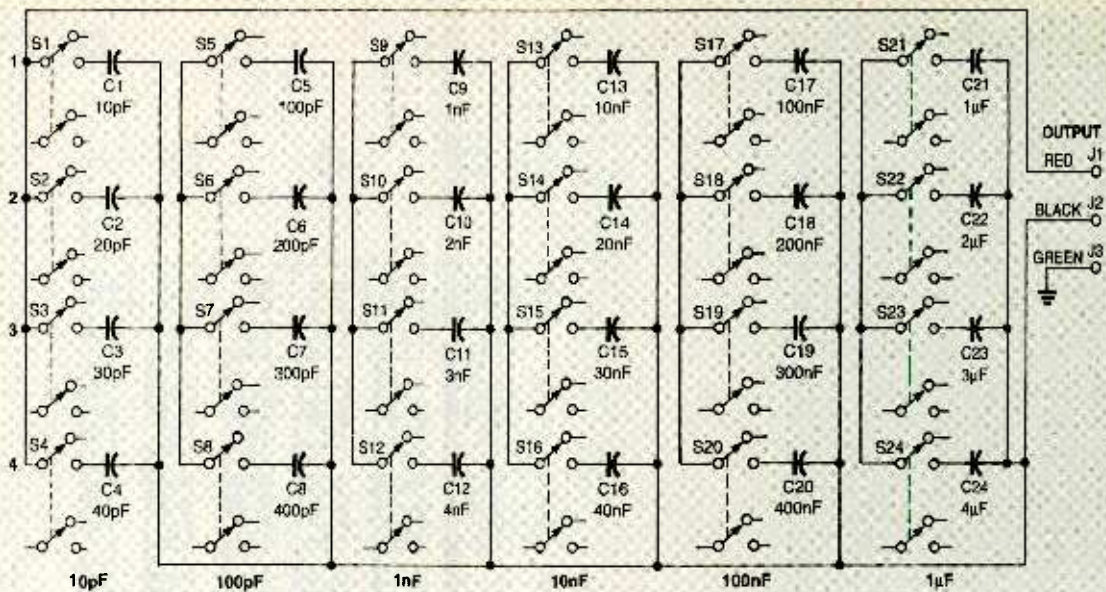

FIG. 2—AS YOU CAN SEE IN THIS SCHEMATIC, the C-Box circuit is simply a combination of capacitors and switches.

trude far enough through the top plate for you to attach the switch knobs. Once the switches are in place, mount the capacitors on the foil side of the board. Do not install J1-J3 at this time.

Once you have mounted all of the components (except J1-J3), carefully inspect the PC-board assembly for the usual construction errors. When you are satisfied all is well, put it aside for the time being.

The next step is to apply the front-panel overlay. If you choose to buy the kit, an overlay and pre-punched enclosure are provided. If you elect not to use the kit, you should create your own overlay. The appropriate markings can be seen in the photograph back in Fig. 1. If you want a drilling guide for the front panel, use the one for the R-Box, which was shown in Fig. 4 in the December 1997 issue. It is identical to the one for this unit. In fact, when we get around to building an inductance box (L Box) in a future issue, it too uses the same drilling pattern.

The overlay supplied with the kit has an adhesive backing. To ensure that it will adhere properly, you must make sure that the front panel is very clean. A small amount of acetone, which can be purchased at any paint store, will do the job nicely. It will remove any grease or dirt that might interfere with attaching the overlay. Since its vapors can be hazardous, make sure you are in a well-ventilated area when you work with acetone.

Now you need a small bottle of water with a spray attachment. It will allow you to move the overlay around for precise

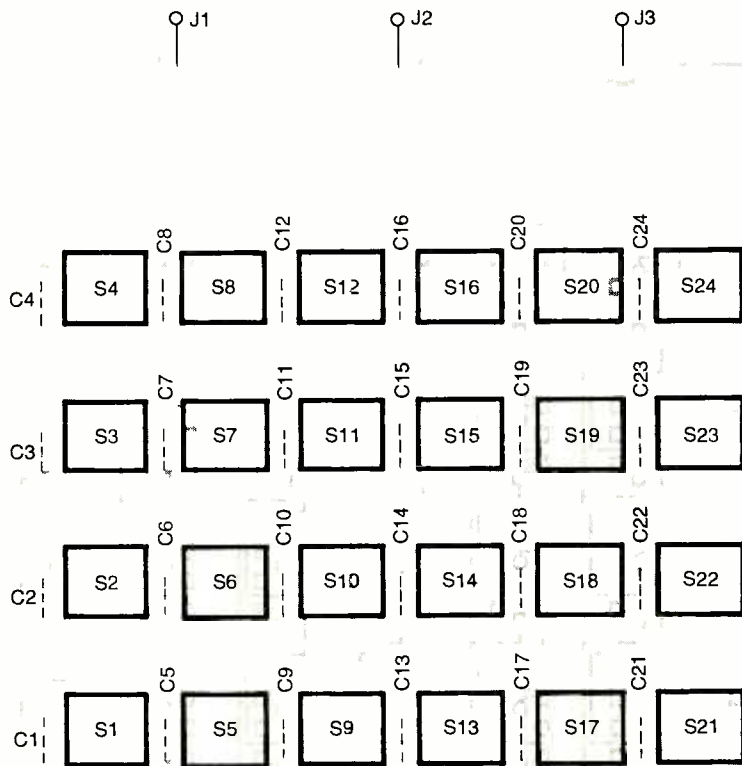

FIG. 3—WHEN BUILDING THE BOARD, remember that the switches go on the component side of the board, and the capacitors go on the foil side.

PARTS LIST

CAPACITORS

(All capacitors are 20%, 50-volt, ceramic disc, selected as described in the text to get the 1% values needed.)

- C1—10-pF
- C2—20-pF
- C3—30-pF
- C4—40-pF
- C5—100-pF
- C6—200-pF
- C7—300-pF
- C8—400-pF
- C9—1-nF (0.001- μ F)
- C10—2-nF (0.002- μ F)
- C11—3-nF (0.003- μ F)
- C12—4-nF (0.004- μ F)
- C13—10-nF (0.01- μ F)
- C14—20-nF (0.02- μ F)
- C15—30-nF (0.03- μ F)
- C16—40-nF (0.04- μ F)
- C17—100-nF (0.1- μ F)
- C18—200-nF (0.2- μ F)
- C19—300-nF (0.3- μ F)
- C20—400-nF (0.4- μ F)
- C21—1- μ F
- C22—2- μ F
- C23—3- μ F
- C24—4- μ F

ADDITIONAL PARTS AND MATERIALS

S1—S24—Pushbutton switch, DPDT, see text

- J1—Banana jack, red
- J2—Banana jack, black
- J3—Banana jack, green

Switch knobs (four each black, red, yellow, green, blue, and white), enclosure (see text); PC board, top-panel overlay, hardware, wire, solder, etc.

Note: The following items are available from Franklin J. Miller, 2100 Ward Drive, Henderson, NV 89015. A complete kit, including pre-drilled aluminum case, front-panel label, pushbutton knobs, PC board and all other components, for \$95.00 postpaid.

placement. Place both the front panel and the overlay in front of you, with the three holes at the top. Remove the overlay backing and align the upper-left corner of both pieces. Once the label is aligned, gradually smooth the balance of the overlay down using the side of your hand. After this is done, use an orange stick (available in the beauty section of any supermarket) as a rolling device to get out all the bubbles. Let the front panel dry overnight to be sure all of the water has evaporated. Do not use heat! It will ruin the overlay material.

The next step is to put the knobs (supplied with the kit) on the switches.

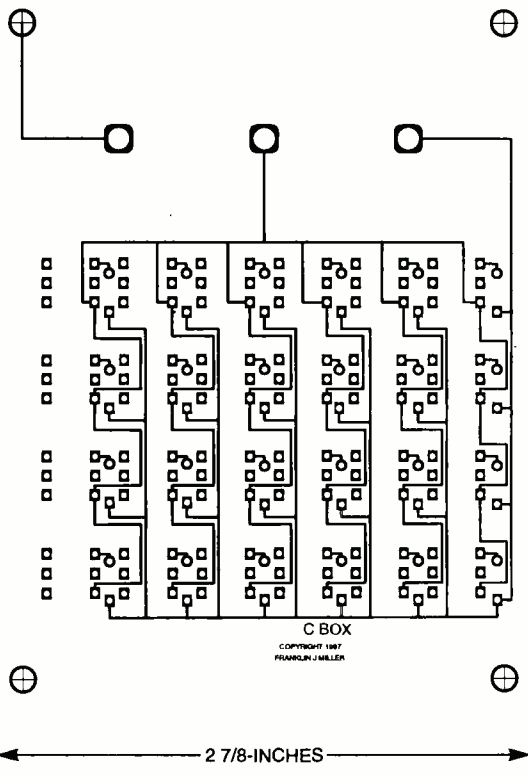

USE THIS FOIL PATTERN when building the C-Box.

Position the PC board in front of you, with the three pads for J1, J2 and J3 toward the top. There are four rows and six columns. Use black buttons for the first column, on the far left. As you go to your right, use the red, yellow, green, and blue buttons in order for each row. Use the white buttons for the row on the extreme right, and you are done. Note that the buttons will just snap on. As you install each one, be sure that you hear a snap, indicating that each button knob is properly seated.

Now install the banana jacks through the front panel. Go from left to right and insert red, black, and green, in order, tightening the nuts that hold them in place as you go. There are four 2.5-mm \times 10-mm long screws, four 1/8-inch long spacers, four nuts, three lock washers, and one ground-lug washer that are inserted in each one of the four corners of the front panel. Insert the four screws and turn the assembly over (put a small piece of cardboard over the top to hold the screws in place while you do this). Slip the spacers over the screws. Now the PC board should fit onto the spacers, followed by the lock washers in three corners and the ground-lug washer in one. Finally, place the nuts on the screws and tighten them only finger tight. Turn the unit over to be sure that all of the push

buttons work without any problems. Once that is confirmed, tighten the four screws and nuts to the final fit. Now you can solder the banana jacks to the PC board. The last step is to assemble the rest of the case.

You have just built a very important test fixture. The C-box is extremely useful when you need to find out about passive and active filters. Also, capacitors determine the low- and high-frequency response of amplifiers. Next time, we will put our new C-box to work. **EN**

THE COLLECTED WORKS OF MOHAMMED ULLYSES FIPS

#166—By Hugo Gernsback.

Here is a collection of 21 April Fools Articles, reprinted from the pages of the magazines they appeared in, as a 74-page, 8 1/2 \times 11-inch book. The stories were written between 1933 and 1964. Some of the devices actually exist today. Others are just around the corner. All are fun and almost possible. Stories include the Cordless Radio Iron, The Visi-Talkie, Electronic Razor, 30-Day LP Record, Teleyglasses and even Electronic Brain Servicing. Get your copy today. Ask for book #166 and include \$16.00 (includes shipping and handling) in the US and Canada, and order from **CLAGGK Inc., P.O. Box 4099, Farmingdale, NY 11735-0793**. Payment in US funds by US bank check or International Money Order. Allow 6-8 weeks for delivery.



MA05

Electronic SHOPPER



The things you'll need for building, trouble-shooting & repairing your electronics projects

Tool Kits, Cases & Specialty Tools . . . Test Equipment . . . Wire/Cable/ Connectors . . . Crimpers . . . Reference Materials . . . Workbenches & Static Control . . . Solder/Desolder Stations . . . and everything else you need to do your job.

PLUS: 100% Satisfaction Guaranteed; Lifetime Guarantee on all Jensen brand hand tools; FREE technical support; and more!

FREE CATALOG
800-426-1194
Dept. 156

JENSEN TOOLS
7815 S. 46th Street, Phoenix, AZ 85044
Tel: 800-426-1194 or 602-968-6231
Fax: 800-366-9662 or 602-438-1690
E-Mail: jensen@stanleyworks.com
Visit us on the WWW - <http://www.jensentools.com>

CIRCLE 334 ON FREE INFORMATION CARD

MICRO SIZE CCD VIDEO CAMERAS

MB-750U
Video Camera
\$99.95

MB-705UX
C-Mount Camera
with Lens Included;
8 or 12mm Lens
your choice!

LP-850i Lipstick
Camera

LP-850i Excellent
monitoring Camera,
and ideal for CU-SeeMe.
\$249.95

**Cost Effective Color
Board Cameras**
MB-1282 \$199.95
with Built-In Audio out

Polaris Industries
<http://www.polarisusa.com>
800.752.3571

Free Catalog

470 Armour Drive NE • Atlanta GA 30324 • Tech Info: 404-872-0722 • FAX 404-872-1038

Pinhole Versions Available

See More Products @

February 1998, Electronics Now

BLOWOUT!

TIMELINE INC.

BLOWOUT!

Over 11 years and 29,000 customers and still growing

LIQUID CRYSTAL DISPLAYS

240x64 dot LCD with built-in controller.
AND 4021ST-EO. Unit is EL back-lit. \$59.00 or 2 for \$109.00 or
OPTREX. DMF5005 (non back-lit) \$49.00 or 2 for \$89.00
20 character x 8 line 7/4L x 2 1/4H The built-in controller allows you to do text and graphics.

Alphanumeric—parallel interface

16x1.....\$7.00	20x2.....\$10.00	32x2.....\$8.00
16x1 (lg. char.).....\$10.00	20x4.....\$15.00	40x1.....\$8.00
16x2.....\$7.00	20x4 (lg. char.).....\$10.00	40x2.....2 for \$20.00
16x2 (lg. char.).....\$10.00	24x2.....\$10.00	40x4.....\$20.00
16x4.....\$15.00	32x4.....\$10.00	4x2.....\$5.00

5V power required • Built-in C-MOS LCD driver & controller • Easy "microprocessor" interface • 98 ASCII character generator • Certain models are backlit, call for more info.

Graphics and alphanumeric—serial interface

size	Mfr.	price	size	Mfr.	price
640x480 (backlit)	Epson	\$25.00	480x128	Hitachi	\$10.00
640x400 (backlit)	Panasonic	\$20.00	256x128	Epson	\$20.00
640x200	Toshiba	\$15.00	240x128 (backlit)	Optrex	\$20.00
480x128 (backlit)	ALPS	\$10.00	240x64	Epson	\$15.00
			160x128	Optrex	\$15.00

6" VGA LCD 640x480, Sanyo LMDK55-22 \$25.00

LASER PRODUCTS

HeNe Laser Head (10mw max. output) TEM00, 15.5" long MFG. NEC \$89.00
Laser Power Supply (for HeNe tube) \$79.00

LASER SCANNER ASSEMBLY \$19.00

Assembly intended for a laser printer. Includes: laser diode, polygon motor (6 sided) and misc. optics and lenses.

LASER DIODE (5mW) with collimator \$20.00

VISIBLE LASER DIODE: 5mw at 670nm \$15.00

Index guided. Threshold current 40 ma typical.

3 and 4mW, 1,300nm LASER DIODES, 5.6mm package, \$15.00

Mitsubishi Electric part number ML701BIR-E21A, General specs are:

1. Vop=1.25, Beam Divergence 25.6° x 28.6°; 2. Tc=24°C, Iop=19 to 20mA,
ITH=10.7mA; 3. Wavelength range between 1,280nm and 1,330 nm

POLYGON MOTOR UNIT & DRIVER \$69.00

Ten-sided first surface mirror mounted on an armature that spins at 125 revolutions per second yielding a beam sweep rate of 1250 sweeps per second. The driver for the polygon unit requires 24 volts and plus and minus 12 volts to operate. There is also an (f) lens in front of the polygon scanning mechanism with a three inch diameter. Great for optical experiments, etc. Very high quality units. (MFR: JAPAN ELECTRONICS)

POS & BAR CODE

MAGNETIC CARD READER \$25.00

Includes: • 20 character dot matrix display with full alpha-numeric capability • keypad with full alpha-numeric entry • separate 7.5 VDC/0.5 Amp power supply • standard telephone interface extension cord • lithium battery and flat-cone speaker.

HP bar code wand (HBCS 2300).....\$25.00

POWER SUPPLIES

SWITCHING POWER SUPPLIES \$12.00 or 2 for \$20.00 115/230 Volts

73 WATT [2] 4 pin power connectors attached • Dim: 8.5" L x 4.5" W x 2" H

Output: +5V @ 2-9.75, A, +12V @ 0-1.5 A, -5V @ 0-0.4 A, -12V @ 0-0.5 A

60 WATT Dim: 8 1/4 x 4 1/4 x 3 • Output: 5V @ 6A + 12V @ 1A - 5V @ 1A - 12V @ 1A

CHARGE COUPLED DEVICES



"The Spy In The Sky" \$29.00 MATRIX TYPE

Thomson 576X550 pixel CCD

400-1,100nm resolution and responsivity. \$500.00 Original cost device

Sony CCD Imager - designed for black and white composite video

cameras. Picture elements: 384 (H) x 491 (V) \$29.00

Chip size 10.7 (H) x 9.3 (V) mm² • Unit cell size 23.0 (H) x 13.4 (V) um².
Ceramic 24 pin DIP package • Mfr: Sony, Part# 016AL

4096 element CCD \$15.00

LINEAR TYPE

1024 element CCD \$10.00

2048 element CCD \$10.00 • 1728 element CCD \$10.00

MISCELLANEOUS

ADAPTEC 4070A (RLI) OR 4000A (MFM), SCSI Controller, your choice \$25.00

IBM 370 option XT and AT emulation boards \$25.00

2539 W. 237th Street, Bldg. F, Torrance, CA 90505

Order desk only: **USA: (800) 872-8878 CA: (800) 223-9977**

L.A. & Technical Info: (310) 784-5488 Fax: (310) 784-7590

OEM INQUIRIES WELCOME

MONITORS

Non-Enclosed TTL

Comes with pinout. 12V at 1.4 Amp input • Horizontal frequency 15KHz. • Ability to do 40 and 80 column.

5 inch Amber \$25.00 • 7 inch Amber \$25.00
9 inch Amber or Green \$25.00

5" COLOR MONITOR \$39.00

• Flat Faceplate • 320 x 200 Dot Resolution • CGA & Hercules Compatible
• 12 VDC Operation • 15.75 KHz Horiz. Freq. • 60 Hz Vert. Sync. Freq.

• Open Frame Construction • Standard Interface Connector • Degaussing Coil included • Mfr. Samtron

2 for \$69

9" COLOR SVGA MONITOR \$249.00

Fully Enclosed - Tilt and swivel type.

HACKER CORNER

Encased Spread Spectrum RF Modem \$199.00

The ProxLink Radio Module is a small communication device which replaces cables between RS-232 devices with wireless RF (Radio Frequency) technology. Attaching a pair of ProxLinks to any two devices with three wire asynchronous RS-232 ports allows wireless data transmission at rates up to 19.2 Kbaud (full duplex) over a range of 500 - 800 feet. Modules use 900 MZ spread spectrum radio for communication which does not require an FCC site license. A variety of configuration information (radio channel, baud rate, serial port configuration, etc.) can be programmed into module's non-volatile memory by host PC to provide compatibility and avoid overlapping systems. Configuration changes are supported by menu driven, on-board software. Commonly used Terminal Emulation software and transfer protocols can be used for configuring modules and transferring data between computers. ProxLinks require only 6-9 VDC (350 mA), RS-232 (9 pin sub - D) interface, and small (~ 4") whip antenna for operation. Unit size is 4.0" x 6.5" x 0.75". Installation schematics and application details available.

US made Micronics 486 VLB ALL in ONE \$39.00 or 2 for \$69.00

motherboard, supports 3.4 or 5V CPU, at either 25 or 33 mhz basic clock. Can use AMD or Intel from 486SX25 thru 486DX4-100 to HOT new AMD 5X86-133 cpu. On board SVGA video. On board 1 meg video ram expandable to 2 meg with ATI Mach 2 chip set. On board 2 high speed serial ports, 1 printer port, floppy and IDE hard drive controller. On board 256K cache. Uses 72 pin simm memory. Landmark speed rating of 479 with AMD chip.

Board will not fit standard All in One case because of non standard location of riser board. VLB riser board is included with motherboard.

COLOR CCD CAMERA \$149.00

• 12 VDC • 1/3-inch. CCD area image sensor • 514 (horizontal) x 491 (vertical) • 2:1 interlaced • 15.734 kHz (horizontal). 59.94 Hz (vertical) • 330 horizontal and 350 vertical lines • 101x • IV. NTSC signal format
• Lens: 1/3-inch. fixed focus (F:2.8 f.5.6) • Dimensions: (W) 67 (2.63) x (H) 34 (1.45) x (D) 112.6 (4.43)

SONY Miniature Color LCD Display (LCX005BKB) \$29.00

• 1.4 CM (0.55 inch) Diagonal Full Color Display • Built In Horizontal and Vertical Drivers • Delta Dot Pattern for High Picture Quality - 537 dots (H) x 222 dots (V) • Compatible with NTSC & PAL Format and Sync Inputs • 12 VDC Operation with -I to +17 V RGB Signal and Driver Input Voltage • Excellent Display for Virtual Reality Projects, Viewfinders, and Miniature Test Equipment Displays • Pin Outs and Specification Included • Unit Requires Clock, Synchronization and Video

CELLSITE TRANSCIEVER \$49.00 2 for \$89.00

These transceivers were designed for operation in an AMPS (Advanced Mobile Phone Service) cell site. The 20 MHz bandwidth of the transceiver allows it to operate on all 666 channels allocated. The transmit channels are 870.030-889.980 MHz with the receive channels 45 MHz below those frequencies. A digital synthesizer is utilized to generate the selected frequency. Each unit contains two independent receivers to demodulate voice and data with a Receive Signal Strength Indicator (RSSI) circuit to select the one with the best signal strength. The transmitter provides a 15 watt modulated signal to drive an external power amplifier. Channel selection is accomplished with a 10 bit binary input via a connector on the back panel. Other interface requirements for operation are 26 VDC (unregulated) and an 18.990 MHz reference frequency for the digital synthesizer. The units contain independent boards for receivers, exciter, synthesizer, tunable front end, and interface assembly (which includes power supplies and voltage-controlled oscillator). Service manual, schematics and circuit descriptions included.

Encased Black & White Composite CCD Camera with Adapter

IR viewing to 1000 nm 7 1/4 L x 2 1/2 W x 1 1/4 H

Comes complete with CCD camera, mounting nut on bottom of casing.

12VDC power supply. Excellent low light capability. standard RCA NTSC video out. **\$89.00**

Great for: entryway security/remote monitoring, video conferencing/desktop video conferencing **2 for \$159.00**

This miniature camera is perfect for multimedia computer applications as well as security and surveillance. NTSC output allows use with all popular video digitizing boards for Apple Macintosh and Microsoft video for Windows. Connects directly to any composite monitor or VCR with "video" input. Its razor-sharp wide-angle lens focuses from two inches to infinity and its state-of-the-art CCD technology accurately captures 16 level grayscale images for Quick Time movies and still pictures. Records at 30 frames per second and 260 lines resolution with excellent low light capability. Uses 12VDC (adapter supplied) and standard RCA cable.

POINT OF SALE BANK TERMINAL \$39.00 or 2 for \$69.00

• LCD Display 20 Char. x 4 Line • Printer 16 Column Dot Matrix - Epson • 24 Key Domed Membrane Keypad • Intel 80C32 Processor • 2 PCMCIA Sockets (I/O Slot) • Dual 161287 Realtime Clock • 2 Solid State Buzzers (Piezo Electric) • 4 Channels • Rockwell System Chip • Telephone Line Interface (4 Pin "RJ") Connector • RS-232C Interface (8 Pin "D") Connector • Backup Battery Pack Inside
Note: We have not been able to pass an access code into the software. Thus, while time of day and other introductory things are included, the original capabilities of this unit cannot be guaranteed. Also, we do not have a source for the simm cards that were to go in the PCMCIA sockets. Requires 12 volt adapter for power. (Not included) Dimensions: 9-1/2 L x 6-1/4 W x 2-1/2 D • Original cost over \$450.00

Minimum Order: \$20.00. Minimum shipping and handling charge \$5.00. We accept cashiers checks, MC or VISA. No personal checks or COD's. CA residents add 8.25% sales tax. We are not responsible for typographical errors. All merchandise subject to prior sale. Phone orders welcome. Foreign orders require special handling. Prices subject to change without notice. 20% restocking fee for returned orders.

CIRCLE 275 ON FREE INFORMATION CARD

Digital Entertainment
also available through
Skyvision



USB



4D TV
FOR C-BAND



BEST Values from Skyvision!

Receivers
from \$229
including 4DTV

Dish Movers
12" to 52" for all
C- and Ku-band dishes

LNBS
All kinds
to heat up your picture

Tune-Up Kits
for C/Ku band & DBS

Programming
Save 30% - 50% with Skypac®

Support
Customers enjoy toll-free technical help

Keep your C-band System Running Strong

Everything on the arc for complete variety

Enjoy debut of new channels
Often in the clear for months

Wild feeds... Action as it happens

Programming you want at a price
you can afford to pay

Whether you're considering your first
satellite TV entertainment system or
looking for an upgrade to your
current system, Skyvision provides
the best in hardware, technical
support, convenience,
low cost and service.

1010 Frontier Drive
Fergus Falls, MN 56537

Fax: 218-739-4879 Int'l: 218-739-5231

All marks shown are registered trademarks
of their respective owners.

1-800-543-3025
www.skyvision.com

Skyvision



RS-232 Networkable Devices

Only 2 Wires are Required to Operate Most NCD Devices from a Single RS-232 Serial Port.

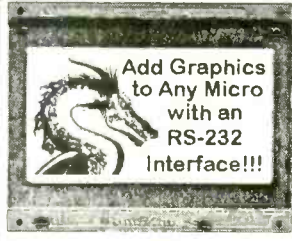

NEW: RS-232 programmable 256x128 Graphic Display Module w/software controlled Backlight. Upload up to 128 BMP Image Files, animate at 960 frames/second, 16 level grayscale capability. Supports 32x16 Text overlaid with graphics Documentation, Windows95 Setup Utility, and QBasic Example Software included. Counts as 2 Devices on the NCD RS-232 Network. Combine up to 8 LCDs on a Single Serial Line or mix with our relay drivers and other devices. **Model described just \$299. Two other models available for \$199 and \$249.**

Includes Drivers in QBasic, Mac & Amiga Software Also Supported.

Combine 16 Devices in ANY Combination to Your RS-232 Port

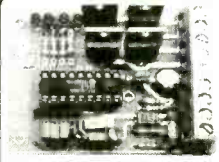

Leds Show Step Pattern.

High-Power Stepper Motor Controller for unipolar motors up to 12 volts 2 amps. Takes a step for every byte received. Control up to 16 steppers from 1 serial port. **STP Kit \$24 Asm \$39**

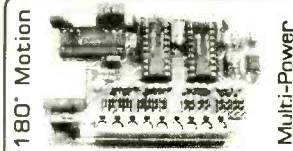

180° Motion

Multi-Power

8/16 Hobby Servo Controller. Futaba-J Compatible, Infrared Receiver Included with SV16 upgrade. Perfect in all animatronic applications. **SV8 Kit \$39 Asm \$54**
SV16 Upgd Kit \$19 Asm \$29



8-Relay Driver (Quad Relay Driver Available) includes 8 LED Status Lights. 12V Operation. Infrared Receiver. With Omron Mech Relays. **R85 (5A) Kit \$89 Asm \$139**
R810 (10A) Kit \$109 Asm \$159

National Control Devices
Contact Ryan Sheldon
Phone: (404) 244-2432
FAX: (417) 646-8302
Include \$5 Shipping.
Visa/MC Accepted.
NCD, Box 384, Osceola, MO 64776

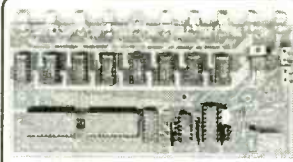

Audio/Video Switcher: 8 Inputs, 2 Outputs, Infrared Controllable, Routes Any Input to Any Output. 12-18 volt DC operation. For Low-Power (Line-Level) Signal Switching. **AVS8 Kit \$89 Asm \$139**

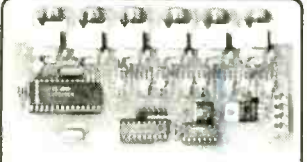

Audio Selector with 4 stereo inputs, 2 stereo outputs. Volume, Treble, Bass, Fader. Controlled by infrared or RS-232 w/Windows95 software. Fully NCD Networkable. **NCD-ASP8X4 Asm \$79**

Infrared Transceiver for Remote RS-232 Communication with 16 IR Controllable Devices. IRTR Kit \$24 Asm \$39
RSB Serial Booster Gives your RS-232 Port the Power It Needs to Drive 16 NCD Devices. RSB Kit \$12 Asm \$24

On-Line Catalog: <http://members.aol.com/ncdcat/> E-mail: ncdryan@aol.com

CIRCLE 330 ON FREE INFORMATION CARD

WHITE-STAR ELECTRONICS

TEL: 405-631-5153 FAX: 405-631-4788

CONVERTERS:	20	50	100+
Regal CR-83.....	.45	39	35
* New, Panasonic TZPC 145.....	.75	69	65
DQN-5 (2 or 3) (unmodified).....	.45	39	35
DRZ-3 PJ (unmodified) 70 Channel Plain.....	.35	32	29
DRX-3 PJ (unmodified) 60 Channel Plain.....	.32	30	27

Call for FREE catalog.
405-631-5153



REMOTE CONTROL HAND UNITS:	20	50	100+
Jerrold Replaces: 400/450/550.....	4.95	4.50	4.25
Scientific Atlanta: 075/175/475.....	4.95	4.50	4.25
8600: On screen display.....	7.50	7.00	6.50
Pioneer: BR 81, 82.....	4.95	4.50	4.25
Panasonic: Call for model #.....	7.50	7.00	6.50
Zenith: All.....	4.95	4.50	4.25
Tocom: 5503-VIP, 5503-A.....	7.00	6.50	6.25
Universal: 4 in 1 R/M.....	7.50	7.00	6.50

Call for Oak, Hamlin, Regal-83, Regency, Texscan, and all others.

Tamper-Bit tools: (10-lot)
Jerrold compatible bits:
1/4" Stacom Bit.....\$8.00
Oval Round D.....\$20.00
Torx Bit:
Tocom T-8.....\$8.00
Zenith T-10, T-15.....\$8.00
Pioneer T-20.....\$8.00
Scientific Atlanta T-20.....\$8.00
Pro 63XX Oval.....\$20.00
Bit Driver Handle.....\$4.00

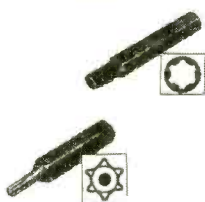

We carry most remote hand units. If you don't find the one you're looking for, we can locate for you.

Specializing in large quantities.

HOURS: Monday thru Friday 9 am to 5 pm Central Time.

Call for FREE catalog.
Email: wse405@aol.com

CIRCLE 314 ON FREE INFORMATION CARD

RF Data Modules

<p>Transmitters</p> <p>TXM-4XX-A..... \$24.50 TXM-4XX-F..... \$25.80</p>	<ul style="list-style-type: none"> •ERP 0.25mW into 50Ω •3V(F), 5V(F) or 6-12V(A) •418 or 433.9Mhz FM •simply add antenna, data, power •Range up to 200m •Analog or digital data i/p •SAW controlled - stability
<p>Receivers</p> <p>SILRX-4XX-A..... \$39.38 SILRX-4XX-F..... \$41.92</p>	<ul style="list-style-type: none"> •Only 21 x 47 x 5mm •13mA; 130uA on power save (100:1) •Carrier detect o/p •418 or 433.9Mhz FM Superhet •SAW controlled - stability •Analog or digital o/p •Wide supply range 4.5-9V (A/F ver.) •Fast enable time <3ms
<p>Transceivers</p> <p>BIM-4XX-F..... \$87.36</p>	<ul style="list-style-type: none"> •Only 23 x 33 x 11mm •Up to 40,000bps of balanced code •Up to 170m range. •5v operation •418 or 433Mhz FM •Direct interface to 5V CMOS logic •Fast 1ms enable from power saving
<p>RS232 Transceiver</p> <p>59 x 40 x 14mm CYPHERNET-RS232..... \$139.30</p>	<ul style="list-style-type: none"> •3 wire RS232 interface •Up to 38400 bps •418 or 433Mhz FM. 7.5-15Vdc •TX/RX LED indication •Up to 150m range



ABACOM
TECHNOLOGIES

Volume Discounts
Free Catalog Available
MasterCard / Visa

Tel: 416-242-3120
Fax: 416-242-2697
FaxBack: 416-242-3082

67 Hamptonbrook Dr • Weston • ON • M9P 1A2 • Canada

Electronics Now, February 1998

Roger's Systems Specialist

800-366-0579

"We Have Great Connections"

Computer - Communications
Network - Audio - Video

www.
rogerssystems
.com

www.
rogerssystems
.com

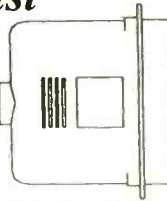
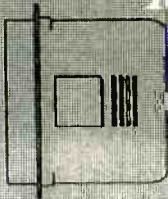

POWER

Battery Backup w/ built in surge and noise suppression



TM-225
\$139⁰⁰ each

Features:

RFI/EMI line noise filtering
protects against brownouts
up-front diagnostic LEDs and alarm
Microprocessor control of on-board
functions

Protects against:

Active Data Loss
Hard Drive Data Loss
Computer and Monitor Damage

Universal AC to DC Converter



- Eliminates Batteries
- Great for small radios,
CD players, and toys

#TM-310 \$5.00 each

1.5v -12v DC/1000 ma

#TM-307 \$3.00 each

1.5v -12v DC/300 ma

Surge Protection

15 AMP fused circuit breaker w/ reset
feature, built-in light indicator,
Metal case, 5' heavy duty cord,
6 outlet with surge protection

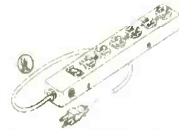

#TM-199

\$6.00 each

Power/Modem Protection

3 stage-EMI/RFI/Surge protection, FAX/
modem protection.

#TM-200

5' cord, 6 outlet \$12.00 each



Microphone

Stick-on monitor or clip on or
stick on shirt 6 ft. cord;
condenser mic.

#TM-MIC-2
\$2⁰⁰ each



Major Brand! Stereo Digital Headphones

Black, foam pads
3.5 mm stereo plug
great for walkman & multi-media use



#TM-170
\$3⁰⁰ each
20/\$2.80

P.C. MultiMedia Speakers

Famous Maker Mini-Size amplified

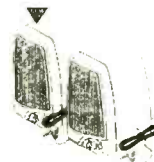

#TM-172
\$8⁵⁰ each set
10/\$7.85 each

4" Stereo Mini Phono Plug to 2 RCA Jacks

3.5 mm stereo mini phono plug
to 2 RCA phono jacks



#AD-561
\$.50 each

SVGA Shielded Cables



6 ft. HD 15 male to female
#CC-VGA-4
\$3⁰⁰ each
4/\$5.00

Parallel Port

DB25 Female to 26 pin socket IDC



#CN-702 \$0.50 each
100/\$.40

CD Jewel Case

Replacement for original case



#TM-CD1
\$.40 each

Uni-Directional Dynamic Vocal Mic

Well suited for professional quality recording & PA
Durable 8 ft cord
Dynamic freq. response: 80-13,000 Hz

#TM-MIC \$3⁰⁰ each
Call for quantity
discounts!

#CC-VGA-4C \$9⁰⁰ each

6 ft. HD 15 male to male
switch box cable

#CC-VGA-3
\$3⁰⁰ each

6 ft. HD 15 male to male
switch box cable

Dual coaxial shield
-helps with ghosting, line
loss, and high resolution
monitors

#CC-VGA-3C
\$9⁰⁰ each

CABLES
CABLES

I-EEE 1284 Printer Cable

10' Bi-Directional
DB25 Male to Mini Centronic 36
A.K.A. type "A" - "C"

#CC-PR6-BIMIN
\$.89 each

14" SCSI III Cables

34 Twisted Pairs with drain wire
Half Pitch Db 68 Male-to-Male

#CC-693-18
\$5⁰⁰ each

Keyboard & Mouse

#TM-KB-1
\$16⁰⁰ each



BTC Extended Keyboard

104 keys with 5 pin DIN Plug
3 LED mode indicator
extra Windows 95 keys

Miniature Mouse

2-Button, black
Great for small hands
or laptop!

#TM-290-MINI
\$4⁰⁰ each

Call for prices on:
PS/2 mouse
Touch Pads
Serial mouse

Local 805-295-5577

Remember, We Have Great Connections...For You!

FAX 805-295-8777

\$10.00 minimum order required • Add \$4.50 shipping for pre-paid orders
California residents add 8.25% tax • eMail Sales@RogersSystems.com

Call for quantity discounts • No out of state checks accepted • Most orders shipped same day

24895 Avenue Rockefeller, Valencia, CA 91355



CIRCLE 320 ON FREE INFORMATION CARD

DIGITAL STORAGE OSCILLOSCOPES

WITH
SPECTRUM
ANALYZER,
DVM, FREQ.
COUNTER,
AND DATA
LOGGER.

from
\$189.

PORTABLE
MODULES
CONVERT PC'S
INTO
MULTIPURPOSE
TEST AND
MEASURING
INSTRUMENTS.

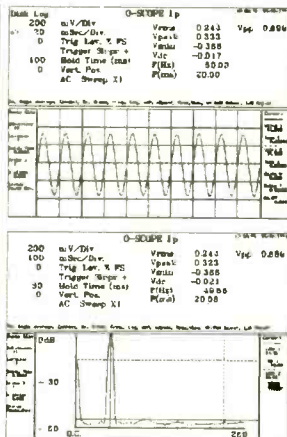

Why lug a scope around? Toss one of our modules into your laptop case or tool kit. For a multi-purpose test device, plug to a PC parallel port and use the PC screen. Continuous, delayed, or triggered sweeps can be frozen on the screen, printed out, or saved to disk. Frequency Spectrums DC to 25 MHz.

Allison now provides PICO TECHNOLOGY Ltd. portable test equipment, including high-speed scopes, and multi channel data loggers. Pico and O-Scope modules accept standard probes and work with 286 or faster PC's.

FEATURES:

- PORTABLE UNITS TO 25 MHz
- USES PRINTER PORT
- USES STD. PROBES

OPTIONS:

- PROBE SETS
- AUTOMOTIVE PROBES
- BATTERY PACKS
- SOFT & HARD CASES

O-Scopes Made in U.S. Picos Made in U.K.
Same Day Shipping
Includes Cable, Software & Manuals

O-Scope I (DC-50KHz, single trace)\$189.
O-Scope II (DC-500KHz, dual trace)\$349.
PICO (ADC 200/20) (DC-10MHz, dual trace) CALL
PICO (ADC 200/50) (DC-25MHz, dual trace)CALL
PICO pc based data loggers from \$99.

Shipping within U.S. UPS Ground \$7.50(Second day \$11.50)

SEND CREDIT CARD INFO., M.O., or CHECK, OR CALL

1-800-980-9806

Allison Technology Corporation

8343 CARVEL, HOUSTON, TX. 77036 U.S.A.

PHONE: 713-777-0401 FAX: 713-777-4746 BBS: 713-777-4753

<http://www.atcweb.com>

CHECK CAPACITORS IN-CIRCUIT WITH 100% ACCURACY IN 3 SECONDS---GUARANTEED

Automatically discharges capacitor, checks for DC leakage (DCR) and beeps below your preset value, measures ESR on LED bar and beeps from 1 to 5 beeps for values from good to bad.

- ONE-HANDED GOLD-PLATED TWEezer PROBE
- HANDY 3-COLOR CHART SHOWS TYPICAL READINGS
- 20 SEGMENT LED METER DISPLAYS ESR FROM 0.1 TO 20 OHMS
- PORTABLE, RUNS ON AAA BATTERIES

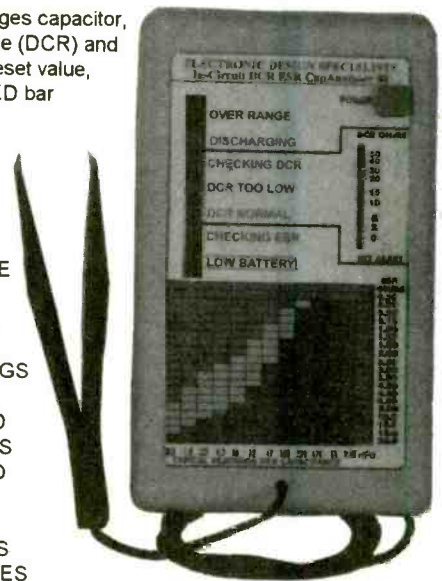

* 60 DAY TRIAL PERIOD WITH MONEY-BACK GUARANTEE
AVAILABLE FROM MOST MAJOR DISTRIBUTORS

(561) 487-6103



\$169

ELECTRONIC DESIGN SPECIALISTS

we make test equipment designed to make you money

CONTROL

RELAYS • LIGHTS • MOTORS

MEASURE

TEMPERATURE • PRESSURE • LIGHT LEVELS • HUMIDITY

INPUT

SWITCH POSITIONS • THERMOSTATS • LIQUID LEVELS

MODEL 30 \$79

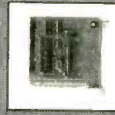

- PLUGS INTO PC BUS
- 24 LINES DIGITAL I/O
- 8 CHANNEL
- 8 BIT A/D IN
- 12 BIT COUNTER
- UP TO 14K SMP/SEC

MODEL 45 \$189

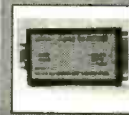

- RS-232 INTERFACE
- 8 DIGITAL I/O
- 8 ANALOG INPUTS
- 2 ANALOG OUTPUTS
- 2 COUNTERS-24 BIT

MODEL 100 \$279



- 12 BIT 190 KHZ A/D
- 4 ANALOG OUTPUTS
- 3 TIMER COUNTERS
- 24 DIGITAL I/O

MODEL 60 \$179



- 8 2-AMP RELAYS
- 16 DIGITAL I/O
- 1 8-BIT ANALOG INPUT

MODEL 40 \$99



- RS-232 INTERFACE
- 28 LINES DIGITAL I/O
- 8 ANALOG INPUTS
- PWM OUTPUT
- OPTIONAL 12 BIT A/D

MODEL 70 \$239



- RS-232 INTERFACE
- 18 BIT A/D
- 5.5 DIGIT
- UP TO 60 SMP/SEC

NEED A CUSTOM PCB? TRY US.

PRAIRIE DIGITAL, INC.

PHONE 608-643-8599 • FAX 608-643-6754

846 SEVENTEENTH STREET • PRAIRIE DU SAC, WISCONSIN 53578

CIRCLE 325 ON FREE INFORMATION CARD

Our Complete Catalog is now online www.csi.com

Circuit Specialists Inc.

SINCE 1971

Check Out What We Have To Offer:

Fantastic DMM Offer!!!

Don't let the price fool you. This meter is a digital multimeter designed for engineers and hobbyists. Equipped with 5 functions and 19 ranges. Each test position is quickly and easily selected with a simple turn of the FUNCTION/RANGE selector rotary switch.

General Rubber Boot Included

Display: 3-1/2 Digit LCD. 21mm Figure Height with Automatic Polarity
Overrange Indication: 3 Least Significant Digits Blank

Temperature for Guaranteed Accuracy:

23°C ± 5°C RH < 75%
Temperature Ranges:
Operating: 0°C to 40°C (32°F to 104°F)
Storage: -10°C to 50°C (14°F to 122°F)

Power: 9V Alkaline or Carbon-Zinc Battery (NEDA1604)
Low Battery Indication: BAT on Left of LCD Display

Dimensions: 188mm long x 87mm wide x 33mm thick
Net Weight: 400g

DC Voltage (DCV)
Range: Resolution: Accuracy:
200mV 100µV
2000mV 1mV ±(1%rdg+2dpts)
20V 10mV
200V 100mV
1000V 1V
Maximum Allowable Input: 1000V DC or Peak AC.

DC Current (DCA)
Range: Resolution: Accuracy:
200µA 100nA
2000µA 1µA ±(1.2%rdg+2dpts)
20mA 10µA
200mA 100µA ±(1.2%rdg+2dpts)
10A 10mA
Overload Protection: mA Input. 2A/250V fuse.

\$19.00 any qty



Our Best Offer Ever on a High Quality Full Sized DMM

Resistance (Ω)
Range: Resolution: Accuracy:
200Ω 100mΩ
2000Ω 1Ω
20KΩ 10Ω ±(1.2%rdg+2dpts)
200KΩ 100Ω
2000KΩ 1KΩ ±(2%rdg+10dpts)
20MΩ 10KΩ
Maximum Open Circuit Voltage: 2.8V
Diode Test
Measures forward voltage drop of a semiconductor junction in mV test current of 1.5mA Max.
hFE Test
Measures transistor hFE.
Frequency Range: 45Hz-450Hz
Maximum Allowable Input: 750V rms
Response: Average Responding. Calibrated in rms of a Sine Wave.

AC Voltage (ACV)
Range: Resolution: Accuracy:
200V 100mV ±(1.2%rdg+10dpts)
750V 1V

CAT NO	DESCRIPTION	PRICE
9300G	Rugged High Quality DMM with Rubber Boot	\$19.00

Special Offer! The next generation of Digital Multimeters with 3-3/4 digits, 4000 count, auto-ranging and analog bargraph, 10MHz frequency counter, True RMS mode and RS-232C interface. **LIMITED TIME OFFER!** You MUST enter your order by December 31st, 1997 to receive this special price! Regular C.S.I. price \$169.00. Plus we'll even include the optional temperature adaptor and K-type thermocouple probe! We even include the holster!

CAT NO	DESCRIPTION	PRICE
PROTEK506	Digital Multimeter	\$139.00

Developer This product is used as the developer on our positive photo-resist printed circuit boards. Includes instructions. 50 gram package, mixes with water, makes 1 quart. **PRICE EACH**

CAT NO	DESCRIPTION	1	10	25
POSDEV	Positive Developer	\$.95	\$.80	\$.50

Etching Chemicals/Ferric Chloride
A dry concentrate that mixes with water to make 1 pint of etchant, enough to etch 400 sq. inches of 1oz board. **PRICE EACH**

CAT NO	DESCRIPTION	1	5
ER-3	Makes 1 pint	\$3.50	\$2.75

CIRCUIT SPECIALISTS, INC. **RECEIVE OUR LATEST 132 PAGE CATALOG!**
SINCE 1971 **800-811-5203**
602-464-2485
602-464-5824(FAX)

WE ACCEPT:

Positive Photo Resist Pre-Sensitized Printed Circuit Boards



These pre-sensitized printed circuit boards are ideal for small production runs. They provide high resolution and excellent line width control. High sensitive positive resist coated on 1oz. copper foil allows you to go direct from your computer plot or art work layout. No need to reverse art.

Single-Sided, 1oz. Copper Foli on Paper Phenolic Substrate **PRICE EACH**

CAT NO	DESCRIPTION	1	10	50
PP101	100mm x 150mm/3.91" x 5.91"	\$2.55	\$1.90	\$1.70
PP114	114mm x 165mm/4.6" x 6.6"	2.98	2.45	1.98
PP152	150mm x 250mm/5.91" x 9.84"	5.40	3.98	3.60
PP153	150mm x 300mm/5.91" x 11.81"	6.15	4.48	4.10
PP1212	305mm x 305mm/12" x 12"	12.78	10.65	8.52

Single-Sided, 1oz. Copper Foli on Fiberglass Substrate **PRICE EACH**

CAT NO	DESCRIPTION	1	10	50
GS101	100mm x 150mm/3.91" x 5.91"	\$ 3.90	\$2.98	\$2.60
GS114	114mm x 165mm/4.6" x 6.6"	4.80	3.49	3.20
GS152	150mm x 250mm/5.91" x 9.84"	8.69	5.98	5.78
GS153	150mm x 300mm/5.91" x 11.81"	10.20	7.20	6.80
GS1212	305mm x 305mm/12" x 12"	18.88	15.73	12.59

Double-Sided, 1oz. Copper Foli on Fiberglass Substrate **PRICE EACH**

CAT NO	DESCRIPTION	1	10	50
GD101	100mm x 150mm/3.91" x 5.91"	\$ 5.07	\$3.68	\$3.38
GD114	114mm x 165mm/4.6" x 6.6"	5.95	4.29	3.99
GD152	150mm x 250mm/5.91" x 9.84"	10.47	7.39	6.98
GD153	150mm x 300mm/5.91" x 11.81"	11.95	8.69	8.30
GD1212	305mm x 305mm/12" x 12"	22.09	18.35	14.68

Etching Tank This handy etching system will handle PC boards up to 8" x 9", two at a time. Ideal for etching your PCB's! System includes an air pump for etchant agitation, a thermostatically controlled heater for keeping etchant at optimum temperature and a tank that holds 1.35 gallons of etchant. A tight fitting lid is also supplied to prevent evaporation when system is not being used. Typical etching time is reduced to 4 minutes on 1oz. copper board!

REDUCES ETCHING TIME! **CAT NO 12-700** **DESCRIPTION Etch Tank System** **PRICE \$37.95**

1/3" CCD Board Cameras
Available with **PINHOLE LENS** with **AUDIO**; **STANDARD LENS** with **AUDIO**; and **STANDARD LENS** with **INFRA-RED**. These are the world's smallest commercially available CCD board cameras!

World's Smallest B&W Board Cameras
Specifications
Image Pick-Up Device 1/3" CCD area Sensor
Picture Elements EIA-512(H) x 492(V)
Pixel Pitch EIA-9.6UM (H) x 7.5UM (V)
Scanning System 2 : 1 Interlace
Scanning Frequency EIA-525 lines, 60 field/sec (II) 15.750 KHz x 60 HK

Resolution 430 Lines
Minimum Illumination 0.03 LUX
S/N Ratio 45DB
Lens Mounting 4.3mm standard, 5mm pinhole
Video Output 1.0 VP-P/750OHM composite signal
Power Requirement 8-12 VDC (9VDC standard)
Power Consumption 100mA
Operating Temperature -20C + 70 C RH 95% Max
Storage Temperature -40C - 85 C RH 95% Max
Audio Pick-Up Sensitivity -60 DB (ODB = 1B/UBAR, 1KHZ)
Audio Frequency Range 20 Hz to 20KHz
Audio S/N Ratio More than 35DB
Audio Output Level 1VP-P/600 OHM

Dimensions
WDP-2000 30mm (H) x 30mm (W)
WDS-2005 30mm (H) x 30mm (W)
WDI-4000 44mm (H) x 30mm (W)

CAT NO	DESCRIPTION	PRICE EACH 1	5
WDP-2000	1/3" B&W Pinhole Lens with Audio	\$89.00	\$77.00
WDS-2005	1/3" B&W Standard Lens with Audio	\$89.00	\$77.00
WDI-4000	1/3" B&W Infra-RED (no audio)	\$89.00	\$77.00
WDPH-55BW	Plastic Housing Option for B&W Board Cameras	13.00	12.00



It's chock full of all types of electronic equipment and supplies. We've got I.C.'s, capacitors, resistors, pots, inductors, test equipment, breadboarding supplies, PC supplies, industrial computers, data acquisition products, personal computers and computer parts, plus much, much more. FAX us your name and address or call **800-811-5203, ext. 5**, to leave a message on our catalog request line.

EARN MORE MONEY!

Be an FCC LICENSED ELECTRONIC TECHNICIAN!



Learn at home in spare time. No previous experience needed!

No costly school. No commuting to class. The Original Home-Study course prepares you for the "FCC Commercial Radiotelephone License." This valuable license is your professional "ticket" to thousands of exciting jobs in Communications, Radio-TV, Microwave, Maritime, Radar, Avionics and more...even start your own business! You don't need a college degree to qualify, but you do need an FCC License.

No Need to Quit Your Job or Go To School
This proven course is easy, fast and low cost! **GUARANTEED PASS**—You get your FCC License or money refunded. **Send for FREE facts now. MAIL COUPON TODAY!**

Or, Call 1-800-932-4268 Ext. 210

COMMAND PRODUCTIONS
FCC LICENSE TRAINING, Dept. 210
P.O. Box 2824, San Francisco, CA 94126
Please rush FREE details immediately!

NAME _____
ADDRESS _____
CITY _____ STATE _____ ZIP _____

TURN YOUR PC INTO A DIGITAL STORAGE OSCILLOSCOPE!

The all new PC-MultiScope 2

10Mhz analog bandwidth!

At right! Actual scope screen as seen on your PC monitor.

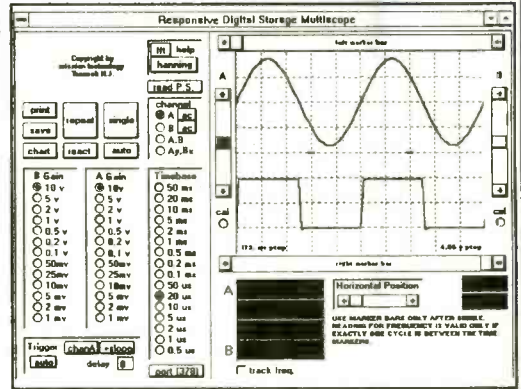

For industrial, educational, hobbyist, auto, and audio test & measurement

\$399 + S/H. Visa/MC/Check OK
Add \$99 for source code option

The top choice of corporations, universities and scientists worldwide!

AMAZE ELECTRONICS CORPORATION
amaze@hooked.net www.hooked.net/users/amaze
Phone: 800-996-2008 Fax: 408-374-1737

FEATURES:

1. Dual channel; external triggered
2. Digital storage; Windows based
3. Connects to PC parallel port
4. 20Megasamples/sec sampling; 10Mhz max. analog bandwidth
5. 8 bit resolution/ 8K RAM buffer
6. Prog. gain: 10v/div to 1mv/div
7. Spectrum analyzer (fft) function
8. Strip chart recorder function
9. TTL output for control app's
10. Visual Basic source code avail.

From MILLIWATTS to KILOWATTS

**RF POWER TRANSISTORS • TUBES
POWER MODULES**



Best pricing on U.S. & Russian
Transmitting & Receiving Tubes



3-500ZG • 811A • 833A • 572B
4-400C • 6146B & W • 8560AS • 8875 • 3CX400A7 & U7
3CX800A7 • 3CX1200A7 & Z7 • 3CX1500A7 • 3CX3000A7
4CX250B & R • 4CX400A • 4CX800A • 5CX1500A & B
including full range through 4CX20,000A



Complete inventory for servicing
amateur and commercial
communications equipment.

Transistors • RF Modules • Trimmers • Doorknob Capacitors
Heatsinks • Bird Wattmeters • Relays
Broadband Transformers & Combiners

MOTOROLA

QUANTITY PRICING AVAILABLE

TOSHIBA



Send for your **FREE 1998 Catalog**

Same Day Shipping on most orders.



800 RF-PARTS • 760-744-0700

Fax: 888-744-1943 • 760-744-1943

e-mail: rfp@rfparts.com



RF PARTS

435 SOUTH PACIFIC STREET
SAN MARCOS, CA 92069

Your Electronics Authority

MCM ELECTRONICS®

Prices Effective
January 6
through
February 27, 1998

To take advantage of
special pricing on the
items listed, you must
provide this code: ▼

SOURCE CODE:
ENS43

IC Cross Reference Software

Looks up/displays
the pin layouts of ICs, regulators, motor
drivers, voltage regulators, TVs, VCRs,
computer, faxes, audio equipment and
more. Basic voltage readings for pin
layouts are available or enter your own.
Approximately 7,000 entries.

Order # (ea.)
81-2455 \$34.95



YOUR CHOICE
\$9.50

8" Poly Cone Woofers

Perfect for replacement, upgrade or
original manufacturing in most
speaker applications. They feature
polypropylene cone, foam surround and
high temperature voice coil. Power
capacity 70W/100W RMS/peak, 40Hz-3KHz response, 1 1/2" voice coil,
18 oz. magnet and SPL 87dB

Order #	Impedance	Regular
55-1195	8ohm	\$11.95
55-1605	4ohm	10.95



Multi-Voltage Power Supply

Use as a battery eliminator or to power
small projects. Fully regulated output
provides 2 amp output at 3, 4, 6, 7, 9 or
12VDC. Color coded binding posts make
connection easy.

Order # (ea.)
28-2200 \$16.95



SAVE
45%

TENMA® DMM with Logic Function

Features 3 1/2 digit LCD display,
10Mohm input impedance, logic test,
transistor and diode test, capacitance
measurement, AC/DC current
measurement and overload protection
Measures AC/DC voltage to 600V,
AC/DC current to 10A, resistance to
2000Mohm and capacitance to 20µF.
Requires 9V battery.

Order # Reg. \$35.95
72-4025 \$65.95



110 Watt Subwoofer Power Amp Module

MCM now offers the ultimate subwoofer
power amp module for all your home
audio and home theater projects. It can
be built directly into most any existing
subwoofer enclosure, requiring a cut-out
of only 10" x 7", and accepts either speaker
level or RCA inputs. Features include
an auto sense circuit to turn on amp
when music is present, and 60-160Hz
continuously variable 12dB crossover.

Order # (ea.)
50-4465 \$179.00



SAVE
30%

Heavy-Duty Aluminum Tool Case

Lightweight durable aluminum case
includes two inside panels and adjustable
compartments to easily carry hand tools,
small soldering equipment and more.
Black finish. Measures approximately
19" x 14" x 6".

Order # Reg. \$34.95
21-3460 \$49.95



FREE
Catalog!

1-800-543-4330

www.mcmelectronics.com

Hours: M-F 7 a.m.-9 p.m., Sat. 9 a.m.-6 p.m., EST.



MCM ELECTRONICS®
650 CONGRESS PARK DR.
CENTERVILLE, OH 45459
A PREMIER FARNELL Company

Pre-Assembled Amplifier Module

Great for repair or
modification of equipment,
projects or prototype work.
Line level input, 15W output @ 4ohm.
Includes oversized heat sink. Requires
12-35VDC (optimum 24VDC), 500mA.
Dimensions 3 1/2" x 2 1/4" x 1 1/4". Contact your
MCM Sales Representative about our
wide variety of other pre-assembled
circuit modules.

Order # (ea.)
28-4797 \$19.95

SOURCE CODE: ENS43

CIRCLE 332 ON FREE INFORMATION CARD

CALL TOLL FREE
(800) 292-7711 orders only
Se Habla Español

C&S SALES

EXCELLENCE IN SERVICE

LOOK FOR OTHER
MONTHLY SPECIALS
ON OUR WEBSITE

NEW XK-700 Digital / Analog Trainer
Elenco's newest advanced designed Digital / Analog Trainer is specially designed for school projects. It is built on a single PC board for maximum reliability. It includes 5 built-in power supplies, a function generator with continuously sine, triangular and square waveforms and a 1560 tie point breadboard area. Tools and meter shown optional. (Mounted in a professional tool case made of reinforced metal).

XK-700
Assembled and Tested
\$189.95

XK-700 - SEMI KIT
w/ Fully Assembled PC Board
\$174.95

XK-700K - Kit
\$159.95



Made in the USA

Volt Alert™ By FLUKE

Volt Alert™ is the new pocket-sized AC line voltage detector from Fluke. Easy to use - just touch the tip to an outlet or cord. When it glows red, you know there's voltage in the line.

Electrician's, maintenance, service, and safety personnel can quickly test for energized circuits and defective grounds on the factory floor, in the shop, or at home.

- Fits in shirt pocket for convenience.
- All outer surfaces are nonconductive for safety.
- Detects voltage metallic contact.

#1AC **\$19.50**



DIGITAL LCR METER

Model LCR-1810 **NEW**
\$99.95



- Capacitance .1pF to 20µF
- Inductance 1µH to 20H
- Resistance .01Ω to 2000MΩ
- Temperature -20°C to 750°C
- DC Volts 0 - 20V
- Frequency up to 15MHz
- Diode/Audible Continuity Test
- Signal Output Function
- 3 1/2 Digit Display

20MHz Sweep / Function Generator with Freq Counter

B&K 4040

- 0.2Hz to 20MHz
- AM & FM modulation
- Burst Operation
- External Frequency counter to 30MHz
- Linear and Log sweep

10MHz B&K 4017 **\$309**
5MHz B&K 4011 **\$239**



\$399



Model M-6100

The M-6100 is Elenco's most sophisticated meter with almost every possible feature available. The M-6100 even has a computer interface for viewing and storing data on a personal computer. It comes complete with software, RS-232 cable, test leads and manual.

\$125

Model XP-581

4 Fully Regulated DC Power Supplies in One Unit
4 DC voltages: 3 fixed - +5V @ 3A, +12V @ 1A, -12V @ 1A
1 Variable - 2.5 - 20V @ 2A

\$89.95



SATELLITE FINDER

Model SF-100A

- Aligns Satellite Dishes
- Range 950-2050MHz
- Audio Tone
- Compact Size
- Self Power Check



\$39.95

Digital Multimeter

Model M-1700

\$39.95

11 functions including freq to 20MHz, cap to 20µF. Meets UL-1244 safety specs.



Technician Tool Kit

TK-1500

28 tools plus a DMM contained in a large flexible tool case with handles ideal for everyone on the go.



\$49.95

Kit Corner

over 100 kits available

AK-700

\$14.95

Phone kit with training course.



RADIO CONTROL CAR KIT

MODEL AK-870

- 7 functions
- Remote control included

\$24.95

No Soldering Required



Model AM/FM-108K Transistor Radio Kit

with training course

\$29.95



35mm Camera Kit

Learn all about photography

AK-540

\$14.95



No Soldering Required

The New DMM900 Series Handheld Digital Multimeters

For high-performance digital multimeters that are accurate, reliable, and rugged, the DMM900 Series extends the Tektronix line of already affordable DMMs. Twice the accuracy. Up to 10 times the resolution. And a full range of capability that spans voltage, current, digital multimeters features a dual numeric display, 3-year warranty, and autoranging capability. All backed by the reliability of the Tektronix brand.

Features
DMM912, DMM914, DMM916

- 40,000 Count Display
- 0.06% Basic DC Volts Accuracy (DMM916)
- DC Voltage Ranges from 400mV to 1,000V
- AC Voltage Ranges from 4V to 750V (True RMS)
- AC and DC Current Ranges from 10,000µA to 10A
- Resistance Ranges from 400Ω to 40MΩ
- Capacitance Ranges from 4nF to 40µF
- Frequency Ranges from 400Hz to 2MHz
- Temperature Measurements from -50°C to +990°C (DMM916, DMM914)
- 3 Year Warranty
- CE Marking

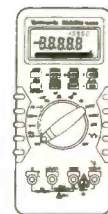

DMM 912
\$189

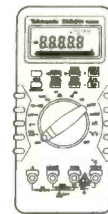

DMM 914
\$235

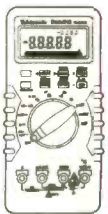

DMM 916
\$275

GUARANTEED LOWEST PRICES ON TEK DMMs

WE WILL NOT BE UNDERSOLD C&S SALES, INC.

150 W. CARPENTER AVENUE
WHEELING, IL 60090
FAX (847) 541-9904 (847) 541-0710
http://www.elenco.com/cs_sales



15 DAY MONEY-BACK
GUARANTEE

FULL FACTORY WARRANTY
PRICES SUBJECT TO CHANGE WITHOUT NOTICE

Same Day
Shipping

C & S SALES

Your one stop source for
all your electronic needs!

CALL OR WRITE FOR OUR
NEW FREE 64 PAGE
CATALOG!
(800) 445-3201

Fluke Scopemeters



123...NEW.....\$950
92B.....\$1445
96B.....\$1695
99B...NEW.....\$2095
105B.....\$2495

**ALL FLUKE
PRODUCTS
ON SALE**

B & K PRECISION SCOPES

100MHZ THREE-TRACE

Model 2190A

- 1mV/division sensitivity
- Sweeps to 5ns/division
- Dual time base
- Signal delay time
- 15KV accelerating voltage



\$1295.00

60MHZ DUAL-TRACE

Model 2160

- 1mV/division sensitivity
- Sweeps to 5ns/division
- Dual time base
- Signal delay time
- V mode - displays two signals unrelated in frequency
- Component tester



\$895.00

40MHZ DUAL-TRACE

Model 1541C

- 1mV/division sensitivity
- Video sync separators
- Z-axis input
- Single Sweep
- V mode displays two signals unrelated in frequency
- Component tester



\$695

60MHZ, CURSORS & READOUTS, DUAL TIME BASE

Model 2260

- Cursors and readouts
- 1mV/div sensitivity
- 23 calibrated ranges - main time base
- 13 calibrated ranges - delayed time base
- Signal delay time
- Single Sweep
- V-mode - displays 2 signals unrelated in frequency
- Component tester
- Z-axis input
- Single sweep



\$1225

20MHZ DUAL-TRACE

Model 2120B - 2 Year Warranty

Special \$375

Model 2125A with delayed sweep

\$539.95



- 1mV/division sensitivity
- AUTO/NORM triggered sweep operation
- AC, TVH, TVV and line coupling
- Calibrated 19 step time-base with x10 magnifier
- Compact low-profile design

Affordable Spectrum Analyzers by B&K

500MHz Series
Model 2615 - \$1595
Model 2620 w/ tracking
generator - \$1895

1.05GHz Series
Model 2625 - \$2395
Model 2630 w/ tracking
generator - \$2995



Quality Scopes by Elenco

Lowest Prices of the Year!



60MHz

DS-603 **\$1350**

- Analog / Digital Storage
- 20MS/s Sampling Rate

S-1360 **\$749**

- Analog with Delayed Sweep

100MHz

S-1390 **\$995**

- Analog

Includes
Free Dust
Cover and
Probes



25/30MHz

DS-303 30MHz **\$1095**

DS-203 20MHz **\$725**

- Analog / Digital Storage

S-1330 **\$439**

- 25MHz Analog
- Delayed Sweep

S-1325 **\$325**

- 25MHz Analog

**2 Year
Warranty**

SIMM MODULE TESTER

B & K 898

\$625

- Tests 72 and 30-pin SIMMs to 36 bits.
- Stand alone and portable. No other equipment required.
- Automatically identifies width, depth and speed of SIMMS.
- 1C built-in tests identify most memory defects. Preheat cycle prior to test.



Fluke Multimeters

Model 70III	\$85	Model 83	\$235
Model 73III	\$115	Model 85	\$269
Model 75III	\$139	Model 87	\$289
Model 77III	\$154	Model 863E	\$475
Model 79III	\$175	Model 867BE	\$650

PORTABLE SEMICONDUCTOR TESTER

B&K 510

- In or out-of-order circuit tests for transistor, FETs, SCRs and darlings.

\$199.00



B&K Precision Multimeters

Model 391	\$143	Model 388A	\$99
Model 390	\$127	Model 2707	\$75
Model 389	\$109	Model 2860A	\$79
Model 5390	\$295	Model 5370	\$219
Model 5380	\$265	Model 5360	\$195

MX-9300

Four Functions in One Instrument

Features:

- One instrument with four test and measuring systems:
 - 1.3GHz Frequency Counter
 - 2MHz Sweep Function Generator
 - Digital Multimeter
 - Digital Triple Power Supply
- 0-30V @ 3A, 15V @ 1A, 5V @ 2A



\$459⁹⁵

GUARANTEED LOWEST PRICES C&S SALES, INC.

UPS SHIPPING - 48 STATES 5%
OTHERS CALL FOR DETAILS
IL Residents add 8.25% Sales Tax

150 W CARPENTER AVENUE
WHEELING, IL 60090
FAX: (847) 541 9904 (847) 541 0710
http://www.elenco.com/cs_sales



15 DAY MONEY BACK
GUARANTEE
FULL FACTORY WARRANTY
(PRICES SUBJECT TO CHANGE WITHOUT NOTICE)

New and Pre-Owned Test Equipment

Goldstar

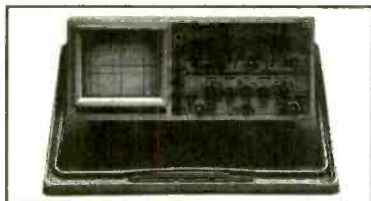

Model OS-9100P → **\$899.00**

Full 100 MHz Bandwidth!

- Dual-Channel, High Sensitivity
- TV Synchronization Trigger
- Calibrated Delayed Sweep
- Includes Two Probes, 2 Year Warranty

FREE SHIPPING!
ON GOLDSTAR EQUIPMENT
ANYWHERE IN THE U.S.
Excluding AK & HI

 **BK PRECISION**
MAXTEC INTERNATIONAL CORP. Model 4040 \$499.00
20 MHz Sweep/Function Generator

- 0.2 Hz to 20 MHz, 5 digit LED Display
- AM & FM Internal or External Modulation
- Sine, Square, Triangle, TTL, CMOS Outputs
- Burst Operation
- External 30 MHz Frequency Counter

NEW!

See us on the Web!
www.fotronic.com

1-800-996-3837

    **TOLL FREE 1-800-99-METER**

Pre-Owned Oscilloscope Specials

B + K Precision 1476 10 MHz \$229.00
Great Starter Scope!

Tektronix 465 100 MHz \$599.00
Tektronix 465B 100 MHz \$699.00
Tektronix 475 200 MHz \$799.00
Tektronix 475A 250 MHz \$899.00

- The Industry Standard of Oscilloscopes
- Dual Channel, Calibrated Delayed Sweep
- Professionally Refurbished
- Aligned & Calibrated to Original Specifications
- 6 Month Warranty - The Longest Available!

LOWEST PRICES EVER!

NEW FLUKE MULTIMETERS & TEKTRONIX OSCILLOSCOPES

The Industry Standard in Multimeters

Fluke Model 87 ..\$285.00

**TEKTRONIX TDS SERIES
ON SALE!**

Test Equipment Depot

A FOTRONIC CORPORATION COMPANY

P.O. BOX 708 Medford, MA 02155

(617) 665-1400 • FAX (617) 665-0780

email: afoti@fotronic.com

CIRCLE 331 ON FREE INFORMATION CARD

❖ ATTENTION CABLE VIEWERS ❖

CABLE VIEWERS. . .get back to your BASIC Cable Needs

Call 800-577-8775

For information regarding all of your BASIC cable needs.



5 GOOD REASONS TO BUY OUR FAR SUPERIOR PRODUCT

- ❖ PRICE
- ❖ EFFICIENT SALES AND SERVICE
- ❖ WE SPECIALIZE IN 5, 10 LOT PRICING
- ❖ ALL FUNCTIONS (COMPATIBLE WITH ALL MAJOR BRANDS)
- ❖ **ANY SIZE ORDER FILLED WITH SAME DAY SHIPPING**

We handle **NEW** equipment **ONLY** - Don't trust last year's **OBSOLETE** and **UNSOLD** stock!
COMPETITIVE PRICING—DEALERS WELCOME

HOURS: Monday-Saturday 9-5 C.S.T.

It is not the intent of B.E.S.W. to defraud any pay television operator and we will not assist any company or individual in doing the same.
*Refer to sales personnel for specifications.

**BASIC
ELECTRICAL
SUPPLY &
WAREHOUSING
CORPORATION**

P.O. Box 8180 ■ Bartlett, IL 60103 ■ 800-577-8775

Does your Desoldering Tool really



If not, try one of my two favorites.

I have attended many trade shows worldwide in the last few years and these are the top two Desoldering Tools that I have found. You have probably seen the testimonials on the DEN-ON SC-7000Z in the last several issues. If you wish to see a copy or referrals from technicians in your state, call toll free and we will fax it to you immediately.



New Features and Specifications

- ◆ Totally Self Contained diaphragm vacuum pump and AC motor (In the handle) for high vacuum suction or reversible hot air blow for SMD removal.
- ◆ 100Watt Ceramic heater with zero-crossover switching heater control circuit which prevents spikes and leakage currents.
- ◆ Unique patented long lasting filter cartridge design. Solder builds up on easily cleaned baffle, while air flows around the outside of baffle.
- ◆ Totally ESD Safe. The housing contains carbon and the tip is at ground potential for complete ESD Protection.
- ◆ Maximum vacuum of 650mmHg is attained in 100 milliseconds.
- ◆ Temperature adjustable from 300°C - 500°C (572°F - 932°F).

- ◆ Voltage — AC100v, 120V, 230V, 50/60HZ
- ◆ Power Consumption — 120W
- ◆ Pump — Diaphragm Type
- ◆ Motor Output — 2W
- ◆ Vacuum Attained — 650mmHg
- ◆ Temperature Range — 300°C — 500°C (572°F — 932°F)
- ◆ Air Flow Rate — 15 Liter/Minute (Open)
- ◆ Heater — 100W (Ceramic)
- ◆ Control System — Feed Back Zero Cross-over Type
- ◆ Net Weight — 420Grams

Check us out on the WEB

<http://www.heinc.com>

EDSYN



New Features

EDSYN has redesigned and improved their most popular ZD500 SOLDA-PULLT Hot Tip Self-Contained Desoldering Station and renamed it the ZD500DX .

- ⇒ New control circuitry for more precise temperature control, heat transfer, stability and calibration.
- ⇒ New vacuum pump design for improved performance and appearance.
- ⇒ New external calibration assists with ISO9000 compliance.
- ⇒ Updated modular design for easier maintenance.
- ⇒ Adjustable trigger and head assembly for comfort and ease of operation.
- ⇒ Wide range of tips available for all applications.
- ⇒ Vacuum Pump starts when handle is lifted from holder, thereby placing full vacuum at the trigger switch waiting for the trigger to be depressed. This allows for increased performance over conventional competitive models.

Demo Units available to Qualifying Companies

Visa - M/C - Discover - American Express - Terms to Qualifying Companies
30 Day Money Back Total Satisfaction Guarantee - One Year Parts and Labor Warranty

HOWARD
HEINC ELECTRONIC
INSTRUMENTS INC
6222 N. Oliver Kechi, KS 67067

Toll Free U.S. and Canada
1-800-394-1984

Web Site www.heinc.com
E-Mail sales@heinc.com
International (316) 744-1993
or Fax (316) 744-1994

CIRCLE 321 ON FREE INFORMATION CARD



- PRODUCT ENGINEERING
- FIRMWARE DEVELOPMENT

"QUALITY IS OUR CAPITAL CONCERN."

**Complete On Site
Electrical Engineering Lab**

- REVERSE ENGINEERING
- RF CIRCUIT DESIGN & MANUFACTURING

- MICRO CONTROLLER & EPROM HARDWARE & SOFTWARE DEVELOPMENT

From Auto-Routing to CNC Routing to Electronic Assemblies...
Capital Electronics is Your Best Route For Printed Circuit Boards.

DESIGN/LAYOUT

- CAD LAYOUT SERVICES
- COMPATIBLE WITH ALMOST ALL CAD SYSTEMS
- FROM SCHEMATICS OR SAMPLE PCB'S
- PHOTOPLOTTING SERVICES
- 28,800 BAUDE MODEM

PRINTED CIRCUIT BOARDS

- SINGLE & DOUBLE SIDED
- MULTI-LAYER & FLEXIBLE PCB'S
- FROM QUICK TURN PROTOYPES TO SCHEDULED PRODUCTION RUNS
- FINE LINES, SMT
- ELECTRICAL TESTING
- PRECIOUS METAL PLATING

ASSEMBLY SERVICES

- FAST TURN BOARD STUFFING
- WIRE HARNESES
- WAVE SOLDERING
- ACQUISITION OF PARTS
- FINAL TESTING
- TURNKEY SERVICES
- CUSTOM ENCLOSURES

**For Quick & Competitive Pricing or More Information,
Please Call Us Today!**

303 Sherman Street • Ackley, Iowa 50601
(515) 847-3888

Fax (515) 847-3889 • Modem (515) 847-3890



Internet Access:

For Automated Info Response:
INFO@capital-elec.com

E-Mail: Quote@capital-elec.com

Web Access: <http://www.capital-elec.com>

CIRCLE 327 ON FREE INFORMATION CARD

Learn by Example!

The PRIMER 8085 Based Microprocessor Training and Control System shows you how to program by example. Examples & exercises in the Self Instruction manual take you from writing simple programs to controlling motors. Start out in Machine language, then move on to Assembler, & then continue on with optional C, Basic, or Forth Compilers. This trainer can be used stand alone via the keypad and display or connected to a PC with the optional upgrade (\$49.95). The Upgrade includes: an RS232 serial port & cable, 32K of battery backed RAM, & Assembler/Terminal software.

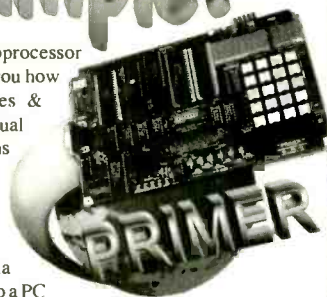

- Measuring Temperature
- Using a Photocell to Detect Light Levels
- Making a Waveform Generator
- Constructing a Capacitance Meter
- Motor Speed Control Using Back EMF
- Interfacing and Controlling Stepper Motors
- Scanning Keypads and Writing to LCD/LED Displays
- Bus Interfacing an 8255 PPI (new)
- Using the Primer as an EPROM Programmer

Examples Include:

The PRIMER is only \$119.95 in kit form. The PRIMER Assembled & Tested is \$169.95. Please add \$5.00 for shipping within the U.S. Picture shown with upgrade option and optional heavy-duty keypad (\$29.95) installed.

EMAC, inc.

11 EMAC WAY, CARBONDALE, IL 62901
618-529-4525 Fax 457-0110 BBS 529-5708
World Wide Web: <http://www.emacinc.com>

1985 - 1997

OVER
12
YEARS
OF SERVICE

THE HACKER'S COMPANION CD-ROM

Are you interested in using the internet in ways you never dreamed possible? Want a war-dialer program or something to crack a password? Do you want to learn how the phone company gets ripped off, or learn how to build a red box, or modify a cellular phone? Want to see what the security holes in Windows NT are? Or how to compromise a Unix machine or a BBS? Want to learn how to use the system in ways you never imagined possible? This CD is the place to look! It contains all kinds of computer, telephone and general hacking information. Even a video of dutch hackers breaking into a classified US military computer! **In all, over 600 megabytes of fascinating information that's hard to get anywhere else!**

PC-COMPATIBLE CD \$29.95 SHIPPING \$3

Cryptography Unlimited CD-ROM

Cryptographic software will soon be outlawed by the US government. Get this important bundle of over 200 megabytes of cryptographic software while you still can! Nobody in the US will even dare to publish a CD like this anymore and we had to import it from Africa! Includes file encryptors, disk encryptors, PGP, steganography, code cracking, PGP phone and lots more!

PC CD-ROM, \$39.95 SHIPPING \$3

Call (800)719-4957 now!

to order (Visa/MC/COD) or call or write for **FREE CATALOG** of hard-to-get information about computer viruses, computer hacking, security and cryptography!

American Eagle Publications, Inc.
P. O. Box 1507, Dept. E
Show Low, AZ 85901

CIRCLE 315 ON FREE INFORMATION CARD

PARTS EXPRESS

ELECTRONICS & MORE

FREE 244 PAGE CATALOG



UNBELIEVABLE VALUE!

4 Way Speaker Switch

Control up to 4 pairs of speakers with this compact speaker selector switch. Features circuit protector, heavy duty rocker switches, spring loaded terminals, and silver plated switch connectors. Includes one pair of amplifier inputs. Load to amplifier is minimum 4 ohms (with 8 ohm speakers) or 220 ohms with all speakers switched off. Net weight: 1 lb.

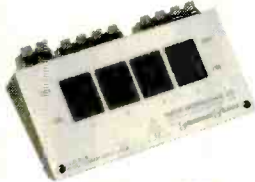

WAS \$22⁵⁰ EACH NOW \$15⁰⁰ EACH

#EN-309-030

"The Sound Bridge" FM Stereo Wireless Transmitter

The Sound Bridge is a mini FM wireless transmitter that can be used to broadcast stereo sound from any audio source like portable CD players, TVs, electronic games, CD-ROM, even computer soundcards, to your home stereo receiver! Adjustable from 89 to 95.5 MHz.



HOT NEW ITEM!

\$14⁹⁵ EACH

#EN-249-220

Weller Professional Irons

Weller



Perfect for a variety of electronic soldering work, this top quality iron features a long life, double coated tip and a quick change, plug-in heater element. Lightweight handle includes a comfortable cushioned grip. Net weight: 1/2 lb.

#EN-372-110 (25 Watt) \$30⁹⁰ (1-3) \$28⁵⁰ (4-UP)
 #EN-372-112 (35 Watt) \$38⁹⁰ (1-3) \$34⁹⁵ (4-UP)

Home Theatre In-Floor Subwoofer

To fully appreciate the potential of movie soundtracks, a dual voice coil subwoofer is a must! Many film special effects are extremely demanding in the low frequency range and require a subwoofer that can duplicate explosions, earthquakes, even the footsteps of Tyrannosaurus Rex!

This subwoofer fits the bill by featuring a 10" dual voice coil woofer for true stereo operation and high pass filters for your main speakers. The most unique feature of this subwoofer is the fact that it is designed to be mounted in between the floor joists in new and existing home constructions. Simply mount the in-floor sub to the joists and mount a heat register grill above opening in subwoofer front enclosure. The subwoofer is now totally out of view and ready to rumble! Includes detailed installation manual.

Specifications: 10" dual voice coil treated paper cone woofer with poly foam surround ◆ Frequency response: 30-100 Hz ◆ Nominal impedance: 8 ohms per coil ◆ Power handling: 100 watts RMS channel/140 watts max ◆ SPL: 89 dB 1W/1m ◆ Dimensions: 27" D x 14-5/8" W x 9" H ◆ Net weight: 29 lbs.

#EN-300-445

\$139⁹⁵ EACH

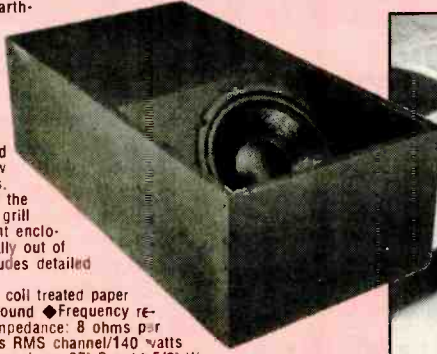

Peak Instrument Co.

"The Woofer Tester"

Peak Instrument Co. proudly introduces "The Woofer Tester". Just ask any loudspeaker engineer, and they will tell that the only way to design enclosures of the correct size and tuning is to measure the Thiele-Small parameters for the actual drivers to be used. The reason? Manufacturers published specs can be off by as much as 50%! But until now, measuring the parameters yourself required expensive test equipment and tedious calculations, or super expensive measurement systems (\$1,200 to \$20,000). The Woofer Tester changes all that. Finally, a cost effective, yet extremely accurate way to derive Thiele-Small parameters, in only minutes! The Woofer Tester is a combination hardware and software system that will run on any IBM compatible computer that has EGA or better graphics capability and an RS232 serial port. The Woofer Tester will generate the following parameters: Raw driver data: Fs, Qms, Qes, Qrs, Vas, BL, Re, Le, SPL @ 1W/1m, Mmd, Cm, and Rm. Sealed box data: Fsb and system Q. Vented box data: Fsb, ha, alpha, and Q loss. The Woofer Tester system includes hardware, test leads, serial cable, AC wall adaptor, detailed instructions, and software.



UNIQUE AND ACCURATE MEASURES F_s Q_{ms} Q_{es} Q_{rs} V_{as} B_L R_e L_e SPL @ 1W/1m M_{md} C_m and R_m IN MINUTES!

◆ 30 DAY MONEY BACK GUARANTEE
 ◆ 1 YEAR WARRANTY ◆ SAME DAY SHIPPING

#EN-390-800

\$249⁰⁰ EACH

900 MHz Wireless Speaker System

- ◆ 900 MHz technology sends signal up to 180 ft., through walls, floors and ceilings.
- ◆ Ideal for use as rear surround speakers or for adding wireless sound to every room in the house!
- ◆ Full range, bass reflex design with built-in high power, low distortion amplifier.
- ◆ Weather resistant cabinet for outdoor use.
- ◆ Selectable battery (six C size for each speaker) or AC operation, adaptor included. Built-in recharging circuitry for ni-cad batteries.
- ◆ System includes: 900 MHz transmitter, wireless speaker pair, AC adaptors, and all cables necessary to hook up system.
- ◆ Limited availability. ◆ Net weight: 9 lbs.
- ◆ Frequency response: 20-18KHz.



#EN-319-030

\$169⁹⁵ EACH

Dayton Loudspeaker Co.®



◆ 30 day money back guarantee ◆ \$20.00 minimum order
 ◆ We accept Mastercard, Visa, Discover, and company C.O.D. orders
 ◆ 24 hour shipping ◆ Shipping charge = UPS chart rate + \$1.90 (\$5.00 minimum charge) ◆ Hours 8:00 am - 8:00 pm ET, Monday - Friday ◆ 9:00 am - 5:00 pm Saturday. Mail order customers, please call for shipping estimate on orders exceeding 5 lbs. ◆ Foreign destination customers please send \$5.00 U.S. funds for catalog. ◆ Quantity pricing available.

1-800-338-0531

340 E. First St., Dayton, OH 45402-1257
 Phone: 937-222-0173 ◆ Fax: 937-222-4644
 E-Mail: sales@parts-express.com

CIRCLE 262 ON FREE INFORMATION CARD

Printed Circuits in Minutes Direct From LaserPrint!

- 8 1/2" x 11"
* Or Photocopy
**Use standard household Iron or P-n-P Press.
1. LaserPrint*
 2. Press On**
 3. Peel Off
 4. Etch



Use Standard Copper Clad Board
20 Shts \$30/ 40 Shts \$50/ 100 Shts \$100
Visa/MC/PO/Ck/MO \$4 S&H

Techniks Inc.
P.O. Box 463
Ringoes NJ 08551
ph. 908.788.8249 fax 908.788.8837
http://chelsea.los.com/~techniks
Retail Dealer Inquiries Invited

7 SECOND IC REMOVER

Remove 100's of good IC's per hour
Won't damage IC's or circuit boards



8 Desoldering Tools
(Remove 6 thru 40 pin IC's) \$ 89.95
10 Desoldering Tools
(Remove 6 thru 64 pin IC's) \$114.95

FRANKS ELECTRONICS

P. O. BOX 357 — GLEN, MISS. 38846
Orders By Mail Only. No COD's.

SC552ES CONTROLLER

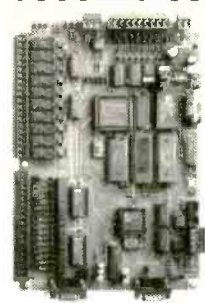

- 80C552 @ 22MHz
- Enhanced BASIC Language
- 6"x9" circuit board
- 10 5A relay outputs
- 3 LED or logic outputs
- 16 opto-isolated inputs
- 8 ch. 10 bit analog inputs
- 2 ch. 8 bit analog outputs
- Real Time clock/calendar
- 128K Static RAM
- 128K FLASH memory
- 256 byte serial EEPROM
- 3 serial ports (RS232/485)
- 1K bus expansion
- Plug-on I/O terminal blocks
- Single 12Vdc operation

APPLICATION
READY ONLY



\$349.95



519 Richard Street, Thunder Bay, Ontario, Canada P7A 1R2
Ph. 807-768-2487 Fax 807-767-0587
www.sylvacontrols.com info@sylvacontrols.com

UPGRADE YOUR COMPUTER!

VISA/MC
Welcome!

TECHNOLOGY ASSOCIATES

959 W. 5th St. • Reno, NV 89503
(702) 322-6875 • Fax (702) 324-3900

www.techass.com • sales@hoopsware.com

Memory	Hard Drives	Modems
4Mb (4x8-70 ns) \$18	WD 1.2Gb IDE \$185	33.6 Int Fax/Modem \$65
4Mb (1x32-60 ns) \$20	WD 1.6Gb IDE \$200	33.6 Int USR Fax/Modem PNP \$140
8Mb (2x32-60 ns) \$34	WD 2.1Gb IDE \$215	33.6 Ext USR Fax/Modem PNP \$170
16Mb (4x32-60 ns) \$55	WD 2.5Gb IDE \$230	33.6 Int USR Fax/Modem w/voice \$185
32Mb (8x32-60ns) \$105	WD 3.2Gb IDE \$245	56K Int Super Fax/Modem w/voice \$150
32Mb (4x64-10ns) \$120	WD 4.3Gb IDE \$325	

Video Cards	Sound Cards
256K ISA VGA \$24	16-bit Sound Blaster \$55
TriMedia 8900 1Mb ISA SVGA \$32	Sound Blaster 32 PNP \$90
Cirrus Logic S429 1Mb VLB SVGA \$38	Sound Blaster AWE value \$105
Trident 9680 1Mb PCI SVGA w/MPEG \$38	

Motherboards	Controller Cards
1.44Mb FDD \$28	ISA Multi I/O IDE \$34
1.2Mb FDD \$55	FDC 2S/1P/1G \$13
8X CD-ROM IDE \$70	PCI Adapter 2940 \$200
16X CD-ROM IDE \$90	SCSI-2 fast \$200
HP T3000 3.2 gb tape backup \$205	
3-button serial mouse \$9	
101-keyboard \$16	

Prices and availability subject to change without notice.
CALL FOR DAILY LOW PRICES!

ADAPT-11 68HC11 Modules for Solderless Breadboards

- miniature 2.0" by 2.8" module
- plug vertically into solderless breadboard for easy development
- BOOT/RUN switch for easy programming via PC serial port
- all I/O lines on dual row connector

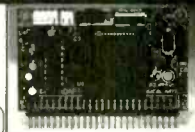

Complete modular prototyping system! Expansion accessories available!

For just US\$74.95, our Starter Package (ADI1SP) provides everything you need to get going fast! Now you can harness the power of the popular 68HC11 in your projects! Includes ADAPT-11 with 68HC11E2, providing 2K EEPROM (re-programmable), 8 channel 8-bit Analog-to-Digital Converter (ADC), hardware timers, counters, interrupts, Serial Peripheral Interface (SPI), Serial Communications Interface (SCI), & more! On-board RS-232 interface (cable included), 5-volt regulator, 8MHz crystal, reset circuit, and convenient program/run switch. Comes with non-commercial versions of HC11 Assembler, BASIC, & C, as well as handy utilities & example code. Includes Motorola 68HC11 Pocket Programming Reference Guide and manual with schematic. All you need is a PC to write & program your software, a DC power supply, and a solderless breadboard (or protoboard) to build your application circuits on (or use our modular accessories).

Visa • MasterCard • American Express • Discover
TECHNOLOGICAL ARTS
309 Aragona Blvd., Suite 102, Box 418, Va. Beach, VA 23462
1644 Bayview Avenue, Box 1704, Toronto, ON M4G 3C2
voice/fax: (416) 963-8996 www.interlog.com/~techart

Slot Machines \$ 449.00



- Free Shipping
- Slot Machine Demo Video \$ 5.99
- 40 - Minutes
- 33" High 20" Wide 14" Deep
- Brochure \$ 1.00
- Magic Box
- Test Chips
- Filter Kits
- Notch Filters

Video Media www.nutnet.com
P.O. Box 93/6025
Margate, FL 33093
(954)-752-9202



Laser Modules

Variety of laser modules from 635 to 830 nm with 5-40 mW output power. World Star Tech. also has TTL modulated laser modules, adjustable focus laser modules, line generators and etc.



Laser Pointer

Pen-size laser pointer has a range of 150-200 yard with high quality laser beam. Ask for laser modules and laser pointers catalog World Star Technologies, Inc. 20 Carlton Str. Unit 1626 Toronto, M5B 2H3 Canada Ph: 416 204 6298 Fax: 416 596 7619 laser@arcos.org You can visit us on http://web.arcos.org/laser

FRIENDLY LITTLE MICRO CONTROLLER



\$149 (single)

...packs a MEAN punch a.k.a. "Steroid Stamp"

- 39 I/O + 8 A/D (10 bit) •
- 128K SRAM + 128K Flash •
- LCD/Keypad Interface •
- Fast 16 bit Motorola CPU •
- Affordable C Compiler •
- Comprehensive s/w Library •

* Intec Automation Inc. v: 250-721-5150
www.islandnet.com/~iii fx: 250-721-4191

Make your own circuit boards at home!!
Don't project-board your electronics circuits. Afford-A-Board them!! Our complete line of circuit board manufacturing equipment lets you create professional single or double-sided circuit boards in your own home. We manufacture affordable, developing, etching and stripping tanks. Afford-A-Board is your source for 2-sided photo-sensitive copperclad board.
12x12 FR4 1 oz. DS \$15.99
Call for our low, low pricing on film chemicals and drill bits.

Afford-A-Board
P.O. Box 32613
Kansas City, MO 64171
Tel: (913) 385-1843
Fax: (913) 895-9330
(800) 847-0157
Visa/AMEX/MC/Cash COD/MO

Any waveform you want!



Starting at

\$795

Quantity 1

Money back guarantee

Telulex Inc. model SG-100

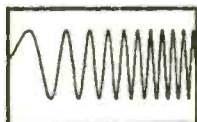

DC to 20 MHz linear and log sweeps

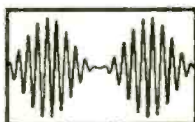

Int/Ext AM, SSB, Dualtone Gen.

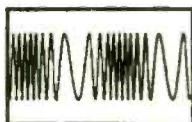

Int/Ext FM, PM, BPSK, Burst

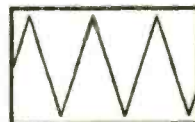

Ramps, Triangles, Exponentials



Pulse Generator



Noise

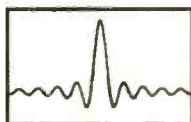

Arbitrary Waveforms

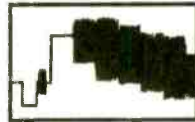

Unlimited Possibilities!

● Synthesized Signal Generator

Clean sinewaves DC-20 MHz with .001% accuracy! .1 Hz steps. DC Offset. RS232 remote control.

● Arbitrary Waveform Generator

40 Megasamples/Second. 32,768 points. 12 bit DAC

● Function Generator

Ramps, Triangles, Exponentials & more to 2 MHz!

● Pulse Generator

Digital waveforms with adjustable duty cycle

Telulex Inc.

2455 Old Middlefield Way S Tel (415) 938-0240 <http://www.Telulex.com>

Mountain View, CA 94043 Fax (415) 938-0241 Email: sales@Telulex.com

CIRCLE 324 ON FREE INFORMATION CARD

NEW

Digital Power Meter



Measures Watts & Watt-hours (kW-hr)

Simple to use. Plug the Power Meter into any 115V AC outlet, and plug the appliance to be measured into the Power Meter. That's it!

- Measure REAL ("true") power 3 to 1850 Watts
- Measure Power used, 1 Watt-hour to 9999 kilo-Watt-hr
- Measure power cost (\$), just enter cost per kilo-Watt-hr
- Microprocessor based circuitry
- 16 character LCD display • 4 button keypad
- Digital processing handles any AC waveform, any power factor
- Lifetime Warranty!

Self Calibrating for excellent accuracy!

Performs the same functions as instruments costing \$500-\$1000!
No other instrument on the market even comes close for this price!!

Only \$149.⁹⁵ Delivered! MC/Visa/MO/Check

To order, call toll free **1-888-433-6600**

Brand Electronics,
421 Hilton Rd.
Whitefield, ME 04353
For information only, call 1-207-549-3401

NEW

Radiotelephone - Radiotelegraph

FCC Commercial License

Why Take Chances?

Discover how easy it is to pass the exams. Study with the most current materials available. Our Homestudy Guides, Audio, Video or PC "Q&A" disks make it so fast, easy and inexpensive. No college or experience needed. The new commercial FCC exams have been revised, covering updated Aviation, Marine, Radar, Microwave, New Rules & Regs, Digital Circuitry & more. We feature the Popular "Complete Electronic Career Guide". 1000's of satisfied customers **Guarantee** to pass or money back. Newest Q&A pools.

Send for **FREE DETAILS** or call **1-800-800-7555**

WPT Publications
4701 N.E. 47th St.
Vancouver, WA 98661

Name _____
Address _____
City _____ St. _____ Zip _____

1-800-800-7555

February 1998, Electronics Now

ELECTRONIX EXPRESS

WELLER SOLDERING STATION - MODEL WLC 100

- Variable power control (5 to 40 watts)
- Replaceable heating element
- Quality light-weight pencil iron

\$36⁹⁵



SOLDERLESS BREADBOARD

830 tie points. MB102PLT model features 3 binding posts and aluminum backplate.

Part No.	1-9	10+
MB102	5.95	5.00
MB102PLT	8.95	8.00



SOLDERING IRON 3-WIRE HIGH PERFORMANCE

#060501

\$5²⁵

SOLDERING IRON STAND W/SPONGE

#060842 **\$3⁵⁰**



DUAL-TRACE OSCILLOSCOPE

Goldstar 9020

20MHZ **\$339⁰⁰**



5 MHZ, DIGITAL DISPLAY

PRECISION FUNCTION GEN. MODEL 4011

\$230⁰⁰



SCOPE PROBE

60 MHZ

SWITCHABLE X1, X10 **\$12⁹⁵**

ALLIGATOR LEADS SET OF 10

\$2¹⁰



DIGITAL MULTIMETER

WITH CAP/FREQUENCY/TRANSISTOR TESTER

Model DM645 **\$34⁹⁵**



SWITCHES

8 POS DIP **60¢ ea.**

Mini Toggle SPDT **50¢ ea.**



HELPING HAND WITH MAGNIFIER

\$3⁵⁰



RESISTOR KIT

1/4W 5% film. 5 pieces each of 73 values. 365 pieces total.

\$3⁹⁵

PAD-234 DIGITAL/ANALOG TRAINER

Complete portable workstation. Variable and fixed power supplies, function generator, digital I/O, rugged design, high impact case.



Assembled **\$150⁰⁰**

Kit **\$110⁰⁰**

HIGH QUALITY TOOLS With Cushion Grips and Return Spring

Needle Nose Pliers **\$2⁹⁵**



Wire Stripper **\$1⁵⁰**



Diagonal Cutter **\$2⁹⁵**



POWER SUPPLIES

0-30 VDC, 0-3 Amp. Built-in current limiting, overload protected, constant voltage and current operation.



01PSGP4303A Analog Display **\$169.00**

01PSGP4303D Digital Display **206.00**

LM555 10 Min.	22¢ ea.
LM741 10 Min.	27¢ ea.
74LS00 10 Min.	18¢ ea.
7805 Regulator 10 Min.	30¢ ea.
2N3904 10 Min.	6¢ ea.
PN2222 10 Min.	6¢ ea.
Red LED T 1 1/4 10 Min.	6¢ ea.
Green LED T 1 1/4 10 Min.	7¢ ea.
Yellow LED T 1 1/4 10 Min.	8¢ ea.
Photo Cell 10 Min.	65¢ ea.
100K Pot., 1" Shaft PC ML 10 Min.	15¢ ea.
CD22402	8.95 ea.

1 LB. 60/40 Solder Roll .031" \$5⁹⁵

DESOLDER PUMP W/TIP #060820 \$3⁵⁰

15 TURN POT 69¢ ea.

Bourms 3006P series. All standard values available.

7 SEG. DISPLAY 60¢ ea.

MAN72 C.ARed 0.3" MAN74 C.CRed 0.3"

FREE CATALOG

MORE Low-Priced Items In Our **FREE** 192-Page Catalog



TERMS: Min. \$20 + shipping. School Purchase Orders, VISA/MC, Money Order, Prepaid. NO PERSONAL CHECKS, NO COD. NJ Residents: Add 6% Sales Tax.

In NJ: 732-381-8020
FAX: 732-381-1572

365 Blair Road • Avenel, NJ 07001-2293

800-972-2225

http://www.elexp.com
Email: electron@elexp.com

CIRCLE 335 ON FREE INFORMATION CARD

"7-WAY COPY CAT \$995.00*"

NEW!
7-Way
StarTac
\$1295.*

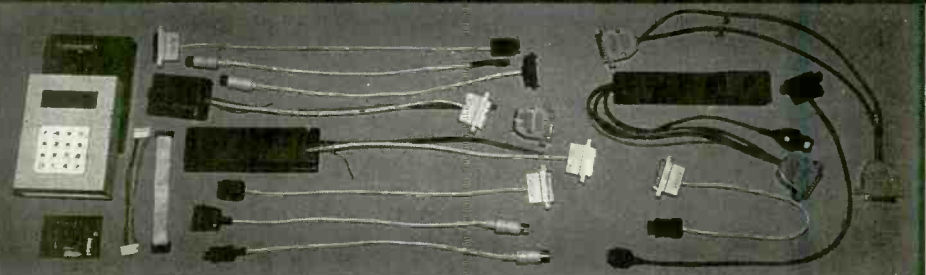

- Does.. 1. MOTOROLA (includes elite and EE3)! 2. NEC (includes P100-200-300-400-600-700)! 3. AUDIOVOX (does new 800 & 850)! 4. PANASONIC! 5. SONY (H333)! 6. MITSUBISHI-DIAMONDTE.L! 7. GE-ERICSSON (includes new version)!

We offer complete upgrade options on older units as well as new and replacement cables. We also offer used and refurbished units. For a complete catalog, visit us on the web at www.celltec.com

Upgrade
Your Old Copy
Cat **NOW**
to a **7-Way**
with **EE3**
& **StarTac**

*cables optional

All units are sold for **EXPERIMENTAL AND EDUCATIONAL PURPOSES ONLY!**

CALL US TODAY AT 770.973.8474

CIRCLE 313 ON FREE INFORMATION CARD

ALL ELECTRONICS

C O R P O R A T I O N

QUALITY PARTS

FAST SHIPPING

DISCOUNT PRICING

CALL, WRITE, FAX
or E-MAIL For A
Free 96 Page
CATALOG.
Outside the U.S.A.
send \$3.00 postage.

60 Watt Switching Supply

Mfg. by Sony for Sun Microsystems # APS-28
Input: 100-240 vac.
Output: 5 vdc @ 4.5 A
and 12 vdc @ 4 A

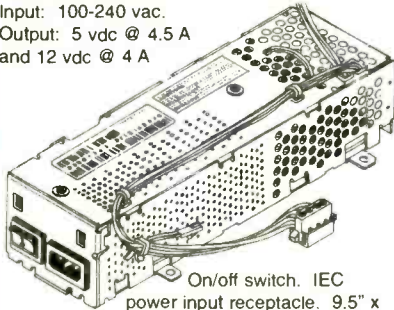

On/off switch. IEC power input receptacle. 9.5" x 2.56" x 2.5". UL, CSA listed.

CAT #PS-60 **\$12⁰⁰** each

Ferrite Bead

TDK # HF70RH 16X28X9
1.1" x 0.63" od x 0.35" id.

CAT # FB-24 \$1.00 each
10 for \$8.50 - 100 for \$70.00



SUPER SAVINGS ON S-VHS TAPES (USED)



Super VHS tape users! Save a bundle on name-brand S-VHS, T-120 tapes. These tapes were used for a brief period, then bulk erased. The record-protect tabs have been broken out, so you will have to cover the notch with a piece of tape, but they work great and cost a fraction of the "new" price. Try some, you'll be back for more.

CAT #S-VHS **\$3⁰⁰** each

10 for \$28.00 • 100 for \$250.00

Shielded Woofer

Designed for use in Infinity center channel video sound systems. These well constructed woofers have shielded magnets to prevent interference with picture quality.

5 1/4" 6 OHM
1" voice coil. 8 oz. magnet. 50 watts max power. 3.125" deep.

CAT # SK-7346

\$10⁰⁰ each

12 for \$96.00

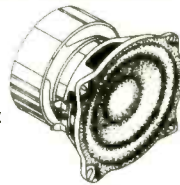

Low Power Audio Amp

Motorola MC34119P

Low power audio amplifier suitable for speaker phones or talking picture frames. The 8 pin DIP package requires only a few additional parts, operates on 2 - 16 volts and drives speakers of 8 ohms or greater. Output power exceeds 250 mW with 32 ohm speaker. Power-down option saves power in battery driven applications. Hook-up sheet.

Large quantity available.

CAT # MC34119P

50¢ each

50 for \$20.00
500 for \$150.00

3 Volt Lithium Coin Cell with PC Leads

Panasonic # BR2330-1GU

3 volt, 255 mAh coin cell. Lithium batteries have a very long shelf life and are great for memory back-up protection. 0.9" diameter x 0.12" thick. 0.7" between positive and negative pc leads.

VERY SPECIAL PRICE
LARGE QUANTITY AVAILABLE

75¢ each

CAT #LBAT-16

20 for \$12.00
100 for \$45.00
1000 for \$300.00



High Brightness FLASHER LEDs

T 1 3/4 (5mm) high brightness RED LEDs with built-in flasher unit.

3-5 Vdc operation

CAT # LED-4 2 for 90¢

100 for \$40.00

1000 for \$300.00



12 Volt LEDs

T 1 3/4 (5mm) diffused LEDs. Connect directly to 12 Vdc (max. 15 Vdc). No resistor necessary.

RED CAT# LED-100

2 for \$1.00 - 10 for \$4.00

GREEN CAT# LED-200

2 for \$1.00 - 10 for \$4.00

YELLOW CAT# LED-300

2 for \$1.20 - 10 for \$5.00



Light Activated Intrusion Alarm

Leviton "Snapit-Alert"

830-51031

This handy light activated alarm buzzes intermittently when exposed to light. Use it in desk drawer, gun rack, medicine cabinet, refrigerator, school locker or file cabinet to prevent children or unwanted intruders from being where they don't belong. Red plastic case with self-adhesive Velcro backing. 2.5" x 3" x 0.84". Operates on 9 volt battery (not included). Good-looking retail packaging.



\$2⁵⁰ each

CAT# SNA-2

10 for \$20.00

ORDER TOLL FREE

1-800-826-5432

MAIL ORDERS TO
ALL ELECTRONICS CORP.
P.O. BOX 567
VAN NUYS, CA 91408-0567

FAX (818) 781-2653 • INFO (818) 904-0524
INTERNET <http://www.allcorp.com/>
E-MAIL allcorp@allcorp.com

NO MINIMUM ORDER • All Orders Can Be Charged to Visa, Mastercard, American Express or Discover • Checks and Money Orders Accepted by Mail • Orders Delivered in the State of California must include California State Sales Tax • NO C.O.D. • Shipping and Handling \$5.00 for the 48 Continental United States • ALL OTHERS including Alaska, Hawaii, P.R. and Canada Must Pay Full Shipping • Quantities Limited • Prices Subject to change without notice.

MANUFACTURERS - We Purchase EXCESS INVENTORIES... Call, Write, E-MAIL or Fax YOUR LIST.

CIRCLE 214 ON FREE INFORMATION CARD

The Only 100% Legal, FCC approved,
DESCRAMBLER you can buy!

NAVIGATOR II

Booth #3752
 In 4 VCC at
 Winter CES

The only legal way to own your converter!

- 250 Channel Capacity
- Subscribe to two different cable systems simultaneously
- Interactive On-Screen Display
- Watch one premium channel while recording another
- Electronic program guide shows all programming over next 7 days
- One Touch Recording

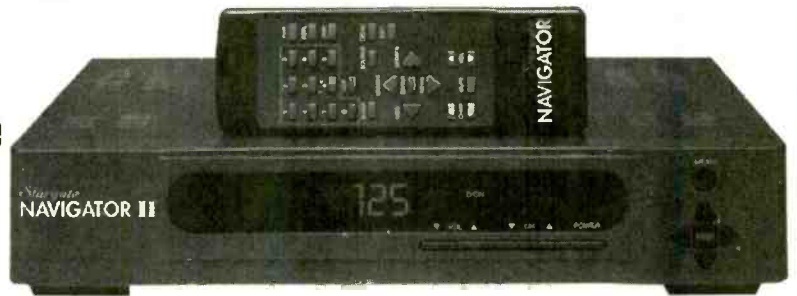

NO RENTAL FEES!
Advanced Features!

Most advanced set-top you can buy!

Save Money!

FCC & UL Approved

DYNAMIC Technologies • Phone: 402-731-9555

Suite 541064 • Boystown, NE 68154

CIRCLE 312 ON FREE INFORMATION CARD

NEW! Cellphone E.S.N. readers \$250 each, cell phone programmers \$175 each, cell phones \$25 each, DSS satellite dish card readers and programmers \$125 each, credit card readers \$250 each, Cable T.V. notch filters 50 cents each, converter boxes \$50 each, magnetic strip card readers for ATM machines, bank cards, drivers license, and all types of data acquisitions all under \$200 each. You pay these super low prices when you deal directly with the manufacturers. When you order "Direct Connection" a 150 page directory published by Ed Treki Publications, you will receive the largest collection of names, addresses, and phone numbers of all the leading American and International manufacturers of these products never before available. Stop paying second, third and fourth hand prices and deal directly with the source!!! Order your copy of "Direct Connection" today for only \$99.95 plus \$5 shipping. All orders are sent C.O.D. Please call Ed Treki Publications 24 hour order hot line 914-544-2829.

Where would Hansel and Gretel be without a forest?

Only You Can Prevent Forest Fires.



USA Forest Service and your State Forester.

ELECTRONIC GAMES

BP69—A number of interesting electronic game projects using IC's are presented. Includes 19 different projects ranging from a simple coin flipper, to a competitive reaction game, to electronic roulette, a combination lock game, a game timer and more. To order BP69 send **\$8.00 (includes s&h)** in the US and Canada to **Electronic Technology Today Inc., P.O. Box 240, Masapequa Park, NY 11762-0240.** US funds only. Use US bank check or International Money Order. Allow 6-8 weeks for delivery.

Electronic Games



MA07



Wireless Video Headquarters



The Cube



World's Smallest TV Transmitter

Perfect video transmission from a transmitter you can hide under a quarter and only as thick as a stack of four pennies- that's a nickel in the picture! Transmits color or B&W up to 150' to any TV tuned to cable channel 59 with a solid 20 mW of power. Crystal controlled for no frequency drift with performance that equals law enforcement models that cost hundreds more! Deluxe model includes sound using a sensitive built-in mike that will hear a whisper 15 feet away! Units run on 9 volts and hook-up to most any CCD camera. Our cameras shown below have been tested to mate perfectly with The Cube and work great. Fully assembled.

- C-2000 Video Transmitter Cube**.....\$89.95
C-3000 Video and Audio Transmitter Cube.....\$149.95



CCD Video Cameras

If you're looking for a good quality CCD board camera, stop right here! Our cameras use top quality Japanese Class 'A' CCD arrays, not the off-spec arrays that are found on many other cameras. You see, the Japanese suppliers grade the CCDs at manufacture and some manufacturers end up with the off-grade chips due to either cost constraints or lack of buying 'clout'. These cameras have nice clean fields and excellent light sensitivity, you'll really see the difference, and if you want to see in the dark, these are super IR (Infra-Red) sensitive! Available with Wide-angle (80°) or super slim Pin-hole style lens. Both run on 9 VDC and produce standard 1 volt p-p video. Add one of our transmitter units for wireless transmission to any TV set, or add our Interface board (below) for Audio sound pick-up and direct wire connection to any Video monitor or TV video/audio input jacks. Fully assembled.

ers grade the CCDs at manufacture and some manufacturers end up with the off-grade chips due to either cost constraints or lack of buying 'clout'. These cameras have nice clean fields and excellent light sensitivity, you'll really see the difference, and if you want to see in the dark, these are super IR (Infra-Red) sensitive! Available with Wide-angle (80°) or super slim Pin-hole style lens. Both run on 9 VDC and produce standard 1 volt p-p video. Add one of our transmitter units for wireless transmission to any TV set, or add our Interface board (below) for Audio sound pick-up and direct wire connection to any Video monitor or TV video/audio input jacks. Fully assembled.

- CCDWA-2 CCD Camera, wide-angle lens**.....\$99.95
CCDPH-2 CCD Camera, slim fit pin-hole lens.....\$99.95

CCD Camera Interface Board

Here's a nifty little kit that eases hook-up of your CCD camera module to any video monitor, VCR or video input TV set. The board provides a voltage regulated and filtered source to power the camera (CCD Cameras require a stable source of power for best operation), sensitive electret condenser mike for great sound pick-up and RCA Phono jacks for both audio and video outputs. Runs on 11 - 20 VDC.

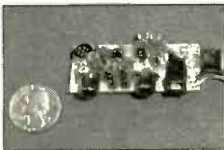

- IB-1 Interface Board Kit**.....\$14.95

Budget TV Transmitter



Transmit audio and video to any TV set with this fully assembled transmitter. Although not tiny, it still offers some neat features. Takes standard 1 volt p-p video and audio and transmits on any UHF TV channel of your choice from 17 - 42. Has rugged metal case, includes AC adapter, whip antenna and even RCA phono plug patch cords! Can also run on 12 VDC.

- VS-2 Video and Audio Sender, Fully Assembled**.....\$29.95

IR Illuminator for CCD Cameras

See in total darkness with one of our CCD video cameras and this IR illuminator! IR light can't be seen, illuminate the scene with IR and a CCD camera 'sees' just fine. The array of 24 extra high intensity LEDs are invisible to anybody - except for aliens and Casper! Runs on 12 VDC. Illuminates similar to that of a bright flashlight.



- IR-1 IR Illuminator Kit**.....\$24.95

MicroEye CCD Camera & Transmitter Combo

We married together one of our quality CCD cameras, a sensitive electret microphone and a small TV transmitter to give you a super neat - and tiny - all in one, 'knows all, sees all, hears all' package!



Small enough to fit into a cigarette pack and powerful enough to transmit up to 150' to any standard TV set. Tunable to operate on TV channels 4, 5, or 6 and runs on 9 to 20 VDC. The sensitive mike picks up normal voice within an average size room. Ideal for private detectives, investigators, hobbyists, babysitters, model rocketeers, RC airplanes and other uses limited only by your imagination. Camera module is fully wired and the transmitter unit is an easy to build kit that goes together in an evening. Includes all parts, handsome jet-black case and clear, concise instructions with ideas for use. And, don't forget, our CCD cameras are very sensitive to IR light - just add the IR-1 IR Illuminator kit for see-in-the-dark operation!

- ME-2000 MicroEye TV Transmitter Combo**\$149.95

Wavecom Wireless Video and Audio Transmission System

Transmit extremely clean and sharp video and audio up to 300 feet.



Wavecom transmits in the 2.4 GHz band using FM and circular polarization for state-of-the-art transmission. There is no fading, ghosting, humming, buzzing or picture rolling when using the Wavecom. System consists of two parts, a transmitter unit and a receiver unit. Switch selectable 4 channel operation allows use of multiple Wavecoms in the same geographic area. Connections are video and audio in and out using standard RCA phono jacks. Includes AC wall plug adapters, patch cords, coax cable jumper, TV antenna A/B switch and complete hook-up instructions. Fully assembled with one year warranty.

The Wavecom Sr. has all of the features above plus adds the capability of transmitting your TV/DSS/VCR remote control signals from the receiver unit back to the transmitter unit. This is great for controlling your DSS satellite receiver or VCR from any room in the house. We also offer the small internal transmitter module assembly for those who wish to make their own concealed video transmitter system. Module is about the size of a couple of matchboxes and includes microwave patch antenna.

- WC-1 Wavecom Jr. Wireless System**.....\$189.95
WC-5 Wavecom Sr. with Remote Capability.....\$239.95
WC-TX Transmitter Module Assembly.....\$105.00



RAMSEY ELECTRONICS, INC.

793 Canning Parkway Victor, NY 14564

Call for our free catalogue or visit us on the web: www.ramseyelectronics.com

Toll-free Order Service: 1-800-446-2295

Sorry, no technical info or order status at this number

For Tech Info or Order Status, Call the Factory Direct

Phone (716) 924-4560

Fax (716) 924-4555



ORDERING INFO: Satisfaction Guaranteed. Examine for 10 days, if not pleased, return in original form for refund. Add \$5.95 for shipping, handling and insurance. Orders under \$20, add \$3.00. NY residents add 7% sales tax. Sorry, no CODs. Foreign orders, add 20% for surface mail or use credit card and specify shipping method.



EZ-EP DEVICE PROGRAMMER - \$169.95

Check Web!! -- www.m2l.com

Fast - Programs 27C010 in 23 seconds

Portable - Connects to PC Parallel Port

Versatile - Programs 2716-080 plus EE and Flash (28F, 29C) to 32 pins

Inexpensive - Best for less than \$200

- Correct implementation of manufacturer algorithms for fast, reliable programming.
- Easy to use menu based software has binary editor, read, verify, copy, etc. Free updates via bbs or web page.
- Full over current detection on all device power supplies protects against bad chips and reverse insertion.
- Broad support for additional devices using adapters listed below.

Available Adapters

EP-PIC (16C5x, 61, 62x, 71, 84)	\$49.95
EP-PIC64 (62-5, 72-4)	\$39.95
EP-PIC12 (12C50x)	\$39.95
EP-PIC17 (17C4x)	\$49.95
EP-51 (8751, C51)	\$39.95
EP-11E (68HC11 E/A)	\$59.95
EP-11D (68HC711D3)	\$39.95
EP-16 (16bit 40pin EPROMs)	\$49.95
EP-Z8 (286E02, 3, 4, 6, 7, 8)	\$39.95
EP-SEE2 (93x, 24x, 25x, 85x)	\$39.95
EP-750 (87C750, 1, 2)	\$59.95
EP-PEEL (ICT22x10, 18v8)	\$59.95
EP-1051 (89C1051, 2051)	\$39.95
EP-PLCC (PLCC EPROMs)	\$49.95
EP-SOIC (SOIC EPROMs)	\$49.95

M²L Electronics

310/837-7818 Fax/BBS: 310/841-6050
3528 Jasmine #4; Los Angeles, CA 90034
CA orders add 8.25% sales tax.
<http://www.m2l.com>

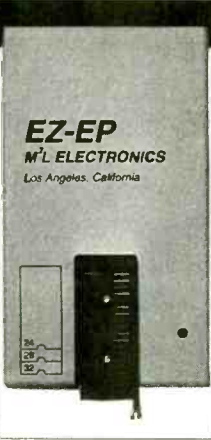

STRANGE BOOKS! for Mad Scientists!

Unusual, detailed how-to books, manuals, references, old & new, for experimenters and

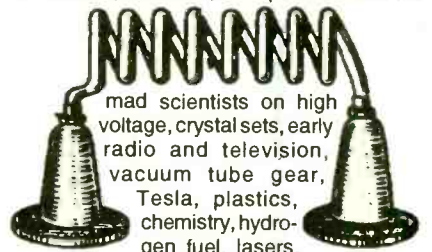

mad scientists on high voltage, crystal sets, early radio and television, vacuum tube gear, Tesla, plastics, chemistry, hydrogen fuel, lasers,

whiskey, solar cells, embalming, telegraphy, more! Highest quality! Guaranteed! Write (or send Igor) for big illustrated catalog! <http://www.keynet.net/~lindsay> fax: 815/935-5477

Lindsay's Technical Books

PO Box 538-EBD, Bradley IL 60915

3 Axis Motion Control System Complete, ready to run

\$ 255.50 + 12.00 S/H

Build or adapt CNC mills, CNC routers, Robots, Etc. Includes: 3 Stepping motors (70 oz/in 200 steps/rev). External board (connects to parallel port of a PC). Power supply. Cables, Manual and the MAXNC drive software, with linear, circular and helical interpolation, acceleration deceleration, full contouring, 'G' code programming, screen plot, code generation from CAD (CAM), and more.

For more information,
phone or write to:

MAXNC

6509 W. Frye Rd. Suite 3
Chandler AZ 85224
Ph (602) 940-9414
Fax (602) 940-2384

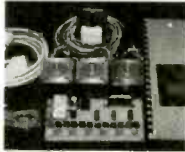

ELECTRONIC EAVESDROPPING EQUIPMENT DESIGN

By Winston Arrington

This revised edition contains 117 schematics and text of our production equipment. 29 Crystal transmitters, 35 Room, 32 Telephone, 15 Subcarrier. Countermeasures equipment, and much more. Request a free detailed explanation sheet of contents.

PRICE: \$65.00 + S.H. \$6.00.

SHEFFIELD ELECTRONICS CO.

P.O. BOX 377940-C, CHICAGO, IL 60637-7940
TEL. (773) 324-2196

Code: 377940-C

ELECTRONIC COMPONENTS

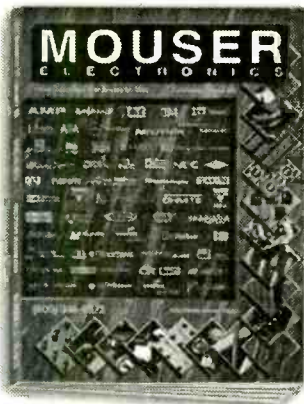

Call for your **FREE** 364
page catalog TODAY!

- 70,000+ Products
- 135 Manufacturers
- Same Day Shipping
- No Minimum Order

800-992-9943

817-483-6828 Fax: 817-483-0931
www.mouser.com catalog@mouser.com

958 North Main St., Mansfield, TX 76063

Hexapod Walker Kit

\$150.00

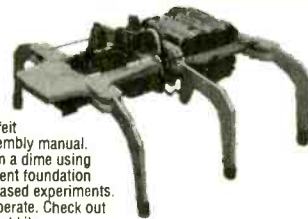

Build your own functional Hexapod Robot

The kit comes complete with all hardware, structural components, 3 Hitec servos, Counterfeit Basic Stamp kit, software and an illustrated assembly manual. This robot can walk forward, reverse and turn on a dime using the alternating tripod walking gait. It is an excellent foundation for many artificial intelligence and behavioural based experiments. It is a lot of fun to build and even more fun to operate. Check out our web site for more information and other robot kits.

• 12 Servo Hexapod \$375.00 • Infrared Proximity Det \$30.00 • Mobile Robots Book \$48.00

Quantity discounts available. \$7.50 Shipping & Handling for USA, call for international and quantity shipping charges. IL residents add 6.25% sales tax to total.

Many more robot kits, ask for our free catalog!

Technical Service & Solutions
104 Partridge Road
Pekin, IL 61554-1403 USA



Tel: 309-382-1816
Fax: 309-382-1254
www.lynxmotion.com
jfrye@lynxmotion.com

The Electronic Experimenter's Journal

It's part catalog, part magazine and part data book with kits, parts, plans, articles, and application notes.

Call for your **FREE**
copy today

Debco Electronics
4025 Edwards Rd.
Cincinnati, OH 45209

1 800 423 - 4499

BUGGED??

EAVESDROPPING is unbelievably widespread! Electronic devices with amazing capabilities can be monitoring your telephone and room conversations RIGHT NOW! Are you sure you're safe? **FREE CATALOG tells you fast!** Includes Free Bonus details on fantastic opportunities now open in Counter-Surveillance field. Exciting, immensely interesting and EXTREMELY profitable (up to \$250/hr) full/part-time income. Call Now!
1-800-732-5000



Take
Stock
in America

U.S. SAVINGS
BONDS



A public service of this magazine

Do You Repair Electronics?

Repair Databases for
TV, VCR, Monitor, UL
Audio, FCC, and more.

- Over 75,000 records
- Private user forums
- Live on-line chat rooms

www.electronix.com

Electronix Corp 313 W Main St. Fairburn, OH 45324 (937) 878-9875

* Do-It-Yourself Electronic Kits *

Mark V Electronics, Inc.
8019 E. Slauson Ave.,
Montebello, CA 90640

http://www.mark5co.com
Email: mark5co@aol.com

1/2
Shipping
Order over \$ 100
!!!

Catalog & Information
213/ 888-8988
Fax 213/ 888-6868

ORDER 1-800-521-MARK / 1-800-423-FIVE

Kit skill levels ▲ beginner ▲▲ intermediate or ▲▲▲ advanced!

Clearance Sale



Kit \$ 12.50 6.99

TY-35
This is a low power real FM transmitter. Transmit frequency within 88-108 MHz. Transmit range about 200 ft. It has high sensitivity sound pickup by a capacitance microphone. May be used strictly for series purposes such as remote wireless monitoring.

Clearance Sale



Kit \$ 7.85 4.85

TA-001
It employs high stability power IC & has a build in temperature compensating system. It has large power output & output & good distortion characteristic. Accept various magnetic & capacitor micro-phone input & other line input. 6-16V DC.

Stereo Loudspeaker Protector



Kit: \$ 16.75

TY-25 ▲ Super fast acting relay protects speakers against destructive DC voltages. Can connect directly to a power amplifier or can use a separate power supply. Has a 3 second turn-on delay to avoid turn-on thumps.

Regulated DC Power Supply



Kit: \$ 18.75

TR-503 ▲▲ It is short circuit proof and has overload protection. Output voltage is variable over a range of 0-50 volts. Current limit trip is adjustable up to max of 3A. May use Mark V #002 transformer.

120-250W Mosfet Power Mono Amplifier AF-2 (6 lbs.) ▲▲



Kit: \$ 89.80 82.80 Asmb.\$ 114.80

Power Output: 250W into 4 ohms RMS(42VX2 6A transformer is used). 120W into 4 ohms RMS(33VX2 4A transformer is used). Frequency Response: 3Hz-22,000Hz. THD: <0.03%. Signal to Noise Ratio: 91dB. Sensitivity: 1V RMS at 47k. Load Impedance: 4 or 8 ohms. Power Requirement: ±46VDC 4A or ±60VDC 6A. May use Mark V model 012 Transformer. Suggested Capacitor 8,200uf 100V Model 020. Suggested Metal Cabinet LG-1925.

300W High Power Mono Amplifier TA-3600 (5 lbs.) ▲▲▲



82.00
Kit \$ 90.00
Asmb.\$ 115.00

Power Output: 300W into 8 ohms RMS. 540W music power into 8 ohms. Frequency Response: 10Hz-20KHz. THD: < 0.05%. Sensitivity: 1V RMS at 47K. Power Requirement: 60 to 75 VDC at 8A. May use Mark V Model 007 or 009 Transformer. Suggested Capacitor: 8,200uf 100V AC Model 020 Capacitor. Suggested Metal Cabinet LG-1925.

120W + 120W Pre & Main Stereo Amplifier TA-800MK2 (4 lbs.) ▲▲



Kit \$ 67.92 Asmb.\$ 86.95

Power Output: 120W into 4 ohms RMS. 72W into 8 ohms RMS. Frequency Response: 10 - 20 KHZ. THD: < 0.01%. Tone Control: Bass ±12dB, Mid ±8dB, Treble ±8dB. Sensitivity: Phono Input, 3mV into 47K. Line, 0.3V into 47K. Signal to Noise Ratio: 86dB. Power Requirement: 40V DC @ 6A. May use Mark V Model 001 or 008 Transformer. Suggested Metal Cabinet Model LG-1924.

80W + 80W Pure DC Stereo Main Power Amplifier TA-802 (4 lbs.) ▲▲



Kit: \$ 49.94
Asmb.\$ 69.94

Power Output: 80W per channel into 8 ohms. THD: < 0.05%. Frequency Response: DC to 200 KHZ, -0 dB, -3dB @ 1W. Power Requirement: 30V AC X 2 @ 6A. May use Mark V Model 001 or 008 Transformer. Suggested Capacitor 8,200uf 50V Model 017. Suggested Metal Cabinet LG-1924

30W + 30W Pre & Main Stereo Amplifier TA-323A (1 lb.) ▲



Kit: \$ 32.50 Asmb.\$ 50.50

Power Output: 30W into 8 ohms RMS per channel. THD: < 0.1% from 100 HZ to 10 KHZ. Sensitivity: Phono 3mV @ 47K. Tuner, Tape 130mV @47K. Signal to Noise ratio: 80dB. Power Requirement: 22 to 36V AC, 3A. May use Mark V Model 002 Transformer. Suggested Cabinet LG-1684.

Metal Cabinets

Aluminum Front Panel

LG-1273	3x12x7"	(4 lbs.)	\$ 26.50
LG-1684	4x16x8"	(7 lbs.)	32.50
LG-1924	4x19x11½"	(10 lbs.)	38.25
LG-1925	5x19x11½"	(10 lbs.)	42.00
LG-1983	2½x19x8"	(7 lbs.)	35.25

Transformers (5-12 lbs.)

**Toroidal Transformers



# 001	28V/30V x2	6A	\$ 30.00
# 002	36V x2	3A	25.00
# 003	40V x2	6A	32.00
# 008**	28V/30V x2	6A	42.00
# 009**	48/53V x2	8A	68.00
# 012**	33/40/42V x2	6A	52.00

Minimum order: \$ 20.00. We accept Visa, MasterCard, Money Orders, and Checks(allow 2 weeks for clearance). We ship by UPS ground inside US (min \$6.00) and ship by US mail outside US. Please call our operator for orders over 2 lbs. or foreign orders.

SCHOOL PROJECT CORNER

po orders welcomed from schools

Melody Generator	▲	Kit \$ 13.85
6W Mini-Amplifier	▲	9.50
0-15V 5A Regulated DC PS	▲	17.50
36W Class A Power Amp.	▲▲	32.50
Dynamic Noise Reduction	▲	26.00
Multi-Function Control Switch	▲	10.50
20 Bar/Dot Level Display	▲▲	41.45
Microphone Mixer Mono Amp.	▲	20.79
Superior Electronic Roulette	▲	21.50
Digital Clock with Melody Alarm	▲	25.00
Stereo Pre-Amp with Mic Amp.	▲	10.78
Mini Stereo Multi-Input Amp.	▲	30.50
130-in-one Electronic Lab		29.99

SEE OUR CATALOG FOR MORE KITS !

Fluorescent Light Driver



Kit: \$ 14.75

TY-2 ▲ (1 lb.) This unit drives 6-40 watts fluorescent light for portable and emergency use. Works from a 7.2 - 16 VDC battery. Includes a "Hi-Efficiency Switching Mode IC Driving Circuit" suitable for use with different lights.

30-in-one Electronic Lab Kit

KA-901 \$ 15.99
12.99



No soldering is required! This simple electronics kit safely teaches the fundamentals of electronics. Build a radio, alarm, timer and more. Earphone

for private listening. Uses safe battery power. Requires 4 "AA" batteries!

150MHz 8 Digit Frequency Counter

SM-100 (2 lbs.)



Kit: \$ 79.00 68.00
Asmb.\$ 99.00

It is used for adjustment, test & repair of any kind of high frequency circuit products. It can give up to 8 digit of resolution for a wide frequency range 10Hz - 150 MHz. The last input frequency can HOLD on the display for future reference & comparison. The circuit structure is compact & reliable for the most updated A/D LSI circuitry. The input impedance is 1M ohm.

60+60W Stereo Power Amp. ▲▲

SM-302 (11 lbs.)



Kit: \$ 85.00

It provides 3 input jack pairs. One pair accept a high impedance micro-phone. The two remaining pairs are for high & low level input sources. Power Output: 60W per channel into 4 ohms RMS. 20Hz-20KHz. THD:<0.1%. Input Sensitivity: Mic /Guitar 10mV, Hi 380mV, Lo 640mV. Ready to plug in when assembled.

¾ Multi-Function LED DPM ▲▲

SM-43 (1 lb.)



Kit: \$ 33.00 18.00
Asmb.\$ 48.00

To use this instrument as a voltmeter, ammeter, ohmmeter, temperature meter.. AC/DC Voltage range: 1mV-1000V. Thermometer range: 0-100C. DC current range: 1 microamp - 2 amp. Capacitance range: 1pf-2 microfarads. Frequency Counter: 10HZ-20KHZ. Max indication ±1999. Power Supply: 5-6V DC, 200ma.

CIRCLE 333 ON FREE INFORMATION CARD

NEW! ELECTRONICS CD-ROM

The most effective way of learning electronics

Two Courses on one CD-ROM!
Only \$49⁰⁰

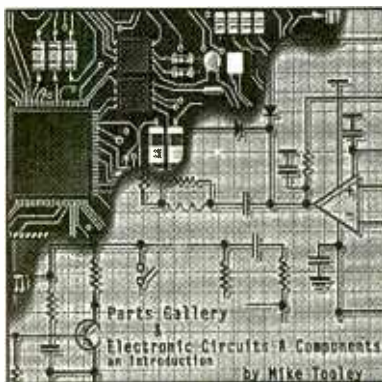

Electronic Circuits and Components

Discover the standards and application of common types of electronic components and how they are used to form complete circuits in **Electronic Circuits & Components**. Sections on the disc include: Fundamental Electronic Theory, Active Components, Passive Components, Analog Circuits, and Digital Circuits. The CD-ROM includes:

- Interactive laboratories • Supervisor notes
- Full audio commentary • Editable worksheets
- About 20 links to pre-designed Electronics Workbench circuits

The Parts Gallery

Many students have a good understanding of electronic theory but still have difficulty in recognizing the vast number of different types and makes of electronic components. **The Parts Gallery** has been designed to help overcome this problem; it will help students recognize common electronic components and their corresponding symbols in circuit diagrams. This CD ROM incorporates a quiz so that students can check their knowledge of electronic components and symbols. The CD-ROM includes:

- Over 150 component and circuit photographs • Supervisor notes
- Self-test component and symbol quizzes • Hundreds of electronic symbols

To Be Released Soon!

A series of interactive CD-ROMs provides a comprehensive and up-to-date introduction to the world of electronics. The series provides a sound understanding of the principles and behavior of electronic components and the circuits to which they are connected. Two new CD ROM discs are to be released in the very near future. They are **Analog Electronics** and **Digital Electronics**. As soon as they are released, information on their contents and availability will be published.

Claggk Inc., PO Box 4099
Farmingdale NY 11735-0792
e-mail: claggk@poptronix.com



Name _____ Phone _____

Address _____

City _____ State _____ Zip _____

Enclosed is \$49 for each Student version (single user) of **The Parts Gallery** and **Electronic Circuits & Components** on a single CD-ROM, shipping included inside the U.S.

I am ordering (....) copies at \$49 each. NY State residents must include sales tax.

I have enclosed my check for \$ _____

Please charge my credit card for \$ _____

Visa MasterCard Discover Expiration Date: ____/____/____

Card Number _____ Signature _____

(Name on order and signature must be same as on Credit Card.)

TRANSFER PAPER FOR PRINTED CIRCUITS

USE WITH REGULAR HOUSEHOLD IRON

FAX (305) 538-3648

• 30 sheets for \$24.00
8 1/2" x 11"

S&H INCLUDED

Send check or money order to

STARLET SYSTEMS

1348 Washington av.
Suite # 189, Miami Beach
Florida, FL 33139

MAKE CIRCUITS EASY FROM YOUR LASER OR PHOTOCOPY MACHINE

SURVEILLANCE

The Latest High Tech Professional Electronic Devices

Our latest catalog offers a HUGE selection of surveillance, counter-surveillance/privacy devices: hidden video equipment, pinhole cameras \$159⁰⁰, telephone recording systems: 7-Hour \$125⁰⁰—10-Hour \$139⁰⁰—16-Hour \$199⁰⁰ touch tone decoders, scanners, bug/phone tap detectors, voice disguisers, telephone scramblers, locksmithing tools, and more.

Catalog \$5.00

SPY OUTLET

P.O. Box 337, Buffalo, NY 14226
(716) 695-8660/(716) 691-3476

Cable TV Outlet



Get the Clearest Coverage of Sports, Movies, News, Main Events and Adult!

- Unbeatable Wholesale Pricing-
- Converters/Descramblers-
- Filters and Accessories-
- Premium Channel Coverage-
- Full Satisfaction Guaranteed-

QB VIDEO

Open M-F 9a to 5p (CT)

1-800-249-3025

Visa, MC & C.O.D.'s Welcome

AMAZING PRODUCTS!



ELECTRONIC & SCIENTIFIC DEVICES

NEW! LASER WINDOW BOUNCE SCIENCE PROJECTS

Remarkable concept allows user to hear sounds within a premise over a beam of laser light reflected from a window or similar surface. Experimental device provides hours of interesting and educational use. Utilizes a visible red laser that simplifies alignment and discourages illegal use. Usable range will vary-expect about 20 to 50 meters. Optional lens will increase range 200 to 400 meters! Further range requires expensive optics. Requires a sturdy video tripod (not incl.) Caution-check local law in your state if planning to use for accessing oral communication.



- LWB5 Plans.....\$20.00 LWB5K KIT/PLANS.....\$149.50
- LWB50 Ready to Use With Selected Laser Pointer.....\$199.50
- LWB70 Above With High Performance Laser Gun Sight, Long Range Extender Lens and Cushioned Headsets.....\$299.50

USES SCATTERED AND DIRECT REFLECTIONS

\$59.95 6 TRANSMITTER Projects

- CAUTION: Check Public Law 90-352
- 1 Super Sensitive Ultra Clear 1 Mile+ Voice Transmitter
 - 2 1 Mile+ Telephone Transmitter
 - 3 Telephone "DROP IN" Transmitter Line Powered- Needs No Batteries!
 - 4 Tracking/Homing Beacon "Beeping Transmitter"
 - 5 Transmitter Rebroadcasts Video or Audio Outputs
 - 6 Short Range TV/FM Disrupter NEAT PRANK!! Discretion Advised
- All 6 Above Kits Plus FREE Info Data Pack on "HELPFUL HINTS" Using Wireless Devices
- COMBOX Kits and Plans.....\$59.50

ULTRA BRIGHT LASERS

4 to 7x brighter 650-630 nm Radiation

ALL METAL CONSTRUCTION
1 YEAR WARRANTY

BATTERIES INCLUDED

LAPN65 15mw equiv 2000 ft.....\$29.95
LAPN63 30mw equiv 3000 ft.....\$69.95

From a Small Dot to a Large Spot

FOCUSABLE LASER POINTER

LAPN65F Focusable Above LAPN65...\$59.95

JACOBS LADDER

Observe a pyrotechnical display of "traveling" fiery plasma. Starts off as 1/2" arc and expands to over 3" before evaporating into space. This is an excellent attention getting display as well as a winning science project!! With arc control.

JACK1 Plans.....\$8.00
JACK1K Kit Minus Case.....\$129.50
JACK10 Ready to Use.....\$249.50

12KVGEN20 Pwr Supply Only.....\$99.50
12KVGEN2K Kit of Pwr Supply.....\$79.50

BURNING LASER RAY GUN

UTILIZES LOSSLESS ENERGY CHARGING

All Parts Available

A FUTURISTIC CONCEPT!!

LAGUN2 Plans.....\$20.00

BURNING CO2 BENCH LASER

HOTTER THAN MOST TORCHES!

All Parts Available

LC7 Plans.....\$20.00

GRAVITY GENERATOR

Demonstrates a unique phenomena of electrical reactions that produce the effect of "anti-gravity". You build and levitate a small mock space ship from simple materials. Excellent scientific demonstration of a fascinating method of levitation. Levitate an Object!

GRA1 Plans and Book.....\$20.00
GRA1K Pwr Sup Kit/Plans.....\$99.50
GRA10 Assembled Pwr Sup...\$149.50

TRANSISTORIZED TESLA COIL

Turns a light bulb into a SPECTACULAR PLASMA DISPLAY

Transmits Wireless Energy
Noiseless Operation
Pyrotechnic Effect
12 VDC/5 Amps or Battery
115 VAC Optional Converter
Adjustable Frequency Control For Effect

TCL5 Plans.....\$8.00
TCL5K Kit/Plans.....\$59.50
TCL50 Ready to Use.....\$99.50
T2DC/7 12VDC@7Amps.....\$39.50

250KV TESLA COIL

10-14" of Explosive Bolts of Lightning

Transmit Wireless Energy
Strange and Bizarre pyrotechnical effects.
Ion Motors Anti-Gravity
Size 20" H x 8" Sq
Weight - 25 Pounds
115 Volts/2 Amps AC
Labeled "Use Caution"

BTC3 Plans.....\$15.00
BTC3K Kit/Plans.....\$349.50
BTC30 Ready to Use.....\$449.50
BTC4 Plans. 500kv Unit.....\$20.00

KINETIC ELECTRIC GUN

PIONEER A FUTURISTIC WEAPON!

500 Joules Energy Storage
Constant Current Charging
Ballistic Velocities
Handheld Battery Operated
Labeled A Dangers product

EGUN1 Plans with Parts List.....\$20.00
All Parts are Individually Available

ELECTRONIC HYPNOSIS AND MIND CONTROL

Generates Highly Effective Audible and Visual Stimuli With Bio-Feedback That Can Induce Hypnotic as Well as ALPHA Related States of the Mind. Place Subjects "Under" Your Control. Enhances Hidden PSYCHIC Ability in Many Peoples!

MIND Plans.....\$15.00
MIND2K Kit and Plans.....\$49.50
MIND20 Assembled.....\$79.50

NEW CYBERNETIC EAR!

Use For Courtesy Lowering of TV Volume Control etc. Detect Rattles and Other Mechanical Abnormalities. Leaking Gases, A/C, or Corona. Great Safety Aid for Shop

Enhances Most Hearing 3 to 4 Times!
Adjustable Volume Control. Fits Easily Into Either Ear. Many Many Uses!

CYBEREAR Ready to use...\$19.95

HIGH CRIME AREA SECURITY! INFINITY+ TRANSMITTER

ROOM MONITOR/ LINE GRABBER/CONTROLLER

MONITOR YOUR PREMISES
Avoid ambushes and break ins.

ACCESS ON GOING CALLS
Longwinded teenagers!

CONTROL 8 APPLIANCES
Remote control your home!!!

EXTRA ADDED FEATURE!!!
Detects "CON HANGERS"
For Calls Made From Pay Phones!

TELCON3 Plans.....\$10.00
TELCON3K Kit/Plans.....\$99.50
TELCON30 Ready to Use.....\$149.50
Programmed With built in BEEPER ALERT!

3 MI TELEPHONE TRANSMITTER

Tunable On FM Broadcast. Excellent Telephone Project. Only Transmits When Phone is Used

VWPM7K Kit/Plans.....\$39.50
BEEP1K BEEPER ALERT KIT.....\$19.95

PHASOR BLAST WAVE PISTOL

130 db of Directional Sonic Shock Waves Energy
Handheld and Battery Operated

PPP1 Plans.....\$8.00
PPP1K Kit/Plans.....\$49.50
PPP10 Ready to Use.....\$79.50

ELECTRIC CHARGE GUN WITH 15 FOOT RANGE!!

Stuns and Immobilizes Attackers From a Distance. More Knockdown Power than a Handgun!!
Check Your State Legality

FREE!! 100KV Stun Gun

ECG10 With STUN100.....\$249.50

STUNGUNS SOLD SEPARATELY

STUN200 200KV StunGun.....\$49.50
STUN300 300KV StunGun.....\$69.50

ATTENTION! HIGH VOLTAGE EXPERIMENTERS

Battery Powered Mini Sized Modules for research in:

HOVERCRAFT, ION GUNS
FORCE FIELDS, SHOCKERS etc

MINIMAX4 4KV@10ma.....\$19.50

3mi FM BC TRANSMITTER

Safety Product Allows Listening to Children or Invalids in Hazardous Areas. Pools, Ponds etc. Great Security Intrusion Alert! Uses FM Table Top Radio.

FMV1K Kit/Plans.....\$39.50

ION RAY GUN PROJECTS ENERGY!

Star Wars Technology
Demonstrates Weapons Potential

IOG7K Kit/Plans.....\$99.50

ATTENTION!! RAILGUN EXPERIMENTERS HIGH ENERGY PULSER

RAIL GUN, COIL GUN, EXPLODING WATER, ANTIGRAVITY, MASS WARPING, LEVITATION, PLASMA PROPULSION, LATTICE SNAPPING, EMAP etc

- Lossless Energy Charging
- Programmable Voltage to 2 KV and Energy Control to 3 KJ
- Triggered Spark Switch [IKJ]
- Universal 12 VDC or 115 VAC
- 7.5 X 7.5 X 7" Light weight

HEP3 Plans High Energy Pulser/Ignitor.....\$15.00
HEP3K Kit/Plans (Minus Energy Storage).....\$199.50
HEP30 Assembled (Minus Energy Storage).....\$299.50
HEPCAP 800 Joules Energy Storage.....\$199.50

INFORMATION UNLIMITED DEPT EN1097
BOX 716 AMHERST, N.H. 03031

24 Hr Toll FREE "Orders Only" Line 1-800-221-1705
Fax Your Order to 1-603-672-5406
9 to 5 pm EST Information Line 1-603-673-4730
See Our Web Site at <http://www.amazing1.com>

We Accept MC, VISA, Cash, MO, Checks. Please add \$5.00 Shipping. COD Orders Add Additional \$4.75.
REQUEST A FREE CATALOG!!

ABC ELECTRONICS 315 7TH AVE N. MPLS. MN. 55401
(612)332-2378 FAX (612)332-8481 E-MAILSURP1@VISI.COM
WE BUY TEST EQUIPMENT AND COMPONENTS.
VISIT US ON THE WEB AT WWW.ABCTEST.COM

TEK 7B15 1 GHZ DELAYING TIME BASE	\$250.00	TEK 2245 100 MHZ 4 CHANNEL O-SCOPE	\$1200.00
TEK 2465A 350 MHZ 4 CHANNEL O-SCOPE	\$3200.00	TEK 7A19 600 MHZ SINGLE TRACE AMPLIFIER	\$150.00
TEK 7A26 200 MHZ DUAL TRACE AMPLIFIER	\$75.00	TEK 7B85 400 MHZ DELAYING TIME BASE	\$125.00
TEK 7904 500 MHZ MAIN FRAME	\$250.00	HP 1630D 25 MHZ LOGIC ANALYZER	\$250.00
TEK 5771/177 CURVE TRACER	\$1500.00	TEK 7S11 SAMPLING PLUG IN	\$200.00
TEK 7S12 GENERAL PURPOSE SAMPLER	\$350.00	FLUKE 95 SCOPE METER NO PROBES	\$600.00
TEK 453 50MHZ OSCILLOSCOPE	\$200.00	FLUKE 97 SCOPE METER WITH PROBES	\$1000.00
DRANETZ 626 DISTURBANCE ANALYZER	\$1500.00	HP 8182A 50 MHZ PATTERN GENERATOR	\$800.00
GENRAD 1657 RLC BRIDGE	\$750.00	PHILLIPS PM3296 400 MHZ OSCILLOSCOPE	\$1000.00
TEK 7D20 PROGRAMMABLE DIGITIZER	\$500.00	EMI SCR 7.5-300 7.5V 300A POWER SUPPLY	\$500.00
TEK 465 100 MHZ OSCILLOSCOPE	\$400.00	HP 8558B SPECTRUM ANALYZER	\$1500.00
TEK 465B 100 MHZ OSCILLOSCOPE	\$450.00	WAVETEK 175 WAVE FORM GENERATOR	\$500.00
TEK 2335 100 MHZ OSCILLOSCOPE	\$1200.00	WAVETEK 157 PROG. WAVE FORM SYNTH.	\$500.00
TEK 2215 60 MHZ OSCILLOSCOPE	\$350.00	RACAL DANA 1901 100 MHZ COUNTER	\$200.00
TEK 496P 1KHZ-1.8GHZ SPECTRUM ANALYZER	\$5000.00	VALHALLA 4790B SYSTEM INTERFACE	\$150.00
BRADLEY 132 SCOPE CALIBRATOR	\$700.00	GENRAD 1683 RLC BRIDGE	\$300.00
PHILLIPS PM3350A 60 MHZ DIG.STORAGE SCOPE	\$1000.00	HP 3455A MULTIMETER	\$300.00
HP 8601A 110 MHZ SWEEP/SIGNAL GENERATOR	\$400.00	HP 3456A MULTIMETER	\$450.00
TEK FG504 40 MHZ FUNCTION GENERATOR	\$500.00	FLUKE 5200A AC CALIBRATOR	\$1500.00
HP 54100A 1GHZ DIGITIZING OSCILLOSCOPE	\$3000.00	TEK TM504 4 SLOT POWER FRAME	\$125.00
HP 8170A LOGIC PATTERN GENERATOR	\$150.00	HP 4955A PROTOCOL ANALYZER	\$500.00
SYSTRON DONNER DPSD 50	\$500.00	MAGTROL 4614 POLYPHASE POWER ANLZR.	\$300.00
LEADER LSG215A 125 MHZ SIGNAL GENERATOR	\$700.00	TEK CT-5 HIGH CURRENT TRANSFORMER	\$500.00

SPECIAL THIS AD ONLY TEK 475 200 MHZ OSCILLOSCOPE REGULAR PRICE \$500.00 SALE PRICE \$400.00
SPECIAL THIS AD ONLY TEK DAS 9100 AS IS NO PROBES THESE UNITS ARE UNTESTED NOT REJECTS \$150.00

Make Life Easy!

Program these PICs in BASIC:

12C671, 12C672, 14000,
 16C554, 16C556, 16C558,
 16C620, 16C621, 16C622,
 16C62, 16C63, 16C64, 16C65,
 16C71, 16C72, 16C73, 16C74,
 16C84, 16F83, 16F84, more.



BASIC makes it easy for you to program the fast and powerful Microchip PIC microcontrollers

- Expanded BASIC Stamp I compatible instructions
- True compiler provides faster program execution and longer programs than BASIC interpreters

PicBasic Compiler - \$99.95
PicBasic Compiler Bundle - \$179.95
 Includes: PicBasic Compiler, EPIC Programmer, AC Adapter, Cable, PICProto18 and PIC16F84
*BASIC Stamp is a trademark of Parallax, Inc.

microEngineering Labs, Inc.
 Box 7532 Colorado Springs CO 80933
(719) 520-5323 fax (719) 520-1867
<http://www.melabs.com>

PIC'n Books

LEARN ABOUT PIC16/17 MICROCONTROLLERS

EASY PIC'n Beginner

- Programming techniques
 - Instruction set
 - Addressing modes
 - Bit manipulation
 - Subroutines
 - Sequencing
 - Lookup tables
 - Interrupts
 - Using a text editor - source code
 - Using an assembler
 - Timing and counting
 - Interfacing - I/O conversion
 - Lots of examples
- \$29.95

PIC'n Up The Pace Intermediate

- Serial communication
 - PIC16 to peripheral chips
 - PIC16 to PIC16
 - Serial EEPROMS
 - LCD interface
 - Scanning keypads
 - D/A conversion
 - Sensors - analog voltage output
 - A/D conversion
 - Math routines
 - Decimal interface
 - PIC16C84 EEPROM data memory
 - Lots of circuits and code
- \$34.95

+ \$4 s/h in US for one book, \$6 both books
 VISA, MC, AMEX, MO, Check
 CA residents please add 7.25% CA sales tax
 PIC is a trademark of Microchip Technology Inc.

SQUARE 1 ELECTRONICS

P.O. Box 501, Kelseyville, CA 95451
 Voice (707) 279-8881 FAX (707) 279-8883
<http://www.sq-1.com>

EPROM Emulator

Socket Rokit



\$99.00*
 Emulates:
 27C256
 27C128
 27C64

The SR256 EPROM Emulator can emulate 8K x 8 to 32K x 8 120 ns EPROMs, with features that provide embedded code developers increased productivity. Advantages include: software selectable device size and target address; download verify; Hex, S-Record and binary file support; status LED; dual polarity reset outputs and single device bus loading.

INCLUDES

- PC Software and Quick Start Manual
- Table Assembler supporting common 8-bit micros
- PC Parallel Port Adapter and 7 ft. Interface Cable
- Reset Jumper Wire

*Shipping and handling not included.
 VISA, MasterCard, Discover and AmEx accepted.

Wisch Communications

2550 Trinity Mills Road
 Suite 132B
 Carrollton, TX 75006

Ph: (972) 417-3533
 Fax: (972) 417-3821
wischcom@cyberramp.net

!!! BROADCAST FARTHER !!!

The model 220 is an 80-110 MHz RF amplifier that connects to mono or stereo FM transmitters and produces a powerful 2-15 watt signal which could broadcast up to 5 miles or more! Requires 50-150 mW drive.
 Step by step plans complete with part source information and antenna designs... **ONLY \$14 PLUS \$2 S&H NO C.O.D.!**

Progressive Concepts
 BOX 586 STREAMWOOD, IL 60107
 (630) 736-9822 FAX: (630) 736-0353

VISA MasterCard

SURVEILLANCE HIDDEN CAMERAS
DIRECT FROM MANUFACTURER - BEST PRICE IN THE MARKET

Ultra miniature hidden camera. In dome, smoke or motion detector. B/W or Color. Wide view angle. Low light sensitivity -> super sharp images, plus video and audio output. From \$150.00. Also 1/3" B/W board Camera w/mic. only \$90.00 USD. Wireless hidden camera. start at only \$249.00 USD. Plus \$5.95 for S/H. Wholesale/Retail Welcome. C.O.D., Check, Money Order or Visa/MC.

BOLIDE INTERNATIONAL CORPORATION
 PH: (800) 355-8895 or (818) 575-8178
 9660 Flair Drive #318, El Monte, CA 91731
<http://www.bolide.com>

CABLE TV CONVERTERS
 Equipment & Accessories
 Wholesalers Welcome
Call C&D ELECTRONICS
1-888-615-5757 M-F 10a-6p

Key Titles from...



Buy more than 1 book and take 15% off total order

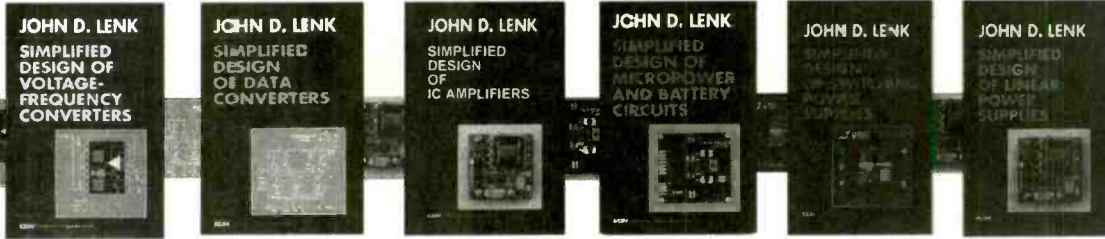

Simplified Design of Switching Power Supplies

by John D. Lenk
1996 • 225pp • pa •
0-7506-9821-7 • \$29.95

Simplified Design of IC Amplifiers

by John D. Lenk
1996 • 240pp • pa •
0-7506-9508-0 • \$29.95

Lenk Series

Simplified Design of Voltage-Frequency Converters

by John D. Lenk **NEW**
September 1997 • 304pp •
pa • 0-7506-9654-0 • \$29.95

Simplified Design of Data Converters

by John D. Lenk **NEW**
April 1997 • 242pp • pa •
0-7506-5509-9 • \$29.95

Simplified Design of Linear Power Supplies

by John D. Lenk
1996 • 246pp • pa •
0-7506-9823-9 • \$29.95

Simplified Design of Micropower and Battery Circuits

by John D. Lenk
1996 • 240pp • pa •
0-7506-9510-2 • \$29.95

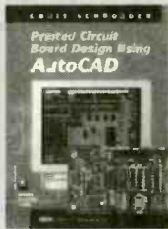
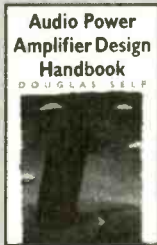

Inside PC Card
by Pascal Heque
1995 • 352pp • ha •
0-7506-9747-4 •
\$52.95

PCB Design Using AutoCAD
by Chris Schroeder
Aug 1997 • 336pp
• pa • 0-7506-9834-9
• \$44.95

Audio Power Amplifier Design Handbook
by Douglas Self
1996 • 256pp • pa •
0-7506-2788-3 •
\$34.95

Understand Electronic Filters
by Owen Bishop
1996 • 180pp • ha •
0-7506-2628-3 •
\$26.95



High Performance Audio Power Amplifiers
by Ber Duncan
1996 • 288pp • ha •
0-7506-2629-1 •
\$59.95



Digital Storage Oscilloscopes
by Ian Hickman
1996 • 206pp • pa •
0-7506-2856-1
\$39.95



More Books from Newnes

Please send me the book(s) listed below. (Buy more than one, and take 15% off the total order.)

Write book number(s) here:

Mail your order to: Butterworth-Heinemann, Fulfillment Center, 225 Wildwood Ave., Woburn, MA 01801 USA

Name _____

Address _____

City _____ State _____ Zip _____

Phone _____ Fax _____

E-mail _____

Please send me a free Newnes catalog, Item #645.

Phone: 1-800-366-BOOK Fax: 1-800-446-6520

E-mail your order to orders@repp.com

I have enclosed a check for \$ _____

Please charge my:

Visa MasterCard American Express

Card no. _____ Exp. date _____

Signature _____

U.S. Customers: Please add \$4.00 handling fee for the first item ordered, \$1.50 for each additional item, on all check and credit card orders. Billed orders will be charged additional shipping based on weight and destination. All U.S. orders must include your state sales tax. Prepayment or company purchase order is required for all orders. Prices subject to change without notice.

Canadian Customers: Please pay by credit card or in U.S. funds and include 7% GST on books and handling.

European Customers: Add £2.00 UK and surface postage. Check for Air Mail; extra cost will be charged.

A member of the Reed Elsevier plc group

TS232

Visit our web site: <http://www.bh.com/newnes>

February 1998, Electronics Now

A WHOLE NEW WORLD IN SCIENCE KITS.

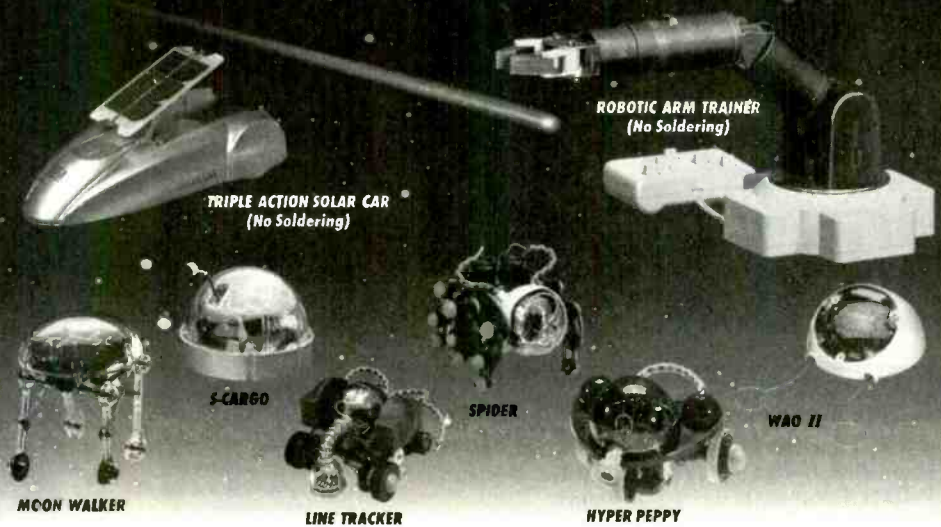

OWI's "Next Generation" of affordable, rugged Robot Kits challenge the enthusiast to solder circuit boards and / or mechanically assemble.

Visit our homepage @ <http://www.owirobot.com>

Each OWIKIT also incorporates the basic principles of robotic experiments, sensing and locomotion, guaranteeing an exciting, hands-on adventure of knowledge and fun!

But remember! OWI is the recognized founder and leader in Educational Robot Kits. ACCEPT NO IMITATIONS.



ROBOTIC ARM TRAINER	OWI-007	5 Axis Control	NEW	69.95
TRIPLE ACTION SOLAR CAR	OWI-685	Solar Sensor	NEW	39.95
S-CARGO	OWI-936K	Sound Sensor	47 Pg. Book	36.95
WAO II	OWI-961K	Programmable - Graphic	59 Pg. Book	69.95
SPIDER	OWI-962K	Infrared Sensor	49 Pg. Book	49.95
LINE TRACKER	OWI-963K	Infrared Sensor	48 Pg. Book	49.95
HYPER PEPPY	OWI-969K	Sound / Touch Sensor	46 Pg. Book	24.95
MOON WALKER	OWI-989K	Solar Sensor	10 Pg. Book	34.95

1160 Mahalo Place, Suite B
Rancho Dominguez, CA 90220-5443
(310) 638-7970
Fax: (310) 638-8347



Order M - F: 8a.m. - 4p.m. PST

CIRCLE 318 ON FREE INFORMATION CARD

MEMBRANE SWITCH KITS!

FLAT PANEL KEYPADS ASSEMBLE IN MINUTES WITH YOUR LEGEND

AVAILABLE IN 4, 12, 16, 24 & 40 KEY TYPES



DSK-4
\$9.89



DSK-12
\$14.29

INDUSTRIAL TYPES AVAILABLE

MORE THAN 30 LAYOUTS TO FIT MOST APPLICATIONS

CALL FOR FREE BROCHURE

SIL-WALKER

880 CALLE PLANO, UNIT N
CAMARILLO, CA 93012

PHONE: (805) 389-8100

FAX: (805) 484-3311

VISA / MASTERCARD

TEST EQUIPMENT SALES

WE RENT THE FOLLOWING EQUIPMENT:

- | | |
|--------------------------|-----------|
| IFR FM/AM 1200 "SUPER" S | HP 4191A |
| HP 4193A | HP 3577A |
| HP 3562A | HP 4275A |
| | HP 6050A |
| | TEK 2465A |

CALL US FOR YOUR NEXT RENTAL

CALL FOR QUOTES ON USED EQUIPMENT

WE SELL, RENT AND BUY TEST EQUIPMENT !!

P.O. BOX 986
LONDONDERRY, NH 03053

PHONE (800) 684-4651
FAX (603) 425-2945

ASK ABOUT OUR NEW
TEKTRONIX & FLUKE
PRODUCTS

"Get the skills you need at a price you can afford!"

Earn up to \$45 an hour or more as a skilled Computer Programmer.

Cash in on the explosion of opportunities. Start your new career or even open a business of your own as a highly-paid computer programmer.

Computer programmers today can almost write their own ticket to financial well-being and job satisfaction. Only Foley-Belsaw's unique in-home training programs can give you the skills you need at a price you can afford.

You'll learn the three hot computer languages — QBasic, C and Visual Basic. You'll even work with the hot new C++. With this easy-to-learn knowledge, you'll write your first QBasic program by the end of the first SkillPak of lessons. Soon you'll be programming sound and graphics, and even learning how to program for the Windows environment — the most popular application program today.

It's easy to cash in!

Look at some of the things professional computer programmers do. "Wrote a C program to clean up a WordPerfect file; edited the resulting file as data errors were found." This work would take a trained programmer less than five hours to complete, and they could make over \$200 for the work. That's money you could be making — and soon — with training from the Foley-Belsaw Institute of Computer Programming.

Everything is included!

We provide you with all the materials you'll need to become a professional computer programmer. You'll receive 37 lessons, designed for you by the Foley-Belsaw Professional Programmer Staff. Other valuable materials include a *Programmer's Handbook*, *Programmer's Examples* on two 3.5 inch disks, *Programmer's Flowchart Template*, and a booklet, *Selecting the Right Computer*.

Other schools force you to buy a complete computer package as part of their training program. At Foley-Belsaw we understand that your needs as a programmer may not fit into a "one size fits all" approach. Why should you pay hundreds of dollars for a computer system that you may not need?

We'll tell you what you need to know so that when you're ready to buy your own computer, you can get the machine that fits your needs at the lowest possible price. That's the Foley-Belsaw way.

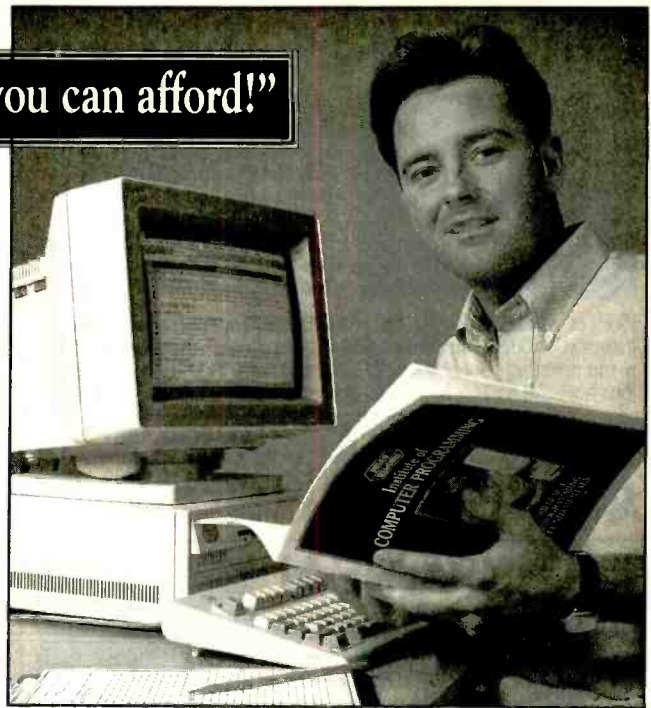

Get the free facts today.

Whether you want to change careers, have a profitable part-time job or start your own business, Foley-Belsaw Institute's new computer programming course is the first step. A profitable future in computer programming can be yours. Call or write today for a fact-filled information kit including a free copy of *Computer Programming — A Profitable Career In Your Spare Time*. See how easy it is to begin a money-making career as a sought-after computer programmer. Our free full-color information kit outlines the steps of the computer programming course and shows you everything you will receive as part of your training.

Mail this coupon or call today
Toll Free 1-800-487-2100!

Your free opportunity kit will be rushed to you!

If coupon is missing, write to: Foley-Belsaw Company, 6301 Equitable Road, Kansas City, MO 64120

Call or complete & return this coupon to: Foley-Belsaw Institute, 6301 Equitable Road, Kansas City, MO 64120

YES! Rush me a free information kit on Computer Programming right away. Dept. 35417

Other career courses:

- Locksmithing, Dept. 13039
- Small Engine Repair, Dept. 52915
- Saw & Tool Sharpening, Dept. 21851
- VCR Repair, Dept. 62737
- Computer Repair, Dept. 64638
- TV/Satellite Dish Repair, Dept. 31509
- Gunsmithing, Dept. 92540
- Woodworking, Dept. 43783
- Upholstery, Dept. 81453
- Vinyl Repair, Dept. 71383
- Electrician, 95312
- Computer Specialist, Dept. 38284
- Networking Specialist, Dept. 39271

I understand that there is ABSOLUTELY NO OBLIGATION and NO SALESMAN WILL CALL.

Name _____

Address _____

City _____ State _____ Zip _____



386 MINI-PC \$83

1K PRICE
EVAL \$295
8088 \$27



- includes:
- 5 Serial, 3 Parallel (32bit max)
 - Up to 8 meg ROM (27C080)
 - 32k RAM exp. to 64Mbyte
 - Battery backed RT Clock
 - LCD and Keyboard ports
 - IRQ x15, DMA x2, TIMER x4
 - On-board LED display
 - Industry Standard PC Bus

Perfect when a full-size PC is too large, expensive, or power hungry. A fully functional single board computer, needs only program and power source. Runs DOS / WINDOWS. Use Turbo C, BASIC, MASM. All utilities to do this included.

A to D D to A CONVERTERS

For PC or SBC
8,12,16 bit resolution
up to 24 channels
starting at \$21 OEM (1k)
eval kit \$75

\$95 UNIVERSAL PROGRAMMER

FLASH, EEPROM, NVRAM, EPROM
up to 8 meg (27C64-080). Adapters for
micros, PLCC, etc. Parallel port version
for notebook. FAST AND EASY TO USE.



LOW COST... LOW POWER...

LOW RISC!

QTY 1K PRICE
\$1.99
EVAL KIT 7.00

LOWER COST, FASTER, EASIER TO PROGRAM SINGLE CHIP COMPUTER

COMPARE:	16C54	MV1200	PINOUT:
OEM (1K) PRICE	\$2.57	\$1.99	RESET 1 20 VCC
RS232 PROGRAM DOWNLOAD	NO	YES	PD0 2 19 PB7
SINGLE CHIP OPERATION	NO	YES	PD1 3 18 PB6
BUILT-IN BASIC	NO	YES	XOUT 4 17 PB5
EEPROM DATA MEMORY	NONE	64	XIN 5 16 PB4
PROGRAM MEMORY	768 OTP	1K FLASH	PD2/INT 6 15 PB3
MATH REGISTERS	1	32	PD3 7 14 PB2
MAX INSTRUCTIONS / SEC	5M	20M	PD4/TMR 8 13 PB1/AD0
MAX COUNTER BITS	16	18	PD5 9 12 PB0/AD0
INPUT / OUTPUT BITS	12	15	GND 10 11 PD6
A TO D COMPARATOR	NO	YES	
HARDWARE INTERRUPTS	NONE	3	
- LONG WORD INSTRUCTION - FRIENDLY SYMMETRIC ARCHITECTURE -			



PC SOLID STATE DISK

\$21 OEM (1k) eval kit 75.00
FLASH / RAM / EPROM
256K-16M PCMCIA/DIPS

No More Hangups...
PC WATCHDOG!
Reboots PC OEM \$21 EVAL \$75



VGA LCD 640x480 controller
for PC or SBC
\$27 oem \$95 eval
combo LCD/CRT
version available



visit our web site: www.star.net/people/~mvs

MVS BOX 850
MERRIMACK, NH 03054
(508) 792-9507



5yr Limited Warranty
Free Shipping
Hrs: Mon-Fri 10-6 EST

Digital Oscilloscope 100 Msa/s

NEW!

2 Channels
100 Msa/s
FFT

\$499



- 2 Ch. Digital Oscilloscope
- 100 Msa/s max single shot rate on both channels
- 32K samples per channel
- Advanced Triggering
- Easy to use Windows and DOS software included
- Small and Lightweight (9 oz and 6.3" x 3.75" x 1.25")
- Parallel Port interface to Laptop or Desktop PC
- Optional FFT Spectrum Analyzer, Advanced Math and TVLine Trigger.

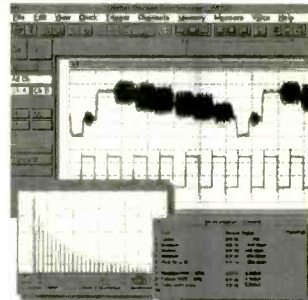

For \$499 you get the model DSO-2102S Oscilloscope, Probes, Interface Cable, Power Adapter, and Windows and DOS Software.



Link Instruments (973) 808-8990
369 Passaic Ave (Suite 100 (Fairfield, NJ 07004
<http://www.LinkInstruments.com> (Email: Sales@LinkInstruments.com

Learn MICROCONTROLLERS EMBEDDED SYSTEMS and PROGRAMMING...

...with the AES learning system/ embedded control system. Extensive manuals guide you through your development project. All programming and hardware details explained. Complete schematics. Learn to program the LCD, keypad digital, analog, and serial I/O. for your applications.

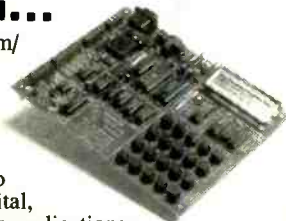

THREE MODELS AVAILABLE. Choose from an Intel 8051, Intel 8088, or Motorola 68HC11 based system. All models come with:

- 32K Byte ROM, 32K Byte RAM • 2 by 16 Liquid Crystal Display • 4 by 5 Keypad • Digital, Analog, and Serial I/O • Interrupts, timers, chip-selects • 26 pin expansion connector • Built-in Logic Probe • Power Supply (can also be battery operated) • Powerful ROM MONITOR to help you program • Connects to your PC for programming or data logging (cable included) • Assembly, BASIC, and C programming (varies with model) • Program disks with Cross Assembler and many, well documented, program examples • User's Manuals: cover all details (over 500 pages) • Completely assembled and ready to use • Source code for all drivers and MONITOR • Optional Text Book

Everything you need. From \$279.
Money Back Guarantee

Call for Free Info Pack, or see
WEB at <http://www.aesmicro.com>
714-550-8094, FAX 714-550-9941



Call 1-800-730-3232

AES 575 ANTON BLVD., SUITE 300, COSTA MESA, CA 92626, USA

Electronic CAD for Windows

Professional Windows EDA tools at an affordable price with powerful features to make designing faster. WinBoard PCB layout delivers sophisticated interactive routing for complex designs, plus it has the tools needed for high-speed circuits, analog, RF and SMT designs.

WinDraft® Schematics

- ◆ Use True-Type fonts. Quickly copy and paste into other applications.
- ◆ Supports hierarchical designs, electrical rules checking, Annotation & Bill of Materials.
- ◆ Thousands of library parts and symbol editor included.

WinBoard™ PCB layout

- ◆ Supports 16 layers, multiple copper pours, and advanced features for RF designs.
- ◆ SMD & through hole library with on-line graphical editor.
- ◆ CAM outputs include BOM, in-circuit test, NC Drill, Gerber, Pick & Place, & Advanced Design Rule Checking (DRC).

With our unique *pin capacity* versions you only pay for what you need. You choose the base configuration to suit your needs today, and expand that configuration to handle increased pin capacity as your design requirements change.

WinDraft 2.0 Available Now

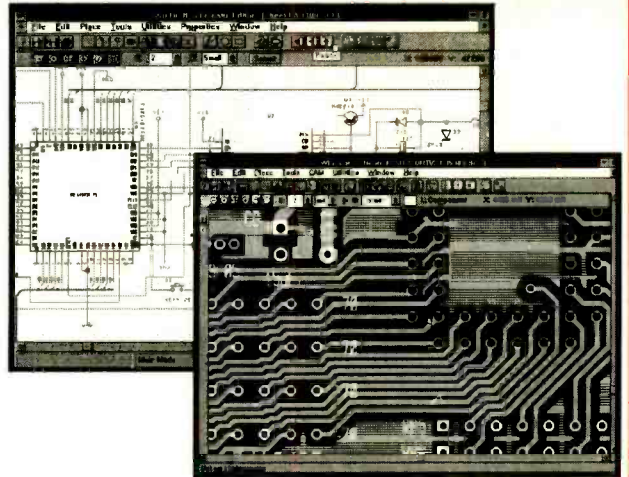

- \$ 250 WinDraft or WinBoard - P650
- \$ 495 WinDraft or WinBoard - unlimited
- \$ 895 WinBoard P650 with CCT Spectra® autorouter.

Thousands of satisfied customers are using this new generation of powerful and affordable Windows EDA tools from Ivex. Your satisfaction is guaranteed!

World Wide Web: <http://www.ivex.com>

Information and free evaluation version is available on the Ivex WW Web, FTP and BBS.

Tel: (503) 531-3555
 Fax: (503) 629-4907
 BBS: (503) 645-0576

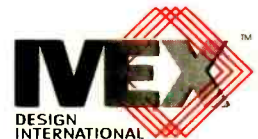

Ivex Design International. 15232 NW Greenbrier Parkway. Beaverton, Oregon 97006. USA.

ADV2_1

CIRCLE 319 ON FREE INFORMATION CARD

PC
PLACE

Don't Put Your
Baby's Health
On The Line.

Get Prenatal Care Early
Call 1-800-311-2229
Confidential

Take Care of Yourself
So You Can Take Care of Your Baby.



**NEREDITH
INSTRUMENTS**



NEW-VISIBLE
LASER DIODES
\$10

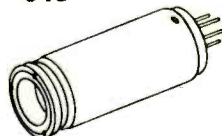

NEW-820NM LASER DIODES
WITH COLLIMATOR

\$20
\$35



GREEN OUTPUT HE-NE TUBES \$99

RUBY LASER ASSEMBLY \$295

<http://www.mi-lasers.com>

Call Or Write For A FREE CATALOG
On LASERS & OPTICS

PHONE: (602) 934-9387
 FAX: (602) 934-9482

5035 N. 55TH AVE., #5, P.O. BOX 1724,
 GLENDALE, AZ 85301

**FREE
SHIPPING
ON ORDERS
OVER
\$100.00**

February 1998, Electronics Now

99

Turn Your Multimedia PC into a Powerful Real-Time Audio Spectrum Analyzer

Features

- 20 kHz real-time bandwidth
- Fast 32 bit executable
- Dual channel analysis
- High Resolution FFT
- Octave Analysis
- THD, THD+N, SNR measurements
- Signal Generation
- Digital Filtering
- Triggering, Decimation
- Transfer Functions, Coherence
- Dynamic Data Exchange (DDE)
- Time Series, Spectrum Phase, Spectrogram and 3-D Surface plots
- Real-Time Recording and Post-Processing modes

Applications

- Distortion Analysis
- Frequency Response Testing
- Vibration Measurements
- Acoustic Research

System Requirements

- 486 CPU or greater
- 8 MB RAM minimum
- Win. 95, NT, or Win. 3.1 + Win.32s
- Mouse and Math coprocessor
- 16 bit sound card

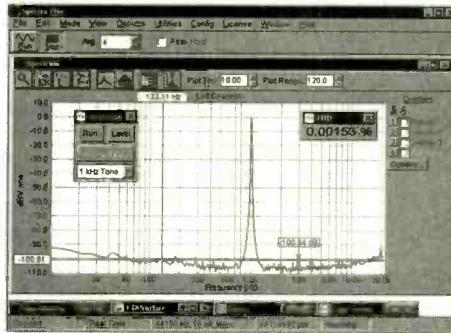

Priced from \$299

(U.S. sales only – not for export/resale)

Professional Quality Sound Cards Available...Call

DOWNLOAD FREE 30 DAY TRIAL!

www.telebyte.com/pioneer

PHS

Pioneer Hill Software
24460 Mason Rd. N.W.
Poulsbo, WA 98370

Spectra Plus 4.0

Affordable Signal Processing Software

Sales: (360) 697-3472

Fax: (360) 697-7717

e-mail: pioneer@telebyte.com

Since 1965, we've worked to make sure all children have the opportunity to learn valuable lessons during the years when it's easiest for them to learn.

To find out how you can help, call your local Head Start.



Nurture the future
BE A HEAD START VOLUNTEER



PROGRAMMERS OVER 50 MODELS

ADVANTECH EETOOLS NEEDHAMS DATA I/O ICE TECHNOLOGY HILO SYSTEM GENERAL CHROMA MODULAR CIRCUIT TECHNOLOGY XELTEK



PROMAX EMP-20 MEGAMAX MEGAMAX4 SIMM/SIP TESTER EMUPA

CALL ADVANTECH LABTOOL	599 EETOOLS SIMMAX
629 ICE TECH MICROWL	795 CHROMA SIMM/SIP
650 EETOOLS ALLMAX +	359 MOD-MCT-EMUPA/R
409 EETOOLS MEGAMAX	279 MOD-MCT-EMUPA/R
509 EETOOLS MEGAMAX4	49 EPROM 1G TO 512K
369 XELTEK SUPERPRO II	69 EPROM 1G TO 1MEG
409 XELTEK SUPERPRO II P	99 EPROM 4G TO 1MEG
249 XELTEK SUPERPRO L	199 EPROM 16G TO 1MEG
165 XELTEK ROMMASTER II	89 EPROM 1G TO 8MEG
479 MOD-MCT-EMUPA	129 EPROM 4G TO 8MEG
739 STAG ORBIT-32	250 EPROM 8G TO 8MEG



LABTOOL48 MICROMASTER SUPERPRO ALLMAX PLUS ROMMASTER2

General Device Instruments

Sales 408-241-7376 Fax 241-6375 BBS 983-1234

Web www.generaldevice.com E-Mail icdevice@best.com

INSIDE CRYSTAL SETS

An easy-to-read book on crystal set theory and construction opens vistas for novices and pros alike. Build radios like Grandpa did, do it better, and know what you are doing. *The Crystal Set Handbook*, published by The Crystal Set Society, is an authentic guide on the topic.

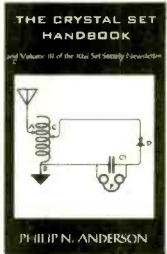

To order *The Crystal Set Handbook*, send \$10.95 plus \$4.00 for shipping in the U.S. and Canada only to Electronics Technology Today Inc., P.O. Box 240, Massapequa Park, NY 11762-0240. Payment in U.S. funds by U.S. bank check or International Money Order. Please allow 6-8 weeks for delivery.

ROBOTIC MACHINING

ROUTE, MILL, DRILL, CARVE, ENGRAVE, PAINT
IN WOOD, PLASTIC, VINYL, PC BOARD, & LIGHT METALS!

STARTING AT
\$695.00

- 4 MOTOR GANTRY MILL CONFIGURATIONS
- PC COMPUTER CONTROLLED CNC/DNC
- IMPORT/ EXPORT FILES TO OTHER CADS
- AUTO-BACKLASH COMPENSATION
- PRE-MACHINED HEAVY CASTINGS
- SIMULTANEOUS 3 AXIS MOTION
- FREE 3D CAD/CAM SOFTWARE
- AVAILABLE IN KITS OR ASSEMBLED
- EXPEDITE SERVICE ALSO AVAILABLE
- OPTIONAL ALUMINUM WAY COVERS
- .001" RESOLUTION / AMERICAN MADE



3 AXIS UNITS
FROM 12" X 12" TO
66" X 66" MACH. AREA

<http://www.uscyberlab.com>

U.S. CYBERLAB, INC. 14786 SLATE GAP RD., WEST FORK, AR 72774

CALL NOW FOR INSTANT SPECS 501-839-8293 24 HR. FAX-BACK

POPTRONIX®

Online Edition

We're on the web

FREE

We are starting up,
but you can watch us grow!

Projects for beginners to experts!
New Product information!
Bookstore—discover what's new!

<http://www.poptronix.com>

WE'RE WITH YOU EVERY DAY
24 HOURS A DAY! DROP IN!
WE'D LOVE TO HAVE YOU VISIT!

Coil Design and Construction Manual

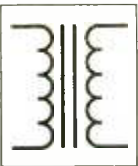

YOU CAN WIND YOUR OWN COILS?

There's no trick to it except knowing what you are doing. In a unique, 106-page book you can become expert in winding RF, IF, audio and power coils, chokes and transformers. Practically every type of coil is discussed and necessary calculations are given

with the mathematical data simplified for use by anyone. Get your copy today!

Mail coupon to:

Electronics Technology Today, Inc.
P.O. Box 240 • Massapequa Park, NY 11762-0240

Please send me my copy of *Coil Design and Construction Manual* (160). I enclose a check or money order for \$8.95 to cover the book's cost and shipping-and-handling expenses. NY state residents must add local sales tax.

Name _____

Address _____

City _____ State _____ ZIP _____

All orders must be paid in U.S. funds only. Sorry, no orders accepted outside of USA and Canada. Please allow 6-8 weeks for delivery.

The World's Largest Source for Home Automation

- The Best & Most Comprehensive Home Automation Catalog in the Industry.
- Best Customer Service & Technical Support

Thousands of hard-to-find automation, X-10 and wireless control products. Computer interfaces, software, development tools, lighting control, telephone systems, security systems, surveillance cameras, infrared audio/video control, home theater, touchscreen control, HVAC, pet care automation, wiring supplies, books and videos and much more!



FREE

128 page full color catalog!

World's Largest Selection!

Lowest Prices Guaranteed!

HOME AUTOMATION SYSTEMS, INC.

Questions: 714-708-0610 Fax: 714-708-0614

e-mail: catalog@smarhome.com

www.smarhome.com

Call for a FREE Catalog! 800-762-7846

800-SMART-HOME

Dealers/Resellers ask about our HASPRO Dealer Program 800-949-6255

EPROM+ A DEVICE PROGRAMMER FOR BENCH AND FIELD



NEW!
16 MEG EPROM
SUPPORT PLUS
MORE!

SUPPORTS ALL STANDARD PARTS!

USES PARALLEL PRINTER PORT!

- FIRST GENERATION EPROMS** (24 PIN) 2708, TMS2716*, 1702*, 25XX
- SECOND GENERATION EPROMS** (24, 28, 32 PIN) 2716 - 27C080 (8 MEG)
- 16 BIT EPROMS*** (40, 42 PIN) 27C1024 - 27C160 (16 MEG)
- FLASH EPROMS** (32 PIN) 28F, 29C, 29EE, 29F FAMILIES PLUS BOOT BLOCK
- EPROM/NVRAMS** (24-32 PIN) 28C04 - 28C010, X2210/12, ER5901, 12XX
- SERIAL EPROMS*** (ALL 8 PIN PARTS) 17, 24, 25, 35, 59, 80011, 85, 93, ER1400
- BIPOLAR PROMS*** (16-24 PIN) 74SXXX AND 82SXXX FAMILIES
- MICROCONTROLLERS*** (ALL FAMILIES) 874X, 875X, 87C5XX, 87C75X, 89C5X, 89CX051 68HC705, 68HC711, PIC12XXX - 16XXX, 17C4X PLUS FLASH AND 14000

- ◆ READ, PROGRAM, COPY COMPARE, FILE LOAD/SAVE (PLUS MORE!)
- ◆ FULL SCREEN EDITOR W/25 COMMANDS + BYTE & WORD MODES
- ◆ SOFTWARE RUNS UNDER DOS, WIN3.1/95 ON ANY SPEED MACHINE
- ◆ MADE IN THE USA • 30 DAY MONEY BACK GUARANTEE *ADAPTER REQUIRED (DIAGRAMS INCLUDED)

SYSTEM INCLUDES: PROGRAMMING UNIT, SOFTWARE, PRINTER PORT CABLE, PRINTED MANUAL AND POWER PACK

ANDROMEDA RESEARCH

P.O. BOX 222

MILFORD, OHIO 45150

(513) 831-9708 FAX (513) 831-7562

\$289

\$5.00 SHIPPING • \$5.00 C.O.D.
VISA • MASTERCARD • AMEX

The Greatest Thing Since Sliced Bread

Our free Consumer Information Catalog lists more than 200 free and low-cost government booklets that are helpful and practical. To get your free copy, send your name and address to:

Consumer Information Center
Department GT
Pueblo, Colorado 81009

PC PLACE

February 1998, Electronics Now

Interactive catalog: www.tekview.com

TV cable

CONVERTERS & EQUIPMENT

TekView Electronics



- * 30 days money back guarantee
- * 1 yr warranty
- * Quantity Discounts
- * Dealers Welcome!

VISA MC AMEX C.O.D.

(800)739-2253

WHOLESALE PRICES
STARTING AS LOW AS \$99.00

CABLE TV DESCRAMBLERS

CONVERTERS FILTERS · VIDEO STABILIZERS

1 Year Warranty on All Products.
Affordable Extended Warranty.
FREE CATALOG!

Call the Cable Professionals 24 Hours A Day!



1-800-379-3976
[HTTP://WWW.ORION-ELECTRONICS.COM](http://www.orion-electronics.com)

NEW DX SERIES DMMs

3 YEAR WARRANTY

DELUXE HOLSTER INCLUDED



Bel MERIT DX Series DMMs have best values for performance, features and dependability with 3 year warranty.

DX460L, full function in a single meter

- Wide LCR Range
Inductance, up to 20H
Capacitance, up to 2000 μ F
Resistance, up to 20M Ω
- Logic, TTL & CMOS
- Auto Frequency, Up to 20MHz
- Diode Test, Continuity Beeper
- Data Hold, Peak Hold
- Input Warning Beeper
- Auto Power Off

Lots More Test Instruments
Oscilloscope, DC Power Supply, Function Generator, Audio Oscillator, Frequency & Universal Counter, Multimeter, Capacitance Meter, Clamp-On, Electrical Tester and More.

C COMPILER

\$49.00

For **PIC microcontrollers**

Supports PIC16C55x, 16C6x, 16C62x, 16C8x, 16C92x microcontroller families. Based on ANSI C standard. Supports arrays, unions, structures, pointers, strings, function calls, if, for, switch, while, interrupt vectors, in-line assembler code, 8 & 16 bit variables, etc. Outputs Intel Hex format and assembly code. Code optimizer included. Excellent development tool!

732-873-1519 fax: 732-873-1582 griehrc@aol.com
Grich RC Inc. 120 Cedar Grove Ln, Ste 340, Somerset NJ 08873

VIDEO INVERTER

Create & Restore Inverted Video

R.C. Distributing
Box 552 · South Bend, IN 46624
www.south-bend.net/rcd



For Free Information Package
on Completed Units and Pricing
Call 219-236-5776

MODEL	DX350	DX355	DX360T	DX400	DX405	DX421	DX451	DX460L
Auto Ranging/Bargraph								
True RMS		•						
AC/DC Voltage (750V/1000V)	•	•	•	•	•	•	•	•
AC/DC Current (10A)	20 μ •							
Resistance (20M Ω)	20 Ω •	20 Ω •	2000M	•		30M	2000M	•
Continuity Beeper/Diode	•	•	•	•	•	•	•	•
Temperature w/Probe, Type K			•					
TRhFE							•	
Capacitance (20 μ F)				•				2000 μ
Frequency (20MHz)		•						
Logic (TTL & CMOS)						•		
Inductance (20H)								
Auto Power-Off	•	•	•	•	•	•	•	•
Input Warning Beeper	•	•	•	•	•	•	•	•
Data Hold	•	•	•	•	•	•	•	•
Peak Hold	•	•	•	•	•	•	•	•
Protective Holster	•	•	•	•	•	•	•	•
PRICE	49.95	74.95	64.95	64.95	69.95	74.95	84.95	99.95

• See your local distributors or Call for Catalog

Bel MERIT

1-800-532-3221
(714) 586-2310 · FAX (714) 586-3399
SOLUTIONS FOR THE TEST INSTRUMENT P.O. Box 744, Lake Forest, CA 92630

CABLE TV CONVERTERS

Equipment & Accessories
Wholesalers Welcome

Call **C&D ELECTRONICS**
1-888-615-5757 M-F 10a-6p

CIRCLE 283 ON FREE INFORMATION CARD

KENWOOD

...from the company you've
been listening to for years...

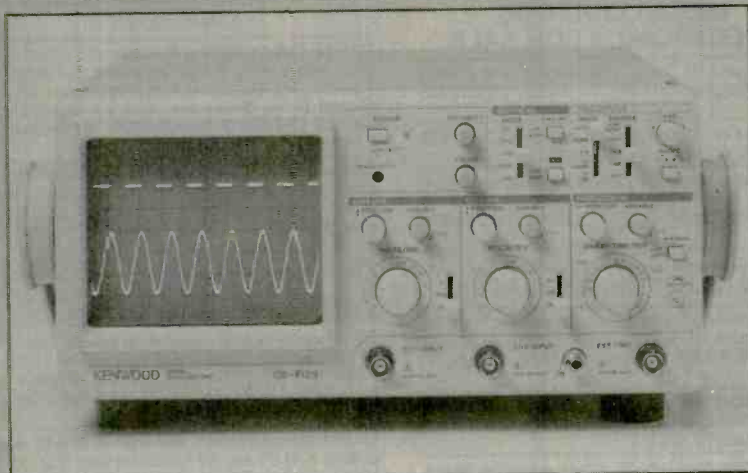

2-Channel, 20-MHz

CS-4125

Regular \$595

Sale \$389

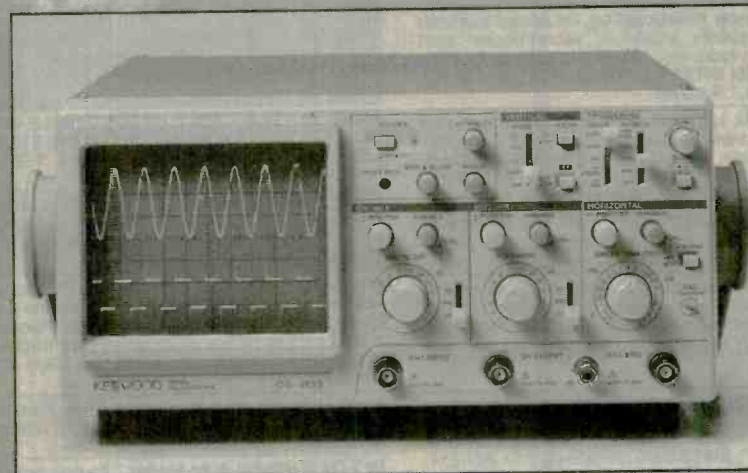

2-Channel, 40-MHz Oscilloscope

CS-4135

Regular \$855

Sale \$685

Hybrid IC Technology is the Key to the High Quality and High Reliability at Low Cost!

- **FIX SYNCHRONIZATION** detects the trigger level automatically for the acquisition of stationary waveforms without complicated sync level adjustments.
- **VERT MODE TRIGGERING** enables the acquisition of stationary waveforms for both CH1 and CH2 even when the input signals to the two channels have different frequencies.
- **HIGH WITHSTAND INPUT** voltage of 400V (800Vp-p).
- **RELAY ATTENUATORS** are provided for reliable logic switchover.
- **SCALE ILLUMINATION** (CS-4135 only)
- **DIMENSIONS** (WxHxD): 300(343) x 140(150) x 415(430)mm () including protrusion.
WEIGHT: approx. 7.2kg (CS-4135) approx. 7kg (CS-4125)



PRINTTM
Products International

Call for your free 84 page test instrument catalog today!!!
8931 Brookville Road * Silver Spring, Maryland * 20910

* Phone 800-638-2020 * Fax 800-545-0058 * email SMPRODINTL@AOL.com

Find Bad Capacitors

In-Circuit with the Capacitor Wizard



The Capacitor Wizard is an extremely FAST and RELIABLE device designed to measure ESR (Equivalent Series Resistance) on capacitors of 1uf and larger "IN CIRCUIT", eliminating the need to remove the capacitor for accurate tests. The Capacitor Wizard finds BAD caps IN CIRCUIT that even VERY EXPENSIVE cap checkers MISS ENTIRELY, even out of the circuit!! Standard capacitor meters cannot detect any change in ESR therefore they miss bad capacitors leading to time consuming "Tough Dog" repairs. *Technicians say it is the most cost effective instrument on their workbench.*



Made in the USA

Order Today

Only \$179.95

Call 1-800-394-1984

<http://www.heinc.com>

Int. # 316-744-1993

Fax 316-744-1994

6222 N. Oliver, Kechi, KS 67067

30 day money back guarantee



CLASSIFIED

MISCELLANEOUS ELECTRONICS FOR SALE

PIECE parts for Delco OEM radios. Low pricing. Factory Original. No subs. Call today, 1 (800) 433-9657.

TUBES: For sale large stock on hand. Call 1-800-370-3390 or dwarders@telepath.com.

CALL for a free electronics catalog or visit our web site at www.bgmicro.com/. B.G. Micro-PO box 280298 Dallas, TX 75228. Order line 800-276-2206

PLANS-KITS-SCHEMATICS

FREE Catalog. 100 Leading-Edge kits. K1, PIC. Full instructions, source code. 1 (800) 875-3214. **SCIENCE FIRST**, 95 Boisford Place, Buffalo, NY 14216.

ELECTRONIC Project Kits. www.qkits.com 1-888-GO-4-KITS. 292 Queen St., Kingston, ON., K7K 1B8. **QUALITY KITS.**

ALL-in-one catalog, 60 mouth-watering pages. CB/HAM/audio/TV/spy/broadcast/science projects, **microwave broadcasting,** broadcast transmitters, amplifiers, antennas, "secret books", start your own radio station and more. Send \$1.00 to **PAN-COM INTERNATIONAL**, PO Box 130-N2, Paradise, CA 95967.

MUSICAL Lights-build a color organ. Let your stereo control your lighting system or Christmas lights. Easy, inexpensive and fun to build. **Complete** documentation \$19.95. **JAK ENGINEERING**, 2712 16th Ave. S., Minneapolis, MN 55407.

TUBES: "oldest." "latest". Parts and schematics SASE for lists. Steinmetz Electronics, 7519 Maplewood Ave., Hammond, Indiana 46324.

Pocket Testbench kit. Digital analyzer, oscilloscope, counter, generator modes. RS232 interface. Handheld, inexpensive. **Oricom Technologies** (303) 444-9776, www.sni.net/~oricom.

REPAIRS-SERVICES

PCB Designs. Professionally mastered in "TANGO". **AWESOME DESIGNS**, P.O. Box 214, Aurora, Ohio 44202-0214. E-Mail: Awesome-Designs@worldnet.att.net

TEST Equipment pre-owned now at affordable prices. Signal generators for \$50.00, oscilloscopes from \$50.00. Other equipment including manuals available. Send \$2.00 US for catalog. Refunded on first order. **J.B. Electronics**, 3446 Dempster, Skokie, IL 60076. (847)982-1973

BUSINESS OPPORTUNITIES

I'M making a "bundle" reclaiming scrap gold from junk computers. Free info: 24 hrs, (603) 645-4767.

ELECTRONICS Businesses. Home based. Part/Full time. 250pg Comprehensive Guidebook, insider information. \$19.95 24hr recording (800) 326-4560 x159.

GREAT extra income idea! Assemble products at home for best companies. Information call: 1(800)377-6000 Ext. 6870.

PERSONAL COMPUTERS OWNERS CAN EARN \$1000 to \$5000 MONTHLY offering simple services part time. Free list of 100 best services. Write: **B.D.R.C.M.** 5667 Harrison #124, Ogden, Utah 84403-4322.

EDUCATION & INSTRUCTION

LEARN Electronics. Home study. Outstanding careers. Free literature. **P.C.D.I.**, Atlanta, Georgia. 1 (800) 362-7070 Dept. ELB342.

PIC controller course, get up and running fast with **Beginners PIC** <http://www.telusplanet.net/public/rhenders>, **Data Burst Software**, Box 1193, Medicine Hat, AB. T1A7H3. 1-403-526-7676.

CABLE TV

CABLE Descrambling New secret manual. Build your own descramblers for cable and subscription TV. Instructions, schematics for **SSAVI**, Gated Sync, Sinewave, \$12.95, \$2 postage. **CABLETRONICS**, Box 30502R, Bethesda, MD 20824.

CABLE TV descramblers. One piece units. Pioneer 6310's, Scientific Atlanta 8580's, Dpv 7's and others. Lowest prices. Money back guarantee. **Precision Electronics**, Houston, TX 1 (888) 693-4610.

CABLE test modules/cubes. Pioneers, S/A, Tomco's, Jerrold. Quantity discounts. Call **DCR Tel:** (718) 624-8334 Fax: (718) 246-9731. No N.Y. calls!

NEW! Jerrold and Pioneer wireless test units \$125.00 each, also 75DB notch filters \$19.95 each, quantity pricing available. Please call **KEN ERNY ELECTRONICS**, 24 hour order and information hot line (516) 389-3536.

CABLE descramblers and converters 10 lot decoders \$38.00 ea. 10 lot converters \$57.00 ea. Visa and Mastercard accepted. (304) 337-8027.

MAESTRO latest technology. Compatible with all major systems: Pioneer, Jerrold, Scientific Atlanta, Zenith. Universal descrambling capabilities. Dealers wanted. Money back guarantee. 1 (800) 676-7966.

DESCRAMBLE CABLE USING SIMPLE CIRCUIT. E-Z TO FOLLOW INSTRUCTIONS \$10.00. COMPLETE KIT WITH FREE BULLET 'TERMINATORE' 420.00. 1-800-522-8053.

CABLE TV EQUIPMENT & ACCESSORIES. Wholesalers Welcome! 30 Day Moneyback Guarantee! Free Catalog! **PERFORMANCE ELECTRONICS, INC.** 1-800-815-1512.

Signal Eliminator can block severe TV interference or unwanted channels! Visit us on the web today at <http://members.aol.com/tvfilter>. Request a free brochure by mail or voicemail. **Star Circuits**, PO Box 94917, Las Vegas, NV 89193. 1-800-433-6319.

Multimode test modules. Master Files. Reverse engineering. Lowest prices, best quality. Dealers welcome. 717-462-3877

RFT-DAM (Digital Auto Mode) The only answer for DPB=> CFT 20XX. Best Prices. 1-800-627-2339

Wholesale Cable Warehouse Decoders for all systems **Best Prices Guaranteed** Helpful, friendly service and support ready to help. 30 day money back guarantee and full 1 year warranty call now 1-800-387-0349 Dealers Welcome Call for free price quote.

Free Cable Descrambler Plans. For Details Write: Sierra Publishing, 909 E. Yorba Linda Blvd., Suite H-181, Dept. ENN, Placentia, CA 92870

Cable TV, Descramblers, Converters Quarterly Discounts, Low Low Prices 30 Day-Money Back Guaranteed. Call Now 888-686-3284 Sky-lab Sales Inc.

SATELLITE EQUIPMENT

VIDEOCYEPHER II descrambling manual. Schematics, video and audio. Explains DES, EPROM, CloneMaster, Pay-per-view \$16.95, \$2.00 postage. Schematics for Videocypher Plus, \$20.00. Schematics for Videocypher 032, \$15.00. Collection of Software to copy and alter EPROM codes, \$25.00. VCII Plus EPROM, binary and source code, \$30.00. **CABLETRONICS**, Box 30502R, Bethesda, MD 20824.

OBTAINING sound for your VCII and VCII Plus is easy. No codes needed. Also **DSS Test Card** information. Details 1 (800) 211-5635.

FREE DSS TEST CARD information package. Works on new system and turns on all channels including PPV, adult and sports channels. Write **Signal Solutions**, 2711 Buford Rd., Suite 180, Richmond VA 23235.

DSS Test Card Authorizes all channels for information plus free bonus call toll free 1-888-416-7296

DSS BIBLE Volume 2. \$85.50 **DSS BIBLE Volume 1** \$55.45 **DSS SECRETS-** All Patents \$69.95. **CELLULAR HACKERS PACKAGE** (3) Hackers Bibles, (2) Videos & Programming Software. \$199.00 + **Master Test Chip Files.** Jerrold, Scientific-Atlanta, Tocom, Pioneer, Zenith. Software & Book. \$79.95. **TELECODE** 1-520-726-2833. <http://www.hackerscatalog.com>

SKYVISION! Your Satellite Home Entertainment Source. **Best values:** DBS and C/Ku-band equipment, including 4DTV. Most complete selection: Parts-Tools-Upgrades-Accessories! **Free Discount Buyer's Guide.** Call 800-543-3025. International 218-739-5231. www.skyvision.com.

DSS Hacking: How to construct and program smart cards. w/pic16C84, software. Complete DSS System schematics. \$16.95 **CABLETRONICS**, Box 30502R Bethesda, MD 20824.

CB-SCANNERS

CB RADIO MODIFICATIONS! Books, plans, frequencies, sliders, 10-meter, amplifiers, repairs, high-performance accessories. Catalog \$3.00. CBCL, Box 31500EN, Phoenix AZ 85046. 888-643-1300.

AUDIO-VIDEO-LASERS

LASERS Astonishing Low Prices Free Catalog T.E.P. PO Box 1353 Glendale, AZ 85311 Phone # 602-487-9897.

SCRAMBLING NEWS

BEST satellite TV news includes coverage of piracy. Voice/Fax (716) 283-6910. www.scramblingnews.com

THE SMART CHOICE

FOR OVER 47 YEARS, THE SERVICEMAN'S CHOICE FOR IN-VOICES AND SALES BOOKS HAS BEEN



OELRICH PUBLICATIONS.

- ⇒ QUALITY YOU CAN COUNT ON
- ⇒ PRICED AS LOW AS 4 CENTS EA.
- ⇒ COMPUTER FORMS AND CHECKS CALL TODAY FOR A FREE CATALOG 1-800-621-0105

BEST BY MAIL

Rates: Write National, Box 5, Sarasota, FL 34230

EDUCATION

HIGH SCHOOL DIPLOMA At Home, Accredited, Fast, "Failure-Proof" 1-800-470-4723: American Academy, 12651 S. Dixie Highway, Miami, FL 33156.

FINANCIAL

CASH NOW FOR FUTURE PAYMENTS! We buy payments from Insurance Settlements, Annuities, and Casino Winnings. We also buy Owner Financed Mortgages. Call R&P Capital Resources at 1-800-338-5815, X500.

"LIVE LIKE A KING" Experience Financial Freedom! Quickly and Easily Become Debt Free! Enjoy The Benefits Of Wealth! For details send SASE: I.P.&T., 1279 "N" Street, Springfield, Oregon 97477.

QUICK CASH No Collateral, No Credit Check, No Front Fees (310) 281-7027.

HEALTH

101 QUESTIONS AND SHOCKING ANSWERS ABOUT AIDS. Only \$10.00. MINORITIES ARE PEOPLE, INC., PO Box 1006-(ELE), New York, NY 10116.

Plug Power
UNIT OF ILSR DESIGNS INC.

The Smallest*, Lightest*, Coolest, 5% Regulated, 10 Watt DC Power Supplies are here!

VDC @ Amps

5.0	1.6
9.0	1.1
12.0	0.8



\$29.95
SINGLE Qty. US\$
* NEXT DAY or 2 DAY AIR

Detailed Specs on web site!

www.plugpwr.com/alpha.htm

CALL FREE In US & Canada:

1-888-PLUGPWR
(1-888-758-4797)

* 1.9 x 2.1 x 1", 2.9 oz. Tiny, aren't they? See the web site!

Quality Microwave TV Systems

WIRELESS CABLE - ITFS - MMDS
ATV - INTERNATIONAL - S-BAND
Amplifiers • Antennas • Books • Components
Filters • Systems • Video Products
• RF Frequency 1990 - 2700 MHz
• Cable Ready - VHF - UHF Outputs
• SASE For "FREE" Catalog or Send \$1

PHILLIPS-TECH ELECTRONICS

PO Box 8533 • Scottsdale, AZ 85252

ORDER LINE 800-880-MMDS

CATALOG/INFO 602-947-7700

FAX LINE 602-947-7799

CHALLENGER SYSTEM
3-Channel 52dB+ Gain
Complete Grid \$265
Five Year Warranty
FREE SHIPPING Visa • MC • Amx • Disc • COD's • Qty Pricing

BEST DEALER PRICING!

CABLE DIRECT
CONVERTERS • FILTERS
DESCRAMBLERS

IMPROVE YOUR IMAGE WITH
VIDEO STABILIZERS

FREE
CABLE TV
CATALOG!

100%
MONEY BACK
GUARANTEE!

Now you can tune-in your favorite
cable TV programming
and **SAVE \$100'S** -
EVEN \$1000'S on premium
CABLE TV EQUIPMENT.



**MODERN
ELECTRONICS**

1-800-906-6664

2609 S. 156TH CIRCLE • OMAHA, NE 68130
<http://www.modernelectronics.com>

ATTENTION DEALERS: WHOLESALE ONLY!



Formerly JES, Inc.

EXCLUSIVE:



NEW!

Wavemaster 99 Channel

• Sleep Timer • Std./HRC Switch • Parental Control

10+	20 +	50+
\$57	52	45

	5+	10+	20+
Panasonic 145	\$72	65	60
Refurb. Panasonic 145	57	55	52
Panasonic 100	52	49	--
Panasonic 175	---	CALL!	---
Starcomm DQN	49	45	39
(99 ch; Refurb.)			

TOLL FREE:
800-322-9690



FAX:
516-246-5634

February 1998, Electronics Now

ADVERTISING INDEX

Electronics Now does not assume any responsibility for errors that may appear in the index below.

Free Information Number	Page	Free Information Number	Page		
—	Abacom Technology.....	72	—	Link Instruments.....	98
—	ABC Electronics.....	94	—	Lynxmotion.....	90
—	AES.....	98	—	M2L Electronics.....	90
214	All Electronics.....	87	333	Mark V Electronics.....	91
—	Allison Technology.....	74	332	MCM Electronics.....	77
—	Amaze Electronics.....	76	—	Meredith Instruments.....	99
315	American Eagle Publications.....	82	323	Merrimack Valley Systems.....	98
—	Andromeda Research.....	101	133	MicroCode Engineering.....	CV2
282	Basic Electrical Supply.....	80	—	microEngineering Labs.....	94
283	Bel-Merit.....	102	—	Modern Electronics.....	105
—	Brand Electronics.....	85	283	Mouser Electronics.....	90
326	Butterworth-Heinemann.....	95	330	NCD Electronics.....	72
322	C&S Sales, Inc.....	78	—	NRI Schools.....	9
327	Capital Electronics.....	82	—	Orion.....	102
328	Circuit Specialists.....	75	318	OWI.....	96
—	CLAGGK, Inc.....	92	262	Parts Express Inc.....	83
—	Cleveland Inst. of Electronics.....	21	—	Pioneer Hill Software.....	100
—	Command Productions.....	76	—	Plug Power.....	105
313	CTG.....	86	—	Polaris Industries.....	69
312	Dynamic Technology.....	88	325	Prairie Digital.....	74
—	EDE - Spy Outlet.....	92	264	Print (Pace).....	103
—	Electronic Design Specialists.....	74	—	QB Video.....	92
—	Electronic Tech.Today.....	45, 101	266	Ramsey Electronics.....	89
335	Electronix Express.....	86	—	RC Distributing Co.....	102
—	Emac Inc.....	82	—	RF Parts.....	76
121	Fluke Corp.....	CV3	320	Roger's Systems Specialist.....	73
336	Foley-Belsaw Co.....	97	—	Sil Walker.....	96
331	Fotronic.....	80	270	Skyvision Inc.....	71
—	General Device Instruments.....	100	—	Square 1 Electronics.....	94
122	Global Specialties.....	7	—	Starlet Sysems.....	92
—	Grantham Col. of Engineering.....	4	—	Tab Books.....	29, 59
—	Home Automation.....	101	—	Tekview.....	102
321	Howard Electronics.....	81	324	Telulex.....	85
—	Howard Electronics.....	104	—	Test Equipment Sales.....	96
—	Information Unlimited.....	93	275	Timeline.....	70
126	Interactive Image Technologies.....	CV4	—	U.S. Cyberlab.....	100
319	IVEX Design.....	99	—	Visual Communications.....	4
134	IWATSU America.....	27	314	White Star Electronics.....	72
—	Jameco.....	3	—	Wisch Communications.....	94
—	James Electronics.....	105	—	World College.....	41
334	Jensen Tools.....	69	—	WPT Publications.....	85
—	Lindsay Publications.....	90			

ADVERTISING SALES OFFICES

Gernsback Publications, Inc.
500 Bi-County Blvd.
Farmingdale, NY 11735-3931
1-(516) 293-3000

Fax 1-(516) 293-3115

Larry Steckler

publisher (ext. 201)

e-mail advertising@gernsback.com

Adria Coren

vice-president (ext. 208)

Ken Coren

vice-president (ext. 267)

Christina Estrada

assistant to the publisher (ext. 209)

Arline Fishman

advertising director (ext. 206)

Marie Falcon

advertising assistant (ext. 211)

Adria Coren

credit manager (ext. 208)

For Advertising ONLY

EAST/SOUTHEAST

Stanley Levitan

Eastern Advertising

1 Overlook Ave.

Great Neck, NY 11021-3750

1-516-487-9357

Fax 1-516-487-8402

slevitan26@aol.com

MIDWEST/Texas/Arkansas/Okla.

Ralph Bergen

Midwest Advertising

One Northfield Plaza, Suite 300

Northfield, IL 60093-1214

1-847-559-0555

Fax 1-847-559-0562

bergenrj@aol.com

PACIFIC COAST

Janice Woods

Pacific Advertising

Hutch Looney & Associates, Inc.

6310 San Vicente Blvd., Suite 360

Los Angeles, CA 90048-5426

1-213-931-3444 (ext. 228)

Fax 1-213-931-7309

woodyowl@aol.com

Electronic Shopper

Joe Shere

National Representative

P.O. Box 169

Idyllwild, CA 92549-0169

1-909-659-9743

Fax 1-909-659-2469

jshere@gernsback.com

Megan Mitchell

National Representative

9072 Lawton Pine Avenue

Las Vegas, NV 89129

Phone/Fax 702-240-0184

Lorri88@aol.com

Customer Service

1-800-999-7139

7:00 AM - 6:00 PM M-F MST

FLUKE®

Introducing the Rugged NEW Fluke 70 Series III Digital Multimeters.

Rough handling and high voltage are tough on a meter. But the new Fluke 70 Series III takes it all in stride.

It's built tough inside and out. With overvoltage protection to guard against spikes up to 6 kV, and safety ratings to prove it. It even protects against measuring voltage if the knob is accidentally set on ohms. Plus its rugged, overmolded body armor case offers constant protection no matter how much you throw it around.

As tough as it is, the 70 Series III is very easy on you. Its tapered design fits more easily in your hand, pocket, and tool box. The display is 40% larger, with extra large characters that are easy to read from a distance. Plus, there's easier access to Fluke's patented Touch Hold® mode which automatically captures the measurement, beeps, and locks it on the digital display for later viewing.

No matter how tough your job is, the new Fluke 70 Series III is even tougher. There are five models to choose from. And of course, they're backed by a lifetime warranty.

Fluke Multimeters
*Keeping your world up
and running.*

Take a demo.

Find out just how tough the new 70 Series III DMMs really are. Visit Fluke at www.fluke.com or call **1-800-44-FLUKE** for the distributor nearest you.



The tough just got tougher.



© 1997 Fluke Corporation, P.O. Box 9090, M/S 250E, Everett WA 98206-9090, U.S. (800) 44-FLUKE or (425) 356-5400.
Canada (905) 890-7500. Europe (31 40) 2 678 200.
Other countries (425) 356-5500.
Web access: www.fluke.com
All rights reserved. Ad no. 01022

CIRCLE 121 ON FREE INFORMATION CARD

Better Designs - Faster

With the Personal Design Solution

The Design Solution Includes: Electronics Workbench Personal Edition + EWB Layout

Electronics
Workbench
Personal Edition

Electronics
Workbench *Layout*
Personal Edition

Full-featured schematic capture and SPICE 3F circuit simulation!

The world's best selling circuit design software. With analog, digital and mixed A/D SPICE simulation, a full suite of analyses and over 4000 devices. Imports netlists. Seamlessly integrated with EWB Layout or exports to other popular PCB programs. Still the standard for power and ease of use. Still the same effective price.

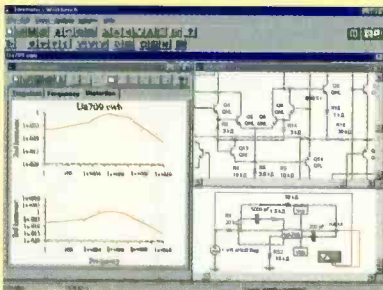

\$299
Version 5

Power-packed PCB layout with autorouting and real-time DRC!

EWB Layout is a powerful board layout package for producing high quality, multi-layer printed circuit boards. Offering tight integration with our schematic capture program, you can incorporate board layout and design and quickly bring well designed boards to production.

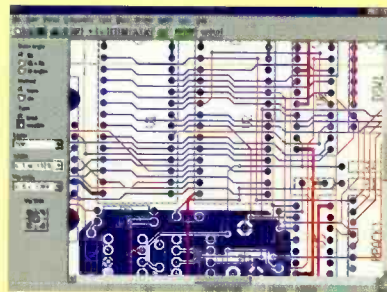

\$299
Version 5

HIGH-END FEATURES

TRUE MIXED ANALOG/DIGITAL	YES
FULLY INTERACTIVE SIMULATION	YES
PRO SCHEMATIC EDITOR	YES
HIERARCHICAL CIRCUITS	YES
VIRTUAL INSTRUMENTS	YES
ON SCREEN GRAPHS	YES
ANALOG AND DIGITAL MODELS	OVER 4,000
FREE TECHNICAL SUPPORT	YES
DC OPERATING POINT	YES
AC FREQUENCY	YES
TRANSIENT	YES
FOURIER	YES
NOISE	YES
DISTORTION	YES

POWER-PACKED FEATURES

AUTOROUTING	YES
REROUTE WHILE MOVE	YES
LAYERS	32 ROUTING LAYERS
BOARD SIZE	50" X 50"
LIBRARY SHAPES	OVER 3,500
BLIND AND BURIED VIAS	YES
EXTENSIVE OUTPUT	YES
SELECTIVE NET HIGHLIGHTING	YES
USER DEFINED PADS	YES
REAL TIME DESIGN RULE CHECK	YES
DENSITY HISTOGRAMS	YES
FREE TECHNICAL SUPPORT	YES

**30-DAY MONEY-BACK
GUARANTEE**

*Join over 85,000 customers
and find out why more circuit designers
buy Electronics Workbench than
any other circuit design tool.*

**CALL FOR INFORMATION
AND PRICING ON OUR
PROFESSIONAL EDITION.**

ELECTRONICS WORKBENCH Personal Edition \$299.00
EWB LAYOUT Personal Edition \$299.00

**BUY
BOTH
AND
SAVE**

PERSONAL DESIGN SOLUTION \$598.00
\$548.00

CALL 800-263-5552

For a free demo, visit our website
at <http://www.interactiv.com>

INTERACTIVE IMAGE TECHNOLOGIES LTD., 908 Niagara Falls Boulevard,
#068, North Tonawanda, New York 14120 2060 / Telephone 416-977-5550.

TRADEMARKS ARE PROPERTY OF THEIR RESPECTIVE HOLDERS. OFFER IS IN U.S. DOLLARS AND VALID ONLY
IN THE UNITED STATES AND CANADA. ALL ORDERS SUBJECT TO \$15 SHIPPING AND HANDLING CHARGE.

Fax: 416-977-1818 E-mail: ewb@interactiv.com
CompuServe: 71333,3435 / BBS: 416-977-3540



CIRCLE 126 ON FREE INFORMATION CARD