

WILL "BEASTIE CABLES" IMPROVE YOUR AUDIO?

# Radio Electronics

FEBRUARY 1991

TECHNOLOGY - VIDEO - STEREO - COMPUTERS - SERVICE

## TURN YOUR PC INTO A UNIVERSAL FREQUENCY COUNTER

Build this plug-in card  
for your lab computer

## BUILD A NEGATIVE-ION GENERATOR

Experiment with high-voltage  
electronics and the effects  
of negative ions

## BUILD A SWEEP/MARKER GENERATOR

Test your audio amplifier and  
filter circuits

## HOT TROUBLESHOOTING TIPS

How to use the horizontal  
output transistor pulse to  
diagnose TV troubles

## ELECTRONICS STANDARDS

A refresher course looks at  
the basis of our measurements

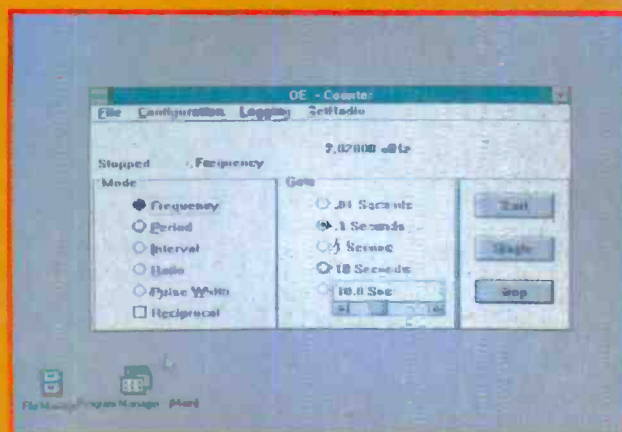
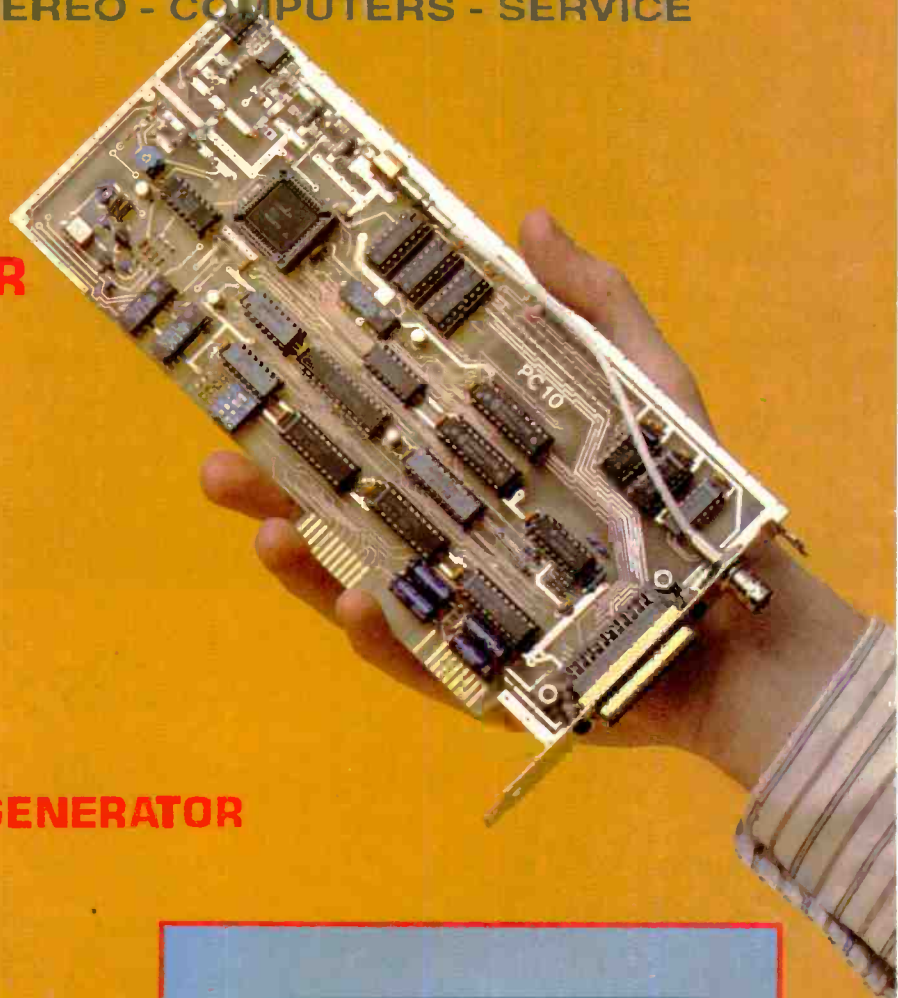

GEFMS3ACK  
PUBLICATION

\$2.95 U.S.  
\$3.75 CAN

XXXXXXXXXXXXXXXX 5-DIGIT 95014  
303092DRK6450M091

C2 36  
MAY 92  
RE

LLOYD DARKNELL  
6450 MYRTLEWOOD DR  
CUPERTINO, CA

95014

**FLUKE**®



**PHILIPS**

9.0125 V DC 17.728 mV AC



# Two displays. One great meter.

**Dual displays provide two accurate measurements. Combined with 16 different measurement capabilities. The Fluke 45 is making people take a second look.**

**The Fluke 45 has the specs to get the job done right.** 0.02% basic dc voltage accuracy and 100,000 count resolution on both displays. Basic dc current accuracy is 0.05%, making the 45 ideal for servicing 4-20 mA current loops. The Fluke 45 measures true-rms voltage and current, including ac + dc. Closed-case calibration simplifies the calibration process and increases uptime.

**Twice as much information.**

The 5-digit, 100,000 count dual displays give you more information in less time—and with less effort. For example, measure the VDC output of a power supply while measuring the VAC ripple. Or check the amplitude and frequency of an AC signal. From a single test connection!

**More measurement combinations.**

With the Fluke 45 complex measurements become simple, with standard features like a 1 MHz frequency counter, Min Max, limits testing (Hi/Low/Pass), Touch Hold® and Relative modes. There are 21 different reference impedances for dB measurements; in the 2Ω to 16Ω ranges, audio power can be automatically displayed in watts. The variety of electrical parameters, measurement functions and display combinations is incredible.

**Even an RS-232 interface is standard.**

Connecting the Fluke 45 to PCs, RS-232 printers and modems is as easy as attaching the cable. An IEEE-488.2 interface and internal, rechargeable lead-acid batteries are available as options.

**Get a great value.**

Contact your local distributor today for complete information on the new Fluke 45. Or call toll-free **1-800-44-FLUKE, ext 33.**

**FLUKE 45 DUAL DISPLAY MULTIMETER**

\$635*	dB, with 21 reference impedances, and audio power calculations
Dual Display	Compare and Relative functions
True-rms voltage and current, including ac + dc	Min Max and Touch Hold® functions
0.02% basic dc voltage accuracy	Optional PC software for RS-232 applications
0.05% basic dc current accuracy	Optional IEEE-488.2 interface, battery pack
1 MHz frequency counter	One year warranty
RS-232 interface standard	

\*Suggested U.S. List Price

John Fluke Mfg. Co., Inc. P.O. Box 9090 M/S 250C Everett, WA 98206  
 U.S. 206-356-5400 Canada: 416-890-7600 Other Countries:  
 206-356-5500 © Copyright 1989, 1990 John Fluke Mfg. Co., Inc.  
 All rights reserved. Ad no. 00015 IBM PC is a registered trademark  
 of International Business Machines Corporation.

**FROM THE WORLD LEADER  
IN DIGITAL MULTIMETERS**

CIRCLE 121 ON FREE INFORMATION CARD

**FLUKE**®

**NEW!!  
FAX US YOUR  
FREE  
INFORMATION  
CARDS FOR  
EVEN FASTER  
SERVICE!**

Now you can send your requests for Free Information by FAX or mail. It's simple, it's easy—just follow these three steps:

- 1** Print your name, address and Zip Code on one of the attached postage-paid cards.
- 2** Circle the number (or numbers) on the card that matches the number at the bottom of each ad or editorial item that you want information on. Advertisers' free information numbers also appear in the ad index.
- 3** FAX the complete card to us at **413-637-4343** or if you prefer, drop the card in the mail—it's still postage paid!

**NOTE:** Submit all Free Information requests by either FAX or mail, **NOT BOTH!** **DUPLICATE REQUESTS WILL BE DISCARDED.** Use the FAX telephone number and the postcard address for Free Information only. Address all editorial inquiries to Editor, Radio-Electronics®, 500-B Bi-County Blvd., Farmingdale, NY 11735

**BUSINESS PROFESSIONAL FREE INFO CARD**



4-291

Name \_\_\_\_\_ Title \_\_\_\_\_  
 Company \_\_\_\_\_  
 Dept. MS \_\_\_\_\_  
 Daytime Business Phone \_\_\_\_\_  
 Company Address \_\_\_\_\_  
 City \_\_\_\_\_ State \_\_\_\_\_ Zip • 4 \_\_\_\_\_

Unclear or incomplete mailing info will prevent our processing this request.

- 2  Please send me 12 issues of RADIO-ELECTRONICS\* for \$17.97 and bill me. (Canada \$23.97 - US Funds only)
- 4  Please send me 12 issues (1 year) of POPULAR ELECTRONICS\* for \$18.95 and bill me. (Canada \$23.95 - US Funds only)

22	43	64	85	106	127	148	169	190	211	232	253	274	295	316	337	358	
23	44	65	86	107	128	149	170	191	212	233	254	275	296	317	338	359	
24	45	66	87	108	129	150	171	192	213	234	255	276	297	318	339	360	
25	46	67	88	109	130	151	172	193	214	235	256	277	298	319	340	361	
26	47	68	89	110	131	152	173	194	215	236	257	278	299	320	341	362	
27	48	69	90	111	132	153	174	195	216	237	258	279	300	321	342	363	
28	49	70	91	112	133	154	175	196	217	238	259	280	301	322	343	364	
29	50	71	92	113	134	155	176	197	218	239	260	281	302	323	344	365	
30	51	72	93	114	135	156	177	198	219	240	261	282	303	324	345	366	
10	31	52	73	94	115	136	157	178	199	220	241	262	283	304	325	346	367
11	32	53	74	95	116	137	158	179	200	221	242	263	284	305	326	347	368
12	33	54	75	96	117	138	159	180	201	222	243	264	285	306	327	348	369
13	34	55	76	97	118	139	160	181	202	223	244	265	286	307	328	349	370
14	35	56	77	98	119	140	161	182	203	224	245	266	287	308	329	350	371
15	36	57	78	99	120	141	162	183	204	225	246	267	288	309	330	351	372
16	37	58	79	100	121	142	163	184	205	226	247	268	289	310	331	352	373
17	38	59	80	101	122	143	164	185	206	227	248	269	290	311	332	353	374
18	39	60	81	102	123	144	165	186	207	228	249	270	291	312	333	354	375
19	40	61	82	103	124	145	166	187	208	229	250	271	292	313	334	355	376
20	41	62	83	104	125	146	167	188	209	230	251	272	293	314	335	356	377
21	42	63	84	105	126	147	168	189	210	231	252	273	294	315	336	357	378

**FREE INFORMATION CARD**

VOID after APRIL 30, 1991.

Allow 6-8 weeks for delivery of first issue

**BUSINESS PROFESSIONAL FREE INFO CARD**



3-291

Name \_\_\_\_\_ Title \_\_\_\_\_  
 Company \_\_\_\_\_  
 Dept. MS \_\_\_\_\_  
 Daytime Business Phone \_\_\_\_\_  
 Company Address \_\_\_\_\_  
 City \_\_\_\_\_ State \_\_\_\_\_ Zip • 4 \_\_\_\_\_

Unclear or incomplete mailing info will prevent our processing this request.

- 2  Please send me 12 issues of RADIO-ELECTRONICS\* for \$17.97 and bill me. (Canada \$23.97 - US Funds only)
- 4  Please send me 12 issues (1 year) of POPULAR ELECTRONICS\* for \$18.95 and bill me. (Canada \$23.95 - US Funds only)

22	43	64	85	106	127	148	169	190	211	232	253	274	295	316	337	358	
23	44	65	86	107	128	149	170	191	212	233	254	275	296	317	338	359	
24	45	66	87	108	129	150	171	192	213	234	255	276	297	318	339	360	
25	46	67	88	109	130	151	172	193	214	235	256	277	298	319	340	361	
26	47	68	89	110	131	152	173	194	215	236	257	278	299	320	341	362	
27	48	69	90	111	132	153	174	195	216	237	258	279	300	321	342	363	
28	49	70	91	112	133	154	175	196	217	238	259	280	301	322	343	364	
29	50	71	92	113	134	155	176	197	218	239	260	281	302	323	344	365	
30	51	72	93	114	135	156	177	198	219	240	261	282	303	324	345	366	
10	31	52	73	94	115	136	157	178	199	220	241	262	283	304	325	346	367
11	32	53	74	95	116	137	158	179	200	221	242	263	284	305	326	347	368
12	33	54	75	96	117	138	159	180	201	222	243	264	285	306	327	348	369
13	34	55	76	97	118	139	160	181	202	223	244	265	286	307	328	349	370
14	35	56	77	98	119	140	161	182	203	224	245	266	287	308	329	350	371
15	36	57	78	99	120	141	162	183	204	225	246	267	288	309	330	351	372
16	37	58	79	100	121	142	163	184	205	226	247	268	289	310	331	352	373
17	38	59	80	101	122	143	164	185	206	227	248	269	290	311	332	353	374
18	39	60	81	102	123	144	165	186	207	228	249	270	291	312	333	354	375
19	40	61	82	103	124	145	166	187	208	229	250	271	292	313	334	355	376
20	41	62	83	104	125	146	167	188	209	230	251	272	293	314	335	356	377
21	42	63	84	105	126	147	168	189	210	231	252	273	294	315	336	357	378

**FREE INFORMATION CARD**

VOID after APRIL 30, 1991.

Allow 6-8 weeks for delivery of first issue



POSTAGE WILL BE PAID BY ADDRESSEE



**SUBSCRIPTION SERVICE**  
**P.O. Box 51866**  
**BOULDER, COLORADO 80321-1866**

**NO POSTAGE  
NECESSARY  
IF MAILED  
IN THE  
UNITED STATES**





**BUSINESS REPLY MAIL**  
FIRST CLASS MAIL PERMIT NO. 132 PITTSFIELD, MA

POSTAGE WILL BE PAID BY ADDRESSEE

**Radio  
Electronics®**

READER SERVICE MANAGEMENT DEPT.  
P.O. BOX 5192  
PITTSFIELD, MA 01203-9989

NO POSTAGE  
NECESSARY  
IF MAILED  
IN THE  
UNITED STATES

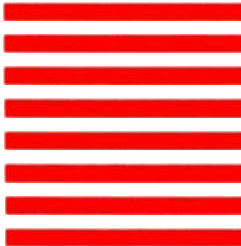

**For New  
Ideas  
In Electronics  
read Radio-  
Electronics®  
every month.**

Radio-Electronics will carry timely articles on:

- audio
- video
- personal computers
- VCR servicing
- test equipment
- interactive video
- robotics
- experimenter circuits
- TV scrambling and descrambling
- solid-state technology
- exceptional construction projects

**Radio  
Electronics®**

4SB18

Subscribe today to the magazine that keeps you up-to-date with the newest ideas and innovations in electronics. (If you already are a subscriber, do a friend a favor and pass this subscription card along to him.)

**check offer preferred**

- 1 year—12 issues **ONLY \$17.97**  
(You save \$17.43 off single copy price)  
Basic Subscription Rate
- Canada—12 issues \$23.97

- 2 Years (**SAVE MORE**)—24 issues \$34.97  
(You save \$35.83 off single copy price)  
Basic Subscription Rate
- Canada—24 issues \$46.97

ALL SUBSCRIPTIONS PAYABLE IN U.S. FUNDS ONLY

- Payment enclosed
- Bill Me
- Check here if you are extending or renewing your subscription

Name (Please print) \_\_\_\_\_

Company Name (if applicable) \_\_\_\_\_

Address \_\_\_\_\_

City \_\_\_\_\_ State \_\_\_\_\_ Zip \_\_\_\_\_

Allow 6-8 weeks for delivery of first issue.



Radio-Electronics offers a unique combination of articles on electronics technology, service, audio, video, computers. Keep up-to-date! **Subscribe Today!**

**USE THE ORDER CARD ON YOUR LEFT**

**Popular Electronics**

Delivers projects for the beginning and advanced builder, articles that help you get the most from your hobby, news and reviews on the hottest new consumer and hobby gear, monthly columns on computers, ham radio, shortwave listening, antique radio, and more!

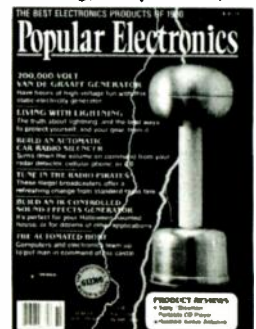

**SUBSCRIBE TODAY!**



**BUSINESS REPLY MAIL**  
FIRST CLASS MAIL PERMIT NO. 132 PITTSFIELD, MA

POSTAGE WILL BE PAID BY ADDRESSEE

**Radio  
Electronics®**

READER SERVICE MANAGEMENT DEPT.  
P.O. BOX 5192  
PITTSFIELD, MA 01203-9989

NO POSTAGE  
NECESSARY  
IF MAILED  
IN THE  
UNITED STATES

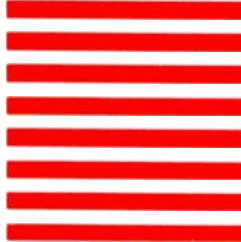

## BUILD THIS

### 37 TURN YOUR PC INTO A UNIVERSAL FREQUENCY COUNTER

Build a frequency-counter/timer board that works with Windows.  
**Joe Grasty and Bill Schulz**

### 43 AUDIO SWEEP/MARKER GENERATOR

Determine the frequency response of your amplifier or filter design.  
**John Wannamaker**

### 55 NEGATIVE ION GENERATOR

Experiment with high-voltage electronics and the effects of negative ions.  
**Anthony J. Caristi**

## TECHNOLOGY

### 50 WILL "BEASTIE" SPEAKER CABLES IMPROVE YOUR AUDIO?

Find out if expensive speaker cables are really worth the money.  
**Richard A. Honeycutt**

### 61 HOT TROUBLESHOOTING TIPS

A look at the horizontal output transistor and how to use it to speed your troubleshooting.  
**Brian Phelps**

### 63 1 VOLT + = ?

A refresher course on standard electric quantities.  
**Dale Nassar**

## DEPARTMENTS

### 6 VIDEO NEWS

What's new in this fast-changing field.  
**David Lachenbruch**

### 20 EQUIPMENT REPORTS

Data Controls Analyst 2.

### 71 HARDWARE HACKER

Inexpensive visible lasers, and more.  
**Don Lancaster**

### 78 COMPUTER CONNECTIONS

Windows pains (and pleasures).  
**Jeff Holtzman**

### 81 AUDIO UPDATE

The Boston sound: Part II.  
**Larry Klein**



**Build this sweep marker generator and the cover the audio-range frequency response of your amplifier or filter design.**

PAGE 43



**WILL "BEASTIE" SPEAKER CABLES IMPROVE YOUR AUDIO?**

*Are expensive speaker cables really worth the money? This article tells how we found out for sure!*

PAGE 50

## AND MORE

96 Advertising and Sales Offices

96 Advertising Index

12 Ask R-E

17 Letters

87 Market Center

31 New Lit

22 New Products

4 What's News

## ON THE COVER



PC's have become an essential part of any electronics test bench. Until recently, however, PC-based instrumentation was considered to be little more than toys with their limited use and features. That's not true any longer. Take, for example, our PC10 frequency counter. It's a card that fits in an expansion slot in your PC and operates in a Windows environment. It can perform direct counts over 200 MHz, it has a 10-digit display, and a 2.4-GHz range. Because it operates in a computer, additional features such as data logging are available. Turn to page 37 for details.

## COMING NEXT MONTH

### THE MARCH ISSUE GOES ON SALE FEBRUARY 1.

#### **BUILD R-E's VIDEO TELEPHONE**

Transmit and receive high-resolution images over standard phone lines!

#### **BUILD A REMOTE-CONTROL ANALYZER**

Examine the output of your IR remote control with this handy device.

#### **MICROWAVES: PART 4**

An in-depth look at solid-state microwave devices.

#### **SEMICONDUCTOR MEMORIES**

Take a look at the advantages and disadvantages of CMOS, TTL, and EEPROM's.

As a service to readers, RADIO-ELECTRONICS publishes available plans or information relating to newsworthy products, techniques and scientific and technological developments. Because of possible variances in the quality and condition of materials and workmanship used by readers, RADIO-ELECTRONICS disclaims any responsibility for the safe and proper functioning of reader-built projects based upon or from plans or information published in this magazine.

Since some of the equipment and circuitry described in RADIO-ELECTRONICS may relate to or be covered by U.S. patents, RADIO-ELECTRONICS disclaims any liability for the infringement of such patents by the making, using, or selling of any such equipment or circuitry, and suggests that anyone interested in such projects consult a patent attorney.

RADIO-ELECTRONICS, (ISSN 0033-7862) February 1991. Published monthly by Gernsback Publications, Inc., 500-B Bf-County Boulevard, Farmingdale, NY 11735 Second-Class Postage paid at Farmingdale, NY and additional mailing offices. Second-Class mail registration No. 9242 authorized at Toronto, Canada. One-year subscription rate U.S.A. and possessions \$17.97. Canada \$23.97, all other countries \$26.97. All subscription orders payable in U.S.A. funds only, via international postal money order or check drawn on a U.S.A. bank. Single copies \$2.95. © 1991 by Gernsback Publications, Inc. All rights reserved. Printed in U.S.A.

**POSTMASTER:** Please send address changes to RADIO-ELECTRONICS, Subscription Dept., Box 55115, Boulder, CO 80321-5115.

A stamped self-addressed envelope must accompany all submitted manuscripts and/or artwork or photographs if their return is desired should they be rejected. We disclaim any responsibility for the loss or damage of manuscripts and/or artwork or photographs while in our possession or otherwise.

## Radio Electronics®

Hugo Gernsback (1884-1967) founder

**Larry Steckler**, EHF, CET,  
editor-in-chief and publisher

#### **EDITORIAL DEPARTMENT**

**Brian C. Fenton**, editor

**Marc Spiwak**, associate editor

**Daniel Goodman**, technical editor

**Kim Dunleavy**,  
assistant technical editor

**Teri Scaduto**, assistant editor

**Jeffrey K. Holtzman**  
computer editor

**Robert Grossblatt**, circuits editor

**Larry Klein**, audio editor

**David Lachenbruch**  
contributing editor

**Don Lancaster**  
contributing editor

**Richard D. Fitch**  
contributing editor

**Kathy Terenzi**, editorial assistant

#### **ART DEPARTMENT**

**Andre Duzant**, art director

**Injae Lee**, illustrator

**Russell C. Truelson**, illustrator

#### **PRODUCTION DEPARTMENT**

**Ruby M. Yee**, production director

**Janice Box**,  
editorial production

**Karen S. Tucker**  
advertising production

**Marcella Amoroso**  
production assistant

#### **CIRCULATION DEPARTMENT**

**Jacqueline P. Cheeseboro**  
circulation director

**Wendy Alanko**  
circulation analyst

**Theresa Lombardo**  
circulation assistant

**Michele Torrillo**, reprint bookstore

Typography by Mates Graphics  
Cover photo by Diversified Photo  
Services

Radio-Electronics is indexed in  
*Applied Science & Technology Index*  
and *Readers Guide to Periodical Literature*.

Microfilm & Microfiche editions are  
available. Contact circulation department  
for details.

**Advertising Sales Offices listed  
on page 96.**

Radio-Electronics Executive and  
Administrative Offices  
**1-516-293-3000.**

Subscriber Customer Service:  
**1-800-288-0652.**

Order Entry for New Subscribers:  
**1-800-999-7139.**

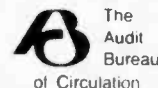

# Cable TV

## Descrambler Article Parts

*We stock the exact Parts for several articles published in Radio-Electronics magazine on building your own Cable TV Descrambler.*

### February 1984 SB-3 Type

**701 Parts Pkg.....\$19.00**  
*Includes all original parts.*

**702 PC Board.....7.95**  
*Original 3X4 etched, drilled and Silk-Screen pc board.*

**704 AC Adaptor.....7.95**  
*12 to 18 Volt DC @ 200ma.*

**701, 702 & 704.....29.00**  
*All three for special saving.*

### February 1987 Tri-Mode

**301 Parts Pkg.....29.00**  
*Includes all original parts.*

**302 PC Board.....7.95**  
*Original 5X8 etched, drilled and Silk-Screen pc board.*

**304 AC Adaptor.....7.95**  
*12 to 18 Volt DC @ 200ma.*

**301, 302 & 304.....39.00**  
*All three for special savings.*

**Tri-Mode Tutorial..7.95**  
*26 pages of in-depth info.*

### May 1990 Universal

**901 Parts Pkg.....\$49.00**  
*Includes all*

**902 PC Board.....9.95**  
*Improved 4X7 etched, drilled and Silk-Screened pc board.*

**904 AC Adaptor.....8.95**  
*12 to 18 Volts AC @ 350ma.*

**901, 902 & 904.....59.00**  
*All three for special savings.*

### Snooper Stopper...\$39.00

*Prevent Descrambler detection with snooper stopper/data blocker and protect your privacy. Includes free article on Cable Snooping.*

### Macrovision Kit...\$29.00

*Macrovision.....now you see it, now you don't with our macro-scrubber kit. Originally Published in Radio-Electronics .*

### Signal Eliminator (tunable notch filters).....\$29.95

*Model number & channel; #23 (channel 2 & 3) #46FM (channel 4 to 6 & FM)  
#713 (channel 7 to 13) #1417 (channel 14 to 17) #1822 (channel 18 to 22)*

### 1 remote replaces 3...

*The MAC 20 wireless remotes replaces any three combinations; TV, VCR, Cable Converter, Stereo, CD or other entertainment system.*

**MAC 20.....\$59.95**

### A VCR in every room..

*with the first FCC approved wireless home broadcast system. 120 ft. range.*

**VC2000.....\$99.95**

### 70 Channel Cable TV Converter.....\$89.95

- \* 6 Function Infra-Red remote.
- \* Fine Tuning.
- \* Memory & Recall.
- \* Compatible with all External Descramblers.
- \* Channel 3 or 4 switchable output.
- \* STD, HRC & IRC compatible.

## CALL TOLL FREE 1-800-332-3557

Outside USA Call 1-508-699-6935

Visa, MasterCard and COD.

Add \$4.00 S&H, \$6.50 Outside USA.

D & D Electronics, Inc. PO Box 3310, N. Attleboro, Ma. 02761

VISA

MC

*A review of the latest happenings in electronics.*

## Telephone-Booth Replacement?

Advanced Cordless Technologies (Montville, NJ) began public testing of its CT-2 technology in New York City last fall. Based on two pieces of equipment—a pocket-sized portable phone and a "telepoint," low-powered radio transmitter—the technology offers an alternative to public telephone booths.

The cordless phones use very little power, getting 20 hours or more from the rechargeable or disposable batteries, and are more private and less expensive than cellular phones. The CT-2 phones must be used within 100 yards of a telepoint.

Each telepoint, which is about the size of the Manhattan phone book, connects callers to the land-line telephone network. From there, calls are forwarded to any location worldwide, and are recorded for billing purposes.

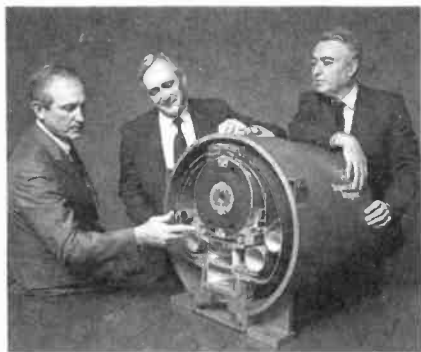

**A SCALE MODEL SECTION** of the superconducting super collider (SSC), the world's largest and most powerful particle accelerator that is planned for operation in Texas in 1998, is examined by executives from Westinghouse Electric Corporation. Westinghouse is competing for the contract to manufacture and test more than 8000 16.5-ton superconducting magnets that will guide thin beams of protons around the SSC's 54-mile underground tunnel at close to the speed of light. The corporation, a leader in producing superconducting magnets, developed the niobium-titanium alloy wire that will be used in the magnets. Pictured from left to right are Bruce Boswell, general manager of the collider dipole magnet division; Chairman and Chief Executive Officer Paul Lego; and Dr. John Hulm, chief scientist emeritus and director of superconductivity technology.

An experimental license granted by the FCC provides two channels, one of them for transmitting calls from handsets and the other for paging the handsets, allowing two-way communications.

Approximately 150 test telepoints are planned for public areas in Manhattan. Each telepoint is capable of handling up to eight calls simultaneously, reducing the usual wait for public phones. In addition, 50 private branch exchanges will be placed in offices participating in the trial, where the CT-2 will function as a cordless extension phone. The private telepoints will be equipped with adapters that automatically transmit calls to each extension on the exchange, so that, with paging, workers will be able to be reached anywhere in the building.

Advanced Cordless Technologies hopes the CT-2 system eventually will change the way public phone calls are made, eliminating the need for coins, and reducing the long waits and incidence of damaged equipment that plague phone booths in urban areas. The trial was the first step in the company's long-term plan to offer the CT-2 telepoint service on a national scale.

## Long-life power source

A patented power-source technology developed by the E.F. Johnson Company, a division of Diversified Energies, Inc. (Minneapolis, MN), couples a unique light-emitting polymer with solar-type cells to generate continuous, low-power electrical energy for more than 25 years. Because the power is not generated by a chemical process, it is not adversely affected by extremely cold temperatures. It has been successfully tested at temperatures ranging from  $-196^{\circ}\text{C}$  (the temperature of liquid nitrogen) to  $+100^{\circ}\text{C}$  (the boiling point of water).

Electricity is generated when a photovoltaic cell is optically coupled to a light-emitting polymer. The light, generated when a phosphor mole-

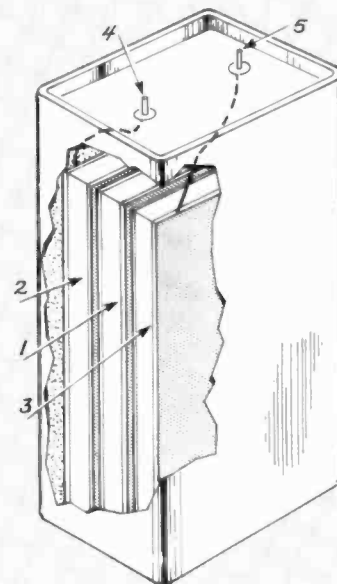

**FIG. 1—E.F. JOHNSON COMPANY'S** long-life, low-power electrical-energy source is created by combining a light-emitting polymer material (1) and a photovoltaic cell (2, 3) that has a light-collecting surface and a pair of electrical contacts (4, 5). When the polymer and the photovoltaic cell are coupled, an open-circuit voltage is generated between the two electrical contacts.

cule is closely coupled to a hydrogen isotope (H-3 or tritium) within the polymer. Tritium is a radioactive material that is currently used in a gaseous form as the basis of light sources in watches and exit lights in theaters, and that will require licensing by the Nuclear Regulatory Commission. In the new power source, the tritium is chemically bound into a solid plastic matrix.

E.F. Johnson has achieved power outputs in the microwatt range—enough to power a pocket calculator or watch, or to charge a capacitor that would supply periodic surge requirements and then recharge—and expects to significantly increase the power output. While no end products have been created, and commercial usage is several years away, potential future applications for the long-life, low-temperature power source could be in medical implants, space, computers, and superconductivity. **R-E**



# A Shocking Offer!

Now for the first time in CIE's 56 year history you do not have to be enrolled at CIE to receive our introductory Electronic and Electricity Lesson Modules. Available for a limited time to non-students for the shockingly low price of only \$99.50.

With CIE's patented AUTO-PROGRAMMED method of learning you'll quickly learn and then master the basics of electronics and electricity and then move on to... DC/AC circuit theories, fundamentals of bi-polar junction transistors (BJT), field effect transistors (FET), wiring, diagram and schematic readings, component identification, soldering techniques... and much, much, more.

Your commitment to CIE ends with your payment, but CIE's commitment to your success just begins when you receive your

39 lessons, exams, binders and equipment. This special introductory price includes all the benefits and assistance CIE normally extends to its students and graduates. You'll be entitled to unlimited access to CIE's faculty and staff to assist you in your studies via a toll free 800 number six days a week, 24-hour turnaround on grading your submitted exams, CIE Bookstore privileges, a patented learning method,

reference library, a student, faculty and alumni electronic bulletin board and a free issue of CIE's school newspaper The Electron. All this knowledge and support will put you on the road to understanding digital electronics, microprocessing principles, computer systems, telecommunications, and much, much, more.



**All This and Much More For ONLY!**

# \$99<sup>50</sup>

- Free Issue of The Electron
- Build your personal burglar alarm
- Instructors available 6 days a week
- 20 lesson books containing 39 theory and hands-on training lessons and exams.

- Bookstore Privileges
- Patented Learning Method
- Electronic Bulletin Board
- 24-Hour Grading

Yes, send me CIE's 39 Introductory Electronic and Electricity Lessons and Equipment.

Name: \_\_\_\_\_

Address: \_\_\_\_\_

City: \_\_\_\_\_ Apt. #: \_\_\_\_\_

State: \_\_\_\_\_ Zip: \_\_\_\_\_

Age: \_\_\_\_\_ Phone ( \_\_\_\_\_ ) \_\_\_\_\_

Total Merchandise: ..... \$99.50

Ohio Residents add 7% Sales Tax: \_\_\_\_\_

California Residents add 6-1/2% Sales Tax: \_\_\_\_\_

Total this order: \_\_\_\_\_

Method of Payment: Amount Enclosed . . . \$ \_\_\_\_\_

Personal Check or Money Order

Master Card  Visa

\_\_\_\_\_

Card Expiration Date: \_\_\_\_\_



## BOOKSTORE

1776 East 17th Street  
Cleveland, Ohio 44114  
(216) 781-9400

BK03

Signature \_\_\_\_\_

**CHARGE BY PHONE!**

9 AM to 4:30 PM Eastern Time; from Ohio 1-800-523-9109  
from all other states 1-800-321-2155

What's new in the fast-changing video industry.

DAVID LACHENBRUCH

## • European HDTV setback.

Europe's plan for an orderly transition to HDTV suffered a severe blow with the announcement that two British direct-satellite broadcasters planned to merge. Sky Channel has been broadcasting in standard PAL, while British Satellite Broadcasting was beaming a signal in the expanded-definition MAC (multiple analog component) system, which separates the chrominance and luminance signals to provide a better picture. Under the merger agreement, the combined satellite system will transmit in PAL only, after a transitional period.

BSB's MAC transmissions were part of a plan to create a new standard for direct-satellite transmission, which would eventually lead to a "compatible" HDTV system—compatible with MAC transmissions, that is. MAC and PAL are incompatible. MAC has already lost favor in Germany, where broadcasters are using Luxembourg's Astra satellite and transmitting in PAL. At this time, only France is still committed to MAC. Under the European Eureka project, the new all-European HDTV service, HD-MAC, was to be phased in about 1992. Now everything is up in the air, so to speak.

## • Japan's HDTV receivers.

While the European HDTV system was to have some measure of compatibility (even if only to MAC transmissions), Japan's Hi-Vision HDTV is compatible with nothing, and will require all-new TV sets, VCR's, videodisc players, and so forth. Hi-Vision is being broadcast by NHK, the government-chartered broadcaster, by satellites. Japanese TV set makers have now introduced the first consumer model Hi-Vision receivers, priced generally in the \$17,000–\$35,000 range, promising prices could be cut in half in about a year.

Newspaper and magazine reports bemoan how far "behind" the United States is as compared to Europe and Japan in instituting HDTV broadcasting, but they neglect to mention that

the American project is far more ambitious than the others. The U.S. plans to integrate HDTV broadcasting with conventional transmissions, broadcasting from terrestrial TV stations rather than instituting a completely new incompatible satellite-transmitted service. Official testing of proposed American HDTV systems is scheduled to start in March.

• **Multimedia.** That's one of today's magic words, and no one knows how it's going to affect the future of television, video, or computing. At least three systems designed to combine video motion, audio, and interactivity are scheduled for major introductions this year. CDTV, which stands for "Commodore Dynamic Total Vision," is scheduled for introduction early this year, as an extension of the Amiga computer system in an attachment for TV sets, with such programs as encyclopedias, cookbooks, atlases, and sophisticated video games. The hardware is scheduled to cost less than \$1,000 to start, with CD-ROM programs at \$25 to \$100 each. CDTV has half-screen full-motion or full-screen half-motion (15 frames per second). The competing CD-I (Compact Disc Interactive), backed by Philips and Sony, will debut in the second half of this year, probably without full motion, but a full-motion adapter will be added later.

Meanwhile, Intel introduced a two-chip set to bring its Digital Video In-

teractive (DVI) system to personal computers at a premium of less than \$1,000 at the start. The DVI chips permit interaction with full-motion video, as well as storage of digital video on PC's. Thus it seems that the TV set moves closer to the computer, and the computer closer to the TV set.

• **Digital VHS sound.** You can't buy it now, but perhaps in a few months there will be another feature for VHS video recorders. At the recent Japan Audio Fair, both JVC and Hitachi demonstrated VCR's with digital audio, and Matsushita (Panasonic) has a similar system. The new digital sound is for Super VHS recorders, whose expanded video bandwidth provides enough additional space for its 16-bit PCM system. The 8mm format already has PCM audio with an 8-bit system. The VHS group is reluctant to commercialize digital audio because of the dispute over digital-audio recorders and copyright protection, but there is anticipation that it will be offered starting this spring. The PCM audio system, standardized for S-VHS recorders, uses a 48-kHz sampling frequency, and depth-multiplex recording to place the video and audio signals on different layers of the tape's magnetic coating. The two other soundtracks (linear and helical FM) of the VHS recording standard will be unchanged to maintain compatibility. **R-E**

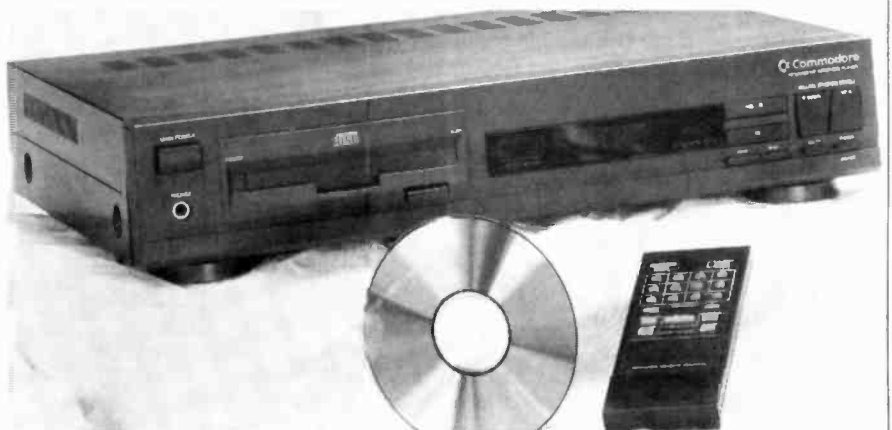

COMMODORE'S CDTV interactive graphics player is expected to cost less than \$1000.

# RADIO SHACK PARTS PLACE

## YOUR SOURCE FOR PROJECT AND REPAIR ESSENTIALS

SM



### PARTS HOTLINE

Your nearby Radio Shack store has a huge selection of popular electronic components. Plus, we can special-order 10,000 items from our warehouse—ICs, tubes, semiconductors, phono cartridges and styli, even SAMS® manuals. Service is fast and there's no minimum order or postage charge.

### BATTERY HOTLINE

In addition to our large in-store stock, Radio Shack can now supply almost any currently manufactured consumer-type battery—for cordless phones, computer memory, camcorders, transceivers, pagers and more. No postage charge!

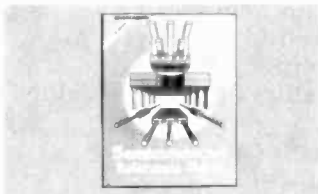

**1991 Semiconductor Reference Guide.** A "must" for electronics building and repair. This new edition gives you a 95,000-item semiconductor substitution guide plus detailed data on Radio Shack ICs, SCRs, LEDs, diodes, transistors and optoelectronics. #276-4014 ..... 3.99

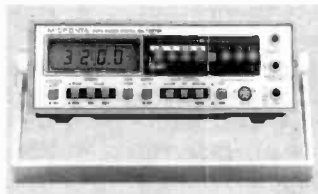

**Bench/Portable LCD Digital VOM.** Our best multimeter! Displays transistor gain directly and has diode-check, memory and continuity functions. Autoranging or manual modes. Measures to 1000VDC, 750VAC, 10 amps AC/DC and resistance. #22-195 ..... 99.95

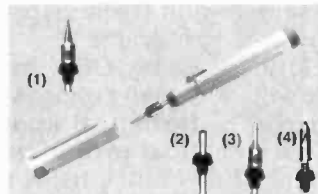

**4-in-1 Soldering Tool.** Operates anywhere on standard butane lighter fuel. Refills in seconds. #64-2161 ... 29.95  
 (1) 1.0 mm Tip. #64-2163 ... 9.95  
 (2) Blow Torch Tip. #64-2168. (3) Heat Blower. #64-2169. (4) Hot Knife. #64-2170 available on special order ..... Each 9.95



**Bright Krypton Bayonet-Style Lamps for Flashlights.** Use in place of standard lamps for super brightness. For example, K4 replaces standard PR4. Each 79¢

Type	Volts	mA	Cat. No.
K4	2.33	480	272-1169
K1	2.4	600	272-1156
K2	2.4	830	272-1157
K3	3.6	800	272-1158
K15	4.8	700	272-1162
K12	6.0	650	272-1163
K18	7.2	700	272-1164

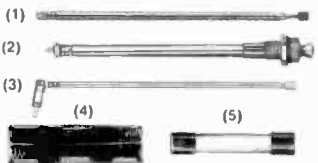

**Replacement Rod Antennas.** For cordless phones, radios, portable stereos, walkie-talkies and your own custom projects. 16 styles in stock!  
 (1) 30 1/2". #270-1401 ..... 2.99  
 (2) 13". #270-1407 ..... 2.79  
 (3) 23 3/8". #270-1417 ..... 3.49

**Battery Holders.** Ideal for projects, for replacement or for building external power packs. Our store near you has 15 different styles in stock!  
 (4) Holder for 8 "AA" Cells. 9V-type snap connector. #270-407, 1.29

**Replacement Fuses.** For appliances and vehicles. Over 60 values in stock!  
 (5) 10-Amp Fuse for Microwave Ovens. #276-1256 ..... Pkg. of 2/1.29

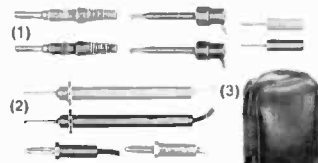

(1) Mini-Clip Test Leads. 48" long. Mini test clip on one end, banana plug at the other. Includes pin-type plug adapters. #278-1160 ..... Pair/3.99  
 (2) Test Probes With Coiled 6-Ft. Leads. #278-750 ..... Pair/4.99  
 (3) Deluxe Soft Carrying Case. Perfect for multimeters. #22-149 ..... 7.95

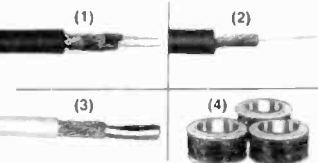

(1) Dual Mike Cable. For balanced hookups. 30 ft. #278-1281 ... 19.95  
 (2) Super-Flex Mike Cable. Extra-supply. 30 ft. #278-1282 ... 14.95  
 (3) 4-Conductor Double-Shielded Cable. 30 feet. #278-777 ..... 7.95  
 (4) Magnet Wire Assortment. 22, 26, 30 gauge. #278-1345 ..... 4.99



**Mercury Bulb Switch.** Just the thing for experiments and alarms. Contacts rated 5 amps at 125VAC. Style may vary. #275-027 ..... 1.29

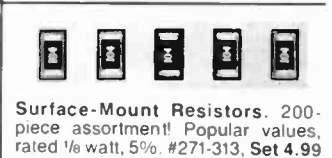

**Surface-Mount Resistors.** 200-piece assortment! Popular values, rated 1/8 watt, 5%. #271-313, Set 4.99



**10-Amp Plug-In DPDT Relays.**  
 With 12VDC Coil. #275-218, 5.99  
 With 125VAC Coil. #275-217, 5.99  
 Relay Socket. #275-220, 1.79



**Piezo Speaker.** Only 1 3/32" dia. by 5/64" thin. This high-efficiency device can be driven by ICs. 500 Hz to 20 kHz. 1200 ohms. #273-091 ... 2.49

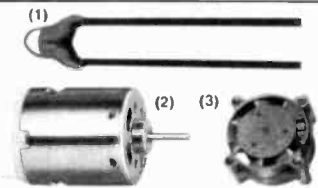

(1) Precision Thermistor. Range: -50 to +110°C. #271-110 ... 1.99  
 (2) High-Speed 12VDC Motor. Up to 15,200 RPM at no load. About 2" long (with shaft). #273-255 ... 2.99  
 (3) 12VDC Brushless Micro Fan. Ideal for cooling mobile equipment and hum-sensitive circuits. 4.6 CFM. 150 mA. #273-244 ..... 17.95



**Electronic Counter Module.** Pre-wired! Great for a traffic or event counter. Counts up to 99,999. Advanced (or reset) by external switch closure or digital circuit. Accepts count rate up to 7 Hz. Has 1/2" liquid crystal display. Requires "AA" battery. Low current drain—only 4 µA. With data. #277-302 ..... 16.95

Since 1921 Radio Shack has been the place to obtain up-to-date electronic parts as well as quality tools, test equipment and accessories at low prices. Over 7000 locations to serve you—NOBODY COMPARES

Prices apply at participating Radio Shack stores and dealers. Radio Shack is a division of Tandy Corporation

**Radio Shack**  
 AMERICA'S TECHNOLOGY STORE™

CIRCLE 78 ON FREE INFORMATION CARD

# The country honors its technicians with the celebration of National Electronics Technicians Day.

IN RECOGNITION OF ITS NEARLY 28,000 members, the International Society of Certified Electronics Technicians (ISCET) is lobbying for a joint resolution of Congress to designate March 5, 1991 as National Electronics Technicians Day. Congressmen Martin Frost and Pete Geren (Texas) have whole-heartedly agreed to serve as the original co-sponsors of this bill in the House. Senate approval is also required for this special legislation, and ISCET is seeking an original Senate sponsor for this bill.

ISCET's chairman, Leonard Bowdre, hopes that by officially declaring March 5, 1991 as National Electronics Technicians Day, nationwide recognition will be focused on the high standards of performance and excellence maintained by professional technicians. Most people underestimate our country's need for highly skilled and specially trained electronics technicians, who play a vital role in the electronics manufacturing, testing, and servicing industry.

## What is ISCET?

As the proud offspring of the National Electronic Association

(NEA), ISCET was founded in 1970 by a committee of Certified Electronics Technicians, whose main purpose was to foster respect and admiration for their profession. By maintaining rigorous standards in its certification program, ISCET is able to separate the highly skilled and knowledgeable technicians from those with less experience. ISCET's main functions include direction and administration of the CET program, the national apprentice and training program, the technical information training and upgrading programs, and the serviceability inspection programs.

The CET program was designed to measure the degree of theoretical knowledge and technical proficiency of practicing technicians. A technician with a CET certificate is thought of in the industry as one who possesses the training and expertise necessary to perform their job with professional competence. Since its inception in 1965, the CET program has become more widely accepted by technicians, manufacturers, and consumers. Many organizations encourage, and sometimes require, their

technical employees to be certified by ISCET.

## The CET exam

To become certified by ISCET, one must pass both a 75-question Associate-level CET test, and a 75-question Journeyman-level test. Each multiple-choice exam must be passed with a grade of 75% or better. An electronics technician or student with less than four years of experience may apply for the Associate-level exam, covering the following subjects:

- Basic Mathematics
- DC Circuits
- AC Circuits
- Transistors and Semiconductors
- Electronic Components
- Instruments
- Test and Measurements
- Troubleshooting and Network Analysis

A fully certified technician must also pass one or more of the several Journeyman options available in specialized fields of electronics. A Journeyman certified technician must also have four or more years of education or experience in electronics. The Journeyman options that are available are:

- **Consumer**—Subjects covered include antennas and transmission lines, digital and linear circuits in consumer products, TV and VCR servicing problems and use of test equipment.
- **Industrial**—Subjects include transducers, switches, power factor, differential amps, closed-loop feedback, basic logic circuits and functions, elements of numeric control, thyratrons, and SCR controls.
- **Communications**—This test covers two-way transceiver theory and servicing, receivers, transmitters, basic communications theory, deviation sensitivity, quieting, and troubleshooting.
- **FCC Legal**—This is a 25-question optional exam covering FCC regulations. Applicants must take the Associate exam, the



ISCET AWARDED MISSION SPECIALISTS George D. Nelson and James D. Van Hoften titles of Honorary Certified Electronics Technicians for servicing and repairing the Solar Max satellite. Their 305-mile high 5-day service call cost \$45 million, but saved the cost of replacing the 5,000 pound, \$300 million satellite.

Communications option, and the FCC Legal exam to receive a general radio-telephone license.

- **Computer**—This test covers operation of computer systems with basic emphasis on hardware. Subjects covered include basic arithmetic and logic operations, computer organization, input and output equipment, and memory and storage. Some knowledge of software and programming is required, and the ability to explain troubleshooting procedures is required.

- **Audio**—Products covered in this option include turntables, tape decks, compact discs, and radios. The exam consists of both digital and analog sections, amplifiers and sound quality, system set-up, speaker installation, and troubleshooting audio systems.

- **Medical**—The priorities of this option are electrical safety and accuracy of calibration for electromedical instruments. The technician must be familiar with basic vocabulary of medical instrumentation, telemetry, measurements, differential and operational amplifier applications.

- **Radar**—A general knowledge of both pulse radar and continuous radar is necessary to take this Journeyman option. The test covers transmitters and receivers, CRT display systems and their power supplies, antennas, transmission lines and their characteristics.

- **Video**—The rapidly growing field of video is covered by this exam. The technician needs to know NTSC standards, video basics, test signals, and the operations of both the electronics and mechanical systems in VCR's. Also covered are 8mm video, camcorders, cameras and monitors, and the microprocessors used in video products.

The fee for the CET exam is \$25.00, which includes both the Associate exam and any one Journeyman option, if taken in one sitting. If the Journeyman option is taken separately from the Associate exam, each test is \$25.00. Each additional Journeyman option is \$25.00. If you fail any portion, the first retake is free, after a 60-day waiting period. The fee for any additional retake is \$12.50. If you choose to take the FCC Legal exam after

you have successfully completed the Communications option, an additional fee of \$10.00 is also required.

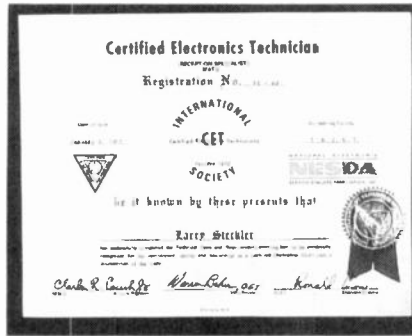

**LARRY STECKLER**, editor-in-chief and publisher of *Radio-Electronics* magazine, received this CET certificate back in 1975.

Don't underestimate the difficulty of the CET exam. Every year over 6,000 exams are taken by hopeful technicians, but only 30% of those taken pass—it's not an easy test. The best way to prepare for this exam is to study diligently. Tab Books, Inc. publishes *The CET Study Guide*, by Sam Wilson, which will help you prepare for both tests. ISCET also has additional study guides available for a nominal fee.

If you're interested in taking the CET exam, you can contact any one of ISCET's volunteer test administrators listed in this article for details. The exams are scheduled to be given the week of March 5, 1991. There are many more test administrators throughout the country than we have provided. Those listed in this article are just the ones who will be giving the exams during the week of March 5. For any additional information you may need, you can contact ISCET at 2708 West Berry St., Fort Worth, TX 76109; phone (817) 921-9101.

Now that we have all of the formalities out of the way, let's take a look at how ISCET honored two technicians who have gone above and beyond their call of duty.

#### The world's farthest service call

ISCET not only acknowledges those who have successfully completed their certification exam, but those who have exhibited outstanding technical achievement. Such is the case of Mission Specialists George D. Nelson (Phd. Astronomy) and James D. Van Hoften (Phd. Hydraulic Engi-

neering) who were awarded the titles of Honorary Certified Electronics Technicians. Figure 1 shows these astronauts being honored by ISCET.

The astronauts were recognized by the ISCET Board of Governors for their exemplary performance in space during the period of April 8–12, 1984, when the Solar Max satellite was serviced, repaired, and returned to Earth's orbit. They were cited for the extremely difficult and delicate work required to repair the electronics box for the coronagraph-polarimeter, an instrument that was not designed to be repaired in space.

While working outside the space shuttle Challenger, where the 5,000 pound Solar Max was berthed, the astronauts used special power tools designed for weightless conditions to repair electronic instruments. The satellite was restored to operational health for the first time in three years, and added years to its useful lifetime. **R-E**

**ISCET VCR Cross Reference**  
VCR Model Number Cross Reference and VCR Parts Cross Reference

**UPDATED** - Feb. 1990. 272-page reference guide. \$35 plus \$3 shipping.

**DISC** - IBM-compatible disc with expandable data base. \$99 plus \$1 shipping.

**COMBO OFFER:** Book and disc for only \$125 plus \$3 shipping.

**MORE INFO?** Contact ISCET, 2708 West Berry St., Fort Worth TX 76109 (817) 921-9101

---

Allow 4-6 weeks delivery when using personal checks or VISA and MasterCard. Money orders and cashiers checks processed immediately

Amount \_\_\_\_\_ VISA      MasterCard  
 Card No. \_\_\_\_\_ Exp. \_\_\_\_\_  
 Name \_\_\_\_\_  
 Business \_\_\_\_\_  
 Address \_\_\_\_\_  
 City \_\_\_\_\_ State \_\_\_\_\_ Zip \_\_\_\_\_  
 Phone \_\_\_\_\_ Member ISCET NESDA

Texas residents multiply dollar value x 7.5% for taxes  
 Foreign shipments please add International postage  
 Send to: ISCET, 2708 W. Berry St., Ft. Worth TX 76109

# ISCET CERTIFIED ADMINISTRATORS FOR THE CET EXAM

- T. Van Iderstine, CET  
Southwest State Tech College  
925 Dauphin Island Pkwy  
Mobile, AL 36605  
(205) 947-4441
- Art Sorensen, CET  
1416 N. Lincoln Ave.  
Loveland, CO 80538  
(303) 669-0883
- Paul K. Tan, CET  
915 Augusta St.  
Oak Park, IL 60302-1678  
(312) 848-6327
- Bob Bellers, CET  
Washtenaw Comm. College  
4800 E. Huron River Dr.  
Ann Arbor, MI 48106  
(313) 973-3316
- Joseph Carney III, CET  
Radio Meter America  
6365 Mills Cedar Lane  
N. Ridgeville, OH 44039  
(216) 871-8900 Ext. 241
- F. Gilbert Smith, CET  
822 Creekridge Dr.  
Dallas, TX 75218  
(214) 348-7734
- John F. Stackhouse, CET  
ITT  
2121 South Blackhawk  
Aurora, CO 80014  
(303) 695-1913
- Paul R. Towbridge  
Inst. of New Cinema Artists  
407 E. 25th St., 6th Floor  
Chicago, IL 60616  
(312) 225-3400
- Dr. Joel Goldberg, CET  
6762 Red Cedar Lane  
Union Lake, MI 48085  
(313) 360-2092
- E. Eugene Ranta, CET  
Macomb Comm. College  
14500 Twelve Mile Rd.  
Warren, MI 48093  
(313) 445-7455
- A.C. Falcone, CET  
Falcon Electronics, Inc.  
3266 Kent Rd  
Stow, OH 44224  
(216) 688-2451
- Frank Grabiec, CET  
Dyna-ironics  
1704 E. Claremont  
Phoenix, AZ 85016  
(602) 279-4176
- Andrew M. Flock, CET  
Hickok Tech, Inst  
5100 Pearl Rd.  
Cleveland, OH 44129-1240  
(216) 351-4600
- Thomas C. Underwood, CET  
Sony Service Company  
3201 Premier #100  
Dallas, TX 75063  
(214) 550-5270
- H.J. Paine, CET  
4631 E. 8th St.  
Tucson, AZ 85711  
(602) 881-6784
- David J. Garwacki, CET  
4846 Oak Glen Dr  
Toledo, OH 43613-3048  
(419) 475-9221
- Preston Wallace, CET  
1757 Triple Crown Dr.  
Corpus Chnsti, TX 78417  
(512) 852-8022
- Silvino Alonso  
CA Business Inst.  
3550 Johnson Ave  
El Monte, CA 91731  
(818) 444-7779
- Gerald P. Breitbach, CET  
KDTH Radio Station  
8th & Bluff St.  
Dubuque, IA 52001  
(319) 588-5694
- Willard Rush, CET  
Oakland College  
3361 Aspen-6304  
Lake Orion, MI 48359  
(313) 391-2152
- Robert D. Jerg, CET  
697 Villa Ave  
Akron, OH 44310  
(216) 762-5816
- Howard Bardach, CET  
The Audio Specialist  
4381 Tujunga Ave.  
Studio City, CA 91604  
(818) 763-3009
- Michael L. Baughman, CET  
KS City Area Vo Tech  
2220 N. 59th St.  
Kansas City, KS 66104  
(913) 334-1000
- John H. Spurlin, CET  
Wayne County Comm. College  
8551 Greenfield  
Detroit, MI 48228  
(313) 496-2691
- J.R. Manchester, CET  
University of Akron  
PO Box 61  
Akron, OH 44309  
(216) 745-0053
- Jim Teeters, CET  
2937 E. Malden Ave.  
Norfolk, VA 23518  
(804) 428-5772
- C.S.E.A.  
Tambra Oberlander  
13666 S. Hawthorne #3  
Hawthorne, CA 90250  
(213) 679-9186
- Stanley Creitz, CET  
NCK Area Vo Tech.  
PO Box 507, West Campus Dr.  
Beloit, KS 67420  
(913) 738-2279
- David Lewicki, CET  
9830-26th Ave.  
Plymouth, MN 55441  
(612) 627-2778 Ext. 5210
- J.S. Glosemeyer, CET  
East OK Cnty Vo Tech  
4701 N Choctaw Rd  
Choctaw, OK 73020  
(405) 390-9591
- Del Dressel, CET  
Oakland TV  
PO Box 110970  
Tacoma, WA 98411-0970  
(206) 840-4975
- John V. Craig, CET  
Oxnard College  
4000 S. Rose Ave.  
Oxnard, CA 93033  
(805) 986-5807
- Keith E. Knos, CET  
Knos Electronics  
1206 Elm Blvd.  
Liberal, KS 67901  
(316) 624-5908
- Roy W. Yonce  
Oklahoma Jr. College  
PO Box 407992  
Tulsa, OK 74147  
(918) 663-9500
- Leonard Laabs, CET  
Walla Walla College  
204 S. College Ave.  
College Place, WA 99324  
(509) 527-2712
- Anthony J. Haag  
PO Box 27264  
Concord, CA 94527-0264  
(415) 682-9010
- Edward J. Kimmel, CET  
2061 Eastern Parkway  
Louisville, KY 40204  
(502) 451-3457  
Test Day Feb. 24th
- James D. Hite, CET  
Pinellas Vo-Tech  
6100 154th Ave. N  
Clearwater, FL 34620  
(813) 531-3531
- Carl A. Hunter, CET  
FL Comm. College  
2007 Callin Dr.  
Jacksonville, FL 32211  
(904) 744-8480
- Perry "Jim" Parks, CET/CA  
Nu-Pro Service  
1055 Hwy 434  
Winter Springs, FL 32708  
(305) 699-8811
- Edward J. Ritchie, CET  
Hazard State Vo-Tech School  
101 Vo-Tech  
Hazard, KY 41702  
(606) 436-3101
- James Blanger, CET  
Beltronics, Inc.  
19 Proctor Hill Rd., Box 330  
Hollis, NH 03049  
(603) 465-2422
- Gene Hedgepeth, CET  
RD 4-639 E. Alberdeen Rd  
Mountaintop, PA 18707  
(717) 868-6566
- L.A. Leibensperger, CET  
Lincoln Tech, Inst.  
5151 Tighman St.  
Allentown, PA 18104  
(215) 398-5300
- James C. Poe, CET  
1012 McClain Dr.  
Sunnyville, WA 98944-1270  
(509) 839-3995
- David Marson, CET  
Golden State School  
3916 S. Chester  
Bakersfield, CA 93307  
(805) 833-0123
- W.H. Hartzfeldt, CET  
Delta-Quachita Vo Tech.  
609 Vocational Pkwy.  
W. Monroe, LA 71291  
(318) 396-7431
- Carl Meyer, CET  
11 Hemlock Dr.  
West Seneca, NY 14224  
(716) 674-7113
- Thomas Plant, CET  
29 Dean St.  
Pawtucket, RI 02861  
(401) 723-3500 Ext. 333
- James C. Shambow, CET  
ITT Tech, Inst.  
12720 Tech, Inst.  
12720 Gateway Dr, Suite 100  
Seattle, WA 98168  
(206) 244-3300
- Fred Potter, CET  
Ameritech College  
6843 Lennox Ave.  
Van Nuys, CA 91405-4043  
(818) 901-7311
- Steven B. Lumpkin, CET  
164 Acadian Dr.  
Lafayette, LA 70503  
(318) 233-6942
- Gregory J. Reiber, CET  
Bryant & Stratton  
5775 South Bay Rd.  
Clay, NY 13041  
(315) 452-1105
- Donald Haag, CET  
RR 3 Box 92  
Watertown, SD 57201  
(605) 886-8932
- Michael Szymkewicz, CET  
Olympic College  
16th & Chester  
Bremerton, WA 98310  
(206) 478-4802
- Kevin J. Price, CET  
N.E.C.  
825 E. Hospitality Ln.  
San Bernardino, CA 92408  
(714) 885-3896
- M.G. McCann Jr., CET  
McCann Electronics  
100 Division St.  
Metairie, LA 70001  
(504) 837-7272
- Larry Steckler, EHF CET  
Radio Electronics Magazine  
500 B-By-County Blvd.  
Farmingdale, NY 11735  
(516) 293-3000
- William S. Warren, CET CSM  
2540 Sutherland Ave.  
Knoxville, TN 37919  
(615) 546-1121
- Lynn Reynolds  
Woodruff Region Occup.  
Cntr. 302 W. Weber  
Stockton, CA 95203  
(209) 944-4612
- James R. Sorrels, CET CSM  
110 Oakridge Dr.  
Shreveport, LA 71106-7113  
(318) 686-4637
- Hubert West, CET  
Adirondack, Comm. College  
Bay Road  
Glens Falls, NY 12801  
(518) 793-4491 Ext. 626
- Joseph H. Hudson Jr., CET  
1500 Yarrowburgh Dr.  
Sherman, TX 75090-5545  
(214) 892-9356
- Richard K. Evans, CET  
PO Box 217  
Wilkinson, W. VA 25653  
(304) 752-7267
- Frederick J. Smith, CET  
Ed. Dept. CA Mens Colony  
PO Box 8101  
San Luis Obispo, CA 93409  
(805) 772-2009
- Gordon L. Burgess, CET  
Great Northern Paper Co.  
E. Millinocket, ME 04430  
(207) 769-9912 Ext. 1300
- Linda Dickinson  
Craven Community College  
PO Box 952  
Havelock, NC 28532  
(919) 447-5559
- Joseph H. Hudson Jr., CET  
1500 Yarrowburgh Dr.  
Sherman, TX 75090-5545  
(214) 892-9356
- David E. Nida  
National Education Center  
5514 Big Tylor Rd.  
Cross Lanes, W. VA 25313  
(304) 776-6290 Ext. 24
- Jon R. Sturtz, CET  
10840 Alandale Way  
Rancho Cordova, CA 95670  
(916) 635-6000
- Earl Tickler, CET  
Rets Tech. Trann Center  
1520 S. Caton Ave.  
Baltimore, MD 21227  
(301) 644-6400
- Ralph V. Polmiller, CET  
Ralph's Electronics  
PO Box 633  
Jacksonville, NC 28540  
(919) 455-2828
- Rodger W. Minatra  
Collin County Comm. College  
2200 W. University  
McKinney, TX 75070  
(214) 548-6830
- Charles Fetters, CET  
Mesa State College  
PO Box 2647  
Grand Junction, CO 81502  
(303) 242-9307
- Robert A. Ciufletti  
444 Fairmont St.  
Fitchburg, MA 01420  
(508) 674-1000 Ext. 250
- Wayne Smith, CET  
224 St. John St.  
Arden, NC 28704  
(704) 255-7671
- Arthur J. Ruppert, CET  
30217 St. Andrews  
Georgetown, TX 78628  
(512) 495-1679
- Rick Page  
Technical Trades Inst.  
2315 E. Pikes Peak Ave.  
Colorado Springs, CO 80909  
(719) 632-7626
- Frank Serra, CET  
Serra's TV Video  
1686 Mass. Ave.  
Cambridge, MA 02138  
(617) 492-2661
- Meivin E. Talbert, CET  
Heilig Meyer Service Co.  
PO Box 64189-2858, Owen Dr.  
Fayetteville, NC 28306-0189  
(919) 483-0801
- Charles R. Schlieper, CET  
Temple Jr. College  
2600 South First  
Temple, TX 76704  
(817) 773-9961 Ext. 255
- Jacob Klein, CET  
Northcentral Tech College  
1000 Campus Ave.  
Wausau, WI 54401  
(715) 675-3331 Ext. 263

# SELECT 5 BOOKS for only \$4<sup>95</sup>

(values to \$127.70)  
and get a **FREE Gift!**

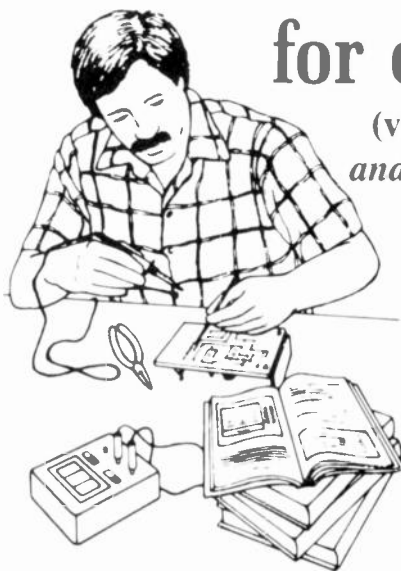

3329 \$29.95  
Counts as 2

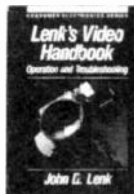

10018 \$39.95  
Counts as 2



2898P \$15.95



2826P \$16.95



3279 \$36.95  
Counts as 2



3031P \$17.95

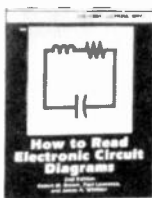

2880P \$14.95



804P \$11.95  
Counts as 2



3370 \$25.95  
Counts as 2



3205 \$24.55

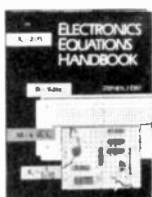

3241P \$16.95

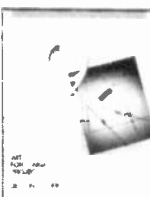

3311 \$23.95



2613P \$17.95

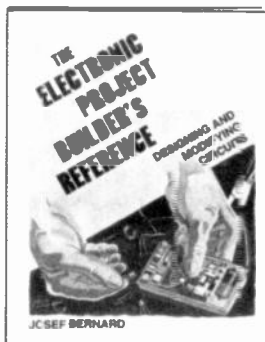

3260 \$22.95

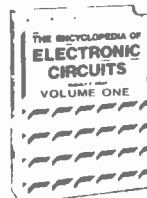

1938 \$60.00  
Counts as 3



2867P \$18.95



2981P \$16.95



3276 \$22.95



1367P \$24.95

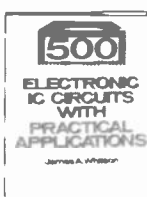

2920 \$29.95  
Counts as 2

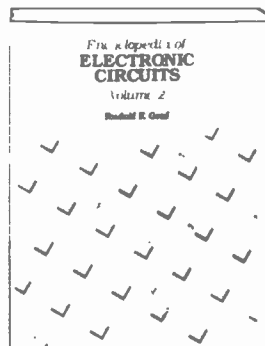

3138 \$60.00  
Counts as 3



2925P \$9.95



3355 \$26.95  
Counts as 2

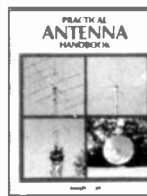

3270 \$32.95  
Counts as 2



2735P \$16.95



2790P \$14.95



2883P \$17.95

For over 25 years, your most complete source for electronics books.

**Membership Benefits • Big Savings.** In addition to this introductory offer, you keep saving substantially with members' prices of up to 50% off the publishers' prices. • **Bonus Books.** Starting immediately, you will be eligible for our Bonus Book Plan, with savings of up to 80% off publishers' prices. • **Club News Bulletins.** 15 times per year you will receive the Book Club News, describing all the current selections—mains, alternates, extras—plus bonus offers and special sales, with scores of titles to choose from. • **Automatic Order.** If you want the Main Selection, do nothing and it will be sent to you automatically. If you prefer another selection, or no book at all, simply indicate your choice on the reply form provided. You will have at least 10 days to decide. As a member, you agree to purchase at least 3 books within the next 12 months and may resign at any time thereafter. • **Ironclad No-Risk Guarantee.** If not satisfied with your books, return them within 10 days without obligation! • **Exceptional Quality.** All books are quality publishers' editions especially selected by our Editorial Board.

(Publishers' Prices Shown)

**FREE** when you join

15 Easy Electronic Projects  
From Delton T. Horn

Projects you can build—some unique, some old favorites—from the author's vast treasury of electronics know-how.

A \$7.95 Value!



**ELECTRONICS BOOK CLUB<sup>SM</sup>**  
Blue Ridge Summit, PA 17294-0810

Please accept my membership in the Electronics Book Club and send the 5 volumes listed below, plus my FREE copy of *Delton T. Horn's All-Time Favorite Electronic Projects* (3105P), billing me \$4.95. If not satisfied, I may return the books within ten days without obligation and have my membership cancelled. I agree to purchase at least 3 books at regular Club prices during the next 12 months and may resign any time thereafter. A shipping/handling charge and sales tax will be added to all orders.

Name \_\_\_\_\_  
Address \_\_\_\_\_  
City \_\_\_\_\_  
State \_\_\_\_\_ Zip \_\_\_\_\_ Phone \_\_\_\_\_  
Signature \_\_\_\_\_

Valid for new members only. Foreign applicants will receive special ordering instructions. Canada must remit in U.S. currency. This order subject to acceptance by the Electronics Book Club. RPIE 291

All books are hardcover unless number is followed by a "P" for paperback

(Publishers' Prices Shown)  
1991 ELECTRONICS BOOK CLUB

# ASK R-E

Write to Ask R-E, Radio-Electronics, 500-B Bi-County Blvd., Farmingdale, NY 11735

## APPLE DISK

**I have an Apple IIe and was recently given a hard-disk system to use with it. I was told that the disk had already been formatted but I haven't been able to get it to work in my computer. Even though I have the interface card plugged into one of the slots, I can't seem to get the hard disk to respond. The manufacturer of the drive is the First Class Company. Can you help me with this problem?—B. Fischer, Indianapolis, IN**

The company you're looking for is called First Class Peripherals and, the last time I dealt with them, they were located in Carson City, Nevada and their phone number was 800 538-1307. It's been a while since I had anything to do with them but, as I remember, they were always extremely helpful.

Your best bet is to get in touch with them and get the software and manuals that were supposed to accompany the drive. If you can't do that, check with a local Apple user's group and see if anyone can help you there. The Sider (the name for their drives), was one of the first hard disks available for the Apple II series of computers and I have no doubt that they sold a lot of them.

There are a few things you can try to make sure the drive is still working. You said that you had the card plugged into the computer, but there's a good chance you're not issuing the proper commands to access it. When the Apple is first turned on, it checks the slots to try and find a disk controller card. Each slot has 256 bytes of memory in the main Apple memory map, and each card is designed to work in a slot that has a particular signature that indicates its function. By examining these signature bytes, the Apple is able to identify the cards connected to it.

At powerup, the Apple wants to find a disk controller card and it scans through the slots looking for one. The scan starts at slot #7 (the one near-

est the video connector), and winds up at slot #1 (the one nearest the power supply). As soon as the Apple finds a disk controller card, it turns control over to the firmware located on the card. What's important to realize is that the computer will recognize the first controller card it finds. If you have one in slot #6, it won't pay any attention (at bootup) to any others in lower numbered slots.

If you want to boot off the Sider, you have to put its controller card in a higher numbered slot than the one used for the regular disk drives. Since the disk controller is usually located in slot #6, the Sider's controller card should be in slot #7. As an alternative, you can access the Sider by typing PR#X' at the Apple prompt (the "X" is the number of the slot in which you've put the Sider's controller card).

Whichever method you choose, accessing the Sider should turn on its activity light and whatever boot program is on the disk should show up on your screen. Both DOS and PRODOS (the two main operating systems for the Apple series of computers) have to be patched to work with the Sider and the only way to do that is by using the software that was originally supplied with the drive.

## VIDEO SYNC

**I'm building a video circuit and want to get the sync signals from a standard composite video input. My ultimate goal is to be able to mix video signals together and, even though I have a good design for the mixer and sync gener-**

**ator, I have to be able to identify the sync on the incoming video. Any ideas?—C. Baldwin, Bangkok, Thailand**

Fortunately for you, what you're trying to do is fairly common. While it's possible to design your own sync separator, it would be a lot of unnecessary work because there are chips around that can do the job for you.

Remember that stripping sync is something that's done in every TV set on the market and, as a result, semiconductor manufacturers have jumped into the market with single-chip solutions to the problem. Several companies make them, but the one I usually use is the LM1881 made by National Semiconductor. I've found it very easy to put in a circuit and fairly tolerant of variations in sync levels and signal voltages.

The pinouts of the chip are shown in Fig. 1 and I've also drawn in the components needed to make it work. As you can see, all it takes is two capacitors and one resistor. Nothing could be simpler but you still should write to National Semiconductor to get a data sheet for the IC (National Semiconductor Corporation, 2900 Semiconductor Drive, Santa Clara, CA 95052-8090).

When you contact them, you should ask where you can get the part since I don't know what the availability is like in your part of the world. You might find it easier to deal with a supplier in the United States but, no matter what you do, it's not a common IC so you're going to have to do some investigating if you want to buy only one or two of them. Minimum orders can be murder.

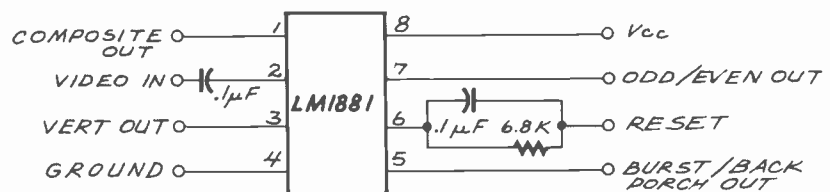

FIG. 1—THE LM1881 SYNC SEPARATOR, made by National Semiconductor, requires very few components to make it work.



**NOW! AT-compatible computer, 20 meg hard drive,  
and new diagnostic hardware and software!**

# Learn to troubleshoot and service today's computer systems as you build a fully AT-compatible micro

Train the NRI way — and learn to service all computers as you build your own fully AT-compatible micro, now with 1 meg RAM, 20 meg hard drive, and exciting new diagnostic hardware and software!

Jobs for computer service technicians will almost double in the next 10 years according to Department of Labor statistics, making computer service one of the top 10 growth fields in the nation.

Now you can cash in on this exciting opportunity—either as a full-time industry technician or in a computer service business of your own—once you've mastered electronics and computers the NRI way.

NRI's practical combination of "reason-why" theory and hands-on building skills starts you out with the fundamentals of electronics, then guides you through more sophisticated circuitry all the way up to the latest advances in computer technology. You even learn to program in BASIC and machine language, the essential language for troubleshooting and repair.

**Get real-world skills as you train with and keep a powerful AT-compatible computer system plus popular Microsoft® Works software**

Only NRI gives you hands-on training with the finest example of state-of-the-art technology: the powerful new West Coast 1010ES computer. As you assemble this fully IBM PC/AT-compatible computer from the keyboard up, you actually see for yourself how each section of your computer works.

You assemble and test your computer's "intelligent" keyboard, install the power supply and 5-1/4" floppy disk drive, then interface the high-resolution monitor.

Your hands-on training continues as you install a powerful 20 megabyte hard disk drive—today's most-wanted computer peripheral—now included in your course to dramatically increase the data storage capacity of your computer while giving you lightning-quick data access.

Plus you now work with today's most popular integrated software package, Microsoft Works, learning to use its word processing, spreadsheet, database, and communications utilities for your own personal and professional applications. But that's not all.

**NEW! Training now includes Ultra-X diagnostic hardware and software for quick, accurate troubleshooting**

Now you train with and keep the latest in diagnostic hardware and software: the extraordinary R.A.C.E.R. plug-in diagnostic card and QuickTech diagnostic software, both from Ultra-X. Using these state-of-the-

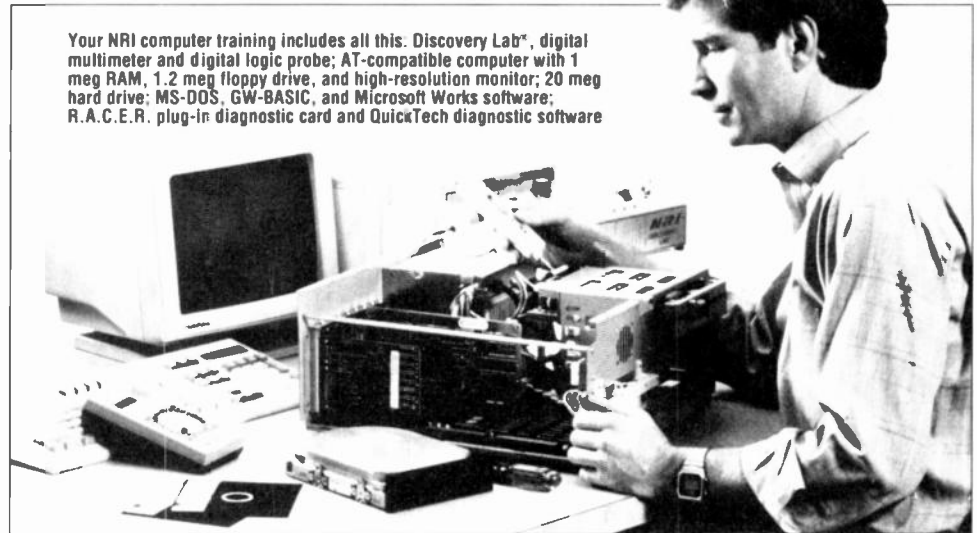

Your NRI computer training includes all this. Discovery Lab®, digital multimeter and digital logic probe; AT-compatible computer with 1 meg RAM, 1.2 meg floppy drive, and high-resolution monitor; 20 meg hard drive; MS-DOS, GW-BASIC, and Microsoft Works software; R.A.C.E.R. plug-in diagnostic card and QuickTech diagnostic software

art tools, you learn to quickly identify and service virtually any computer problem on XT, AT 80286/80386, and compatible machines.

You discover how to use the R.A.C.E.R. diagnostic card to identify individual defective RAM chips, locate interfacing problems, and pinpoint defective support chips. Plus you learn to use your QuickTech software to test the system RAM and such peripheral adapters as parallel printer ports, serial communications ports, video display memory, floppy drives, and hard disk drives.

Only NRI gives you such confidence-building, real-world experience. Only NRI gives you both the knowledge and the professional tools to succeed as today's in-demand computer service technician.

**No experience needed, NRI builds it in**

With NRI training, you learn at your own convenience in your own home. No classroom pressures, no night school, no need to quit your present job until you're

ready to make your move. NRI starts you with the basics, building on that foundation step by step until you have the knowledge and skills you need for success.

And all throughout your training you've got the full support of your personal NRI instructor and the entire NRI technical staff, always ready to answer your questions and help you achieve your training goals.

**FREE catalog tells more**

Send today for NRI's big, free catalog that describes every aspect of NRI's innovative computer training, as well as hands-on training in other growing high-tech career fields.

If the coupon is missing, write to: NRI School of Electronics, McGraw-Hill Continuing Education Center, 4401 Connecticut Avenue, NW, Washington, DC 20008.

IBM and AT are registered trademarks of International Business Machines Corporation R.A.C.E.R. and QuickTech are registered trademarks of Ultra-X, Inc.

**SEND CARD TODAY FOR FREE NRI CATALOG**

**NRI Schools**

McGraw-Hill Continuing Education Center  
4401 Connecticut Avenue, NW, Washington, DC 20008



For career courses approved under GI Bill check for details.

**✓ CHECK ONE FREE CATALOG ONLY**

- |  |  |  |
|--|--|--|
| <input type="checkbox"/> Microcomputer Servicing     | <input type="checkbox"/> Computer Programming        | <input type="checkbox"/> PC Software Engineering Using C           |
| <input type="checkbox"/> TV Video/Audio Servicing    | <input type="checkbox"/> PC Systems Analysis         | <input type="checkbox"/> Industrial Electronics & Robotics         |
| <input type="checkbox"/> Automotive Servicing        | <input type="checkbox"/> Electrician                 | <input type="checkbox"/> Building Construction                     |
| <input type="checkbox"/> Telecommunications          | <input type="checkbox"/> Desktop Publishing & Design | <input type="checkbox"/> Small Engine Repair                       |
| <input type="checkbox"/> Security Electronics        | <input type="checkbox"/> Locksmithing                | <input type="checkbox"/> Word Processing Home Business             |
| <input type="checkbox"/> Electronic Music Technology | <input type="checkbox"/> Bookkeeping & Accounting    | <input type="checkbox"/> Paralegal                                 |
| <input type="checkbox"/> Basic Electronics           | <input type="checkbox"/> Fiction/Nonfiction Writing  | <input type="checkbox"/> Air Conditioning, Heating & Refrigeration |

Name (please print)

Age

Address

City/State/Zip

Accredited Member, National Home Study Council

3-021

# Safety, Security, Convenience, Entertainment and Energy Management

## Home Automation from Heath, the catalog that has it all...

Enter the world of Home Automation. Remote lighting and appliance controls. Security alarms and lighting. Automated thermostats. Video monitoring systems. Whole-house security systems. They're all yours in the Heath Home Automation Catalog. To receive your FREE copy, call today toll-free.

**1-800-44-HEATH**  
(1-800-444-3284)

### HOME AUTOMATION

MAKING YOUR HOUSE SAFER AND EASIER TO LIVE IN



Heath Company  
A LEADER IN ELECTRONICS FOR OVER 40 YEARS

## Heath Company

Marketing Dept. 020-024  
Benton Harbor, MI 49022

CL 807

CIRCLE 86 ON FREE INFORMATION CARD

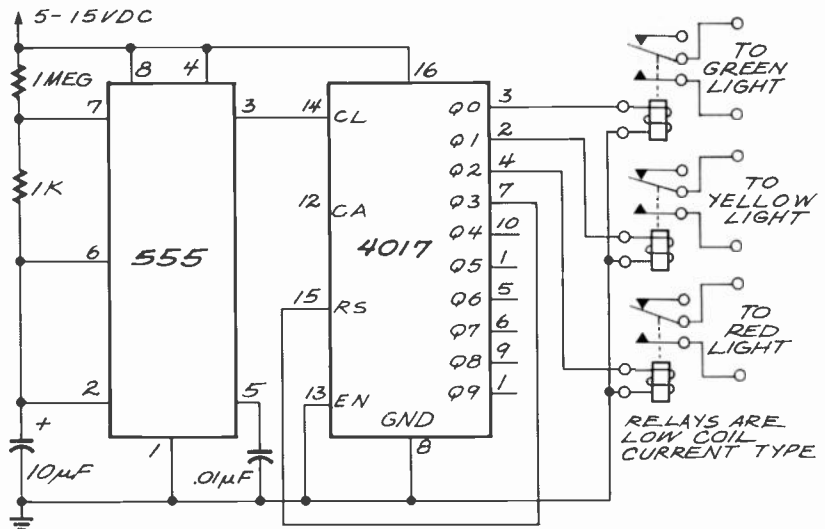

FIG. 2—YOU CAN CONTROL a traffic light, or any other similar device, using this circuit. An AC-powered battery eliminator can be installed right inside the light, along with the circuit itself.

### TRAFFIC LIGHT

**I have an old traffic light and want to get it working and use it as a yard light in my driveway. What I need is some way to control the AC and make it work like a real traffic light. There must be some simple way to do this.—A. Haycock, Corvallis, MT**

Before we get started on your problem, let me tell you that I think it's a great idea. As a matter of fact, if there are any of those lights left, I'd like to find out where I can get one for myself.

I'm not sure how you want the thing to operate and you haven't told me how many lights you have to control. Traffic lights can have one, two, three, or more individual lights. Whatever the case, there are several ways you can get the thing working.

I'm guessing that you want the lights to cycle back and forth and, since I can't imagine that there's that much traffic in your driveway, absolute accuracy in timing isn't really all that critical.

One simple way to control the light is shown in Fig. 2. All you need is a handful of parts and the layout isn't at all critical. You can build the circuit on a piece of perforated construction board and put it inside the light itself. You'll have to put a power supply in there as well but the circuit draws so little power that you can use an AC-powered battery eliminator.

The 555 is set up as a timer with an output frequency of about 10 sec-

onds. That is the rate at which the light will change and, even though it's a bit fast for a real traffic light, it should make for a more interesting display in your driveway.

The clock pulses from the 555 drive a 4017 whose outputs control relays that turn on each of the traffic lights in turn. The reason I'm using a 4017 here is that it can control 10 relays and I don't know how many you have in your traffic light. All you have to do to add more lights is add more relays and move the reset connection on the 4017.

I think your idea is great and I would have done exactly the same thing if I had managed to get my hands on one of those traffic lights.

### WORD/HOME PROCESSOR

**At a recent garage sale, I purchased a word processor made by an outfit in Sunnyvale, California called Systel. Although the only I/O port is the keyboard connector, I intend to use it as the basis for a home monitor/control system. The system is based around a Z-80A but I don't have any DOS software that will work with it. Do you have any suggestions?—G. Farr Jr., Garden City, KS**

I have several suggestions, but they all add up to the same thing, and I'm afraid that none of them are what you're looking for. Trying to build or convert a computer to a home con-

continued on page 80

# LETTERS

Write to Letters, Radio-Electronics,  
500-B Bi-County Blvd., Farmingdale, NY 11735

## STILL MORE ON AM RADIO

I read with interest the letter from Matthew Bailey ("More on AM Radio") that appeared in the December issue of **Radio-Electronics**. He stated that in the beginning many AM stations used standard telephone lines with 5-kHz upper limits for studio-to-transmitter links. I can't comment on that, but his next sentence said that AM radios were built with narrow bandwidth IF filters to minimize interference.

What interference? In the beginning, there were not many commercial power lines or much electrical equipment to generate interference. There certainly weren't enough stations on the air to interfere with each other.

In fact, radios did not have narrow IF's. Many sounded great—once technology produced better speakers, of course. Some units had selectable bandwidth that used a switch labeled "Voice-Music." I believe the main reason for that was to allow for more intelligible speech.

In the sixties, some radio programmer decided that the loudest station in a market would have the most listeners. That started a new trend that caused stations to use greater amounts of audio processing (compression, limiting, and clipping). Before that, most stations used modest amounts of compression (AGC) to counteract operator gain-riding errors. Limiting was used to prevent overmodulation by loud peaks.

When stations used more processing, the average program-material level increased greatly. That caused the occupied bandwidth of stations to increase in density as well. Now there was real interference.

Manufacturers gradually began to reduce the bandwidth of receivers to reduce the interference. The programmers noticed that treble was lacking and began to use pre-emphasis to get the sparkle back in their sound.

The more that receiver bandwidth was cut, the more treble boost was necessary, which caused more inter-

ference, which required further bandwidth reductions. That's what happened to the sound of AM radio. Throughout that time, of course, man-made interference was also on the rise.

Many people suspect that the radios in their old cars sounded better—and they did. Today it's hard to find AM radios with decent bandwidth. I possess a few, and have amazed many friends who thought they were listening to FM. The sound of many AM stations is very good, if you can find something suitable on which to listen.

GEORGE THOMAS  
Chief Engineer, WJDX/WMSI  
Jackson, MS

## SATELLITE TV PROGRAMMING

In his article "The Changing Face of Satellite TV" (**Radio-Electronics**, November 1990), Robert Angus did a good job of describing the tip of the iceberg, but he either ignored or was unaware of the most important part—what you cannot see. He also short-changed the existing home reception of satellite retransmitted signals that include network television, cable programming, audio data, narrowcasts, and a variety of excellent educational programming. Existing satellite capacity makes available more than 500, not 200, channels. Less than 20% of those channels carry "cable programming to viewers."

Mr. Angus and others hype the potential for smaller reflectors. Phased-array panels have been used for years by the military. The size of reflectors and phased arrays that are capable of supplying sufficient signal levels is shrinking because of advances in HEMT technology. Size is also influenced by geographic location, sources of interference, obstacles, weather, equipment used—and, yes, TWT (Traveling Wave Tube) output power. With every reduction in size comes other trade-offs. The problem of non-compatible encryption-decryption technologies, which Mr. Angus so correctly addressed, is

## Data Acquisition and Control the Easy Way

### What is the A-Bus?

A-Bus is a system for connecting devices to your computer. Whatever your computer, use A-Bus for:

**Sensing.** Detecting or reading a switch closure or voltage presence.

**Measuring.** Determining a force, frequency, temperature, weight, or any other quantity.

**Control.** Open or close a circuit. Switch any type of electrical device. Adjust level or position.

### Why should you choose A-Bus?

**It's affordable.** From a \$65 Digital Input Card to a \$299 Motor Controller, you get much more than your money's worth.

**It's simple.** Easy to connect to your computer and to your application. Designed to adapt to your software easily.

**It's versatile.** You mix and match low cost boards to fit your project.

**It's proven.** Thousands of applications installed around the world.

### Call for a Catalog (800) 221-0916

#### A Sampling of our Products

**Relay Card:** 8 individually controlled relays. 3A at 120VAC, SPST. RE-140: \$142

**High-Speed 12-bit A/D converter:** 8 10µs analog inputs. 0-5V. amp. FA-154: \$179

**8 Bit A/D:** 8 inputs. 0-5.1V in 20mV steps. 7500 conversions/second. AD-142: \$142

**12 Bit A/D:** ±4V. On-board amp. 7 readings/sec. 1 input. expandable AN-146: \$153

**Temperature Sensor:** 0-200° TS-111: \$12

**Digital Input:** 8 opto-isolated. Read voltage presence or switch closures. IN-141: \$65

**Latched Input:** Each of 8 inputs is latched to catch switch closures LI-157: \$85

**Digital Output Driver:** 8 outputs: 250mA at 12V. For relays, solenoids... ST-143: \$78

**Smart Quad Stepper Controller:** On board processor controls 4 motors simultaneously. Simple English commands to set position, speed, units, read limits, etc. SC-149: \$299

**D/A:** 4 Channel, 8 Bit Output DA-147: \$149

**24 line TTL I/O:** Connect TTL 0/5V levels or switches. (8255A) DG-148: \$72

**32 Channel Multiplexer:** Switches up to 32 channels to a single common. MX-155: \$83

**Touch Tone Decoder:** PH-145: \$87

**Counter Timer:** 3 16-bit counters. Count pulses, measure frequency CT-150: \$132

**A-Bus Prototyping card:** PR-152: \$16

**OdIn Software:** For PC's Control relays from inputs or time schedules OS-189: \$129

**Motherboard:** For 5 cards. MB-120: \$108

**A-Bus Adapters:**

**IBM XT/AT & compatibles:** AR-133: \$69

**MicroChannel Adapter:** AR-170: \$93

**Parallel Adapters** also available for Apple II, Commodore 64, 128, TRS-80

**Serial Adapter:** RS-232 SA-129: \$149

**Serial Processor:** Built in BASIC for off-line monitoring, logging. SP-127: \$189

**New! C-Net:** Connect thousands of RS-232 serial devices to one computer port. Printers, modems, data acquisition devices, etc.

 **ALPHA Products**

242-RE West Avenue, Darien, CT 06820  
Call (203) 656-1806 or Fax 203 656 0756

CIRCLE 180 ON FREE INFORMATION CARD

## JAN CRYSTALS

*your reliable source for  
a world of crystal clear  
communication*



- Commercial Two-Way
- MicroProcessors
- Amateur/Experimental
- Scanners/Monitors/Pagers
- Satellite-Telemetry
- Plus custom applications

**EXPEDITED ORDER SERVICE!**

FOR FREE CATALOG,  
CALL OR WRITE:



**JAN CRYSTALS**

P.O. Box 06017  
Ft. Myers, FL 33906  
(813) 936-2397



**TOLL FREE 1-800-526-9825**

**FAX ORDERS: 1-813-936-3750**

CIRCLE 104 ON FREE INFORMATION CARD

## ATTENTION! ELECTRONICS TECHNICIANS

EARN YOUR  
**B.S.E.E.  
DEGREE**

**THROUGH HOME STUDY**

Our New and Highly Effective Advanced-Placement Program for experienced Electronic Technicians grants credit for previous Schooling and Professional Experience, and can greatly reduce the time required to complete Program and reach graduation. No residence schooling required for qualified Electronic Technicians. Through this Special Program you can pull all of the loose ends of your electronics background together and earn your B.S.E.E. Degree. Upgrade your status and pay to the Engineering Level. Advance Rapidly! Many finish in 12 months or less. Students and graduates in all 50 States and throughout the World. Established Over 40 Years! Write for free Descriptive Literature

**COOK'S INSTITUTE  
OF ELECTRONICS ENGINEERING**



4251 CYPRESS DRIVE  
JACKSON, MISSISSIPPI 39212

a hurdle, not an impasse. VLSI circuits will soon permit multiple digital- and analog-signal-processing and decryption equipment all within the same receiver and/or the television itself. But all of this technical information is just the tip of the iceberg!

The article stated, "Since the same pool of feature films should be available to all the PPV hopefuls, and the majors promise to offer basic programming comparable to current basic cable ..." That's where the rest of the story begins. Most existing "cable" programming is controlled by very few MSO's or Multiple System Operators (giant cable companies), and/or by production companies that either own or are owned by MSO's. Those giants control programming and, more important, the major sources of programming. Since the networks want to be carried on cable in favorable channel spots (2-13), they are not a source of competitive programming.

Without programming, the assertion "Satellite television received on small, flat antenna panels, promises to give cable TV a run for the money" ignores reality. Congress and many of us in the industry have wrestled with program-access problems for more than four years. Without programming, any technology that is not owned or at least controlled by cable interests will wither and die on the vine!

ROBIN ADAIR  
Columbia, KY

### SPICE VARIETY

I just finished reading T.J. Byers' article about SPICE in the November issue of **Radio-Electronics**, in which he mentioned PSpice and IsSpice. I'd like to mention another product, called Micro-CAP II, which is a student version of the original Micro-CAP. It has all the capabilities of the original except that it is set up for only 25 nodes instead of 150 nodes. The student version has a vast built-in library for such components as op-amps, transformers, NPN and PNP transistors, MOS transistors, diodes, and more. It also includes a schematic editor, netlist, bode plots, time-domain plots, Fourier analysis, and more. The student version costs less than \$50.00 and comes with a manual written for the non-professional. I found that to be much better than the sample ver-

sions mailed out by PSpice or IsSpice. There is also a student version for digital circuits called Micro-Logic II. It also costs about \$50.

I just graduated from an electrical engineering program and I used both of those software packages extensively, with excellent results. Both book/software packages are available from Addison-Wesley Publishing Company (ISBN 0-201-50552-5: Micro-Logic II; ISBN 0-201-50542-8: Micro-CAP II).

DONALD HAROOTUNIAN  
Webster, TX

### NTSC-TO-RGB CONVERTER

Several incorrect statements appeared in Jim Harrigfeld's article "Build an NTSC-to-RGB Converter" (**Radio-Electronics**, October 1990). The subheading says, "Put a TV in your VGA monitor," and the text says that standard NTSC video rate requirements eliminate "most fixed-frequency (digital) monitors—i.e., most CGA and EGA types."

Both statements are false. As a reference, I cite the *Ask R-E* column on page 12 of the same issue. To display a standard NTSC signal, a 15.75-kHz horizontal scanning rate is required. The table on page 12 shows that VGA does not use that rate, while CGA uses exactly that rate. In fact, CGA video was originally designed so that PC users could use their color TV sets as monitors. Please take care to make your articles technically correct!

I also agree with Mr. Burton ("Throwing Caution to the Wind," *Letters*, October 1990) that cautions about handling CMOS seem overdone. The first CMOS chips were indeed static sensitive, but manufacturers quickly added input-protection diodes.

EARL MORRIS  
Midland, MI

Both of the statements in which Mr. Morris finds fault appeared as a result of editing errors. The subhead, of course, should have read "Put a TV in your Multisync Monitor." The text that Mr. Morris quotes is not as clear as it should be. The point we tried to make is that there are two requirements for a monitor: (1) that it accept analog inputs, and (2) that it be capable of scanning at 60 Hz vertical and 15.75 kHz horizontal. Although a CGA monitor scans adequately, it generally has only dig-

ital inputs and thus will not work. An EGA not only scans at the wrong frequency but it also has digital inputs. And a VGA monitor, although it has analog inputs, will not scan at the correct rate. That's the reason for our recommendation for multi-frequency-type monitors.—JIM HARRIGFELD

#### BRAIN POWER

While I was not surprised that there were objections to Don Lancaster's claim of a four-billion-bit human brain capacity (*Hardware Hacker*, **Radio-Electronics**, January 1990), I was disappointed in the nature of the objections (*Letters*, May and November 1990), given the recent popularity of neural network research. While it is true that the brain compresses data, it is also true that the compression algorithms are part of the brain and (theoretically) could be mimicked by a computer. The real issue is that the "program" of the human brain is not totally contained in its four-billion neurons. It is the ten thousand (rough average) interconnections to each neuron that determine the "program." I'm not sure how much resolution the analog connection strengths have, but I'll guess about 3-bits worth. Therefore, to mimic the brain, you would need an associative memory structure with a capacity of about

$(2^3)(4 \times 10^9)(1 \times 10^4) = 3.2 \times 10^{14}$  bits. Keep in mind that many of the brain's functions have been efficiently "hard-wired" over a billion years of evolutions to avoid the waste of connections during trial-and-error programming. We are still a long way from constructing anything with the complexity and power of the human brain.

GEORGE LEGTERS  
Melbourne Beach, FL

#### CONSUMER ELECTRONICS FOR THE BLIND

In response to David Plumlee's letter regarding electronic appliances for the blind (**Radio-Electronics**, November 1990), unless products with such features find widespread acceptance among the sighted, it's not very likely that they'll appear on the market. However, I would think that he could retrofit some appliances himself, or have it done for very little cost. "Dymo" label-making machines include a model that produces Braille-character labels that can be

placed over many touch controls. When used over a touch-control panel on a unit that has an audible signal when buttons are pressed, the beep and the Braille might be enough to provide reliable operation by the sightless.

As for a clock radio, perhaps he could use a separate clock that chimes at the hour and each quarter hour. He could interface it with a radio to turn the radio on at the appropriate time. If that didn't work, maybe a talking clock would be easier to use.

Mark V Electronics (8019 E. Slauson Ave., Montebello, CA 90640) offers two such models.

One other possible source of information is an organization called Christian Record Braille (P.O. Box 6097, Lincoln, NE 68506). They make audio/visual products for the blind. Most of their products are Christian study and information materials, but they might offer guidance in other areas as well.

ROGER DOERING  
Camp Verde, CA 86322

R-E

Test them  
all for  
just \$99.



#### New B&K-PRECISION Parts Tester checks capacitors, resistors, transistors, diodes, SCRs, LEDs and more.

There's no need to guess about components with B&K-PRECISION's 815 Parts Tester. It accurately measures the most-used components and displays their values on a large 0.8" LCD readout. Rugged design and tilt stand make it well suited for field or bench.

One look at this quality instrument will convince you the B&K-PRECISION 815 is the best buy. For detailed specifications or immediate delivery, contact your local distributor.

- Tests capacitance from 0.1pF to 20mF in capacitors, cables, switches, other components.
- Tests resistance from 0.1 ohm to 20 megohms.
- Tests SCRs, diodes and LEDs.
- Tests transistor gain and leakage.
- Tests batteries under true load conditions.
- 26 measurement ranges.
- 5 foot drop-resistant case.
- Tilt stand for bench use.
- Includes test leads



**BK PRECISION**  
MAXTEC INTERNATIONAL CORP.

Domestic and International Sales  
6470 W Cortland St., Chicago, IL 60635  
312-889-1448 • FAX: 312-794-9740  
Canadian Sales, Atlas Electronics, Ontario

CIRCLE 77 ON FREE INFORMATION CARD

## Data Controls Analyst 2 Data Line Monitor

**W**e've all had the experience of trying to troubleshoot a PC's serial data line to establish reliable communications between a PC and external device such as a modem, printer, or serial-to-parallel converter. It's usually a difficult job because you can't see what's going on. Sure, you can use breakout boxes with LED indicators to try to get the lines matched up correctly, but if the communications problem is caused by an incorrect transmission rate, glitches on signal lines, or an unreliable data-communications channel, simple tools just won't do the job. That's when you need a device like the *Analyst 2* data-line monitor and digital test set from Data Controls (2183 Buckingham Road, Suite 217, Richardson, TX 75081).

The *Analyst 2* is a handheld unit, but with a size of about 4¼ × 8¼ × 1¼ inches, you'll probably prefer to leave it on your benchtop. A wall transformer provides power to the bottom of the unit through a detachable cable. The front panel features 8 function keys, a 2-line by 32-character backlit LCD readout, and eight tri-color LED's across the top of the unit.

On power-up the *Analyst 2* performs a self test, after which it's ready to test data lines. The main menu of the unit contains twelve choices for the appropriate mode of operation. Each mode is displayed one at a time, and the list is scrolled through using up or down cursor keys.

### Operating modes

In the Data Monitor mode, the *Analyst 2* can capture and display RS-232 serial data streams. Asynchronous, synchronous, or a user-defined bit-oriented protocol are supported, and the display can be in a character-oriented format or in hexadecimal. To aid in troubleshooting, the *Analyst 2* can be triggered to start recording when it sees a specific group of characters. Sub menus let you select the proper signal clocking, data format, how the data is stored in



CIRCLE 10 ON FREE INFORMATION CARD

*Troubleshoot, test, and analyze data circuits quickly.*

the capture buffer, whether specific signal transitions are captured, and how the display should show the captured data.

The Review Data mode provides a way to examine and manipulate the data stored in the non-volatile capture buffer. As in the monitor mode, various sub menus are used to select data formats.

The Distortion mode is used to detect the deviation of a signal's actual timing parameters from what it should theoretically be. Three types of distortion, gross, isochronous, and bias, can be measured.

In the Time Delay mode, the *Analyst 2* measures a device's response delay. It sends out control signals, and waits for responses. For example, the length of time between a request-to-send (RTS) and the corresponding clear-to-send (CTS) can be measured.

The *Analyst 2* can also act as a source of data in its Simulate mode, where it outputs data to verify that a data channel is working properly. It can also be used to test printers, modems, terminals, and the like. When requested the unit will output, in either ASCII or EBCDIC coding a QBF or quick-brown-fox message, which contains every letter of the alphabet, the numbers 0 through 9, a carriage return, and a line feed. As you might expect, data-framing and -format modes are selectable.

To simulate a loopback device, the *Analyst 2* can be run in its Echo mode. When running, the unit digitally loops back all data presented on pin 3 (receive data) onto pin 2 (transmit data).

A bit-error rate test or BERT is provided to determine the performance level of a data-communications line, and whether it can support communications with an acceptable number of bit errors. Excessive line noise, crosstalk, and random burst errors on the line can be detected. A block-error rate test or BLERT is similar to a BERT, except that it specifically tests the capability of a data-communications line to handle blocks of messages of specific length. Another test mode—CERT or character-error rate test—is very similar to the BLERT mode, except that the block size is determined by the bits-per-character selection. A final rate-test mode—error seconds test—is used to determine the performance of a data line over time.

We found that putting the *Analyst 2* to work was not too difficult—once we got the hang of it. Unfortunately, the operating manual supplied with the unit was difficult to decipher in many cases. For example, we were at first confused about the proper way to select the right choices from the menu. We did figure it out, but without help from the manual. All things considered, that's a minor complaint. We think that the \$965. *Analyst 2* data-line monitor is certainly worth a look from data-communications professionals. **R-E**

Add frequency-measurement capabilities to your workbench with this inexpensive counter.

ARL BERGGUST

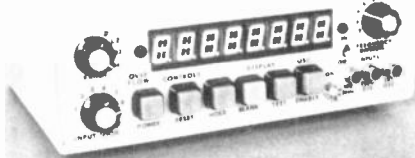

In "Build This Benchtop Frequency Counter," (December 1990) we were unable to provide the PC-board foil patterns. They are reproduced here.

We greatly exaggerated the capabilities of the counter. Because of the components used, the counter cannot perform at frequencies above 25 MHz. We're sorry for any confusion our misstatements caused.

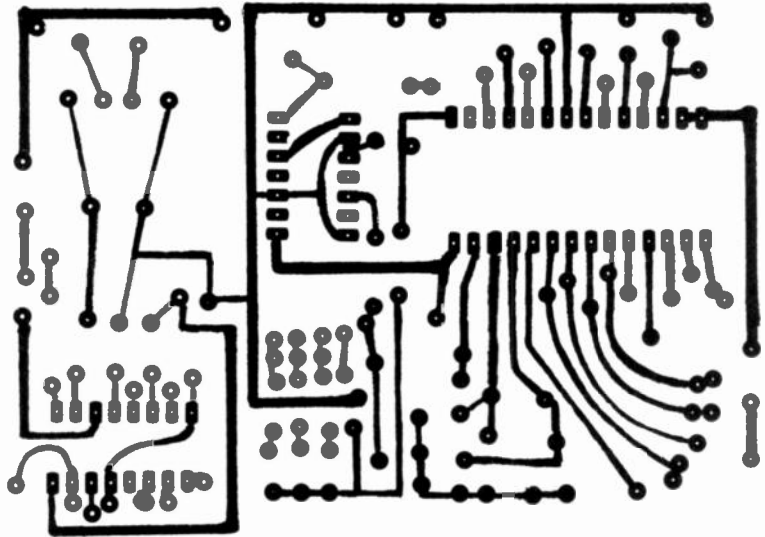

47<sup>1/16</sup> INCHES

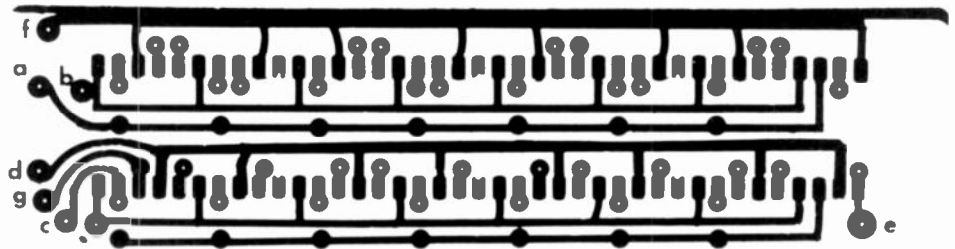

41<sup>5/16</sup> INCHES

## Train at Home to be an Electronics Technician!

Professional training and equipment can help you qualify for a dynamic, high-paying career in your spare time.

As the demand for computers and microprocessors in business and manufacturing continues to grow, so does the need for qualified technicians. It's not unusual for experienced technicians to earn from \$35,000 to more than \$40,000 a year.\* Now there's a way you can train for this exciting field without interrupting your job or home life.

### Choose From These Programs of Study

- Electronics & Microprocessor Technology
- Industrial Electronics & Microprocessor Technology
- Computer Servicing & Electronics Technology
- Specialized Associate Degree In Electronics Technology

### You Get Professional Equipment For Professional Training

Depending on the program you select, you'll perfect your skills using this advanced equipment, included in the price of tuition:

- IBM-Compatible Personal Computer
- Digital Multimeter
- Digital Logic Probe
- Elenco Oscilloscope

### Exclusive Extras That Enhance Your Training

Peoples College introduces some training firsts to make your learning experience more complete:

- Accelerated Learning System — a scientifically proven study system that lets you learn faster and easier than ever before.
- Optional One-Week Seminar — available with our advanced programs. Conducted on our campus near Orlando, Fla. Not required for graduation, but a valuable opportunity to fine tune your skills with personal guidance.
- Video Tutor Training Tapes — give you a permanent, visual record of informative lectures and close-up demonstrations.
- Experience Labs — professionally designed experiments that give you hands-on "bench" experience.
- Industry Certification Training Guide — provided with three of our programs. Gives you first-hand insight into the examination you may take for your professional license.



For COLOR CATALOG Mail Coupon or Call TOLL FREE

1-800-765-7247

*Programs offered only in United States, Canada, Puerto Rico and Virgin Islands. No Obligation. No sales person will call.*

Our programs are accredited by the Accrediting Commission of the National Home Study Council

YES! I would like to know more about your training programs. Send a catalog to:

Name \_\_\_\_\_

Address \_\_\_\_\_

City \_\_\_\_\_

State \_\_\_\_\_ Zip \_\_\_\_\_



**PEOPLES COLLEGE**  
OF INDEPENDENT STUDIES

233 Academy Drive • P.O. Box 421768  
Kissimmee, FL 34742-1768

Member, D.I. Peoples Group

R0291

\*Source: U.S. Bureau of Labor Statistics

CIRCLE 192 ON FREE INFORMATION CARD

# NEW PRODUCTS

Use the Free Information Card for more details on these products.

## PALM-SIZED CPU MODULES.

Measuring only  $3.6 \times 3.8 \times 0.6$  inches, Ampro's CoreModules are fully configured PC-compatible CPU modules with memory, solid-state disk, serial and parallel I/O ports, real-time clock, and keyboard and speaker interfaces. The CoreModule/XT (pictured) was introduced in late 1990; the CoreModule/286 and CoreModule/386 should be available in 1991. Designed for embedded applications, each module can be used alone as a component-like, PC-compatible engine, or can be combined with Ampro's MiniModule expansion peripherals to build complete systems.

The CoreModule/XT is equipped with a CMOS-enhanced 8088-compatible microprocessor that operates at 9.82 MHz, and a full complement of PC-compatible DMA controllers, interrupt controllers, and timers. It comes with two byte-wide sockets for EPROM, flash EPROM, static RAM, or NOVRAM memory that can be used as bootable, DOS-compatible solid-state disk (SSD), eliminating the need for floppy drives. Op-

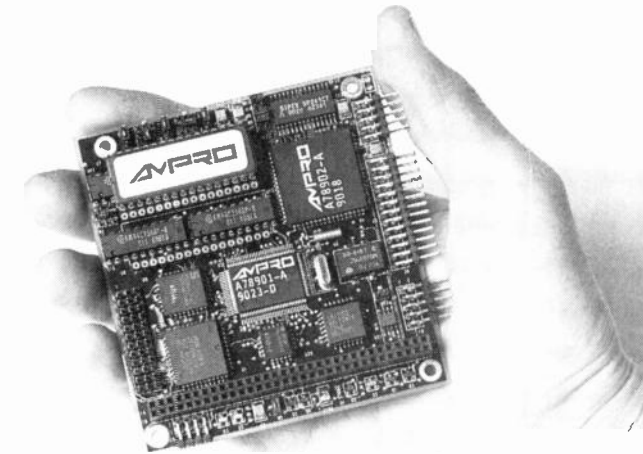

CIRCLE 16 ON FREE INFORMATION CARD

tional utility programs automatically converts any disk-based PC software to SSD operation.

The MiniModule expansion boards, which stack over or under the CoreModule, add configuration flexibility, allowing the addition of CGA, EGA, VGA, LCD, and electroluminescent flat-panel controllers; a 2400-bps modem; a LAN interface; and other capabilities. The MiniModule/FSS provides floppy drive, SCSI, and serial port controllers in one extremely compact package.

The CoreModule/XT ranges in price (to OEM's) from below \$100 in quantities of 10,000 and up to \$130 for quantities of 1000. A CoreModule/XT Development Kit that includes the CoreModule/XT, MiniModule/FSS, MiniModule/VGA, all cables, mounting hardware, manuals, and DR DOS costs \$100 in quantities of 100. The MiniModule/SSD costs \$90 in 100's.—

**Ampro Computers, Inc.**, 990 Almanor Avenue, Sunnyvale, CA 94086; Tel: 408-522-2100; Fax: 408-720-1305.

## HF SWR ANALYZER.

Providing a complete picture of an antenna SWR over an entire band—without a transmitter, SWR meter, or any other equipment—the MFJ-207 HF SWR analyzer makes it easy to set up and precisely trim an antenna. It is used by plugging the antenna into the coax connector, setting the analyzer to the desired frequency, and reading the SWR. The battery-operated, hand-held unit can be brought to the antenna to directly measure its SWR without the distorting effects of the coax. SWR changes can be monitored while adjustments are being made, and the user can immediately



CIRCLE 18 ON FREE INFORMATION CARD

see the effects of shortening or lengthening the dipole. The user can instantly check multi-band dipoles and trap verticals to see if the low SWR points are positioned correctly, and adjust the antenna until they are right. The MFJ-207 helps locate the best place on a car to mount a mobile antenna. In addition, it can be used to observe the effects of rain or snow on the beam or dipole, tune up

**OVERHEAD IONIZER.** To neutralize static charges on the workbench without taking up bench space, Desco's model A60420 ionizer mounts overhead and plugs into a standard AC outlet. The ionizer offers an automatic shut-down feature that turns the unit off if proper ionizing conditions cannot be main-

tained. A built-in alarm circuit continuously monitors



CIRCLE 17 ON FREE INFORMATION CARD

ion production and ensures proper balance. A variable speed control adjusts three fans that move the ions toward the work surface.

The A60420 overhead ionizer costs \$630.—**Desco Industries, Inc.**, 761 Penarth Avenue, Walnut, CA 91789; Tel: 714-598-2753; Fax: 714-595-7028.



# Discover Your Career Potential In The Fast Growing Field Of High-Tech Electronics!

CIE Gives You The Training You Need to *Succeed...*  
At Your Own Pace...& In Your Own Home!

If you're anxious to get ahead...and build a *real* career...you owe it to yourself to find out about the Cleveland Institute of Electronics!

CIE can help you discover *your* career potential in the fast growing field of high-tech electronics. A career that will challenge and excite you every day...reward you with a powerful feeling of personal accomplishment...and deliver a level of financial security you may have only dreamed of before!

As the leading school in home-study electronics, CIE has helped over 150,000 students in the U.S.A. and over 70 foreign countries get started in this exciting field. To find out how CIE could be helping you...read on...then send for a CIE catalog TODAY!

## A Growing Need For Trained Professionals!

The career opportunities shown here are only a few of the challenging, high-paying careers you could enjoy as an electronics technician.

You could be the "brains" behind the scenes of an exciting TV broadcast...trouble-shoot life-saving medical equipment...design exotic new aeronautics systems...CIE's job-oriented programs offer you the quickest possible path to the career of your dreams! And CIE also features military and union re-training, to build on what you already know.

## Dozens Of Fascinating Careers To Choose From!

Even if you aren't sure which career is best for you, CIE can get you started with core lessons applicable to *all* areas of electronics. As you advance, CIE makes job opportunities available to you through the bimonthly school paper, *The Electron*.



Data Communications

Automotive Electronics

Aircraics

Computer-Assisted Manufacturing

Consumer Electronics

Military Electronics

## Personal Training From A Renowned Faculty.

Unlike the impersonal approach of large classroom study, CIE offers you one-on-one instructional help 6 days a week, toll-free. Each CIE lesson is authored by an independent specialist, backed by CIE instructors who work directly with you to answer your questions and provide technical assistance when you need it.

## Practical Training... At Your Own Pace.

Through CIE, you can train for your new career while you keep your present job. Each course allows a generous completion time, and there are no limitations on how fast you can study. Should you already have some electronics experience, CIE offers several courses which start at the intermediate level.

## "State-Of-The-Art" Facilities & Equipment.

In 1969, CIE pioneered the first electronics laboratory course, and in 1984, the first Microprocessor Laboratory. Today, no other home study school can match CIE's state-of-the-art equipment. And all your laboratory equipment is included in your tuition cost. There is no extra charge—it's yours to use while you study at home and on the job after you complete your course!

## Earn Your Degree To Become A Professional In Electronics!

Every CIE course you take earns you credit towards the completion of your Associate in Applied Science Degree, so you can work towards your degree in stages. And CIE is the only school that awards you for part study, which can save you thousands of dollars in obtaining the same electronics education found in four-year Bachelor's Degree programs! Write for details today!

## Send For Your Catalog Today!



### CIE World Headquarters

Cleveland Institute of Electronics, Inc.  
1776 East 17th St., Cleveland, Ohio 44114

**YES!** Please send me your independent study catalog (For your convenience, CIE will have a representative contact you—there is no obligation.)

Print Name \_\_\_\_\_

Address \_\_\_\_\_ Apt # \_\_\_\_\_

City/State/Zip \_\_\_\_\_

Age \_\_\_\_\_ Area Code/Phone No \_\_\_\_\_

Check box for G.I. Bill bulletin on educational benefits:  Veteran  Active Duty

## Mail This Coupon Today!

AE03

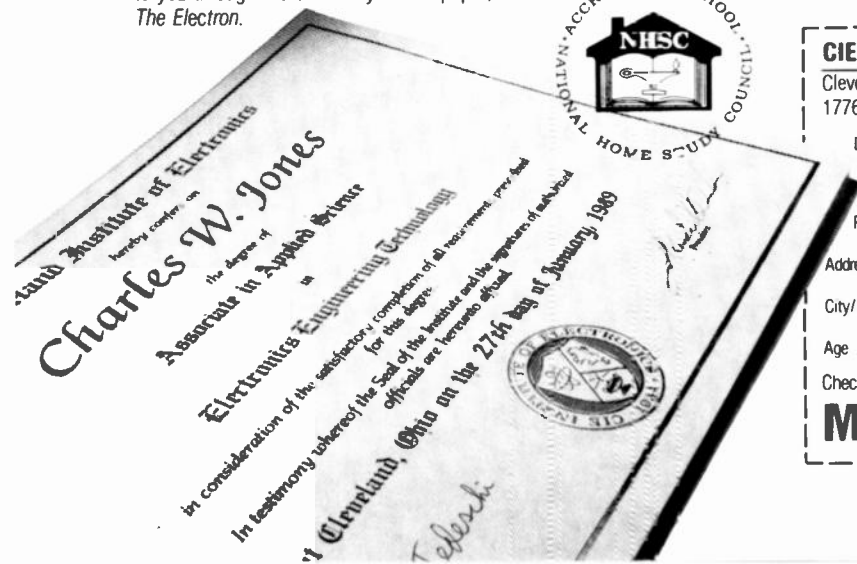

# NEW!

# Create real circuits instantly on your

# PROTO LAB™ a total including Free built-in Instruments and Tools to

Phase Shift Circuit  
using built-in oscilloscope

*Easy to use, menu-driven, mouse controlled circuits come alive on your terminal!*

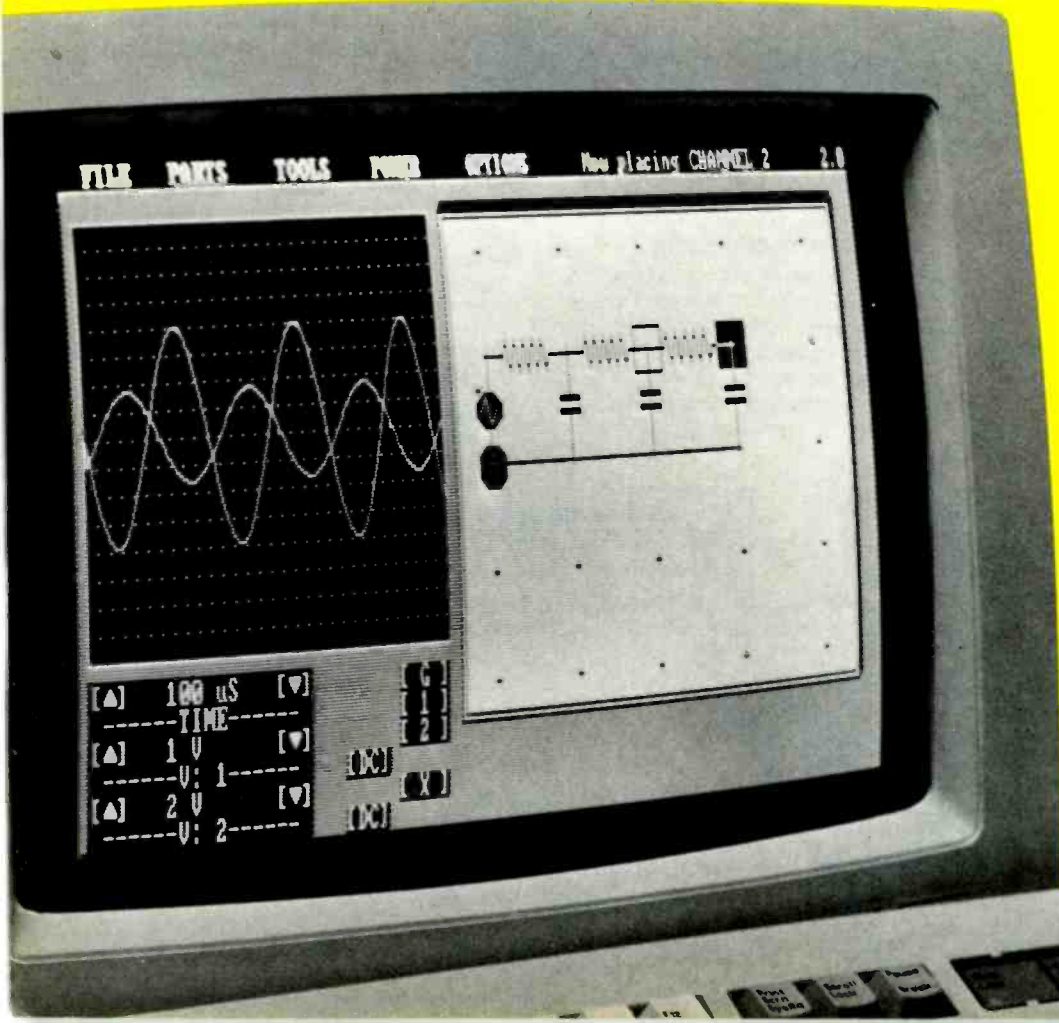

- **DC Series Circuits**  
Ohm's Law • Kirchoff's Voltage Law
- **Temperature Effects**  
Voltage sources • Resistances in series
- **Voltage Dividers**  
Internal source resistance  
Voltage regulation
- **DC Parallel Circuits**  
Networks • Current dividers
- **DC Series-Parallel Circuits**  
DC Circuit analysis by reduction
- **DC Circuit Analysis**  
Mesh circuit and branch current analysis
- **Superposition Theory**  
Circuit analysis using superposition
- **Bridge Circuits**  
Delta - Wye conversions
- **Phasor Mathematics**  
Phasor theory
- **Series AC Circuits**  
RC, RL and RLC circuits  
Power and power factors
- **Resonance**  
Tuned series circuits  
Parallel resonance
- **Parallel Resonance**  
Tank circuits
- **Polyphase Systems**  
Power in polyphase systems

# pc!

## computer simulated electronics laboratory build and test actual circuits.

New PROTO LAB™, a state of the art electronics lab for the hobbyist's, student's or engineer's pc. Now, you can build and experiment with actual circuits, choosing from an unlimited number of components, including resistors, capacitors, inductors, general impedance, AC voltage sources, batteries, AC/DC current sources. Then, analyze

your circuits with built-in high tech instruments — voltmeter, ammeter, ohmmeter, oscilloscope, wattmeter, sweep generator, breadboard, temperature adjustment and frequency control. This complete electronics lab, simulates thousands of dollars worth of parts and instruments . . . all built-in with easy to use, menu driven, mouse controlled PROTOWARE™ software. Plus, you get a unique experiment book, featuring over 75 experiments and circuits. Enjoy countless hours of fun, while learning. And, you won't blow up your "lab", because it's fool proof and safe on your pc.

Here are some typical circuits you can build and test...

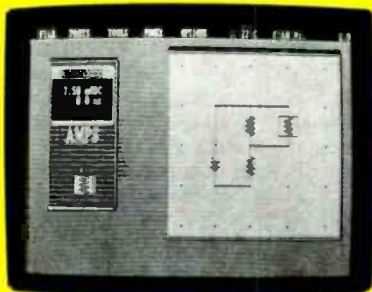

Resistor Series/Parallel Circuit demonstrates current division in a parallel circuit

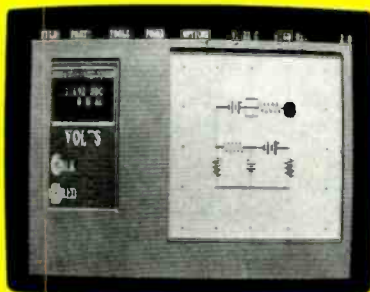

Thevenin Equivalent Circuit calculating voltage drop and current flow using built-in ammeter/voltmeter

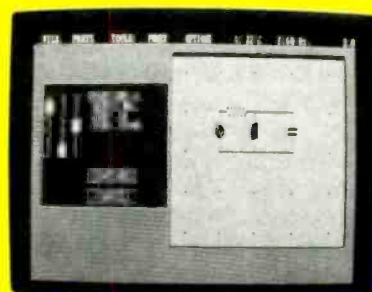

Parallel Resonance LC Tank Circuit using sweep generator to vary voltage across tank, monitoring circuit response

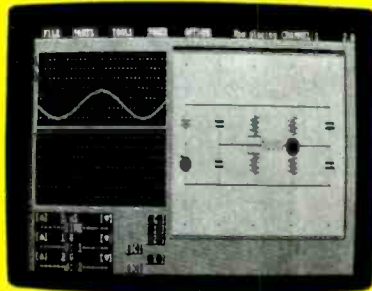

Frequency Compensated Bridge using oscilloscope to measure AC signal offset by DC voltage

PROTO LAB provides a complete lab station of high tech equipment including...

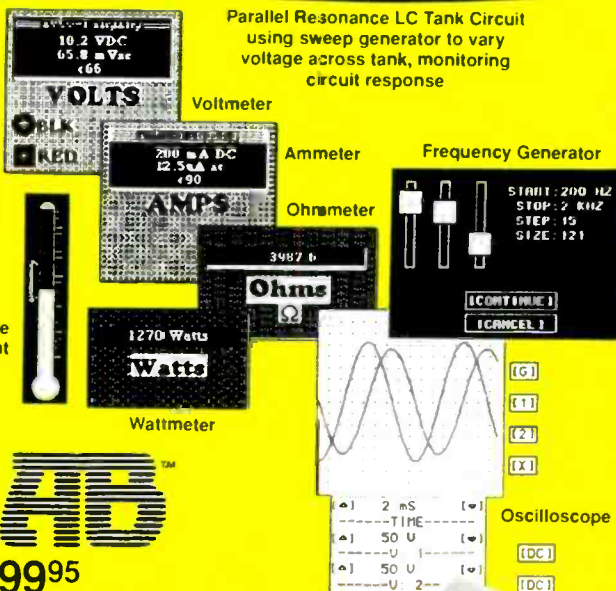

Order today...  
start building  
and testing  
circuits today...

# PROTO LAB™

Complete, for IBM/compatibles\*... ONLY \$9995

For Macintosh with high resolution, enhanced graphics\*\*... \$12995

\*IBM/compatibles require 384K RAM, CGA [640x200] video display and mouse  
\*\*Macintosh requires Macintosh 512E, MAC XL, MAC PLUS, MAC SE, MAC II

includes lab experiment book and exclusive PROTOWARE™



Call toll-free for details  
1-800-572-1028

**GLOBAL SPECIALTIES**

Global Specialties  
70 Fulton Terrace, New Haven, CT 06512  
Telephone: [203] 624-3103 • Interplex Electronics, 1990  
All Global Specialties breadboarding products made in USA.



A021

CIRCLE 186 ON FREE INFORMATION CARD

an antenna tuner without transmitting, or check the SWR of a linear amplifier's input.

The SWR analyzer has a low-distortion RF generator that covers 10–160 meters, an SWR bridge that gives forward and reflected components, and it automatically computes and displays the SWR. A frequency-counter output allows a counter to be connected for precise digital readout. Operation is completely automatic.

The MFJ-207 HF SWR analyzer costs \$99.—**MFJ Enterprises, Inc.**, P.O. Box 494, Mississippi State, MS 39762; Tel: 601-323-5869; Fax: 601-323-6551.

**HANDHELD LOGIC ANALYZER.** Targeted for use by design engineers and field service technicians, *Trace-Tek's Logic Boy* is a full-featured, 16-channel, 50-MHz logic analyzer. The handheld diagnostic and development



CIRCLE 19 ON FREE INFORMATION CARD

tool is easy to use, with extensive menus for user prompting and system setup. All state information, timing data, and menus are displayed on the LCD readout. The *Logic Boy* weighs only 21 ounces with NiCd batteries installed, and is designed to be held and operated with one hand—a

convenience when troubleshooting digital circuits at remote locations lacking AC power. It can be coupled with a battery-operated printer to form a complete portable diagnostic and troubleshooting system.

The *Logic Boy* offers 50-MHz operation on all 16 channels, non-volatile system setups and reference memory, a built-in IBM-compatible printer port, and a BNC trigger output terminal that lets the logic analyzer be used as a four-level word recognizer when connected to the external trigger input of most oscilloscopes. The *Logic Boy* is compatible with both TTL and CMOS logic levels, and features 1K×16 capture-and-reference memory, synchronous or asynchronous clocking, a clock qualifier, and programmable trigger delay.

The *Logic Boy*, complete with probes, AC wall adapter, IBM printer-cable adapter, NiCd batteries, and a one-year warranty, costs \$1795.—**Trace-Tek Instruments**, 1301 North Denton Drive, Suite 204, Carrollton, TX 75006.

**GRAPHIC POWER MONITOR.** To help electronics technicians and hobbyists find and solve power problems, the *PowerVisa* power monitor detects all power disturbances that can affect electronic equipment. By simply plugging it into an outlet, a complete power analysis can be made. When any type of power disturbance—including



CIRCLE 20 ON FREE INFORMATION CARD

sags, surges, impulses, failures, waveshape faults, frequency errors, high-frequency noise, wiring errors, and total harmonic distortion—is detected, an LED lights. A disturbance graph can be printed immediately or, at the users' convenience, a text report of the ten worst events of each disturbance type can be generated. The *PowerVisa* also prints daily and weekly summaries. It monitors true RMS AC voltage, AC current, and temperature. An RS-232 port is included for remote operation. The instrument automatically selects appropriate thresholds depending on the voltage being monitored, or the user can choose to manually set the desired thresholds.

"Help" messages that explain its operation can be printed, and a push of the Advice button generates a printout of the types of disturbances that have been recorded and the times they occurred.

The *PowerVisa* power monitor has a suggested price of \$3,295.—**Basic Measuring Instruments**, 355 Lakeside Drive, Foster City, CA 94404; Tel: 415-570-5355; Fax: 415-574-2176.

**BI-POLAR POWER SUPPLIES.** The *POW* series of single-output, bi-polar power supplies can "sink"—absorb current from external sources—or "source"—supply power to external loads—current. They can be used for applications involving servo systems and precision drives, as variable output power supplies, or as power amplifiers with frequency characteristics ranging from 0 ± 30 kHz. The power supplies are available with three different operating ranges: +35 to -35 VDC at 1A;

+35 to -35 VDC at 5A; and +70 to -70 VDC at 2A. Without switching polarity, both gain and positive/negative voltage can be varied continuously by adjusting panel-mounted, 10-turn potentiometers. Constant-current crossover overload protection is provided.

The power supplies are



CIRCLE 21 ON FREE INFORMATION CARD

available with either a top luggage strap for portability, or a built-in rack-mounting frame.

The *POW* series of single-output, bi-polar power supplies are priced starting at \$925.—**Kikusui International Corporation**, 19601 Mariner Avenue, Torrance, CA 90503; Tel: 800-KIK-8784.

**SURFACE-MOUNT SOLDER KITS.** Two SMT solder cream kits, for evaluation of component soldering using different types of flux systems, each contain 250-grams of stencil-grade solder cream packed in five



CIRCLE 22 ON FREE INFORMATION CARD

50-gram "Flexpaks." The five different types of mildly activated fluxing systems included are standard, fine pitch, water washable, and two with no-clean residues. The latter leave clear, hard,

non-corrosive residues; one is off-fillet residue and the other is on-fillet residue. Kit 7 provides the flux systems with an Sn62 alloy, while Kit 8 is supplied with an Sn63 alloy. Each kit comes with a "Vac-Tweezer" set that includes a vacuum pickup and five tips with various sizes of clear pads.

Surface-mount solder Kit 7 and Kit 8 are priced at \$89 each.—**ESP Solder Plus**, 14 Blackstone Valley Place, Lincoln, RI 02865; Tel: 800-338-4353.

**DIGITAL CLAMP-ON METER.** The model ACD-10 clamp-on meter directly measures AC current, voltage, and resis-



CIRCLE 23 ON FREE INFORMATION CARD

tance. The drop-proof instrument weighs eight ounces and is 6¾ inches long. Its half-inch display provides over-range and low-battery indicators. The autoranging meter provides circuit protection up to 550 volts. The ACD-10 comes with a wrist strap and a removable belt clip. A 9-volt battery, safety test leads, a carrying case, and instructions are included.

The model ACD-10 digital volt/amp/ohm meter has a list price of \$89.95.—**Amprobe Instrument**, 630 Merrick Road, P.O. Box 329, Lynbrook, NY 11563; Tel: 516-593-5600.

**HARD-DRIVE SECURITY SYSTEM.** Providing password access security for IBM PC, XT, AT, 386, and compatible computers, PC Access version 2.1 consists of an easily-installed plug-in card and a

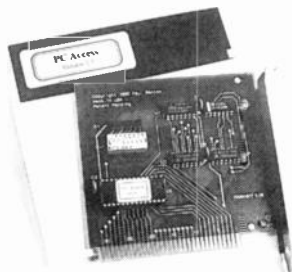

CIRCLE 24 ON FREE INFORMATION CARD

diskette of programs. Either a valid password or, optionally, a user-ID and a password must be entered each time the computer is booted before DOS will be loaded or executed. One master password and as many as 15 user passwords are allowed. The master password must be used to access the user password list and to select the security system's functions. Version 2.1 features menu-driven selections for establishing the passwords and other security settings. DIP switch selections of the security board's address, and a half-size card with a bracket for easy installation. PC Access does not modify COMMAND.COM or any system files, and does not interfere with the operation of any other software.

PC Access version 2.1 has a suggested list price of \$79; distributor and quantity discounts are available.—**Renton Products**, P.O. Box 16271, Seattle, WA 98116; Tel: 206-682-7341.

**RADIO-FREQUENCY FINDER/COUNTER.** The model 1500A RF finder/counter from Startek runs

# CRAMOLIN® DeOxidizer

**IMPROVES CONDUCTIVITY**

DEOXIDIZES • CLEANS • PRESERVES • LUBRICATES

For All Metals, Including Gold!

CRAMOLIN® DeOxidizer improves conductivity by dissolving oxides that form on metal connector and contact surfaces, eliminating unwanted resistance that impedes electrical performance.

CRAMOLIN® is an active ingredient that does not rely on solvents for performance. Due to the excellent migration properties, CRAMOLIN® coats the entire metal surface and protects it from future oxidation.

CRAMOLIN® continues to be the most effective and economical product for improving and maintaining electrical component reliability.

**FOR MANUFACTURE, MAINTENANCE AND SERVICE OF:**

- Switches & Relays • Cable Connectors & Adaptors
- Edge Connectors • Terminal Strips • Plugs & Sockets
- Gold Plated Connectors • Potentiometers • Battery Contacts

**USED BY THOSE WHO DEMAND THE BEST:**

- Bell & Howell • Capital Records • Dolby Laboratories
- Hewlett Packard • John Fluke Mfg. • McIntosh Labs
- MCI (Sony) • Motorola • NASA • Nektarichi
- RCA • Switchcraft • and Many More.



P.O. Box J  
Escondido, CA 92033-3679  
(619) 743-7143  
FAX: (619) 743-2460

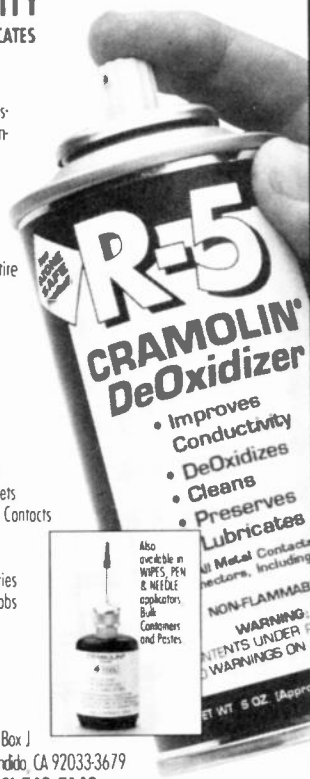

CIRCLE 50 ON FREE INFORMATION CARD

# KENWOOD OSCILLOSCOPES

**ANALOG OSCILLOSCOPES W/O READOUT**

**MODEL CS-5135**  
40 MHz, Dual Channel,  
Delayed Sweep.  
REG. \$895.00 SALE \$739.95

**MODEL CS-5155**  
50 MHz, 3 Channel,  
6-Trace, Delayed Sweep.  
REG. \$995.00 SALE \$819.95

**MODEL CS-5165**  
60 MHz, 3 Channel,  
6-Trace, Delayed Sweep.  
REG. \$1095.00 SALE \$899.95

**MODEL CS-2150**  
150 MHz, 4 Channel,  
8-Trace, Delayed Sweep.  
REG. \$2395.00 SALE \$1455.95

**ANALOG OSCILLOSCOPES W/READOUT/CURSORS**

**MODEL CS-5130**  
40 MHz, Dual Channel,  
4-Trace, Delayed Sweep.  
REG. \$1095.00 SALE \$899.95

**MODEL CS-5170**  
100 MHz, Dual Channel,  
4-Trace, Delayed Sweep.  
REG. \$1695.00 SALE \$1399.95

**MODEL CS-6010**  
100 MHz, 4 Channel,  
10-Trace, Delayed Sweep.  
REG. \$1495.00 SALE \$1699.95

**MODEL CS-6020**  
150 MHz, 4 Channel,  
10-Trace, Delayed Sweep.  
REG. \$2795.00 SALE \$1999.95

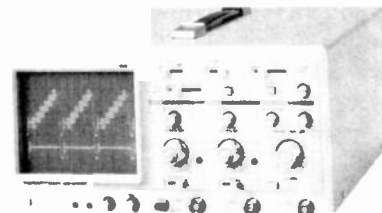

**MODEL CS-4025**  
20 MHz, Dual Channel  
Oscilloscope.  
REG. \$495.00

**SALE \$349.95**



**Products International**  
8931 Brookville Rd.  
Silver Spring, MD 20910  
(800)638-2020 (301)587-7824  
FAX# 301-585-5402  
EASY ORDER FAX LINE (800)545-0058

**800-638-2020**



CIRCLE 182 ON FREE INFORMATION CARD

# CABLE - TV

## SIGNAL REMOVERS

- FOR ELIMINATION OF SEVERE INTERFERENCE
- FOR "CENSORING" OF ADULT BROADCASTS



FOR FULL DESCRIPTION OF USES ask for our free brochure

- ATTENUATION - 45 dB TYPICAL
- BANDWIDTH - 4 MHz AT 5 dB POINTS
- INSERTION LOSS - 2 dB

MODEL	TUNING RANGE	FOR CHANNELS	PASSBAND	PRICE	SHIPPING
23H	50-66 MHz	2 3 (or 6 meter ham)	50-300 MHz	\$10	NO SHIPPING or C.O.D. CHARGES
46FM	66-108 MHz	4 5 6 (or any FM)	50-300 MHz	\$10	
1417	120-144 MHz	14(A) 15(B) 16 (C) 17(D)	50-400 MHz	\$30	
1822	144-174 MHz	18(E) 19(F) 20(G) 21(H) 22 (I)	50-400 MHz	\$30	
713	174-216 MHz	7 8 9 10 11 12 13	50-400 MHz	\$10	

3 for \$75 - 10 for \$200 - mix or match

CALL TOLL FREE FOR C.O.D. OR SEND CHECK TO OF DER  
FAST DELIVERY  
30 DAY MONEY BACK GUARANTEE (3 FILTER LIMIT)

**Star Circuits**

P. O. Box 94917  
Las Vegas, NV 89193-4917

1-800-433-6319

on 110 VAC, 12 VDC, or rechargeable NiCd batteries, and is small enough to fit in a shirt pocket. It is housed in a rugged anodized-aluminum case and weighs less than 9 ounces with the batteries installed. The highly sensitive instrument can be used with its telescoping RF antenna to accurately and easily identify and measure transmit frequencies from handheld, mobile, or stationary radio transmitters.

The 1500A has two overlapping ranges—1-500 MHz and 200-1500 MHz. Two "gate" or "sample" times are switch selectable. A fast gate time of

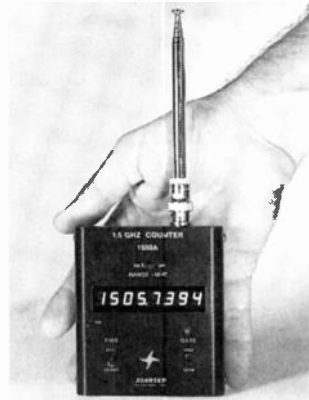

CIRCLE 25 ON FREE INFORMATION CARD

0.25-seconds yields a 1-kHz resolution, and a slow gate time of 2.5 seconds yields a 100-Hz resolution. A TXCO timebase provides accuracy of  $\pm 1$  ppm.

The unit can be operated and charged simultaneously with a  $9 \pm 12$  VDC, AC adaptor. The input signal of the device is coupled via a BNC connector on the top, and various types of probes and antennas can be used to optimize performance for specific uses and frequency ranges.

The model 1500A radio-frequency finder/counter costs \$99.95, the factory installed NiCd batteries cost \$20.00, and an AC adapter/battery charger

costs \$9.00—**Startek International, Inc.**, 398 NE 38th Street, Fort Lauderdale, FL 33334; Tel: 800-638-8050 or 305-561-2211; Fax: 305-561-9133.

**ANTENNA STATIC DISCHARGER.** Precipitation static and corona discharge noise, which can raise the noise level 20 to 30 dB above ambient, are bled off by the model AS-1 antenna static discharger,



CIRCLE 26 ON FREE INFORMATION CARD

which reduces the undesired electrical noise that causes receiver desensitization. The AS-1 is the same type of device that's used on aircraft and in ground stations to minimize electrostatic interference. It has been modified for use on antennas to prevent any detuning, even if it is element mounted. The antenna static discharger mounts easily to any antenna, boom, or tower and weighs only one ounce. It offers increased range during noisy conditions, minimized receiver desensitization, and lower antenna noise on long wires, dipoles, yagis for HF through UHF, verticals, TV, and TVRO antennas.

The AS-1 antenna static discharger costs \$12.95. —**Static Buster Inc.**, 3535 Shepherdsville Road, Elizabethtown, KY 42701; Tel: 502-769-2244. **R-E**

## Be an FCC LICENSED ELECTRONIC TECHNICIAN!



No costly school. No commuting to class. The Original Home-Study course prepares you for the "FCC Commercial Radiotelephone License." This valuable license is your professional "ticket" to thousands of exciting jobs in Communications, Radio-TV, Microwave, Maritime, Radar, Avionics and more...even start your own business! You don't need a college degree to qualify, but you do need an FCC License.

**No Need to Quit Your Job or Go To School** This proven course is easy, fast and low cost! **GUARANTEED PASS**—You get your FCC License or money refunded. **Send for FREE facts now. MAIL COUPON TODAY!**

### COMMAND PRODUCTIONS

FCC LICENSE TRAINING, Dept. 90  
P.O. Box 2824, San Francisco, CA 94126  
Please rush FREE details immediately!

NAME \_\_\_\_\_  
ADDRESS \_\_\_\_\_  
CITY \_\_\_\_\_ STATE \_\_\_\_\_ ZIP \_\_\_\_\_

Try the

**Radio Electronics**

bulletin board system

(RE-BBS)  
516-293-2283

The more you use it the more useful it becomes.

We support 300 and 1200 baud operation.

Parameters: 8N1 (8 data bits, no parity, 1 stop bit) or 7E1 (7 data bits, even parity, 1 stop bit).

Add yourself to our user files to increase your access.

Communicate with other R-E readers.

Leave your comments on R-E with the SYSOP.

RE-BBS  
516-293-2283

Use The Free Information Card for fast response.

**PASSPORT TO WORLD BAND RADIO;** from International Broadcasting Services, Ltd., Box 300, Penn's Park, PA 18943; \$16.95.

This magazine in book format could be described as the *TV Guide* for radio, *National Geographic*, *Consumer Reports*, and

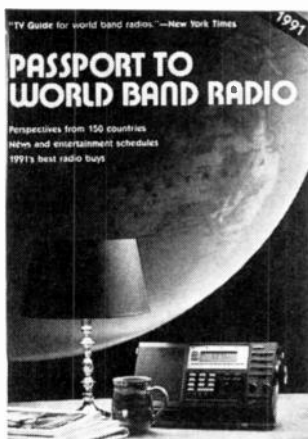

CIRCLE 27 ON FREE INFORMATION CARD

*Time* rolled into one. Its 384 pages are filled with articles on topics ranging from music behind the Iron Curtain to how to write to radio stations for free goods, from international politics and current events to how to get started in world-band listening, from Alistair Cooke's long-running *Letter From America* show to the Salt Lake City world-band station that broadcasted rock-n-roll used by American troops in Panama to drive Noriega nuts. In-depth consumer reports provide comparative ratings of portable and table-top radios, as well as a review of a world-band receiver for cars. Comprehensive program guides are listed by time, country, and channel. Newcomers to the hobby will

appreciate tips on what features to look for in a world-band receiver, a glossary of terms, and informational articles. Interspersed throughout the book are helpful hints, definitions, and pointers, along with intriguing photographs from around the world and dozens of advertisements for radio stations and equipment.

**1991 ELECTRONIC COMPONENTS/COMPUTER PRODUCTS CATALOG;** from Jameco, 1355 Shoreway Road, Belmont, CA 94002; Tel: 415-592-8097; Fax: 415-592-2503; free.

Featuring just about everything the electronics enthusiast or computer buff

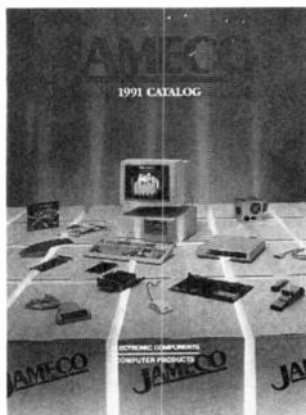

CIRCLE 28 ON FREE INFORMATION CARD

could need, the new Jameco catalog offers tools, test equipment, cables, connectors, IC's motherboards, computer kits, floppy- and hard-disk drives, computer accessories, and more. New to this edition of the catalog are two 386 computer kits, 386 motherboards, a 2400-baud mini external modem, and a 9600-baud fax board.

The Jameco catalog features full product descriptions, photographs, and pricing information.

**TONER CARTRIDGE RECHARGE: Kits—Supplies—Service;** from Chenesko Products Inc., 62 North Coleman Road, Centereach, NY 11720; Tel: 800-221-3516 or 516-736-7977; Fax: 516-732-4650; free.



CIRCLE 29 ON FREE INFORMATION CARD

With the high price of new toner cartridges for laser printers, many people prefer to use cartridges that have been cleaned out, modified, and recharged. This catalog offers toner-cartridge recharge products and services, and explains how to recharge cartridges used with laser printers including the HP LaserJets, Apple LaserWriters, and many others. Six do-it-yourself kits include full instructions for recharging. For those who want to start a recharge business, the catalog offers a complete selection of products—including generic toner, graphic toner, fixing rods, sealing strips, plugs, bags, tools, and vacuums—at bulk prices. For those who

aren't handy with toner cartridge recharging, or are short on time, the catalog offers a mail-in recharging service.

**SOLDER CREAMS: A COMPLETE GUIDE TO THE SELECTION AND USE OF SOLDER CREAM;** from Multicore Solders, Cantiague Rock Road, Westbury, NY 11590; Fax: 516-334-7098; free with request on company letterhead.

This comprehensive 24-page brochure explains and describes the formulation, application methods, and uses of solder creams. It covers the various alloys, fluxes, properties, and rheology of solder creams for surface-mount applications, as well as techniques for deposition, reflow soldering, and cleaning. A chart that illustrates good

## Multicore SOLDER CREAMS

A complete guide to the selection and use of Solder Cream



CIRCLE 30 ON FREE INFORMATION CARD

working practices is followed by explanations of how to apply solder creams for various purposes. A three-page glossary of commonly used technical terms is also included in the booklet.

# Electronics Engineers & Designers!

Take any **3** books for only **\$4<sup>95</sup>**  
(Values to \$119.40)

**SHARPEN YOUR SKILLS**—With Quality, Affordable Professional Books

## COMPUTER SCIENCE

## ENGINEERING MATH

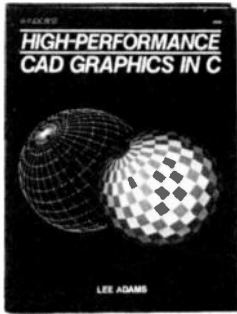

**3059** **\$34.95**  
Master the art of modeling, rendering, and animating on your IBM® PC. 524 pp. *Counts as 2.*

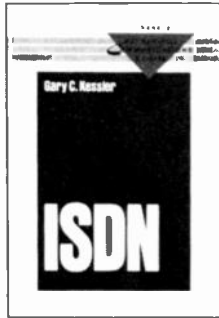

**10015** **\$42.95**  
The most up-to-date introduction available on the many facets of ISDN. 320 pp. *Counts as 2.*

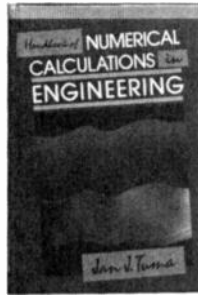

**9321** **\$49.50**  
This time-saving handbook provides problem-solving calculations for engineering design, production and research. 416 pp. *Counts as 2.*

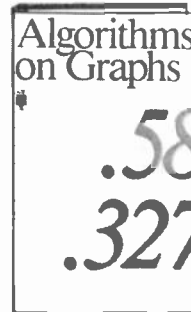

**3429** **\$29.95**  
Your source for well-developed, ready-to-use computer algorithm codes. 180 pp.

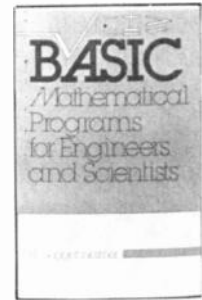

**8225P** **\$19.95**  
Tested programs for most mathematical computing needs. 233 pp.

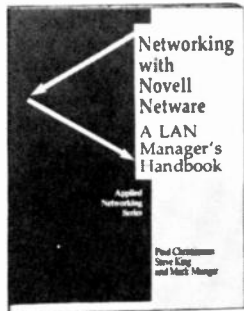

**3283** **\$28.95**  
Covers all aspects of LAN planning, installation, and operation, including standard and non-standard arrangements. 240 pp.

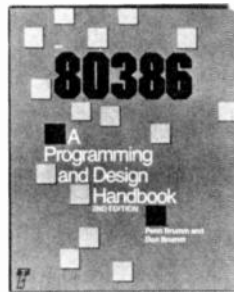

**3237P** **\$24.95**  
This handy guide demonstrates such advanced features as debugging applications and Virtual 8086 Mode. 432 pp.

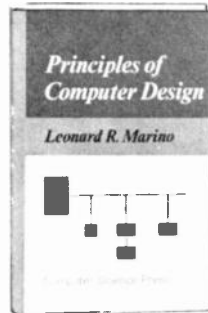

**9813** **\$39.95**  
Covers logic design, register transfer design, architecture, programming and more. 578 pp.

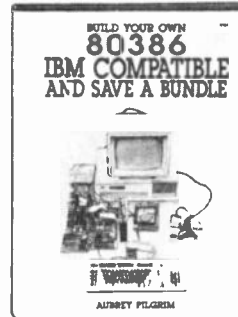

**3131** **\$26.95**  
Assemble your own powerful microcomputer system... it's easy and inexpensive. 224 pp.



**3279** **\$36.95**  
Master the proven repair techniques of an expert electronic technician. 570 pp. *Counts as 2.*

## ELECTRONIC CIRCUITS & COMPONENTS

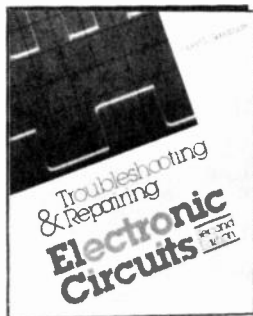

**3258** **\$27.95**  
Step-by-step instructions for troubleshooting and repairing the latest in electrical equipment. 310 pp.

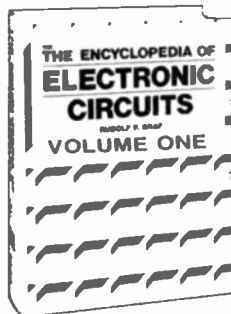

**1938** **\$60.00**  
Over 1,300 useful and versatile electronic circuit designs. 768 pp. *Counts as 2.*

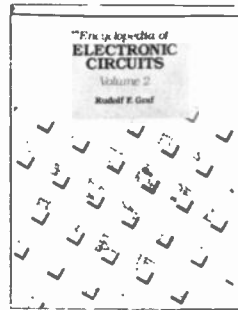

**3138** **\$60.00**  
More than 700 state-of-the-art electronic circuit designs for on-the-job use. 738 pp. *Counts as 2.*



**9243P** **\$12.95**  
This book will eliminate the guesswork in choosing the best circuit or tracking down malfunctions in a completed circuit. 282 pp.

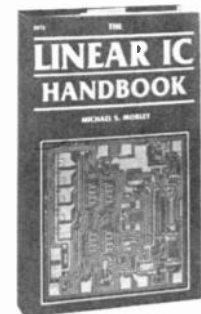

**2672** **\$49.50**  
Linear integrated circuits—specifications, prices & data. 614 pp.





3203 \$44.50  
An indispensable guide to technology from composition to applications and testing. 400 pp. *Counts as 2*

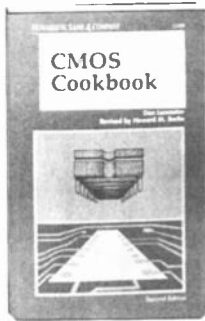

92441P \$18.95  
This revised and updated edition is both a comprehensive, industry-wide reference, and a valuable collection of project ideas. 512 pp.



3329 \$29.95  
A practical introduction to the latest devices, techniques, and shielding methods. 239 pp.

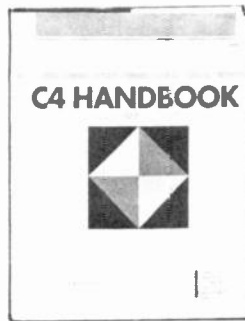

3098 \$44.50  
A comprehensive overview of CAD/CAM, CAE, and CIM concepts, capabilities and applications. 438 pp. *Counts as 2*

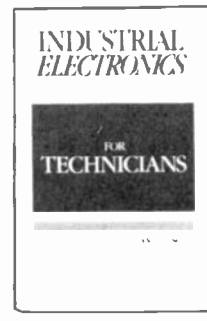

3321 \$24.95  
A valuable workbench companion covering industrial hardware theory and application. 334 pp.

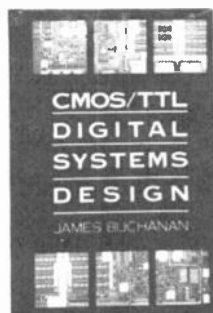

9340 \$44.95  
High-performance design techniques for today's high-speed logic devices. 272 pp. *Counts as 2*



3151 \$39.95  
Provides detailed insight into every aspect of the engineering design process—from the pre-concept phase through the life-cycle costs and commercial applications. 334 pp. *Counts as 2*

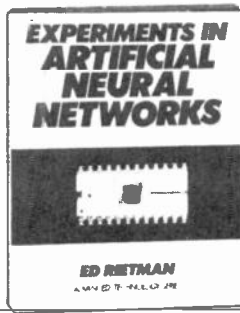

3037 \$24.95  
Build your own neural networking breadboards—systems that can store and retrieve like the brain! 160 pp.



9290 \$36.00  
Provides many never-before-published troubleshooting techniques and case histories. 315 pp. *Counts as 2*



9305 \$59.50  
The solution-oriented handbook for practicing engineers at all levels. Contains hundreds of informative illustrations and diagrams demonstrating key principles. 600 pp. *Counts as 3*

## How the Club Works:

**YOUR BENEFITS:** You get 3 books for \$4.95 plus shipping & handling when you join. You keep on saving with discounts of up to 50% as a member.

**YOUR PROFESSIONAL BOOKSTORE BY MAIL:** Every 3-4 weeks, you will receive the EE&D Book Club News describing the Main Selection and Alternates, as well as bonus offers and special sales, with scores of titles to choose from.

**AUTOMATIC ORDER:** If you want the Main selection, do nothing and it will be sent to you automatically. If you prefer another selection, or no selection at all, simply indicate your choice on the reply form provided. You will have at least 10 days to decide. As a member, you agree to purchase at least 3 books within the next 2 years and may resign at any time thereafter.

**BONUS BOOKS:** Starting immediately you will be eligible for our *Bonus Book Plan* with savings of up to 80% off publishers' prices.

**IRONCLAD NO-RISK GUARANTEE:** If not satisfied with your books, return them within 10 days without obligation!

**EXCEPTIONAL QUALITY:** All books are quality publishers' editions especially selected by our Editorial Board.

All books are hardcover unless number is followed by a "P" for paperback (Publishers' Prices Shown)

1991 EE&D BC, Blue Ridge Summit, PA 17294-0860

## SEND NO MONEY NOW!

INTRODUCTORY 10-DAY FREE EXAMINATION



**ELECTRONICS ENGINEERS & DESIGNERS BOOK CLUB<sup>SM</sup>**

Blue Ridge Summit, PA 17294-0860

YES! Please accept my membership in the ELECTRONICS ENGINEERS & DESIGNERS BOOK CLUB and send my 3 volumes listed below billing me \$4.95. If not satisfied, I may return the books within 10 days and have my membership cancelled. I agree to purchase 3 or more books at regular Club Prices during the next 2 years, and may resign any time thereafter. A shipping/handling charge and sales tax will be added to all orders.

--	--	--

Name \_\_\_\_\_

Address \_\_\_\_\_

City \_\_\_\_\_

State \_\_\_\_\_ Zip \_\_\_\_\_ Phone \_\_\_\_\_

Signature \_\_\_\_\_

Valid for new members only. Foreign applicants will receive special ordering instructions. Canada must remit in U.S. currency. This order subject to acceptance by the Electronics Engineers & Designers Book Club. DRE291

# ELENCO & HITACHI PRODUCTS AT DISCOUNT PRICES

**NEW!**

**RSOs (Real-Time & Storage Oscilloscopes) From HITACHI**  
The RSO - its the new solution  
View, Acquire, Test, Transfer and Document Your Waveform Data

**4-Channel, 100MS/s Model** **Introductory Price**  
100MS/s (25MS/s on 4 channels simultaneously), 100MHz, 4kw x 1ch., 2kw x 2ch., 1kw x 4ch. VC-6145 \$4,695.00

**Compact, Full Feature Models**  
40MS/s, 100MHz, 4kw x 1ch., 2kw x 2ch. VC-6045 \$3,049.00  
20MS/s, 50MHz, 2kw x 2ch. VC-6025 \$2,295.00

**Low Cost/High Value Models**  
20MS/s, 50MHz, 2kw x 2ch. VC-6024 \$2,049.00  
20MS/s, 20MHz, 2kw x 2ch. VC-6023 \$1,749.00

RSOs from Hitachi feature such functions as roll mode, averaging, save memory, smoothing, interpolation, pretriggering, cursor measurements, plotter interface, and RS-232C interface. With the comfort of analog and the power of digital.



**V-212 Hitachi Portable Scopes**  
**\$435**  
DC to 20MHz  
Dual Channel  
DC to 50MHz, 2-Channel, DC offset function, Alternate magnifier function  
V-525 CRT Readout, Cursor Meas. \$1,025  
V-523 Delayed Sweep \$995  
V-522 Basic Model \$895

V-422 40MHz Dual Trace \$795

## 20MHz Elenco Oscilloscope



**\$375**  
MO-1251

- Dual Trace
- Component Tester
- 6" CRT
- X-Y Operation
- TV Sync
- 2 p-1 Probes

## FREE DMM

with purchase of  
ANY SCOPE

## SCOPE PROBES

P-1 65MHz, 1x, 10x \$19.95  
P-2 100MHz, 1x, 10x \$23.95

## Compact Series Scopes



Delayed Sweep  
Lightweight (13lbs)  
2mV Sens  
3 Yr Warranty

Model V-1065  
Shown

This series provides many new functions such as CRT Readout, Cursor measurements (V-1085/1065/665), Frequency Ctr (V-1085), Swepttime Autoranging and Trigger Lock using a 6-inch CRT. You don't feel the compactness in terms of performance and operation.

V-660 60MHz Dual Trace \$1,195  
V-665 60MHz Dual Trace w/Cursor \$1,345  
V-1060 100MHz Dual Trace \$1,425  
V-1065 100MHz Dual Trace w/Cursor \$1,695  
V-1085 100MHz Quad Trace w/Cursor \$2,045  
V-1100A 100MHz Quad Trace w/Cursor \$2,295  
V-1150 150MHz Quad Trace w/Cursor \$2,775

## Elenco 35MHz Dual Trace Good to 50MHz

**\$495**

MO-1252



- High luminance 6" CRT
- 1mV Sensitivity
- 6KV Acceleration Voltage
- 10ns Rise Time
- X-Y Operation • Z Axis
- Delayed Triggering Sweep
- Includes 2 P-1 Probes

All scopes include probes, schematics, operators manual, and 3 year (2 yrs for Elenco scopes) world wide warranty or parts & labor. Many accessories available for all Hitachi scopes. Call or write for complete specifications on these and many other fine oscilloscopes.

## WE NOW CARRY COMPLETE LINE OF FLUKE MULTIMETERS Models

- 21F 83
- 23F 85
- 25F 87
- 27F 8050A
- 73 8060A
- 75 8062A
- 77F + More

CALL FOR SPECIAL PRICING



**True RMS 4 1/2 Digit Multimeter**  
**M-7000**  
**\$135**  
.05% DC Accuracy  
1% Resistance  
with Freq. Counter  
and deluxe case



**10 Function Multimeter**  
**CM-365**  
**\$65**  
AC + DC Voltage & Amps  
Resistance to 2000MΩ  
Diode, Logic, & Trans test  
Capacitance to 200uF



**Digital Capacitance Meter**  
**CM-1550**  
**\$58.95**  
9 Ranges  
1pf-20,000uFd  
.5% basic acy  
Zero control  
with case



**Digital LCR Meter**  
**LC-1801**  
**\$125**  
Measures:  
Coils 1uH-200H  
Caps 1pf-200uF  
Res. .01-20M

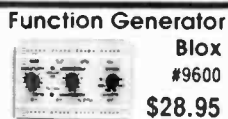

**Function Generator Blox**  
**#9600**  
**\$28.95**

Provides sine, triangle, square wave from 1Hz to 1MHz AM or FM capability

## Triple Power Supply XP-620



**Assembled \$65**  
**Kit \$45**

2 to 15V at 1A,  
-2 to -15V at 1A  
(or 4 to 30V at 1A)  
and 5V at 3A

Contains all the desired features for doing experiments. Features short circuit protection, all supplies.

## Wide Band Signal Generators

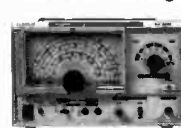

**SG-9000**  
**\$129**

RF Freq 100K-450MHz  
AM Modulation of 1KHz  
Variable RF output

SG-9500 w Digital Display and 150MHz built-in Counter \$249



**AC Current Meter**  
**ST-1010**  
**\$69.95**  
1000 Amps  
Data & Peak hold  
8 Functions  
Deluxe Case



**Decade Blox**  
#9610 or #9620  
**\$18.95**  
#9610 Resistor Blox  
47 ohm to 1M & 100K pot  
#9620 Capacitor Blox  
47pf to 10MFD



**Quad Power Supply XP-580**  
**\$59.95**  
2-20V at 2A  
12V at 1A  
5V at 3A  
-5V at 5A  
Fully regulated and short circuit protected  
XP-575 without meters \$39.95

## LEARN TO BUILD AND PROGRAM COMPUTERS WITH THIS KIT!

INCLUDES: All Parts, Assembly and Lesson Manual



**Model**  
**MM-8000**  
**\$129.00**

Starting from scratch you build a complete system. Our Micro-Master trainer teaches you to write into RAMs, ROMs and run a 8085 microprocessor, which uses similar machine language as IBM PC. You will write the initial instructions to tell the 8085 processor to get started and store these instructions in permanent memory in a 2816 EPROM. Teaches you all about input and output ports, computer timers. Build your own keyboard and learn how to scan keyboard and display. No previous computer knowledge required. Simple easy to understand instruction teaches you to write in machine language.

ROBOTICS KIT FOR ABOVE (MM-8010) \$71.95



**Digital Triple Power Supply XP-765**  
**\$249**  
0-20V at 1A  
0-20V at 1A  
5V at 5A

Fully regulated, Short circuit protected with 2 limit control, 3 separate supplies

XP-660 with Analog Meters \$175



**GF-8016 Function Generator**  
with Freq. Counter  
**\$249**  
Sine, Square, Triangle  
Pulse, Ramp, 2 to 2MHz  
Freq Counter .1 - 10MHz

GF-8015 without Freq. Meter \$179

**WE WILL NOT BE UNDERSOLD!**  
UPS Shipping: 48 States 5%  
(\$10 Max) IL Res., 7% Tax



**C & S SALES INC.**  
1245 Rosewood, Deerfield, IL 60015  
(800) 292-7711 (708) 541-0710

**15 Day Money Back Guarantee**  
**2 Year Warranty** Prices subject to change  
**WRITE FOR FREE CATALOG**

# TURN YOUR PC INTO A UNIVERSAL FREQUENCY COUNTER

*Build a frequency-counter board  
that operates in a Windows  
environment in your personal computer.*

JOEY GRASTY and BILL SCHULZ

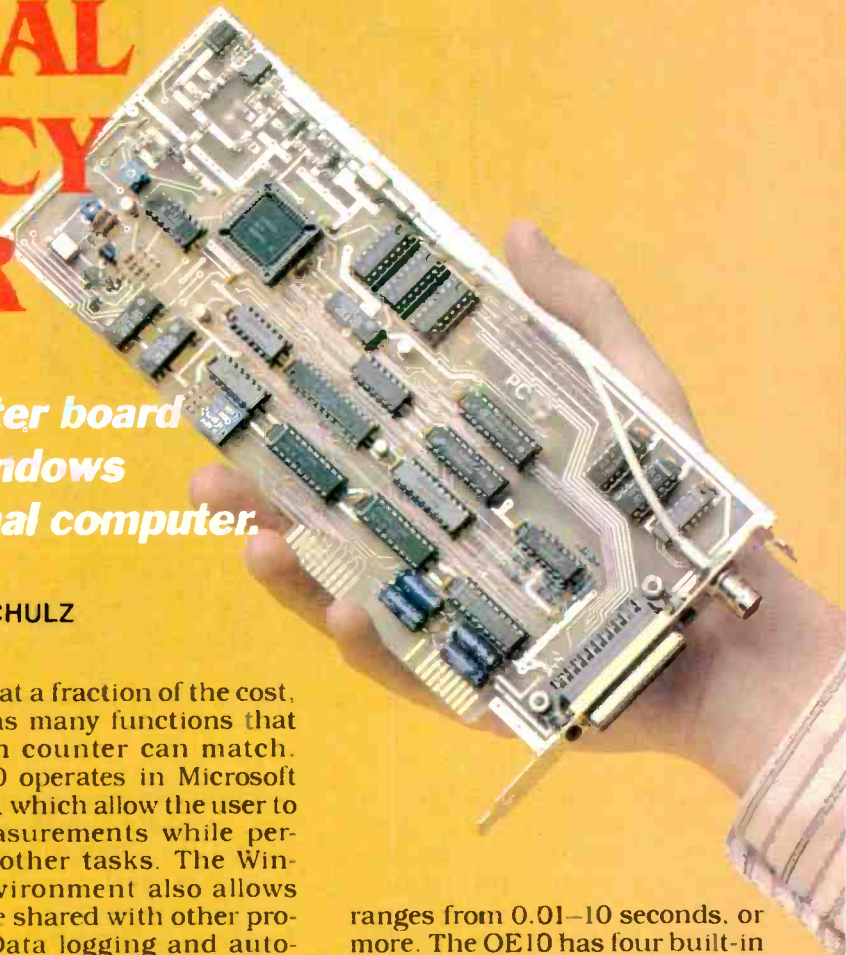

FREQUENCY COUNTERS HAVE COME A long way since Hewlett Packard introduced the 524A back in 1952. It was a huge instrument, containing more than 70 vacuum tubes, but it could measure frequencies up to 10 megahertz, and time intervals as small as 100 nanoseconds. In late 1988, a project began to reduce the major parts of a universal frequency counter into a single integrated circuit, which greatly increased the performance and measurement capability of frequency counters built with this new IC. The project culminated with the OE10, an IC that could directly measure frequency up to 240 MHz and measure time intervals with resolution to 0.1 nanoseconds. The OE10 was then incorporated into the PC10, a high-performance universal frequency-counter board for IBM PC/XT/AT and compatibles—and now you can build it yourself.

The combination of a PC and a frequency counter produces a powerful tool useful for a wide range of measurements. Not only does the PC10 contain most of the features of more expensive laboratory benchtop frequency

counters at a fraction of the cost, it also has many functions that no bench counter can match. The PC10 operates in Microsoft Windows, which allow the user to take measurements while performing other tasks. The Windows environment also allows data to be shared with other programs. Data logging and automatic software calibration of the timebase are also provided. Finally, the PC10 can directly tune a receiver to the measured frequency using the computer's serial port.

However, before we discuss how the PC10 operates and how you can build one for yourself, let's first talk about how universal frequency counters work.

## Frequency measurements

A frequency measurement is defined as a number of cycles of an incoming signal occurring during a given time period. The unit of frequency is Hertz (Hz), or cycles per second (cps). A frequency measurement is performed by counting the number of cycles occurring within a specific gate time, which typically

ranges from 0.01–10 seconds, or more. The OE10 has four built-in gates—0.01, 0.1, 1.0 and 10 seconds—as well as programmable gate times that can be set from less than a microsecond to more than 28 seconds. The gate time, along with the timebase oscillator frequency (10,000 MHz), determines the *resolution* of the frequency measurement, or the number of significant digits that can be displayed.

A frequency measurement may also be *prescaled*—that is, before the signal to be measured enters the frequency counter, it is divided by an integer number. Prescaling allows signals to be measured that are higher in frequency than the counter is normally capable of measuring. The OE10 supports three prescaler values: 4, 16, and 64. However, prescaling requires that the gate time must be multiplied by the prescale to

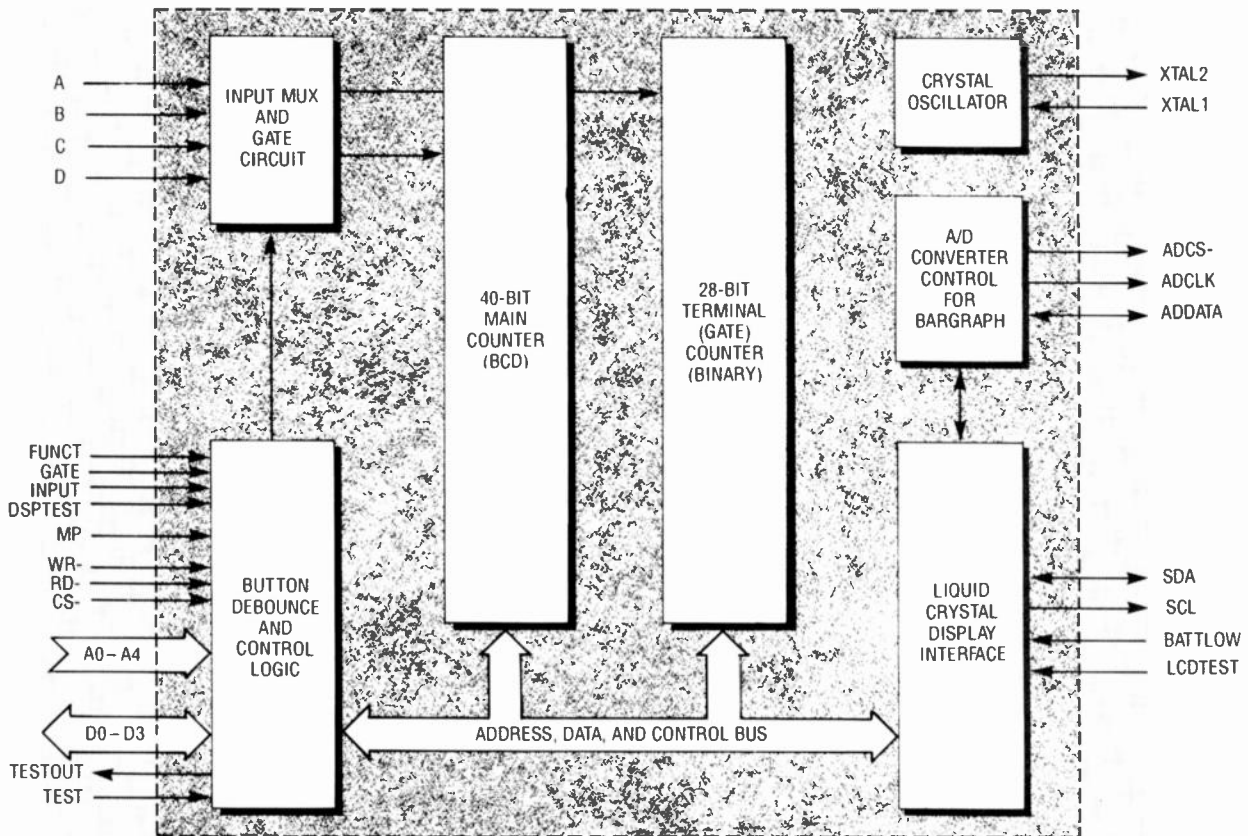

FIG. 1—BLOCK DIAGRAM of the OE10 gate array. The device is packaged in a 44-pin plastic leaded chip carrier.

retain the same resolution. For example, with a divide-by-4 prescaler, the gate times for the same number of significant digits become 0.04, 0.4 and 4 seconds. The final gate time of 40 seconds, is not supported by the OE10. The PC10 board contains two cascaded divide-by-4 prescalers, allowing prescales by 4 and 16. That feature raises the PC10's maximum measurable frequency to 3 GHz.

A period measurement, the inverse of a frequency measurement, is the length of time of one cycle of a signal. A period measurement counts the number of clocks of the time base oscillator between two consecutive rising edges of the input signal. A period average function is also built-in, allowing 10, 100, or 1000 periods to be measured and averaged to give a final value. Programmable averages are also available.

One difficulty with frequency measurements is getting good resolution at low frequencies. For

example, with a gate time of 1 second, a 10-Hz signal will be displayed as 0.0000010 MHz, with only one hertz resolution. To counter that problem, the OE10 can be programmed to perform a *reciprocal*, or inverse frequency measurement, which is a period measurement converted to frequency. A 10-Hz signal has a period of 0.1 seconds, or 1,000,000 counts with a 10-MHz timebase. That yields a frequency measurement of 10,00000 Hz, with six digits of resolution. Better yet, the reciprocal frequency measurement required only 0.1 seconds to give 6 digits of resolution, compared to the 1-second frequency measurement that gave a paltry 1 digit of resolution! The disadvantage of this measurement technique is that the gate time is no longer fixed; it is the same length as one period of the signal that is being measured.

Short period measurements have the same resolution problem as low-frequency measure-

ments. A signal with a 1-microsecond period, for example, gives a count of 10 with a 10-MHz timebase; a resolution of only 1 digit. If that measurement is performed as a reciprocal period measurement (a frequency measurement), the same signal would be measured as 1.000000 MHz with a 1-second gate, which gives a period measurement of 1.000000 microseconds, or 6 digits of resolution. The main disadvantage of reciprocal period measurements is that the length of the measurement is greatly increased, and single-shot events cannot be measured.

A time-interval measurement determines the time between two events. A time-interval measurement starts when the OE10 detects a rising edge on the A input. The measurement ends when a rising edge is detected on the B input. Any additional edges detected on the A input are ignored until a rising edge is detected on the B input. The number of counts of the time base oscillator

**TABLE 1—OE10 REGISTER MAP**

Address	D3	D2	D1	D0
00000 MC0	MC0D	MC0C	MC0B	MC0A
00001 MC1	MC1D	MC1C	MC1B	MC1A
00010 MC2	MC2D	MC2C	MC2B	MC2A
00011 MC3	MC3D	MC3C	MC3B	MC3A
00100 MC4	MC4D	MC4C	MC4B	MC4A
00101 MC5	MC5D	MC5C	MC5B	MC5A
00110 MC6	MC6D	MC6C	MC6B	MC6A
00111 MC7	MC7D	MC7C	MC7B	MC7A
01000 MC8	MC8D	MC8C	MC8B	MC8A
01001 MC9	MC9D	MC9C	MC9B	MC9A
01010 TC0	TC0D	TC0C	TC0B	TC0A
01011 TC1	TC1D	TC1C	TC1B	TC1A
01100 TC2	TC2D	TC2C	TC2B	TC2A
01101 TC3	TC3D	TC3C	TC3B	TC2A
01110 TC4	TC4D	TC4C	TC4B	TC4A
01111 TC5	TC5D	TC5C	TC5B	TC5A
10000 TC6	TC6D	TC6C	TC6B	TC6A
10001 CREG 1	GATE1	GATE0	MSEL1	MSEL0
10010 CREG2	EXTGATE	TSOURCE	DT	INSEL
10011 CLRCNT	—	—	—	—

MSEL1/MSEL0				
GATE1/GATE0	Frequency (00)	Period (01)	Interval (10)	Ratio (11)
00	0.01s	1	1	100,000
01	0.1s	10	10	1,000,000
10	1.0s	100	100	10,000,000
11	10.0s	1000	1000	100,000,000
INSEL	Frequency (00)	Period (01)	Interval (10)	Ratio (11)
0	A	A	A/B	A/B
1	B	B	C/D	C/D

between the two events is then displayed as the measured value in seconds. A time interval average function is also available, with built-in averages of 10, 100, and 1000 time intervals. Programmable time-interval averages are also present.

A ratio measurement is a frequency measurement with an external signal replacing the time-base oscillator. Therefore, instead of giving a measurement in Hz, the OE10 measures the ratio between the input signal and the reference signal. If the two signals have identical frequency, the

display will read 1.000000. Ratio measurements are especially useful for tuning radio receivers and transmitters to a reference frequency. Resolution of a ratio measurement is determined by setting the number of counts that the reference signal must make before displaying the ratio measurement.

Another useful feature is a pulse-width measurement. This measurement is performed by measuring the number of counts of the time-base oscillator between a rising edge and a falling edge (a positive-going pulse) or

between a negative edge and a positive edge (a negative-going pulse). The OE10 does not support pulse-width measurements directly, but using a simple external circuit and the time-interval capability, pulse-width measurements are easy to accomplish.

**Theory of operation**

Figure 1 is a block diagram of the OE10 gate array. The device is packaged in a 44-pin plastic leaded chip carrier. The OE10 typically draws about 25 mA from a 5-volt supply. The OE10 can be configured for two modes of operation by setting the MP pin to logic 0 or logic 1. Logic 0 configures the device for stand-alone operation, used for building handheld or benchtop universal counters (which will not be discussed in this article); logic 1 configures the device for microprocessor-controlled operation, the mode used for this project. When configured in microprocessor-controlled mode, the microprocessor bus interface becomes active and controls all chip operations.

Table 1 shows the internal register map of the OE10. The OE10 has a 5-bit address bus and a 4-bit data bus that allow access to the internal registers. The first ten locations, MC0–MC9, are the 10 BCD digits of the main counter, where the results of the measurement are stored. The most significant digit is MC9. Since the digits are BCD, only binary values 0000 through 1001 are valid. The least significant digit, MC0, can only be read, not written, and any write clears MC0. The 28-bit binary terminal counter occupies the next seven locations, TC0 through TC6. The terminal counter controls the length of the measurement.

The next two locations are control register 1 (CREG1) and control register 2 (CREG2). The MSEL1 and MSEL0 bits control the type of measurement to be performed. The GATE1 and GATE0 bits control the gate times for a frequency measurement, the number of averages for period or time-interval measurements, or the number of counts for ratio measurements. Bit INSEL controls which input (for frequency or period measurements) or input pair (for time interval or ratio measurements) is

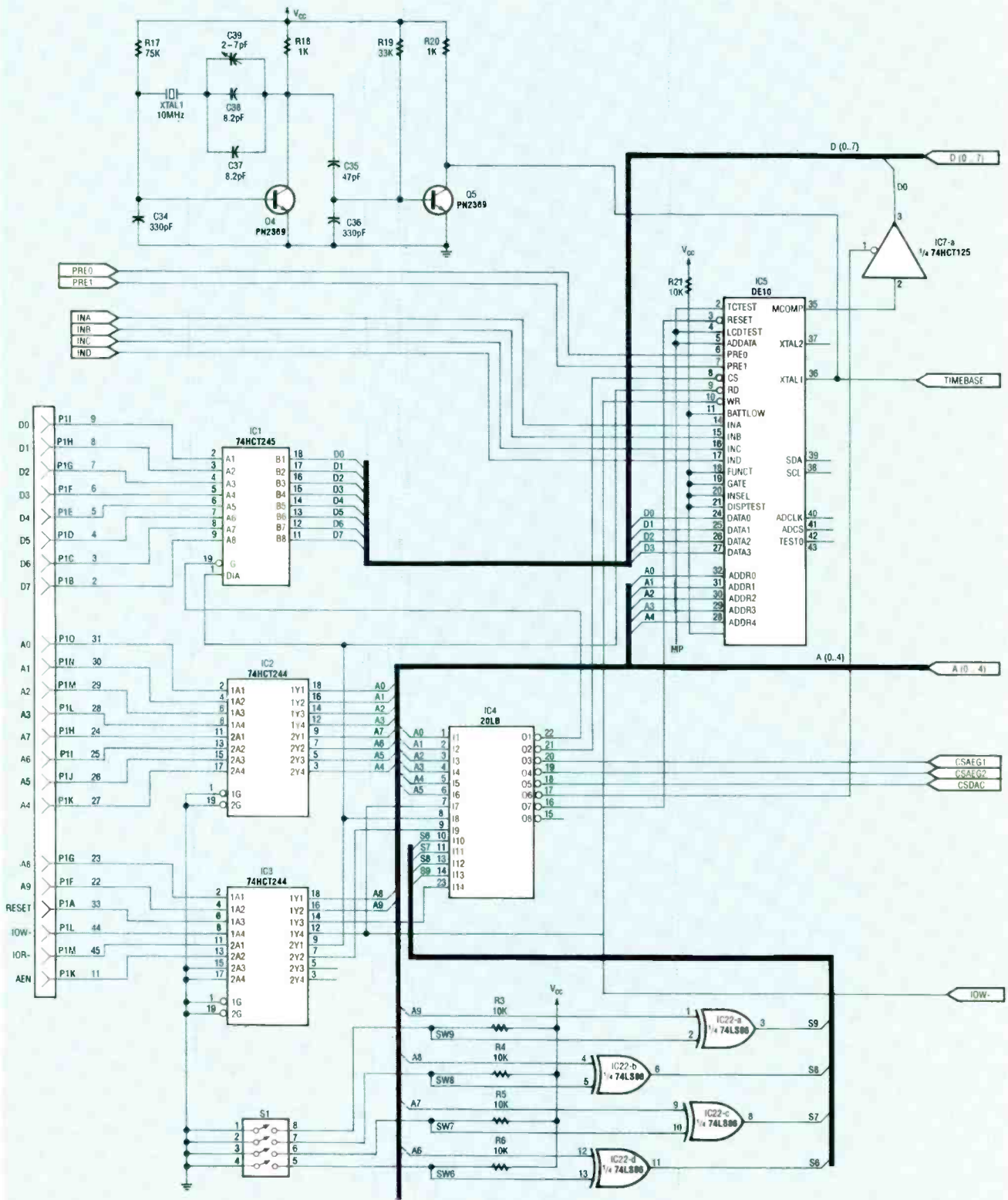

FIG. 2—THE PC10 INTERFACE is an 8-bit industry standard architecture (ISA) bus used in IBM personal computers and compatibles.

used for the measurement. Bit DISPTST controls the display test, which is not used in the

microprocessor mode. Bit TSOURCE determines whether built in or programmable gates

are used. Bit EXTGATE is used only for manufacturing test.

Register CLRCNT provides a simple way to clear both the main counter and the terminal counter. A write of any value to this

location clears both counters. Likewise, writing any value to location STARTM starts a measurement cycle.

To perform a measurement, clear both counters by writing to location CLRCNT. Next, program CREG1 and CREG2 for the proper type of measurement, gate time, and input source. If programmable gate times are required, program the terminal counter to the required value. Finally, start the measurement by writing to location STARTM. The end of the measurement cycle can be monitored by polling MCOMP, the measurement complete pin.

The OE10 has four signal inputs: A, B, C, and D. A and B can be used for all types of measurements, with the exception that input A is the only input that can be used for prescaled frequency measurements; frequency and period measurements require only one input, and use inputs A and B only. Time-interval and ratio measurements require two inputs, A/B or C/D. Inputs C and D are used only for time-interval and ratio measurements.

The OE10 has two counters, the main counter and the terminal (or gate) counter. The main counter, which is a 36-bit binary-coded decimal (BCD) counter, is used to collect the measurement data. It is driven by a 5-bit Johnson counter that divides the incoming signal by 10. The terminal counter is a 28-bit binary counter that generates gate signals for a frequency or ratio measurement, or provides an average count for period or time interval measurements.

The PC10 interface, shown in Fig. 2, is an 8-bit industry standard architecture (ISA) bus used in IBM personal computers and compatibles (but not PS/2 computers). The PC10 is controlled by the PC through 32 input/output (I/O) ports. Since the PC decodes only the bottom 10 bits of the I/O address, the base address of the board is set by the four DIP switches (S1). The PC10 decode logic consists of a programmable array logic (PAL) device, IC4, a 74LS86 quad xor gate, IC22, four pull-up resistors R3-R6, and a 4-position DIP switch, S1. The 20L8 PAL decodes the I/O addresses into signals that enable

## PC10 PARTS LIST

**All resistors are 1/4-watt, 5%, unless otherwise noted**

R1—2200 ohms  
R2—not used  
R3-R6, R21—10,000 ohms, 1/8 watt  
R7, R10—4990 ohms, 1%  
R8, R9—10,000 ohms, 1%  
R11-R14—20,000 ohms, 1%  
R15, R16, R21—10,000 ohms, 1/8 watt  
R17, R30—75,000 ohms, 1/8 watt  
R18, R20—1000 ohms, 1/8 watt  
R19—33,000 ohms, 1/8 watt  
R22, R23—75 ohms, chip resistor  
R24—91 ohms, chip resistor  
R25-R28—1000 ohms, chip resistor  
R29—47 ohms, chip resistor  
R31—100,000-ohm potentiometer

### Capacitors

C1, C3, C4—10  $\mu$ F, 25 volts, radial electrolytic  
C2—22  $\mu$ F, 25 volts, radial electrolytic  
C5-C33—0.1  $\mu$ F, 50 volts, monolithic  
C34, C36—330 pF, NPO  
C35—47 pF, NPO  
C37, C38—8.2 pF, NPO  
C39—2-7 pF NPO trimmer  
C40-C53, C67—0.001  $\mu$ F, 1206 chip capacitor  
C54-C56, C58-C64, C68—0.1  $\mu$ F, 1206 chip capacitor  
C57—330  $\mu$ F, 16 volts, radial electrolytic  
C65—not used

### Semiconductors

IC1—74HCT245 octal tristate transceiver  
IC2, IC3—74HCT244 octal tristate buffer  
IC4—20L8 programmable array logic (PAL)  
IC5—OE10 application-specific integrated circuit (ASIC)  
IC6, IC8, IC14, IC15—not used  
XXX  
IC7—74HCT125 tristate quad buffer  
IC9, IC10—74HC374 tristate octal D-type flip-flop  
IC11—AD7528 dual 8-bit multiplying digital-to-analog converter (DAC)  
IC12—TL074 quad op-amp  
IC13—AD580 voltage reference  
IC16-IC18—74AC1151 eight-to-one multiplexer  
IC19—74HCT74 D-type flip-flop  
IC20—74HC00 quad NAND gate  
IC21—74HC157 quad two-input multiplexer

different devices on the PC10 board. The address bus and various control signals from the PC are buffered by two 74LS244 buffers, IC2 and IC3. Data buffering is performed by IC1, a 74LS245 octal transceiver.

Although the OE10 contains a crystal oscillator, much better performance can be obtained by using a temperature-compensated crystal oscillator as the timebase clock. The 10-MHz crys-

tal, XTAL1, controls the frequency of oscillation; the frequency may be set precisely using trim-capacitor C39.

IC22—74LS86 quad XOR gate  
IC23—74ALS12 triple 3-input NAND gate  
IC24—LM339 quad voltage comparator  
IC25, IC26, IC29—MAR6 MMIC  
IC27—UPB582C high-performance divide-by-four prescaler  
IC28—CA3199E general-purpose divide-by-four prescaler  
D1, D2—HSMP3800 surface-mount pin diode  
Q1-Q3—2N2907 PNP transistor  
Q4, Q5—PN2369 NPN transistor

**Other components**  
J1—BNC bulkhead (R141-306)  
J2—SMB right-angle PC board connector (R114-665)  
RY1-RY3—SPDT DIP reed relay, 5-volt coil, form 1C  
L1-L3—100  $\mu$ H choke  
P2—female DB25 connector (ITT DBU-25S-AA)  
P3—SMB plug, cable (R114-082)  
S1—4-position DIP switch  
XTAL1—10-MHz crystal

**Miscellaneous:** seven 14-pin IC sockets, four 16-pin IC sockets, six 20-pin IC sockets, one 24-pin IC socket (0.3-inches), one PLCC 44-pin IC socket, one G57 modified stamped PC bracket (Globe Mfg.), one lug (Zierick #334), 6-inch 50-ohm coaxial cable RG187 (0.1-inch diameter), PC board, solder, etc.

**Note:** The following items are available from Optoelectronics Inc., 5821 N.E. 14th Ave., Ft. Lauderdale, FL 33334 (800) 327-5912, in Florida (305) 771-2050, FAX (305) 771-2052: Complete Kit of all parts to build the PC10, including software, \$299; OE10 ASIC, \$49; PC10 PC board, \$59; software, \$5; programmed PAL, \$19; assembled and tested PC10, \$339; complete kit of all parts to build the AP10H, \$179; AP10H PC board, \$39; machined and painted cabinet, \$49; 6-foot 25-conductor straight-through cable, \$20; assembled and tested AP10H, \$229. Send SASE for priced out parts list. Include 5% shipping and 6% sales tax when shipped to Florida address.

tal, XTAL1, controls the frequency of oscillation; the frequency may be set precisely using trim-capacitor C39.

That's all we have room for, so we'll have to finish up this story next month. We will then finish up the discussion on the PC10 circuitry, we'll talk about the optional external amplifier board, the AP10H, and we'll show you what is involved in building both of them.

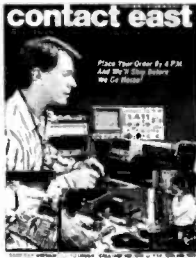

**FREE CATALOG OF TEST INSTRUMENTS & TOOLS** is packed with thousands of products for testing, repairing, and assembling electronic equipment. Featured are brand name instruments such as Fluke, Tektronix, Leader, Weller, 3M plus many more. Also included are DMM's, hand tools, power supplies, tool kits, test equipment, static supplies plus many other new products. Orders placed by 4 PM are shipped before we go home!

**CONTACT EAST, 335 Willow St., No. Andover, MA 01845. (508) 682-2000, FAX: (508) 688-7829.**

CIRCLE 55 ON FREE INFORMATION CARD

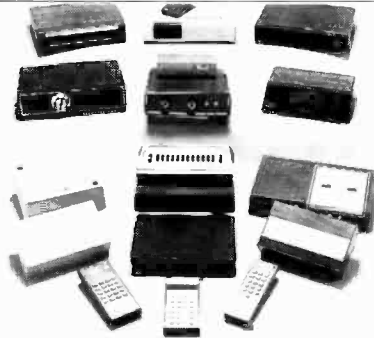

**CABLE TV CONVERTERS AND DE-SCRAMBLERS** SB-3 \$79.00 TRI-BI \$95.00 MLD-\$79.00 M35B \$69.00 DRZ-DIC \$149.00. Special combos available. We ship COD. Quantity discounts. Call for pricing on other products. Dealers wanted. **FREE CATALOG.** We stand behind our products where others fail. One year warranty. **ACE PRODUCTS, P.O. Box 582, Saco, ME 04072 1 (800) 234-0726.**

CIRCLE 75 ON FREE INFORMATION CARD

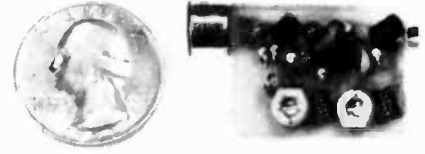

**SIMPLY SNAP THE WAT-50 MINIATURE FM TRANSMITTER** on top of a 9v battery and hear every sound in an entire house up to 1 mile away! Adjustable from 70-130 MHz. Use with any FM radio. Complete kit **\$29.95 + \$1.50 S + H.** Free shipping on 2 or more! COD add \$4. Call or send VISA, MC, MO. **DECO INDUSTRIES, Box 607, Bedford Hills, NY 10507. (914) 232-3878.**

CIRCLE 127 ON FREE INFORMATION CARD



**GET YOUR RECHARGE CATALOG FREE...EARN BIG \$\$ IN YOUR SPARE TIME**—All supplies and Do-It-Yourself kits with complete instructions available. Supplies cost from **\$9.95** in qty and you can sell recharged toner cartridges for **\$40.00** to **\$55.00** each. Printers include HP LaserJet and Series II, Apple LaserWriter, QMS, etc. Canon PC-25 Copier also. **CHENESKO PRODUCTS, 62 N Coleman Rd., Centereach, NY 11720, 516-736-7977, 800-221-3516, Fax: 516-732-4650**

CIRCLE 179 ON FREE INFORMATION CARD

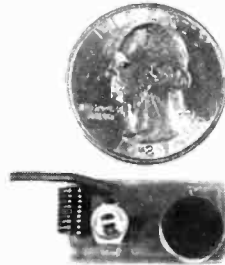

**NEW XST500 SUPER-MINIATURE FM** transmitter uses Surface Mount Technology (SMT)! Own the smallest high performance FM transmitter available. Transmits whispers to any FM receiver up to a mile away. Uses 9V battery. Complete, easy to assemble kit, with SMT components already assembled to circuit board. **\$39.95** Cash, VISA, MC, COD add \$5. **XANDI ELECTRONICS, 201 E. Southern Ave., Suite 114, Tempe, AZ 85282. 1-602-829-8152, (1-800-336-7389 orders only).**

CIRCLE 191 ON FREE INFORMATION CARD

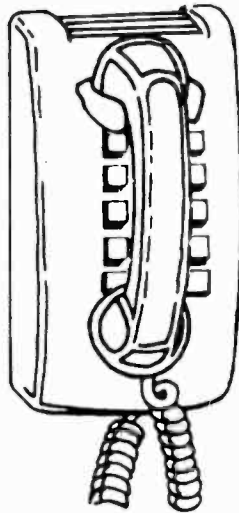

## CALL NOW AND RESERVE YOUR SPACE

- 6 x rate \$940.00 per each insertion.
- Fast reader service cycle.
- Short lead time for the placement of ads.
- We typeset and layout the ad at no additional charge.

Call **516-293-3000** to reserve space. Ask for Arline Fishman. Limited number of pages available. Mail materials to: mini-ADS, RADIO-ELECTRONICS, 500-B Bi-County Blvd., Farmingdale, NY 11735.

FAX: 516-293-3315



**THE MODEL WTT-20 IS ONLY THE SIZE OF A DIME**, yet transmits both sides of a telephone conversation to any FM radio with crystal clarity. Telephone line powered - never needs a battery! Up to 1/4 mile range. Adjustable from 70-130 MHz. Complete kit **\$29.95 + \$1.50 S + H.** Free Shipping on 2 or more! COD add \$4. Call or send VISA, MC, MO. **DECO INDUSTRIES, Box 607, Bedford Hills, NY 10507. (914) 232-3878.**

CIRCLE 127 ON FREE INFORMATION CARD



**GENERAL TECHNICS COMPUTER KITS** offer a complete line of 8088, 286, and 386 models. Designed to the highest degree of *quality* and *reliability* available today. They're also fun, easy to build, educational, fully **IBM compatible**, very *powerful*, and at wholesale prices. All kits are pre-tested and include a one year warranty, step by step assembly manual, free software, and a 24 hour tech support/order phone line. For free catalog contact **GENERAL TECHNICS, P.O. BOX 2676, LAKE RONKONKOMA, NY 11779, or call (516) 981-9473, VISA, MasterCard, American Express. COD**

CIRCLE 185 ON FREE INFORMATION CARD



A PICTURE IS WORTH A THOUSAND words—especially when you're trying to determine the frequency response of an audio amplifier or filter design. Our sweep/marker generator lets you create an oscilloscope display that shows the response of an of an audio system. It can be a useful tool for designing and analyzing amplifier and filter circuits.

With the sweep/generator, the user programs a desired frequency range that is swept into the input of the device under test. The response curve of the frequency sensitive circuit is displayed on the scope screen. When using a conventional storage scope, multiple response curves can be superimposed for a helpful comparison of waveform characteristics.

The sweep/generator can be used to examine the tuning response of an amplifier, check circuit stability or even be used by acoustic engineers. Let's take a closer look into the operation of this versatile unit.

### Operating features

The sweep/generator operates in two basic modes: READ or RUN. In the READ mode, the frequency sweep range can be programmed by adjusting the START and STOP multi-turn potentiometers on the front panel. Three user adjustable frequency ranges can be swept into the device under test—3 Hz to 1000 Hz, 35 Hz to 20 kHz, and 3 kHz to 100 kHz. The user adjusts the exact beginning and end of the frequency range to be swept.

While in the RUN mode, each of the frequency ranges may be swept in its entirety, or any portion of the range, as low as 0.4%, may be swept. The upper 100-kHz frequency range may have up to 12% error over the entire band, the amount of error is roughly reduced in proportion to the amount of the band being swept.

There is also a SWEEP RATE potentiometer, which can be adjusted from 50 milliseconds to 30

seconds per ten graticule divisions in each of the three frequency ranges. The SWEEP output provides a sawtooth ramp for the X input to an oscilloscope.

The frequency range that is being swept uses five markers, or brightened spots, equally spaced at 25% intervals along the horizontal graticules. The first and fifth markers are adjusted to the outer most graticule lines. The frequency at each graticule line can then be determined by taking the difference between the

start and stop frequencies and dividing by ten. All markers are indicated on the front panel LED's. Figure 1 shows a swept sine output of the sweep/generator displaying such markers at 25% intervals along the horizontal graticule lines.

When you are in the RUN mode, the markers should be turned off when sweeping. A momentary overshoot could occur that is not actually present if the marker switch was on during sweeping. That effect is less likely to happen at higher frequencies.

The amplitude level of the swept sine-wave output may be varied from 10 millivolts to 5 volts peak-to-peak by the SINE LEVEL control. The output impedance is about 700 ohms, and the output level is maintained within 0.5 dB from 10 Hz to 100 kHz. Two on-board trimmer potentiometers allow adjustment of the sine shape to as little as 0.5% total harmonic distortion. The very act of sweeping generates its own type of distortion, which can be minimized by using a long-duration sweep.

Another feature of the READ mode is its capability to move between the five markers and cursor with the SKIP button, and stay at a position with the HOLD button. When held at a particular position, the frequency of that marker or cursor can be read on the front panel display. The initial display is dim, when it brightens after a few seconds you'll have an accurate frequency reading.

The cursor is an additional marker which can be adjusted to a particular point of interest while in the RUN mode. The user can move the cursor marker with the CURSOR potentiometer to any point on the swept frequency. The CURSOR is best used to determine the frequency of a point before going to the memory mode. The cursor frequency is read in the READ mode the same way as the marker frequency is read.

Input and output jacks are located on the front panel for connection to an audio amplifier or

# AUDIO SWEEP/MARKER GENERATOR

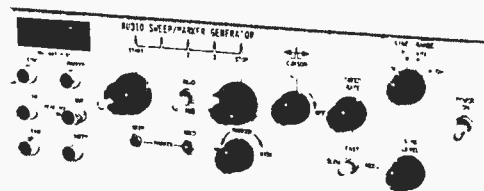

JOHN WANNAMAKER

**Build this sweep/marker generator and discover the audio-range frequency response of your amplifier or filter design.**

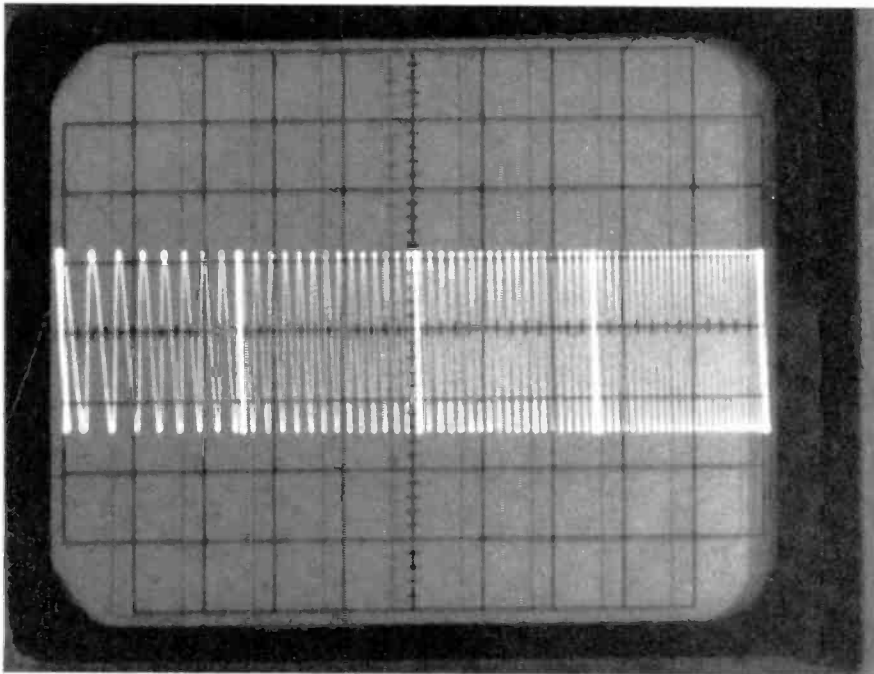

FIG. 1—THE AUDIO OUTPUT SINE wave of the sweep/generator shows five equally spaced markers.

filter device and an oscilloscope. A conventional, digital memory or storage scope may be used with the sweep/generator, however the connections are different. Figure 2 shows a basic connecting diagram that can be used with a conventional scope. The swept sine output connects to the audio input jack, the audio output jack connects to the peak-hold input jack of the sweep/generator. The sweep output and peak-hold outputs of the sweep/generator connect to channels X and Y of the scope, respectively. The scope must be used in the X-

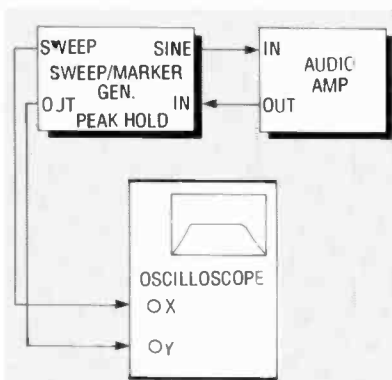

FIG. 2—A CONNECTING diagram shows how the sweep/generator can be used with a conventional scope.

Y mode for a proper display.

Conventional analog storage scopes are best suited for use with the sweep/generator. When

that type of scope is used, the SWEEP output connects to the scope's external trigger. Some digital-memory scopes, unfortunately, do not have the memory capability when used in the X-Y mode, nor can they remember superimposed sweeps of different shapes. To use the storage mode of a digital-memory scope, the sweep/generator must be synchronized with the scope's internal sweep, and the sweep rates must be adjusted for similar times. When a digital-memory scope is used, the SYNC output of the sweep/generator connects to the external trigger of the scope. The dual-trace feature of a digital-memory scope must be used in order to achieve a suitable display. Those various connections are shown in the side bar under Operating Instructions.

A peak-hold circuit is incorporated in the sweep/generator to create a clear base line reference of the frequency response curve. The output signal from the product to be tested may be fed directly into the scope's Y input, but there will be no well-defined base line because of the mirror-image of the audio response. The peak-hold circuit overcomes that problem by momentarily holding the peak value of each positive alternation of the signal, and then quickly reducing to zero. The output from the tested device

is connected to the peak-hold input, the peak-hold output is then connected to the scope's Y input. The scope will display a contour line that follows the positive "envelope" of the response curve. That rather nice feature has a nearly flat frequency response from 20 Hz to 20 kHz (within 0.25 dB) and can be used up to 50 kHz.

The input to the peak-hold circuit should not exceed 3.5 volts peak-to-peak. The circuit works adequately with an input as low

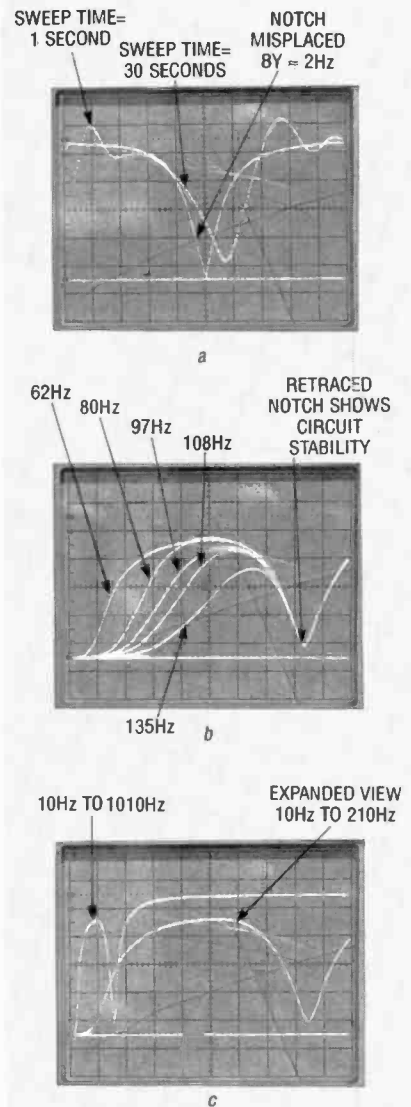

FIG. 3—FILTER RESPONSES: (a) shows a 60-Hz notch filter, a smooth response is displayed with a slow sweep of 30 seconds, a faster sweep of 1 second gives overshoots and misplaces the notch by almost 2 Hz; (b) shows a 180-Hz notch filter with selectable low-end gains, note the same notch is retraced, indicating circuit stability; and (c) shows a low-end response of an amplifier with a 180 Hz notch filter, one trace covers a 10- to 1010-Hz range, the expanded view covers a 10- to 210-Hz range.

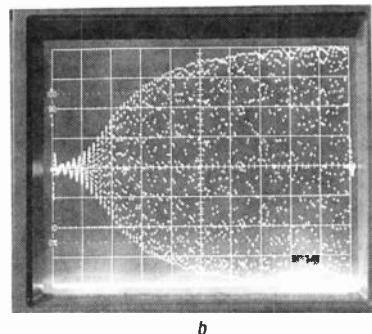
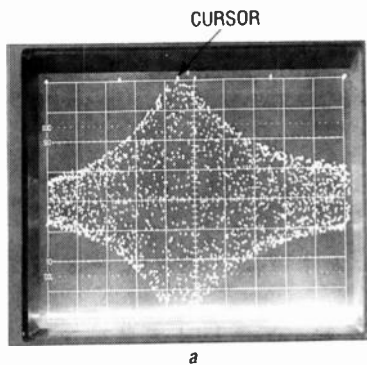

FIG. 4—PEAK-HOLD CIRCUIT not in use, note how the mirror image is displayed: (a) shows an L-C tuned circuit, the frequency sweep is 50 kHz at 5 kHz per division, with the cursor marker at the curve peak, 52.48 kHz; (b) shows an audio amplifier frequency response from 20 Hz to 120 Hz.

as 35 millivolts peak-to-peak, but any value below 20 millivolts peak-to-peak will come out as a base-line value of about +5 millivolts peak-to-peak.

Now that we've introduced you to some of the operating features of the sweep/generator, let's examine some of the scope displays it can produce.

### Sweep/generator uses

An example of the sweep/generator being used to determine the frequency response of a notch filter is shown in Fig. 3-a. The advantage of a slow sweep with its inherent little distortion of the sine wave is seen in the two superimposed sweeps. The smoothest response is at a sweep time of 30 seconds. The faster sweep of 1 second shows overshoots and a displacement of the notch frequency that are not present at the slower sweep rate.

Two interesting displays are shown in Figs. 3-b and -c. Figure 3-b shows five superimposed response curves of a 180-Hz notch filter with variable low-end gains

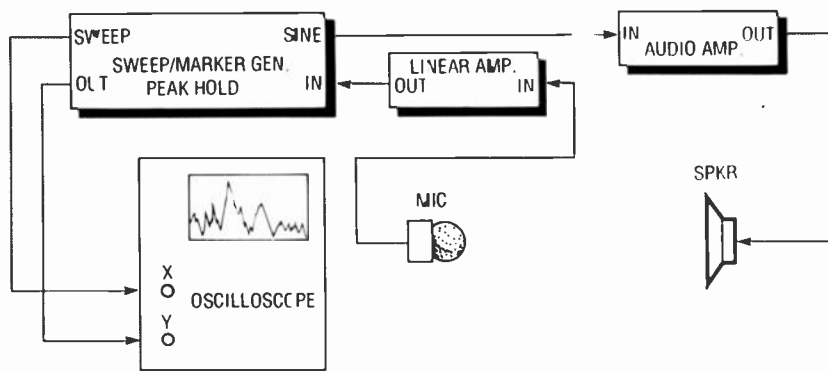

FIG. 5—THE SWEEP/GENERATOR CAN BE USED as a tool in testing the acoustic response of a room. The amplified swept sine wave is projected into a room, and is picked up by a microphone, whose signals are then amplified with a linear amp and fed into the peak-hold circuit.

selected at 62 Hz, 80-Hz, 97 Hz, 108 Hz and 135 Hz. The filter's stability is illustrated by retracing the same notch at the various frequencies. Figure 3-c shows a low-end response of an amplifier with a 180-Hz notch filter. One trace ranges over a frequency of 10 Hz to 1010 Hz, the other trace is an expanded view with a frequency range of 10 Hz to 210 Hz.

Figure 4-a shows the use of a cursor in an L-C circuit. The total

frequency sweep is 50 kHz, at 5 kHz per CRT graticule division. The cursor marker, at 52.5 kHz, is at the peak of the curve.

Figure 4-b shows an audio amplifier's frequency response from 20 to 120 Hz. The mirror image of the response curve is displayed in both Figs. 4-a and -b because the peak-hold circuit is not in use.

An unusual application of the sweep/generator is in the field of acoustic engineering. The generator can be used as an aid in acoustic design by amplifying a swept sine wave into a speaker, and projecting that sound into a room, or perhaps an auditorium. The acoustic response of the room is picked up by a microphone, whose signals are fed into a linear amplifier. The output of the linear amplifier is connected into the peak-hold circuit of the sweep/generator. A block diagram showing the connections for an acoustic response arrangement is shown in Fig. 5. A high quality linear amplifier should be used to pick up microphone signals. Also, the frequency response of the audio amplifier and speaker should be known to avoid misinterpretation of the amplifier response with that of the acoustic response of the room.

Figure 6-a shows a line contour-display of an acoustic response of a room with the peak-hold circuit in use. The upper display is swept over a frequency range of 1 kHz to 3 kHz (200 Hz per graticule division), while the lower display varies over a 45 Hz to 5045 Hz range (500 Hz per

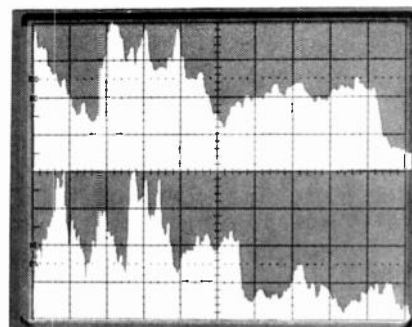
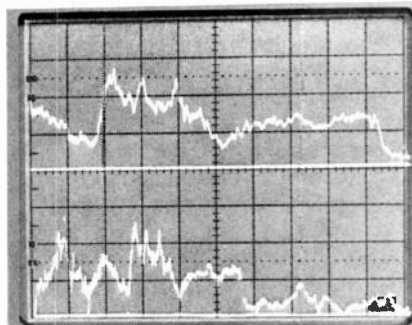

FIG. 6—SCOPE DISPLAYS show an acoustic response of a room: (a) shows a line-contour display where the top is swept over 1 kHz to 3 kHz, the bottom is swept over 45 Hz to 5045 Hz; (b) shows a filled-in display which is achieved by increasing the scope's intensity.

## PARTS LIST

All resistors are ¼-watt, 5%, unless otherwise indicated.

R1—3900 ohms  
 R2, R5, R15, R19, R24, R25, R26, R39, R41, R58, R59, R77, R99—10,000 ohms  
 R3, R47—3300 ohms  
 R4, R28, R31—50,000-ohm potentiometer  
 R6—10,000-ohm multiturn potentiometer  
 R7—2000-ohm 10-turn potentiometer  
 R8—2200 ohms  
 R9—2000-ohm multiturn potentiometer  
 R10—6800 ohms  
 R11—10,000-ohm 10-turn potentiometer  
 R12, R13—1 megohm, 1%  
 R14, R17—47,000 ohms, 1%  
 R16—5000-ohm multiturn potentiometer  
 R18, R80, R90—100,000 ohms  
 R20, R79—1000 ohms  
 R21, R23—10,000-ohm potentiometer  
 R22—12,000 ohms  
 R27—500-ohm potentiometer  
 R29, R32, R33, R36, R49, R54, R56, R67—R71, R92, R102, R103—4700 ohms  
 R30, R34, R38, R48, R50, R51, R53, R73, R76, R78, R81, R82—47,000 ohms  
 R35, R40—68,000 ohms  
 R37—15,000 ohms  
 R42—1.5 megohms  
 R43, R83, R87—150 ohms  
 R44, R46, R91, R100, R101—1500 ohms  
 R45—50,000-ohm potentiometer with SPST switch  
 R52—270,000 ohms  
 R55—4.7 megohms  
 R60—R66, R94, R95—100 ohms  
 R72—68 ohms  
 R74—1 megohm  
 R75—10 megohms

R85, R86—10 ohms  
 R84, R87—R89—unused  
 R93, R97—4.7 ohms  
 R98—330 ohms  
**Capacitors**  
 C1, C2, C17, C26, C29, C32, C66, C68, C69—10 µF, 25 volts, electrolytic  
 C3, C6, C7, C15, C30, C31, C36, C37, C65, C91, C94—0.001 µF, Mylar  
 C5, C9, C11, C14, C23, C28, C33, C61—0.01 µF, Mylar  
 C4, C13, C16, C25, C60, C73, C74, C75—0.1 µF, Mylar  
 C8, C64—22 pF, ceramic disc  
 C10—470 pF, ceramic disc  
 C12, C39—C59, C76—C89—unused  
 C18—100 µF, electrolytic  
 C19—.0068 µF, Mylar  
 C20—0.004 µF (four 0.001 µF 1% capacitors in parallel), Mylar  
 C21—0.8 µF (0.33µF and 0.47µF wired in parallel), Mylar  
 C22—0.033 µF, Mylar  
 C24, C27, C35—0.005 µF, Mylar  
 C34, C38, C62, C67—47 µF, 16 volts, electrolytic  
 C63, C95—100 pF, ceramic disc  
 C70—3300 µF, 25 volts, electrolytic  
 C71, C72—1000 µF, 25 volts, electrolytic  
 C90—10 µF nonpolar, electrolytic  
 C92—470 µF, 16 volts, electrolytic  
 C93—see text  
 C95—47 pF, ceramic disc  
 C96—0.05 µF, Mylar  
 C97—2200 µF, electrolytic  
**Semiconductors**  
 IC1, IC14, IC15—XRL555 timer  
 IC2—CD4040, 12-stage binary ripple counter  
 IC3—DAC1222LCN D/A converter  
 IC4, IC6, IC7, IC8, IC9, IC23—IC25—CA3140E op-amp  
 IC5—LM336Z 2.5-volt reference diode  
 IC10, IC26—CA3130E op-amp  
 IC11—CD4068 8-input NAND gate

IC12—CD4538BCN/BCP or MM14538BCN dual-precision monostable multivibrator  
 IC13—CD4017 decade counter/divider  
 IC16—XR2206 monolithic function generator  
 IC17, IC18—RDD104 timebase  
 IC19—74C926 counter  
 IC20—7812 12-volt positive regulator  
 IC21—7912 12-volt negative regulator  
 IC22—7805, 5-volt positive regulator  
 Q1—Q13—2N4401 transistor  
 Q14—2N2219 transistor or VN0300M MOSFET (see text)  
 D1—D7—1N914 diode  
 D8, D9, D10—1N4001 diode  
 DSP1—NSB3881, 4-digit, 7-segment LED display  
 LED1—7—LN28CAL(US) Panasonic high-efficiency light emitting diodes  
**Other components**  
 S1, S2—momentary contact push-button switch, SPST  
 S3—ON-OFF-ON toggle switch, SPDT  
 S4—SPST switch mounted on R45  
 S5—3PDT toggle switch  
 S6—3-pole, 4-position rotary switch  
 S7—SPST toggle switch, 1.0 amp, 125 volts AC  
 T1—120 volts primary, 12.6 volts secondary, 0.6 amps  
 J1—J6—RCA chassis mount phono jacks  
 XTAL1—5-MHz crystal  
 F1—0.5-amp fuse  
**Miscellaneous:** Fuseholder, 3-conductor 18 AWG line cord, Jameco enclosure type H2507, DIP sockets and hardware.

**Note: A set of 2 PC boards is available from John Wannamaker, Route 4, Box 550, Orangeburg, S.C. 29115: \$43.00, postage paid, S.C. residents add 5% sales tax.**

graticule division).

An alternate filled-in display is shown in Fig. 6-b. The area under the response curve is filled-in, rather than having only a base line and contour line. A filled-in display can be achieved by increasing the intensity level on the scope. The main disadvantage of that type of display is its inability to display multiple traces.

### Theory of operation

Two PC boards are used in the

sweep/generator: a main board, consisting of a function generator, counter, and analog-to-digital conversion circuitry, and a power supply board, which also includes the peak-hold circuit. A schematic of the main PC board is shown in Fig. 7. On this board, an XR2206 function generator chip, IC16, is used as a current-controlled oscillator. A low-to-high frequency sweep occurs when current flow from ground into pin 7 varies from near zero to about 3 milliamps. That current

change takes place when a digitized ramp, or sweep voltage, is applied to the base of Q1.

The ramp voltage is created by applying pulses from an astable multivibrator, IC1, into a 12-stage binary counter, IC2. The resulting binary-coded outputs are converted into an analog voltage by a 12-bit digital-to-analog converter, IC3. The output of the converter at pin 1 must feed into the virtual ground of op-amp IC4. The output of IC4 has an apparent straight-line voltage rise, but

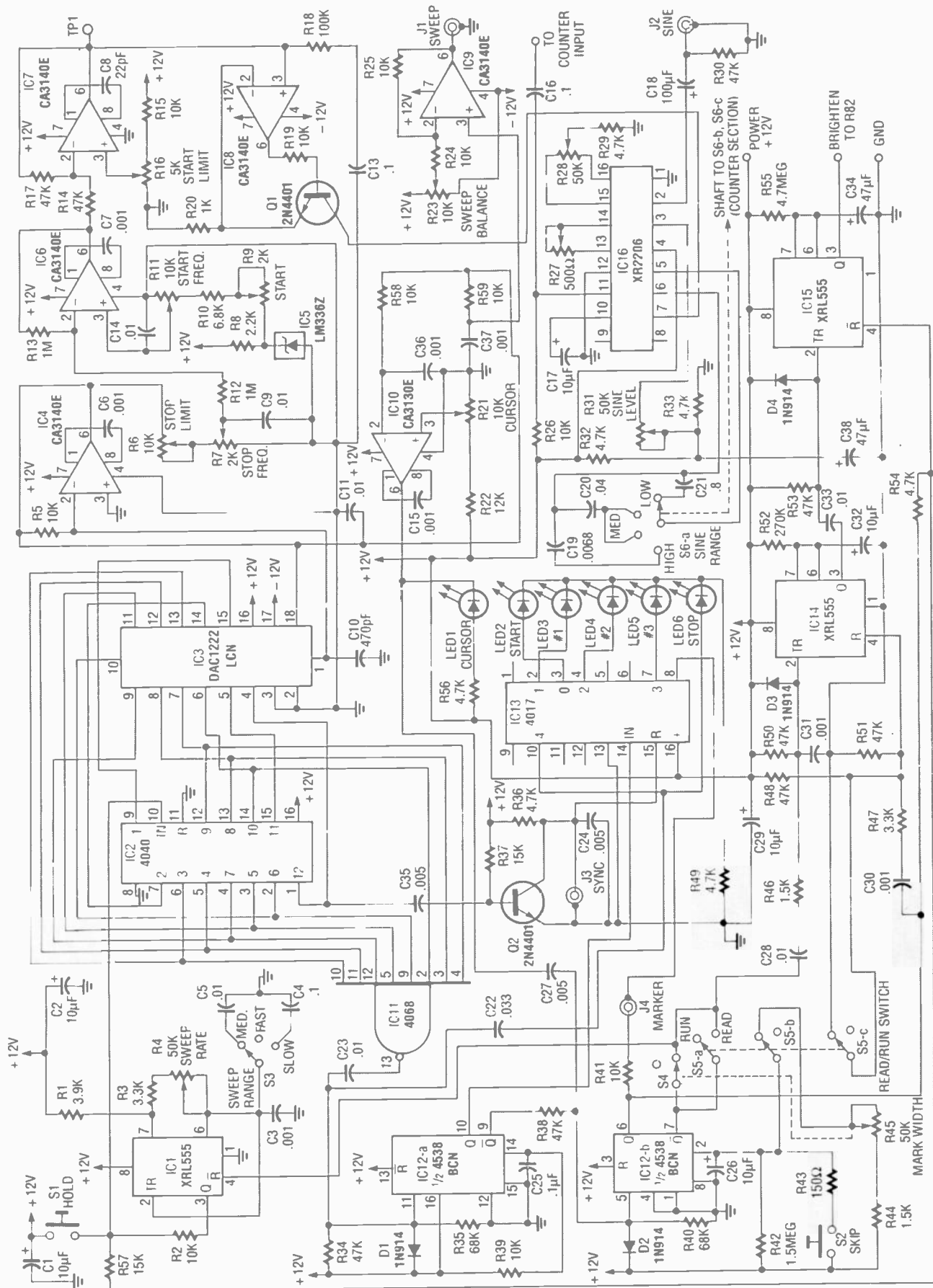

FIG. 7—THE MAIN BOARD SCHEMATIC; IC16 IS USED AS A current-controlled oscillator—a frequency sweep is generated when current flow from ground to pin 7 varies from 0 to 3 milliamps. IC5 is a 2.5-volt precision voltage regulator used to minimize frequency drift

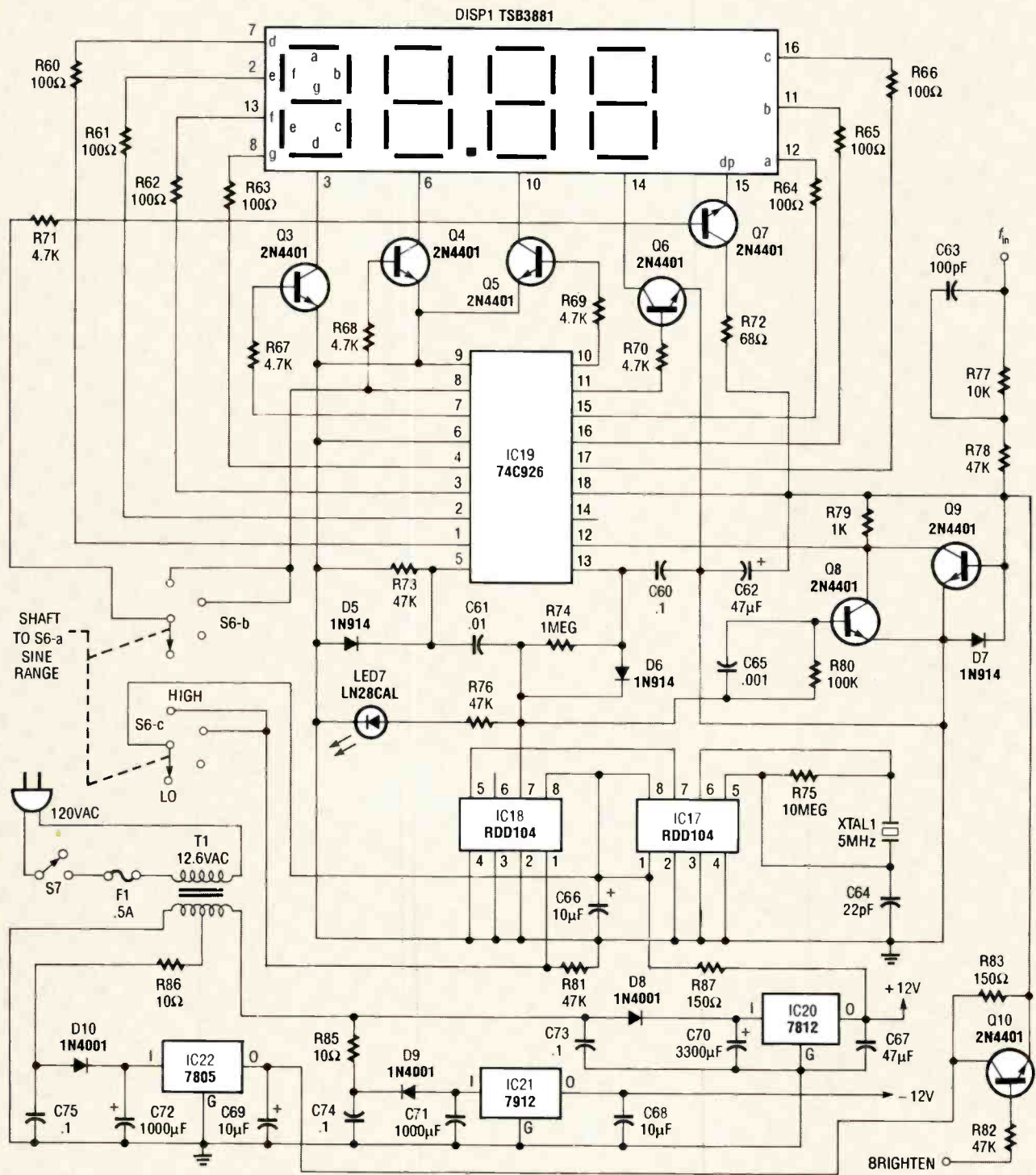

FIG. 8—THE COUNTER AND POWER-SUPPLY BOARD SCHEMATIC; The time-base for the counter originates from IC17 and IC18. A 5-MHz crystal oscillator is used by IC17 and is programmed via pins 1 and 2. The output of IC18 is a square wave which provides a 0.1 or 1 second sampling of the frequency to be measured by the shorting or non-shorting action of Q8.

in reality it is composed of 4.096 small steps. When the frequency of IC1 changes, the ramp's slope and duration change.

Two inverting unity-gain op-amps, IC6 and IC7, provide level-shifting controls for adjusting

both ends of the ramp. That permits adjustable start and stop points as well as some limit-setting to protect IC16.

Op-amp IC8 and transistor Q1 act as a voltage-to-current converter for the most linear control

over the frequency of the IC16. Frequency drift is a problem, especially within the true audio range, which is at the low end of the middle range. When a device operates in the audio range, a 1-millivolt drift can cause a change of 18 Hz. To minimize frequency drift, a 2.5 volt precision voltage regulator, IC5, is used, and after one hour of warmup time, the

drift averages about 5 or 6 Hz per hour.

An 8-input NAND gate, IC11, provides a falling edge output at 25% increments as the ramp is taking shape. That falling voltage triggers IC12-a, a one-shot monostable multivibrator, which then applies a 10-millisecond input pulse to decade counter, IC13, which has one-of-ten decoded outputs. Each of the five counts light separate LED's to indicate which marker is in progress.

The highlighted marker frequency is established by the technique described below. The pin 9 output of IC12-a triggers a one-shot monostable multivibrator, IC12-b. Its pulse width may be either fixed at 15 seconds or variable from 10 to 150 milliseconds depending on whether the unit is in the READ or RUN mode. During the time that the voltage at pin 7 has dropped to zero, astable IC1's RESET pin is held and cannot furnish pulses to the 12-stage counter. The counter holds whatever count exists at that time which ultimately translates into a steady control current at IC16, and a steady frequency out of it. The continuous frequency out of IC16 is the marker frequency. Each time the ramp stops, the sweep applied to the scope's X input holds a steady value. That stops the trace in its tracks and the unmoving electron beam creates a bright spot which is the marker. If there is a signal at the Y input, the marker becomes a brightened vertical line.

The STOP marker is generated on the count of 4.092. After its completion, four more counts return the 12-stage counter to an all-zeros output condition, the ramp returns to its starting point, and a synchronized pulse is generated by transistor Q2. That same pulse resets IC13, the LED markers counter, and the voltage that had previously lit the stop LED falls to zero. That fall retriggers IC12-a and a new sequence begins.

The built-in counter that displays the marker frequency cannot give a meaningful readout when it is in the RUN mode because the frequency is continually changing. A valid frequency readout can be displayed only in the READ mode, where a

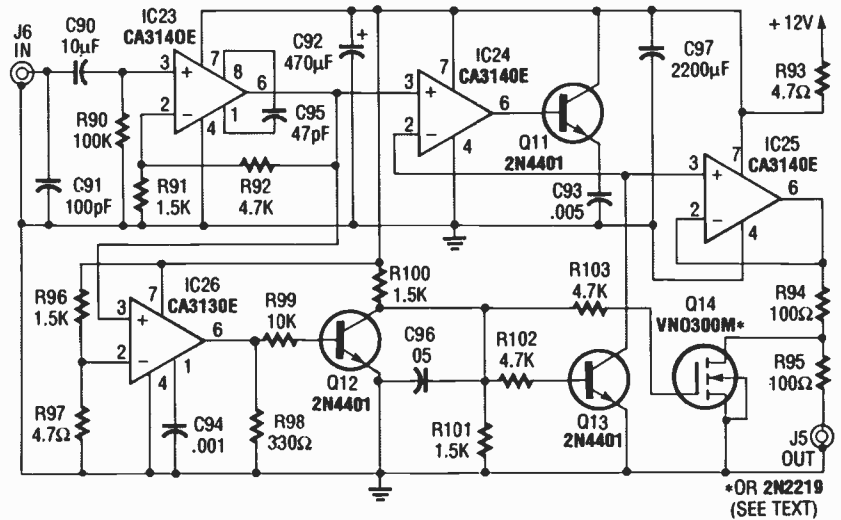

FIG. 9—A SCHEMATIC OF THE PEAK-HOLD CIRCUIT; IC23 AMPLIFIES the signal from the tested device, and reproduces only the positive alternation of the waveform. Transistors Q13 and Q14 act as switches—when open, C93 charges to the peak value of the positive alternation, then holds the peak value. The top portion of that charge is one segment of the positive contour line.

one-second sampling of an unchanging frequency can be taken. To keep the user aware of that, the display is dimmed until the readout is valid. An accurate readout may not be available to the user until three seconds after stopping on a marker. A three-second delay is provided for all automatic stops before the display is brightened.

Integrated circuit IC14 is used as the one-shot, three-second delay for the automatic stops. A three-second delay is triggered every time the marker one-shot, IC12-b, is activated. The delayed falling edge out of IC14 at pin 3 triggers another one-shot, IC15, which produces a long duration "brighten" pulse to Q10 in the power supply. Once the brighten one-shot is triggered, it has the capacity to remain on for several minutes, but its time is cut short by IC12-b, which resets after 15 seconds. The HOLD pushbutton can extend this time if held pressed. The HOLD pushbutton also applies a positive voltage to the input of the 12-stage counter and prevents pulses from entering. Timers IC14 and IC15 are type XRL555 made by Exar. Standard 555 IC's do not work in this application.

The CURSOR marker is generated in a totally different manner from all other markers. A single op-amp, IC10, is used as a comparator. A digitized ramp is ap-

plied to the inverting input and an adjustable DC voltage from the cursor potentiometer is applied to the non-inverting input. When the ramp rises to equal the DC voltage, the op-amp's output falls to zero and actuates IC12-b to provide an added marker. The reason for the complexity of having two one shots to generate markers is that the cursor marker must be counted by all markers, not just by IC13. The CURSOR marker must hold the astable IC1 reset for a period of time.

The MARKER WIDTH control is a variable resistor with an attached switch, S4. When S4 is turned off, there are no markers, but the sweep will cover the same frequencies as if the markers were present.

The frequency sweep for the middle range, or audio spectrum range, presents a problem for a four-digit counter display. Resolution is poor at the low end if the readout is in kHz, and if the readout is in Hz, the most significant digit would be missing on the high end. To overcome that problem, the middle range occupies two positions on the SINE RANGE switch, and the user may select a readout in either hertz or kilohertz.

The counter and power-supply circuit is shown in Fig. 8. The timebase for the counter comes from IC17 and IC18, both are

continued on page 70

THE PURIST WILL TELL YOU THAT IF something's worth doing at all, it's worth doing well—and that's the case with the author of this story. The author always loved music, and was probably doomed to permanent audiophilia from day one. Even in 1960 at age 12, when he and his sister pooled resources to buy their first 45-RPM record (Pat Boone's "Love Letters in the Sand"), he recalls that, even on a monophonic, crystal-cartridge record player, there was an audible difference between the quality of a decent LP and the 45. Even though it should have sounded better than an LP, the 45 was bassier, noisier, and somewhat distorted, being pressed on what a broadcast engineer later

poetically described as a blend of straw and chicken manure. Predictably, he soon became dissatisfied with the quality of the record player, and his junior-high and high-school years were marked by repeated attempts to upgrade the equipment without spending any money.

Along came the late '70's, and a new product was aimed at the purists: beastie cables (the name has been changed to protect the author!), which are expensive heavy-gauge speaker cables. The old purism surged forward, remembering the effects of cable resistance on damping factor and the effect of cable capacitance on high-frequency response—but the ads also spoke of skin effect,

which has to do with the fact that at high frequencies, alternating currents tend to travel mainly at the outside surface, or skin, of a conductor. Since the skin effect essentially removes current from the center of a conductor, effectively reducing its cross-sectional area, it causes an increase in the impedance of a conductor at high frequencies.

Actually, when frequency is high enough, a tube or pipe will have the same effective resistance as a wire of the same diameter. That fact can be used simplistically to account for the use of waveguides rather than wiring at microwave frequencies. But concerning high frequencies, how high is high?

Supposedly, the skin effect becomes important above about 30 MHz, but a recent ad for speaker cables claimed perceptible benefits from reducing skin effect at 20 kHz. Soon after, articles ap-

# WILL "BEASTIE" SPEAKER CABLES IMPROVE YOUR AUDIO?

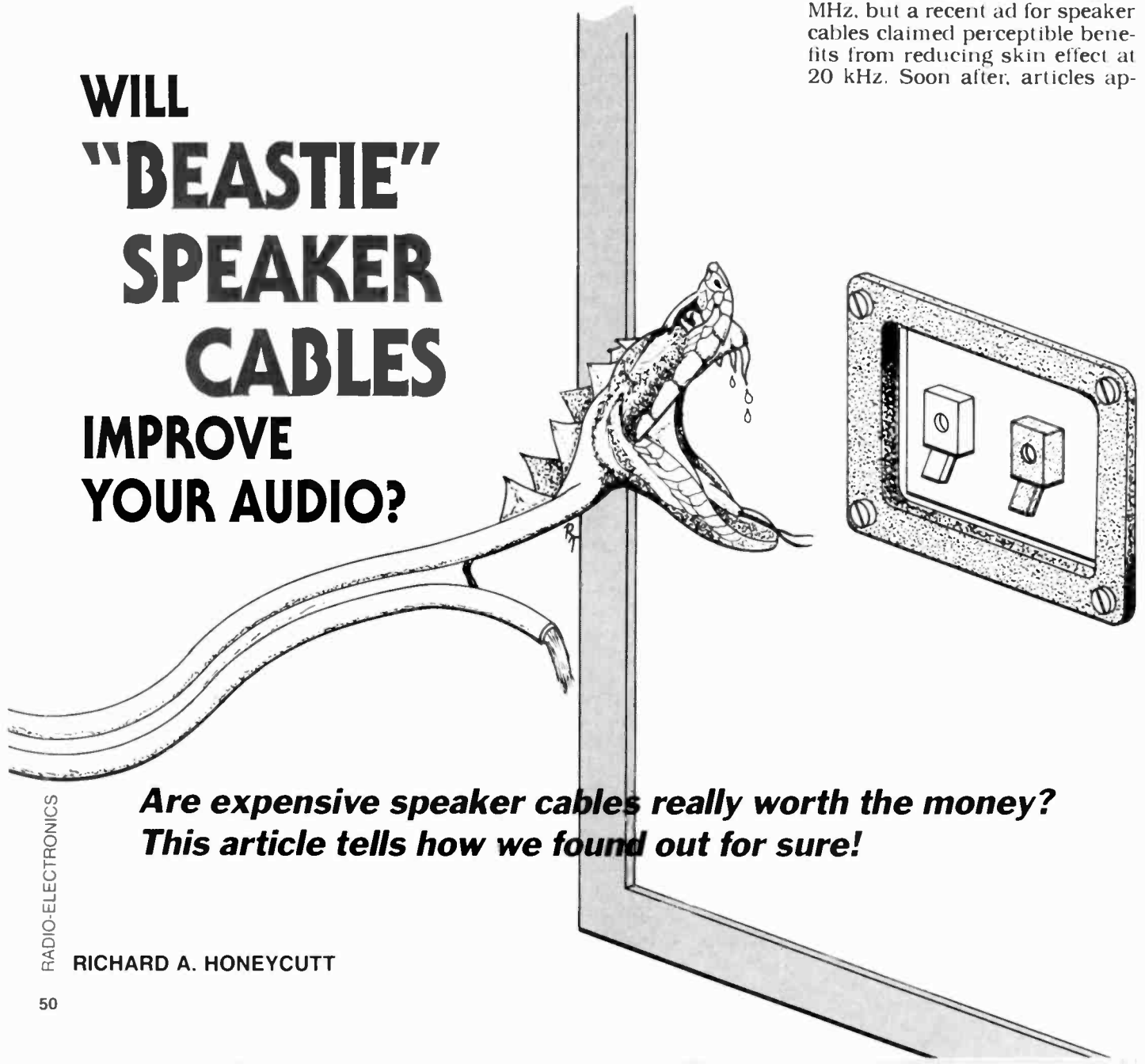

***Are expensive speaker cables really worth the money?  
This article tells how we found out for sure!***



peared in professional trade journals mentioning the likes of Lucasfilm using the enormous cables, so some real research was in order.

The goal was to find out whether beastie cables did in fact:

- Reduce the amount of power lost in the cable enough to provide a significant improvement in efficiency, or
- Increase the damping factor of the speaker/amplifier system enough to provide audible improvement, or
- Provide any significant benefit in the frequency response of the system.

No other benefits are claimed for these cables, so it is not necessary to look for undiscovered or presently unmeasurable effects.

The problem was attacked both analytically and experimentally. The equivalent circuit of a real loudspeaker driven by a real amplifier through real cables is shown in Fig. 1. Any effects produced by the cables must show up in the cable resistance, capacitance, or inductance. The efficiency and damping-factor questions depend almost exclusively upon the cable resistance, whereas the frequency-response question is mainly a function of the capacitance. Wire inductance is so small compared with the semi-inductive nature of speaker impedance at high frequencies that it can be ignored, as we will see.

The cable resistance is made up of three components: the contact resistance, the ohmic resistance of the wire, and any contribution from skin effect. The ohmic resistance can easily be found from wire tables in most electronics reference books. Table 1 shows the resistance of a representative sampling of copper cables, listed according to gauge. For years, selection of cable gauge has been made according to the criterion of 10% loss. In other words, for a given cable length, what resistance will give no more than 10% (0.46 dB) power loss at the speaker? Figure 2 shows the calculations involved in determining that value. For short cable runs, the resulting gauge is surprisingly small.

About fifteen years ago when the author was an audio consultant, he would specify 18-gauge

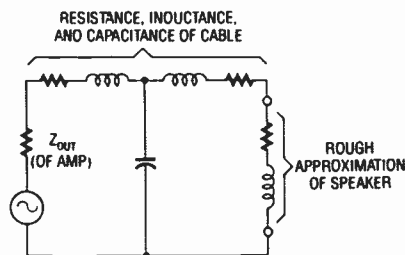

FIG. 1—THIS CIRCUIT IS roughly equivalent to an amplifier, speaker, and length of cable.

cable for amplifiers up to 100 watts feeding impedances of 8 ohms or more with runs of 25 feet or less. For each halving of impedance or doubling of amplifier power or distance, the wire size would increase by two gauges: 16 gauge for 100 watts into 8 ohms at 50 feet or 4 ohms at 25 feet, etc. That rule of thumb includes a safety factor so that the loss will always be less than 10%.

The National Electrical Code specifies cable gauges based upon safety considerations: if a wire carries too much current over a long enough period of time, it can become dangerously hot and start a fire. Going back to the rule of thumb, a speaker with an average impedance of 8 ohms fed by a 100-watt amplifier will draw about 3.5 amperes at full power. However, even running at full tilt, it's unlikely that the average power will be greater than one-third of your amplifier's maximum, so the rule of thumb provides a large safety margin from a fire-prevention standpoint.

The damping factor can be defined as the ratio of a speaker's impedance to the total resistance

TABLE 1  
RESISTANCE OF COPPER WIRE

Gauge	Resistance (ohms/foot)
0	0.000098
2	0.000156
4	0.000249
6	0.000395
8	0.000628
10	0.000999
12	0.00159
14	0.00253
16	0.00402
18	0.00639

Note: The wire must make a complete round trip, so there's 20 feet of wire in a 10-foot speaker cable.

in series with the speaker. Since the simple loss calculation in Fig. 2 depends upon the combined resistance of the speaker and the cable, the resistive power loss will be related to the damping factor. Thus we can find a relationship between damping factor and low-frequency loss. In the *Audio Cyclopedia* Howard Tremaine established that there is no value in trying for a damping factor greater than  $20^4$ . That is based on the fact that the speaker's voice-coil resistance appears in the circuit, and its value—typically 6 to 7.5 ohms for an 8-ohm speaker—sets a practical limit on the benefits of reducing other resistances. The effective damping factor is equal to:

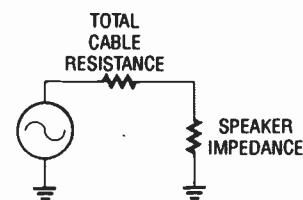

1. CABLE RESISTANCE =  $0.1 \times \text{SPEAKER RESISTANCE}$
2. RESISTANCE PER FOOT =  $\frac{\text{TOTAL CABLE RESISTANCE}}{\text{TWICE THE AMPLIFIER-TO-SPEAKER DISTANCE}}$
3. SELECT GAUGE FROM TABLE 1

FIG. 2—HERE'S THE TRADITIONAL method normally used to determine speaker-cable gauge by loss.

$$= \frac{Z_{\text{SPEAKER}}}{R_{\text{VOICE COIL}} + R_{\text{AMP}} + R_{\text{CABLE}}}$$

A stated amplifier damping factor of 20 would represent a total resistance of 8 ohms divided by 20, or 0.4 ohms in series with the amplifier. That would give an effective damping factor of:

$$\frac{8\Omega}{6\Omega + 0.4\Omega} = 1.25$$

assuming a 6-ohm voice-coil resistance. With most amplifiers having output impedances on the order of 0.1 ohm or less, this would mean that the cable resistance could be 0.3 ohms. The loss in dB corresponding to an 8-ohm speaker fed through a 0.3-ohm cable is:

$$= 20 \log_{10} \left( \frac{8\Omega}{8\Omega + 0.3\Omega} \right) = -0.32 \text{dB}$$

That means that for an optimum effective damping factor, the resistive cable loss should be

less than 0.32 dB. Just for comparison purposes, a 1-dB cable loss, which would result from a 0.9-ohm cable resistance, would result in an effective damping factor of 1.14, which is not much lower than 1.25.

As mentioned earlier, skin effect increases the effective impedance of a wire, and can be best explained by looking at Fig. 3. The skin depth of a conductor is the distance into that conductor, measured from the outside surface, at which current density is 1/e times that at the surface. (The symbol  $e$  stands for the base of natural logarithms, and equals approximately 2.72.) For a direct current, the current density (amperes per unit cross-sectional area) is the same throughout the wire. For AC, the current density is less at the center of the wire and greater at the surface.

At low frequencies, the skin depth (which depends on characteristics of the bulk conductor material) is usually greater than the radius of the conductor, which means that for all practical purposes the current density is the same throughout the conductor. Larger-diameter conductors can exhibit measurable skin effect at relatively low frequencies, including audio frequencies.

The simplest indicator of skin effect is the ratio  $R_{AC}/R_{DC}$ , where  $R_{AC}$  is the resistance per unit length of a wire to alternating current of a certain frequency and  $R_{DC}$  is the ohmic resistance per unit length. As long as  $R_{AC}/R_{DC}$  equals 1, skin effect is negligible. When  $R_{AC}/R_{DC}$  rises sig-

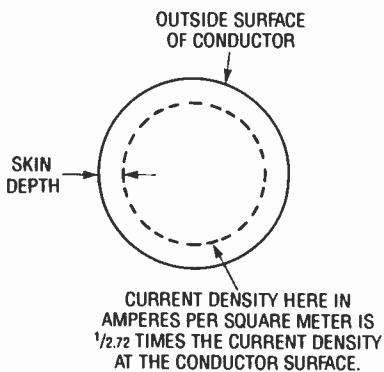

FIG. 3—THE SKIN EFFECT increases the effective resistance of a wire. The skin depth is the distance into the conductor at which the current density is approximately 1/3 of that at the surface.

TABLE 2—MEASURED CHARACTERISTICS OF CABLES

Cable Type	C (pF/ft)	L ( $\mu$ H/ft)	R* (ohms/ft)
22-ga. cheap	10.7	0.29	0.0178
18-ga. zip	14.0	0.28	0.007
20-ga. twist	18.0	0.36	0.0107
4-ga. cable	50.8	0.29	0.0007
16-ga. "drop cord"	22.4	0.38	0.006
shielded "guitar cord"	105.8	0.30	0.048
16-ga. zip	12.5	0.23	0.0127

\*One-way resistance, not loop resistance; that includes the contact resistance of the terminations.

nificantly above 1, skin effect may begin to matter. We say *may*, because it only matters if the total resulting increase in cable resistance causes a perceptible effect in the reproduction. For a frequency of 15 kHz,  $R_{AC}/R_{DC}$  equals 1.1 when a 15-gauge solid wire is used. Larger wires will exhibit a greater proportional increase in resistance as frequency increases. Of course, since the resistance of large wires is lower to begin with, the actual change in measured resistance may or may not matter.

Stranded wire is extremely difficult to analyze. Naturally, each strand has a certain surface area, so that all the strands connected in parallel would have a very large surface area. In actuality, though, much of the surfaces of the individual wires are in contact with each other, making the actual effective surface area virtually impossible to determine—unless the individual strands are insulated from each other, as in litz wire. At any rate, we can use solid wire as a worst case to analyze, knowing that we'll really be

using stranded wire that has less skin effect.

The actual resistance, capacitance, and inductance of a cable are distributed evenly along its length. Telephone engineers found out long ago that, for analysis purposes, a cable's R, C, and L can be lumped into a single component if certain conditions are met. The conditions depend upon the attenuation constant and length of the cable. The attenuation constant ( $\alpha$ ) is given by:

$$\alpha = \sqrt{(R^2 + \omega^2 L^2)(G^2 + \omega^2 C^2) + RG - \omega^2 LC/2}$$

where R, L, C, and G are the cable's resistance, capacitance, inductance, and leakage conductance per unit length, and  $\omega$  is the angular frequency, or  $2\pi f$ .

The author does not like to lie awake nights solving equations like that, and tables of attenuation constant versus frequency are not generally available for the kinds of cables used for speaker leads. However, tables for 19-gauge pulp-insulated telephone cable indicate that a 3-kilometer cable section can be analyzed using the lumped-constant

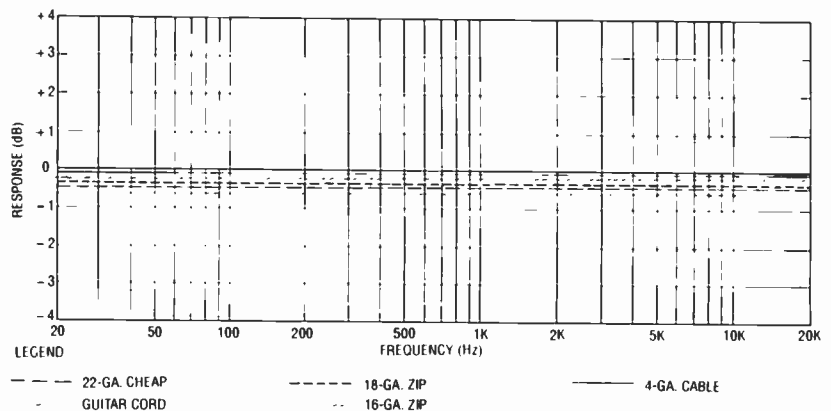

FIG. 4—A COMPUTER SOLUTION, or prediction, of the model in Fig. 1 yielded these results. The worst-case loss is well under 1 dB at 20 kHz.

method at 1 kHz with a total attenuation under 1 dB and a phase accuracy within 5 degrees. Although it may not be immediately obvious to the casual observer, attenuation constant is proportional to the square root of frequency, so that would mean that the same accuracy could be expected at 20 kHz if the length were reduced by

$$\sqrt{20 \text{ kHz}/1 \text{ kHz}}$$

that works out to about 2100 feet. Since we rarely extend speaker cables anywhere near that far, we can safely use the lumped-constant method with no qualms. That's what was assumed in Fig. 1.

Table 2 shows the types of cables chosen for the analysis, along with their measured resistance, capacitance, and inductance. The values were measured using a Hewlett-Packard 4261A LCR meter and a test frequency of 1 kHz. Instead of a speaker, a resistance of 7.9 ohms and an inductance of 6.3 microhenries were used in the calculations. Instead of "real" beastie cables, we used ones that were on hand, including a very large (4-gauge) stranded cable. If those cables showed no measurable detrimental effects on efficiency, damping-factor, or frequency response, then the alleged beastie benefits would turn out to be solutions to a nonexistent problem!

A computer solution of the circuit of Fig. 1 yielded the results plotted in Fig. 4. A 10-foot length was assumed for each cable, and it included the effects of cable capacitance and inductance, but not the skin effect. Notice that the worst-case loss was well under 1 dB at 20 kHz.

Computer solutions without experimental verification are not

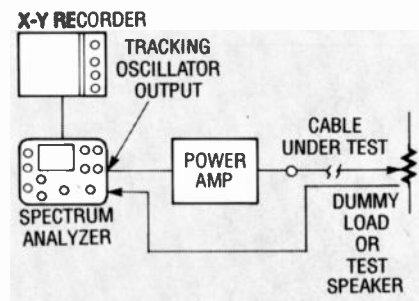

FIG. 5—THIS TEST SETUP was used to measure the effects on an audio signal caused by speaker cables.

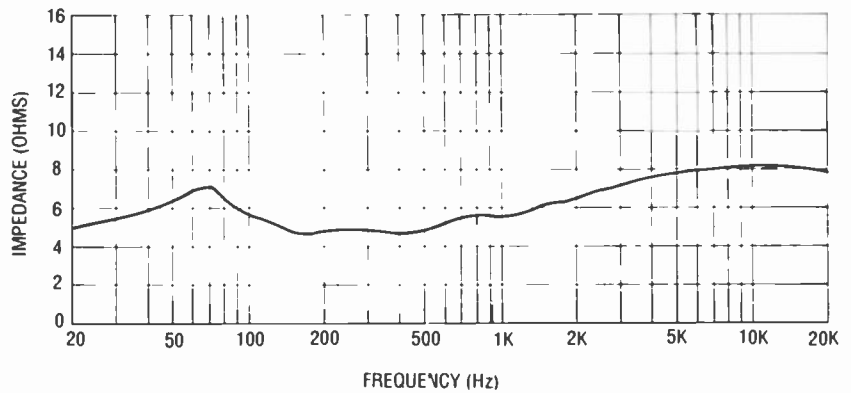

FIG. 6—THE MEASURED IMPEDANCE CHARACTERISTICS of the test speaker.

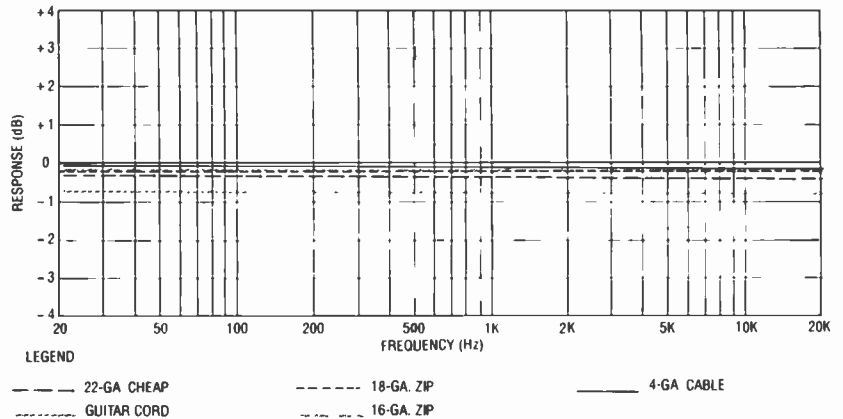

FIG. 7—SEE HOW THE ACTUAL MEASURED CABLE LOSSES compare to the predicted losses of Fig. 4.

always trustworthy, so the actual response of the cables was measured on the setup shown in Fig. 5. The impedance characteristic of the test speaker is shown in Fig. 6. Although the amplifier was flat within  $\pm 0.2$  dB from 20 Hz to 20 kHz, the amplifier's calibration curve was nevertheless subtracted from the measured results in order to provide maximum accuracy. The test results are shown in Fig. 7.

Initial results seem to indicate that virtually anything can be used to connect a speaker to an

amplifier and, if the distance is short, no serious detriment to efficiency will result. Damping factor is degraded slightly when cables lighter than 18-gauge are used, as shown by the loss exceeding 0.32 dB. But what will happen if longer cables are used?

From previous measurements, ordinary Romex house-wiring cable is found to have about the highest capacitance per foot of any common wire. With the factors mentioned earlier that control skin effect, it is also clear that small wires will not experience

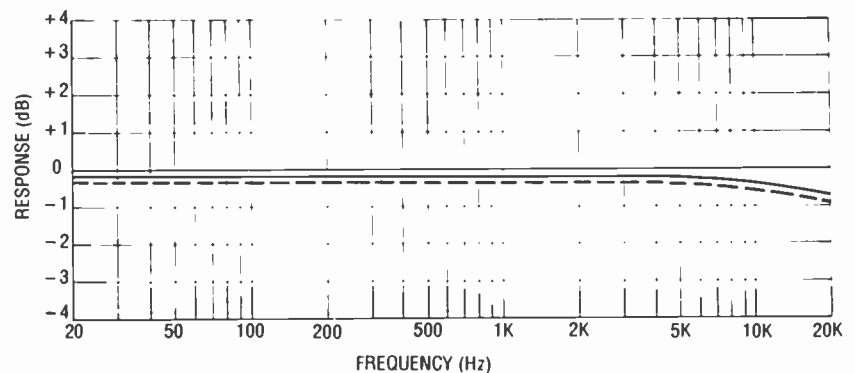

FIG. 8—SIGNAL LOSS OF 40 FEET of 12-gauge Romex cable.

# Earn Your B.S. Degree in ELECTRONICS or COMPUTERS



## By Studying at Home

Grantham College of Engineering, now in our 41st year, is highly experienced in "distance education"—teaching by correspondence—through printed materials, computer materials, fax, and phone.

No commuting to class. Study at your own pace, while continuing on your present job. Learn from easy-to-understand but complete and thorough lesson materials, with additional help from our instructors.

Our Computer B.S. Degree Program includes courses in the BASIC, PASCAL, and C languages — as well as Assembly Language, MS DOS, CADD, and more.

Our Electronics B.S. Degree Program includes courses in Solid-State Circuit Analysis and Design, Control Systems, Robotics, Analog/Digital Communications, and more.

An important part of being prepared to *move up* is holding the right college degree, and the absolutely necessary part is knowing your field. Grantham can help you both ways—to learn more and to earn your degree in the process.

Write or phone for our free catalog. Toll free, 1-800-955-2527, or see mailing address below.

Accredited by  
the Accrediting Commission of the  
National Home Study Council

**GRANTHAM**  
**College of Engineering**  
Grantham College Road  
Slidell, LA 70460

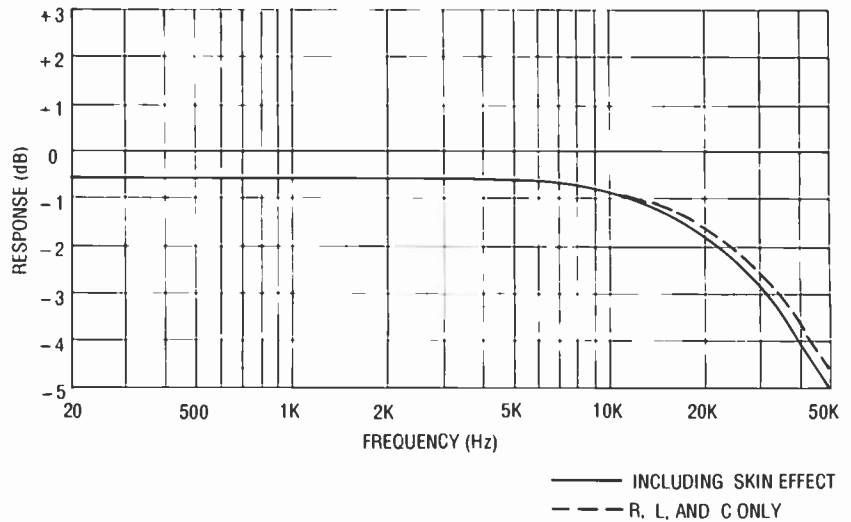

FIG. 9—SIGNAL LOSS OF 100 FEET of 12-Gauge Romex cable.

significant skin effect, and large ones will, but even a large percentage change in a large wire's small resistance is of little consequence. Trying the  $R_{AC}/R_{DC}$  values for various cable diameters in conjunction with the computer analysis, 12-gauge solid wire is found to have about the worst skin effect of any cable.

Therefore, if any type of speaker cable could cause frequency-response problems, the high capacitance and the skin effect of 12-gauge Romex should make it the ideal bad example. Another run was made using a 40-foot length of Romex, both into a dummy load and into the test speaker. In the graph of Fig. 8, we see a hefty ½-dB droop at 20 kHz, compared to the response at 20 Hz. The overall signal loss and damping-factor degradation are less than those of the smaller cables that are shown in Figure 8, due to the lower resistance of 12-gauge cable.)

Since that still wasn't significant, a computer simulation of 100 feet of 12-gauge Romex was performed, with response run clear out to 50 kHz. The results

are shown in Fig. 9. Here, at last, is something the beastie people can sink their teeth into! Anyone who can hear 50 kHz will find a full 4.5-dB drop resulting from the use of 100 feet of 12-gauge Romex—providing, of course, they're using an amplifier and speaker that can reproduce it. Of course, the skin effect is still only about half a dB, and effective damping is not degraded, so maybe they'd better drop those points from their ads.

The results of that rather involved bit of research clearly indicate that ordinary speaker cables, including the ones that any knowledgeable audiophile would sneer at, do not significantly degrade frequency response. They vindicate the rule-of-thumb advice (18-gauge for 100 watts, 25 feet, into 8 ohms) except for a slight degradation in damping factor: 1.21 with a 25-foot cable run. For optimum damping factor, that rule should be changed to 18-gauge for 100 watts, 20 feet, into 8 ohms. Also, only 20-gauge, 22-gauge, and guitar-cord cables are a serious detriment to damping factor.

R-E



# BUILD A NEGATIVE ION GENERATOR

LAST MONTH WE STARTED building our negative-ion generator. Let's now finish up the project. We were discussing the flyback transformer and what the various connections are used for.

Pin 7 is used as ground, since it presents the highest resistance between itself and the flyback transformer output lead, which is often quite short to avoid high-voltage breakdown, so be careful how much insulation you remove. The bottom of the voltage-tripler PC board, with D6, D8, and D10, and the attachment points of the ground wire and both high-voltage leads was shown in Fig. 5 in last month's article.

Figure 6-a shows the top of the main PC board mounted in the case and held down with RTV, while Fig. 6-b shows a drawn exploded rendition, giving the same components with greater clarity and definition, but adding the top of the voltage-tripler PC board, connecting leads, and emitter needle.

The wire shown balanced on top of the emitter needle in Fig. 6-b is the rotor for an ion motor discussed later. The foil pattern for the main PC board in the prototype differs from the one shown in this article, primarily due to T1 mentioned in the parts list, which differs from the one used in the prototype.

In the prototype, the resistances between the lower-voltage taps and the flyback transformer output lead were measured, and the tap corresponding to the highest resistance (about 100 ohms) was taken as the ground terminal, since it was electrically furthest from the output lead. The low-voltage taps generally have numbers stamped on the metal bracket surrounding the ferrite core, numbered clockwise.

***Build this negative ion generator and put some charge in your life.***

ANTHONY J. CARISTI



**WARNING!!** This article deals with and involves subject matter and the use of materials and substances that may be hazardous to health and life. Do not attempt to implement or use the information contained herein, unless you are experienced and skilled with respect to such subject matter, materials, and substances. Neither the publisher nor the author make any representation as for the completeness or the accuracy of the information contained herein, and disclaim any liability for damages or injuries, whether caused by or arising from the lack of completeness, inaccuracies of the information, misinterpretations of the directions, misapplication of the information, or otherwise.

In the prototype, the tap used as ground happened to be pin 7.

Although almost any flyback would work in this project, use one from a small-screen black-and-white TV. It'll usually be smaller and have a better turns ratio, but make sure it's wired for positive output, and has an open ferrite core for the new feedback and bifilar primary windings.

Note the manufacturer, model, and chassis number of the TV you salvage it from, in case you need more information about it later. Either that, or go to any TV service store and buy a new one, but know the specifics about it in advance, including the maximum safe flyback transformer output winding voltage, and the number of turns in the flyback transformer bifilar primary and output windings.

If your flyback transformer has a high-voltage diode attached to its output lead, remove it before adding the new feedback and bifilar primary windings. Then use an ohmmeter to find the transformer taps coming off of the flyback transformer output winding. One tap is the high-voltage common, originally going to the TV chassis; use the highest resistance tap as ground. In the version shown here, which was used in the prototype, pins 1-3 are hidden by the ferrite core, while pins 4-7 are shown.

Figure 7 is a magnified view of the feedback and bifilar primary windings, showing how they're added: use 20-24 gauge enamel wire, for ease of handling and adequate breakdown voltage. Use Mylar tape to insulate both new feedback and bifilar primary windings from the ferrite core. Start with the feedback winding,

wrapping a thin layer of tape around a clear part of the core where the feedback winding will go. Use nine inches of magnet wire, five inches for the turns themselves and two inches for each lead, and wind five close turns around the core.

At the end of the fifth turn, form a U-loop about 4 inches long as a center tap, and then wind an additional five turns in the same direction, as shown. Secure the feedback winding with tape, mark the start of the feedback winding with a "1," the U-loop with a "2," and the end with a "3," using masking tape; remember the direction of the feedback winding.

The bifilar primary winding is next. Although you can wind both halves adjacent to one another, as shown in Fig. 7, the performance should improve if you superpose them, actually winding one half on top of the other for optimal coupling. Twist two pieces of magnet wire together, with five turns spread along the entire length as a twisted pair, for close proximity between the two wires during the winding process. At one end of the twisted pair, mark one wire with a "4," and the other with a "5."

Obviously, for the center tap in the feedback winding, if you break the wire segment making the loop at the point where it bends, there's no electrical effect on the feedback winding, provided you route both segments of the loop (now two separate leads) to the same pad on the PC board. Thus, if you prefer, you can break the loop at the point of the bend.

However, in the case of the bifilar primary winding, you really should make an effort to superpose both halves, one on top of the other. However, if you do that, you have to wind both halves in the same direction, and in that case, if you bend the enamel wire into a loop, you'll have to spread both ends after completing the *first* half, in order to retrace it on the *second* half. Thus, it's probably easier in that case to physically break the wire, and wind the second half separately.

Start with those ends, and allowing four inches of lead length, wind six turns of twisted pair through and around the core in the same direction as the feed-

## PARTS LIST

**All resistors are 1/4-watt, 5%, unless otherwise noted.**

R1—1000 ohms, PC-board mounted potentiometer

R2—220 ohms

R3, R4—560 ohms (the former for the astable-flyback transformer combination, the latter optional for the battery-operated version)

R5-R6—200- and 40-megohm series high-voltage focus divider, RCA SK3868/DIV-1, used for an optional high-voltage range extender for a conventional high-impedance (10-megohm) voltmeter (see text)

R7—2.7 megohms

### Capacitors

C1—1000  $\mu$ F, 25 volts, electrolytic

C2—100  $\mu$ F, 16 volts, electrolytic

C3-C8—0.001  $\mu$ F, 10 kilovolts, ceramic disc

C9—0.001  $\mu$ F, 500 volts, ceramic disc, optional for aluminum can/neon bulb experiment (see text)

**Semiconductors** D1, D2—1N4004 silicon diode

D3, D4—1N4148 silicon diode

D5-D10—RCA SK3067/502 high-voltage diode, 12 kilovolts PIV

LED1—light-emitting diode for the battery-operated version

Q1, Q2—TIP31B NPN transistor

IC1—LM317T adjustable voltage regulator

### Other components

F1—0.5-amp slow-blow fuse with holder  
NE1—120-volt AC neon-bulb assembly with 47-100K built-in series resistor for the plug-in version (Radio Shack 272-712)

NE2—neon bulb, type NE2 (not the part number), optional for experiment (see text)

S1—SPST toggle switch

S2—SPST toggle switch

T1—18-volt center-tapped transformer (Radio Shack 273-1515)

T2—standard TV flyback transformer (see text)

**Miscellaneous:** Plastic case (7.5 x 4.25 x 2.25-inches, Radio Shack 270-224), enamel magnet wire, three-wire line cord, emitter needle (made from either straight pin or sewing needle), RTV silicon rubber, heat sinks, four alkaline "D" cells (optional for battery operation), 2-liter plastic soda bottle, and a sewing needle.

**Note:** The following are available from Anthony J. Caristi, 69 White Pond Road, Waldwick, NJ 07463: Two etched and drilled PC boards (one each for the main and voltage-tripler sections) for \$15.95, IC1 for \$3.25, Q1 and Q2 for \$2.75 each. Please add \$2.00 for postage and handling with each order; NJ residents please add 7% sales tax.

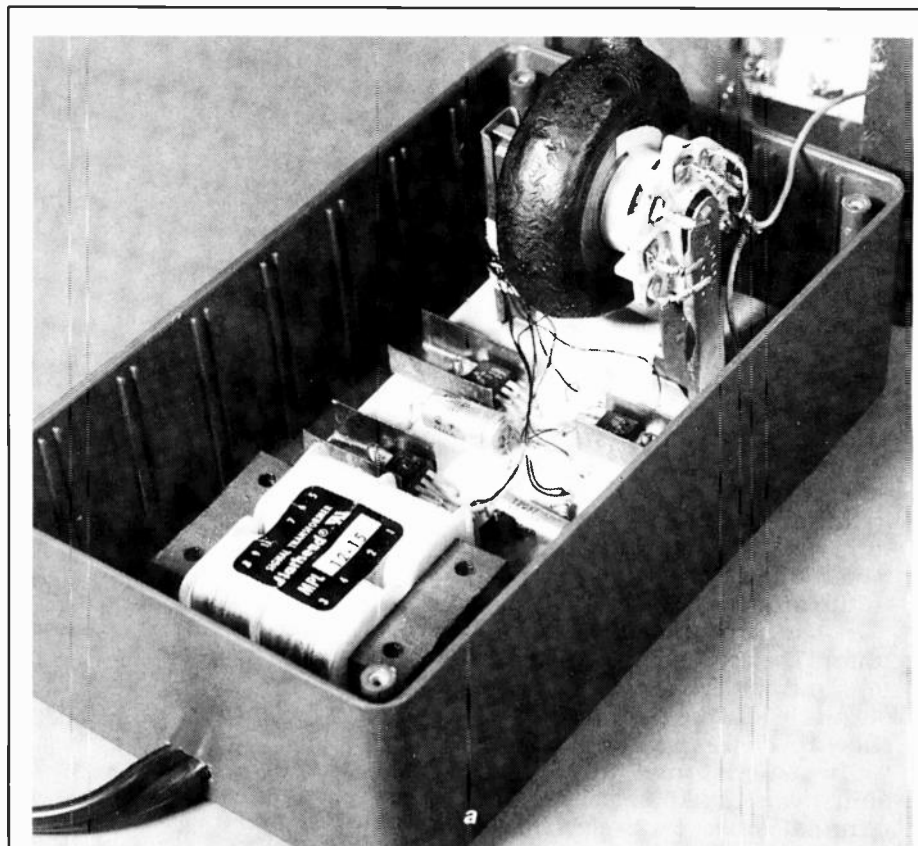

FIG. 6—THE TOP OF THE MAIN PC BOARD, held down with RTV (a), and an exploded view (b), with D2, D4, and D6 not visible. You can see the new feedback and bifilar primary windings, with Mylar tape insulating them from the ferrite core. The enamel leads are "1"- "6," as in Fig. 1; "2" and "5" are paired.

back winding. The directions of both new feedback and bifilar primary windings must be correct to achieve oscillation. Place the closely wound turns directly over the feedback winding, and secure the bifilar primary winding to the core with plastic tape.

Scrape away  $\frac{3}{8}$ -inch of enamel at the four ends of the bifilar primary winding, and locate the unmarked end connected to wire "4" with an ohmmeter. That's the center tap of the bifilar primary winding, and is marked with a "5." using a piece of masking tape. The duplication is deliberate, and it'll be connected to the other "5" wire later; mark the remaining wire with a "6."

You can also see the new feedback and bifilar primary windings, and the Mylar tape insulating them from the ferrite core. The enamel wires are numbered "1"-"6," as in Fig. 1; remember that "2" and "5" are paired. Lead "2" is really a loop in the feedback winding, with the enamel scraped off the end where it's bent and folds back, while "5" is

really two separate wires from the bifilar primary winding. In Fig. 6, on flyback transformer T2, you can clearly see the low-voltage taps. Their corresponding numbers are stamped on the metal frame of the ferrite core, increasing clockwise when facing the taps, so that pin 7, the ground, is at the lower right.

Mount the flyback transformer

to the main PC board with suitable hardware. Using Figs. 1, 2, and 7 as a guide, connect the feedback and bifilar primary windings after cutting the leads and scraping the enamel. Remember, there are two leads marked "2" and two marked "5," so don't mix them up. When finished, position the leads to avoid a short, and be sure the

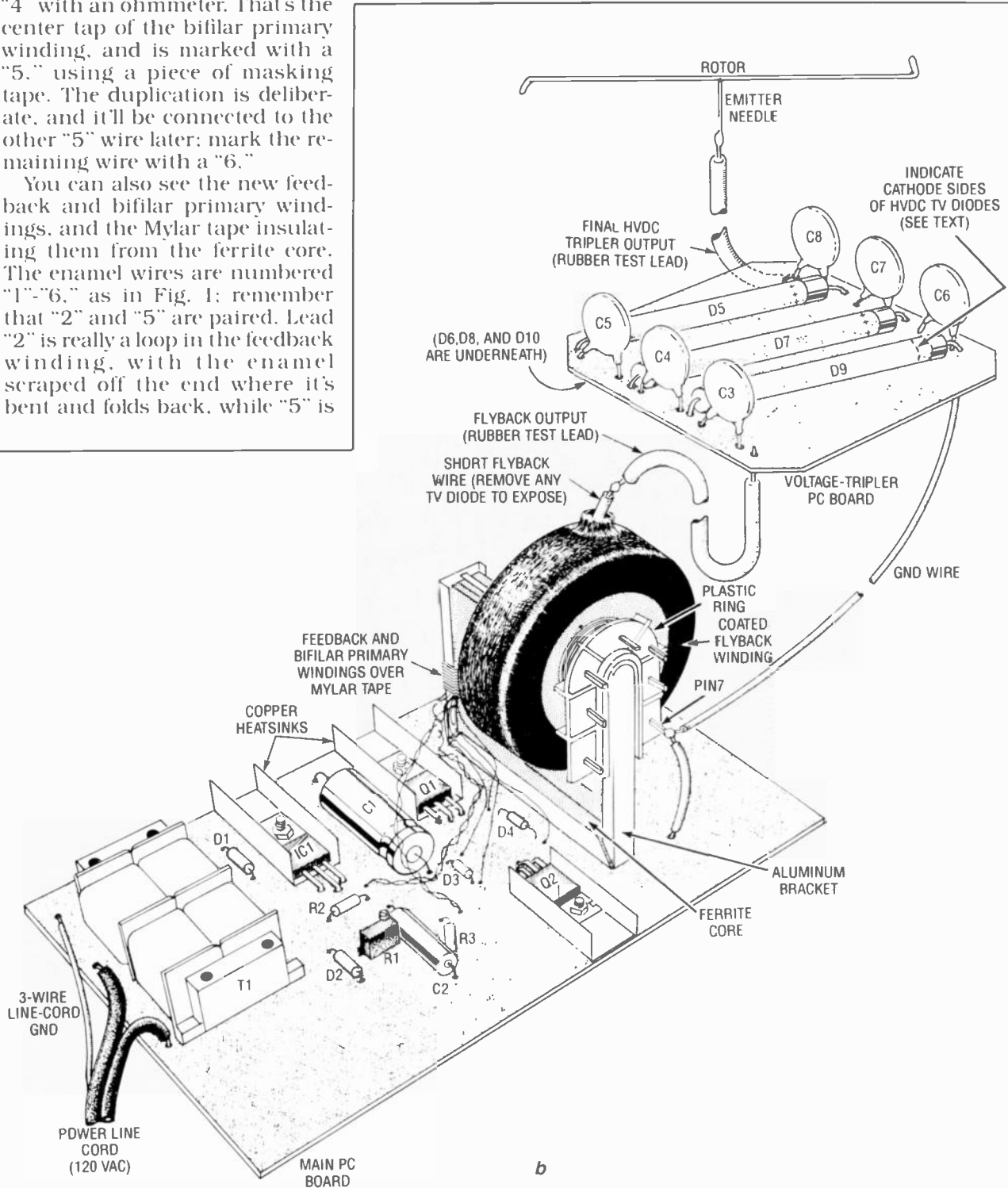

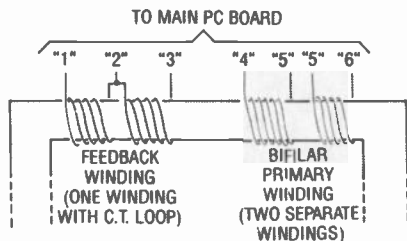

FIG. 7—THE NEW FEEDBACK and bifilar primary windings, wound on the ferrite core of the flyback transformer, using 20–24 gauge enamel wire and insulated from the ferrite core with Mylar tape. Do the feedback winding first, then the bifilar primary winding. Position all leads to avoid a short, and be sure the high-voltage common is grounded (see text).

high-voltage common goes to ground.

### Preliminary checkout

Check the power-supply before connecting the voltage tripler. Use a voltmeter to be sure the flyback transformer high-voltage output lead isn't shorted, or a shock hazard could occur; an oscilloscope would be useful. Also, you need some way to measure high voltage: if you don't have a high-voltage meter, you can use a voltage divider with a normal meter, as shown in Fig. 8 with a 100:1 ratio.

The RCA focus divider shown is a standard TV part, used to reduce the potential at the CRT anode for use on the focus electrode. It has a 200- and a 40-megohm resistor (R5 and R6) in series internally. To achieve 100:1 reduction, R6 goes in parallel with R7 (external) and a high-im-

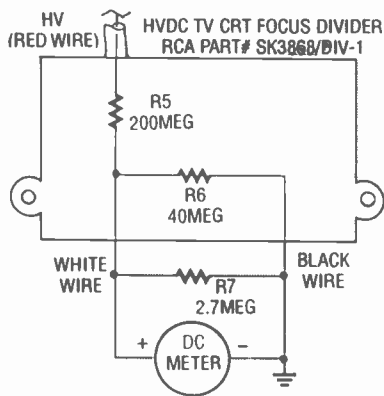
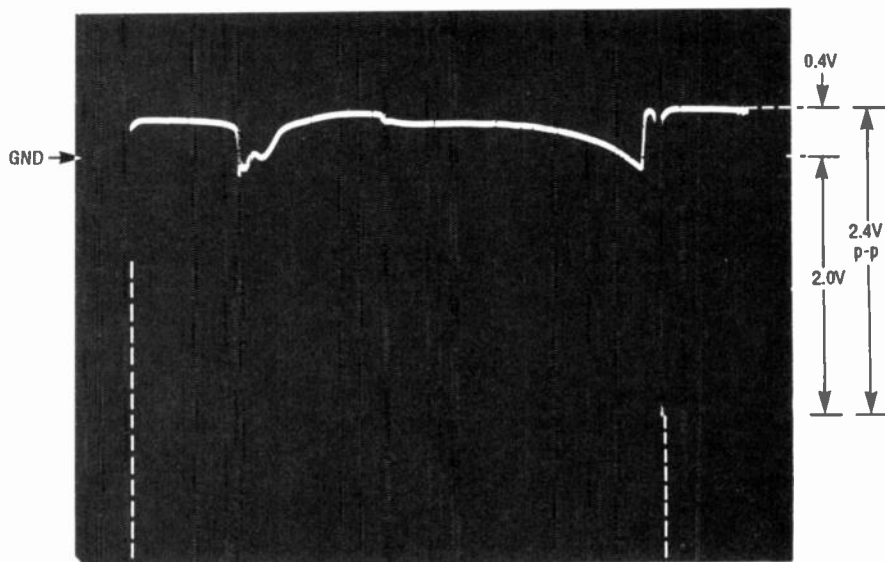

FIG. 8—IF YOU HAVE NO HIGH-VOLTAGE voltmeter, this RCA focus divider extends the range of a voltmeter with at least a 10-megohm input impedance by 100:1, so it reads up to 20 kilovolts on a 200-volt scale. R5 and R6 are in series, and R6 goes in parallel with both R7 and the DC voltmeter.

TYPICAL BASE WAVEFORM



TYPICAL COLLECTOR WAVEFORM

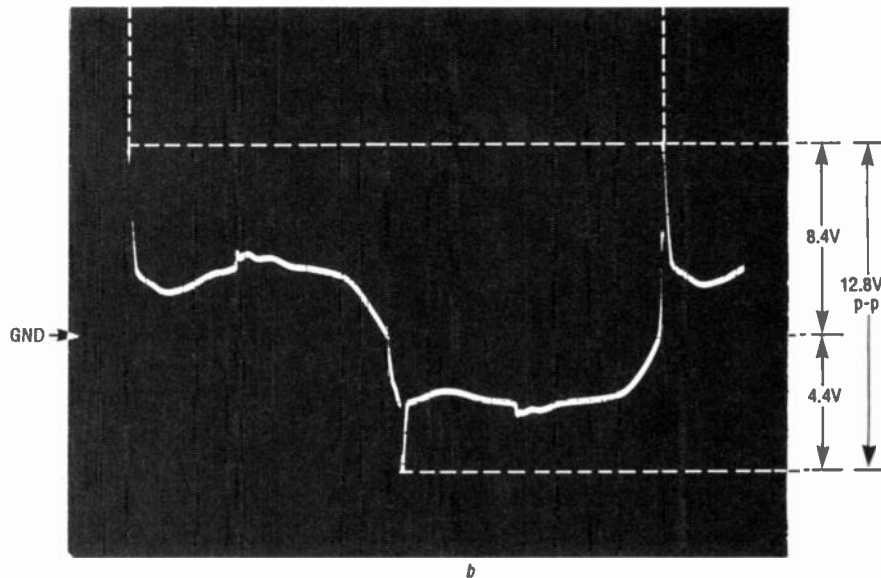

FIG. 9—NORMAL ASTABLE WAVEFORMS from the base (a) and collector (b) of either Q1 or Q2. With IC1 set to 3–4 volts DC, the fundamental is 23.26 kHz. Both are irregular, with sharp, narrow spikes, upward for the collector, downward for the base. The flyback transformer you use may create different waveforms, so expect variations.

pedance DC voltmeter. The DC voltmeter used needs at least a 10-megohm input impedance to avoid loading. If the meter is set to 200 volts full-scale, its full-scale range will now be 20 kilovolts.

Turn the power off before connecting to the final high-voltage output terminal at the anode of D10, and dissipate the remaining voltage to ground with an insulated clip lead. Set R1 midway, ap-

ply power, and measure the voltage across C2. As you adjust R1, you should see 1.25–5 volts DC or more. Set R1 for about 4 volts DC, and don't proceed until you do.

Check the orientation of all semiconductors and electrolytics, disconnect the bifilar primary winding center tap (marked with a "5") to remove the oscillator load, and troubleshoot the power supply until you find





THE FOIL PATTERN OF THE main PC board in the negative ion generator.

the fault. If you use batteries, be certain their terminal potential is at least 6 volts DC.

With IC1 set to 3–4 volts DC, measure the astable fundamental frequency with a scope, if possible: it should be about 20–30 kHz. Figure 9-a shows a typical collector waveform of the prototype, for either Q1 or Q2. Its amplitude is 2.4 volts p-p, double the DC voltage obtained from IC1: it goes 400 millivolts above ground, and 2 volts below. Fig. 9-b shows the base waveform: its amplitude is 12.8 volts p-p, going 8.4 volts above ground, and 4.4 volts below. Both of the waveforms are quite irregular, with sharp spikes, upward for the collector, downward for the base, generated by the high inductance of the flyback transformer output winding.

Since the inductance, resistance, and number of turns in whatever flyback transformer you use may differ considerably

by comparison with the version used in the prototype, as well as the current gains and saturation voltages of both Q1 and Q2, the waveforms shown here may also vary considerably, so expect variations. The waveforms shown here are shown purely to illustrate typical responses, *not* as ironclad guarantees of what you'll see.

If you don't have a scope, touch a large screwdriver with a plastic handle to the flyback transformer output. If the oscillator isn't running, there'll be no spark, so the phasing is wrong. Try reversing wires "1" and "3," and then check the orientation of Q1, Q2, D3, and D4, and the T2 connections. When you get the astable working, disconnect the power and let C1 and C2 discharge.

#### Final checkout

Connect the voltage-tripler to the flyback transformer. For the

connection from high-voltage winding to transformer and C3, use wire rated to at least 5 kilovolts, preferably 18-gauge rubber-covered test lead. The common of the high-voltage assembly can be made using ordinary hookup wire since it's at ground potential. Don't forget the transformer and voltage tripler common connections.

With the circuit fully assembled and power off, connect the high-voltage voltmeter adapter or a high-voltage DC voltmeter to the emitter needle and common with suitable clip leads. Don't go near the high-voltage output, and position the clip leads to avoid arcing. Apply power, and note the meter, adjusting R1 for –9 to –14 kilovolts. Any more, and you'll generate ozone, an undesirable byproduct, which has a peculiar odor. Correct any arcing or corona by insulating the connection with RTV.

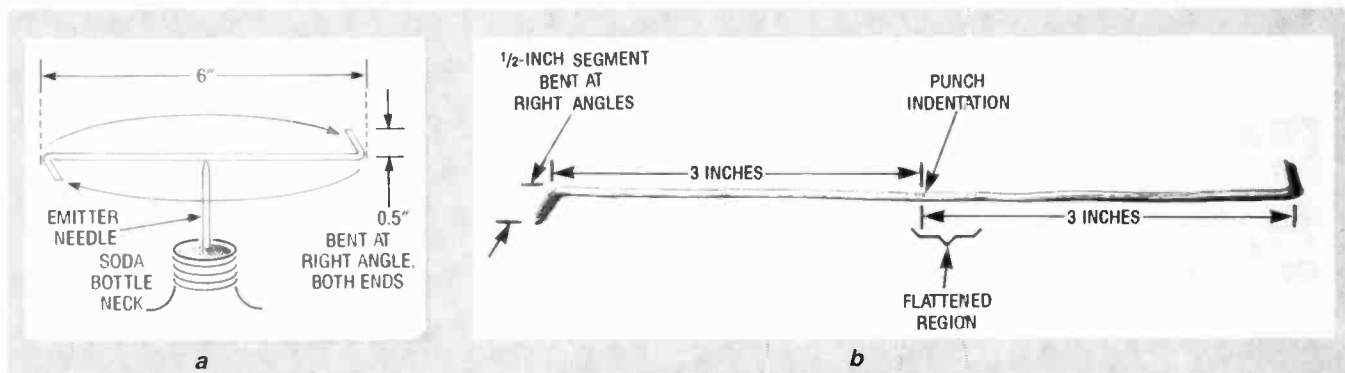

FIG. 10—THE ROTOR FOR AN ION MOTOR; it's a 7-inch piece of 16" gauge wire, with two 1/2-inch pointed ends at right angles to the 6-inch center section, as shown in (a). The center is flattened, with an indentation made in the middle with a punch (b).

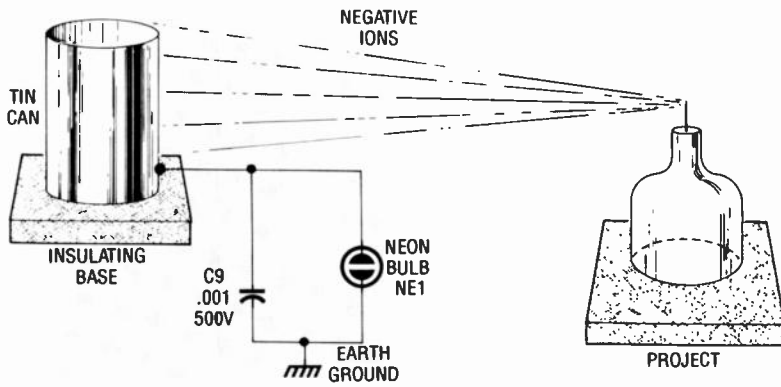

FIG. 11—AN EXPERIMENT TO SHOW NEGATIVE ions charging a nearby insulated metal object to high voltage. Negative ions travel through the air, collecting on the empty can on a rubber mat, with an earth ground. As negative ions hit the can, charge builds; at 90–100 volts DC, NE2 fires. The flash rate increases as distance decreases, or when the emitter is aimed at the can.

Don't arc the high voltage to ground with power on to observe a spark, or you'll damage the high voltage rectifiers. You should do so when power is off, when no shock hazard exists. Unplug the line cord and touch the ground prong to the emitter needle; otherwise you can use an insulated clip lead connected to ground on battery-operated versions.

### Using the ion generator

You can use the negative ion generator as an air purifier, to clear a room of smoke, dust, or pollen. As the negative ions are generated, they'll attach them-

selves to any particles, and fall to the floor or a nearby grounded object. Other phenomena can also demonstrate that it really does emit negative ions. The "ion motor" is quite dramatic, and proves the existence of negative ions and that they can perform work. Ion propulsion is a viable means of space travel, since escaping ions at high velocity can produce speeds approaching the speed of light in free space. The ion-motor experiment demonstrates the principles that are involved with Newtonian action and reaction.

An ion motor can be built as shown in Fig. 10; it's just a 7-inch

piece of gauge 16 wire with both ends sharpened to fine points, and bent at right angles, as depicted in Fig. 10-a. The bent ends are each 0.5 inch long, while the main body of the rotor is 6 inches long. The middle of the center section is slightly flattened in a vise, and an indentation is made on one side with a punch, in the exact center of the 6-inch segment, as shown in Fig. 10-b. You have to find the exact balance point, in order to balance the rotor on the emitter needle at the indentation point of the 16 gauge wire.

However, Fig. 10-b shows the rotor from below, with the right tip pointing upward, and the left tip pointing downward. Thus, the rotor shown rotates clockwise when viewed from below, and counterclockwise when viewed from above. When the indentation is on the bottom (the right tip pointing downward and the left pointing upward), the reverse is true. In Fig. 10-a, the rotor shown rotates clockwise when viewed from above, since the tips are reversed in orientation to those of Fig. 10-b. You can obviously make the rotor turn in either direction as long as both rotor tips face in opposite directions.

The emitter needle won't work with its point covered. Instead, the ends of the rotor now become the emitters. Since negative ions are emitted in opposite directions from each end, it spins like an aircraft propeller, reaching high angular speed in just a few seconds.

Actually, the word "emitted" is a misnomer, since neither the needle nor the rotor actually absorb or generate ions, per se. Rather, polarized air molecules collide with the surface of the pointed tips of either the needle or the rotor, absorbing electrons from the molecules, or releasing them to un-ionized atoms. The absorption process produces positive ions, the latter generation process produces negative ions.

Since the effective discharge surface area is doubled when using the rotor, as opposed to the needle, the negative ion density emitted from each rotor tip is about half of that emitted from

*continued on page 70*



THE FOIL PATTERN OF THE voltage-tripler PC board in the negative ion generator.

# HOT TROUBLESHOOTING TIPS

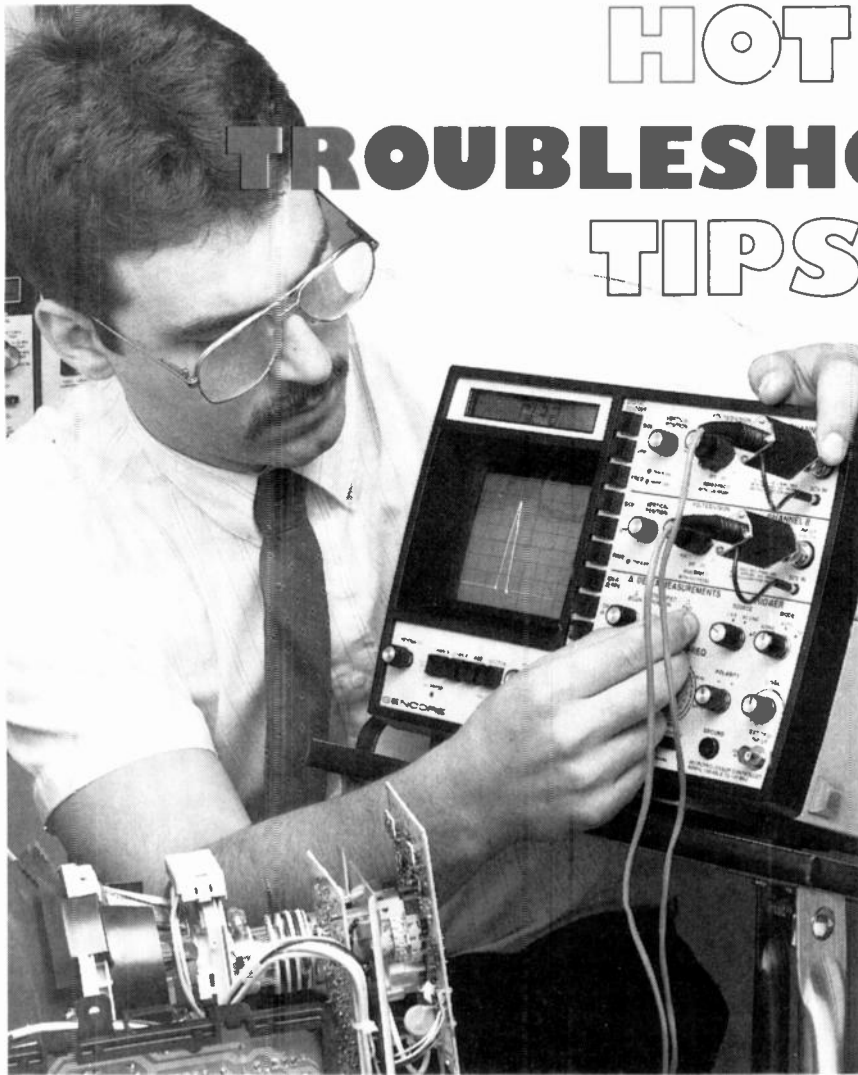

*The horizontal output transistor is a critical component in any TV set. Let's examine some of the procedures involved in measuring its output.*

BRIAN PHELPS

FOR ANYONE WHO HAS EVER TRIED TO repair a television with defective signals throughout, or changed a horizontal output transistor only to have it fail once more, we have a technique that can save hours of work and needless replacement of parts. All you have to do is check the "HOT pulse," or the signal at the collector of the horizontal output transistor. Let's see why this waveform is so important, and some key procedures for measuring the signal.

The HOT pulse is important because it performs many functions other than just sweeping the CRT beam horizontally. Some of the key functions of the horizontal output waveform are:

- It generates 0.7 amps of horizontal deflection current every 63.5 microseconds.
- It generates a 700–1,500 volts peak-to-peak retrace pulse every 63.5 microseconds.

- It generates 15,000–30,000 volts DC for the picture tube.
- It generates 3,000–8,000 volts DC for the focus circuit.
- It delivers "trace-derived" high-current DC power from 16 to 30 volts to operate most circuits.
- It delivers "retrace-derived" low-current DC power of 185 to 220 volts.
- It provides 6.3 volts for the pulse current of CRT filaments.
- It is a critical safety feature.
- It provides accurate pulse voltages for the tuner's frequency-synthesis power source.

#### What to look for

The horizontal output pulse supplies operating voltages for the entire TV. It is therefore the most important waveform to check on every TV before and after changing parts. **Note:** In order to make any of the following measurements, your scope

must be capable of measuring, and have input protection up to 2 kilovolts or more. Also, a digital-readout oscilloscope, although not essential to troubleshooting, will make it easier to make the measurements.

The first thing to check when analyzing the horizontal output pulse is the wave shape; it should look like the one shown in Fig. 1, and be symmetrical in shape during the retrace time. A wide peak at the top of the retrace, or deep saddle conditions, can be caused by an off frequency or glitch in the horizontal transistor base-drive signal. Such problems are often caused by a change in the value of the output-transistor timing capacitors, or by an excessive load on a B+ supply.

Any excessive ringing or noise is a clear indication of deflection-system problems, such as a cracked integrated high voltage

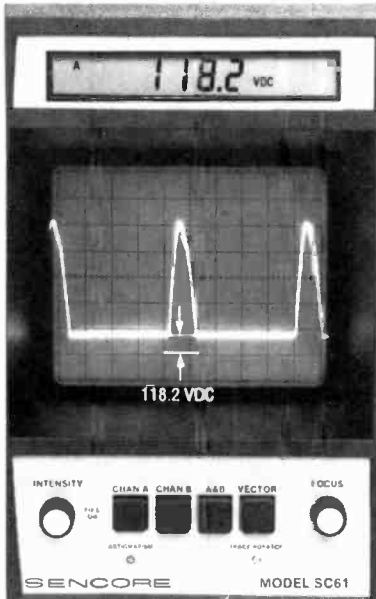

**FIG. 1—THE WAVE SHAPE** should be symmetrical during the pulse retrace time.

transformer (IHVT) core, or open or shorted IHVT windings. Figure 2 shows an example of a faulty horizontal output. Make sure the waveform looks good before you proceed.

Check to see if there are any noise pulses during the trace time. Many of the noise pulses may not be detected when viewing the low-level horizontal waveforms, but they become very noticeable at the collector with

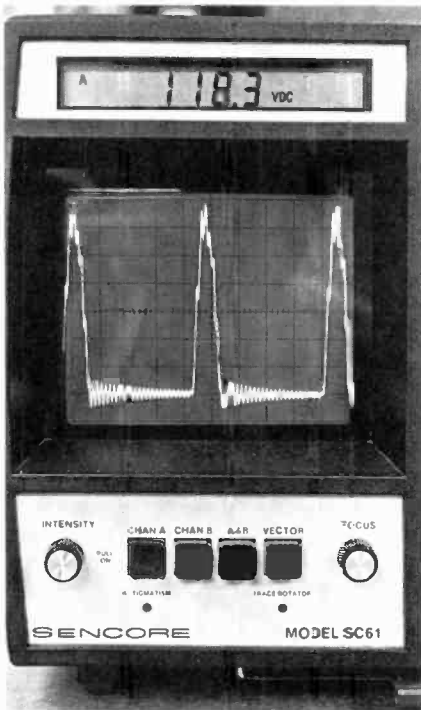
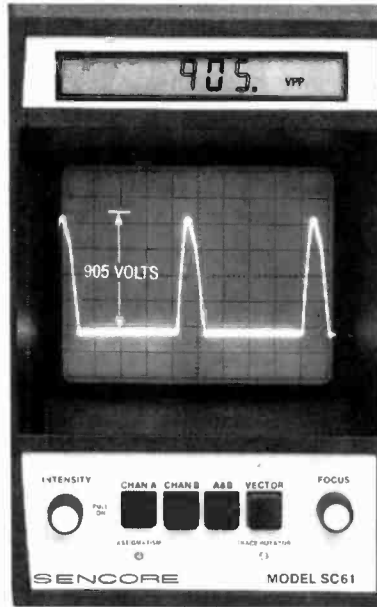

**FIG. 2—HERE'S AN EXAMPLE** of a faulty horizontal output. Make sure the waveform looks good before you check anything else.

an amplitude reaching 1500 volts peak-to-peak. The noise could cause symptoms from drive lines in the video picture to faint noise throughout the TV's circuits.

First measure the DC voltage level of the horizontal waveform. In Figs. 1 and 2 you can see that the digital display shows approximately 118 VDC, which is the regulated B+ voltage. Next measure the peak-to-peak voltage of the waveform. As you can see from Fig. 3, the display shows 905 volts peak-to-peak.

The frequency of the waveform must also be measured. That's as simple as pushing a button on a digital scope. Figure 4 shows the

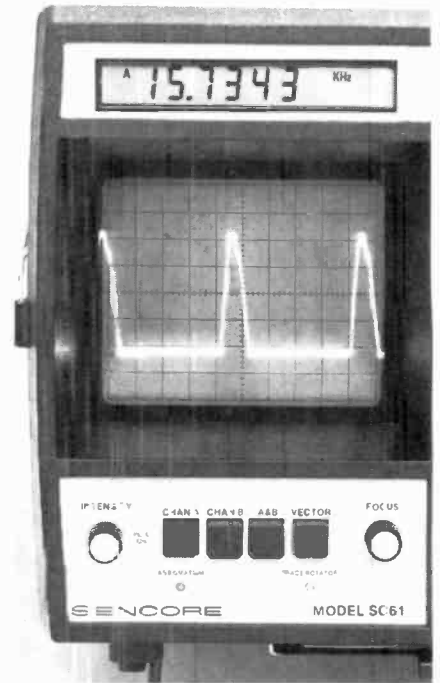

**FIG. 3—THE PEAK-TO-PEAK** voltage of the waveform should be between 900 and 1500 volts peak-to-peak. It's shown here as 905 volts peak-to-peak.

frequency to be 15.7343 kHz. If everything checks out so far, you know the condition of the regulated B+ supply, that the TV is not in the shut-down mode, and that the horizontal oscillator is locked to the composite video sync pulse.

The duty cycle of the horizontal transistor output waveform is helpful in troubleshooting. The manufacturer specified that the retrace time should be from 11–14 microseconds, and the trace time should be 49–50 microseconds. Those recommended duty cycles should be observed when troubleshooting.

The time-duration measurement of the retrace pulse should be made between the 10% levels



**FIG. 4—THE FREQUENCY** of the waveform is important; here it is measured to be 15.7343 kHz.

of the waveform. Some digital scopes are equipped to measure portions of a waveform with a delta-time feature. To make that measurement on a digital scope, align the pulse so that the top of it is at the 100% graticule marking and the bottom is at the 0% marking, using the volts/division and calibration knobs. (Make sure your scope will allow accurate measurement.)

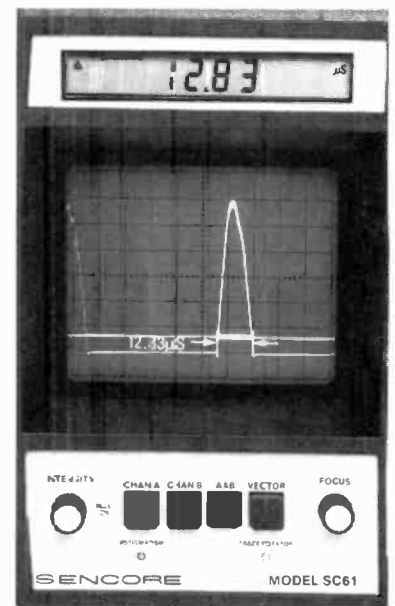

**FIG. 5—THE TIME DURATION** of the retrace pulse should be between 11 and 14 microseconds; 12.83 microseconds in this case.

MOST PEOPLE INVOLVED IN ELECTRONICS, either as a hobby or a profession, start out by building simple electronic kits. Along the way, they become familiar with electrical terms like voltage, current, resistance, power, and energy, developing a "common-sense" knowledge of them, without fully understanding their meaning.

When asked, "What is a volt?", one might be tempted to respond by quoting Ohm's law: "If 1 amp flows through a 1-ohm resistor, a 1-volt potential is developed across it." That definition, however, isn't much help in defining a volt because one electrical term is used to define another, which

**Here's a  
refresher course  
that will help you  
brush up on  
standard  
electric quantities.**

mass is the kilogram, kg, which is 1000 grams, the variable being either m or M. The difference in usage is that m, with or without subscript, normally denotes the mass of an object. While M can also be used this way, it generally refers to very large, celestial bodies, such as the earth, sun, and moon.

Mass is a measure of quantity, not to be confused with weight. Weight is the force due to gravity, which varies slightly over the surface of the earth, due to the change in altitude relative to sea level. The standard kilogram is a platinum-iridium (Pt-Ir) alloy cylinder at the International Bureau

# 1 VOLT = ?

DALE NASSAR

leads to vicious-circle reasoning. A proper definition of electrical quantities demands examining length, time, mass, force, charge, and some simple atomic physics.

### Standard units

In any scientific field, accurate and reproducible measurements must be possible. The results of a scientific experiment must be described in well-defined units. Since the metric system will eventually prevail worldwide, all derivations here will be metric, although British units will be mentioned occasionally, as a frame of reference.

We'll now examine length, time, and mass, the basic units from which all other quantities are derived. In some cases, a given letter may have multiple uses as a variable and/or a unit, such as the letter C, which is used as both the variable of capacitance, and the unit of charge. Italic lettering will be used when a label is used as a variable, to avoid confusion. Thus, *C* will denote the variable of capacitance, while C will indicate the coulomb.

The standard variable for

length is *l*, although other variables are similarly used, especially *d* for distance, *s* for displacement, and *x*, *y*, and *z*, relative to a set of axes. The standard metric unit of length is the meter, abbreviated m, equal to 39.37 inches. The meter is defined as 1,650,763.73 wavelengths of orange-red light emitted by Krypton (Kr)-86 in electrical discharge, a phenomenon that can be remeasured with great precision and comparative ease, given the right equipment.

The standard variables for time are *t* and *T*, and the standard unit is the second, s. Normally, *t* with no subscript is considered to be time as a running, independent variable. By contrast, *t* with a subscript, like *t<sub>0</sub>*, *t<sub>1</sub>*, and so on, indicates either an initial or specific reference time. The variable *T*, with or without subscripts, is normally used in electronics to indicate either periods or specific times on waveforms. One second is defined as 9,192,631,770 cycles of radiation from Cesium (Ce)-133. Clocks using Ce-133 from Hewlett-Packard (HP) Corp. are typically accurate to 1 ps.

The standard metric unit of

of Standards (IBS), in Sevres, France. When an object exactly balances the 1-kg standard on a balance, it's said to be a 1-kg mass, weighing about 2.21 lbs on earth. The British equivalent of the kilogram is the slug, where 1 slug = 14.59 kg.

The first derived quantity is force, *F*. The metric unit is the Newton, *N*, named after Sir Isaac Newton. Thus, 1 N is the force (a push or pull) needed to accelerate a 1-kg mass at 1 m/(s<sup>2</sup>), written as 1 N = 1 kg × m/(s<sup>2</sup>); this nomenclature is explained below. Note how this definition uses length, mass, and time. For example, suppose you have a toy car with a mass of 1 kg, and you move it along the surface of a long smooth table. Neglecting friction, no additional force is needed to keep the car moving at its present velocity, the variable for which is *v*.

However, to accelerate or decelerate an object means to change its velocity, whether in magnitude (speed) or direction. To do so always requires a force, even in space, in the absence of gravity. If the car uniformly accelerates at 1 m/s per second, that means its speed increases by an

additional 1 m/s with each passing second. The variable for acceleration is  $a$ , while deceleration is a negative acceleration. On or near the earth's surface, the acceleration due to gravity is presumed constant for practical purposes, and is denoted by  $g = 9.8 \text{ m/(s}^2) = 32.2 \text{ ft/(s}^2)$ . Thus,  $1 \text{ kg} = 9.8 \text{ N}$  on earth, and since  $1 \text{ kg} = 2.21 \text{ lbs}$ , then  $9.8 \text{ N} = 2.21 \text{ lbs}$ , or  $1 \text{ N} = 0.225 \text{ lb}$ .

A concept that's very closely related to force is momentum ( $p$ ), also known as impulse and is the product of mass times velocity. Momentum is defined by  $p = m \times v = F \times t$ . Momentum, like velocity, acceleration, and force, is a vector quantity, in that it has both a magnitude and a direction, whereas energy (whether kinetic or potential) is a scalar, possessing only a magnitude.

Throughout this article, we'll discuss several other derived units, all of which are listed in Table 1.

### The discovery of electric charge

Electric charge was first recorded in 550 B.C. by Thales of Miletus (Greece, c. 640–546 B.C.). He noted that if amber were rubbed with fur, it attracted small objects, such as bits of cork. The Greek word for amber is "elekton," the origin of "electricity." He also found that other objects reacted similarly if rubbed with a suitable material. Such objects, after rubbing in this fashion, possess a net electric charge, or become electrified. A glass rod will become electrified when rubbed with silk, and a lucite or hard rubber rod will become electrified when rubbed with fur.

Both rods contain different kinds of electric charge, shown by the simple experiment in Fig. 1. If the electrified glass rod is suspended at its center by a long thin thread so that it rotates easily, it's repelled by a second similarly charged glass rod nearby, as shown in Fig. 1-a. If the charged lucite rod is brought near the charged glass rod, attraction occurs, as shown in Figure 1-b. That simple experiment illustrates the basic principle where it can be observed that two similarly charged objects repel, while two oppositely charged objects attract.

One very important property of

TABLE 1—LIST OF PRINCIPAL

Quantity	Variable(s) and defining equations	Unit (MKS unless otherwise noted)	Dimensional Equivalents
Length (distance or displacement)	$l, d, s, x, y, z$	meter (m)	m
Time	$t, T$	second (s)	s
Mass	$m, M$	kilogram (kg)	kg
Velocity (magnitude is speed)	$v$	m/s	m/s
Acceleration	$a$ (general)	$\text{m/s}^2$	$\text{m/s}^2$
	$g$ (due to gravity)	MKS: $9.8 \text{ m/s}^2$	
		CGS: $32.2 \text{ ft/s}^2$	
Force (a push or pull)	$F (= m \times a)$	Newton (N)	$\frac{\text{kg} \times \text{m}}{\text{s}^2}$
Momentum (impulse)	$p (= F \times t)$ $(= m \times v)$	$\frac{\text{kg} \times \text{m}}{\text{s}}$	$\frac{\text{kg} \times \text{m}}{\text{s}}$
Energy (work)	$W$	joule (J)	$\frac{\text{kg} \times \text{m}^2}{\text{s}^2}$
Charge, or electric flux	$q, Q, \Phi_D$	coulomb (coul or C) for charge, or lines for electric flux	$6.24 \times 10^{18}e$
Electric potential (EMF or voltage)	$V$	volt (V), or J/C	$\frac{\text{kg} \times \text{m}^2}{\text{C} \times \text{s}^2}$
Current	$i, I$	ampere (A)	C/s
Power	$P$	watt (W), or J/s	$\frac{\text{kg} \times \text{m}^2}{\text{s}^3}$
Power density	$S$	$\text{W/m}^2$	$\text{kg/s}^2$
Electric field strength (or intensity)	$E$	V/m	$\frac{\text{kg} \times \text{m}}{\text{C} \times \text{s}^2}$
Electric flux density	$D = \Phi_D/A$	$1\text{C/m}^2$ $= 1\text{A} \times \text{s/m}^2$	$1\text{C/m}^2$
Magnetic field strength (or intensity)	$H$	A m	$\frac{\text{C}}{\text{m} \times \text{s}}$

charge is *conservation*. In any closed circuit involving capacitors, if a charge of  $-Q$  appears on one plate, an opposite charge of  $+Q$  must correspondingly appear on the other plate. In a circuit that's off, the total initial displaced charge must be zero. For charge to be conserved, that

must also apply when the circuit is on. Thus, in any closed circuit, the net displaced charge must be zero, which is something that becomes very important when discussing capacitance.

### The atom

To thoroughly understand elec-

## AND DERIVED QUANTITIES

Quantity	Variable(s) and defining equations	Unit (MKS unless otherwise noted)	Dimensional Equivalents
Magnetic flux	$\Phi_B$ $= B \times A$	CGS: maxwell	$\frac{g \times cm^2}{C \times s}$
		MKS: 1 Wb = 1 V × s 8 = 10 maxwell	$\frac{kg \times m^2}{C \times s}$
Magnetic flux density	$B = \mu \times H$	CGS: 1 gauss (G) = 1 maxwell/cm <sup>2</sup>	$\frac{g}{C \times s}$
		MKS: 1 tesla (T) = 1 Wb/m <sup>2</sup> = 1 V × s/m <sup>2</sup> = 1 N/(A × m) 4 = 10 G	$\frac{kg}{C \times s}$
Current density	$J = I/A$ , $= \Sigma \times E$	$\frac{C}{m^2 \times s}$	$\frac{C}{m^2 \times s}$
Resistance	$R = V/I$ $= \frac{\rho \times l}{A}$	$\Omega, V/A$	$\frac{kg \times m^2}{s \times C^2}$
Conductance	$G = 1/R$	siemen (S), A/V [formerly the mho ( $\Omega$ )]	$\frac{s \times C^2}{kg \times m^2}$
Resistivity	$\rho$ $= \frac{R \times A}{l}$	$\Omega \times m$	$\frac{kg \times m^3}{s \times C^2}$
Conductivity	$\Sigma$ $= 1/\rho$	S/m	$\frac{s \times C^2}{kg \times m^3}$
Permittivity	$\epsilon$	F/m	$\frac{C^2 \times s^2}{kg \times m^3}$
Permeability	$\mu$	H/m	$\frac{kg \times m}{C^2}$
Capacitance	$C$ $= q/V$ , $= \tau/R$ , $= \epsilon \times A/d$	farad (F), C/V or S × s	$\frac{C^2 \times s^2}{kg \times m^2}$
Inductance	$L = \tau \times R$ , $= \frac{\mu \times N^2 \times A}{l}$	henry (H), $\Omega \times s$	$\frac{kg \times m^2}{C^2}$

tricity requires understanding matter. All matter is composed of one or more elements that can't be chemically decomposed any further, like gold (Au), aluminum (Al), and silicon (Si). The smallest complete subdivision of an element is the atom, as shown in Fig. 2, with an extremely dense

central nucleus, containing one or more positively charged protons, and neutral particles called neutrons, and one or more negatively charged electrons, equal to the number of protons.

The atom in Fig. 2 is lithium (Li), the third simplest atom. Normally, Li has three electrons or-

biting a nucleus with three protons and three neutrons. The electrons are much lighter than the protons and neutrons, and orbit the nucleus at very high speed. If electron orbits were drawn to scale relative to the nucleus, they'd go way off the page.

All electric charge is quantized, or composed of packets of charge. The magnitude of charge depends on the number of electrons extra or absent. A single electron is the smallest unit of charge, usually denoted "e", and the magnitudes of all other charges are then integer multiples of e.

The charge on an electron is defined as negative, while that on a proton is positive. However, the charges are identical in magnitude.

Normally, unionized atoms have as many electrons as they do protons. The opposite charges cancel, leaving no net charge. Electrons have particular orbits about a nucleus; the closer their orbit is to a nucleus, the tighter they're held. The outer electrons are easily removed by friction or light, leaving the atom with a net positive charge, since it would then contain more protons than electrons. An atom may also gain extra electrons, leaving it with a net negative charge; that's why rubbing an object produces net surface charge.

When lucite is rubbed with fur, electrons are transferred from the fur to the rod since they're more loosely bound to the fur than the rod, leaving the rod with excess electrons and a net negative charge (the fur becomes positively charged). When glass is rubbed with silk, electrons are transferred from the glass to the silk (they're more loosely bound to the glass than the silk), leaving the glass with a net positive charge.

### Electric field and Coulomb's law

Electric energy, which acts in a space surrounding an electric charge or charged body is called "lines of force." Figures 3-a and 3-b show the lines of force of isolated positive and negative charges, respectively. Figures 3-c and 3-d show the force field produced by two like charges and two unlike charges, respectively. The arrows in the diagrams rep-

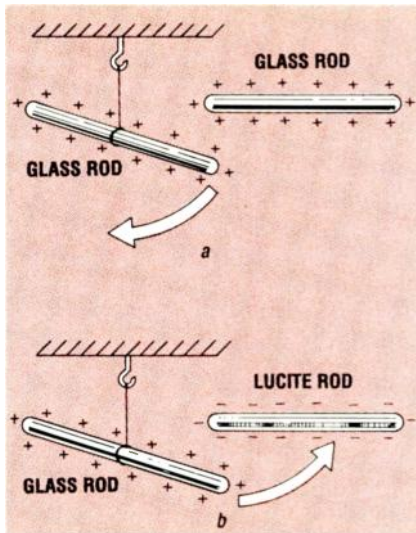

FIG. 1—THIS EXPERIMENT illustrates the acquisition of electrostatic charge. The glass rods in (a) are both positively charged. If one is suspended at its center by a long thin thread so it rotates easily, it will be repelled by a second one brought nearby. If a negatively charged lucite rod is brought near the positive glass rod, attraction occurs, as shown in (b).

resent the direction of force on a positive charge, and the field lines emanate from the charge in all directions. The relative density of the field lines is proportional to the field strength.

In 1785, Charles Augustin Coulomb (France, c. 1736–1806) used a torsion balance to perform delicate experiments to learn about electric forces between

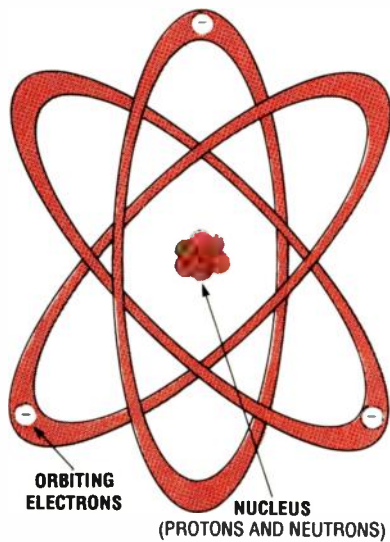

FIG. 2—THE SMALLEST complete subdivision of an element is the atom, as shown here for lithium (Li). The electrons are much lighter than the protons and neutrons, and orbit the nucleus at high speed. If electron orbits were drawn to scale relative to the nucleus, they'd go way off the page.

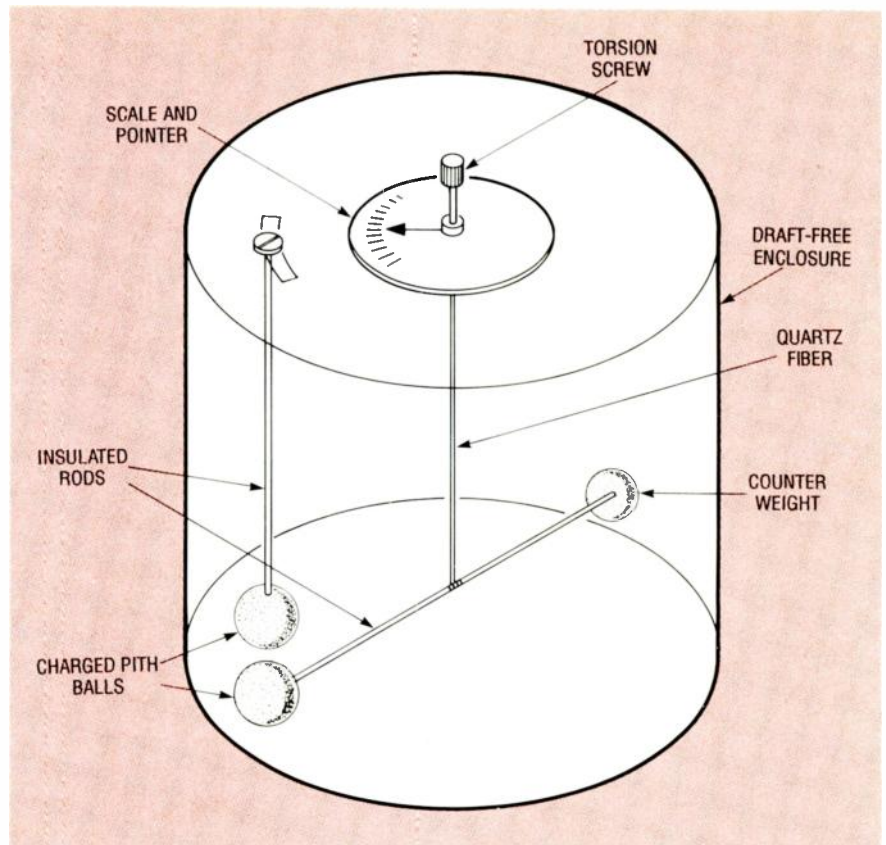

FIG. 3—THESE ARE "LINES OF FORCE" DIAGRAMS, (a) and (b) are isolated positive and negative charges, (c) and (d) are two like charges and two unlike charges, respectively.

pairs of charged objects; a basic version is shown in Fig. 4. The force between the charged balls is determined from the torsion (twist) in the quartz fiber.

Coulomb found that the force,  $F$ , between charges  $Q_1$  and  $Q_2$  is directly proportional to their product, and inversely proportional to the square of their separation,  $R$ . That relationship is known as Coulomb's law, and is expressed as  $F = k(Q_1 \times Q_2)/(R^2)$ , where  $k$  is the Coulomb proportionality constant, which depends on the medium. Coulomb's Law is only valid for  $R$  much greater than the radii of  $Q_1$  and  $Q_2$ . The units of  $F$  are in Newtons,  $N$ , while  $R$  is in meters,  $m$ . The signs of  $Q_1$  and  $Q_2$  depend on the type of net charge, whether + or -

The unit of charge is the coulomb,  $C$ . In a vacuum,  $k = 9 \times 10^9 (N \times m^2)/C^2$ ; the value in air is slightly higher. If  $Q_1 = Q_2 = 1 C$ , and  $R = 1 m$ , then  $F = 9 \times 10^9 N$ . Thus,  $1 C$  is the charge, that when in vacuum  $1 m$  from a similar charge of identical or opposite sign, yields either a repulsion or attraction, respec-

tively, of  $9 \times 10^9 N$ .

The magnitude of the electron charge  $e$  was first measured in 1909 by Robert Andrews Millikan (USA, c. 1868–1953). Measuring the charges on charged droplets of oil suspended against gravity in an electric field, he found that all charges are integer multiples of  $1.6 \times 10^{-19} C$ /electron, or  $6.25 \times 10^{18}$  electrons/ $C$ .

As stated above, a charged particle in an electric field is subject to a force. If electrons aren't tightly bound, as in the outer orbits of metal atoms, they actually move; such materials are conductors. Materials where essentially no charges are free to move are non-conductors, or insulators. Different types of materials have different degrees of conductivity. The unit of conductivity is the Siemen ( $\sigma$ ), which is the reciprocal of resistance, which we will discuss shortly.

### Electric current and the ampere

Since conductors contain relatively mobile electrons, many are always in motion even in the absence of electric field due to random thermal vibration. Such



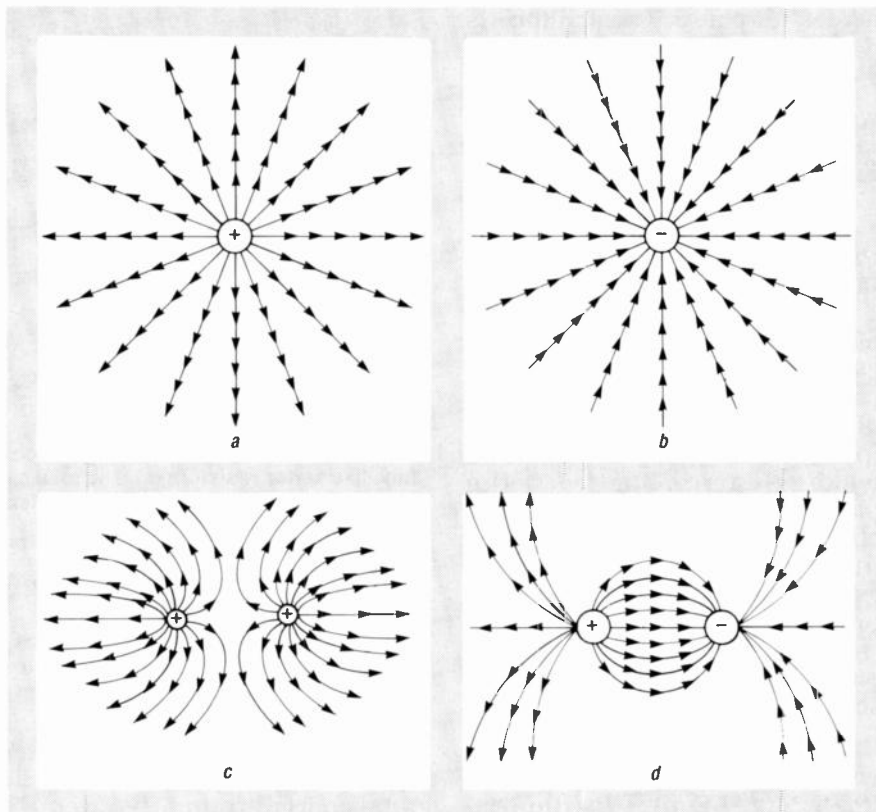

FIG. 4—IN 1785, CHARLES AUGUSTIN COULOMB used a torsion balance like this to measure electrostatic forces between pairs of charged objects by measuring the torque (twist) in the quartz fiber, to determine the proportionality constant. The force  $F$  between them is directly proportional to their product of their charges, and inversely proportional to the square of their separation  $R$ .

motion is fairly rapid, with an instantaneous velocity of about  $10^5$  m/s. Electrons undergoing such motion in the absence of an electric field follow an erratic zig-zag path, remaining in the same localized region, as shown in Fig. 5-a.

When an electric field is applied to a conductor, the erratically moving electrons drift due to the force generated by the field, causing an electric current, as shown in Fig. 5-b. Drift velocity is much lower than instantaneous velocity; about 1mm/s compared to  $10^5$  m/s for the instantaneous velocity when no electric field is present.

The variable for current is either  $i$  or  $I$ , for AC and DC current, respectively. The unit of current is the ampere, abbreviated either amp or A, after Andre Marie Ampere (France, c. 1775–1836). By definition  $1\text{ A} = 1\text{ C/s}$ , independent of conductor area; the symbol A is used for the amp, as distinguished from A for area. If 1 A flows in a wire, then  $6.25 \times 10^{18}$  electrons pass through a cross-section of it every second.

Many people incorrectly assume that electric current flows at an extremely high speed, when it literally moves at a snails pace! It is the electric field that moves down the conductor at very high speeds. It can be mathematically shown that if several amps of current (either AC or DC) flows through standard household copper wire, the drift velocity of the electrons move only a fraction of a millimeter per second, but those slowly creeping electrons produce considerable heat due to friction, in the wire.

#### A volt by any other name...

The definition of potential, or electromotive force (EMF) involves the concepts of work and energy. Energy is the ability to do work. Work results in motion of an object, and is defined as the product of the force applied to an object and the distance through which it travels. The unit of work is therefore the Newton-meter (N·m). The unit of work, or one Newton-meter, is called a joule, abbreviated J, after James Prescott Joule (England, c. 1814–1889).

For example, if a force of 5 Newtons is required to push an object, and that object moves a distance of 3 meters in the direction of the applied force, then 15 joules of work is performed. Whatever pushed the object obviously had to have the initial energy to do so.

The concept of work and potential difference can be illustrated by examining the basic operation of a battery. Two terminals of a battery consist of two unlike charges (+ and -) that maintain a constant potential difference by chemical means. Because of the difference in charge, an electric field must exist between them. That electric field has the ability to do work on an electric charge. For instance, if you wanted to move a positive charge from the negative battery terminal to the positive, you would have to work against the electric field between the terminals. A greater potential difference between battery terminals creates a higher electric field, and therefore, it stands to reason that greater work must be done in order to move a charge against it.

We have now come to the unit of potential difference, which is defined as the number of joules per coulomb (J/C), or work per charge. This unit is called, as you might have guessed, the volt (V), and was named after Alessandro Guisepppe Antonio Anastasio Volta (Italy, c. 1745–1827). For example, in a 12-volt battery, 12 J of energy are needed to move 1 C from one terminal to the other; and 24 J would be needed to move 2 C, since  $24\text{ J}/2\text{ C} = 12$  volts. The terms voltage, potential difference, and EMF are equivalent, and are very often used interchangeably.

#### Resistance and Ohm's law

When current flows in a con-

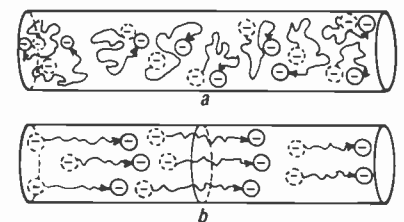

FIG. 5—A DEPICTION OF random thermal motion in (a), versus a nonzero drift velocity in (b).

ductor due to an electric field, electrons gain energy because of their motion, called kinetic energy. As they move, they collide with atoms of the conductor, dissipating kinetic energy as heat. The conductor can be said to have a degree of resistance to the flow of electric current.

Georg Simon Ohm (Germany, c. 1787–1854), for whom the unit of resistance, the ohm ( $\Omega$ ) is named, showed that current flowing in a conductor is directly proportional to the voltage across it. That concept may be apparent to you since we know that a higher voltage produces a stronger electric field, and therefore exerts a greater electric force on the charges of the conductor. That relationship is known as Ohm's law, and can be written as  $V = IR$ , where  $V$  is the voltage across the conductor,  $I$  is the current in amperes through the conductor, and  $R$  is the proportionality constant, which is a direct measure of the electrical resistance of the conductor. If the equation is solved for  $R$ , we get  $R = V/I$ . The unit  $R$ , therefore, is in volt/amperes and is called an ohm ( $\Omega$ ). Ohm's law states that if a current of one ampere flows through a conductor when a potential of one volt is placed across it, the conductor is said to have a resistance of one ohm.

### Capacitors and capacitance

A capacitor is basically two conducting surfaces separated by a dielectric, or insulator, as shown in Fig. 6. The capacitance of an element is its ability to store electric charge on its plates. The larger the capacitance ( $C$ ), the more charge ( $Q$ ) will be stored on its plates for the same voltage ( $V$ )

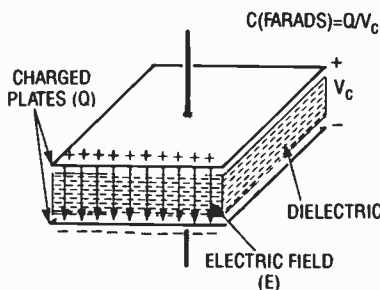

FIG. 6—A CAPACITOR consists of two conducting plates separated by a dielectric, or insulating material. When the plates are charged, an electric field is established between them. Capacitance (F) =  $Q/V$ .

across its plates. Capacitance is defined as

$$C = Q/V$$

where capacitance is in units of farads (F), named after Michael Faraday (Great Britain, c. 1791–1867).

If a capacitor is rated at 1 F, then 1 C of charge can be maintained on the plates when there's 1 volt between them. One farad, of course, is an extremely large capacitance; most practical capacitors have values on the order of microfarads ( $\mu\text{F}$ ) or picofarads (pF). Ideally, assuming there is no leakage current between the plates through the dielectric, the charge on the plates can remain intact indefinitely, although such leakage always occurs in actual practice.

The factors that affect the capacitance of a capacitor can be seen in the equation

$$C = \epsilon_0 \times \epsilon_r \times A/d$$

where  $\epsilon_0$  is the permittivity of air ( $8.85 \times 10^{-12}$  F/m),  $\epsilon_r$  is the relative permittivity,  $A$  is the area of each plate in square meters and  $d$  is the distance between the plates in meters.

The preceding equation reveals that capacitance will increase with a larger plate area, or when the distance between the plates decreases. The permittivity factor  $\epsilon$  is a measure of how well a given dielectric allows electric field lines to be established between the plates. When an insulator is used between the plates, the capacitance will increase by a factor of  $\epsilon_r$ . The  $\epsilon_r$  factor equals  $\epsilon/\epsilon_0$ , which is better known as the dielectric constant,  $k$ . As a point of interest, the relative permittivity  $\epsilon_r$  of air is 1.0006, rubber is 3.0 and that of water is 80.0.

You're probably aware that capacitances in parallel add. To show this, consider  $C_1$  and  $C_2$  in parallel across battery  $B_1$  of voltage  $V$ , as shown in Fig. 7-a. The total capacitance  $C_T$ , as shown in Fig. 7-b, can be found by the following analysis. If  $Q_1$  and  $Q_2$  are the charges on  $C_1$  and  $C_2$ , then  $Q_T = Q_1 + Q_2$ . Since the voltage across both  $C_1$  and  $C_2$  is  $V$ , then  $Q_1 = C_1 \times V$ ,  $Q_2 = C_2 \times V$ . Therefore,  $Q_T = (C_1 \times V) + (C_2 \times V) = (C_1 + C_2) \times V$ . Dividing by  $V$  gives us  $Q_T/V = C_1 + C_2$ , but  $C_T = Q_T/V$ , so  $C_T = C_1 + C_2$ . The same rea-

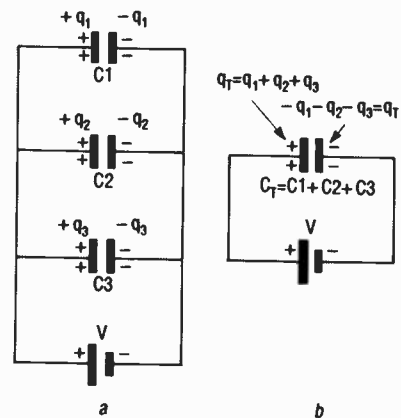

FIG. 7—PARALLEL CAPACITANCES combine like series resistors (a). The total capacitance  $C_T = C_1 + C_2 + C_3$  (b). (See text for the derivation.)

soning is easily extended to any number of parallel capacitors.

To combine capacitances in series, consider  $C_1$  and  $C_2$  in series across battery  $B_1$  of voltage  $V$ , as shown in Fig. 8-a. To find  $C_T$ , as shown in Fig. 8-b, you can see that  $V = V_1 + V_2$ , and since the total charge around the circuit is zero,  $Q_1 = Q_2 = Q$ . Therefore,  $Q/C_T = (Q/C_1) + (Q/C_2) = (Q/C_1) + (Q/C_2)$ . Canceling  $Q$  gives  $1/C_T = (1/C_1) + (1/C_2)$ .

### Inductors and inductance

The inductor consists of a length of wire wound into a solenoidal or toroidal shape, with or without a center core as shown in Fig. 9. When current passes through the coil, magnetic flux lines are established, as shown in Fig. 10. Inductance ( $L$ ) of a coil is its ability to store energy in the

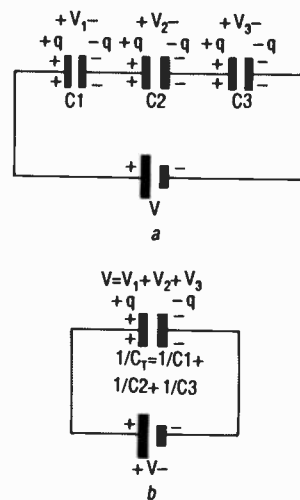

FIG. 8—SERIES CAPACITANCES combine like parallel resistors (a). The reciprocal of the total capacitance  $1/C_T = 1/C_1 + 1/C_2 + 1/C_3$  (b). (See text for the derivation.)

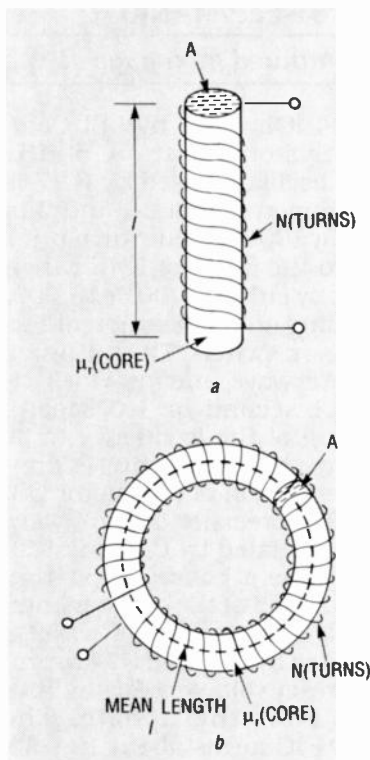

FIG. 9—TWO TYPICAL COIL constructions are the solenoid (a) and the toroid (b). Inductance in henrys (L) is defined as  $L = N^2 \times \mu A/l$ .

form of a magnetic field. The unit of inductance is the henry. One henry is the amount of inductance necessary to produce 1 volt across a coil with a current that changes at a rate of 1 ampere per second, and is expressed mathematically as

$$L = E/(di/dt)$$

where E is the induced voltage and di/dt is the rate of current change in amperes per second.

For most applications, 1 henry is a very large unit of inductance. Inductance is usually specified in units of millihenrys (mH), microhenrys ( $\mu$ H) or nanohenrys (nH).

Inductance can also be expressed by the equation

$$L = N^2 \times \mu A/l$$

where N is the number of turns of wire, A is the core area in square meters, l is the core length in meters, and parameter  $\mu$  is the permeability of the material. The permeability of a material is a measure of its magnetic properties, and is determined by the equation

$$\mu = \mu_r \times \mu_0$$

where  $\mu_0$  is the permeability of air ( $4 \times \pi \times 10^{-7}$  H/m) and  $\mu_r$  is the relative permeability of the mate-

rial compared to air. As the magnetic properties of a material increase, so does its relative permeability. Some materials, such as steel and iron, have permeabilities that are hundreds or thousands of times higher than air, or  $\mu_r \geq 100$ . A coil with no core has a permeability factor of  $\mu_r = 1$ . The inductance can be increased by placing a core with a high permeability, such as a ferromagnetic material, within the coil.

Our discussion now leads us to series and parallel inductors. The total inductance for inductors in series can be determined the same way as series resistors;  $L_T = L_1 + L_2 + L_3 + \dots + L_n$ . For inductors in parallel, the total inductance can be found the same way as for parallel resistors;  $1/L_T = 1/L_1 + 1/L_2 + 1/L_3 + \dots + 1/L_n$ .

### Power and the watt

Power is a measure of the time rate of either expenditure or storage of energy, whether electrical, thermal, or any other form. Power, therefore has units of work per time, and is measured in J/s, called a watt (W), named after James Watt (Scotland, c. 1736–1819). To derive the definition of a watt, we must think in terms of the rate at which work is being done on electrical charges. Since  $1 \text{ A} = 1 \text{ C/s}$ , and  $1 \text{ W} = 1 \text{ J/s}$ , then the proportionality constant must have units of J/C, or voltage. Therefore,  $P = E \times I$ , and since Ohm's Law gives  $E = I \times R$ , then  $P = I^2 \times R = (E^2)/R$ .

Power is directly related to electric and magnetic field quantities mentioned earlier. If you take the product of electric and magnetic field strengths E and H, then  $(\text{V/m}) \times (\text{A/m}) = (\text{V} \times \text{A})/(\text{m}^2) = \text{W}/(\text{m}^2)$ . This is power per unit area, also known as power density, and is generally denoted by S.

In electromagnetic waves, the electric field strength E and magnetic field strength H vectors are perpendicular to one another. You can't simply take the arithmetic product of the magnitudes of the vectors at a given point to obtain the power density.

For example, the solar constant, or the mean power density reaching the earth outside its atmosphere, at normal incidence, and at a mean orbital radius from the sun, is about  $0.14 \text{ W/cm}^2$ . Of

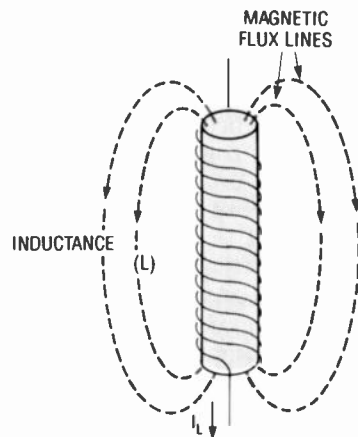

FIG. 10—AN INDUCTOR CONSISTS of a coil of wire wound around a core of air or ferromagnetic material. When current goes through a coil, magnetic flux lines are established.

course, since the atmosphere absorbs a considerable amount of this energy, you never actually feel all that power. Similarly, a 100-W light bulb literally radiates 100 J/s, but becomes dimmer the further you get from it because the power is dissipated over a wider area.

### Some additional points

Many interesting and important derivations can be made from the concepts discussed in this article. We'll take a look at a few examples of some commonly used electrical terms.

All timers use time constants, whether capacitive (RC) or inductive (RL). For an RC time constant, the units are  $\tau = R \times C = \Omega \cdot \text{F} = (\text{V/A}) \times (\text{C/V}) = \text{C/A} = \text{C}/(\text{C/s}) = \text{s}$ . Therefore, the units of an RC time constant are in seconds.

A couple of additional, more practical units for both charge and energy are the amp-hour (Ah) and the kilowatt-hour (kWh). A 1-Ah rating is found on many batteries. If a battery is rated at 4 Ah, it can supply 4 A for one hour, or 1 A for 4 hours, or 0.5 A for 8 hours, and so on. Since  $1 \text{ A} = 1 \text{ C/s}$ , and  $1 \text{ hr} = 3.6 \times 10^3 \text{ s}$ , then  $1 \text{ Ah} = 3.6 \times 10^3 \text{ C}$ .

The exact charge obtainable from a battery depends on the current drain, usually decreasing as current drain increases, due to heating. Electric utilities determine bills from the kWh your house consumes every month. Since  $1 \text{ kW} = 10^3 \text{ W}$ ,  $1 \text{ hr} = 3.6 \times 10^3 \text{ s}$ , and  $1 \text{ W} = 1 \text{ J/s}$ , then  $1 \text{ kWh} = 3.6 \times 10^6 \text{ J}$ .

## NEGATIVE ION GENERATOR

*continued from page 60*

the needle directly. When power is removed, the rotor spins until the capacitors completely discharge. Before removing the rotor, turn the power off, and discharge any remaining voltage across the capacitors.

A simple experiment can show how negative ions travel to a nearby insulated object, charging it to high voltage. With the power on, the negative ions travel through the air, and in doing so, collect on any metal surface. You can show how that works with an empty can as a collector, as shown in Fig. 11.

Rest the can on an insulated surface, such as a rubber mat, so the charge won't leak off. Use an earth ground for discharging, such as an AC outlet ground screw or a water pipe. As the negative ions hit the can, charge builds until the can is charged to 90–100 volts DC. NE2 fires, and the process repeats as long as the negative ion generator runs. Start with the can 1–2 feet away; you will notice how the flash rate of NE2 increases as the distance between the negative ion generator and the collector decreases, or if the emitter needle points toward the can.

Both experiments can run simultaneously: as the ion motor rotates, dissipating charge into the air, the can collects the negative ions and flashes the neon bulb. Another experiment uses a 40-watt fluorescent tube in a very dark room: be very careful while handling the glass tube in darkness—they're very fragile and you could hurt yourself if one implodes.

Connect a ground wire to a terminal at one end. Hold the tube near the grounded end without touching metal. Bring the other end toward the negative ion generator without touching it. The tube should flash or glow, indicating the presence of negative ions. As you move the tube away, both the flash rate and glow should decrease. When you're finished with the negative ion generator, turn it off, discharge it, and be sure to cover the emitter needle with the cork or other type of insulator. **R-E**

## HOT TROUBLESHOOTING

*continued from page 62*

rate digital readings when it is unscaled.)

Select the dual-channel mode, couple channel B to ground, and align the trace so it lies on the 10% graticule marking. Select the time-measurement mode, and set the "begin" and "end" knobs so that the intensified trace section is as shown in Fig. 5. The digital display should show between 11 and 14 microseconds. (The display in Fig. 5 shows 12.83 microseconds.)

If you measure, say, 9 microseconds, instead of 11–14 microseconds, even though the peak-to-peak value, the DC voltage, the wave shape, and the frequency are correct, the TV will work for awhile, but will more than likely fail at some point. That's because the horizontal output system sees a 35.7% reduction in retrace time—meaning that retrace is faster and generates higher voltage. Therefore, the horizontal output transistor is on longer at full-scan conduction, producing increased heat, increased scan-derived power supply levels, and higher voltages throughout the set. All the circuits are now stressed working at the higher voltages. That, in time, will cause components to fail.

Your scope can also be used to watch for an instantaneous start-up pulse. Simply connect the scope and preset it to view the HOT pulse. Then, watch the CRT as you apply power to the TV's circuitry. If you see a pulse appear and then disappear, your start-up circuitry is operating and the set is in the shut-down mode.

If that happens, service the chassis in a "powered-down" condition by either halving the normal B+ level separately, or reducing the AC input power to 60–90 VAC. Then monitor the collector of the horizontal output transistor with your scope.

Many underlying performance problems can be uncovered by examining specific characteristics of the "HOT pulse." The waveform shape, symmetry, and duty cycle of horizontal output transistor is critical in diagnosing and troubleshooting electrical malfunctions in your TV set. **R-E**

## SWEEP/MARKER

*continued from page 49*

RDD104 IC's made by LSI Computer Systems, Inc. A 5-MHz crystal oscillator used by IC17 is programmed via pins 1 and 2 to divide by 1000. Its output at pin 7 is fed to the input of IC18 which divides by either 1,000 or 10,000, depending on the position of the SINE RANGE switch. The output is a square wave and provides either 0.1 second or 1.0 second sampling of the frequency to be measured by the shorting or non-shortening action of transistor Q8. The same precision square wave is differentiated by C61 and R73 to originate a positive updating spike at pin 5 of the counter chip, IC19. The same square wave is integrated by C60 and R74 to provide a reset voltage a few milliseconds after the update. The RDD104 IC needs about 12 volts to oscillate at 5 MHz, and since the counter IC requires 5 volts, dual-voltage supplies are really necessary.

The schematic of the peak-hold circuit is shown in Fig. 9. In that circuit, op-amp IC23 amplifies the signal from the device under test about four times.

The positive alternation of the waveform is squared and inverted by op-amp IC26. That near-square wave is applied to the bases of transistors Q13 and Q14, both of which act as switches and behave as either open circuits or shorts to ground. If Q14 is a 2N2219 transistor, it shorts to within 5 millivolts with reference to ground. If a VN0300M power MOSFET is used, it shorts to within 1 millivolt to ground.

When Q13 and Q14 act as open circuits, C93 charges to the peak value of the positive alternation, following the rising edge of the alternation and then holding the peak value because there is no discharge path. The flat-top portion of that charge is one segment of the positive contour line. Transistor Q13 discharges C93, and the next time it acts as a short circuit. This varying between charge-time and short-circuit time continues for each cycle.

We're going to have to stop at this point. Next month we'll build and test out the unit. **R-E**

This month we'll talk about cheap visible lasers, electric motor resources, induction motor controls, new wavelet math theory, and a dual digital potentiometer.

DON LANCASTER

Let's start off this month's column with a very hackable circuit opportunity that has not quite seen the light of day. At least not yet...

## Induction motor speed controls

Why should it be cheap, easy, and trivial to regulate the speed of your electric drill, yet super expensive and next to impossible to control the speed of a compressor or blower motor on an air conditioner? After all, a motor is a motor, isn't it?

Sadly, the answer is no. Those AC induction motors simply were never designed to have their speed changed, and they throw all sorts of really ugly hassles at you when you try to do so. Let's see why that's so.

Just about all electric motors are based on two fundamental electrical principles. The first of those is that like magnetic poles repel and opposite ones attract. The second is known as *Fleming's Rule*, which states that "a current carrying conductor at right angles to a magnetic field will produce a force and attempt to move in a direction at right angles to both the magnetic field and the current."

When using conventional current, that produces the familiar *right-hand generator rule*, wherein your thumb points in the direction of the motion, your index finger towards the south pole of the magnetic field, and your middle finger in the direction of the conventional current.

For a motor, the same rule applies to your left hand. The only theoretical difference between a motor and a generator is that you input motion to get an output current with the generator, while you input current to get a force and hopefully a motion with a motor. In reality, all motors do some generating, and vice versa.

So, your only trick to building a motor is to constantly rearrange your magnetic fields and their strengths so they are either attracting one another

or shoving each other away, or use some ongoing combination of *attraction and repulsion* together.

A motor usually consists of a stationary part called a *stator* and a moving part known as a *rotor*, or *armature*. If it's necessary to physically transfer current to your rotor, either *brushes* and a *commutator*, or else *slip rings* are used. Slip rings apply continuous power to your rotor, while fixed brushes and a commutator selectively switch in and out chosen windings that happen to be aligned with the brush axis at any particular point in time.

You'll find quite a few different possible motor designs. But by far the two most economically important are the *series DC motor with brushes*, which is sometimes called a *universal motor*, and the *AC induction motor*. Let's take a look at each one.

Figure 1 shows a universal motor and its torque versus speed curve. You'll recognize this one in your electric drill, hot tub blower, vacuum cleaner, blender, sewing machine, or older car starter.

There's a pair of wound stator coils that, when run on DC, will produce a constant stationary magnetic *field*. In series with the stator coil is a pair of brushes with a commutator, which selectively switch rotor windings in and out so that one or more windings is constantly getting attracted to the fixed stator field. As the armature rotates, new windings get switched in by the commutator, so that a more or less continuous attraction, and thus a rotary motion gets produced.

The same universal motor works

almost as well with AC, except sometimes you have strong fields and sometimes weak ones as the current alternates. Usually, the mechanical inertia of your load will more or less average all those variations into continuous rotary power.

Even with AC, you still always have opposite poles attracting one another. They just happen to change their polarity 120 times a second. But they always change together. Note that you can reverse your universal motor by placing a DPDT switch between the commutator and the stator coils. But that can cause excessive wear if the motor brushes were not designed for two-way use.

As your universal motor slows down, its torque will increase, which tends to add to the motor *stability*. As you slow down, the available "twist" increases to speed you back up, and vice versa.

Since you have lots of torque at zero speed, your motor self-starts. It may overheat if you stall it permanently, but given half a chance, a universal motor easily gets itself up to speed.

Any motor is simultaneously a generator, and vice versa. A universal motor that is lightly loaded and running at a high speed produces an output voltage and resultant current in *series* with your input current. The voltage that is generated is known as a *back emf*, which *opposes* the input current. When lightly loaded, very little current is drawn from the supply, since the back emf and its resultant current nearly cancels out the input current, which is real handy from a conservation of energy standpoint. If you're doing no useful work, and if your motor isn't getting particularly hot, then you shouldn't need too much input energy just to spin things.

As you add mechanical load, your series machine will become less of a generator and more of a motor. The back emf and its canceling current drops, and the input current goes up. Your new energy needed is mostly

## NEED HELP?

Phone or write your **Hardware Hacker** questions directly to:  
Don Lancaster  
**Synergetics**  
Box 809  
Thatcher, AZ 85552  
(602) 428-4073

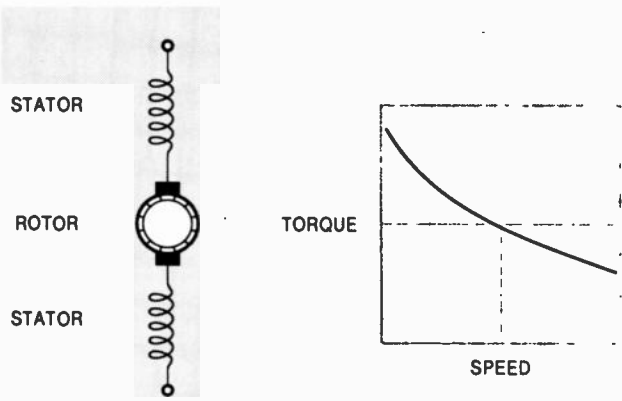

FIG. 1—A UNIVERSAL SERIES motor with brushes used on an electric drill, along with its speed-torque characteristics. The speed of the motors can be easily electronically controlled by using simple circuits.

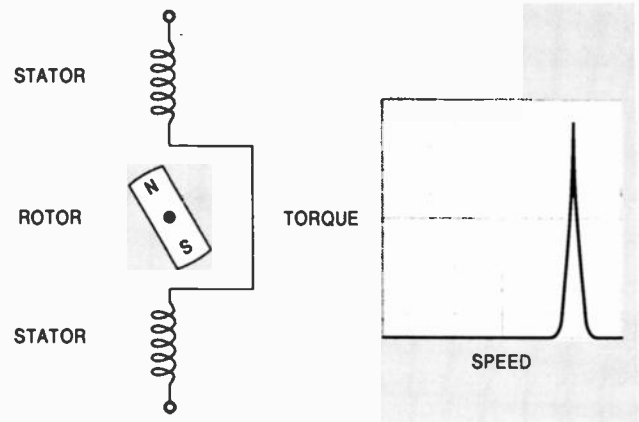

FIG. 2—A SYNCHRONOUS AC MOTOR used on a clock, along with its speed-torque characteristics. The speed is determined by the line frequency. The input current determines how strong a load can be driven.

transferred to your mechanical load. Again by conservation of energy, you're putting more energy in so you can get more energy out.

Neglecting nonlinearities such as air resistance, the speed of a universal motor for a given load is determined only by the input current. You raise your current to go faster; reduce it to slow down. That means you can just throw any old high power resistor in series with your universal motor to control its speed, just like sewing machine motors used to use. Better yet, you can use a far more efficient *triac* style light dimmer for control.

Best of all, you can sense the back emf or otherwise measure the actual motor speed and use electronic feedback with a triac or SCR circuit which is only slightly more complex than a plain old dimmer. That gives you a tightly regulated speed control plus the ability to run real slow with lots of torque.

The bottom line is that it's trivial these days to electronically regulate the speed of a universal motor. We've seen several circuits in past issues and in those *Hardware Hacker II* reprints. *LSI Systems* is a good source for fancy universal motor controller chips, while lots of detailed application notes appear in the usual triac data books from *Motorola*, *SGS*, *Texas Instruments*, and several others.

So what's wrong with universal motors? If they are so universal, why aren't they used everywhere? The biggest problem lies in their brushes. Brushes wear out. They are inefficient. They are both acoustically and electrically noisy. They spark and can start fires or explosions. And those

problems really get out of hand when you need more horsepower.

Look around, and you'll see that virtually all universal motors in your home only run on an *intermittent* basis. Mostly because the brushes cannot run continuously without grinding themselves into oblivion, or driving you up the wall with noise.

Ideally, we would like to conjure up some scheme to get power onto the rotor without any brushes or other physical contact. And that's where the induction motor comes in.

Figure 2 shows a brushless beastie known as an *AC synchronous motor*. It has a wound stator and a permanent magnet rotor. Assume that we are plugged into the 60-Hz AC line and that the rotor just happens to already be spinning at 3600 RPM.

On a positive line peak, the north magnet pole will get attracted to the upper stator coil. By the time your magnet is pointing straight up, the current will be going through zero and there will be no mutual attraction or repulsion. Soon afterward, the line current swings negative, and that opposite polarity starts repelling the magnet, continuing it on its merry way. The exact opposite happens to the other pole, and the motor will continue to spin.

The *synchronous speed* is set *only* by the number of poles and the line frequency, and is *totally independent* of your input current. The two pole synchronous motor runs at 3600 RPM off the 60-Hz line; a four pole job spins at 1800 RPM, and so on.

We can see that a synchronous motor is real handy for maintaining a constant speed. Important uses are in electric clocks, phonograph

motors, timers, chart drives, and other lower power uses where an absolutely constant speed, independent of the load or input current, is essential.

What happens when we apply too much of a load? If your magnet gets 90 mechanical degrees out of phase, there will be no attraction or repulsion, and zero power routed to the load. If it gets further out of phase, it actually tries to stall itself. Therefore, the slower the speed, the less the torque.

You really have a two-speed device here: 3600 RPM and 0 RPM. One consequence here is that any true single-phase synchronous motor will not start by itself. You will have to help it along with a switchable starting winding, a pole shading, an iron hysteresis cup, or a second or third winding driven from a two-phase or three-phase source.

A second consequence is that the speed of a synchronous motor with varying load or current can end up unstable. If it ever breaks out of sync, you almost surely will stall. That happens because a slowdown produces less torque, which in turn produces less speed. Just the same as an auto in too high a gear for the grade.

The load current does decide how large of a load it can drive at synchronous speed. The more input current, the more power you can deliver to the load without having to break your synchronization.

Figure 3 shows a variation on a synchronous machine known as the *AC induction motor*. It is by far the most common motor in use today. You will find AC induction motors in your air conditioners, heater blowers,

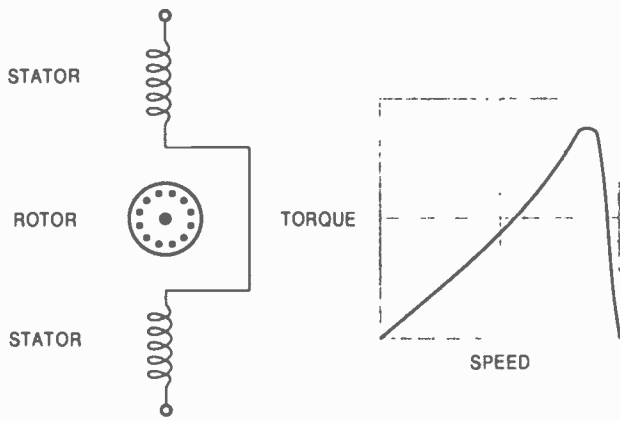

FIG. 3—AN AC INDUCTION MOTOR used on a washing machine, along with its speed-torque characteristics. The current controls the speed over a very narrow range between the optimum slip speed and the synchronous speed. To control the speed of this type of motor over a wider range, you must use a complex cycloconverter circuit that can change both the input frequency and current.

washers, most table saws, dish-washers, dryers, drill presses, water pumps, and many circulation fans.

Motors used in those types of products are also the ones you would most like to be able to inexpensively control the speed of. You would especially like to raise the efficiency of heating and cooling systems.

The concept of the AC induction motor was positively brilliant. Tesla strikes again. Somehow you have to get currents onto the rotor, but we definitely want to avoid any brushes or other mechanical contacts.

Question: What do you get when you have coils and iron driven from AC current? Answer (A) a motor, or (B) a transformer (!).

Instead of brushes or slip rings, you *transformer couple* the rotor current in an induction motor. That's usually done by creating a special low-impedance transformer secondary known as a *squirrel cage*. The purpose of the squirrel cage is to serve both as the transformer secondary and as rotor coils to simulate the rotor magnet of Fig. 3.

But not so fast. Literally. If you're running at synchronous speed, no lines of flux will be cut, and there will be no current induced into the squirrel cage. Which gives you synchronous speed, but zero power. Now, let your speed *slip* just a little bit. There's now a very *low-frequency* AC current induced in the squirrel cage. That creates a changing magnetic field, and you now have more torque than you do at synchronous

speed.

If you lower the speed slightly, you create even more torque. But if you slow it down too far, your torque starts dropping radically.

Thus, an AC induction motor has optimum torque at a speed which is only modestly less than synchronous. That's why your "quarter horse" motor is usually rated at 3450 RPM for a two-pole motor and 1734 RPM for a four-pole one.

As you can see, we have a well-behaved torque-speed curve between the synchronous speed and the optimum, but only a slightly slower peak torque speed. Below the peak speed, you'll have the same instability and dropout problems that you'd have with a pure synchronous machine.

Like a synchronous motor, a single-phase induction motor will not start itself. Usually there will be a second starting winding that gets kicked in only when getting the motor up to speed. Other starting variations can include a pole shading or multiple phase windings.

In theory, you could reverse your induction motor by reversing the direction the starting method shoves the rotor. Details vary with the motor type. In some cases, the only way to reverse the motor is to remove the rotor and put it back in pointing the other way.

Another problem with induction motors is that the optimum motor speed is usually far too fast for useful real-world work. You almost always

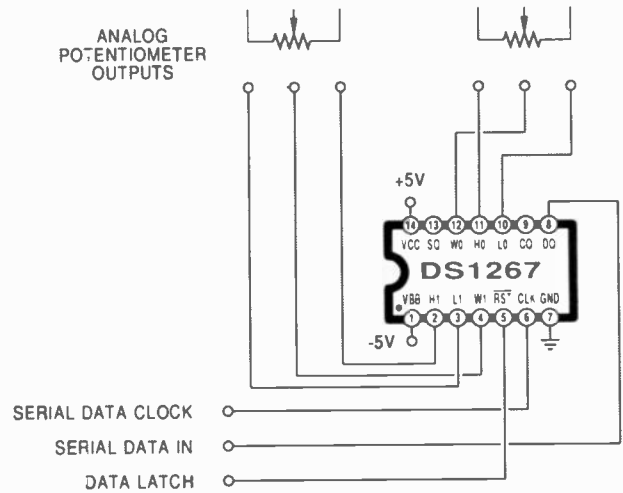

FIG. 4—A DUAL DIGITAL POTENTIOMETER using the Dallas Semiconductor DS1267. A 17-bit serial word determines which of the 256 steps for each potentiometer gets selected. Unlike EEPROM chips, the settings are easily read but forgotten on power-down. A serial output lets you daisy chain your digital commands.

have to use pulleys and belts or some other speed-reduction scheme. Or go to lots and lots of poles, as is done in those fancy ceiling fans.

Thus, any attempt to control the speed of an induction motor with a series resistance or a simple phase control is doomed to failure. Flat out,

## NEW FROM DON LANCASTER

### HARDWARE HACKER STUFF

Hardware Hacker Reprints II or III	24.50
Incredible Secret Money Machine	10.50
CMOS Cookbook	18.50
TTL Cookbook	16.50
Active Filter Cookbook	15.50
Micro Cookbook vol I or II	16.50
Lancaster Classics Library	99.50
Enhancing your Apple I or II	17.50
AppleWriter Cookbook	19.50
Apple Assembly Cookbook	21.50
Absolute Reset IIe & IIc	19.50
Enhance I or II Companion Disk	19.50
AppleWriter CB or Assy CB Disk	24.50

### POSTSCRIPT STUFF

Ask The Guru Reprints I, II or III	24.50
LaserWriter Secrets (IIe/Mac/PC)	29.50
PostScript Show & Tell	39.50
Intro to PostScript VHS Video	39.50
PostScript Beginner Stuff	39.50
PostScript Cookbook (Adobe)	16.50
PostScript Ref. Manual (Adobe)	22.50
PostScript Program Design (Adobe)	22.50
Type I Font Format (Adobe)	15.50
LaserWriter Reference (Apple)	19.50
Real World Postscript (Roth)	22.50
PostScript Visual Approach (Smith)	22.50
Thinking in PostScript (Reid)	22.50
The Whole Works (all PostScript)	299.50

FREE VOICE HELPLINE

VISA/MC

## SYNERGETICS

Box 809-RE  
Thatcher, AZ 85552  
(602) 428-4073

## ELECTRONIC MOTOR RESOURCES

### Appliance

1110 Jorie Boulevard  
Oak Brook, IL 60522  
(708) 990-3484  
CIRCLE 301 ON FREE INFORMATION CARD

### Appliance Manufacturer

29100 Aurora Road, Ste 200  
Solon, Ohio 44139  
(216) 349-3060  
CIRCLE 302 ON FREE INFORMATION CARD

### Asea Brown Bovari

1460 Livingston Avenue  
North Brunswick, NJ 08902  
(201) 932-6000  
CIRCLE 303 ON FREE INFORMATION CARD

### Bodine Electric

2500 West Bradley Place  
Chicago, IL 60618  
(800) 7BODINE  
CIRCLE 304 ON FREE INFORMATION CARD

### C&H Sales

PO Box 5356  
Pasadena, CA 91117  
(800) 325-9465  
CIRCLE 305 ON FREE INFORMATION CARD

### Design News

44 Cook Street  
Denver, CO 80206  
(303) 388-4511  
CIRCLE 306 ON FREE INFORMATION CARD

### Fair Radio Sales

PO Box 1105  
Lima, OH 45802  
(419) 227-6573  
CIRCLE 307 ON FREE INFORMATION CARD

### Fasco Industries

500 Chesterfield Center, Ste 200  
St Louis, MO 63017  
(314) 532-3505  
CIRCLE 308 ON FREE INFORMATION CARD

### Grainger

2738 Fulton Street  
Chicago, IL 60612  
(312) 638-0536  
CIRCLE 309 ON FREE INFORMATION CARD

### Herbach & Rademan

401 East Erie Avenue  
Philadelphia, PA 19134  
(215) 426-1700  
CIRCLE 310 ON FREE INFORMATION CARD

### IEEE/Energy Conversion

445 Hoes Lane  
Piscataway, NJ 08855  
(201) 981-0060  
CIRCLE 311 ON FREE INFORMATION CARD

### IEEE/Industrial Applications

445 Hoes Lane  
Piscataway, NJ 08855  
(201) 981-0060  
CIRCLE 312 ON FREE INFORMATION CARD

### JerryCo

601 Linden Place  
Evanston, IL 60202  
(708) 475-8440  
CIRCLE 313 ON FREE INFORMATION CARD

### Lindsay Publications

PO Box 538  
Manteno, IL 60950  
(815) 468-3668  
CIRCLE 314 ON FREE INFORMATION CARD

### Machine Design

1100 Superior Avenue  
Cleveland, OH 44114  
(216) 696-7000  
CIRCLE 315 ON FREE INFORMATION CARD

### Molon Motor & Coil

3737 Industrial Avenue  
Rolling Meadows, IL 60008  
(800) 52-MOTOR  
CIRCLE 316 ON FREE INFORMATION CARD

### Motion

Box 6430  
Orange, CA 92613  
(714) 974-0200  
CIRCLE 317 ON FREE INFORMATION CARD

### Northern

PO Box 1499  
Burnsville, MN 55337  
(800) 533-5545  
CIRCLE 318 ON FREE INFORMATION CARD

### PCIM

2472 Eastman Avenue, Bld. 33-34  
Ventura, CA 93003  
(805) 650-7070  
CIRCLE 319 ON FREE INFORMATION CARD

### SAE

400 Commonwealth Drive  
Warrendale, PA 15096  
(412) 776-4970  
CIRCLE 320 ON FREE INFORMATION CARD

that will never work and probably will burn up your motor as well. It's like plowing with a pig.

Now, you *can* use current control to alter the speed of your motor between its synchronous speed and its slightly slower optimum speed. But that range is usually far too narrow to be useful, unless you're willing to vary the *frequency* applied to your motor. But since the impedance of a motor varies with frequency, you'll also want to vary the voltage or the input current as you change frequency. Keeping the magnetic flux at a constant strength seems like a good starting point, so raising the voltage with the line frequency seems like a good idea. You'll also have to quite accurately sense your motor speed at all times, and feed back all of that information into your controller.

In addition, you do have to guarantee that the starting windings do not kick in at slower speeds. Most starting windings are for *very* intermittent duty only and will rapidly burn up if run continuously.

Circuits which sense motor speed and vary both the frequency and the current are often known as *cycloconverters*. Yes, you can get them. One major supplier is *Asea Brown Bovari*, a Swiss firm with a wide range of induction motor speed controls. But they're not cheap. And cycloconverter-controlled induction motors tend to whine a lot, owing to nonlinear magnetic harmonics in the audio range, unacceptably so for many uses.

But a \$19.95 wide range and quiet quarter horse induction motor speed control is not likely to show up in your hardware store in the next few months. Even though we do have lots of better magnetics and new intelligent-power integrated circuits available that should make the task far easier than it once was.

What you're more likely to see are modifications of traditional induction motors which can make them more amenable to electronic speed control. You'll come across such things as dual stators, variable-frequency rotors, and internal speed sensors.

What's the bottom line? A lot of thought and time and effort has gone into induction-motor speed controls for several decades now, and nothing really useful has yet seen the light of day. Despite an incredibly big bag of nickels waiting for the winner.



I strongly urge you to try and hack this one. But don't expect any prompt or easy results. Needless to say, we here at **Radio-Electronics** editorial will be very interested in the first hackable, wide-range, and sanely priced quarter-horse induction-motor speed-control construction project.

### Electric-motor resources

To get you started, I've put together some *electric-motor resources* for you in the resource sidebar this month. Here's a quick rundown...

One very good starting point is the \$5.00 *Small Motor and Gearmotor* handbook from *Bodine*. *W.W. Grainger*, of course, is by far the leading wholesale distributor of just about any type of small motor. And your best source for electric motor hacking books remains *Lindsay Publications*.

Good surplus motor sources include *C & H Sales*, *Northern*, *JerryCo*, *Herbach and Rademan*, and *Fair Radio Sales*. Two higher-volume suppliers of smaller motors are *Molon* and *Fasco*.

As we've just seen, one international source for AC-induction motor-speed controls is *Asea Brown Boveri*.

Important trade journals involving motors include *Motion*, *PCIM*, *Machine Design*, *Appliance*, *Appliance Manufacturer*, and *Design News*.

Some of the more scholarly stuff comes down in either of the *IEEE Transactions on Energy Conversion* or their *IEEE Transactions on Industrial Applications*. For automotive motor uses, try the publications in the *SAE* library.

Uh, even though this is one of our longer resource listings, I've got a hollow feeling I'm missing several major and obvious motor hacking resources here. Something that you electrical types out there might be able to help us on.

So, for the first of this month's contests, let me know what I've left off the sidebar in the way of motor resources. They'll be all the usual *Incredible Secret Money Machine* book prizes, along with an all expense paid (FOB Thatcher, AZ), *tinaja quest* for two going to the best entry of all.

Or, as a second contest, just add to our ongoing induction motor speed control dialogue in some useful way.

As usual, be sure to send all your written entries directly to me at *Synergetics*, rather than over to **Radio-Electronics** editorial.

### Dual digital potentiometer

A ways back (*Hardware Hacker*, January 1989), we looked at a *Xicor X9103* digitally controlled 100-step potentiometer. This dude was a single-channel device, had a permanent memory that remembered even when it was unpowered, and let you increment or decrement the potentiometer setting with a simple interface. But it had no way to sense the present setting, nor any way to jump to any setting without moving through all of the intermediate ones.

*Dallas Semiconductor* has just introduced a new *DS1267* dual digital potentiometer chip that has strengths where the *X9103* was weak, and vice versa. As Fig. 4 shows us, this one gives you two 256-step potentiometers in a single package in your choice of 10K, 50K, or 100K total resistance.

Those are *not* memory devices. They return you to a 50% "mid-wiper" position on power up and *must* get rewritten each time. As is becoming common on many new chips these days, there is a three-wire serial control provided, intended to interface with three computer port lines.

To set up your potentiometers, clock in seventeen data bits by using the *CLK* and *DQ* lines, while keeping the *RST* line high. Eight of those bits are for the first potentiometer, eight for the second, with the final bit being used to optionally cascade the potentiometer pair into a single potentiometer with 512 steps of resolution.

Drop the *RST* line to enter the new settings for the potentiometer pair. There's also a serial out that lets you read out the present settings or else cascade chips for such things as multi-band equalizers.

As long as *RST* remains high, your old setting gets saved. Thus, you can do 17 clocks to read out your existing settings, and 17 more to enter the new ones, without getting any noise or glitches.

The digital end of the chip works off your usual 0 and +5 volts. The analog end can be anywhere from 0 to +5 volts with a grounded VB substrate pin, or can be used over a -5 to +5 volt range with -5 volts on

# It's no fluke.



Made in the U.S.A.

Building the best DMM for the money is no accident. The new RMS225 was carefully designed to give you what you wanted at a price you could afford. Visit your local distributor today and you'll agree the choice is obvious.

Fluke Model 77	Beckman Industrial RMS225
3-1/2 Digits	4 Digits
3,200 Counts	10,000 Counts
0.3% Accuracy	0.25% Accuracy
Touch Hold <sup>®</sup>	Probe Hold™
31 Segment Analog Bar Graph	41 Segment Analog Bar Graph
2,000 Hour Battery Life	1,000 Hour Battery Life
10A Range (Fused)	10A Range (Fused)
Protective Holster	Protective Holster
3 Yr. Warranty	3 Yr. Warranty
—	True RMS
—	Auto Min Max™
—	Relative Mode
\$159*	\$149

<sup>®</sup> Touch Hold is a registered trademark of the John Fluke Mfg. Co., Inc. \*1990 Fluke and Philips Catalog

**Beckman Industrial™**  
An Affiliate of Emerson Electric Co.

Instrumentation Products Division  
3883 Ruffin Road, San Diego, CA 92123-1898  
(619) 495-3200 • FAX (619) 268-0172 • TLX 249031  
Outside California 1-800-854-2708 Within California 1-800-227-9781  
© 1990 Beckman Industrial Corporation. Specifications subject to change without notice. Fluke is a registered trademark of John Fluke Mfg. Co., Inc.

**DIGITAL VIDEO STABILIZER  
ELIMINATES ALL VIDEO COPY  
PROTECTIONS**

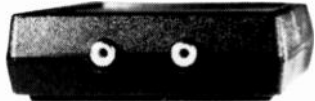

While watching rental movies, you will notice annoying periodic color darkening, color shift, unwanted lines, flashing or jagged edges. This is caused by the copy protection jamming signals embedded in the video tape, such as Macrovision copy protection. Digital Video Stabilizer: RXII completely eliminates all copy protections and jamming signals and brings you crystal clear pictures.

**WARNING :**  
**SCO**  
**Electronics and**  
**RXII dealers do**  
**not encourage**  
**people to use**  
**the Digital**  
**Video Stabilizer**  
**to duplicate**  
**rental movies**  
**or copyrighted**  
**video tapes.**  
**RXII is in-**  
**tended to stabi-**  
**lize and restore**  
**crystal clear**  
**picture quality**  
**for private**  
**home use only.**

(Dealers Welcome)

- FEATURES:**
- Easy to use and a snap to install
  - State-of-the-art integrated circuit technology
  - 100% automatic - no need for any troublesome adjustments
  - Compatible to all types of VCRs and TVs
  - The best and most exciting Video Stabilizer in the market
  - Light weight (8 ounces) and Compact (1x3.5x5")
  - Beautiful deluxe gift box
  - Uses a standard 9 Volt battery which will last 1-2 years.

To Order: \$49.95 ea + \$4 for FAST UPS SHIPPING  
**1-800-445-9285** or **516-568-9850**  
 Visa, M/C, COD M-F: 9-6 (battery not included)  
 SCO ELECTRONICS INC.  
 Dept. CRE 2 581 W. Merrick Rd. Valley Stream NY 11580  
 Unconditional 30 days Money Back Guarantee

**CIRCLE 177 ON FREE INFORMATION CARD**

**CABLE TV  
DESCRAMBLER**  
How You Can Save Money  
on Cable Rental Fees



- 1 Unit 5+
- Jerrold SB w/Tri-Bi.....\$99.....\$70
  - SuperTri-Bi (TBM).....\$109.....\$75
  - Jerrold 450 combo.....\$189.....\$139
  - Scientific Atlanta.....\$109.....\$75
  - SA 8536.....\$250.....\$195
  - Pioneer.....\$109.....\$79
  - Oak KN12 (w/VS).....\$109.....\$65
  - Hamlin MLD 1200.....\$89.....\$59
  - Tocom.....\$169.....\$129
  - Stargate converter.....\$89.....\$69
  - Panasonic TZPC145.....\$99.....\$79

**US Cable will**  
**Beat Anyone's**  
**Price**  
**Advertised in**  
**this Magazine!**

**30 Days Money Back Guarantee**  
 Free 16 page Catalog  
 Visa, M/C, COD or send money order to:  
**US Cable TV Inc.** Dept. KRE 2  
 4100 N. Powerline Rd., Bldg F-4  
 Pompano Beach, FL 33073

**1-800-445-9285**

**For Our Record**

I, the undersigned, do hereby declare under penalty of perjury that all products purchased, now and in the future, will only be used on Cable TV systems with proper authorization from local officials or cable company officials in accordance with all applicable federal and state laws. FEDERAL AND VARIOUS STATE LAWS PROVIDE FOR SUBSTANTIAL CRIMINAL AND CIVIL PENALTIES FOR UNAUTHORIZED USE.

Date: \_\_\_\_\_

Signed: \_\_\_\_\_

**No Florida Sales!**

**CIRCLE 178 ON FREE INFORMATION CARD**

**NAMES AND NUMBERS**

**Burr-Brown**  
 6730 South Tucson Blvd.  
 Tucson, AZ 85706  
 (602) 746-1111  
**CIRCLE 321 ON FREE INFORMATION CARD**

**Circuit Specialists**  
 PO Box 3047  
 Scottsdale, AZ 85271  
 (800) 528-1417  
**CIRCLE 322 ON FREE INFORMATION CARD**

**Dallas Semiconductor**  
 4350 Beltwood Pkwy South  
 Dallas, TX 75244  
 (214) 450-0400  
**CIRCLE 323 ON FREE INFORMATION CARD**

**GEnie**  
 401 North Washington Street  
 Rockville, MD 20850  
 (800) 638-9636  
**CIRCLE 324 ON FREE INFORMATION CARD**

**Haltek Electronics**  
 1062 Linda Vista Avenue  
 Mountain View, CA 94043  
 (408) 744-1333  
**CIRCLE 325 ON FREE INFORMATION CARD**

**H&R Enterprises**  
 21521 Blythe Street  
 Canoga Park, CA 91304  
 (818) 703-8892  
**CIRCLE 326 ON FREE INFORMATION CARD**

**Integrated Device Technology**  
 2972 Stender Way  
 Santa Clara, CA 95054  
 (408) 727-6116  
**CIRCLE 327 ON FREE INFORMATION CARD**

**International Micro Electronics**  
 PO Box 170415  
 Arlington, TX 76003  
 (817) 561-2244  
**CIRCLE 328 ON FREE INFORMATION CARD**

your substrate pin. Thus, you can easily handle bipolar analog signals that go above and below ground.

Your maximum clock frequency is 10 MHz, which means you can upgrade your potentiometer settings as often as 580 kHz or so. Their series wiper resistance is typically 400 ohms, and you're allowed a maximum potentiometer or wiper current of one milliampere. Be sure to see the data sheet for additional specs and timing details.

**LSI**  
 1235 Walt Whitman Road  
 Melville, NY 11747  
 (516) 271-0400  
**CIRCLE 329 ON FREE INFORMATION CARD**

**Midnight Engineering**  
 111 East Drake Road, Ste 7041  
 Fort Collins, CO 80525  
 (303) 491-9092  
**CIRCLE 330 ON FREE INFORMATION CARD**

**Motorola**  
 5005 East McDowell Road  
 Phoenix, AZ 85008  
 (800) 521-6274  
**CIRCLE 331 ON FREE INFORMATION CARD**

**National Semiconductor**  
 475 Ellis Street  
 Mountain View, CA 94043  
 (800) 632-3531  
**CIRCLE 332 ON FREE INFORMATION CARD**

**SGS-Thompson**  
 1000 East Bell Road  
 Phoenix, AZ 85022  
 (602) 867-6259  
**CIRCLE 333 ON FREE INFORMATION CARD**

**Synergetics**  
 Box 809  
 Thatcher, AZ 85552  
 (602) 428-4073  
**CIRCLE 334 ON FREE INFORMATION CARD**

**Texas Instruments**  
 PO Box 809066  
 Dallas, TX 75380  
 (800) 232-3200  
**CIRCLE 335 ON FREE INFORMATION CARD**

**Xicor**  
 851 Buckeye Court  
 Milpitas, CA 95035  
 (408) 432-8888  
**CIRCLE 336 ON FREE INFORMATION CARD**

For our third contest this month, just tell me what you would do with one or more cascaded dual digitally controlled potentiometers.

**Making wavelets**

There's a brand-new math revolution taking off that appears certain to profoundly change much of what electronics is and what it will be able to do. All the noise is over *wavelet theory*, an incredibly powerful new technique that promises to blow the

- A New wave in applied mathematics  
B. Cipra, *Science* 24 Aug 1990, pp 858-859.
- New wave number crunching  
C. Brown *E.E. Times*, 5 Nov 1990, pp 31-34
- Video compression using 3D wavelet transforms.  
A. Lewis, *Electronic Letters*, vol 26 no 6 pp 396-8.
- Non-orthogonal wavelet representations in relaxation networks.  
J. Daugman, *New Developments in Neural Computing*, pp 233-50.
- A theory for multiresolution signal decomposition.  
S. Mallat, *IEEE Transactions on Machine Intelligence*, v11-7 pp 674-93.
- Wavelet transformation in signal detection.  
F. Tuteur, *8th IFAC/IFORS Symposium*, vol 2 pp 1061-5.
- Entropy reduction and decorrelation in visual coding.  
J. Daugman, *IEEE Trans. Biomedical Engineering*, vol 36 no 1 pp 107-14.
- Wavelet transformation in signal detection.  
F. Tuteur, *ICASSP Speech Conference 88*, vol 3 pp 1435-8.
- Complete discrete 2-D Gabor transforms.  
J. Daugman, *IEEE Trans Acoustics & Speech*, vol 36 no 7 pp 1169-79.
- Dispersive noise removal in t-x space.  
Beresford-Smith, *Geophysics USA*, vol 53 no 3 pp 346-58.
- Adaptive deconvolution by lattice filters.  
S. Persoglia, *Bulletin of Geophysics Theory*, vol 27 no 107 pp 169-83.
- A critique of seismic deconvolution methods.  
A. Jurkevics, *Geophysics*, vol 49 no 12 pp 2109-16.
- Statistical pulse compression.  
E. Robinson, *IEEE Proceedings*, vol 72 no 10 pp 1276-89.

**FIG. 5—SOME KEY PAPERS on the new wavelet math theory which is now revolutionizing just about everything in electronics.**

200-year-old *Fourier* analysis, synthesis, and transforms completely out of the water.

Why worry about some obtuse new math theory? Well, first of all, because it's there. Second, because it's a sure fire winning topic for a school paper. And third, there's a lot of electronic doors about to suddenly get slammed in your face if you do not *quickly* pick up on exactly what wavelet theory is and what it can do for you.

Fourier analysis is, er—better make that *was*, a method of giving you a second way of looking at and dealing with electronic signals. Besides the intuitive or "real-world" *time domain*, Fourier techniques let you create a separate *frequency domain*. Things not at all obvious in the time domain become quite clear when they are in the frequency domain, and vice versa.

For instance, a square wave in the time domain is just a signal that keeps bouncing up and down between two levels. In the frequency domain, that same square wave can be shown to consist of an infinite string of sine waves. Specifically, you can build up a square wave from its fundamental sine wave, one third its third harmonic, one fifth the fifth harmonic, and so on up the line.

A few of the zillions of places that

the frequency domain can become important include spectrum analysis, holograms, video-image compression, music synthesis, side-looking radar, picture deblurring, etc.

But the big problem with Fourier analysis is that everything was connected to everything else. Make even the slightest change, and you had to go back to square one and recompute everything. And while Fourier series is a great way to handle *most* of a square wave, it sure has troubles with the suddenly changing leading and trailing edges.

What wavelet theory does is let you selectively mix and match *wavelets* that can both deal *locally* with sudden changes and *globally* with averages and backgrounds. You can thus selectively apply all your math power precisely where it will do you the most good, and do so with speeds and efficiencies that were totally unheard of with traditional Fourier analysis.

What wavelet theory does is let you selectively mix and match *wavelets* that can both deal *locally* with sudden changes and *globally* with averages and backgrounds. You can thus selectively apply all your math power precisely where it will do you the most good, and do so with speeds and efficiencies that were totally unheard of with traditional

Fourier analysis.

Figure 5 shows a few of the newer key papers involving wavelet theory. Start out with the *Science* and *E.E. Times* overview summary stories before you get into the heavy stuff. Let me know if you want to get into this any deeper.

### New tech literature

The prices of bright-red visible laser diodes are starting to drop bunches, with a \$45.00-in-singles unit now being offered by *Haltek Electronics*. They are the newer, high-visibility 630-nanometer wavelength, which is same as helium neon. Plan on \$5.00 visible lasers within two years or so.

New data books for this month include that *Special Purpose Linear Devices* entry from *National*. Be sure to check out their LMC835 digitally-controlled graphics equalizer you'll find on page 1-227.

Three other new data books are the *Logic Databook* from the *Integrated Device Technology* folks, a new *Optoelectronics and Image Sensors* from *Texas Instruments*, and an *Integrated Circuits Data Book #33B Supplement* from *Burr-Brown*.

Static memory RAM specs cleverly disguised as baseball trading cards are being offered by *SGS* in an unusual promotion. Those are the same folks that previously gave you soup cans full of assorted free integrated circuits and soap boxes full of EPROM's.

Three interesting new surplus catalogs showed up in today's mail. They include *Circuit Specialists*, *International Micro Electronics*, and *H&R Enterprises* publications.

Turning to my own products, for the fundamentals of digital integrated circuits, be sure to check into my classic *TTL* and *CMOS Cookbooks*. And, as you can tell from my nearby *Synergetics* ad, we've now got *Hardware Hacker III* and *Ask the Guru III* reprints available, as well as some new PostScript books.

Also, a reminder that I do have this great new PostScript PSRT roundtable and library up on *GEnie*. You'll also find lots of *Hardware Hacker* and all of the *Midnight Engineering* reprints and other resources here.

Finally, I do have a new and free mailer for you which includes dozens of insider hardware hacking secret resources. Write or call for info. **R-E**

# COMPUTER CONNECTIONS

## Windows pains (and pleasures)

JEFF HOLTZMAN

Last month, we discussed how and why Windows is going to irrevocably change the PC industry. Now let's look at how to put Windows to use today.

You probably know that Windows can run in three different modes: Real, Standard, and Enhanced. Real mode should have been called Unreal mode, because it is so slow that it's unrealistic to expect anyone to use it. Real mode was created for marketing reasons, not technical ones. Windows will run on an 8088, and older applications will run under it. But you'd have to be crazy to want to. Even on a relatively fast (16-MHz) 386, real mode is *much* slower than the other two modes.

Technically, Enhanced mode is the most sophisticated. It allows you to run regular DOS applications on-screen in graphics mode, in simulated text-mode windows, simultaneously with regular Windows applications. For example, before I got a real Windows communication program (Crosstalk for Windows, dis-

cussed below), I used to run ProComm in a window, uploading and downloading files, while I worked in a Windows word processor. Technically, it worked; I was able to send and receive files at 2400 bps without error. However, keyboard response was extremely slow, and screen updates were distracting. If you've ever used Desqview, you know how it feels.

Another example of why enhanced mode is useful: Several years ago I wrote a TSR (terminate and stay resident) program for printing envelopes. On a word processor, I put the cursor on the address block of a letter, load up the LaserJet, press a hotkey, and out comes a nicely formatted envelope. When running in Enhanced mode, I can bring up the word processor (in the graphical simulated-text mode) and the TSR still works.

As for speed, I've seen benchmarks that show Enhanced mode to be about 15% slower than Standard mode (while running Windows, not DOS, programs), but in

use it's very hard to notice much difference.

Enhanced doesn't work for me, however. The problem manifests itself as an occasional keyboard lock-up, seemingly without cause. Only the keyboard dies; I can still use a mouse to save files and shut down Windows. Then it's time for a cold boot. Note: The problem happens only in Enhanced mode, not in Standard mode or DOS.

It first happened when I installed a scanner-interface card. In tracking down the problem, I spoke with Microsoft and the PC manufacturer to no avail, and ended up locating the card in another computer. However, after installing a Lantastic network interface card, the problem resurfaced. This time, however, the adapter had to remain in the computer. Trying to resolve the problem, I have spent hours on the phone with Microsoft, the PC manufacturer, and the manufacturers of the interface cards. In the process I've received several BIOS upgrades, hints about keyboard settings in Windows' initialization files, and lots of finger pointing, all to no avail.

The only solution is to operate exclusively in Standard mode. I lose my envelope printer, the ability to multi-task DOS apps, and the ability to run them in windows. In standard mode, when you make a DOS app current, Windows clears the screen, swaps some stuff to disk, and then lets the DOS app do its thing. The swapping process is slow and distracting.

On the other hand, standard mode is more than bearable when running only Windows applications. For example, you can start a 2400-bps file transfer and go do something else. I regularly transfer megabytes of data while working undistracted in Word for Windows, Corel, ToolBook, etc.

### Font issues

I love my LaserJet II, but sometimes wish I'd never bought it. For the

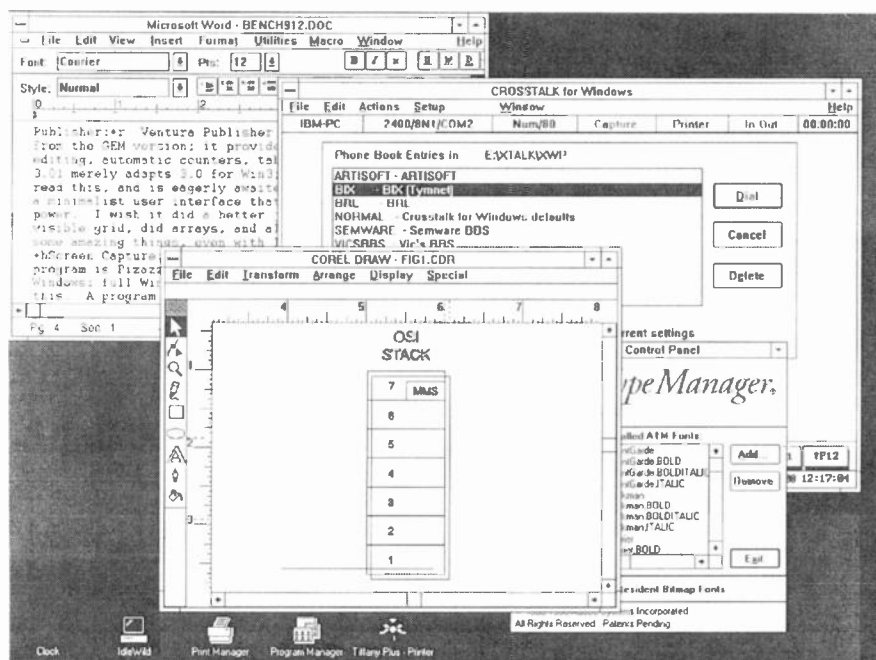

FIG. 1—HERE IS WINDOWS AT WORK, showing a few of the best Windows products.

# R-E Computer Admart

Rates: Ads are 2 1/4" x 2 7/8". One insertion \$995 each. Six insertions \$950 each. Twelve insertions \$925 each. Closing date same as regular rate card. Send order with remittance to Computer Admart, Radio-Electronics Magazine, 500-B Bi-County Blvd., Farmingdale, NY 11735. Direct telephone inquiries to Arline Fishman, area code-1-516-293-3000. FAX 1-516-293-3115. Only 100% Computer ads are accepted for this Admart.

## GETTING THE MOST FROM YOUR PRINTER

Getting The Most From Your Printer



**BP181**—It is probable that 80% of dot-matrix printer users only ever use 20% of the features offered by their printers. This book will help you unlock the special features and capabilities that you probably don't even know exist. To order your copy send \$6.95 plus \$1.50 for shipping in the U.S. to Electronic Technology Today Inc., P.O. Box 240, Massapequa Park, NY 11762-0240.

## SECRETS OF THE COMMODORE 64

Secrets of the COMMODORE 64



**BP135**—A beginners guide to the Commodore 64 presents masses of useful data and programming tips, as well as describing how to get the best from the powerful sound and graphics facilities. We look at how the memory is organized, random numbers and ways of generating them, graphics-color and simple animation, and even a chapter on machine code. Get your copy today. Send \$5.00 plus \$1.25 for shipping in the U.S. to Electronic Technology Today Inc., P.O. Box 240, Massapequa Park, NY 11762-0240.

**ICs PROMPT DELIVERY!!!**  
SAME DAY SHIPPING (USUALLY)  
QUANTITY ONE PRICES SHOWN FOR DEC. 2, 1990

**Memory For Almost ALL Computers**

DYNAMIC RAM	
4M Board for hp LJs w 2MB	\$160.00
SIMM 2M IBM PS 2 Model 70	160.00
SIMM 1M AST Prem386 33Mhz	120.00
SIMM 1Mx9 80 ns	45.00
SIMM 256Kx9 100 ns	18.00
1Mbit 1Mx1 60 ns	9.95
1Mbit 1Mx1 80 ns	4.90
41256 256Kx1 80 ns	2.75
41256 256Kx1 100 ns	1.95
41256 256Kx1 120 ns	1.45
4464 64Kx4 100 ns	1.95
41264* 64Kx4 100 ns	5.95
EPROM	
27C1000 128Kx8 200 ns	\$14.00
27C512 64Kx8 120 ns	5.25
27256 32Kx8 150 ns	6.75
27128 16Kx8 250 ns	3.65
STATIC RAM	
62256P-10 32Kx8 100 ns	\$6.95
6264P-12 8Kx8 120 ns	4.25

**OPEN 6 DAYS, 7:30 AM-10 PM SHIP VIA FED-EX ON SAT.**

SAT DEL ON FED-EX ORDERS RECEIVED BY 7:30 PM EST P. 1 \$17.00 1 B 1.00 AVAILABLE	MasterCard VISA or UPS CASH COD MICROPROCESSORS UNLIMITED INC 24 000 S Peop's Ave BE GGS Q# 13421 (918) 267-4961 No minimum order
---	---

CIRCLE 61 ON FREE INFORMATION CARD

amount of unbillable time I have wasted on soft font problems, I could have bought a PostScript printer. Windows has a mechanism for installing soft fonts, but soft-font installation programs have a habit of really messing up WIN.INI. Several times the file has gotten so badly screwed up that I had to re-install Windows and some apps from scratch. And don't forget about dedicating 10 or 20 megabytes of space just to store the common sizes of half dozen fonts.

That said, I've found Bitstream fonts to be the most reliable and of the highest visual quality. They are, however, expensive compared with the fonts sold by some vendors, and they're also limited as to special effects. The best package I've found for generating wild headline fonts and the like is MoreFonts, from Micro-Logic Corp.

Flash: a copy of Adobe's ATM (Adobe Type Manager) just arrived. It is the equivalent of putting a PostScript font engine inside Windows itself, and because fonts are scaled as they are needed, disk storage is minimal—about a megabyte for 35 fonts, each of which can be scaled as needed to any reasonable size. Of course what you gain in storage space, you lose in processing speed; file printing and screen updates take longer because fonts must be built as they are needed.

To alleviate that problem, ATM reserves a user-selected amount of memory for a font cache; figure at least 100K; 500K works, and for documents with lots of font changes, a megabyte is better. The basic ATM includes Times, Helvetica, Courier, and Symbol fonts; at about \$100 list, it's a steal. **Note:** ATM does its tricks with PostScript printers, LaserJets, and most common dot-matrix devices (Proprinter, Epson, etc.), but only with text; it can't print PostScript graphics. The Plus Pack adds 22 additional fonts, rounding out the typical PostScript complement.

### Windows applications

I'd like to be able to operate exclusively in Windows, but cannot do so yet. There are extremely powerful programs in some areas, and a complete dearth in others. What I miss most is a decent file manager—Windows' own file manager is awkward and limited. It doesn't even show the amount of free and used space on a disk drive. What's needed is a Windows version of Magellan, probably the best DOS file manager on the market.

Even so, the basic Windows package is surprisingly powerful. Several of the major applications—Write, Paint, Terminal—are as powerful as decent stand-alone packages of just a few years back. In a way, the Win-

dows apps really are more powerful than the old stand-bys, because they work together, smoothly and efficiently. You can use Terminal to transfer files in the background while working elsewhere. You can create attractive drawings using Paint and paste them directly into write. Both Paint and Write will use whatever fonts you have installed on your system. I can see Windows 3.0 being used by anyone who doesn't need the utmost in power.

The following are my picks for best Windows products.

**Word processing:** Word for Windows. Allows multi-file editing, multiple views into the same file via (what else) panes; a macro language as powerful as some versions of BASIC; efficient style sheets; the ability to load and save files *directly* in WordStar, WordPerfect, and other formats; outlining; graphics import and printing. Could substitute for desktop publishing in many circumstances, but it is indisputably large and slow.

**Telecomm:** Crosstalk for Windows. Extremely powerful script language for automated telecomm sessions. Runs beautifully in the background; minimize it to an icon, and it displays percent of transfer complete, beeps when done.

**Utilities:** hDC's FirstApps. Provides real-time memory-usage display, ability to save complete

## ASK RE

continued from page 16

troller is hard enough even when you have all the documentation for the computer. To try doing the same thing with a completely unknown machine that has no supporting paperwork and (so you say) no I/O ports strikes me as an exercise in futility.

How you expect to control lights using a machine with no I/O ports is beyond me. And adding them to a machine for which you have no paperwork, and built by a company you can't get in touch with is a job only Sisyphus would want.

If you've got the urge to build a home controller, you'll be much, much better off spending five hundred bucks or so for a PC clone and using that as the basis for the project. You'll have a known machine with real ports and languages available to write the software.

I don't like to discourage anybody from doing whatever project they set their minds to, but yours is only slightly less difficult than striking a match on a bar of soap. **R-E**

### Get A Complete Course In

## ELECTRONIC ENGINEERING

8 volumes, over 2000 pages, including all necessary math and physics. 29 examinations to help you gauge your personal progress. A truly great learning experience.

Prepare now to take advantage of the growing demand for people able to work at the engineering level.

Ask for our brochure giving complete details of content. Use your free information card number, or write us directly. **\$99.95**, Postage Included. Satisfaction guaranteed or money refunded.



**Banner  
Technical  
Books, Inc.**

1203 Grant Ave.  
Rockford, IL 61103

CIRCLE 67 ON FREE INFORMATION CARD

## ITEMS DISCUSSED

● Adobe Type Manager (\$99), Plus Pack (\$198), Adobe Systems Incorporated, 1585 Charleston Road, P.O. Box 7900, Mountain View, CA 94039-7900.  
(800) 83-FONTS.

CIRCLE 41 ON FREE INFORMATION CARD

● MoreFonts (\$149.94), MicroLogic Software, 6400 Hollis Street, Suite 9, Emeryville, CA 94608.  
(415) 652-5464.

CIRCLE 42 ON FREE INFORMATION CARD

● ToolBook 1.0 (\$395), Asymetrix Corp., 110 110th Avenue NE, Suite 717, Bellevue, WA 98004.  
(800) 624-8999, (206) 462-0501.

CIRCLE 43 ON FREE INFORMATION CARD

● Windows 3.0 (\$149), Word for Windows 1.1 (\$495), Entertainment Pack (\$39.95), Microsoft Corp., 17011 NE 36th Way, Box 97017, Redmond, WA 98073-9717.  
(206) 882-8080.

CIRCLE 44 ON FREE INFORMATION CARD

● *Windows 3 Companion*, Lori L. Lorenz and R. Michael O'Mara (\$27.95), *ToolBook Companion*, Joseph R. Pierce, (\$27.95), The Cobb Group/Microsoft Press, One Microsoft Way, Redmond, WA 98052-6399.

CIRCLE 45 ON FREE INFORMATION CARD

Windows environment and reload later. Good alarm clock too. Updates will provide file manager and Lap-Link type communications.

**Desktop Publisher:** Ventura Publisher 3.0 is pretty much a straight port from the GEM version; it provides excellent table and equation editing, automatic counters, table of contents, indexing. PageMaker 3.01 merely adapts 3.0 for Win3; PM 4 is due out around the time you read this, and is eagerly awaited.

**Illustration:** Corel Draw has a minimalist user interface that continues to amaze me with its power. I wish it did a better job with small font sizes, displayed a visible grid, did arrays, and allowed symbols.

**Screen Capture:** My unabashed favorite screen-capture and print program is Pizazz Plus. The current version only partially supports Windows; full Windows support should be out by the time you read this.

**Development Environment:** ToolBook. For user-interface prototyping, there's nothing like it. Extremely powerful and fun.

**Games:** I'm not much of a gamester,

● FirstApps (\$99.95), hDC Computer Corporation, 6742 185th Avenue NE, Redmond, WA 98052.  
(206) 885-5550.

CIRCLE 46 ON FREE INFORMATION CARD

● CrossTalk for Windows (\$195), DCA, 1000 Alderman Drive, Alpharetta, GA 30202-4199.  
(404) 442-4000.

CIRCLE 47 ON FREE INFORMATION CARD

● Ventura Publisher Windows Edition (\$895), Ventura Software, Inc., 15175 Innovation Drive, San Diego, CA 9212.  
(800) 822-8221.

CIRCLE 48 ON FREE INFORMATION CARD

● Corel Draw (\$XXX), Corel Systems Corporation, 1600 Carling Avenue, Ottawa, Ontario, Canada K1Z 8R7.  
(613) 728-8200.

CIRCLE 34 ON FREE INFORMATION CARD

● Pizazz Plus (\$149), Application Techniques, Inc., 10 Lomar Park Drive, Pepperell, MA 01463.  
(508) 433-5201.

CIRCLE 35 ON FREE INFORMATION CARD

but I've seen a few Windows games that are attractive. Microsoft has released an Entertainment Pack with a version of Tetris, several card games, a screen blanker, and more. Also, I've collected a few shareware games (Chess, Checkers, a Tetris clone) that I'll post on the R-E BBS.

**Books:** Microsoft's *Windows User's Guide* is infinitely better than previous versions, but is really a reference guide. The *Windows 3 Companion* provides a view from the user's perspective. For ToolBook programming, the *ToolBook Companion* in the same series is quite useful.

### Conclusion

If I complained about Windows, it's only because it's worth complaining about—I see plenty of bad software that isn't worth the magnetic ink it's printed on. In spite of my complaints, I really like Windows. The program is not perfect, but it got a whole lot better with version 3.0. This version is more than just a passing fad because it represents not just a new way of doing things, but a better way. Try it—you really will like it. **R-E**

## The Boston Sound: Part II

LARRY KLEIN

Last month we traced the intertwined history of some of the important New England-based loudspeaker manufacturers. Without exaggeration, it can be said that those companies established new technical standards for home loudspeakers. In general, their products were smoother, had wider range, and had far less coloration than either previous designs or those of most of their competitors on the West Coast. Although I covered only the most prominent New England companies and designers, I'm sure that there are others who made contributions that also advanced the state of the speaker art.

As discussed in last month's column, one of today's leading manufacturers of high-quality speaker systems is Boston Acoustics. Last fall I had the pleasure of visiting BA's new, highly automated plant and spending the day with the president of the company, Andy Petite. In the course of our conversations, we touched on a number of issues and matters that are of concern to anyone interested in how loudspeakers are designed and manufactured—and particularly what makes them sound good. What follows is a random selection of Andy's views, somewhat condensed and paraphrased.

- As you know, the crossover networks found in today's speakers range from the incredibly complex to the surprisingly simple. We try to design the simplest possible crossover that will do the job in a particular system. Many of the components that you see in complex crossovers are in there to compensate for the deficiencies of the system's drivers. For example, if you design a woofer with a smooth response at the crossover-frequency area and above—which is the right thing to do with respect to overall performance—you can considerably simplify your crossover network. Not only does that save money, but it also minimizes power losses

and provides a smoother impedance curve for the amplifier to drive.

- In production, our assembled crossovers are checked against a reference network to a tolerance of  $\pm 0.5$  dB. Aside from helping ensure the frequency performance of the system as a whole, that procedure eliminates the crossover assembly as the cause if system response is not up to spec in the final checkout. That's important because, while it's easy to replace drivers if necessary, it's a real pain to get to and fix a crossover once it's finally installed in an enclosure.

- We usually prefer to use acoustic-suspension woofers rather than bass-reflex or vented designs for two reasons: The woofer in a vented system is inherently uncontrolled below its low-frequency cutoff. The very low frequencies generated by turntable rumble and tone-arm resonances can cause excessive cone excursions in the infrasonic area and, therefore, intermodulation distortion at audible frequencies. Of course, as LP's fade from the marketplace, the sonic problems produced by the equipment that is used to play them will also disappear.

Another difficulty has to do with the



FIG. 1—BOSTON ACOUSTICS' SW10 powered subwoofer features a 100-watt internal amplifier with electronic crossover.

way a woofer ages. Its suspension becomes more compliant over time, which can mistune a critically tuned vented system. In contrast, an acoustic suspension design is relatively immune to bass-response changes through woofer aging. Both of those problems are a lot less severe these days, although we question how well small and/or inexpensive vented systems react to the strong low bass found on many CD's.

- When it's technically and economically feasible to do so, there's a definite advantage in directly powering a woofer or subwoofer. By electronically controlling the characteristics of the signal fed to the woofer you can easily achieve very low frequency crossovers, response curves, and very steep rolloffs that would be quite impractical with passive inductive/capacitive networks. That allowed us to use a vented system for our powered subwoofer—which has the advantage of reduced excursion at low frequencies compared to an acoustic suspension—without running into the infrasonic problems I just mentioned.

You can also avoid many types of acoustic problems with non-powered vented designs by designing them for a good low-bass response. If the cutoff frequency is made low enough, the speaker will be controlled properly down to the lowest musical frequencies.

- There's a common assumption that the larger the woofer in a system, the better the bass. But for a large woofer to be effective it must be installed in a large enough enclosure. For example, if you put a 12-inch woofer in a 1.5-cubic-foot enclosure, the small volume of the enclosed air raises the system resonance, and the bass response decreases. To restore the bass you have to add more mass to the cone, and then use a heavier magnet to maintain efficiency. That is not a very cost-effective process. The only advantage of a large cone

# LEARN VCR

## CLEANING/MAINTENANCE/REPAIR

EARN UP TO \$1000 A WEEK, WORKING PART TIME FROM YOUR OWN HOME!



Secrets Revealed!

NO Special Tools or Equipment Needed.

EARN UP TO \$60 AN HOUR AND MORE!

### THE MONEY MAKING OPPORTUNITY OF THE 1990'S

IF you are able to work with common small hand tools, and are familiar with basic electronics (i.e. able to use voltmeter, understand DC electronics) . . .

IF you possess average mechanical ability, and have a VCR on which to practice and learn. . . then we can teach **YOU** VCR maintenance and repair!

**FACT:** up to 90% of ALL VCR malfunctions are due to simple MECHANICAL or ELECTRO-MECHANICAL breakdowns!

**FACT:** over 77 million VCRs in use today nationwide! Average VCR needs service or repair every 12 to 18 months!

Viejo's **400 PAGE TRAINING MANUAL** (over 500 photos and illustrations) and **AWARD-WINNING VIDEO TRAINING TAPE** reveals the **SECRETS** of VCR maintenance and repair—"real world" information that is **NOT** available elsewhere!

Also includes all the info you'll need regarding the **BUSINESS-SIDE** of running a successful service operation!

#### FREE INFORMATION

CALL TOLL-FREE 1-800-537-0589

Or write to: Viejo Publications Inc.

5329 Fountain Ave.

Los Angeles, CA 90029 Dept. RE

CIRCLE 189 ON FREE INFORMATION CARD

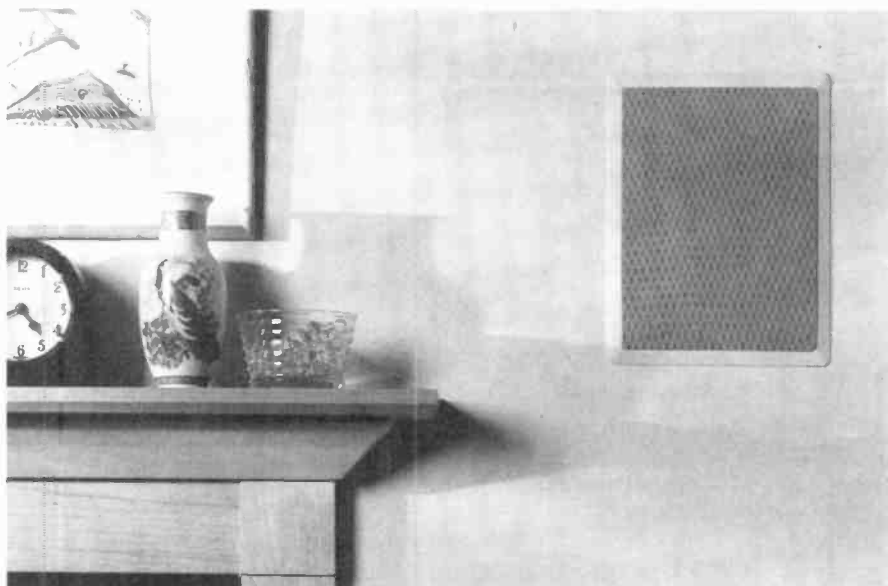

FIG. 2—BOSTON ACOUSTICS' 380 is the smallest 8-inch, two-way, flush-mount speaker system available.

woofer is a somewhat higher maximum output level—assuming that it's installed properly in an adequately sized box. If you can get the loudness levels you want with smaller cones, you are better off using them—in pairs if necessary. Using small cones in pairs has definite advantages.

- Some of the basic enclosure ground rules change when you're dealing with car-stereo speakers or speakers meant to be flush mounted in a wall. In both cases, we design the woofers with a fairly stiff-suspension—which makes them more rugged—because their free-air resonance is not shifted upward to any degree by the mounting. In general, there is not a significant variation in the rear loading seen by woofers in most car installations. We get a very good correlation between tests in a car door or rear package shelf and tests done with the woofer mounted on a simulated infinite plane baffle—in other words, a large sheet of plywood.

- Over the years I've observed that there is a real dichotomy between the views of the empirical and the theoretical speaker designers. For example, for years the academic theorists would give loudspeaker-design papers at various Audio Engineering Society conventions. Those were frequently greeted by snickers from the designers in the room, because it was clear that the theoreticians had not tried out their ideas by designing and building systems. A favorite example: One particular professor of acoustics had for years

been giving papers on phase-correct crossover networks. At one point he and a grad student decided to build a speaker system based on the professor's theories. It turned out that the system didn't work very well because real-world drivers have a complex impedance, quite unlike the resistors on which the design calculations had been based. The next year his paper was based on his work with real world drivers.

- Except when dealing with audiophiles, speaker designers have always had a tough job satisfying interior decorators, architects, and others who would prefer that speakers be heard but not seen. Electronic woofer control has made possible substantial reductions in cabinet size while still realizing adequate bass. However, the laws of physics put a limit on how loudly a very small woofer can play and how low it can go even with everything optimized. Built-in wall speakers and subwoofer/satellite systems are two variable solutions to make speakers invisible, or at least unobtrusive in the home or workplace.

A final word: Andy Petite's views on speaker design should be particularly interesting to anyone who likes to know the technical thinking and design process behind commercial audio products. As the proof of the pudding is in the eating, so too the test of any design approach is the performance of the product. To my ears, Andy's thinking—and design approach—make an exceptional amount of sense.

R-E

# SUPER LONG PLAY TAPE RECORDERS

12 Hour Model — USES 120 TAPE \$119.00\*

Modified Panasonic Slimline, high quality AC-DC provide 6 continuous hours of quality recording & playback on each side of cassette for 12 hours total. Includes • Voice level control • Digital counter, etc. TDK - 120 Cassette Furnished.



## PHONE RECORDING ADAPTER

Records calls automatically. All Solid state connects to your telephone jack and tape recorder. Starts recording when phone is lifted. Stops when you hang up.

\$28.50\*

FCC APPROVED

**VOX VOICE ACTIVATED CONTROL SWITCH**  
Solid state. Self contained. Adjustable sensitivity. Voices or other sounds automatically activate and control recorder. Uses either recorder or remote mike. \$28.50\*



\*Add for ship & hdg. Phone Adapter & Vox \$1.50 ea. Recorders \$4.00 ea. Cal. Res. add tax. Mail order: VISA, M/C, COD's OK. Money Back Guarantee. Qty. disc avail.. Dealer Inquiries invited. Free data.  
**AMC SALES INC. Dept. A 9335 Lubec St. Box 928. Downey, CA 90241. Phone (213) 869-8519 FAX (213) 923-1478**

CIRCLE 108 ON FREE INFORMATION CARD



# How to build a high-paying career, even a business of your own, in computer programming.



**RICK BRUSH,  
NRI PROGRAMMER/ANALYST**

**Start with training that gives you hands-on programming experience—at home and at your own pace. Training that begins with BASIC, then continues with Pascal, C, and COBOL—today's hottest computer languages. Training that even includes a powerful IBM-compatible computer, modem, and programming software you keep.**

**Start with real-world training. The kind of training only NRI provides.**

Now with NRI's new at-home training in Computer Programming, you can be one of today's highly paid, creative team of computer wizards who give computers the power to carry out an astonishing range of business, professional, and personal applications. Now, with NRI, you can be a computer programmer, ready to build a high-paying career—even a business of your own—making computers do anything you want them to do.

**The only programming course that includes a powerful computer system and software you keep.**

Unlike any other school, NRI gives you hands-on programming experience with a powerful IBM compatible West Coast computer system, including 2400

baud internal modem, 640K RAM, disk drive, monitor, and invaluable programming software—BASIC, Pascal, C, and COBOL—all yours to keep.

You get the experience and the know-how, the computer and the software to get to the heart of every programming problem, design imaginative solutions, then use your choice of four key computer languages to build original, working programs.

**No matter what your background, NRI gives you everything you need to succeed in programming, today's top-growth computer career field.**

You need no previous experience to build a successful programming career with NRI training. Indeed, your NRI lessons start by walking you step by step through the fundamentals, giving you an expert understanding of the programming design techniques used every day by successful micro and mainframe programmers. And then the fun really begins.

C, and COBOL. Then, rounding out your training, you use your modem to "talk" to your instructor, meet other NRI students, even download programs through NRI's exclusive programmers network, PRONET.

**Your career in computer programming begins with your FREE catalog from NRI.**

For all the details about NRI's at-home training in Computer Programming, send the coupon today. Soon you'll receive NRI's fascinating, information-packed, full-color catalog.

Open it up and you'll find vivid descriptions of every aspect of your NRI training. You'll see the computer system included in your course up close in a special, poster-sized foldout section. And, best of all, you'll find out how your NRI training will make it easy for you to build that high-paying career—even a business of your own—in computer programming.

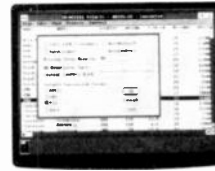
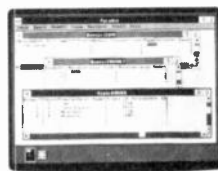

**You master today's hottest computer languages, gaining the skills you need to build programs for a wide variety of real-world applications.**

With your personal NRI instructor on call and ready to help, you use your computer and software to actually design, code, run, debug, and document programs in BASIC, Pascal,

**Send for your NRI catalog today. It's yours, free.**

If the coupon is missing, write to us at the NRI School of Computer Programming, McGraw-Hill Continuing Education Center, 4401 Connecticut Avenue, NW, Washington, DC 20008.

IBM is a Registered Trademark of the IBM Corporation

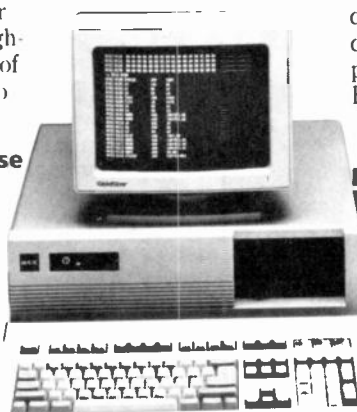

**Only NRI gives you an IBM-compatible computer with modem, 640K RAM, disk drive, monitor, and software—BASIC, Pascal, C, and COBOL—all yours to keep!**

## **NRI** School of Computer Programming

McGraw-Hill Continuing Education Center  
4401 Connecticut Avenue, NW  
Washington, DC 20008



**YES!** Please rush me my FREE catalog describing NRI's at-home training in Computer Programming.

NAME \_\_\_\_\_ (please print) \_\_\_\_\_ AGE \_\_\_\_\_

ADDRESS \_\_\_\_\_

CITY/STATE/ZIP \_\_\_\_\_ 5413-031

Accredited Member National Home Study Council

# R-E Engineering Admart

Rates: Ads are 2 1/4" x 2 1/8". One insertion \$995 each. Six insertions \$950 each. Twelve insertions \$925 each. Closing date same as regular rate card. Send order with remittance to Engineering Admart, Radio-Electronics Magazine, 500-B Bi-County Blvd., Farmingdale, NY 11735. Direct telephone inquiries to Arline Fishman, area code-1-516-293-3000. FAX 1-516-293-3115. Only 100% Engineering ads are accepted for this Admart.

**Surface Mount Chip Component Prototyping Kits—Only \$49.95**



CC-1 Capacitor Kit contains 365 pieces, 5 ea. of every 10% value from 1pf to 33µf. CR-1 Resistor Kit contains 1540 pieces, 10 ea. of every 5% value from 10Ω to 10 megΩ. Sizes are 0805 and 1206. Each kit is ONLY \$49.95 and available for Immediate One Day Delivery!

Order by toll-free phone, FAX, or mail. We accept VISA, MC, AMEX, COD, or Pre-paid orders. Company P.O.'s accepted with approved credit. Call for free detailed brochure.

**COMMUNICATIONS SPECIALISTS, INC.**  
426 West Taft Ave. • Orange, CA 92665-4296  
Local (714) 998-3021 • FAX (714) 974-3420

**Entire USA 1-800-854-0547**

CIRCLE 187 ON FREE INFORMATION CARD

## FCC LICENSE PREPARATION

The FCC has revised and updated the commercial license exam. The NEW EXAM covers updated marine and aviation rules and regulations, transistor and digital circuitry. THE GENERAL RADIOTELEPHONE OPERATOR LICENSE - STUDY GUIDE contains vital information. VIDEO SEMINAR KITS ARE NOW AVAILABLE.

WPT PUBLICATIONS  
979 Young Street, Suite E  
Woodburn, Oregon 97071  
Phone (503) 981-5159 Dept. 50

CIRCLE 190 ON FREE INFORMATION CARD

## MIDI PROJECTS

BP182—MIDI interfacing enables any so equipped instruments, regardless of the manufacturer, to be easily connected together and used as a system with easy computer control of these music systems. Combine a computer and some MIDI instruments and you can have what is virtually a programmable orchestra. To get your copy send \$6.95 plus \$1.25 for shipping in the U.S. to Electronic Technology Today Inc., P.O. Box 240, Massapequa Park, NY 11762-0240.

# NEW LIT

Use The Free Information Card for fast response.

**STAYING WITH DOS: GETTING THE MOST FROM YOUR COMPUTER WITHOUT CHANGING YOUR OPERATING SYSTEM;** by Dan Gookin. Ventana Press, P.O. Box 2468, Chapel Hill, NC 27515; Tel: 919-942-0220; Fax: 919-942-1140; \$22.95.

Even though today's sophisticated computers and applications software are increasingly demanding, there's a good chance that

you can get by with DOS, and not have to upgrade to an expensive new operating system. This book can help you decide whether you should stay with DOS as it is, use other products to enhance it, or move on to a new operating system. It emphasizes that DOS can remain a viable alternative to OS/2 or Unix, and explains how users can get more memory, more speed, better graphics capabilities, and even do multi-tasking and networking with their old operating system. A chapter on Windows 3.0 and other graphical user interfaces provides a detailed overview of how to use those to make DOS perform like the newer, more powerful operating systems, without having to invest money and time in buying and learning to use a new operating system. Convenient checklists help readers evaluate their needs, and appen-

dices provide detailed buying information on new products that help boost the speed and power of DOS.

replacement parts and replacement RF modulators—is described in the second edition of this catalog and cross-reference guide. Several previous ECG publications have been consolidated in this one book, which presents more than 270 products. The catalog contains pictorial selector guides, specifications, cross-reference sections, and related replacement information on a variety of VCR modulators, opto-sensing devices, pinch rollers, idler wheels, assemblies and tires, individual belts and belt kits, and VHS/Beta replacement heads. Also featured are service aids for making fine adjustments to tape equipment, such as audio/video test cassettes, lubricants, and cleaning materials. The catalog cross references 31 popular VCR brands and more than 2400 industry model/part numbers. **R-E**

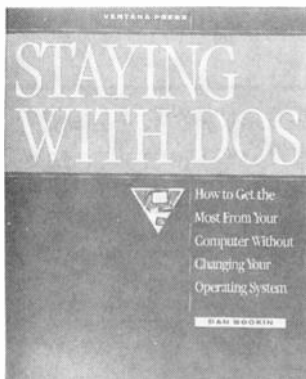

CIRCLE 31 ON FREE INFORMATION CARD

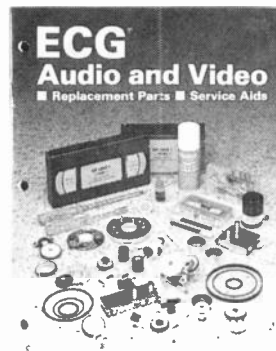

CIRCLE 32 ON FREE INFORMATION CARD

**ECG AUDIO AND VIDEO: Replacement Parts & Service Aids;** from Philips ECG; 1025 Westminster Drive, Williamsport, PA 17701; Tel: 800-526-9354.

Philips ECG's expanding audio and video product line—including a larger selection of VCR mechanical

# MARKET CENTER

## FOR SALE

**DESCRAMBLERS.** All brands. Special: Combo Jerrold 400 and SB3 \$165.00. Complete cable descrambler kit \$39.00. Complete satellite descrambler kit \$45.00. Free catalog. **MJM INDUSTRY**, Box 531, Bronx, NY 10461-0208.

**ENGINEERING** software, PC/MSDOS. Hobbyists — students — engineers. Circuit design and drawing, PCB layout, Logic simulation, FFT analysis, Mathematics, Circuit analysis. Call or write for free catalog. 1 (800) 728-3805, **BSOFT SOFTWARE**, 444 Colton Rd., Columbus, OH 43207.

**RESTRICTED** technical information: Electronic surveillance, schematics, locksmithing, covert sciences, hacking, etc. **Huge selection. Free brochures.** **MENTOR-Z**, Drawer 1549, Asbury Park, NJ 07712.

## CB RADIO OWNERS!

We specialize in a wide variety of technical information, parts and services for CB radios 10-Meter and FM conversion kits, repair books, plans, high-performance accessories. Thousands of satisfied customers since 1976! Catalog \$2.

### CBC INTERNATIONAL

P.O. BOX 31500RE, PHOENIX, AZ 85046

**CABLE TV converters:** Jerrold, Oak, Scientific Atlantic, Zenith & many others. "New MTS" stereo add-on: mute & volume. Ideal for 400 and 450 owners! 1 (800) 826-7623, Amex, Visa, M C accepted. **B & B INC.**, 4030 Beau-D-Rue Drive, Eagan, MN 55122.

**TUBES**, new, up to 90% off, SASE, **KIRBY**, 298 West Carmel Drive, Carmel, IN 46032.

**PROGRAMMABLE stepper motor drive** & control for under \$100. IBM PC/XT compatible. **Commodore 64**, or other with 25 pin parallel port, PCB, interface & software. Send for detailed literature to: **MASE, R.D.** #2 Box 166, Mohrsville, PA 19541.

**CABLE TV converters and descramblers.** We sell only the best. Low prices. **SB-3 \$79.00.** We ship C.O.D. Free catalog. **ACE PRODUCTS**, PO Box 582, Dept. E, Saco, ME 04072. 1 (800) 234-0726.

**PRINTED** circuit boards etched & drilled. Free delivery. **K & F ELECTRONICS, INC.**, 33041 Groesbeck, Fraser, MI 48026. (313) 294-8720.



**Quality Microwave TV Antennas**

WIRELESS CABLE • IFTS • MMDS • Amateur TV  
Ultra High Gain 50db (+) • Tuneable 1.9 to 2.7 Ghz.

- 36-Channel System Complete \$149.95
- 12-Channel System Complete \$114.95
- Call or write (SASE) for "FREE" Catalog

**PHILLIPS-TECH ELECTRONICS**  
P.O. Box 8533 • Scottsdale, AZ 85252  
(602) 947-7700 (\$3.00 Credit all phone orders)  
MasterCard • Visa • C.O.D.'s • Quantity Pricing

LIFETIME WARRANTY

**FREE** catalog: Save hundreds on sought after electronic, electro mechanical, and computer related hardware and components — including hard-to-find items. Call toll free: 1 (800) 776-3700. **AMERICAN DESIGN COMPONENTS/Dept.** 119-021, 815 Fairview Avenue, Fairview, NJ 07022.

**ARTWORK** created for use in printed circuit board production from your engineering schematics. Professional quality hardcopy, Gerberfile, or Photoplotter outputs. Reasonable rates. Send for details to: **JTD ENGINEERING**, 10628 Grandview Place, Alta Loma, CA 91701.

**TUBES:** "oldest," "latest." Parts, schematics. SASE for lists **STEINMETZ**, 7519 Maplewood Ave., RE Hammond, IN 46324.

**CABLE TV converters & descramblers for Jerrold and Scientific Atlanta.** Low prices, one year warranty. We ship COD. **BAY STATE ELECTRONICS**, PO Box 103, Boston, MA 02188. 1 (800) 359-9806.

**SURVEILLANCE** telephone, monitor room conversation, \$175.00. Monitor room and telephone conversations, \$275.00. Dialer, calls you whenever telephone is used, \$305.00. Catalog, \$3.00 to: **LIS-TEN ELECTRONICS**, 603 Elgin, Muskogee, OK 74401. 1 (800) 633-8277.

## FREE CATALOG

**FAMOUS "FIRESTIK" BRAND CB ANTENNAS AND ACCESSORIES. QUALITY PRODUCTS FOR THE SERIOUS CB'er. SINCE 1962**

**FIRESTIK ANTENNA COMPANY**  
2614 EAST ADAMS  
PHOENIX, ARIZONA 85034

**CABLE** descramblers (Jerrold) from \$40.00. Tocom VIP test chip. Fully activates unit. Also Zenith test board. Fully activates Z-Tacs. \$50.00. Call (213) 867-0081.

**T.V.** notch filters, surveillance equipment, brochure \$1.00. **D.K. VIDEO**, Box 63 6025, Margate, FL 33063. (305) 752-9202.

## WIRELESS CABLE RECEIVERS 1.9 TO 2.7 GHZ



VISA MC AMEX

30 CH PARABOLIC DISH SYSTEM \$173.90  
30 CH ROD ANTENNA SYSTEM \$193.90  
30 CH CRYSTAL CONTROLLED SYSTEM \$294.95

SUN MICROWAVE INT'L INC. SEND \$1.00 FOR P.O. BOX #34522 CATALOG ON THESE AND OTHER FINE VIDEO PRODUCTS  
PHOENIX, AZ 85067  
(602) 230-0640  
QUANTITY DISCOUNTS

**CABLE TV** brokers and distributors high volume of descramblers Jerrold SB-3 refurbished or as is. converters Jerrold models DRX-400, JRX and hand remote control (no Canada sales for descramblers). Affitech, ask **DANIEL PERREAULT** (514) 656-9150.

**KITS**, MC68701 programmer \$135.00 Morse code keyboard \$75.00, ten meter FM conversion \$25.00. **SINGLE CHIP SOLUTIONS**, Box 680, New Hartford, CT 06057-0680.

**COMMUNICATIONS SECURITY ASSOCIATION** — Electronic surveillance, countersurveillance, communications security topics — membership information — POB 7069, Gaithersburg, MD 20898. (301) 309-3731.

**NEW** devices: proximity switch, static snooper, personal defender, laser supplies, bug snooper, PC interfaces and more. Catalogue \$2.00 **BAUER**, 35 Soucy, Delson, Quebec, J0L 1G0.

**FLUKE SUPER SALE**

Model 73 ... \$ 79	Model 83 ... \$199	VISA
75 ... \$119	85 ... \$229	M/C
77 ... \$149	87 ... \$269	

▲ NEW! Model 45 ... \$79 ▼

**KELVIN Electronics**  
7 Fairchild Ave. Plainville, NY 11803  
(516) 349-7620 1(800) 645-9212



**PROTOQUICK Z8**, single board computer with prototype area. \$69.00. **SOFTWARE SCIENCE**, 3750 Roundbottom Road, Cincinnati, OH 45244. (513) 561-2060.

**RADIO** tubes, parts. Extensive listings. \$1.00 (refundable). **DIERS**, 4276-E6 North 50th Street, Milwaukee, WI 53216-1313

## CABLE TV DESCRAMBLERS! BARGAIN HEADQUARTERS!



- JERROLD™ • TOCOM • HAMLIN
- OAK • ZENITH
- SCIENTIFIC ATLANTA

6 month warranty! We ship C.O.D.!  
Lowest retail/wholesale prices!

### FREE CATALOG:

Global Cable Network  
1032 Irving St. Suite 109  
S.F., CA 94122

NO CALIFORNIA SALES!!!

**ORDER TODAY! 800-327-8544**

**FREE** catalogue. Computers. Electronic parts and kits. Filters, amplifiers, power supplies. Radio Shack Dealer. **MCDOWELL ELECTRONICS**, Box 1206, Brewton, AL 36427. (205) 867-8805.

**ROBOTICS** software, PC MSDOS. Explore computer vision, sonar sensing. Free brochure. **ROBOTS ETC**, Box 122, Tempe, AZ 85280.

**TEST** equipment pre-owned now at affordable prices. Signal generators from \$50.00, oscilloscopes from \$50.00, other equipment, including manuals available. Send \$2.00 U.S. for catalog, refunded on 1st order. **J.B. ELECTRONICS**, 3446 Dempster, Skokie, IL 60076. (708) 982-1973.

1/4 WATT resistor kit 161 values 5 each in its own labeled envelope. All in a neat file box. 5 more each of popular values. 990 resistors. \$19.95 shipped. **DELTA DISTRIBUTORS**, Box 87, E. Derry, NH 03041.

## CABLE T.V. CONVERTERS WHY PAY A HIGH MONTHLY FEE?

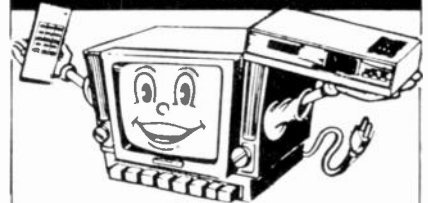

All Jerrold, Oak, Hamlin, Zenith, Scientific Atlanta, Magnavox and all specialized cable equipment available for shipment within 24 hours. For fast service MC / VISA or C.O.D. telephone orders accepted (800) 648-3030 60 Day Guarantee (Quantity Discounts) 8 A.M. to 5 P.M. C.S.T. **CLOSED WEEK-ENDS.** Send self-addressed Stamped envelope (60¢ postage) for Catalog.

**MIDWEST ELECTRONICS INC.**  
P.O. Box 5000  
Suite 311 (R)  
Carpentersville, IL 60110

No Illinois Orders Accepted

## MOVIE VIEW SALES

Cable T.V. Converters

Descramblers / Low Prices

PO Box 26 • Wood Dale, IL 60191  
(708) 766-5222/Fax (708) 766-5269  
Call CST Mon.-Fri. - 9-5 / Sat.-10-2

JERROLD • SCIENTIFIC ATLANTA  
OAK • ZENITH • HAMLIN • PIONEER

Converter Only • Hand Helds

Ch. 3 Filters • 3 Ft. Jumper Cable

VISA/Mastercard  C.O.D.

Friendly Knowledgeable Service

10 Yrs. Experience

6 Mos. Warranty

(NO ILLINOIS SALES)

CB DX 1990'S, get more out of your radio. CBR, Box 212, Rochelle Park, NJ 07662. Catalog.

GREAT buys, surplus prices. DC motors, PS-13VDC-20A, light chasers, fiber optics, transformers, scope probes, vacuum pumps. LSASE, FER-TIK'S, 5400 Ella, Phila., PA 19120.

## REMOTE CONTROL KEYCHAIN

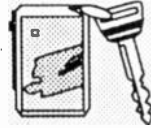

Complete w/mini-transmitter and +5 vdc RF receiver Fully assembled including plans to build your own auto alarm Quantity discounts available

**\$24.95** Check, Visa or M/C Add \$ 3 shipping

VISITECT INC. BOX 5442, SO. SAN FRAN., CA. 94080  
(415) 872-0128 Fax (415) 872-2635

## PLANS AND KITS

MINIATURE FM transmitters! Tracking transmitters! Voice disguisers! Bug detectors! Phone Devices! More! Available in kits or assembled! Catalog \$2.00: XANDI ELECTRONICS, Box 25647, Dept. 60N, Tempe, AZ 85285-5647.

CATALOG: hobby/broadcasting/HAM/CB: Cable TV, transmitters, amplifiers, surveillance devices, computers, more! PANAXIS, Box 130-F2, Paradise, CA 95967

CB Tricks II book. Power amplifier design and theory. UHF CB tune ups. Send \$19.95 MEDICINE MAN CB, PO Box 37, Clarksville, AR 72830.

DESIGN your own custom circuits with our user friendly electronic engineering software. IBM and compatibles, Commodore 64, and 128. Free information. Write or call today! WEASEL GRAPHICS, PO Box 51697, Riverside, CA 92517-2697. Phone 1 (800) 356-8113 Visa/Mastercard.

## Cable TV Descramblers

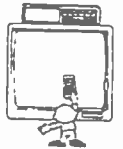

If you find a better deal, we'll better our deal.

\*Jerrold \*Tocom \*Hamlin \*Oak

\*Scientific Atlanta \*Zenith

Ask about our extended warranty program.

COD, Visa, M/C welcome.

Free Call - Free Catalog.

Video Tech **800-562-6884**

3702 S. Virginia St., Ste. 160-304  
Reno, NV 89502.

TOCOM VIP converters w remote from \$279.00. Tocom super chips turn on everything. \$69.00 each. Phone (219) 935-4128.

PHOTOFACT folders under #1400 \$4.00. Others \$6.00. Postpaid. LOEB, 414 Chestnut Lane, East Meadow, NY 11554.

FM 2-way, CB/amateur, scanners, radar detectors, auto alarms, catalog \$1.00, RAYS, PO Box 14862, Fort Worth, TX 76117.

VIDEO game circuit boards, some working, all good for parts. (Processors, eproms, ETC.) \$3.00 and up. Call (301) 233-2600. Ask for BARRY or CHUCK.

TV troubleshooting solutions. 450 solutions by area and components. Symptom remedy make model Sams ref. Save time, you'll love it. Send \$24.50 to PHASE CONTROL ENG., Box 222, Chanhassen, MN 55317.

TOCOM VIP turn on chip that does it all. \$40 1. \$35 50 comes with instructions (419) 475-9453.

# CABLE TV

TB-3 (Tri-Bi) or SA-3

Quantity Prices

10

20

**\$48.**

Each

**\$43.**

Each

50

100

**\$39.**

Each

**\$35.**

Each

Hours open 10:00 am to 4:00 pm Eastern time

Minimum order 5 units 55.00 ea.

Dealers wanted. We ship COD.

King Wholesale

**1-800-729-0036**

Fax number 6173400053

"No one beats the King's prices!"

# DESCRAMBLERS

Try the

**Radio Electronics.**

bulletin board system

(RE-BBS)

**516-293-2283**

The more you use it the more useful it becomes.

We support 300 and 1200 baud operation.

Parameters: 8N1 (8 data bits, no parity, 1 stop bit) or 7E1 (7 data bits, even parity, 1 stop bit).

Add yourself to our user files to increase your access.

Communicate with other R-E readers.

Leave your comments on R-E with the SYSOP.

RE-BBS

**516-293-2283**

PC TV interface - RGB to TV Video VCR. Switchable between PC and composite video inputs. Channels 3 or 4, RF output. Complete PC card kits \$59.95. PC board only \$19.95. INNOVONICS CORP., 9 Bartlet St., Dept. 36, Andover, MA 01810.

POWERFUL single-chip FM room transmitter, size of a postage stamp, transmits to any FM radio up to one mile away. Complete kit \$19.95 postpaid. HERTZ MICRODEVICES, Box 41771, LA. CA 90041-41771.

SURVEILLANCE - Audio video infra-red laser equipment. Industrial or private. 500 item catalog \$7.00. SECURITY SYSTEMS, 3017G Hudson, New Orleans, LA 70131.

TRANSMIT VCR to any set in house. Inexpensive. No construction. Complete instructions. \$4.00. VENTURA, Box 377, Beverly, MA 01915.

BUILD from easy-to-follow schematics: audio mixers equalizers (stage, studio, business, home, basic to sophisticated), feedback controllers, active filters, guitar super-fuzz box, loudspeaker enclosures (including car van), power supplies, more. vSSE reliability. Send \$5.00 for descriptions. Reasonable prices. VON SPRECKEN SOUND ENGINEERING, Dept. B, Box 1315, Clinton, MS 39060.

## CABLE DESCRAMBLERS OAK M35B COMBO \$39.95

Jerrold, Zenith, Hamlin, Sci. Atlanta, Pioneer & MORE! OUR PRICES ARE BELOW WHOLESALE!

**CABLE + PLUS**

14417 Chase St. #481-A Panorama City, CA 91402

1-800-822-9955 • Other Info. 1-818-785-4500

NO CALIF SALES - DEALERS WANTED

DESCRAMBLING, new secret manual. Build your own descramblers for cable and subscription TV. Instructions, schematics for SSAVI, gated sync, sinewave, (HBO, Cinemax, Showtime, UHF, adult) \$12.95, \$2.00 postage. CABLETRONICS, Box 30502R, Bethesda, MD 20824.

AMAZING device disables any remote keychain car alarm via radio! Cheap one evening project. Sell to car "Repo" companies for hundreds \$profit! Or just fool friends and neighbors. Complete theory and plans \$12.95. HUMAN MOVEMENT SYSTEMS, 131-30 234 St., Rosedale, NY 11422.

BUILD a remote controlled video switch. Send \$1.00 for schematic. D. SCHWEIGART, PO Box 1352, Wellsville, NY 14895.

MIDI and music accessories, plans, kits, and assembled, catalog \$1.00. M-SEQ, Box 231233, San Diego, CA 92194.

REMOVE copy protection distortion while viewing rental movies. Complete plans using \$5-10 in parts. Send \$9.95 and SASE to AUTOSOLVE, PO Box 3997, Oak Park, IL 60301.

AUDIO! Plans/products - inexpensive, professional, amps, mixers, more! Literature cassette - \$3.00! DAVISOUND, Box 521, Newberry, SC 29108.

INVESTIGATORS, experimenters - Quality new plans. Micro and restricted devices. Free catalog. Self addressed stamped envelope required KELLEY SECURITY INC., Suite 90, 2531 Sawtelle Blvd., Los Angeles, CA 90064.

**FREE CATALOG!**  
**1-800-648-7938**  
 For all information 1-702-362-9026  
**JERROLD HAMLIN OAK ETC.**  
**CABLE TV**  
**DESCRAMBLERS**  
 • Compare our low Low Retail Prices!  
 • Guaranteed Prices & Warranties!  
 • Orders Shipped Immediately!  
**REPUBLIC CABLE PRODUCTS INC.**  
 4080 Paradise Rd. #15 Dept. RE-90  
 Las Vegas, NV 89109

KITS — alarms, games, and test equipment. Send \$1.00 for catalog. RAKJAB, PO Box 1875, Apopka, FL 32704.

LASER lighting entertainment systems and accessories. Create 3-dimensional laser light shows with these professional secrets! Electronic and mechanical designs for all budgets! \$20.00. MILLENIUM, 229 McAfee, Thousand Oaks, CA 91360

*Phonvu Videophone in a Chip*  
**STILL FRAME TV PICTURE TELEPHONE**  
**TRANCEIVER KIT**  
 Sends Slow Scan TV pictures over The phone line in Twelve Seconds

**Captures any TV Camera, Camcorder VCR, NTSC Video output and holds the display and sends on command**

Auto Mode allows hands free send and receive. Displays on any TV

**IC Chip Replaces 150 SSI Dips**

50 Levels of Grey Scale  
 Serves as:  
 TV FAX  
 Camera 290 x 242.5 High Res. 50,000 Pixels

Phonvu  
 Tel. Mon. Line  
 Modulator  
 Use VCR Mod. TV

THIS DEVICE IS COMPLETE AND READY TO OPERATE. PLUG IN THE CAMERA AND TV AND GO. TWO SETS ARE REQUIRED FOR END TO END COMMUNICATION.

RECORD PICTURES TO ALSO CASSETTE RECORDERS  
**ENHANCE YOUR PHONE COMMUNICATIONS**

Videophone Chip and Schematic	48P DIP	\$59.95
A/D, DRAM, D-Reg.		\$35.00
PC Board (BARE)		\$18.95
50 Res. Cap. Diode		\$28.75
Cabinet (uncut)		\$12.75
Power Pack		\$ 8.75
KIT PRICE:		\$ 164.15
ASSEMBLED		TOTAL \$ 233.00

PHONE and FAX Order (213) 827-1852  
**PMC Electronics** Box 1148  
 Marina Del Rey, CA 90292

CIRCLE 20 ON FREE INFORMATION CARD

METAL project boxes — 50% off! Huge selection. Plus storage capacitors, amplifier kits, electronic parts. Free catalog. SCC, Box 551RE, Dublin, OH 43017.

PCB and schematic CAD software. Easy multilayer rubberband zoom pan and more. CGA EGA IBM compatibles. \$195.00. NUMBER ONE SYSTEMS, 10565 Bluebird Street, Coon Rapids, MN 55433. Demo Disc (612) 757-8584

**CABLE TV "BOXES"**  
**Converters — Descramblers**  
**Remote Controls — Accessories**  
 ★ Guaranteed Best Prices ★  
 ★ 1 Year Warranty — C.O.D. ★  
 ★ Immediate Shipping ★  
 ★ FREE CATALOG ★

Call or Write  
**TRANS-WORLD CABLE CO.**  
 12062 Southwest 117th Court, Suite 126  
 Miami, Florida 33186  
 1-800-442-9333

VISA MasterCard

AC DC VOLTAGE  
 AC DC CURRENT  
 DIODE TEST Stock No  
 LOGIC TEST 990092  
 LED TEST GOOD BAD  
 5 FREQ RANGES  
 CAPACITANCE RANGES  
 LOW BATTERY Warning  
 CONTINUITY TEST BUZZER  
 TRANSISTOR CHECKER  
**20 MHZ FREQ COUNTER**

**PRO 400**  
**\$69.95**

30 DAY MONEY BACK GUARANTEE!

VISA  
**KELVIN Electronics MC**  
 7 Fairchild Ave. Plainview NY 11803  
 (516) 349-7620 (1800) 645-9212  
 FAX (516) 349-7830

SURVEILLANCE transmitter kits! Four models of each: telephone, room, combination telephone room transmitters tune from 65 to 305 MHz. Catalog with Popular Communications and Popular Electronics book reviews of "Electronic Eavesdropping Equipment Design," \$1.00. SHEFFIELD ELECTRONICS, 7223 Stony Island Ave., Chicago, IL 60649-2806.

DAZER II personal protection device! Plans \$8.00. Lasers! Transmitters! Detectors! More! Kits or assembled! Catalog \$2.00. QUANTUM RESEARCH, 16645-113 Avenue, Edmonton, Alberta T5M 2X2.

**SATELLITE TV**

VIDEOCIPHER II manuals. Volume 1 — Hardware. Volume 2 — Software — either \$34.95. Volume 3 — Projects Software. Volume 5 — Documentation or Volume 6 — Experimentation \$44.95 each. Volume 4 — Repair \$99.95. Volume 7 — 032 Hacking \$54.95. Cable Hacker's Bible — \$34.95. Clone Hacker's Bible — \$34.95. Catalog — \$3.00. COD's (602) 782-2316. TELECODE, PO Box 6426-RE, Yuma, AZ 85366-6426.

**Parts Express International Inc.**

**2-1/2" SANYO TWEETER**  
 Paper cone with gold tone dust cap 8 oz magnet 8 ohm 1/2" ferro fluid voice coil Power handling. 50W RMS. 70W max Frequency response 3K 20KHz

#RC-271-020 **\$1.95 \$1.75 95c**  
 (1 9) (10 79) (60 up)

**SUPER HORN TWEETER**  
 Original piezo tweeter made by Motorola SPL=94 dB 2 83V/1M. Response 4KHz-27KHz Handles approximately 50 watts.

#RC-270-010 **\$5.30 \$4.50 \$3.95**  
 (1 9) (10 79) (80 up)

**2" DOME MIDRANGE**  
 Textile dome midrange made by Philips. 8 ohm SPL=90 dB 1W/1M. 30W RMS. 40W max Response 550-5KHz

#RC-280-210 **\$27.30 \$25.70**  
 (1 3) (4 up)

**15" SUBWOOFER**  
 Dual voice coil 40 oz magnet 6 ohm imp 100W RMS. 140W max Response 20-1 2KHz Resonant frequency 21Hz SPL=93 dB 1W/1M

#RC-290-190 **\$54.50 \$49.80**  
 (1 3) (4 up)

**SUBWOOFER COVER**  
 200W RMS crossover designed specifically for use with dual voice coil sub woofers. 12 dB per octave roll-off at 150Hz

#RC-260-220 **\$28.80 \$24.40**

**10" POLY WOOFER**  
 Medium duty 60W RMS. 80W max. 14 oz. magnet Response 25-2 5KHz fs=28Hz

#RC-290-096 **\$18.50 \$16.90**  
 (1 3) (4 up)

**TITANIUM COMPOSITE TWEETER**  
 The advantages of both hard and soft dome technologies. 8 ohm Ferro fluid cooled voice coil SPL=90 dB 1W/1M 50W RMS. 70W max 4" round. Polydax #DTW100T125

#RC-270-047 **\$27.50 \$24.80**  
 (1 9) (10 up)

**SPEAKER BUILDING BOOK**  
 Revised edition of David Weems' best selling book Learn to build low cost speakers that rival the high priced models

#RC-500-021 **\$16.95**

**12" CAST FRAME WOOFER**  
 12" woofer made in the USA by Eminence Paper cone and dust cap with treated cloth surround 80 oz magnet 2 1/2" vented voice coil 8 ohm 170W RMS. 235W max 40-4 5KHz response

#RC-290-147 **\$72.90 \$69.50**  
 (1 3) (4 up)

• 15 day money back guarantee • \$15.00 minimum order • We accept Mastercard, Visa, Discover and C O D orders • 24 hour shipping • Shipping charge = UPS chart rate + \$1.00 (\$3.00 minimum charge) • Hours 8:30 am - 7:00 pm EST, Monday - Friday • Mail order customers, please call for shipping estimate on orders exceeding 5 lbs • Foreign customers please send \$5.00 U.S. funds for catalog postage

**CALL TOLL FREE 1-800-338-0531**

**FREE CATALOG**

CIRCLE 56 ON FREE INFORMATION CARD

## Cable Descramblers

New Auto Tri-Bi guaranteed no flashing \$165.00

SB-3.....	\$99.00	ZENITH SUPER	
TRIMODE.....	\$109.00	SAAVI.....	\$199.00
HAMLIN.....	\$99.00	TOCOM.....	\$319.00
SCIENTIFIC.....		EAGLE.....	\$119.00
ATLANTA.....	\$119.00	COPY GUARD.....	\$59.95
OAK M35B.....	\$99.00	STARGATE 2000.....	\$88.00
ZENITH.....	\$175.00		

M.D. Electronics will match or beat any advertised wholesale or retail price.

Your best buys and warranties for cable converters and descramblers start with a FREE catalog from MD

For Information Call

402-554-0417

To order or request a free catalog

1-800-624-1150



**M.D. ELECTRONICS**

875 SO. 72nd St.  
Omaha, NE 68114

BY ORDERING CABLE TV EQUIPMENT FROM M.D. ELECTRONICS THE PURCHASER AGREES TO COMPLY WITH ALL STATE AND FEDERAL LAWS REGARDING PRIVATE OWNERSHIP OF CABLE TV EQUIPMENT IF YOU ARE UNSURE OF THESE LAWS CHECK WITH YOUR LOCAL OFFICIALS

CIRCLE 53 ON FREE INFORMATION CARD

## EXCELLERATOR™ Series CABLE CONVERTERS WHEN QUALITY COUNTS



New Dynatrack™ fine tuning provides unmatched picture quality  
550 Mhz tuner provides 83 channel capacity  
Sleep timer for automatic shut off within 15-90 minutes  
2/3 switchable IIRC / IRC / Standard Switchable  
2 Year warranty, Last channel recall, Favorite channel select, Scan  
Double vented high efficiency transformer for cool performance  
Stargate-2001 \$99.00

Stargate-550XL \$119.00 With Volume Control

Don't settle for anything less.



EASY work! Excellent pay! Assemble products at home. Call for information (504) 641-8003 Ext. 5192.

## TUBES - 2000 TYPES DISCOUNT PRICES!



Early, hard-to-find, and modern tubes. Also transformers, capacitors and parts for tube equipment. Send \$2.00 for 28 page wholesale catalog.

## ANTIQUE ELECTRONIC SUPPLY

6221 S. Maple St. • Tempe, AZ 85238 • 602-820-5411

## BEST BY MAIL

Rates: Write National, Box 5, Sarasota, FL 34230

OF INTEREST TO ALL

IT PAYS YOUR DRINKS? 900% profit possible with super novelty. Sample \$20.00 + \$2.00 SH. Imorex(RE), Box 8300-103, Dallas, TX 75205.

11.88% CREDIT CARDS. Why pay high interest? \$2/min. 1-900-535-9800 X545.

"MONEYMAKING DEVICE"! INCREASES mileage 27%, reduces pollution 85%. 100% guaranteed, \$2.00/min. 1-900-535-9800, Ext-544.

FREE LOANS! VISA! Credit repair! Box 5408(RE), Corpus Christi, TX 78465.

## WANTED

INVENTIONS/ new products/ideas wanted: call TLCI for free information 1 (800) 468-7200 24 hours/day - USA/Canada.

Z-80 microprocessor trainer with manuals. ERNIE, (619) 873-4693.

INVENTORS: We submit ideas to industry. Find out what we can do for you. 1 (800) 288-IDEA.

## ANTIQUE RADIO CLASSIFIED

Free Sample!

Antique Radio's  
Largest Circulation Monthly.  
Articles, Ads & Classifieds.

6-Month Trial: \$13. 1-Yr: \$24 (\$36-1st Class).  
A.R.C., P.O. Box 802-L6, Carlisle, MA 01741

## INVENTORS

INVENTORS! Can you patent and profit from your idea? Call AMERICAN INVENTORS CORPORATION for free information. Over a decade of service 1 (800) 338-5656. In Canada call (413) 568-3753.

## CABLE TV EQUIPMENT

Converters, Remote Controls,  
Descramblers, CD Players.



JERROLD-OAK-SCIENTIFIC ATLANTA-HAMLIN  
ZENITH MANY MORE CALL TODAY!

✓ Only quality products sold ✓ Easy to use  
✓ Satisfaction guaranteed ✓ Knowledgeable sales staff  
✓ Most orders shipped within 24 hours

CALL FOR YOUR FREE CATALOG

MC 1-800-228-7404 VISA

MAKE THE CONNECTION

WITH

**NU-TEK ELECTRONICS**

5114 Balcones Wood Dr.#307 Dept.298

Austin, TX. 78759

FREE catalog — Lowest prices worldwide, save 40 — 60%. Systems, upgrades, parts, all major brands factory fresh and warranted. SKYVISION, 2009 Collegeway, Fergus Falls, MN 56537. 1 (800) 334-6455.

CABLE TV secrets — the outlaw publication the cable companies tried to ban. HBO, Movie Channel, Showtime, descramblers, converters, etc. Suppliers list included. \$9.95. CABLE FACTS, Box 711-R, Pataskala, OH 43062.

VIDEOCYPHERII descrambling manual. Schematics, video and audio. Explains DES, Eprom, Clonemaster, 3Musketeer, Pay-per-view (HBO, Cinemax, Showtime, adult, etc.) \$16.95, \$2.00 postage. Schematics for Videocypher Plus. \$20.00. Schematics for Videocypher 032. \$15.00. Collection of software to copy and alter Eprom codes, \$25.00. CABLETRONICS, Box 30502R, Bethesda, MD 20824.

### PAY TV AND SATELLITE DESCRAMBLING ALL NEW 1991 EDITION

The very best of the Pay TV series. The very latest in build-your-own, turn-ons, bypasses, ECM's etc., for cable wireless and satellite including VCI+ and B-MAC. Only \$14.95. Volume 1(basics) \$14.95. 1989 Edition \$14.95. Build Satellite Systems Under \$600. \$12.95 Wireless Cable Handbook \$9.95. Any 3/\$29 or 5/\$42 Scrambling News Monthly, Articles, Circuits, Sources, News and more \$19.95/yr. Sample \$3. New catalog \$1. COD's are DK.

SCRAMBLING NEWS, 1552 Hertel Ave.,  
Buffalo, NY, 14215. 716-874-2088

## BUSINESS OPPORTUNITIES

MAKE \$50/hr working evenings or weekends in your own electronics business. Send for free facts. INDUSTRY, Box 531, Bronx, NY 10461-0208.

YOUR own radio station! AM, FM, TV, cable. Licensed unlicensed. BROADCASTING, Box 130-F2, Paradise, CA 95967.

MAKE hot selling products! 30+ plans \$3.00, guaranteed. NRG, 11580 Okahurst Road, Largo, FL 34644.

## THE JOY OF PROGRAMMING!

# Algorithm

THE PERSONAL PROGRAMMING NEWSLETTER

► features how-to projects for beginners and experts: fractals, moiré patterns, ecological simulations, black holes, sand-piles, wallpaper for the mind and much more!

► Write today for a free sample issue to:

Algorithm - Special Order Department  
P.O. Box 29237, Westmount Postal Outlet  
785 Wonderland Road South  
London, Ontario, CANADA N6K 1M6

## ZENITHS & TOCOMS

**SUPER Zenith (Z-TAC) converters (flashing)... \$169.00. Zenith "turn-on" module... \$49.00. Tocom 5503(A) & 5504 converters... \$139.00. Tocom (add-on) descramblers... \$79.00. Tocom (5503-VIP & 5507) "turn-on" chips... \$49.00. CIN-EMPLEX VIDEO GROUP. 1 (800) 726-4627.**

## COMPUTER BOOKS

**DISCOUNT computer books!** Thousands of titles available. Including recent releases. Please call or write for our latest free catalog. **BOOKWARE**, 344 Watertown Road, Thomaston, CT 06787. 1 (800) 288-5662. (203) 283-6973.

## CABLE TV DESCRAMBLER LIQUIDATION!

**FREE CATALOG!**  
HamlIn Combos \$44, Oak M35B \$60 (min. 5), etc.  
**WEST COAST ELECTRONICS**  
For Information: 818-709-1758  
Catalogs & Orders: 800-628-9656

## ALARM SYSTEMS

**ALARMING!** Over 22 features are packed into our security board! Protect your house, car, or boat. Just add switches, any speaker, and a battery! **Special \$59.95**, including S&H! Check or M.O. CCT, PO Box 1532, Allentown, PA 18105-1532.

## EDUCATION & INSTRUCTION

**LEARNING** electronics troubleshooting? Basic electronics simulations and problems program can help. PC/MSDOS \$32.95 EES-RE2, POB 1391, Lubbock, TX 79408.

**BIOMEDICAL** letter covers medical electronics, anatomy, equipment function, electrical safety, troubleshooting. PNP, Box 333, Brooklyn, NY 11204.

**SURFACE mount technology.** Learn to build your own SMT projects, concise tutorial by leading expert. Component supplier listings \$24.00. CIS, 1836 North Fifth Place, Port Hueneme, CA 93041.

**FCC General Radiotelephone license!** The easy way with these short cuts, and latest Q & A material. Don't study more than necessary! \$25.00 postpaid. SMI, Box 5500, Lakeland, FL 33807.



**CONSOLIDATED ELECTRONICS**  
VOLUME I - TEST EQUIPMENT  
INCLUDES 4 INDUSTRIAL ELECTRONICS IDENTIFICATION

### CONSOLIDATED ELECTRONICS

Get two of the most valuable electronic catalogs ever! These 2 catalogs contain over 16,000 hard to find electronic parts & equipment. VOL. I - features 112 pages of high quality test equipment. VOL. II - features 144 pages of electronic parts, tools & cross references. Send \$5 check or money order, or call today & use your VISA or MasterCard.

## 1-800-543-3568

CONSOLIDATED ELECTRONICS, INCORPORATED 705 WATERY JET AVENUE DAYTON, OHIO 45420-2599  
FAX: 1-(513)-252-4066 / TEL: 1-(513)-252-5662 / TELEX: 288-229 / COMPUSERVE: 76057.3347 / EASYLINK: 62850013



**CONSOLIDATED ELECTRONICS**  
VOLUME II - PARTS & ACCESSORIES  
INCLUDES 4 INDUSTRIAL ELECTRONICS IDENTIFICATION

CIRCLE 70 ON FREE INFORMATION CARD

# MARK V ELECTRONICS, INC.

Competitive Pricing \* Fast Shipping

Since 1985

ORDER IN CALIFORNIA 800-521-MARK

ORDER OUTSIDE CA 800-423-3483

FREE CATALOG & INFORMATION (213)888-8988

FAX (213) 888-6868

▲ indicates the level of difficulty in the assembling of our Products. ▲ Beginner ▲▲ Intermediate ▲▲▲ Advanced ★ Fully Assembled



AMPLIFIERS		KIT	ASSEMB.
MODEL	DESCRIPTION		
TA-28MK2	Digital Voice Memo ▲▲	\$ 30 00	
TA-50A / B	Multi-Purpose Melody Generator ▲	12 84	17 20
TA-50C	Multi-Purpose Melody Generator ▲	13 65	18 71
TA-120MK2	35W Class 'A' Main Power Mono Amp ▲▲	31 50	42 80
TA-300	30W Multi-Purpose Single Channel Amp ▲▲	20 00	29 00
SM-302	60W + 60W Stereo Power Amplifier (with Mic. input)▲▲		78 00
TA-323A	30W X 2 Stereo Pre-main Amp ▲	31 50	42 80
TA-377A	Hi-Quality FET Stereo Pre Amp ▲▲▲	59 95	75 00
TA-400	40W Solid State Mono Amp ▲	28 00	34 93
TA-477	120W Mosfet Power Mono Amp ▲▲	68 00	85 00
TA-800MK2	120W + 120W Low Imp Pre-Main Stereo Power Amp ▲▲	63 95	
TA-802	80W - 80W DC Stereo Main Power Amp ▲▲	45 94	59 72
TA-820A	60W - 60W DCL DC Pre-Main Stereo Amp ▲▲	40 39	49 37
TA-1000A	100W Dynamic Class 'A' Main Power Mono Amp ▲▲	59 65	80 58
TA-1500	100W X 2 Class 'A' DC Stereo Pre-Main Amp ▲▲▲	73 76	95 81
TA-2200	Fet Super Class 'A' DC Pre-Amp ▲▲	47 76	58 24
TA-2400A	Electronic Echo & Reverberation Amp *		96 00
TA-2500	HQ Pre-Amp w/10 band graphic equalizer *		68 80
TA-2800	Hi-FET IC Pre-Amp w/3 way tone control ▲	48 90	63 57
TA-3000	Stereo Simulator (For Mono TV or Any Mono Source) ▲▲	27 00	38 50
TA-3600	300W HQ Hi-Fi Power Mono Amp ▲▲▲	85 00	110 00

POWER SUPPLIES		KIT	ASSEMB.
TR-100A	0-15V 2A Regulated DC Power Supply (w/Case) *	\$	\$ 69 50
TR-355A	0-15V 5A Regulated DC Power Supply ▲	15 65	21 76
TR-355B	0-30V 3A Regulated DC Power Supply ▲	15 65	21 76
TR-503	0-50V 3A Regulated DC Power Supply ▲▲	16 75	23 65

INSTRUMENTS		KIT	ASSEMB.
SM-43	3 1/2 Multi-Functional Led D P M (w/ABS plastic case) ▲▲	\$ 34 50	\$ 43 00
SM-48	4 1/2 Hi-Precision D P M ▲▲▲	38 00	48 00
SM-48A	4 1/2 Hi-Precision D P M (w/ABS plastic case) ▲▲▲	41 20	52 00
SM-49	3 1/2 Multi-Functional LCD D P M (w/Hold Function) ▲▲	36 00	44 50
SM 100	150MC Digital Frequency Counter ▲	79 00	90 00
FC 1000A	1 GHz Frequency Counter *		179 00

MISCELLANEOUS		KIT	ASSEMB.
MODEL	DESCRIPTION		
TY-23B	3 Channel Color Light Controller *		\$ 14 85 \$ 65 00
TY-25	Stereo Loudspeaker Protector ▲		20 85
TY-35	FM Wireless Microphone ▲▲		11 25
TY-36	AC/DC Quartz Digital Clock ▲		19 00 26 20
TY-38	Sound Touch Control Switch ▲		12 00
TY-41MK V	Infrared Remote Control Unit (w/Case) ▲▲▲		22 00 35 00
TY-42	Bar / Dot Level Meter ▲▲		24 15 33 81
TY-43	3 1/2" Digital Panel Meter ▲		29 00 38 00
TY-45	20 Steps Bar / Dot Audio Level Display ▲▲		38 45 46 14
TY-47	Superior Electronic Roulette ▲▲		19 46 27 24
SM-222	7 Band Hi-Fi Graphic Equalizer ▲▲▲		26 80 38 80
SM-328	4 Channel Professional Color Light Controller *		145 00
SM-333	Audio/Video Surround Sound Processor ▲▲▲		65 00 75 00
SM-666	Dynamic Noise Reduction ▲		26 00 34 00
SM-888	Universal Audio/Video KARAOKE Mixer Pre-Amp *		225 00
10,000uF	80 V Capacitor (Suggested for TA-3600 TA-477 TA-1000A & TA-802)		23 00

METAL CABINETS WITH ALUMINUM PANEL		PRICE
MODEL	H x W x D MATCHING	
LG-1273	3' x 12' 7" TA-2800 TA-377A TA-2200	\$ 22 85
LG-1684	4' 16' 8" TA-323A TA-377A TA-2200	27 50
LG-1924	4' 19' 11 1/2" TA-802 TA-820A TA-500 TA-120MK 2 TA-800 TA-1000A	32 80
LG-1925	5' 19' 11 1/2" TA-477 TA-800 TA-1500 TA-1000A TA-3600	35 80
LG-1983	2' x 19' 8" TA-377A TA-2800 TA-2200 TA-120MK 2	29 25

POWER TRANSFORMERS		PRICE
MODEL	DESCRIPTION MATCHING	
001	28V x 2 6A to 30V x 2 6A TA-800 TA-802 TA-820A TA-1000A TA-1500	\$ 27 00
002	36V x 2 3A TR-503 TA-323A TA-400 TA-300	22 00
003	40V x 2 6A TA-477	28 00
004	24V x 2 6A TA-120 MK 2	24 00
005	26V x 2 3A TR-255B	16 00
006	18V x 2 5A TR-255A	15 50
007	53V x 2 8A TA-3500	43 00

We accept major Credit Cards. Money Orders. Check and C.O.D. Orders. C.O.D. fee is \$5.00. Minimum order is \$20.00. \* We ship by UPS ground inside US (min. \$3.95) and ship by US Mail Business & Showroom hours: (Pacific Time) Mon. thru Fri. 9:30 am to 5:00 pm Sat. 10:00 am to 5:00 pm

**MARK V ELECTRONICS, INC. - 8019 E. Slauson Ave, Montebello, CA 90640**

CIRCLE 93 ON FREE INFORMATION CARD

# Be a TV/VCR Repair Specialist

Now you can train at home in spare time for a money-making career as a TV VCR Repair Specialist. No previous experience necessary. No need to quit your job or school. Everything is explained in easy-to-understand language with plenty of drawings, diagrams and photos. We show you how to troubleshoot and repair video-cassette recorders and TV sets, how to handle house calls and shop repairs for almost any make of television or VCR. Tools are included with your course so you can get hands-on practice as you follow your lessons step by step. Send for free facts about the exciting opportunities in TV VCR Repair and find out how you can start making money in this great career. **MAIL COUPON TODAY** K03C

**SCHOOL OF TV/VCR REPAIR, Dept. ADE011S**  
925 Oak Street, Scranton, PA 18515

Please send me full information and color brochure on how I can learn TV VCR Repair at home in my spare time. I understand there is no obligation and no salesman will visit me.

Name \_\_\_\_\_ Age \_\_\_\_\_  
Address \_\_\_\_\_ Apt. # \_\_\_\_\_  
City/State \_\_\_\_\_ Zip \_\_\_\_\_  
Phone (\_\_\_\_) \_\_\_\_\_

**MAGIC!** Four illustrated lessons plus inside information shows you how. We provide almost 50 tricks including equipment for four professional effects. You get a binder to keep the materials in, and a one-year membership in the International Performing Magicians with a plastic membership card that has your name gold-embossed. You get a one-year subscription to our quarterly newsletter "IT's MAGIC!" Order now! \$29.95 for each course + \$3.50 postage and handling. (New York residents add applicable state and local sales tax). **THE MAGIC COURSE**, 500-B BiCounty Boulevard, Farmingdale, NY 11735.

**F.C.C. Commercial General Radiotelephone license.** Electronics home study. Fast, inexpensive! "Free" details. **COMMAND**, D-176, Box 2824, San Francisco, CA 94126.

**LEARN IBM PC assembly language.** 80 programs. Disk \$5.00. Book \$18.00. **ZIPFAST**, Box 12238, Lexington, KY 40581-2238.

**CONSUMER advocate.** Help sources, any problem. **SASE** for description. **HELPI**, Box 132, Indian Rocks, FL 34635.

**ENTER THE WORLD OF PROFESSIONAL VIDEO!** Pro's tell techniques and secrets of U-matic VCR's 32 pg. illus. Send \$12.95 to **ANIBAL NEGRON**, 64 Mason Blvd., S.I., NY 10309.

## Copies of articles from this publication are now available from the UMI Article Clearinghouse.

Yes! I would like to know more about UMI Article Clearinghouse. I am interested in electronic ordering through the following system(s):

- DIALOG/Dialorder  ITT Dialcom  
 OnType  OCLC ILL Subsystem  
 Other (please specify) \_\_\_\_\_

- I am interested in sending my order by mail  
 Please send me your current catalog and user instructions for the system(s) I checked above.

Name \_\_\_\_\_  
Title \_\_\_\_\_  
Institution/Company \_\_\_\_\_  
Department \_\_\_\_\_  
Address \_\_\_\_\_  
City \_\_\_\_\_ State \_\_\_\_\_ Zip \_\_\_\_\_  
Phone (\_\_\_\_) \_\_\_\_\_

**U MI Article Clearinghouse**

Mail to: University Microfilms International  
300 North Zeeb Road, Box 91 Ann Arbor, MI 48106

Try the  
**Radio Electronics®**

bulletin board system

(RE-BBS)  
516-293-2283

The more you use it the more useful it becomes.

We support 300 and 1200 baud operation.

Parameters: 8N1 (8 data bits, no parity, 1 stop bit) or 7E1 (7 data bits, even parity, 1 stop bit).

Add yourself to our user files to increase your access.

Communicate with other R-E readers.

Leave your comments on R-E with the SYSOP.

RE-BBS  
516-293-2283

# UNICORN - YOUR I.C. SOURCE!

## COLLIMATOR PEN (INFRA-RED)



- Output: 2.5 mW (max.)
- Current: 90-150 mA
- Operating Voltage: 2.2-2.5V
- Wavelength: 820nm
- Collimation: .18mrad (typ.)
- Size: 11mm diameter

STOCK # PRICE  
SB1052 \$39.99

## LASER DIODE (INFRA-RED)

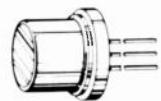

- Output: 10 mW (max.)
- Current: 90-150 mA
- Operating Voltage: 2.2-2.5V
- Wavelength: 820nm

STOCK # PRICE  
SB1053 \$9.99

## LASER DIODE (VISIBLE-RED)



- Output: 5 mW (max.)
- Current: 65-100 mA
- Operating Voltage: 1.75-2.2V
- Wavelength: 780nm

STOCK # PRICE  
LS022 \$19.99

## LASER DIODE (VISIBLE-RED)

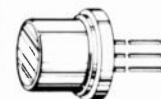

- Output: 4 mW (max.)
- Current: 20 mA
- Operating Voltage: 2.2-3.0V
- Wavelength: 665nm

STOCK # PRICE  
LS3200 \$119.99

## POWER SUPPLY

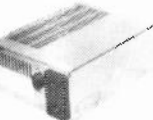

- Input: 115/230v
- Size 7" L x 5 1/4" W x 2 1/2" H
- Output: +5 volts @ 3.75 amps
- Output: +12 volts @ 1.5 amps
- Output: -12 volts @ 4 amps

STOCK # PRICE  
PS1003 \$19.99

## LASER DIODE (VISIBLE-RED)

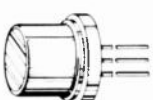

- Output: 3 mW
- Current: 85-100 mA
- Operating Voltage: 2.3-3.0V
- Wavelength: 670nm

STOCK # PRICE  
LS9200 \$49.99

## ANTI-STATIC SCREEN WIPES



- Individually wrapped
- Dispenser pack

STOCK # DESC. PRICE  
SB1104 25 \$1.99  
SB1107 100 \$4.99

## Canon

## DISC DRIVE & COMPUTER CLEANING KIT



- Includes Cleaning swabs, head-cleaning fluid, anti-static cleaner, screen wipes and cleaning diskette

STOCK # DESC. PRICE  
SB1099 3 1/2" kit \$6.99  
SB1100 5 1/4" kit \$6.99

## EPROMS

STOCK #	1-24	25-99	100+	STOCK #	1-24	25-99	100+
1702	3.99	3.79	3.41	2764A	3.29	3.13	2.82
2708	6.49	6.17	5.55	TMS2564	6.79	6.45	5.81
2716	3.29	3.13	2.82	27C64	4.19	3.98	3.58
2716-1	3.79	3.60	3.24	27128-20	5.79	5.50	4.95
TMS2716	6.29	5.98	5.38	27128	5.09	4.84	4.35
27C16	3.99	3.79	3.41	27128A	5.79	5.50	4.95
2732	3.79	3.60	3.24	27C128	5.79	5.50	4.95
2732A-2	3.79	3.60	3.24	27256-20	5.29	5.03	4.53
2732A	3.69	3.51	3.16	27256	4.79	4.55	4.09
2732A-4	3.19	3.03	2.73	27C256	5.29	5.03	4.53
TMS2532	5.79	5.50	4.95	27512-20	7.49	7.12	6.41
TMS2532P	1.99	1.89	1.70	27512	6.99	6.64	5.98
27C32	4.19	3.98	3.58	27C512	6.99	6.64	5.98
2764-20	3.99	3.79	3.41	27C1024	17.99	17.09	15.38
2764	3.79	3.60	3.24	68764	13.99	13.29	11.96
2764A-20	3.99	3.79	3.41	68766	14.99	14.24	12.82

## DYNAMIC RAMS

STOCK #	1-24	25-99	100+	STOCK #	1-24	25-99	100+
MK4027	.59	.56	.50	4464-100	4.79	4.55	4.10
4116-120	1.39	1.32	1.19	4464-120	4.19	3.98	3.58
4116-150	.99	.94	.85	4464-150	3.99	3.79	3.41
4116-200	.89	.85	.77	41256-60	4.79	4.55	4.10
4116-250	.59	.56	.50	41256-80	3.49	3.32	2.99
4164-100	2.59	2.46	2.21	41256-100	2.99	2.84	2.56
4164-120	2.29	2.18	1.96	41256-120	2.69	2.56	2.30
4164-150	1.99	1.89	1.70	41256-150	2.99	2.18	1.96
4164-200	1.59	1.51	1.36	511000-70	12.99	12.34	11.11
4416-120	5.99	5.69	5.12	511000-80	11.99	11.39	10.25
4416-150	4.99	4.74	4.27	511000-100	10.99	10.44	9.40



10010 Canoga Ave., Unit B-8 • Chatsworth, CA 91311  
OUTSIDE CALIFORNIA: (800) 824-3432 (Orders Only)  
IN CALIFORNIA: (818) 341-8833  
(818) 998-7975  
Minimum Order \$15.00



# ALL ELECTRONICS CORP.

## 12 Vdc STARTER SOLENOID

Brand NEW automotive-type solenoid (relay). 12Vdc, 4 ohm coil. SPST normally open. Negative chassis ground. Designed for switching very heavy loads. 5/16" copper screws on switch terminals.  
**CAT# SOL-32 \$4.50 each**



## Experimenter's Delight CORDLESS TELEPHONE/TRANSCIVER

Phonemate# IQ 4210  
 Base station for a cordless telephone, this transceiver contains hundreds of useful parts. Includes power transformer, 600 ohm phone coupling transformer, crystals, heat sinks, voltage regulator, power cord, phone cord and jack. relay and 30" telescoping antenna. The beige chassis box has only a few holes in the back panel and would be an excellent housing for other projects. 7.25" X 5.87" X 2.15".  
**CAT# PMB-1 \$3.75 each SOLD AS-IS For Parts Only. No returns accepted.**

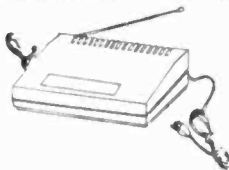

## New Reduced Price PHOTOFASH CAP.

Rubicon CE  
 210 Mfd 330 Volt photoflash capacitor. 0.79" dia. X 1.1" high. These are new capacitors that have been prepped with 1.4" black and red wire leads soldered to the terminals.  
**CAT# PPC-210 \$1.25 each**  
 10 for \$11.00 • 100 for \$100.00  
 Large quantities available.  
 Call for pricing.



## SWITCHES

### THUMBWHEEL SWITCH

1 pole 10 position decimal encoded switches which interlock to make up desired number or digits. Terminates to 11 pc pins (1 common and 10 poles). Each section measures .31" wide X .20" high X .78" deep. End plates can be added to form a .94" high bezel.  
**CAT# SWTH-9 \$1.25 each**  
 10 for \$10.00  
**2 END PLATES**  
**CAT# SW-9EC \$1.00/Set**



### MINIATURE TOGGLE

Rated: 3 amps @ 120 Vac

**S.P.D.T. (ON-ON) P.C. mount**  
**CAT# MTS-4PC \$1.00 each**  
 10 for \$9.00 - 100 for \$80.00  
**S.P.D.T. (ON-ON) solder lugs**  
**CAT# MTS-4 \$1.35 each**  
 10 for \$12.50 - 100 for \$110.00  
**D.P.D.T. (ON-ON) solder lugs**  
**CAT# MTS-8 \$1.75 each**  
 10 for \$15.00  
**D.P.D.T. (ON-ON) P.C. mount**  
**CAT# MTS-8PC \$2.00 each**  
 10 for \$17.50



## POWER SUPPLIES

### 5Vdc 3 AMP

ACDC Electronics #5N3-1 New, prepped power supply with wires and connectors soldered to the inputs and outputs. Open frame style. Regulated. 4.94" X 4.03" X 2". UL and CSA listed. **CAT# PS-53 \$10.00 each**



### 12 Vdc 5 AMP

ACDC Electronics #12N5 or equiv. Input: 100-240 Vac (wired for 115 Vac) Output: 12 Vdc @ 5 amps. Open frame style. 7" X 4 3/4" X 3" high. Regulated. **CAT# PS-125 \$37.50 each**

### 24 Vdc 2.4 AMP

Power-One Inc. #HC-24-2.4 Input: 115/230 Vac (wired for 115 Vac) Output: 24 Vdc @ 2.4 amps. Open frame style. 5.62" X 4.87" X 2.50" CSA listed. **CAT# PS-2424 \$30.00 each**

## RECHARGEABLE BATTERIES

### 6 Volt 1 Amp/Hour

Japan Storage Battery Co. Portolact PEGV1  
 6 Volt 1 Ah rechargeable sealed lead-acid (gell cell). 2" X 1.635" X 2" high. Batteries are prepped with 5" black and red leads terminated with 2 pin connector.  
**CAT# GC-61 \$4.75 each**  
 10 for \$42.50



### Nickel-Cad

**AAA SIZE \$1.50 each**  
 1.2 volts 180 mAh  
**CAT# NCB-AAA**  
**AA SIZE \$2.00 each**  
 1.25 volts 500 mAh  
**CAT# NCB-AA**  
**AA SIZE \$2.20 each**  
 WITH SOLDER TABS  
**CAT# NCB-SAA**  
**C SIZE \$4.25 each**  
 1.2 volts 1200 mAh  
**CAT# NCB-C**  
**D SIZE \$4.50 each**  
 1.2 volts 1200 mAh  
**CAT# NCB-D**

### HEAVY DUTY "C"

YUASA 1800C  
 Nickel-cad heavy duty "C" cell  
 1.2 volt, 1800 mah  
 Price reduced on 10 or more.  
**CAT# HDNCB-C**  
 10 for \$42.50/100 for \$375.00



## Experimentors Delight ATARI 5200 Vidio Game

Atari video game controllers returned to the dealer because of various defects. None of them work properly, but they have lots of great parts. A RF video modulator, eight 16K dynamic RAMs in sockets, microprocessors and D-A converters in sockets, two voltage regulators on a heavy-duty heatsink and lots of other ICs, capacitors, resistors, connectors and other component. Does not include the power transformer or controls (joysticks).  
**CAT# A-5200 \$7.50 each • 2 for \$13.50 SOLD AS-IS For Parts Only.**



## INSTRUMENT ENCLOSURES

High quality molded ABS Instrument enclosures. Integrated PC board standoffs and two sets of vertical mounting slots for front and rear sub panels. All enclosures are 6" wide X 6 1/4" deep. Choice of three fits. Includes non-skid rubber feet and hardware. Available in beige, ivory, black, and blue.  
 Please specify color.  
**2 1/4" CAT# MB-A \$7.50 each 10 for \$65.00**  
**2 5/8" CAT# MB-B \$7.75 each 10 for \$67.50**  
**3" CAT# MB-C \$8.00 each 10 for \$70.00**



## RG-11/U VIDEO CABLE

100 ft. or 200 ft. rolls of RG 11/U 75 ohm cable terminated to heavy duty F connectors. Includes 75 ohm terminator and F-61 splicer on one end. New cables manufactured for IBM PC networks. IBM P/N 1501908 COM/SCOPE.  
**CAT# RG-11-1 100 ft. roll \$15.00**  
**CAT# RG-11-2 200 ft. roll \$27.50**



## ONE MINUTE TIMER

This white box with a blue button will drive you crazy. Box measures 3 1/4" square X 2" high. When the button is pressed 4 LEDs light and a beeper pulses. Every 15 seconds one led goes out and the speed of the beeping increases. At the end of 60 seconds the unit gives off a long beep followed by a low squelch, all LEDs shut off and the unit stops. Unit requires a 9 volt transistor battery (not included) to operate.  
**CAT# TMR-1 \$2.25 each • 10 for \$20.00**



## L.E.D.'s

### Standard JUMBO

Diffused T 1-3/4 size (5 mm)

**RED CAT# LED-1**  
 10 for \$1.50 • 100 for \$13.00  
**GREEN CAT# LED-2**  
 10 for \$2.00 • 100 for \$17.00  
**YELLOW CAT# LED-3**  
 10 for \$2.00 • 100 for \$17.00

### FLASHING LED

W/ built in flashing circuit  
 5 volt operation. T 1-3/4 (5mm)

**RED \$1.00 each**  
**CAT# LED-4 10 for \$9.50**  
**GREEN \$1.00 each**  
**CAT# LED-4G 10 for \$9.50**  
**YELLOW \$1.00 each**  
**CAT# LED-4Y 10 for \$9.50**

### LED HOLDER

Two piece holder.  
**CAT# HLED 10 for 65¢**

## OPTO SENSORS

Honeywell #HOA 0866-N55  
 U-shaped opto sensor. 1/8" gap. 4 pc leads.  
**CAT# OSU-8 75¢ each**

TRW# OPB-818  
 U-shaped opto switch. 0.2" gap between sensor and emitter.  
**CAT# OSU-9 75¢ each**

TRW# OPB 822SD  
 Reflective scanner module. U-shaped device with 4 leads each side (8 total) 0.09" gap. 0.75" mounting centers.  
**CAT# OSU-10 75¢ each**

TRW# OPB-708  
 Wedge-shaped reflective opto sensor.  
**CAT# OSR-6 75¢ each**

## KITS

### L.E.D. FLASHER KIT

Two L.E.D.'s flash in unison when a 9 volt battery is attached. This kit includes a p.c. board, all the parts and instructions to make a simple flasher circuit. A quick and easy project for anyone with basic soldering skills.  
**CAT# LEDKIT \$1.75 per kit**



### L.E.D. CHASER KIT

Build this variable speed led chaser. 10 leds flash sequentially at whatever speed you set them for. Easy to build kit includes pc board, parts and instructions. Ideal for special lighting effects, costumes, etc. Operates on 3 to 9 volts. PC board is 5" X 2.25". A great one hour project.  
**CAT# AEC \$6.50 each**



### STEPPING MOTOR CONTROLLER KIT

Learn about stepping motors while building this simple circuit. Includes circuit board, stepping motor and all parts except 12 Vdc power supply. **CAT# SMKIT \$18.00 each**



### METRONOME KIT

This simple device can be set to click from 20 to 1,000 beats per minute. Easy to build, includes circuit board, all components and instructions. Operates on a 9 volt battery (not included).  
**CAT# METRO \$3.75 each**



## PHOTO RESISTOR

1,000 ohms bright light.  
 16K ohms dark.  
 0.182" dia. X .08" high. 0.18" long leads.  
**CAT# PRE-7 2 for \$1.00**  
 100 for \$45.00 • 1000 for \$400.00



# ORDER TOLL FREE 1-800-826-5432

FAX (818) 781-2653 • INFORMATION (818) 904-0524

Call Or Write For Our Free 60 Page Catalog

Outside the U.S.A. send \$2.00 postage for a catalog.

Minimum Order \$10.00 • All Orders Can Be Charged To Visa, Mastercard Or Discovercard • California, Add Sales Tax • Shipping And Handling \$3.50 For the 48 Continental United States - All Others Including Alaska, Hawaii, P.R. And Canada Must Pay Full Shipping • Quantities Limited • No C.O.D. • Prices Subject to change without notice.

DISCOVER

VISA

MasterCard

MAIL ORDERS TO: ALL ELECTRONICS CORP. • P.O. BOX 567 • VAN NUYS, CA 91408

# Freedom of Choice.

Test / Measurement  
and Prototype Equipment

## GoldStar 20MHz Oscilloscope

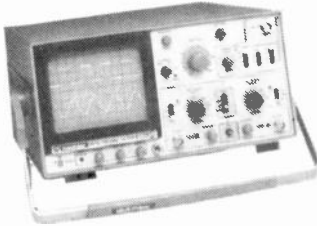

### Features:

- 6" rectangular CRT display, internal graticule & scale
- Phase difference measurements between two forms under two methods x-y scope and Dual Trace
- Two different scale probes: x1 and x10
- Bandwidth from DC to 20MHz
- Includes: Two 40MHz probes, two fuses, power cord, operation manual, schematics and block and wiring diagram
- High sensitivity: 1mV/div
- Two-year manufacturer's warranty

GS7020.....\$499.95

## Jameco Logic Pulser

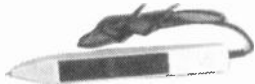

- Compatible with TTL DTL RTL HTL, HNIL MOS and CMOS ICs • 1M $\Omega$  Sync input impedance • Pulser mode output current 10mA • Square wave current output 5mA • Audible tone

LP540.....\$16.95

## Jameco Logic Probe



- Max Frequency 80MHz • Minimum detectable pulse 10ns • 120K $\Omega$  input impedance • Max supply voltage +25V • TTL threshold (Lo)-0.8V -0.1V (Hi) +2.3V • CMOS threshold (Lo) 30% VCC • 10% (Hi) 70%VCC • 10%

MS104.....\$24.95

## Global Specialties Protoboard® Design Station

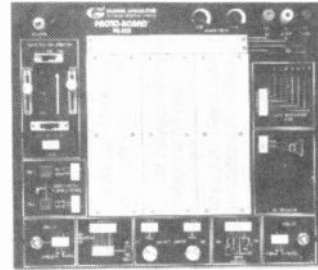

### Features:

- Ideal for analog, digital and microprocessor circuits
- Triple DC regulated power supplies, +5V, +15V, -15V
- 8 logic probe circuits
- Digital pulser
- Function generator with sine, square, and triangle waveforms
- Includes power supply, instrumentation and breadboarding

PB503.....\$299.95

## A.R.T. EPROM Programmer

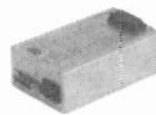

- Programs all current EPROMs in the 2716 to 27512 range plus the X2864 EEPROM
- RS232 port • Software included

EPP.....\$199.95

## UVP EPROM Eraser



- Erases all EPROMs • Erases 1 chip in 15 minutes and 8 chips in 21 min
- UV intensity: 6800 UW CM<sup>2</sup>

DE4.....\$79.95

## PROTOTYPING PRODUCTS Jameco Solderless Breadboards

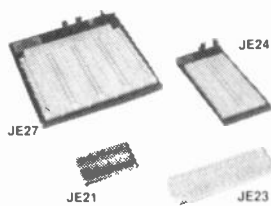

Part No.	Dim. L" x W"	Contact Points	Binding Posts	Price
JE21	3.25 x 2.125	400	0	\$4.95
JE23	6.5 x 2.125	830	0	\$6.95
JE24	6.5 x 3.125	1360	2	\$12.95
JE25	6.5 x 4.25	1660	3	\$17.95
JE26	6.875 x 5.75	2390	4	\$22.95
JE27	7.25 x 7.5	3220	4	\$32.95

## Metex Digital Multimeters

### General Specs:

- Handheld, high accuracy • AC DC voltage, AC DC current, resistance, diodes continuity transistor hFE
- Manual ranging w overload protection

- M3650 & M4650 only: • Also measure frequency and capacitance

- M4650 only: • Data hold switch • 4.5 digit

M3610	3.5 Digit Multimeter .....	\$59.95
M3650	3.5 Digit Multimeter w Frequency & Capacitance .....	\$74.95
M4650	4.5 Digit w Frequency, Capacitance and Data Hold Switch .....	\$99.95

## Handheld Multimeter

- 3.5 digit LCD with automatic polarity indication
- AC DC voltage measurement up to 500 volts
- AC DC current measurement up to 200mA
- Resistance measurement up to 20M $\Omega$  • Continuity checker with audible tone • Diode and logic tester • Auto manual range and data hold functions • All range protection and function indications

DMM905.....\$49.95

## EPROMs - for your programming needs

Part No.	Price	Part No.	Price	Part No.	Price
TMS2516	\$4.95	2764-20	\$4.95	27256-15	\$5.95
TMS2532	6.95	2764-25	4.75	27256-20	5.75
TMS2532-35	7.49	2764-45	4.49	27256-25	5.25
TMS2532A	7.95	2764A-20	4.25	27C256-15	6.95
TMS2564	5.95	2764A-25	3.95	27C256-20	4.95
TMS2716	5.95	27C64-15	4.49	27C256-25	4.49
1702A	4.89	27C64-25	3.49	27512OTP	5.95
2708	6.95	27128OTP	4.95	27512-20	7.95
2716	3.49	27128-20	6.95	27512-25	6.95
2716-1	3.95	27128-25	6.25	27C512-15	8.95
27C16	4.25	27128A-15	6.95	27C512-20	6.95
2732	4.95	27128A-20	5.95	27C512-25	6.49
2732A-20	3.95	27128A-25	4.95	27C010-15	14.95
2732A-25	3.75	27C128-15	5.95	27C010-20	13.95
2732A-45	3.49	27C128-25	5.75	68764	14.95
27C32	3.95	27256OTP	4.95	68766-35	12.95

## Soldering and Desoldering Stations

60 Watt Analog Display Soldering Station • Electronic temperature control from 200° to 878 F • Cartridge heating element for a longer life of the soldering tip

XY1683.....\$69.95

30 Watt Electronic Temperature Controlled Desoldering Station • Electronic temperature control from 212° to 842 F • Self contained high rotary vacuum pump

XY999.....\$299.95



XY999

• Partial Listing • Over 4000 Electronic and Computer Components in Stock!

CIRCLE 114 ON FREE INFORMATION CARD

# JAMECO

24 Hour Order Hotline  
(415) 592-8097

FAX: (415) 592-2503  
(415) 595-2664

# 24 Hours a Day.

Computer Products  
and Electronic Components

## Assemble Your own Computer Kit!

### Jameco 16MHz 80386SX Desktop Computer Kit

- Building your own computer provides you with a better understanding of components and their functions
- In-depth assembly instructions included
- Have your new computer assembled and running in an evening, using common tools
- Software included
- Purchase computer kits configured by Jameco or design your own

### Jameco 16MHz 80386SX Desktop Computer Kit

#### Includes:

- 80386SX Motherboard with 2MB RAM (expandable to 8MB)
- 101-key enhanced keyboard
- Multi I/O Card
- Toshiba 1.44MB, 3.5" DSHD floppy disk drive
- Baby sized desktop case
- 200 Watt power supply
- DR DOS 5.0 by Digital Research and Diagsoft's QAPLUS diagnostic software

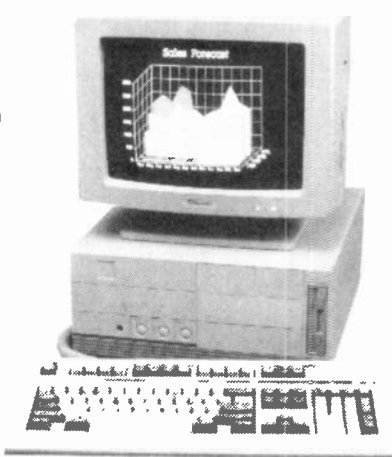

**\$1199.95**  
JE3816 monitor extra

### Hard Drives

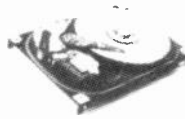

#### Conner (16-bit IDE)

CP3044 40MB 3.5" Low Profile.....\$469.95  
CP3184 80MB 3.5"HH.....\$699.95  
CP3104 100MB 3.5"HH.....\$799.95

ADP20 Host Adapter.....\$29.95

#### Relisys 14" VGA Color Monitor



- Max resolution: 720 x 480
- Bandwidth: 30MHz
- Input: DB15-pin (analog)

RE9513.....\$449.95

#### Jameco 16-bit VGA Card



- Supports VGA, EGA, CGA, MDA and Hercules modes • Comes with 256KB video RAM upgradable to 512KB (eight 41464-80) • Capable of 640 x 480 with 256 colors, 800 x 600 with 16 colors

VG2000.....\$149.95

# JAMECO

24 Hour Order Hotline  
**(415) 592-8097**

FAX: (415) 592-2503  
(415) 595-2664

1355 Shoreway Road  
Belmont, CA 94002

## Look to Jameco.....

- Wide selection of integrated circuits and components
- Quality prototype and test equipment
- Computer kits and accessories

#### Additional items that Jameco offers:

- Tools
- Cables
- Connectors
- Data Books
- Motherboards
- Memory
- Math Coprocessors
- Computer Accessories
- Power Protection Equipment
- Much, much more!

Let us show you what we have to offer; call or write for the latest Jameco catalog!

#### \$50.00 Minimum Order

Data Sheets - 50c each

For a FREE 90-Page catalog send \$2.00 to cover first Class Postage and Handling  
© 1991 Jameco Electronics 2-91

#### CA Residents Add

6 25%, 6 75% or 7 25% Sales Tax  
Shipping - Add 5% plus \$1.50 Insurance  
(May vary according to weight and shipping method)  
Terms: Prices subject to change without notice.  
Items subject to availability and prior sale.

Complete list of terms warranties is available upon request  
IBM is a registered trademark of International Business Machines



Please refer to Mail Key 2 when ordering

### Integrated Circuits

Part No.	1-9	10+	Part No.	1-9	10+
74LS00	\$.25	\$.15	74LS154	\$1.29	\$1.19
74LS02	.25	.15	74LS155	.49	.39
74LS03	.25	.15	74LS156	.49	.39
74LS04	.25	.15	74LS157	.45	.35
74LS05	.28	.18	74LS158	.39	.29
74LS06	.59	.49	74LS166	.79	.69
74LS07	.59	.49	74LS169	.99	.89
74LS08	.28	.18	74LS173	.49	.39
74LS10	.25	.15	74LS175	.39	.29
74LS11	.29	.19	74LS181	1.39	1.29
74LS13	.35	.25	74LS189	3.95	3.85
74LS14	.49	.39	74LS190	.59	.49
74LS20	.28	.18	74LS191	.59	.49
74LS21	.29	.19	74LS193	.69	.59
74LS27	.35	.25	74LS194	.69	.59
74LS30	.28	.18	74LS221	.69	.59
74LS32	.28	.18	74LS240	.59	.49
74LS38	.35	.25	74LS241	.59	.49
74LS42	.49	.39	74LS323	2.49	2.25
74LS47	.85	.75	74LS541	1.09	.99
74LS48	.85	.75	74LS590	5.95	5.75
74LS112	.39	.29	74LS670	.89	.79
74LS122	.55	.45	74LS688	2.19	1.95
74LS123	.49	.39	81LS95	.99	.89
74LS125	.49	.39	81LS97	.99	.89

### Miscellaneous Components

#### Potentiometers

Values available (insert ohms into space marked "XX")

500Ω, 1K, 5K, 10K, 20K, 50K, 100K, 1MEG  
43PXX 3/4 Watt, 15 Turn ..... \$ .99  
63PXX 1/2 Watt, 1 Turn.....\$ .89

#### Transistors And Diodes

PN2222.....\$.12 1N4735.....\$.25 2N4401.....\$.15  
PN2907......12 2N3904......12 1N4148......07  
1N4004......10 1N751......15 2N3055......69  
2N2222A......25 C106B1......49 1N270......25

#### Switches

JMT123 SPDT, On-On (Toggle) .....\$1.25  
206-8 SPST, 16-pin (DIP).....\$1.09  
MPC121 SPDT, On-Off-On (Toggle).....\$1.19  
MS102 SPST, Momentary (Push-Button) .....\$ .39

#### D-Sub Connectors and Hoods

DB25P Male, 25-pin .....\$ .65 DB25H Hood .....\$ .39  
DB25S Female, 25-pin.....\$.75

#### LEDs

XC209R T1, (Red).....\$.14 XC556R T1 3/4, (Red) ...\$.12  
XC556G T1 3/4, (Green) ...\$.16 XC556Y T1 3/4, (Yellow) ...\$.16

#### IC Sockets

Low Profile	Wire Wrap (Gold) Level #2
8LP.....\$.11	8WW.....\$.49
14LP......12	14WW......65
16LP......13	16WW......69
24LP......19	24WW.....1.05
28LP......22	28WW.....1.29
40LP......28	40WW.....1.79

Soldertail Standard & Header Plug Sockets Also Available

• Customer Service • Technical Assistance • Credit Department • All Other Inquiries • (415) 592-8097 • 7AM - 4PM P.S.T.

CIRCLE 114 ON FREE INFORMATION CARD

# AMAZING SCIENTIFIC & ELECTRONIC PRODUCTS

## LASERS AND SCIENTIFIC DEVICES

VRL2K	3mw Vis Red Laser Diode System Kit	\$159.50
LLIS1K	Laser Beam "Bounce" Listener Kit	\$199.50
LLC2K	Visible Simulated 3 Color Laser Kit	\$44.50
LC7	40 Watt Burning Cutting Laser Plans	\$20.00
RUB4	Hi Powered Pulsed Drilling Laser Plans	\$20.00
LGU40	1 to 2mw HeNe Vis Red Laser Gun Assembled	\$199.00
LLS1	Laser Lite Show - 3 Methods Plans	\$20.00
SD5K	See in the Dark Kit	\$299.50
EML1K	Electromagnetic Coil Gun Kit	\$69.50
MCP1	Hi Velocity Coil Gun Plans	\$15.00
LEV1	Levitating Device Plans	\$10.00
EH1	Electronic Hypnotism Techniques Plans	\$10.00

## HIGH VOLTAGE AND PLASMA DISPLAY DEVICES

HVM7K	75,000 Volt DC Variable Output Lab Source Kit	\$149.50
IDG3K	Ion Ray Gun Kit, project energy without wires	\$69.50
NG9K	12V/115 VAC Hi Out Neg Ion Generator Kit	\$34.50
EMA1K	Telekinetic Enhancer/Electric Man Assembled	\$99.50
LG5K	Lightning Display Globe Kit	\$54.50
BTC1K	World's Smallest Tesla Coil Kit	\$49.50
BTC3K	250KV Table Top Tesla Coil Kit	\$249.50
BTC5	1.5 Million Volts Tesla Coil Plans	\$20.00
JL3	Jacobs Ladder - 3 Models Plans	\$15.00
GRA1	Anti Gravity Generator Plans	\$10.00
PFS20	Plasma Fire Saber Assembled	\$69.50
DPL20	Dancing Plasma to Music and Sounds Assembled	\$79.50

## SECURITY AND PROTECTION DEVICES

ITM10	100,000 Volt Intimidator up to 20' Assembled	\$129.50
IPG70	Invisible Pain Field Blast Wave Gen Assembled	\$74.50
PSP4K	Phasor Sonic Blast Wave Pistol Kit	\$59.50
LIS10	Infinity Xmtr, Listen in Via Phone Assembled	\$199.50
TAT30	Automatic Tel Recording Device Assembled	\$24.50
VWPM7K	3 Mi. FM Auto Tel Transmitter Kit	\$49.50
FMV1K	3 Mi. FM Voice Transmitter Kit	\$39.50
HDD1K	Homing/Tracking Beeper Transmitter Kit	\$49.50

EASY ORDERING PROCEDURE TOLL FREE 1-800-221-1705  
or 24 HRS ON 1-603-673-4730 or FAX IT TO 1-603-672-5406  
VISA, MC, CHECK, MO IN US FUNDS. INCLUDE 10% SHIPPING. ORDERS  
\$100.00 & UP ONLY ADD \$10.00. CATALOG \$1.00 OR FREE WITH ORDER

## INFORMATION UNLIMITED P.O. BOX 716, DEPT. R3, AMHERST, NH 03031

## THE ELECTRONIC GOLDMINE



The Electronic Goldmine has one of the greatest selections of unique electronic kits available in the world! We have over 130 kits and over 1,400 unique, bargain priced, components in our catalog!

**FREE CATALOG**  
With OVER 1400 DIFFERENT ITEMS INCLUDING 135 KITS! REQUEST YOUR COPY TODAY!

**Special Item**

### MINI GEIGER COUNTER KIT

- \* Detects ALL Types of Radiation
- \* Uses Sensitive Alpha Window Tube
- \* Operates from 9V Battery (not incl.)
- \* Comes with PC Board, Parts, Tube and Instructions
- \* Size of PC Board: 3" x 1 9/16"

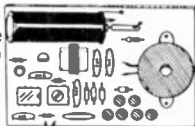

C6430 \$59.95

### 4KV TRIGGER COIL

Use with any strobe tube that needs a 3 lead 4KV trigger

N1700 \$1.25 EA  
100 for \$80.00

### INVERTER TRANSFORMER

Small 4 lead transformer for use with 555 IC to convert 12VDC to 250V for strobe/fluorescent tubes with schematic

N1703 \$2.00 EA  
1,000 for \$1,500

### CDS CELL ASSORTMENT

Great for hundreds of projects and experiments. These change their resistance with light. 5 different types

G764 5 for \$2.00

### GIANT HORSESHOE XENON STROBE TUBE

Largest Horseshoe Tube we have ever seen! Make a behemoth strobe to frighten everyone on Halloween, or use it in a wrapper of a disco strobe! Size: 2" tall x 1 1/8" wide, glass tubing dia. 5/16". Operates on 300VDC and can be used with our 4KV trigger transformer (stock# N1700 to left)

G762 \$7.00 EACH

### RARE EARTH MAGNET

Many times stronger than other magnets, these are among the world's strongest commercially available magnets for this size. Small size only about 1 1/2" x 5/8" x 4/8" yet can lift up to 10 lbs. Try to remove this magnet from a steel plate, and you'll find that unless you slide it, you can't get it off! Great for thousands of experiments and applications. Normally these sell for over \$50 each, but these are surplus and have a few chips (does not effect performance)

G765 \$9.00

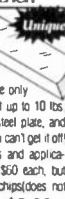

MINIMUM ORDER: \$10.00 plus \$3.00 shipping and handling.  
We accept MC, Visa and Money Orders.  
SEND ORDERS TO: The Electronic Goldmine  
P.O. Box 5408 Scottsdale, AZ 85261  
PHONE ORDERS: (602) 451-7454

## ADVERTISING INDEX

RADIO-ELECTRONICS does not assume any responsibility for errors that may appear in the index below.

Free Information Number	Page		Page	
108	AMC Sales	82	56 Parts Express	89
75	Ace Products	42	193 People's College	21
107	All Electronics	93	182 Print Products International	29
180	Alpha Products	17	78 Radio Shack	7
—	Amazing Concepts	96	177 SCO Electronics	76
77	B&K Precision	19	— Star Circuits	30
67	Banner Technical Kit Books	80	194 Unicorn	92
98	Beckman	75	178 U.S. Cable	76
109	C&S Sales	36	189 Viejo Publications	82
70	CEI	91	190 WPT Publications	86
—	CIE	5, 25	191 Xandi Electronics	42
50	Caig Laboratories	29		
179	Cheneko Products	42		
—	Command Productions	30		
187	Communications Specialists	86		
183	CompuServe	CV4		
55	Contact East	42		
58	Cook's Institute	18		
184	D&D Electronics	3		
127	Deco Industries	42		
188	Electronic Goldmine	96		
—	Electronics Book Club	11, 32		
121	Fluke Manufacturing	CV2		
185	General Technics	42		
186	Global Specialties	27, 26		
—	Grantham College	54		
86	Heathkit	16		
—	ISCET	9		
114	Jameco	93, 94		
104	Jan Crystals	18		
—	King Wholesale	88		
53	MD Electronics	90		
93	Mark V. Electronics	91		
61	Microprocessors Unltd.	79		
—	NRI Schools	15, 85		
181	Optoelectronics	CV3		

## ADVERTISING SALES OFFICE

**Gernsback Publications, Inc.**  
500-B Bi-County Blvd.  
Farmingdale, NY 11735  
1-(516) 293-3000  
President: Larry Steckler  
Vice President: Cathy Steckler

**For Advertising ONLY**  
516-293-3000

Fax 1-516-293-3115

Larry Steckler  
publisher

Arline Fishman  
advertising director

Denise Haven  
advertising assistant

Christina Estrada  
advertising associate

Kelly McQuade  
credit manager

**Subscriber Customer Service**  
1-800-288-0652

**Order Entry for New Subscribers**  
1-800-999-7139

7:00 AM - 6:00 PM M-F MST

## SALES OFFICES

### EAST/SOUTHEAST

**Stanley Levitan**, Eastern Sales Manager  
Radio-Electronics  
259-23 57th Avenue  
Little Neck, NY 11362  
1-718-428-6037, 1-516-293-3000  
Fax 1-718-225-8594

### MIDWEST/Texas/Arkansas/Okla.

**Ralph Bergen**, Midwest Sales Manager  
Radio-Electronics  
540 Frontage Road—Suite 339  
Northfield, IL 60093  
1-708-446-1444  
Fax 1-708-446-8451

### PACIFIC COAST/ Mountain States

**Marvin Green**, Pacific Sales Manager  
Radio-Electronics  
5430 Van Nuys Blvd. Suite 316  
Van Nuys, CA 91401  
1-818-986-2001  
Fax 1-818-986-2009

# Charter Subscriber's Special Offer

FOR FASTER SERVICE CALL TODAY!  
1-800-777-5489

4RB13

## POWER PACKED TRIO

### #1 Premier Edition for Charter Members!

**SCIENCE PROBE!** is published for the recreational, observational, and experimental amateur Scientist. Discover what's happening in Astronomy, Photography, Medicine, Mechanics, and other interesting fields.

### #2 First Time ever offered!

No-holds barred Video Tape reveals the pros views on the science of debugging. Learn how to protect yourself and your business. Consider a whole new profession!

### #3 Modern Short Stories

—a magazine packed with the imagination of upcoming authors who will parade their imagination and creativeness as you devour every word of fantasy and fiction.

Gain new insights to the sciences! Enjoy hours of pleasurable reading. View and learn how thieves steal your very words! But most of all, increase your knowledge and improve your mind.

**SCIENCE PROBE!**—the *only* magazine devoted entirely to Amateur Scientists! If you are fascinated by science in all its many forms. . . if you can't stay away from a microscope, telescope or test tube. . . if you like to tinker with gadgets, test equipment, and high-tech consumer gear—we invite you to share the wonders in every issue of **SCIENCE PROBE!**

Order your one-year subscription of **SCIENCE PROBE!** now, and save \$4.05 off the cover price—pay only \$9.95 for 4 quarterly issues. Order now! Become a Charter Subscriber and the Premier Edition of **SCIENCE PROBE!** will be yours!

Name \_\_\_\_\_  
Address \_\_\_\_\_  
City \_\_\_\_\_ State \_\_\_\_\_ Zip \_\_\_\_\_

All payments must be made in U.S.A. funds. Add extra for postage: Canada \$5.00; Foreign \$7.50. Single copies may be purchased at quality newsstands, convenience stores and supermarkets for \$3.50 U.S.A., \$3.95 Canada. Allow 6-8 weeks for delivery.



## Wake up! Discover your future in Countersurveillance Technology The Science of De-bugging

View it on your TV

**Y**ou may be the victim of stolen words—precious ideas that would have made you very wealthy! Yes, professionals, even rank amateurs, may be listening to your most private conversations

**Wake up!** If you are not the victim, then you are surrounded by countless victims who need your help, provided you know how to discover telephone taps, locate bugs, "sweep" a room clean.

There is a thriving professional service steeped in high-tech techniques that you

can become a part of! But first, you must know and understand *Countersurveillance Technology*. Your very first insight into this highly rewarding field is made possible by a video VHS program that you can view at home, and nowhere else! It presents an informative program prepared by professionals in the field who know their industry, its techniques, kinks and loopholes. Discover more in 45 minutes in a straightforward, exclusive personal seminar that was never attempted before. (See other side of Card)

IS SOMEONE SNOOPING ON YOUR PRIVATE DISCUSSIONS? YOU CAN STOP THAT!

## Discover the Human Imagination!

**Modern Short Stories** uncovers the mysterious workings of the human mind and heart within the magic of its easy-to-read stories. Encounter a parade of fascinating people. Become involved with their lives, their failures and triumphs. Human vignettes that move you to laughter and tears, excite your sense of wonder, and engage your sense of outrage!

- Six (6) issues now for **only \$7.95—save \$5.55** off the cover price.
- Twelve (12) issues now for **only \$14.95—save \$12.05** off the cover price.

Name \_\_\_\_\_  
Address \_\_\_\_\_  
City \_\_\_\_\_ State \_\_\_\_\_ Zip \_\_\_\_\_

All payments must be made in U.S.A. Funds. Add extra for postage: Canada \$3.00; Foreign \$4.50. Single copies may be purchased at quality newsstands, convenience stores and supermarkets for \$2.25 U.S.A., \$2.75 Canada. Allow 6-8 weeks for delivery.

FOR FASTER SERVICE CALL TODAY!  
1-800-435-0715  
(7:30 AM-8:30 PM) EST

BREB1





NO POSTAGE  
NECESSARY  
IF MAILED  
IN THE  
UNITED STATES

**BUSINESS REPLY MAIL**  
FIRST CLASS MAIL PERMIT NO. 1164 BOULDER, COLORADO

POSTAGE WILL BE PAID BY ADDRESSEE

# SCIENCE PROBE!

P.O. BOX 54098  
BOULDER, COLORADO 80321-4098



## Don't pass by these ACTION CARDS!

### Bring some excitement to your life. Some Tips:

Print your name, address and ZIP code on the cards you select.

Credit card users: Be sure to copy accurately your card's number and expire date. Don't forget to place your signature on the card when required.

When payment is sent with order, be sure to use U.S. funds only. Send check or money order. Do not send cash or stamps.

These offers make excellent gifts for family and friends. Surprise someone who is near and dear to you.

### Foiling Information Thieves

Discover the targets professional snoopers seek out! The prey may be stock brokers, manufacturers, high-tech companies, any competitive industry, or even small businesses in your community. The valuable information they filch may be marketing strategies, customer lists, product formulas, manufacturing techniques, even advertising plans. Information thieves eavesdrop on court decisions, bidding information, financial data. The list is unlimited in the mind of man—especially if he is a thief!

To obtain the information contained in the video VHS cassette, you must attend a professional seminar costing \$350-750 and possibly pay hundreds of dollars more if you had to travel to a distant city to attend. Now, for only \$49.95 (plus \$4.00 P&H) you can view Countersurveillance Techniques at home and take refresher views as often as you like. To obtain your copy, complete the coupon below. For faster service call today 1-800-522-6260

RE  
**RADIO-ELECTRONICS VIDEO OFFER**  
500-B Bi-County Blvd.  
Farmingdale, NY 11735

Please rush my copy of the *Countersurveillance Techniques* Video VHS Cassette for \$49.95 plus \$4.00 for postage and handling.

No. of Cassettes ordered \_\_\_\_\_ Amount of payment \$ \_\_\_\_\_  
Bill my  VISA  MasterCard  
Card No. \_\_\_\_\_ Expire Date \_\_\_\_\_  
Signature \_\_\_\_\_  
Name \_\_\_\_\_  
Address \_\_\_\_\_  
City \_\_\_\_\_ State \_\_\_\_\_ Zip \_\_\_\_\_

Canadian orders: All payments in U.S. funds. No foreign orders. NY State residents add applicable sales tax.

ALL INFORMATION  
CONTAINED  
HEREIN  
IS UNCLASSIFIED



NO POSTAGE  
NECESSARY  
IF MAILED  
IN THE  
UNITED STATES

**BUSINESS REPLY MAIL**  
FIRST CLASS MAIL PERMIT NO. 144 MT. MORRIS, IL

POSTAGE WILL BE PAID BY ADDRESSEE

# MODERN SHORT STORIES.

P.O. Box 473  
Mt. Morris, IL 61054-8026

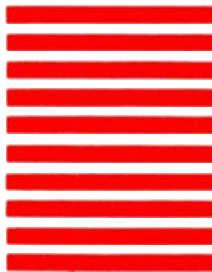

# OFF THE BENCH AND RUNNING

When **PTOELECTRONICS** took frequency counters off the bench we created a whole new dimension - **Frequency Finding**.

Our **Hand-Counters™** make Frequency Finding a reality by allowing you to pick-up radio transmitters at the maximum possible distance.

Monitoring Enthusiast, Security Specialists, Broadcast and Design Engineers, Two Way and Amateur Radio Operators and Service Technicians have all made the move. **Shouldn't you?**

3000

Top of the Line Universal  
Handi-Counter™.

\$375.



2600

Super Sensitive RF  
Frequency Finder.  
\$325.



2210A

Full Range  
Pocket  
Size LED.  
\$239.



1300H/A

Low Cost Ultra  
Sensitive (HF,  
UHF, VHF).  
\$179.



8030

Bench Portable (Fits in an attache  
case) with ALL the Handi-Counter™  
Features plus More. \$579.



Model	Range Low High	Display 8 Digit LED	Display 10 Digit LCD	Signal Strength Bargraph	Universal Counter	TCXO Option
8030	10Hz 2.4GHz		•	•	•	± .1ppm add \$125.
3000	10Hz 2.4GHz		•	•	•	± .2ppm add \$ 80.
2500	1MHz 2.4GHz		•	•	•	± .2ppm add \$ 80.
2210A	10Hz 2.4GHz	•				± .5ppm add \$ 75.
1300H/A	1MHz 1.3GHz	•				± .5ppm add \$ 75.

Sensitivity: <1 to <10mV typical. HiCads & AC Charger/Adapter Included. Carry Case, Antennas and Probes extra. One year parts & labor warranty on all products.

## PTOELECTRONICS

Toll Free Order Line:

1-800-327-5912

In Florida call (305) 771-2050

FAX (305) 771-2052

5821 NE 14th Avenue • Ft. Lauderdale, FL 33334  
Visa, MC, COD, Cash, M.O. accepted. Personal  
Check allow 3 weeks. 5% Shipping, Handling;  
(Maximum \$10) U.S. & Canada. 15% outside  
continental U.S.A.

# There's nothing new about having everything you need in one place.

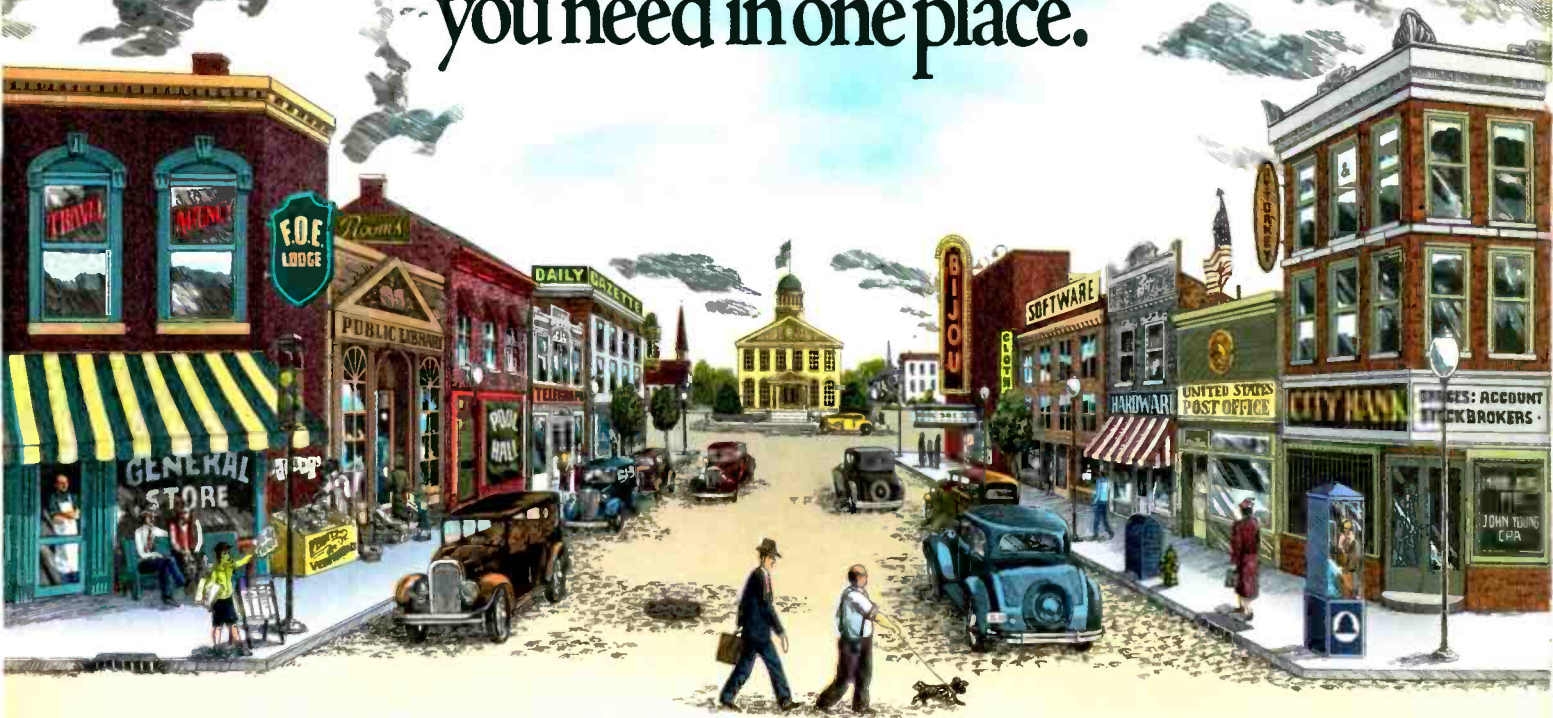

## With CompuServe, it's all at your fingertips.

When you become a member of CompuServe, you join a vital, active community of over 500,000 friends and neighbors from all over the world.

**Small-town friendly.** We keep in touch with electronic mail and faxes, and by posting messages on our bulletin boards. We even meet in forums to discuss everything from science fiction to sharing software, and to get invaluable personal computer software and hardware support. And that's one of the best things about small towns: people helping people.

**Big-city opportunities.** But we can also shop coast-to-coast at hundreds of nationally known stores, and take advantage of a world-class library. We have

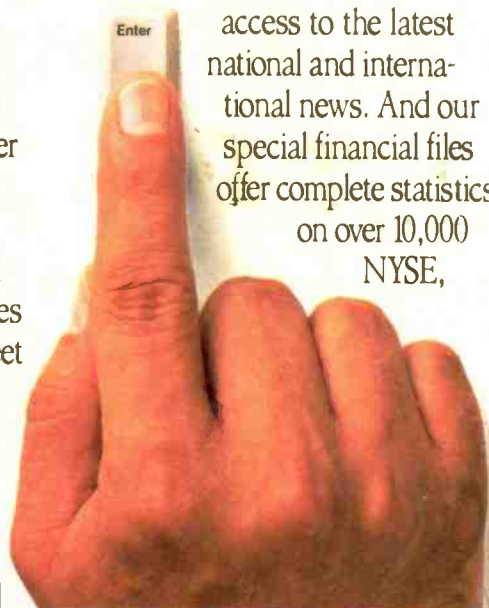

access to the latest national and international news. And our special financial files offer complete statistics on over 10,000 NYSE,

AMEX, and OTC securities.

We can even trade online with our local discount brokers.

**And, just for fun . . .** We've also got games — everything from trivia to TV-style game shows with

live entertainment to interactive space and fantasy adventures.

We've got airline schedules, so you can check out the bargains and book your own flights online. We even have listings from over 35,000 hotels.

**It's not hard to get here.** To get to CompuServe, all you need is a computer and a modem. We'll send you everything else, including a \$25.00 Usage Credit. In most places you'll be able to go online with a local phone call.

To buy a CompuServe Membership Kit, see your nearest computer dealer. To receive our informative brochure or to order direct, call 800 848-8199.

### CompuServe®

CIRCLE 183 ON FREE INFORMATION CARD