

Radio **VCR REPAIRS
YOU CAN DO**

SEPTEMBER 1989

Electronics®

TECHNOLOGY - VIDEO - STEREO - COMPUTERS - SERVICE

BUILD THIS SPECTRUM MONITOR

Convert your oscilloscope into a spectrum analyzer!

BUILD AN LF CONVERTER

Use any AM radio to tune in the world below the broadcast band

BUILD AN LF TRANSMITTER

Explore the license-free low-frequency bands!

THE SOUND RETRIEVAL SYSTEM

Stereo like you've never heard before

CIRCUIT COOKBOOK

Op-amp instrumentation circuits

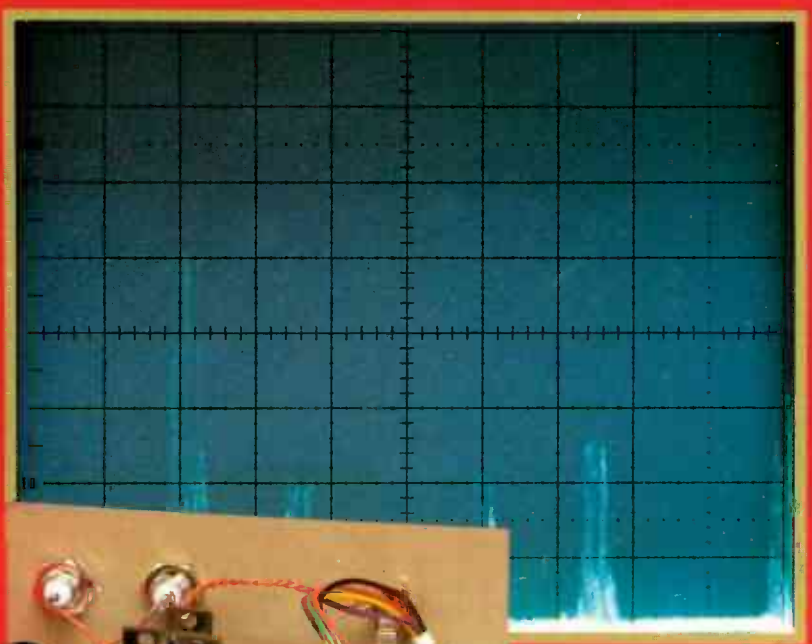

COMPUTER DIGEST
Programmable architectures:
The next breakthrough?



\$2.25 U.S.
\$2.75 CAN



***** 5-DIGIT 8205
39178041097023 09 12
JAN 20
MR. ROBERT DAHN
927 GRAND AV
AURORA, IL 60506

FLUKE



PHILIPS

Other meters show half the picture

The new Fluke 45 has dual display versatility.

With 2 multifunction displays and 16 different measurement capabilities, the new Fluke 45 does virtually everything you want a meter to do. And for a surprisingly affordable price.



Get everything you've ever wanted.

Dual displays. 16 functions. Even the security of an optional two-year warranty extension for only \$35. For all the information on the new Fluke 45, contact your local distributor. Or call toll-free 1-800-44-FLUKE, ext. 33.

The 5-digit, 100,000 count dual displays give you more information in less time — and with less effort. For example, measure the VDC output of a power supply while measuring the VAC ripple. Or check the amplitude and frequency of an AC signal. From a single test connection!

And the Fluke 45 is designed to make complex measurements easier, with standard features like a 1 MHz frequency counter, Min Max, limits testing (Hi/Low/Pass), Touch Hold® and Relative modes. There are 21 different reference impedances for dB measurements; in the 2 Ω to 16 Ω ranges, audio power can be automatically displayed in watts.

Accuracy to get the job done right.

The Fluke 45 is a true-rms meter, with 0.02% basic dc voltage accuracy and 100,000 count resolution on both displays. Basic dc current accuracy is 0.05%, making the 45 ideal for servicing 4-20 mA current loops. Closed-case calibration simplifies the calibration process and increases uptime.

Even an RS-232 interface is standard.

Connecting the Fluke 45 to PCs, RS-232 printers and modems is as easy as attaching the cable. An IEEE-488.2 interface and rechargeable batteries are available as options.

FLUKE 45 DUAL DISPLAY MULTIMETER

\$595*	Compare and Relative functions
Dual Display	Min Max and Touch Hold® functions
True-rms voltage and current, including ac+dc	Optional PC software for RS-232 applications
0.02% basic dc voltage accuracy	Optional IEEE-488.2 interface, battery pack
0.05% basic dc current accuracy	One year warranty
1 MHz frequency counter	Optional two year warranty extension \$35*
RS-232 interface standard	
dB, with 21 reference impedances, and audio power calculations.	
*Suggested U.S. List Price	

John Fluke Mfg. Co., Inc. P.O. Box C9090 M/S 250C Everett, WA 98206
U.S.: 206-356-5400 Canada: 416-890-7600 Other Countries: 206-356-5500

© Copyright 1989 John Fluke Mfg. Co., Inc. All rights reserved. IBM PC is a registered trademark of International Business Machines Corporation. Ad No. 0591-F45

CIRCLE 121 ON FREE INFORMATION CARD

www.americanradiohistory.com

FLUKE

September 1989 **Radio Electronics**

Vol. 60 No. 9

BUILD THIS

- 33 SPECTRUM MONITOR**
Convert your oscilloscope into a spectrum analyzer!
Fred Baumgartner
- 43 LOW-FREQUENCY TRANSMITTER**
Transmit on the no-license-required 1750-meter band.
Richard A. Nelson
- 47 LOW-FREQUENCY CONVERTER**
Explore the frequency range just below the AM band.
William Sheets and Rudolf F. Graf

TECHNOLOGY

- 51 BEYOND STEREO**
Get better stereo from your TV with the Sound Retrieval System.
Len Feldman
- 55 KEEP YOUR VCR HEALTHY**
How to troubleshoot tape-loading problems.
Peter M. Hansen

COMPUTERS

- 77 PROGRAMMABLE ARCHITECTURES**
A possible new direction in computer technology.
Andrew Reeve
- 82 687025 MICROCONTROLLER**
Build a single-IC microprocessor system.
Thomas Henry

CIRCUITS

- 59 OP-AMPS IN INSTRUMENTATION**
Put op-amps to work in instrumentation circuits.
Ray Marston

DEPARTMENTS

- | | |
|--|---|
| <ul style="list-style-type: none"> 6 VIDEO NEWS
The latest happenings.
David Lachenbruch 22 EQUIPMENT REPORTS
Elenco Digital Trainer XK-220, and Sibex FG-1 Function Generator. 65 HARDWARE HACKER
Humidity sensors, and more!
Don Lancaster | <ul style="list-style-type: none"> 70 AUDIO UPDATE
The evolution of car stereo.
Larry Klein 72 DRAWING BOARD
The contest is over.
Robert Grossblatt 77 EDITOR'S WORKBENCH
Software and book reviews.
Jeff Holtzman |
|--|---|

COMPUTER DIGEST



EDITOR'S WORKBENCH

Programmers: Are you still using BASIC?

I wish to have a word with you about the use of BASIC in programming. It is a very popular language, but it is also a very slow language. It is not the best choice for many applications, especially those that require high speed and efficiency. There are many other languages available, such as C, C++, and Pascal, which are much faster and more efficient. If you are still using BASIC, you may want to consider switching to one of these other languages. This will save you a great deal of time and frustration in the long run.

ANSWER TO Q1

I wish to have a word with you about the use of BASIC in programming. It is a very popular language, but it is also a very slow language. It is not the best choice for many applications, especially those that require high speed and efficiency. There are many other languages available, such as C, C++, and Pascal, which are much faster and more efficient. If you are still using BASIC, you may want to consider switching to one of these other languages. This will save you a great deal of time and frustration in the long run.

PAGE 77

TECHNOLOGY

BEYOND STEREO



BEYOND STEREO

The Sound Retrieval System adds a new dimension to audio reproduction.

LEN FELDMAN

As a stereo enthusiast, you know that the quality of your audio reproduction is crucial to your enjoyment of music. The Sound Retrieval System (SRS) is a new technology that promises to take your stereo system to the next level. It is designed to extract and enhance the stereo information hidden in the left and right channels of a stereo signal. This means that you can enjoy a more realistic and immersive listening experience, even with a standard stereo system. The SRS is a simple-to-use device that can be connected to your stereo system in a matter of minutes. It is a great investment for anyone who values high-quality audio reproduction.

PAGE 51

AND MORE

- 104 Advertising and Sales Offices**
- 104 Advertising Index**
- 8 Ask R-E**
- 105 Free Information Card**
- 14 Letters**
- 87 Market Center**
- 25 New Products**
- 64 PC Service**
- 4 What's News**

ON THE COVER



What is the first item on your test-equipment wish list? If you're like most of us, it's a spectrum analyzer. And the reason you don't have one is because of its high price. We're here to offer a solution. Convert your oscilloscope into a 2-600 MHz spectrum monitor for a fraction of the cost of a real analyzer. For all the details, turn to page 33.

COMING NEXT MONTH

THE OCTOBER ISSUE GOES ON SALE SEPTEMBER 5.

BUILD THE R-E FAX MATE

Now you can use your fax and your regular phone on the same line!
(It works with modems, too.)

BUILD A REMOTE A/B SWITCH

The ultimate couch potato's dream: Never leave your easy chair again!

CIRCUIT COOKBOOK

Dozens of CMOS bilateral switch circuits.

COMPUTER DIGEST

Put the 68705 microcontroller to work.

As a service to readers, RADIO-ELECTRONICS publishes available plans or information relating to newsworthy products, techniques and scientific and technological developments. Because of possible variances in the quality and condition of materials and workmanship used by readers, RADIO-ELECTRONICS disclaims any responsibility for the safe and proper functioning of reader-built projects based upon or from plans or information published in this magazine.

Since some of the equipment and circuitry described in RADIO-ELECTRONICS may relate to or be covered by U.S. patents, RADIO-ELECTRONICS disclaims any liability for the infringement of such patents by the making, using, or selling of any such equipment or circuitry, and suggests that anyone interested in such projects consult a patent attorney.

RADIO-ELECTRONICS, (ISSN 0033-7862) September 1989. Published monthly by Gernsback Publications, Inc., 500-B Bi-County Boulevard, Farmingdale, NY 11735 Second-Class Postage paid at Farmingdale, NY and additional mailing offices. Second-Class mail registration No. 9242 authorized at Toronto, Canada. One-year subscription rate U.S.A. and possessions \$17.97. Canada \$23.97, all other countries \$26.97. All subscription orders payable in U.S.A. funds only, via international postal money order or check drawn on a U.S.A. bank. Single copies \$2.25. © 1989 by Gernsback Publications, Inc. All rights reserved. Printed in U.S.A.

POSTMASTER: Please send address changes to RADIO-ELECTRONICS, Subscription Dept., Box 55115, Boulder, CO 80321-5115.

A stamped self-addressed envelope must accompany all submitted manuscripts and/or artwork or photographs if their return is desired should they be rejected. We disclaim any responsibility for the loss or damage of manuscripts and/or artwork or photographs while in our possession or otherwise.

Radio- Electronics®

Hugo Gernsback (1884-1967) founder
M. Harvey Gernsback,
editor-in-chief, emeritus

Larry Steckler, EHF, CET,
editor-in-chief and publisher

EDITORIAL DEPARTMENT

Art Kleiman, editorial director

Brian C. Fenton, editor

Marc Spiwak, associate editor

Daniel Goodman, technical editor

Jonathan A. Gordon,
assistant technical editor

Teri Scaduto, assistant editor

Jeffrey K. Holtzman,
computer editor

Robert A. Young, assistant editor

Byron G. Wels, editorial associate

Jack Darr, CET, service editor

Robert Grossblatt, circuits editor

Larry Klein, audio editor

David Lachenbruch,
contributing editor

Don Lancaster,
contributing editor

Richard D. Fitch,
contributing editor

Kathy Campbell, editorial assistant

Andre Duzant, technical illustrator

Injae Lee, assistant illustrator

PRODUCTION DEPARTMENT

Ruby M. Yee, production director

Robert A. W. Lowndes,
editorial production

Karen Tucker, advertising production

Marcella Amoroso, production traffic

CIRCULATION DEPARTMENT

Jacqueline P. Cheeseboro,
circulation director

Wendy Alanko,
circulation analyst

Theresa Lombardo,
circulation assistant

Typography by Mates Graphics

Cover photo by John D. McManus

Radio-Electronics is indexed in

Applied Science & Technology Index

and Readers Guide to Periodical Literature.

Microfilm & Microfiche editions are

available. Contact circulation department

for details.

Advertising Sales Offices listed

on page 104.





DELUXE TEST LEAD KIT

Users call TPI test leads **The Absolute Best**. The TLS2000 features the highest quality cable in the industry — with spring-loaded safety-sleeved plugs. U.L. listed (file E79581). Kit: \$29. Leads & probes only: \$19. Satisfaction guaranteed. **TEST PROBES INC.** Call toll-free for catalog: 1-800-368-5719.

CIRCLE 211 ON FREE INFORMATION CARD

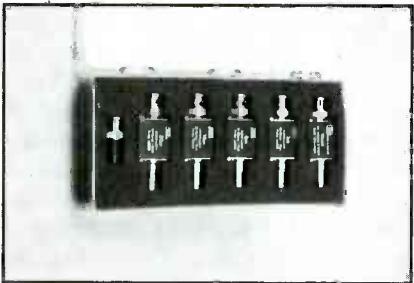

BNC ATTENUATOR KIT

Contains 4 attenuators — 3dB, 6dB, 10dB, 20dB; 1 feedthrough and 1 termination. Thick-film circuitry for low reactances. Rugged design resists shock and lasts longer. Rectangular shape stays put on the bench. **Impedance:** 50Ω **Frequency:** 1GHz. **Maximum Power:** 1kW peak, 1W avg. **VSWR** 1.2:1. Attenuator Accuracy: ±0.2dB. Terminations Resistance Tolerance: ±1%. \$150.

TEST PROBES INC. Call toll-free for catalog: 1-800-368-5719.

CIRCLE 212 ON FREE INFORMATION CARD

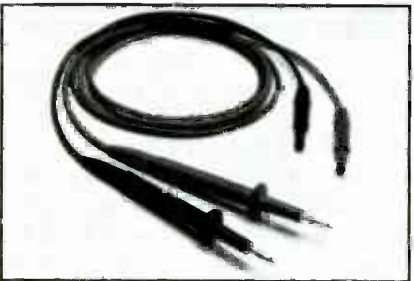

ECONOMICAL SILICON RUBBER TEST LEADS

Best value in moderately priced leads. High quality, soft, silicon rubber cable. Banana plug on measuring tip accepts push-on accessories. Plugs have spring-loaded safety sleeves. Model TL1000 \$14.00. Satisfaction guaranteed. **TEST PROBES INC.** Call toll-free for catalog: 1-800-368-5719.

CIRCLE 213 ON FREE INFORMATION CARD



COAX ADAPTER KIT

- Create any adapter in seconds
- Make all combinations of BNC, TNC, SMA, N, UHF, Mini-UHF, F and RCA

The TPI 3000A kit contains male and female connectors of all 8 types, and 6 universal interfaces. Simply screw any combination of 24 connectors to one of the interfaces to create the desired adapter. \$150.

TEST PROBES INC. 9178 Brown Deer, San Diego, California 92121. Call toll-free for catalog: 1-800-368-5719.

CIRCLE 210 ON FREE INFORMATION CARD

New

No Better Probe Ever at This Price!



Shown here
Model SP150 **\$49**
Switchable 1x-10x

CIRCLE 181 ON FREE INFORMATION CARD

Risetime less than 1.5 nsec.

- **Universal** - works with all oscilloscopes
- **Removable Ground Lead**
- **Excludes External Interference** - even on scope's most sensitive range
- **Rugged** - withstands harsh environments including high temperature and humidity
- **Advanced Strain Relief** - cables last longer
- **Available in 10x, 1x and switchable 1x-10x**
- **10 day return policy** - performance and satisfaction guaranteed

TEST PROBES, INC. TPI

9178 Brown Deer Road
San Diego, CA 92121
Toll Free 1-800-368-5719
1-800-643-8382 in CA

Call for free catalog and Distributor in your area

CIRCLE 123 ON FREE INFORMATION CARD

WHAT'S NEWS

Fastest megabit DRAM chip.



JIM BALLARD OF IBM'S semiconductor manufacturing and development facility runs a robotic tool that processes the world's fastest one-million-bit DRAM chips on 8-inch-diameter silicon wafers.

IBM's one-million-bit *Dynamic Random Access Memory (DRAM)* chip is now being manufactured in volume at the company's plant in Essex Junction, VT. The chip can access a bit of data in only 65 nanoseconds (billionths of a second)—almost a 20% improvement over IBM's other megabit chip. The faster speed is a result of advancements in the manufacturing process. The chips are fabricated on 8-inch diameter silicon wafers, rather than the industry-standard

4- to 6-inch wafers. Because the larger 8-inch wafers hold more chips, manufacturing-line productivity is significantly increased.

The first application for the new chip is in the recently announced Application System/400 (AS/400) model *B70*, a powerful high-end addition to the line of computers designed for small and intermediate-sized companies. The 65-nanosecond chip helps make the *B70's* processor faster by improving main storage-access time.

"Smart fluids" control hydraulic equipment

Dr. Frank Filisko, a physicist at the University of Michigan, Ann Arbor, has developed a water-free *electro-rheological* fluid, which temporarily thickens when subjected to electrical current. The "smart fluid" might provide some unusual alternatives to the valves that are used today to control the liquid pressure that powers hydraulic systems.

Those complex, expensive, and relatively slow valves are the weak links in all types of modern hydraulic systems, and scientists have been working on electro-rheological fluid as a valve replacement for several decades. Because the fluid thickens as the electric field is increased, by controlling the electrical field it is possible to exert precise control on the thickness of the fluid—which can change from its at-rest milk-like consistency to a gel-like state and back to its original form in fractions of a thousandth of a second. All previous versions of electro-rheological fluid, however, contained water molecules that froze at low temperatures and boiled away at high temperatures, rendering those fluids impractical for mechanical applications.

Dr. Filisko's formulation contains equal parts of electrically nonconductive liquid and fine particles of a solid—for instance, petroleum or silicon oil interspersed with particles of baking soda, glass, or silica gel—but no water. Already being used experimentally by Chrysler in advanced-design prototype automobiles, "smart fluids" lead to improved shock absorbers, clutches, brakes, and power steering in cars as well as improvements in any electrical and mechanical products that contain hydraulic systems. Actually, there are probably many future applications that have not yet been thought of. **R-E**

Where's Your **ELECTRONICS** Career Headed?

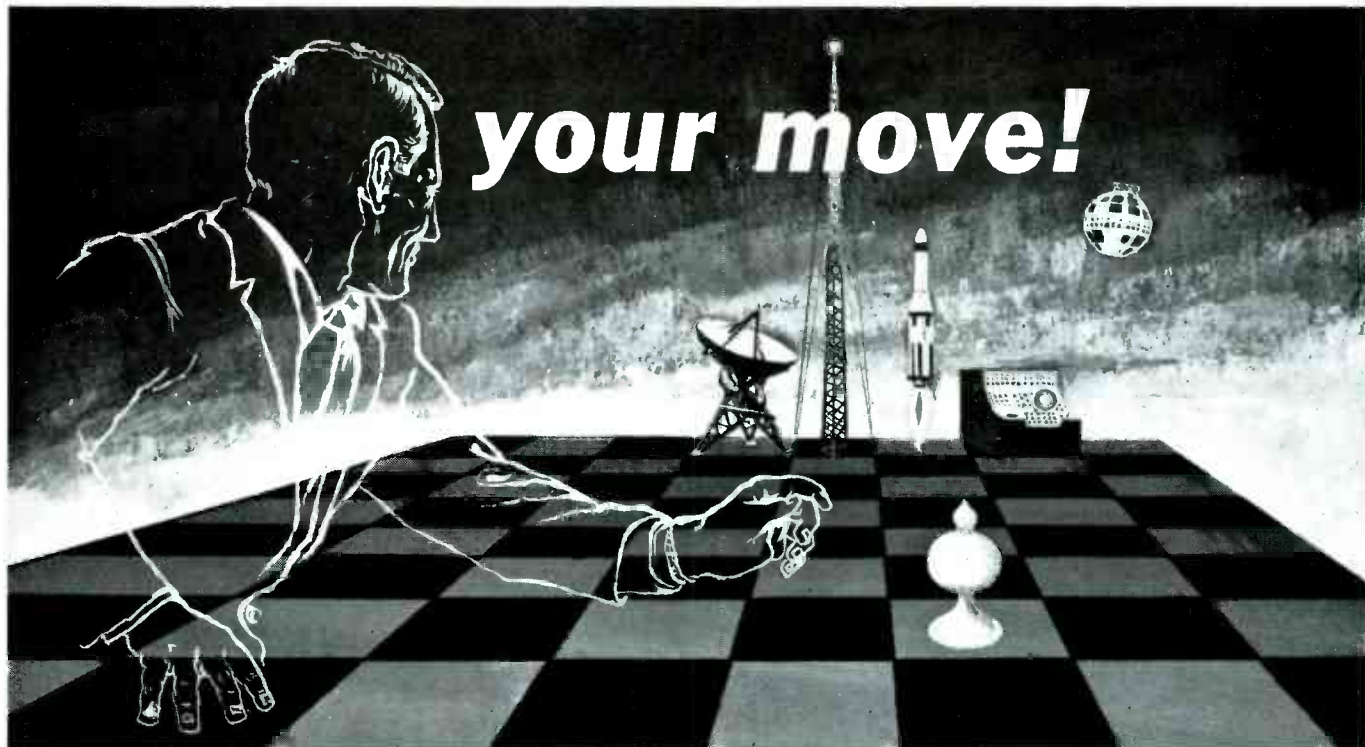

The Move You Make Today Can Shape Your Future

Yes it's your move. Whether on a chess board or in your career, you should plan each move carefully. In **electronics**, you can *move ahead* faster and further with a

B. S. DEGREE

Put professional knowledge and a COLLEGE DEGREE in your electronics career. Earn your degree through independent study at home, with Grantham College of Engineering. No commuting to class. Study at your own pace, while continuing your present job.

The accredited Grantham non-traditional degree program is intended for mature, fully employed workers who want to upgrade their careers . . . and who can successfully study electronics and supporting subjects through

INDEPENDENT STUDY, AT HOME

Free Details Available from:

Grantham College of Engineering
10570 Humbolt Street
Los Alamitos, California 90720

Independent Home Study Can Prepare You

Study materials, carefully written by the Grantham staff for independent study at home, are supplied by the College, and your technical questions related to those materials and the lesson tests are promptly answered by the Grantham teaching staff.

Recognition and Quality Assurance

Grantham College of Engineering is accredited by the Accrediting Commission of the National Home Study Council.

All lessons and other study materials, as well as communications between the college and students, are in the English language. However, we have students in many foreign countries; about 80% of our students live in the United States of America.

Grantham College of Engineering R-989
10570 Humbolt Street, Los Alamitos, CA 90720

Please mail me your free catalog which explains your B.S. Degree independent-study program.

Name _____ Age _____

Address _____

City _____ State _____ Zip _____

VIDEO NEWS



DAVID LACHENBRUCH,
CONTRIBUTING EDITOR

● **No barriers.** Electronics may accomplish what politics never could do—the elimination of technological barriers to visual communications between nations. In the past, standards converters costing hundreds of thousands of dollars were used by television networks to convert between PAL, SECAM, and NTSC television standards. In the very near future—like next year—our home VCR's will be able to do the job. Both Panasonic and JVC have shown video recorders that can convert from any of the world's TV standards to any other. Neither company has announced a definite price for its standard-converting VCR, but both have indicated that the VCR's will be consumer products. Both use digital technology to play tapes recorded in any one standard on a TV set of any other. Thus, within a year or two, families separated by oceans may be able to communicate irrespective of arbitrary video standards.

● **More small ones.** Just about every manufacturer is adding new carry-along video systems combining LCD color screens with VCR's. Sony has just introduced its second model—a “giant-screen” 4-incher—as a step up from its 3-inch Video Walkman. Both use 8mm VCR's. Panasonic has introduced a 3-inch model using a Super VHS-C compact cassette mechanism, to be followed by a 4-inch with full-size VHS. Sharp, which makes the 4-inch LCD used in both the Sony and Panasonic models, introduced its own 4-inch carry-along with a full-size VHS recorder. Hitachi is offering a “laptop VCR” combining a VHS Hi-Fi recorder with a 5-inch LCD screen. JVC has shown a mini-modular model consisting of a tiny camera, a VHS-C deck, a tuner, and an LCD monitor that can be used in different combinations. Snapped together, the deck and camera comprise a miniature camcorder, while the tuner, deck, and screen make up a portable entertainment center.

Also getting smaller are 8mm camcorders. Using a compact new transport and a 4-layer circuit board, Sony has miniaturized a full-feature camcorder to the point where it weighs less than two pounds and fits easily in the palm, or even in

a coat pocket. Yet it has a 6:1 zoom lens and a variable-speed shutter.

● **The big game battle.** It would be different if it were only a game, but this one is for keeps. Nintendo, which has been responsible for the video-game resurgence and has at least 80% of the market, now finds its 8-bit game challenged by two more-advanced, 16-bit games. One is from its rival, Sega, and the other is a new entry by NEC. Both systems have more sophisticated graphics and are capable of playing more complex games. While the basic Nintendo game lists at about \$150 (and sells for somewhat less), the two newcomers will have tags of about \$200. The NEC game will even have a CD-ROM as an accessory—for an additional \$400. The big question is whether Nintendo is vulnerable, particularly from games whose price takes them out of the toy category. Just in case, Nintendo has a 16-bit game that it has already introduced in Japan but hasn't brought here yet.

Nintendo has another ace up its sleeve. At press time, it was negotiating with AT&T for a service interconnecting its video games with phone lines to provide stock-market reports, home-shopping services, and other communications functions. It already provides similar services in Japan, where its video game is called “Family Computer.”

● **Laserdisc on the brink?** Is the laserdisc family poised for a takeoff? It could be, with more than a half-dozen companies marketing players (most of which can also play CD's) and an ever-increasing number of discs available. Pioneer expects to sell 80,000 players in the second half of this year—three times the number it sold in the same period in 1988. Pioneer thinks that total player sales in the U.S. this year will be about 130,000 units, probably double last year's figure. Some 500,000 players and 12,000,000 discs were sold in Japan last year. Pioneer has doubled the capacity of its American disc-pressing plant in Carson, CA to 600,000 a month, and Sony is beginning to press laserdiscs at its Terre Haute, IN, compact-disc plant.

R-E

SELECT 5 BOOKS for only \$4⁹⁵

(values to \$108.70)

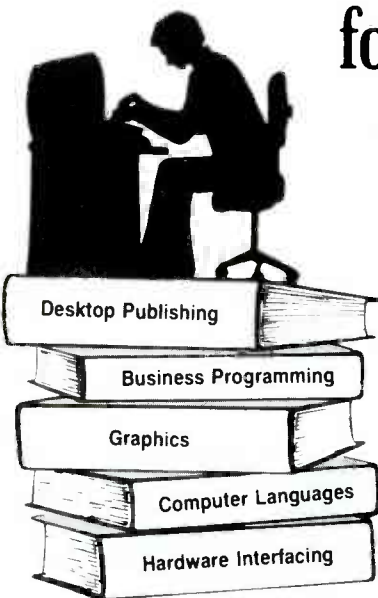

3122 \$27.95
Counts as 2

When it's new and important in business or personal computing, The Computer Book Club® has the information you need . . . at savings of up to 50% off publishers' prices!

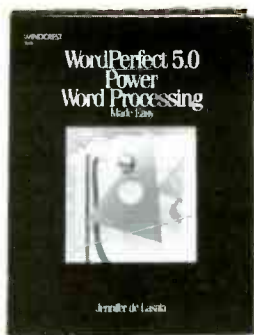

3249P \$24.95



2807P \$14.95



3032P \$12.95



3047 \$34.95
Counts as 2



3119P \$21.95



3146P \$17.95



3115 \$27.95
Counts as 2



2791P \$14.95



2856P \$18.95



2870 \$24.95



2879P \$22.95



2859P \$20.95

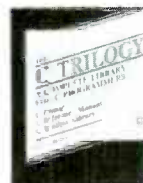

2890 \$34.95
Counts as 2



2968P \$19.95



2997 \$25.95



2767P \$21.95



3105 \$28.95
Counts as 2



3128P \$22.95
Counts as 2



3226P \$16.95



2809 \$27.95
Counts as 2



9168P \$22.95
Counts as 2



1752 \$18.95



2852P \$17.95



3049 \$36.95
Counts as 2



2913P \$15.95



2812P \$14.95

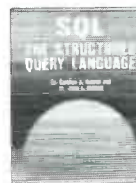

3016P \$17.95

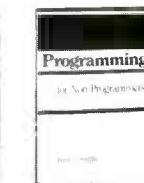

8226 \$29.95
Counts as 2

Membership Benefits • Big Savings. In addition to this introductory offer, you keep saving substantially with members' prices of up to 50% off the publishers' prices. • **Bonus Books.** Starting immediately, you will be eligible for our Bonus Book Plan, with savings of up to 80% off publishers' prices. • **Club News Bulletins.** 14 times per year you will receive the Book Club News, describing all the current selections—mains, alternates, extras—plus bonus offers and special sales, with scores of titles to choose from. • **Automatic Order.** If you want the Main Selection, do nothing and it will be sent to you automatically. If you prefer another selection, or no book at all, simply indicate your choice on the reply form provided. As a member, you agree to purchase at least 3 books within the next 2 years and may resign at any time thereafter. • **Ironclad No-Risk Guarantee.** If not satisfied with your books, return them within 10 days without obligation! • **Exceptional Quality.** All books are quality publishers' editions especially selected by our Editorial Board.



The Computer Book Club®
Blue Ridge Summit, PA 17294-0820

Please accept my membership in The Computer Book Club® and send the 5 volumes listed below, billing me \$4.95 plus shipping and handling charges. If not satisfied, I may return the books within ten days without obligation and have my membership cancelled. I agree to purchase at least 3 books at regular Club prices (plus shipping/handling) during the next 2 years and may resign any time thereafter.

Name _____
Address _____
City _____
State _____ Zip _____ Phone _____
Signature _____

Valid for new members only. Foreign applicants will receive special ordering instructions. Canada must remit in U.S. currency. This order subject to acceptance by The Computer Book Club® RPI/C989



2838 \$19.95



2841P \$15.95



3030P \$17.95



3084 \$29.95
Counts as 2



2817P \$14.95



3031P \$16.95

1989 THE COMPUTER BOOK CLUB®
Blue Ridge Summit, PA 17294-0820

CIRCLE 188 ON FREE INFORMATION CARD

ASK R-E

WRITE TO:

ASK R-E
Radio-Electronics
500-B Bi-County Blvd.
Farmingdale, NY 11735

640K REJECTION

I'm the proud owner of an IBM XT clone motherboard, but I'm having a problem with it. Everything is fine when I set it up with 256K of memory, but it will lock up whenever I try to put 640K on the board. After some extensive troubleshooting, I've determined that the problem is the bipolar PROM used to generate bit nine for the 256K RAM chips. I can't read the one I have, and nobody will sell a replacement PROM. Any ideas?—
C. Ellis, Tacoma, Washington

As a matter of fact, I have three ideas. The first is to replace the motherboard, the second is to replace the PROM, and the third is to simulate the action of the PROM with some discrete logic. Let's take those one at a time.

The easiest thing to do is just replace the motherboard. That's what most people would do but

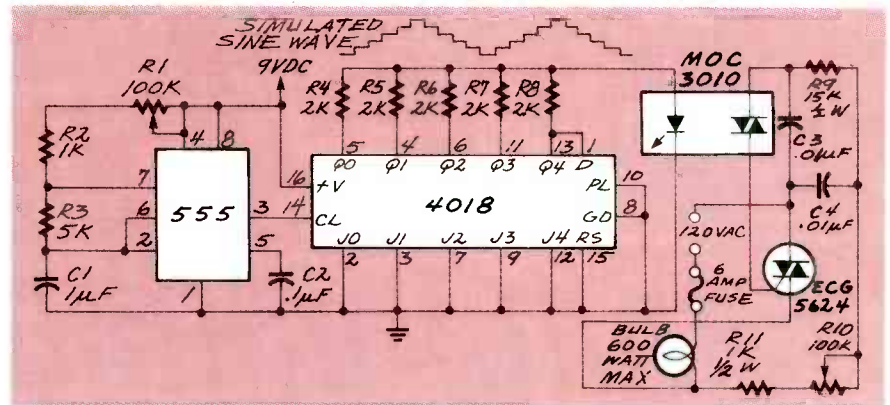

FIG. 2

it would rub me the wrong way to toss the motherboard away just because one chip is bad—call it a matter of principle. Even though the cost of an XT motherboard is a lot less than the cost of your time, the fact that you're writing for help indicates that you're also a man of principle. So option one goes out the window.

The right way to fix the board is to replace the PROM. And even though lots of companies in the USA are selling Taiwanese XT and AT computers, there are relatively few companies in Taiwan that actually etch the boards. Most computer companies buy the boards, stuff them with components, build them into computers, and put their name on the case. That means that there aren't that many different boards on the market, so there's a chance of finding a replacement PROM.

Every motherboard I've seen that can handle 640K uses a 74S287 256 × 4 bipolar PROM to map in the extra 384K of memory, and all the PROM's contain the listing in Fig. 1. If you can't burn PROM's yourself, check the advertisers in the back of this magazine; several of them have PROM-burning services.

The last alternative is to use some logic to generate the needed address lines. However, before you even *think* of taking on a job like that, you *must* have

Hex Dump of the 74S287 PROM that Creates Bit '9'

	0	1	2	3	4	5	6	7	8	9	A	B	C	D	E	F
00 -	00	02	04	06	01	03	05	07	09	0B	0D	0F	03	05	07	01
10 -	00	00	00	00	02	04	06	05	07	09	0B	0D	0F	07	09	0B
20 -	00	00	00	00	02	02	02	02	04	06	09	0B	0D	0F	0B	0D
30 -	00	00	00	00	02	02	02	02	04	04	0D	0F	0F	01	03	05
40 -	01	03	05	07	09	0B	0D	0F	01	03	05	0F	07	09	0D	0F
50 -	03	05	07	09	0B	0D	0F	01	03	05	0F	07	09	0D	0F	03
60 -	05	07	09	0B	0D	0F	01	03	05	0F	07	09	0D	0F	07	05
70 -	07	09	0B	0D	0F	01	03	05	0F	07	09	0D	0F	03	05	07
80 -	07	09	0B	0D	0F	01	03	05	0F	07	09	0D	0F	03	05	07
90 -	09	0B	0D	0F	01	03	05	0F	07	09	0D	0F	03	05	07	09
A0 -	0B	0D	0F	01	03	05	0F	07	09	0D	0F	03	05	07	09	0B
B0 -	0D	0F	01	03	05	0F	07	09	0D	0F	03	05	07	07	09	0B
C0 -	09	0B	0D	0F	01	03	05	0F	07	09	0D	0F	03	05	07	09
D0 -	0B	0D	0F	01	03	05	0F	07	09	0D	0F	03	05	07	09	0B
E0 -	0D	0F	01	03	05	0F	07	09	0D	0F	03	05	07	09	0B	0D
F0 -	0F	01	03	05	0F	07	09	0D	0F	03	05	07	07	09	0B	0D

FIG. 1

EXPAND YOUR CAREER HORIZONS...



The CIE Microprocessor Trainer helps you to learn how circuits with microprocessors function in computers.

START WITH CIE.

Microprocessor Technology. Satellite Communications. Robotics. Wherever you want to go in electronics... start first with CIE.

Why CIE? Because we're the leader in teaching electronics through independent study. Consider this. We teach over 25,000 students from all over the United States and in over 70 foreign countries. And we've been doing it for over 50 years, helping thousands of men and women get started in electronics careers.

We offer flexible training to meet your needs. You can start at the beginner level or, if you already know something about electronics, you may want to start at a higher level. But wherever you start, you can go as far as you like. You can even earn your Associate in Applied Science Degree in Electronics.

Let us get you started today. Just call toll-free 1-800-321-2155 (in Ohio, 1-800-362-2105) or mail in

CIRCLE 60 ON FREE INFORMATION CARD

the handy reply coupon or card below to:
Cleveland Institute of Electronics,
1776 East 17th Street, Cleveland, Ohio 44114.

CIE World Headquarters

Cleveland Institute of Electronics, Inc.
1776 East 17th Street • Cleveland, Ohio 44114

Please send your independent study catalog.

For your convenience, CIE will try to have a representative contact you — there is no obligation.

Print Name _____

Address _____ Apt. _____

City _____ State _____ Zip _____

Age _____ Area Code/Phone No. _____

Check box for G.I. Bill bulletin on Educational Benefits

Veteran Active Duty **MAIL TODAY!**

Just call toll-free 1-800-321-2155 (in Ohio, 1-800-362-2105)

ARE-140

When performance & price really count...



Reliability & Quality
From Start To Finished Product

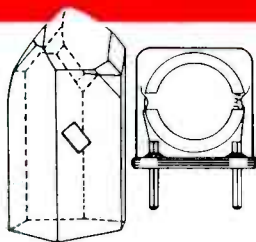

**QUARTZ
CRYSTALS/OSCILLATORS FOR
ELECTRONIC — INDUSTRIAL**

- Micro-Processor Control
- Computers/Modems
- Test/Measurement
- Medical

COMMUNICATIONS — REPLACEMENT

- Mobile/2-way/Channel Elements
- Pagers
- Marine
- Aircraft
- Telemetry
- Monitors/Scanners

AMATEURS

- CB
- Hobbies
- Experimenters

COST EFFECTIVE
MODERATE PRICING
FAST DELIVERY



Replacement Crystals Catalog

Custom Made Crystals Catalog

The Pulse of Dependable Communications

Crystek Crystals offers their new 16 page **FREE** catalog of crystals and oscillators. Offering state-of-the-art crystal components manufactured by the latest automated technology. Custom designed or "off the shelf." Crystek meets the need, worldwide. Write or call today!

CRYSTEK CORPORATION
DIVISION OF WHITEHALL CORPORATION

2351/2371 Crystal Dr. • Ft. Myers, FL 33907
P.O. Box 06135 • Ft. Myers, FL 33906-6135
TOLL FREE 1-800-237-3061
(813) 936-2109 — TWX 510-951-7448



CIRCLE 69 ON FREE INFORMATION CARD

an accurate schematic of the board. You indicated in your letter that you were including the board schematic, but it never got to me so there's really no way I can suggest a circuit for you. If you send me a copy of the schematic, I'll take a closer look at the problem.

ALTERNATE DIMMING

I'm looking for a special-effect lighting-control circuit. It has to alternately increase the brightness of one bulb while decreasing the brightness of another. I'm presently using two regular dimmers with small motors that physically rotate the shafts. Is there some easier way to do that electronically?—L. Hurst, New Orleans, Louisiana

From what you described in your letter, just about anything else would be easier, although nothing could be anywhere as straightforward. You can do the whole thing electronically, but the problem has to be broken down into a few parts.

In order to alternately dim and brighten a light bulb, a circuit has produce a low-frequency sine wave or other similar output waveform. If you use the sine-wave to control a light, as the voltage increases and decreases, the light bulb will get brighter and dimmer, and you'll want to be able to adjust the cycle time from about 1 to 10 seconds.

The circuit in Fig. 2 uses a 555 oscillator, and the potentiometer can vary the frequency from ten to one hundred Hz. We've multiplied the required frequencies by ten because we're using the 555 clock to control the 4018, which is a programmable counter set to divide by ten.

By summing the outputs of the 4018, and connecting the Q5 output to the Data input, the chip will produce a rising and falling staircase waveform at a frequency of one-tenth the 555's clock rate. It's a kind of make-believe sine wave. There's not enough room here to go into a complete description of the 4018, but a good data book will help you understand what the chip is doing.

The stepped output from the 4018 looks something like a cross

between a triangle wave with a flat top, and sine wave with steep sides. If you want a better approximation, you have to cascade 4018's to get more steps, and add filtering to smooth the output.

Since we're only controlling an incandescent bulb, however, the waveforms we're getting from the circuit are good enough. You can add more stages and filtering if you want, but first try the circuit as shown to see if you really need the extra stages.

The actual control of the bulb is being done by a standard light dimmer. You can either build the one shown or modify a store-bought one. Whichever you choose, remember that you're playing around with the AC line voltage, so be careful where you stick your fingers.

The varying voltage from the 4018 is directly driving the LED half of an MOC3010 optocoupler. The other half of the optocoupler is controlling the light dimmer's triac. As the 4018's output voltage increases, the incandescent bulb will get brighter, and as the 4018's output voltage decreases, the bulb will dim.

The circuit in Fig. 2 controls only one dimmer, but there are ways around that. You can invert the output of the 4018 and use it to drive a second optocoupler and dimmer or, if you want to be slick and sneaky about things, you can use a single light dimmer to do the whole job.

Remember that when the dimmer's triac turns off the bulb, you've got 120 volts across the dimmer. That means you can hang one bulb on the dimmer outputs, and a second one across the dimmer itself. That way, the brightness of the two bulbs will always be exactly out of phase with each other.

If you decide to use one dimmer to control both bulbs, make sure that both bulbs have the same wattage. The bulb sitting across the dimmer will be drawing its operating current through the filament of the first bulb, and nothing can cause more trouble than using the filament of a 60-watt bulb to supply current to a 500-watt flood light. **R-E**

HIGH PLACES



TIGHT SPACES

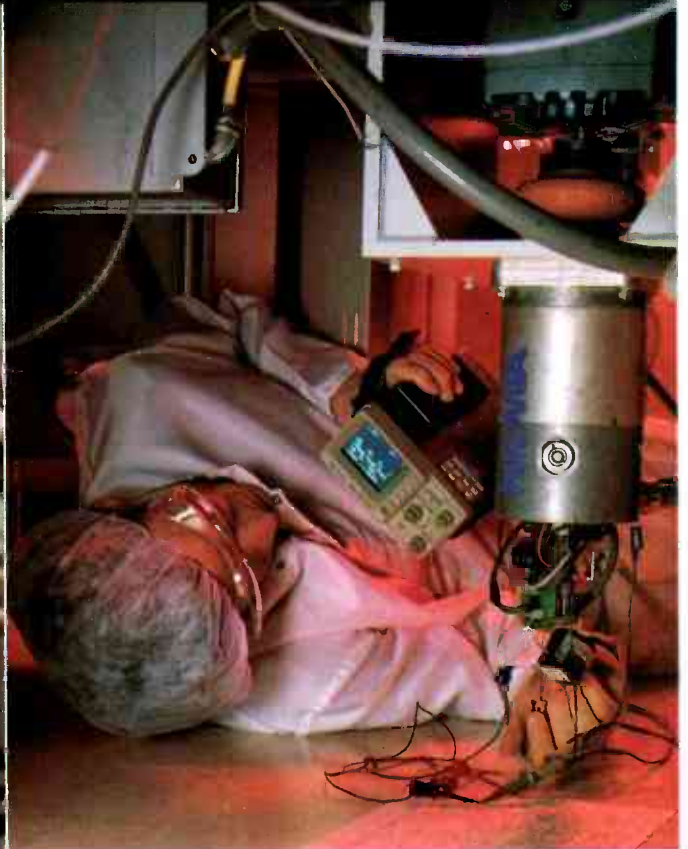

No matter where you go, Tek's new 222 is a perfect fit.

Introducing Tek's new 222 Digital Oscilloscope. Weighing in at under 4.5 pounds, the new Tek 222 is an ultra-portable, 10-MHz digital storage scope that's perfect for service applications. So tough, rugged, and totally self-contained, it can go just about anywhere. And it's incredibly easy to use—even in extreme conditions.

Extraordinary capability and reliability at a great price. The 222 is a dual-channel scope that can measure a wide variety of electronic instrumentation and circuitry. It has rechargeable on-board batteries with a floating ground to 400 volts, and meets tough environmental standards.

Plus, the 222 lets you pre-define front-panel setups, and call them up with a single button in the field. You can also save waveforms in the scope's memory, then transfer them to a PC for analysis and hard-copy output when you get back to the shop.

Best of all, the 222 is yours for only \$2350. And that includes Tek's remarkable three-year warranty on parts, labor, and CRT.

Get one to go! Pack a handful of power with you wherever you go. To order your 222, or for a free brochure, contact your local Tek representative or authorized distributor.

In a hurry? Call
1-800-426-2200.



Copyright © 1988, Tektronix Inc. All rights reserved.
Prices subject to change without notice.

CIRCLE 92 ON FREE INFORMATION CARD

Tektronix
COMMITTED TO EXCELLENCE

THH-911

LETTERS



ISDN QUESTIONS...

First, let me congratulate you. I consider **Radio-Electronics** to rank right at the top of publications available for experimenters. You're doing a great job.

I'd like to comment on the article "ISDN Prototyping Telephone" (**Radio-Electronics**, May and June 1989). I've been keenly interested in ISDN for many months now. In my mind, it may portend a revolution in the way that information is transmitted, affecting the very roots of our social, political, and educational systems. For those reasons, I recently tried to ascertain the status of ISDN with both AT&T and my local carrier, GTE. What I discovered was quite dismaying—the corporate giants are, once again, mounting a campaign of secrecy to maximize their future financial gain from a digital phone system.

It seems that some people just never learn their lesson. In the case of ISDN, AT&T has everything to gain, and nothing to lose, from public dissemination of the technology. Moreover, there is still no standardization of the NT1's—yet GTE has announced their intention to begin widespread marketing in 1991!

For those reasons I was most interested in the ISDN articles. I was somewhat disappointed, however, that it did not mention the video-data capabilities of ISDN (using either or both of the 64-Kbit channels), the D-channel potential for controlling or manipulating the signal level, and the structure and role of the NT1. Does the TE1 replace the NT1 in your application? Can the two 64-Kb channels be combined, using the D channel, to

yield an effective data-rate transmission of 128-Kb?

HOWARD BARNES
Longoc, CA

...AND ANSWERS

I understand your chagrin with "Corporate America," but I think that we must remember that they are in business to make money, not to produce engineering magic. When the users demand a product like ISDN, the vendors will respond. In my area, Southwestern Bell is aggressively marketing ISDN.

The Millcom Prototyping Telephone does need an NT1 before it is connected to an ISDN subscriber line, like any other TE1. We mentioned video capabilities twice in the article, but we didn't dwell on it. Nor did we go into much detail about how an ISDN network is engineered. We wanted to provide the readers—some of whom may be unfamiliar with the specifics of ISDN and telephone-company networking—with a general overview. There are publications that describe ISDN and baseband networks in greater detail (see **Radio-Electronics**, October 1988); we just felt that it was beyond the scope of our article.

William Stallings has written a book, *ISDN: An Introduction*, that I'm looking forward to reading. It's available from the Small Computer Book Club.

As far as I know, the multiplexing of the B and D channels is a function of the ISDN switching equipment and not under user control, if I understand your question correctly. Also, in some ISDN trials, I believe that they are using D-channel data to manipulate ana-

log devices, though that falls outside my area.

Several publications have described ISDN as a "cult" technology. I feel that because users have become technology-conscious after mastering the PC and LAN's, they don't immediately trust anything that's not as easily understood. It's our job to explain to those users that ISDN is simply a problem-solving tool for professional communications people to use—it's not a religion.

DOUG TOUSIGNANT
St. Peters, MO

PROPER TERMINOLOGY

I would appreciate it if your writers, especially those with scientific and technical backgrounds, would stop using the phrase "light-years ahead" incorrectly, as in the sentence: "Windows/386 is light-years ahead of Windows/286."

A light-year is a measure of *distance* (approximately 5.86×10^{12} miles)—not of time! Simply stating that one product is *years* ahead of another would convey the message correctly.

By the way, in the same article ("Put a 386SX Tiger in Your Tank," **Radio-Electronics**, June 1989), reducing the number of parts required in a standard AT design from 100 to 29 is a reduction by about $\frac{2}{3}$ and not $\frac{1}{3}$, as stated.
BUD DAMYANOVICH
Utica, MI

But, what the author meant to say is that it's miles ahead! (You're right about the $\frac{2}{3}$!)—Editor

ASK R-E CORRECTION

For anyone who is interested in the retriggerable monostable cir-

cuit that was in Fig. 1 of the June 1989 Ask R-E, take note of this correction. The direct connection between the transistor's emitter and +V should be removed. Doing so will prevent +V from shorting to ground when the transistor is turned on.—Editor

TO BE (OR NOT TO BE) CONTINUED

I am commenting on your editorial style in the hope that you will stop using a cheap marketing technique in favor of an approach that will better serve your readers, as well as your own long-term interests. I am referring to the method you use of having a "teaser" construction article that runs in several parts in subsequent issues. As a subscriber, I've had to wait as long as two months to get the full information on a kit or project. When I have to wait that long, I generally lose interest.

If you ever decide to start putting the whole project in a single issue, I might start subscribing again. I just wish that you'd stop revealing your projects a bit at a time, like a cheap stripper.

I realize that this letter could be more diplomatic, but the comments are honest and well intended. People do not pay for a product alone; they pay for satisfaction. As long as you satisfy—no tease—they'll pay.

JAMES GREENBERG
Carrollton, TX

We're sorry that you feel as you do, but please consider the alternatives. Radio-Electronics would have to (1) turn down any manuscript, no matter how interesting and well-presented, if it is too long to fit in a single issue; (2) print only projects that are simple enough to fit on three or four pages; or (3) print only one or two complex construction projects each issue. Obviously (1) and (2) are too intellectually limiting, and (3) would greatly reduce each reader's chance of finding a project that appealed to him. We feel we're offering a good compromise. Electronics is a complex, challenging, and rewarding hobby—even if it doesn't always offer immediate gratification! —Editor

TV-TRANSMITTING LEGALITIES

The article "Build This Amateur TV Transmitter" (*Radio-Electronics*, June and July 1989), was fine technically—but I must point out a few things about it.

The title should really tell the tale: The *only* valid use of the device is by a licensed Radio Amateur (ham) of Technician Class or higher. The article does say that is the case with the 2-watt version. However, it seems to suggest that if a person has such a license he

would be allowed to use the device for the purposes named both in the first paragraph of the article and/or those listed in the "Liability" paragraph on page 46 of the June issue. Part 97 of the FCC rules governing amateur radio specifically limit the nature of transmissions to non-commercial—in other words, not for profit or consideration of any kind.

In the article's first paragraph, seven possible uses are listed. The first, amateur TV transmitting, is

OPTOELECTRONICS



You Have Counted on Us for 15 Years

You have counted on OPTOELECTRONICS Hand Held Frequency Counters to be the best quality, to be affordable and reliable. We have been there for you with Frequency Counters that are compact and ultra sensitive.

And more and more of you are counting on us, technicians, engineers, law enforcement officers, private investigators, two-way radio operators, scanner hobbyists, and amateur radio operators, just to name a few.

Hand Held Series Frequency Counters and Instruments

MODEL	2210	1300H/A	2400H	CCA	CCB
RANGE: FROM TO	10 Hz 2.2 GHz	1 MHz 1.3 GHz	10 MHz 2.4 GHz	10 MHz 550 MHz	10 MHz 1.8 GHz
APPLICATIONS	General Purpose Audio-Microwave	RF	Microwave	Security	Security
PRICE	\$219	\$169	\$189	\$299	\$99
SENSITIVITY					
1 KHz	< 5 mv	NA	NA	NA	NA
100 MHz	< 3 mv	< 1 mv	< 3 mv	< .5 mv	< 5 mv
450 MHz	< 3 mv	< 5 mv	< 3 mv	< 1 mv	< 5 mv
850 MHz	< 3 mv	< 20 mv	< 5 mv	NA	< 5 mv
1.3 GHz	< 7 mv	< 100 mv	< 7 mv	NA	< 10 mv
2.2 GHz	< 30 mv	NA	< 30 mv	NA	< 30 mv

ACCURACY ALL HAVE +/- 1 PPM TCXO TIME BASE.

All counters have 8 digit red .28" LED displays. Aluminum cabinet is 3.9" H x 3.5" x 1". Internal Ni-Cad batteries provide 2-5 hour portable operation with continuous operation from AC line charger/power supply supplied. Model CCB uses a 9 volt alkaline battery. One year parts and labor guarantee. A full line of probes, antennas, and accessories is available. Orders to U.S. and Canada add 5% to total (\$2 min, \$10 max). Florida residents, add 6% sales tax. COD fee \$3. Foreign orders add 15%. MasterCard and VISA accepted.

Orders to U.S. and Canada add 5% to total (\$2 min, \$10 max). Florida residents, add 6% sales tax. COD fee \$3. Foreign orders add 15%. MasterCard and VISA accepted.

OPTOELECTRONICS INC.

5821 N.E. 14th Avenue • Fort Lauderdale, Florida 33334
1-800-327-5912 FL (305) 771-2050 FAX (305) 771-2052

CIRCLE 178 ON FREE INFORMATION CARD

legitimate. The second, video installations where cable hookups are not possible, is only OK for non-commercial purposes by a licensed ham. Number three, security and industrial work, is definitely not allowed. The regulations regarding the fourth use, simultaneous viewing of several remote TV receivers, are vague, but the ham-only rules apply, as they do for number five, remote sensing. The low-power version of the device might be useful as a modulator for a home-type MATV system for the sixth use, cable transmission—but one must be careful not to radiate any signal. The seventh suggested use, as a wireless VCR link, is another that's absolutely not allowed.

As for the uses listed in the "Liability" paragraph: The ham-only rule applies to educational purposes; for legitimate TV broadcasting, even low-powered TV stations have a minimum power output, and it's not 2 watts; and industrial and scientific purposes are forbidden. Amateur TV trans-

mitting is perfectly all right (for licensed hams, of course).

The article mentions the authors' February 1986 article about a wireless TV link. As I recall, one of the following issues contained a letter from the FCC reminding **Radio-Electronics** and your readers that this type of device is *not* allowed under FCC rules. That is still the case. Although Part 15 has recently undergone some changes, it specifically precludes the wireless VCR link use.

I must object to the Parts List for offering kits with crystals in the 430-MHz ham band while not making it clear that not just anyone can operate those for any purpose. Do you know if the supplier checks to see if those who order the kit are licensed radio amateurs? Many commercial radio dealers that sell amateur-radio equipment insist that purchasers be licensed. Crystals for operation on TV channels 14 and 15 are also offered—that is a definite no-no.

I am a long-time subscriber to **Radio-Electronics** and I really enjoy

the articles. I believe that the TV-transmitter article could encourage many technically oriented readers to study and obtain their Amateur Radio Licenses. It should have been presented in that light.
JOHN ANTONUK, AL7ID
Rhineland, WI

LESSONS LEARNED

I built the "Active Antenna" (**Radio-Electronics**, February 1989). It didn't work, so I sent it back to the author, Rodney Kreuter. He fixed it for *no charge!* I was very happy and surprised. He found that there were two poorly soldered joints, the FET was in wrong, and the battery was intermittent.
FRED B. KOLCHIN
Texarkana, TX

We're happy that Mr. Kreuter was able to help you. He certainly went beyond the call of duty. We hope you've learned something from the experience—not only about Rod Kreuter, but about proper soldering and construction techniques.—Editor R-E

BK PRECISION



Test
Instrument
SALE!

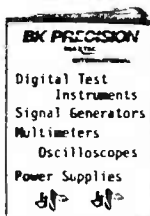

FREE CATALOG

MODEL 2120

Oscilloscope, 20MHz,
Dual Trace
Reg. \$549.00 SALE Call for Quote

MODEL 1541A

Oscilloscope, 40MHz,
Dual Trace
Reg. \$845.00 SALE \$598.00
FREE FREIGHT!!

MODEL 2160

Oscilloscope, 60MHz, Dual-
Trace, with Delayed Sweep
Reg. \$1045.00 SALE \$836.95

MODEL 560

Programmable In/Out-
of Circuit IC Tester
Reg. \$3500.00 SALE \$2940.95
FREE AK560 SOFTWARE!!

MODEL CP-1

Clamp-On AC Current
Probe
Reg. \$65.00 SALE \$29.95



MODEL 388-HD
Test Bench
Reg. \$139.00
SALE \$106.95



Products International Inc.
8931 Brookville Rd
Silver Spring, MD 20910 U.S.A.
(800) 638-2020 (301) 587-7824

EASY ORDER FAX LINE
(800) 545-0058

Complete B & K Line Available.
"Call for your Price Quotations"

CIRCLE 186 ON FREE INFORMATION CARD

CABLE - TV band - stop filters

- FOR ELIMINATION OF SEVERE INTERFERENCE
- FOR "CENSORING" OF ADULT BROADCASTS

NEW ADDRESS
↓



- ATTENUATION - 45 dB TYPICAL
- BANDWIDTH - 4 MHz AT 5 dB POINTS
- INSERTION LOSS - 2 dB

MODEL	TUNING RANGE	FOR CHANNELS	PASSBAND	PRICE	SHIPPING/HANDLING
23H	50-66 MHz	2,3 (or 6 meter ham)	50-300 MHz	\$30	FREE
46FM	66-108 MHz	4,5,6 (or any FM)	50-300 MHz	\$30	FREE
1417	120-144 MHz	14(A) 15(B) 16(C) 17(D)	50-400 MHz	\$30	FREE
1822	144-174 MHz	18(E) 19(F) 20(G) 21(H) 22(I)	50-400 MHz	\$30	FREE
713	174-216 MHz	7,8,9,10,11,12,13	50-400 MHz	\$30	FREE

3 for \$72 - 10 for \$180 - mix & match

Call Toll Free For C.O.D. or Send Check To Order
No Shipping Charges

- Shipped Within 3 Days
- 30 Day Money Back Guarantee

FACTORY DIRECT FROM

Star Circuits

P.O. Box 94917
Las Vegas, NV 89193-4917

1-800-433-6319



Now Testing Is Seven Times Easier.

1. End Blown Fuses.

The new 200 Series multimeter is protected from excess voltage or surges with a self-resetting fuse.

2. Keep Your Eyes On Your Work.

Quickly probe a circuit board listening for audible tone changes that pinpoint the problem without glancing at the LCD.

3. Detect Intermittents.

Hear a distinctive crackling sound when an intermittent occurs.

4. Find Dead Capacitors.

Capacitor voltage build-up or

bleed-off is heard loud and clear with the 200 Series' Audible Readout.

5. Find Logic Stuck-Ats.

Using standard leads, a fast Logic Pulse Detector lets you easily detect pulses down to 50ns.

6. Adjust Voltage Levels.

When adjusting audio or video response, an audible tone that changes pitch as measured signals increase or decrease permits faster and easier adjustments.

7. Stop Third Hand Problem.

Tilt stand and Skyhook™ auto-ranging,

and Audible Readout allow you to spend less time fiddling with your meter.

FEATURES	222	223
Audible Readout		•
Logic Pulse Detector		•
Fast Auto-Ranging	•	•
Self-Resetting Fuse	•	•
Auto-off Battery Saver	•	•
DC Voltage Accuracy	0.5%	0.25%
Warranty	2 years	2 years
Price	\$129.00	\$149.00

The 200 Series. Multimeters that take the work out of work. Call or write for complete information. 1-800-227-9781 Inside California. 1-800-854-2708 Outside California.

**30 DAY
MONEY BACK
GUARANTEE**

Beckman Industrial™

An Affiliate of Emerson Electric Co.

Instrumentation Products Division
3883 Ruffin Road, San Diego, CA 92123-1898
(619) 495-3200 • FAX (619) 268-0172 • TLX 249031

CIRCLE 98 ON FREE INFORMATION CARD

© 1989 Beckman Industrial Corporation
Specifications subject to change without notice.

Join the Electronics and Control Engineers' Book Club®

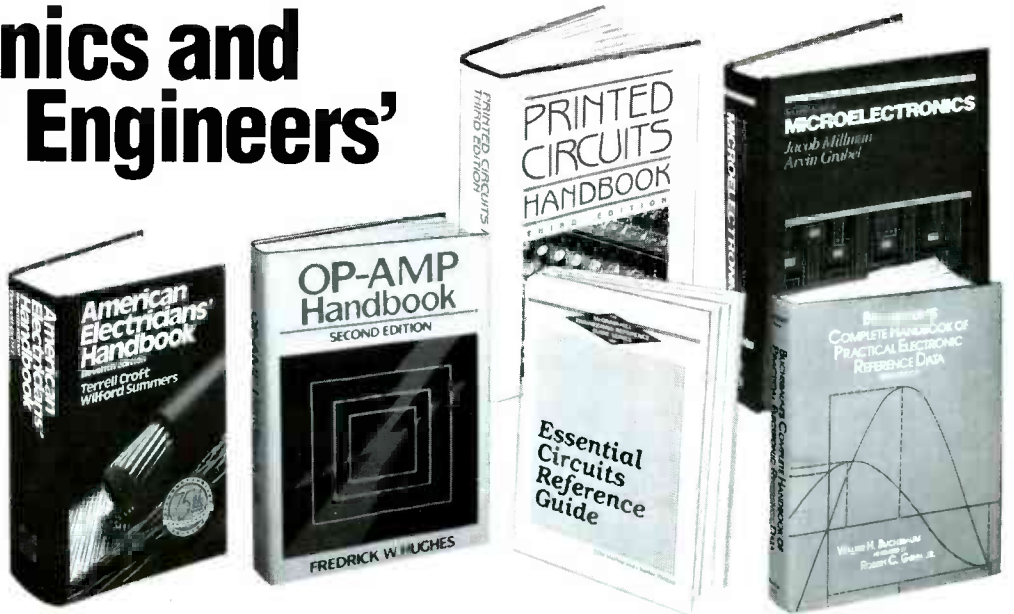

BUCHSBAUM'S COMPLETE HANDBOOK OF PRACTICAL ELECTRONIC REFERENCE DATA, Third Ed. By W.H. Buchsbaum, revised by R.C. Genn, Jr. 635 pp., 357 illus. & tables. This best-selling reference is invaluable for engineers whose work involves going outside their own area of expertise. Coverage includes digital logic; optoelectronics; antennas and transmission lines; RF and microwave fundamentals; communications systems; television systems; computers; radio; recording; and more. 583880-X Pub. Pr., \$34.95 Club Pr. \$26.50

PRINTED CIRCUITS HANDBOOK, Third Edition. By C.F. Coombs, Jr. 960 pp., 556 illus. Here in one handy volume is all the information you need to design, manufacture, test, and repair printed wiring boards and assemblies. This new edition features ten all-new chapters, including three on SMT. 126/097 Pub. Pr., \$63.50 Club Pr., \$45.50

32-BIT MICROPROCESSORS. Edited by H. J. Mitchell, 248 pp., 104 illus. and tables. A complete survey of the architecture, operation, and applications of today's most important new devices from AT&T, Imros, Intel, and Motorola. 425/85X Pub. Pr., \$48.50 Club Pr., \$35.00

MICROWAVE AMPLIFIERS AND OSCILLATORS. By C. Gentili. 150 pp., 79 illus. A thorough, practical introduction to the theory and design of microwave amplifiers and oscillators, with coverage of the scattering matrix, the gallium arsenide field-effect transistor, and microstrip technology. 229/953 Pub. Pr., \$39.95 Club Pr., \$27.95

COMMUNICATIONS RECEIVERS: Principles and Design. By Ulrich L. Rohde and T.T.N. Bucher, 608 pp., 402 illus. Everything you need to know if you design or work with communications receivers, from theory to practical design approaches. Coverage includes all types of receivers, shortwave, broadcast, radar, military, marine, aeronautical, and more. 535/701 Pub. Pr., \$62.50 Club Pr., \$44.50

- your one source for engineering books from over 100 different publishers
- the latest and best information in your field
- discounts of up to 40% off publishers' list prices

New Members!
Take any one of these great professional books for only **\$289** as a premium with your first selection!

Spectacular values up to **\$99.90**

ENGINEERING FUNDAMENTALS FOR THE PROFESSIONAL ENGINEERS' EXAM, Third Ed. By L. M. Polentz, 432 pp., 170 illus. Features worked-out solutions and full explanations for all sample problems so you can learn how to solve them. It's a dependable way to prepare for the exam or a perfect on-the-job reference. 503/931 Pub. Pr., \$39.50 Club Pr., \$27.95

AUTOMATIC CONTROL SYSTEMS, Fifth Ed. By B. C. Kuo. 736 pp., illus. Provides an overview of automatic control systems, including in-depth coverage of classical control techniques, optimal control theory, and analog and digital control system design. This up-dated edition discusses the latest ideas on the use of computers to design control systems and as components of such systems. 583706-4 Pub. Pr., \$51.00 Club Pr., \$36.95

OP-AMP HANDBOOK, Second Ed. By F. W. Hughes. 320 pp., 231 illus. Organized for on-the-job reference, this handbook covers all facets of op-amps, from stability and protection to signal processing using op-amps. Includes a collection of over 60 practical circuits for a variety of applications, procedures, and experiments. 583651-3 Pub. Pr., \$39.00 Club Pr., \$27.50

HANDBOOK FOR SOUND ENGINEERS: The New Audio Cyclopaedia. Edited by G. Ballou. 1,247 pp., over 1,200 illus. This giant handbook gives you truly comprehensive coverage of sound — and the methods of producing, reproducing, controlling, changing, reinforcing, and measuring it. 583913-X Pub. Pr., \$79.95 Club Pr., \$55.95

ESSENTIAL CIRCUITS REFERENCE GUIDE. By J. Markus & C. Weston. 528 pp., illus. Collects into one convenient volume more than 1,000 ready-to-use circuit diagrams for today's electronics applications. Now you can have the circuit you need in a matter of seconds — without having to reinvent the wheel. 404/623 Pub. Pr., \$59.50 Club Pr., \$47.50

CIRCUIT DESIGN FOR ELECTRONIC INSTRUMENTATION: Analog and Digital Devices from Sensor to Display, Second Ed. By D. Wobtschall. 400 pp., 365 illus. Brings you the entire process of circuit design in a comprehensive, easy-to-follow format. This new edition reflects the latest in IC technology, including CMOS and ECL devices. 712/31X Pub. Pr., \$49.50 Club Pr., \$36.95

AMERICAN ELECTRICIANS' HANDBOOK, Eleventh Ed. By T. Croft and W. Summers. 1,824 pp., 1,560 illus. This newly updated handbook shows you how to select, install, maintain, and operate all the latest electrical equipment and wiring. It includes the most recent code requirements, basic formulas, and a wealth of circuit diagrams and illustrations. 139/326 Pub. Pr., \$69.50 Club Pr., \$49.50

MICROELECTRONICS, Second Ed. By J. Millman and A. Grabel. 1,001 pp., 646 illus. Takes you from the basics of semiconductor properties to an understanding of the operation of solid-state devices, and then to more advanced topics. Its up-to-date coverage, real-life examples, and practical data make this an ideal reference for the working engineer. 423/30X Pub. Pr., \$53.95 Club Pr., \$41.50

ENGINEERING MATHEMATICS HANDBOOK, Third Ed. By J. J. Tuma. 512 pp., illus. This best-selling handbook gives you the essential mathematical tools—formulas, definitions, theorems, tables, and models for computer programming — that you need for your day-to-day engineering calculations. 654/433 Pub. Pr., \$49.50 Club Pr., \$34.50

ELECTRONICS SOURCEBOOK FOR TECHNICIANS AND ENGINEERS
592 pp., 800 illus., softbound 335/591
This condensed, paperback version of the Handbook for Electronics Engineering Technicians is the perfect on-the-job reference for all electronics professionals. From fully worked-out examples, explanations, tables, and graphs ... through up-to-date coverage of active filters, microwaves, and fiber optics ... to using the full spectrum of technical equipment, the Sourcebook is the single most convenient professional electronics reference available.

A \$24.95 Value—Yours ABSOLUTELY FREE when you join!

BASIC TELEVISION AND VIDEO SYSTEMS, Fifth Ed. By B. Grob. 592 pp., illus. Provides the clearest picture of how television and video systems work, and what to do when they don't. Covers television receivers, VCR's, video cameras, and cable systems — all in readable, practical detail.

249/334 Pub. Pr., \$35.95 Club Pr., \$24.95

ANALOG ELECTRONIC CIRCUITS. By G. M. Glasford. 480 pp., 350 illus. Gives you the detailed information and equations you need to create and analyze top quality circuit designs or effectively utilize the designs of others.

583768-4 Pub. Pr., \$55.00 Club Pr., \$39.50

HANDBOOK OF ELECTRONIC NOISE MEASUREMENT AND TECHNOLOGY, Second Ed. By C. A. Vergers. 440 pp., 213 illus. Provides answers to all your questions about noise origins, causes, effects. Also shows you how to predict and measure noise, and how to design low-noise circuits.

583947-4 Pub. Pr., \$39.95 Club Pr., \$29.95

SWITCHGEAR AND CONTROL HANDBOOK, Second Ed. Edited by R. W. Smeaton. 1,056 pp., 789 illus. The only handbook that treats all aspects of switchgear control, including design, applications, safety, and maintenance. Updated to reflect the changes brought about by the use of computers, solid-state devices, and programmable controls.

584/494 Pub. Pr., \$79.50 Club Pr., \$56.95

ANTENNA APPLICATIONS REFERENCE GUIDE. Edited by R. C. Johnson and H. Jasik. 496 pp., 368 illus. and tables. Covers the major applications of antenna technology in all areas of communications and their design methods. Emphasizes important new applications such as earth station, satellite, seeker, aircraft, and microwave-relay antennas.

322/848 Pub. Pr., \$56.95 Club Pr., \$42.50

RADIO HANDBOOK, Twenty-Third Ed. Edited by W. I. Orr. 667 pp., 1,073 illus. and tables. The latest edition of the most complete, current resource on radio technology and its applications. Expert contributors show you how to select, design, build, test and operate all kinds of equipment.

584638-1 Pub. Pr., \$29.95 Club Pr., \$23.95

BOB MIDDLETON'S HANDBOOK OF ELECTRONIC TIME-SAVERS AND SHORTCUTS. By R. G. Middleton. 378 pp., illus., softbound. Packed with little-known tricks of the trade and brand-new techniques, this popular handbook makes it easier than ever to troubleshoot radio, TV, audio equipment, CCTV, and more.

583865-6 Pub. Pr., \$29.95 Club Pr., \$22.50

Be sure to consider these important titles as well!

INTRODUCTION TO RADAR SYSTEMS, Second Ed. By M. I. Skolnik. 579/891 Pub. Pr., \$54.95 Club Pr., \$42.50

ELECTRONIC TEST EQUIPMENT: Principles and Applications. By T. J. Byers. 095/221 Pub. Pr., \$44.95 Club Pr., \$29.95

OPERATIONAL AMPLIFIERS AND LINEAR INTEGRATED CIRCUITS, Third Ed. By R. F. Coughlin and F. F. Driscoll. 583754-4 Pub. Pr., \$40.00 Club Pr., \$25.95

McGraw-Hill's NATIONAL ELECTRICAL CODE HANDBOOK, 19th Ed. By J. F. McPartland. 457/077 Pub. Pr., \$46.50 Club Pr., \$31.95

HANDBOOK OF ELECTRONICS CALCULATIONS FOR ENGINEERS AND TECHNICIANS, Second Ed. Edited by M. Kaufman & A. H. Seidman. 335/281 Pub. Pr., \$49.50 Club Pr., \$37.50

PROBABILITY, SIGNALS, NOISE. By J. Dupraz. 183/309 Pub. Pr., \$49.95 Club Pr., \$34.95

POWER GENERATION CALCULATIONS REFERENCE GUIDE. By T. G. Hicks. 288/003 Pub. Pr., \$41.00 Club Pr., \$27.50

HUMAN FACTORS REFERENCE GUIDE FOR ELECTRONICS AND COMPUTER PROFESSIONALS. By W. E. Woodson. 717/664 Pub. Pr., \$39.95 Club Pr., \$29.50

REFERENCE DATA FOR ENGINEERS: Radio, Electronics, Computer, and Communications, Seventh Ed. Edited by E. C. Jordan. 583619-X Pub. Pr., \$69.95 Club Pr., \$49.95

THE LASER GUIDEBOOK. By J. Hecht. 277/338 Pub. Pr., \$55.95 Club Pr., \$41.50



FOR FASTER SERVICE IN ENROLLING CALL TOLL-FREE 1-800-2-MCGRAW

MAIL THIS COUPON TODAY

**McGraw-Hill Book Clubs
Electronics and Control Engineers'
Book Club®**

P.O. Box 582, Hightstown, NJ 08520-9959

Please enroll me as a member and send me the two books indicated, plus the ELECTRONICS SOURCEBOOK FOR TECHNICIANS AND ENGINEERS. I am to receive one book for just \$2.89, the other at the discounted member's price, plus local tax, shipping and handling charges. I agree to purchase a minimum of one additional book during my first year of membership as outlined under the Club plan described in this ad. I understand that a shipping and handling charge is added to all shipments.

Your FREE Sourcebook	
335/591	
Write Code No. of the \$2.89 selection here	Write Code No. for the First selection here
<input type="text"/>	<input type="text"/>

Signature _____

Name _____

Address/Apt. # _____

City _____

State _____ Zip _____

This order subject to acceptance by McGraw-Hill. All prices subject to change without notice. Offer good only to new members. Foreign member acceptance subject to special conditions.

E34085

Here's how the Club works to serve YOU:

■ IMPORTANT INFORMATION ... WE MAKE IT EASY TO GET!

In our rapidly changing world, those who perform best are those who are best informed. Designed exclusively for the practicing engineer, the Electronics and Control Engineers' Book Club provides you with information that is relevant, reliable, and specific enough to meet your needs. Each Club bulletin comes your way 14-16 times a year and offers you more than 30 books to choose from — the best and newest books from all publishers!

■ DEPENDABLE SERVICE ... WE'RE HERE TO HELP!

Whether you want information about a book or have a question about your membership, our qualified staff is here to help. Just call us toll-free or write to our Customer Service. We also make sure you get only the books you want. All you do is simply tell us your choice on the Reply Card and return it to us by the specified date. If you want the Main Selection, do nothing — it will be sent to you automatically. (A small shipping and handling charge is added to each shipment.)

■ CLUB CONVENIENCE ... WE DO THE WORK!

Beyond the benefit of timely information, Club membership offers many other benefits. For example, you get a wide choice of books that cannot be matched by any bookstore — anywhere. And all your books are conveniently delivered right to your door. You also get the luxury of 10 full days to decide whether you want the Main Selection. If you should ever receive a Main Selection you don't want because the Club bulletin came late, just return it for credit at our expense.

■ SUBSTANTIAL SAVINGS ... AND A BONUS PROGRAM TOO!

In keeping with our goal to provide you with the best information at the greatest possible savings, you will enjoy substantial discounts — up to 40%! — on every book you buy. Plus, you're automatically eligible for our Bonus Book Plan which allows you savings up to 70% on a wide selection of books.

■ EASY MEMBERSHIP TERMS ... IT'S WORTHWHILE TO BELONG!

Your only obligation is to purchase one more book — at a handsome discount — during the next 12 months, after which you enjoy the benefits of membership with no further obligation. Either you or the Club may cancel membership anytime thereafter.

EQUIPMENT REPORTS

Elenco XK-220 Digital Trainer

The Elenco XK-220 Digital Trainer is the logical choice for your logic designs.

CIRCLE 45 ON FREE INFORMATION CARD



DESIGNING DIGITAL CIRCUITS ON PAPER is always pretty easy; getting the circuits to work in real life is another story. But when you use the right tools for the job, you can at least minimize the hassles. The *XK-220 Digital Trainer* from Elenco Electronics (150 W. Carpenter Avenue, Wheeling, IL 60090) is the right tool to use for developing digital circuits. It provides you with many convenient features, such as +5-, +12-, and -12-volt DC power supplies; three clock outputs at 1 Hz, 1 kHz, and 100 kHz; eight LED logic indicators; eight data switches; two no-bounce logic switches; a 590-pin breadboard; and 100-pin function-output breadboard.

The *XK-220* is especially good for students, because it is available assembled or as kit, which includes everything you need to complete the unit, including solder. The *XK-220* should be affordable even for people on a budget; the kit costs \$110.00, and the assembled version costs \$150.00.

The *XK-220* comes with a well-written assembly/operating manual, with step-by-step assembly instructions to guide you through the project. It also thoroughly

covers testing and troubleshooting, and includes a complete schematic. It goes a long way to ensure your getting the trainer to work properly. Unfortunately, the manual makes no mention of what to do once you've completed the trainer. We think that a couple of sample experiments would have been appropriate.

Specifications

The *XK-220* is powered by an AC transformer, so there's no need for any batteries, and an on/off switch is provided on the control panel. All of the *XK-220's* circuitry is contained on two PC boards, one for the power supply and one for the rest of the circuitry. Both are silk-screened for easy parts placement. The +5-volt DC power supply can provide half an amp, and the +12- and -12-volt supplies can deliver 150 mA—all three power supplies are fuse protected.

Eight single-pole double-throw data switches are provided, each with one end connected to +5 and one end connected to ground. And while data switches are fine for permanently holding a line high or low, the problem with ordinary switches is that, when

they are activated, their contacts have a tendency to bounce (they open and close several times before coming to rest). Of course, you could never visually see the bounce in, say, an LED's output, but a high-speed digital circuit sees each bounce as a separate throw of the switch. Therefore, no-bounce circuitry is provided for the two logic switches to provide single-pulse inputs for counting circuits and the like. The no-bounce circuitry is made up of NAND gates arranged as flip-flops, allowing only the first change at its input to appear at its output.

A 555-timer circuit generates the three output clock pulses, 1 Hz, 1 kHz, and 100 kHz. A 60-Hz pulse derived from the AC line voltage is available as well. All clock pulses are 5-volt peak-to-peak square waves. Eight LED logic indicators are provided, so that you can monitor the logic state of inputs, outputs, and whatever else you like. They are set up to turn on when their input is over 2.8 volts.

A 2-pin by 50-pin breadboard provides the outputs for each of the *XK-220's* functions—+5, +12, -12, the clock, etc; each function has 5 connecting pins. A 590-pin breadboard is provided for wiring your own digital circuits. It will accommodate up to eight 14-pin IC's at once, with plenty of room for external components. The sturdy steel control panel is completely labelled, and housed inside a rugged plastic case. Space is provided for storing the linecord.

The *XK-220* allows you to simply "pop" IC's in and out of a circuit, to help you quickly develop an understanding of how digital circuits work, and with the kit you can also develop assembly skills as well. The Elenco *XK-220* Digital Trainer kit may just be the perfect project for an electronic's student, but anyone involved in electronics would find it to be useful. **R-E**

WITH CIE, THE WORLD OF ELECTRONICS CAN BE YOUR WORLD, TOO.

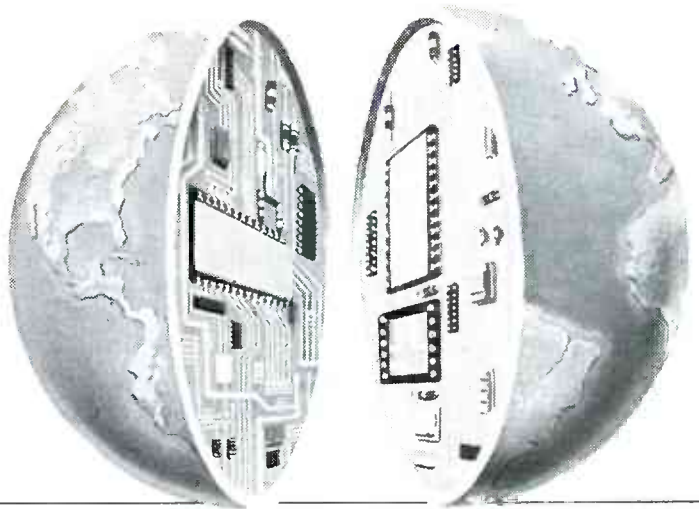

Look at the world as it was 20 years ago and as it is today. Now, try to name another field that's grown faster in those 20 years than electronics. Everywhere you look, you'll find electronics in action. In industry, aerospace, business, medicine, science, government, communications—you name it. And as high technology grows, electronics will grow. Which means few other fields, if any, offer more career opportunities, more job security, more room for advancement—if you have the right skills.

SPECIALISTS NEED SPECIALIZED TRAINING.

It stands to reason that you learn anything best from a specialist, and CIE is the largest independent home study school specializing exclusively in electronics, with a record that speaks for itself. According to a recent survey, 92% of CIE graduates are employed in electronics or a closely related field. When you're investing your time and money, you deserve results like that.

INDEPENDENT STUDY BACKED BY PERSONAL ATTENTION.

We believe in independent study because it puts you in a classroom of one. So you can study where and when you want. At your pace, no somebody else's. And with over 50 years of experience, we've developed proven programs to give you the support

such study demands. Programs that give you the theory you need backed with practical experience using some of the most sophisticated electronics tools available anywhere, including our Microprocessor Training Laboratory with 4K of random access memory. Of course, if you ever have a question or problem, our instructors are only a phone call away.



START WHERE YOU WANT, GO AS FAR AS YOU WANT.

CIE's broad range of entry, intermediate, and advanced level courses in a variety of career areas gives you many options. Start with the Career Course that best suits your talents and interests and go as far as you want—all the way, if you wish, to your Associate in Applied Science Degree in Electronics Engineering Technology. But wherever you start, the time to start is **now**. Simply use the coupon below to send for your FREE CIE catalog and complete package of career information. Or phone us, toll-free, at 1-800-321-2155 (in Ohio, 1-800-523-9109). Don't wait, ask for your free catalog now. After all, there's a whole world of electronics out there waiting for you.

CIE

Cleveland Institute of Electronics, Inc.
1776 East 17th Street, Cleveland, Ohio 44114

Member NHSC
Accredited Member National Home Study Council

CIE **Cleveland Institute of Electronics, Inc.**
1776 East 17th Street, Cleveland, Ohio 44114

ARE-141

YES... I want to learn from the specialists in electronics—CIE. Please send me my FREE CIE school catalog, including details about CIE's Associate Degree program, plus my FREE package of home study information.

Name (print): _____

Address: _____

City: _____ State: _____ Zip: _____

Age: _____ Area Code/Phone No.: _____ / _____

Check box for G.I. Bill bulletin on educational benefits:

Veteran Active Duty

**MAIL
TODAY!**

CIRCLE 60 ON FREE INFORMATION CARD

www.americanradiohistory.com

**NEW
SUPER
LONG PLAY
TAPE RECORDERS**

12 Hour Model — \$119.00*
USES D-120 TAPE

Modified Panasonic Slimline, high quality, AC-DC Recorders provide 6 continuous hours of quality recording & playback on each side of cassette for a total of 12 hours.
Built-in features include:
• Voice level control • Digital counter, etc. TDK DC 120 Cassette Furnished.

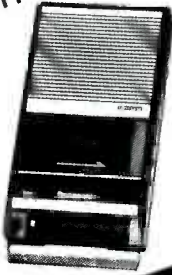

PHONE RECORDING ADAPTER

Records calls automatically. All Solid state connects to your telephone jack and tape recorder. Starts recording when phone is lifted. Stops when you hang up.



VOX VOICE ACTIVATED CONTROL SWITCH

Solid state. Self contained. Adjustable sensitivity. Voices or other sounds automatically activate and control recorder. Uses either recorder or remote mike.



*Add for ship & hdg. Phone Adapter & Vox \$1.50 ea. Recorders \$4.00 ea. Cal. Res. add tax. Mail order, VISA, M/C, COD's OK. Money Back Guarantee. Qty. disc. avail., Dealer Inquiries invited. Free data.
AMC SALES INC. Dept A9335 Lubec St., Box 928, Downey, CA 90241 Phone (213) 869-8519

CIRCLE 108 ON FREE INFORMATION CARD

**ATTENTION!
ELECTRONICS
TECHNICIANS**

EARN YOUR
**B.S.E.E.
DEGREE**



THROUGH HOME STUDY

Our New and Highly Effective Advanced-Placement Program for experienced Electronic Technicians grants credit for previous Schooling and Professional Experience, and can greatly reduce the time required to complete Program and reach graduation. No residence schooling required for qualified Electronic Technicians. Through this Special Program you can pull all of the loose ends of your electronics background together and earn your B.S.E.E. Degree. Upgrade your status and pay to the Engineering Level. Advance Rapidly! Many finish in 12 months or less. Students and graduates in all 50 States and throughout the World. Established Over 40 Years! Write for free Descriptive Literature.

**COOK'S INSTITUTE
OF ELECTRONICS ENGINEERING**



4251 CYPRESS DRIVE
JACKSON, MISSISSIPPI 39212

CIRCLE 58 ON FREE INFORMATION CARD

**Sibex FG-1 Handheld
Function Generator**

*A miniature function
generator that's truly
pocket-sized!*



CIRCLE 44 ON FREE INFORMATION CARD

ONE OF THE DISADVANTAGES OF HAVING a well-stocked test bench is that you can't take it with you—on a service call, that is. But like other electronic gear, test equipment is getting smaller all the time. A good case in point is the FG-1 function generator from Sibex, Inc. (1040 Harbor Lake Drive, Safety Harbor, FL 34695).

The FG-1 is a handheld function generator that is powered by a 9-volt alkaline battery. It's certainly not a replacement for a bench-top generator. But then again, a full-sized function generator can't fit in your shirt pocket like the FG-1 can.

The FG-1 offers three waveform outputs: sine, triangle, and square waves. The output frequency is variable from 1 Hz to 1 MHz over six decade ranges, and a maximum distortion of .5% THD is claimed by Sibex.

The entire unit is housed in a

plastic trapezoidal case that measures roughly 3.5 x 2 x 1 inches. The front panel features 4 controls: a power switch, a sine/square/triangle selector, a range switch, and a continuously variable control to adjust the output frequency within each range. The output of the FG-1 is made available at two 5-way binding posts at the top of the case. The output waveforms are 5 volts peak-to-peak.

The heart of the FG-1 is an Exar 2206 function-generator IC. That, coupled with well-designed packaging, keeps the size to a minimum. Four internal PC-mounted potentiometers are available for calibration of the output level, symmetry, and distortion. (See Fig. 1)

The only feature we didn't like about the FG-1 was its power switch. That miniature toggle switch is sure to get turned on when the FG-1 is tossed into a tool box. A pushbutton switch would be better.

The FG-1 unquestionably doesn't offer any new technology, and its range of functions is quite limited. Yet we were impressed by how useful such a simple generator could be—especially when it's compared to a full-featured generator that is sitting behind on a test bench when you're out on a service call. The FG-1 also makes sense for a student or a hobbyist who is unsure of what features are really important for the first-time function-generator purchase. With a suggested retail price of \$96.95, the FG-1 should find a home in a lot of shirt pockets. R-E



FIG. 1

NEW PRODUCTS

CONDUCTIVE PEN. *Planned Products' Circuit Works Pen* makes applying solderable electronic traces to most surfaces as easy as writing with a normal pen. The pen "writes" in a highly conductive silver ink, providing a low-cost and easy means of making solderable terminations and traces for applications such as making and repairing PC boards, electromagnetic shielding, and conductive point-to-point traces.

The Circuit Works Pen has a valved tip that allows the smooth application of the liquid-silver conductor. The pen tip opens under normal writing pressure, and the liquid conductor flows easily. The spring-loaded tip closes to prevent drying when not in use. Traces as narrow as $\frac{1}{16}$ -inch can be drawn with the pen, which comes filled with enough silver conductor to make 150 feet of conductive



CIRCLE 10 ON FREE INFORMATION CARD

traces. The polymer ink—which is many times more conductive than solder, with resistivity in the .03-.05-ohms-sq/mil range—dries in minutes at room temperature.

Solderable terminations can be made using a 250°F cure for 15 to 20 minutes after application. Tin, lead, or silver solder can be used,

but should not exceed 350°F for more than 5 seconds. Hand soldering is possible, but not recommended; wave soldering is preferred.

The Circuit Works Pen costs \$9.95 (plus \$1.00 postage and handling; \$2.00 outside the US).—**Planned Products**, 21105 Santa Cruz Hwy., Los Gatos, CA 95030; Tel. 408-353-4251.

The TeleServicing package simplifies the troubleshooting of obscure or difficult signals. It enables users to build libraries of reference information for archival purposes, for documenting performance characteristics of the equipment being serviced, and for comparing known-to-be-good waveforms to on-site waveforms.

In its "babysitting" mode, the package can be used for remote monitoring of equipment during normal operation in distant, hazardous, or hard-to-reach sites, or for monitoring intermittent failures.

The TeleServicing Software Package (*S49-TSS1*) requires a Tektronix 2230 portable digital storage oscilloscope with RS-232-C interface; an IBM PC, XT, AT, or compatible personal computer; and a Hayes-compatible modem. It has a suggested price of \$295.00.—**Tektronix**, P.O. Box 1700, Beaverton, OR 97075; Tel. 1-800-426-2200.

TELESERVICING SOFTWARE PACKAGE. The *Tektronix TeleServicing Software Package* incorporates three teleservicing functions—data communications, data management, and waveform graphics. Designed for use in field service, remote monitoring, and data-logging applications, the package links, via modem, a Tektronix 2230 portable Digital Storage Oscilloscope (DSO) with an IBM PC, XT, AT, or compatible.

Standard telephone lines and an RS-232-C interface are used to transfer information between the DSO and a PC, or between two DSO's. The package fea-



CIRCLE 11 ON FREE INFORMATION CARD

tures windows and pop-up menus for easy access to a variety of functions. It has a phone directory that stores 20 user-programmable automatic-dialing entries. For data communications, the

software can quickly configure PC communication ports, initialize modems, and direct data to and from the remote digital scope. Data management functions include file capture, storage, and retrieval; i.e., waveform data can be retrieved from a remote DSO, displayed or stored to disk on the computer, or transferred to a local DSO for additional analysis. By adding a compatible graphics card to the PC, waveforms can be plotted on screen and printed either graphically or numerically. Users can also add titles and descriptions to the waveforms for subsequent recall.

SWEEP/FUNCTION GENERATOR. *B&K-Precision's Model 3026* sweep/function generator is a 0.5-Hz to 5-MHz signal source with the added versatility of a built-in frequency counter. Its features include internal or external AM modulation; variable DC-offset; internal or external gated-burst operation; three calibrated steps; and variable attenuators.

The multifunction instrument offers fully variable sweep width and rate, and a sweep-ramp output for oscilloscope sync. The sine-wave, square-wave, and triangle-wave outputs are available with normal or inverted polarity selection



CIRCLE 12 ON FREE INFORMATION CARD

and variable duty-cycle control. The 3026 can also generate ramp and pulse signals. A separate TTL output provides the proper output level without set-up adjustments. The 5-digit LED display can be used to indicate output frequency or to measure external signals to 10 MHz. Four selectable gating times are available in the external-counter mode.

The model 3026 sweep/function generator has a suggested user price of \$595.00.—**B&K-Precision**, Mextec International Corp., 6470 West Cortland St., Chicago, IL 60635.

AC-CURRENT TESTER. The *Volt Stick* from **MBD International** provides immediate, safe, non-intrusive testing for the presence of 110 to 480 volts AC. The pocket-sized device can distinguish between live and neutral wires without coming into contact with the wire or its insulation, and no current flow is required.

The *Volt Stick*—which can be used to detect single- and three-phase circuitry, and return loops—works by detecting the E-field created by the 60-Hz cycle in alternating current. When the device's plastic tip is within 1/8-inch of the wire insulation, it will glow bright red to indicate the presence of 110 to 480 volts AC. It will not glow if no voltage is present. Warm-up and response time is instantaneous.



CIRCLE 13 ON FREE INFORMATION CARD

The tester is about the size of a Magic Marker, and weighs less than 2 ounces including the batteries that come with it. It can be used to quickly locate breaks in cables, defective in-series light bulbs, and blown fuses inside plugs or fuse boxes. It can identify voltage-carrying cables in junction boxes, or faulty switches in-line. The device can also be used to check circuit breakers, outlets, power tools, and appliances.

The *Volt Stick*, which carries a lifetime guarantee, has a suggested list price of \$24.98.—**MBD International Inc.**, P.O. Box 870596, Dallas, TX 75287-0596.

DIGITAL MULTIMETER A.W. Sperry's DM-4000A is an economical 3½-digit multimeter designed for hobbyists as well as engineers and technicians. The portable unit fits in a shirt pocket, and has 150-hour battery life. It has overload protection and a large, easy-to-



CIRCLE 14 ON FREE INFORMATION CARD

read LCD. The *DM-4000A* offers 6 functions—including DC volts, AC volts, DC amps, Ohms, diode check, and a continuity buzzer—on 19 ranges.

The *DM-4000A* digital multimeter has a suggested retail price of \$44.95.—**A.W. Sperry Instruments Inc.**, 245 Marcus Boulevard, Hauppauge, NY 11788.

DUAL-BAND RADIO. **Kenwood's** model *TM-701A* FM dual-band amateur radio produces 25 watts on 2 meters and 70 centimeters. It has 20 memory channels,

selectable full-duplex operation, and a bright amber LCD display.

The radio provides extended frequency coverage on 2 meters, receives from 136–174 MHz, and can be modified to pick up MARS and CAP. (Permits are required for modification information.) The *TM-701A* comes with a DTMF/control-function microphone. Besides the standard DTMF for autopatch use, the microphone can control call channel, VFO, memory recall, and one user-programmable function key, and it can be used to change



CIRCLE 15 ON FREE INFORMATION CARD

memory channels. The radio offers adjustable frequency step selection of 5, 10, 12.5, 15, 20, and 25 kHz, and multi-mode scanning with carrier- or time-operated stop. It has dual digital VFO's and a built-in CTCSS tone encoder. (An optional *TSU-6* enables tone decoding.)

The *TM-701A* dual bander has a suggested retail price of \$599.95.—**Kenwood U.S.A. Corporation**, Communications & Test Equipment Group, 2201 East Dominguez Street, Long Beach, CA 90810.

AUTORANGING DMM. The **Elenco M-5000** is a handheld, 3½-digit autoranging multimeter that's designed for one-hand operation. It provides all VOM functions, plus Hi-Low ohms, diode check, 10-amp AC/DC current ranges, audible continuity check, and 1/2% basic accuracy. The device also has a data-hold feature to manually freeze the display, memory to compensate for test leads or to make relative measurements, and manual or autoranging operation.



CIRCLE 16 ON FREE INFORMATION CARD

The *M-5000* digital multimeter, complete with manual, test leads, and battery has a suggested retail price of \$69.95.—**Elenco Electronics, Inc.**, 150 West Carpenter Avenue, Wheeling, IL 60090.

2-IN-1 CAMCORDER LENS. **Ambico's Auto Flip** (model *V-0365*) lens lets you get 0.6× wide-angle and 1.5× telephoto shots from your camcorder without changing lenses. In one setting, the Auto Flip creates a shot that is approximately 60% broader than a camcorder's normal wide-angle field of view. By pulling out the lens



CIRCLE 17 ON FREE INFORMATION CARD

barrel slightly and rotating it until the lens is "flipped" around in the opposite direction, it instantaneously converts to a 50% longer telephoto zoom lens. The lens contains four multi-coated glass elements. It has a 3-inch diameter and is 1½-inches deep, and weighs just 6 ounces.

The *V-0365* Auto-Flip 2-in-1 camcorder lens has a suggested retail price of \$109.95.—**Ambico, Inc.**, 50 Maple Street, Norwood, NJ 07648.

NEW LIT

RF DATA MANUAL. Motorola's *RF Products Data Manual (DL110/D)* is a 2-volume set that has been expanded to include an additional 280 devices and 23 application notes. Volume 1 features discrete transistors, and Volume 2 in-



cludes amplifiers, diodes, and application literature. The comprehensive reference contains a total of 63 application notes and engineering bulletins. The *RF Products Data Manual* costs \$11.60.—**Motorola Inc.**, Literature Distribution Center, P.O. Box 20924, Phoenix, AZ 85063.

AMATEUR-RADIO CATALOG. The 16-page brochure from *MFJ Enterprises* features more than 80 amateur-radio accessories. Included among them are popular antenna tuners, the *MFJ-1278* multi-mode data controller, the *MFJ-931* artificial RF ground, and several new products. The catalog also describes MFJ's full line of keyers, filters, packet-radio controllers, computer interfaces, dummy loads, ham software, antenna switches, code-practice oscillators, wattmeters, clocks, and other useful accessories. The *MFJ 1989 Catalog* is free upon request.—

MFJ ENTERPRISES, INC. 1989 CATALOG

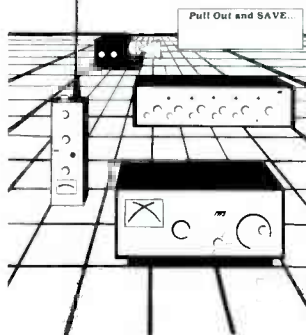

CIRCLE 18 ON FREE INFORMATION CARD

MFJ Enterprises Inc., 921 Louisville Road, Starkville, MS 39759; Call toll free 1-800-647-1800.

DMM SELECTOR GUIDE. *Beckman's HD150 Series Heavy-Duty Digital Multimeter Guide* describes their new line of 3½-digit, heavy-duty, autorangeing DMM's. Models *HD151*, *HD152*, and *HD153* are exceptionally rugged instruments, and each carries a 5-year warranty against outside con-

tamination as well as Beckman's 2-year warranty. There is no charge for the brochure.—**Beckman Industrial**



CIRCLE 19 ON FREE INFORMATION CARD

Beckman Industrial Corporation, Instrumentation Products Division, 3883 Ruffin Road, San Diego, CA 92123-1898.

With Just One Probe Connection, You Can Confidently Analyze Any Waveform To 100 MHz, 10 Times Faster, 10 Times More Accurately, Absolutely Error Free, Guaranteed — Or Your Money Back!

SC61 Waveform Analyzer™
Patented
\$3295

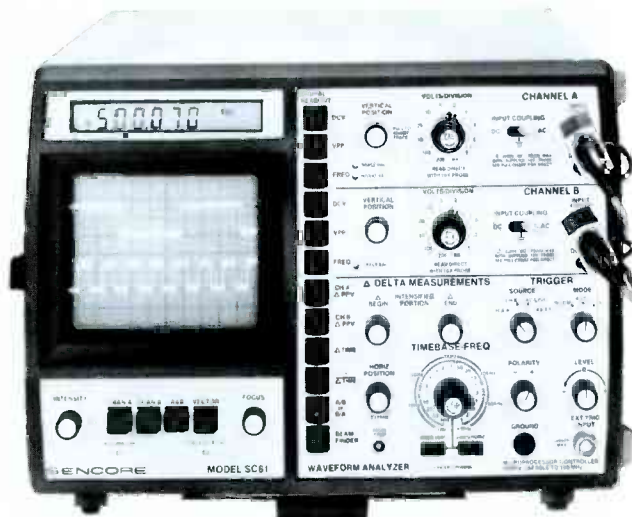

There are other digital readout oscilloscopes, but none of them completely eliminate graticule counting and calculations like the SC61 Waveform Analyzer. The innovative, time-saving AUTO-TRACKING™ digital readout automatically gives you every waveform parameter you need for fast troubleshooting.

The SC61 Waveform Analyzer is a triple patented high performance scope that provides you with a digital LCD read-out of all key waveform parameters (DC volts, peak-to-peak volts, and frequency) at the push of a button, and all with one probe connection.

Other time-saving features include exclusive ECL sync circuits that allow you to lock quickly onto waveforms up to 100 MHz. Plus, with 3000 volts of input protection, you never have to worry about an expensive front end repair job.

Call **1-800-843-3338** to find out more about what the SC61 can do for your service business. In Canada call **1-800-851-8866**.

SENCORE

3200 Sencore Drive, Sioux Falls, SD 57107

100% American Made

CIRCLE 177 ON FREE INFORMATION CARD

Learn to troubleshoot and service today's computer systems as you build a fully XT-compatible micro, complete with 512K RAM and powerful 20 meg hard drive

Train the NRI Way— and Earn Good Money Servicing Any Brand of Computer

Jobs for computer service technicians will almost double in the next 10 years according to Department of Labor statistics, making computer service one of the top 10 growth fields in the nation.

Now you can cash in on this exciting opportunity— either as a full-time industry technician or in a computer service business of your own—once you've mastered electronics and computers the NRI way.

NRI's practical combination of "reason-why" theory and hands-on building skills starts you with the fundamentals of electronics, then guides you through more sophisticated circuitry all the way up to the latest advances in computer technology. You even learn to program in BASIC and machine language, the essential language for troubleshooting and repair.

Train With a Powerful XT-Compatible — Now With 20 Meg Hard Drive!

To give you hands-on training with the absolute in state-of-the-art computer



You build this powerful Packard Bell VX88 computer, all the while gaining a true mastery of computer electronics. Best of all, it's yours to keep for all your professional and personal computing needs.



technology, NRI includes the powerful new Packard Bell VX88 computer as the centerpiece of your training. As you assemble this fully IBM XT-compatible micro from the keyboard up, you actually see for yourself how every section of your computer works.

You assemble and test your computer's "intelligent" keyboard, install the power supply and 5 1/4" disk drive, then interface the high-resolution monitor. But that's not all.

Your hands-on training continues as you install a powerful 20 megabyte hard disk drive—today's most-wanted computer peripheral—now included in your course to dramatically increase

Your NRI computer training includes all this: • NRI's unique Discovery Lab® for circuit design and diagnosis • NRI's hand-held digital multimeter featuring "talk-you-through" instructions on audio cassette • A digital logic probe that lets you visually examine computer circuits • The new Packard Bell VX88 computer with "intelligent" keyboard, 360K double-sided, double-density disk drive, 512K RAM, 16K ROM • 20 megabyte hard disk drive • Bundled software including MS-DOS, GW-BASIC, word processing, spreadsheet, and database programs • Packard Bell reference manuals with programming guidelines and schematics.

NEW!

Includes 20 meg Hard Drive

throughout your training, you've got the full support of your personal NRI instructor and the NRI technical staff, always ready to answer your

questions and help you whenever you need it.

FREE 100-Page Catalog Tells More

Send today for NRI's big, 100-page, full-color catalog that describes every aspect of NRI's innovative computer training, as well as hands-on training in robotics, video/audio servicing, electronic music technology, security electronics, data communications, and other growing high-tech career fields. If the coupon is missing, write to: NRI School of Electronics, McGraw-Hill Continuing Education Center, 4401 Connecticut Avenue, NW, Washington, DC 20008.

NRI School of Electronics

McGraw-Hill Continuing Education Center
4401 Connecticut Avenue, NW
Washington, DC 20008

IBM is a registered trademark of International Business Machines Corporation



the data storage capacity of your computer while giving you lightning-quick data access. Plus you work with exclusive word processing, database, and spreadsheet software, yours to use for your own professional and personal applications.

As you build your computer, performing key demonstrations and experiments at each stage of assembly, you get the confidence-building, real-world experience you need to work with, troubleshoot, and service today's most widely used computer systems.

service. You learn at your own convenience in your own home.

No classroom pressures, no night school, no need to quit your present job until you're ready to make your move. And all

No Experience Needed, NRI Builds It In

Name _____
Address _____
City _____
Accredited _____

SEND TODAY FOR FREE CATALOG!

NRI

McGraw-Hill Continuing Education Center
4401 Connecticut Avenue, NW, Washington, DC 20008

For Career courses approved under GI Bill
 check for details.

- CHECK ONE FREE CATALOG ONLY**
- Computer Electronics
 - TV/Video/Audio Servicing
 - Robotics
 - Electronic Music Technology
 - Security Electronics
 - Digital Electronics Servicing
 - Electronic Design Technology
 - Industrial Electronics
 - Communications Electronics
 - Basic Electronics
 - Bookkeeping and Accounting
 - Building Construction
 - Automotive Servicing
 - Air Conditioning, Heating & Refrigeration
 - Small Engine Repair
 - Electrician
 - Locksmithing & Electronic Security
 - Travel Careers
 - Computer Programming
 - Paralegal

Name (Please print) _____ Age _____
Street _____
City/State/Zip _____ We'll give you tomorrow. Accredited by the National Home Study Council 3-099

SEPTEMBER 1989

Radio-Electronics mini-ADS



NEW TOOLS & TEST INSTRUMENT SUPPLEMENT to the Contact East General Catalog is now available at no charge. It contains hundreds of products for engineers, hobbyists, and technicians involved in testing, repairing and assembling electronic equipment. Products include: oscilloscopes, static protection products, soldering supplies and stations, test equipment, hand tools and tool kits shown in full color, with prices and specs. **CONTACT EAST, 335 Willow St. So., North Andover, MA 01845 (508) 682-2000.**

CIRCLE 55 ON FREE INFORMATION CARD

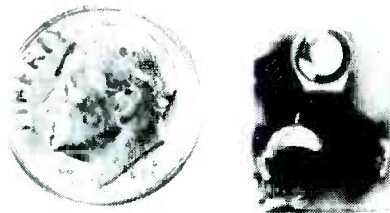

THE MODEL WTT-20 IS ONLY THE SIZE OF A DIME, yet transmits both sides of a telephone conversation to any FM radio with crystal clarity. Telephone line powered - never needs a battery! Up to 1/4 mile range. Adjustable from 70-130 MHZ. Complete kit **\$29.95 + \$1.50 S + H**. Free Shipping on 2 or more! COD add \$4. Call or send VISA, MC, MO. **DECO INDUSTRIES, Box 607, Bedford Hills, NY 10507. (914) 232-3878.**

CIRCLE 127 ON FREE INFORMATION CARD



GET YOUR RECHARGE CATALOG FREE...EARN BIG \$\$ IN YOUR SPARE TIME—All supplies and Do-It-Yourself kits with complete instructions available. Supplies cost from **\$9.95** in qty and you can sell recharged toner cartridges for **\$40.00** to **\$55.00** each. Printers include HP LaserJet and Series II, Apple LaserWriter, QMS, etc. Canon PC-25 Copier also. **CHENESKO PRODUCTS, 62 N Coleman Rd., Centereach, NY 11720, 516-736-7977, 800-221-3516, Fax: 516-732-4650**

CIRCLE 179 ON FREE INFORMATION CARD

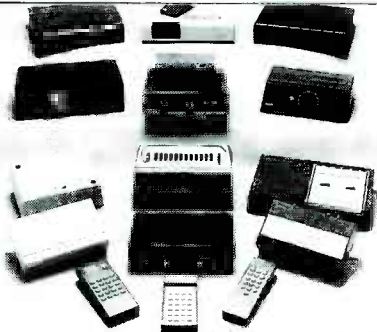

CABLE TV CONVERTERS AND DE-SCRAMBLERS SB-3 **\$79.00** TRI-BI **\$95.00** MLD **\$85.00** M35B **\$89.00** JRX-DIC **\$129.00** Special combos available. We ship COD. Quantity discounts. Call for pricing on other products. Dealers wanted. **FREE CATALOG.** We stand behind our products where others fail. One year warranty. **ACE PRODUCTS, P.O. Box 582, Saco, ME 04072 (207) 967-0726.**

CIRCLE 75 ON FREE INFORMATION CARD



APPLIANCE REPAIR HANDBOOKS—13 volumes by service experts; easy-to-understand diagrams, illustrations. For major appliances (air conditioners, refrigerators, washers, dryers, microwaves, etc.), elec. housewares, personal-care appliances. Basics of solid state, setting up shop, test instruments. **\$2.65 to \$7.90** each. Free brochure. **APPLIANCE SERVICE, P.O. Box 789, Lombard, IL 60148. (312) 932-9550.**

CIRCLE 84 ON FREE INFORMATION CARD

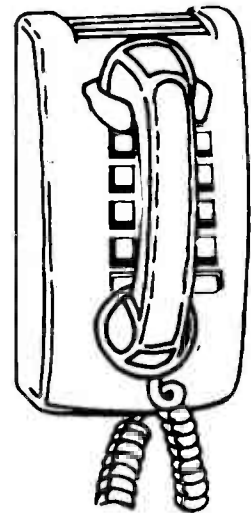

CALL NOW AND RESERVE YOUR SPACE

- 6 x rate \$890.00 per each insertion.
- Fast reader service cycle.
- Short lead time for the placement of ads.
- We typeset and layout the ad at no additional charge.

Call **516-293-3000** to reserve space. Ask for Arline Fishman. Limited number of pages available. Mail materials to: mini-ADS, RADIO-ELECTRONICS, 500-B Bi-County Blvd., Farmingdale, NY 11735.



FREE CATALOG OF HARD-TO-FIND TOOLS is packed with more than 2000 quality items. Your single source for precision tools used by electronic technicians, engineers, instrument mechanics, schools, laboratories and government agencies. Also contains Jensen's line of more than 40 tool kits. Send for your free copy today! **JENSEN TOOLS INC., 7815 46th St., Phoenix, AZ 85044. (602) 968-6231.**

CIRCLE 115 ON FREE INFORMATION CARD

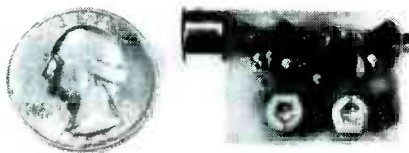

SIMPLY SNAP THE WAT-50 MINIATURE FM TRANSMITTER on top of a 9v battery and hear every sound in an entire house up to 1 mile away! Adjustable from 70-130 MHZ. Use with any FM radio. Complete kit **\$29.95 + \$1.50 S + H**. Free shipping on 2 or more! COD add \$4. Call or send VISA, MC, MO. **DECO INDUSTRIES, Box 607, Bedford Hills, NY 10507. (914) 232-3878.**

CIRCLE 127 ON FREE INFORMATION CARD

BUILD THIS

SPECTRUM MONITOR

WE HAVE ALL, AT ONE TIME OR ANOTHER, needed some of the capabilities that a spectrum analyzer offers. Unfortunately, sophisticated analyzers can cost more than a new car! So most of us have managed to live without the benefits that those instruments offer. After all, a meter, oscilloscope, frequency counter, and RF probe can actually give quite a bit of information about a signal environment. But none of those instruments can depict the total spectral content clearly and unambiguously, and give you information on modulation or spurs.

The solution is the spectrum monitor presented here. It doesn't have the frequency or amplitude resolution of a professional version, but it costs only around \$200, and you'll be able to view the 20-600 MHz range and compare relative levels.

The spectrum monitor has two operating modes; you can use it to either visually display an amplitude spectrum on an oscilloscope, or as a receiver to help identify FM signals.

Spectrum analyzer theory

The function of a spectrum analyzer is to tune across a controlled frequency range and display RF amplitude versus frequency on a CRT. Frequency increases from left to right (the +x-direction), while amplitude increases from bottom to top (the +y-direction). The signal being analyzed is applied to the vertical amplifier of an oscilloscope, and the horizontal amplifier is driven by a linear ramp like a triangle or sawtooth.

The simplest spectrum analyzer requires an oscilloscope and two sine/square/triangle function generators, connected as shown in Fig. 1. The oscilloscope time base is set for external sweep, and the scope's horizontal input is grounded. The beam is positioned at the bottom center of graticule, which will be the origin.

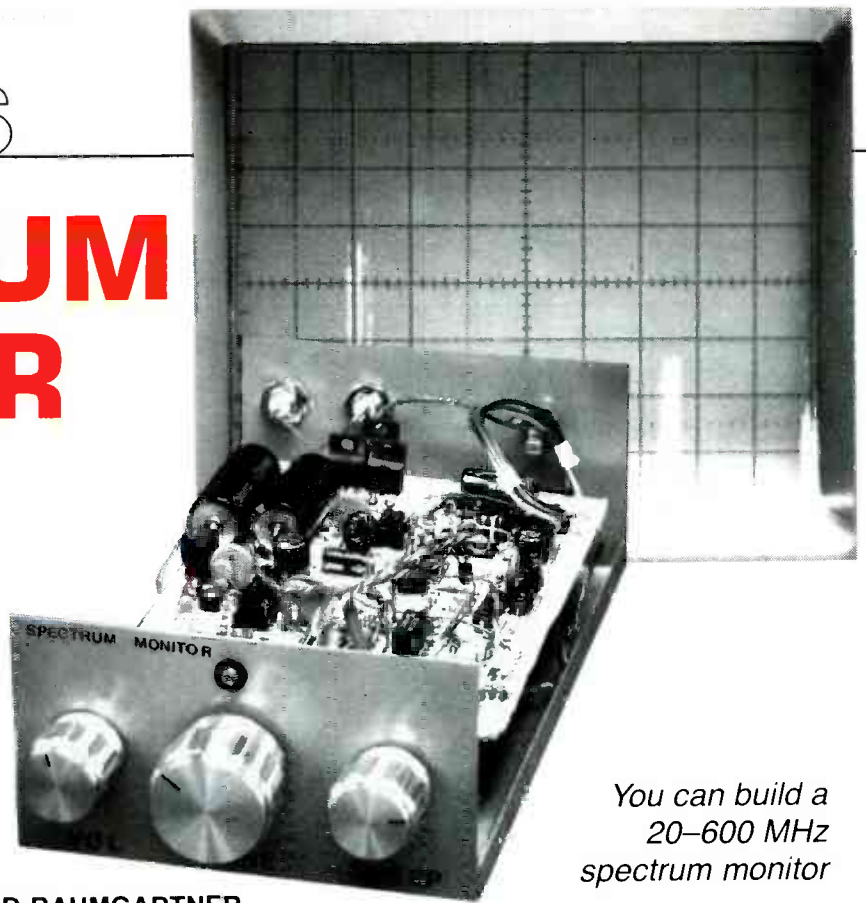

*You can build a
20-600 MHz
spectrum monitor*

FRED BAUMGARTNER

If V_1 , the output of the first function generator, is a 1-kHz triangle wave applied to the FM input of the second function generator, and if V_2 is a 10-kHz sine wave, then V_2 would be an FM sinusoid. Varying the frequency of V_1 varies the rate of change about the carrier frequency, and varying the amplitude of V_1 varies the deviation from that center frequency, or the modulation index. However, while the FM waveform is needed to generate a spectrum, it isn't the spectrum itself.

If the 1-kHz triangle wave is ap-

plied to the horizontal oscilloscope inputs, the CRT beam will sweep out a horizontal line along the x-axis of the graticule. Varying the amplitude of V_1 controls the length of the line on the oscilloscope screen. By making the frequency of V_1 high enough and experimenting with its amplitude, you can make the beam occupy the whole length of the bottom of the graticule, and make its retrace completely invisible.

Now take any audio filter or amplifier, a piece of stereo equipment, for example. If you apply V_2 to this filter

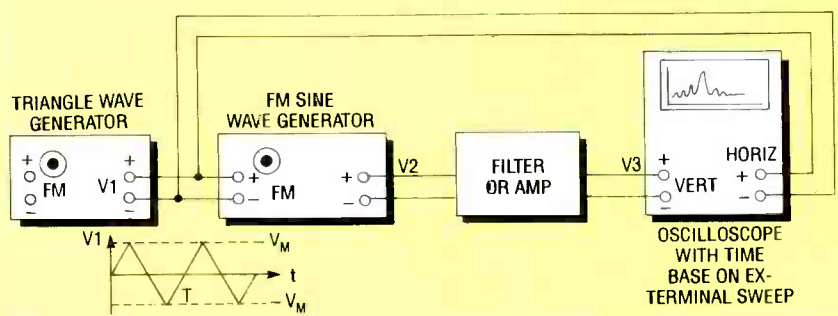

FIG. 1—BASIC SPECTRUM ANALYZER. The first function generator produces a linear ramp waveform (either a triangle or a sawtooth) V_1 . That is applied to the FM input of the second function generator to produce an FM sinusoid, V_2 , which is applied to the inputs of a filter or amplifier. The output, V_3 , is applied to the vertical amplifier of an oscilloscope, the time base of which is set to external sweep. The ramp V_1 is applied to the horizontal amplifier, and the amplitude spectrum appears on the CRT.

ZENITH SX SERIES 17S-2292A TUNER/CONVERTER

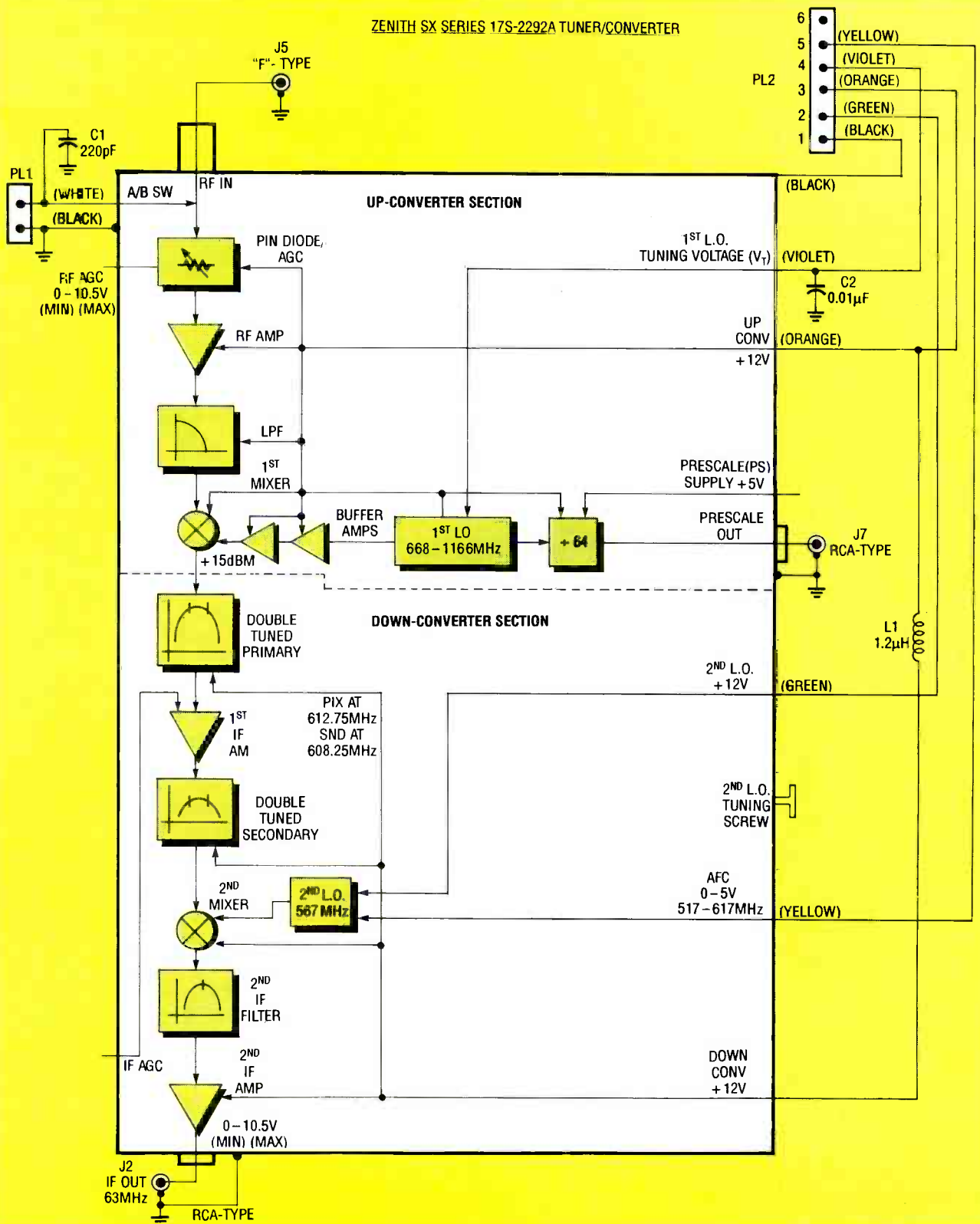

FIG. 2—TUNER/CONVERTER BLOCK DIAGRAM. The Zenith SX Series 17S-2292A tuner/converter is the heart of the project. It accepts RF signals from about 55–553 MHz and downconverts them to a standard 63-MHz constant-level IF.

or amplifier, and apply the filter or amplifier's output V_3 to the oscilloscope's vertical amplifier, you should see some smooth continuous

curve with valleys and plateaus in its shape. That is the amplitude frequency-response of the filter or amplifier, a visual depiction of the amplitude of

the FM signal coming out as a function of frequency. The voltage gain in decibels (A_{dB}) as a function of frequency is equal to 20 times the base-10 logarithm (log) of the ratio of V_3 to V_2 . Or:

$$A_{dB} = 20 \times \log_{10}(V_3/V_2)$$

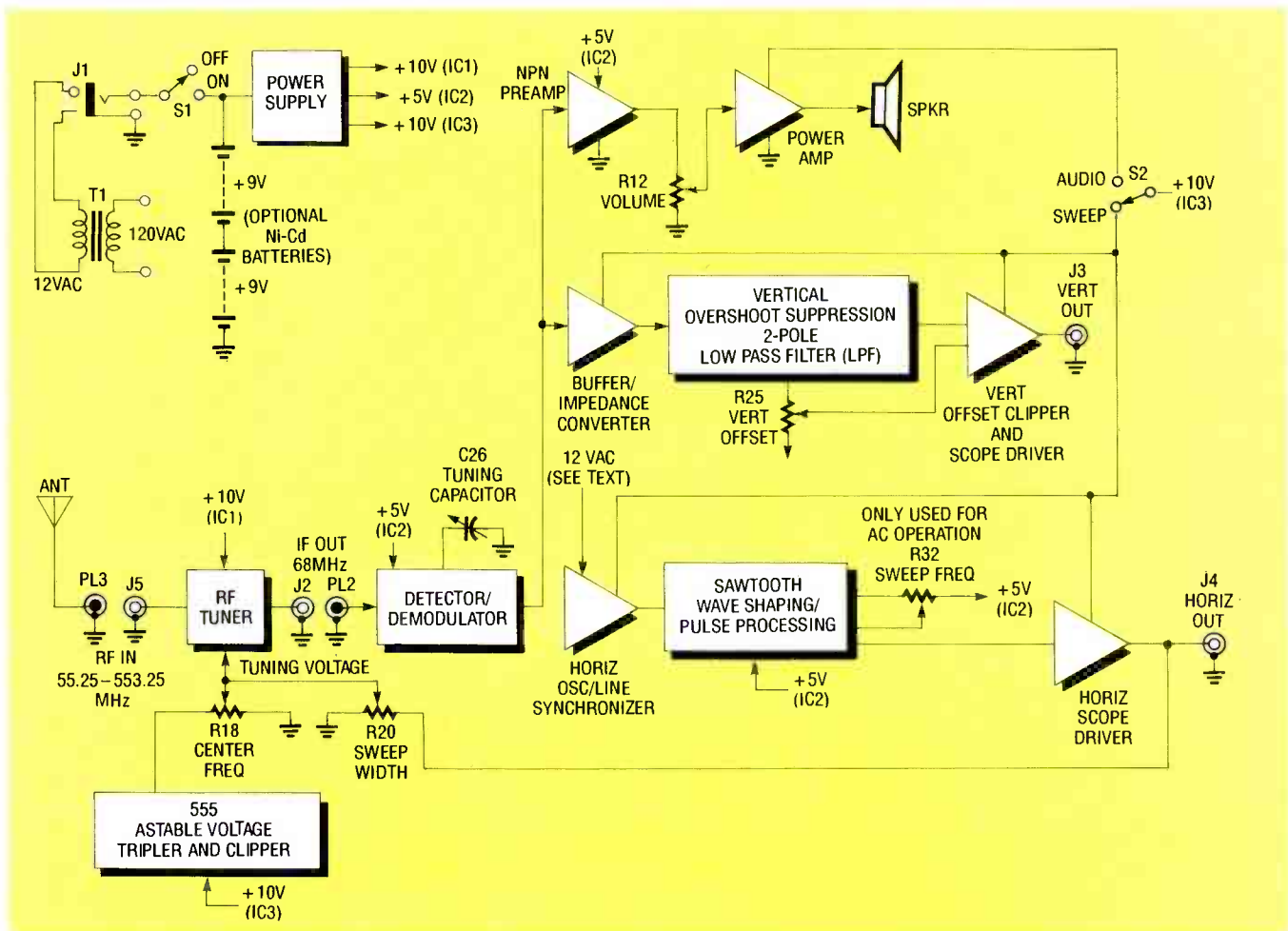

FIG. 3—SPECTRUM MONITOR BLOCK DIAGRAM.

Note that A_{dB} is a function of frequency, not time. That ratio (or the log of it) is called the amplitude spectrum of a signal, and is a plot of how a filter, amplifier, or any other electronic component responds to variations in frequency.

Tuner/converter principles

The previous example was at audio frequencies, while the spectrum monitor discussed here works at RF. Certain variations in the previous idea are necessary to make spectral analysis practical at such frequencies. An RF spectrum analyzer ordinarily uses a sawtooth wave rather than a triangle wave as the horizontal scanning waveform, since that waveshape is easier to generate at RF. Also, rather than generating an FM sinusoid as the driving waveform which generates the spectral response, most spectrum analyzers use a tuned receiver to scan over a frequency range.

The real object behind using a triangle or sawtooth waveform is that their slopes are essentially linear, so

the resulting FM generation is also. The minimum frequency for a triangular waveform corresponds to the negative-most point of each cycle, and the maximum frequency to its positive-most point. The frequency range for a sawtooth waveform goes from minimum to maximum during its long rise time, with a sharp retrace at the end of a cycle. In both cases, the duration of each ramp must occupy the entire length of the x-axis of the CRT graticule.

The spectrum monitor uses a commercially available tuner/converter normally found in TV's, VCR's, and cable converters to down-convert normal RF to a standard 63-MHz constant-level IF, tunable over the desired frequency range. As mentioned earlier, there are two distinct operating modes; you can either observe a signal in sweep mode regardless of modulation type, or you can demodulate FM using the internal FM receiver IC.

There are all sorts of ways to obtain tuner/converters from cable converters and TV or VCR front ends; the rest

of the parts are readily available. If you use the Zenith tuner discussed here, enough information is provided regarding its internal circuitry and pinouts so that you shouldn't have any real difficulty. Without proper test gear and some reasonable familiarity with RF electronics, you shouldn't use a different model.

The spectrum monitor can be made to work with a wide variety of tuners, including those that use bipolar supplies or need negative tuning voltages. The important tuner characteristic to look for is continuous tuning. Many tuners also have band switching, like those for TV's and VCR's, although they require a switch to supply band-change voltages. Also, there may be gaps in frequency coverage, like between channels 5 and 6, or between the VHF and UHF bands. Cable converters use those spaces, so a cable-ready set or cable tuner probably won't have that problem. However, they may not tune all of the UHF band (approximately 470-850 MHz). Ideally, the tuner should reach at least 550 or 600 MHz.

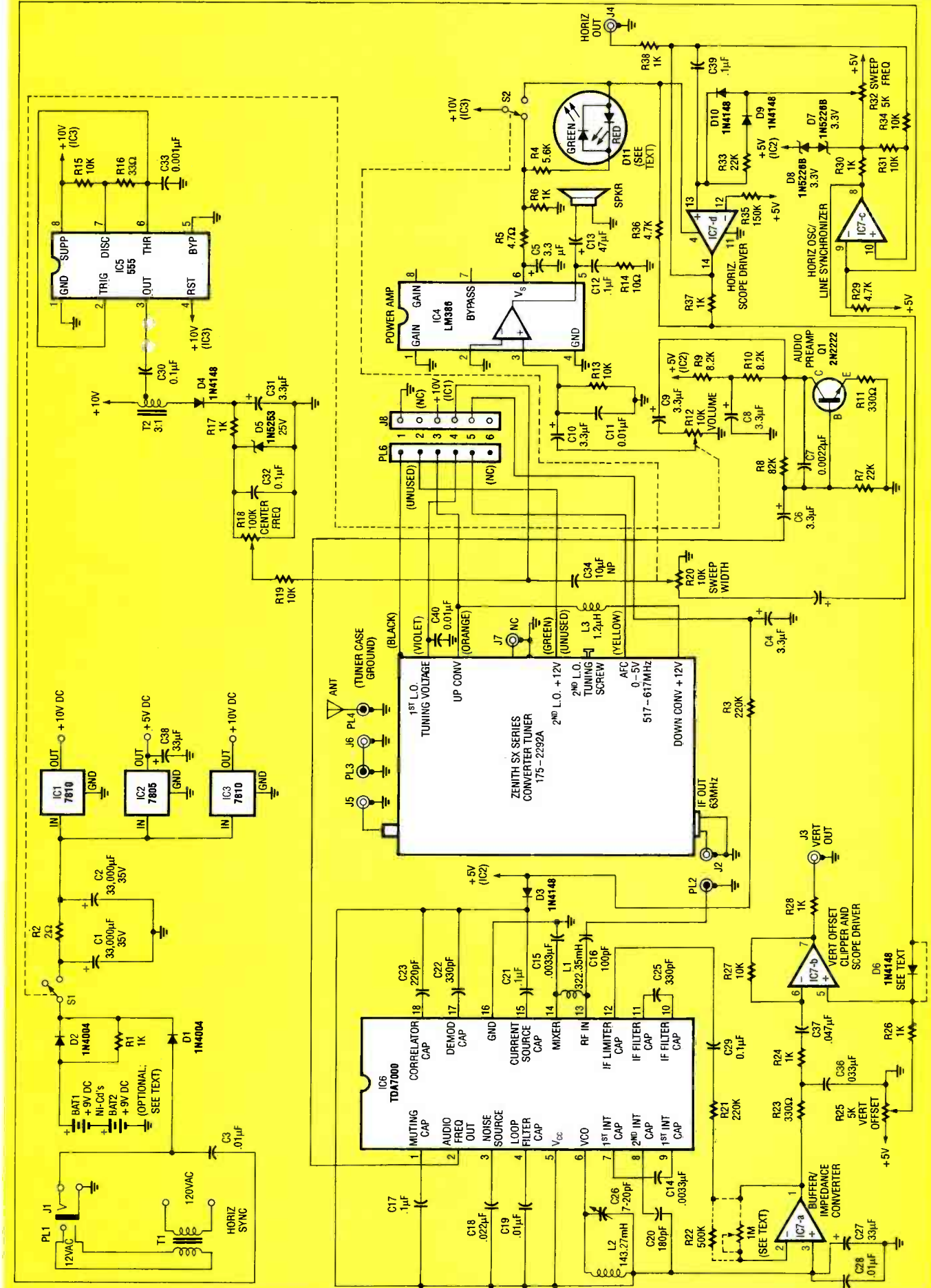

FIG. 4—SCHEMATIC OF THE SPECTRUM MONITOR.

HITACHI SCOPES AT DISCOUNT PRICES



V-212
\$419

List \$560
Save \$141

20MHz Dual Trace Oscilloscope

All Hitachi scopes include probes, schematics and Hitachi's 3 year warranty on parts and labor. Many accessories available for all scopes.



V-425
List \$995 **\$835**

- DC to 40MHz
- Dual Channel
- CRT Readout
- Cursor Meas
- DC Offset
- Alt Magnifier
- Compact Size



V-1060
List \$1595 **\$1,325**

- DC to 100MHz
- Dual Channel
- Delayed Sweep
- CRT Readout
- Sweep Time
- Autoranging
- Trigger Lock
- 2mV Sensitivity

V-223	20MHz
V-422	40MHz
V-423	40MHz
V-660	60MHz
V-1065	100MHz
V-1100A	100MHz
V-1150	150MHz

D.T., 1mV sens, Delayed Sweep, DC Offset, Vert Mode Trigger
D.T., 1mV sens, DC Offset Vert Mode Trigger, Alt Mag
D.T., 1mV sens, Delayed Sweep, DC Offset, Alt Mag
D.T., 2mV sens, Delayed Sweep, CRT Readout
D.T., 2mV sens, Delayed Sweep, CRT Readout, Cursor Meas
Q.T., 1mV sens, Delayed Sweep, CRT Readout, DVM, Counter
Q.T., 1mV sens, Delayed Sweep, Cursor Meas, DVM, Counter

LIST	PRICE	SAVE
\$770	\$695	\$75
\$875	\$725	\$150
\$955	\$825	\$130
\$1,195	\$1,025	\$170
\$1,895	\$1,670	\$225
\$2,295	\$2,045	\$250
\$3,100	\$2,565	\$535

ELENCO PRODUCTS AT DISCOUNT PRICES

20MHz Dual Trace Oscilloscope



\$359
MO-1251

- 6" CRT
- Built in component tester
- TV Sync
- X-Y Operation

SCOPE PROBES

P-1 65MHz, 1x, 10x **\$19.95**
P-2 100MHz, 1x, 10x **\$23.95**
Fits all scopes with ENC connector

35MHz Dual Trace Good to 50MHz



\$495
MO-1252

- High luminance 6" CRT
- 1mV Sensitivity
- 6KV Acceleration Voltage
- 10ns Rise Time
- X-Y Operation • Z Axis
- Delayed Triggering Sweep

Top quality scopes at a very reasonable price. Contains all desired features. Two 1x, 10x probes, diagrams and manual. Two year guarantee.

Autoranging DMM



M-5000
\$45

- 9 Functions
- Memory and Data hold
- 1/2% basic acc
- 3 1/2 digit LCD

True RMS 4 1/2 Digit Multimeter



\$135
M-7000

- .05% DC Accuracy
- .1% Resistance with Freq. Counter and deluxe case

Multimeter with Capacitance and Transistor Tester



\$55
CM-1500

- Reads Volts, Ohms, Current, Capacitors, Transistors and Diodes with case

Digital Capacitance Meter



CM-1550
\$58.95

- 9 Ranges
- .1pf-20,000ufd
- .5% basic accy
- Zero control with case

Digital LCR Meter



LC-1801
\$125

- Measures Coils 1uH-200H
- Caps .1pf-200uf
- Res .01-20M

AC Clamp-On Current Adapter



ST-265
\$22

- 0-1000A AC
- Works with most DMM

Bench DMMs



M-3500 **\$125**
3 1/2 digit .1% accy

M-4500 **\$175**
4 1/2 digit .05% accy

SOLDERING STATION TEMPERATURE CONTROLLED



SL-30
\$135

- Digital display
- Temp range: 300F-900F
- Grounded tip
- Overheat prot

Solderless Breadboards



9430 1,100 pins **\$15**
9434 2,170 pins **\$25**
9436 2,860 pins **\$35**
All have color coded posts

Low Cost Multimeter



M-1600
\$25

- 3 1/2 digit LCD
- 1% DC Accy
- 10A Scale
- Auto zero
- polarity

Wide Band Signal Generators



SG-9000 **\$129**

- RF Freq 100K-450MHz
- AM Modulation of 1KHz
- Variable RF output

SG-9500 with Digital Display and 150MHz built-in Freq Ctr \$249

3 1/2 Digit Probe Type DMM



M-1900
\$39

- Convenient one hand operation with batteries and case
- Measures DCV, ACV, Ohms
- Audible continuity check, Data hold

Function Generator



Blox
#9600
\$28.95

- Provides sine, tri, squ wave
- From 1Hz to 1MHz
- AM or FM capability

Decade Blox



9610 or 9620
\$18.95

- #9610 Resistor Blox 47 ohm to 1M & 100K pot
- #9620 Capacitor Blox 47pf to 10MFD

Digital Triple Power Supply



XP-765
\$249

- 0-20V at 1A
- 0-20V at 1A
- 5V at 5A

Fully Regulated, Short circuit protected with 2 Limit Cont., 3 Separate supplies
XP-660 with Analog Meters \$175

Quad Power Supply

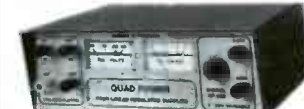

XP-580
\$59.95

- Fully regulated and short circuit protected

XP-575 without meters \$39.95

10MHz XT 100% IBM® Compatible

5 Year Warranty



\$595
MODEL PC-1000

- 5/10MHz Motherboard
- 8 Expansion Slots
- Math Compressor Slots
- 360K Floppy Drive
- AT Style Keyboard
- 150W Power Supply
- 256K RAM
- Expandable to 640K
- Monochrome Monitor
- Monographic Video Card
- Parallel Printer Port

FREE spreadsheet and word processor
3.XXMS DOS and GW Basic add \$75

Four-Function Frequency Counters



F-1000 1.2GH
\$259
F-100 120MH
\$179

- Frequency, Period, Totalize, Self Check with High Stabilized Crystal Oven Oscillator, 8 digit LED display

GF-8016 Function Generator with Freq. Counter



\$239

- Sine, Square, Triangle Pulse, Ramp, .2 to 2MHz
- Freq Counter .1 - 10MHz

GF-8015 without Freq. Meter \$179

WE WILL NOT BE UNDERSOLD!
UPS Shipping: US 5%
(\$10 Max) IL Res., 7% Tax



C & S SALES INC.
1245 Rosewood, Deerfield, IL 60015
(800) 292-7711 (312) 541-0710

15 Day Money Back Guarantee
2 Year Warranty

WRITE FOR FREE CATALOG

SELECT 5 BOOKS for only \$4⁹⁵

(values to \$144.70)
and get a **FREE Gift!**

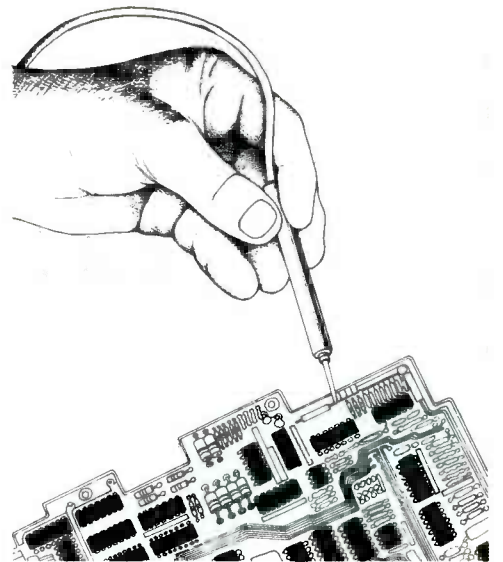

- | | | | |
|--|--|--|--|
| 
2707 \$26.95
Counts as 2 | 
2883P \$16.95 | 
3195 \$28.95
Counts as 2 | 
2975 \$24.95 |
| 
3034 \$19.95 | 
1964P \$12.95 | 
2831P \$14.95 | 
2910 \$24.95 |
| 
2898 \$23.95 | 
3090 \$25.95
Counts as 2 | 
2826P \$15.95 | 
1625P \$18.95 |
| 
2812P \$14.95 | 
2922P \$15.95 | 
2735P \$14.95 | 
2970P \$15.95 |
| 
2875 \$17.95 | 
3156 \$23.95 | 
2800P \$14.95 | 
2985 \$24.95 |
| 
2880 \$20.95 | 
2900P \$24.95
Counts as 2 | 
9776 \$36.95 | 
1493P \$15.95 |

Build Your Electronics Skills—Join Now!

An Absolutely No-Risk Guarantee.

Customize Your Home Entertainment System: TV and VCR Enhancement P
Steve Sokolowski
3234 \$24.95

THE NOOBY ELECTRONICS
Basic Electronics Course
2nd Edition
NORMAN H. CROWHURST
2613 \$24.95
Counts as 2

THE ENCYCLOPEDIA OF ELECTRONIC CIRCUITS
1938 \$60.00
Counts as 3

How to Test Almost Everything Electronic
2925 \$16.95

MASTER HANDBOOK OF PRACTICAL ELECTRONIC CIRCUITS
2980 \$28.95

PERSONAL COMPUTERS
2809 \$27.95
Counts as 2

The Complete Electronics Career Guide
3110 \$19.95

THE GIANT BOOK OF ELECTRONIC PROJECTS
1599P \$17.95

Understanding ELECTRONICS
3044 \$18.95

Elementary Electricity and Electronics
composed by component
2753 \$23.95

The Master Handbook of IC Circuits
3185 \$34.95
Counts as 2

LAST MINUTE REPAIR ON VCRs
1604P \$16.95

SMALL HOME APPLIANCES
2912P \$14.95

THE GIANT BOOK OF ELECTRONIC PROJECTS
1367P \$18.95

20 INNOVATIVE ELECTRONICS PROJECTS For Your Home
2947 \$21.95

BEGINNER'S GUIDE TO TV REPAIR
1897P \$14.95

FREE when you join!

Here's 15 Easy Electronic Projects From Delton T. Horn

Projects you can build—some unique, some old favorites—from the author's vast treasury of electronics know-how.

(a \$7.95 value!)

Delton T. Horn's
All-Time Favorite
Electronic Projects



Membership Benefits • Big Savings. In addition to this introductory offer, you keep saving substantially with members' prices of up to 50% off the publishers' price. • **Bonus Books.** Starting immediately, you will be eligible for our Bonus Book Plan, with savings of up to 80% off publishers' prices. • **Club News Bulletins.** 14 times per year you will receive the Book Club News, describing all the current selections—mains, alternates, extras—plus bonus offers and special sales, with hundreds of titles to choose from. • **Automatic Order.** If you want the Main Selection, do nothing and it will be sent to you automatically. If you prefer another selection, or no book at all, simply indicate your choice on the reply form provided. As a member, you agree to purchase at least 3 books within the next 12 months and may resign at any time thereafter. • **Ironclad No-Risk Guarantee.** If not satisfied with your books, return them within 10 days without obligation! • **Exceptional Quality.** All books are quality publishers' editions especially selected by our Editorial Board.



ELECTRONICS BOOK CLUB

Blue Ridge Summit, PA 17294-0810

Please accept my membership in the Electronics Book Club® and send the 5 volumes listed below, plus my FREE copy of *Delton T. Horn's All-Time Favorite Electronic Projects* (3105P), billing me \$4.95 plus shipping and handling charges. If not satisfied, I may return the books within ten days without obligation and have my membership canceled. I agree to purchase at least 3 books at regular Club prices (plus shipping and handling) during the next 12 months and may resign any time thereafter.

Name _____
Address _____
City _____
State/Zip _____ Phone _____
Signature _____

Valid for new members only. Foreign applicants will receive special ordering instructions. Canada must remit in U.S. currency. This order subject to acceptance by the Electronics Book Club®

RE989

SEPTEMBER 1989

PARTS LIST

All resistors are 1/4-watt, 5%, unless otherwise indicated.

R1, R6, R17, R24, R26, R28, R30, R37, R38—1,000 ohms

R2—2 ohms

R3, R21—220,000 ohms

R4—5600 ohms

R5—4.7 ohms

R7, R33—22,000 ohms

R8—82,000 ohms

R9, R10—8200 ohms

R11—330 ohms

R12-S1—cabinet-mounted 10,000-ohm potentiometer with SPST switch

R13, R15, R19, R27, R31, R34—10,000 ohms

R14—10 ohms

R16—33 ohms

R18—cabinet-mounted 100,000-ohm 10-turn potentiometer

R20-S2—cabinet-mounted 10,000-ohm potentiometer with SPDT switch

R22—1 megohm

R23—330 ohms

R25, R32—5000-ohm PC-board potentiometer

R29, R36—4700 ohms

R35—150,000 ohms

Capacitors

C1, C2—3300 μ F, 35 volts, electrolytic

C3, C11, C19, C28—0.01 μ F, 25 volts, ceramic disc

C4—C6, C8—C10—3.3 μ F, 25 volts, electrolytic

C7—0.0022 μ F, 25 volts, ceramic disc

C12, C17, C21, C29, C30, C32—0.1 μ F, 25 volts, ceramic disc

C13—47 μ F, 25 volts, electrolytic

C14, C15, C24—0.0033 μ F, 25 volts, ceramic disc

C16—100 pF, 25 volts, ceramic disc

C18—0.022 μ F, 25 volts, ceramic disc

C20—180 pF, 25 volts, ceramic disc

C22, C25—330 pF, 25 volts, ceramic disc

C23—220 pF, 25 volts, ceramic disc

C26—7–70-pF PC-board trimmer capacitor

C27, C38—33 μ F, 16 volts, electrolytic

C31—3.3 μ F, 50 volts, electrolytic

C33—0.001 μ F, 25 volts, ceramic disc

C34—10 μ F, 50 volts, nonpolarized electrolytic

C35—10 μ F, 25 volt, electrolytic

C36—0.033 μ F, 25 volts, ceramic disc

C37—0.047 μ F, 25 volts, ceramic disc

C39—0.1 μ F polystyrene

C40—0.01 μ F polystyrene

C41—220 pF ceramic disc

Inductors

L1—12 turns, 1/8-inch, No. 26 enamel wire

L2—8 turns, 1/8-inch, No. 26 enamel wire

L3—1.2- μ H RF choke

Transformers

T1—RODCO Class 2 power transformer, Model DV-1260, 120-volts AC/12-volts AC, 60-Hz, Digi-Key catalog number T201-ND

T2—3:1 toroidal auto-transformer using No. 26 enameled wire on a toroidal core (Mouser Electronics 542-T68-2), with eight turns for the primary and 24 turns for the secondary (see text)

Semiconductors

D1, D2—1N4004 silicon diode

D3, D4, D6, D9, D10—1N4148 germanium diode

D5—1N5253B 25-volt Zener diode

D7, D8—1N5226B 3.3-volt Zener diode

D11—combination red/green LED (Mouser Electronics ME351-261)

Q1—2N2222 NPN transistor

IC1, IC3—7810 10-volt DC regulator

IC2—7805 5-volt DC regulator

IC4—LM386 audio amplifier

IC5—555 timer

IC6—Signetics TDA7000 FM receiver (Radio Shack 276-1304)

IC7—NE5514 quad op-amp

Modules

MODULE1—multipurpose cable TV/VCR tuner/converter (Motorola SX Series 175-2292A)

Other components

PL1—miniature monophonic plug

PL2—RCA-type monophonic plug connecting to braided-shield coaxial cable

PL4-ANT—folding monopole antenna with BNC plug (optional)

PL5—2-socket PC-board-mounted SIP version, not a separate item, attached to the tuner (MODULE1), intended for A/B SWITCH (unused)

PL6—6-socket PC-board-mounted SIP version, not a separate item, attached to the tuner (MODULE1), used for the majority of the tuner pinouts

J1—miniature monophonic jack

J2—RCA-type monophonic jack, not a separate item, built into cabinet of the tuner (MODULE1), used for IF OUT

J3, J4—BNC jack

J5—"F"-type jack, not a separate item, built into cabinet of the tuner (MODULE1), used for IF OUT (63 MHz)

J7—RCA-type monophonic jack, not a separate item, built into cabinet of the tuner (MODULE1), used for PRESCALE OUT

J8—6-pin PC-board-mounted Single-Inline Package (SIP) jack

PL3-J6—adapter with "F"-type plug and BNC jack (optional)

SPKR—8-ohm loudspeaker, 2- x 2-inch

Miscellaneous: Cabinet (minimum size 8- x 4.5- x 2.5-inches), large knob (for R18), small knob (for R25 and R32), four 1-inch standoffs, LED bezel, wire, solder, etc.

NOTE: The following is available from FM Broadcast Services, 3825 South Olathe Street, Aurora, CO, 80013: A complete spectrum monitor kit with all parts, PC board, hardware, tuner, cabinet, transformer and postage for \$187.00. The PC board alone is \$12.00.

Third, you'll want a usable output IF. TV Channel 3 (63 MHz) is popular, but Channel 4 (69 MHz) is suitable and within the range of the project. Also, you'll want relatively stable gain characteristics and few images or spurs.

Some adjustment of the spectrum monitor may be necessary for use with your tuner. Automatic Gain Control (AGC) voltages can be brought out to a front panel control to set RF

gain, or tied to a voltage representing full gain. Measuring the local oscillator output with a frequency counter will enable you to calculate the center frequency.

Zenith SX tuner/converter

The Zenith SX series tuner/converter (part number 175-2292A) used in the prototype is representative of a suitable tuner; a block diagram is shown in Fig. 2. It can be bought with

the kit described in the Parts List, or directly from Zenith Corp. It contains both up- and down-converter sections, and fits into a 4.25- x 2.78- x 1.05-inch aluminum shell with one "F"-type and two RCA-type jacks.

The "F"-type jack (J5) is the RF IN, with a frequency range of 55.25–553.25 MHz. One RCA-type jack (J2) is the 63-MHz IF OUT, and the second (J7) is the PRESCALE output,

continued on page 64

LOW FREQUENCY TRANSMITTER

Here's how to join the "lowfers" on the no-license-required 1750-meter band.

RICHARD A. NELSON

RECENT DEVELOPMENTS IN SOLID-STATE TECHNOLOGY have pushed the high end of the usable RF spectrum well into the millimeter-wavelength region. Simply because there is so much emphasis on the very-short wavelengths, an electronics hobbyist might easily assume that there is little interest at the LF (*Low Frequency*) end of the RF spectrum. However, the truth of the matter is that the frequencies below the AM broadcast band—what is called “the basement of radio”—aren't deserted at all. In fact, the low frequencies are heavily populated, and they are wide open to hobbyist experimentation because the FCC has authorized unlicensed operation in the 160–190 kHz portion of the band. The only restrictions are that the antenna—including the feedline—must not exceed fifty feet, and that the power input to the transmitter's final amplifier must not exceed 1-watt.

Unlike the millimeter-wavelength bands where circuits take the form of critically-etched striplines on expensive substrates, often using high cost and hard-to-handle surface-mounted components, LF construction is simple even for a beginner. No delicate GaAsFET's are needed, audio transistors are adequate, and only normal audio-wiring techniques are required. If you can solder, you can build an LF Morse-code transmitter that will work right the first time!

How it works

Designing a 1-watt transmitter for 180 kHz is very straightforward. A few inexpensive FET's or transistors are all that are needed. Unfortunately, the price of the frequency-determining crystal is about \$20, which is somewhat on the high side for experimentation.

But crystals for 1.8–1.9 MHz (the 160-meter band) can be found at hamfests and surplus dealers for almost pocket change, and almost as common as those surplus crystals are inexpensive 1.8432 MHz microprocessor-clock crystals. Even though those crystals will oscillate at ten times the desired 185 kHz transmit frequency, by dividing down with a simple CMOS divider, inexpensive 160-meter crystals can easily be used to generate a 1750-meter signal.

The complete transmitter circuit—including the antenna tuning network—is shown in Fig. 1. The crystal oscillator, which uses two sections of IC1, a 4001 quad 2-input NOR gate, is a standard and reliable design. The oscillator's 1.85-MHz squarewave output feeds IC2, a 4017 divide-by-10 counter. The count ENABLE and RESET terminals, pins 13 and 15, are normally held high by



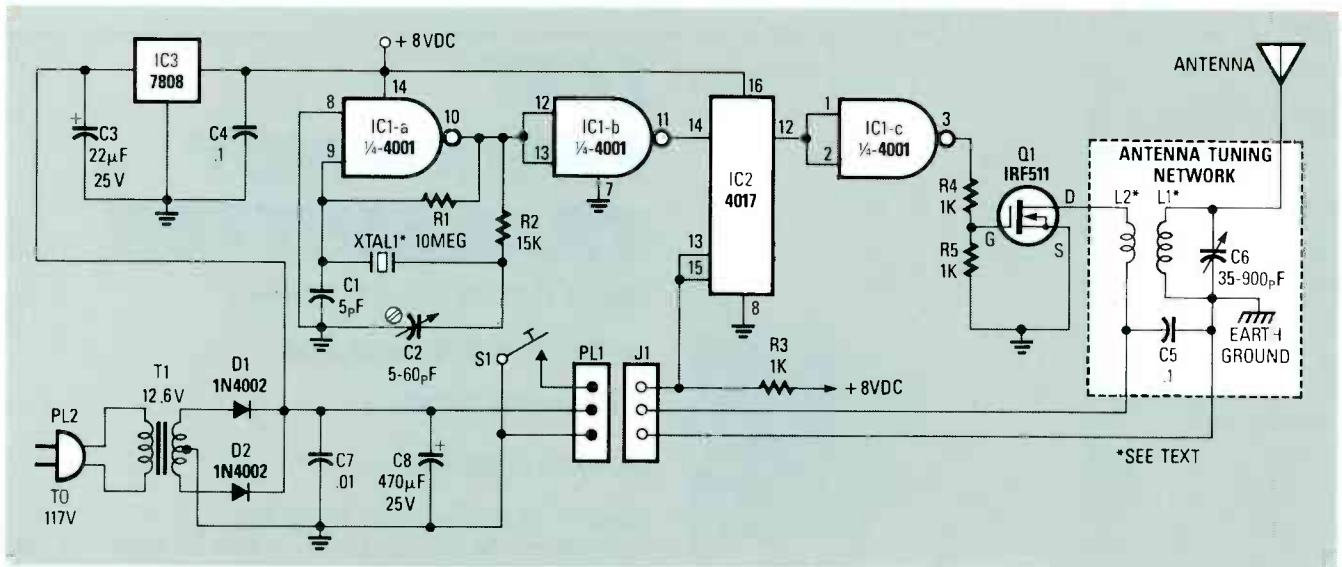

FIG. 1—THE HEART OF THE TRANSMITTER is the oscillator section, which actually divides the crystal frequency by a factor of 10.

resistor R3, and the counter is activated by bringing those pins low by closing telegraph key S1—an arrangement that guarantees that the final state of IC2 pin 12 is always high. The high on IC2 pin 12 is inverted by a third section of the 4001, IC1-c, to prevent DC current flow through power-amplifier Q1 during key-up periods.

Because it requires a low drive current, a VMOS transistor is used for the power amplifier. While the device is available from several manufacturers, note that the pinout isn't standardized, and devices having similar characteristics may not be directly interchangeable. The PC layout provided is for an IRF511.

To ensure maximum stability and

thereby prevent any trace of chirp caused by keying, the oscillator circuit is powered by a three-terminal voltage regulator (IC3). Power amplifier Q1 is powered by the same source that feeds the voltage regulator. The main power source, T1, D1, D2, etc., is external to the transmitter and can be assembled any way that you want. Although a transformer with a 12.6 volt secondary is specified in the Parts List, anything can be used that will result in 12–18-volts DC at 500 mA.

Building the oscillator

Wiring techniques aren't critical at 185 kHz and virtually any construction technique can be used; but to reduce the chance of wiring errors and assure repeatable results, a

printed-circuit assembly is suggested, for which a foil pattern is provided in PC Service.

Parts placement and external connections to the PC board are shown in Fig. 2. Coils L1 and L2, and variable-capacitor C6 comprise an antenna-tuning network that is external to the oscillator circuit. Note, in particular, that an earth ground is shown for both the antenna-tuning network and the oscillator. While you can use a common ground for the circuit, that circuit must eventually connect to an earth ground because an earth connection is extremely important for propagation of the low frequencies.

Getting it all together

The prototype transmitter is shown in Fig. 3. It is actually assembled on a piece of 12 × 16-inch particle board. Since the transmitter will be mounted outdoors, several coats of paint are applied to the board to prevent decay, and a wood cover is installed over the board during severe weather. Coils L1 and L2, and capacitor C6, are mounted directly on the board. The remainder of the circuit—the oscillator—is mounted inside a 5 1/4 × 3 × 2 1/8-inch aluminum cabinet. The power supply and key connections are brought in via the connector on the front of the aluminum cabinet.

Since any feedline is considered to be part of the antenna, it is convenient to install the transmitter at the base of the antenna, as shown in Fig. 4. The only maintenance it will require is to occasionally brush spider webs from the tuning capacitor.

RADIO-ELECTRONICS

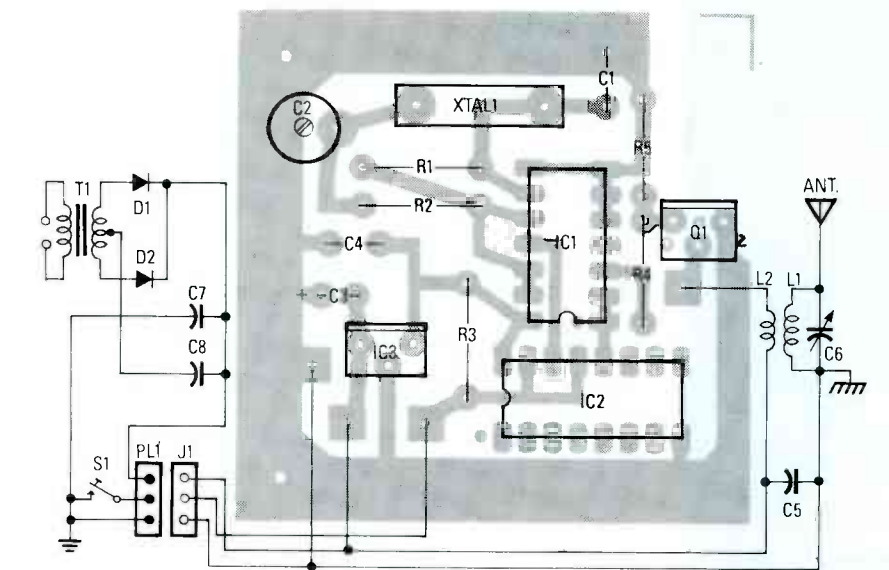

FIG. 2—The PC BOARD'S PARTS PLACEMENT. Coils L1 and L2, and C6 for an external antenna tuner.

Antenna and matching network

A resonant $\frac{1}{4}$ -wavelength vertical antenna is approximately 1250-feet high at 185 kHz. Obviously, that's a shade too long for the average backyard so it must be shortened. But as an antenna is shortened its radiation resistance (R_{RAD}) decreases and the feedpoint becomes capacitively reactive. At a height of 50 feet, R_{RAD} has decreased to approximately .04 ohm, with about 7000 ohms of capacitive reactance (depending on the diameter of the radiating conductor). Looking at the formula for antenna efficiency:

$$\text{EFFICIENCY} = R_{RAD} / (R_{RAD} + R_{LOSS})$$

it is obvious that with a very short antenna (less than $\frac{1}{10}$ wavelength) even a fraction of an ohm of loss resistance can tremendously reduce the radiated power.

Significant resistive losses will occur in two portions of the transmitter/antenna circuit: the ground system and the matching network's tank coil. The matching network is necessary to transform the high feedpoint impedance (consisting of a large capacitive-reactance component and a small resistive component) to the approximately 100-ohm output impedance of final-amplifier Q1. One might be tempted to eliminate tuning-network losses by eliminating the tuning network, but attempting to drive the antenna directly from power-amplifier

Q1 will result in a tremendous mismatch, and essentially zero radiated power. The matching network also reduces harmonics from the transmitter; without it, the harmonic-rich square-wave signal could radiate overtones of the 185-kHz fundamental frequency.

The resistance of tank-coil L1 will be the primary source of matching-network loss. Losses are decreased by using larger-diameter wire for L1. Copper tubing would be ideal, but to obtain adequate reactance at 185 kHz, such a coil would be very large; the tank coil is therefore a compromise between efficiency and size. Because of the much higher circuit resistance, losses in coupling-link L2 are negligible and the size of the wire used for L2 isn't of great importance.

Coil L1 is close-wound from #16 enameled magnet wire on a 16-inch length of $3\frac{1}{2}$ " outside diameter PVC water pipe. A total of 200 turns are wound, covering slightly more than 10 inches of the form. The measured inductance of the tank coil is 0.86 mH, which gives an inductive reactance of about 1000 ohms. The coil form is attached to the chassis by a pair of 5" standoffs cut from a piece of broom handle. They help keep the magnetic field isolated from the lossy ground surface.

Tuning capacitor C6 is a dual-section broadcast-band variable unit having a measured range of 35–900 pF

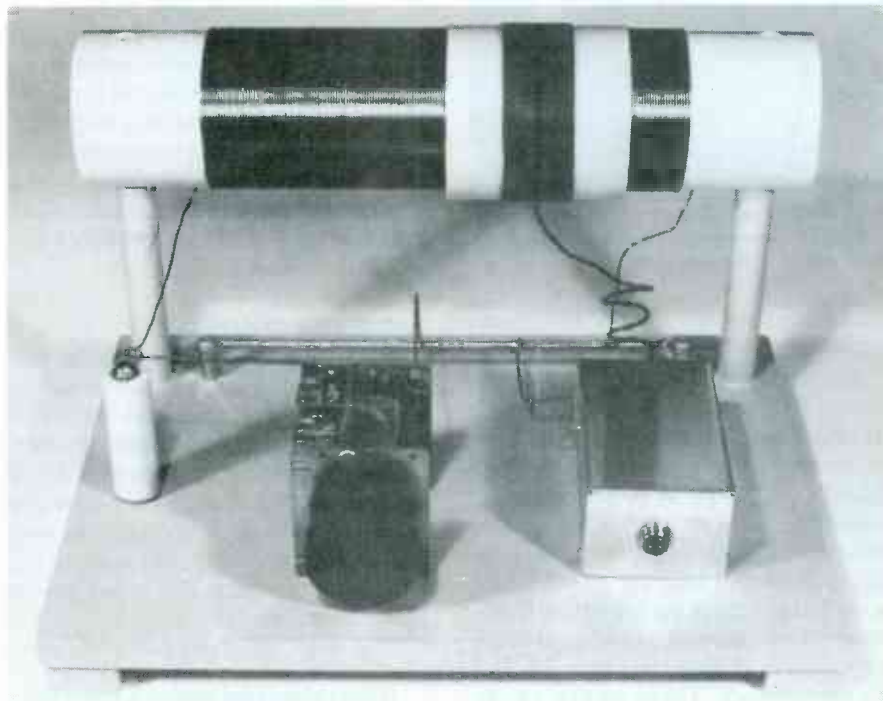

FIG. 3—THE TRANSMITTER IS ASSEMBLED on a breadboard. Note how the small link coil, L2, slides over the larger coil, L1.

PARTS LIST

All resistors $\frac{1}{4}$ -watt, 5%.

R1—10 megohms

R2—15,000 ohms

R3, R4, R5—1000 ohms

Capacitors

C1—5-pF, ceramic disc

C2—6–50 pF, trimmer

C3—22 μ F, 25 volts, electrolytic

C4, C5—0.1 μ F, ceramic disc

C6—Dual-section air-variable capacitor, 18–450 pF per section, see text

C7—.01 μ F, ceramic disc

C8—470 μ F, 25 volts, electrolytic

Semiconductors

IC1—CD4001, quad 2-input NOR gate

IC2—CD4017, divided-by-10 counter

IC3—7808, 8-volt regulator

Q1—IRF511 or IRFZ10 power FET

D1, D2—1N4002, silicon rectifier

Other Components

PL1—Control cable connector, any type

PL2—AC powerline plug

S1—Telegraph key

T1—12.6 volts, 500 Ma, center-tapped

XTAL1—1.6 MHz to 1.9 MHz crystal

Miscellaneous: $5\frac{1}{4}$ x 3 x $2\frac{1}{8}$ inch aluminum enclosure, 3" PVC pipe (16 inches required), #16 enameled magnet wire (approx. 180 feet)

NOTE: The following are available from Analog Technology, PO Box 8964, Fort Collins, CO 80525: Etched and drilled PC board, \$3.75; PC Board kit (all parts required, including 184.320 kHz crystal, to build PC board assembly—does not include power supply, matching network, enclosure, etc.) \$18.00. Antenna-matching network parts are also available (write for current prices). Add \$1 postage and handling per order (Visa and MasterCard accepted).

when both sections are connected in parallel. (The capacitor must be able to resonate with L1 at the transmit frequency—approximately 185 kHz). A smaller-value variable capacitor can easily be substituted by connecting one or more fixed-value capacitors in parallel to achieve the required range. In that instance, silver-mica capacitors rated for at least 600 volts are suggested.

Coupling link L2 is 30 turns of close-wound #20 stranded wire wound on a piece of tubing cut from a $3\frac{5}{8}$ " diameter polyethylene bottle. The required number of turns for L2 will vary depending on your antenna's impedance and the power-supply volt-

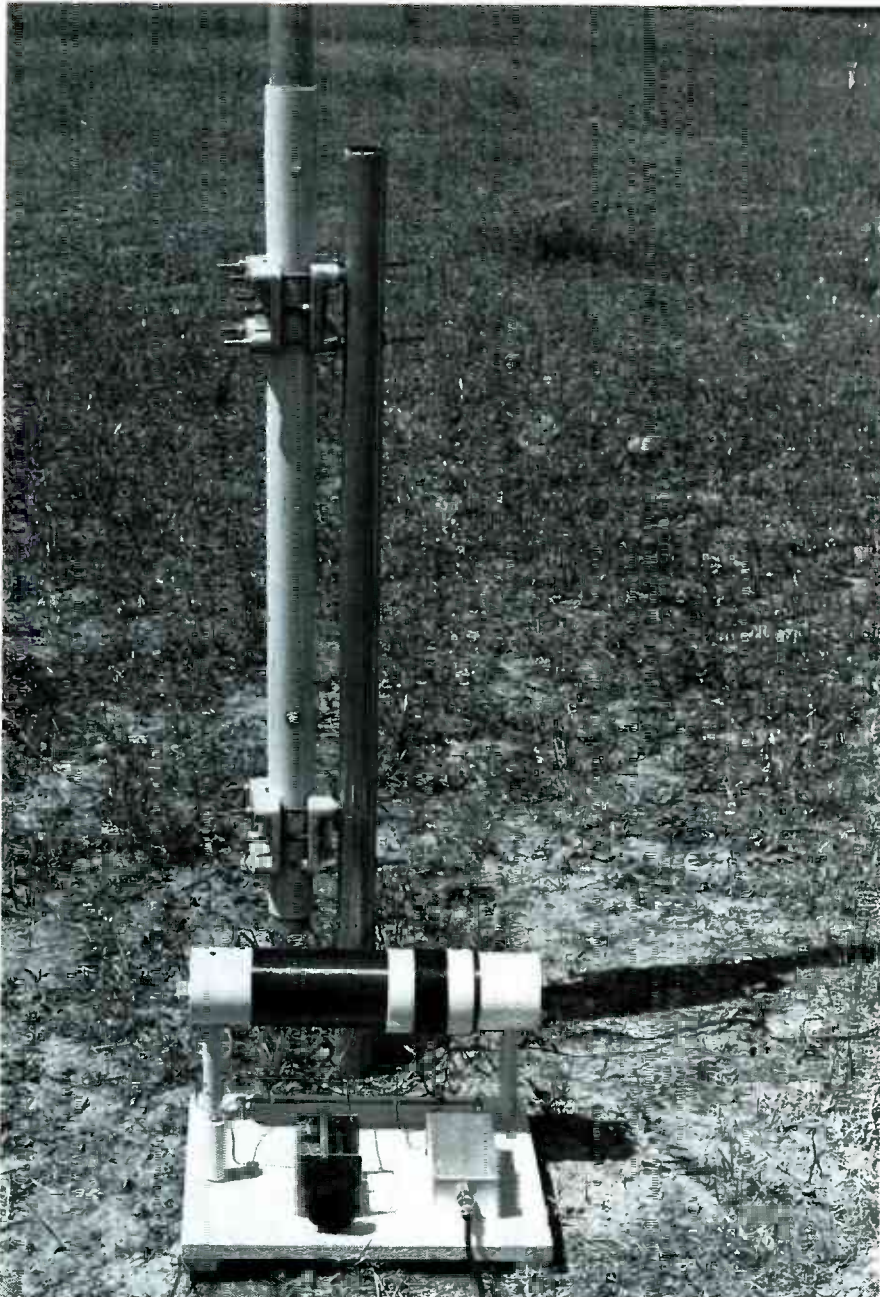

FIG. 4—SINCE THE FEEDLINE is considered part of the antenna, the transmitter should be installed directly at the base of the antenna. The antenna/ground post design allows the antenna to pivot on a single bolt, making installation a one-man job.

age to Q1; you can tweak L2's turns by measuring the RF radiated from the antenna. Coupling-link L2 slides over L1 to allow the coupling factor to be optimized in order to achieve the best match to the antenna.

For maximum efficiency, you should use a vertically-polarized antenna with a total height as close to 50 feet as possible. The antenna shown in the photograph at the top of the page is assembled from pieces of aluminum tubing salvaged from old ham-radio antennas. It tapers from a 2" diameter at the base to 1/4" diameter at the tip. The tubing is all 6061-T6 (the

preferred alloy and temper for antennas) with a .058 inch wall.

A four foot length of 2" schedule-40 PVC pipe insulates the antenna from ground. It is attached to the base of the antenna with two bolts and two aluminum clamps. A seven foot long, two-inch diameter steel fence post is used as the ground anchor. It is driven about three feet into the ground, and is drilled to accept the mounting hardware. The antenna is secured with nylon-cord guys located at 24 feet above ground. Three heavy-gauge steel tent posts act as guy anchors.

Vertical antennas in that height

range may also be constructed from sections of telescoping TV mast or similar thin-wall steel tubing. The key to building an efficient but inexpensive LF antenna is creativity; the antenna details are presented only as a guideline; your design will depend on the materials available. But whatever design you decide to use, *be extremely careful of overhead power lines when erecting that or any other type of antenna!*

The ground system

Once you have built your antenna you must provide a ground system to carry the return current. Establishing a low-resistance ground for a vertical antenna can be a tedious job. An ideal ground system consists of 120 wires each about 1/2-wavelength long extending radially from the base of the antenna. Even if you have the acreage to lay 2500-foot radials, such a system would require almost 60 miles of wire. The design of your ground system will depend on existing grounds and local soil conditions. Highly resistive soils (granite, limestone, and sandstone) will require a more extensive ground system than conductive soils (clay, shale, loam). You should hammer several ground rods around the base of your antenna, connecting them with heavy-gauge wire or straps. The use of multiple rods significantly reduces ground losses through parallel connection of the individual ground-rod resistances. If possible, run a heavy wire to your water main (assuming, of course, that it is metallic). If you have access to a deep well with a metallic casing you are really in luck. Deep-buried grounds are a good choice for the experimenter, while limited radial fields are probably not worth the effort and wire.

Setup and operation

With the transmitter/matching network installed at the base of the antenna, apply voltage and key the oscillator. Quickly but carefully, turn C6 to resonance as indicated by a field-strength indicator or a monitor receiver, and check voltage and current to the power amplifier stage using a VOM. Compute the input power using the formula:

$$W = E \times I$$

If the calculated power is more than 1 watt, reduce the power amplifier's

continued on page 63

BUILD THIS

LOW FREQUENCY CONVERTER

Find out what's happening below the AM-broadcast band with our low-frequency converter.

WILLIAM SHEETS AND RUDOLF F. GRAF

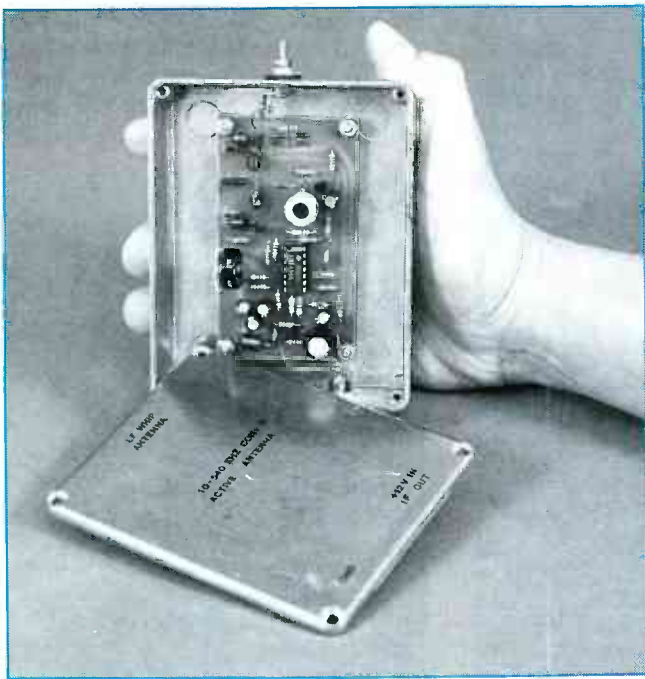

THE FREQUENCY RANGE JUST BELOW THE AM-BROADCAST band (from 10 kHz to 550 kHz) has been clearly omitted from most communication receivers. How come? It appears that the extra coil sets, increased assembly costs, and additional RF circuitry has not justified the inclusion of the low-frequency band. But that doesn't have to stop you from sneaking a peek at the band "down-under." Among the signals you'll find below 550 kHz are maritime mobile, distress, radio beacons, aircraft weather, European longwave-AM broadcast, and point-to-point communications. A brief summary of those signals is found in Table 1.

Up convert

Low frequencies make conventional shortwave radio design impractical. In the usual four-band general-coverage receiver, four coil sets are used to cover the frequencies from 550 kHz to 25 MHz, and sometimes up to 30 MHz, the upper limits of shortwave reception. To adequately cover the low-frequency (LF) spectrum an additional three, and more likely four coil sets are needed; moreover, with the usual 400-pF variable capacitors used in medium-frequency (MF) tank circuits, inductances of around 600 mH are needed to reach the 100-kHz low-frequency limit used for radio communications.

Many radios produced for the European markets cover the 150-kHz to 400-kHz range; however, they're usually designed solely for AM reception where a high-sensitivity figure is not required. That's because European longwave stations generally run 50–100 kW (or possibly more) to their antennas.

Here in America, it's more practical to up-convert the low-frequency range to a medium-frequency range. Our converter does just that. It converts the 10-kHz to 550-kHz LF range to a 1.01-MHz to 1.55-MHz MF range, by

simply adding 1 MHz to all received signals. Connect our converter to any communications receiver, or AM-broadcast radio for that matter, and bingo—you have a longwave receiver. Radio calibration is unnecessary because signals are received at the AM-radio's dial setting, plus 1 MHz. A 100-kHz signal is received at 1100 kHz, a 335-kHz signal at 1335 kHz, etc., just drop the first digit to read the longwave frequency.

One problem at low frequencies is man-made noise; many of our everyday devices and appliances are notorious in that regard. Motors, fluorescent lighting, light dimmers, computers, TV-receiver sweep radiation, and many small household digital devices generate "hash" in the spectrum below 550 kHz. Fortunately, most noise is carried chiefly on power lines, and doesn't radiate very far.

One misconception is that tremendous antennas are needed for longwave reception. It's easy to understand why someone might think that way. At *shortwave* frequencies (3–30 MHz), it's common to erect a halfwave dipole at the operating frequency; the resulting antenna length is usually quite reasonable for anyone's backyard. Try to do the same for *longwave* (10–550 kHz), and you'd end up with a dipole 1-mile long. The remedy is to use an active antenna, where excellent longwave reception can be had with a simple vertical only a few-meters long. In fact, our converter (using an active antenna) even picks up quite a few signals with a clip lead only 30-centimeters long.

Circuit description

According to Fig. 1-a, low-frequency signals that are picked up by an 8-inch whip antenna (a standard CB/ham 10-meter whip) are fed to the Q1's gate, a source follower. FET-transistor Q1 matches the whip's high-impedance (which looks like a small 20–30-pF capacitor) to the low-pass filter formed by C1 through C3, and L1 through L4. That filter rejects signals above 500 kHz, preventing breakthrough and cross modulation from strong broadcast and shortwave signals. Coupling capacitor C4 is selected to attenuates frequencies below 10 kHz.

Resistor R1 provides a DC ground for Q1's gate. Resistor R2 is needed for a return path for Q1's drain current because capacitor C1 blocks the DC-path to ground. Diodes D1–D4 bleed-off any static charge on the antenna that

TABLE 1—LONGWAVE SIGNALS BELOW 550 kHz

Frequency Range	Signals Found	Remarks
510–535 kHz	Misc. Radio Beacons	
500 kHz	Distress (CW)	Ship to Shore
415–490 kHz	Maritime Mobile (CW)	
285–400 kHz	Radio Beacons, Weather: Aeronautical and Marine	Weather info, AM, voice and Carrier Current (Power Line) Transmissions
190–285 kHz	Radio Beacons, Weather: European Longwave Broadcast	
160–190 kHz	Fixed Public, License-Free Experimental, European Long Wave Broadcast, Fixed	Some experimenters run 1-watt transmitters in this band, no license needed
110–160 kHz	Maritime Mobile, Lowest Freq. Long-Wave Broadcast, Fixed (point to point)	Tends to be noisy, also some RTTY transmissions
90–110 kHz	Loran Navigation	
30–90 kHz	Fixed, Mobile, Standard Freq. and Time Signals	RTTY transmissions, some CW, noisy
14–30 kHz	Submarine Communications, VLF Worldwide High-Power, Military and Commercial	RTTY transmissions, some CW heard at times, noisy
10–14 kHz	Omega Signals, Freq. Standards, Atmospheric Phenomena, Whistlers	Lowest part of radio spectrum, frequently used
Below 10 kHz	Atmospheric Noise, Whistlers, Experimental Transmissions, Military	Experimental

might have accumulated, while having no effect on RF signals that are less than about 1 volt on the antenna.

The low-frequency signals are fed to IC1, a doubly-balanced mixer, that's easy to use and quite reliable. It has balanced (dual polarity) inputs and outputs but, as used here, single-ended (unbalanced) inputs and outputs may be accommodated by using only one of the balanced lines (either will do). Resistors R3–R7 provide an adjustable bias network for the input pins 1 and 4. Resistors R8–R10 and R14 provide the correct DC operating voltages and bias levels. Capacitors C5–C7 are supply-bypass capacitors. Resistor R11 sets the mixer's gain (at about $\times 3$). Resistors R12 and R13 feed bias to the local-oscillator inputs 8 and 10.

Transistor Q2 and associated circuitry form a Hartley 1.000-MHz local-oscillator, which is coupled from Q2's drain, through C8, to IC1 pin 8.

Signals in the 10–550 kHz range are converted to 1010–1550 kHz. A 450–990-kHz output is also produced, but it's ignored because direct readout of those frequencies isn't possible with most AM radios, which only cover down to 530 kHz, or thereabouts. (Actually, if you're so inclined, other local-oscillator frequencies may be used. For example, to receive the 80-meter ham band use a 3.500-MHz crystal-controlled oscillator.) Components R15 and C9 are supply decoupling components. Resistor R16 provides bias to Q2. Tank circuit L5–C11 is slug-tuned to resonant at 1 MHz. Capacitor C10 couples Q2's source to the top of the tank. The local-oscillator signal via R17 is set to the correct level at pin 8 of IC1.

The mixer heterodynes the incoming low-frequency signal and local-oscillator signal. The output frequencies then appears at both pins 6 and 12 of IC1: Pin 12 is used arbitrarily for

easier PC-board layout. Small-value resistor R21 is used as a PC board jumper, so its value is not critical. Resistors R18 and R20 provide bias to the output stages of IC1, while R19 and C12 decouple the DC power supply. Transistor Q3 reduces IC1's high-output impedance to about 100 ohms to match most receiver inputs. Capac-

PARTS LIST

All resistors are 1/4-watt, 5%.

- R1—2.2 megohms
- R2, R12, R13, R15, R16—2200 ohms
- R3, R4—100,000 ohms
- R5, R6—22,000 ohms
- R7—25,000-ohm trimmer potentiometer
- R8—680 ohms
- R9—470 ohms
- R10, R19, R23—220 ohms
- R11—1000 ohms
- R14—1500 ohms
- R17—15,000 ohms
- R18, R20, R22—3300 ohms
- R21—10 ohms

Capacitors

- C1, C3—82 pF, $\pm 5\%$, NPO, ceramic disc
- C2—270 pf, $\pm 5\%$, NPO, silver mica
- C4—0.001 μ F, 50 volt, mylar
- C5, C6, C7, C9, C12—47 μ F, 16 volt, electrolytic
- C8, C10, C13, C15, C16, C18—0.01 μ F, 50 volt, ceramic disc
- C11—180 pF, $\pm 5\%$, NPO, ceramic disc
- C14—470 μ F, 16 volt, electrolytic
- C17—22,000 μ F, 16 volt, electrolytic

Inductors

- L1, L4—680 μ H, $\pm 5\%$
- L2, L3—1000 μ H, $\pm 5\%$
- L5—100–160 μ H, tapped
- L6—4.7 μ H, RF choke

Semiconductors

- D1–D5—1N914B diode
- Q1, Q2—MPF102 transistor
- Q3—2N3563 transistor
- IC1—MC1496L

Other components

- J1, J2, J5, J6—suitable connector of your choice

J3, J4—F-type chassis connector

Miscellaneous: Weatherproof box for the main converter, small metal box for the RCVR/DC adaptor, CB-whip antenna and mounting hardware, PC board, wire, cable, solder, hardware, etc.

Note: A kit containing the PC board and all parts that mount on the board is available from North Country Radio, P.O. Box 53, Wykagyl Station, New Rochelle, NY 10804. Price is \$33.75 plus \$2.50 postage and handling.

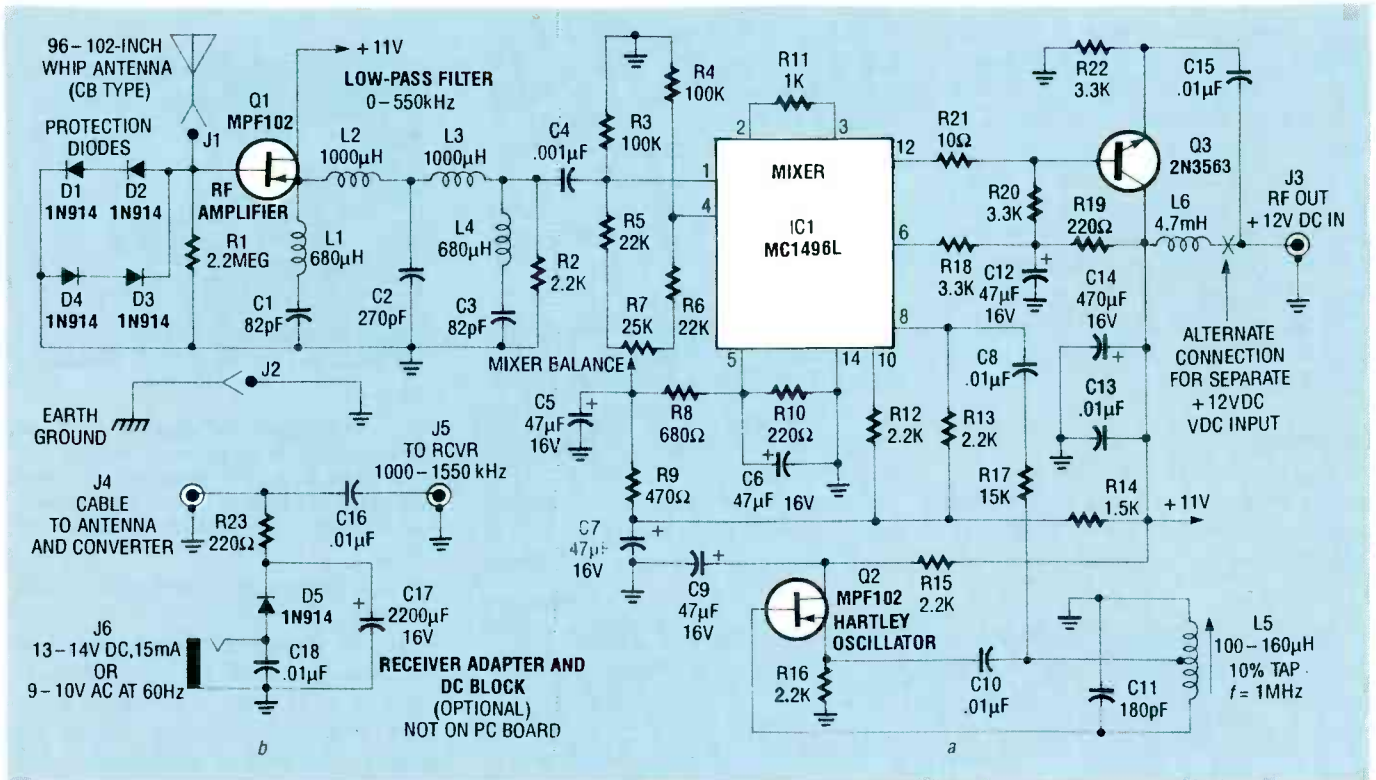

FIG. 1—THIS LOW-FREQUENCY CONVERTER (a) USES A FET-transistor front end, an IC mixer, and Hartley oscillator. Up-converted signals can be heard on any standard AM radio. The receiver/DC adaptor (b) doesn't need a PC board, and can be hard wired in its own metal box.

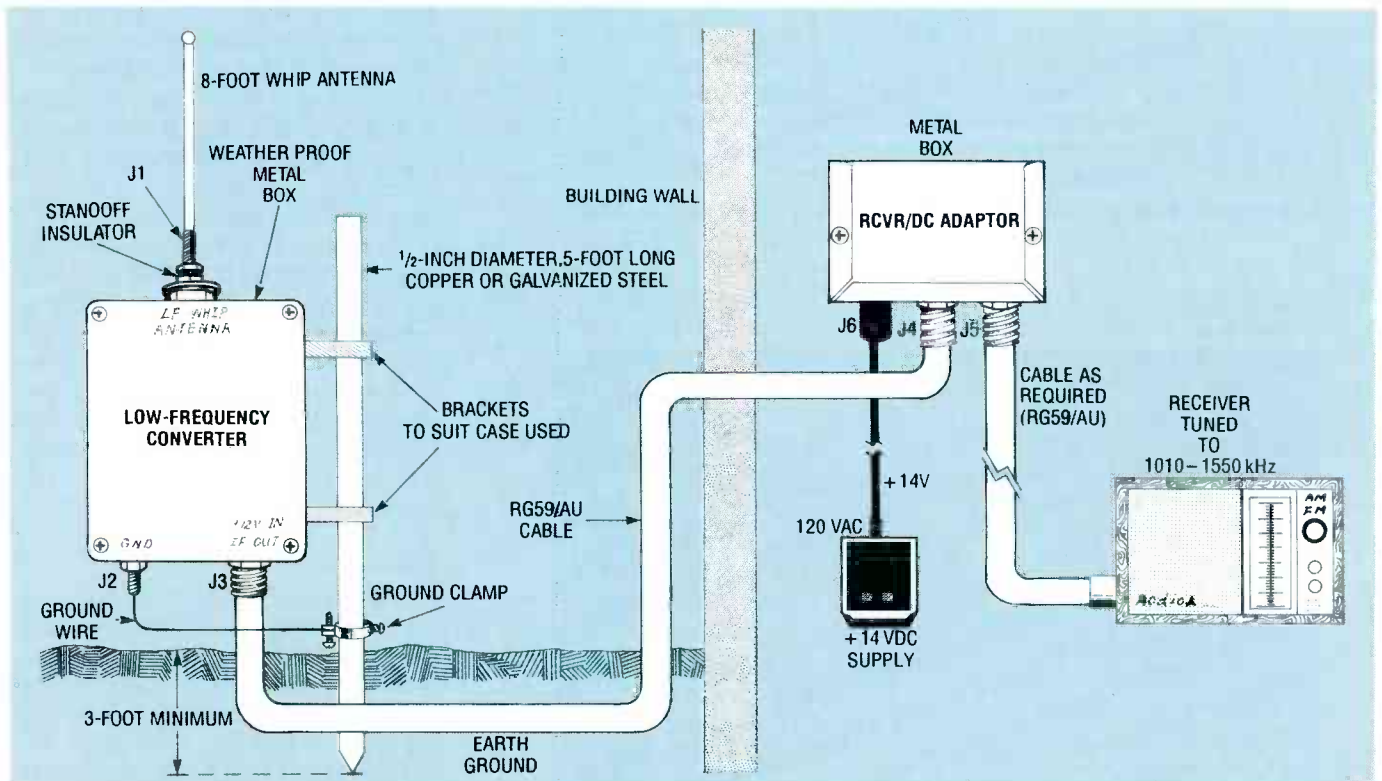

FIG. 2—YOU CAN REDUCE RECEIVED NOISE (HASH) by *not* mounting the LF converter within 50 feet of AC high-tension lines (power poles), near any AC outlet, or near any telephone-service entrance cables.

itor C15 couples the 1010-1550 kHz frequencies from Q3's emitter to output-jack J3, while blocking any DC

bias. Resistor R22 is a DC return and bias resistor for Q3.

Inductor L6 couples the DC volt-

age that's carried in the RF-signal cable from the RCVR/DC adaptor. The DC voltage and RF signals don't in-

terfere with one another at all; that saves running a separate power-supply wire, which simplifies installation at a remote location. Capacitors C14 and C13 provide DC supply filtering.

Figure 1-b shows that the RCVR/DC adaptor is small enough to fit in a small shielded box containing J4, J5, DC-blocking (RF coupling) component C16, and DC filter capacitors C17 and C18. DC is fed in via J6, which should be well filtered (less than 1% ripple).

Installation

The converter with its antenna works best, and has the least noise and interference, when remotely mounted as far away from any AC

wiring and other interfering devices as possible. If you live in a quiet country location or are willing to tolerate some line noise, the converter can be mounted near the receiver. The location is entirely up to you.

Figure 2 shows one possible remote installation. The coaxial cable from J3 carries both RF signals and DC power; that cable is run from the remote converter to a RCVR/DC adaptor or located in your radio shack. The RCVR/DC adaptor helps out in two ways. It pumps DC power down the cable to the converter, and routes RF from the converter into the receiver. An extra volt or two of output DC is recommended to make up for losses in L6 and L7 that have about 60-ohms

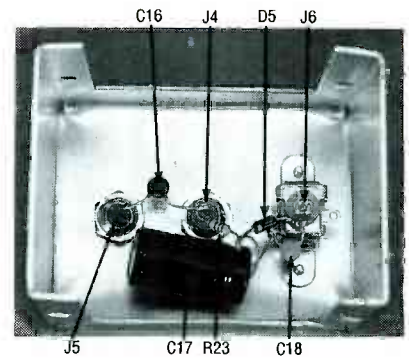

FIG. 5—RECEIVER/DC ADAPTOR allows the converter to be powered through its RF output in remote installations. That way you don't have to run an extra power-supply line all the way out to the converter.

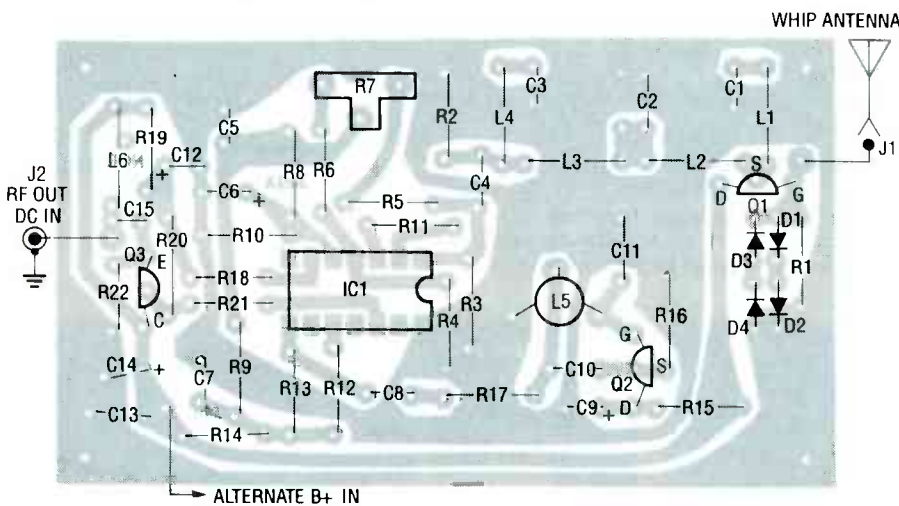

FIG. 3—STUFFING THIS PC BOARD should be easy, even for the inexperienced.

DC resistance each, and cable losses as well.

For local installation (non-remote), inductor L6 may be disconnected from jack J3. The +12-volts DC is then fed directly from any convenient supply, about 11–15 milliamps is all that's required.

Construction

You can etch your own PC board using the artwork in PC service, or order the kit of parts that includes an etched and drilled PC board from the source in the Parts List. Figure 3 should help you stuff the PC board correctly. As you might expect, first mount the resistors and capacitors, then mount D1 through D4, Q1, Q2, Q3, and last install L1 through L6, and IC1. A socket for IC1 is desirable but unnecessary. If you are using a remote installation, then assemble the RCVR/DC adaptor; its parts layout isn't critical, but be sure to completely shield the adaptor in its own metal box to avoid picking up strong AM stations in the 1010–1550-kHz range.

Tuneup

Tuneup is simple. First check all your wiring and components to make sure they're all properly seated and polarities are correct. If everything checks out, connect +12 volts to the adaptor-box jack J6. Now check for +12 volts at J3, or L6 if you are not using a remote setup. Next verify that +11 volts or so is across capacitor C14. Measure the current drain from your +12-volt DC supply, and if you measure more than 15 mA, that may indicate problems.

continued on page 76

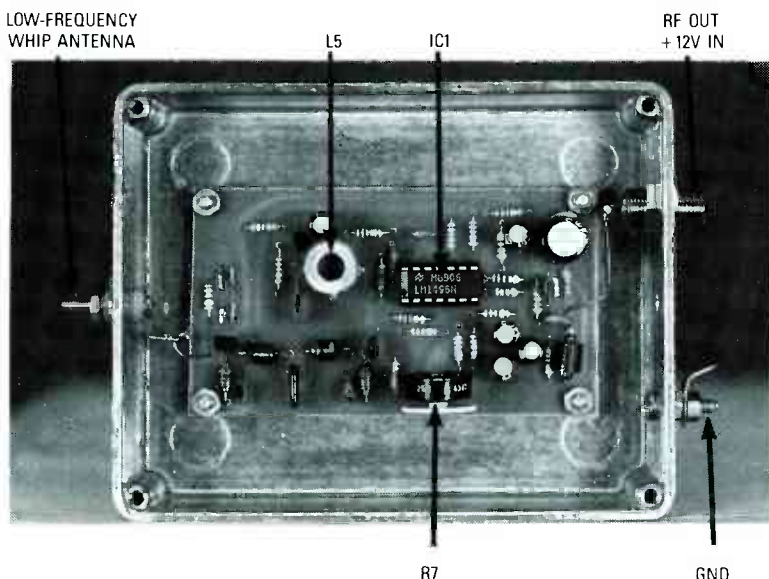
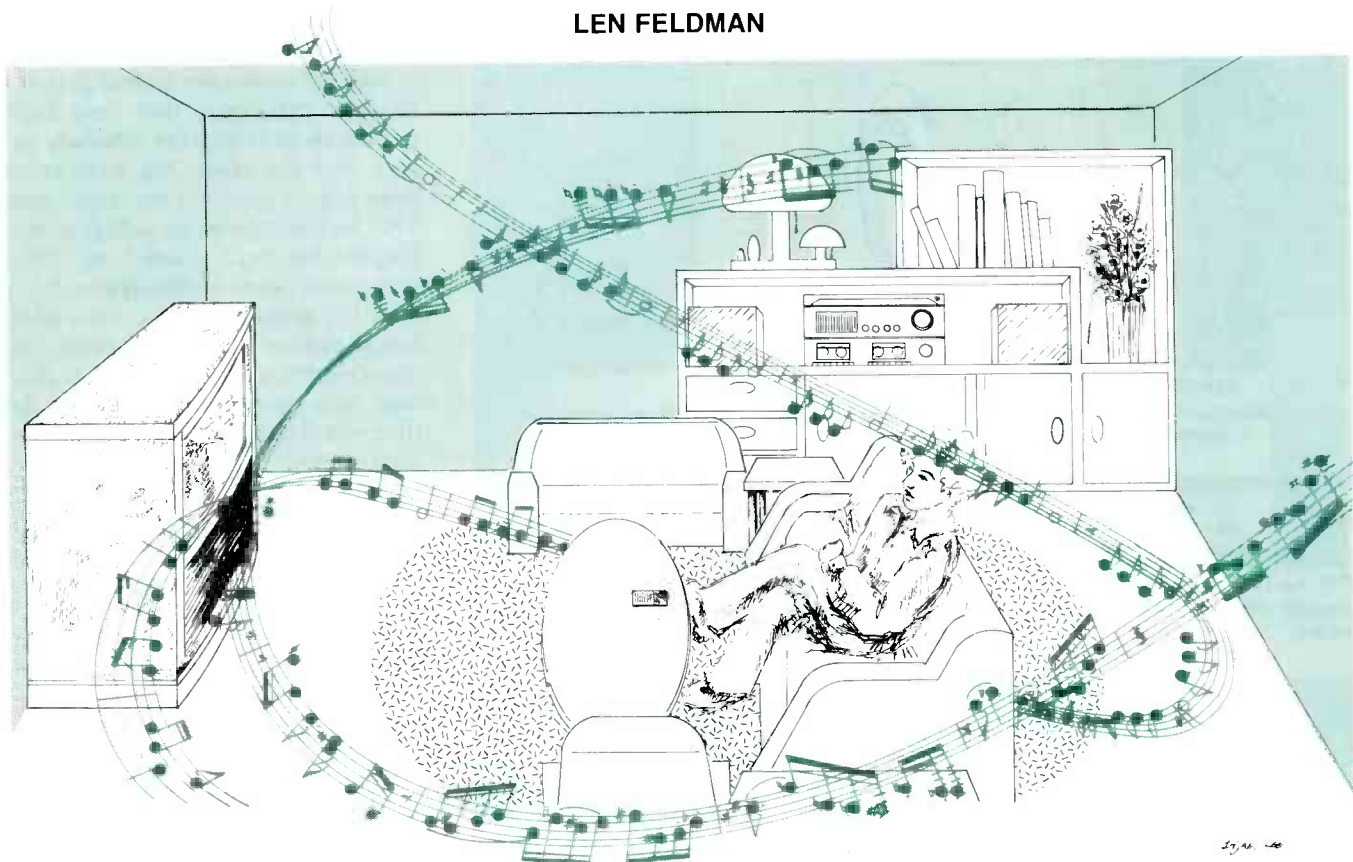

FIG. 4—THE PC BOARD IS MOUNTED IN A METAL BOX FOR RF SHIELDING. Make sure you use small standoffs under the PC board to prevent the copper traces from shorting against the metal box. The author shimmed up the PC-board 1/8 inch by screwing an extra nut under the board at all four corners.

BEYOND STEREO

The Sound Retrieval System adds a new dimension to audio reproduction.

LEN FELDMAN



STEREO SOUND ON BROADCAST TELEVISION HAS BEEN available for about five years, and nearly half of the TV sets sold last year incorporated MTS (Multi-channel Television Sound) decoders. They enable viewers to hear stereo sound tracks from programs that are transmitted locally in stereo, as well as a SAP, or Secondary Audio Program channel, which can be a second-language translation of a movie sound track.

However, for all the success that stereo TV has enjoyed, there are still two major problems with the way stereo TV sound is reproduced in the home. If you depend on your TV's two built-in speakers to provide the stereo effect, you are likely to be disappointed. That's because the two speakers are usually spaced too close to each other to provide a pleasing stereo "sound stage."

If your TV monitor/receiver has jacks for external speakers, you can use a pair of separate speakers, or even your home-stereo speakers. The stereo effect will be best if they are separated by eight feet or more, but then a new problem arises: When actors on the TV screen speak, if you are even slightly off center between the two speakers, you will get the impression that sounds are coming from the nearest loudspeaker instead of from the actor who is speaking.

A psychoacoustic solution

More than two years ago, Hughes Aircraft, a division of the General Motors Corporation, developed what originally started out as a car-stereo enhancement system. It is called the Sound Retrieval System, or SRS for short. Hughes demonstrated the system by placing two small speakers so close together that their side panels practically touched. As you might expect, music played over the speakers sounded "cramped," because it lacked proper stereo imaging and spread. By merely pressing a button, the two little speakers could be made to *sound* as though they had been moved apart to the corners of the room.

Two more knobs allowed the music to be adjusted so that you could walk all around the room without altering the tremendous spread of sound and sense of ambience. The demonstration was so dramatic and effective, that people couldn't help but look for additional hidden speakers. Of course, there were none.

A similar demonstration, this time in a car, revealed that same spread of sound when the "magic" button was pressed. Instead of the sound being confined to the narrow width of the automotive interior, it seemed to extend well outside the car. And while Hughes' primary interest was in enhancing the stereo effect in car-stereo systems, it was

HUMAN HEARING FACTORS

HOW WE PERCEIVE DIRECTION:

RELATIVE PHASE FOR LOW FREQUENCIES (20–200Hz)

RELATIVE INTENSITY FOR MID-RANGE (300–4000Hz)

RELATIVE TIME OF ARRIVAL FOR FAST RISE-TIMES

TRANSFER FUNCTION OF EAR VARIES WITH AZIMUTH DUE TO OUTER EAR (PINNA) COMPLEX SHAPE

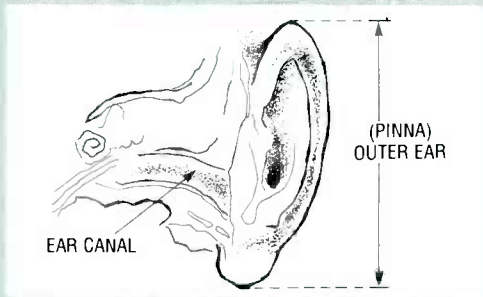

EAR CANAL IS RESONANT AT APPROX 2.5kHz AVERAGE

RESPONSE TO IN-PHASE SOUNDS IS VERY DIFFERENT FROM RESPONSE TO SOUNDS WHICH ARE 180 OUT OF PHASE

CANNOT TELL DIRECTION OF SOUNDS WHOSE WAVE LENGTH IS CLOSE TO EAR-TO-EAR DISTANCE 1.3kHz TO 1.5kHz

FIG. 1—THERE IS A FOURTH FACTOR, that governs the way in which we judge where sounds originate. It has to do with the way our hearing system's frequency response varies.

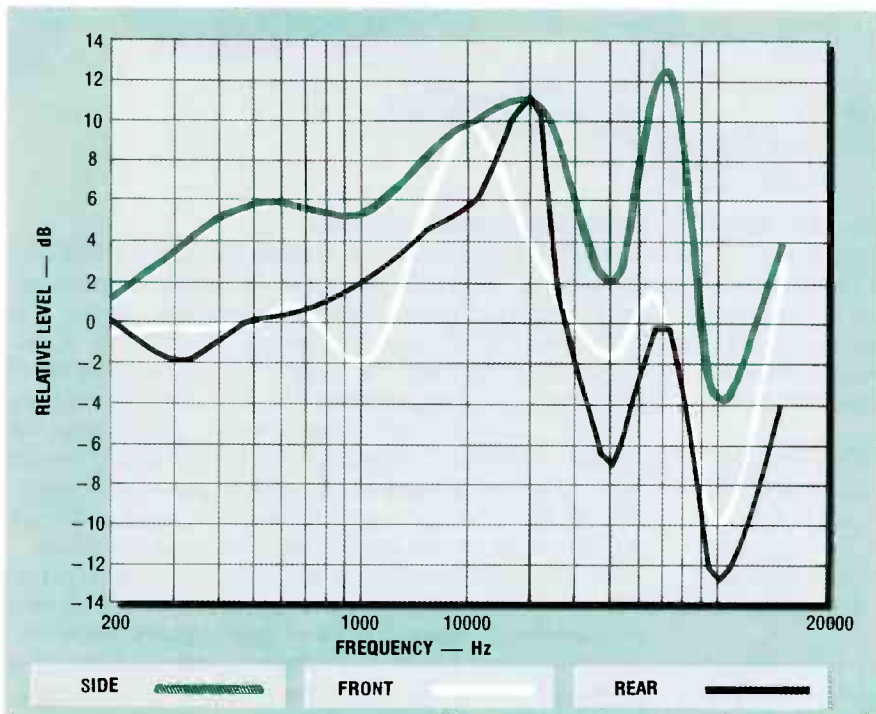

FIG. 2—THE EAR'S FREQUENCY RESPONSE CHANGES with both azimuth and elevation. Here is an example of our hearing system's response to frontal, side, and rear sounds.

clear that stereo TV, which was then just gaining a foothold, could also benefit from this remarkable enhance-

ment. More than a year and a half later, Sony Corporation, having licensed the SRS Technology from

Hughes, has incorporated it into nearly a dozen new stereo TV models, and the sound is truly incredible. (Editor's note: For those of you who don't believe that this new system sounds as good as we say it does, we encourage you to prove it to yourself by going to your local Sony dealer and listening to one of their new SRS-equipped televisions.

Theory and operation of SRS

SRS is based upon several psychoacoustic principles that have been written about in obscure scholarly papers over the years, but have never been put to practical use until now. SRS technology is so valuable that Hughes has been granted one comprehensive patent containing no fewer than 159 separate claims. Two additional patents involving further improvements and additional claims may well have been granted by the time you read this article. Here is how SRS works.

Much of what happens when SRS is working involves psychoacoustics. As Arnold Klayman, the inventor of the system explains it, humans perceive the direction from which sounds come by at least three different means. We detect the relative phase of sounds in the case of low frequencies (between about 20 Hz and 200 Hz.) For mid-range sounds (300 Hz to 4000 Hz), we detect the relative intensity. That means that sounds coming from one side sound louder to the nearest ear, and softer to the other ear. For higher frequency sounds—those having a fast rise time—we judge direction by the relative time of arrival. Those sounds reach the closest ear sooner than they reach the farther one.

There is, however, a fourth factor that governs the way in which we judge where sounds originate, which, up to now, has been ignored in stereo-reproducing systems. That factor has to do with the way our hearing system's frequency response varies (see Fig. 1).

The outer ear, known as the pinna, has an effect on the spectrum of the sound reaching the eardrum, while the concha (the section that leads to the ear canal) has an effect on the frequency at which the ear canal is resonant. Together, those two parts of the ear control the spectral shape (frequency response) of the sounds reaching the eardrum. In other words, the system functions as a sort of multiple

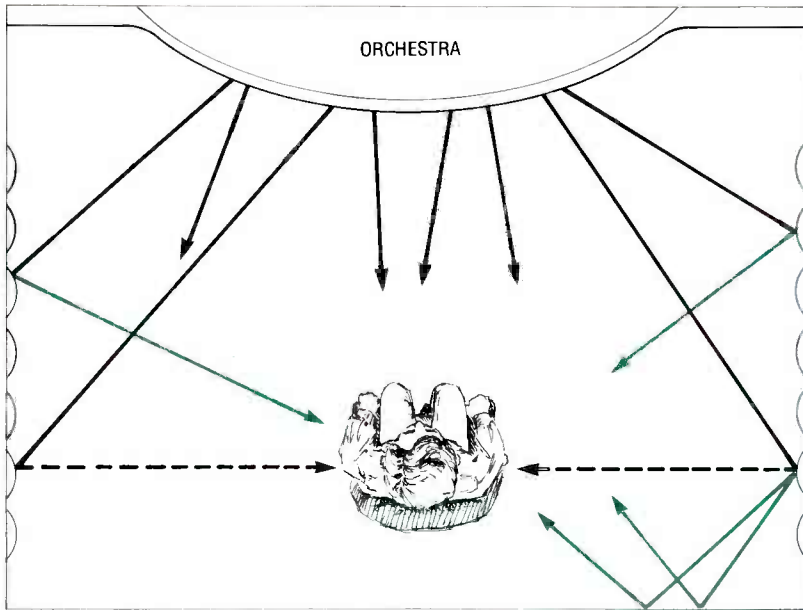

FIG. 3—AMBIENT, REFLECTED, AND SIDE SIGNALS produce a complex sound field.

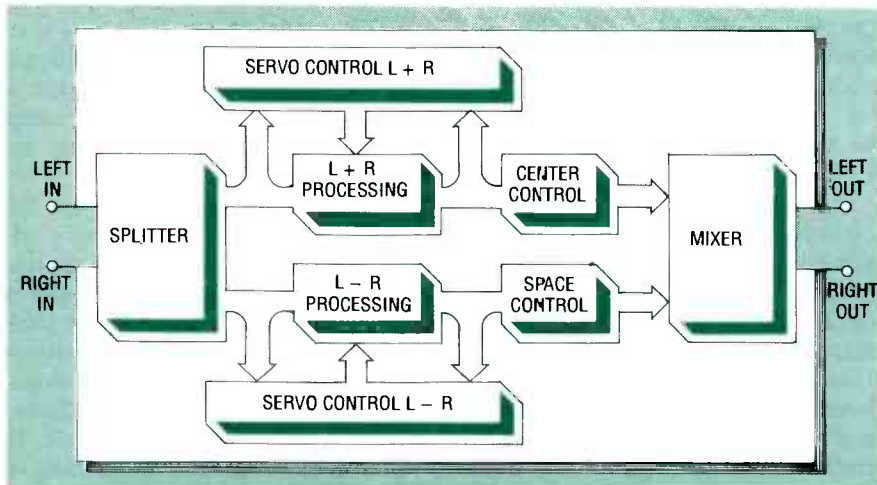

FIG. 4—BLOCK DIAGRAM OF THE SRS CIRCUITRY. Control circuits detect the content of the music, and dynamically adjust both the level and the spectral content of the sum and difference signals.

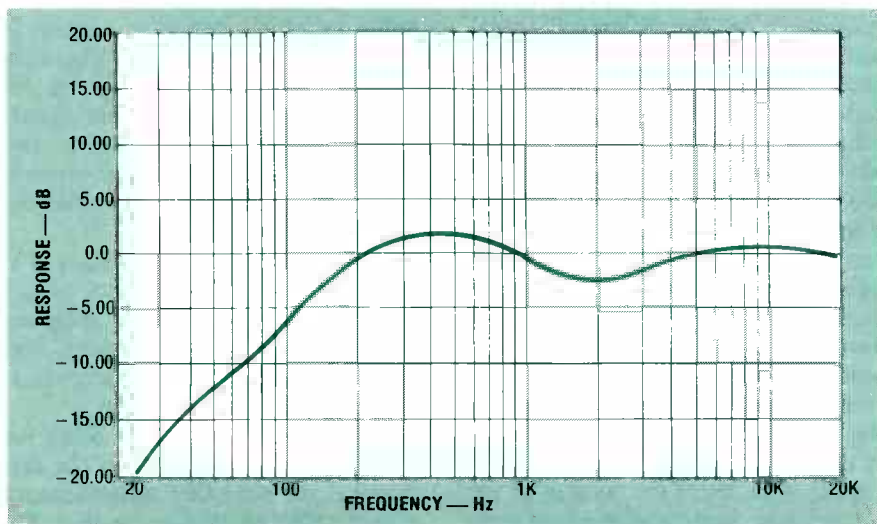

FIG. 5—FREQUENCY RESPONSE at the L - R test point, with only the left signal applied to the input.

filter, emphasizing some frequencies, attenuating others, and letting some through without any change at all. The ear's frequency response changes with both azimuth and elevation, and together with our binaural (two ear) capabilities, they help us determine whether a sound is coming from above, below, the left, the right, ahead, or behind. Examples of our hearing system's response to frontal sounds, sounds from the side, and from behind are shown in Fig. 2.

As Klayman went on to explain, "Microphones used in making recordings don't behave like human ears. Omnidirectional microphones have a flat frequency response for sounds coming from all directions. Cardioid, or directional microphones have a flat response for sounds coming from the sides and from the front, but are 'dead' to rear sounds. So, during playback, if sounds that originally came from the side are reproduced by speakers located 'up front,' those sounds are heard with an incorrect spectral response. The result is a spatial distortion of the sound field, and we are prevented from hearing the proper spatial cues of what was originally performed."

The SRS technique helps to correct those problems by processing the audio signals so that the spatial cues are restored. SRS first combines or adds together the left and right channels to create a sum signal ($L + R$). It then subtracts each one from the other to create two difference signals; ($L - R$) and ($R - L$).

The signals are then subjected to various forms of processing and equalization. Ambience and spatial characteristics are derived from the processed difference signals. Dialogue, vocalist, and soloist sounds are derived from the processed sum signal. Once the complex and dynamic processing sequence has taken place, the signals are revised and reconstructed into new ($L + R$) and ($L - R$) signals, which are matrixed back together in the same fashion used in stereo FM and in stereo TV. That is, using simple algebra, the new ($L + R$) is added to the new ($L - R$), yielding a new L signal (actually $2L$, but the 2 is simply an amplitude coefficient which can be ignored). The new ($R - L$) signal is added to the new ($L + R$) signal to form a new R signal.

In a stereophonic signal, sounds coming from "in front" of you pro-

Be an FCC LICENSED ELECTRONIC TECHNICIAN!



No costly School. No commuting to class. The Original Home-Study course prepares you for the "FCC Commercial Radio-telephone License". This valuable license is your "ticket" to thousands of exciting jobs in Communications, Radio-TV, Microwave, Computers, Radar, Avionics and more! You don't need a college degree to qualify, but you do need an FCC License.

No Need to Quit Your Job or Go To School
This proven course is easy, fast and low cost! **GUARANTEED PASS**— You get your FCC License or money refunded. **Send for FREE facts now. MAIL COUPON TODAY!**

COMMAND PRODUCTIONS

FCC LICENSE TRAINING, Dept. 90
P.O. Box 2824, San Francisco, CA 94126
Please rush FREE details immediately!

NAME _____
ADDRESS _____
CITY _____ STATE _____ ZIP _____

LEARN VCR CLEANING/MAINTENANCE/REPAIR

EARN UP TO \$1000 A WEEK, WORKING PART TIME FROM YOUR OWN HOME!



THE MONEY MAKING OPPORTUNITY OF THE 1990'S

IF you are able to work with common small hand tools, and are familiar with basic electronics (i.e. able to use voltmeter, understand DC electronics)...

IF you possess average mechanical ability, and have a VCR on which to practice and learn... then we can teach YOU VCR maintenance and repair!

FACT: up to 90% of ALL VCR malfunctions are due to simple MECHANICAL or ELECTRO-MECHANICAL breakdowns!

FACT: over 77 million VCRs in use today nationwide! Average VCR needs service or repair every 12 to 18 months!

Viejo's 400 PAGE TRAINING MANUAL (over 500 photos and illustrations) and AWARD-WINNING VIDEO TRAINING TAPE reveals the SECRETS of VCR maintenance and repair—"real world" information that is NOT available elsewhere!

Also includes all the info you'll need regarding the BUSINESS-SIDE of running a successful service operation!

FREE INFORMATION
CALL TOLL-FREE 1-800-537-0589

Or write to: Viejo Publications
3540 Wilshire BL. STE 310
Los Angeles, CA 90010 Dept RE

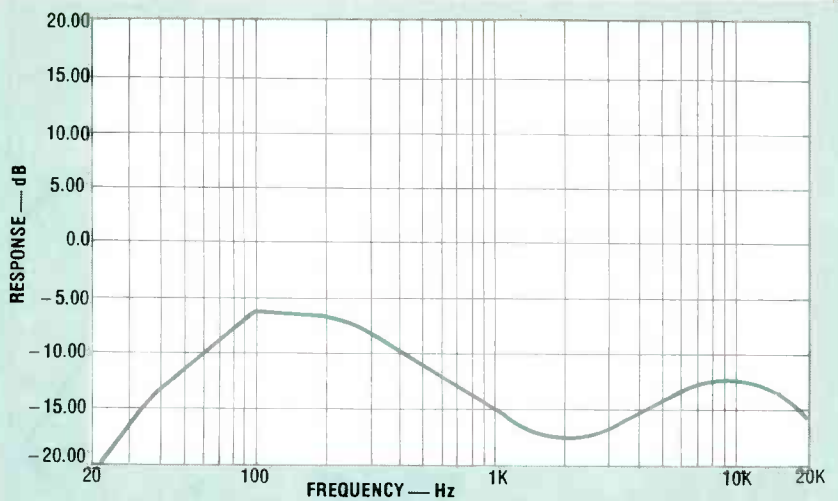

FIG. 6—FREQUENCY RESPONSE at the R - L test point, with only the left signal applied to the input.

duce equal-amplitude sounds in the left and right channels, and are therefore present in the sum signal (L + R). Ambient, reflected, and side signals produce a complex sound field (see Fig. 3), and are present primarily in the difference signals (L - R and R - L).

The Hughes SRS circuitry processes the difference signals to bring back the missing spatial cues and directional information. The difference signals are then dynamically increased in amplitude in order to increase the apparent image width. However, since the ear has increased sensitivity to mid-range frequencies, selective emphasis of the difference signals is necessary to produce a realistically wider stereo image without introducing annoying image shifts.

The selective emphasis of certain frequencies in the difference signal accomplishes several things. For the quieter components, it further enhances the stereo image by restoring the ambience of the live performance, which is normally masked out by the louder, direct sounds. It also provides a much wider listening area, as you can walk about the room and still retain a sense of direction of all the musical instruments—you no longer have to sit midway between the two loudspeakers!

There's a lot more going on inside the SRS circuit than what we've briefly described. There are many control circuits that detect the content of the music, and dynamically adjust both the level and the spectral content of the sum and difference signals. Figure

4 shows the block diagram of the SRS circuitry.

The frequency response curves of the (L - R) and (R - L) signals are shown in Figs. 5 and 6 respectively. It is clear that the SRS system does alter or equalize the response of the derived signals.

The selective boosting of the difference signal is automatically adjusted while audio signals are applied so that the perceived stereo effect is relatively consistent. Without such automatic adjustment, the amount of enhancement provided would have to be manually adjusted for different program material. For example, in order to avoid excessive boosting of artificial reverberation, which is sometimes added to stereo recordings, the enhancement technique of the SRS deemphasizes the frequency range in which excessive reverberation is most likely to occur. That area is then reinforced by appropriate injection or addition of the sum signal. The perceived effect is that the amount of artificial reverberation does not change appreciably when the SRS is turned on and off.

In the SRS-equipped Sony TV sets, there is only an SRS on/off switch. That's because the speakers are at a known distance apart, and because stereo TV broadcasts are handled in a predictable manner.

The license acquired by Sony for SRS is non-exclusive, so don't be surprised if you see other manufacturers offering SRS technology in their TV sets and audio components in the not too distant future.

R-E

KEEP YOUR VCR HEALTHY

Troubleshooting VCR tape-loading problems

PETER M. HANSEN

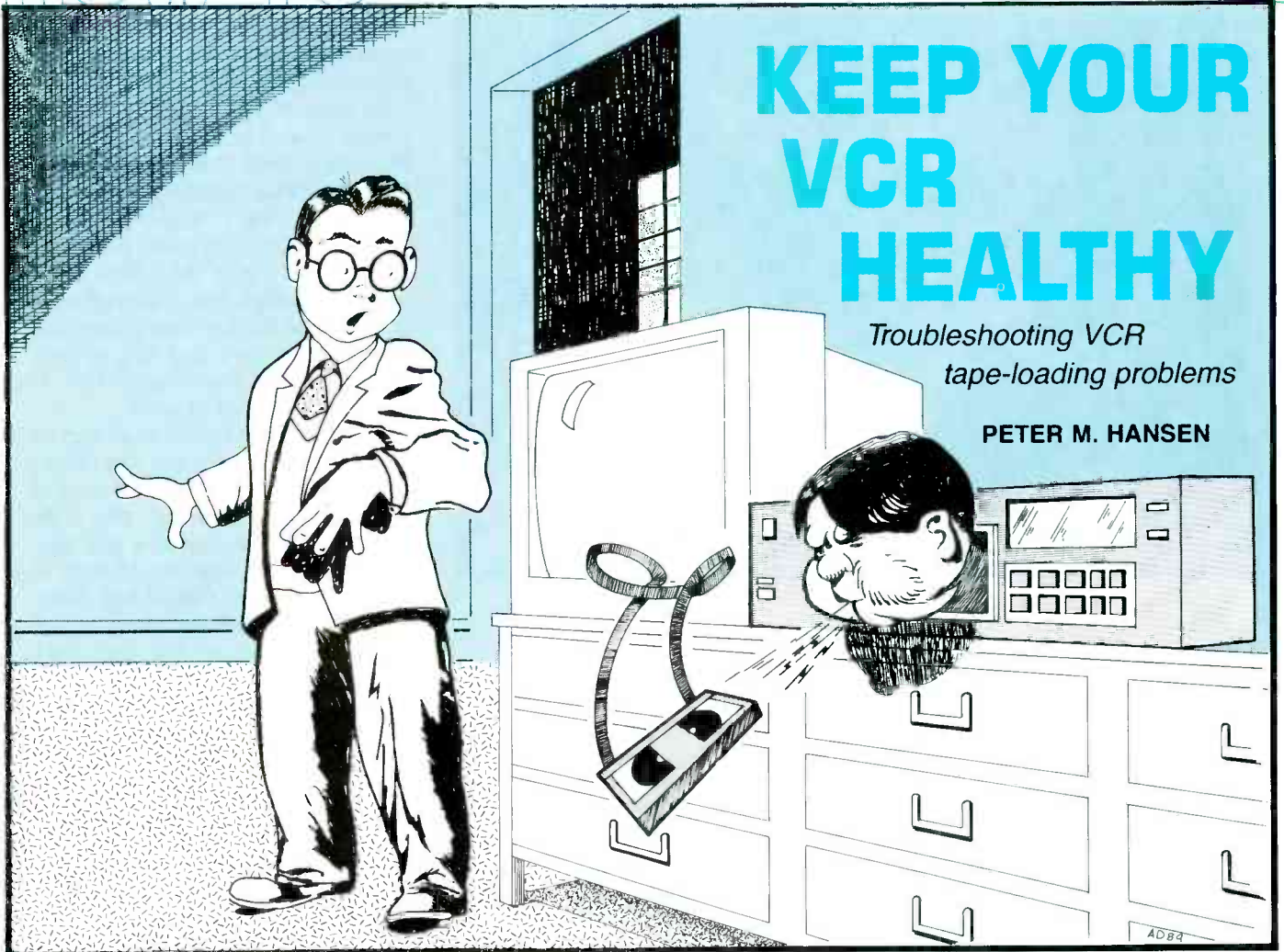

ONE OF THE MOST COMMON PROBLEMS found in VCR's is the inability to properly load a tape. Before you try to fix any VCR, though, you should be somewhat familiar with basic VCR disassembly skills and simple servicing precautions. You can learn about the various components inside a VCR by reading our last article on VCR maintenance (**Radio-Electronics**, March 1989). That article covered basic VCR mechanism identification, cleaning techniques, and the necessary hand tools.

Tape-load problems

It is important that you clearly understand the difference between cassette-loading problems and tape-loading problems. A cassette-loading problem is where the cassette carriage assembly does not properly accept the cassette (the shell) into the VCR. A tape-loading problem is when the tape is not properly extracted from the

cassette once the cassette is fully seated inside the VCR.

Figure 1 shows the basic VCR components. You should be somewhat familiar with them before attempting any servicing, but right now our main concern is the tape-loading process. To be able to see the internal components, you first have to remove the VCR's top cover and head shield. You may also have to remove the cassette carriage in order to fully access the components involved in the tape-loading process. Figure 2 shows the cassette carriage being removed from a VCR—there are usually four Phillips-head screws on the top of the assembly that secure it to the VCR chassis. Figure 3 shows the cassette carriage assembly by itself. The gear block and motor assembly on the right side of the carriage is the drive system that is used in front-loading VCR's to load the cassette into the VCR when it is first inserted.

The VCR's guide rollers and slant poles are what actually extract the tape from the cassette and guide it across the video head/drum assembly. After you select play or record, you will see the two guide posts start the tape-extraction process; the video drum starts to spin counterclockwise (it reaches 30 rpm in about 3 seconds), and the pinch roller starts its short movement toward the capstan shaft. It is the action of the pinch roller "pinching" the rotating capstan shaft that actually pulls the tape through the machine during play or record.

Most recent VHS VCR's use a dedicated DC motor to load the tape across the video-drum assembly. The motor is located either above or below the mechanism, and is usually driven by an integrated circuit that receives the motor load and unload signals from the VCR's main microprocessor. Figure 4 shows a typical tape-load

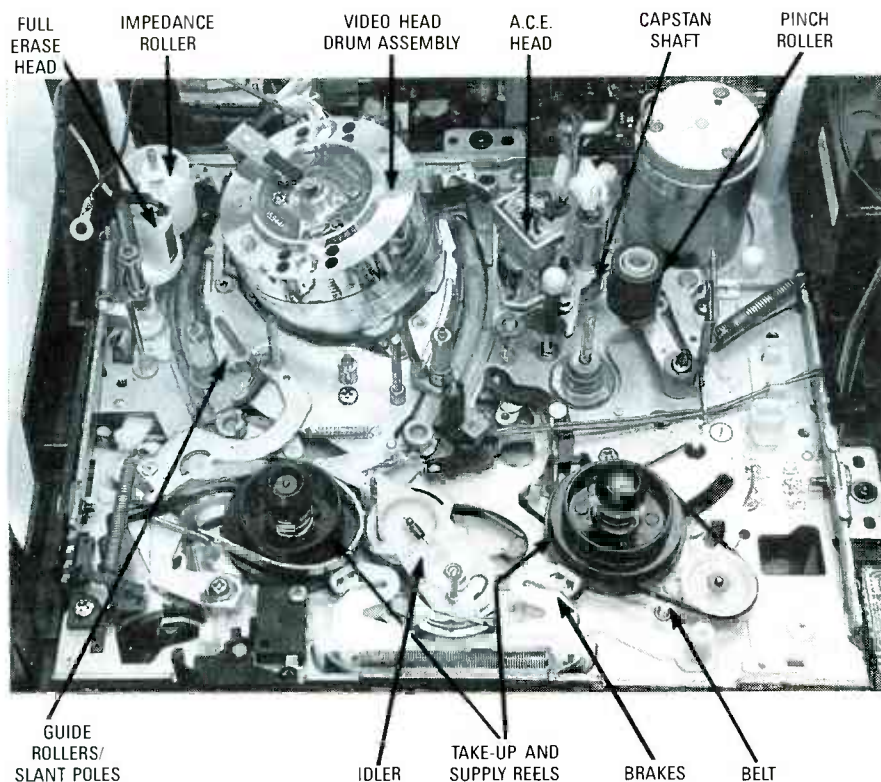

FIG. 1—MAJOR VCR COMPONENTS. You should be able to identify these basic mechanisms found in all VCR's.



FIG. 2—THE CASSETTE CARRIAGE assembly is usually secured to the VCR chassis by four Phillips-head screws.

motor located on the bottom of the VCR's chassis; in this case, the unit is a later model Fisher VCR. In Fig. 5 we see a load motor that is located on the top of the mechanism, with the video drum behind it.

Tape-loading components

The load gear train is located (almost always) on the VCR's bottom side chassis. The load gear train is connected to the load motor via the load belt (or worm gear) and associated linkage rods and connectors. The load-gear assemblies are made out of hard plastic, and have one and sometimes two cam gears with grooves that contain a lubricant. Figure 6 shows a typical loading-gear train on the bot-

tom side of the chassis.

To get at components on the underside of the chassis, first make sure that power is off and the unit is unplugged, and then remove the VCR's bottom plate. There are usually several Phillips screws securing the bottom plate to the chassis. Next, you have to identify the screws that secure the PC

board to the chassis. Many times there will be identifying arrows printed on the PC board indicating which screws must be removed. If you remove the wrong ones, you may be dismantling the wrong thing.

In some VCR's, you must remove the front panel in order to release the PC board. Many times the front-panel assembly (which contains the switches, display, etc.) is secured to the chassis by small (fragile) plastic retaining tabs—give the unit a close visual inspection *before* attempting to remove it so that you don't crack anything! Remember that any mistake can cause you much grief—not to mention the added expense.

With the VCR placed in its service position (see Fig. 7), you can closely observe the loading components during a tape load. To do that, plug in the unit, insert an inexpensive test tape, and hit the play button. As soon as you hit play, you should see movement of the loading gear train as well as the the guide posts. On many units, you'll also see the cam gear as it shifts position from "stop" to "fully loaded." Sometimes a mirror placed on your workbench surface can help you see both sides of the VCR's loading mechanism simultaneously.

Diagnosing malfunctions

A very common malfunction in VCR's is cracked, dirty, or worn (slippery) load belts. The major symptom of that is that when the operator se-

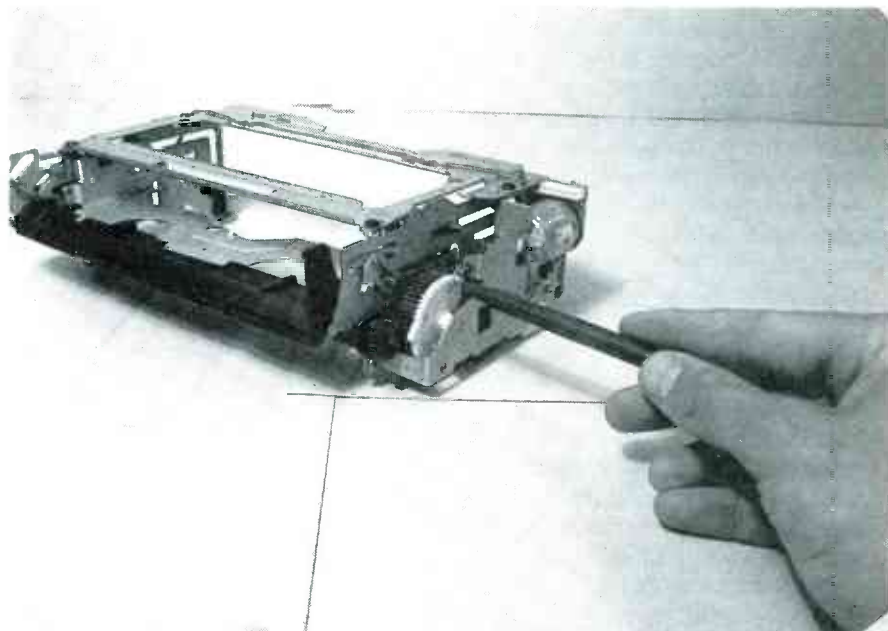

FIG. 3—THE GEAR BLOCK AND MOTOR ASSEMBLY on the right side of the carriage is the drive system that accepts the cassette into a front-loading VCR.

lects play or record, the guide posts will start their path toward the "V" stoppers (the metal brackets situated at the end of the loading grooves), but they will not reach the end of their path. Many times they will appear to have completed the load process, but closer inspection reveals that they only completed about 90% or 95% of the load process. The loading posts will then start retracting back toward the stop position and the video drum will stop spinning. Most of the time, that type of failure is due to a bad load belt.

Because the slipping load belt prevented the load posts from traveling their full distance, the microprocessor did not receive what's called the "load complete," the "after load," or, more simply, the "AL" signal. Some of the older units have a small microswitch embedded in the load gear train that is activated when the load posts are fully extended. However, most newer VCR's have infrared sensors built into the cam-gear assembly that transmit the various mechanical load stages during the tape-load mode to the microprocessor.

In an aborted tape-load attempt, you will also be able to see that the pinch roller does not come in contact with the capstan shaft. The pinch roller will come in contact with the capstan shaft only when the system microprocessor receives a load-complete signal.

A simple test for a malfunctioning load belt is to "assist" the load pro-



Peter M. Hansen is the author of the *Viejo Method of VCR Maintenance and Repair* and president of Viejo Publications. The manual is available with or without the VCR-maintenance kit and training video. The kit contains VCR cleaning materials and an assortment of replacement belts, tires, idlers, etc. Contact Viejo Publications, 3540 Wilshire Blvd., Suite 310, Los Angeles, CA 90010. 1-800-537-0589.



FIG. 4—A TYPICAL LOAD MOTOR is located on the bottom side of the VCR's chassis.

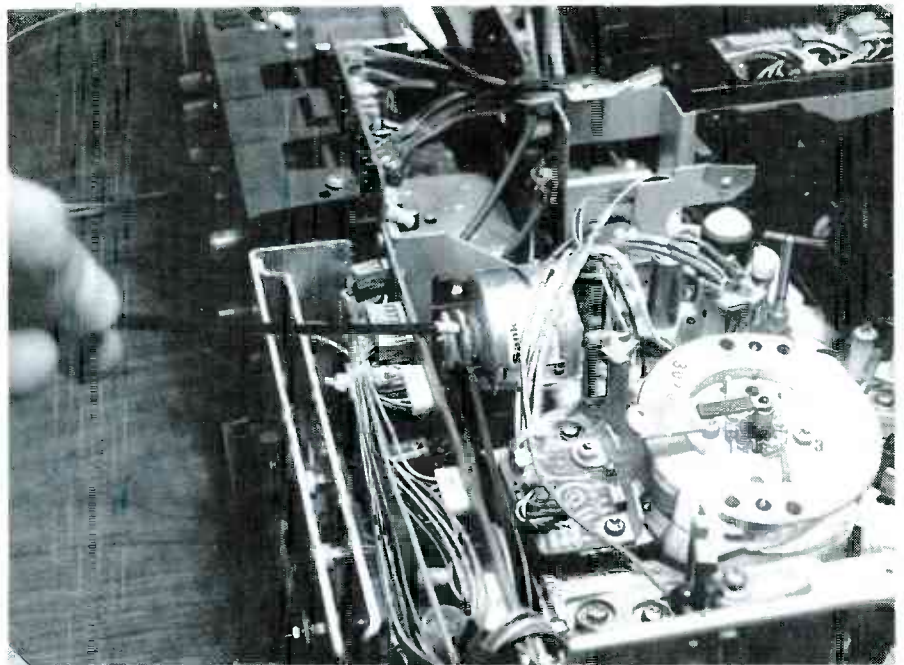

FIG. 5—THIS LOAD MOTOR is located on top of the mechanism, with the video drum directly behind it.

cess with your finger (see Fig. 8). With the VCR in its service position, and a tape inside the machine, select the play mode; you should have your index finger or thumb placed gently on the load-motor shaft. You will feel the rotation of the load motor shaft against your finger. Wait for the load process to be completed (when the load posts appear to have reached the end of their travel), and then "assist" the load process by manually turning

the load motor shaft in the same direction as it was turning by itself. If the belt is bad, the action of your finger will most likely complete the load. The load-complete signal will now be received by the microprocessor, which will issue the signal to activate the pinch roller. A bad belt should be replaced, but sometimes you can extend its life a bit by cleaning the belt and applying some rubber revitalizer.

Sometimes the lubricant that is ap-

Get A Complete Course In

ELECTRONIC ENGINEERING

8 volumes, over 2000 pages, including all necessary math and physics. 29 examinations to help you gauge your personal progress. A truly great learning experience.

Prepare now to take advantage of the growing demand for people able to work at the engineering level.

Ask for our brochure giving complete details of content. Use your free information card number, or write us directly. **\$99.95**, Postage Included. Satisfaction guaranteed or money refunded.



**Banner
Technical
Books, Inc.**

1203 Grant Ave.
Rockford, IL 61103

CIRCLE 67 ON FREE INFORMATION CARD

If You Fix VCR's, Ask Yourself These Questions

Q Are Most VCR Problems Mechanical?

A Yes, most agree more than 3 out of 4 VCR problems are due to a mechanical malfunction.

Q Are There Universal Test Tools Available Or Do You Have To Buy All The Different Tools Shown In Service Manuals?

A TENTEL provides easier to use, universal, more powerful gauges than all factory tools combined.

Q What Mechanical Measurements Should Be Made To Properly Check Out A VCR?

A Hold back tape tension, tension servo check, reel table heights, carriage alignment, tape guide height, take up torque, restoring torque, brake torques, FF/REW torques & video head wear.

NEW - Just released 68 minute Video Training Tape covering over 28 mechanical VCR tests and measurements
INTRODUCTORY **\$24⁹⁵**
PRICE Shipping Included

New Address! TENTEL® Corporation
4475 Golden Foothills Pkwy
El Dorado Hills, CA 95630
(800) 538-6894 / (916) 939-4005
(In California)

CIRCLE 185 ON FREE INFORMATION CARD

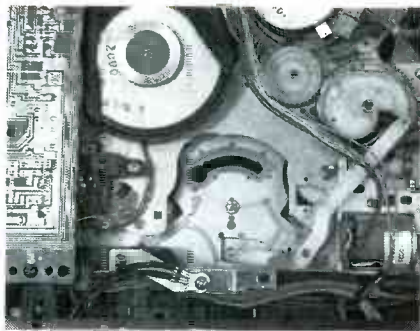

FIG. 6—A TYPICAL LOADING GEAR train is usually covered by a protective plastic guard that must be removed for servicing. This gear train is on the bottom of the chassis.

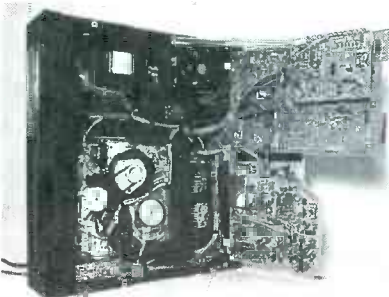

FIG. 7—A VCR IN ITS SERVICE POSITION. A mirror on your workbench surface will allow you to see both sides of the VCR simultaneously.

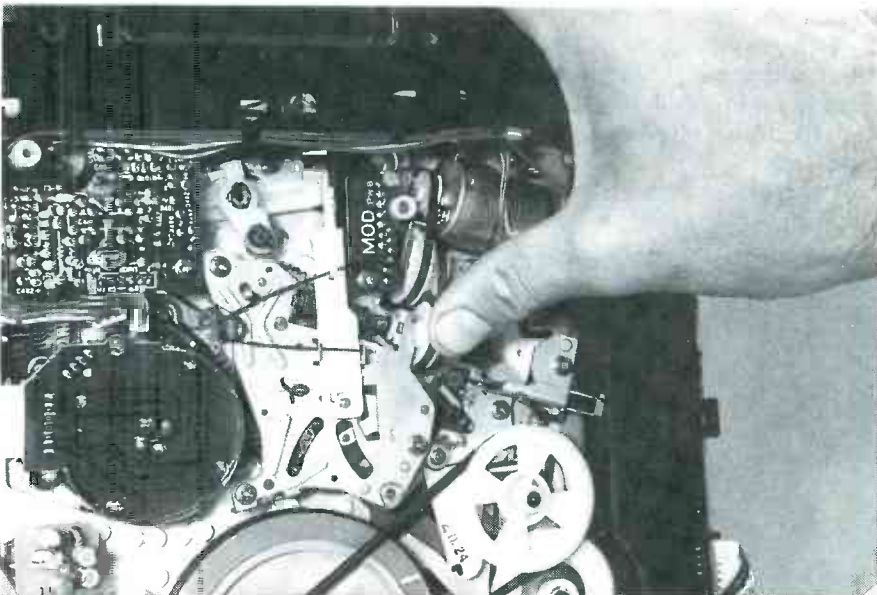

FIG. 8—A MALFUNCTIONING LOAD BELT is can be tested by "assisting" the load process with your finger.

plied in sliding tracks and to various components dries up and hardens. That can cause much added friction for the load components, and may cause the load to be aborted. If that's the case, you have to dismantle the assembly, clean off the dried-up lubricant, and apply a fresh coat. It is best to use a cleaner like acetone for re-

moving the old lubricant. It is also a good idea to first take a photo or make a quick sketch of an assembly before dismantling it for cleaning, so that everything goes back correctly. Many times there will be small alignment arrows imprinted on the gears themselves—pay careful attention to any arrows, as they must be exactly aligned during reassembly.

If the load belt appears to be good, and there is no dried-up lubricant, then you have to inspect the load gears for any signs of cracking—especially hairline cracks. Any gears that show signs of cracking must be replaced. Note that load motors do not usually go bad, but if there is excess freedom of shaft movement, or any signs of excessive friction in the motor, it may have to be replaced.

Another quick test of the load system is to perform a tape "load" by hand, with the unit unplugged and no tape inserted. That will provide an unobstructed view of the loading mechanisms as they operate. Also, the loading process will be greatly slowed down, so you'll be able to see—and perhaps even feel—exactly when a problem occurs. Then you can

determine which part might be causing it to happen. To perform the test, turn the load-motor shaft by hand and observe the unit's operation. Watch for freedom of movement of all of the mechanical components involved in the load process, and check for any obstructions that may impede proper loading.

R-E

OP-AMPS IN INSTRUMENTATION

Op-amps show their versatility in instrumentation circuits.

RAY MARSTON

PRECISION VOLTMETERS, AMMETERS, AND ohmmeters use op-amps in a wide variety of applications. You'll find op-amp rectifiers, range-scaling networks, converters, and voltage references. Let's take a look at how those circuits work.

Electronic rectifiers

Conventional diodes can't rectify millivolt AC signals because they don't conduct until their *knee* voltage is exceeded. Silicon diodes have knee values of about 600 mV, and thus don't rectify AC voltages below that value. Luckily, op-amps can effectively reduce the diode's knee voltage by a factor equal to the open-loop gain; a diode can then rectify AC-signal amplitudes that are smaller than a millivolt.

Figure 1 is a half-wave rectifier connected as a noninverting amplifier; feedback is through D1. (Notice that the rectified output is taken from the inverting input.) When the noninverting AC- V_{IN} swings positive by only a few microvolts, the output is quickly driven to D1's 600-mV knee voltage. The feedback through D1 forces the inverting input to accurately follow the positive-input signals. However, when the AC- V_{IN} swings negative, the negative output causes D1 to become reverse-biased, whose reverse-leakage resistance (typically hundreds of megohms) acts as a voltage divider with R1; that determines the op-amp's voltage gain during the negative-input swing. The circuit thus follows the positive-input signals, but rejects the negative ones and, hence, has the characteristics of a nearly perfect rectifier.

Figure 2 shows a peak-voltage detector. Capacitor C1 charges rapidly through D1 to the peak positive value of AC V_{IN} , but discharges slowly

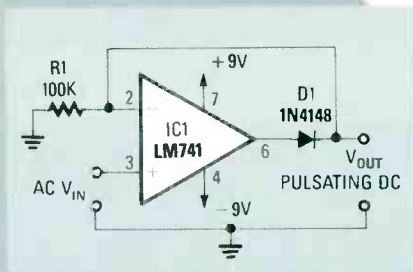

FIG. 1—HALF-WAVE RECTIFIER circuit.

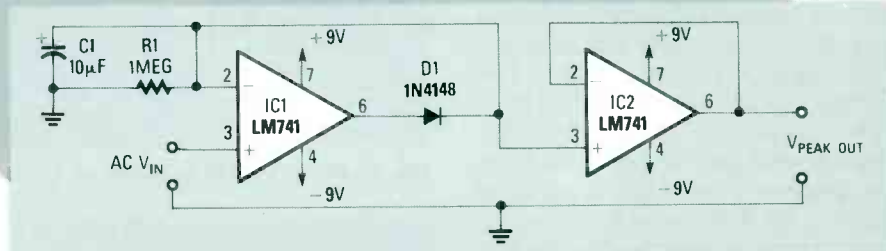

FIG. 2—PEAK DETECTOR with buffered output.

through R1 when the signal falls below the peak value. Meanwhile, IC2 is used as a (voltage follower) buffer stage, so that R1 is not shunted by any external loading.

Precision rectifiers

Figure 3 shows a precision half-wave rectifier. When the AC V_{IN} goes negative, the output swings positive, which forward biases D1. The op-amp's gain equals unity because D1's forward resistance is negligible. When the AC V_{IN} goes positive, the output swings negative, but is limited to -600 mV by D2. Resistor R3 corrects for op-amp DC-current errors, and holds the noninverting input at ground potential. The negative-feedback loop will always try to hold pin 2 at virtual ground (because the idea is to drive the inverting input to the same potential as the noninverting input.) Consequently, the output at D1's cathode does not swing much below zero. The V_{OUT} is a positive-going half-wave rectified signal that resembles pulsating DC. To produce a

negative-going half-wave rectified output, the polarities of the two diodes must be reversed.

Figure 4 shows how to combine an op-amp half-wave rectifier and an inverting amplifier to build a precision full-wave rectifier. When the AC V_{IN} swings negative, the inverted output of IC1 goes to near zero because of D2. At the inverting input of IC2, the

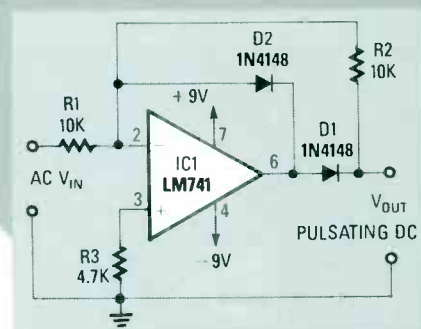

FIG. 3—PRECISION HALF-WAVE rectifier.

AC V_{IN} (via R4-R5) is simply inverted to produce a $+V_{OUT}$. The circuit analysis for the positive swing of AC V_{IN} is a bit more complicated. Op-amp IC1 inverts the signal to produce a negative output that is passed through D1 to the summing junction of IC2, where it's combined with the positive AC V_{IN} (via R4-R5). At the summing junction, the negative output of IC1 is doubled and inverted via IC2, R3-R5, to produce a $+2V_{OUT}$, while the positive AC V_{IN} is only inverted via IC2, R4-R5, to produce

is distinguished from power supplies using an output filter-capacitor, which delivers a steady-state DC equal to the rectifier's peak output-voltage.

Digital meters

Precision Digital Volt Meter (DVM) modules using op-amps can form the basis of a DC multimeter. To function as a multirange DC voltmeter, the input voltage is conditioned through an attenuation network; for a multirange DC ammeter, the input current is applied through a multi-range current shunt.

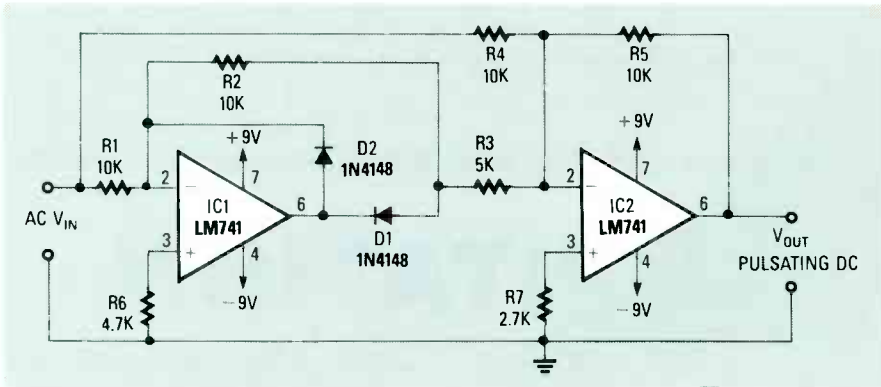

FIG. 4—PRECISION FULL-WAVE rectifier.

a $-V_{OUT}$. The summing resultant is $+V_{OUT}$ at the IC2 output that is equal to the original AC V_{IN} positive swing. Therefore, the IC2 output signal is always a positive-going full-wave rectified signal.

AC-to-DC converters

In a standard DC power supply, a rectifier takes the AC current from a step-down transformer and produces a pulsating DC current, which is then filtered into steady-state DC by a large filter capacitor. That system has worked great for years, and still does, but designers' would like to get rid of those bulky filter capacitors; and indeed, a more compact arrangement is possible by using an op-amp rectifier combined with an integrating feedback-capacitor.

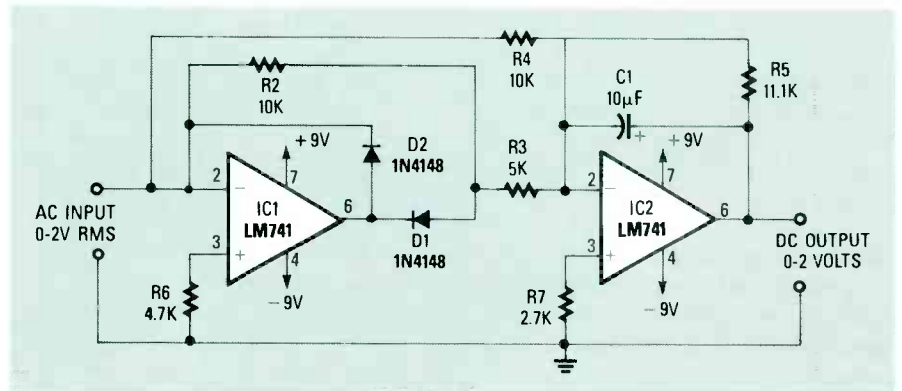

FIG. 6—PRECISION FULL-WAVE AC/DC converter.

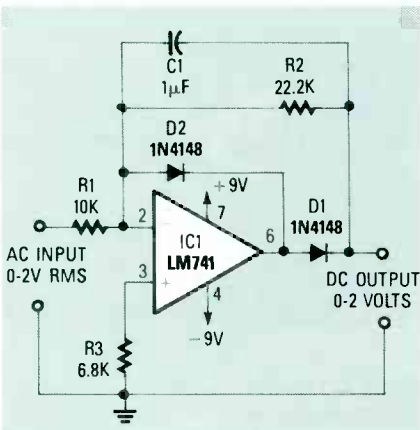

FIG. 5—PRECISION HALF-WAVE AC/DC converter.

Figure 5 shows a half-wave converter that uses a voltage gain of 2.22 via $R2/R1$, while integration is accomplished via $C1-R2$. Figure 6 shows a full-wave converter with a voltage gain of 1.11, while integration is accomplished via $C1-R5$. Notice that op-amp converters compute the average value of rectified AC-voltage; that

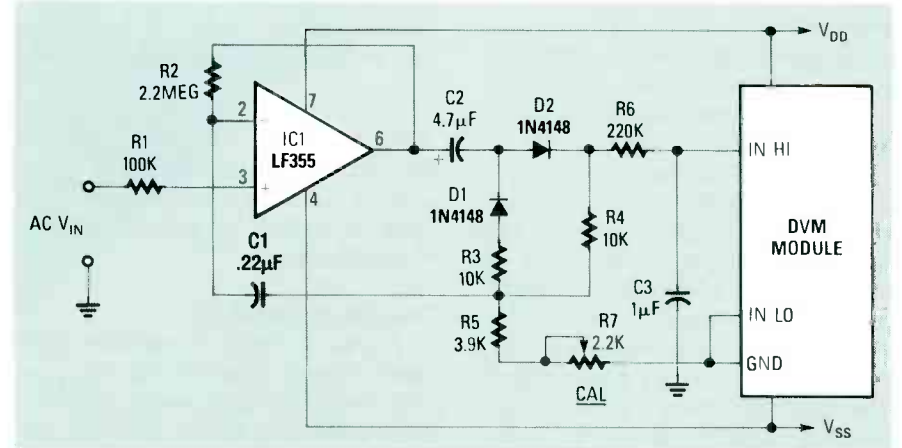

FIG. 7—AC/DC CONVERTER used with a DVM module.

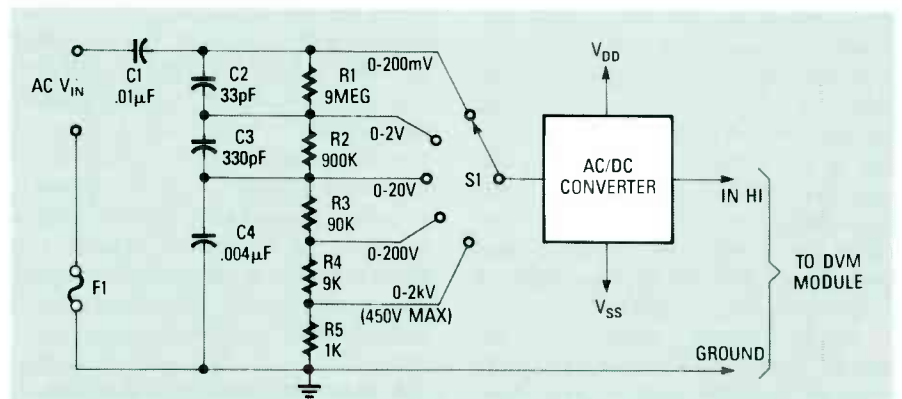

FIG. 8—5-RANGE AC VOLTMETER (converter) using a DVM module.

As shown in Fig. 7, a DVM module can be used to measure AC (rather than DC) voltage by connecting a suitable AC-to-DC converter to its input. Op-amp IC1 is used in the noninverting mode, with DC feedback applied through R2, and AC feedback applied through C1-C2 and the diode-resistor network. Resistor R7 adjusts the amplifier gain over a limited range. The rectified output of the circuit is filtered by components R6-C3 for DC conversion.

Figure 8 shows a frequency-compensated attenuator network used to convert a standard DVM module into a 5-range AC voltmeter. Figure 9 shows how a switched-shunt network can be used to convert a DVM module into a 5-range AC ammeter.

Figure 10 shows how to convert a DVM module into a 5-range ohmmeter. The circuit actually functions as a multi-range constant-current generator, where a constant current feeds (from Q1 collector) into R_x . The resulting voltage drop across R_x —which is directly proportional to the unknown R_x value—is read by the DVM module.

Transistor Q1 and the op-amp are wired as a voltage-follower—the emitter-voltage follows the voltage set by potentiometer R8. In practice, that voltage is set at precisely 1 volt below V_{DD} . Consequently, the Q1 current source equals 1 volt divided by the selected (R3 to R7) range-resistor value. For example, the current through the R3 range resistor when the noninverting input is set to 1 volt equals 1 volt/1000 ohms, or 1.0 mA. The DVM module typically reads full scale when its input voltage equals 200 mV. That reading is obtained when $1.0 \text{ mA} \times R_x$ has a value equal to 200 mV; therefore, R_x should equal 200 ohms for a full-scale DVM reading.

Analog meters

As shown in Figs. 11 to 15, an op-amp can also convert a standard (D'Arsonval) moving-coil meter into a sensitive voltage, current, or ohmmeter. All of the circuits are designed around the LF356 JFET op-amp, which has a high input impedance, and operates from a ± 9 -volt supply. Offset nulling is provided to set the output to precisely zero. The moving-coil meter should have a full-scale sensitivity of 1 mA.

Instead of using a 1-mA moving-

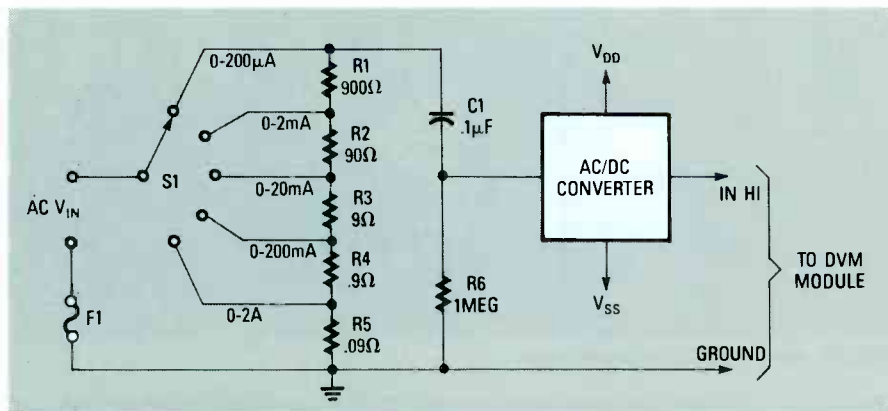

FIG. 9—5-RANGE AC AMMETER (converter) using a DVM module.

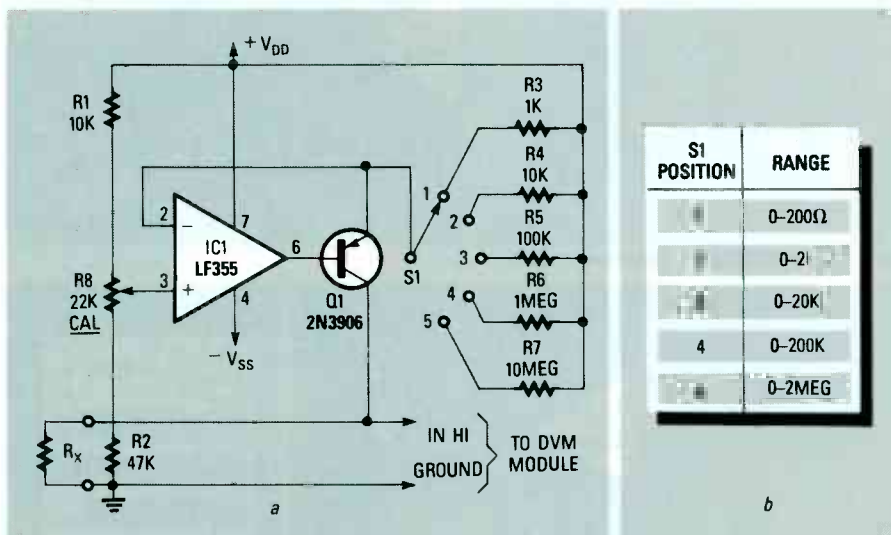

FIG. 10—5-RANGE OHMMETER (converter) using a DVM module.

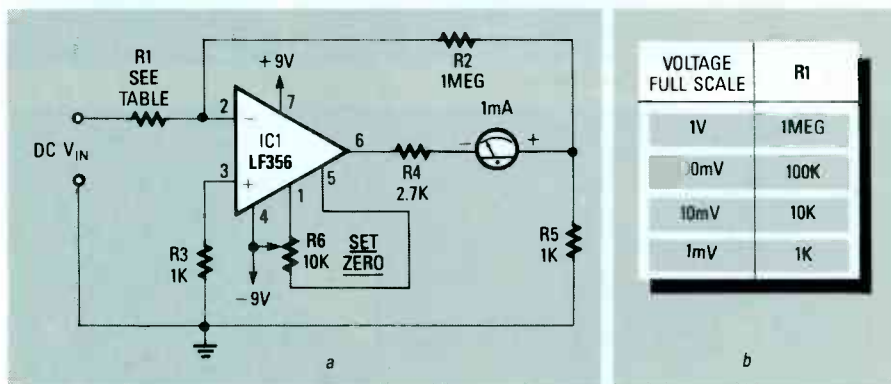

FIG. 11—A DC MILLIVOLT meter.

coil meter, the 1-mA DC range of an existing multimeter can be substituted, and the circuits shown in Figs. 11 to 15 will function as “range converters.” Notice that each circuit has a 2.7K resistor in series with the op-amp’s output. That resistor limits the available output current to a few milliamps, thereby providing the meter movement with automatic overload protection.

Figure 11 shows a simple method to

convert a 1-mA meter into a fixed-range DC-mV meter having a full-scale sensitivity of 1 mV, 10 mV, 100 mV, or 1 volt. The table shows appropriate values of R1 for the full-scale sensitivities. To null the op-amp’s input-offset voltage, short-circuit the input terminals and adjust R6 for zero deflection of the meter.

Figure 12 shows how you can put together a 4-range DC-mV meter having full-scale ranges of 1 mV, 10 mV,

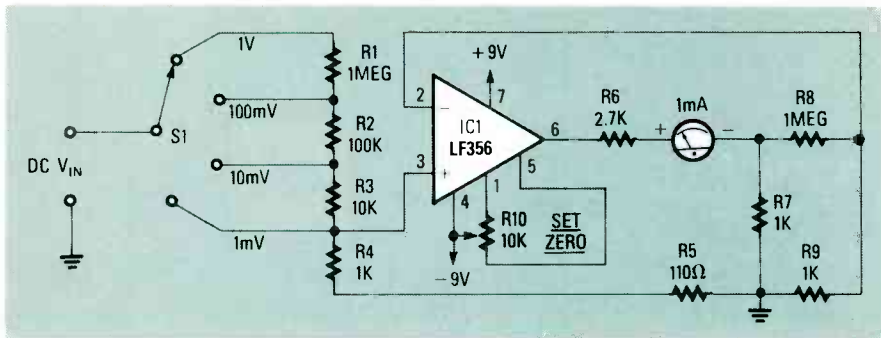

FIG. 12—4-RANGE DC millivolt meter.

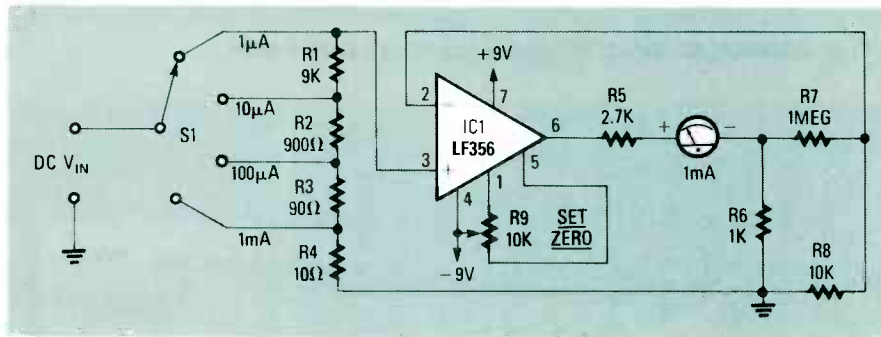

FIG. 13—4-RANGE DC microammeter.

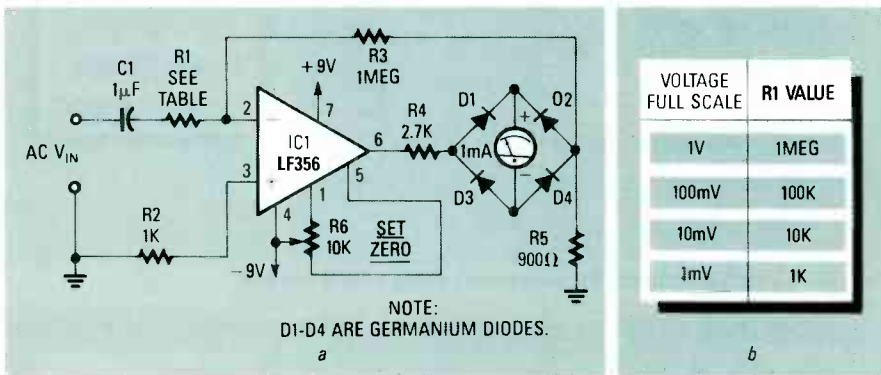

FIG. 14—4-RANGE AC millivolt meter.

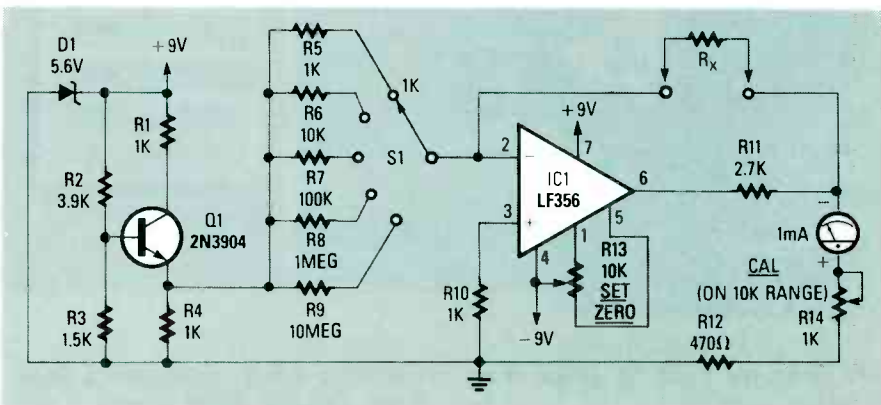

FIG. 15—5-RANGE LINEAR-SCALE ohmmeter.

100 mV, and 1 volt. Figure 13 shows how you can make a DC- μ A meter having full-scale ranges of 1 μ A, 10 μ A, 100 μ A, and 1 mA. The range resistors should have a tolerance of 2% or better.

Figure 14 shows a useful fixed-range AC-mV meter. The circuit's in-

put impedance is equal to R1, which varies from 1000 ohms at 1-mV full-scale sensitivity, to 1 megohm at 1-volt full-scale sensitivity. The useful frequency range is about 100 kHz when used in the 1- to 100-mV range, and 50 kHz for the 1-volt range.

Figure 15 shows a 5-range linear-

scale ohmmeter, having full-scale ranges from 1000 ohms to 10 megohms. Range resistors R5-R9 determine the full-scale values. Transistor Q1 applies 1 volt to one side of the range-resistor network. The gain of the op-amp is determined by the ratios of the selected range resistor and R_X. When the range resistor and R_X are equal, the meter will read full scale.

To zero-set the meter in Fig. 15, follow this procedure: Set S1 to the 10,000-ohm position and short circuit the R_X terminals. Now adjust R13 to set the meter needle to zero. Next, remove the short circuit and connect an accurate 10,000-ohm resistor in the R_X position. Now adjust R14 for full-scale deflection. The circuit is now fully calibrated and ready to be used.

Voltage reference

An op-amp can function as a voltage reference by connecting a known voltage to its noninverting input. Figure 16 shows a positive-voltage reference whose output is fully variable from +0.2 to +12 volts. Zener diode D1 provides a regulated

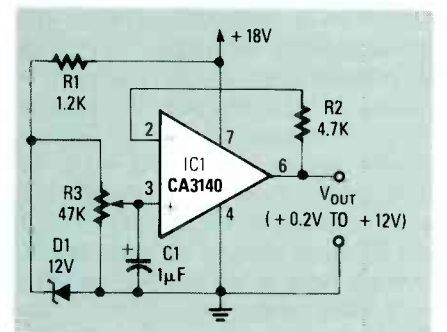

FIG. 16—VARIABLE POSITIVE-VOLTAGE reference.

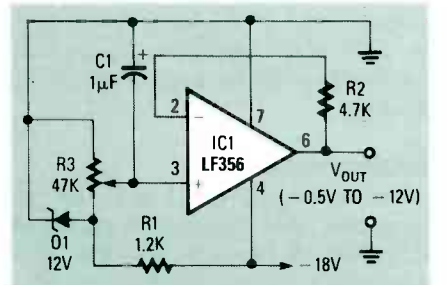

FIG. 17—VARIABLE NEGATIVE-VOLTAGE reference.

12-volt source voltage. The CA3140 op-amp can track input reference voltages to within 200 mV above ground. Figure 17 shows a negative-voltage reference whose output is fully variable via R3 from -0.5 to -12 volts.

The LF356 op-amp can track input reference voltages to within -0.5 volts below ground. The op-amps in Figs. 16 and 17 are wide-band devices; resistor R2 is used to enhance their circuit stability.

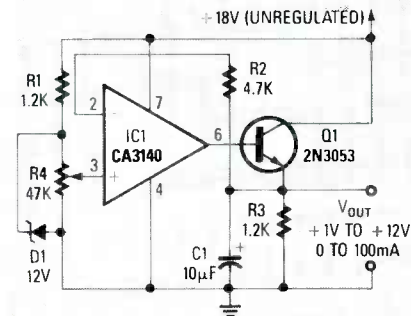

FIG. 18—VARIABLE-VOLTAGE regulated power supply.

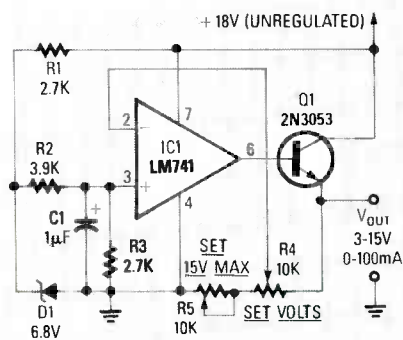

FIG. 19—STABILIZED POWER SUPPLY, 3-15 volt, 0-100 mA.

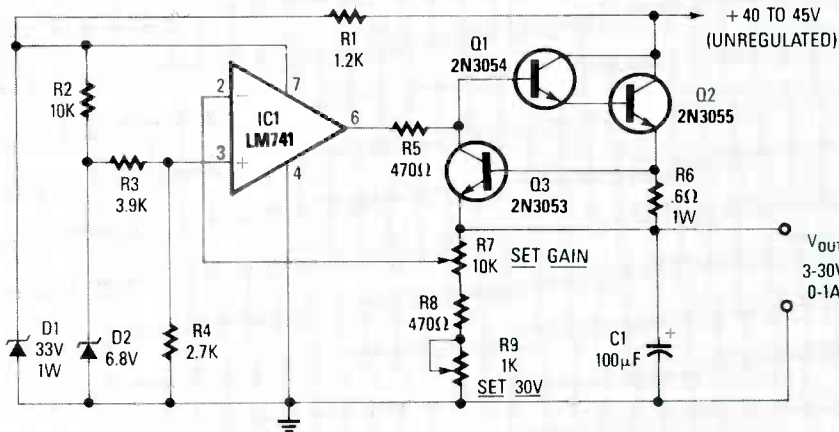

FIG. 20—OVERLOAD PROTECTED, 3-30-volt stabilized power supply.

Voltage regulators

Figure 18 shows how to modify Fig. 16 to function as a 1-12-volt variable power supply having an output current capability of about 100 mA. Notice that the base-emitter junction of the output transistor is included in the negative feedback loop to mini-

mize the affects of temperature changes on the junction voltage. The output-current limit is determined by the power rating of the transistor. To extend the output range down to zero volts, connect pin 4 to a -2 -volt power supply.

Figure 19 shows an alternative type of power supply circuit, whose output voltage is variable from $+3$ to $+15$ volts at currents up to 100 mA. A fixed 3-volt reference is applied to the non-inverting input via Zener diode D1 and the R2-R3 divider network. Variable voltage gain is set by potentiometer R4. When R4's wiper is at one extreme position, the circuit has unity gain for an output of $+3$ volts; when the wiper is in the other extreme position, the circuit has a gain of $\times 5$ for an output of $+15$ volts. The gain is fully variable between the two values.

It is quite easy to modify the power-supply circuit shown in Fig. 19 so that it can supply up to ten times the output current. That can be done by using a Darlington transistor pair at the output instead of the single transistor shown, to supply the current. You'll also have to power the circuit with 40 to 45 volts, instead of 18.

Of course, any of the circuits we've shown can be altered to suit your specific needs. Just don't exceed any component's ratings.

Figure 20 shows how you can incor-

porate automatic overload-protection circuitry. Here, resistor R6 senses the magnitude of the output current. When 1 amp is exceeded, the resulting voltage drop across R6 starts to bias Q3 on; that shunts away transistor Q1's base-drive current, thereby limiting the output current. R-E

LF TRANSMITTER

continued from page 46

voltage or increase the number of turns on L2. Now you have to tune C6 again, and note the shape of the tuning curve. If you see only a single peak while tuning C6, try increasing the loading by moving L2 toward the "hot" end of L1. If you see a double-peaked tuning response, reduce the loading by moving L2 toward the ground end of L1. Repeat those steps as necessary in order to achieve the most efficient match at 1-watt input power.

The exact transmit frequency can be trimmed by adjusting trimmer capacitor C2. The adjustment range will depend on the particular crystal used in your unit.

Fortunately for beginners and newcomers to "basement radio," slow-speed CW is the favored operating mode, so you won't have to do much brushing up on your dits and dahs. At 185 kHz the biggest enemy is noise—both atmospheric and man-made. It is for those and other reasons, that the best signal-to-noise ratio can be obtained by using a low data-rate mode (slow keying).

Most operators congregate toward the upper end of the band, centering around 185 kHz. Keep in mind that many stations use crystal control, so it is important that you tune your receiver as carefully as possible when calling CQ, and don't be surprised to hear a reply several kHz away from your calling frequency. The winter months are the most popular for experimental LF operation because northern latitudes suffer from extreme atmospheric noise from May through September. The best openings generally occur on cold winter nights when the band is stable and quiet. Under those conditions it is possible to establish regular contacts to 100 miles or so, with occasional DX of several hundred miles.

The trick to successful LF operation is experimentation, so don't hesitate to try different antenna and matching network designs. Even though you will find the transmitter useful, once you get hooked, you will find yourself constantly planning changes. You will always be on the lookout for a big spool of #6 magnet wire, and daydreaming about helium cooled, superconducting coils. R-E

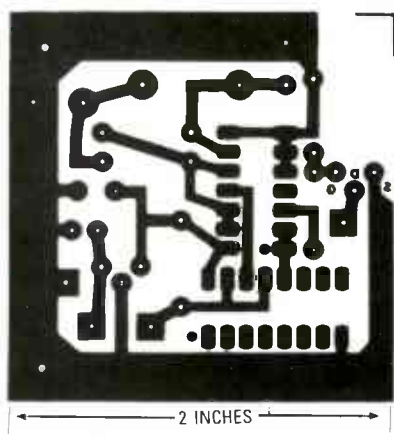

LF TRANSMITTER FOIL PATTERN.

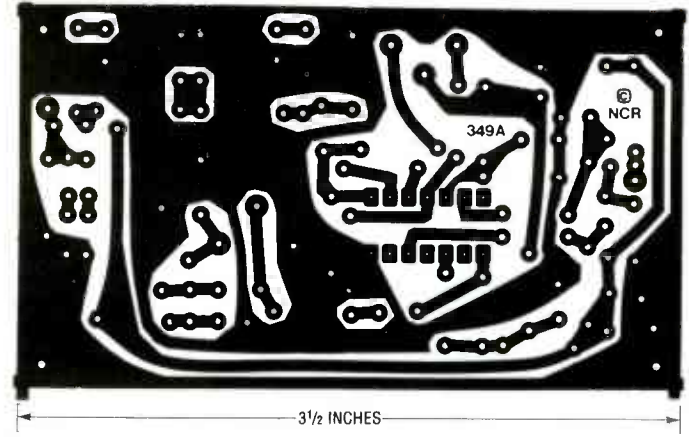

LF CONVERTER FOIL PATTERN.

SPECTRUM MONITOR

continued from page 42

which isn't used here.

There are two PC-board plugs supplied with the tuner. One is a two-pin version, PL5, used for A/B SWITCH, which along with C1 is unused. The other is a Single-Inline-Pin (SIP) plug, PL6, which connects to most of the pinouts. Pin 1 (black) of PL2 is ground, pin 2 (green) is the SECOND LOCAL OSCILLATOR +12-volt supply (unused), pin 3 (orange) is the UP-CONVERTER +12-volt supply, pin 4 (violet) is the FIRST LOCAL-OSCILLATOR TUNING VOLTAGE, and pin 5 (yellow) is the AUTOMATIC FREQUENCY CONTROL (AFC) voltage for tuning the second local oscillator over the range 517-617 MHz. Pin 6 is not wired.

Even though the up- and down-converter supplies are labeled as nominally needing +12 volts, +10 volts proved to be adequate. The AFC potential on pin 5 of PL2 should nominally be +2.5 volts, to keep the second local oscillator at 567 MHz. Enough information is provided to let you look into suitable replacements if you can't get this version, or want to experiment with others.

Spectrum monitor operation

The block diagram of the spectrum monitor is shown in Fig. 3. It can operate using either 12-volts AC or +12-volts DC, and provision is also made for optional Ni-Cd batteries. An RF signal over the frequency range 55.25-553.25 MHz is applied to the Zenith tuner via J5. The tuner will down-convert to a 63-MHz IF, the center frequency being adjusted using R18, and the sweep width using R20;

the IF exits the tuner via J2. It is then fed to an FM receiver IC that acts as detector/demodulator. The input resonant frequency of the IC is adjusted using trimmer capacitor C26.

The output of the detector/demodulator IC is applied simultaneously to a discrete NPN transistor preamplifier and an op-amp buffer/impedance converter. The preamplifier output goes to an IC power amplifier and speaker, the volume being adjusted using R12. This is the FM-receiver audio output, letting you listen to FM broadcast stations, TV audio, two-way FM communications, etc.

The buffer/impedance converter is part of the vertical output section, and is followed by a two-pole low-pass filter which suppresses any signal amplitude overshoots, preventing the spectrum monitor from forcing the oscilloscope beam off the graticule. That's followed by a vertical offset clipper and oscilloscope driver amplifier, which is adjusted using R4. The output of this amplifier is fed to the VERT OUT jack J3.

Note that S2 feeds power to either the audio amplifier for receiver operation, or IC7 for sweep operation in spectrum monitor mode. The two operating modes are mutually exclusive; you can't use the monitor to simultaneously observe a region of the RF spectrum, and listen to whatever station is at the center frequency of the display. However, it is a simple matter to switch between modes.

The horizontal circuitry begins with a horizontal oscillator, which also acts as a line-voltage synchronizer. When the spectrum monitor is powered by 60-Hz AC, the 12-volts AC from the secondary of T1

is coupled into the horizontal oscillator, locking it to the 60-Hz power-line frequency automatically. When 12-volts DC is applied directly to J1, synchronization to 60 Hz becomes impossible, so the horizontal oscillator will be free running.

The horizontal-oscillator waveform then passes through a network that generates the sawtooth waveform used for horizontal scan/retrace. That sawtooth is amplified by a horizontal driver and appears at HORIZ OUT jack J4. The sweep frequency is adjusted using R32, but the adjustment is effective only when the spectrum monitor is operated using AC.

Circuit description

The complete schematic of the spectrum monitor is shown in Fig. 4. The spectrum monitor uses 12-volts AC or +12-volts DC, allowing operation from a car battery, or a plug-in 12-volt AC adapter. It also can operate off of a Ni-Cd power pack.

Diode D1 is the power rectifier for 12-volts AC, D2 and resistor R1 provide a charging path for the Ni-Cd cells, and S1 is an SPST ON/OFF switch. While a full-wave rectifier would be much easier to filter, it would prevent AC/DC compatibility. The filter is composed of R2 and capacitors C1 and C2. Also, C3 samples AC to synchronize the sweep oscillator to 60 Hz. The three voltage regulators provide regulated +10-volts DC to the tuner, and +5-volts DC to the sweep circuits. The TDA7000 receiver uses +4.5 volts; the drop across D3 provides +4.3 volts, which is adequate.

While the 555 timer (IC5) is con-
continued on page 92

HARDWARE HACKER

More on cold fusion
Mystery chip solved!
Cheap digital compass
Humidity measurement
Book-on-demand publishing

Humidity sensors

DON LANCASTER

WELL, A MONTH HAS PASSED. FOR ME, this is still late May. Incredibly, the cold fusion has neither been fully proven nor disproven. Here's how things stand at this writing:

- Very low level and *muon catalyzed* fusion effects have now been demonstrated at room temperature, pretty much to everyone's satisfaction.
- Among other tests, some cells are producing a tritium fusion by-product that is nearly a thousand times above the expected background levels.
- While apparently useless for power production, the low-level studies do point towards solving some sticky geochronology problems, and have opened up major thinking about new directions for fusion research.
- Separately, a few labs (somewhere between 4 and 35, depending on who is counting and who is talking) have demonstrated a very substantial heat generation in test setups which far exceed their electrical energy input and which appear to be way in excess of what you would expect from any reasonable or easily explained chemical reaction. To date, the argument that high-level cold fusion is taking place is based on a "What else could it possibly be?" theory.
- Apparently, the metallurgy of the palladium anodes is very critical, and there is some other black magic involved which certain researchers refuse to talk about. At least so far.
- The big reason for worrying about whether the excess heat production is really cold fusion or

not is that any chemical reaction would require some earlier energy input.

- All cold fusion would require is nickel-a-gallon heavy water. Thus, if the reaction is physical, chemical, or simply a subtle form of a catalyzed hydrogen explosion, we will probably end up with an improved yuppie ski-boot heater, or a possible new direction for battery research.
- If the reaction is, in fact, cold fusion, then we now have the development of the century, if not the millennium.

So what's a hacker to do? First and foremost, get and keep informed! The best places to do that are the *News and Comments* section from *Science* magazine; in the *Technology* columns (usually on page B-4) of your *Wall Street Journal*; and the many on-line resources of the *Dialog Information Service* at your library.

What you want to watch out for is something someplace that says "Do exactly this exactly this way, and the odds will be very high that you will get excess heat production." Then go for it. But till then, there's no sense in buying palladium rods that end up with the

wrong metallurgy or involve other fundamental problems.

I will let you know where to look next, just as soon as I find out myself.

Meanwhile, there appears to be nothing but bad news from the high-temperature superconductor research these days. It seems that there are some very fundamental (and possibly insurmountable) reasons why all the known types of the high-temperature superconductors appear to be unable to ever support the extreme current densities needed to levitate trains or make commercial power distribution more efficient. See *Science* magazine for the ongoing bad news.

For some good news, we have a *tinaja quest* winner from our phase place contest. And he has some great new free stuff for you, namely an IBM Pascal program that can directly generate full color or hard-copy Lorenz attractor "owl's mask" chaotic trademarks for you. Just send a disk and a postpaid return package to Toni Patti of the *Cryptosystems Journal* for your free copy. If you can afford to, it wouldn't hurt to throw in an engraved portrait or two of Abe Lincoln for his trouble.

Our big feature for this month involves several new humidity-sensor products. But first...

Mystery chip solved!

Every once in a while, some new chip comes along that every hacker wants to glomp onto, in one way or another. So much so that I've been getting over a dozen

NEED HELP?

Phone or write your **Hardware Hacker** questions directly to:
Don Lancaster
Synergetics
Box 809
Thatcher, AZ 85552
(602) 428-4073

calls a day on this one. This dude is a stereo FM modulator chip, intended to wirelessly couple a CD player to a FM car radio. And do so with top quality.

Now, the normal way you find out about new hacker chips is through all of those electronics trade journals. Especially *E.E. Times*, *Electronics*, *EDN*, *Electronic News*, *Electronic Design*, *Electronic Products*, and the *Electronic Component News*. As per usual, you get addresses on those and the 55,000 other trade journals (many free to qualified subscribers) through *Uhrlicht's Periodicals Dictionary* on the reference shelf at your library.

A second way of getting at chips is by going to those low-cost ECG and NTE directories. They are great for leafing through backwards on a chip pinout-by-pinout basis to get at the good stuff. And they do sell single quantities of most listed chips on a no-hassle basis.

This particular chip hasn't made it yet to the trade journals. The CD-

to-FM converter is a *Rohm* part number BA-1404, and is available through *Jay Ohm Electronics*. Cost is around \$1.50 each in lots of twenty.

Ready-to-go kits are also listed in several classified-ad sources here in **Radio-Electronics**, and in the *Nuts and Volts* shopper.

I don't have my samples yet, so we'll hold off on full details for a column or two. But for the first contest this month, just tell me what you would do with a cheap, low-power, high-quality stereo FM broadcaster chip.

There'll be all the usual *Incredible Secret Money Machine* books for the better entries, along with an all-expense-paid (FOB Thatcher, AZ) *tinaja quest* going to the very best of all.

Be sure to send all of your entries directly to me per that *Need Help?* box, and not to the **Radio-Electronics** editorial offices.

Book-on-demand publishing

Those of you that are following my sister column to this one over in the *Computer Shopper* magazine know that I am doing book-on-demand publishing in a very big way.

Very simply, you can now produce books on any subject while using nothing but a PostScript laser printer on your kitchen table, and do so fully professionally, and at the costs and quality levels that today can match and often surpass jiffy printing.

You can now literally beat your own book out on a brick in the back yard, and have it turn out as good as commercial publishing.

Among the many overwhelming advantages of the book-on-demand printing are that the author can be paid as much as a 50 percent royalty of your final selling price; that the production time gets measured in minutes rather than months; that no monumental (and non-refundable!) front-end costs are involved, since you only print the books you need at any given time; that the customer's name can be custom printed in gold on the cover; that your back list can continue forever without any inventory tax and similar IRS penalties; that review and promotional copies are available twenty

minutes after the author submits his manuscript; and that changes, revisions, or updates can be made at any time.

If we were to sum up four years of research and countless *Ask the Guru* columns into five book-on-demand rules, they would be as follows: (1) use only a later version PostScript speaking laser printer; (2) use a local hard-disk directly attached to your printer; (3) do all your own cartridge refiling to get your toner costs under 0.33 cents per page; (4) use duplex (two sided) printing if possible; and (5) compile your PostScript run-time code to eliminate or minimize page make-ready times.

So what does all that have to do with our hardware hacking? Just this—the new or used printing machinery is outrageously expensive and most used-printing-equipment salesmen are totally useless and incredibly arrogant epsilon minuses. There is a whole new world of laser printing out there that needs brand-new and ultra low-cost designs of *small-scale* press and bindery systems.

For instance, in previous columns we've seen a low-cost substitute for the grossly overpriced *Kroy* and *Omicrom* fusion machines. And I am currently working up a new method to convert a \$25 sander into a paper jogger. The stuff we really need, though, is a clamping guillotine paper cutter that costs the end user less than \$99; cheap folders and padders, low-cost home binding systems that could use any cover materials and support spine printing; paper drills; sane color-proofing technology; home foil hot stamping systems; slitters and perforators; cheaper "print on anything" pad printers; new die-cutting methods; laser-compatible thermography solutions; etc., etc.

To get an idea of what is needed, pick up a free copy of *The Printer's Shopper*, and open it to nearly any page. Then figure out how to reduce all the prices by not less than 5:1.

I suspect that your ultimate approach would be build-your-own kits of only the essential parts needed for any of those. And all you hardware hackers have the inside track on that sort of thing. Go

**NEW FROM
DON LANCASTER**

HANDS-ON BOOKS

Hardware Hacker Reprints II	24.50
Ask The Guru Reprints I or II	24.50
CMOS Cookbook	18.50
TTL Cookbook	16.50
Active Filter Cookbook	15.50
Micro Cookbook vol I or II	16.50
Enhancing your Apple I or II	17.50
AppleWriter Cookbook	19.50
Apple Assembly Cookbook	21.50
Incredible Secret Money Machine	10.50
LaserWriter Reference (Apple)	19.50
PostScript Cookbook (Adobe)	16.50
PostScript Ref. Man. (Adobe)	22.50
PostScript Prog. Design (Adobe)	22.50

UNLOCKED SOFTWARE

PostScript Show & Tell (Ile/Mac/PC)	39.50
Intro to PostScript VHS Video	39.50
PostScript Perspective Draw	39.50
PostScript Beginner Stuff	39.50
PostScript Technical Illustrations	39.50
PostScript Work in Progress	39.50
PostScript BBS stuff	19.50
Absolute Reset Ile & Ilc	19.50
AppleWriter/Laserwriter Utilities	49.50
Enhance I or II Companion Disk	19.50
AppleWriter CB or Assy CB Disk	24.50

FREE VOICE HELPLINE VISA/MC

SYNERGETICS
Box 809-RE
Thatcher, AZ 85552
(602) 428-4073

CIRCLE 83 ON FREE INFORMATION CARD

for it.

So, as a second contest this month, just show me any ultra-cheap way you can think of to slash the end-user cost of any printing or production equipment that is suitable for use with home book-on-demand publishing.

Let's have your input on this subject. It's a hot topic with unlimited potential.

Fundamentals of humidity

The price of hacker humidity sensors is at long last dropping down into the \$5 range, so I

HUMIDITY RESOURCES

Abbeon-Cal

123 Gray Ave.
Santa Barbara, CA 93101
(805) 966-0810

Edmund Scientific

101 E. Gloucester Pike
Barrington, NJ 08007
(609) 573-6250

Fair Radio Sales

Box 1105
Lima, OH 45802
(419) 223-2196

General Eastern

50 Hunt St.
Watertown, MA 02172
(800) 225-3208

Heathkit

PO Box 1288
Benton Harbor, MI 49022
(616) 982-3200

Measurement & Control

2994 West Liberty Ave.
Pittsburgh, PA 15216
(412) 343-9666

Mitsubishi/Shibaura

520 Madison Ave.
New York, NY 10022
(212) 605-2146

Omega Engineering

Box 4047
Stamford, CT 06907
(203) 359-1660

Panametrics

221 Crescent St.
Waltham, MA 02254
(617) 899-2719

Phys-Chem Scientific

36 West 20th St.
New York, NY 10011
(212) 924-2070

Pollution Equipment News

8650 Babcock Blvd.
Pittsburgh, PA 15237
(412) 364-5366

Weathertronix

1165 National Drive
Sacramento, CA 95834
(800) 824-5873

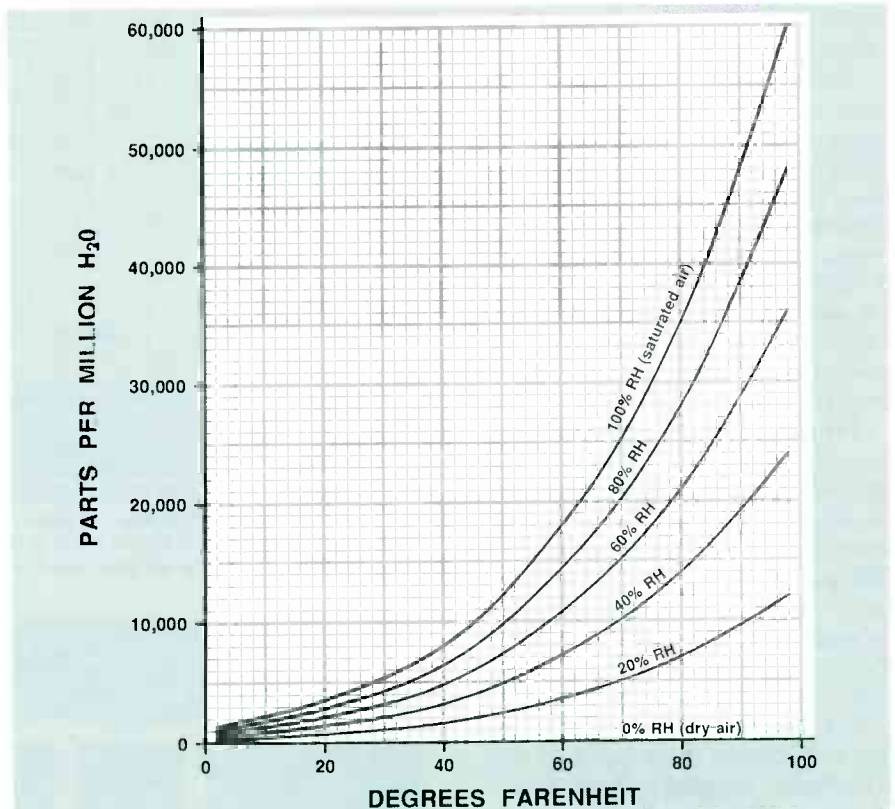

FIG. 1—THE ALLOWABLE AMOUNT OF WATER VAPOR in air is a very strong function of temperature. Absolute humidity is a direct measure of that amount, expressed in parts per million or similar units. Relative humidity is instead a percentage ratio of how much moisture is really present, compared against the maximum allowed for the current temperature.

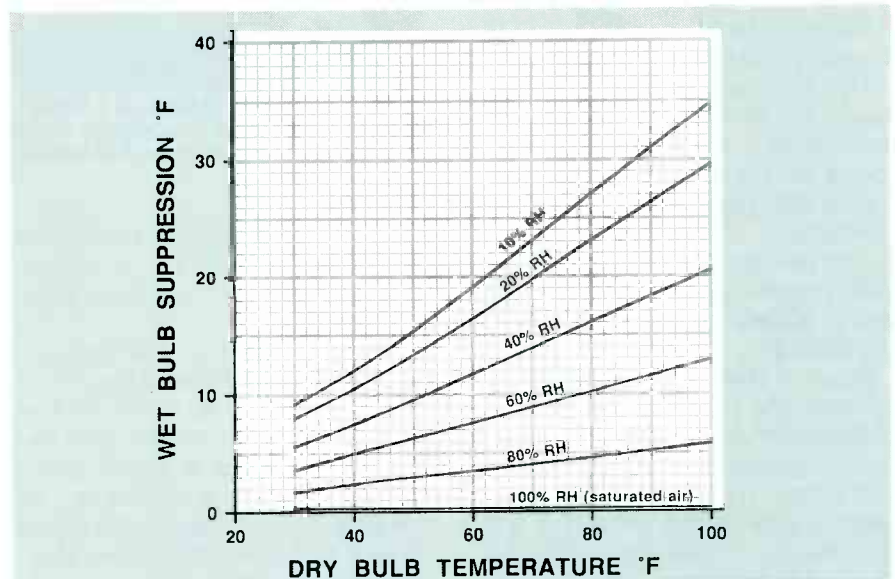

FIG. 2—WEATHER FORECASTERS OFTEN will use a wet-bulb dry-bulb sling psychrometer to measure the relative humidity. The lower the humidity, the more the evaporative cooling of the wet bulb, and the lower its temperature. This graph calculates the relative humidity for you.

thought that we might review just what humidity is and how we might sense it.

"The humidity" is simply how much water vapor is present in the air at any particular time. That gets

very important for weather forecasting, air conditioning, environmental monitoring, process controls, home comfort, and cave studies; also in energy management, and it can become

positively crucial in wildland fire fighting.

Air consists of a mixture of many gases which is mostly $\frac{1}{5}$ ths nitrogen and $\frac{1}{5}$ th oxygen. Since water vapor is also a gas, it can form a mixture with the other gases in air, following a chemical *law of partial pressures*. The maximum amount of water vapor possible in the air will vary with the exact air composition and the atmospheric pressure. It also changes very strongly with temperature.

One way to measure the amount of water in air is in *parts per million*. At zero degrees Fahrenheit, the maximum amount of allowable water vapor in the air is around 1200 parts per million; at 100 degrees Fahrenheit, your maximum allowable amount of water vapor is something like 63,000 parts per million.

This temperature relationship is very non-linear. Rule number one in humidity sensing is that humidity is a very strong and a highly non-linear function of temperature; you *always* have to measure and specify your temperature at the same time you make your humidity measurement.

There are two ways of specifying humidity: *absolute* and *relative*.

The absolute humidity is how much water vapor that really is present at a given temperature, and is expressed in parts per million, grains per pound, or in some similar way. The relative humidity is the percentage of water vapor that's present as a ratio of the maximum allowable for the current temperature.

Figure 1 shows the relationship between the two. Air that holds all of the water vapor it possibly can at some temperature is said to be *saturated*. Try to add any more water vapor to the air and it will rain on you, or else turn to fog. Air that holds no water vapor at all is said to be *dry* air.

Totally saturated air has a relative humidity of 100 percent. Totally dry air has a relative humidity of 0 percent. Air that holds half the allowable moisture has a relative humidity of 50 percent.

Cool air can not retain as much water vapor a warm air can. Thus, as you lower the temperature, you often will raise your humidity, and

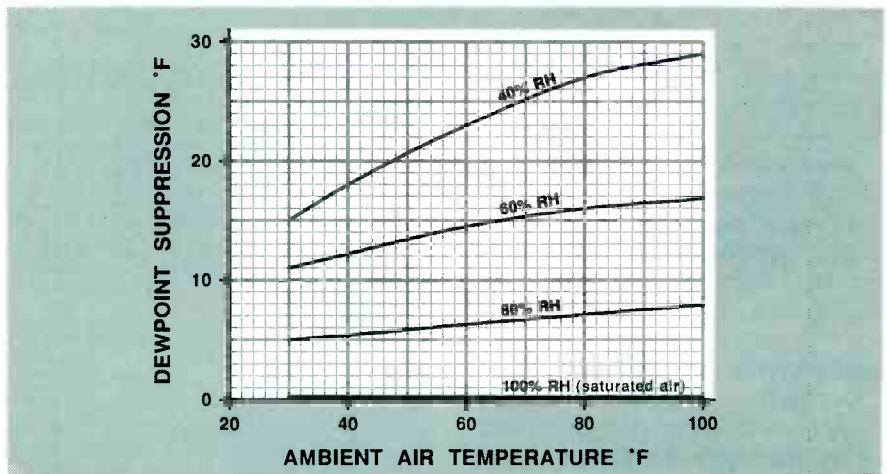

FIG. 3—PRECISION LABORATORY MEASUREMENT of relative humidity is done by chilling the air to its dewpoint to find the equivalent air temperature for full saturation. Usually a servo-driven mirror will fog or frost at the dewpoint, altering a sensing beam of light. Dewpoint measurements are best used at the higher humidity and temperature ranges.

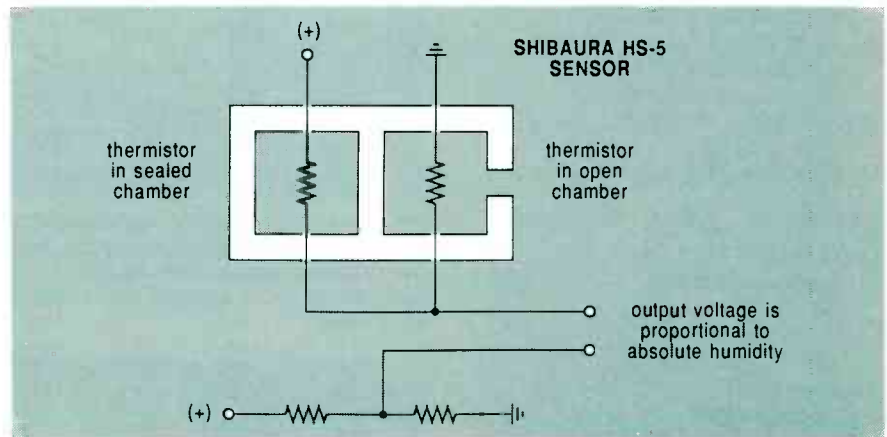

FIG. 4—THIS NEW ABSOLUTE HUMIDITY SENSOR from Shibaura makes use of the difference of thermal conductivity between dry and humid air to produce an output voltage. Both thermistors are run in their self-heating range.

vice versa. In particular, cooling air conditioners have to condense out some water as the temperature is lowered.

There is often a *condensate pump* or a *condensate line* in air conditioners to dispose of the "rain" that results as you cool the air. In some parts of the country, the evaporative coolers, or "swamp boxes" purposely inject water into the air. The evaporation lowers the temperature and raises the humidity.

Unfortunately, evaporative coolers are really useful only in the driest of climates. They can get unbearably muggy elsewhere.

Humidity sensors

As you might guess, there are many different methods of measuring both absolute and relative humidity. They depend on the ac-

curacy you need, and each method will work best over some specified range of temperatures and relative humidities.

The *Humidity Resources* sidebar shows you some of the many places to go to get info on humidity sensors and sensing systems.

The simplest humidity sensor is a long, unwashed blond hair. This is an example of a *hygroscopic* material that will get longer or shorter as it absorbs or releases the water vapor. Some nylon cords are also moisture sensitive. For years, there have been *Honeywell* humidity sensors based on a nylon strip, that have been kicking around the surplus market. One \$1.95 source for them is *Fair Radio Sales*, as stock #H46B1150.

Dial-type analog humidity displays are available in small quantities from *Abbeon-CAL*, *Heathkit*,

NAMES AND NUMBERS

Advanced Micro Devices

PO Box 3453
Sunnyvale, CA 94088
(408) 732-2400

Computer Shopper

5211 South Washington
Titusville, FL 32780
(407) 269-3211

Cryptosystems Journal

9755 Oatley Lane
Burke, VA 22015
(703) 451-6664

Crystal Semiconductor

4210 S. Industrial Dr.
Austin, TX 78744
(800) 888-5016

Dialog

3460 Hillview Ave.
Palo Alto, CA 94304
(415) 858-2700

Dinsmore Instrument

1814 Remell St.
Flint, MI 48503
(313) 744-1330

ECG

70 Empire Dr.
W Seneca, NY 14224
(716) 325-2620

Electronic Manufacturing

17730 W. Peterson Rd.
Libertyville, IL 60048
(312) 362-8711

Fifth Dimension

801 New York Ave.
Trenton, NJ 08638
(609) 393-8350

Interlink Electronics

PO Box 40760
Santa Barbara, CA 93103
(805) 684-2100

New Equipment Digest

1100 Superior Ave.
Cleveland, OH 44114
(216) 696-7000

Nordic Lite

14124 East 10 Mile Rd.
Warren, MI 48089
(313) 772-8120

NTE Electronics

44 Farland St.
Bloomfield, NJ 07003
(201) 748-5089

Nuts and Volts

Box 1111
Placentia, CA 92670
(714) 632-7721

Ohm Electronics

746 Vermont
Palatine, IL 60067
(312) 359-5500

PMP

125 Leader Dr.
Piedmont, SC 29673
(803) 269-0749

Printers Shopper

Drawer 1056
Chula Vista CA 92012
(800) 854-2911

Rohm Corporation

Box 19515
Irvine, CA 92713
(714) 855-0819

Science Magazine/AAAS

1333 H Street NW
Washington, DC 20005
(202) 326-6400

Signetics

811 E. Arques Ave.
Sunnyvale, CA 94088
(408) 991-2000

Surface Mount Technology

17730 West Peterson Rd.
Libertyville, IL 60048
(312) 362-8711

Texas Instruments

Box 655012
Dallas, TX 75265
(800) 232-3200

TRW LSI Products

Box 2472
La Jolla, CA 92038
(619) 457-1000

Wall Street Journal

420 Lexington Ave.
New York, NY 10170
(212) 808-6960

or *Edmond Scientific*.

The traditional weather-forecasting method of measuring relative humidity is with a *sling psychrometer*. With a psychrometer, you have two thermometers. One is kept dry, while the other is kept wet with a moisturizing wick. What you have, in essence, is a miniature evaporative cooler. The wet-bulb temperature will suppress as the evaporating water cools it. The amount of suppression can be related to your humidity simply by following the curve of Fig. 2.

In practice, the wet-bulb dry-bulb setups do not perform all that accurately, owing to water contamination and deposit buildups.

The traditional laboratory method of measuring relative humidity is by lowering the temperature until it rains or fogs, and then measuring that *dewpoint temperature* where the air becomes fully saturated with water.

In many instruments, a *chilled mirror* gets thermoelectrically

cooled. A light beam bounces off the mirror. If the mirror is not fogged, the light beam reaches a photosensor. If the mirror fogs at the dewpoint, the light beam diffuses and causes a different reading. Normally a servo system is used to continuously track the dewpoint over time.

The dewpoint is different from and lower than the wet-bulb temperature. That happens because of the highly non-linear relation between the temperature and humidity. Figure 3 shows you the relationship between dewpoint and relative humidity.

In general, dewpoint instruments are quite accurate and quite costly. They also will work across the full range of relative humidities and are one of the few methods which can accurately measure extremely high humidity values.

There are a number of electronic humidity sensors, and the prices are finally dropping to a point where they are of hacker interest. For instance, *Phys-Chem Scientific*

has a line of humidity sensors that are based on the surface resistivity of a custom polymer. Their resistance changes as a non-linear function of relative humidity. Surface sensors of that type tend to be fast, but they are also sensitive to contamination.

The *Panametrics* people have a line of *Minicap* humidity sensors that do, in fact, drop down to \$5 per unit in large quantities. These sensors are essentially a capacitor whose dielectric is humidity-sensitive. Unlike the surface-sensing units we just looked at, the sensing takes place throughout all the volume of the material. The sensor works best at medium relative humidity values. While less sensitive to contamination, the response time can also be longer. Since the sensor is basically a capacitor, it lends itself very well to low-power sensing. The CMOS 555 timer can be used with it to convert relative humidity to frequency.

The big news this month, *continued on page 74*

AUDIO UPDATE

The evolution of car stereo



LARRY KLEIN,
AUDIO EDITOR

THE FEATURES, FUNCTIONS, AND CAPABILITIES of today's autosound equipment are remarkable—and were certainly undreamed of when I did car-audio repairs and installations at a Delco-Radio warranty station in Queens, New York. It was my first civilian job after an 18-month stint in the U.S. Army Signal Corps.

The new car radios that I handled in 1949 were impressive by the standards of the day. Push-pull 6V6 or 6K6 output tubes provided 8 to 10 watts of power—which was about as high as you were likely to find in the typical home console radio. All of the sets had vibrator-driven transformer power supplies that were a sort of mechanical version of today's solid-state switching power supplies. The supplies provided 250 volts or so to the plates and screen elements of the output tubes, while the tube filaments were directly heated by the car's 6-volt battery. As many as seven tubes were found in the higher powered sets with their extra RF stages and push-pull output circuits. Although primitive by today's standards, the radios were the end product of a long evolutionary process that started during the late 1920's.

The first "car" radios were actually big battery-operated sets in wooden cabinets that were wrested out of their normal living-room locations and into the back seats of cars. Of course, the separate horn had to come along, too, unless you were content with headphone listening. Despite all

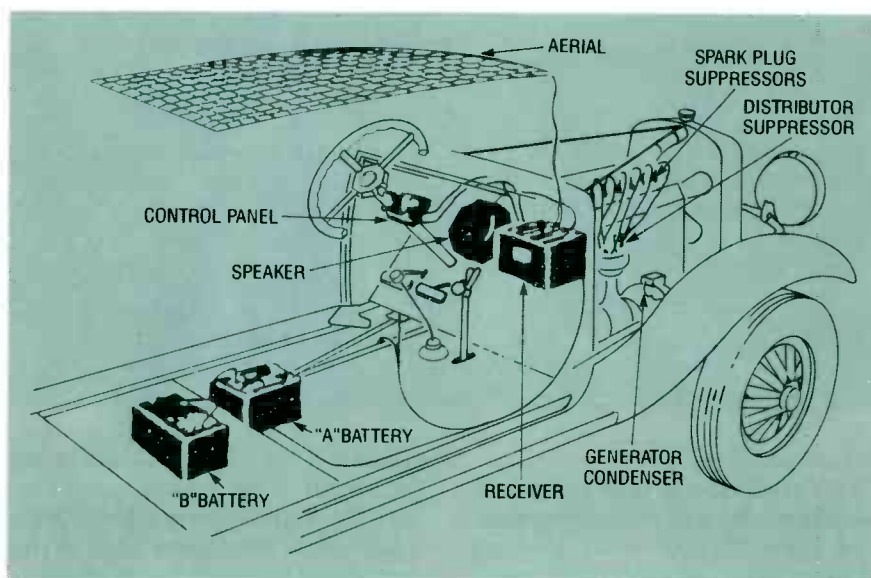

FIG. 1

the effort, the electrically noisy automotive ignition systems of the day eliminated any possibility of music on the move. But if you were parked with your motor off in an area of reasonable reception, and if your antenna was good enough, you could usually find something to listen to. Some of the early photos show home-grown antennas strung high over a car on front and back T-bars that bear a striking resemblance to backyard clotheslines.

Dedicated car radios

Since radio in those days was very much of a build-it-yourself hobby, it wasn't long before some drivers began assembling and installing sets designed specifically for car use. Their task, I imagine,

was not too much different from that faced by today's autosound installers dealing with high-powered triamplified multi-speaker systems. In other words, where do you fit all the parts?

The radio's electronic components were housed in a metal cabinet about the size of a large bread box, and it was connected to a separate enclosed speaker the size (and shape) of a hat box. The volume and tuning controls were usually housed in a separate small module, which was clamped to the steering column and *mechanically* linked to the electrical components within the chassis box. The "aerial" might be a large grid of chicken wire hidden beneath the car's cloth-covered roof. The separate tube-filament

"A" batteries, high-voltage "B" batteries, and bias "C" batteries were installed, if possible, under the car's floorboards. To ease the installation task, companies such as Chrysler, Studebaker, Pierce-Arrow, and others shortly began building cars with built-in-roof antennas and the required floor-cut-out battery compartments (see Fig. 1).

Eventually, shielding techniques and "suppressors" were developed that reduced electrical-ignition noise to an acceptable level for music on the go—and OEM car-radio installation took off. In a promotional effort late in 1929, the Automobile Radio Corporation joined forces with a large New York City Dodge dealer in a successful 30-day showroom demonstration. By 1930, 34,000 units had been sold, and the car radio was slowly evolving from a novelty to a necessity. Despite magazine articles claiming that radios kept drivers awake and alert, more than one locality tried to pass ordinances against them on the grounds that they caused loss of attention and drowsiness and could even distract the drivers of *other* cars. The Radio Manufacturers Association (RMA)—now the EIA—successfully fought all such efforts to outlaw car radios.

When cars with solid-steel tops appeared in 1934, the chicken-wire grid in the roof was suddenly no longer a feasible antenna option. All sorts of alternative locations for the antenna were tried, including a wire strung under the running board. As radios became more sensitive, the whip antenna became a practical and easy-to-install alternative, and it's been in use ever since.

Car-radio sales really took off during the post-WWII boom. In early 1947, the National Association of Broadcasters (NAB) reported that there were over seven million sets on the road. Of course, they all used tubes and were AM only. FM was barely off the ground as a broadcasting media, and the invention of the transistor was about a year away. In the late fifties, FM was finally judged sufficiently popular to warrant its use in a car. It first appeared as an optional below-dash adaptor de-

signed to be connected to the existing radio. By that time, the AM radio itself had evolved into a sleek unit, only a little larger than a cigar box.

Hybrid radios

In the mid-1950's, transistors began to appear in consumer products, but it took several more years before they found their way into car radios. A 1960 Lafayette radio catalog offered several models with "transistor powered" chassis. The sets were actual "hybrids" in that the transistors were used only in the output circuits and the rest of the functions were handled by tubes. The advantage of such a configuration was that the newly developed RF tubes, like the output transistors, could work directly from the car's 12-volt battery, thus eliminating the need for a high-voltage supply with its trouble-prone vibrator.

The transistor-output circuits had the virtues of cool operation and very low current drain, but they did result in lower power-output ratings and some strange output impedances. I remember installing a hybrid AM/FM Motorola that required a 32-ohm speaker. In the early 1960's, stereo came to FM, but not yet to the car radio. Considering the barely adequate specs of the typical FM set, it's likely that the engineers found that a stereo FM radio had excessive multipath and signal-fluctuation problems in a moving vehicle. In fact, it was well into the 1970's before AM/Stereo FM car radios became commonplace.

Tape players appeared somewhat earlier, particularly on the West Coast. A 4-track Fidelity-based machine made a brief showing but was shortly swamped under by the proliferation of the 8-track format. It was only after the early success of 8-track car players that North American Philips decided that cassettes might also be a viable source of mobile music.

Future formats

Judging from the number of prototypes I saw in Japan, the Japanese at one time were seriously considering making the microcassette a hi-fi medium for both home and car. But either the

task proved too difficult (which I doubt) or they were diverted by other formats that they considered more promising. Speaking of promising formats—despite all the promotional efforts, I'm not optimistic about widespread public acceptance of CD car players—and I feel only slightly more positive about DAT.

As to convenience, the DAT format has more going for it than CD, but I doubt that the typical car-sound buff will rush to trade in a high-quality cassette player for a DAT machine whose only real advantage is extra playing time and convenient random access—particularly considering how costly it will be to buy and feed. As with CD, the genuine sonic advantages of DAT are unlikely to be heard in a moving vehicle. Within a year or so, we should know whether CD and DAT were able to successfully take their shows on the road. **R-E**

Try the Radio- Electronics

bulletin board
system

(RE-BBS)
516-293-2283

The more you use it the more
useful it becomes.

We support 300 and 1200 baud
operation.

Parameters: 8N1 (8 data bits, no
parity, 1 stop bit) or 7E1 (7 data
bits, even parity, 1 stop bit).

Add yourself to our user files to
increase your access.

Communicate with other R-E
readers.

Leave your comments on R-E with
the SYSOP.

RE-BBS
516-293-2283

DRAWING BOARD



ROBERT GROSSBLATT,
CIRCUITS EDITOR

The contest is over.

I'VE BEEN PUTTING THIS OFF FOR A FEW months now, but it's time to wrap up the EPROM contest that I ran some months ago. There were lots of entries and I was really impressed with both the number of entries and the amount of time that was put into some of them.

It's been some time since the contest started so, before we look at the entries and start handing out medals, let's go over the rules.

The contest

The rules were really simple. We had spent some time talking about custom-character generators and had gone through the design of one using a 2716 EPROM. That worked out well but a lot of the space in the EPROM was wasted. The simple design we started with used only four of the EPROM's eleven address lines, and even the complex one we ended with (it did

CHARACTER GENERATOR TRUTH TABLE											
INPUTS		OUTPUTS									
BINARY DATA	HEX DATA	D7 DP	D6 'G'	D5 'F'	D4 'E'	D3 'D'	D2 'C'	D1 'B'	D0 'A'	HEX DATA	LED'S LIT
0000	0	0	0	1	1	1	1	1	1	3F	□
0001	1	0	0	0	0	0	1	1	0	06	/
0010	2	0	1	0	1	1	0	1	1	5B	2
0111	7	0	0	0	0	0	1	1	1	07	7

FIG. 2

hex and some ASCII characters) used only eight of the address lines and also left lots of holes in the 2716.

The aim of the contest was to develop a use for all the remaining space in the EPROM, given that the basic purpose of the EPROM was as a custom-character generator for seven-segment LED displays.

The mail

It's terrific to get reader mail be-

cause, aside from letting me know that people actually read this stuff, it also indicates whether or not I'm explaining things clearly. And in going through the contest mail, it became evident that some of you are a bit confused about what an EPROM actually is.

Without mentioning names, several entries suggested (occasionally at great length and considerable detail) using an EPROM to do a variety of math and logical operations. It would be nice if you could do those things, but things are only what they are.

An EPROM can only output what it's stuffed with in the first place. The closest you'll get to having an EPROM do something like math is to use it as a state machine to do oddball logic decoding. That's really what's going on with the custom-character generator, but it's a far cry from some of the suggestions that came in the mail.

Let's put a cap on this by pointing out that an EPROM isn't the kind of memory you can re-program on the fly. In essence it's just a passive device and, as such, you can't expect it to change as circuit conditions change. A programmed EPROM isn't anywhere

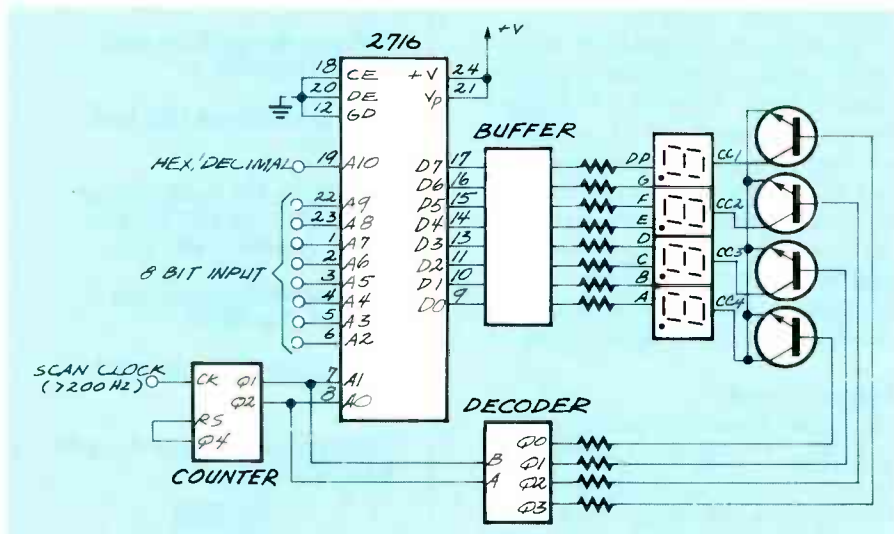

FIG. 1

near the same as a programmed microprocessor. The words may be the same but that's where any kind of similarity ends.

Some of the entries included ways to display the entire ASCII character set on a seven-segment LED. That's great in theory, but unless you're willing to devote a portion of your life to remembering how to translate some weird looking characters, it's not a very practical thing to do. The character set we developed was shown in Fig. 1 in the March, 1989 column. We did only a small portion of the ASCII set and, as you can see, even some of the ones we did choose weren't exactly what Albrecht Durer would comfortably refer to as a "well-formed character."

When it comes right down to it, seven-segment displays were made to display numbers, and it's only by a stroke of luck that you can also get it to display all the hex numbers as well.

The rest of the entries were from people who understood the limits of the display and concentrated their efforts on increasing the amount of things you could do with the display. In general, those included adding some of the features you'd find in a standard MSI display chip like a 7447, 4511, 4543, or any of the others. That includes things like lamp testing, display blanking, and the ability to handle more than one seven-segment display. That last one wasn't strictly the kind of thing addressed (no pun intended) by the contest since it does take some external parts, but it's a neat idea otherwise.

The envelope please

It's hard to pick one winner when there were so many terrific entries, but that's what I have to do. However, before I pick the winner I'd like to thank everyone who took the time to send in an entry. I know (believe me, I *really* do know) how much time it takes to put an idea into practice. If you're one of the people who sent something in, you should award yourself nine design points and I'll keep a special eye on the mail for anything else you'd care to send in.

Before I congratulate *the* winner, let me announce the three

runners up. They are Heath Kehoe of Waterloo, Iowa, Christopher Eddy of Pittsburgh, Pennsylvania, and Steve Trapp of Columbia Heights, Minnesota. And now, the winner of the contest is Randall Logan of Coquitlam, British Columbia in Canada. He decided to use the EPROM to convert eight-bit binary data into either hex or decimal and then add some additional circuitry to allow the EPROM to control four digits.

The block diagram of his circuit is shown in Fig. 1. The best use for the circuit, as Randall pointed out, is to display port status. That could be an eight-bit port on a computer, the end product of an eight-bit A-to-D conversion, and so on.

The EPROM's address lines are divided into three groups. One line (A10) is the page-select control for choosing either hex or decimal characters. The A2-A9 lines are the data inputs, and they actually select the character pattern you want at the EPROM outputs. The last group is made up of the lower two address lines and it selects the digit you want the output character displayed on.

If you want to use the circuit to convert binary to hex, you'll be using only two of the displays since two hex digits can handle eight bits of binary. The idea of using the circuit to convert binary to decimal is cute and it's a good one to remember.

Each decimal number is stored in the EPROM in the form of four sequential bytes. Assuming that the A segment on the display is controlled by the EPROM's D0 output, the B segment by D1, C by D2, etc., and D7 controlling the decimal point, a decimal display of 0127 would be stored as 3Fh, 06h, 5Bh, 07h (see Fig. 2). For a common-cathode display, those bytes would light the segments needed to display 0127. That's a kind of brute-force method for conversion to decimal numbers, but it's also a neat way to get the job done.

You may find it a bit misleading to have four digits there, since the circuit needs only two of them for hex and can handle only three of them for decimals. It's certainly possible to do away with one of the displays but, as Randall men-

tions in his letter, the fourth digit lets you display either signed or unsigned decimal. If you're using signed decimal, the first digit in the display can be turned into a dash by lighting just the G segment (a 40h in the EPROM), indicating a negative number.

The display multiplexing in Randall's circuit is done in a very straightforward fashion. A scan oscillator drives a counter whose first two outputs are connected to the EPROM's two low-order address pins as well as to the two select inputs of a two- to four-line decoder. When the first digit is selected, the first of the four numbers is present on the EPROM outputs, selecting the second digit selects the second in the sequence of four bytes, and so on.

The idea of stuffing the EPROM with four sequential bytes is an original way to do binary-to-decimal conversion—it's also what made Randall's idea stand out from all the others. I'm filing it carefully away and I strongly suggest that all of you do the same. Good ideas are really rare; and any time you come across one you should treat it like gold.

The counter and two- to four-line decoder in the diagram can be any ones you want to use (although the decoder has to have active high outputs). Your choice should depend on the logic family that you feel most comfortable using, and also what chips you happen to have around when you're building the circuit. Nothing is particularly critical.

Randall says that he has also written a program in BASIC to generate the EPROM data. If he sends it to me, I'll print it in the column and also put it on the RE BBS.

Once again, congratulations on your design, Randall, and I hope you enjoy your year's subscription to **Radio-Electronics**. **R-E**



R-E Engineering Admart

Rates: Ads are 2 1/4" x 2 7/8". One insertion \$900. Six insertions \$875. each. Twelve insertions \$845. each. Closing date same as regular rate card. Send order with remittance to **Engineering Admart**, Radio Electronics Magazine, 500-B Bi-County Blvd., Farmingdale, NY 11735. Direct telephone inquiries to Arline Fishman, area code-516-293-3000. **Only 100% Engineering ads are accepted for this Admart.**

Surface Mount Chip Component Prototyping Kits—

Only \$49.95

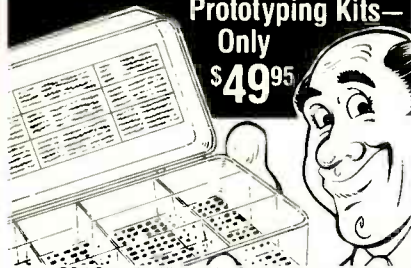

CC-1 Capacitor Kit contains 365 pieces, 5 ea. of every 10% value from 1pf to .33μf. CR-1 Resistor Kit contains 1540 pieces, 10 ea. of every 5% value from 10Ω to 10 megΩ. Sizes are 0805 and 1206. Each kit is ONLY \$49.95 and available for Immediate One Day Delivery!

Order by toll-free phone, FAX, or mail. We accept VISA, MC, AMEX, COD, or Pre-paid orders. Company P.O.'s accepted with approved credit. Call for free detailed brochure.



COMMUNICATIONS SPECIALISTS, INC.
426 West Taft Ave. • Orange, CA 92665-4296
Local (714) 998-3021 • FAX (714) 974-3420

Entire USA 1-800-854-0547

CIRCLE 180 ON FREE INFORMATION CARD

FCC LICENSE PREPARATION

The FCC has revised and updated the commercial license exam. The **NEW EXAM** covers updated marine and aviation rules and regulations, transistor and digital circuitry. **THE GENERAL RADIOTELEPHONE OPERATOR LICENSE - STUDY GUIDE** contains vital information. **VIDEO SEMINAR KITS ARE NOW AVAILABLE.**

WPT PUBLICATION
979 Young Street, Suite A
Woodburn, Oregon 97071
Phone (503) 981-5159

CIRCLE 183 ON FREE INFORMATION CARD

MIDI PROJECTS

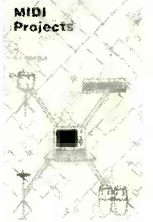

BP182—MIDI interfacing enables any so equipped instruments, regardless of the manufacturer, to be easily connected together and used as a system with easy computer control of these music systems. Combine a computer and some MIDI instruments and you can have what is virtually a programmable orchestra. To get your copy send \$6.95 plus \$1.25 for shipping in the U.S. to **Electronic Technology Today Inc.**, P.O. Box 240, Massapequa Park, NY 11762-0240.

HARDWARE HACKER

continued from page 69

though, is that there is a brand new, accurate, and cheap way of measuring absolute humidity that can completely bypass all the problems of all the relative humidity methods we've just looked at. A typical example is the HS-5 sensor from *Shibaura*, which is distributed by *Mitsubishi*. Figure 4 shows the sensor.

It uses a sneaky and indirect way of measuring the humidity. The thermal conductivity of the air varies with humidity, being lowest with dry air and highest at the high-humidity values. That's one reason why dry air is generally far more comfortable than humid air.

A pair of thermistor sensors is used. One is hermetically sealed into a container holding extremely dry air. The other lies inside a similar container that has access to the ambient air. Since both containers are in contact with each other, they should both remain at the same temperature.

Currents are then applied to both thermistors in a bridge arrangement. Both thermistors are run up into their non-linear self-heating range. The dry sensor will

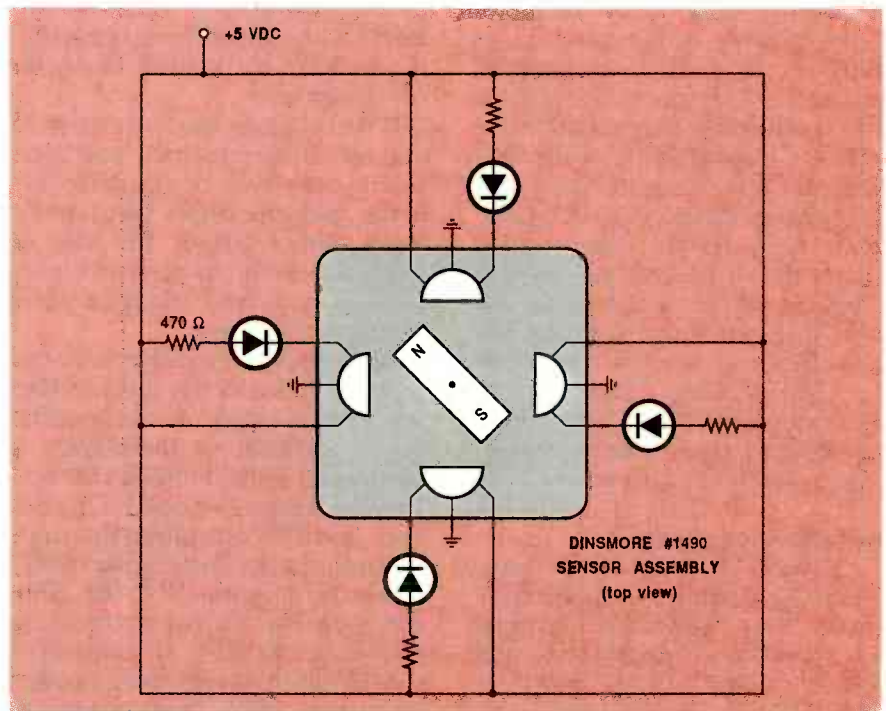

FIG. 5—LOW-END DIGITAL COMPASS is cheaper than a fluxgate but has a very poor resolution. Hall-effect sensors are used to drive the LED outputs as shown here. Eight-point LCD compass rose displays are also possible.

lose very little heat through thermal conductivity, while the wet sensor will lose heat in proportion to the humidity present. The result will be an output voltage difference that's related to absolute humidity for a given temperature.

Pricing in large quantities is in the \$5 area. The sensor would seem to work best where enough power (half a watt) is available to keep it up at its operating temperature, and where an output computer can do all of that lin-

READY-TO-USE PROFESSIONAL INSTRUMENTS NOW FROM HEATH

Backed by the expertise that makes our instruments famous

- An engineering department that insists on honest value in every product.
- Rigorous quality assurance inspection.
- Full one year warranty.
- Outstanding manuals with complete specifications, operating instructions, schematics and more.
- Technical assistance hotline: (616) 982-3315.
- Our own factory service department.

A DMM THAT'S GOT IT ALL



This powerful handheld does more than any DMM we've seen. It lets you measure frequency to 20 MHz, works as a logic probe to 20 MHz, tests transistor beta, measures capacitance plus does everything you'd expect a DMM to do. Even measures resistance to 2000 MΩ!

SM-2372 \$99.95

Specifications: At 23 ± 5° C, DC Volts: ±0.5% of reading ±1 digit, 200 mV - 1000 V. Input impedance 10 MΩ. Overload protection: 200 mV range, 500 VDC/350 VAC 15 seconds. Other ranges, 1200 VDC/850 VAC, 60 seconds. AC Volts: 200 mV - 750 V. Accuracy ±1.0% of reading ± 4 digits except 1.5% on 750 V range. DC Amps: 200 μA - 10 A. ±1% of reading ±1 digit except 2.0% on 10 A range. AC Amps: 200 μA - 10 A. Accuracy ±1.2% of reading ± 4 digits except ±2% on 10 A. Resistance: 200 Ω - 2000 MΩ. Overload Protection, 200 mV range, 500 VDC/350 VAC for 15 seconds; Other ranges, 1200 VDC/850 VAC for 60 seconds. Capacitance: 2 nF - 20 μF. Frequency: 2 KHz - 20 MHz. Logic: TTL to 20 MHz. Other: Diode test, continuity beeper, beta.

ONE OF OUR BEST SELLERS



Here's a 3-1/2 digit DMM that will give you excellent and reliable service. Full DMM functions include current to 10 A, capacitance and transistor beta. A lined carrying case keeps your DMM safe from the bumps and scrapes of everyday use. Kit version also available.

SM-2320 \$77.95

Specifications: DC Volts: 200 mV - 1000 V ±0.5% of reading ±1 digit. Overload protection: 1000 VDC/750 VAC except 500/350 on 200 mV. Input 10 MΩ. AC Volts: 200 mV - 750 V ±1.25% of reading ±4 digits, 40 Hz - 10 kHz. Overload: 1000 VDC/750 VAC except 500/350 on 200 mV. Input 10 MΩ. DC Amps: 200 μA - 10 A, ±1% of reading ±1 digit except ±2%/±3 digits on 10 A. AC current: 20 mA - 10 A ±1.5% ±3 digits except ±2.5%/±4 digits on 10 A. Resistance: 200 Ω - 20 MΩ. Overload protection, 500 VDC/VAC. Capacitance: 2 nF - 20 μF. Other: diode check, continuity beeper, beta.

HALF PRICE SPECIAL!



ONLY \$12.47

Order any product from this ad and get our popular shirt pocket miniature DMM SM-2300-A for only \$12.47 — half our regular price.

Specifications: Autoranging 3-1/2 digit DMM. DC volts: 2000 mv to 450 V, ±1.3% ±4 counts. Approx. 11 MΩ input resistance. Max input, 450 VDC. AC volts: 2000 mV to 450 V, ±2.3% ±8 counts, 50 to 400 Hz. Approx. 11 MΩ input resistance. Max input, 450 V. Resistance: 2000 Ω to 2 MΩ ±2% ±4 counts.

A POWER SUPPLY FOR EVERY WORKBENCH



Here's an excellent value in an all-around bench power supply. Dual meters let you continuously monitor voltage and current, and 0-30 volt 3-amp output fills most common power supply needs. Use the constant current mode to charge rechargeable batteries, limit power to circuits under test and operate devices that are current dependent.

SP-2762 \$199.95

Specifications: Output voltage: 0-30 VDC continuously variable. Coarse and fine controls. Output load: 0-3 A continuous. Output impedance: Typically less 0.2 Ω to 10 KHz. Ripple: To 10 KHz, less than 5 mV p-p (0.5 mV rms typical). Load regulation: ±0.25% ±3 mV, 1-100% of rated current. Line regulation: ±0.25% ±2 mV for ±10% line variation. Current limiting: 0-3 A, variable. Power: 120 VAC/240 VAC, ±10%, 50-60 Hz, 180 watts.

DELUXE SCOPES ARE A PLEASURE TO USE

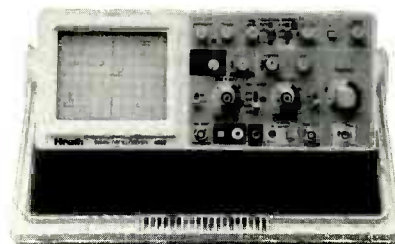

These oscilloscopes offer the measurement capability you need, plus luxury features that make them fun to own. TV triggers, 1 mV/div sensitivity, differential and X-Y measurements, plus beam finder, component tester, graticule illumination, and other features many manufacturers omit. Enjoy a top-quality 25 or 40 Mhz scope backed by a reliable name, full warranty and complete specifications.

25 MHz: SO-4552 \$399.95

40 MHz: SO-4554 \$599.95

Specifications: Vertical: 1 mV/div - 5 V/div. Bandwidth less at 1 mV/div. Accuracy ±3% at 1 KHz, ±5% at 1 mV/div. Overshoot: less than 5%. Max input: 400 V. Modes: CHA, CHB, dual, add. Horizontal: 2 s - .1 μs/div, plus X10 magnifier. Trigger: CHA, CHB, line, ext. Auto, norm, TV-V, TV-H, +/- . Power: 90-132/198-264 VAC, 50/60 Hz, 45 W. Weight: 16.7 lbs.

To order CALL TOLL FREE 1-800-253-0570

Use order code 217-320



for credit card orders, 24 hrs a day

For your free HEATHKIT catalog call 1-800-44-HEATH

We guarantee every specification we publish on every product we sell.

Heath Instruments

PO Box 8589

Benton Harbor, MI 49022

CIRCLE 187 ON FREE INFORMATION CARD

earization and absolute-to-relative humidity conversions for you.

Since absolute humidity is being measured, your operation should be equally good for low, medium, or high relative-humidity.

The same company offers thermistors for temperature measurement and for air-flow measurement using *hot wire anemometer techniques*. Lots of free data sheets, price lists, and ap-notes are available on request.

One handy source of ready-to-use industrial-grade humidity sensors is *General Eastern. Weather-Tronics* is a second.

A final company that has a very wide line of humidity sensors is *Omega Engineering*. Their stuff is usually very expensive, but be sure to pick up their free catalogs.

Two good sources for humidity sensing info are *Measurements and Control* and *Pollution Equipment News*.

For our third contest this month, just tell me how or why you would like to measure either the relative or absolute humidity.

A low-end digital compass

We have looked at some solid-state digital fluxgate compasses in previous columns. They are probably the best way to electronically measure a magnetic heading. Important uses of fluxgate sensors are for cave mapping, navigation, for car compasses, and for satellite-dish pointing.

I've recently found a cheaper and simpler method for electronic sensing of a magnetic heading. It is also considerably less accurate than a fluxgate and, being a moving mechanical device, has all of your typical compass damping and hunting problems.

This is the *Dinsmore digital compass sensor*. It is available for \$10 in hacker quantities, and much less in production quantities. The sensor consists of four hall-effect transistors facing each other and a moving central magnet on a carefully damped pivot. The maximum theoretical resolution is plus or minus 22.5 degrees. The intended market is for low-end auto and bike compasses, but there should be plenty of other low-end robotic and toy uses.

A simple four-LED display is

shown in Fig. 5. A liquid-crystal display showing N, NE, E, SE, S, SW, W, and NW is also available. It uses the same sensor in a slightly more complex circuit.

For our fourth contest, just show me some new or unusual use for a low-accuracy but very cheap digital compass.

New tech literature

New data books this month include the "must have" *TTL Logic Data Book* from *Texas Instruments*, that *LSI Products Data Book* from *TRW*, a *Specialty Memory Products Data Book* from *Advanced Micro Devices*, and a major upgrade of the *Smart Analog Data Book* from *Crystal Semiconductor*. That last jewel has some outstanding digital-audio integrated circuits in it.

A \$15 kit full of unusual tilt and impulse switches is now available from *Fifth Dimension*, while a free new *PLC-V8 Design Kit* is available from *Signetics*, that involves their new *erasable* logic arrays. Free electroluminescent lamp samples are available from *Nordic Lite*, while free force-sensing resistor cards are provided by *Interlink Electronics*.

Turning to mechanical samples, free baggies of vinyl-dipped products are gotten through *PMP*. One great place to pick up free samples of any mechanical goodie is through *New Equipment Digest*.

The new trade journals this week include *Surface Mount Technology* and *Electronic Manufacturing*. As usual, you can qualify with your own laser-printed business letterhead.

For those of you that want or need more info on all my book-on-demand publishing, there's my *Ask the Guru* reprints, volumes I and II, and the *Hardware Hacker* reprints for this column series. We also stock lots of PostScript books, software, and even videos. The *Hardware Hacker* help line may also be used for PostScript, book-on-demand and laser printing help, or networking.

Note that there are two *Names and Numbers* sidebars this month, one for the humidity stuff and one for just about everything else. Let's hear from you, and get to work on those contests. **R-E**

VLF CONVERTER

continued from page 50

If all is OK so far, check these measurements:

1. +0.5-+2 volts at junction of L1 and L2.
2. +2-+4 volts at Q2 source.
3. +8-+10 volts across R22.
4. +5-+7 volts, IC1 pins 8, 10.
5. +3.5-+5 volts across C5.
6. +0.8-+1.5 volts, IC1 pin 5.
7. +8-+10 volts, IC1 pins 6, 12.

So far so good. Now connect any radio that covers the AM-broadcast band to J3, and tune to 1.000 MHz on the AM dial (you're actually tuning to 000 kHz). Adjust L5 for the strongest signal. Adjust R7 to minimize that signal. Resistor R7 should cause a definite null around the middle of its range; if not, check IC1, R7, and R3 to R6. Tune the radio dial between 1010 kHz and 1550 kHz, where you should hear signals in the 10-kHz to 550-kHz longwave range. At 1100 kHz on the AM dial (you're actually tuning to 100 kHz), a loud rattling noise will be heard in most areas of the US and Canada; that's the LORAN navigational signals.

Obviously, you shouldn't hear any AM-broadcast stations; if you do, check your cables and grounding because something's wrong. Make sure the shielding is adequate, especially the box used for the DC block. As a last resort, check L1 through L4, C1, C2, C3, and R7's setting. The circuit should work when it's fired up.

An extremely strong AM-broadcast signal may occasionally cause "crud" to seep through that rides on all the longwave signals. That may occur when you live within a few miles of a high-powered broadcast station. If so, try installing a 47-pF capacitor across R1. If that helps, then try smaller values (or larger) until the smallest value is found that reduces the interference to a satisfactory level. You might also try using a smaller whip antenna, or try removing D1 through D4, although the protection they afford Q1 will be lost.

With the LF converter assembled and operating properly, you can now put it to use. Try listening to the wide variety of unusual broadcasts that you'll receive in the low-frequency band, such as maritime, distress, military, and amateur. **R-E**

COMPUTER DIGEST

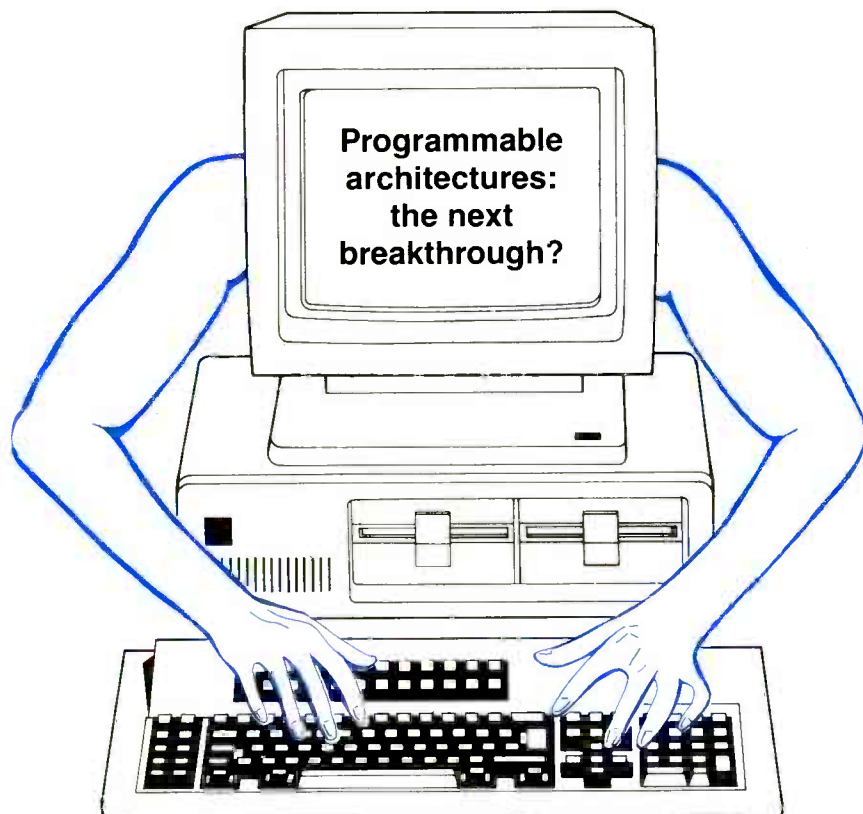

ANDREW REEVE

I often become frustrated with the limitations of the computers I use. When I feel the tension rising, rather than let it get to me, I enjoy just sitting back and dreaming up better ways of designing and building the integrated circuits that make up our computing machines.

One day I had an inspiration about a new type of IC that I call the programmable architecture. It's not the type of thing that a hobbyist can build on his own; rather it requires expensive resources that only the largest semiconductor manufacturers possess. But perhaps this article will stimulate those manufacturers into developing the ideas outlined here.

Programmable array

Imagine a large array inside an IC; the array contains thousands

of cells. Now imagine that each cell can function as any one of the five basic logic gates (AND, NAND, OR, NOR, NOT) or as a data line (a connecting wire), and that its function in any given situation is determined by you.

Not only would you decide the function of each cell; you'd also decide on the interconnections among cells. Thus you'd be able to create your own Programmable Logic Circuitry (PLC). Additionally, if what you just created didn't suit your fancy, you could simply erase the whole thing and start over.

How could anyone build such an amazing chip? It's simple: just use existing technology.

A look inside

If you know anything about the EPROM (Erasable Programmable
continued on page 80

EDITOR'S WORK- BENCH

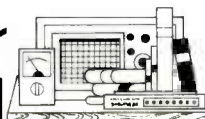

386SX kit

Peripheral Technology, supplier of the 386SX motherboard kit described in the June, July, and August issues, can be reached at 1710 Cumberland Point Drive, Suite 8, Marietta, GA 30067. (404) 984-0742. Incorrect information was printed in the June issue; we regret the error.

File transfer with LapLink III

Traveling Software has just released the ultimate file-transfer program. LapLink Release III combines the best features of its competitors, throws in several new ones of its own, and wraps the whole thing up in a fast, easy-to-use package.

Highlights include: serial and parallel mode transfers, both with "turbo" options; a six-headed cable with both serial and parallel connectors; the ability to duplicate itself on a remote PC; integrated disk and file manager; a batch mode for automating common transfers; and a special device driver that allows one PC to have DOS-level access to another PC's disk drives and printers.

If you're new to this type of product, it was originally designed to solve the problem of how to get files from a laptop PC (with a 3.5-inch disk drive) to a desktop PC (with a 5.25-inch

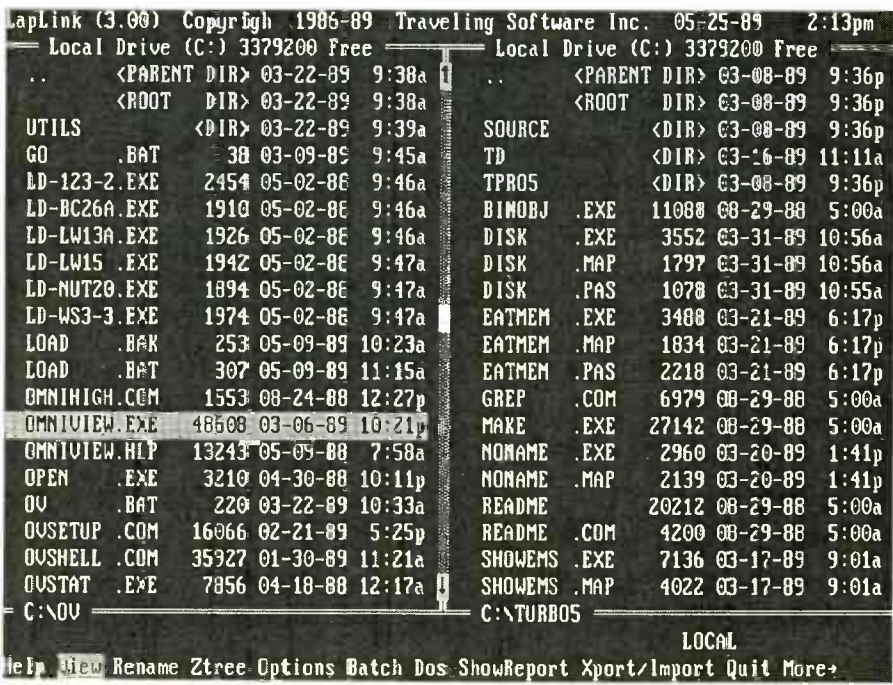

FIG. 1

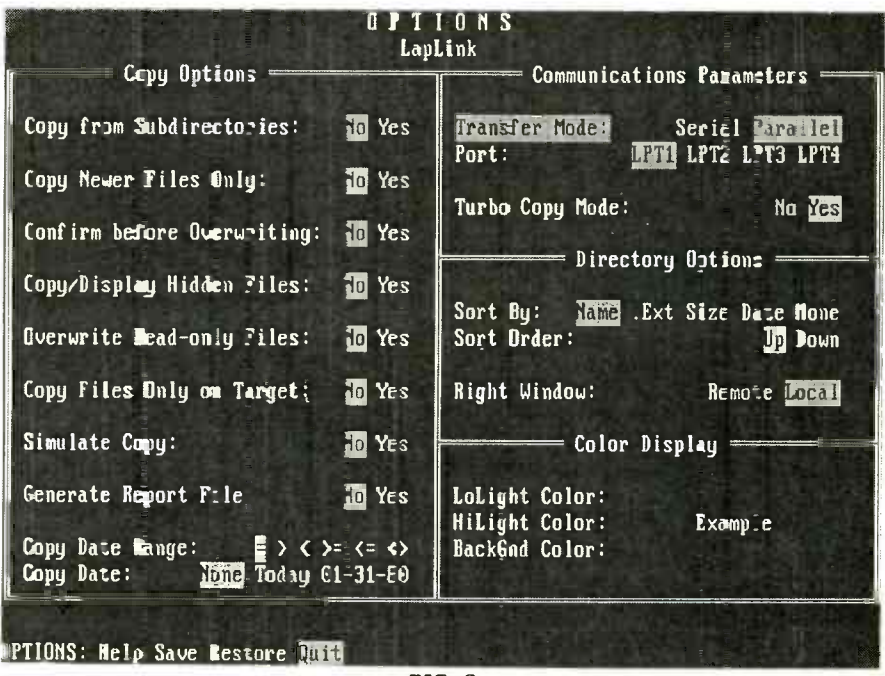

FIG. 2

The basics

LapLink III runs on PC compatibles with 256K of free memory, a free serial or parallel port, and any version of DOS from 2.11 through 4.00. Both 5.25-inch and 3.25-inch diskettes are included in the package.

After starting the program on both machines, you're presented with two side-by-side windows (as shown in Fig. 1). The left window lists the contents of the current directory of the local drive; the right lists the contents of the remote. (You can reverse the meanings of the two windows, or make both windows views into the local drive, thereby allowing LapLink to function as an ordinary file/disk manager.) You switch between the two windows using the left and right arrow keys; for copy operations, the window containing the highlight bar is the source, and the other is the destination.

LapLink III has twenty commands, about half of which are displayed along the bottom line of the screen; you can see the other half by pressing M (More). You can move a highlight bar through the list by pressing the Spacebar and Backspace keys, and then execute the desired command by pressing Enter. Or you can simply press the first letter of a command to execute it. Some commands bring up secondary screens.

The Options command, for example, brings up a screen that allows you to set several aspects of program operation. You can choose between parallel and serial modes, communications port, baud rate (9600-115,200 Kbps) for serial transfers, and turbo mode. To increase speed, LapLink apparently decreases the frequency of clock "ticks" (normally about 18.2 per second). Doing so decreases DOS overhead and thereby allows communications to proceed at a faster rate. However, it causes your PC's clock to lose time.

Other options allow you to choose how directories are displayed, screen colors, and copy options. And here LapLink III shows itself powerful and flexible (see Fig. 2).

disk drive). However, systems integrators and PC support techs soon discovered that file-transfer programs have other uses as well. When IBM first introduced the PS/2 line (which has only 3.5-inch drives), for example, a big problem for many was simply getting their software transferred. LapLink and similar products made it easy, but only for those who knew the secret.

Once you learned that secret, you found that there were other similar uses as well. For example,

if you had to set up six PC's with identical software, you really only had to set up one from the installation disks supplied by the software manufacturers. Then you'd let the file-transfer program duplicate the entire disk, subdirectories and all, while you did something more interesting.

Some versions of those programs include their own disk and file managers to help you copy, erase, rename, move, etc., files around your hard disk, and even to back it up.

After you've got the options set, you're ready to get to work. To act on files individually, you move the highlight bar with the cursor keys and then execute the desired operation. For example, to copy a file from the source to the destination, just highlight the file and press C. Or erase (delete) it by pressing E. When a subdirectory is highlighted, you can change to it by pressing Ctrl-Enter or L (Log). Log also lets you change drives, or specify a complete subdirectory path. A separate command (Ztree) presents a graphic representation of your hard disk's structure, allows you to scroll through it using the cursor keys, and log into the desired directory.

Working on one file at a time can be tedious, so LapLink III lets you tag one or more files or groups of files. You tag files individually by highlighting them and pressing T, or by groups by pressing G (Grouptag). You might, for example, tag all the program files (*.COM, *.EXE, *.BAT) in a directory. You could then un-tag a few of those (the T command toggles tags on and off) and transfer the whole mess when you've got it right. If you run out of space on the target drive, or if you lose contact (if the cable comes loose, for example), LapLink III will halt but give you a chance to resume after changing disks, deleting some files, reattaching the cable, etc.

When the operation is through, you can re-tag all the previously tagged files. For example, after copying a group of files from a laptop to a desktop PC you might want to delete them from the Laptop. Doing so is easy: Just press A (Againtag) followed by E (Erase).

Advanced features

One of LapLink's neatest tricks is the ability to clone itself across the communications line. It works only in serial mode, and you must use Traveling Software's supplied cable. To clone a copy, all you do is type two DOS commands at the remote, and then let LapLink loose. In about a minute you've got fully functional versions of the program on

both machines. Other manufacturers are already starting to copy that ability.

LapLink also has the ability to help manage ViewLink files. (ViewLink is another Traveling Software product; it allows you to group files together in logical units, called views, regardless of the locations or types of those files. See "Editor's Workbench," June 1989, **Computer Digest** for more information.)

In addition, LapLink includes a device driver that allows you to access the printers and disk drives of a "slave" machine. You load the device driver via a statement in the CONFIG.SYS file in the "master" machine, and then run DD.EXE on the slave. At that point the slave's drives and printers are available to the master, but you can't use the slave for anything else. The device driver won't work under DOS 4.0. Traveling Software sells another product, DeskLink, that extends the device driver concept so that the two linked PC's are both active and both have access to each other's resources—like a miniature network.

In use

Learning LapLink III is easy, and using it is a pleasure, because of the well-thought-out, intuitive interface. There are a few command discrepancies. For example, from the window display you can change directory quickly by pressing Ctrl-Enter, but from the Ztree display you must press L (Log).

Table 1—Transfer times (seconds)

	Regular	Turbo
Serial	404	367
Parallel	282	245

As for speed, Table 1 shows the time it took to copy the contents of one subdirectory from a Dell System 300 to an AST Premium 386/16. The subdirectory contained 194 files, and consisted of about 4.5 MB of programs and data. As shown in the table, the turbo modes run 10% to 15%

faster than the regular modes. Other programs run faster than LapLink III. (FastWire II accomplished the same copy operation about 20% faster.) However, LapLink's user interface and documentation are superior. So, all in all, Traveling Software has set a standard for other file-transfer programs to emulate. ♦CD♦

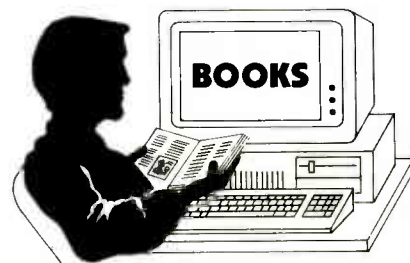

DOS books

Microsoft Press has released updated versions of Van Wolverton's *Running MS-DOS* and *Supercharging MS-DOS*. *Running MS-DOS* starts at the beginning, discussing files, disks, directories, etc. Batch files are also discussed, as well as useful but often unused DOS commands like FIND. *Supercharging MS-DOS* takes over from there, showing you how to customize your screen display and keyboard using ANSI.SYS, how to use DEBUG.COM, how to build your own menu-based DOS shell using batch files and the fancy "extended" character set (lines, boxes, etc.). Both books have been updated to include information on DOS 4.0. ♦CD♦

ITEMS DISCUSSED

- LapLink III (\$139.95), Traveling Software, 18702 North Creek Parkway, Bothell, WA 98011. (206) 483-8088.

CIRCLE 50 ON FREE INFORMATION CARD

- *Running MS-DOS* (\$22.95), *Supercharging MS-DOS* (\$19.95), Microsoft Press, Microsoft Corp., 16011 N.E. 36th way, Box 97017, Redmond, WA 98073-9717. (206) 882-8080.

CIRCLE 49 ON FREE INFORMATION CARD

R-E Computer Admart

Rates: Ads are 2 1/4" x 2 7/8". One insertion \$900. Six insertions \$875. each. Twelve insertions \$845. each. Closing date same as regular rate card. Send order with remittance to Computer Admart, Radio Electronics Magazine, 500-B Bi-County Blvd., Farmingdale, NY 11735. Direct telephone inquiries to Arline Fishman, area code-516-293-3000. Only 100% Computer ads are accepted for this Admart.

ICs

PROMPT DELIVERY!!!
SAME DAY SHIPPING (USUALLY)
QUANTITY ONE PRICES SHOWN for JUNE 25, 1989

OUTSIDE OKLAHOMA: NO SALES TAX

DYNAMIC RAM			
SIMM (1)	1Mx9	80 ns	\$400.00
SIMM	1Mx9	80 ns	220.00
SIMM (2)	1Mx9	85 ns	195.00
SIMM	256Kx9	80 ns	95.00
1Mbit	1Mx1	100 ns	16.25
41256	256Kx1	60 ns	8.50
41256	256Kx1	80 ns	7.35
41256	256Kx1	100 ns	5.95
41256	256Kx1	120 ns	5.75
4464	64Kx4	120 ns	8.50
41264 (3)	64Kx4	120 ns	12.50
EPROM			
27C1000	128Kx8	200 ns	\$27.50
27512	64Kx8	200 ns	9.95
27256	32Kx8	150 ns	7.25
27128	16Kx8	250 ns	4.50
STATIC RAM			
62256P-10	32Kx8	100 ns	\$26.50
6264P-12	8Kx8	120 ns	7.95
6116AP-12	2Kx8	120 ns	4.95

OPEN 6 1/2 DAYS, 7:30 AM-10 PM; SHIP VIA FED-EX ON SAT.

SAT DELIVERY INCLUDED ON FED-EX ORDERS RECEIVED BY: The 3rd Air \$6.30 Fr: \$1 \$12.25 1 lb

MasterCard VISA or UPS CASH COD
MICROPROCESSORS UNLIMITED, INC.
24,000 S. Peoria Ave.
BEGGS, OK 74421 (918) 267-4961

No minimum order. Please note: prices subject to change!
Shipping insurance extra, up to \$1 for packing materials.

GETTING THE MOST FROM YOUR PRINTER

Getting The Most From Your Printer



BP181—It is probable that 80% of dot-matrix printer users only ever use 20% of the features offered by their printers. This book will help you unlock the special features and capabilities that you probably don't even know exist. To order your copy send \$6.95 plus \$2.00 for shipping in the U.S. to Electronic Technology Today Inc., P.O. Box 240, Massapequa Park, NY 11762-0240.

SECRETS OF THE COMMODORE 64

Secrets of the COMMODORE 64



BP135—A beginners guide to the Commodore 64 presents masses of useful data and programming tips, as well as describing how to get the best from the powerful sound and graphics facilities. We look at how the memory is organized, random numbers and ways of generating them, graphics-color-and simple animation, and even a chapter on machine code. Get your copy today. Send \$5.00 plus \$1.25 for shipping in the U.S. to Electronic Technology Today Inc., P.O. Box 240, Massapequa Park, NY 11762-0240.

ARCHITECTURE

continued from page 77

Read Only Memory), then you understand the principle behind PLC. Using basic EPROM technology, you would create three programmable switches, S1-S3 in each cell. Those switches would be connected as shown in Fig. 1. Only one switch at a time could be closed: depending on which switch was closed, you'd get AND, OR, or a straight-through function.

Two additional switches, S4 and S5, allow you to choose between inverted or non-inverted output, thus providing the NAND, NOR, and NOT functions. Table 1

shows the different switch combinations that are required to achieve various logic functions. (We'll discuss the vertical data lines in a moment.)

The interconnections between cells poses another problem. The proposed solution is shown in

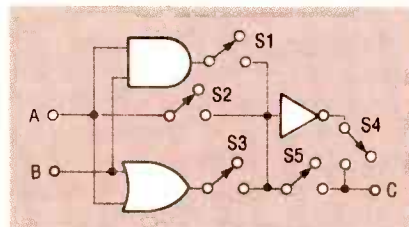

Fig. 1. BASIC PLC CELL STRUCTURE: each "switch" is implemented with EPROM-like technology, thereby allowing quick prototyping and design changes.

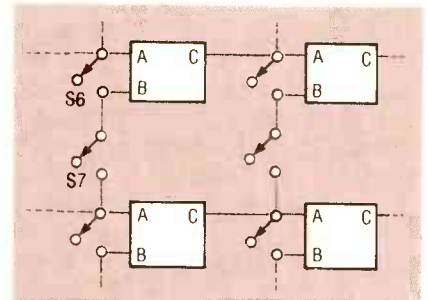

Fig. 2. INTERCONNECTING PLC CELLS horizontally relies on switches S2 and S5 (in Fig. 1) and vertically on switches S6 and S7.

Fig. 2. As shown, vertical connections are straightforward. For horizontal connections, the A input of a given cell can be connected directly to that cell's C output by closing switches S2 and S5 (in Fig. 1). In that scheme, the B input cannot be connected to the output line. That may seem unappealing, but the circuits discussed represent the least number of components per cell, thus allowing more cells to fit in an array.

One difficulty is creating an XOR gate. Four NAND gates would be required, but that would greatly increase the cost of each cell. Therefore we wouldn't provide prewired XOR gates. Instead we'd leave it up to the designer to build XOR's as necessary, to fit the particular application.

For many applications, the PLC

TABLE 1—LOGIC FUNCTIONS

	S1	S2	S3	S4	S5	S6	S7
AND	1	0	0	0	1	—	—
OR	0	0	1	0	1	—	—
NOT	0	1	0	1	0	—	—
NAND	1	0	0	1	0	—	—
NOR	0	0	1	1	0	—	—
Data Line	0	1	0	0	1	—	—
VDL 1	—	—	—	—	—	1	0
VDL 2	—	—	—	—	—	0	1

Note: VDL = Vertical Data Line.

array will need a clock to synchronize internal operation of the array. Therefore, the PLC would have a special clock cell that could be switched in at certain points on the outer edge of the array. Clock frequency would be determined by an external quartz crystal, just as many microprocessors are.

Programming the PLC

Programming each cell would be done in the same way EPROM's are programmed, one address location at a time. Of course, you'd have to toggle more than one switch in each cell in order to program the function of each cell. In an EPROM, that would be analogous to programming a byte instead of a bit at each memory location.

Unlike an EPROM programmer, however, the PLC programmer would not use a computer running an assembler program to feed a PLC with its programming data. Instead, a PLC-oriented CAD (Computer Aided Design) program would be used. Ideally, the CAD program would include debugging tools, chip simulation, and function creation, i.e., creating symbolic, higher-level functions from simpler ones. The XOR gate is a good example of function creation. A fast 16-bit computer would be the minimum for running a PLC CAD program.

Modes of operation

The PLC operates in two different modes. Mode 1 is used when you are programming the chip, and Mode 2 is used when you are actually executing the programmed functions in a circuit. Figure 3 shows a block diagram of the internal arrangement of the PLC.

Note that there are two sets of data buses. The one routed through the address decoder is used during programming (Mode 1); the other is for actual use (Mode 2). The switch bank determines which bus is used; the Mode input, which is directly connected to one of the pins on the outside of the chip, toggles the switch bank between the two buses.

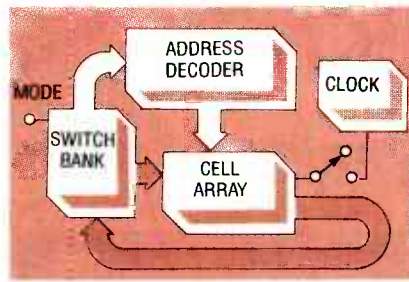

Fig. 3. A SWITCH BANK, controlled by an external Mode input, switches the PLC data bus between programming and in-use modes.

PLC applications

The manufacture and open distribution of PLC's would be a boon to everyone. IC manufacturers would benefit from easier, faster, and cheaper prototyping. Hobbyists would enjoy almost unparalleled freedom in playing with circuit variations. IC manufacturers would also be able to draw upon the pool of hobbyists for their own research and development efforts.

Here are a few ideas for possible PLC applications:

- Prototype microprocessors
- Parallel processor chips
- Lisp language machines
- Prototype "Neuro-Chips"
- Customized electronic lock and key circuitry
- Video, audio, and digital signal processing

Variations on the PLC

Using EPROM technology to build the switches in the PLC would enable one to erase the architecture of a PLC. But for a design that has stabilized, you might want to etch it permanently in silicon. The solution would be to use the same fuse design found in the PROM (Programmable Read Only Memory). To store something in a PROM, fuses are selectively blown. And whereas you can erase an EPROM, you can't fix internal fuses, so a programmed PLC PROM is permanent.

Other changes might include altering the basic cell structure. For example, rather than forming the basic cell from several logic gates, you might form it from fairly powerful micro-processing units. The effect would be the creation of a parallel processor. (See "A PC Run Circles Around a

Cray?" in the April 1989 edition of **Computer Digest** for more information on parallel processors.) Each of those processing units would be limited in how much it could do by itself. But when combined with others, as a whole they could have enormous computing power.

For that matter, forget about digital logic altogether. How about building an array of op-amps? An array of programmable op-amps would allow one to experiment with analog computing. Building an analog computer was the never-realized dream of computer pioneer Alan Turing. Perhaps the prime motivating factor for Turing was the fact that the brain (at the neural level) operates more in an analog fashion than in a digital one. So with an array of programmable op-amps one could experiment with neural networks.

Returning to the digital realm, a bizarre variation would be a self-modifying architecture, which might be used in systems with an evolving knowledge base, expert systems, etc.

Conclusion

The Programmable Logic Circuit is really a very simple idea. No new and revolutionary technology need be developed, nor must any horrific physical barriers be overcome. I hope that the elegance of the idea of programmable architectures has converted you—or at least given you some provocative ideas that you can consider. ♦CD♦

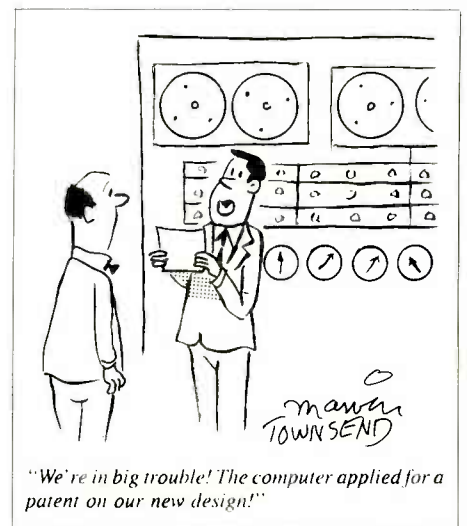

"We're in big trouble! The computer applied for a patent on our new design!"

68705 MICROCONTROLLER

How to build a single-IC microprocessor system

Sophisticated burglar alarms, stage-lighting controllers, digital music synthesizers, frequency counters, and other test instruments—they all have one thing in common. Designing each of those circuits (and others) using microprocessors is fast and easy if you use the right technology.

That technology needn't consist of expensive ICE's (In-Circuit Emulators) and the like. In fact, by using a single-chip Motorola microcontroller and building a low-cost (well under \$100) programmer, you can create custom designs as fast as you can think them up!

The MC68705P3 is a complete microcomputer on a chip. It contains CPU, ROM, EPROM, RAM, timer, interrupt input, clock, and twenty bidirectional I/O lines. Magically, it's all contained in a 28-pin package, which means that the data and address buses are completely hidden from the designer, so circuit-board layout becomes trivial.

In this article we'll discuss the 68705's architecture, its register structure, and programming considerations. Then we'll go on to build a programmer that burns your software into the 68705's internal EPROM. Next time, we'll put theory into practice when we design a two-IC digital alarm clock.

Hardware overview

To use the 68705 in your own projects, you must understand both its hardware and its software capabilities. Let's examine the hardware first. Figure 1 shows a block diagram of the main subsystems that comprise the 68705. First, note the CPU, which is itself composed of an ALU (Arithmetic Logic Unit) and a controller. Every instruction that the 68705 can execute (addition, subtraction, etc.) is performed by the ALU under

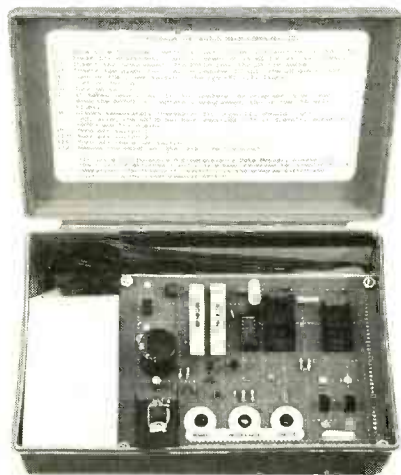

THOMAS HENRY

direction of the controller. The controller provides the timing necessary to carry out the microinstructions (even basic operations such as addition are composed of smaller steps called "microinstructions"), and ensure that they are performed in the correct order.

The 68705 has several types of memory. For starters, there are 112 bytes of RAM. That may not sound like much, but keep in mind that it is used only for storing variables and the stack; the application program itself is stored elsewhere. Typical microcontrollers seldom use even 30 or 40 variables, so the 68705 has plenty of RAM to handle almost all situations.

The 68705 also contains ROM. Actually, it has both ROM (Read Only Memory) and EPROM (Erasable Programmable Read Only Memory). The ROM, comprising 115 bytes, contains the EPROM burner program, which Motorola calls the "bootstrap." That means that the means for programming the EPROM is built right into the chip itself!

The EPROM itself consists of 1804 bytes; it is used to hold your application program and con-

stant data. Since EPROM is non-volatile memory, even if you interrupt power to the IC and later re-apply it, your program is still there ready to be executed.

In addition, many I/O lines are available. Logically they are grouped into three ports (parallel groupings of I/O lines). Port A and Port B are each eight bits wide; Port C is four bits wide. To send a message to the outside world, you simply store a byte in the desired port register, and the associated lines will reflect what was written. In an analogous way, the outside world can talk back; a byte placed on the lines of a port may be read by the CPU. I/O in the 68705 is memory-mapped, unlike the case in the Intel family, which has a separate address space and separate instructions for reading I/O ports.

Electrically speaking, the three ports are easy to use. They're all TTL compatible for both input and output. Also, Port B can sink as much as 10 mA, so it can drive LED's directly.

Associated with each port is a DDR (Data Direction Register). It is the duty of the DDR to configure the associated I/O lines for either input or output operations. The DDR itself is programmed by writing to special memory locations.

Referring to Fig. 1 again, note that there is an external interrupt line (\overline{INT}). Normally, the 68705 executes some sort of program. But there may be times when you wish to temporarily halt execution of the main program and then continue execution in a subsidiary program. An external signal (a fire sensor or burglar alarm) applied to \overline{INT} might cause such a change. Most microprocessors and microcontrollers have interrupt inputs, but what makes \overline{INT} especially useful is the fact that it can accept both digital and analog inputs!

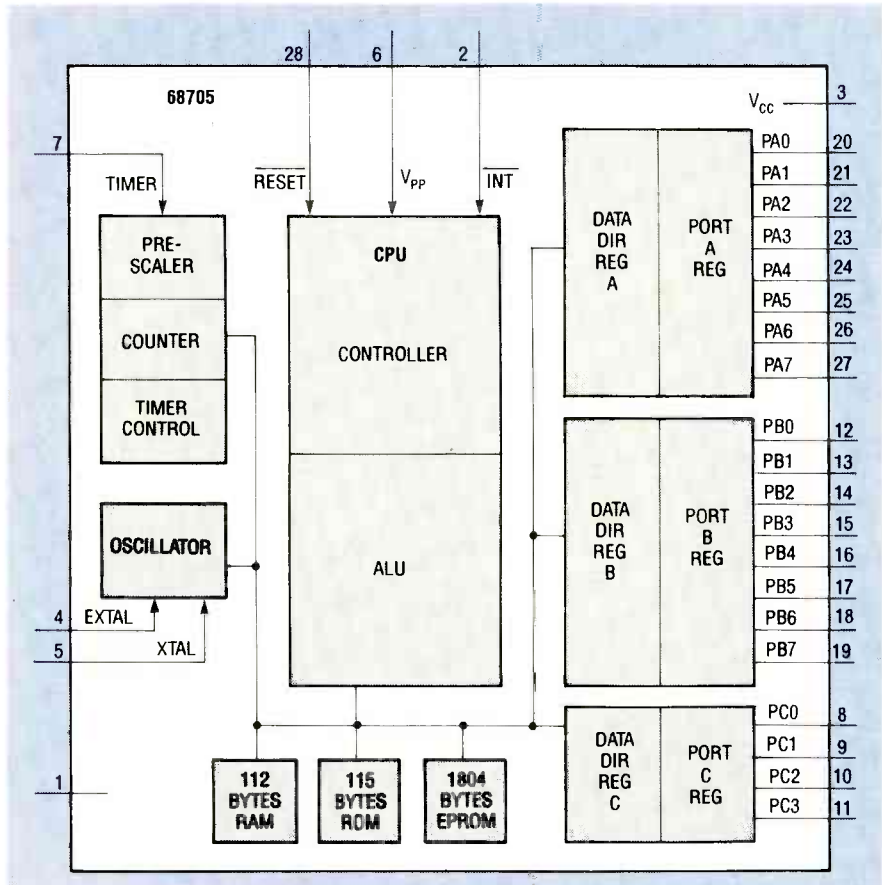

Fig. 1. THE 68705 IS A 28-PIN MICROCONTROLLER with RAM, ROM, EPROM, and 20 bytes of I/O.

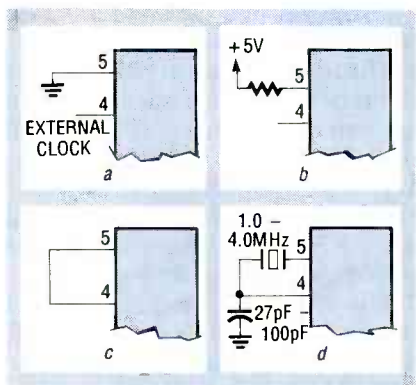

Fig. 2. CLOCKING THE 68705: (a) using an external clock, (b) using a resistor, (c) using the default clock, and (d) by crystal control.

The reason is that the 68705 has an internal Schmitt trigger, which means that it can detect zero-crossings of an analog signal. That capability might be useful in frequency-counter applications, in which a timebase is derived from a 60-Hz AC signal.

The 68705 also contains a timer with an optional prescaler. The timer, which is actually an 8-bit countdown register, can be

loaded with a number. The register will then proceed to decrement at the processor's internal clock rate; when the register hits zero, an interrupt is generated that causes the processor to continue execution at a special program location. The prescaler allows for longer periods between timeouts. The timer can also be clocked from an external source, if desired.

Of course, all computers must have some sort of clock to synchronize activities (access I/O ports, execute the microinstructions in the CPU, etc.) The 68705 has quite versatile clocking options. In fact, as shown in Fig. 2, it can be clocked in four distinct ways.

In Fig. 2-a we see how the 68705 can be clocked by an external source; you would use that method when a master clock is present in existing circuitry with which the microcontroller must interface. Figure 2-b shows how an external resistor can be used to set up the internal clock, and

Fig. 2-c shows how installing a jumper will allow the internal clock to run at a default rate. Last, in Fig. 2-d, a crystal is used for best accuracy and reliability.

Software overview

Now let's change focus and consider the software side of the 68705. If you've any experience with the 6800 or other 8-bit microprocessors, the 68705 will appear quite similar. Figure 3 shows the programming model. Both the accumulator and the index register are eight bits wide. As the name suggests, the results of most arithmetical and logical instructions "accumulate" in the accumulator. The index register, on the other hand, is typically used to access individual elements of tables and lists; it does so using special address modes discussed shortly.

The program counter is 11 bits wide, giving the 68705 a total address range of 2048 (\$0800) locations. Those locations include all the RAM, ROM, EPROM, DDR's, and I/O ports.

Also included in the programming model is the stack pointer. The stack is a LIFO (Last In, First Out) type; it's maintained in the user area of RAM, and its pointer always aims at the next usable

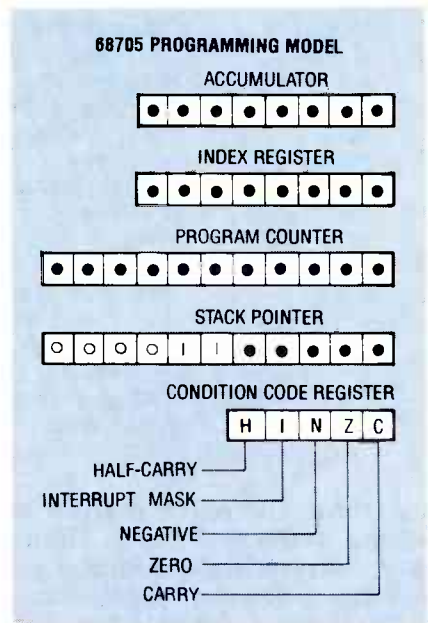

Fig. 3. THE 68705 consists of an eight-bit accumulator and index register, an 11-bit program counter and stack pointer, and a condition-code register.

known condition. (2) \overline{INT} (external interrupt) occurs when there is activity on pin 2 of the 68705, as discussed earlier. (3) An SWI, or *SoftWare Interrupt*, happens when the CPU executes an SWI instruction, which is typically used for debugging purposes. (4) The last type of interrupt is triggered when the internal timer times out.

One additional location in the memory map is interesting: the mask options register (\$784), which is a location in EPROM that allows the designer to determine how the 68705 operates. For example, by burning various bits in the location low or high, you can specify what type of clock you're using, how the timer is used, whether the prescaler is used, etc.

Address modes

The 68705 has ten address modes; many instructions are functional in several address modes. Unfortunately, we haven't space to discuss operation of each instruction in detail; consult the appropriate Motorola data sheets for more information. We will, however, discuss the basic address modes and several unusual instructions.

The immediate addressing mode is concerned with constants. For example, LDA #20 says to load the accumulator with the decimal constant 20. The pound sign is what indicates immediate mode.

Contrast that with the direct-address mode instruction LDA 20, which says to load the accumulator with the number contained in memory location 20. Here the accumulator loads a variable, not a constant. The direct mode can only access locations in page zero, because the operand (the address) is specified by a single byte.

The extended-address mode overcomes that liability by allowing two-byte operands. For example, LDA 450 says to load the accumulator with the contents of location 450. Of course, extended-mode instructions take more space and execute slower than direct-mode instructions.

The relative-address mode is

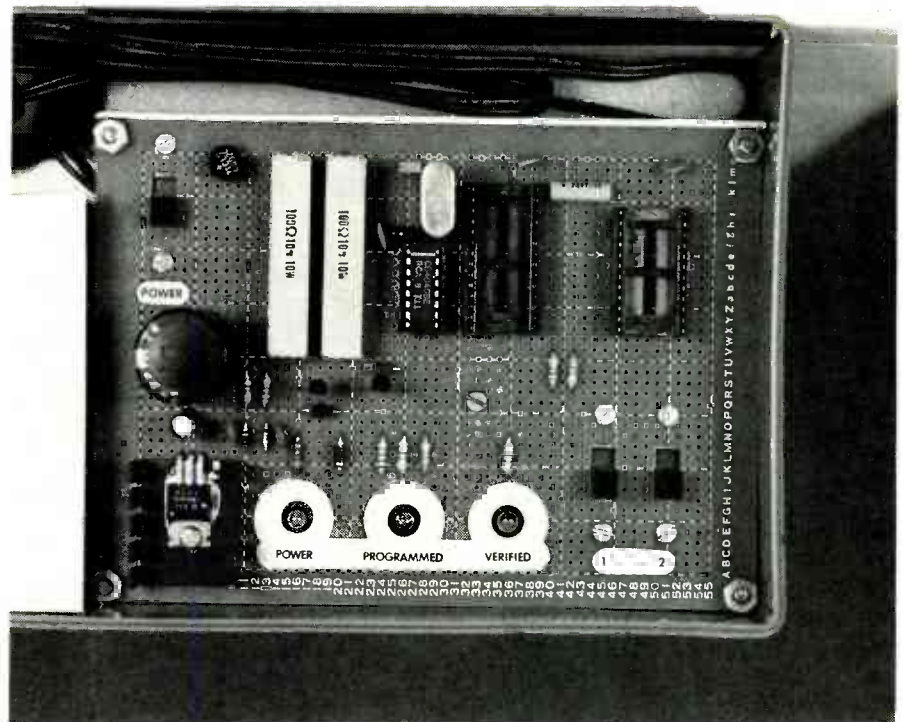

Fig. 5. PROTOTYPE OF THE EPROM BURNER. The author used wirewrap and point-to-point wiring techniques.

used in branching instructions. Rather than specifying a precise location to branch to, the relative mode allows the programmer (or the assembler program) to designate an address relative to the current address at which execution should continue. For example, BRA 10 would move execution to the tenth location following completion of the current instruction.

There are three types of indexed addressing modes available. The no-offset indexed mode takes its argument from the index register. For example, LDA (X) says to load the accumulator with the contents of the location pointed to by the index register.

The one-byte indexed mode extends that concept. For example, LDA 20,X1 tells the processor to add the number 20 to the contents of the index register and then access the resulting location. If the index register contained the number 35, say, then the contents of location 55 would be fetched ($20 + 35 = 55$).

The two-byte indexed mode extends the concept even further by allowing a larger number to be used. For example, LDA 450,X2 adds the two-byte number 450 to the contents of the index register

and then accesses the location specified by that sum.

The inherent addressing mode covers one-byte instructions whose operand is implied in the nature of the instruction. For example, CLR A says to clear (reset to zero) the accumulator; obviously, no external memory locations are involved. Unusually, the 68705 also allows the inherent mode with the index register. So, for example, CLR X would clear the index register.

Bit twiddling

Although we don't have space to discuss the entire instruction set, it's worthwhile mentioning several special instructions. With most microprocessors, to access individual bits within a byte, you must "mask" that byte; AND and OR it with constants. The 68705 has four special instructions that allow you to get at bits directly. BRSET allows your program to branch if a bit is set, and BRCLR allows your program to branch if a bit is clear. For example, BRSET 7,20,46 says to test bit 7 of location 20. If that bit is set, then branch forward 46 locations and resume program execution there.

BSET and BCLR allow you to set

Parts List

Resistors

All resistors are 1/4-watt, 5% unless otherwise noted.

R1	100 ohms, 10 watts
R2	100 ohms
R3-R5	470 ohms
R6-R10	4700 ohms

Capacitors

C1	75 pf, silver dipped mica
C2	100 pf, silver dipped mica
C3, C4	0.01 μ F disk
C5-C8	0.1 μ F disk
C9	1 μ F, 10 volts, electrolytic
C10	4.7 μ F, 10 volts, electrolytic
C11	1000 μ F, 50 volts, electrolytic

Semiconductors

BR1	50-volt bridge rectifier
D1	not used
D2-D4	1N4001
D5	1N4742A 12-volt Zener
D6	1N4748A 22-volt Zener
LED1	red
LED2	yellow
LED3	green
Q1, Q2	2N2222 NPN, general purpose
IC1	7805 5-volt regulator
IC2	4040 CMOS counter

Other components

F1	0.5-amp fuse
J1	28-pin ZIF socket
J2	24-pin ZIF socket
S1-S3	SPST switch

and clear bits individually. For example, BSET 4,20 sets the fourth bit of location 20, and BCLR 4,20 clears that bit.

Designing with the 68705

The question now is how to get a program into the 68705's internal EPROM. The process is actually quite simple. First, you need to write the desired program. If it is a short program, you can hand-assemble it (that is, look up the instructions and find the appropriate opcodes). Of course, it's

faster and more accurate to use a cross-assembler, a translator that runs on one computer, say a PC, and converts the ASCII source code into 68705-compatible object code (hex bytes). You can either buy a commercial cross-assembler or write one yourself in BASIC or PASCAL.

After writing and assembling the program, it takes two steps to burn the program into the 68705. First you must burn the code into a 2716 EPROM (a common device for which burners are likewise commonplace). Then the program is transferred from the 2716 to the 68705 using the bootstrap program in the latter. A circuit for doing that is shown in Fig. 4. The basic idea is that under direction of the bootstrap program, the bytes in the 2716 are sent one at a time to I/O Port A, where the 68705 reads them and then burns them into the appropriate locations of its EPROM.

In the schematic, J1 and J2 are Zero Insertion Force (ZIF) IC sockets for the 68705 to be burned and the 2716 containing the program, respectively. The 4040, IC2, is a counter that is clocked by PB3 of the 68705. The 4040's outputs allow locations in the EPROM to be accessed sequentially. The data outputs of the EPROM are then read by Port A of the 68705.

How does the 68705 know to execute the bootstrap program? Note that the TIMER input (pin 7) of the 68705 is tied to +12 volts. Pin 7 normally acts like a standard TTL input, but if the voltage on this pin rises to +12V, the CPU halts all other activity and starts executing the bootstrap program.

How to burn

To understand the remaining circuitry, let's trace through the sequence of steps involved in actually burning a 68705. Start by assuming that S1 is open (no power applied), and that S2 and S3 are closed. After inserting a 68705 and a 2716, close S1, which powers up the device. Now +12V is applied to the timer input, so the CPU knows that it must execute the bootstrap program. However, since S3 is still

closed, the microprocessor is stuck in a reset condition, so nothing happens yet. In addition, since S2 is closed, Q1 is off, so only +5 volts is applied to the V_{PP} input, rather than the +22-volt programming voltage. Also, both programming indicators (LED2 and LED3) are extinguished.

Now open switch S2. That allows Q1 to turn on, which allows it to pass the regulated +22V. Thus the programming voltage, not +5V, appears at V_{PP} . Now open S3; that brings the CPU out of the reset condition and allows it to execute the bootstrap program. After all bytes have been transferred, LED2 lights up, indicating that the internal EPROM has been burned.

However, the bootstrap isn't done yet. As a check, it goes back and compares each byte in its internal EPROM with the associated byte in the 2716. If they match successfully all the way down the line, then LED3 lights up, indicating that verification is complete. At this point, you would close S3, close S2, and then open S1. At this point the 68705 is ready for use.

Construction

The 68705 programmer uses only garden-variety components and is easy to build. Figure 5 shows the author's prototype; it was built ordinary wirewrap techniques; the entire unit is housed in a plastic pencil box.

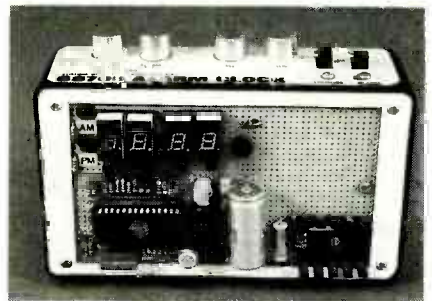

Fig. 6. NEXT MONTH we'll show you how to build this alarm clock.

In the next installment, we'll discuss the design of a complete alarm clock using the 68705 (see Fig. 6), and show you how it can replace dozens if not hundreds of discrete components—and lead to a better and much more versatile design! **CD**

MARKET CENTER

FOR SALE

PHOTOFACT folders, under #1400 \$4.00. Others \$6.00. Postpaid. **LOEB**, 414 Chestnut Lane, East Meadow, NY 11554.

GREAT buys! Surplus prices, ICs, linears, transformers, PS, stepping motors, vacuum pump, phototransistor, meters, LSASE, **FERTIK'S**, 5400 Ella, Phila., PA 19120.

DESCRAMBLERS. All brands. Special combo Jerrold 400 and SB3 \$165. Complete cable descrambler kit \$39. Complete satellite descrambler kit \$45.00. Free catalog. **MJM INDUSTRY**, Box 531, Bronx, NY 10461-0531.

BANDSTOP filters — Clear up channels affected by interfering signals. Channels 2, 3, 4, 8, 14, 15, 16, 17, 18, 19, 20, 21 and 22 available. \$20 each — 10 for \$130. **dB ELECTRONICS**, PO Box 98031, Las Vegas, NV 89193-8031.

T.V. tunable notch filters. Free brochure. **D.K. VIDEO**, Box 63/6025, Margate, FL 33063. (305) 752-9202.

CABLE descrambler liquidation. Major makes and models available. Industry pricing! (Example: Hamlin Combo's, \$44 each...minimum 10 orders). **Dealers only!** Call **WEST COAST ELECTRONICS**, (818) 709-1758.

SURPLUS ELECTRONICS. New giant wholesale catalog. Hundreds of amazing bargains. \$2. Box 840, Champlain, NY 12919.

SOLAR electric systems. Discount prices. **SUN POWER-TEXAS**, PO Box 2788A-R, Freeport, TX 77541. (409) 233-8350.

TUBES: "oldest," "latest." Parts and schematics. SASE for lists. **STEINMETZ**, 7519 Maplewood Ave., RE, Hammond, IN 46324.

CABLE converters and descramblers. Call or write for free catalog. Includes Jerrold, Oak, Zenith, Hamlin, Scientific Atlanta, many more. **NU-TEK ELECTRONICS**, 5114 Balcones Woods Dr. #307, Suite 298, Austin, TX 78759-5212. (512) 250-5031.

FREE CATALOG

FAMOUS "FIRESTIK" BRAND CB ANTENNAS AND ACCESSORIES. QUALITY PRODUCTS FOR THE SERIOUS CB'er. SINCE 1962
FIRESTIK ANTENNA COMPANY
 2614 EAST ADAMS
 PHOENIX, ARIZONA 85034

LASER Listener II, other projects. Surveillance, descrambling, false identification, information. Plans, kits, other strange stuff. Informational package \$3.00 refundable. **DIRIJO/BOND ELECTRONICS**, Box 212, Lowell, NC 28098.

ENGINEERING software, PC/MSDOS. Hobbyists — students — engineers. Circuit design, FFT analysis, mathematics, logic simulation, circuit analysis. Free catalog, (614) 491-0832, **BSOFT SOFTWARE**, 444 Colton Rd., Columbus, OH 43207.

CABLE-TV AT ITS BEST

SCIENTIFIC ATLANTA:
 Models 8500-8550-8580 ... \$275.00
 SA-3 [Add-On Descrambler] ... \$ 99.00
JERROLD:
 SB-3 [Inband Gated Sync] ... \$ 74.00
 TRI-BI [Trimode/Bistate] ... \$ 95.00
OAK:
 M-35B [Combo W/Vari-sync] ... \$ 99.00
 N-12 [Add-On W/Vari-sync] ... \$ 89.00
HAMLIN:
 MLD-1200 [Add-On] ... \$ 89.00
 ZENITH: [Z-TAC Descrambler] ... \$169.00
CONVERTERS: [80-Channels] ... \$ 95.00

DEALER DISCOUNT
ON <\$> UNITS

DISTRIBUTOR DISCOUNT
ON <10> UNITS

N.A.S. INTERNATIONAL
 LONG BEACH, CA (213) 631-3552

LOW prices capacitors, ICs, transistors, switches. Special: 27128-25 \$3.25. Flyer SASE. **SANTECH**, 11 Revere Place, Tappan, NY 10983. (914) 359-1130.

TOCOM V.I.P. shutdown? This "complete" module "turns on" descrambler. All modes; inverted video; no vertical jitter! Free schematic \$37.00 COD's. **MIKE**, Box 2837, Champaign, IL 61825-2837.

CABLE TV converters and descramblers. We sell only the best. Low prices. SB-3 \$79.00. We ship C.O.D. Free catalog. **ACE PRODUCTS**, PO Box 582, Dept. E, Saco, ME 04072. (207) 967-0726.

ERASE YOUR PROBLEMS

MCM ELECTRONICS HAS THE ANSWERS

Having trouble finding the electronic parts and components you need? Finding it impossible to get answers to order status inquiries or technical questions? Been bitten once too often by the "backorder bug?"

Then it's time you look to MCM Electronics for... ■ A huge selection of more than 11,000 in-stock items ■ Competitive prices that boost your profits ■ Convenient TOLL-FREE customer service and order hotlines ■ Virtually no backorders!

Ask for your FREE MCM Electronics Catalog today. When it arrives, place an order and find out how thousands of satisfied customers have erased their problems by turning to MCM for all their electronic parts and components needs.

FOR YOUR FREE ONE-YEAR SUBSCRIPTION TO THE MCM ELECTRONICS CATALOG...

CALL TOLL-FREE 1-800-543-4330



MCM ELECTRONICS
 650 CONGRESS PARK DR.
 CENTERVILLE, OH 45459-4072
 A PREMIER Company

SOURCE NO. RE-60

CIRCLE 87 ON FREE INFORMATION CARD

CONSOLIDATED ELECTRONICS

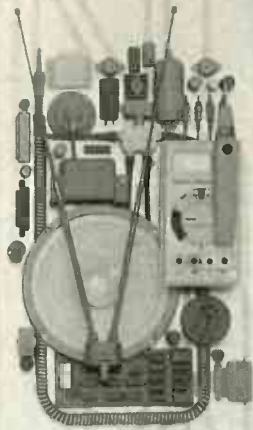

CONSUMER & INDUSTRIAL ELECTRONICS CATALOG • 17TH EDITION

THE ULTIMATE ELECTRONICS CATALOG.

Order your 260 page catalogue packed with over 10,000 money saving electronic parts and equipment. Send \$3.00 check or money order, or call 1-800-543-3568 today and use your Mastercard or Visa Consolidated Electronics, Incorporated 705 Watervliet Ave., Dayton, Ohio 45420-2599

NAME _____
ADDRESS _____
CITY _____
STATE _____ ZIP _____

CIRCLE 70 ON FREE INFORMATION CARD

3 FOR 1 SPECIAL ON SUB-MINIATURE VOICE FM TRANSMITTERS. KITS CONTAIN PC BOARDS



*FMX-1 LONG RANGE (3 MI) ULTRA SENSITIVE FM VOICE XMTR with fine tune, range control plus.....\$29.50



*TELX-1 TELEPHONE FM XMTR (3 MI) automatically operates when phone is used. Crystal clear clarity with fine tune and range control. Non detectable.....\$29.50



*ATR-1 AUTOMATIC TELEPHONE RECORDING DEVICE tapes telephone conversation all automatically.....\$19.50

ALL THREE OF ABOVE FOR.....\$59.50

CALL OR SEND VISA, MASTER CHARGE, MONEY ORDER, ETC. TO AMAZING CONCEPTS, BOX 716, AMHERST, NH 03031. (603) 673-4730.

MICROWAVE TV RECEIVERS 1.9 to 2.7 GHz



2 CH Compact Dish System - \$77.95
5 CH Dish System - \$93.95
12 CH Yagi (Rod) System - \$123.95
30 CH Dish System-\$163.90 Yagi-\$183.90
SUN MICROWAVE INT'L. INC. Send \$1⁰⁰ for
P.O. BOX 34522 catalog on these
PHOENIX, AZ 85067 and other fine
(602) 230-0640 video products.
VISA/MC/COD QUANTITY DISCOUNTS LIFETIME WARRANTY

LASERS, from \$40, for brochure write **MWK INDUSTRIES**, 9852 W. Katella, Suite 340R, Anaheim, CA 92804. Or call (714) 956-8497.

RESTRICTED technical information: Electronic surveillance, schematics, locksmithing, covert sciences, hacking, etc. **Huge selection. Free brochures. MENTOR-Z**, Drawer 1549, Asbury Park, NJ 07712.

TUBES, new, up to 90% off list. **KIRBY**, 298 West Carmel Drive, Carmel, IN 46032.

CABLE TV converters and descramblers bargain headquarters. Zenith, Jerrold, Scientific Atlanta, Tocom. Hamlin combo w/re-mote \$130. Oak M35B \$60.00. Jerrold 400-DRX3DIC w/re-mote \$134. Visa-M/C-COD. Call now (415) 584-1627.

CB RADIO OWNERS!

We specialize in a wide variety of technical information, parts and services for CB radios. 10-Meter and FM conversion kits, repair books, plans, high-performance accessories. Thousands of satisfied customer since 1976! Catalog \$2.

CBC INTERNATIONAL
P.O. BOX 31500RE, PHOENIX, AZ 85046

SOUTHWESTERN Bell home, business phone products. Wholesale dealer pricing to all. Cordless phone battery, antennas, more. \$5.00 refundable, for dealer catalog. **RADD**, 104 S. Broadway, Peru, IN 46970.

CANADA. Quality electronic components. Commercial and retail distribution. Competitive prices. No minimum order. For catalogue send \$2.00 (credited to first order) to **M.U.C. SALES**, Box 994, Kingston, Ontario K7L 4X8.



Quality Microwave TV Antennas

Multi-Channel 1.9 to 2.7 GHz. 40dB Gain
30-Channel System complete \$149.95
12-Channel System complete \$104.95
2-Channel System complete \$79.95

Philips-Tech Electronics
P.O. Box 8533 • Scottsdale, AZ 85262
(602) 947-7700 (\$3.00 Credit all phone orders!)

LIFETIME WARRANTY MasterCard • Visa • COD's Quantity Pricing

STEPPER motor drive & control with **Commodore 64**. Affordable hardware, interface, & software. Send for detailed literature & prices to: **MASE**, R.D. #2 Box 166, Mohrsville, PA 19541.

FASTEST color TV repairs, eliminate "Guesstimation" 100 priceless secrets. \$2.00 for sample. **MARTIN AND ASSOCIATES**, 60 Surfview Drive, Pittsburg, CA 94565.

HELP — someone needed to "revive" SA 8550-321 Box & then "fix" it. **MIKE**, 104 S. Broadway, Peru, IN 46970.

INFRARED remote tester, cable converters, more. Free Brochure. **ACTION PRODUCTS**, Box 916, New Castle, IN 47362.

SATELLITE TV

VIDEOCYPHER II descrambling manual, schematics, video and audio. Explains **DES**, EPROM, CloneMaster, 3Musketier. Pay-per-view (HBO, Cinemax, Showtime, adult, etc.) \$13.95, \$2 postage. **CABLETRONICS**, Box 30502R, Bethesda, MD 20814.

CABLE T.V. CONVERTERS WHY PAY A HIGH MONTHLY FEE?

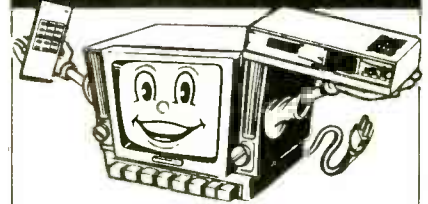

All Jerrold, Oak, Hamlin, Zenith, Scientific Atlanta, Magnavox and all specialized cable equipment available for shipment within 24 hours. For fast service MC / VISA or C.O.D. telephone orders accepted (800) 648-3030 60 Day Guarantee (Quantity Discounts) 8 A.M. to 5 P.M. C.S.T. **CLOSED WEEK-ENDS**. Send self-addressed Stamped envelope (60¢ postage) for Catalog.

MIDWEST ELECTRONICS INC.
P.O. Box 5000
Suite 311 (R)
Carpentersville, IL 60110

No Illinois Orders Accepted.

CABLE TV secrets — the outlaw publication the cable companies tried to ban. **HBO**, Movie Channel, Showtime, descramblers, converters, etc. Supplier's list included \$8.95. **CABLE FACTS**, Box 711-R, Pataskala, OH 43062.

DESCRAMBLERS for movies, networks, \$175, vic eo only \$450 complete. Visa, MC accepted. Catalog \$4. **SKYWATCH**, 238 Davenport Road, Toronto, Canada, M5R 1J6.

FREE catalog systems, Upgrades, Houston, Union, Chaparral, etc. **Save \$\$\$\$\$. SKYVISION**, 2009 Collegeway, Fergus Falls, MN 56537. 1 (800) 334-6455.

VIDEOCIPHER II manuals. Volume 1 — hardware, Volume 2 — software. Either \$32.45. Volume 3 — projects/software — \$42.45. Volume 4 — repair — \$97.45. **COD's** (602) 782-2316. Catalog — \$3.00. **TELECODE**, Box 6426-R, Yuma, AZ 85366-6426.

PAY TV AND SATELLITE DESCRAMBLING NEW... 1989 EDITION... NEW

The newest systems, parameters, turn-ons, harassment and countermeasures being used by and against cable, wireless and satellite operators. New original information \$15.95 Pay TV Vol. 1 \$14.95. Volume 2 \$12.95. Experiences with VC \$12.95. MDS/MMDS Handbook \$9.95. Build Satellite Systems Under \$600. \$12.95. Any 3/\$28 or 6/\$42. Scrambling News Monthly \$24.95/yr. Sample \$3. Scrambling News Year 1 (200 pages) \$22.95. New Spring Catalog \$1 or call.

Scrambling News, 1552 Hertel Ave., Buffalo, N.Y. 14216 COD's 716-874-2088

DESCRAMBLER: Build our low cost video only, satellite TV descrambler for most satellite channels. Uses easy to get, everyday parts. Boards & plans \$35.00 US funds. Board, plans & parts \$99.00 US funds. Wired & tested unit \$189.00 US funds. Send check, money order or Visa to: **VALLEY MICRO-WAVE ELECTRONICS**, Bear River, Nova Scotia, Canada B0S 1B0 or phone (902) 467-3577. 8am to 4pm eastern time. Note: educational project only. Not to be used illegally.

SATELLITE TV receiver kits! Instruction manuals! Boards! Semiconductor Parts! 59 deg LNA's! LNB's! Ku-Band LNB's! Catalog \$1.00: **XANDI ELECTRONICS**, Box 25647, 21YY, Tempe, AZ 85285-5647.

BUSINESS OPPORTUNITIES

EASY work! Excellent pay! Assemble products at home. Call for information. (504) 641-8003 Ext. 5192.

MECHANICALLY inclined individuals desiring ownership of small electronics manufacturing business-without investment. Write: **BUSINESS-R**, C.S. 9008, Baldwin, NY 11510-9008.

AMAZING SCIENTIFIC & ELECTRONIC PRODUCTS

PLANS

Build Yourself — All Parts Available in Stock

LC7— BURNING CUTTING CO ₂ LASER	\$20.00
RUB4— PORTABLE LASER RAY PISTOL	\$20.00
TCC7— 3 SEPARATE TESLA COIL PLANS TO 1.5 MEV	\$25.00
IOG2— ION RAY GUN	\$10.00
GRAT— GRAVITY GENERATOR	\$10.00
EM1L— ELECTRO MAGNET COIL GUN/LAUNCHER	\$8.00

KITS

With All Necessary Plans

VMP7K— FM VOICE TRANSMITTER 3 MI RANGE	\$49.50
VMP7K— TELEPHONE TRANSMITTER 3 MI RANGE	\$39.50
BTC3K— 250,000 VOLT 10-14" SPARK TESLA COIL	\$249.50
LHC2K— SIMULATED MULTICOLOR LASER	\$44.50
BLS1K— 100,000 WATT BLASTER DEFENSE DEVICE	\$69.50
NIG7K— NEGATIVE ION GENERATOR KIT	\$34.50
PSP4K— TIME VARIANT SHOCK WAVE PISTOL	\$59.50
STATK— ALL NEW SPACE AGE ACTIVE PLASMA SABER	\$59.50
SDSK— SEE IN DARK VIEWER KIT	\$199.50
PG5K— PLASMA LIGHTNING GLOBE KIT	\$49.50

ASSEMBLED

With All Necessary Instructions

BFTC10— 50,000 VOLT-WORLD'S SMALLEST TESLA COIL	\$54.50
LGU40— 1MW HeNe VISIBLE RED LASER GUN	\$249.50
TAT30— AUTO TELEPHONE RECORDING DEVICE	\$24.50
ITM10— 100,000 VOLT 20" AFFECTIVE RANGE INTIMIDATOR	\$99.50
LST10— SNOOPER PHONE INFINITY TRANSMITTER	\$169.50
IPG70— INVISIBLE PAIN FIELD GENERATOR MUTLI MODE	\$74.50

● CATALOG CONTAINING DESCRIPTIONS OF ABOVE PLUS HUNDREDS MORE AVAILABLE FOR \$1.00 OR USE OUR PHONE FOR "ORDERS ONLY" 603-673-4730.

PLEASE INCLUDE \$3.00 PH ON ALL KITS AND PRODUCTS PLANS ARE POSTAGE PAID. SEND CHECK, MO, VISA, MC IN US FUNDS.

INFORMATION UNLIMITED
P.O. BOX 7160EPT. RE AMHERST, NH 03031

REMOTE CONTROL KEYCHAIN



Complete w/mini-transmitter and +5 vdc RF receiver Fully assembled including plans to build your own auto alarm. Quantity discounts available

\$19.95 Check, Visa or M/C Add \$2 shipping

VISITECT INC. (415) 872-0128
PO BOX 5442, SO. SAN FRAN., CA 94080.

LEARN to develop microcontroller projects. New platform reveals how. Interfaces to IBM PC/Compatibles. **INTERRUPT TECHNOLOGIES**, 117 E. Apollo, Garland, TX 75040.

DAZER defense devices! Micro transmitters! Plans, kits! Catalog \$1.00. **QUANTUM RESEARCH**, 17919-77 Avenue, Edmonton, Alberta T5T 2S1.

PRINTED circuit boards etched & drilled. Free delivery. **K & F ELECTRONICS, INC.**, 33041 Groesbeck, Fraser, MI 48026. (313) 294-8720.

RADIO astronomy! Monthly magazine, books, components. \$3.00 brings sample package. **BOB'S ELECTRONIC SERVICE**, 7605 Deland, Ft. Pierce, FL 34951.

DETECTION — surveillance, debugging. Plans, kits, assembled devices. Latest high-tech catalog \$5. **DETECTION SYSTEMS**, 2515 E. Thomas, #16-864F, Phoenix, AZ 85016.

CATALOG: hobby/broadcasting/HAM/CB: Cable TV, transmitters, amplifiers, surveillance devices, computers, more! **PANAXIS**, Box 130-F9, Paradise, CA 95967.

CONSTRUCT and package industrial circuits using E-Z Buss prototyping system. Free brochure. **NATIONAL SYSTEMS**, Suite 150, 17 Hammatt Street, Ipswich, MA 01938. (508) 356-1011.

SCRAMBLE FACTS

718-343-0130

PHONE TODAY for 3 minutes of satellite TV industry news, technical tips, and new product information.

SURVEILLANCE equipment design gives 58 schematics of Sheffield Electronics surveillance devices. Circuits explained. Transmitters range from pens to one-mile VOX's including crystal, subcarrier, carrier current, infrared, firefly, automobile. Demodulators given. Cube tap and duplex mains powered transmitters presented. Eighteen telephone transmitters are leech and battery types including crystal and subcarrier. Countermeasures chapter. Much more. This 8 1/2 x 11 inch 110-page book is illustrated with photographs. Price \$30.00 + \$4.00 S & H. First class mail U.S. & Canada. Overseas Airmail S & H \$9.00. One-day processing, pay with Money Order or Cashier's Check. Send to: **WINSTON ARINGTON**, 7223 Stony Island Ave., Chicago, IL 60649-2806.

PROJECTION TV Convert your TV to project 7 foot picture... Easy... Results comparable to \$2,500 projectors... **Plans and 8" Lens \$24.95...** Professional systems available... **Illustrated catalog free...** **MACROCOMA**, 15GA Main Street, Washington Crossing, PA 18977. Creditcard orders 24 Hrs. (215) 736-3979.

EDUCATION & INSTRUCTION

MAGIC! Four illustrated lessons plus inside information shows you how. We provide almost 50 tricks including equipment for four professional effects. You get a binder to keep the materials in, and a one-year membership in the International Performing Magicians with a plastic membership card that has your name gold-embossed. You get a one-year subscription to our quarterly newsletter "IT'S MAGIC!" Order now! \$29.95 for each course + \$3.50 postage and handling. (New York residents add applicable state and local sales tax). **THE MAGIC COURSE**, 500-B BiCounty Boulevard, Farmingdale, NY 11735.



SINGERS! REMOVE VOCALS FROM RECORDS AND CDs!

SING WITH THE WORLD'S BEST BANDS!

An Unlimited supply of Backgrounds from standard stereo records! Record with your voice or perform live with the backgrounds. Used in Professional Performance yet connects easily to a home component stereo. This unique product is manufactured and sold Exclusively by LT Sound - Not sold through dealers. Call or write for a Free Brochure and Demo Record.

LT Sound, Dept. RL-3, 7980 LT Parkway Lithonia, GA 30058 (404) 482-4724
Manufactured and Sold Exclusively by LT Sound
24 HOUR PHONE DEMO LINE: (404) 482-2485

IBM PC. Learn assembly language. Spaceship game. Find princess game. \$5 each. Book \$18. **ZIPFAST**, Box 12238, Lexington, KY 40581-2238.

LEARN before you leap, plain-english guide to buying computers. What questions to ask, what answers mean. \$8.50 PP, check, MC/Visa. **HMI**, 5908-R Pleasantridge Road, Arlington, TX 76016.

CCD Video camera. Learn how imaging IC's work and how to use them to build a low cost video camera. Send \$19.95, **VITRONICS**, PO Box 7, Station G, Calgary, Alberta, T3A 2G1.

WANTED

SEISMOMETER wanted to measure earthquakes. Pay cash. **D. HUTCHISON**, 4000 Little Timber, Edmond, OK 73034. (405) 341-9615.

DESCRAMBLER MODULE

LATEST technology alternative to Jerrold SB-3 or Radio-Electronics Feb. 1984 project. Featuring electronic tuning, AGC, auto-on/off, AC/DC power, mini-size, A&T, and more. For literature — **SOUTH-TECH DISTRIBUTING**, (813) 527-2190.

CABLE TV DESCRAMBLERS

***** PRESENTING *****
***** STARRING *****
JERROLD, HAMLIN, OAK
AND OTHER FAMOUS MANUFACTURERS

- FINEST WARRANTY PROGRAM AVAILABLE
- LOWEST RETAIL/WHOLESALE PRICES IN U.S.
- ORDERS SHIPPED FROM STOCK WITHIN 24 HOURS

FOR FREE CATALOG ONLY **1-800-345-8927**
FOR ALL INFORMATION 1-818-716-5914

PACIFIC CABLE CO. INC.
7325V RESEDA BLVD., DEPT. RE1189
RESEDA, CA 91335



DIGITAL CAR DASHBOARDS

BUILD yourself a complete electronic dashboard. Free details, \$1.00 P&H. **MODERN LABS**, 2900 Ruisseau, St.-Elizabeth, QC, J0K 2J0, Canada.

BUY BONDS

CABLE TV DESCRAMBLERS

JERROLD™ Tri-Bi Mode	\$105.00	10 Lot	\$85.00
JERROLD™ SB-3 OR 2	\$89.00		\$65.00
Hamlin ML-D-1200	\$99.95		\$62.00
Oak N-12 W/V.S.	\$99.95		\$62.00
Oak M-35-B W/V.S.	\$99.00		\$78.00
OAK E-13	\$99.95		\$58.00
Zenith SSAVI	\$185.00		\$145.00
Eagle PD-3	\$120.00		\$85.00
Scientific Atlanta	\$129.95		\$105.00
SA-Cornbo's	CALL		\$Call
Tocom	\$350.00		\$295.00
Oak N-12 W/ Auto	\$140.00		\$105.00
Jerrold Starcom CSV	\$139.95		Call

M.D. ELECTRONICS
WILL MATCH ANY
ADVERTISED PRICE
IN THIS MAGAZINE

*NEW STARGATE 2000 CABLE CONVERTER



1-\$89.00 10-\$69.00 100-Call

Last channel recall-Favorite channel select-75 channel-Channel scan-Manual fine tune-One year warranty-surge protection-HRC & Standard switchable-and much more. **Call Today!**

INFORMATION (402) 554-0417

Orders Call Toll Free
1-800-624-1150

M.D. ELECTRONICS
115 NEW YORK MALL
SUITE 133E
OMAHA, NE. 68114



CIRCLE 53 ON FREE INFORMATION CARD

SPECTRUM MONITOR

continued from page 64

figured as an astable, its real purpose is to function as an additional voltage source. It works in conjunction with T2, a 3:1 toroidal auto-transformer, to provide the tuning voltage. Most tuner/converters need 0-25 volts for full-range control. The primary of T2 is supplied by the +10 volts from IC3, and the 143.056-kHz oscillation superposes an additional 20 volts, producing 30 volts across C31. The duty cycle is very low to conserve power. Next, D5, a 25-volt Zener, clamps and regulates the tuning voltage, and R18 controls the tuning voltage for the first local oscillator in the tuner.

For tuners requiring negative or multiple voltages, T2 will have to be modified. For a different maximum amplitude required, change the ratio of T2, and for a negative voltage, reverse D4 and D5 and also the non-tap terminals on the auto-transformer. This will force the auto-transformer to generate negative-going pulses, which will be superposed upon the

+10-volts DC. Reversing D4 and D5 allows current to be passed in the reverse direction, and the Zener voltage of D5 could be changed if needed. The horizontal sweep generator produces both sawtooth and pulse waveforms, and can be externally synchronized.

The purpose of D9, D10, and R33 is to allow the negative and positive slopes to be set independently. Note that R33 is in series with D9, but that there's no comparable resistor in series with D10. Thus, R33 extends the duration of the sawtooth waveform up-ramp so the CRT beam fits on the horizontal axis of the graticule. Then, D10 permits a steep, rapid discharge, minimizing the sawtooth waveform fall time and permitting fast horizontal retrace. Sweep-frequency potentiometer R32 allows the time constant to be varied.

Zener-diodes D7 and D8 clamp the output of the oscillations from IC7-c, D7 the negative-going direction, and D8 the positive-going direction. Then, IC7-d buffers the sawtooth generated across C39, and IC7-c switches C39 from charge to discharge based on the feedback through

R34. Finally, D6 routes the blanking/sync pulse to the vertical section (IC7-a and IC7-b) for vertical retrace. Note that D6 may need to be shorted or left out for faster vertical retrace, although some oscilloscopes will experience vertical overshoot as a result. You'll have to experiment with whatever oscilloscope you use, in order to decide.

True "Z"-axis control (blanking or brightness) is difficult to obtain on many oscilloscopes. If yours permits external blanking control, it's available as a positive pulse from pin 8 of IC7-c. This pulse drives the CRT beam vertically off the screen during retrace and turns the vertical amplifier off, preventing retrace from being seen.

The Signetics TDA7000, IC6, is a complete FM receiver on a chip. The tank L1-C26 for the Voltage-Controlled Oscillator (VCO) on pin 6 is the only RF adjustment. Only L2, C15, and C16 are required on IC5 as external components to create the RF input filter and perform matching. If the IF is 45 MHz, the value of L1 may need to be increased. By altering L1, any IF from 30-110 MHz may be

		EMINENCE 		 MOTOROLA			
1-800-338-0531							
3-WAY 100W CROSSOVER 12 dB/octave rolloff. 800Hz, 5000Hz crossover points. 8 ohm. 100 watts RMS.  \$12.50 \$9.95 #260-210 (1-9) (10-up)		WALNUT SPEAKER CABINET KIT Super quality, genuine walnut veneer cabinet. Kit includes: routed and mitred top, sides, and bottom in unfinished 3/4" walnut veneer. Cut your own custom holes in the front and rear to match your drivers. 15" x 24" x 11". Volume: 1.9 cubic feet.  \$22.50 \$19.95 #260-350 (1-3) (4-up)		12" SUB WOOFER Dual voice coil sub woofer. 30 oz. magnet, 2" voice coils. 100 watts RMS, 145 watts max. fs = 25 Hz. 6 ohm (4 and 8 ohm compatible). SPL = 89 dB 1W/1M. Response: 25-700 Hz. QTS = .31, VAS = 10.3 cu. ft.. Pioneer # A30GU30-55D. Net weight: 6 lbs.  \$39.80 \$36.80 #290-145 (1-3) (4-up)		18" EMINENCE WOOFER MADE IN USA 100 oz. magnet, 3" voice coil. 250 watts RMS, 350 watts max. 8 ohm, 30 Hz resonant frequency. 22-2700 Hz response. Efficiency: 95 dB 1W/1M. Paper cone, treated accordion surround. Net weight: 29 lbs.  \$98.90 \$89.50 #290-200 (1-3) (4-up)	
SPEAKER CONTROL PANEL Panel with 50 watt L-pads for tweeter and midrange and built-in LED power meter. 5" x 2 1/2" 100 watt version available  \$14.50 \$12.90 #260-235 (1-5) (6-up)		PIONEER HORN TWEETER Mylar dome. 2.93 oz. barium ferrite magnet. 8 ohm. Response: 1800-20000 Hz. 35W RMS, 50W max. fs = 2000 Hz, SPL = 106 dB. Pioneer # AHE60-51F  \$6.50 \$5.90 #270-050 (1-9) (10-up)		15" THRUSTER WOOFER Thruster by Eminence. Made in USA. Poly foam surround, 56 oz. magnet. 2-1/2", 2 layer voice coil. 150 watts RMS, 210 watts max. 4 ohm. fs = 23.5 Hz. QTS = .33, VAS = 17.9 cu ft. SPL = 94.8 dB 1W/1M. Net weight: 15 lbs.  \$43.50 \$39.80 #290-180 (1-3) (4-up)		TITANIUM COMPOSITE TWEETER Titanium is deposited on a polymer dome to combine the advantages of both hard and soft dome technologies. 8 ohm. Ferro fluid cooled voice coil. fs = 1200 Hz. SPL = 90 dB 1W/1M. 50 watts RMS. 70 watts max. 4" round. Polydax part # DTW100T12S.  \$27.50 \$24.80 #270-047 (1-9) (10-up)	
12" POLY WOOFER Super duty, 40 oz. magnet. 100 watts RMS, 145 watts max. 4 and 8 ohm compatible (6 ohm). 2" voice coil. fs = 25 Hz. QTS = .166, VAS = 10.8 cu ft. Response: 25-1500 Hz. Net weight: 9 lbs. Pioneer # A30GU40-51D  \$36.80 \$34.50 #290-125 (1-3) (4-up)		GRILL FRAME KIT With this kit you can make speaker grill frames up to 30" x 40". Kit includes 4 corner pieces, 2 T brackets, and 7 frame bars. Grill mounting kit included.  \$8.50 \$7.80 #260-333 (1-9) (10-up)					
		* 15 day money back guarantee * \$15.00 minimum order * We accept Mastercard, Visa, Discover, and COD orders * 24 hour shipping * Shipping charge = UPS chart rate + \$1.00 (\$3.00 minimum charge) * Hours: 8:30 am-6:00 pm EST, Monday - Friday * Mail order customers, please call for shipping estimate on orders exceeding 5 lbs.					

used. It's also possible to similarly adapt L2.

The TDA7000 reduces the received signal deviation from ± 75 kHz to ± 15 kHz (suitable for the internal IF of 70 kHz), using an internal Frequency (not phase) Locked Loop (FLL). The TDA7000 greatly simplifies the circuitry for many tuned circuits and filters, and neither needs nor uses AGC. In its place, a sample of IF limiter voltage is fed back to the IF LIMITER CAPACITOR input (pin 12), after being buffered and amplified by IC7-a. The gain of IC7-a is controlled by R22. The prototype used 500 K for R22, but the gain can be varied by using a potentiometer.

The positive signal portion of the IF envelope is amplified by IC7-b to produce the vertical drive. Potentiometer R25 sets the base line to "rectify" the signal from IC7-a. Between IC7-a and IC7-b, a two-pole low-pass filter smoothes DC ripple and reduces vertical overshoots. Also, IC7-a converts the high-impedance receiver section AGC, where the RF level is derived, to something low enough for proper filter design, while also providing some gain. Overall, IC7-a and IC7-b

provide a gain of about 40.

The tuner is the heart of the spectrum monitor. It accepts the RF IN (J5) and produces a 63-MHz IF OUT (J2). The FIRST LOCAL-OSCILLATOR TUNING VOLTAGE controls the first local oscillator. Remember that there are two operating modes, FM receiver and spectrum monitor. In the former, the tuning voltage is steady DC and is determined by center frequency potentiometer R18. In the latter, the tuning voltage is swept.

Sweep-width potentiometer R20 controls the tuner sweep-voltage and how much of the spectrum is displayed. The SPDT switch S2 selects between modes, not merely by selecting between the outputs for each with both sections (IC4 and IC7) operating simultaneously, but actually switches power between them, saving power and avoiding any coupling problems.

Well, we regret that we must stop here for now, as our space has come to an end. However, next month we will continue with complete construction details, including PC Service. We'll also show you how to troubleshoot any problems. We will then, of course, show you how to use it. R-E

ASSEMBLE YOUR OWN COMPUTER FOR LESS

IBM XT 10 MHz Compatible Kit.....\$379

- 4.77/10 MHz Motherboard
- 256KB RAM (640KB max)
- 150W Power Supply
- Floppy Disk Controller
- One 5 1/4" 360KB Drive
- MonoGraphics Card w/ P
- 101 Key Keyboard
- Case (3LED,2Button,Key)
- 12" Amber Mono Monitor
- Installation Guide & Manual



IBM AT 12 MHz Compatible Kit.....\$705

- 8/12 MHz Motherboard
- 512 KB RAM (4 MB max)
- 200W Power Supply
- Floppy Disk Controller
- One 5 1/4" 1.2 MB Drive
- MonoGraphics Card w/ P
- 101 Key Keyboard
- Case (3LED,2Button,Key)
- 12" Amber Mono Monitor
- Installation Guide & Manual



Display Upgrade:

- CGA Package \$200
- EGA Package \$455
- VGA Package \$500

Hard Drive Option:

- 20MB w/CTRL XT-\$275 AT-\$315
- 30MB w/CTRL XT-\$310 AT-\$410
- 40MB w/CTRL XT-\$390 AT-\$415

MS-DOS with GWBASIC \$75

All Components Fully Tested Before Ship
VISA & M/C subject to 3% surcharge
Price & Quantity subject to change without prior notice
15% Restocking Fee on All Items

JINCO COMPUTERS INC.

5122 WALNUT GROVE AVE.

SAN GABRIEL, CA 91776

Tel: (818) 309-1108

Fax: (818) 309-1107

IBM, XT, AT are registered trademarks of International Business Machine.

CIRCLE 184 ON FREE INFORMATION CARD

YOU CAN ONLY FIND SUCH LOW PRICES AND ADVANCE TECHNOLOGY AT MARK V ELECTRONIC KITS AND PROJECTS FOR AMATEURS AND PROFESSIONALS.

▲ indicates the level of difficulty in the assembling of our Products. ▲ Beginner ▲▲ Intermediate ▲▲▲ Advanced ★ Fully Assembled

AMPLIFIERS				MISCELLANEOUS			
MODEL	DESCRIPTION	KIT	ASSEMBLED	MODEL	DESCRIPTION	KIT	ASSEMBLED
TA-001	1W Mini-Amplifier ▲	\$ 5.07		TY-1A	Battery Fluorescent Light Driver ▲	\$ 5.19	
TA-006	6W Mini-Amplifier ▲	6.90		TY-7	Electronic Touch Switch ▲	7.15	
TA-007	12W Mini-Amplifier ▲	11.20		TY-8	Electronic Loto ▲	15.00	
TA-10	Stereo Pre-Amp. w/magnetic mic. amp. ▲	8.20		TY-11A	Multi-Functional Control Switch ▲	5.19	
TA-28MK2	Digital Voice Recorder ▲	30.00	\$ 40.00	TY-12A	Digital Clock w/timer ▲	20.15	
TA-50A/B	Multi-Purpose Melody Generator ▲	11.84	16.58	TY-13	Color Led Audio Level Meter ▲	5.19	
TA-50C	Multi-Purpose Melody Generator ▲	12.65	17.71	TY-14	Electronic Shock ▲	16.63	
TA-120MK2	Class "A" Main Power Mono Amp. ▲	31.25		TY-18	High Precision Sound Control Switch ▲	9.22	
TA-300	30W Multi-Purpose Single Channel Amp. ▲	15.00		TY-20	V Shape Color Led Level Meter ▲	21.45	
TA-302	60W Stereo Power Booster ▲▲	50.00	70.00	TY-23B	3 Channel Color Light Controller ▲▲▲	71.50	\$82.50
TA-322I	50W - 50W IC Stereo Amp. w/led level display ▲	35.50		TY-25	Stereo Loudspeaker Protector ▲	12.65	
TA-323A	HQ 30W + 30W Stereo Amp. ▲	29.50		TY-35	FM Wireless Microphone ▲	9.22	
TA-377A	FET Stereo Pre-Amp. ▲▲▲	59.95	75.00	TY-36	AC/DC Quartz Digital Clock ▲	18.00	
TA-400	40W Solid State Mono Amp. ▲	16.62		TY-38	Sound/Touch Control Switch ▲	12.00	
TA-477	120W Mostel Power Mono Amp. ▲▲	68.00		TY-41 MK111	Infrared Remote Control Unit ▲▲▲	15.00	25.00
TA-800	80W - 80W DC Pre-Main & Power Amp. ▲▲	60.92		TY-41 MKV	Infrared Remote Control Unit ▲▲▲	20.00	35.00
TA-802	80W + 80W DC Stereo Main Power Amp. ▲▲	45.94		TY-42	Bar/Dot Level Meter ▲	24.15	
TA-820A	60W + 60W DCL DC Pre-Main Stereo Amp. ▲▲	48.00		TY-43	3 1/2" Digital Panel Meter ▲	33.00	46.20
TA-1000A	100W Class "A" Main Power Mono Amp. ▲▲	59.69	80.58	TY-45	20 Steps Bar/Dot Audio Level Display ▲	38.45	
TA-1500	100W x 2 Class "A" DC Stereo Pre-Main Amp. ▲▲▲	73.70		TY-47	Superior Electronic Roulette ▲▲	19.46	
TA-2400A	Electronic Echo & Revelation Amp. ▲▲▲	93.30	116.80	SM-222	7 Bands Graphic Equalizer ▲▲▲	26.80	38.80
TA-2500	HQ Pre-Amp. w/10 band graphic equalizer ★		90.00	SM-328	4 Channel Professional Color Light Controller ★		150.00
TA-2800	Hi-Fi Bi-Fet Pre-Amp. w/3 way tone control ▲	48.90		SM-353	Audio/Video Surround Sound Processor ▲▲	62.00	83.00
TA-3000	Stereo Simulator ▲	33.20	43.38	T-1	LCD Thermometer Clock w/in-outdoor sensor ★		22.00
TA-3600	300W HQ Hi-Fi Power Mono Amp. ▲▲▲	86.00	110.00	T-2	LCD Thermometer Clock w/ F & C measurement ★		15.50
				# 8501	Parrot Talking Clock ★		15.50
				# 8504	Mynah Talking Clock ★		15.50
METAL CABINETS				POWER SUPPLIES			
MODEL	DESCRIPTION	MATCHING	EA SET	MODEL	DESCRIPTION	KIT	ASSEMBLED
LG-1273	3' x 12" x 7"	TA-2800, TA-377A	\$20.16	TR-100A	0-15V 2A Regulated DC Power Supply ▲▲▲	\$59.50	\$69.50
LG-1684	4' x 16" x 8"	TA-322I, TA-323A, TA-377A	24.64	TR-355A	0-15V 5A Regulated DC Power Supply ▲	12.92	
LG-1924	4' x 19" x 11.5"	TA-802, TA-820A, TA-1500, TA-120, TA-800, TA-1000A	30.00	TR-358B	0-30V 3A Regulated DC Power Supply ▲	12.92	
LG-1925	5' x 19" x 11.5"	TA-477, TA-800, TA-1500, TA-1000A	33.00	TR-503	0-50V 3A Regulated DC Power Supply ▲▲	14.76	
TRANSFORMERS				INSTRUMENTS			
MODEL	DESCRIPTION	MATCHING	PIECE	MODEL	DESCRIPTION	KIT	ASSEMBLED
# 001	56V CT to 60V CT 6A	TA-800, TA-802, TA-820A, TA-1000A, TA-1500	\$25.00	SM-43	3 1/2" Multi-Functional Led D.P.M. ▲▲	\$34.50	\$ 43.00
# 002	72V CT 3A	TR-503, TA-322I, TA-323A, TA-400	19.00	SM-48	4 1/2" Hi-Precision D.P.M. ▲▲▲	38.00	48.00
# 003	80V CT 6A	TA-477	24.00	SM-48A	4 1/2" Hi-Precision D.P.M. w/ stndrd case ▲▲▲	41.20	52.00
# 004	48V CT 6A	TA-120	19.00	SM-100	150MC Digital Frequency Counter ★		90.00
# 005	52V CT 3A	TR-355B	12.00	FC1000A	1 GHz Frequency Counter ★		182.00
# 006	36V CT 5A	TR-355A	13.60				
# 007	112V CT 8A	TA-3600	38.00				

WE ACCEPT MAJOR CREDIT CARDS, MONEY ORDERS AND CHECKS. - BUSINESS & SHOWROOM HOURS: (PACIFIC TIME) MON. - FRI. 9:30 A.M. - 5:00 P.M., SAT: 10:00 A.M. - 5:00 P.M. TERMS: \$10.00 MIN. ORDER * \$20 MIN. CHARGE CARD ORDER * WE SHIP UPS GROUND * ADD 10% OF TOTAL ORDER (MIN. \$3.00) FOR SHIPPING OUTSIDE USA. ADD 20% (MIN. \$5.00) * TRANSIT INSURANCE: ADD 5% OF TOTAL (OUTSIDE USA ONLY). CA RESIDENTS ADD SALES TAX * ALL MERCHANDISE SUBJECT TO PRIOR SALE * PRICES ARE SUBJECT TO CHANGE WITHOUT NOTICE * WE ARE NOT RESPONSIBLE FOR TYPOGRAPHICAL ERRORS.

INFORMATION: (213) 888-8988, CALL OR WRITE FOR OUR FREE CATALOG * PHONE ORDER: 1-800-423-3483 (IN CALIF.) 1-800-521-MARK FAX: 213-888-6868
MARK V ELECTRONICS, INC. - 8019 E. Slauson Ave., Montebello, CA 90640

CIRCLE 93 ON FREE INFORMATION CARD

NEC V20 & V30 CHIPS

Replace the 8086 or 8088 in Your IBM PC and Increase Its Speed by up to 30% Price

UPD70108-5 (5MHz) V20 Chip	\$6.49	\$5.95
ULS70108-8 (8MHz) V20 Chip	\$9.49	\$7.95
UPD70108-10 (10MHz) V20 Chip	\$12.28	\$10.95
UPD70116-8 (8MHz) V30 Chip	\$9.96	\$7.95
UPD70116-10 (10MHz) V30 Chip	\$16.96	\$15.49

7400

Part No.	1-9	10+	Part No.	1-9	10+
7400	SALE	15	7471	SALE	25
7402		29	7475		39
7404	SALE	15	7476		35
7405		35	7483		69
7406		39	7485	SALE	45
7407	SALE	25	7486	SALE	29
7408		35	7489		1.95
7410	SALE	15	7490		49
7411	SALE	15	7493		45
7414	SALE	25	7495	SALE	29
7416	SALE	19	74107	SALE	13
7417	SALE	19	74121	SALE	25
7420		25	74123	SALE	35
7427	SALE	13	74125	SALE	35
7430	SALE	15	74147	SALE	1.49
7432		39	74150	SALE	1.10
7438	SALE	25	74151	SALE	13
7442	SALE	29	74154		1.35
7445		89	74171		69
7446		89	74173	SALE	59
7447		89	74174	SALE	59
7448		1.95	74175	SALE	35
7473		39	74193		79

74LS

74LS00	SALE	15	74LS139	SALE	29
74LS02	SALE	15	74LS151	SALE	29
74LS03	SALE	15	74LS153	SALE	25
74LS04	SALE	15	74LS154		1.19
74LS05	SALE	19	74LS157		0.95
74LS06		59	74LS161	SALE	29
74LS07		59	74LS163	SALE	35
74LS08		28	74LS164	SALE	35
74LS09	SALE	15	74LS165		75
74LS10	SALE	15	74LS166	SALE	69
74LS11		89	74LS173	SALE	29
74LS14	SALE	29	74LS174	SALE	29
74LS20	SALE	15	74LS175	SALE	29
74LS21	SALE	19	74LS191	SALE	39
74LS27	SALE	19	74LS192		69
74LS30	SALE	15	74LS193	SALE	59
74LS32	SALE	19	74LS194	SALE	55
74LS36		59	74LS221	SALE	49
74LS42		59	74LS240	SALE	45
74LS47		89	74LS241	SALE	49
74LS73	SALE	25	74LS244	SALE	49
74LS74	SALE	19	74LS245	SALE	59
74LS75	SALE	25	74LS257	SALE	29
74LS76		39	74LS259		99
74LS83		59	74LS273		89
74LS85		59	74LS279		49
74LS86		29	74LS367	SALE	29
74LS90	SALE	29	74LS373	SALE	59
74LS93	SALE	29	74LS374	SALE	49
74LS123	SALE	35	74LS393	SALE	69
74LS125		49	74LS41	SALE	99
74LS132	SALE	29	74LS590		5.95
74LS138		49	74LS688		2.39

74S/PROMS*

74S00	SALE	19	74S189		1.49
74S04	SALE	19	74S189		1.49
74S32	SALE	19	74S240		1.39
74S74	SALE	19	74S244	SALE	1.49
74S112	SALE	25	74S287		1.49
74S124	SALE	25	74S288		1.49
74S138	SALE	49	74S373	SALE	99
74S153		25	74S374	SALE	99
74S163	SALE	25	74S397		2.49
74S174	SALE	25	74S472	SALE	2.49
74S175	SALE	25	74S571		2.49

CD-CMOS

CD4001	19	CD4051	59
CD4002	19	CD4052	59
CD4007	25	CD4053	59
CD4011	19	CD4060	69
CD4012	25	CD4066	29
CD4013	29	CD4069	19
CD4015	49	CD4070	19
CD4016	29	CD4071	19
CD4017	49	CD4072	22
CD4018	59	CD4073	22
CD4020	59	CD4081	22
CD4021	59	CD4093	35
CD4024	45	CD4094	89
CD4027	45	CD503	39
CD4028	49	CD4071	19
CD4029	69	CD4511	25
CD4030	35	CD4518	75
CD4040	69	CD4522	79
CD4042	59	CD4528	69
CD4043	65	CD4538	79
CD4046	65	CD4543	79
CD4047	29	CD4584	49
CD4049	29	CD4585	69

EEPROMS

2816A	2048x8	350ms (9V 15V) 5V Read/Write	5.25
2816A 25	2048x8	250ms (9V 15V) 5V Read/Write	5.49
2817A	2048x8	350ms 5V Read/Write	7.95
2864A	8192x8	200ms 5V Read/Write (Pin 1 No Rb)	13.95
2864A-30	8192x8	300ms 5V Read/Write (Pin 1 No Rb)	12.95
2865A	8192x8	200ms 5V Read/Write	12.95
52B13	2048x8	350ms (21V) 5V Read Only	1.49

MICROPROCESSOR COMPONENTS

Z80, Z80A, Z80B, SERIES		8000 SERIES Continued		8000 SERIES Continued	
Part No.	Price	Part No.	Price	Part No.	Price
Z80	1.19	8155-2	3.49	8286	2.29
Z80A	1.29	81C55	4.95	8747	9.95
Z80A CTC	1.65	8156	2.95	8742	14.95
Z80A-DART	4.95	8205	9.49	8748 (25V)	7.95
Z80A-PIO	1.49	82C11	6.95	8748H (H-MOS)(21V)	9.95
Z80A-SIO-C	3.95	8212	2.29	8749	9.95
Z80B	2.75	8216	1.39	8751H (3.5-12MHz)	36.95
Z80B CTC	3.95	8224	1.45	8755	13.95
Z80B PIO	3.95	8228	1.99	80286-10 (10MHz)LCC	49.95
Z8681B1	8.95	8237-5	4.25	80287-3 (5MHz)	109.95
		8243	1.75	80287-8 (8MHz)	209.95
		8250A	4.95	80287-10 (10MHz)	259.95
		8250B (For IBM)	5.95	80386 16 Pin	279.95
		80331	3.95	80387-16 (16MHz)	395.95
		80335	1.95	80387-20 (20MHz)	459.95
		80339	1.59	80387-25 (25MHz)	569.95
		8052AH-BASIC	1.95	82284 (8MHz)	9.49
		8080A	2.25	82288 (8MHz)	9.95
		8085A-2	2.49		
		8085A-2	3.59		
		8087-1 (5MHz)	99.95		
		8087-1 (10MHz)	94.95		
		8087-2 (8MHz)	134.95		
		8088 (5MHz)	4.95		
		8088-2 (8MHz)	6.95		
		8116	4.95		
		8155	2.49		

STATIC RAMS

Part No.	Function	Price
2016-12	2048x8 120ms	2.75
2102	1024x1 350ms	1.95
2112	256x4 450ms MOS	4.99
2114N	1024x4 450ms	2.49
2114N-2L	1024x4 200ms Low Power	1.49
21C14	1024x4 200ms (CMOS)	1.95
5101	256x4 450ms (CMOS)	2.44
6118P-1	2048x8 100ms (16K) CMOS	3.95
6118P-3	2048x8 150ms (16K) CMOS	4.99
6116P-1	2048x8 100ms (16K) LP CMOS	4.99
6116P-3	2048x8 150ms (16K) LP CMOS	3.95
6264P-10	8192x8 100ms (64K) CMOS	9.95
6264P-15	8192x8 150ms (64K) CMOS	9.25
6264P-10	8192x8 100ms (64K) LP CMOS	10.25
6264P-15	8192x8 150ms (64K) LP CMOS	10.45
6264P-15	8192x8 150ms (64K) LP CMOS	10.25
6514	1024x4 350ms CMOS	3.75
4235E-10L	32.768x8 100ms (256K) Low Power	26.95
4235E-15L	32.768x8 150ms (256K) Low Power	26.95
6225P-10	32.768x8 100ms (256K) LP CMOS	27.26
6225P-12	32.768x8 120ms (256K) LP CMOS	27.26
6225P-15	32.768x8 150ms (256K) LP CMOS	27.26

DYNAMIC RAMS

42100A9A-10	1,048,576x9 100ms 1MEGx9 SIM	399.95
42100A9B-10	1,048,576x9 100ms 1MEGx9 SIM	449.95
42100A9A-80	1,048,576x9 80ms 1MEGx9 SIM	449.95
42100A9B-80	1,048,576x9 80ms 1MEGx9 SIM	449.95
TMS4416-12	16,384x4 120ms	6.75
TMS4416-15	16,384x4 150ms	6.25
4116-15	16,384x4 150ms (MM5290N 2)	1.99
4128-15	131,072x1 150ms (Pggvbaoc)	4.25
4164-100	65,536x1 100ms	3.95
4164-120	65,536x1 120ms	3.95
4164-150	65,536x1 150ms	2.59
4126E-60	262,144x1 60ms	11.99
4126E-80	262,144x1 80ms	10.19
4126E-100	262,144x1 100ms	9.25
4126E-120	262,144x1 120ms	8.95
4126E-150	262,144x1 150ms	8.49
41264-12	64Kx4 120ms Video RAM	12.95
4164-10	65,536x4 100ms	12.49
4164-12	65,536x4 120ms	11.95
4164-15	65,536x4 150ms	10.95
51256E-10	262,144x1 100ms Static Column	74.95
41256A-10	262,144x1 100ms 256x9 SIM	149.95
41256A9B-10	262,144x1 100ms 256x9 SIM	149.95
51100P-10	1,048,576x1 100ms (1 Meg)	36.95
51100P-80	1,048,576x1 80ms (1 Meg)	36.95
514256P-10	262,144x4 100ms (1 Meg)	34.95
514258-10	262,144x4 100ms Static Column	31.95

EPROMS

TMS2516	2048x8	450ms (25V)	5.95
TMS2532	4096x8	450ms (25V)	5.95
TMS2532A	4096x8	450ms (12.5V)	4.49
TMS2564	8192x8	450ms (25V)	6.25
TMS2716	2048x8	450ms (-5V -5V +12V)	6.95
1702A	256x8	2K (1µs)	4.45
2708	1024x8	450ms	6.95
2716	2048x8	450ms (25V)	3.75
2716-25	2048x8	350ms (25V)	2.95
27C16	2048x8	450ms (25V) CMOS	4.25
2732	4096x8	450ms (25V)	3.95
2732A-20	4096x8	200ms (21V)	4.24
2732A-25	4096x8	250ms (21V)	3.95
27C32	4096x8	450ms (25V) CMOS	4.95
2764-20	8192x8	200ms (21V)	4.25
2764-25	8192x8	250ms (21V)	3.25
2764A-25	8192x8	250ms (12.5V)	3.69
27C64-15	8192x8	150ms (12.5V) CMOS	5.95
27128-20	16,384x8	200ms (21V)	5.45
27128-25	16,384x8	250ms (21V)	5.45
27128A-20	16,384x8	150ms (12.5V)	7.75
27128A-25	16,384x8	200ms (12.5V)	6.25
27128-25	16,384x8	250ms (12.5V) CMOS	5.95
27256-15	32,768x8	150ms (12.5V)	8.95
27256-20	32,768x8	200ms (12.5V)	6.25
27256-25	32,768x8	250ms (12.5V)	5.49
27C256-15	32,768x8	150ms (12.5V) CMOS	2.65
27C256-25	32,768x8	250ms (12.5V) CMOS	5.49
27512-20	65,536x8	200ms (12.5V)	9.95
27512-25	65,536x8	250ms (12.5V)	9.95
27C512-25	65,536x8	250ms (12.5V) CMOS	9.49
27C1024	131,072x8	200ms (12.5V) CMOS (1 Meg)	44.95
68764	8192x8	64K 450ms (25V) (Chip Enable)	19.95
68766-35	8192x8	64K 350ms (25V) (Output Enable)	16.95

6500/6800 6800 Series

Part No.	Price
6402	3.95
6502	2.65
6502A	2.65
65C02 (CMOS)	7.75
6520	1.95
6522	2.95
65C22	4.25
6502	5.49
6551	9.95

Now Available...Jameco's NEW Summer Sizzler Flyer #139 with 48 pages of Computer Peripherals, Components & More!

15th ANNIVERSARY YEAR 1974 - 1989

SPECIAL! Monochrome Text Card

Sperry Monochrome Display Adapter

- IBM PC/XT Compatible
- Allows for Connection between Computer and Monochrome Monitor
- Use for Text only
- Great for Network Servers and Dedicated Work Stations



TEXT\$12.95

TEST EQUIPMENT

Metex Digital Multimeters

Metex General Specs:

- Handheld, high accuracy
- AC/DC Voltage, AC/DC Current, Resistance, Diodes, Continuity, Transistor hFE • Manual ranging w/overload protection
- M3650/B & M4650 only:**
- Also measures frequency and capacitance
- M4650 only:**
- Data Hold Switch
- 4.5 Digit



M4650 Pictured

M3610	3.5 Digit Multimeter.....	\$49.95
M3650	3.5 Digit w/Freq. & Capacitance	\$69.95
M3650B	Same as M3650 w/Bargraph.....	\$79.95
M4650	4.5 Dig. w/Freq., Capacitance and Data Hold Switch	\$99.95

Metex Autoranging Jumbo Readout DMM

- AC/DC Voltage, AC/DC Current, Resistance, Diodes, Continuity and Frequency
- 3.75 Digit (.8" High)
- Ruggedized, Water-resistant case
- Easy-to-use pushbutton switches



M80.....\$59.95

A.R.T. EPROM Programmer

- Programs all current EPROMs in the 2716 to 27512 range plus the X2864 EEPROM • May be operated by any RS232 port w/terminal emulation • Fully intelligent • ASCII command driven • Menu driven software included



EPP.....\$179.95

Oscilloscope Probes

- Attenuation: x1 / x10
- Capacitance (LF180): 180pF / 22pF; (LF210): 40pF / 17pF



LF180	40MHz Oscilloscope Probe.....	\$19.95
LF210	100MHz Oscilloscope Probe.....	\$29.95

Digital Logic Probes and Logic Pulser



- Logic Probes:** PRB20 Pictured
- High, low and pulse indication • 20MHz and 50MHz versions available • Circuit powered w/over/undervoltage indicators
- Logic Pulser (LP540):**
- Generates "one-shot" pulse or continuous 5Hz pulse train • Audible tone • Compatible with TTL, DTL, RTL, HTL, HINIL, MOS and CMOS ICs

PRB20	20MHz Logic Probe.....	\$26.95
PRB20A	20MHz Audible Logic Probe.....	\$33.95
PRB50	50MHz Logic Probe.....	\$47.95
LP540	Logic Pulser.....	\$19.95

JAMECO IBM PC/XT 8MHz Turbo Compatible Kit With 256K RAM

- Free! QAPLUS Diagnostic Software Included!
- Free! PC Write Word Processing Software Included!
- 256K RAM Included, Expandable to 640K
- AMI BIOS ROMs Included
- 4.77 or 8MHz Operation
- Flip-Top Case w/150 Watt Power Supply
- 360K Disk Drive
- Parallel Printer Port
- 84-Key Keyboard
- Monochrome Amber Monitor



SAVE \$108.06!

JE3002	IBM Compatible PC/XT 8MHz Turbo Kit	\$499.95	\$479.95
EZDOS	Digital Research MS/PC-DOS Comp. Operating System.....	\$49.95	
EZDOSP	Same as above with TrueBASIC.....	\$69.95	

IBM COMPATIBLE DISPLAY MONITORS

AMBER	12" Amber Mono.....	\$99.95	
HD55H	14" RGB 640x240.....	\$249.95	
TM5154	EGA 14" 720x350.....	\$399.95	\$369.95
JE1059	EGA Monitor & Card.....	\$619.95	\$499.95
TM5155	14" Multiscan 800x560.....	\$649.95	\$499.95
QC1478	14" VGA 720x480.....	\$449.95	\$399.95
JE2055	VGA Monitor & Card.....	\$649.95	\$599.95



QC1478 Pictured

JAMECO IBM PC/XT/AT COMPATIBLE CARDS

JE1050	Monochrome Graphics Card w/Parallel Printer Port (PC/XT/AT).....	\$59.95
JE1052	Color Graphics Card w/Parallel Printer Port (PC/XT/AT).....	\$49.95
JE1055	EGA Card w/256K Video RAM (PC/XT/AT).....	\$159.95
JE1071	Multi I/O Card w/Controller & Monochrome Graphics (PC/XT).....	\$119.95
JE1060	I/O Card w/Serial, Game, Printer Port & Real Time Clock (PC/XT).....	\$59.95
JE1061	RS232 Serial Half Card (PC/XT).....	\$29.95
JE1062	RS232 Serial Half Card (AT).....	\$34.95
JE1065	I/O Card w/Serial, Game and Parallel Printer Port (AT).....	\$59.95
JE1081	2MB Expanded or Extended Memory Card (zero-K on-board) (AT).....	\$99.95
JE1041	20/40MB Hard Disk Controller Card (PC/XT).....	\$79.95
JE1043	360K/720K/1.2MB/1.44MB Floppy Disk Controller Card (PC/XT/AT).....	\$49.95
JE1044	360K Floppy/Hard Disk Controller Card (PC/XT).....	\$129.95
JE1045	360K/720K/1.2MB/1.44MB Floppy/Hard Disk Controller Card (AT).....	\$149.95

SEAGATE HALF-HEIGHT HARD DISK DRIVES

ST225	20MB Drive only (PC/XT/AT).....	\$224.95
ST225XT	20MB w/Controller (PC/XT)	\$269.95
ST225AT	20MB w/Controller (AT)	\$339.95
ST238	30MB Drive only (PC/XT/AT).....	\$249.95
ST238XT	30MB w/Controller (PC/XT)	\$299.95
ST238AT	30MB w/Controller (AT)	\$389.95



ST225XT Pictured

Seagate 40MB and 60MB Hard Disk Drives Also Available!

IBM PC/XT/AT COMPATIBLE MOTHERBOARDS

JE1001	4.77/8MHz (PC/XT).....	\$89.95
JE1002	4.77/10MHz (PC/XT)	\$109.95
JE3005	Baby 8.12MHz (AT).....	\$329.95
JE3010	Baby 8.16MHz NEAT (AT).....	\$469.95
JE3020	Baby 16MHz 80386 (AT).....	\$1199.95
JE3025	Baby 20MHz 80386 (AT).....	\$1199.95
JE3026	Full-Size 25MHz 80386 (AT).....	\$1999.95

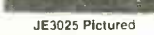

JE3025 Pictured

IBM PC/XT/AT COMPATIBLE 3.5"/5.25" DISK DRIVES

352KU	3.5" 720KB (PC/XT/AT).....	\$109.95
356KU	3.5" 1.44MB (PC/XT/AT).....	\$129.95
JE1020	5.25" 360KB (PC/XT/AT) Black.....	\$89.95
JE1021	5.25" 360KB (PC/XT/AT) Beige.....	\$89.95
JE1022	5.25" 1.2MB (PC/XT/AT) Beige.....	\$99.95



JE1022 Pictured

IBM PC/XT/AT COMPATIBLE INTERNAL MODEMS

1200H	1200/300 Baud Internal Modem w/MaxMite Comm. Software (PC/XT/AT).....	\$69.95
2400H	2400/1200/300 Baud Internal Modem w/MaxMite Comm. Sw. (PC/XT/AT).....	\$129.95

External Modems and Pocket-Size Modem Also Available!

PROTOTYPING PRODUCTS

Jameco Solderless Breadboards

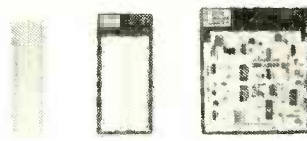

Part No.	Dim. L" x W"	Contact Points	Binding Posts	Price
JE20	6.5 x .75	200	0	\$1.95
JE21	3.25 x 1.125	400	0	\$4.95
JE22	6.5 x 1.325	630	0	\$5.95
JE23	6.5 x 1.125	830	0	\$7.95
JE24	6.5 x 1.125	1,360	2	\$12.95
JE25	6.5 x 4.25	1,660	3	\$19.95
JE26	6.875 x 5.75	2,390	4	\$24.95
JE27	7.25 x 7.5	3,220	4	\$34.95

DATAK Photo Etch PCB Kit MAKE your own circuit boards!

The ER4 photo etch kit contains all the chemicals necessary for any hobbyist, engineer or student to create professional circuit boards. Contains: Print frame, photo copy film, resist developer, etch resist, 2 copper circuit boards, concentrated etchant, film developer and fixer, resist patterns and complete instructions. Must be shipped ground (surface).
ER4 Photo Etch PCB Kit.....\$34.95

Jameco Prototype PC Boards

Specs: Laminated glass epoxy .062" thick 2 oz. copper clad with solder tin finish. All holes are .042" dia. on 10" x 10" grid pattern.
JE401 4.5"x6.5" 1-sided 3-hole pad pattern.....\$9.95
JE402 4.5"x6.5" 1-sided pwr & gnd busses.....\$9.95
JE403 4.5"x6.5" 1-sided general purpose.....\$9.95
JE407 5"x13.25" 2-sided general purpose.....\$19.95
JE417 4.2"x6.5" PC/XT 1/2 card proto board.....\$19.95
JE421 4.75"x3.7" IBM PC/XT Card Extender ..\$19.95

ENGINEERING/DATA BOOKS

21035	Sams TTL Cookbook (88).....	\$14.95
21398	Sams CMOS Cookbook (88).....	\$19.95
22453	Sams Op-Amp Cookbook (88).....	\$21.95
270645	Intel 8-bit Controller Hndbk. (89).....	\$19.95
270646	Intel 16-bit Controller Hndbk. (89).....	\$19.95
270647	Intel 32-bit Controller Hndbk. (89).....	\$19.95
400041	NSC Linear Data Book Vol. 1 (88)	\$14.95
400042	NSC Linear Data Book Vol. 2 (88)	\$9.95
400043	NSC Linear Data Book Vol. 3 (88)	\$9.95
ICM89	1989 IC Master (3 Volume Set).....	\$119.95

EDUCATIONAL KITS

JE310/315: Fiber optics kits demonstrate the principles of fiber optic system design. Complete step-by-step instructions, theory of operation and tutorial info. incl. JE2206: Function generator kit provides three basic waveforms: sine, triangle and square wave. Frequency range: 1Hz to 100kHz
JE310 Fiber Optics Experimenter Kit \$19.95
JE315 Advanced Fiber Optics Kit..... \$29.95
JE2206 Function Generator Kit..... \$19.95



JE2206 Pictured

1355 Shoreway Road
Belmont, CA 94002
24 Hour Order Hotline (415) 592-8097
FAX's (415) 592-2503 or (415) 595-2664
Telex 176043 - Ans. Back, Jameco Blmt
Data Sheets - 50c each
Send \$2.00 Postage for a FREE 1989 CATALOG
1989 Jameco Electronics 9/89
IBM is a registered trademark of International Business Machines



\$20.00 Minimum Order - U.S. Funds Only
CA Residents Add 6% 6.5% or 7% Sales Tax
Shipping - Add 5% plus \$1.50 insurance (May vary according to weight)
Terms: Prices subject to change without notice. We are not responsible for typographical errors. We reserve the right to substitute manufacturers. Items subject to availability and prior sale. Products pictured may only be representative.
Complete list of terms/warranties is available upon request.
24-Hour Order Hotline (415) 592-8097 • The Following Phone Lines Are Available From 7AM - 5PM P.S.T.:
• Customer Service (415) 592-8121 • Technical Assistance (415) 592-9990 • Credit Department (415) 592-9983 • All Other Inquiries (415) 592-7108

POWER SUPPLIES



135 WATT POWER SUPPLY

- UL APPROVED
- +5V @ 15A, +12V @ 4.2A, -5V @ 5A, -12V @ 5A

PS-135 \$59.95
PS-150 150W SUPPLY \$69.95



200 WATT POWER SUPPLY

- UL APPROVED
- +5V @ 20A, +12V @ 7A, -5V @ 5A, -12V @ 5A

PS-200 \$89.95



APPLE TYPE SUPPLY

- WITH APPLE CONNECTOR
- +5V @ 6A, +12V @ 3A, -5V @ 1A, -12V @ 1A

PS-A \$59.95



36 WATT POWER SUPPLY

- +5V @ 2.5A, +12V @ 1.5A
- 3 PIN INPUT, 6 PIN OUTPUT
- SELECTABLE 110V-220V

PS-3045 \$12.95



SOLDER STATIONS

SOLDER/DESOLDER STATION

- OIL-FREE VACUUM PUMP
- TEMP ADJUSTS (212° F-900° F) & VACUUM (0-60 CM-HG)
- WITH GUN-REST, COOLING TRAY, WIRE BRUSH & TIP CLEANER ROD

XY999SD \$399.95
XY999D DESOLDER ONLY \$349.99



DELUXE SOLDER STATION

- ROTARY SWITCH TEMP CONTROL (200° F-878° F RANGE)
- LED TEMPERATURE READOUTS
- INCLUDES COOLING TRAY

XY9-60L \$79.95



SOLDER STATION

- UL APPROVED
- HEAT SETTING ADJUSTS
- TIP TEMPERATURE READOUT
- REPLACEMENT TIPS @ \$2.95

168-3C \$59.95

WIREWRAP PROTOTYPE CARDS

FR-4 EPOXY GLASS LAMINATE WITH GOLD PLATED EDGE CARD FINGERS AND SILK SCREENED LEGS



FOR XT
JDR-PR1 WITH +5V AND GROUND PLANE \$27.95
JDR-PR2 ABOVE WITH I/O DECODING LAYOUT \$29.95
JDR-PR2PK PARTS KIT FOR JDR-PR2 ABOVE \$8.95

FOR AT
JDR-PR10 16 BIT WITH I/O DECODING LAYOUT \$34.95
JDR-PR10PK PARTS KIT FOR JDR-PR10 ABOVE \$12.95

FOR PS/2
JDR-PR32 32 BIT PROTOTYPE CARD \$69.95
JDR-PR16 16 BIT WITH I/O DECODING LAYOUT \$49.95
JDR-PR16PK PARTS KIT FOR JDR-PR16 ABOVE \$15.95
JDR-PR16V 16 BIT FOR VIDEO APPLICATIONS \$39.95

DATA SWITCH BOXES

TYPE	# OF POS.	PARALL.	SERIAL	PRICE
PUSHBTM.	2-WAY	AB-P	AB-S	39.95
ROTARY	2-WAY	RSP-2	RSS-2	24.95
ROTARY	3-WAY	RSP-3	RSS-3	27.95
ROTARY	4-WAY	RSP-4	RSS-4	29.95

EXTENDER CARDS

FOR PROTOTYPE DEBUGGING, TESTING AND TROUBLESHOOTING

EXT-8088 XT COMPATIBLE \$29.95
EXT-80286 AT COMPATIBLE \$39.95
EXT-16 MICROCHANNEL 16-BIT \$69.95
EXT-32 MICROCHANNEL 32-BIT \$99.95



JDR INSTRUMENTS--2 YEAR WARRANTY!

35 MHZ DUAL TRACE OSCILLOSCOPE

- WIDE BAND WIDTH • VARIABLE HOLDOFF

MODEL-3500 (SHOWN) \$499.95

20 MHZ DUAL TRACE OSCILLOSCOPE

- TV SYNC FILTER • COMPONENTS TESTER

MODEL 2000 \$389.95

3.5 DIGIT PROBE TYPE DMM

- AUTORANGING • AC/DC 2V - 500V, RESIS 2K-2M

DPM-1000 (SHOWN) \$54.95

3.5 DIGIT POCKET SIZE DMM

- BASIC DC ACCURACY ±0.5% • 14 RANGES

DMM-100 \$29.95

3.5 DIGIT FULL FUNCTION DMM

- BASIC DC ACCURACY ±0.25% • 22 RANGES

DMM-200 \$49.95

THE ULTIMATE 3.5 DIGIT DMM

- BASIC DC ACCURACY ±0.25% • 34 RANGES
- TEMP. TRANSISTOR & RESISTANCE FEATURES

DMM-300 (SHOWN) \$79.95

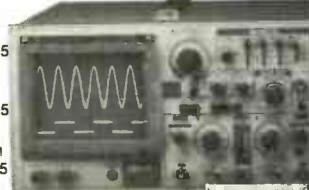

RELIABLE, HIGH QUALITY TEST EQUIPMENT, REASONABLY PRICED

MOLDED COMPUTER CABLES

GOLD-PLATED CONTACTS; 100% SHIELDED

CBL-PRINTER	PC PRINTER CABLE	9.95
CBL-PRINTER-25	AS ABOVE-25 FT.	15.95
CBL-PRINTER-RA	RT. ANGL. PRINTER	15.95
CBL-DB25-MM	DB25 MALE-MALE	9.95
CBL-DB25-MF	DB25 MALE-FEMALE	9.95
CBL-9-SERIAL	9 PIN-25 PIN SERIAL	6.95
CBL-KBD-EXT	KEYBOARD EXTEN.	7.95
CBL-CNT-MM	36 PIN CENTRON/M/M	14.95
CBL-HD-20	20 PIN HARD DISK	2.95
CBL-HD-34D	34 PIN DUAL HARD DISK	4.95
CBL-FDC-EXT	37 PIN EXT. FLOPPY	9.95
CBL-MNT-9	9 PIN MONITOR EXTEN.	6.95
CBL-MODEM	DB25 DB25 FEMALE	6.95

NEW LOW PRICES! SOLDERLESS BREADBOARDS

PDS-100	1360 TIE PTS	\$12.95
PDS-200	1660 TIE PTS	\$19.95
PDS-300	2390 TIE PTS	\$24.95
PDS-400	3220 TIE PTS	\$34.95

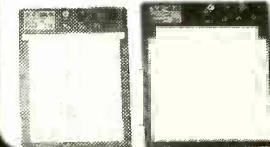

PC BREADBOARD

- 62 CLEARLY LABELLED BUS LINES
- ACCEPTS UP TO 24 14-PIN IC'S
- 1940 TIE POINTS
- EXT FEMALE DB25 D SUB CONNECT.

PDS-604 \$49.95

GENDER CHANGERS

GENDER-FF	FEMALE-FEMALE	\$7.95
GENDER-MM	MALE-MALE	\$7.95
GENDER-MF	MALE-FEMALE	\$7.95
GENDER-NM	NULL MODEM	\$8.95
GENDER-JB	JUMPER BOX	\$8.95
GENDER-MT	MINISTER	\$14.95
GENDER-VGA	DB9-DB15	\$19.95
GENDER-9-25	DB9-DB25	\$4.95



"SNAPABLE" HEADERS

SNAP APART TO MAKE ANY SIZE HEADER, WITH 1/8" CENTERS

1 x 40	STRAIGHT LEAD	.99
1 x 40	RIGHT ANGLE LEAD	\$1.49
2 x 40	STRAIGHT LEAD	\$2.49
2 x 40	RIGHT ANGLE LEAD	\$2.99

IDC CONNECTORS/RIBBON CABLE

DESCRIPTION	ORDER BY	CONTACTS					
		10	20	26	34	40	50
SOLDER HEADER	IDHxxS	.82	1.29	1.68	2.20	2.58	3.24
RIGHT ANGLE SOLDER HEADER	IDHxxSR	.85	1.35	1.76	2.31	2.72	3.39
WIREWRAP HEADER	IDHxxW	1.86	2.98	3.84	4.50	5.28	6.63
RIGHT ANGLE WIREWRAP HEADER	IDHxxWR	2.05	3.28	4.22	4.45	4.80	7.30
RIBBON HEADER SOCKET	IDSxx	.55	.55	.75	.75	1.19	1.19
RIBBON HEADER	IDMxx	--	5.60	6.25	7.00	7.50	8.50
RIBBON EDGE CARD	IDExx	.55	.55	.75	.89	1.29	1.69
RIBBON CABLE 10 FT.	RCxx	1.50	3.00	3.90	5.10	6.00	7.50

FOR ORDERING INSTRUCTIONS, SEE D-SUBMINIATURE CONNECTORS BELOW

D-SUBMINIATURE CONNECTORS

DESCRIPTION	ORDER BY	CONTACTS					
		9	15	19	25	37	50
SOLDER CUP	MALE	DBxxP	.45	.59	.69	1.35	1.85
	FEMALE	DBxxS	.49	.69	.75	1.39	2.29
RIGHT ANGLE PC SOLDER	MALE	DBxxPR	.49	.69	--	.79	2.27
	FEMALE	DBxxSR	.55	.75	--	.85	2.49
WIREWRAP	MALE	DBxxPWW	1.69	2.56	--	3.89	5.60
	FEMALE	DBxxSww	2.76	4.27	--	6.84	9.95
IDC RIBBON CABLE	MALE	IDBxxP	1.39	1.99	--	2.25	4.49
	FEMALE	IDBxxS	1.45	2.05	--	2.35	4.49
HOODS	METAL	MHOODxx	1.05	1.15	1.25	1.25	--
	PLASTIC	HOODxx	.39	.39	--	.39	.69

ORDERING INSTRUCTIONS: INSERT THE NUMBER OF CONTACTS IN THE POSITION MARKED "xx" OF THE "ORDER BY" PART NUMBER LISTED. EXAMPLE: A 15 PIN RIGHT ANGLE MALE PC SOLDER WOULD BE DB15PR

MOUNTING HARDWARE .59

IC SOCKETS/DIP CONNECTORS

DESCRIPTION	ORDER BY	CONTACTS								
		8	14	16	18	20	22	24	28	40
SOLDERTAIL SOCKETS	xxST	.11	.11	.12	.15	.18	.15	.20	.22	.30
WIREWRAP SOCKETS	xxWW	.59	.69	.69	.99	1.09	1.39	1.49	1.69	1.99
ZIF SOCKETS	ZIFxx	--	5.95	5.95	--	6.95	--	7.95	7.95	10.95
TOOLED SOCKETS	AUGATxx	.55	.58	.69	.79	.85	.85	.99	1.09	1.29
TOOLED WW SOCKETS	AUGATxxWW	1.30	1.80	2.10	2.40	2.50	2.90	3.15	3.70	5.40
COMPONENT CARRIERS	ICCCxx	.49	.59	.69	.99	.99	.99	.99	1.09	1.49
DIP PLUGS (IDC)	IDPxx	.95	.49	.59	1.29	1.49	--	.85	1.49	1.99

FOR ORDERING INSTRUCTIONS SEE D-SUBMINIATURE CONNECTORS ABOVE



JDR MICRODEVICES, 2233 BRANHAM LANE, SAN JOSE, CA 95124

LOCAL (408) 866-6200 FAX (408) 559-0250 TELEX 171-110

RETAIL STORE: 1256 SOUTH BASCOM AVE. SAN JOSE, CA

(408) 947-8881 HOURS: M-F 9-7 SAT. 9-5 SUN. 12-4

Terms: Minimum order \$10. For shipping and handling include \$3.50 for ground and \$4.50 for air. Orders over 1 lb and foreign orders may require additional shipping charges—please contact the sales department for the amount. CA residents must include applicable sales tax. Prices subject to change without notice. We are not responsible for typographical errors. We reserve the right to limit quantities and to substitute manufacturer. All merchandise subject to prior sales. A full copy of our terms is available upon request. Items pictured may only be representative.

ORDER TOLL FREE 800-538-5000

MON.-FRI. 7 A.M. TO 5 P.M., SATURDAY, 10 A.M. TO 3 P.M. (PST)

COPYRIGHT 1989 JDR MICRODEVICES

CIRCLE 170 ON FREE INFORMATION CARD

www.americanradiohistory.com

2400 BAUD MODEM

\$89⁹⁵

- HAYES COMPATIBILITY
- AUTO DIAL/ANSWER
- SELF-TEST ON POWER UP
- FULL AND HALF DUPLEX
- TOUCHTONE OR PULSE DIALING
- 2ND PHONE JACK

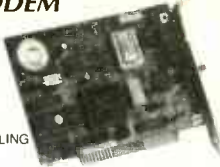

MCT-241

PROMETHEUS MODEMS

PRO-241 2400 BAUD INTERNAL 1/2 CARD \$99.95
 PRO-121 1200 BAUD INTERNAL 1/2 CARD \$69.95
 PRO-24E 2400 BAUD EXTERNAL MODEM \$149.95
 PRO-12E 1200 BAUD EXTERNAL MODEM \$99.95

DFI HANDY SCANNER—400 DPI

\$199⁹⁵

- QUICKLY SCANS UP TO 4.1" WIDE IMAGES • 100, 200, 300, 400 DPI BOTH DIRECTIONS • B&W & 3 HALF-TONE MODES • 32 LEVELS OF GRAY SCALE • HERCULES, CGA, EGA AND VGA COMPATIBLE
- INCLUDES HALO DPE AND IMAGE EDITOR SOFTWARE



HS-3000

OCR-SOFT CHARACTER RECOGNITION SOFTWARE \$99.95

UPRIGHT CASE

\$299⁹⁵

- SPACE SAVING DESIGN HOLDS ALL SIZES OF MOTHERBOARDS AND INCLUDES:
- 250W POWER SUPPLY • MOUNTS FOR 3 FLOPPY & 4 HARD DRIVES
- TURBO & RESET SWITCH • LED SPEED DISPLAY • POWER & DISK LED'S
- ALL HARDWARE, FACEPLATES & SPEAKER

CASE-100

CASE-FLIP FOR 8088 BOARDS \$39.95
 CASE-SLIDE FOR 8088 BOARDS \$39.95
 CASE-70 FOR 286 BOARDS \$89.95
 CASE-50 FOR 8088/286 BOARDS \$59.95
 CASE-JR MINI-286 W/150W PS \$149.95



DFI SERIAL MOUSE

\$39⁹⁵

- 3-BUTTON OPTO MECHANICAL
- 200 D.P.I. • 5-1/2" CABLE
- USES SERIAL PORT COM 1/2
- INCL. SOFTWARE DRIVERS

DMS-200E

MOUSE & HALO-DPE SOFTWARE
 DMS-200 \$59.95



NEW LOGITECH 3-BUTTON MICE

NEW SERIES 9 MICE FEATURE 320 DPI RESOLUTION. SERIAL MICE ARE ALSO PS/2 COMPATIBLE.

LOGC9 SERIAL MOUSE \$98.95
 LOGC9-P SERIAL MOUSE WITH PAINTSHOW \$109.95
 LOGC9-PBL SERIAL MOUSE WITH PUBLISHER \$149.95
 LOGC9-PC SERIAL MOUSE WITH PAINT/CAD \$154.95
 LOGB9 BUS MOUSE \$89.95
 LOGB9-P BUS MOUSE WITH PAINTSHOW \$104.95
 LOGB9-PBL BUS MOUSE WITH PUBLISHER \$139.95
 LOGB9-PC BUS MOUSE WITH PAINT/CAD \$149.95

MODULAR PROGRAMMING SYSTEM

INTEGRATED MODULAR SYSTEM EASILY EXPANDS! ALL MODULES USE A COMMON HOST ADAPTOR CARD—USE JUST ONE SLOT TO PROGRAM EPROMS, PROMS, PALS & MORE

HOST ADAPTOR CARD \$29.95

- UNIVERSAL INTERFACE FOR ALL THE PROGRAMMING MODULES!
- SELECTABLE ADDRESSES PREVENTS CONFLICTS
- MOLDED CABLE

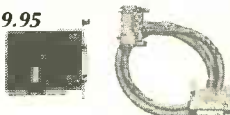

MOD-MAC

UNIVERSAL MODULE \$499.99

- PROGRAMS EPROMS, EEPROMS, PALS, BI-POLAR PROMS, 8748 & 8751 SERIES DEVICES; 16V8 AND 20V8 GALs (GENERIC ARRAY LOGIC) FROM LATTICE, NS, SGS • TESTS TTL, CMOS, DYNAMIC & STATIC RAMS • LOAD DISK, SAVE DISK, EDIT, BLANK CHECK, PROGRAM, AUTO-READ MASTER, VERIFY AND COMPARE
- TEXT/COL SOCKET FOR .3" TO .6" W. IC'S (8-40 PINS)



MOD-MUP

VGA COMPATIBLE PACKAGE \$499

- 720 X 540 MAX RESOLUTION, 640 X 480 IN 16 COLORS, 528 X 480 RESOLUTION IN 256 COLORS • IBM STYLE MONITOR
- VGA, EGA, CGA, AND MGA COMPATIBLE

VGA-PKG (INCLUDES VGA CARD AND MONITOR)
VGA MONITOR \$359
 • 14" ANALOG VGA • GLARE RESISTANT SCREEN • 720 X 480
 • TILT/SWIVEL BASE • FRONT MOUNTED POWER SWITCH
VGA-MONITOR \$429

RELISYS MULTISYNCH \$429
 • FULL FEATURED MULTISCAN MONITOR WITH UNLIMITED COLORS • 800 X 560 RESOLUTION, 14" NON-GLARE DISPLAY
 • AUTO SWITCHING • TTL/ANALOG VIDEO INPUT
JDR-MULTI \$339

EGA MONITOR \$339
 • 640 X 200/350 RESOLUTION • 14" BLACK MATRIX SCREEN
 • 16 COLOR DISPLAY • 9-PIN CABLE
EGA-MONITOR \$479

EGA SPECIAL! CARD & MONITOR—JUST \$479

JDR-RGB 14" RGB MONITOR TILT/SWIVEL BASE \$239.95
 JDR-MONO 12" TTL MONOCHROME-GREEN \$69.95
 JDR-AMBER 12" TTL MONOCHROME-AMBER \$69.95

KEYBOARDS

101 KEY ENHANCED, WITH SEPARATE CURSOR PAD:
 BTC-5339 AUTOSENSE FOR XT/AT, AUTOREPEAT \$69.95
 K103-A AUDIBLE 'CLICK' STYLE \$84.95
 MAX-5339 MAXI-SWITCH W/TACTILE FEEDBACK \$84.95

84 KEY STYLES:

BTC-5060 AUTOSENSE FOR XT/AT \$59.95
 MAX-5060 MAXI-SWITCH W/TACTILE FEEDBACK \$64.95

MODULAR CIRCUIT TECHNOLOGY

DRIVE CONTROLLERS:
 MCT-FDC FLOPPY DISK CONTROLLER \$29.95
 MCT-FDC-1.2 1.2 MB FLOPPY CONTROLLER \$49.95
 MCT-HDC HARD DISK CONTROLLER \$79.95
 MCT-RLL RLL CONTROLLER \$89.95
 MCT-FH FLOPPY/HARD CONTROLLER \$139.95
 MCT-AFH 286/386 FLOPPY/HARD \$149.95
 MCT-AFH-RLL 286/386 RLL CONTROLLER \$199.95

DISPLAY ADAPTOR CARDS:

MCT-MGP MONOCHROME GRAPHICS \$59.95
 MCT-CG COLOR GRAPHICS ADAPTOR \$49.95
 MCT-EGA ENHANCED GRAPHICS ADAPTOR \$149.95
 MCT-VGA-8 8-BIT VGA ANALOG ONLY \$199.95
 MCT-VGA-16 16-BIT VGA 1024X768 RES. \$329.95
 MCT-MGMIO MONOGRAPHICS MULTI I/O \$119.75
 MCT-MGAI0 286/386 MONOGRAPHICS I/O \$99.95

MULTIFUNCTION CARDS:

MCT-MIO MULTI I/O FLOPPY CONTROLLER \$79.95
 MCT-IO MULTI I/O CARD \$59.95
 MCT-AMF 286/386 MULTIFUNCTION \$139.95
 MCT-AIO 286/386 MULTI I/O CARD \$59.95

MEMORY CARDS:

MCT-RAM 576K RAM CARD \$59.95
 MCT-EMS EXPANDED MEMORY CARD \$129.95
 MCT-AEMS 286/386 EMS CARD \$139.95

EPROM MODULE \$119.95

- PROGRAMS 24-32 PIN EPROMS, CMOS EPROMS & EEPROMS FROM 16K TO 1024K • HEX TO OBJ CONVERTER • AUTO, BLANK CHECK/PROGRAM/VERIFY • VPP 5, 12.5, 12.75, 13, 21 & 25 VOLTS
- NORMAL, INTELLIGENT, INTERACTIVE & QUICK PULSE PROGRAMMING ALGORITHMS

MOD-MEP

MOD-MEP-4 4-EPROM PROGRAMMER \$169.95
 MOD-MEP-8 8-EPROM PROGRAMMER \$259.95
 MOD-MEP-16 16-EPROM PROGRAMMER \$499.95

DIGITAL IC MODULE \$129.95

- TESTS TTL, CMOS, DYNAMIC & STATIC RAM
- AUTO SEARCH FOR UNKNOWN PART NUMBERS
- USER PROGRAMMABLE TEST PROCEDURES

MOD-MIC

PAL MODULE \$249.95

- PROGRAMS MMI, NS, TI 20 & TI 24 PIN DEVICES
- BLANK CHECK, PROGRAM, AUTO, READMASTER, VERIFY & SECURITY FUSE BLOW

MOD-MPL

CUPL SOFTWARE—ENTRY-LEVEL PAL DEV. KIT
 MOD-MPL-SOFT

HARD DISKS

20 MB \$199
 30 MB \$219
 40 MB \$319
 28 MS \$389
 60 MB \$389
 80 MB \$569

KITS

20 MB \$249
 30 MB \$279

Seagate



SIZE	MODEL	AVG. SPEED	FORM FACTOR	DRIVE ONLY	XT KIT	AT/F/H KIT
20MB	ST-225	65 MS	5-1/4"	\$199	\$249	\$309
20MB	ST-125	40 MS	3-1/2"	\$259	\$299	\$373
30MB RLL	ST-238	65 MS	5-1/4"	\$219	\$279	\$379
30MB RLL	ST-138	40 MS	3-1/2"	\$289	\$339	\$429
40MB	ST-251	40 MS	5-1/4"	\$319	\$369	\$429
40MB	ST-251-1	28 MS	5-1/4"	\$389	\$439	\$499
60MB RLL	ST-277	40 MS	5-1/4"	\$389	\$449	\$549
80MB	ST-4096	28 MS	5-1/4"	\$569	—	\$679

80MB SCSI \$499

SCSI DRIVES ARE FASTER
 ST-296N BY SEAGATE
 MCT-SCSI HOST ADAPTOR CARD \$49.95
 ST-02 SCSI ADAPTOR W/FLOPPY \$79.95

1.44 MB 3-1/2" DRIVE \$99⁹⁵

- ULTRA HIGH DENSITY
- READ/WRITE 720K DISKS, TOO
- FDD-1.44X BLACK FACEPLATE \$29.95
- FDD-1.44A BEIGE FACEPLATE \$29.95
- FDD-1.44 SOFT SOFTWARE DRIVER \$19.95

1/2 HEIGHT FLOPPY DISK DRIVES:
 FD-55B 5-1/4" TEAC DS/DD 360K \$99.95
 FD-55G 5-1/4" TEAC DS/HD 1.2M \$129.95
 FDD-360 5-1/4" DS/DD 360K \$69.95
 FDD-1.2 5-1/4" DS/HD 1.2M \$95.95
 FDD-3.5X 3-1/2" 720K (BLACK) \$97.95
 FDD-3.5A 3-1/2" 720K (BEIGE) \$97.95

MOTHERBOARDS

25 MHZ 386 \$1049

- 1025 MHZ
- 16 MB RAM CAPACITY • 8MB ON-BOARD(OK), 8 MB RAM CARD
- USES 256K OR 1MB DRAMS
- 8 SLOTS: 1X32-BIT RAM 2X 8-BIT & 5X 16-BIT
- SHADOW RAM FOR BIOS VIDEO • AMI BIOS
- INTERLEAVED MEMORY
- ADJUSTABLE BUS SPEEDS

MCT-386MB25 10/20 MHZ 386 \$849.00
 MCT-386MB20 8MB RAM CARD (OK) \$149.95

12 MHZ MINI-286 \$299

- AT COMPATIBLE • KEYBOARD SELECTABLE 8/12MHZ
 - EXPANDABLE TO 4MB ON-BOARD WITH 1MB DRAMS (OK)
 - SIX 16-BIT & TWO 8-BIT SLOTS • AMI BIOS • LED SUPPORT
- MCT-M286-12 6/10 MHZ MINI-286 \$269.95
 MCT-M286-16 8/16 MHZ 286 \$489.95
 MCT-M286-20 10/20 MHZ 286 \$589.00
 MCT-XMB STANDARD 4.77 MHZ 8088 \$87.95
 MCT-TURBO 4.77 MHZ 8088 \$95.95
 MCT-TURBO-10 4.77/10 MHZ SINGLE CHIP 8088 \$99.00

EPROM PROGRAMMER \$129⁹⁵

- PROGRAMS 27XX AND 27XXX EPROMS UP TO 27512
- SUPPORTS VARIOUS PROGRAMMING FORMATS & VOLTAGES • SPLIT OR COMBINE CONTENTS OF SEVERAL EPROMS OF DIFFERENT SIZES
- READ, WRITE, COPY, ERASE, CHECK & VERIFY
- SOFTWARE FOR HEX AND INTEL HEX FORMATS



JDR MICRODEVICES, 2233 BRANHAM LANE, SAN JOSE 95124
 LOCAL (408) 866-6200 FAX (408) 559-0250 TELEX 171-110
 RETAIL STORE: 1256 S. BASCOM AVE., SAN JOSE, CA
 (408) 947-8881 HOURS: M-F 9-7 SAT. 9-5 SUN. 12-4

Terms: Minimum order \$10.00. For shipping & handling include \$3.50 for ground and \$4.50 air. Orders over 1 lb and foreign orders may require additional shipping charges—please contact the sales department for the amount. CA residents must include applicable sales tax. Prices subject to change without notice. We are not responsible for typographical errors. We reserve the right to limit quantities and to substitute manufacturer. All merchandise subject to prior sales. A full copy of our terms is available upon request. Items pictured may only be representative.

ORDER TOLL FREE 800-538-5000

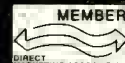

★ **QUALITY PARTS** ★ **DISCOUNT PRICES** ★ **FAST SHIPPING**

ALL ELECTRONICS CORP.

3 to 6 Vdc MOTOR with GEARBOX

Probably designed for child's toy. Lever selects 2 forward and one reverse speed. 1st gear approx. 120 rpm/6vdc, 2nd gear approx. 300 rpm/6vdc. Reverse approx. 120 rpm/6vdc.

3.35" X 1.75" X 3.25"

CAT# DCM-10 \$6.00

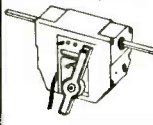

CASSETTE MECHANISM

Alpine cassette transport mechanism. Includes stereo tape head, Mitsubishi # MET-3RF2B 13.2 Vdc motor, belt, pulleys, capstan, fast-forward, rewind and eject actuator. Does not include amplifier section. 6 1/2" X 5 1/4" X 1 3/4".

CAT# CMEC-5 \$7.50 each
10 for \$65.00



6 VOLT D.C. 9.5 AMP/HOUR GEL-CELL

Elpower# 695
6 volt, 9.5 amp/hour rechargeable gel-cell battery. 4.25" X 2.75" X 5.5". Quick connect terminals.

CAT# GC-695 \$15.00 each



12-36 VDC GEAR-HEAD MOTOR

Brevell# 780-953075
Rated for 36 Vdc: 95 rpm. 0.5 amps no load. 65 rpm, 1.5 amp @ 12 lb/in torque. Gearbox is 3 1/4" X 3 1/4" X 1 15/16" deep. Motor is 1 1/2" diameter X 3 1/2" long with double flatted 5/16" X 1" shaft. Ideal for pumps, lift mechanisms, robotics and other high torque applications. **CAT# MOTG-11 \$15.00 each • 2 for \$25.00**



WALL TRANSFORMERS

ALL PLUG DIRECTLY INTO 120 VAC OUTLET

6 Vdc @ 200 ma. **CAT# DCTX-620 \$2.25**
6 Vdc @ 750 ma. **CAT# DCTX-675 \$3.50**
9 Vdc @ 250 ma. **CAT# DCTX-925 \$2.50**
12 Vdc @ 930 ma. **CAT# ACTX-1293 \$3.50**
18 Vdc @ 1 amp. **CAT# ACTX-1885 \$3.50**



LED'S

STANDARD JUMBO DIFFUSED T 1-3/4 size

RED CAT# LED-1 10 for \$1.50 • 100 for \$13.00
GREEN CAT# LED-2 10 for \$2.00 • 100 for \$17.00
YELLOW CAT# LED-3 10 for \$2.00 • 100 for \$17.00

FLASHING LED
with built in flashing circuit operates on 5 volts...

RED \$1.00 each
CAT# LED-4 10 for \$9.50
GREEN \$1.00 each
CAT# LED-4G 10 for \$9.50

BI-POLAR LED
Lights RED one direction, GREEN the other. Two leads.

CAT# LED-8 2 for \$1.70

LED HOLDER
Two piece holder.
CAT# HLED 10 for 65c



DOOR/WINDOW ALARM

Protects doors and windows from intruders.

Opening of door or window pulls pin from alarm module and triggers loud buzzer. Simple installation. Operates on 2 AA batteries (not included). Plastic case is 3.32" X 2.29" X 1.19". Ivory with brushed aluminum face.

CAT# DWA \$2.00 each
5 for \$9.00



PIEZO WARNING DEVICE

Murata Erie # PKB8-4A0
High pitched audible alarm. Operates on 3 - 20 Vdc @ 20 ma. 1" high x 7/8" dia. P.C. board mount.

CAT# PBZ-84 \$1.75 each



WIDE BAND AMPLIFIER

NEC# UPC1651G. 1200 Mhz @ 3 db. Gain: 19db @ 1-500 hz. 5 volt operation. Small package 4mm dia. X 2.5 mm thick.

CAT# UPC-1651 2 for \$1.00
10 for \$4.50 • 100 for \$35.00

N-CHANNEL MOSFET
IRF-511 TO-220 case
CAT# IRF 511
\$1.00 each • 10 for \$9.00
LARGE QUANTITY AVAILABLE



SWITCHES

ITT PUSH BUTTON

ITT MDPL series. 3/4" X 1/2" gray rectangular key cap. S.P.S.T. N.O.

Push to close. RATED: 0.1 amp switching, 0.25 amp carry current. P.C. mount. **CAT# PB-8** 65c each • 10 for \$6.00 • 100 for \$50.00



RELAYS

12 VOLT D.C. COIL S.P.D.T.
Omron# G2E-184P 4 AMP contacts 335 ohm coil. Sugar cube size. .61" X .42" X .44" high. P.C. mount with pins on DIP spacing.

CAT# RLY-787 \$1.50 each

5 VOLT DC SIP RELAY
Gould, Allied Controls SR-1A-5VDC
SPST-normally open SIP reed relay. 95 ohm coil. 2 amp contacts. .67" X .29" X .39" high. Housing resists liquids fluorocarbon and chlorinated commercial solvents. **CAT# RLY-SIP6** \$1.00 each • 10 for \$8.50



SOUND AND VIDEO MODULATOR

The UM1381-1. Designed for use with T.I. computers. Can be used with video cameras, games or other audio/video sources. Built in AB switch enables user to switch from T.V. antenna without disconnection. Operates on channel 3 or 4. Requires 12 Vdc. Hook up diagram included.

CAT# AVMOD \$5.00 each



NICKEL-CAD BATTERIES (RECHARGEABLE)

SPECIALII AAA SIZE
Panasonic P-18AAA
1.2 volt @ 180 MAH
CAT# NCB-AAAX \$1.50 each
10 for \$13.50 • 100 for \$125.00



STROBE KIT

Variable rate strobe kit. Flashes between 60 to 120 times per minute. Will operate on either 6 or 12 Vdc depending upon how you wire the circuit. Comes complete with P.C. board and instructions for easy assembly.

CAT# STROBE-1 \$7.50 each



10 POSITION MINI-ROTARY

Grayhill# 56P36-01-1-10N-C
Mini rotary switch. Non-shorting. 1 deck, 10 positions. .125" dia. shaft X .375" long. .377" behind the panel depth. P.C. pins.

CAT# MRS-10 WAS \$2.50 NOW \$1.50 each

SPDT PUSHBUTTON
Marquardt# 1843
Rated 6 amps @ 125/250 Vac. Black plastic pushbutton. Switch body: .92" X .94" X .65".

CAT# PB-18 \$1.65 each • 10 for \$15.00 each

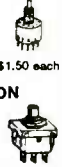

TELEPHONE COUPLING TRANSFORMER

Multi Products International# A19N-HO-1D/1
Primary 600 ohm
Secondary: 600/600 ohm
.77" X .61" X .63" high.
6 p.c. pins on .187" centers.
Primary inductance: 300 mH min., at 1kHz, 1 volt.

CAT# TCTX-1 \$1.25 each
10 for \$11.00 • 100 for \$95.00



LIGHT ACTIVATED MOTION SENSOR

This device contains a photocell which senses sudden change in ambient light. Could be used as a door annunciator or modified to trigger other devices. 5 1/2" X 4" X 1". Operates on 3 Vdc. Requires 4 AA batteries (not included).

CAT# LSM2 \$5.75 per unit

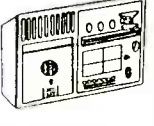

TRANSISTORS

ORDER BY PART #

PN2222 NPN
TO-92 5 for 75c
PN2907 PNP
TO-92 5 for 75c
2N3055 NPN
TO-3 \$1.00 each
MJ2955 PNP
TO-3 \$1.50 each
MJE2955T PNP
TO-220 75c each
MJE3055T NPN
TO-220 75c each
TIP31 NPN
TO-220 75c each
TIP32 PNP
TO-220 75c each
TIP121 NPN
TO-220 75c each
TIP126 PNP
TO-220 75c each



OPTO SENSOR

U shaped package with mounting ears. 1/8" opening. 3/4" mounting holes. **CAT# OSU-6** 50c each
10 for \$4.50 • 100 for \$40.00



A.C. LINE CORDS

Black 6ft., 18/2, apt-2

NON POLARIZED PLUG
CAT# LCAC 2 for \$1.00 • 100 for \$45.00

POLARIZED PLUG
CAT# LCP-1 60c each • 100 for \$50.00

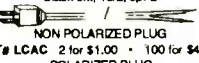

10 AMP SOLID STATE RELAY

ELECTROL# SZ8181
CONTROL:
Rated 5.5 kv 10 Vdc (will operate on 3-32 Vdc).
LOAD: 10 amp @ 240 Vac
2 1/4" X 1 3/4" X 7/8"

CAT# SSRLY-10B \$9.50 each

QUANTITY DISCOUNT
10 for \$85.00 • 25 for \$175.00
50 for \$300.00 • 100 for \$500.00



1/4 WATT RESISTOR KIT

Ideal for the workshop, this 1/4 watt resistor kit contains 10 pieces each of 42 of the most popular values (420 pieces total). Includes a divided box and a parts locator.

VALUES in this kit are:
1 ohm, 10 ohm, 39 ohm, 47 ohm, 51 ohm, 68 ohm, 100 ohm, 130 ohm, 150 ohm, 180 ohm, 220 ohm, 330 ohm, 470 ohm, 560 ohm, 680 ohm, 1K, 1.2K, 1.5K, 2K, 2.2K, 2.7K, 3K, 4.7K, 5.1K, 5.6K, 10K, 15K, 22K, 30K, 33K, 39K, 47K, 56K, 68K, 100K, 120K, 150K, 220K, 470K, 1 MEG, 5.1 MEG, 10 MEG

The resistors alone would sell for \$21.00.
Complete kit - **CAT# REKIT-14 \$17.00**



12 VOLT DC SOLID STATE BUZZER

Star# CMB-12 fits 14 pin DIP socket. CMOS compatible. Operates on 7 - 17 Vdc @ 1 ma. PC pins. Has trigger terminal. 70 dB @ 20 cm. 0.886" X 0.63" X .575" high.

CAT# CMB-12 \$1.25 each



LOOK WHAT \$1.00 WILL BUY

200 ASSORTED 1/4 WATT RESISTORS
Bent leads, carbon comp. and carbon film. **CAT# GRES** \$1.00 per assortment

200 ASSORTED 1/2 WATT RESISTORS
Bent leads, carbon comp. and carbon film. **CAT# GRABE** \$1.00 per assortment

50 ASSORTED DISC CAPACITORS
Most are air (p.c. leads). Same to 500 volts. **CAT# GRABDC** \$1.00 per assortment

15 VALUES OF ELECTROLYTICS
Contains both axial and radial styles from 1 mfd. **CAT# GRABEC** \$1.00 per assortment



XENON TUBE

1" long flash tube prepped with 3 1/2" red and black leads. Ideal for electronic flash or strobe projects.

CAT# FLT-3 2 for \$1.00



14.7 VOLT TRANSFORMER

Sprite Industries# CS-510A. 14.7 volt, 60 hz, 8.82 Va. 1.61" high X 1.95" X 1.47". Mounting holes on 2.32" centers.

CAT# TX-147 \$3.00 each
10 for \$27.00 • 100 for \$250.00



CALL OR WRITE FOR OUR FREE CATALOG OVER 400 PARTS!



Now 60 pages!

MAIL ORDERS TO:
ALL ELECTRONICS
P.O. BOX 567
VAN NUYS, CA 91408
TWX-5101010163 (ALL ELECTRONIC)

OUTSIDE THE U.S.A.
SEND \$2.00 POSTAGE FOR A CATALOG!!

ORDER TOLL FREE
800-826-5432
INFO: (818)904-0524
FAX: (818)781-2653
MINIMUM ORDER \$10.00
QUANTITIES LIMITED
CALIF. ADD SALES TAX
USA: \$3.00 SHIPPING
FOREIGN ORDERS
INCLUDE SUFFICIENT SHIPPING. NO C.O.D.



Radio Shack Parts PlaceSM

EVERYTHING FOR BUILDERS, FIXERS, HOBBYISTS AND HAMS!

Essentials at Everyday Low Prices



- (1) Xenon Strobe Tube. 100,000 flash life. #272-1145 3.29
- (2) 12V Flashing Lamps. Red, yellow, green. #272-1097 . . . Pkg. 3/1.29
- (3) PC Board Kit. Includes two 4 1/2 x 3" copper-clad boards and everything needed to etch them. #276-1576 9.95
- (4) Package of Five Photocells. #276-1657 1.98
- (5) IC Pin Aligner. For 6-pin to 40-pin DIPs. #276-1594 3.49
- (6) Jumper/Test Cables. Set of 10, 5 different colors. #278-1156, 3.99

Save With Our "Hotline" Order Service



One-Week Delivery on Most Items

Your Radio Shack store manager can special-order a wide variety of parts and accessories not shown in our catalog—tubes, ICs, phono cartridges and styli, microprocessor chips, scanner and CB crystals, modules for TV/audio equipment, even SAMS Photofacts®. There's no minimum order or handling charges. Come in for details.

RS-232 Connectors and Accessories

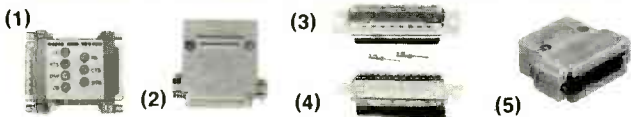

- (1) RS-232 Mini Test. Data status indicator for TD, RTS, DSR, CD, CTS and DTR lines. Connects inline. #276-1401 14.95
- (2) RS-232 Modular Jack Adapter. 25-position D-Sub male to 6-position modular phone jack. #276-1405 2.99
- (3) 25-Position Male D-Sub. #276-1429 2.49
- (4) 25-Position Female D-Sub. #276-1430 2.99
- (5) Metalized Plastic Hood, 25-Position. #276-1536 1.99

General Class Ham Exam Package

Upgrade to
General Class
FCC License
The Quick and
Easy Way

19⁹⁵

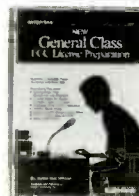

Painlessly prepares the novice/technician for the big step up to world-wide voice privileges. Includes an instruction manual with exam questions and answers, two self-paced code cassettes and FCC form 610 application. #62-2404 19.95

Alligator Clips



- (1) 50-Amp Car Battery Clips. One red, one black. #270-342 . . . Set of 2/2.49
- (2) Claw Clips. Screwdriver terminals. #270-345 Pkg. of 8/1.99
- (3) Insulated. #270-347, Pkg. 10/1.99

Sight 'n Sound



- (1) PC-Mount Transducer. 700 to 3000 Hz. #273-090 4.99
- (2) Super-Bright LED. Requires 1.85V, 20 mA. #276-087 1.69
- (3) Loud Buzzer. #273-070, 9.95

R & C Bargains



- (1) Thermistor. #271-110 1.99
- (2) 5W, 25-Ohm Rheostat. Handy to attenuate speakers. #271-265 2.99
- (3) 8-Ohm Non-Inductive Resistor. Rated 20 watts. #271-120 1.39

AC-Line Insurance

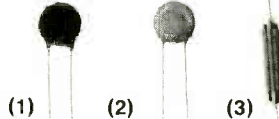

- (1) Heavy-Duty MOV. #276-568, 1.99
- (2) 0.01 µF, 2 kV Disc Ceramic Caps. Bypass value with a "workhorse" rating. #272-160 Pkg. of 2/99c
- (3) 100 µH RF Choke. #273-102, 99c

Cable and Ties

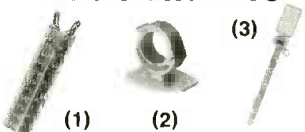

- (1) Speaker MEGACABLE™. 12-gauge. #278-1268, Per Foot 99c
- (2) Cable Clips. Adhesive backing. #278-1641 . . . Pkg. of 3/1.79
- (3) Cable/Tie Marker. #278-1648 Pkg. of 10/2.49

Audio Connectors



Gold-Plated Plugs.

Fig.	Description	Cat. No.	Each
1	Phono	274-850	2.49
2	3-Conductor, 1/4" Phone	274-856	3.99
3	3-Conductor, 1/8" Phone	274-858	3.49
4	8-Pin Mike Plug.	274-025	2.19

Instrument Cases

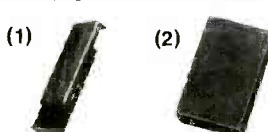

- (1) Professional Project Case. Ideal remote enclosure. 5 5/8 x 2 1/4 x 1 1/16". #270-257 4.99
- (2) Transmitter Case. Perfect for an RF or IR transmitter or beeper. 3 3/4 x 2 5/16 x 1". #270-293 . . . 3.99

DC Hobby Motor

89^c

High Torque
Low Voltage



Just the thing for projects in robotics, solar power and science class. High torque. 8300 RPM max. 1 1/2 to 3VDC. About 1 1/2" long (including shaft). by 19/16" diameter. #273-223 89c

Handy Assistants

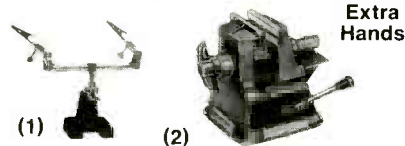

- (1) Project Holder. A third hand for soldering, gluing, repairing. Ball joints and two alligator clips adjust to hold work. #64-2093 7.99
- (2) Mini-Vise. Vacuum base firmly fastens to smooth surface. #64-2094 4.19

Extra
Hands

Speech-Recognition IC



9⁹⁵

Clipped Analog Input—Requires No Analog-to-Digital Conversion

VCP200. Recognizes spoken commands, regardless of the person speaking. Five motion and two on/off or yes/no commands. Few external parts needed. 20-pin DIP. With data. #276-1308 9.95

Universal Breadboard

19⁹⁵



640 Plug-In Tie Points

The 2 1/4 x 6 1/2" universal board is mounted on a 4 x 7" "stay-put" steel base with rubber feet. Accepts DIPs, discrete components and up to 22-gauge wire. Three binding posts for external power connections. #276-169 19.95

Over 1000 items in stock! Binding Posts, Books, Breadboards, Buzzers, Capacitors, Chokes, Clips, Coax, Connectors, Fuses, Hardware, ICs, Jacks, Knobs, Lamps, Multitesters, PC Boards, Plugs, Rectifiers, Resistors, Switches, Tools, Transformers, Wire, Zeners, More!

Prices apply at participating Radio Shack stores and dealers

Radio Shack®
The Technology Store

A DIVISION OF TANDY CORPORATION

Heath[®] Summer Electronic Celebration.

Make life easier...

Full-featured remote control center for your TV, VCR and CATV. Designed to control units operated via infrared signals. Three AAA batteries included. GDZ-143 (1 lb.).....**\$29.95**



Recharge your NiCd batteries BP-1234 (4 lbs.).....**\$17.95**

Amber screen fish finder MI-2020 (6 lbs.).....**\$244.95**

Accessories: Tansom Mount Transducer MIA-2020-1 (4 lbs.).....**\$44.95**
Through-Hull Transducer MIA-2020-2 (6 lbs.).....**\$99.95**



Full color fish finder MI-2040 (10 lbs.).....**\$399.00**



Save \$20 on portable electronic speller/game player. Words checked against 80,000-word dictionary. SA-103 (1 lb.).....**Now \$59.95**

Save 28% on portable dictionary/thesaurus/speller. LM-2000 (1 lb.).....**Now \$179.95**

Dial up these savings...

Save 28% on Southwestern Bell wall phone. Switchable for tone and pulse (rotary) phone systems. Easy hookup. FC-2505 (3 lbs.).....**Now 24.99**



Full-featured Southwestern Bell memory phone. One-touch dialing of up to 24 numbers and three emergency numbers. Last number redial and hold. Switchable pulse/tone dialing. Styled for desk or wall. BT-1550 (3 lbs.).....**Now \$49.95**

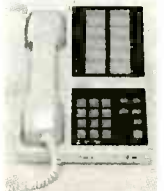

For the electronic hobbyist...

Connector adapter kit. Make 108 different coaxial connector adapters with gold-plated pins and Teflon insulation. Kit contains male and female, N, BNC, UHF, SMA TNC and mini UHF connectors. Special in-between fittings allow you to assemble your own adapters in seconds. HCA-3000 (2 lbs.).....**\$69.95**



Coax adapter cables. Solves frustrating coax connection problems. Twenty cables let you make almost any connection. 50 ohm impedance. TPI-5000 (5 lbs.).....**Now \$49.95**



Smallest auto-ranging DMM made. Fits in shirt pocket. This practically goof-proof, 3 1/2 digit display shows readings up to 1999. A handy extra meter that's affordable and accurate. SM-2300-A (1 lb.).....**\$24.95**



Two modular 10X 350 MHz scope probes. Perfect for 50 or 100 MHz Oscilloscope. P-350-2 (1 lb.).....**\$99.95**

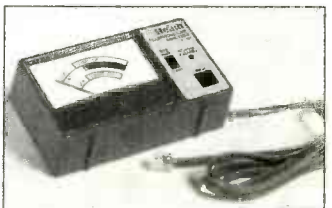

Do-it-yourself telephone line analyzer. Save yourself the cost of expensive service calls by checking your own lines, phones and phone cords. Check out do-it-yourself wiring, too. Phone-line powered; doesn't require batteries or external power. ST-2204 (1 lb.).....**Now \$19.95**

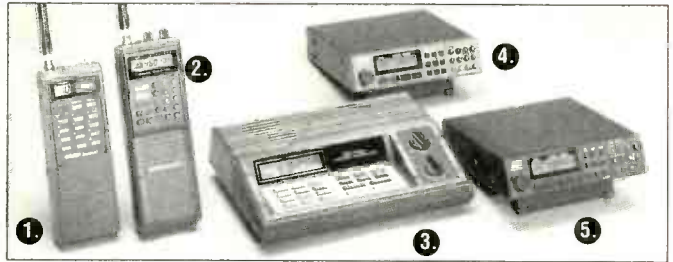

Kit projects...

Heathkit Flood Alarm. detects leaking water pipes or basement wall seepage. Three hours to build. Needs 9V battery. Kit GD-1701 (2 lbs.).....**\$12.95**



Program your doorbell with a favorite tune. Includes songbook with 50+ college, seasonal, Christmas and special occasion songs. Back door button activates a part-tune. Takes standard 16 VAC, 50/60 Hz bell transformer. Two-evening kit. Kit TD-1089 (3 lbs.).....**\$32.95**



Noise generator kit. To properly check out any stereo or sound system with a spectrum analyzer, you need a noise source with a nearly constant energy output. One-evening kit. Kit AD-1309 (2lbs.).....**\$24.95**



Save time and money with breakout box. Access all 25 lines of RS-232C cable linking computer system devices. One-evening kit. Kit PMK-130 (2 lbs.).....**\$79.95**



Power line monitor. Warns you of problem-causing AC line conditions by displaying line voltage at any AC electrical outlet. Accuracy of 1.5%. Kit IM-2203 (3 lbs.).....**\$39.00**



Measure RF voltages. Easy-to-build probe measures RF voltage for DC voltmeters with 10 and 11 megohm input impedances. Kit PK-3-A (1 lb.).....**Now \$9.95**



Save on Scanners...

1. Save \$31 on Uniden 10-channel/10-band handheld scanner. Super portable, programmable, direct channel access, channel lockout, keyboard lock switch prevents accidental reprogramming. Requires 5, AA (not included) or rechargeable NiCd batteries. BC-55X-LT (1lb.).....**Now \$108.88**

2. Save \$51 on 100-channel/11-band Uniden handheld scanner. Automatic and manual search, weather search, 10 priority channels, squelch, lockout and delay. Snap on battery pack included. BC-100X-LT (3 lbs.).....**\$178.88**

3. Save \$30+ on Uniden tabletop scanner. 11 bands of coverage, 5 or 15 channels-per-second scanning speed. Features automatic memory search, backup, priority, programmable lockout, scan speed control and automatic squelch setting. Takes 117 VAC, 60 Hz from an external wall outlet. BC-175X-L (3 lbs.).....**Now \$138.88**

4. Save \$61+ on 100 channel/11-band Uniden mobile scanner. Auto search aircraft, police, marine and emergency bands. Programmable. Audio output is 1.5 watts at 10% THD; requires 13.8 VDC (vehicle battery or AC adapter). BC-580X-LT (5lbs.).....**\$198.88**

5. Save \$81+ on deluxe Uniden 10-channel/12-band mobile scanner. Covers 800 MHz band for full 12-channel coverage. Weather search, priority, squelch, lockout, delay, auto + manual band search. Takes 13.8 VDC. BC-760X-LT (5 lbs.).....**\$248.88**

Heathkit[®]
to order CALL TOLL FREE
1-800-253-0570
Use order code 217-020



for credit card orders, 24 hours a day.
Some items are close outs. All items are available in limited quantities. Prices for some items were previously reduced.
For your free Heathkit catalog call 1-800-44-HEATH.

CIRCLE 86 ON FREE INFORMATION CARD

VCR PARTS

SANYO RF Modulator #4-1164-031600	\$17.95 Ea.
FISHER RF Modulator 191002-143-9-4300	17.95 Ea.
MITSUBISHI RF Modulator #PU57855-01	19.95 Ea.
TOSHIBA RF Modulator #MSU-911	19.95 Ea.
RCA Loading Belt 157061 or 157062	10/For 8.50
FISHER Loading Belt 143-2-7504-01000	10/For 8.50
GOLDSTAR Samsung Photo Interrupter	1.99 Ea.
RCA Idler 164113	3.25 Ea.
FISHER Idler 143-0-4204-00400	3.99 Ea.
SHARP Idler NIDL0005	2.99 Ea.
SHARP Idler NIDL0006	2.99 Ea.

POPULAR SEMICONDUCTORS

2SD1341P	Original Sanyo	10 For \$19.90
2SD869	Original Toshiba	10 For 19.90
BU208A	Original Toshiba	10 For 19.90
2SD1398	Original Sanyo	10 For 19.90
STR3115	Original Sanken	3.95 Ea.
STR3125	Original Sanken	3.95 Ea.
STR30120	Original Sanken	3.95 Ea.
STK4273	Original Sanken (10 min.)	9.95 Ea.
STK0080	Original Sanken	15.95 Ea.
375 Replacement	(10 min.)	99¢ Ea.

POPULAR CAPACITORS

100MFD/50 Volts	Radial	20 For \$10.00
4.7MFD/250 Volts	Radial	10 For 5.50
10MFD/350 Volts	Radial	10 For 7.50
1000MFD/200 Volts	Snap-In	5 For 12.50
680MFD/200 Volts	Snap-In	5 For 12.50
100MFD/200 Volts	Radial	10 For 12.50
47MFD/50 Volts	Radial	10 For 4.50
10MFD/25 Volts	Non Polarized	10 For 5.00
825MFD/250 Volts	Snap-In	3.95 Ea.
80MFD/450 Volts	Axial	10 For 19.90

POPULAR ITEMS

Sharp Flyback	FO009G	\$27.95 Ea.
Sharp Flyback	FO003G	27.95 Ea.
Sanyo Flyback	FO260	14.95 Ea.
Sanyo Flyback	FO192	14.95 Ea.
Tripler	523A/526A	9.95 Ea.
Sanyo Focus Divider	Z0064	11.95 Ea.
Minus-62	Freeze Spray	4.95 Ea.
Freon TF Clnr./Precision Clnr. Degreaser		4.95 Ea.
Chemtronics Solder—1 Lb. Spool .031 Dia.		7.95 Lb.
Chem-Wick Lite	1/8 Dia. 25' Spool	5.50

ASK FOR OUR FREE CATALOG!

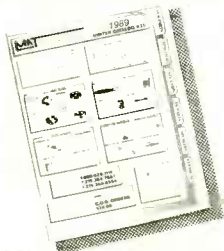

MAT ELECTRONICS

975 Jaymor Rd.
Southampton, PA 18966

CALL TOLL FREE:
1-800-628-1118

CIRCLE 89 ON FREE INFORMATION CARD

ADVERTISING INDEX

RADIO-ELECTRONICS does not assume any responsibility for errors that may appear in the index below.

Free Information Number	Page		Page
		56	Parts Express 92
108	AMC Sales 24	186	Print Products International 16
75	Ace Products 32	78	Radio Shack 101
52	Active Electronics 92	—	Scope Electronics CV4
107	All Electronics 99	176, 177	Sencore CV3, 27
—	Amazing Concepts 88, 90	—	Star Circuits 16
106	American Design Components . . 103	83	Synergetics 66
84	Appliance Service 32	—	Tektronix 13
67	Banner Technical Books 58	185	Tental 58
98	Beckman Industrial 17	123, 181	Test Probes 3
109	C & S Sales 37	210-213	Test Probes 3
70	CEI 88	182	Viejo Publications 54
60	CIE 11, 23	183	WPT Publications 74
179	Chenesko Products 32		
—	Command Productions 54		
180	Communications Specialists 74		
55	Contact East 32		
58	Cook's Institute 24		
69	Crystek 12		
127	Deco Industries 32		
82	Digi-Key 100		
188	Electronics Book Club 7, 38		
121	Fluke Manufacturing CV2		
—	Grantham College of Engineering . 5		
187	Heath Instruments 75		
86	Heathkit 102		
113, 170	JDR Microdevices 96, 97		
171	JDR Microdevices 98		
114	Jameco 94		
115	Jensen Tools 32		
184	Jinco Computers 93		
89	MAT Electronics 104		
87	MCM Electronics 87		
53	MD Electronics 90		
93	Mark V. Electronics 93		
—	McGraw Hill Book Club 18		
61	Microprocessors Unltd 80		
—	NRI 28		
178	Optoelectronics 15		
—	Pacific Cable 89, 92		

Gernsback Publications, Inc.
500-B Bi-County Blvd.
Farmingdale, NY 11735
1-516-293-3000
Fax 1-516-293-3115
President: **Larry Steckler**
Vice President: **Cathy Steckler**

For Advertising ONLY
1-516-293-3000
Fax 1-516-293-3115
Larry Steckler
publisher
Arline Fishman
advertising director
Shelli Weinman
advertising associate
Lisa Strassman
credit manager
Christina Estrada
advertising assistant

SALES OFFICES

EAST/SOUTHEAST
Stanley Levitan
Eastern Sales Manager
Radio-Electronics
259-23 57th Avenue
Little Neck, NY 11362
1-718-428-6037, 1-516-293-3000

MIDWEST/Texas/Arkansas/ Okla.
Ralph Bergen
Midwest Sales Manager
Radio-Electronics
540 Frontage Road—Suite 339
Northfield, IL 60093
1-312-446-1444
Fax 1-312-446-8451

PACIFIC COAST/ Mountain States
Marvin Green
Pacific Sales Manager
Radio-Electronics
5430 Van Nuys Blvd. Suite 316
Van Nuys, CA 91401
1-818-986-2001
Fax 1-818-986-2009



\$1995

Dynamically Analyze Stereo Audio Power Amplifiers To A Full 500 Watts To IHF/EIA* Specifications In Less Than 1/2 The Time It Now Takes

The PA81 Is Truly The "Missing Link In Audio Servicing"

Introducing the "Missing Link In Audio Servicing," with the NEW PA81 Stereo Power Amplifier Analyzer™ from Sencore Electronics. The PA81 provides everything you need for power amplifier analyzing integrated into one complete package, with:

- **Twin Frequency Compensated Autoranged Wattmeters:** 250 watts per channel (500 watts if paralleled), and listen to audio clarity with built-in volume control.
- **Built-in IHF/EIA Testing Components At Your Fingertips:** 2, 4, 8, 16, and 32 ohm-zero reactance loads, and all specified bandpass audio filters.
- **Measure RMS Volts And dB As You Trace Through Circuits:** Plus, programmable dB to measure stage gain.
- **Test Intermittents To Prevent Amplifier Damage:** Built-in DC balance test, automatically opens loads.
- **Test Audio Line Levels To Make Sure The Driver Input Signal Is Correct:** Check turntables, AM tuners, FM tuners, TV stereo demodulator outputs, CD players, etc for standard line levels.
- **Monitor Stereo Separation To 126 dB:** Monitor, troubleshoot, or align AM-FM or TV Stereo separation circuits.

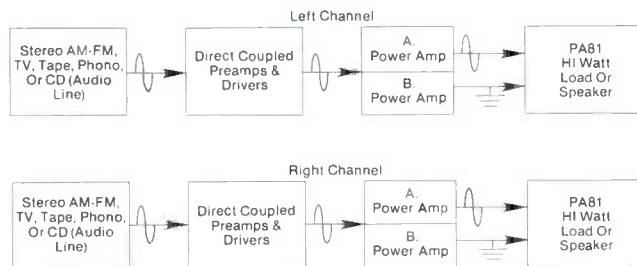

Walk troubles out of any power amplifier stage, step by step, with the PA81.

SENCORE
3200 Sencore Drive, Sioux Falls, South Dakota 57107

Call 1-800-SENCORE
(736-2673)

In Canada Call 1-800-851-8866

**Ask About
A 10 Day
Video Preview**



* IHF—Institute Of High Fidelity
EIA—Electronics Industries Association

CIRCLE 176 ON FREE INFORMATION CARD

QUICK FIX

Super values on the tools and instruments you need to identify problems, get to them quickly and make repairs easily!

PRECISION HAND-HELD INSTRUMENTS

- Lightweight convenience. Easy to read
- Fast, precise results

B & K Precision Test Bench™

- 41 range voltmeter • Ammeter
- Ohmmeter • Frequency counter
- Capacitance meter
- Logic probe
- Transistor & diode tester
- Extra-large LCD display



Model
388-HD
Reg.
\$129.95
Our Price

\$119.00

SCOPE Digital Multimeter

- 11 function, 38 ranges including: Logic Level Detector, Audible and Visual Continuity, Capacitance & Conductance measurements.



Model
DVM-638
Reg.
\$87.50
Our Price

\$79.95

CA-92 Deluxe Padded Case for DVM meters \$9.95
TL-216 Transistor and Capacitance Test Leads \$9.95

ALL-PURPOSE 92-PC. TOOL CASE

- Complete kit for home, workshop and auto
- Includes 52-pc. socket set with extenders • 2 tool pallets with roomy rear storage compartments • Attractive, rugged carry case.



Model
FTK-28
Reg.
\$169.95
Our Price

\$129.95

DUAL TRACE OSCILLOSCOPES

A.W. SPERRY 20 MHz OSCILLOSCOPE

- Built-in component checker • Z-axis input
- Low power consumption • TV Video sync filter • High-sensitivity X-Y mode • Front panel trace rotator • Includes 2 test probes



Model 620C

\$349.95

Our Price

Special Price

HITACHI 35 MHz OSCILLOSCOPE

- 19 calibrated sweeps
- 6" CRT with internal graticule, scale illumination & photographic bezel • Auto focus • X-Y operation
- TV sync separation • Includes 2 probes (10:1 and 1:1)



Model V-355

Reg.
\$899.95
Our Price **\$598.00**

ASK FOR YOUR FREE CATALOG

SCOPE ELECTRONICS

260 Motor Parkway
Hauppauge, New York 11788

TOLL FREE 800-648-2626

(In NY State 800-832-1446 Ext. 242)

TELEPHONE
ORDERS
NOW!



Service & Shipping Charge Schedule Continental U.S.A.

FOR ORDERS	ADD
\$25-50	\$4.50
\$51-100	\$5.50
\$101-200	\$7.00
\$201-300	\$8.00
\$301-400	\$9.00
\$401-500	\$10.00
\$501-750	\$12.50
\$751-1000	\$15.00
\$1,001-1,250	\$17.50
\$1,251-1,500	\$20.00
\$1,501-2,000	\$25.00
\$2,001 and Up	\$30.00