

Radio- Electronics

TV INTERFERENCE:
CAUSES AND CURES

\$1.25 NOV. 1980

Metal detectors—how they differ
Control AC power with your computer
Interfacing hi-fi components

How to build your own robot
Use a PIA for simpler μ P circuits
Tips and tricks for TTL design

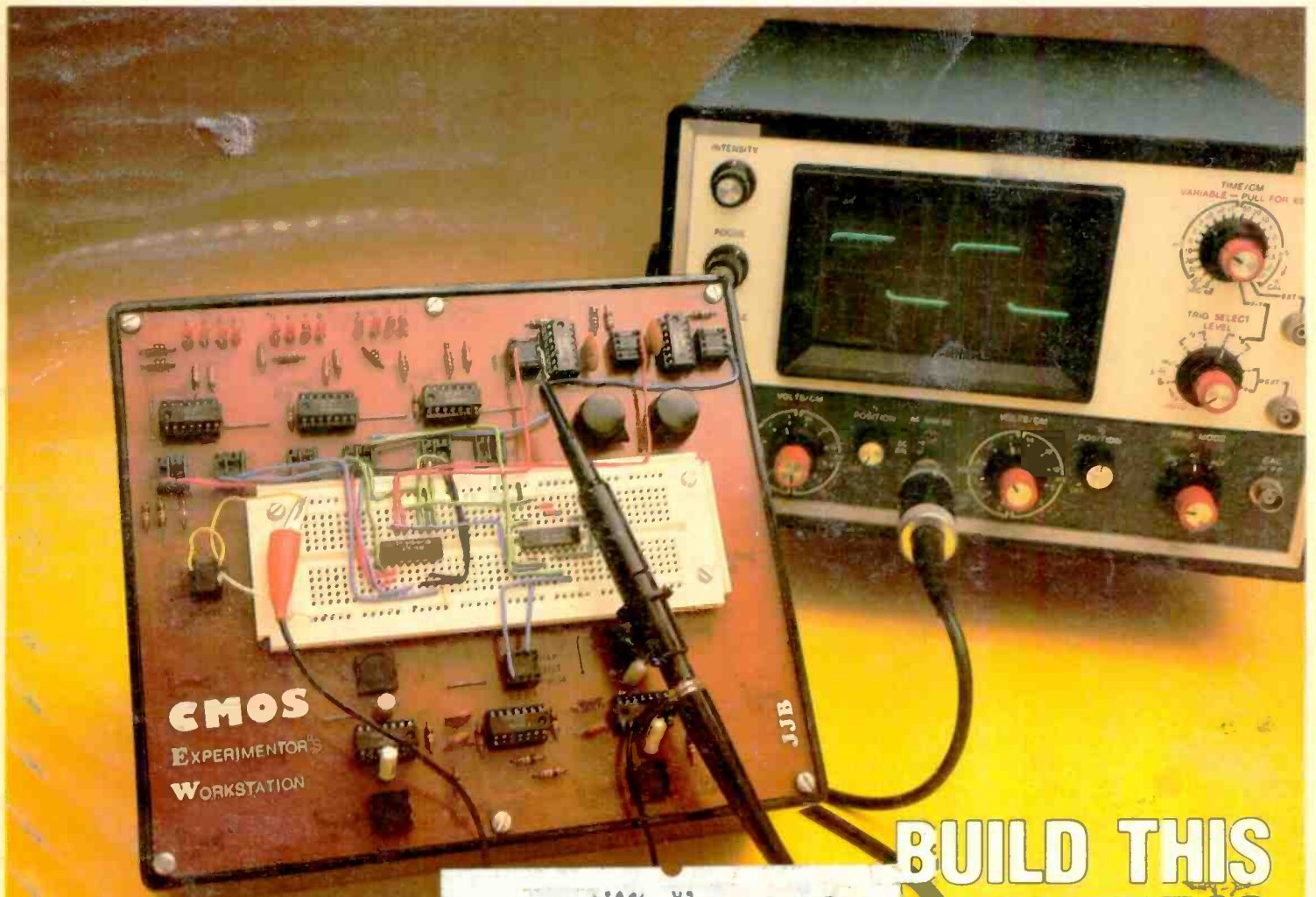

303092 DRK 6450M091 14 A DEC86
LLOYD DARRNELL
6450 MYRTLEWOOD DR
CUPERTINO CA 95014

BUILD THIS
EXPERIMENTER'S
WORKSTATION



We've got it all together.



Xcelite



Lufkin



Boker



Nicholson



Xcelite



Xcelite

**Boker
Crescent
Lufkin
Nicholson
Weller, Wiss
Xcelite**

When you think about tools for a customized tool kit remember these leading brand names from Cooper. They ensure uncompromising quality and years of dependable service.

They are designed to meet your unique service, repair and maintenance needs. So, be sure you specify Cooper Tools when ordering.

And don't forget, customized tool kits containing Cooper Tools are available from a selected group of Cooper distributors. Don't take chances on tools. Ask for Cooper tools or write for the name of the nearest custom kit supplier.



Wiss



Crescent



Weller

from Cooper The Toolmaker. T.M.

CIRCLE 58 ON FREE INFORMATION CARD



The Cooper Group

BOKER® CRESCENT® LUFKIN®
NICHOLSON® PLUMB® WELLER® WISS® XCELITE®
P.O. Box 728, Apex, North Carolina 27502

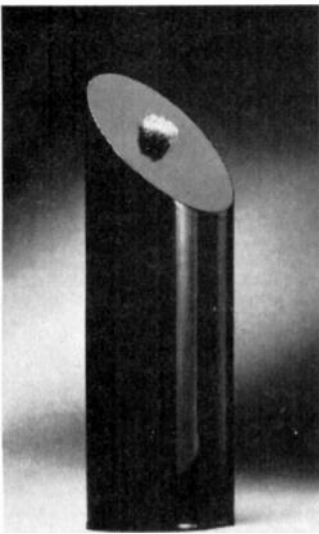

The new Energaire ionized oxygen generator will make a handsome addition to any desk.

Miracle Fuzz

A new space-age invention and the same effect as lightning combine to create the world's first home oxygen regeneration system.

OVER
50,000
SOLD

You need oxygen to live. You can live without food for 60 days, without water for seven days, but without oxygen, you won't make it past two minutes.

That small piece of fuzz located on top of the cylinder shown above emits negatively-charged electrons which attach themselves to molecules of oxygen, thus creating ionized oxygen.

You are already familiar with ionized oxygen if you've smelled the air after a thunderstorm. You feel great, revitalized, and alert. The lightning from the storm adds a small negatively-charged electron to each oxygen molecule in a process called ionization.

SCIENTISTS DISCOVER

Scientists discovered that air quality can actually affect your moods, your feelings and your sense of well being. Air that is positively charged caused people to be depressed, moody and tired. Negatively-charged air made people feel good. We have all experienced air that is positively charged in air-conditioned buildings or in a polluted environment.

Scientists looking for a way to turn positively charged air into negatively charged air developed the negative ion generator—a product that produces negatively charged particles that attach themselves to air molecules and thus create the same fresh feeling you get after a thunderstorm.

The new space-age product shown above is an ionized oxygen generator called the Energaire air purifier. The copper mesh fuzz on top of the unit is one of the secrets of the system.

Although it has no moving parts, you can actually feel a wind of ionized oxygen produced from the fuzz which spreads to fill an average-sized room in one minute.

CIGARETTE SMOKE TEST

To show the dramatic effect of ionized oxygen, you can take the Energaire, blow cigarette smoke into a clear bowl, and hold the bowl inverted over the system. The smoke will vanish. The charged oxygen particles appear to dissolve the smoke particles, precipitating them from the air.

In a room, the Energaire air purifier surrounds you with these oxygen ions and cleans and purifies the air so that even in a smoke-filled room, you will be breathing cleaner, country-fresh air all day long.

WALL TEST

Take our unit and place it next to a wall. Also

put a large piece of paper on the wall. Within a few days notice how black the paper gets. That black film is finite carbon particulate matter—the same pollutants you would normally breathe and that would pass through most air filters. By placing the unit in the center of a room or away from a wall, that same matter falls to the ground as dust.

A trip into the mountains exposes you to nature's freshly ionized oxygen. The Energaire produces this same effect. It will clean your room of odor-causing bacteria and stale, musty, or smoky air.

Ionized oxygen should not be confused with ozone. Ozone has a molecular formula of O_3 , whereas the molecular formula for ionized oxygen is O_2 with a negatively-charged ion.

DON'T BE CONFUSED

After we announced the Energaire last year, many companies came out with their own ion generators. We purchased a unit from each company and tested them at an independent laboratory. The results are shown below:

Name	*Ions	Price
Energaire	438,000	49.95
Omega 700	63,000	245.00
AirCare	72,000	149.95
Modulion	75,000	79.95

*Measurements indicate total number of ions per cubic centimeter per second at one meter. These figures may vary by plus or minus 10%.

Note: One unit not mentioned above produced no ions and actually produced ozone or several times the maximum ozone concentration allowed by federal government standards.

USED IN HOSPITALS

Many hospitals are now using ionized oxygen systems in their operating rooms and burn centers. Their units not only purify the air, but they also eliminate pollen and other irritants.

Working in a clean air environment, you think clearer, are more alert, and you function better. The Energaire is actually a miniature lightning machine. The minute you plug it in, energy is converted into ionized oxygen. This efficient system uses one watt of power or less than a penny per day to operate, so you leave it plugged in continuously.

We are so impressed with the pleasant effect of Energaire that we urge you to personally test it yourself in your home or office. Order one at no obligation. Put it by your desk, or in any room where you spend a great deal of time. See if it doesn't rid your room of odor-causing bacteria and stale, musty or smoky air. Try the smoke and paper tests mentioned in this advertisement.

SLEEP FASTER

At home, use the Energaire by your bed and see how country-fresh air allows you to sleep easier, deeper, and more relaxed.

You should notice the difference within one day—especially in a work environment. But use the Energaire for a full month. Then, if you do not feel totally convinced of the positive effects of ionized oxygen, return your unit for a prompt and courteous refund.

The Energaire is manufactured by the Ion Foundation, a leading ion research and development company.

Service should never be required, but if it is, there's a prompt service-by-mail center as close as your mailbox. JS&A is America's largest single source of space-age products—further assurance that your modest investment is well protected. The Energaire measures 9" high by 3" in diameter and weighs 24 ounces.

To order your Energaire ionized oxygen generator, send \$49.95 plus \$3.00 for postage and handling (Illinois residents, please add 6% sales tax) to the address shown below or credit card buyers may call our toll-free number below. We will send your Energaire ion generator complete with 90-day limited warranty on the electronics, a five-year warranty on the fuzz, and complete instructions.

Let space-age technology revitalize your life with the world's first home ionized oxygen generator. Order one at no obligation today.

NEW LOW PRICE

JS&A PRODUCTS
THAT
THINK®

Dept. RA One JS&A Plaza
Northbrook, Ill. 60062 (312) 564-7000
Call TOLL-FREE 800 323-6400
In Illinois Call (312) 564-7000

© JS&A Group, Inc., 1980

Save on Scanners! NEW Rebates!

Communications Electronics™, the world's largest distributor of radio scanners, celebrates Christmas early with big savings on Bearcat synthesized scanners. Electra Company, the manufacturers of Bearcat brand scanners is offering consumer rebates on their fantastic line of crystalless scanners purchased between September 15 and November 15, 1980.

We give you excellent service because CE distributes more scanners worldwide than anyone else. Our warehouse facilities are equipped to process thousands of scanner orders every week. We also export scanners to over 300 countries and military installations. Most items are in stock for quick shipment. Do your Christmas scanner shopping early and order today from CE!

Bearcat® 300

The Ultimate Synthesized Scanner!
List price \$519.95/CE price \$329.00/\$20.00 rebate
Your final cost is a low \$309.00

4-Band, 50 Channel • Service Search • No-crystal scanner • AM Aircraft and Public Service bands • Priority Channel • AC/DC Bands: 32-50, 118-136 AM, 144-174, 421-512 MHz. The new Bearcat 300 is the most advanced automatic scanning radio that has ever been offered to the public. The Bearcat 300 uses a bright green fluorescent digital display, so it's ideal for mobile applications. The Bearcat 300 now has these added features: Service Search, Display Intensity Control, Hold Search and Resume Search keys, Separate Band keys to permit lock-in/lock-out of any band for more efficient service search.

Bearcat® 250

List price \$419.95/CE price \$259.00/\$20.00 rebate
Your final cost is a low \$239.00

50 Channels • Crystalless • Searches Stores • Recalls • Digital clock • AC/DC Priority Channel • 3-Band • Count Feature. Frequency range 32-50, 146-174, 420-512 MHz. The Bearcat 250 performs any scanning function you could possibly want. With push button ease you can program up to 50 channels for automatic monitoring. Overseas customers should order the Bearcat 250FB at \$349.00 each. This model is like a Bearcat 250, but designed for international operation with 220 V AC/12 V DC power supply and 66-88 MHz low band coverage instead of 32-50 MHz.

Bearcat® 220

List price \$419.95/CE price \$259.00/\$20.00 rebate
Your final cost is a low \$239.00

Aircraft and public service monitor. Frequency range 32-50, 118-136 AM, 144-174, 420-512 MHz. The Bearcat 220 is one scanner which can monitor all public service bands plus the exciting AM aircraft band channels. Up to twenty frequencies may be scanned at the same time. Overseas customers should order the Bearcat 220FB at \$349.00 each. This model is like a Bearcat 220, but designed for international operation with 220 V AC/12 V DC power supply and 66-88 MHz low band coverage instead of 32-50 MHz.

NEW! Bearcat® 210XL

List price \$319.95/CE price \$209.00/\$20.00 rebate
Your final cost is a low \$189.00

18 Channels • 3 Bands • Crystalless • AC/DC Frequency range: 32-50, 144-174, 421-512 MHz. The Bearcat 210XL scanning radio is the second generation scanner that replaces the popular Bearcat 210 and 211. It has almost twice the scanning capacity of the Bearcat 210 with 18 channels plus dual scanning speeds and a bright green fluorescent display.



NEW! 50-Channel Bearcat 300

FREE Bearcat® Rebate Offer

Get a coupon good for a \$20 rebate when you purchase a Bearcat 300, 250, 220 or 210XL. \$10 rebate on models 211, 210 and 160. To get your rebate, mail this coupon with your original dated sales receipt and the Bearcat model number from the carton to Electra. You'll receive your rebate in four to six weeks. Offer valid only on purchases made between September 15, 1980 and November 15, 1980. All requests must be postmarked by November 29, 1980. Limit of one rebate per household. Coupon must accompany all rebate requests and may not be reproduced. Offer good only in the U.S.A. Void where taxed or prohibited by law. Resellers, companies, clubs and organizations—both profit and non-profit—are not eligible for rebates. Employees of Electra Company, their advertising agencies, distributors and retailers of Bearcat Scanners are also not eligible for rebates. Please be sure to send in the correct amount for your scanner. Pay the listed CE price in this ad. Do not deduct the rebate amount since your rebate will be sent directly to you from Electra. Orders received with insufficient payments will not be processed and will be returned.

NEW! Bearcat® 160

List price \$279.95/CE price \$189.00/\$10.00 rebate
Your final cost is a low \$179.00

16 Channels • 3 Bands • AC only • Priority Dual Scan Speeds • Direct Channel Access Frequency range: 32-40, 144-174, 440-512 MHz. The Bearcat 160 presents a new dimension in scanning form and function. The keyboard is smooth. No buttons to punch. No knobs to turn. Instead, finger-tip pads provide control of all scanning operations, including On/Off, Volume and Squelch. Green easy to read fluorescent display.

NEW! Bearcat® 5/800 MHz

The world's first 800 MHz scanner!
This is a new model. Shipments will begin in November, 1980

List price \$179.95/CE price \$129.00
8 Crystal Channels • 4 Bands • AC only Frequency range: 33-50, 144-174, 440-512, 806-870 MHz. The Bearcat 5/800 MHz is the only scanner on the market today that offers coverage of the 800 MHz, public service band and the other public service bands. Individual channel lockout. Scan Delay. Manual Scan.

Bearcat® 5

List price \$129.95/CE price \$94.00
8 Crystal Channels • 3 Bands • AC only

Frequency range: 33-50, 146-174, 450-508 MHz. The Bearcat 5 is a value-packed crystal scanner built for the scanning professional — at a price the first-time buyer can afford. Individual lockout switches.

Bearcat® Four-Six ThinScan™

List price \$179.95/CE price \$114.00
Frequency range: 33-47, 152-164, 450-508 MHz.

The incredible, new Bearcat Four-Six Thin Scan™ is like having an information center in your pocket. This three band, 6 channel crystal controlled scanner has patented Track Tuning on UHF. Scan Delay and Channel Lockout. Measures 2 3/4 x 6 1/4 x 1 1/2". Includes rubber ducky antenna. Order crystals for each channel. Made in Japan.

NEW! Fanon Slimline 6-HLU

List price \$169.95/CE price \$109.00
Low cost 6-channel, 3-band scanner!

The new Fanon Slimline 6-HLU gives you six channels of crystal controlled excitement. Unique Automatic Peak Tuning Circuit adjusts the receiver front end for maximum sensitivity across the entire UHF band. Individual channel lockout switches. Frequency range 30-50, 146-175 and 450-512 MHz. Size 2 3/4 x 6 1/4 x 1 1/2". Includes rubber ducky antenna. Order crystal certificates for each channel. Made in Japan.

NEW! Fanon Slimline 6-HL

List price \$149.95/CE price \$99.00
6-Channel performance at 4-channel cost!

Frequency range: 30-50, 146-175 MHz. If you don't need the UHF band, get this model and save money. Same high performance and features as the model HLU without the UHF band. Order crystal certificates for each channel. Made in Japan.

FANON SCANNER ACCESSORIES

CHB-6 AC Adapter/Battery Charger \$15.00
CAT-6 Carrying case for Fanon w/Belt Clip \$15.00
AUC-3 Auto lighter adapter/Battery Charger \$15.00

OTHER SCANNER ACCESSORIES

SP50 AC Adapter \$12.00
SP51 Battery Charger \$12.00
SP58 Carrying Case for Bearcat 4-6 ThinScan™ \$15.00
FB-E Frequency Directory for Eastern U.S.A. \$15.00
FB-W Frequency Directory for Western U.S.A. \$15.00
FFD Federal Frequency Directory for U.S.A. \$18.00
B-4 1.2 V AAA Ni-Cad's for ThinScan™ and Fanon \$15.00
A-135CC Crystal certificate \$4.00
Add \$3.00 shipping for all accessories ordered at the same time.

INCREASED PERFORMANCE ANTENNAS

If you want the utmost in performance from your scanner, it is essential that you use an external antenna. We have six base and mobile antennas specifically designed for receiving all bands. Order #A60 is a magnet mount mobile antenna. Order #A61 is a gutter clip mobile antenna. Order #A62 is a trunk-clip mobile antenna. Order #A63 is a 3/4 inch hole mount. Order #A64 is a 3/8 inch snap-in mount, and #A70 is an all band base station antenna. All antennas are \$30.00 and \$3.00 for UPS shipping in the continental United States.

TEST ANY SCANNER

Test any scanner purchased from Communications Electronics™ for 31 days before you decide to keep it. If for any reason you are not completely satisfied, return it in original condition with all parts in 31 days, for a prompt refund (less shipping/handling charges and rebate credits).

NEW! Regency® M400

List price \$379.95/CE price \$259.00
30 Channel • Synthesized • Service Search Digital clock • Digital timer • M100 styling Search/Store • Priority Channel • AC/DC Frequency range: 30-50, 144-174, 440-512 MHz. The new Regency M400 is a compact programmable FM monitor receiver for use at home or on the road.

OTHER REGENCY SCANNERS

Touch K100 \$199.00
Touch M100 \$199.00

NEW! Telephone Products

Electra's cordless Freedom Phone does everything an ordinary phone does and more. Because it is cordless, you can take it anywhere, inside or outside—on the patio, by the pool, in the garage, in the workshop...even next door at the neighbor's.

Model FF-500 has pushbutton dialing. Rechargeable ni-cad batteries included. Battery low light. Secure feature. Telescopic antenna. Your cost is \$179.00. Model FF-1500 has the same features as the FF-500 but also includes a charger/cradle that allows the phone's handset to be recharged away from the base station. Your cost for this cordless phone is \$199.00. The model FF-3000 has all the standard features (except charger/cradle) plus interchangeable telescopic and rubber ducky antenna. Redial feature. Belt clip. Carrying case. Greater range. Your cost is \$229.00.

World Scanner Association™

The WORLD SCANNER ASSOCIATION is sponsored as a public service by Communications Electronics™. When you join, you'll receive a one-year membership and our quarterly newsletter with scanner news and features. You'll also get a wallet I.D. card, an Official WSA Membership Certificate, and more. FREE classified ads for members so you can contact other scanner owners when you want to sell or buy a scanner. FREE membership in the WSA Buyer's Co-op. Your Co-op membership will allow you to get special discounts on scanners and scanner related products. Since the WSA Buyer's Co-op gives you group purchasing power, you can easily pay for your membership dues the first time you make a Co-op purchase. To join, send \$12.00 (\$20.00 outside U.S.A.) for your membership materials.

BUY WITH CONFIDENCE

To get the fastest delivery from CE of any scanner, send or phone your order directly to our Scanner Distribution Center™. Be sure to calculate your price using the CE prices in this ad. Michigan residents please add 4% sales tax. Written purchase orders are accepted from approved government agencies and most well rated firms at a 10% surcharge for net 30 billing. All sales are subject to availability. All sales on accessories are final. Prices, terms and specifications are subject to change without notice. Out of stock items will be placed on backorder automatically unless CE is instructed differently. Most products that we sell have a manufacturer's warranty. Free copies of warranties on these products are available prior to purchase by writing to CE. International orders are invited with a \$20.00 surcharge for special handling in addition to shipping charges. All shipments are F.O.B. Ann Arbor, Michigan. No COD's please. Non-certified and foreign checks require five weeks bank clearance.

Mail orders to: Communications Electronics™, Box 1002, Ann Arbor, Michigan 48106 U.S.A. Add \$6.00 per scanner or phone product for U.P.S. ground shipping, or \$12.00 for faster U.P.S. air shipping to some locations. If you have a Master Charge or Visa card, you may call anytime and place a credit card order. Order toll free in the U.S.A. 800-521-4414. If you are outside the U.S. or in Michigan, dial 313-994-4444. Dealer inquiries invited. All order lines at Communications Electronics™ are staffed 24 hours.

WSA™ Scanner Distribution Center™ and CE logos are trademarks of Communications Electronics™. Bearcat and Freedom Phone are federally registered trademarks of Electra Company, a Division of Masco Corporation of Indiana.

‡ Regency is a federally registered trademark of Regency Electronics Inc.

Copyright © 1980 Communications Electronics™



854 Phoenix □ Box 1002 □ Ann Arbor, Michigan 48106 U.S.A.
Call TOLL-FREE (800) 521-4414 or outside U.S.A. (313) 994-4444

We're first with the best.™

Radio- Electronics

THE MAGAZINE FOR NEW
IDEAS IN ELECTRONICS

Electronics publishers since 1908

NOVEMBER 1980 Vol. 51 No. 11

BUILD THIS

- 47 **CIRCUIT DESIGN STATION**
Prototype and debug your circuits using this battery-powered design station. **James Barberello**
- 61 **BUILD YOUR OWN ROBOT**
Part 4. Construction details for the body frame and body rotation mechanism. **James A. Gupton, Jr.**
- 65 **A BYTE OF POWER AC CONTROLLER**
Interface card for your computer lets you independently switch on or off 8 AC power circuits. **L. Steven Cheairs**

TECHNOLOGY

- 4 **LOOKING AHEAD**
Tomorrow's news today. **David Lachenbruch**
- 16 **SATELLITE TV NEWS**
The latest happenings in an exciting new industry. **Gary H. Arlen**
- 52 **METAL DETECTORS**
A look at the different types, the circuitry, and how they differ. **Robert F. Gallagher**
- 98 **STATE OF SOLID STATE**
High-efficiency photovoltaic solar panels. **Karl Savon**

CIRCUIT APPLICATIONS

- 56 **TTL DESIGN: TIPS AND TRICKS**
Tips and tricks you should know the next time you design a circuit using TTL IC's.
- 78 **μ A783 IC AUDIO AMPLIFIER**
Circuit applications for this nifty IC. **Jim Essex**
- 80 **NEW IDEAS**
A winning circuit application from our readers.

VIDEO

- 70 **TV INTERFERENCE**
A look at the various types of TV interference and how to eliminate them. **Jack Darr**
- 101 **SERVICE CLINIC**
A look at several useful hints from our mailbag. **Jack Darr**
- 102 **SERVICE QUESTIONS**
R-E's Service Editor solves technicians' problems.

AUDIO

- 73 **HOW TO INTERFACE SYSTEM COMPONENTS**
If you're the owner of a stereo system using separate components, here's how to put them all together. **Len Feldman**
- 76 **R.E.A.L. SOUND LAB TESTS SHURE M97HE PHONO CARTRIDGE**
This medium/high priced cartridge rates superb.

RADIO

- 90 **COMMUNICATIONS CORNER**
Why pay extra for features and performance we may never use? **Herb Friedman**

COMPUTERS

- 58 **USE A PIA FOR SIMPLER μ P-BASED CIRCUITS**
Your next microprocessor-based project should include a PIA for simpler circuitry. **David R. Anderson**

EQUIPMENT REPORTS

- 26 **Heath IM-2215 Portable DMM**
- 36 **B&K-Precision 820 Digital Capacitance Meter**
- 37 **Bearcat BC-211 Programmable Scanner**
- 38 **Realistic TRC-209 Walkie-Talkie**
- 40 **Daiwa CS-201/CS-401 Coaxial Antenna Switches**
- 44 **Netronics Elf II Microcomputer**

DEPARTMENTS

- | | |
|----------------------------|----------------------------------|
| 6 What's News | 107 Computer Products |
| 14 Editorial | 108 New Lit |
| 22 Letters | 109 Radio Products |
| 86 New Products | 112 Market Center |
| 94 Books | 134 Advertising Index |
| 106 Stereo Products | 135 Free Information Card |

ON THE COVER

The experimenter's circuit design station will make a great addition to your workbench. Use it to prototype and debug your circuits before hardwiring them. The station is battery powered and includes a two-phase clock oscillator, LED status indicators, debounced switches, and a solderless breadboard. Get started building yours today. Construction details start on page 47.

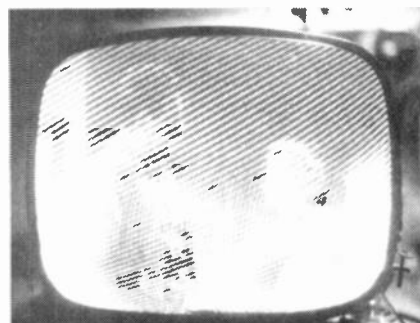

TV INTERFERENCE can be more than just annoying. For a look at the different types and what you can do to eliminate them, turn to page 70.



BUILD YOUR VERY OWN ROBOT with manipulator arms and mobile base. Multi-part construction series continues on page 61.

Radio-Electronics, (ISSN 0033-7862) Published monthly by Gernsback Publications, Inc. 200 Park Avenue South New York NY 10003 Phone 212-777-6400 Controlled Circulation Postage Paid at Concord NH One-year subscription rate USA and US possessions \$13.00 Canada \$16.00 Other countries \$18.00 Single copies \$1.25 c 1980 by Gernsback Publications Inc. All rights reserved. Printed in U S A

Subscription Service: Mail all subscription orders, changes, correspondence and Postmaster Notices of undelivered copies (Form 3579) to Radio-Electronics Subscription Service Box 2520 Boulder CO 80322

A stamped self-addressed envelope must accompany all submitted manuscripts and/or artwork or photographs if their return is desired should they be rejected. We disclaim any responsibility for the loss or damage of manuscripts and/or artwork or photographs while in our possession or otherwise.

As a service to readers, Radio-Electronics publishes available plans or information relating to newsworthy products, techniques and scientific and technological developments. Because of possible variances in the quality and condition of materials and workmanship used by readers, Radio-Electronics disclaims any responsibility for the safe and proper functioning of reader-built projects based upon or from plans or information published in this magazine.

looking ahead

VIDEODISC WINNER?



By at least one way of measuring, the battle for the mass-market videodisc system may be over. In terms of adoption by color-TV brand names, RCA has won hands down, without having sold a single player or disc. At press time, color-TV brands representing 52.5% of color-TV set sales had announced they're adopting RCA's CED (Capacitance Electronic Disc) system, which RCA will sell under the SelectaVision name.

Based on market shares for the 1980 model year as published by the newsletter *Television Digest*, here's how videodisc-system adherents stack up: The RCA CED system has 52.5%—composed of RCA (21% of the color market), Zenith (20.5%), Sears Roebuck (7.5%), Sanyo (2%), J.C. Penney (1.5%). The VHD (Video High Density) system developed by JVC and Matsushita has 14.5%—composed of General Electric (7.5%), the choice is still subject to approval by GE's board of directors at press time, Quasar (5%), Panasonic (2%), JVC (less than 1%). The VLP (Video Long Play) developed by Philips and MCA has 8.6%—composed of Magnavox (7%), Pioneer (not in TV market), Gold Star (less than 1%). Of those color-TV brands still uncommitted at press time, largest were Sony (6.5% of color market), Sylvania (4%), Montgomery Ward (2.25%) and Hitachi (1.7%).

The VLP optical system is already on the market in many areas of the United States, with players by Magnavox and Pioneer. The VHD grooveless capacitance system is scheduled for marketing late in 1981. RCA plans to introduce its system to distributors next month (December 1980), to dealers in February 1981, and to start retail marketing with a nationwide ad campaign in March. The player is scheduled to cost "under \$500;" movie-length discs will cost \$20 to \$25.

Although the RCA system frequently has been unfavorably compared with the other two because its lack of special effects—such as freeze-frame, fast and slow motion, and random access—the production-model player does have a visual search feature that permits rapid scanning of the disc in either direction with a fully synchronized picture on the screen. If both the forward and reverse visual-search push-buttons are depressed simultaneously, a single revolution of the disc is repeated until the buttons are released. In cases of titles and other scenes lacking motion, that gives a stop-action effect, because each revolution consists of four TV frames. RCA says that future deluxe models may have the same special effects as the other systems.

RCA also revealed that its second model, at a "slight increase in cost," will have stereophonic sound capability, and will be introduced in 1982.

A MINI-CASSETTE VCR



On the heels of Sony's demonstration of a single-piece developmental combination camera-VCR using a micro-cassette (R-E, October 1980), Technicolor Audio-Visual has started marketing a compact, seven-pound, portable VCR that uses a cassette only slightly larger than a standard audio cassette. The cassette currently can hold 30 minutes of helically scanned color picture and sound, but Technicolor says it will have a compatible one-hour cassette early next year.

The VCR carries a suggested list price of \$995, the 30-minute cassette \$8.95, about the same as the 3-minute cartridge of super-8 film it is designed to replace. The unit is designed for both the amateur home movie market and the industrial-educational audio-visual field. It can be used with any consumer color or black-and-white video camera. Technicolor is selling a Hitachi-made color camera as a companion to the VCR, but says it plans to introduce a more miniaturized camera in 1981 using a standard pickup tube (not a CCD or other solid-state pickup). Also in the works is a single-piece camera-VCR.

Technicolor says the new VCR isn't intended to compete with the Beta and VHS formats, but with film cameras and projectors. The VCR is made in Japan by Funai Electric, the tape and cassette by Fuji. Although Technicolor hopes to have an exclusive on the VCR for some time, it invited other manufacturers to develop recorders that can use the same cassette. Inside, the VCR looks like a miniaturized VHS recorder. A small rechargeable battery (included in the seven-pound weight) is capable of 40 minutes of recording or 80 minutes of playback; it can be recharged in one hour.

AM STEREO DELAYED

Don't look for AM stereocasting to start any time soon. The best guess now is early 1982 at the soonest, as a result of the bitter controversy that erupted over the FCC's choice of the Magnavox system over four others. After the Commission chose Magnavox, critics were quick to point out that it generated "pops" at 95% negative modulation. Magnavox retorted that the pops are completely eliminated by special circuitry in the IC designed for the system.

Nevertheless, the Commission took note of the brouhaha over its choice by letting its engineering staff go back and refine and improve the decision-making that led to the choice of Magnavox. The decision will be released and the public will be given the opportunity to comment. That could result in the choice of another system, or in reaffirmation of the system originally chosen—but it means more delay. Although FCC staff sources say the delay could be as short as six months, past experience indicates it's more likely to be a year or more before there is AM stereocasting.

DAVID LACHENBRUCH
CONTRIBUTING EDITOR



BUZZ BOX

My wall timers were great for the first year. Then a strange thing happened.

*By Joseph Sugarman, President
JS&A Group, Inc.*

This advertisement is about a few wall timers I installed in my home. I expected them to automatically turn my lights on and off and make my home appear lived-in, even when I wasn't at home.

But I was in for a surprise. The timers started to buzz. Not loudly, at first, but still very noticeably. Then, after a few months, they started buzzing more loudly. And finally a few of them popped out completely.

ABSOLUTELY SILENT

No wonder. The timers I bought were mechanical devices with a motor and moving parts that switched on and off every 24 hours. In time, the parts aged and buzzed as they wore out. Eventually, they went out completely. I called my light timers, "Buzz Boxes" and knew the electronic revolution was not far behind with a silent and more dependable unit that would do a lot more.

Last month Dynascan Corporation contacted me with a new wall timer which they called the "Night Sentry." This one was totally solid state, no moving parts and above all, absolutely silent. But there were a few pleasant surprises.

LIVING PATTERN PROGRAM

The Night Sentry is very easy to program. Just turn a dial to the time (an AM or PM indicator appears) and press a button which turns on the light. Set the time you want the light to go off and press the same button to turn the light off. Keep repeating this process and the Night Sentry will remember the entire program and repeat it for you in silent accuracy year after year after year.

You can also program it in its 'living-pattern' mode. Simply turn your lights on and off throughout a typical day as you normally do. After 24 hours the Night Sentry will remember the exact pattern and your timer will operate your lights just as you yourself did—all automatically.

LONGER BULB LIFE

If by chance you have a power failure, the Night Sentry will keep its memory for at least 5 minutes. Since most power failures are

momentary, you won't have to reprogram it. But if the power failure is longer than five minutes, when the power does come back on, your lights will remain in their off position.

The Night Sentry has a unique feature that in time could actually pay for the unit. Most bulbs burn out because the power surges each time a bulb is turned on. These power surges weaken a bulb. The Night Sentry has a built-in 'soft start' system that eliminates the surge and thus your bulb will last up to three times longer than its normal life. This is a very important feature for outdoor lighting where bulbs are often more difficult to change and seem to always go out in the dead of winter.

BATTLESHIP CONSTRUCTION

When Dynascan Corporation developed the Night Sentry, they decided to go overboard and produce a product that far exceeded standard specifications. For example, the Raytheon Triac used in the system was designed for 220-volt products—not just your

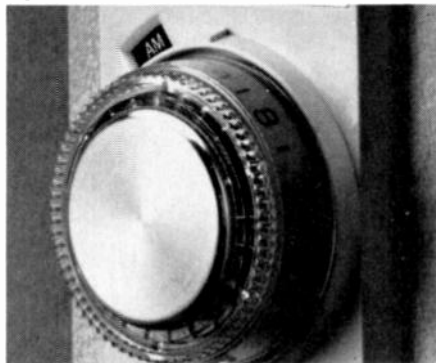

The Night Sentry is almost as small as a typical light switch so you could even install two of them in a double gang wall plate.

standard 110-volt wall switch. There are transient suppressors built to take a voltage surge of up to 2500 volts—in short the Night Sentry was built like a battleship.

Even if you've never installed a light switch in your life, you'd find it a snap to install the Night Sentry. Just turn off the power at your

fuse box, connect two wires by twisting them together and screw the Night Sentry into your old electrical box. Installation takes less than five minutes and you use the same wall plate you had on your switch before.

I have recently replaced all of the timers in my home. I even added a few in places like my bedroom so that all my lights turn on when it's time to get up. I don't need an alarm clock now. My outdoor and indoor lights are now silently and efficiently controlled, and my house looks lived in even when I'm away.

TRY ONE OUT

We urge you to order a Night Sentry for only \$24.95 plus \$2.50 for postage and handling (Illinois residents add 6% sales tax) or order two for \$47 plus \$3.00 postage and handling. Credit card buyers may call our toll-free number below. We'll send you a Night Sentry solid-state timer complete with easy-to-install instructions and a one-year limited warranty. There is also a three-way switch timer for \$5 extra per unit.

Then use the Night Sentry for a month. Program it. See how silently it operates and then order more for the other rooms in your house. If, however, you're not completely satisfied, return your unit within 30 days for a prompt and courteous refund, including your postage and handling.

I can personally recommend the Dynascan Night Sentry timers. I have them throughout my home and my friends have them too. They really add to our security and peace of mind and I urge you to at least order one at no obligation, today.



Dept. RA One JS&A Plaza
Northbrook, Ill. 60062 (312) 564-7000
Call TOLL-FREE 800 323-6400
In Illinois Call (312) 564-7000
© JS&A Group, Inc., 1980

Videodiscs or VCR's?

Most retailers believe, says Massachusetts consulting firm Venture Development Corp, that videocassette recorders (VCR's) and videodisc systems are non-competitive products (like audio tape decks and turntables). Consumers don't agree.

People who do not own video playback equipment tend to prefer VCR's by over three to one. About 20 percent want both kinds of systems. Another fifth have no preference but are sure they wouldn't buy both VCR and disc equipment.

Among owners of VCR equipment the number who would want both systems is higher. About 30 percent of VCR owners would like to have a videodisc system in addition to their present VCR's.

Newest computer

Panasonic is introducing what it describes as a "revolutionary" hand-held computer (HHC) system. It consists of the RL-H1000 hand-held computer plus peripheral devices that include an input/output interface that permits attaching six additional peripherals; an acoustic coupler/telephone modem, a cassette inter-

face, a video RAM interface for hookup to a home TV set, a mini-printer, RAM memory expanders, and ROM memory expanders.

The RL-H1000 has a built-in RAM, which permits the user to store up to 500 characters for use as a portable, electronic memo pad. A self-contained world-time clock shows date, hour, and minute. There is also a programmable timer, with alarm and message function, to work as an electronic secretary.

The HHC is compatible with virtually every computer bank in the world via its telephone modem/acoustic coupler. It is expected to be on the market in late 1980. Price has not yet been finalized.

The electronic newspaper

Predicted by this and other magazines for many decades, the "electronic newspaper" has come into actual being. The *Columbus (OH) Dispatch* began early in July to transmit its entire editorial content to 3,000 home-computer terminals around the country, on a system called CompuServe. Subscribers to the service can select any desired item from a condensed index and display it on their home terminals. Cost of the service is \$5 per hour.

Thirteen other newspapers, ranging from *The New York Times* to *The Middlesex News* of Framingham, MA, expect to be on the CompuServe system within a year.

The Knight-Ridder newspapers are taking a somewhat different approach in an experiment started in Coral Gables, FL. Two hundred personal computers have been installed in homes in the area, at no cost to the families involved. Knight-Ridder is supplying the computers and the Bell System the terminals and the phone lines that link the individual home computers to the system.

Both news and advertising are transmitted, with 31 advertisers participating in the project. Viewers seeing the ads can type orders on their own terminals, and the central computer will relay the orders to the company offering the goods for sale.

News is supplied by the Associated Press, which transmits 60,000 to 100,000 words daily to the project. It is stated that if the Associated Press puts out a bulletin, the Coral Gables viewer may be able to see it on his own screen before he hears it on the radio.

"Clear-channel" abandonment

Up to 125 new AM stations may be able come on the air as a result of the recent FCC decision to abandon the "clear-channel" concept. Many of the new slots will be earmarked for groups that have not been able to get a proportional share of air time up to the present. The same decision, of course, will greatly cut the coverage of the present 25 clear-channel stations, which have been in complete possession of a single frequency, or have shared it with only one or two stations at great distances.

The clear-channel concept was developed in the earliest days of broadcasting, when listening for distance was to many the important reason for owning a radio set. A station that could be heard 2,000 miles away was considered to be performing an important service. (That went so far that in a number of large cities, the broadcast stations shut down for one night a week, so that listeners in the city could hear distance without local blanketing.) With improved broadcast quality and content, dx-ing dropped in popularity and practically disappeared.

The FCC voted to protect the signals of the former 25 clear-channel stations within a radius of 750 miles, thus still giving them greater coverage than other stations.

The Commission stated that, in considering new applicants, it would give preference to organizations at least 50-percent owned by minority groups or non-profit operations, or applicants who would be pioneers, offering the first full-time service to their communities.

continued on page 12



PANASONIC HAND-HELD COMPUTER RL-H1000, shown here in a briefcase combination with cassette interface, acoustic coupler/telephone modem, and mini-printer.

Facts from Fluke on low-cost DMM's

For a measurement like this, every millivolt matters.

In digital multimeters, accuracy and resolution go hand in hand. After all, an extra millivolt of resolution means nothing unless you can trust its accuracy. For critical measurements like checking avionics, calibrating medical systems, or simply verifying the performance of your circuit, it takes a precision DMM to fill the bill.

The new 4½-digit Fluke 8050A delivers 0.03% basic dc accuracy and 0.005% of full scale resolution. Measure ac and dc voltages with 10 µV of sensitivity. Or resolve 10 nA of current and 10 milliohms of resistance. All guaranteed for one full year.

That's the kind of performance you demand in a

bench/portable DMM. And it's from Fluke, the leader in DMM's with a thirty year reputation for reliable, high-quality precision instrumentation.

Of course, there's more to the 8050A story. With our hybrid True RMS converter you get honest, accurate ac answers to 50 kHz without missing any significant distortion components. A dB function features 16 selectable reference impedances. And the relative mode lets you make offset measurements in all instrument functions.

You'll also find all the other dependable Fluke features on the new 8050A. Conductance for those high resistance and leakage measurements to 100,000 Megohms. Extensive overload protection and safety features. A full line of accessories. And a low price of only \$349 U.S.

For all the facts on the new 8050A's accuracy and reliability, call toll free **800-426-0361**; use the coupon below; or contact your Fluke stocking distributor, sales office or representative.



IN THE U.S. AND NON-EUROPEAN COUNTRIES: IN EUROPE: RE-11/80

John Fluke Mfg. Co., Inc.
P.O. Box 43210 MS # 2B
Mountlake Terrace, WA 98043
(206) 774-2481
Telex: 152662

Fluke (Holland) B. V.
P.O. Box 5053, 5004 EB
Tilburg, The Netherlands
(013) 673 973
Telex: 52237

- Please send 8050A specifications.
- Please send all the facts on Fluke low-cost DMM's.
- Please have a salesman call.

Name

Title

Mail Stop

Company

Address

City

State

Zip

Telephone ()

Ext.

For technical data circle no. 72

**NRI training in TV
and Audio Servicing
keeps up with the
state of the art.
Now you can learn to
service video cassette
and disc systems.**

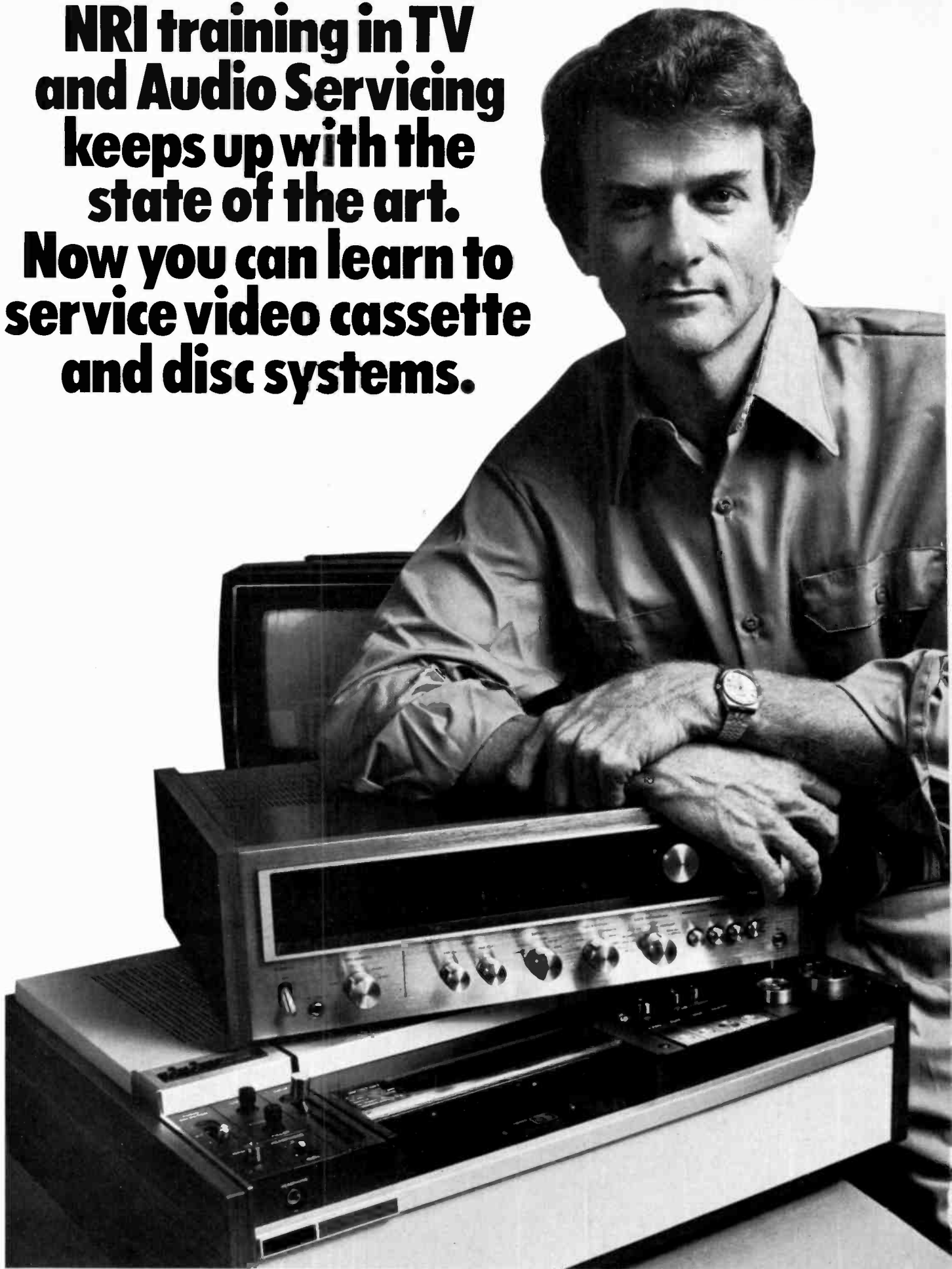



You build color TV, hi-fi, professional instruments

Now, in addition to learning color TV and audio systems servicing, you get state-of-the-art lessons in maintaining and repairing video cassette recorders, and the amazing new video disc players, both mechanical and laser-beam types.

Learn at Home in Your Spare Time

And you learn right at home, at your own convenience, without quitting your job or going to night school. NRI "bite-size" lessons make learning easier...NRI "hands-on" training gives you practical bench experience as you progress. You not only get theory, you actually build and test electronic circuits, a complete audio system, even a color TV.

Build Color TV with Computer Programming

As part of your training in NRI's Master Course in TV/Audio/Video Systems Servicing, you actually assemble and keep NRI's exclusive designed-for-learning 25"

Learn at home at your convenience

(diagonal) color TV. It's the only one that comes complete with built-in computer tuning that lets you program an entire evening's entertainment. As you build it, you introduce and correct electronic faults, study circuit operation, get practical bench experience that gives you extra confidence.

You also construct a solid-state stereo tuner and amplifier complete with speakers. You even assemble professional-grade test instruments so you know what makes them tick, too. Then you use them in your course, keep them for actual TV and audio servicing work.

NRI Includes the Instruments You Need

You start by building a transistorized volt-ohm meter which you use for basic training in electronic theory. Then you assemble a digital CMOS frequency counter for use with lessons in analog and digital circuitry; FM principles. You also get an integrated circuit TV pattern generator, and an advanced design solid-state 5" triggered-sweep oscilloscope. Use them for learning, then use them for earning.

NRI Training Works... Choice of the Pros

More than 60 years and a million students later, NRI is still first choice in home study schools. A national survey of successful TV repairmen shows that more than half have had home study training, and among them, it's NRI 3 to 1 over any other school.

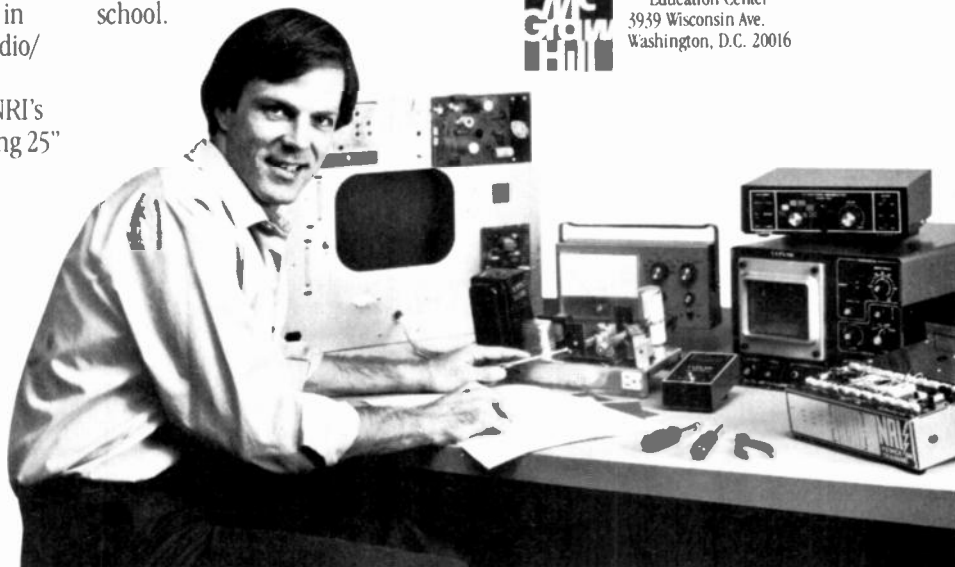

(Summary of survey on request.)

That's because you can't beat the training and you can't beat the value! For hundreds of dollars less than competing schools, NRI gives you *both* color TV and audio...



Other NRI training includes Computer Technology, Complete Communications Electronics

and now includes training in video cassette and disc systems. Send for our free catalog and see for yourself why NRI works for you.

Free Catalog... No Salesman Will Call

Send today for our free 100-page catalog which shows all the kits and equipment, complete lesson plans, and convenient time payment plans for courses to fit your needs and budget. Or explore the opportunities in other NRI home study courses like Microcomputers & Microprocessors, CB and Mobile Radio, Aircraft and Marine Radio or Complete Communications. Send the postage-paid card today and get a head start on the state of the art. If card has been removed, write to:



NRI Schools
McGraw-Hill Continuing
Education Center
3939 Wisconsin Ave.
Washington, D.C. 20016

continued from page 6

Electronic credit card

The electronic credit card, long familiar to science fiction readers, has now been developed in the real world, and is in actual use in some Italian pay telephones. Working with the Italian telephone company SIP (Società Italiana per l'Esercizio Telefonico), SGS-ATES of Waltham, MA, has brought out a new and unique low-cost XCARD. This new card uses a non-volatile memory technology.



THE ELECTRONIC CREDIT CARD, as designed for pay telephone use. The instructions on the face of the "card" show how to use it and tell the user to remove the tab before trying to insert it.

The XCARD consists of a 17×8 bit memory in a credit-card style package. The consumer buys a card with memory cells representing 100 credit units (the other 36 bits are for security, control, and testing). The credit cells are blank. When inserted in the payphone or other vending device, the vending terminal writes into some of the memory cells, to the extent of the customer's purchase. When the cells are all written into, the credit is exhausted and the card is thrown away.

Misuse is prevented by a security code in the memory. Resale of used cards as new is prevented by a plastic tab, which must be removed to insert the card in the phone.

Designed for pay telephones, the XCARD can be as useful for other applications, highway toll booths for example.

Fuel control system for jets

Tests of the Delco Flight Management System on Pan American planes showed a fuel efficiency improvement of 1.5 percent

on 10 Boeing 747's. While the improvement is not startling statistically, it translates to an annual saving of 7.5 million gallons of aviation fuel on Pan American's fleet, or a saving of 5.5 million dollars.

The flight management system minimizes fuel consumption by closed-loop control of aircraft pitch and thrust, adjusting the throttle and pitch control for conditions of flight—climb, cruising, and descent, and taking into account the altitude, the aircraft's continually changing weight, the outside temperature and other factors. With the help of Motorola LSI circuitry, the whole system is compressed into four "black boxes," weighing a total of 28 pounds.

Computer crime

"Computer crimes have to date been shoe-horned into existing, but inadequate, laws dealing with crimes ranging from mail and wire fraud to obscene phone calls," states Philip R. Manuel, former chief investigator of the U.S. Permanent Subcommittee on Investigation, and now an investigative consultant in the area of white-collar crime.

Urging the adoption of the Federal Computer Systems Protection Act (S-240), introduced by Senator Abraham Ribicoff in 1977, and again in January 1979, Manuel said, "In spite of its rhetoric concerning the severity of white-collar crime, Congress has refused to take action on S-240, thereby helping to perpetuate the theft of perhaps a billion dollars annually."

The Ribicoff bill, he said, "... clearly defines computer crimes as computer crimes and affords a large measure of protection to the computer systems of the Federal Government, financial institutions, and all businesses that operate in interstate commerce. It further envisions protection for sophisticated electronic fund transfer systems whose vulnerability to computer fraud is enormous."

Home, personal electronics

According to a research report recently issued by Venture Development Corp of Wellesley, MA, home and personal electronics will by no means stand still in this sluggish industrial period. Instead, the value of U.S. home and personal electronic products will increase by almost 20 percent annually through 1982.

The factory value of home electronic products will more than double, from \$336.8 million in 1978 to \$764.1 million in 1982. Personal electronics—\$1,261.6 million in 1978—will reach \$2,421 million in 1982. Products most heavily dependent on microelectronics will show the strongest growth, the researchers believe.

Personal electronics—as defined in the

report—includes calculators, electronic watches and personal computers. Greatest growth is expected in computers—49.5 percent annually.

Home security equipment has been grouped with more conventional home electronics for the growth figures quoted. Production of intrusion detectors is expected to increase by 71.4 percent annually through 1982.

Columbia tries new record

CBS Records has recently placed on the market a "new" disc—a 10-inch, 33 $\frac{1}{2}$ rpm mini-album that will retail for about \$3 instead of the \$6 to \$9 of standard albums. Each Nu-Disk, as it is called, will carry two songs on each side, rather than the five or six songs of "standard" albums.

An important reason for the new record is the great slump in demand for standard albums. CBS Records reported earnings for 1979 only a little over half those for 1978. Part of the slump, says the East Coast director of artists and repertory for Epic Records (one of the Columbia group) is that too many albums were trying to get by on one good cut, padded with rubbish. The new record will be directed to the customer who wants more for his money.

The first Nu-Disks consist of releases by Cheap Trick, leading British band, and three other British groups: the Continentals, New Musik, and Propaganda.

Belgian videotext

The Antiope videotext system, which enables TV viewers to dial up news, weather information, sports results, stock and market prices, and other services on their TV sets, is being used by RTBF, the Belgian radio-TV system, in an experiment beginning in November. Antiope will supply the system for the service, and Belgians will supply the material to be transmitted.

The new service is being broadcast to the French-speaking population of Belgium from a transmitter in the city of Liege.

In France, home of Antiope, teletext terminals have been installed at numbers of gas stations, to inform motorists of weather and road conditions. Each terminal is attended by a hostess, who uses a small key pad to dial up information requested by drivers. The information then appears on the screen almost immediately, for the motorists' perusal while their cars are being serviced.

The Antiope system is being tested in the United States, under the sponsorship of the French company's subsidiary, Antiope Videotext Systems, of Washington, DC. Several stations, including KMOX-TV, St. Louis, and KNXT-TV and KCET-TV in Los Angeles, have tested or have already begun experimental Antiope broadcasts. R-E

Very sharp printout at very low payout

\$595*

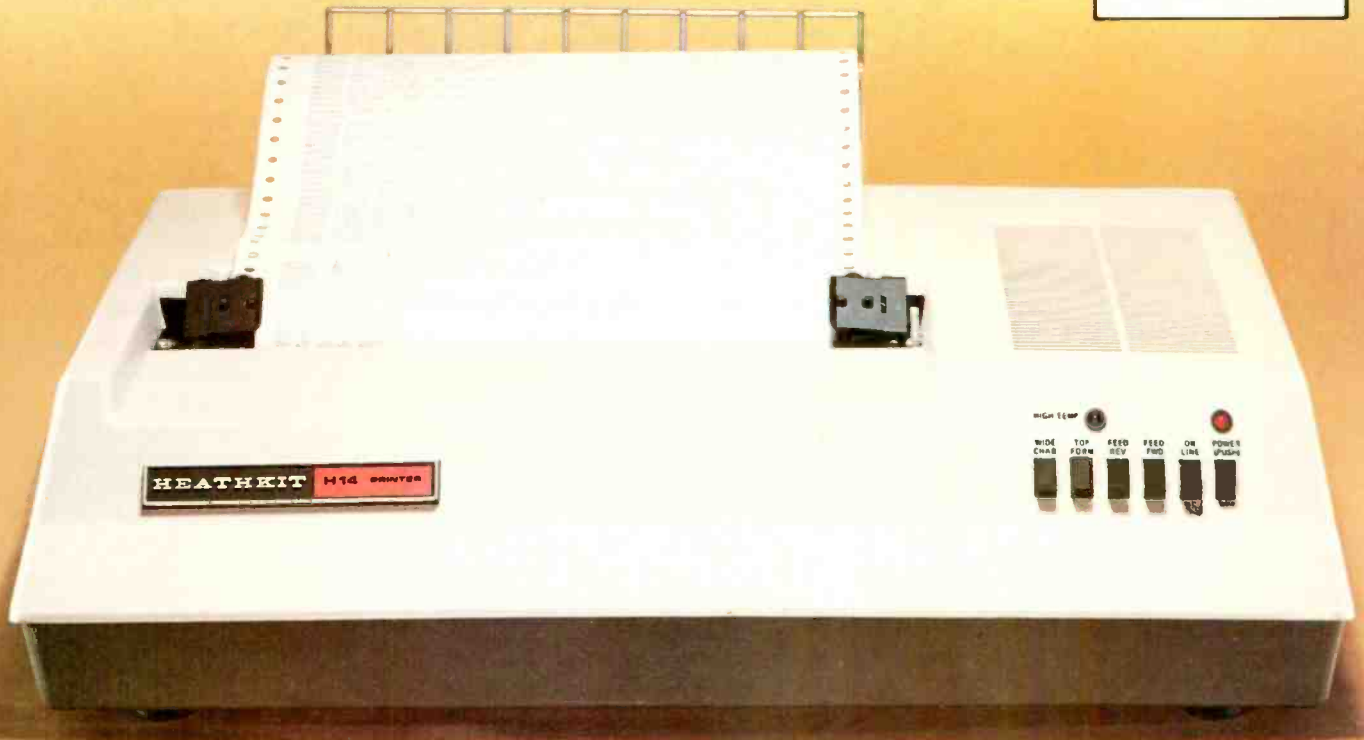

The Heath H-14 Printer gives you high-performance features at one of the lowest prices anywhere...

- 5 x 7 dot matrix and high quality impact printhead give you clear, easy-to-read images
- Standard 96-character ASCII set, UPPER and lower case
- Operator or software-selectable line widths; 132, 96, or 80 characters
- Compatibility with any computer having RS-232C or 20 mA current loop serial interface, with handshaking
- Sprocket paper feed, with adjustable spacing, to keep paper moving smoothly
- Sustainable print speed approximately 30 characters per second
- "Paper jammed" and "paper out" signals to prevent loss of data
- Selectable baud rates from 110 to 4800
- Convenience of standard fan-fold paper, 2.5 to 9.5 inches wide
- Chrome wire rack to keep paper neat

Visit your Heathkit Service Center

H-14 Printers are on display at the 61 Heathkit Electronic Centers throughout the U.S. and Canada. See your telephone white pages for the location nearest you.

In the U.S. Heathkit Electronic Centers are units of Veritechnology Electronics Corporation.

*In kit form, FOB Benton Harbor, MI. Also available completely assembled at \$895.00, FOB Benton Harbor. Prices subject to change without notice.

CIRCLE 25 ON FREE INFORMATION CARD

The H-14's remarkable price includes connecting cables, paper rack, paper, and ribbon — so you're all ready to run. And service for the H-14 is available at 61 Heathkit Electronic Centers in the U.S. or Canada.

Check out the microprocessor-based H-14 Printer today, in kit form or factory assembled. You'll find complete details in the newest, FREE Heathkit Catalog. Send for yours today, or pick one up at the nearest Heathkit Electronic Center. Dealer inquiries on assembled units are invited, too.

Complete service, so you're never left out in the cold

Heath[®]
Computer Systems

**Send for
FREE Catalog**

Write to: Heath Company,
Dept. 020-714
Benton Harbor, MI 49022



New Life for CB

There are many occasions during the course of our lives when we sit up, take notice of an ingenious idea, and say "Why didn't I think of that?" That's how this month's editorial was born. I wish I could take the credit for the idea behind this month's editorial, but that credit belongs to Mr. Earl Heider of Salem, Oregon. Mr. Heider forwarded me a copy of a letter he sent to the Governor of the State of Oregon. In that letter, Mr. Heider outlines a plan to put CB radio to better use. I agree with that plan.

The fourth anniversary of 40-channel CB radio is right around the corner. Four years ago, CB was growing rapidly. In response, the FCC expanded the service from 23 channels to 40 channels. Then, consumers stopped buying 23-channel radios in anticipation of the coming 40-channel units. Unfortunately, that occurred at the same time that CB manufacturers were churning out 23-channel units at an incredible rate building up an inventory in an attempt to get ahead of the incredible consumer demand. Twenty-three channel CB radios were everywhere; in retail stores, warehouses—and there were many, many thousands in the Japan-to-U.S. pipeline. Manufacturers found themselves in a sea of 23-channel units and they wound up taking a bath. Prices were lowered to incredibly low levels in an attempt to sell off the 23-channel stockpiles. One by one, CB manufacturers became extinct. CB radio has never been the same.

Unfortunately, throughout all this, 40 channels were never really necessary. In fact, even the 23-channel spectrum was never fully used. Sure there was overcrowding and the fight for airtime resembled something of a brawl. But the active channels will always be the same few. Channel 19 is likely to remain the most popular mobile channel, no matter how many additional channels are added. The net result is a few overcrowded channels and many blank ones.

Now for Mr. Heider's idea. Why not put one of those unused channels to good use. Let's install a series of transmitters along the major highways to transmit road and traffic conditions. Those transmitters would be tied into the central traffic office in each locality. In addition, other unused channels could be used to broadcast such topics as health information, educational material, energy saving ideas, etc. The only potential problem is the possible effect of skip reception on such a system. West Germany has a similar system already in operation. That system is experimental and uses FM broadcast frequencies.

Mr. Heider's proposal is for the State of Oregon. I feel that part of the funding for that should be provided by the Federal Department of Transportation and instituted on a nationwide scale. There are many, many CB radios still in service. Let's put them to better use. That will benefit not only the public but it might just revitalize the CB industry.



ART KLEIMAN
Managing Editor

Radio- Electronics®

Hugo Gernsback (1884-1967) founder
M. Harvey Gernsback, editor-in-chief
Larry Steckler, CET, publisher
Arthur Kleiman, managing editor
Josef Bernard, K2HUF, technical editor
Jack Darr, CET service editor
Leonard Feldman
contributing high-fidelity editor
Karl Savon, semiconductor editor
Herb Freidman, communications editor
Gary H. Arlen, contributing editor
David Lachenbruch, contributing editor
Earl "Doc" Savage, K4SDS, hobby editor
Ruby Yee, production manager
Robert A. W. Lowndes, production
associate
Marie J. Stolfi, production assistant
Gabriele Margules, circulation director
Arline R. Fishman,
advertising coordinator

Cover photo by Robert Lewis

Radio-Electronics is indexed in *Applied Science & Technology Index* and *Readers Guide to Periodical Literature*.

Gernsback Publications, Inc.
200 Park Ave. S., New York, NY 10003
President: M. Harvey Gernsback
Vice President: Larry Steckler
Secretary/Treasurer: Carol A. Gernsback

ADVERTISING SALES 212-777-6400

Larry Steckler
Publisher

EAST

Stanley Levitan
Radio-Electronics
200 Park Ave. South
New York, NY 10003
212-777-6400

MIDWEST/Texas/Arkansas/Okla.

Ralph Bergen
The Ralph Bergen Co.
540 Frontage Road—Suite 361-A
Northfield, Illinois 60093
312-446-1444

PACIFIC COAST

Mountain States

Jay Eisenberg
J.E. Publishers Representative Co.,
8732 Sunset Blvd.,
4th Floor,
Los Angeles, CA 90069
213-659-3810
San Francisco, CA 94124
415-864-3252

SOUTHEAST

Paul McGinnis
Paul McGinnis Company
60 East 42nd Street
New York, N.Y. 10017
212-490-1021



ADVANCE IS PROUD TO INTRODUCE



**Non-Linear Systems, Inc. NEW TOUCH TEST 20 D M M
A PORTABLE LAB IN ITSELF**

The remarkable Touch Test 20 DMM. With the Touch Test 20, Non-Linear Systems introduces the 2 lb. 4 oz. test lab. Now, with 20 key test functions at your fingertips (plus the ability to measure 10 electrical parameters and 44 ranges), you can take one lab to the field instead of a cumbersome collection of individual testers.

Another bright idea. The Touch Test 20 is the only DMM with light pressure touch function selection. No more dials to fiddle with. Instead, an LED shows the function you choose. And when you switch, you get an audible bleep and visual blip to let you know.

This small wonder is miniaturization at its best. The new Touch Test 20 is the most innovative portable/bench-type multimeter in the industry today.

Or, you can choose from Non-Linear Systems' eight other

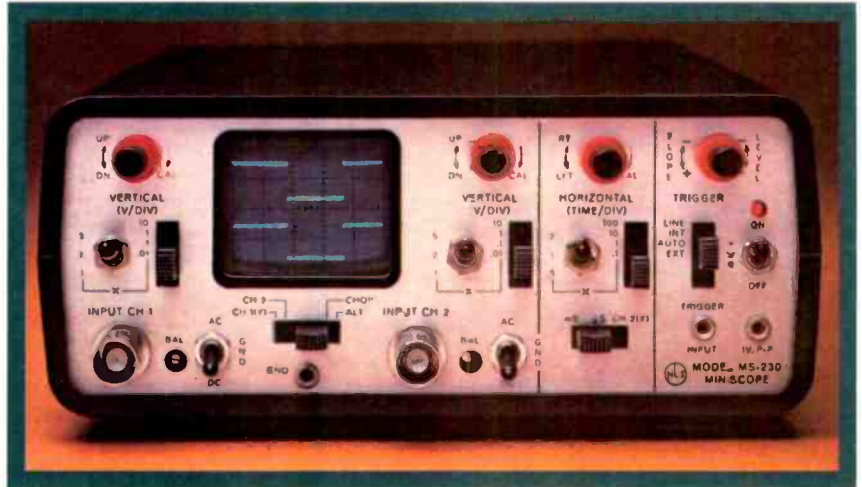

At 3 lbs. 10 oz., the MS-230 is the lightest miniscope around. Now you can take the scope to the problem. Or bring the problem to the scope.

MS-230. A whale of a miniscope.

With our ingenious, new MS-230, 30-megahertz, battery-operated, dual-trace miniscope, portability's suddenly not a problem anymore. At 3 lbs. 10 oz., it's the smallest, lightest miniscope in the field today.

The state-of-the art MS-230 works wonders on site or in the shop. Anywhere there's a need to accurately test or measure electronics equipment.

The versatile MS-230 is perfect for TV repairmen. Services microcomputer systems when the chips are down. Maintains avionics equipment with flying colors. And diagnoses sophisticated medical equipment with the precision of a surgeon.

However, if your budget or needs demand something more economical or less sophisticated, chances are the MS-215 dual-trace or MS-15 single-trace will fit the bill.

The new Touch Test 20 D M M features:

- *Built in temperature measurement (including probe; F° and C°)
- *Capacitance measurement
- *DC Voltage (200 MV—1000V)
- *AC Voltage (200 MV—1000V)
- *DC Current (200 μA—10A)
- *AC current (200 μA—10A)
- *Resistance (200 Ω—20MΩ)
- *Diode Test

**Call For
Special Introductory
Price Offer**

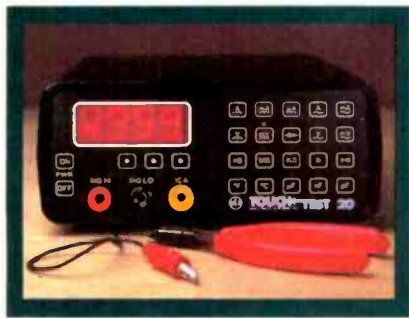

Remarkably light and versatile, the Touch Test 20 DMM is perfect in-shop or on-site.

sophisticated DMMs. And rest assured that you'll be getting the kind of performance and value-packed instrument we've been making for nearly thirty years.



Non-Linear Systems, Inc.
Specialists in the science of staying ahead.



THE TEST EQUIPMENT SPECIALISTS

**TOLL FREE HOT LINE
800-223-0474**

54 WEST 45th STREET, NEW YORK, N.Y. 10036 212-687-2224



**ADVANCE
ELECTRONICS**

MORE NEW HARDWARE



The scramble to come out with more variations on satellite signal receivers was evident during the recent Satellite Users Conference in Denver. At least two new multi-satellite antennas were introduced, along with a new range of equipment from various manufacturers.

Satelco (5540 West Pico Blvd., Los Angeles, CA 90019), the company that has pioneered several low-cost satellite terminal devices, unveiled a new spherical antenna that can pick up five or six birds simultaneously. The \$2,500, five-meter unit includes several LNA mounts, although you have to move the LNA for various satellites, or else buy several LNA's dedicated to each bird. Satelco is also working on a remote-controlled receive package tied in to a home computer, which includes a program for steering the antenna directly to the bird you want to see. That computer-package will cost about \$10,000.

Vidiark Electronics Development (P.O. Box 57, Salem, AR 72576) is now offering an "8-ball" antenna kit, priced at \$750. The 12-foot spherical dish is built with redwood strips that support an aluminum screen reflector surface.

Standard Communications (Box 92151, Los Angeles, CA 90009), a veteran manufacturer of two-way radio equipment, made its entry into the satellite reception market with a new receiver/converter unit capable of picking up 24 channels. Avcom (10139 Apache Rd., Richmond, VA 23235) brought out the latest addition to its line of LNA's, the COM-3 plus a remote-control version.

In other recent equipment developments, Avantek (3175 Bowers Avenue, Santa Clara, CA 95051) introduced a \$795 earth-terminal preamplifier that can handle the 3.7 to 7.2 GHz band, with a 120°K guaranteed maximum noise temperature and 50-dB typical gain.

On the other side of the coin, however, there was a new push to develop signal-scrambling devices. At the Denver conference, Westinghouse Electric unveiled equipment which scrambles every line of video and independently scrambles audio. Oak Systems also showed its satellite-scrambling devices again, a follow-up to last spring's demonstration during the National Cable TV Association convention.

SATELLITE BUSINESS CONFERENCE

The first Satellite Business Opportunities Conference will be held in Houston November 17-19; it is an outgrowth of the Satellite Private Terminal Seminars which Bob Cooper has been running for several years. The Houston meeting will concentrate on new business areas created by the boom of low-cost satellite technologies. In addition to covering topics in retailing and distributing home terminals, the sessions will deal with cost-sharing program packages, non-video transmissions and low-cost transmit terminals. Information is available from Cooper, PO Box G, Arcadia, Oklahoma 73007.

Two other major trade shows which are taking an increasing satellite posture are also coming up. The Western Cable Show, a trade convention sponsored by the California Community TV Association, will be held December 10-13 at the Disneyland Hotel in Anaheim, and the Consumer Electronics Show is slated for January 8-11 in Las Vegas.

AROUND THE SATELLITE CIRCUIT

Comsat's plans to launch a direct-to-home satellite broadcasting service loom ever closer. The official presentation of the plan is expected to be submitted to the FCC this fall (it was announced in August 1979, but no formal request has ever been made to the FCC, which would have to license the project). Comsat has hired a major ad agency's programming consultant staff to develop an agenda of the type of shows which would be carried on the service. In addition, Comsat is negotiating with the Corporation for Public Broadcasting to come up with ideas for cultural programs which can be incorporated into the program package. Comsat's efforts in this area are now handled by a separate subsidiary called Satellite Television Corp.

NASA confirms that it plans to launch the first Space Shuttle in March 1981; there has been speculation that the launch would be pushed back again because of a recent fire in the Shuttle engine during a test. Early Shuttles will carry communications satellites aloft.

The first Torus multiple satellite antenna will be installed at a new cable-TV system in Anchorage. The 10-meter Torus antenna is capable of picking up signals for several satellites at once; it was developed by Comsat and will be built by Comtech Antenna Corp.

Western Union Broadcast Services has published a booklet about its audio program services, including Single Channel Per Carrier and combined satellite terrestrial facilities. The free brochure can be obtained by writing to WU Telegraph Co., One Lake Street, Upper Saddle River, NJ 07458.

GARY H. ARLEN
CONTRIBUTING EDITOR

EASY DOES IT!



EZ 6200
\$100

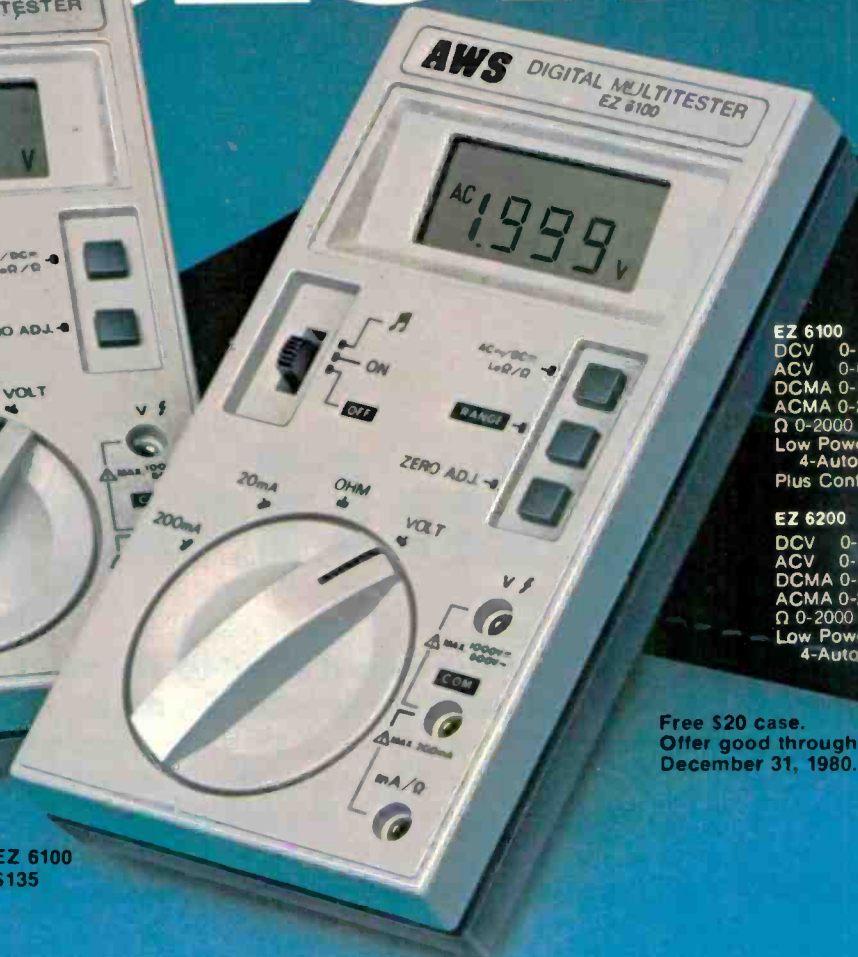

EZ 6100
\$135

EZ 6100
DCV 0-1000 5-Autoranges
ACV 0-600 4-Autoranges
DCMA 0-200 2-Ranges
ACMA 0-200 2-Ranges
 Ω 0-2000 K Ω 5-Autoranges
Low Power Ω 0-2000K
4-Autoranges
Plus Continuity Buzzer

EZ 6200
DCV 0-1000 5-Autoranges
ACV 0-600 4-Autoranges
DCMA 0-200 1-Range
ACMA 0-200 1-Range
 Ω 0-2000 K Ω 5-Autoranges
Low Power Ω 0-2000K
4-Autoranges

Free \$20 case.
Offer good through
December 31, 1980.

A.W. SPERRY'S NEW EASY-METER™ EASY TO USE. EASY TO READ. EASY TO BUY. WITH A 5-YEAR REST-EASY WARRANTY.

"Easy does it" says it all! A. W. Sperry's new Easy-Meters take the misunderstanding out of meter reading. Simply set the function switch, for example AC volts, and Easy-Meter gives you four autoranges up to 600 VAC. A large, easy-to-read LCD digital readout displays both the precise reading and function.

Best of all, Easy-Meters have easy prices with features found only in more expensive DMMs. As a special bonus, buy before December 31,

1980, and we'll send you a FREE \$20 Ever-Ready case. And don't overlook our unprecedented 5-Year Warranty which tells you how dependable and tough we know Easy-Meters will be on the job.

To make your trouble-shooting easier, more accurate, and more dependable, switch to Easy-Meter today. See your A.W. Sperry distributor or contact A.W. Sperry Instruments Inc., 245 Marcus Boulevard, Hauppauge, New York 11787, 516-231-7050.

A.W. SPERRY INSTRUMENTS INC.
The Measurable Advantage.

CIRCLE 76 ON FREE INFORMATION CARD

At CIE, you get electronics career training from specialists.

If you're interested in learning how to fix air conditioning, service cars or install heating systems – talk to some other school. But if you're serious about electronics...even earning an Associate Degree... come to CIE – The Electronics Specialists.

John E. Cunningham

**Special Projects Director
Cleveland Institute of Electronics**



My father always told me that there were certain advantages to putting all your eggs in one basket. "John," he said, "learn to do one important thing better than anyone else, and you'll always be in demand."

I believe he was right. Today is the age of specialization. And I think that's a very good thing.

Consider doctors. You wouldn't expect your family doctor to perform open heart surgery or your dentist to set a broken bone, either. Would you?

For these things, you'd want a specialist. And you'd trust him. Because you'd know if he weren't any good, he'd be out of business.

Why trust your education and career future to anything less than a specialist?

You shouldn't. And you certainly don't have to.

FACT: CIE is the largest independent home study school in the world that specializes exclusively in electronics.

We have to be good at it because we put all our eggs in one basket: electronics. If we hadn't done a good job, we'd have closed our doors long ago.

Specialists aren't for everyone.

I'll tell it to you straight. If you think electronics would make a nice hobby, check with other schools.

But if you think you have the cool—and want the training it takes—to make sure that a sound blackout during a prime time TV show will be corrected in seconds—then answer this ad. You'll probably find CIE has a course that's just right for you!

At CIE, we combine theory and practice. You learn the best of both.

Learning electronics is a lot more than memorizing a laundry list of facts about circuits and transistors. Electronics is interesting because it's based on some fairly recent scientific discoveries. It's built on ideas. So, look for a program that starts with ideas—and builds on them.

That's what happens with CIE's Auto-Programmed® Lessons. Each lesson uses world-famous "programmed learning" methods to teach you important principles. You explore them, master them completely... before you start to apply them!

But beyond theory, some of our courses come fully equipped with the electronics gear to actually let you perform hundreds of checking, testing and analyzing projects.

In fact, depending on the course you take, you'll do most of the basic things professionals do every day—even use a Digital Learning Laboratory to apply the digital theory essential today to keep pace with electronics in the eighties.

Plus there's a professional quality oscilloscope you build and use to "see" and "read" the characteristic waveform patterns of electronic equipment.

You work with experienced specialists.

When you send us a completed lesson, you can be sure it will be reviewed and graded by a trained electronics instructor, backed by a team of technical specialists. If you need specialized help, you get it fast... in writing from the faculty specialists best qualified to handle your question.

People who have known us a long time, think of us as the "FCC License School."

We don't mind. We have a fine record of preparing people to take... and pass... the government-administered FCC License exams. In fact, in continuing surveys nearly 4 out of 5 of our graduates who take

the exams get their Licenses. You may already know that an FCC License is needed for some careers in electronics—and it can be a valuable credential anytime.

Associate Degree

Now, CIE offers an Associate in Applied Science Degree in Electronics Engineering Technology. In fact, all or most of every CIE Career Course is directly creditable towards the Associate Degree.

Find out more! Mail this card for your FREE CATALOG today!

If the card is gone, cut out and mail the coupon.

I'll send you a copy of CIE's FREE school catalog, along with a complete package of independent home study information.

For your convenience, I'll try to arrange for a CIE representative to contact you to answer any questions you may have.

Remember, if you are serious about learning electronics... or building upon your present skills, your best bet is to go with the electronics specialists—CIE. Mail the card or coupon today or write CIE (and mention the name and date of this magazine), 1776 East 17th Street, Cleveland, Ohio 44114.

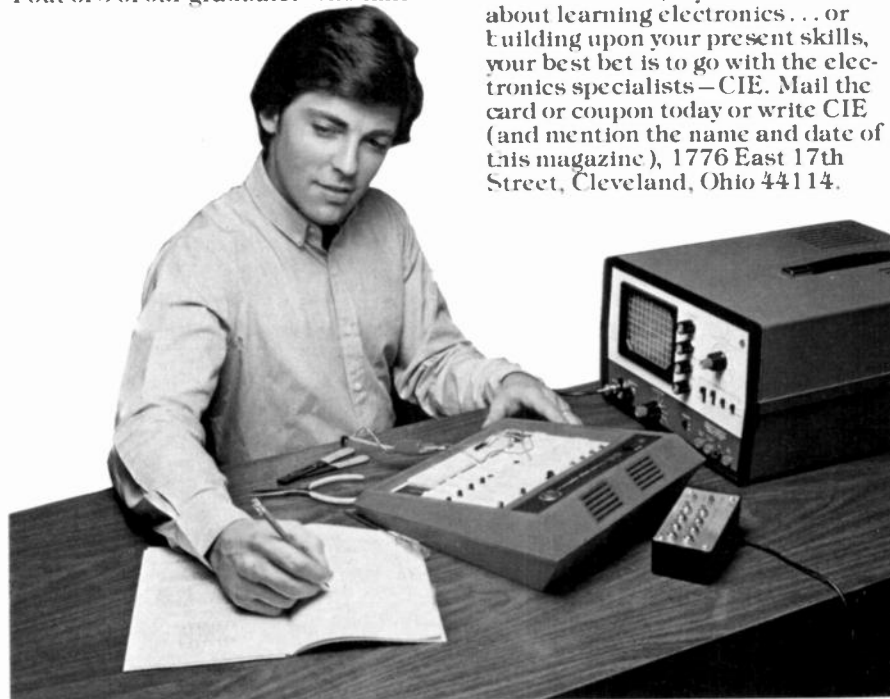

Pattern shown on oscilloscope screen is simulated.

CIE **Cleveland Institute of Electronics, Inc.**

1776 East 17th Street, Cleveland, Ohio 44114

Accredited Member National Home Study Council

YES... John, I want to learn from the specialists in electronics—CIE. Send me my FREE CIE school catalog—including details about the Associate Degree program—plus my FREE package of home study information.

Print Name _____

Address _____ Apt. _____

City _____

State _____ Zip _____

Age _____ Phone (area code) _____

Check box for G. I. Bill information: Veteran Active Duty

Mail today!

RE-83

letters

NUMBERS STATIONS

I was intrigued by your article on numbers stations in the June issue. I logged some offbeat DX myself on a backpacking trip into the Sierras. Our party was at Lake Wiremuca (Tahoe-Yosemite trail) and I was using a coax-fed long-wire dipole strung through the pine trees and into my Yaesu FRG-7.

Around 1 PM the second day I got bored and began flipping the dial. The 20-meter hams were at it, as were the 40's. But at 6700 or so kHz, I picked up a noise that I recognized. I've heard it often, yet this time there was an SSB signal under it.

So I tweaked, poked, and prodded my radio into an intelligible signal. I began to hear air-to-ground communications on bombing missions and targetting, kill ratios, etc. Well, the U.S. Army was nearby in Nevada (right over the mountain or so) and I was logging drills. Interesting, to say the least.

Eventually, I went home, but that experience put me onto listening for jamming sounds, then waiting to pull down what I could. That led to various weird communi-

cations, skipping from Hawaii and Florida on the state of the Coast Guard and the Cubans (respectively). Perhaps I should update my logs and do an article on such DX. I've heard some pretty weird and cloak-and-dagger stuff (most isn't from the military, by the way).

I just wonder what other insomniacs have heard, merely by chance—which seems to be how I've done it.

TODD
address unknown

POPULAR WORKSHOPS

A series of popular workshops is being offered by Virginia Tech, and will be held on the Tech campus in Blacksburg, Virginia. The programs will be directed by Dr. Paul Field, Dr. Chris Titus, Dr. Jon Titus, Mr. Andy Staugaard, and Mr. David Larsen.

The subject matter and dates of the four workshops are:

1. Digital Electronics for Automation and Instrumentation: December 8, 9, and 10, 1980.
2. Microcomputer Interfacing Programming and Application using the Z80/8085/

8080: December 11, 12, and 13, 1980.

3. TRS-80 Radio Shack Microcomputer Interfacing and Programming for Scientific Instrumentation: December 15, 16, and 17, 1980.

4. Motorola Single Chip Interfacing and Programming Using the 6801, 6809, and 6800: December 18, 19, and 20, 1980.

All workshops are hands-on with the participant designing and testing concepts with actual hardware. For more information, write or call Dr. Linda Leffel, C.E.C., Virginia Tech, Blacksburg, VA 24061. (703-961-5241).

DAVID G. LARSEN
Blacksburg, VA.

E = MC²

Mr. M. A. Alvarado II's letter "The Radar Detector" in the May 80 issue requires further comment. If the wavefront simply arrives at the detector earlier or later, depending on the closing velocity of the source, what keeps changing the wavelength after the wavefront arrives?

If scientists are in hot debate about the
continued on page 24

HICKOK
the value innovator



Model 333
Model 331

DMM + Vari-Pitch + Logi-Trax = MX-333 World's Fastest Troubleshooter

- 0.1% Basic Accuracy
- LCD Display In Unique Wide View Case
- Uses Single 9V Battery
- Compact Size. Rugged Construction
- Overload Protection
- Exclusive VARI-PITCH Audible Output (MX333)
- Fast LOGI-TRAK Logic Function (MX333)
- 20Ω Range (MX333)

... plus these popular sellers in stock and available for immediate delivery.



Compact Video Generator

- Video output for VTR, CCTV and monitor applications
- Adjustable RF channel 2-4
- 11 rock stable patterns • 10 step gray scale staircase • 3 bar and 10 bar gated rainbows
- Adjustable chroma levels (0-150%)
- Crystal controlled chroma and timing oscillators for stability from 20 to 125'
- Rugged high impact thermoplastic case and protective cover.

Model 240



Pocket Semiconductor Analyzer

- Automatic, hands-off operation — frees both hands for troubleshooting
- Instant GOOD-BAD analysis — including LEAKAGE — of NPN's, PNP's, FET's, diodes & SCR's: in or out-of-circuit.
- Rugged, all solid state — no moving parts.
- Compact polypropylene case.
- Will not damage transistors, diodes, or circuits under test.
- Powered by 2 std. 9 V batteries (not inc.)

Model 216



LCD Digital Multimeter

- Automatic polarity, zero and overrange indication
- Easy-to-read 1.2" high LCD display
- 2 year battery life in typical use
- 12 oz. including 9V battery
- Withstands 4 ft. drop without loss of accuracy
- Automatic decimal point, built in low battery indicator diode and transistor testing capability (LX304 only)

LX 304 LX 303

Order with Confidence and get the Fordham Advantage!

Call for our prices **TOLL FREE**
(800) 645-9518
in N.Y. State call (516) 752-0050

FORDHAM

855 Conklin St. Farmingdale, N.Y. 11735



- Master Charge
- BankAmericard
- VISA • COD
- Money Order
- Check
- COD's extra



Digital IC Probe & Logic Pulser

PRB-1 DIGITAL LOGIC PROBE

Compatible with DTL, TTL CMOS, MOS and Microprocessors using a 4 to 15V power supply. Thresholds automatically programmed. Automatic resetting memory. No adjustment required. Visual indication of logic levels, using LED's to show high, low, bad level or open circuit logic and pulses. Highly sophisticated, shirt pocket portable (protective tip cap and removable coil cord).

- Automatic threshold resetting • DE to > 50 MHZ
- Compatible with all logic families 4-15 VDC • 10Nsec. pulse response
- Supply O.V.P. to ± 70 VDC • 120 K Ω impedance
- No switches/no calibration • Automatic pulse stretching to 50 Msec.
- Open circuit detection • Automatic resetting memory
- Range extended to 15-25 VDC with optional PA-1 adapter

PLS-1 LOGIC PULSER

The PLS-1 logic pulser will superimpose a dynamic pulse train (20 pps) or a single pulse onto the circuit node under test. There is no need to unsolder pins or cut printed-circuit traces even when these nodes are being clamped by digital outputs.

PLS-1 is a multi-mode, high current pulse generator packaged in a hand-held shirt pocket portable instrument. It can source or sink sufficient current to force saturated output transistors in digital circuits into the opposite logic state. Signal injection is by means of a pushbutton switch near the probe tip. When the button is depressed, a single high-going or low-going pulse of 2 μ sec wide is delivered to the circuit node under test. Pulse polarity is automatic: high nodes are pulsed low and low nodes are pulsed high. Holding the button down delivers a series of pulses of 20 pps to the circuit under test.

- High input impedance (off state) 1 meg ohm • Multi mode single pulses or pulse trains
- Low output impedance (active state) 2 ohms • Automatic polarity sensing
- Output pulse width 2 μ sec nominal • Automatic current limiting; 7 arps nominal
- Input over voltage protection +50 volts • Automatically programmed output level
- Finger tip push button actuated • Circuit powered
- Power lead reversal protection • No adjustments required

Multi-family RTL, DTL, TTL, CMOS, MOS and Microprocessors.

PRB 1	DIGITAL LOGIC PROBE	\$36.95	PA 1	HIGH VOLTAGE ADAPTER	\$8.50
PC 1	POWER CORD, Alligator Clips	\$4.95	PT 2	REPLACEMENT PROBE TIP (2)	\$1.50
PC 2	POWER CORD, Micro Hooks	\$9.95	PLS 1	LOGIC PULSER	\$48.95

OK Machine & Tool Corporation

3455 Conner St., Bronx, N.Y. 10475 U.S.A.

Tel. (212) 994-6600 Telex 125091

* Minimum billings \$25.00, add shipping charge \$2.00
New York State residents add applicable tax



THIN SOLAR

12/24-Hour Quartz Alarm Chronograph

Now with fashionably thin styling, long-lasting solar power, 12- or 24-hour selection, alarm and full chronograph.

- Featuring:
- Famous Quartz Accuracy to ± 5 Seconds a Month
 - Built-in Electronic Calendar
 - Night Light for Evening Viewing
 - Constant LCD Display
 - Day of the Week Indicator
 - Easily Adjusted "Snap" Type Bracelet

Thinnest Solar Alarm Chronograph Available at This Low Price!

\$44.88

Solar Power is now combined with remarkably thin styling and famous quartz accuracy in our best selling 12/24-Hour Alarm Chronograph. A combination that Seiko and Citizen can't match, even at \$200 more!

See the value you get for only \$44.88

- **24-Hour Alarm** — Pleasant, but effective, alarm can be preset for any minute of day or night. Constantly read indicator lets you know when it's set.
- **12/24-Hour Selection** — You get conventional 12-hour time or 24-hour military time at the touch of buttons. Switch back and forth as often as you choose. Or, leave it on 12- or 24-hour time for as long as you want. A must for pilots, military personnel or anyone who needs the option of 12 or 24 hour time.
- **Powerful Solar Recharger** — Fully recharges itself even in artificial light. Power that's guaranteed for three full years with life expectancy of many more. No more troublesome battery charges!
- **Full 12-Hour Chronograph** — With 1/10 second precision, add time and lap time. Add time lets you time everything from a telephone call to a trip — up to 12 full hours. Lap time lets you time each component within an event. Ideal for production managers, coaches, sports fans, anyone with a critical time dependent activity.

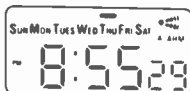

- **Continuously Shows:**
- Hours, Minutes and Seconds
- Day of Week Flag
- AM/PM Notation in 12-Hour Mode

- **Quartz Accuracy** — to ± 5 seconds a month

- **Month, Day and Date** — at the push of a button.



Shown September 18 Tuesday

COMPARE THINNESS!

Thinnest Solar Alarm Chronograph available at this low price

Brand	Price	Thickness
Seiko	\$250	10.5 mm
Citizen	\$255	11.0 mm
Texas Instruments	\$125	12.0 mm
Thin Solar	\$44.88	9.5 mm

- **Handsome Styling** — Crafted, quality stainless steel back and bracelet. Optional goldtone model now available with 3 micron quality gold plating at \$49.88.
- **15-Day No-Risk Trial** — Try it for 15 days, if you're not completely satisfied with its quality and features, return it to us for a prompt refund of your purchase price. In addition, there's a full One-Year Manufacturer's Warranty against defective parts and workmanship.
- **Easy To Order**. Just call our toll free number below, or fill in the convenient order form. Order yours today!

MEDIA MARKETING, INC.

10155-9 Plano Road, Dallas, TX 75238

- Yes! Please send me _____ Thin Solar 12/24-Hour Quartz Alarm Chronograph(s), with 15-Day No-Risk Return Privilege, at \$44.88 each, plus \$2.50 postage and handling. Texas residents add 5% sales tax.
- Silvertone Goldtone \$49.88

Name _____

Address _____

City _____

State _____ Zip _____

Check or money order enclosed

For even faster service, charge to

Master Charge Visa Expires _____

Account # _____

Signature _____

ORDER TOLL FREE 1-800-527-7066
In Texas Call 1-214-349-3120

©MMI - 1980

RE 110

CIRCLE 57 ON FREE INFORMATION CARD

LETTERS

continued from page 22

possibility of electromagnetic energy moving at a speed greater than light why don't they ask about electric and magnetic fields separately? After all it is very easy to divert a magnetic field alternately between a longer and a shorter magnetic path. Then if $E=mc^2$ and c varies we can get energy by changing c instead of m with fission or fusion. Since c is a squared term, that method would be far more efficient than fission or fusion and there would be no detrimental radiation.

JOHN W. ECKLIN
Alexandria, VA

OOOOPS

In our October issue, readers saw a reference to "Figure 2" on page 116 (Communications Corner), and a few lines below were asked to turn to page 122. Alas, Fig. 2 was inadvertently mislaid when we made up page 122. Here is the missing figure.

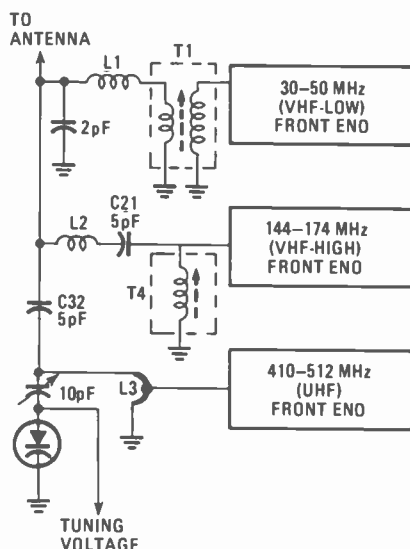

In our October issue, Figure 19 on page 93, in the story "Unicorn Robot," is shown without dimensions. Here is the correct Fig. 19.

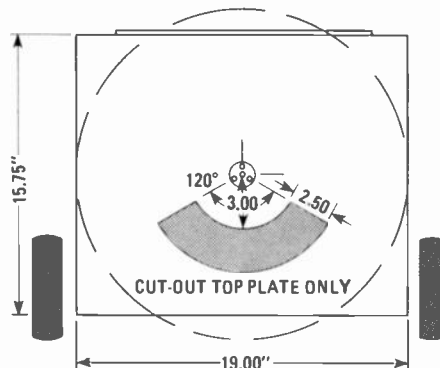
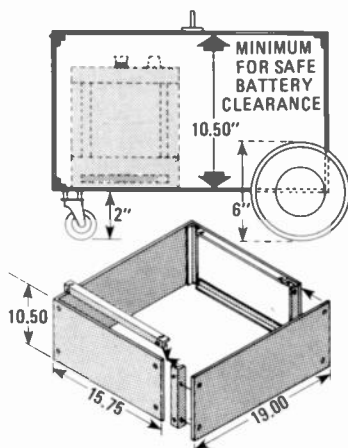

ALL DIMENSIONS IN INCHES

CABLE TV

Congratulations on your editorial in the August issue, in which you remind us that the same logic that caused the FCC to require access to sales and service on telephone equipment and independent interconnect companies should also apply to cable TV.

Since day one, the National Association of Television and Electronic Servicers of America (NATESA) has been in the forefront of actions to assure that independent electronics' technicians have earned the right to install sets on cable-TV systems. Thus far, to assure that right has required that each franchise had to be treated separately. Advance technology now indicates that cable TV may move ahead much faster; thus, the need for a uniform ruling on the rights of independent servicers is clearly in order.

We shall therefore renew our plea to the FCC for a decision regarding our rights without delay.

Again, congratulations.
FRANK J. MOCH
Executive Director, NATESA
Chicago, IL

MORE ABOUT ETCHANT DISPOSAL

Robert K. Deunk's scathing attack on one of my PC etchant disposal methods was totally unwarranted (Letters, May 1980 issue.). He predicted grave consequences if sodium carbonate is added directly to the expended etchant, which he calls a "strong" acid. If Deunk had done his homework he would have realized that fresh, undiluted ferric chloride etchant contains less than 6% acid (HCl), a relatively weak solution in chemical terms.

A six percent solution of HCl is hazardous to the eyes and skin but is far too weak to cause the predicted violent reaction even if a large amount of sodium carbonate were added *en masse* to pure etchant. The recommended procedure of diluting the expended etchant with water and adding the sodium carbonate *slowly* is to control foaming, not because of an overheating problem. The method is both safe and convenient.

L. SCOTT HOFER
Federal Way, WA

R-E

Problem:
Build an oscilloscope light enough to carry in the field, yet sophisticated enough to use in the repair shop. And bring it in at under \$600.

Solution:
Non-Linear Systems' MS-230. A 3 lb. 10 oz. miniscope.

at \$465.45. Or the MS-15, 15 MHz, single-trace at \$349.80.

And each model is available with optional accessories to help you get the job done. Like a 10:1, 10 megohm probe and leather carrying case with shoulder strap and belt loop.

When it comes to portable, affordable, accurate miniscopes Non-Linear Systems leads the way.

MS-230 at a glance

Vertical Bandwidth:	30 MHz
Deflection Factor:	10 mV/div to 50 V/div, 12 calibrated ranges
Input Impedance:	1 megohm in parallel with 50 pF
Time Base:	0.05 μ Sec/div to 0.2 Sec/div, 21 calibrated ranges
Horizontal Bandwidth:	200 kHz
Trigger Modes:	Automatic, Internal, External and Line
Power Sources:	
Internal:	Rechargeable lead acid batteries
External:	115 VAC or 230 VAC, 50-60 Hz via plug-in transformer
Size:	2.9" H x 6.4" W x 8.6" D (74 mm x 163 mm x 218 mm)
Weight:	3 lbs. 10 oz. (1.65 Kg)

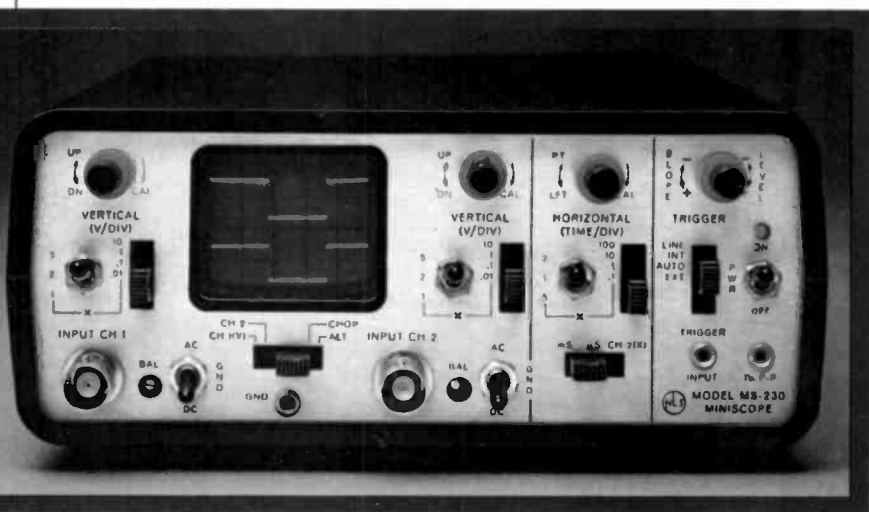

At 3 lbs. 10 oz., the MS-230 is the lightest miniscope around. Now you can take the scope to the problem. Or bring the problem to the scope.

It's easy to get carried away with the MS-230. Our remarkable, new 30-megahertz, battery-operated, dual-trace miniscope. At 3 lbs. 10 oz., it's the smallest, lightest miniscope in the field today. Suddenly, portability's not a problem anymore.



On a benchtop or a belt, over a shoulder or in a tool kit, the MS-230's ready to go.

Sets up shop. Makes housecalls. The state-of-the-art MS-230 is at home anywhere there's a need to accurately test or measure electronics equipment.

TV repairmen find it works

wonders in the field. Tuck it in the tool kit, sling it over a shoulder or slip it on a belt, and it's ready to make a quick on-site diagnosis.

It's a great benchmate in the shop, too. Checks distortion, compares circuit inputs and outputs, finds faulty components. All with equal ease. And the MS-230 is so compact it doesn't clutter up the work area.

What's more, the versatile MS-230 is perfect for servicing microcomputer systems, maintaining avionics equipment and diagnosing sophisticated medical equipment.

A trio to pick from. If your work demands an oscilloscope that handles virtually all normal applications with unblinking accuracy, we've got your number. The MS-230. A superb value at \$598.15.

We also make miniscopes to match other budgets and needs. Take the MS-215, for example. It's a 15 MHz, dual-trace scope priced

Get the word on us. Non-Linear Systems has been intelligently innovating in the digital testing industry for nearly three decades. From the introduction of the first digital voltmeter to breakthrough products like the MS-230.

To get the whole story, from product facts to philosophy, write for our free 1980 Catalog today. Non-Linear Systems, Inc., Box N, Del Mar, California 92014. Telephone (714) 755-1134, TWX 910-322-1132.



Non-Linear Systems, Inc.

Specialists in the science of staying ahead.

© 1980 Non-Linear Systems, Inc.

003

Non-Linear Systems, Inc.
 Box N, Del Mar, California 92014

Please send me your free 1980 Catalog.

Name _____

Company _____

Phone _____

Address _____

City _____

State _____ Zip _____

CIRCLE 48 ON FREE INFORMATION CARD

Heath Co. Model IM-2215 Portable Digital Multimeter



CIRCLE 50 ON FREE INFORMATION CARD

THE MODEL IM-2215 3 1/2-DIGIT LCD HAND-HELD digital multimeter is Heath's latest entry into

the DMM arena. The operating controls are mounted along the side of the case, in a design that has been popularized by many manufacturers recently. The IM-2215 is available only in kit form.

Our test sample, however, was received factory assembled and we therefore cannot comment on how difficult it would be to assemble. Since it was pre-wired, the calibration was also done at the factory. There are built-in references for use in the calibration of the multimeter. However, if you have access to lab-grade equipment for the calibration procedure, you can improve the accuracy of the IM-2215. According to the specifications provided, that difference is quite small and in most cases can be ignored. For instance, using laboratory standards it is possible to attain an accuracy of $\pm .25\%$ of reading + 1 count. Using Heath's built-in references it is possible to set your meter to an accuracy of $\pm .35\%$ of reading + 1 count. Those settings are for the DC voltage ranges but the same basic variation is carried throughout the specifications. In practice, there are few times when more accuracy is needed than what can be found in the Heath IM-2215.

All readings are displayed on a large-sized LCD (Liquid Crystal Display) which can be easily seen from at least 10 to 12 feet away. The digits are approximately 1/2-inch in height and about 1/4-inch wide. The use of LCD read-outs allows long battery life, especially important for field work. Speaking of battery life, typically a carbon-zinc battery can be expected to provide 100-150 hours of operation, while an alkaline unit will provide in the neighborhood of 200 hours. In either case, there is a LO BAT indication displayed on the LCD when 80% of the battery life has been consumed. That warning will mean that there should be at least 20 hours of operation still possible with the present battery. Of course, it will depend upon the type installed so that is a minimum amount of operating time.

Heath has provided built-in safeguards to prevent damage to the IM-2215 when the input is subjected to overloads. Those protective devices will prevent damage within certain specified limits. The limits are listed as 1000 volts DC, 750 volts AC on all voltage ranges of the DMM. To that guy who always decides to check voltages while the meter is still set up to

continued on page 32

Reaching is Easier than Searching NEW! FROM KEYSTONE SPACER STANDOFF ORGANIZER

The following Organizer Kits are available from stock!

 1/4" O.D. Round (Threaded) Standoff
Brass Nickel Plated
Assortment of 1500 pcs.
in 1/2", 3/4", 1", 1 1/2" and 1" lengths.
With thread sizes of 4-40, 6-32 and 8-32.
100 pcs. of each size complete with cabinet
KIT NO. STR-15 \$140.00

 1/4" O.D. Round (Clear) Spacer
Brass Nickel Plated
Assortment of 1500 pcs.
in 1/2", 3/4", 1", 1 1/2" and 1" lengths.
With clearance holes for #4, #6 and #8
100 pcs. of each size complete with cabinet
KIT NO. SPR-13 \$110.00

 1/4" HEX (Threaded) Standoff
Brass Cadmium Plated
Assortment of 1500 pcs.
in 1/2", 3/4", 1", 1 1/2" and 1" lengths.
With thread sizes of 4-40, 6-32 and 8-32
100 pcs. of each size complete with cabinet
KIT NO. STH-14 \$145.00

 1/4" HEX Male/Female Standoffs
Brass Nickel Plated
Assortment of 750 pcs.
in 1/2", 3/4", 1", 1 1/2", and 1 1/2" lengths.
With thread sizes of 4-40, 6-32 and 8-32
50 pcs. of each size complete with cabinet.
KIT NO. STH-19 \$150.00

 1/4" O.D. Round (Threaded) Standoff
Aluminum Iridite Finish
Assortment of 1500 pcs.
in 1/2", 3/4", 1", 1 1/2" and 1" lengths.
With Thread sizes of 4-40, 6-32 and 8-32.
100 pcs. of each size complete with cabinet
KIT NO. STR-35 \$140.00

 1/4" O.D. Round (Clear) Spacers
Aluminum Iridite Finish
Assortment of 1500 pcs.
in 1/2", 3/4", 1", 1 1/2" and 1" lengths.
With clearance holes for #4, #6, and #8
100 pcs. of each size complete with cabinet
KIT NO. SPR-34 \$110.00

 1/4" HEX (Threaded) Standoff
Aluminum Iridite Finish
Assortment of 1500 pcs.
in 1/2", 3/4", 1", 1 1/2", and 1" lengths.
With thread sizes of 4-40, 6-32 and 8-32
100 pcs. of each size complete with cabinet
KIT NO. STH-22 \$145.00

 1/4" Round (Clear) Spacer
Nylon 6/6
Assortment of 1500 pcs.
in 1/2", 3/4", 1", 1 1/2", and 1" lengths.
With clearance holes for #4, #6 and #8.
100 pcs. of each size complete with cabinet.
KIT NO. SPR-8 \$70.00



Ideal for Engineering Labs, R&D Facilities, Workshops and Repair Shops. Avail yourself of all the practical sizes & types of spacers and standoffs and maintain a neat complete inventory of the most frequently used parts in your day-to-day operations. Your choice of "8" different kits of the most popular spacers and standoffs. An assortment of various sizes and styles in Brass, Aluminum and Nylon with tapped or thru-hole. Metal cabinet is designed to be stacked upon one another or can be wall mounted. Clear plastic drawers are labeled for easy identification.

 **KEYSTONE**
ELECTRONICS CORP

49 BLEECKER ST., NEW YORK, N.Y. 10012 (212) 475-4600
CABLE-KEYELCO NYK TWX: 710-581-2861

CIRCLE 45 ON FREE INFORMATION CARD

Non-Linear Systems introduces the 2 lb. 4 oz. test lab.



The new Touch Test 20 DMM weighs only 2 lbs. 4 oz. Yet it puts twenty key test functions at your fingertips. Plus exclusive light pressure touch function selection. Shown from above on leather shoulder sling (optional).

Introducing the remarkable Touch Test 20. Now, with its 20 key test functions at your fingertips, (plus the ability to measure 10 electrical parameters and 44 ranges) you can take one lab to the field instead of a cumbersome collection of individual testers.

Another bright idea. The Touch Test 20 is the only DMM with light pressure touch function selection. No more dials to fiddle with. Instead, an LED shows the function you choose. And when you switch, you get an audible bleep and a visual blip to let you know.

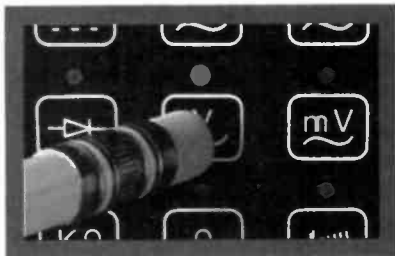

Operation's a snap. A light touch chooses the function. An LED shows it.

Functional. Not gimmicky. We believe that in DMM design, form should follow function. For example, it's rare that a DMM is used hand-held. Usually it's placed so the operator's hands are free to manipulate the test leads and the equipment being tested. That's why we developed the Touch Test 20 — to fit where and how it would be used. The result is the

most innovative portable/bench-type multimeter in the industry today.

Small wonder. The Touch Test 20 is designed specifically for mainline electronics measurement and testing. It checks AC and DC voltage, AC and DC current as well as resistance. Analyzes temperature in Celsius and Fahrenheit. Measures conductance and capacitance. It also performs diode/transistor and continuity tests. All with the accuracy that's synonymous with the name Non-Linear Systems.

Shop-proven. Field-proven. The Touch Test 20 is ideal for benchtop use. The large, 0.55-inch LED numbers make it easy to read. And its dial-free, light touch selection system prevents the unit from skittering across the tabletop. Light and versatile, it's the perfect, portable road lab, too.

The Touch Test 20 comes with test leads, temperature probe and resistor/capacitor test adapter. It features automatic polarity and overload indication plus in-circuit test capabilities. The Touch Test 20 is available in two models — rechargeable battery or line operated. All parts and labor are guaranteed for a full year. And each model is available with optional accessories like a leather carrying case with shoulder strap and belt loop, to help you get the job done.

Touch Test 20 at a glance

Measurements

AC Voltage	10 μ V to 750 VRMS, 6 ranges.
DC Voltage	10 μ V to 1000 VDC, 6 ranges.
AC Current	10 μ A to 10 A, 4 ranges.
DC Current	0.01 μ A to 10 A, 7 ranges.
Resistance	10 milli Ω to 20 meg Ω , 7 ranges.
Temperature	-40°C to 150°C, -40°F to 302°F, 2 ranges.
Conductance	0.01 nS to 200 nS (equivalent to 5 megohms to 100,000 megohms) 2 ranges.
Capacitance	1 pF to 200 μ F, 6 ranges.

Tests

Diode	Diode and transistor junctions in conducting and non-conducting directions.
Continuity	Audible signal.

Size

2.9" H x 6.4" W x 7.5" D
(74 mm x 163 mm x 191 mm)

Weight

2 lb. 4 oz. (1.02 kg)

Price

\$425.00 with batteries
\$399.50 without batteries

8 DMMs. One right for you. Non-Linear Systems also offers eight other outstanding digital multimeters. Trim and low-priced, each of our three, three and one-half and four-digit DMMs is a performance and value-packed instrument.

Get the word on us. NLS has been intelligently innovating in the digital instrument industry for nearly three decades. From the introduction of the first digital voltmeter to breakthrough products like the Touch Test 20.

To get the whole story, from product facts to philosophy, write for our free 1980 Catalog today. Non-Linear Systems, Inc., Box N, Del Mar, California 92014. Telephone (714) 755-1134, TWX 910-322-1132.



Non-Linear Systems, Inc.

Specialists in the science of staying ahead.

© 1980 Non-Linear Systems, Inc.

004
Non-Linear Systems, Inc.
Box N, Del Mar, California 92014.
Please send me your free
1980 Catalog.

Name _____

Company _____

Phone _____

Address _____

City _____

State _____ Zip _____

CIRCLE 47 ON FREE INFORMATION CARD

**THESE ARE NOT
HOME-MADE TRAINING DEVICES.
THESE ARE PRODUCTION MODEL
MICRO-SYSTEMS.
NO OTHER HOME STUDY SCHOOL
OFFERS THEM EXCEPT NTS.**



1.



2.

3.

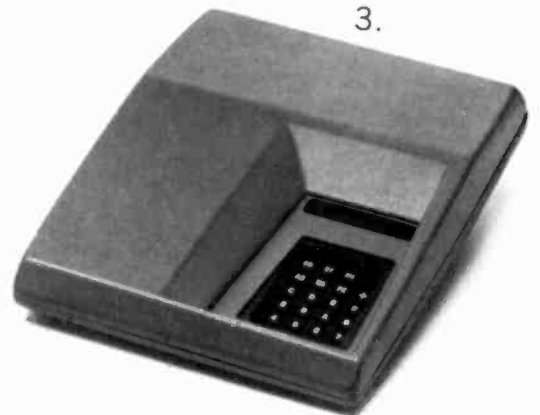

IN FACT, NTS ELECTRONICS PROGRAMS INCLUDE THE WIDEST ARRAY OF SOLID-STATE AND DIGITAL EQUIPMENT EVER OFFERED BY ANY HOME STUDY SCHOOL.



2-Meter FM Transceiver

Now, for the first time, you can learn all about microcomputers by working with your own production model at home. We'll explain the principles of troubleshooting and testing this remarkable instrument and, best of all, we'll show you how to program it to do what you want.

It's the perfect opportunity for you to learn BASIC high level language programming and assembly language programming.

Then, to learn how to localize microcomputer problems and solve them, you'll experiment and test with a digital multimeter and other testing gear.

But most important, you get to assemble and work with today's most sophisticated microcomputers, not home-made training devices. We believe this makes learning a lot more relevant and exciting.

In fact, production-model equipment is featured in all NTS electronics programs.

Our Color TV servicing program boasts the NTS/HEATH digital color TV (25" diagonal) you actually build and keep.

In Communications Electronics you'll build and keep an NTS/HEATH 2-meter FM transceiver, along with digital multimeter and service trainer.

Whichever NTS electronics program you choose, you can count on working with much the same kind of equipment you'll encounter in the field.

Find out more in our full color catalog on the program of your choice.

NTS also offers course in Auto Mechanics, Air Conditioning and Home Appliances. Check card for more information.

Simulated TV Reception



Digital Multimeter

1. The NTS/HEATH H-89 Microcomputer features floppy disk storage, "smart" video terminal, two Z80 microprocessors, 16K RAM memory, expandable to 48K. Available in NTS's Master Course in Microcomputers.
2. The NTS/Rockwell AIM 65 Microcomputer A single board unit featuring an on-board 20 column alphanumeric printer with 20 character display. A 6502-based unit 4K RAM, expandable. Available in NTS's Microprocessor Technology Course.
3. The NTS/KIM-1 Microcomputer A single board unit featuring a 6 digit LED display with an on-board 24 key hexadecimal calculator-type keyboard. A 6502 based microcomputer with 1K of RAM memory, expandable. Available in NTS's Master Course in Electronic and Industrial Technology.

NO OBLIGATION. NO SALESMAN WILL CALL.
APPROVED FOR VETERAN TRAINING.

NTS NATIONAL TECHNICAL SCHOOLS
TECHNICAL-TRADE TRAINING SINCE 1905
Resident and Home-Study Schools
4000 SO. FIGUEROA ST., LOS ANGELES, CA. 90037



NATIONAL TECHNICAL SCHOOLS
4000 South Figueroa Street, Dept. 206-110
Los Angeles, California 90037

Please rush FREE color catalog on course checked below

- | | |
|---|---|
| <input type="checkbox"/> MicroComputers/MicroProcessors | <input type="checkbox"/> Auto Mechanics |
| <input type="checkbox"/> Communications Electronics | <input type="checkbox"/> Air Conditioning |
| <input type="checkbox"/> Digital Electronics | <input type="checkbox"/> Home Appliances |
| <input type="checkbox"/> Industrial Technology | <input type="checkbox"/> Color TV Servicing |

Name _____ Age _____

Address _____

Apt. _____ City _____

State _____ Zip _____

- Check if interested in G.I. information.
 Check if interested ONLY in classroom training in Los Angeles.



CURRENT GUN plus™

SELF-CONTAINED
3½ DIGIT LCD READOUT

Hand-held Non-contact Current Meter

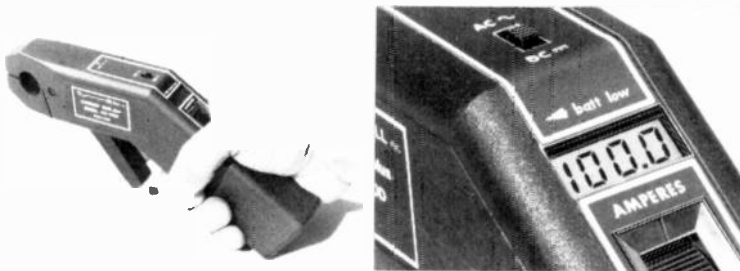

Now the famed Bell Current Gun probe goes a giant step further, and puts the "answer" right in your hand with a built-in readout. Reads dc to 400 Hz from 0 to 200 A. Features automatic reading hold. Has output for use with scope. Utilizes principles tried and proven in Bell's broad line of Hall effect current measuring instruments.

Request full specs, or order direct.

Send check or company P.O. for \$249 (plus \$3.50 shipping) to F.W. Bell, 6120 Hanging Moss Rd., Orlando, FL 32807.

F.W. BELL

Subsidiary, Magnetics & Electronics, Inc.

read resistances: Take heart; you can now apply as much as 300 volts AC or DC to any of the resistance ranges without damage. Those figures are taken from the Heath manual and no attempt was made to verify their accuracy. The current ranges are also protected by a combination of clamp diodes and a fuse.

Whenever there is an overload, or when an overrange condition occurs, the display will show *only* the most significant figure ("1" in the leftmost position) and all other digits will be blanked out. That same overrange indication will be displayed when a resistor being checked is higher in value than the setting selected by the range switch. The fact that an overrange indication is being displayed, however, does not mean that the instrument is being damaged.

The input connections to the meter are made using the conventional banana plug and jack system. That means that you may still make use of any special test leads you may have already constructed for your old, reliable, analog meter because most of them have used that series of connectors. The leads supplied are of fine quality and are long enough for nearly any normal servicing operation. The leads are coded red and black in the normal fashion, and the black lead is fitted with an alligator clip on the free end, as is often the case. Three jacks are used for connection.

Physical measurements of the IM-2215 are 2"H × 3¼"W × 7½"L (5.1 × 8.3 × 19.1 cm), which makes it easy to hold in one hand while using your other hand to attach the probes to a circuit. The range switches are easily operated with the same hand that is holding the unit. There are eight push-type switches, located along the left side of the DMM and recessed slightly to prevent them from being damaged or bent. The tip of the thumb can be used to push the selector switch and still allow the other fingers to maintain a firm grip on the case. (In case one is left-handed, the tip of a finger can be used to select the proper range.)

The selector switches are arranged in a convenient manner. The switch nearest the input jacks is the one that selects the ohmmeter function or the current/voltage scales. The actual choice of current and voltage is made by the connection of the input leads in the proper jacks. By the way, the current ranges are called-out on the panel by a pink background while the voltage sections are highlighted in blue. A green-colored background is used to highlight the ohms ranges.

Other physical features of the Heath IM-2215 include a display that is tilted forward slightly with respect to the main body of the unit. That feature aids in allowing better visibility of the readout when the case is lying flat on the workbench. If a steeper angle is required for viewing, there is a bail-type stand attached to the rear side of the case. That stand allows the unit to be placed at an approximately 45-degree angle with reference to the bench's surface.

Ranges include four current choices from 2 mA to 2000 mA, AC and DC. The five voltage ranges cover from a low of 200 mV to 1000 volts on DC. AC voltage measurement is limited to a maximum of 750 volts. The resistance ranges include a low range of 200 ohms full scale and a maximum of 20 megohms full scale. The resistance measurements are spread over six ranges. The top switch on the front

continued on page 36

Your future in electronics depends on knowing microprocessors

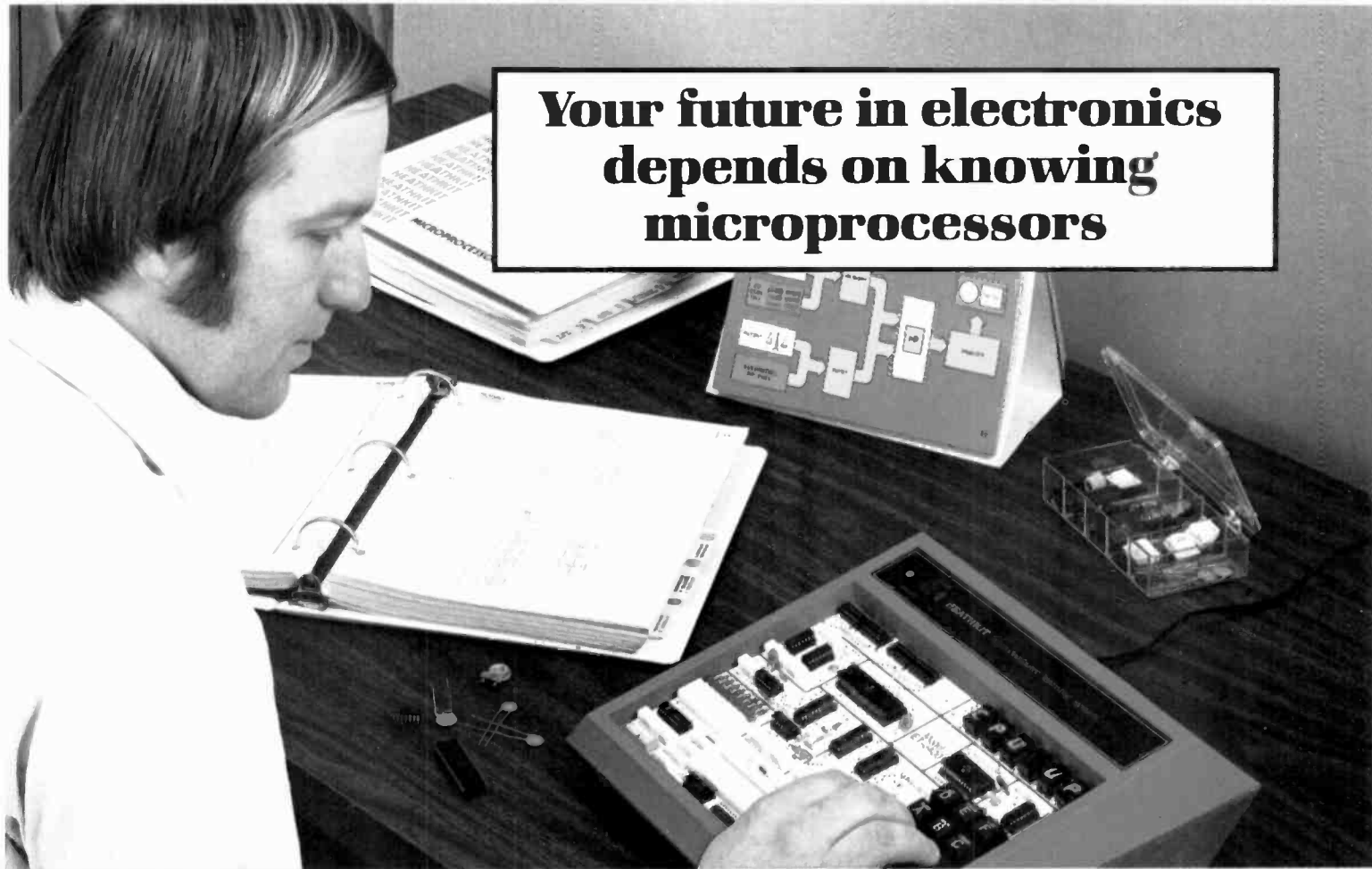

To advance in the electronic-oriented world of today – and tomorrow – you need to understand microprocessors. Now, Heath/Zenith Educational Systems brings everything together in one complete, easy-to-follow self-instructional course on microprocessors – so you can gain the knowledge needed to secure your future in electronics.

Heath/Zenith's Microprocessor Course – as does every program in the Heath/Zenith Electronics Education line – reinforces each concept **FOUR** ways:

1. You **READ** clear, concise text material.
2. You **SEE** large, colorful visuals.
3. You **HEAR** audio cassette tapes which reinforce material presented in the text material and visuals.
4. You **PERFORM** programming and interfacing experiments, which give you hands-on experience in programming and interfacing microprocessors.

Sixty-two different electronic components are included, to make the Heath/Zenith Course an even better value. These parts are used in the hands-on programming and interfacing experiments.

The Heath/Zenith Microprocessor Course is backed by a Microprocessor Trainer, used to perform the experiments. Based on the popular 6800 microprocessor, this Trainer functions as a miniature digital computer. Built-in 1K ROM monitor program controls operation. Six-digit LED display provides address, data readout.

In the experiments, you work with actual components – to gain hands-on experience and confidence, and to make learning more effective.

Here is what you will know when you finish this easy-to-learn course:

Programming – including branching, algorithms and flow-charting.

The 6800 Microprocessor – including architecture, instruction set, addressing modes and interrupts.

Interfacing – with ROM, RAM, displays and switches, D/A and A/D converters; using the Peripheral Interface Adapter (PIA).

Number Systems and Codes, Microcomputer Basics and Computer Arithmetic.

Turn to pages 74 and 75 of the latest Heathkit Catalog for full details on the Microprocessor Course and Trainer – and our complete line of top-quality Heath/Zenith Courses.

If you don't already have a Heathkit Catalog, send for your free copy at one of the addresses below. Or pick up your copy at the nearest Heathkit Electronic Center* in the U.S. and Canada, where Heath/Zenith Educational Courses are displayed and sold.



Start on the road to your future in electronics with the award-winning Heath/Zenith Microprocessor Course.

Don't wait until tomorrow for knowledge you can learn today.

HEATH
ZENITH
Educational Systems

Dept. 020-713, Benton Harbor, MI 49022

In Canada: contact Heath/Zenith Educational Systems, 1480 Dundas St. E., Mississauga, Ontario L4X 2R7

Also at Heathkit Electronic Centers from coast-to-coast.

(*See the white pages of your phone book for the location nearest you. In the U.S., Heathkit Electronic Centers are units of Veritechnology Electronics Corporation.)

Sabtronics Hand-held Digital Multimeters

Having such excellent instruments makes it tough to explain our low price.

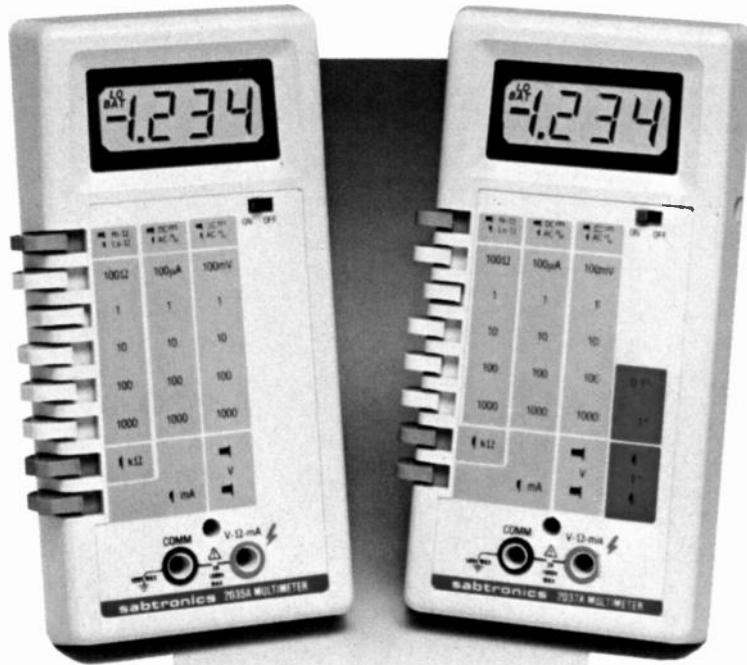

Accurate performance you can rely on, time after time. That's what you expect from a quality DMM. But don't expect to pay as much for it any more. Because now Sabtronics brings you top quality DMMs with more features and better accuracy than other comparable units on the market today. And ours cost surprisingly less!

We cut the price. Not the quality.

What you get is a precision crafted instrument that features single-chip LSI logic, as well as a laser trimmed resistor network. And a stable band-gap reference element ensures better long-term accuracy. Basic DCV accuracy is 0.1%. The Model 2035A gives you 32 measurement ranges and 6 functions. The Model 2037A has an additional temperature measurement function and comes complete with a sensor probe.

First in features. First in price.

Both models feature touch-and-hold capability with the optional probe — it's so convenient, you'll wonder why the expensive models don't have it yet! And two-terminal input for all measurement functions — this eliminates lead switching and makes your job easier.

Of course, auto zero, auto polarity and overload protection are standard. And you get 200 hour operation from a single 9V transistor battery. A low battery indicator warns you of the last 20% of battery life. And the big, sharp LCD readouts allow easy viewing in bright sunshine or low ambient light. Built-in calibration references let you calibrate the unit any time, any place.

You can buy Sabtronics multimeters assembled or in kit form with simple step-by-step instructions.

Why the low price?

We sell what we manufacture, directly to you.

Send in the coupon and order your new digital multimeters now. Credit card holders may call.

BRIEF SPECIFICATIONS
 DC Volts: 100 μ V to 1000V, 5 ranges;
 AC Volts: 100 μ V to 1000V, 5 ranges;
 DC Current: 0.1 μ A to 2A, 5 ranges;
 AC Current: 0.1 μ A to 2A, 5 ranges;
 Hi-Ohms: 0.1 Ω to 20M Ω , 6 ranges;
 Lo-Ohms: 0.1 Ω to 20M Ω , 6 ranges;
 Temperature: -50°C to +150°C
 (-58°F to +302°F), 2 ranges (Model 2037A only); **Dimensions:** 3 1/2" wide X 6 3/4" long X 1 5/8" deep (89 X 171 X 36mm); **Weight:** 11 oz. (excl. battery); **Overload Protection:** 1000V DC or AC peak all voltage ranges, 250V DC or AC peak all Ohms ranges, 2A/250V fuse all current ranges.

Making Performance Affordable

sabtronics INTERNATIONAL INC.

Sabtronics International, Inc., 5709 N. 50th Street, Tampa, FL 33610, (813) 623-2631

Please send me the following

_____ Model 2035A Hand-held Multimeter kit(s) @ \$74.95 each	\$ _____
_____ Model 2035A Hand-held Multimeter(s), assembled @ \$99.95 each	\$ _____
_____ Model 2037A Hand-held Multimeter kit(s) @ \$99.95 each	\$ _____
_____ Model 2037A Hand-held Multimeter(s), assembled @ \$119.95 each	\$ _____
_____ THP-20 Touch-and-Hold Probe(s) @ \$19.95 each	\$ _____
Shipping and handling @ \$5.00 per instrument*	\$ _____
For delivery in Florida, add 4% Sales Tax	\$ _____
10% deposit for C.O.D. orders	\$ _____

I enclose check money order (Allow 2 to 3 weeks for personal checks to clear)
 Charge. Visa Master Charge
 Account No _____ Exp. Date _____
 Name _____
 Address _____
 City _____ State _____ ZIP _____
 *Continental U.S. only. AK, HI, & PR \$6.00. Canada \$7.50; overseas air mail \$21.00



A superb frequency counter is frequently not counted—just because it doesn't have a high price-tag.



The truth is, our 8000B 1 Gigahertz is an excellent counter. In fact, it's preferred by many engineers, technicians, and electronic enthusiasts. Not a single competitor on the market today can surpass our price/performance ratio.

And we've deliberately kept our prices down. First, we've refused to join everybody else in their high mark ups. Instead of "charge what the market will bear," for us it's "charge a fair price." Second, we sell what we manufacture, directly to you. So extra costs of extra steps are automatically eliminated. Third, we have to build a lot of frequency counters to meet the demand. Because we do sell so many, we don't have to charge a high price to make a profit.

And about quality . . . Sabtronics frequency counters always have the most innovative features available. For example, our 8000B 1 Gigahertz Frequency Counter has a 10 Megahertz precision crystal timebase. But most important, the 8000B, using the most advanced LSI circuitry, has a guaranteed sensitivity of 30 millivolts up to 1 Gigahertz, with 20 millivolts typical. The three-stage differential amplifier IC makes this possible. Altogether, the 8000B uses only 6 IC's, making the chance of failure virtually nonexistent.

Three selectable gate times provide the measurement speed you need — and greater resolution. The resolution is further enhanced by our counter's 9-digit display.

Like the 8000B, Sabtronics' 8610B is a high-quality precision frequency counter. It features only 4 IC's, and offers a frequency range up to 600 Megahertz.

The cases of both counters are high strength impact-resistant ABS plastic. Elegant but very rugged. Sabtronics doesn't believe in skimping on the high quality construction that brings excellent performance. But we're not about to charge a high price just because we could get it!

Send in the coupon and order your new frequency counter now. Credit card holders may call.

BRIEF SPECIFICATIONS:

Frequency Range: 10 Hz to 1 GHz (Model 8000B), 10 Hz to 600 MHz (Model 8610B); **Timebase:** Frequency: 10 MHz, Stability: ± 1 ppm (20 to 40°C.), Aging Rate: < 1 ppm/year; **Sensitivity (adjustable):** Input A < 15 mV to 100 MHz, Input B < 30 mV, 100 MHz to 1 GHz (Model 8000B), < 30 mV, 100 MHz to 600 MHz (Model 8610B); **Gate Times:** .1 sec., 1 sec., 10 sec.; **Resolution:** 0.1 Hz to 10MHz, 1 Hz to 100 MHz, 10 Hz to 1 GHz; **Display:** 9-digit LED 0.4"; **Power Requirements:** 4.5 to 6.5 VDC (4 C-cells) or optional AC adapter; **Dimensions:** 8" wide X 6.5" deep X 3" high (203 X 165 X 76 mm), 1.3 pounds (590 g) excluding battery.

Making Performance Affordable

sabtronics INTERNATIONAL INC.

Sabtronics International, Inc., 5709 N. 50th Street, Tampa, FL 33610, (813) 623-2631.

Please send me the following

_____ Model 8000B 1 GHz Frequency Counter(s), Assembled @ \$199.00 each . . .	\$ _____
_____ Model 8000B 1 GHz Frequency Counter(s), Kit @ \$184.00 each	\$ _____
_____ Model 8610B 600 MHz Frequency Counter(s), Assembled @ \$129.00 each	\$ _____
_____ Model 8610B 600 MHz Frequency Counter(s), Kit @ \$114.00 each	\$ _____
Shipping and handling, \$6.00 per unit*	\$ _____
10% deposit for C.O.D. orders	\$ _____
Florida residents add 4% Sales Tax	\$ _____

I enclose check money order (Allow two to three weeks for personal checks to clear)

Charge Visa Master Charge

Account No _____ Exp Date _____

Name _____

Address _____

City _____ State _____ ZIP _____

*U.S. only Canada \$7.50, overseas air mail \$25.00

RE



EQUIPMENT REPORTS

continued from page 32

panel is the AC/DC selector, and the on/off switch is located on the left side of the case for ease in turning the unit on or off with the DMM being held in the one hand.

Testing diodes and transistors has been considered and the 2K, 200K, and the 20 Meg ranges contain terminal voltages in the .800 to 1 volt range which is sufficient to turn-on most solid-state devices. The balance of the resistance ranges will not provide enough current to cause a diode to conduct and therefore are handy for making in-circuit measurements.

All in all, when it comes to digital multimeters, the *IM-2215* is hard to beat especially for the price. The large digits, coupled with a 3½ digit resolution, and the accuracy that is built into the Heath portable DMM should provide the professional service technician, maintenance worker, or serious hobbyist with a measuring capability in excess of his normal needs.

A heavy leather carrying case is available that allows the unit to be carried on your belt. Line-voltage operation is also possible with an optional AC adaptor. Two AC adaptors are available for either 120-volt or 220-volt use.

The *IM-2215* sells for \$94.95. The model *PS-2350* adaptor for 120-volt operation sells for \$4.95 while the 220-volt model *PS-2450* adaptor costs \$14.95. The handsome leather carrying case sells for \$14.95.

The rugged-looking *IM-2215* should be able to stand up to anything in its price range. The calibration on the unit tested was well within the published specifications. No deviations were noticed. The instruction manual is repre-

sentative of all Heath manuals in that they are construction manuals, service manuals, user's manuals, and theory-of-operation manuals all combined into one booklet. Since there are many charts showing how to construct and assemble the unit, identifying the parts and their locations should not be difficult if that issue should arise. Parts and service (if needed) are also readily available from the Heath Company, Benton Harbor, MI 49022. **R-E**

B&K-Precision Model 820 Digital Capacitance Meter



CIRCLE 101 ON FREE INFORMATION CARD

THE B&K-PRECISION DIVISION OF THE DYNASCAN corp., 6460 West Cortland St., Chicago, IL 60635, has proudly issued a new test instrument. It's a portable digital capacitance meter. With a 4-digit LED display and ten ranges, the *model 820* will read capacitance directly over a

range that really amazed me. The lowest is a 1,000 picofarad range (pF) with a resolution of 0.1 pF. The highest range is 1 Farad.

Being one of the older types who started in thinking that a "big capacitor" was about an 8- μ F, this simply boggles my mind. That is one million microfarads. Wow! It means that you can read the actual capacitance of any capacitor you're likely to find in electronic equipment, all the way from trimmers to filters.

You can read the total capacitance of a piece of coaxial cable, or read the stray capacitance between conductors on experimental or production type boards, or anything else that calls for direct reading of capacitance. Circuits that require two precisely matched capacitors are a snap with this instrument.

The test hookup is about as easy as you can get. There is a special socket with slots and spring-loaded contacts on the front panel. All capacitors with leads can be checked by pushing the leads into the slots. Polarity should be observed, although with good electrolytics I didn't see any difference when I reversed them. For others, there's a pair of banana jacks that can be used with test-leads. To check very small capacitors with the test leads, accurately, you can zero out the capacitance of the leads with the zero-adjust control. That is also used to set up the display to zero, for maximum accuracy. Those, and a switch, and that's all the controls—except for the range switch.

This is a 10-position type, calibrated in a 10-100-1,000 sequence. The lowest is the 1,000 picofarad range. Then three nanofarad ranges, 10, 100 and 1,000 nF, then three microfarad ranges (μ F) and then the last three, calibrated in millifarads (mF), up to the 1,000 mF range or one Farad. (A word of caution to

Now – two RCA replacement guides custom-tailored to fill your solid state replacement needs!

the oldtimers like me, who were taught that one 'mfd' is a microfarad. The mF here is millifarad, or one thousandth of a Farad! Or, 1,000 microfarads.)

Display readout on all of the lower ranges is very fast. On the two highest, the 100 mF and 1,000 mF, a longer delay may be noted. However, I read some good-sized capacitors, and it didn't seem to be as long as the instruction manual indicated it would. If you get a delay, just clip the leads to the capacitor and wait. The manual cautions that on very large capacitors, the first reading may not be quite right. That's because of the long charging time and the fact that the capacitor may have been hooked up in the middle of the charge cycle. The second reading will be precise, so wait if you're critical. Overrange indication is shown by all of the digits going out except the bottom lines. A 'row of dashes' means switch to the next higher range.

The Model 820 is built in a neat plastic case, not much bigger than a DMM—so it really is portable. Power is from 4 C-size cells of any kind. If nickel-cadmiums are used, they can be recharged by an optionally available charger. That plugs into a jack on the top of the case. It can also be used to check the battery voltage with non-rechargeable types. Battery life should be very good since the circuitry uses only minute currents and low voltages. It will work with voltages as low as 4.0 volts before the accuracy is affected. That is claimed to be 0.5% and I believe it. Checks out on our bench, anyhow.

All in all, a very useful and accurate little instrument, and one that should be ideal for any application in service shops, labs, production line and experimental work, and most

especially in electronics schools. Evidently it's popular, for it took them almost three months to grab one off the production line (that wasn't already sold) so that I could get a sample to make these tests! The Model 820 has a suggested retail price of \$155. **R-E**

Bearcat BC-211 Programmable Scanner



CIRCLE 02 ON FREE INFORMATION CARD

PROBABLY IN NO OTHER AREA OF CONSUMER electronics has such a dynamic evolution of products been seen as in those using microprocessors. Cameras, TV tuners, home computers, stereo receivers, and many other appliances and conveniences are feeling the impact of digital technology.

One of the most dynamic and fiercely competitive markets is that of scanner radios. Pro-

grammable, crystal-less scanners have virtually wiped out crystal scanners except in low-cost pocket portables. Only a handful of scanner manufacturers remain, and Electra, manufacturer of the Bearcat line, is certainly a dominating trendsetter in the field.

Among a flurry of new Bearcat products to be released within the last year, the BC 211 is finally in production after several months advance advertising.

A look-alike to the venerable model 210, the BC-211 is advanced over that earlier instrument. The BC-211 has a typical sensitivity of .4 microvolt on both the low and high band. Frequency coverage on those two bands is 30-50 MHz and 144-174 MHz. UHF coverage is 420.475-512 MHz. Sensitivity is typically .6 microvolts on UHF.

Like its predecessors, pushbutton simplicity highlights the BC-211. Some of the more popular older features are still retained: automatic or manual squelch, rescan delay, random channel selection or automatic scan, lockout of temporarily unwanted channels, manual stepping through sequential channels, 12-volt DC/120-volt AC power options, and external speaker jack.

A few recently introduced features are also included: clock display including seconds, slow/fast search and scan rates, 18-channel operation, a search hold, and simplified search-limit programming.

There is no priority feature on the BC-211; probably that omission will not be missed by too many owners. The memory is volatile, and an internal battery must be provided to secure the memory during power outages. That minor inconvenience is certainly tolerable, since the

continued on page 38

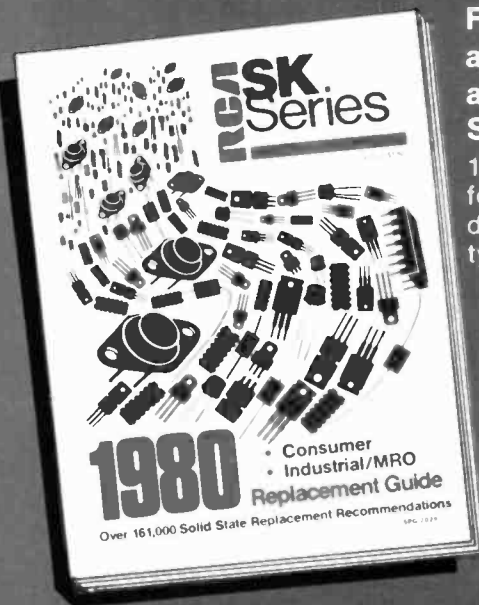

For consumer and industrial applications SK Guide SPG-202Y

1,100 SK replacements
for more than 161,000
domestic and foreign
types.

Especially for MRO Applications MRO Manual 1K6386

Make MRO replacements right from your shelf with 3,000 RCA-manufactured JEDEC* and RCA Commercial types.



*Joint Electron Device Engineering Council

To fill your solid state replacement needs, see your RCA SK distributor for copies of the 1980 RCA SK Replacement Guide, SPG-202Y and the 1980 RCA MRO Replacement Manual 1K6386.

RCA SK Replacement Solid State

For a list of SK Series distributors write to Marketing Services, RCA Distributor and Special Products Division, P.O. Box 100, Deptford, N.J. 08096.

battery need be changed only infrequently.

IF selectivity is a sharp 60-dB down for 25-kHz adjacent channel rejection. Audio output is an ample 2 watts into 8 ohms, either internal or external speaker. Distortion is only 10% maximum at full output.

The size and weight are typical of the 200-series: 10¼ × 3½ × 8 inches; 5 pounds. The cabinet is still vinyl-clad steel (or painted texture, depending upon the particular run). Power required for the unit is 117 VAC at 20 watts, or 13.8 VDC at 9 watts.

An internal telescoping antenna is supplied, and is recommended for most metropolitan listening. For mobile operation, or if distant weak signals are to be monitored, a Motorola-type

jack is supplied on the rear apron for connection of an external antenna.

The clock uses the 60-Hz time base of the AC line current; it is not operable in mobile applications. The clock is easily reset by direct time entry into the keyboard, and displays seconds as well as minutes and hours.

Microprocessors use a great deal of current in their operation. For that reason, if the scanner is to be left unplugged for more than 24 hours, the 9-volt battery must be removed. Even an alkaline battery will be virtually drained of its power after that length of time. The only purpose of the internal battery is to provide continuity in power to preserve instructions in the memory during brief power outages such as power-line dropouts.

It will not last indefinitely.

Occasionally, programmable scanners are

tricked by their own spurious signals (often called "birdies"). They may latch onto one while in the search mode looking for signals. Search may be quickly restored by pressing the search key.

Additionally, oscillator radiation will interfere with other nearby receivers, especially other scanners tuning the same frequency ranges as the BC-211. Some of the oscillations from the busy circuitry may be heard on short-wave and broadcast band radios as well.

As with all other Bearcat products, the BC-211 is warranted against defects for one year. An accessory mounting-bracket with accompanying hardware and wiring are included.

The accompanying manual is easy to understand. Once the basic function of the pushbuttons is grasped, the user will find that the radio very nearly works itself. Operation becomes quite automatic.

We may have a tendency to become somewhat numbed by the fast-paced release of products in a competitive market like scanner manufacturing. But keeping everything in perspective, this latest release from the Electra factory is nicely engineered, a hot performer, and competitively priced. The BC-211 programmable scanner has a suggested retail price of \$329.95. Manufactured by the Electra Company, 300 South of East County Line Road, Cumberland, IN 46229. **R-E**

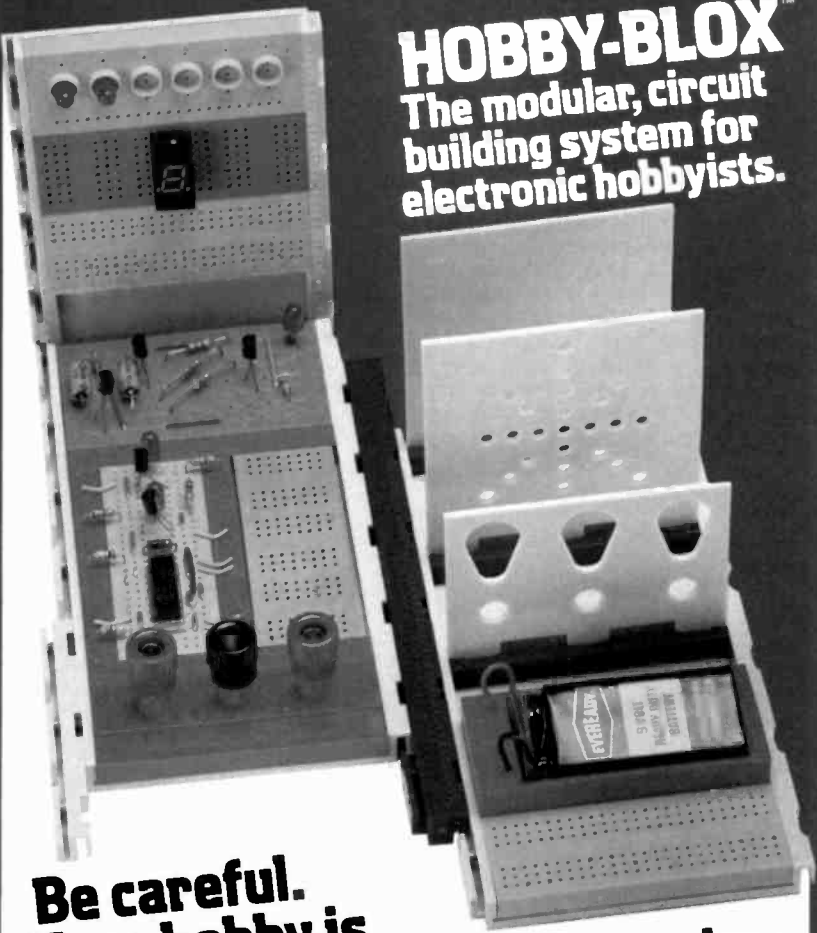

HOBBY-BLOX™
The modular, circuit building system for electronic hobbyists.

Be careful. Your hobby is about to become an obsession.

The 14 modular units in the solderless, Hobby-Blox™ system are color-coded and cross-indexed. Projects go faster, easier.

For the beginner, there are two starter packs. One for integrated circuits, one for discrete components. Each has its own 10 project booklet.

Once you get into Hobby-Blox, look out. You're going to get hooked.

For a free catalog and the name of your nearest Hobby-Blox dealer, call Toll Free 800 321-9668. In Ohio call collect (216) 354-2101.

Patents Pending.
©AP PRODUCTS INCORPORATED 1980

 **AP PRODUCTS INCORPORATED**
1359 West Jackson Street
Painesville, OH 44077
(216) 354-2101
TWX: 810-425-2250
In Europe, contact A P PRODUCTS GmbH
Baumlesweg 21 • D-7031 Weil 1 • W. Germany

Free Project-of-the-Month to Hobby-Blox purchasers!
CIRCLE 12 ON FREE INFORMATION CARD

Realistic Model TRC-209 Walkie-Talkie

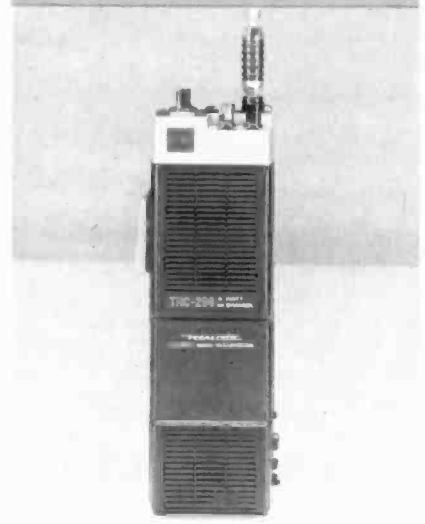

CIRCLE 103 ON FREE INFORMATION CARD

THERE ARE SEVERAL REASONS WHY FEW 5-WATT, 40-channel CB walkie-talkies are offered by manufacturers: battery consumption, high cost, relatively large size and weight, and limited range.

The model TRC-209 walkie-talkie by Realistic is an exception. The unit weighs in at 2¼ pounds and measures only 2½ × 3 × 10 inches. It fits comfortably into an adult hand. While you hold it, your fingers press against a set of metal grounding panels; thus you are using your own body as part of the radiating system, which increases the transmitting range.

Standard "AA" batteries may be used to power the transceiver, but because of the high battery drain during transmission (nearly 1½

continued on page 40

Yesterday you could admire all-band digital tuning in a short wave receiver.* Today you can afford it.



RF-4900

Tune in the Panasonic Command Series™ top-of-the-line RF-4900. Everything you want in short wave at a surprisingly affordable price. Like fluorescent all-band readout with a five-digit frequency display. It's so accurate (within 1 kHz, to be exact), you can tune in a station even before it's broadcasting. And with the RF-4900's eight short wave bands, you can choose any broadcast between 1.6 and 31 MHz. That's all short wave bands. That's Panasonic.

And what you see on the outside is just a small part of what Panasonic gives you inside. There's a double superheterodyne system for sharp reception stability and selectivity as well as image rejection. An input-tuned RF amplifier with a 3-ganged variable tuning capacitor for excellent sensitivity and frequency linearity. Ladder-type ceramic filters to reduce frequency interference. And even an antenna trimmer that changes the front-end capacitance for reception of weak broadcast signals.

To help you control all that sophisticated circuitry, Panasonic's RF-4900 gives you all these sophisticated controls. Like an all-gear-drive

tuning control to prevent "backlash." Separate wide/narrow bandwidth selectors for crisp reception even in crowded conditions. Adjustable calibration for easy tuning to exact frequencies. A BFO pitch

control. RF-gain control for improved reception in strong signal areas. An ANL switch. Even separate bass and treble controls.

And if all that short wave isn't enough. There's more. Like SSB (single sideband) amateur radio. All 40 CB channels. Ship to shore. Even Morse communications. AC/DC operation. And with

Panasonic's 4" full-range speaker, the big sound of AM and FM will really sound big. There's also the Panasonic RF-2900. It has most of the features of the RF-4900, but it costs a lot less.

The Command Series from Panasonic. If you had short wave receivers as good. You wouldn't still be reading. You'd be listening.

*Short wave reception will vary with antenna, weather conditions, operator's geographic location and other factors. An outside antenna may be required for maximum short wave reception.



RF-2900

Panasonic
just slightly ahead of our time.

EQUIPMENT REPORTS

continued from page 38

A!) heavy-duty alkaline or rechargeable nickel-cadmium batteries are recommended (an optional charger is available).

The *model TRC-209's* 3 1/2-watts output provides considerably greater transmission range than that of most hand-held units; and for limited range and lower battery consumption, a slide switch selects reduced 1 1/2-watt power (at a saving of some 30% of current drain).

The two randomly selected units we tested showed very low output power; the cause was determined to be poor alignment in the driver and final output stages of the transmitter; a quick realignment by a licensed technician restored full output. It would be wise to request a wattmeter check before buying the unit.

In actual use, a center-loaded telescoping whip antenna is extended, the volume control is advanced about halfway, and the squelch is adjusted to remove background noise. When the transceiver is first switched on, a large LED display shows the channel selected; the display turns off automatically after about two seconds to conserve battery power. The display may be re-illuminated by pressing a small button next to the transmit bar or by changing channels, after which it will again turn off automatically.

The volume control is a little tricky to use. Once it is turned up far enough for a transmission to be heard, the slightest rotation of the control results in an enormous change in speaker output; add to that the fact that when the receiver is squelched, some audio hiss comes from the speaker regardless of the volume-control setting, and you have the perfect combination for missing a call. That will take some getting used to, but occasionally re-adjust the squelch to make sure that you can hear incoming signals and that the volume control has been set properly.

Because a separate electret-condenser microphone is built in well below the speaker, the *model TRC-209* can be held like a telephone handset. Modulation is automatically adjusted to about 90% while the user is speaking in a normal voice two or three inches away. Audio quality is crisp and clear during both transmit and receive modes.

The receiver's specifications are impressive: sensitivity is 0.5 microvolts (10 dB S+N/N); and selectivity is ±3 dB at 6 dB down, thus resulting in an adjacent-channel rejection of about 90 dB. Squelch will trigger with signals as low as 0.5 microvolt.

The transceiver can be used either as a base unit or as a mobile rig by using an external 12-VDC power source. In a car, that supply would be provided by the battery bus (the *model 270-1533*, power cord is an optional accessory); while in a home or an office, an AC adapter (*model 22-124*, also optional) can provide the DC voltage. When an external antenna is used, an adapter will be required between the transceiver and a standard PL-259 coax connector.

A 5-pin DIN microphone connector allows using an external push-to-talk microphone such as the Realistic *model 21-1172*.

A small meter indicates low battery voltage and relative output power; unfortunately, the meter does not double as an S-meter.

In sum, we rate the *model TRC-209* as quite satisfactory where total portability is required. The transceiver should provide reliable com-

munications for a camping trip or hunting expedition. The unit is available from local Radio Shack retail outlets, and costs \$169.95. For more information, write to Radio-Shack, 1300 One Tandy Center, Fort Worth, TX 76102. R-E

Daiwa Models CS-201, CS-401 VHF Coaxial Antenna Switches

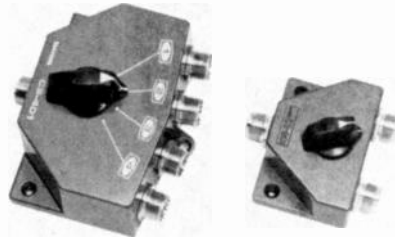

CIRCLE 104 ON FREE INFORMATION CARD

WHILE COAXIAL SWITCHES ARE PLENTIFUL in the CB antenna market, most of them decline rapidly in their frequency performance above 50 MHz or so.

With the proliferation of VHF/UHF radios, it is refreshing to know that a suitable coax switch has become available to handle those upper frequencies.

J. W. Miller (a division of Bell Industries), an old and respected name in amateur radio, is producing the Daiwa line of RF equipment. Two items in this line are the *model CS-201* (two-position) and the *model CS-401* (four-position) coaxial antenna switches.

As soon as you unbox these switches, their difference from standard CB-type coax switches becomes apparent. First, they are heavy. An internal inspection reveals that the internal circuit paths are coaxial cavities, carefully engineered to preserve constant impedance. That is accomplished by manufacturing the units from heavy-gauge metal castings. Second, they are rugged. The heavy-duty contacts are mounted on leaf springs that are aligned coaxially through the cavities. Spring-loaded ball bearings provide positive detent positions during switching. The unused terminals are automatically grounded, thus assuring excellent isolation from stray RF pickup.

Rubber foot pads provide nonskid, non-scratch placement at the operating position, and integral screw holes are included for permanent installation. The switches also come with standard SO-239 coaxial connectors for both input and output connections to the transmission lines.

The operational specifications are quite impressive: Adjacent terminal isolation is better than 45 dB at 500 MHz. At the lower frequencies isolation improves even more, becoming 80 dB below 10 MHz.

The nominal impedance is the standard for radio communications—50 ohms. Insertion loss measures less than 0.2 dB; maximum VSWR at 500 MHz is 1.2:1, and contact resistance is less than 20 milliohms. The low contact resistance and the cavity spacing permit maximum amateur RF power levels of 1000 watts continuous, 2500 watts PEP.

While the specifications seemed good, only an actual test would tell the whole story. So several test frequencies of up to 500 MHz were selected for monitoring with a VHF/UHF

continued on page 44

CAPACITORS LEDS DIODES KITS BOOKS

Jim-pak KITS
electronic components



FUNCTION GENERATOR KIT

Provides three basic waveforms: sine, triangle & square wave. Freq. range from 1Hz to 100K Hz. Output amplitude from 0-volts to over 6 volts (peak to peak). Uses a 12V supply or a ±6V split supply. Includes chip, PC board, components and instructions.
JE2206B \$19.95

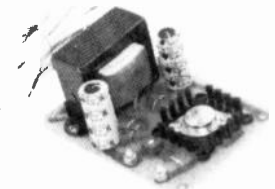

VARIABLE POWER SUPPLY KIT

Full 1.5 amp @ 5-10V output. Up to .5 amp @ 15V output. Heavy duty transformer. 3-terminal I.C. voltage regulator. Heat sink provided for cooling efficiency. PC board construction. 120VAC input. Size: 3 1/2" x 5" x 2" H

JE210 \$19.95

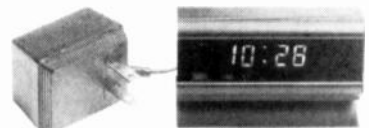

4-DIGIT CLOCK KIT

Bright .357" h. red display. Sequential flashing colon. 12 or 24 hr. operation. Extruded aluminum case (black). Pressure switches for hrs., min. and hold functions. Incl. all components, case and wall transformer. Size: 3 1/4" x 1 3/4" x 1 1/4"

JE730 \$14.95



Digital Thermometer Kit

Dual sensors, control switch for indoor/outdoor or dual monitoring — can be extended to 500 ft. Continuous LED .8" ht. display. Range: -40°F to 199°F. -40°C to 100°C. Accuracy: ±1° nominal. Calibrate for Fahrenheit or Celsius. Simulated walnut case. AC wall adapter included. Size: 3 1/4" h x 5-5/8" w x 1-3/8" d.

JE300 \$39.95

Available Today At Your Local JIM-PAK® Distributor!
JIM-PAK® Belmont, Calif. 94002

SWITCHES CRYSTALS CONNECTORS HEAT SINKS FUSEHOLDERS TEST CLIPS BOOKS KITS DIP JUMPERS CABLE ASSEMBLIES INTEGRATED CIRCUITS MICROPROCESSOR LEDS

SWITCHES CRYSTALS CONNECTORS HEAT SINKS FUSEHOLDERS TEST CLIPS BOOKS KITS DIP JUMPERS CABLE ASSEMBLIES INTEGRATED CIRCUITS MICROPROCESSOR LEDS

One-Stop Component Center AUTHORIZED DISTRIBUTORS

ALABAMA Birmingham Birmingham Huntsville Huntsville Mobile Tuscaloosa ALASKA Anchorage Anchorage ARIZONA Flagstaff Green Valley Serra Vista Tucson Yuma ARKANSAS Little Rock CALIFORNIA Anaheim Anaheim Asacadero Azusa Bakersfield Berkeley Buena Park Buena Park Chula Vista Cypress Davis Paradise Fontana Fresno Fresno Glendale Half Moon Bay Harbor City Hawaiian Gardens Hollywood Inglewood Le Habra Le Mesa Lancaster Modesto Modesto Monterey Morro Bay National City Northridge Oceanside Dana Point Palmdale Palo Alto Palo Alto Pasadena Paso Robles Pomona Redding Sacramento Salinas San Carlos San Diego San Fernando San Francisco San Jose San Jose San Luis Obispo San Rafael Santa Barbara Santa Cruz Santa Fe Springs Santa Maria Santa Rosa South Lake Tahoe Sunnyvale Torrance Torrance Tustin Vallejo Van Nuys Westminster Whittier Whittier Woodland Hills COLORADO Aurora Colorado Springs Denver Denver CONNECTICUT Avon New Haven Westport DELAWARE New Castle Newark Wilmington Wilmington FLORIDA Clearwater Ft. Lauderdale Ft. Lauderdale Gainesville Hialeah Jacksonville Lakeland Lakeland Miami Miami Oakland Park Doral Pensacola	J.L.S. Electronic Inc. Micrologic Inc. Industrial Electronic Supply W&W Electronics Lafayette Radio Electronics Radio Parts Inc. The Electronic Company TV Mart Jim's Audio & Stereo Repair Radio Shack B&S Electronics Electronic City Yuma Electronics Southern Electronics Co. Heathkit Electronic Center R.F. Electronics Coast Electronics Amco Electronics Jay-Kern Electronics Al Lasher Electronics Ford Electronics S.J. Electronics Lion Electronics SCR Electronics Paradyne Consumer Electronics Fontana Electronics A.B.C. Electronics Sparky Electronics Eagle Electronics Radio Shack Buff's Electronics Carson Electronics Pacific Radio Exchange Radioland/Inglewood Electronics A.B.C. Electronics Heathkit Electronic Center Consumer Electronics Computer Magic Pacific Radio Zackit Coast Electronics Willy's Electronics Pacific Radio Electronics Electronic Center Dow Radio Radio Shack A.S.C. Palm Dale U.S. Electronics Zack Electronics Dow Radio Inc. Mission Electronics Heathkit Electronic Center Radio Mart Zackit Salinas Radio J&H Outlet Store Radio Shack A.S.C. Mira Mesa San Fernando Electronics Zack Electronics Peninsula Electronic Supply Inc. United Radio & TV Supply Mid-State Electronic Supply Electronics Plus Lombard Electronics Santa Cruz Electronics Industrial Electronics Cap's Communications Electronics Inc. CalPine Electronics Sunnyvale Electronics SE Electronics Torrance Electronics A-B&B Electronics Zackit Thrifty Electronics Supply Inc. JK Electronics D&S Electronics Whittier Electronics Co. Heathkit Electronic Center Aurora Electronics Centennial Electronics Inc. Mt. Com Distributing Co. Micro World Electronics Heathkit Electronics Center Customized Computer Systems Computerworks Delaware Amateur Supply Computerland Laraco Wholesale Electronics Inc. AGL Electronics Computers For You Lafayette Radio Electronics Lafayette Radio Heathkit Electronic Center Laraco of Florida Inc. Lakeland Specialty Electronics Herman Electronics N&G Distributors Lafayette Radio Southeast Micro Data Corp. Grice Electronics Inc.	FLORIDA (Continued) Tampa Tampa Tampa GEORGIA Atlanta Atlanta Atlanta Columbus Stone Mountain HAWAII Honolulu Honolulu Honolulu IDAH Caldwell ILLINOIS Carbondale Chicago Chicago Evanston Geneva Grovefield Mount Prospect Niles Peoria Peoria Rockford Schaumburg Skokie Villa Park INDIANA Bloomington Chesterton East Chicago Evansville Gary Indianapolis Muncie South Bend IOWA Ames Des Moines Des Moines Des Moines Des Moines Hutchinson Kansas City Mission Salina Wichita KENTUCKY Lexington Louisville Richmond LOUISIANA Baton Rouge Baton Rouge Baton Rouge Kenner Lake Charles Lake Charles New Orleans Shreveport MARYLAND Annapolis Baltimore Baltimore Baltimore Baltimore Churchville Damascus Richmond La Vale Rockville Silver Spring Towson Towson Towson Towson Wheaton MASSACHUSETTS Boston LITTLETON Peabody Pittsfield Walworth Wellesley West Springfield Worcester MICHIGAN Adrian Allen Park Ann Arbor Battle Creek Bay City Canton Clawson Crawford Detroit Detroit Detroit Oxford East Detroit Flint Grand City Grand Rapids Grand Rapids Grand Rapids Jackson Kalamazoo	AMF Microcomputer Center Inc. Micrologic Inc. Heathkit Electronic Center Microcomputer Systems Atlanta Computer Mart CompuShop Heathkit Electronic Center Radio Wholesale Coleman's Electronics Industrial Electronic Inc. Integrated Circuit Supply Custom Electronics A-Gem Supply Inc. Picks Electronics Howard Electronic Sales Oscar Electronics Tri-State Electronic Corp. Malvin Electronics Moyer Electronics Tri-State Electronic Corp. Computer Land Computer Land of Peoria Warren Radio Co. Computer Store of Rockford Pete Domain of Schaumburg Liggett Computer Melia Electronics Stanley Radio Co. Inc. Chesterton Electronics Aero Electronics Corp. Hutch & Son Inc. Colamer Electronic Supply Heathkit Electronic Center Pierce Electronics Radio Distributing Inc. Electronic Supply Inc. Memory Bank Bifford Brown Incorporated Radio Trade Supply Co. Hutchinson Electronics Electronic Supply Sales Heathkit Electronic Center Electronic Inc. Amateur Radio Equipment Co. Radio Electronic Equipment Co. Pieris Electronic Equipment Co. Madison County Electronics Davis Electronics Supply Co. Memard Electronics Inc. Polican Electronics Heathkit Electronic Center Gulf Power & Controls Wholesale Radio & Equipment Wm. B. Aiken Supply Co. Industrial Electronic Supply J&M Electronics Inc. American Distributing Co. Everything Electronic Herc Electronics Tronics, Inc. Churchville Electronics Damascus CB Radio Shack J&M Electronics Heathkit Electronic Center Computers Etc. Bayneville Electronic Inc. Computers Etc. Computers Unlimited Heathkit Electronic Center Computer Crafters Tel-Com Inc. Heathkit Electronic Center Pittsfield Radio Co. Inc. Computer Mart Inc. Heathkit Electronic Center Norbill's Electronics Inc. RM Electronics Inc. E&B Electronics Inc. Electronic Parts Co. Wedemeyer Electronic Supply Warren Radio Co. Kinde Distributing Co. The Electronic Connection Radio Supply & Engineering Co. B&M Electronics Heathkit Electronic Center Radio Supply & Engineering Co. S&S Electronics Oxford Software Co. Heathkit Electronic Center Shand Electronics Inc. Computer Center Micro Computer World Radio Parts Inc. Warren Radio Co. Fulton Radio Supply Warren Radio	MICHIGAN (Continued) Lansing Livonia Livonia Livonia Madison Heights Midland Midland Milan Mt. Pleasant Muskegon Muskegon Niles Pontiac Port Huron Saginaw St. Clair Shores St. Joseph Taylor Traverse City Traverse City Fulton Radio Supply Inc. Lafayette Radio Radio Supply & Engineering Co. Inc. Warren Radio Co. Computronix Corporation C&S Electronics Mart Ltd. H.R. Electronics Niles Radio Supply Electronic Supply Electronic Mart Bell Electronics Heath Customer Center Electronic World Traverse City Electronic Supply Northwest Radio of Duluth Inc. Heathkit Electronic Center Pal Electronics Heathkit Electronic Center Hawatha Electronics Inc. Ellington Electronic Supply Forsythe Computers Beckman Electronics Computer County Computer County (Downtown) Conley Radio Supply Electronic Service & Dist. Inc. Arts Electronics Computer Systems Scott Electronic Supply Inc. Scott Electronic Supply Corp. Midwest Computer Scott Electronic Supply Corp Heathkit Electronic Center Century 23 The Computer Emporium Radio Shack Heathkit Electronic Center Heathkit Electronic Center Lafayette Radio Computer Corner Typetronic Computer Store Lafayette Radio Electronics Lafayette Radio Electronics Albion Audio Inc. Fort Orange Electronics Greylock Electronics Heathkit Electronic Center Radio Equipment Corp. Action Audio Inc. Computer Tree Inc. Action Audio Inc. Red-Tronics Richmond Roanoke Action Audio Inc. Greylock Electronics Action Audio Inc. Action Audio Inc. Aristo Craft Digitbyte Systems Corp. T&H Electronics #5 Corp. Radio Equipment Corp. Action Audio Inc. Greylock Electronics North White Plains Heathkit Electronic Center Trojan Electronics Am-Com Electronics Central Electronics Action Audio Inc. The Computer Corner Byte Shop of Raleigh S&S Electronics Heathkit Electronic Center Micro-Solution Heathkit Electronic Center Heathkit Electronic Center Universal Amateur Radio Heathkit Electronic Center Warren Radio Amateur Electronic Supply Ross Radio Company Bits, Bytes & Micros Heathkit Electronic Center Trick Wholesale Electronics Dragon Ham Sales Norvac Electronics Zero-Gee Eugene Amateur Radio Supply Portland Radio Supply Comm-Shack Leff Electronics Sunrise Electronic Dist. Co.	PENNSYLVANIA (Continued) Drexel Hill Drums Erie Erie Frazier Horsham Peoli Philadelphia Philadelphia Pittsburgh Pittsburgh Wilkes Barre York RHODE ISLAND Cranston Pawtucket Warwick TENNESSEE Cookeville Knoxville Memphis Memphis Memphis Nashville Nashville Dakridge Tullahoma TEXAS Beaumont Brownsville Dallas Dallas Dallas Fort Worth Houston Houston Lubbock McAllen San Antonio San Antonio San Antonio Waco UTAH Midvale Provo Salt Lake City Salt Lake City VERMONT Essex Junction VIRGINIA Alexandria Alexandria Annadele Arlington Blacksburg Charlottesville Falls Church Hampton McLean Norfolk Norfolk Portsmouth Richmond Roanoke Vienna Virginia Beach Warrenton WASHINGTON Bellevue Everett Kennewick Longview Moses Lake Pasco Richland Seattle Seattle Seattle Spokane Spokane Tacoma Tacoma Northwest Radio Supply Kass Electronics Distributors Mr. D's Digital Electronics Warren Radio Heathkit Electronic Center Mighty Byte Computer Centers Personal Computer Corporation Heathkit Electronic Center Reaco Electronics Stevens Electronics Heathkit Electronic Center South Hills Electronics Hamline Electronics G.Y.C. Company Jabbour Electronics City Jabbour Electronics City Heathkit Electronic Center Wagon's Stereo Center Shields Electronics Supply Inc. Bluff City Electronics Sere-Rose & Spencer Electronics Warren Radio Company Eddie Warner's Parts Company Electra Distributing Co. National Electronics H&H Electronics Co. Inc. Electro-Hut George's Electronics Mart CompuShop Heathkit Electronic Center Ram Micro Systems Fort Worth Concept Heathkit Electronic Center Interactive Computers Trice Wholesale Electronics Carlos Franco Electronics Appliance & Equipment Co. Inc. C&K Electronics Inc. Heathkit Electronic Center L&M Wholesale Electronics Heathkit Electronic Center Alpine Electronic Supply Co. Best Distributing Computerland of Salt Lake Lafayette Radio Computers Plus Inc. Arcade Electronics Arlington Electronic Wholesalers Scott's Radio & TV Inc. Graves Electronics Crossroad Electronics Electronic Sales Inc. Tyson's Computer Emporium Avec Electronics Corp. Priest Electronics Electronic Unlimited Avec Electronics Corp. Avec Electronics Corp. Electronic Equipment Bank Heathkit Electronic Center Radio Shack ABC Communications ABC Communications CBJ Electronics Inc. Progress Electronics Ron's Electronics Riverview Electronics C&J Electronics ABC Communications Amateur Radio Supply Empire Electronics Don's Stereo Center Personal Computers C&G Electronics Northwest Radio Supply TPS Electronics Inc. The Computer Corner Electro Distributing Co. Inc. Lafayette Radio Associate Store Computer Concepts CompuShop Alberta Ltd. House of Computers Marianas Electronics NewBear Computing Store Electronica Pan-América Tratopco, S.A. Applied Digital System Sys-Tech LSI Electronics HB The Hobby Centre
---	--	---	---	--	--

For Distributor Information, write or phone JIM-PAK[®] 1355 Shoreway Road, Belmont, CA 94002 (415) 595-5936



HITACHI

KEITHLEY

VIZ formerly RCA

TRIPLETT



PHILIPS

HICKOK



New Portable Digital Capacitance Meter

BK PRECISION



Call For Our Price

MODEL 820

- Measures capacitance from 0 1pF to 1 Farad
- Resolves to 0 1pF
- 10 ranges for accuracy and resolution
- 4 digit easy-to-read LED display
- 0 5% accuracy
- Special lead insertion jacks or banana jacks
- Fuse protected
- Uses either rechargeable or disposable batteries
- Overrange indication

FLUKE DIGITAL MULTIMETERS

Model 8022A: The Troubleshooter

\$139

- Six functions
- 3½-digit resolution
- dc voltage
- ac voltage
- dc current
- ac current
- resistance
- diode test
- 0 25% basic dc accuracy
- LCD display
- Overload protection

Model 8020A: The Analyst

\$179



• Seven functions

- dc voltage
- ac voltage
- dc current
- ac current
- resistance
- diode test
- conductance (1/R)
- 3½-digit resolution
- 0 1% basic dc accuracy
- LCD display
- Overload protection
- Free case
- Two year parts and labor warranty

NEW

Model 8024A: The Investigator

\$219



• Nine functions

- dc voltage
- ac voltage
- dc current
- ac current
- resistance
- diode test
- conductance (1/R)
- logic level and continuity detect
- temperature (K-type thermocouple)
- Peak hold on voltage and current functions
- Selectable audible indicator for continuity or level detection
- 3½-digit resolution
- 0 1% basic dc accuracy
- LCD display
- Overload protection

DATA PRECISION Model 938

0.1%, 3½-Digit, LCD DIGITAL CAPACITANCE METER

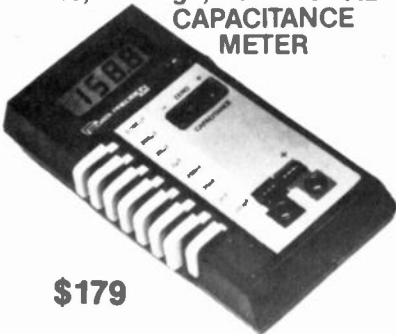

\$179

- WIDE RANGING — from 199 9 pF full scale (0 1 pF resolution) up to 1999 µF full scale, in eight ranges, virtually every capacitance you'll ever need to measure
- FAST AND EASY TO USE — Direct reading, pushbutton ranges. Just plug in and read
- EXCEPTIONALLY ACCURATE — provides ±0 1% basic accuracy
- TOUGH AND COMPACT — Built to take rough usage without loss of calibration accuracy. Fits and goes anywhere, takes very little bench space, always handy for quick capacitance checkout, matching, calibration, and tracking.
- PORTABLE — Palm-sized, lightweight, operates up to approximately 200 hours on a single 9V alkaline battery
- EASY READING — big, clear, high-contrast 3½-digit LCD display, a full 0 5" high, readable anywhere
- VALUE PACKED — Outstanding measurement capability and dependability. Outperforms DC time-constant meters, and even bridges costing 2 to 5 times as much
- RELIABLE — warranted for 2 full years

HICKOK

LX304 DIGITAL MULTIMETER

FAST, EASY, ONE HAND OPERATION

NEW



AVAILABLE NOW \$89⁹⁵

New Low Distortion Function Generator

BK PRECISION



Call For Our Price

MODEL 3010

- Generates sine, square and triangle waveforms
- Variable amplitude and fixed TTL square-wave outputs
- 0 1 Hz to 1MHz in six ranges
- Push button range and function selection
- Typical sine wave distortion under 0 5% from 0 1Hz to 100kHz
- Variable DC offset for engineering applications
- VCO external input for sweep-frequency tests

New Sweep/Function Generator

BK PRECISION



Call For Our Price

MODEL 3020

- Four instruments in one package—sweep generator, function generator, pulse generator, tone-burst generator
- Covers 0 02Hz-2MHz
- 1000 1 tuning range
- Low-distortion high-accuracy outputs
- Three-step attenuator plus vernier control
- Internal linear and log sweeps
- Tone-burst output is front-panel or externally programmable

Simpson

BK PRECISION

LEADER

DORIC

NLS Non-Linear Systems

WESTON

DATA PRECISION

PORTABLE OSCILLOSCOPES
BATTERY OPERATED

MS-15



Single Trace 15MHz
Reg. price \$349.
\$299⁹⁵

NLS Non-Linear Systems

MS-215

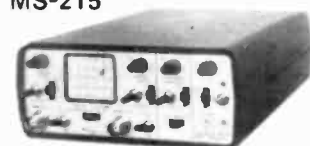

Dual Trace 15 MHz
Reg. price \$465.
\$399⁹⁵

MS-230

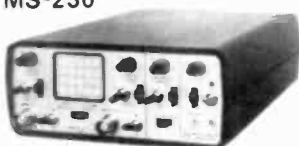

Dual Trace 30MHz
Regular price \$598.
\$499⁹⁵

THESE 1980 B&K OSCILLOSCOPES
ARE IN STOCK AND AVAILABLE
FOR IMMEDIATE DELIVERY



BK PRECISION

- 1479A Dual-Trace 30 MHz
- 1477 Dual-Trace 15 MHz
- 1432 Dual-Trace 15 MHz Portable
- 1476 Dual-Trace 10 MHz
- 1466 Single-Trace 10 MHz
- 1405 Single-Trace 5 MHz

CALL FOR OUR
EARLY BIRD SPECIAL LOW PRICE

KEITHLEY

Model 169
BENCH/PORTABLE DMM

- 3½ Digit liquid crystal display
 - 0.25% basic accuracy
 - 26 Ranges
- \$159.00**



WESTON

The Roadrunner
Model 6100

- 5 Range audible signaling function
- 0.5" LCD display
- 6 Functions
- 29 Ranges

\$139.00



BEEP!
BEEP!

80MHz Counter with Period Function



MODEL 1820

- 5Hz to 80MHz reading guaranteed—100MHz typical
- Period measurements from 5Hz to 1MHz.
- Period average, auto and manual positions
- One PPM resolution
- Totalizes to 999999 plus overflow
- Elapsed time measurements from .01 to 9999.99 seconds plus overflow
- One-megohm input resistance
- Bright .43" high LED readouts

BK PRECISION

Call For Our Price



THE TEST EQUIPMENT SPECIALISTS

TOLL FREE HOT LINE
800-223-0474

54 WEST 45th STREET, NEW YORK, N.Y. 10036 212-687-2224



ADVANCE ELECTRONICS

EQUIPMENT REPORTS

continued from page 40

receiver, to evaluate the system.

Coaxial transmission lines were connected both to a Daiwa switch and a competitive CB-type coaxial switch. We alternated between direct-coupling the transmission lines to the receiver and routing them through the coaxial switches.

The upper limit of the CB switch seemed to be about 150 MHz. Beyond that frequency, losses became quite noticeable, as indicated by both decreasing signal indication on an S-meter and increasing background hiss on the signal itself.

With the Daiwa unit no losses could be detected up to nearly 500 MHz. At that frequency a barely perceptible decrease in the S-

meter reading was noted.

It is apparent that a number of applications would benefit from the low losses of either Daiwa coaxial switch. Amateurs working the VHF band (144 MHz and 220 MHz) can select from among a variety of antennas with virtually no loss right up through maximum legal power. Even at 420 MHz, power loss and SWR would be inconsequential.

Scanner listeners will find that the unit is handy for switching between antennas cut for various bands, or between an omnidirectional multiband monitor antenna and a directional beam.

Electronic technicians could use the switches to select inputs to VHF/UHF test equipment using standard probes. Even low-frequency amateurs will welcome the high power ratings, since they are certainly superior to

those of CB-style coaxial switches.

The models CS-201 and CS-401 coaxial switches are available from J. W. Miller, Division of Bell Industries, 19070 Reyes Avenue, Box 5825, Compton, CA 90224. The model CS-201 has a suggested retail price of \$20.95; the CS-401 retails for \$65.95. **R-E**

Netronics Elf II Microcomputer

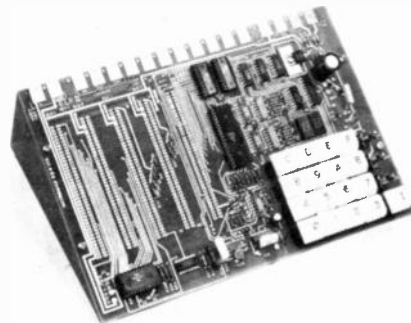

CIRCLE 105 ON FREE INFORMATION CARD

THE ELF II IS AN EXPANDABLE MICROCOMPUTER learning-tool. It is designed around the RCA COSMAC 1802 microprocessor and is controlled through three toggle switches and a 17-key hex keypad. One of the advantages of a COS/MOS system like this is the low current drain. Program output is displayed on an on-board two-digit LED display and through a video output provided by an 1861 video graphics integrated circuit. The 64-bit by 32-bit graphics format is particularly nice for game programs where selected screen elements are illuminated. A demonstration program displays the overworked Enterprise of Star Trek fame.

The *Elf* concept gets you started in the addictive world of microcomputers with a minimum of complication and expense. The basic *Elf II* kit sells for only \$99.95. However, you will need a 5-volt power supply and a television RF modulator. (The modulator can be bypassed if you have the necessary skills to connect into the TV video circuits directly.) Those are both low cost items; the power supply costs \$5 and the modulator is \$8.95.

The unexpanded *Elf* is programmed in machine language, but several publications can help you through that important stage. *A Short Course in Programming* by Tom Pittman is a Netronics publication that will get you started. Even if your eventual goal is to use a high-level language such as BASIC, you should be familiar with the machine-language operation of the host computer. There are going to be times when you will want to write a machine-language routine to do something that has not been built into the high-level language, or to do it faster than the relatively clumsy language interpreter will allow.

The *Elf II* is constructed on a large 7½ × 11½ inch printed-circuit board that also acts as a mother board for up to 5 plug-in modules. As with all other microcomputer kits, soldering is a vital part of the assembling process; if you are not yet expert at soldering, find someone to help, or pay the extra dollars for an assembled board. The construction is straightforward, but the potential for solder bridges is high. Large, complete schematics and board layouts are included, a definite plus when encounter-

continued on page 103

The MORE store...



...your Sprague distributor.

Sprague distributors have *MORE* to offer . . . more component types, more styles, more ratings, more sizes, more quality, more value. With Sprague distributors, you save time by getting *what you want when you want it*, faster and easier.

For the name of your nearest Sprague distributor and a copy of Catalog C-622, write to:

Sprague Products Company
Distributors' Division of the Sprague Electric Co.
81 Marshall Street
North Adams, Mass. 01247.

Where **MORE** is more than a promise.



CIRCLE 38 ON FREE INFORMATION CARD a subsidiary of GK Technologies

Right Out Of Electronic
Counterintelligence . . .

The Hieronymus Machine Voice Stress
Computer, U.S. made. It can help
you tell the difference between truth
and falsehood in more ways than one.

VOCAL "TRUTH" ANALYZER

The Hieronymus Machine Voice Stress Detector

It's almost beyond belief. This tiny solid-state instrument measures 3" x 6" x 1 1/2" and fits in a pocket. Yet it contains sophisticated electronic circuitry, a microphone, and three red diodes. It analyzes the human voice for stress.

Once you learn, in about 30 minutes, how to use the Hieronymus Machine, you will be able to discover whether a person is calm or stressful — merely by monitoring his or her voice.

DEFINITELY NOT A "LIE DETECTOR"

The Hieronymus Machine is not a lie detector. Nor is it a "truth" device. Even the famed polygraph machine is not a lie detector, plain and simple. The polygraph can be used to monitor a person's pulse, respiration, blood pressure, and galvanic skin response, bodily functions affected by stress.

And in the hands of a skilled operator, the polygraph can be used to gain insights about a person's stress levels when talking about certain topics. But a very real part of the polygraph's usefulness is the "Hieronymus Effect," which we'll get to in a moment.

SPIES AND COUNTERSPIES

During wartime, counterintelligence experts wondered if science could come up with something simpler than the polygraph to help ferret out spies. Researchers became attracted to the theory that human voices emit "micro-tremors," low-frequency vibrations that are generally inaudible or masked by other voice components.

An article in *Popular Electronics* (April 1980) describes the theory in detail. But the short story is that after spending millions of dollars, researchers developed a voice stress analyzer. Now, the authors of the definitive article in *Popular Electronics* have perfected a personal voice stress analyzer, which we call the Hieronymus Machine.

WHAT IT DOES, HOW YOU USE IT

The Hieronymus Machine electronically measures changes in voice micro-tremors. The read-out is simple: one red diode indicates normal, two show moderate stress, and three reveal greater stress, ranging from mild to severe anxiety.

You, as the operator, could use the Hieronymus Machine like a thermometer, checking the "fever level" of stress. As you gain skill, your judgment will im-

prove, enabling you to pursue or avoid a line of questioning or discussion that produces stressful responses.

MANY USES AT HOME OR WORK

You can use the Hieronymus Machine at home to have fun with your family. You'll discover how it responds to different people's voices, what effect laughter and singing have on it, and even evaluate politicians' speeches over TV or radio. It works quite well on transmitted voices, as well as over the telephone or with tape recordings.

Next, try it on friends. See how well someone's favorite fish story holds up when you point out that the Hieronymus Machine doesn't believe a word of it. And watch that poker face disappear as the "stress" diode steadily insists you're not getting the whole story.

BIOFEEDBACK FOR YOU

If you're required to talk in front of groups or need to speak convincingly to one person at a time, you can use the Hieronymus Machine to monitor your voice and learn a more relaxed, self-assured, persuasive style of delivery. If you wanted to learn hypnosis, a relaxed voice would be a real asset — and the Hieronymus Machine could help you achieve it.

At work, there are numerous situations in which the Hieronymus Machine could work wonders. Here's how: Hieronymus Bosch was a 15th-century painter known for his startling originality. He was also something of a medical practitioner, and he believed that patients could be cured by passing stones over their bodies. Bosch achieved success because his patients **believed** that a cure was taking place.

Nearer our own time, a couple of science fiction writers concocted a device they named after Bosch: it produced varying sensations in the user depending on where a dial was set, from zero to 100. The amazing thing was that this machine worked on subjects even when it wasn't plugged in — a perfect Hieronymus Effect!

Now we have a true Hieronymus Machine, the Voice Stress Analyzer. It actually works, and among other things of a scientifically verifiable nature, it produces the Hieronymus Effect. In its presence, people suddenly become more forthright. In some cases, with such a machine present, employees being

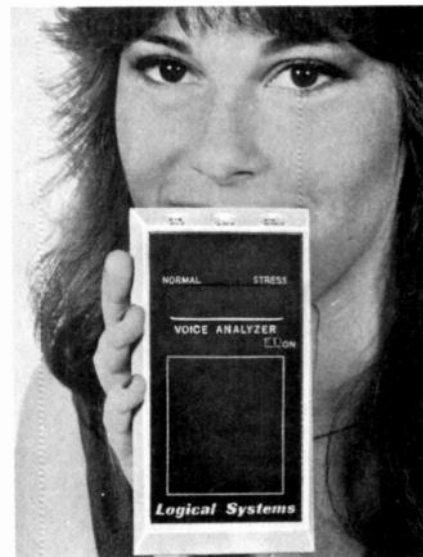

asked about office theft became very cooperative in answering questions truthfully. Naturally, you'll want to use the Hieronymus Machine in plain sight and tell people what it does. This actually gets more cooperation from them.

30-DAY TRIAL, MONEY-BACK GUARANTEE

The potential uses of the Hieronymus Machine are limited only by your imagination. Try it at no risk for 30 days. We'll send you one or more with complete instructions (9v. battery not included). You'll be able to try it, experiment, even conduct your own "investigation."

Governments and police departments and huge corporations are already using large (briefcase-sized) versions of this kind of machine, and they have to pay \$3,000 or so for theirs. But you can have a personal Hieronymus Machine for only **\$119.95**. If you're not satisfied, send it back (insured) for a full refund, no questions asked. If you want two, the cost is **\$109.95** each. And if you want three or more for business use, it's only **\$99.95** each. You're also protected by a 1-year parts and labor warranty.

EXCLUSIVE BY MAIL FROM MERCURY

The Hieronymus Machine cannot be obtained in stores or from any other source. To order, send check or money order to the address below. Or charge it on American Express, Carte Blanche, Diners Club, Master Charge or Visa. You can also call us toll free:

800-526-2801
or
800-257-7850

In New Jersey, call toll free 800-322-8650. Include **\$2.50** insured shipping charge per Machine. N.J. residents please add 5% sales tax.

Or mail your order to:

NATIONAL SALES GROUP
MERCURY
THE IMAGINATION PEOPLE®

Dept. RE11, Lakewood Plaza
Lakewood, N.J. 08701

CIRCLE 54 ON FREE INFORMATION CARD

You can't beat The System.

The Experimentor System™ — a quicker transition from imagination through experimentation to realization.

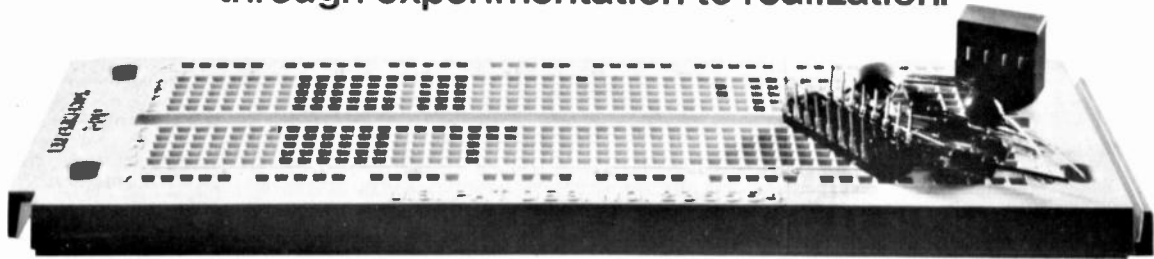

Experimentor solderless breadboard.

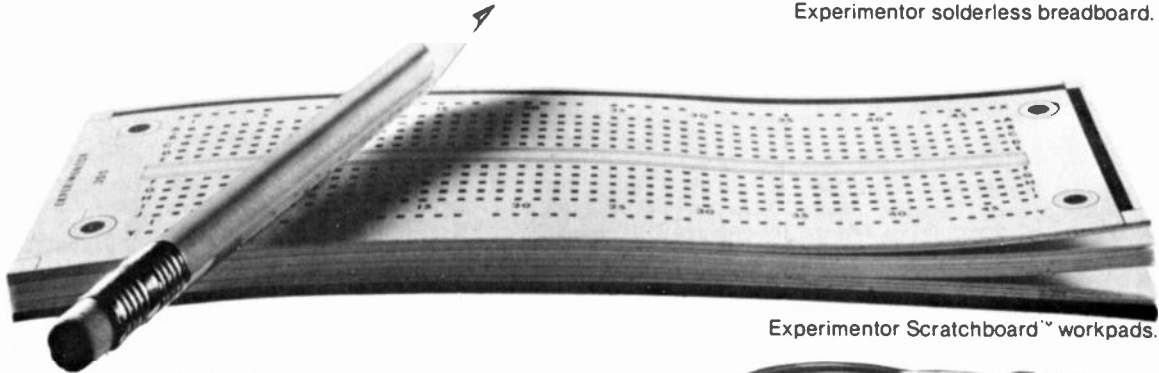

Experimentor Scratchboard™ workpads.

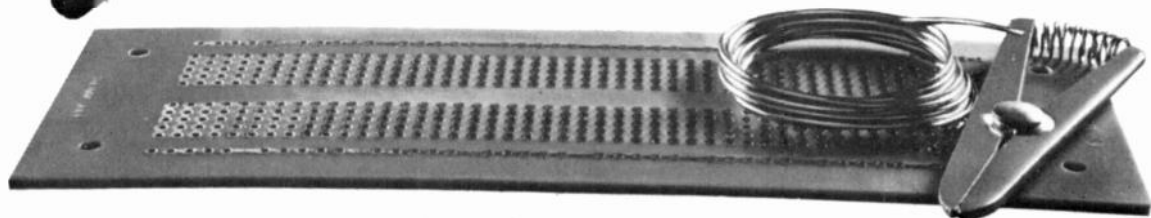

Experimentor Matchboard™ pre-drilled PCBs.

When you have a circuit idea that you want to make happen, we have a system to make it happen quicker'n'slicker'n ever before: The Experimentor System.

You already know how big a help our Experimentor solderless breadboards can be. Now we've taken our good idea one step farther. Twice.

We've added Experimentor Scratchboard workpads, with our breadboard hole-and-connection pattern printed in light blue ink. To let you sketch up a layout you already have working so you can reproduce it later.

With Experimentor Matchboard you can go from breadboard to finished nonstop! We've matched our breadboard pattern again, this time on a printed circuit board, finished and ready to build on. All for about \$2.69*.

There's even a letter-and-number index for each hole, so you can move from breadboard (where they're molded) to Scratchboard™ (where they're printed) to Matchboard™ (where they're silkscreened onto the component side) and always know where you are.

When you want to save time and energy, you can't beat The Experimentor System.

Smarter tools for testing and design.

70 Fulton Terr. New Haven, CT 06509 (203) 624-3103. TWX 710-465-1227
OTHER OFFICES: San Francisco (415) 421-8872. TWX 910-372-7992
Europe Phone Saffron-Walden 0799-21682 TLX 817477
Canada Len Finkler Ltd., Downsview, Ontario

**GLOBAL
SPECIALTIES
CORPORATION**

Call toll-free for details
1-800-243-6077
During business hours

*Suggested U.S. resale Prices specifications subject to change without notice © Copyright 1980 Global Specialties Corporation

CIRCLE 66 ON FREE INFORMATION CARD

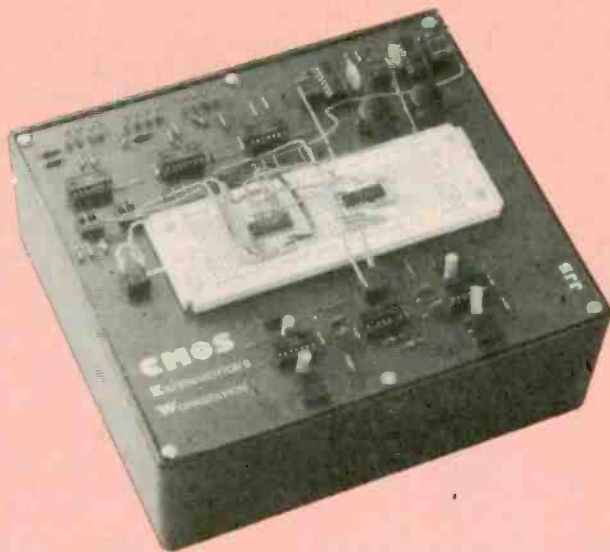

CIRCUIT DESIGN STATION

Prototyping CMOS circuits becomes a breeze with this Experimenter's Work Station. With it, you're done almost as soon as you start!

JAMES BARBARELLO

WHETHER YOU'RE A WEEKEND EXPERIMENTER wishing to duplicate circuits you've seen elsewhere, or a full-time circuit designer, the CMOS Experimenter's Work Station is for you. The Work Station centers around a solderless breadboard. Commonly called "Q" or "L" sockets, those devices allow components and jumper wires to be plugged in quickly and disconnected easily when no longer needed. That makes for a speedy buildup (and modification) of a circuit. They also allow the same components to be used over and over again.

In addition to a solderless breadboard and battery power-supply, the Work Station includes three features that are commonly used in experimental work. These are:

1. Buffered light emitting diodes (LED's)
2. Two-phase clock (oscillator)
3. Debounced switches

The Work Station integrates all the above items on a single PC board that also serves as the top cover. When designing or building up a circuit on the Work Station, you need not duplicate clocks, LED's, or debounced switches—they're already right there for your use!

This highly portable project is easy to construct, uses readily available components and can be built for under \$40.00.

How it works

The Work Station consists of 12 buffered LED's, two two-phase clocks, four debounced switches, a battery

power supply and the solderless breadboard. Each circuit is independent of each other; so, we'll discuss each separately.

Buffered LED's: Most logic circuits require some type of output indicator, the most common being a LED. Since a LED requires a current of between 10 and 20 mA to glow brightly, direct connection to most CMOS IC's is not recommended (they can't provide sufficient drive). Rather, the LED should be connected to a buffer circuit to allow a small current (in this case, fractions of a milliampere) to cause the LED to glow. The Work Station contains 12 identical buffered-LED circuits, four of which are shown in Fig. 1.

Taking LED1 as an example, current can flow from +V through R1 and LED1 to the output of CMOS NAND gate IC1-a. If pin 3 of IC1-a is high (approximately +V), then no current will flow through LED1 and it will remain dark. If pin 3 of IC1-a is low (approximately ground), current will flow through the LED and it will glow. NAND gate IC1-a can sink (route to ground) greater than 10 mA and, therefore, will suit our purpose well. For IC1-a to go low, *both* inputs must be high. Under any other conditions, pin 3 of IC1-a will be high. Let's assume that the GATE 1 input (IC1-a pin 2) is high; if we provide a high logic-level input to IC1-a via pins 1 or 8 of socket SO1, the LED will glow.

In most circumstances, the GATE 1

input will be connected to R25 by jumpering SO1 pin 2 to SO1 pin 7. This will provide a high logic-level input to pin 2 of IC1-a. The GATE input can be used in another way. Assume that we are designing a game where, at some time, all the LED's that are glowing must blink on and off. By connecting the GATE inputs of all the LED's to the same level, we can make all the LED's that are lit via their input's blink on and off. Access to the 12 LED's is via the six 8-pin DIP sockets, SO1 through SO6.

Two phase clock: The term clock is simply another name for an oscillator. A two-phase clock has two outputs that alternate between high and low states. Thus while one output is high, the other is low.

In many applications, it is desirable to be able to turn (or *gate*) the clock on and off. The Work Station contains two such two-phase clock circuits, as shown in Fig. 2. The two clock circuits are identical. For discussion purpose, we'll look at the Clock-A circuit which consists of IC4-d, IC4-c, R29, R49 and C2. The rate of oscillation is determined by the resistance of R29, and R49 (and the capacitance of C2). Pin 13 of IC4-d is the gating input. If pin 13 is high (as when jumpered to R27), the clock will run. If pin 13 is low (as when jumpered to ground on SO8), the clock will stop. If we were to jumper pin 13 to R27 and then connect a switch between ground and pin 13, we could turn the clock on and off simply by

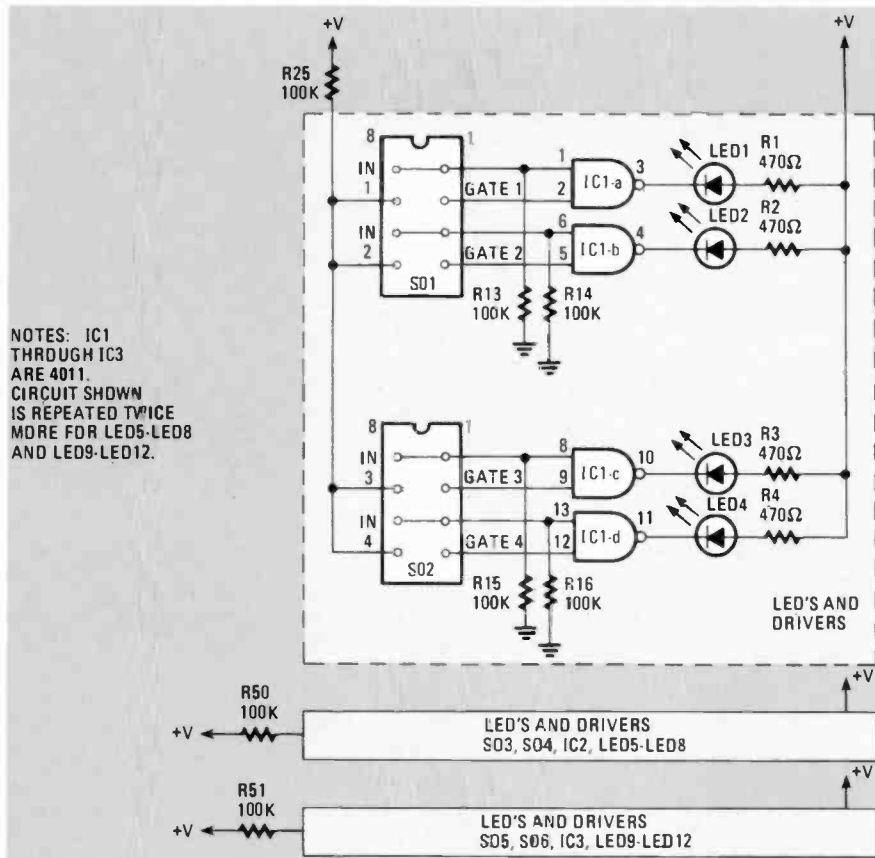

NOTES: IC1 THROUGH IC3 ARE 4011. CIRCUIT SHOWN IS REPEATED TWICE MORE FOR LED5-LED8 AND LED9-LED12.

FIG. 1—BUFFERED LED's are included in the Work Station's design for use as output indicators. Buffer circuitry is required because many CMOS IC's cannot drive LED's directly.

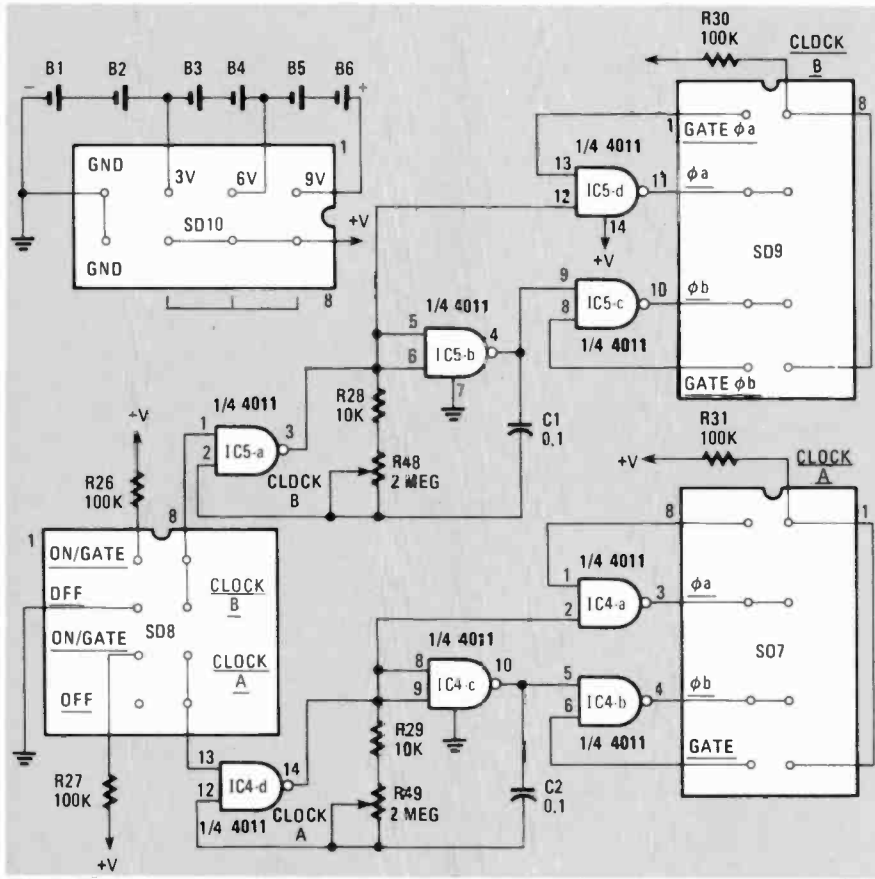

FIG. 2—TWO-PHASE CLOCK circuit includes buffering and permits gating of each phase, allowing a variety of pulse combinations. Power supply provides 3, 6 or 9-volts.

additional gating input. That is convenient if you would like to keep one phase of the clock high while letting the other phase run normally.

Figure 2 also shows the Work Station's power supply. Since CMOS devices require very little current, batteries can be used as the power source; that allows the Work Station to be highly portable. The six "C" cells are connected to SO10 so as to provide 3, 6, or 9-volts DC. Jumping the desired voltage to pins 6, 7, or 8 of socket SO10 will provide that voltage to the Work Station's circuitry. One of the remaining pins of those three can be used to jumper the selected voltage to the solderless breadboard. Power can be removed from the breadboard and the Work Station by removing the jumper in socket SO10.

Debounced switches: No switch is truly ideal. That is, the switch does not make (or break) contact at the instant you activate it. Actually, the mechanical contacts in the switch open and close quickly many times (bounce) before they come to rest. While that may not be of much consequence in your living-room lamp, the CMOS circuits you are using will more than likely see the operation as multiple switch closures. As a result, your circuit might seem to act quite erratically, although it is doing exactly what the switch is telling it to do! For that reason, switches should be *debounced*, or made to act more nearly in the "ideal" manner.

The Work Station contains four debounced switches as shown in Fig. 3. Taking S1 as an example, we see that prior to pressing S1, C3 is charged to +V. When S1 is closed, C3 rapidly discharges to ground. When the voltage across C3 goes below the CMOS logic-low level (about +V/2), pin 11 of IC8-d goes high. When S1 is opened again, C3 begins charging towards +V through R32. When the charge on C3 goes above the CMOS logic-low level, pin 11 goes low. That "STEP" output is available at pin 1 of socket SO11.

It is also desirable to have a very short duration (pulse) output that does not depend on how long the switch is depressed. The STEP output from pin 11 is processed by IC8-c, C4, R33 and IC7-d to produce a short positive going pulse that is available at pin 1 of SO11.

Construction

A PC board is recommended, although any other form of construction will serve as well. The foil pattern is shown in Fig. 4 and the component placement is shown in Fig. 5. When mounting the resistors and capacitors, save the excess leads for jumpers. IC sockets for IC1 through IC8 are recommended. Note that resistors R15 through R24, R28, and R29 are mounted on the *foil* side of the PC board. They are "tack"-soldered by melting a small

using the switch. The two phases of Clock A are buffered by IC4-a and IC4-b. Each buffering NAND gate also has available an

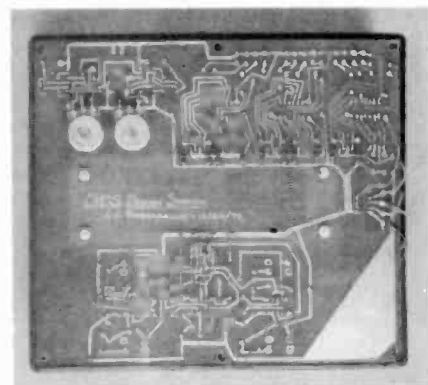

SOME COMPONENTS are mounted and tack-soldered on foil side of PC board.

amount of solder on the foil area and then reheating that solder while placing the component lead on the foil area. One lead of R28 is tack-soldered to variable resistor R48, and the same is done with R29 and R49. The battery connections are also tack-soldered to the foil side of the PC board. The battery connections should be of sufficient length to allow the PC board to be easily removed when batteries need replacement.

Eighteen "U" shaped jumpers should be formed from the excess component leads. Those jumpers can then be used in sockets SO1 through SO9 when the gating inputs are not being used.

It is advisable to mark the PC board in a fashion similar to that indicated in the photo of the author's mode. That can be accomplished with a felt-tipped pen or transfer lettering. If transfer lettering is used, the PC board should be marked *before* mounting any components on it.

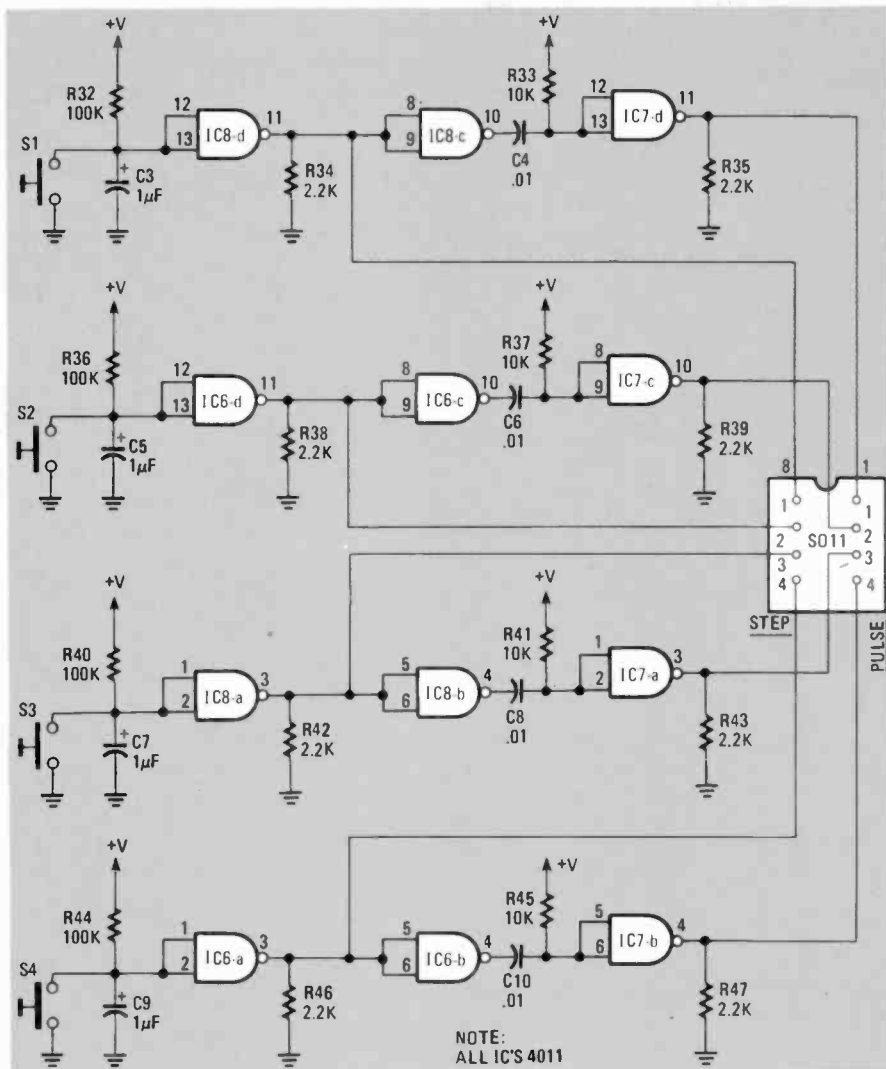

FIG. 3—FOUR DEBOUNCED SWITCHES are provided. STEP outputs remain active as long as switch is depressed; PULSE outputs provide brief, momentary change-of-state.

PARTS LIST

All resistors ¼ watt, 5% unless otherwise noted

- R1-R12—470 ohms
- R13-R27, R30-R32, R36, R40, R44, R50, R51—100,000 ohms
- R23, R29, R33, R37, R41, R45—10,000 ohms
- R34, R35, R38, R39, R42, R43, R46, R47—2200 ohms
- R48, R49—2 megohms, potentiometer, linear taper

Capacitors

- C1, C2—0.1 μF ceramic disc
- C3, C5, C7, C9—1 μF, 15 volts, electrolytic
- C4, C6, C8, C10—0.01 μF ceramic disc

Semiconductors

- IC1-IC8—4011 CMOS quad, 2-Input, NAND gate
- LED1-LED12—jumbo red LED
- S1-S4—momentary pushbutton switch, N.O., PC-mount (Digi-Key EQV-P1R or equivalent)
- SO1-SO11—8-pin DIP socket
- B1-B6—1½-volt "C" cell

Miscellaneous: solderless breadboard (Global Specialties EXP-300 or equivalent), PC board, case, three dual-"C" cell battery holders, two knobs, hardware, wire, solder, etc.

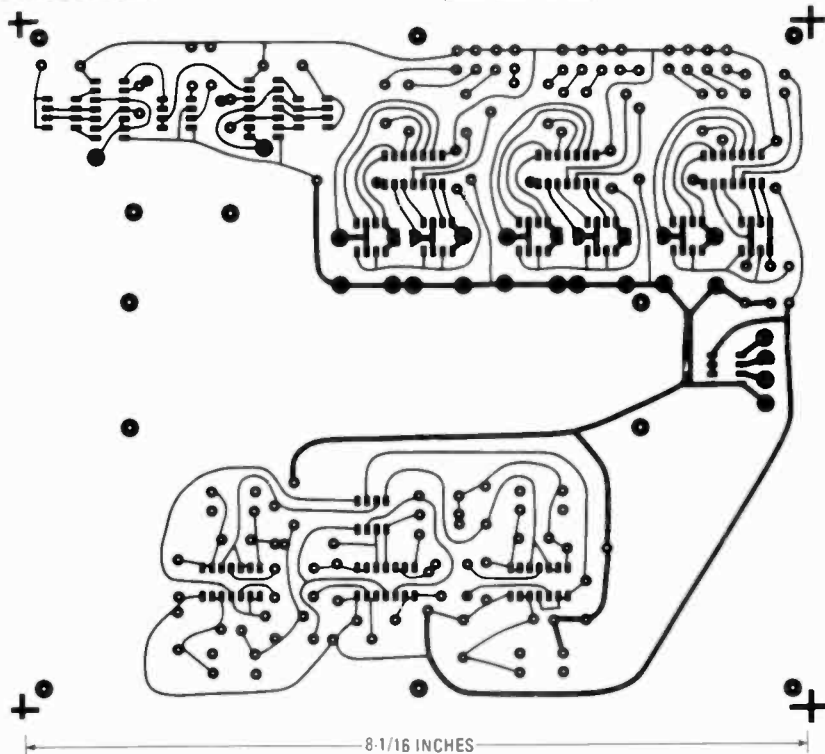

FIG. 4—LARGE PADS on foil side of PC board are used for tack-soldering components. Component side of board also serves as work surface.

Finally, obtain a 12-foot length of No. 20 or No. 22 solid-conductor insulated wire. From that, cut five 1-inch lengths, five 1½-inch lengths and so forth up to five 5-inch lengths. Strip ¼-inch of insulation from each end of each wire. Those 45 wires will serve as jumpers on the breadboard and for connections between sockets SO1 through SO11 and the breadboard.

Checkout

Place "U"-shaped jumpers between the pins of the sockets indicated in Table 1. All these connections are done from the top sides of the sockets, of course. Place an insulated jumper between pins 2 and 7 of POWER socket SO10. That will supply six volts to the Work Station. Place one end of a 5-inch jumper into pin 6 of SO10. Starting with SO1, touch the other end of the jumper to pin 1 and then pin 8. In both instances, LED1 should light. Repeat that procedure for the remaining 11 LED's. Again starting with SO1, move the end of the "U"-shaped jumper connected to pin 7 over to pin 8. Similarly move the jumper-end at pin 5 to pin 6. Now, place the free end of the 5-inch jumper into pin 7. You should see LED1 light. Move the 5-inch jumper end to pin 5. Now, LED2 should light. Repeat that procedure for the remaining 10 LED's. Finally, reposition the "U"-shaped jumpers.

Next we will check for proper oper-

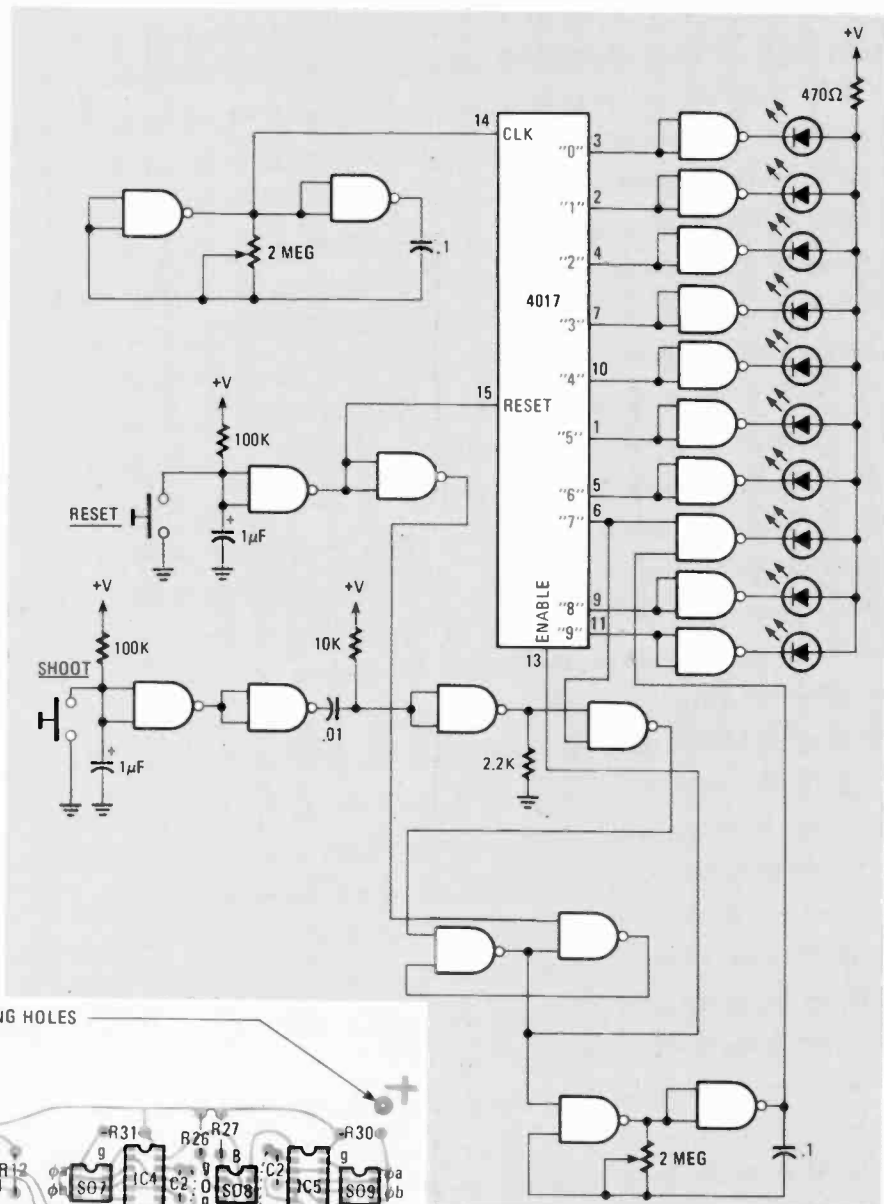

FIG. 6—TARGET-SHOOTING GAME circuit calls for among other things, seven integrated circuits, ten LED's and two push-button switches. Compare this with circuit in Fig. 7.

ation of the switches. Place one end of a 5-inch jumper in pin 1 of SO6 (LED11). Place the other end into pin 8 (Switch 1 STEP output) of SWITCH OUTPUT socket SO11. Press and hold S1. As long as S1 is depressed, LED11 should glow. Move the jumper end to pin 1 of SO11 (Switch 1 PULSE output). When S1 is depressed, LED11 should glow very faintly for an instant and then go dark. Release S1. Repeat that procedure for the remaining three switches.

Now we will check the operation of the clocks. Place a jumper between pin 8 of SO6 and pin 2 of SO7. Place another jumper between pin 6 of SO6 and pin 3 of SO7. That connects LED11 to φa of Clock A and LED12 to φb of Clock A. Rotate R48 fully counterclockwise. You should see LED11 and LED12 blink alternately. As you rotate R48 clockwise, the rate should increase until both LED's appear to be on con-

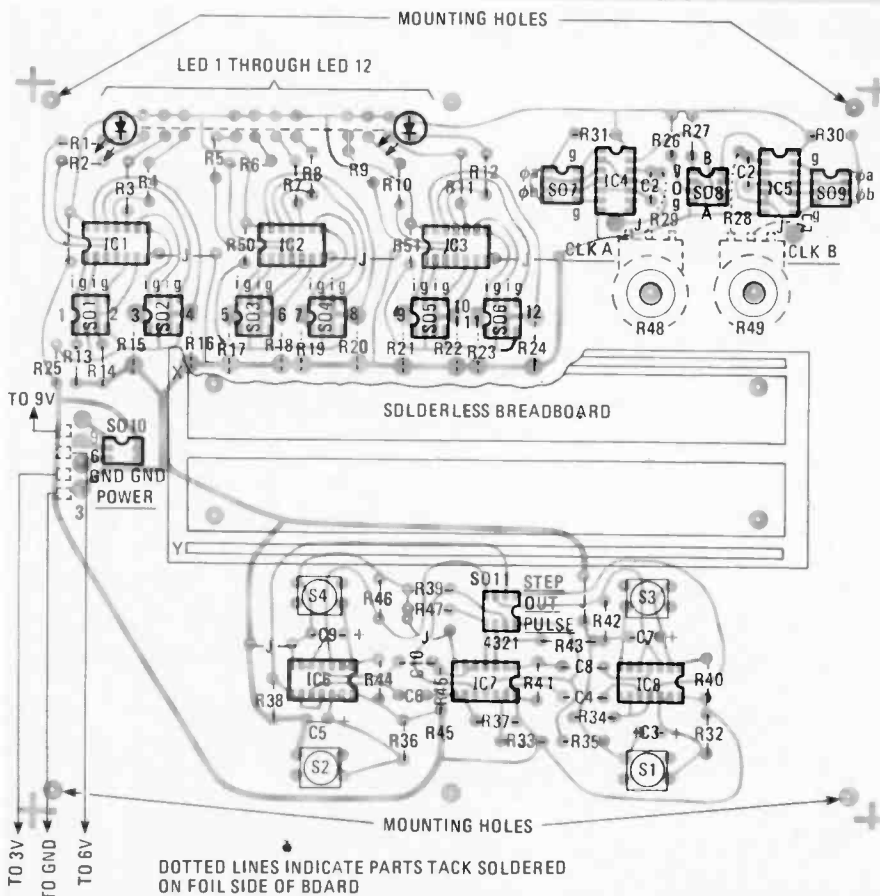

FIG. 5—SOLDERLESS BREADBOARD is mounted in middle of board using four sets of 6-32 hardware.

tinuously. Place one end of a jumper into pin 8 of SO11 (Switch 1 STEP output). Rotate R48 fully counterclockwise and remove the "U" jumper from pins 4 and 5 of SO7. Place the jumper from S1 into pin 5 of SO7. That should result in LED12's staying lit. Pressing S1 should cause LED12 to blink again. Repeat that procedure with the S1 jumper in pin 8 of SO7 for LED11. Rotate R48 clockwise. Finally, move the jumper from S1 to pin 5 of SO8 (CLOCK A GATE). You should see LED11 go dark. Pressing S1 should cause LED11 to glow again. Repeat that procedure for Clock B, after replacing the jumpers in SO7.

At this point, we have determined that all circuits are operating properly. Now let's try out the Work Station.

Putting it to work

Let's make a target shooting game. We'll have 10 LED's in a row. When we start the game, LED1 will come on for a short time. When it goes dark, LED2 will come on for a short time, and so forth. After the tenth LED goes dark, the sequence will start again with LED1. We'll select one LED which we want to be the target (say LED8). If we press a switch when LED8 is on, the sequence will stop and LED8 will start to blink, indicating a "hit". Otherwise the LED's will continue circulating. We must also have a RESET switch that restarts the game when we want to continue.

One possible circuit for that game is shown in Fig. 6. You will note that seven IC's are required. Let's breadboard that circuit on the Work Station. The breadboard connections are shown in Fig. 7. Notice that with the Work Station, only two IC's are required.

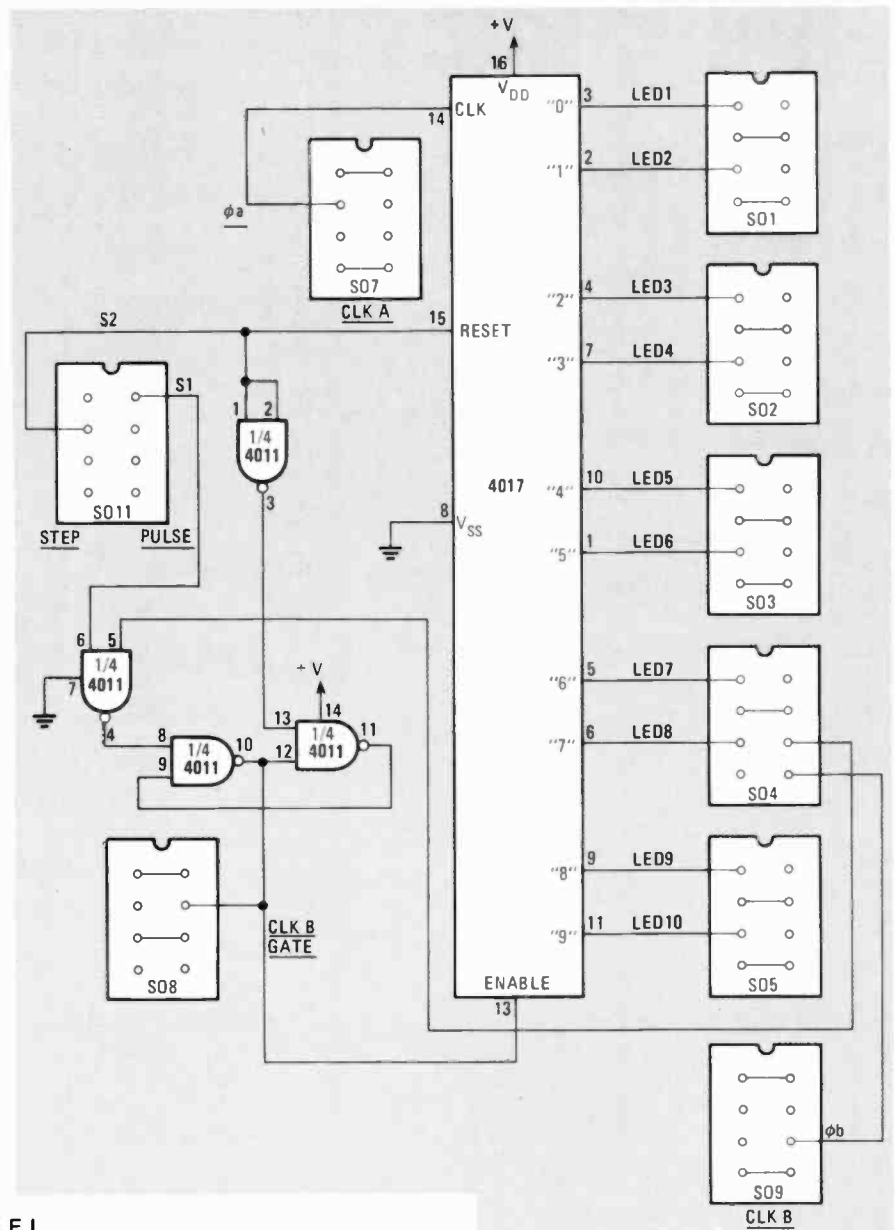

TABLE I

Socket	From pin	To pin	Function
SO1	2 4	7 5	LED1 GATE LED2 GATE
SO2	2 4	7 5	LED3 GATE LED4 GATE
SO3	2 4	7 5	LED5 GATE LED6 GATE
SO4	2 4	7 5	LED7 GATE LED8 GATE
SO5	2 4	7 5	LED9 GATE LED10 GATE
SO6	2 4	7 5	LED11 GATE LED12 GATE
SO7	1 4	8 5	ϕ a GATE (Clock A) ϕ b GATE (Clock A)
SO8	1 3	8 6	Clock B GATE Clock A GATE
SO9	1 4	8 5	ϕ a GATE (Clock B) ϕ b GATE (Clock B)

FIG. 7—GAME CIRCUIT shown in Fig. 6, as constructed using Experimenter's Work Station. The only components required are two IC's, along with jumper wires.

Once the circuit has been breadboarded, rotate R48 and R49 to mid-position and apply power. LED's 1 through 10 will begin lighting in sequence. Pressing S2 will reset the circuit and LED1 will remain lit as long as S2 is depressed. Release S2 and the sequencing will begin again. If S1 is depressed when LED 8 is lit, the sequencing will stop and LED8 will blink on and off. By rotating R49 more clockwise, the sequencing rate will increase, making the game more difficult. The blinking rate for LED8 can be adjusted with R48.

That is just one example of the use of the Work Station. From it you can see how the Work Station allows you to create circuits, quickly and easily, modify them at will, and reuse the components when the circuit is no longer needed.

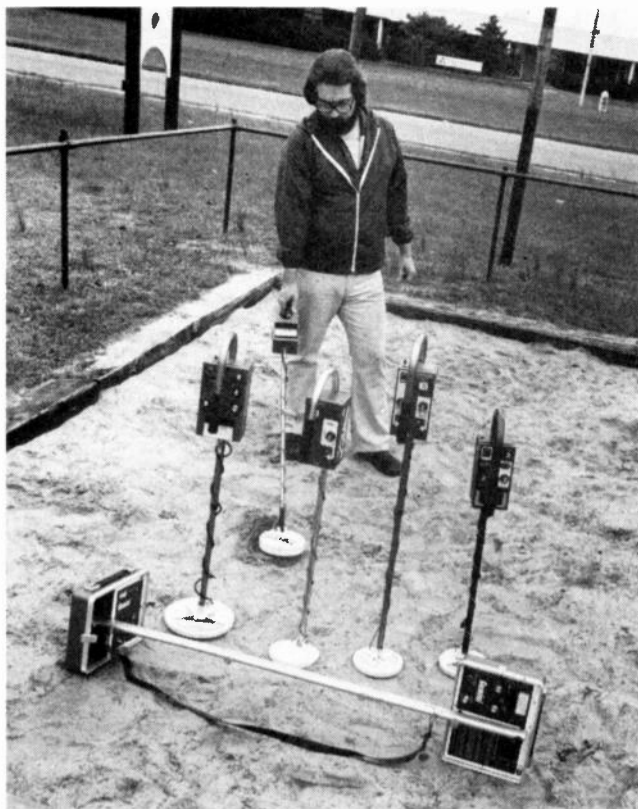

METAL DETECTORS

Searching for buried treasure can be a profitable—and sometimes expensive—pastime. Before you purchase any equipment, know its capabilities.

ROBERT F. GALLAGHER

MOST PEOPLE WHO USE METAL DETECTORS don't seem to be too concerned with what makes their detectors detect. After reading over the instructions, they blithely set out to make their fortunes.

Many coin collectors are using their metal detectors for what is called "coin shooting." Other hobbyists are concerned with digging up artifacts—things that were popular during Revolutionary times—like cannon balls as big as shotputs, or tools and eating utensils from that era. Other treasure hunters look for valuable objects on the bottom of streams and lakes.

Some experts say it doesn't matter whether you're using an inexpensive or expensive detector. But as we see it, the construction of a detector, and its circuitry, are important in the production of a quality product, and in doing the job for which it has been purchased.

We spoke with a man who decided about a year ago to make "coin shooting" a hobby. His advice is to gather as much literature as possible on various types of metal detectors before you make a decision to buy one. He selected a detector that has helped him dig up about 1500 coins during the past year.

That's prudent—when you figure that metal detectors cover a price-

range from \$40.00 to \$350.00-plus. It's much like any other hobby or sport. Initially, you wouldn't buy the most expensive golf clubs after making the decision to become a weekend golfer.

Today, there are a number of amateur treasure hunters who not only are concerned with what they find, but who want to know something about the circuitry that stirs up the buzzing sounds that indicate when they should start digging.

Kinds of metal detectors

There are two basic types of metal-detector circuits—the transmitter/receiver (T/R) and the very low frequency (VLF) type.

The T/R type is where a transmitter circuit radiates a signal, that, when bounced back, is detected by the receiver circuit. When a conductive target interrupts the field, an audio response is generated.

Basically, the VLF unit is a T/R type circuit that operates below 30 kHz. It is typically more sensitive and has greater depth capabilities than the higher-frequency T/R type circuit.

The word "discrimination" is important to the treasure hunter. He doesn't want to spend half of his free time digging up bottle caps, pull tabs, foil, or other useless objects. The dis-

criminator is a circuit with a built-in ability to tell the differences among an extremely wide variety of objects while rejecting trash.

Metal detectors are much more sophisticated today than they were a few years ago. There were no discriminators, and no matter what the detector cost, it could not tell the difference between trash and treasure.

Today, leading manufacturers offer a diversity of detectors with prices falling in the range of \$40.00 to \$440.00.

What's available

Metal detectors are available from many sources. We have listed the most available ones at the end of this article. For more information circle the appropriate numbers on the Free Information card in this issue.

Although considered low-priced, the \$79.95 *Deluxe TR Earth Challenger* has a sensitivity found in higher-priced models. Features include a 10-turn metal/mineral tuner, 6-inch waterproof search coil, a ¼-inch stereo earphone jack for plugging into the user's own headset, eight "AA" batteries with snap-lock battery door, and an adjusting telescope shaft which extends to 44 inches. It's of all-metal construction and weighs two pounds, five ounces. Its circuit is shown in Fig. 1.

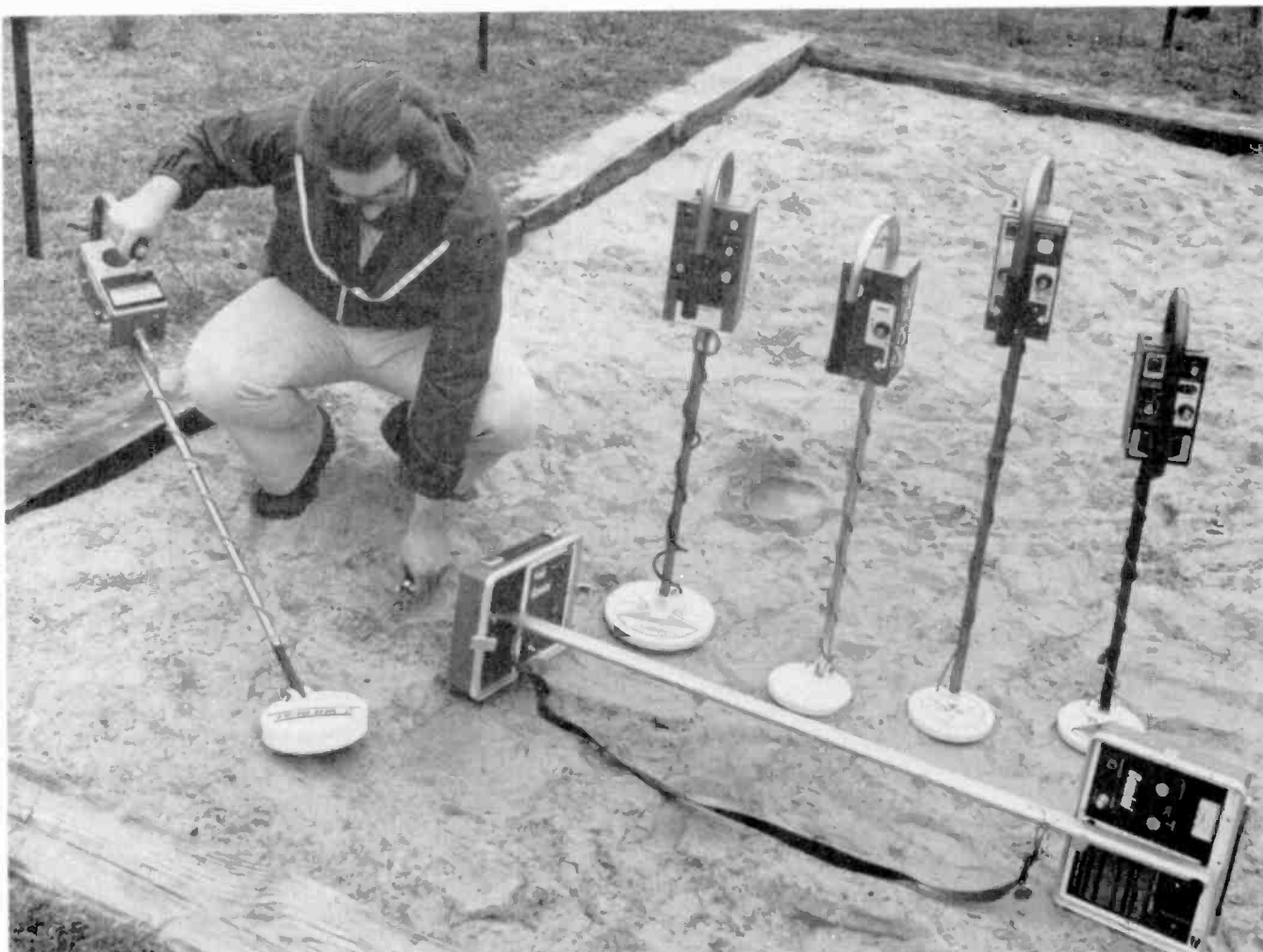

ALMOST LIKE SELECTING golf clubs. Prospective metal detector buyer checks them out.



GROUNDTRACK metal locator from Heathkit is said to work in up to two feet of water.



COIN SHOOTING is the function of the Heath GD-1190. Search coil is optimized for this.

Bounty Hunter, a Tempe, Arizona based detector manufacturer, has introduced a unit called the *Red Baron*. Considered high-priced, it sells for about \$400.00 and comes with an eight-inch coil.

A versatile detector, mode changing, and retuning are combined in one control button. It handles mineralized and non-mineralized soil in all-metal or discriminate modes.

The *Red Baron's* synchronous-phase discrimination circuitry enables discrimination at VLF depths. It's a technique that uses a type of analog computer that reads the sensing signal of the combined targets and matrix (supporting soil around the target) then subtracts the effects of the matrix—leaving only the sound of the target itself to analyze.

Recently, Bounty Hunter added a

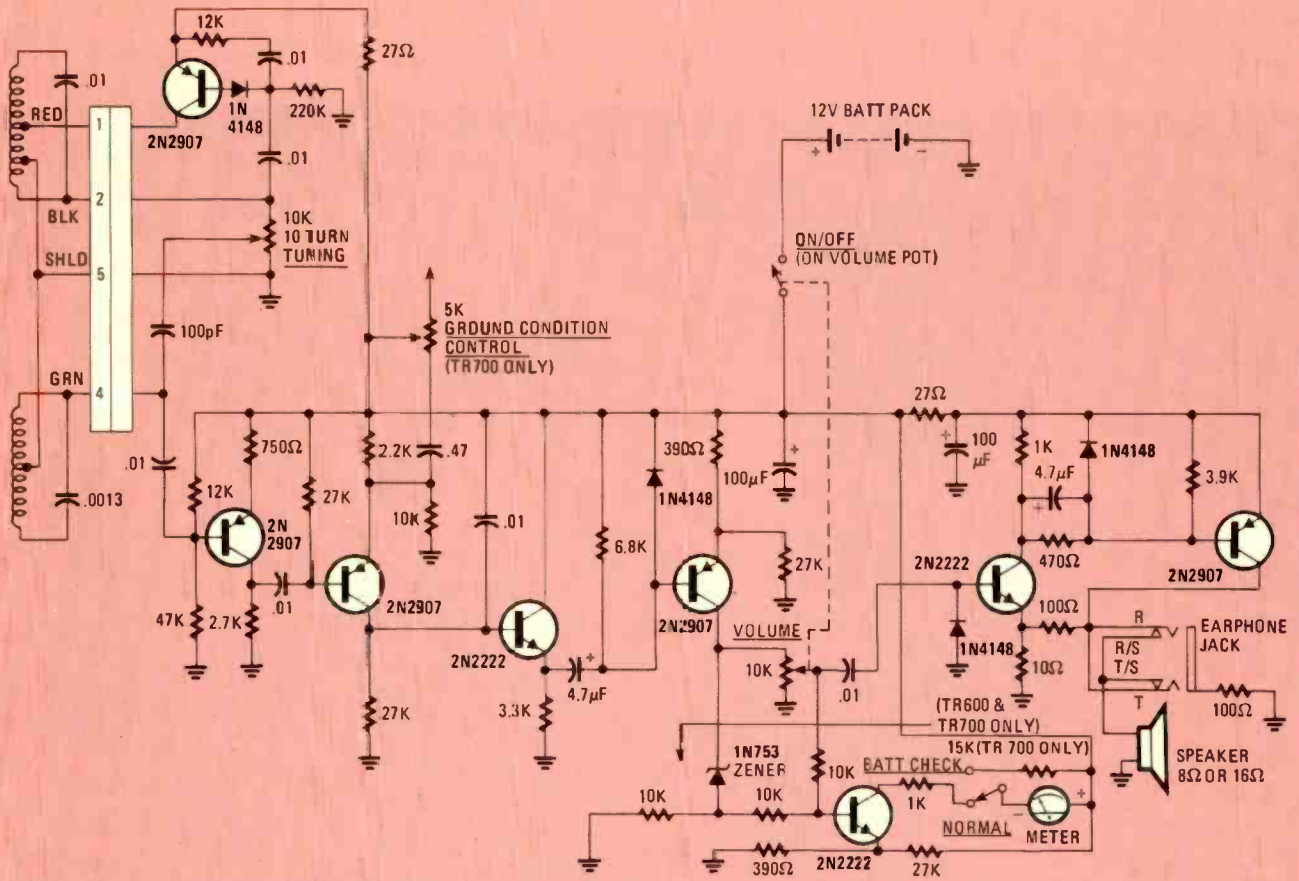

FIG. 1—COMPLETE CIRCUIT OF the Deluxe Earth Challenger II.

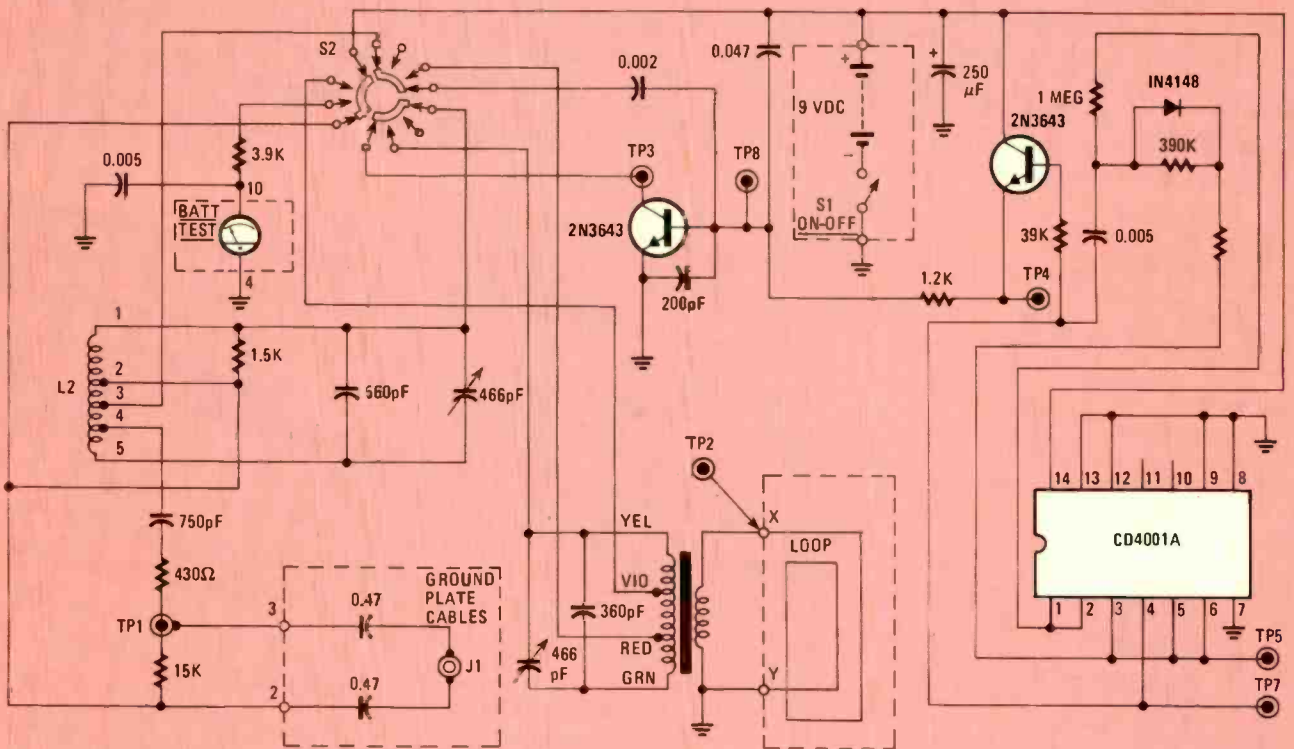

FIG. 2—TRANSMITTER IN THE Gemini II.

TR discriminator to the *Red Baron*, and now offers a selection of three modes: VLF (normal mode) SPD (ground-reject discrimination) and TR discrimination (for standard TR

operation with good depth and stability in non-mineralized ground).

Another popular Bounty Hunter offering is the *840 VLF/TR*. A discriminator with pushbutton tuning, it in-

cludes a battery check and a sensitivity meter. It weighs only 3¾ pounds and reportedly is ideal for those who fancy "coin shooting."

Edmund Scientific has a unit priced

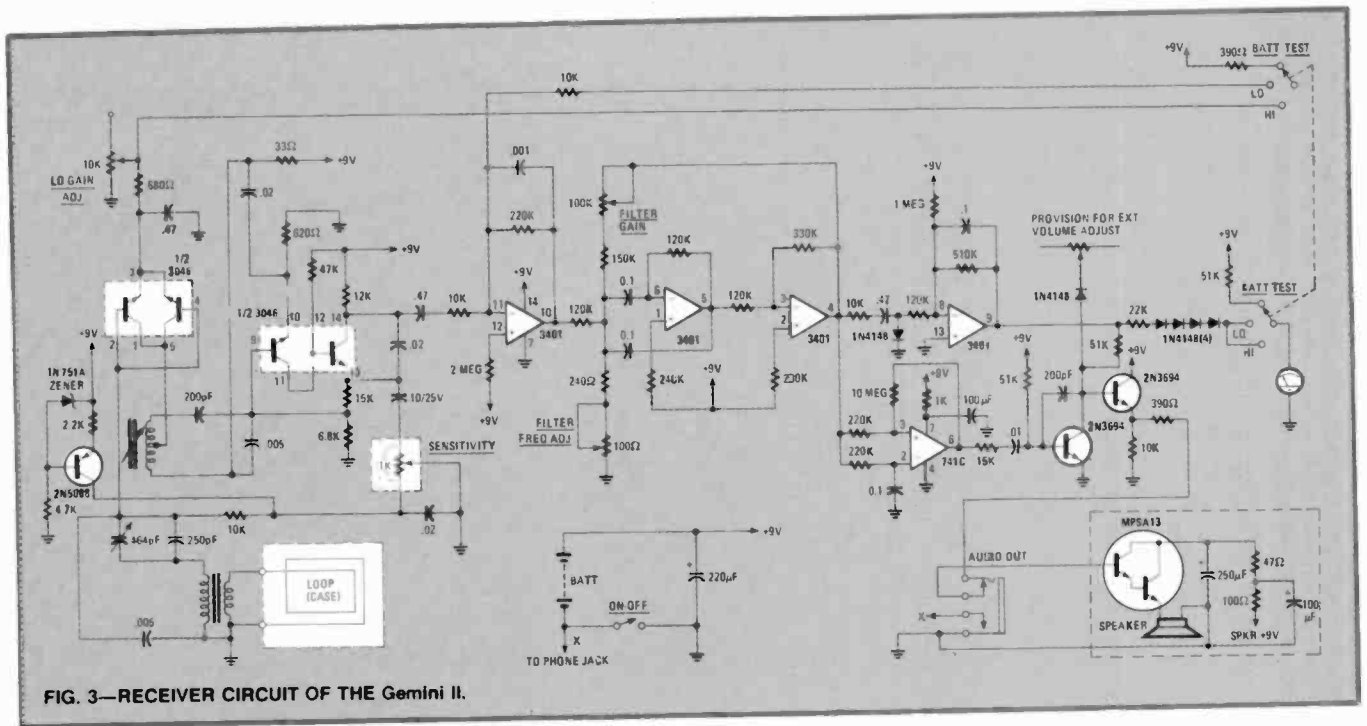

FIG. 3—RECEIVER CIRCUIT OF THE Gemini II.



HUNTING UP THE RIGHT SPOT to dig takes practice to fine-tune your skill in using the device.

at about \$40.00. It is recommended for the beginner who wants a fully transistorized detector offering quality performance.

Another respected name in the metal detector field is "Fisher." The Fisher Research laboratory at Los Banos, California, has developed an effective research and development program.

One of their most popular T/R detectors is called *Gemini II*, and sells for about \$350.00. (See schematic. Transmitter in Fig. 2, receiver in Fig. 3.) It fills the needs of an enthusiastic group of serious treasure hunters, who actively search for—and sometimes locate—major treasures.

Gemini II users have come up with

hoards of coins, gold and silver bullion, treasure chests, ore veins, and other deep treasure caches. This unit also has industrial uses, as it is capable of tracing water, gas, and sewer pipes—and electrical or phone cables—whose whereabouts have been forgotten.

When assembled, it measures 51 inches, weighs just 11 pounds, and has an output frequency of 82 kHz + 5 kHz. Housed in a closable, two-section, high-impact plastic case, it features moisture-proof solid-state circuits and offers quite a good penetration sensitivity.

Fisher's top-of-the-line model is listed as a *VLF 555-D*. The VLF discriminate mode rejects unwanted targets while still detecting deep coins that other detectors miss, claims the manufacturer.

Edmund Scientific reports many

compliments on its *Wildcat VLF Discriminator*. Priced at about \$280.00, it boasts instant tuning and true discrimination when used in just about any kind of terrain.

Batteries are included with this unit, which features a 6¼-inch, water-proofed search coil, a sensitivity adjuster, 3½-inch intensity meter, battery tester, and push-button tuning for making quick adjustments.

The Heath Company, a well known manufacturer of electronic kits, also has a line of metal detectors. All of their detectors are available only in kit form. The top-of-the-line model *GD-1290* features a VLF circuit, adjustable discrimination, 6-inch search coil, and collapsible shaft. It contains both a meter and speaker for the detector output plus a headphone jack. Power is supplied by 6 "AA" cells or an optionally available nickel-cadmium battery pack. The model *GD-1290* sells for \$189.95.

There are two more metal detectors in the Heath Company line. The model *GD-1190* has many of the features of the model *GD-1290*, but it sells for \$119.95. Known as the "Cointrack," its purpose is obvious from its name.

The lowest-priced model in the Heath line is the *GD-348* and it sells for \$79.95.

It seems to us that there is a metal detector available in just about anybody's price range. But all of the experts emphasize: Don't invest too much money until you really know what you're doing, or what you're looking for. Everyone agrees that treasure hunting is fun and profitable—and the more knowledge you gain, the more profitable it becomes. And we mean that in more than one sense of the word.

METAL DETECTORS

For more information, circle the corresponding number on the Free Information card inside the back cover.

Bounty Hunter, Inc.
1309 West 21st Street
Tempe, AZ 85282
CIRCLE NO. 96

Edmund Scientific
101 E. Gloucester Pike
Barrington, NJ 08007
CIRCLE NO. 97

Fisher Research Laboratory
1005 I Street
Los Banos, CA 93635
CIRCLE NO. 99

Heath Company
Benton Harbor, MI 49022
CIRCLE NO. 98

TTL DESIGN: TRICKS & TIPS

Designing with TTL? Check out the tip sheet in this article before you go one step further. If you aren't aware of all of the notes in this article, learn them before you continue.

JOSEPH E. POWELL, JR.

DURING THE LAST FIVE YEARS, THE integrated-circuit industry has made tremendous technological advances and has created new and exciting IC families. We now have CMOS, PROM's, ROM's, and a host of other families; but the designer's "workhorse" is still the old reliable TTL (Transistor-Transistor Logic).

Texas Instruments introduced the first TTL package to the electronics industry in 1964. From that early beginning, the TTL logic family has become so economical, versatile, and easy to use that today almost all digital circuits contain at least one of the packages.

Even though TTL chips are relatively easy to use, designers, (particularly the first-time user), often overlook simple but critical design procedures. This article identifies those procedures and offers tips and short-cuts for implementing them.

All TTL inputs and outputs exist either in a HIGH or as a LOW condition. These two conditions are often referred to as states. A HIGH, or positive state is any input or output that is between +2.4 volts and +5.0 volts. A HIGH state must also allow for leakage currents. An input or output is called LOW any time its voltage is between +.8 volt and ground. A LOW input also needs a low-impedance path to ground that can handle 1.6 mA. A good rule of thumb to follow when dealing with inputs is: *Input swings must not exceed the positive supply voltage (+5.0V) or go below ground (0 volts).*

When selecting a power supply, remember that each gate in an IC pack-

age draws current. A practical method of determining how much current each gate draws is to divide the total supply current (I^{CC}) by the number of gates contained in that package. The most reliable method, however, is to check the data sheet for each component.

Every gate has a fan-in (input requirements or capabilities) of one and an output (fan-out) that can drive up to ten different loads. If more than ten loads are connected to any one output line, that gate's noise margin is severely impaired. Once the noise margin is impaired, the voltage and current swings become too small to operate all the loads properly. A gate's output voltage (HIGH state) is typically 3.3 volts but it can be boosted to a full +5.0 volts by adding a 2.2K pull-up resistor as shown in Fig. 1. An output transistor and a 1K resistor added to a gate's output (Fig. 2), will provide more current.

If a gate is used as a line driver, remember to use it for that purpose only. Also, never connect the inputs of other gates directly to the output of a gate that is being used as a line driver. If a receiving gate is hooked directly to the output of a line driver, line reflections can cause false inputs. The line-driving gate itself may become excessively

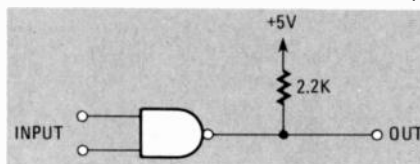

FIG. 1—ADDING A PULL-UP RESISTOR, 2.2K, is all it takes to boost a gate's HIGH output to a full 5.0 volts.

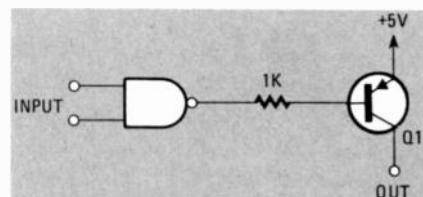

FIG. 2—IF YOU NEED MORE CURRENT from the gate's output add an output transistor and a 1K resistor.

loaded and cause long delay times. Therefore, the line driver's output must first be properly terminated through a resistor network or by some other means. Always decouple line driver and receiver gates by placing a 0.1- μ F capacitor across the IC package ground and supply voltage.

Most TTL gates are high-speed devices that can switch at speeds of 20 MHz or more. That rapid switching causes high-frequency current spikes to appear on the power lines. Even though those current spikes are noise, some gates (flip-flops and counters) may see them as trigger pulses. Noise caused by current spikes is only one of the many problems that TTL gates are susceptible to. In a real circuit, noise can come from crosstalk, line reflections, the power supply, or from the environment itself.

Those noises and other associated problems don't have to be "hair-raisers" or "eye-rollers" if the simple and practical design procedures outlined below are followed:

1. USE A REGULATED +5 VOLT SUPPLY! The key word here is *regulated*. TTL circuits are usually designed to operate from a single +5-volt sup-

ply. Manufacturers usually guarantee the proper operation of their IC's as long as the supply voltage is between +4.75 and +5.25-volts ($\pm 5\%$). Therefore, a regulated +5-volt supply must be one of your most important design considerations.

2. USE HEAVY WIRE FOR ALL POWER CONNECTIONS. For your circuit to operate properly, it must first receive all the power that it requires. Number 20 AWG wire works in most TTL power-line applications. These power lines should be laid out so the transmission path impedance is as low as possible.

3. USE GROUND AND POWER PLANES—IF POSSIBLE. As we said before, TTL circuits are high-speed switching devices. To minimize current spikes caused by that fast switching, keep power and ground planes (PC board areas) as large as possible. A large ground plane acts as a low inductance return for the supply voltage. A ground plane is used if it is not essential to avoid ground loops.

4. USE BYPASS CAPACITORS. The internal design of most regular TTL circuits uses the totem-pole output arrangement shown in Fig. 3. As the TTL gate switches from one state to the other, there is a short time period when both internal output transistors, Q1 and Q2, will be ON. When that occurs, there is a direct low-impedance path between the supply voltage and ground. The result can be 10-to-

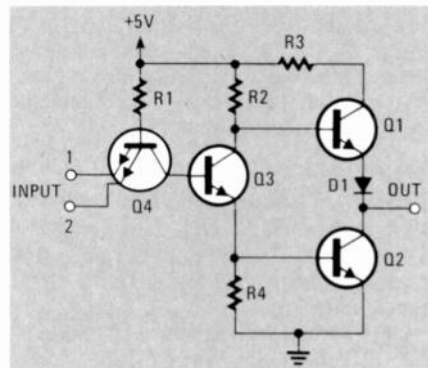

FIG. 3—TOTEM-POLE ARRANGEMENT is used in the internal design of most TTL IC's.

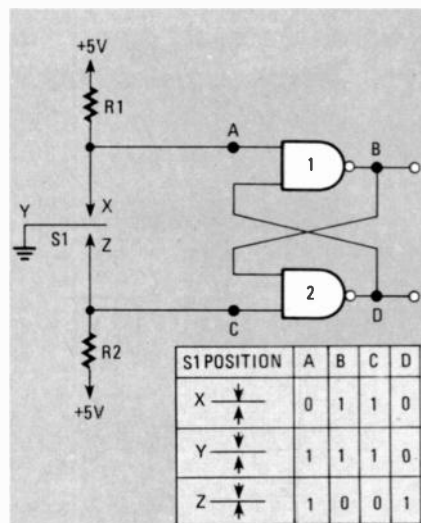

FIG. 4—DEBOUNCING CIRCUIT quickly and easily eliminates the problems of contact bounce.

100-mA current spikes. To solve this problem, place a .01- μ F capacitor between the IC's supply input and ground. Keep capacitor leads short and locate it as close as possible to the IC package. If two to five packages are close together, a single capacitor connected across the +5V and ground lines is needed to do the job.

5. AVOID CROSSTALK! If wires that carry similar current or voltage signals are grouped too closely together, you'll get crosstalk. The magnetic or static field created by one wire interacts with the fields created by adjacent wires. To avoid crosstalk don't use wires that are longer than 10 inches. If you must use wires that are 10 to 20 inches long, route them close to a ground plane and **do not bundle them tightly together with similar wires.**

Twisted-pair wire and coaxial cable also effectively reduce crosstalk. Coax cable, however, is usually used only in very noisy environments.

6. DECOUPLE SUPPLY VOLTAGES. A power supply is not an ideal voltage source; therefore, it must be decoupled. An electrolytic capacitor

that is rated for at least 10 volts and has a value of 4 to 100 μ F will do this job nicely. The capacitor must be placed across ground and the point where the supply voltage first comes into the board.

7. DEBOUNCE GATES THAT ARE CONNECTED TO MECHANICAL SWITCHES. The contacts of a mechanical switch actually strike each other several times before they finally close. Each time those contacts "bounce", a pulse is created. Flip-flops, counters, and other trigger-dependent gates interpret those pulses as signals. Two NAND gates placed between the switch and the receiving gate (Fig. 4) act as a "contact debouncer".

When setting up a debounce circuit, always follow these four rules:

- Use a SPDT 'break-before-make' switch.
- Cross-couple the two NAND gates by using the output of gate one as input of gate two and vice-versa.
- Connect the switch input of gate one and gate two to +5 volts through a 1K resistor.
- Ground the switch to signal ground.

As a final precaution, never leave an unused input unconnected. An unconnected input will rise to a HIGH and become susceptible to noise.

Therefore, tie all unused inputs either to logically similar inputs or to +5V via a 1K resistor. Unused output pins can be left unconnected.

On most schematics, the connections for +5 volts and ground are not shown. Every TTL IC, however, needs those connections to work properly. If the guidelines set forth in this article and in the IC data sheets are followed, then the procedure of going from design to breadboard will be a snap. **R-E**

REFERENCES:

- Ott, Henry W., *Noise Reduction Techniques*, John Wiley & Sons, New York, 1976.
- Lancaster, Don, *TTL Cookbook*, Howard W. Sams, Indiana. Pgs. 7-23, 1975.
- Texas Instruments, Inc., *Designing with TTL Integrated Circuits*, McGraw-Hill, New York, 1971.

USE A PIA FOR SIMPLER μ P-BASED

The peripheral interface adaptor is a versatile IC that allows a microprocessor to communicate with the outside world with ease. This article explains how it transfers data back and forth.

DAVID R. ANDERSON

THE PERIPHERAL INTERFACE ADAPTER (PIA) is one of the family of chips associated with a microprocessor. It operates as an I/O port interfacing the microprocessor with peripheral devices such as video terminals and cassette recorders. It is especially useful in computers and microprocessor-based projects. The PIA contains registers that can transfer data between the microprocessor data bus and the peripheral data bus under microprocessor control. Those registers provide the ins and outs that we will discuss here.

PIA in a computer system

Figure 1 shows how the PIA is connected in a typical computer system. The peripheral device could be any external device—such as a video terminal or cassette recorder. The peripheral data bus is an eight-line bus that is connected between the peripheral device and the PIA. It is a bidirectional bus—which means that it can move data in either direction.

The microprocessor data bus is also connected to the PIA. That bus is an 8-line bidirectional bus. As shown in Fig. 1, the microprocessor data bus is also connected to the random access memory (RAM) and read only memory (ROM).

An address bus is connected to the PIA, RAM, ROM, and the microprocessor. That enables the microprocessor to address the registers in the PIA which transfer the data between the microprocessor and peripheral data busses.

PIA operation

To understand how the PIA operates, let us assume that the microprocessor is ordered by the program to transfer a data byte from RAM to the cassette recorder. The first thing the microprocessor will do is to address the RAM byte and place it on the microprocessor data bus. Then, the micro-

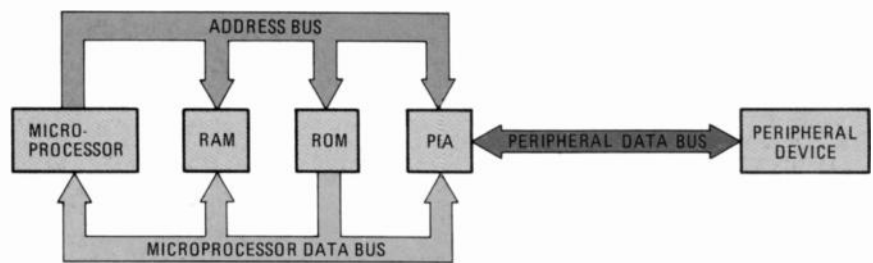

FIG. 1—HOW THE PIA IS CONNECTED in a typical computer system.

processor will set up the PIA registers as output interfaces. That causes the RAM data byte to appear on the peripheral data bus and to be applied to the cassette-recorder input.

If the microprocessor is ordered to write a data byte into RAM, the process just described is reversed. The microprocessor sets up the PIA registers as input interfaces and the data byte from the peripheral data bus is transferred by the PIA registers to the microprocessor data bus. From there the data is written into a specific RAM address.

As can be seen from Fig. 1, the PIA registers can input and output data bytes between the microprocessor data bus and the peripheral data bus. The PIA registers that perform the actual transfer of data can be programmed to function as inputs, outputs, or both at the same time. To see how that is possible let us examine a typical PIA.

A look at a typical PIA

A functional diagram of a typical PIA is shown in Fig. 2. The PIA has two sides, the microprocessor side and the peripheral side. The microprocessor side connects to the microprocessor data, address, and control bus lines. Those bus lines connect to their respective data, address, and control circuits.

The data circuits process the data from the microprocessor's data bus and load it into the I/O data register on the

peripheral side of the PIA. Or, the data circuits read the data contained in the I/O data register and load it onto the microprocessor data bus. The address circuits process the address information received from the microprocessor. The address information is used to address the desired registers on the peripheral side of the PIA.

The control circuits receive information from the microprocessor. That information consists of control and timing signals necessary for the operation of the PIA.

There you have it, a very brief description of the microprocessor side of the PIA. If more detail is desired about the microprocessor side of the PIA see the data sheets for the PIA in question.

As shown in Fig. 2 the peripheral side of the PIA is divided into two parts, A and B. Each part contains three main registers. They move data between the peripheral data bus and the microprocessor data bus.

PIA registers

Figure 3 shows the main registers of a typical PIA. I/O data registers A and B transfer the data between the microprocessor data bus and the peripheral data bus.

Data-direction register A controls the direction in which data flows through I/O data-register A. If all eight bits of data-direction register A are

CIRCUITS

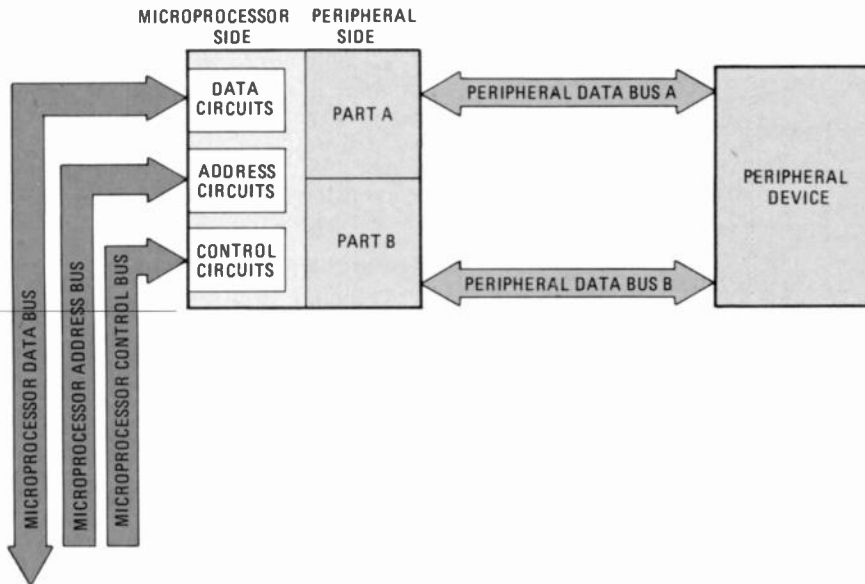

FIG. 2—FUNCTIONAL DIAGRAM SHOWS THE TWO faces of the PIA—the microprocessor side and the peripheral side.

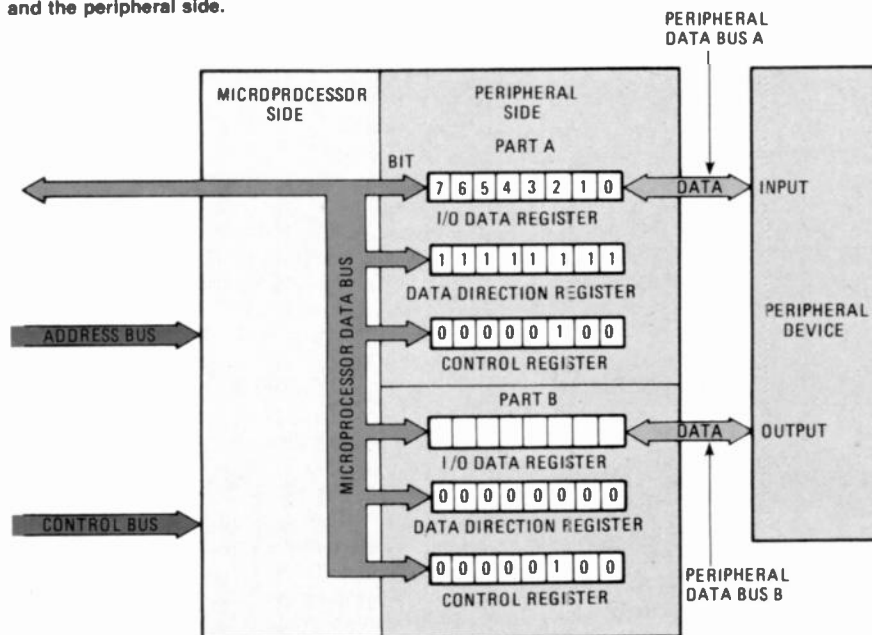

FIG. 3—MAIN REGISTERS OF A TYPICAL PIA. They include both data and control registers.

set to 1, all eight bits of I/O data-register A will output data to the peripheral data bus. If all eight bits of data-direction register A are set to 0, data flow will be from the peripheral data bus to

the microprocessor data bus.

Each bit of I/O data-register A can be controlled individually by loading a 1 or 0 into the corresponding bit of data-direction register A. For example,

if the binary number 11110000 is loaded into data-direction register A bits 0, 1, 2, and 3 of I/O data-register A will be inputs, while bits 4, 5, 6, and 7 will be outputs.

In Fig. 3, data-direction register A is shown loaded with all ones. That sets up I/O data-register A to output eight bits of data to the peripheral data bus. Data-direction register B is shown loaded with all zeros. That sets up I/O data-register B to input eight bits of data from the peripheral data bus.

The number loaded into control-register A determines whether data-direction register A or I/O data-register A is addressed. If control-register A is loaded with binary number 0000-0000 data-direction register A will be addressed. Any data from the microprocessor data bus will be loaded into data-direction register A. If control-register A is loaded with binary number 00000100, as shown in Fig. 3, then I/O data-register A is addressed.

The microprocessor can then read data from I/O data-register A or load data into it depending on the number loaded into data-direction register A. The same principles apply to control-register B which is shown loaded with binary number 00000100 in Fig. 3.

Addressing PIA registers

The PIA registers with typical addresses assigned are shown in Fig. 4. As can be seen, both the I/O data registers and the data-direction registers have the same address. That makes it possible to change the direction of data flow through the I/O data register at any time during the running of a program.

To show how that works, let us assume we are running a program. During the first half of the program we want the I/O data register to function as an input (transfer data from the peripheral data bus to the microprocessor data bus). During the second half of the program we want the I/O data register to function as an output (transfer data from the microprocessor data bus to the peripheral data bus).

To do that, first we initialize the

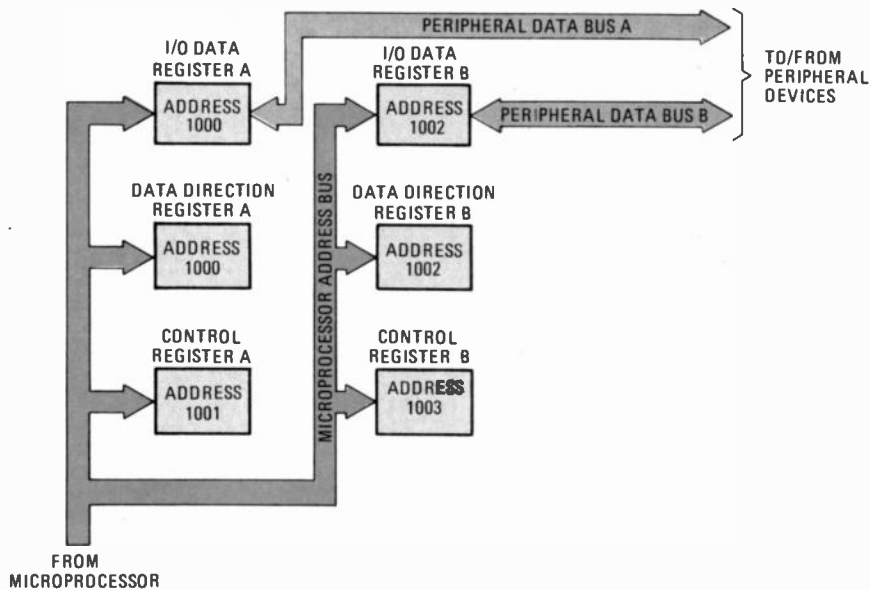

FIG. 4—PIA REGISTERS WITH TYPICAL addresses assigned. Both the I/O data registers and the data-direction registers have the same address.

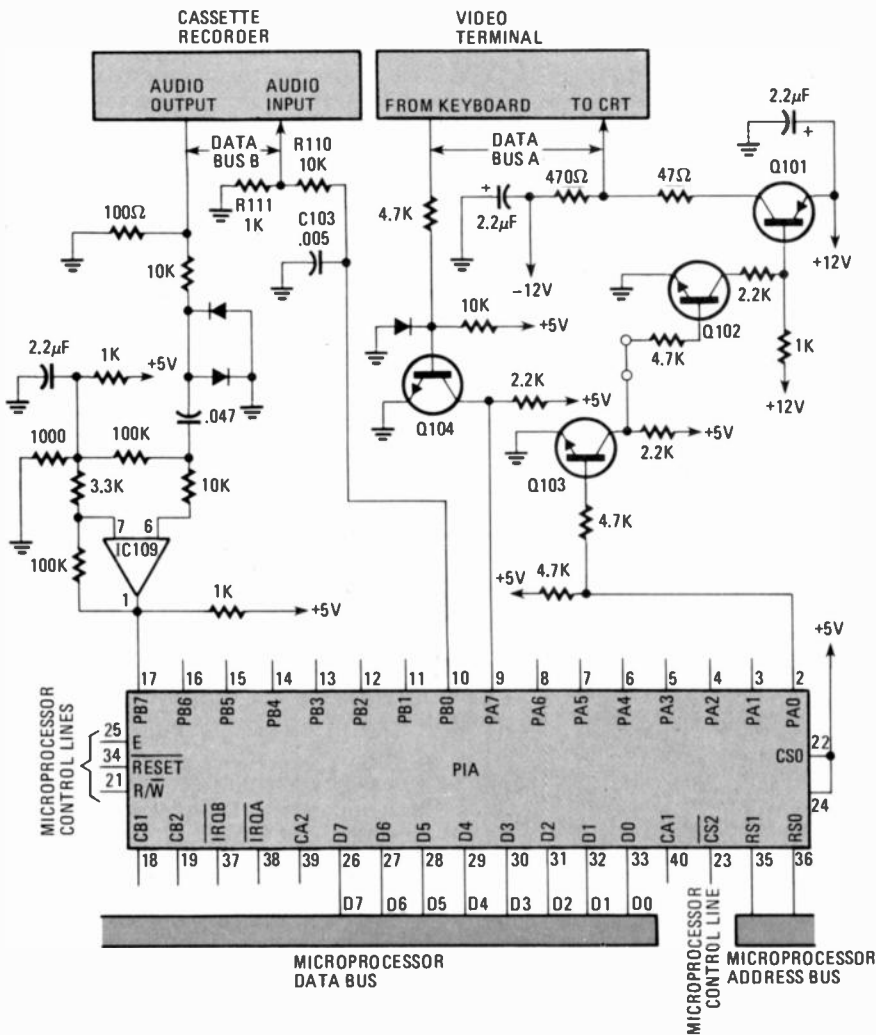

FIG. 5—SIMPLIFIED SCHEMATIC SHOWS how a PIA can be connected as an I/O port.

PIA with the following program instructions:

1. Reset all PIA registers to zero.
2. Load number 4 into address 1001.

Resetting PIA registers to zero sets up the eight bits of the I/O data register

to input data from the peripheral data bus. That is so because the data-direction register which determines the direction of flow through the I/O data register contains all zeros. The second instruction loads the number 4 into the control registers. That causes data sent

to address 1000 to be applied to the I/O data register instead of the data-direction register.

After half the program has been run, the I/O data register may be programmed to output data to the peripheral data bus using the following instructions:

1. Load zero into address 1001.
2. Load 255 into address 1000.
3. Load 4 into address 1001.

With zero loaded in address 1001 all control-register bits are set to zero. That causes address 1000 to be assigned to the data-direction register. Loading 255 into address 1000 sets all eight bits of data-direction register to 1. That causes all eight bits of the I/O data register to output data to the peripheral data bus.

Loading 4 into address 1001 causes address 1000 to be assigned to the I/O data register. Any data sent to address 1000 is stored in the I/O data register. Since that register is configured as an output, the data stored in it will appear on the peripheral data bus.

Using the PIA

There are many uses for the PIA in microcomputer systems. For example, assume we want to use the PIA as an I/O port which can interface the microprocessor to a video terminal and a cassette recorder. Figure 5 shows how it can be done.

The video terminal is connected by peripheral data-bus A to the I/O data register in part A of the PIA. Since the video terminal requires a serial input, only one bit of I/O data-register A is required to output data to the video terminal. Transistors Q101, Q102, and Q103 act as buffers between the PIA output and the terminal input.

The video-terminal outputs serial data and only one bit of I/O data-register A is required to input data to the microprocessor data bus. Transistor Q104 acts as a buffer between the video-terminal keyboard output and PIA bit-7 input.

The cassette recorder is connected by data-bus B to the I/O data register in part B of the PIA. Since the cassette recorder audio input requires serial data, only one bit of I/O data-register B is required to output data. Resistors are part of R111, and R110 form a voltage divider to limit the signal level applied to the audio input. Capacitor C103 filters unwanted noise signals.

The audio output of the cassette recorder outputs serial data and is connected to one bit of I/O data-register B. The network between the audio output and I/O data-register B limits the signal to a level compatible with the input requirements of I/O data-register B.

Once the ins and outs of the PIA are understood, finding new applications should be relatively simple. R-E

BUILD THIS

UNICORN-1 ROBOT



Assembling the Body

Part 4—Here's the first of two installments dealing with how to construct a body for the robot. This part describes the body frame and rotation mechanism.

JAMES A. GUPTON, JR.

SO FAR, WE'VE DISCUSSED THE DESIGN and construction of the *Unicorn-1* robot's manipulators (arms), end effectors (hands) and mobility base (legs). We are now past the most difficult aspects of its construction. This part of the series will deal with the body, and that is where the robot will begin to look like a robot.

Body frame

As shown in Fig. 27, *Unicorn-1's* body dimensions allow plenty of interior space for whatever hardware—up to, and including, a computer—you desire to add. The prototype body is 19 inches in diameter and about 20 inches in height. That has been more than adequate for the author's needs, but does not restrict you from using other designs; after all, one of the aims of this project is to allow you to use your own ingenuity. The skin of the robot will be made of *Formica* (which comes in standard widths of 30 inches) so you will easily be able to make a body 30 inches in height, if it suits you. That is an increase of 50% in height over the original specs.

And, of course, you don't have to be restricted to the *R2D2* format. You can use just about any shape you desire.

If you haven't already done so, take an evening or two to decide what your robot will finally look like. That will not require any significant changes in the frame of the body, the principles of which we'll discuss here, but may affect you in the long run.

In any event, your robot's body will

need a supporting structure, and a mechanism to turn it from side to side. That's what this section is about.

Whether the ultimate form of the body is cylindrical or otherwise, a reinforcing structure will be needed. What's shown here is for a cylindrical body, although it can easily be adapted to other shapes. Figure 28 illustrates the top and bottom bulkheads, along with the locations of the eight supporting columns. The bulkheads are made from $\frac{3}{8}$ -inch particle board, cut to dimension with a saber saw. If you have no saber saw, inscribe the circumference of the bulkheads on the board, and drill a closely-spaced series of $\frac{1}{4}$ -inch holes along its *outside* as shown in Fig. 29. After those holes are drilled, the piece can be knocked out with a chisel. Whichever way you proceed, allow a bit extra for wastage—that part of the material that gets turned into sawdust or is chipped away in the process.

When the bulkheads have been rough-cut, they can be dressed to their final dimensions with a wood rasp. Who says that robots are made entirely of metal!

If you make the effort, you will probably be able to find pieces of particle board at your local lumberyard as scrap at a very reasonable price. Should you have to purchase brand-new material, you may be able to get a "special cut," if you tell the person in charge exactly what you need.

The dimensions for the interior bulkheads for *Unicorn-1* were given in Fig. 28. The top bulkhead is nothing more than a ring-shaped section of particle

board, while the bottom bulkhead has a three-legged shape, to support the body during rotation. The larger bulkhead opening in that bottom part permits maximum freedom for the cables running between the body and the mobility base.

After the two bulkheads have been cut to their final shape, the locations of the bulkhead support-columns should be marked (refer again to Figs. 27 and 28). First, draw a pencilled line completely around the bulkheads' circumference. That should be done .040-inch from the perimeter. The holes drilled along that line will be used to attach the columns to the bulkhead. Figure 28 identifies the specific holes that will be required.

Some of those holes, as has been indicated, will have to be countersunk (Fig. 30). That allows the screw heads to sit flush with the outside surface, and eliminates awkward bumps or bulges when the skin is fitted.

The eight wooden bulkhead-support columns are attached to the bulkhead with wood glue or epoxy, wood screws, and aluminum angle-braces. We don't take any chances.

After drilling the bulkheads for the support columns, drill "lead holes", top and bottom, to start the wood screws. That will help prevent splitting the columns. The lead holes should be about one-third the diameter of the wood screws themselves. Then, drill *through* those holes for attachment of the aluminum braces shown in Fig. 27. Lubricate the screws with soap to permit them to

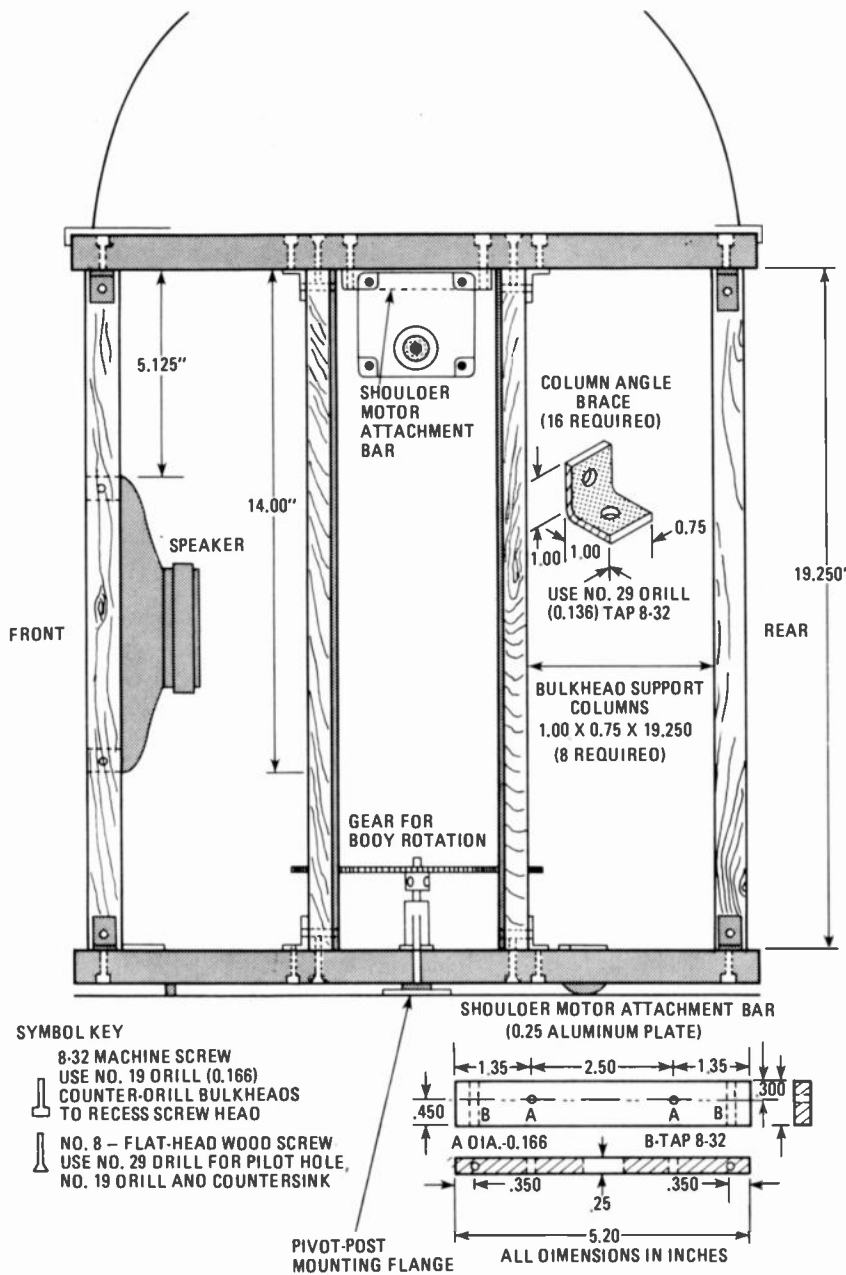
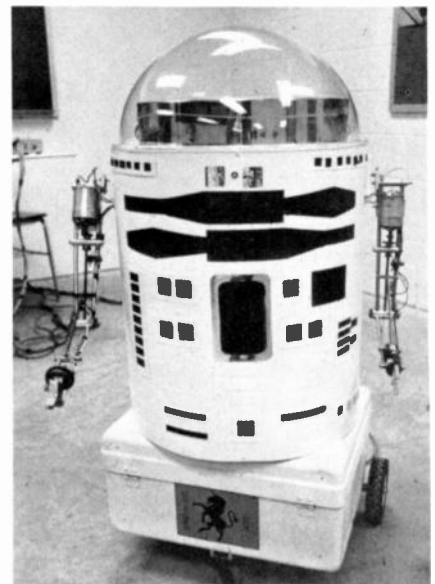
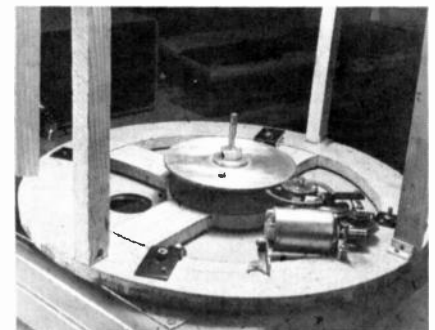

FIG. 27—ROBOT BODY supporting structure is of wooden construction. Note pivot-post mounting flange and ball-bearing wheels beneath the bottom bulkhead.



BENEATH THIS RUGGED EXTERIOR lies a frame of wood. Next installment will describe skin.



COMPLEX GEAR TRAIN used to slow 10,000-RPM motor to 11-RPM for body rotation.

4. Gear-shaft bore diameters: .125-inch to .750-inch (.250-inch preferred).
5. Body rotation speed: 4 to 22 RPM (10 to 12 RPM preferred).

Just as in the design of the mobility base, there is a choice of methods to drive the body. An inexpensive, high-speed motor may be used if its speed is reduced through a series of gears. A speed-reduction of about 1000:1 is required with this method to obtain a rotational speed of 11 RPM. That, it should be obvious, requires several gears.

The amount of speed reduction is a factor of the number of teeth on each gear. If one gear has 16 teeth and another has 48, the gears have a ratio of 1:3 and driving the second gear with the first will reduce the speed by that factor (the second gear will only make one revolution for each three made by the first). A train of such gears would eventually reduce the small motor's 10,000 RPM to a useable rate, but, as Fig. 32 shows, could turn out to be somewhat complex.

Also, the speed of rotation will be affected by the weight of the load (the robot's body, in this case)—the motor speed could be slowed by 10 to 20 percent by that factor.

As in the case of using gears to drive

penetrate more easily, and to prevent splitting.

Body rotation

Unicorn-1's body turns on ball-bearing wheels that ride on the steel plate forming the top of the mobility base. The size of those wheels is not particularly significant, as long as the body maintains its clearance from the base. The units used in the original *Unicorn-1* had a diameter of .875-inches, giving the bulkhead a clearance of .125-inch from the mobility base. One of these is shown in Fig. 31.

As we have done previously, we stress the fact that nothing about this robot is critical. Since you may be "scrounging"

many of the components for this section, we'll present a list of allowable parameters, along with the dimensions we've found to be most satisfactory.

1. **Ball-bearing wheels:** .375-inch to 1.125-inches diameter. For wheels larger than .5-inch, turn the mounting plate upside down (bearing mounting-flange facing up).
2. **Pivot-post mounting flange:** .062-inch to 1-inch thick. Mount any flange thicker than .125-inch inside the top of the mobility base.
3. **Pivot-post diameter:** .250-inch to 1-inch (.250-inch to .375-inch preferred).

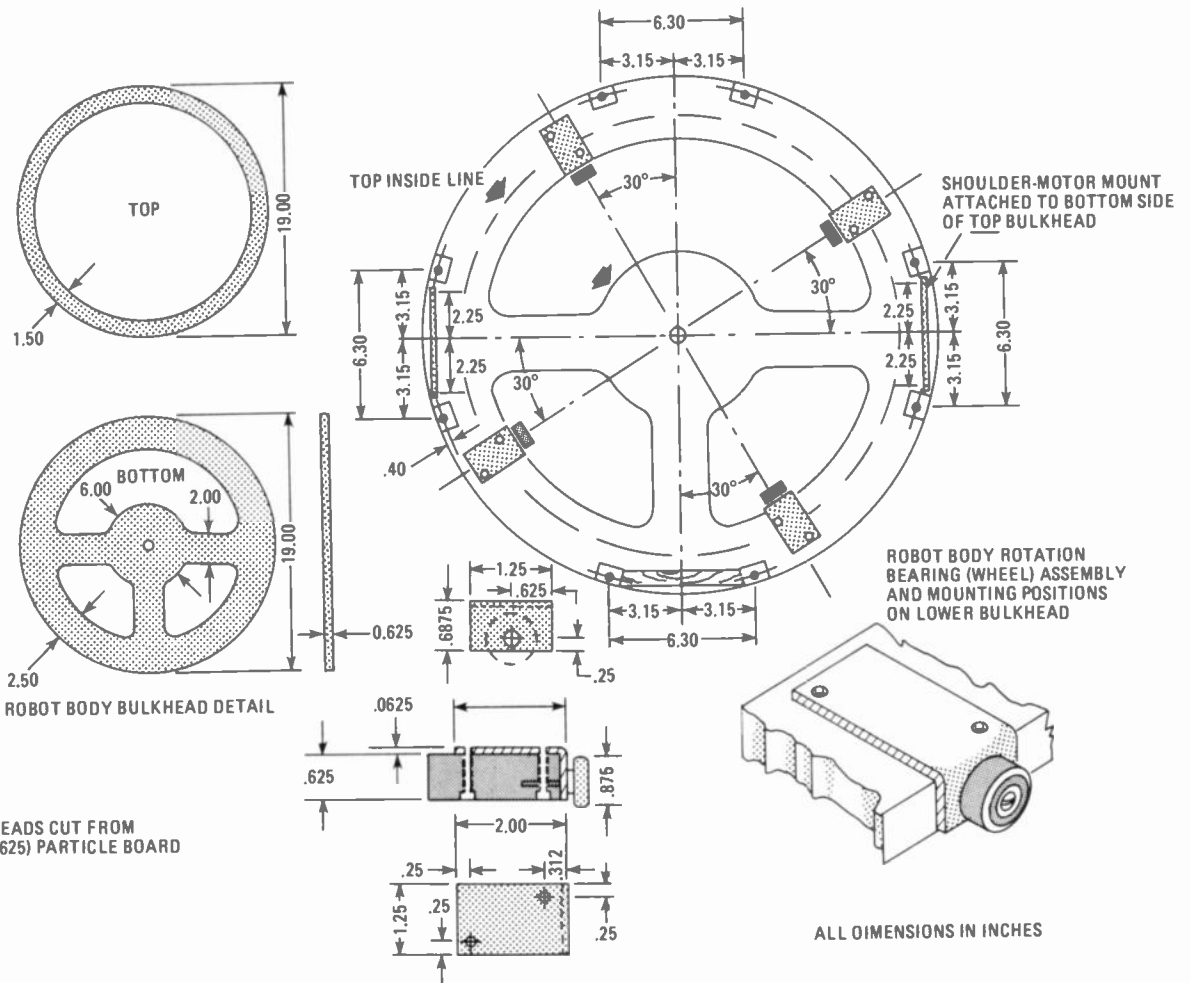

ALL DIMENSIONS IN INCHES

FIG. 28—TOP AND BOTTOM BULKHEADS are cut from particle board. Bottom bulkhead is sturdier to bear body weight. Bearing mounting brackets are made from 1/4-inch aluminum.

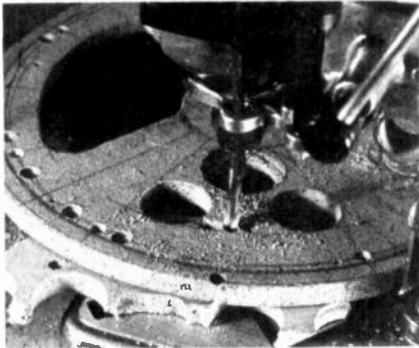

FIG. 29—A SERIES OF SMALL HOLES can be drilled to rough-cut bulkheads to shape.



FIG. 30—COUNTERSINKING holes in the bulkhead prevents screwheads from protruding.

the mobility base, this method presents more problems, perhaps, than it solves.

A much simpler method uses the same type of low-speed gear motor that was used to drive the mobility base. As shown in Fig. 33, this motor can be mounted directly on the bottom bulkhead and its shaft connected directly to the pivot post and/or the pivot-post mounting flange, located on the mobility base.

Mounting of this type of motor is fairly straightforward and presents the least number of complications. A 22-RPM gearmotor may be used, or, if you can locate it, a slightly slower-speed one (about 10 or 12 RPM) may prove to be preferable.

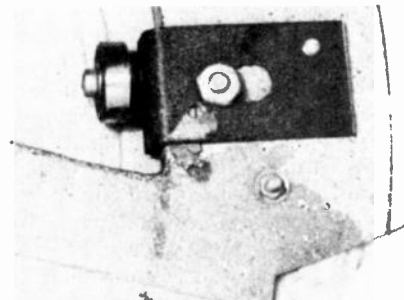

FIG. 31—BALL-BEARING WHEELS mounted on bottom bulkhead support body as it rotates.

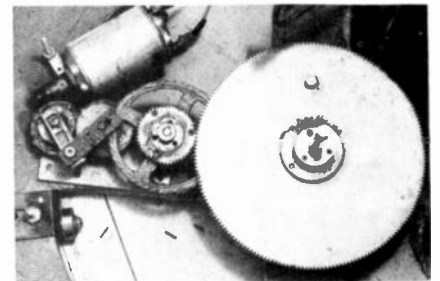

FIG. 32—COMPARE complexity of this speed-reduction train with drive shown below.

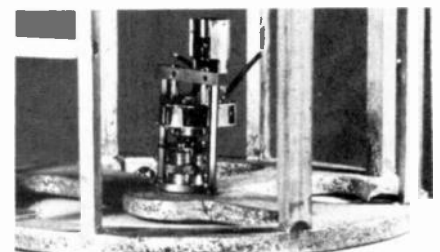

FIG. 33—22-RPM gear motor provides simplest and most direct means of rotating body.

Motor connection will be made to a small terminal strip mounted in the body.

Shoulder motors

When the manipulators and end effectors were described, the robot was given

PARTS LIST

Item	Size	Quantity	Supplier's part no.	Supplier	Item	Size	Quantity	Supplier's part no.	Supplier
Particle board	19 X 19 in. minimum	2		Local	gears (for use with high-speed motor)	teeth, 1/4-in. face, 1/4-in. bore		023	
Wood strips	.25 X 1 X 19.25 in.	8		Local					
Aluminum plate	.25 X .75 X 5.2 in.	2	AP52	(A) or local		48 pitch, 120 teeth, 1/4-in. face, 1/4-in. bore	3	C48A18-120	(A), (B)
Aluminum angle	.0625 X 1 X 1 X .75 in. (make from .0625 X 1-in. angle, 13 in. long)	16		Local	Pivot post	See text. Length to suit design	1		Local
					Pivot-post mounting flange	See text	1		Local
Aluminum sheet	.125 X 1.25 X 3 in.	4	AS3	(A) or local	Body motor (high-speed)	3-amp, split phase, 12 volts DC	1	61.085	(C)
Ball bearing wheels	.875 in. diameter, .375 in. shaft diameter	4	B11-10	(A),(B)	Body motor (22-RPM gearmotor)	22-RPM gearmotor, 12 volts DC	1	715-900153	(A), (D)
	or				Shoulder motor	22-RPM gearmotor, 12 volts DC	2	715-900153	(A), (D)
	.625 in. diameter, .25 in. shaft diameter	4	B11-9	(A),(B)					
Wheel mounting screws (known as "shoulder screws")	To fit wheel centers	4		Local					
Shoulder motor mounting screws	8-32	4		Local					
Gearmotor mounting screws	8-32, length as needed	4		Local					
Machine screws	8-32 X 1, Fillister-head	44		Local					
Wood screws	#8 flat-head X 1 in.	20		Local					
Precision spur	48 pitch, 23	3	C48A18-	(A),(B)					

SUPPLIERS

- (A) **The Robot Mart**
Room 1113
19 W. 34th St.
New York, NY 10001
(Catalog \$3.00)
- (B) **Winfred M. Berg, Inc.**
499 Ocean Avenue
E. Rockaway, NY 11518
- (C) **Edmund Scientific Co.**
101 East Gloucester Pike
Barrington, NJ 08007
- (D) **Gledhill Electronics**
P.O. Box 1644
Marysville, CA 95901

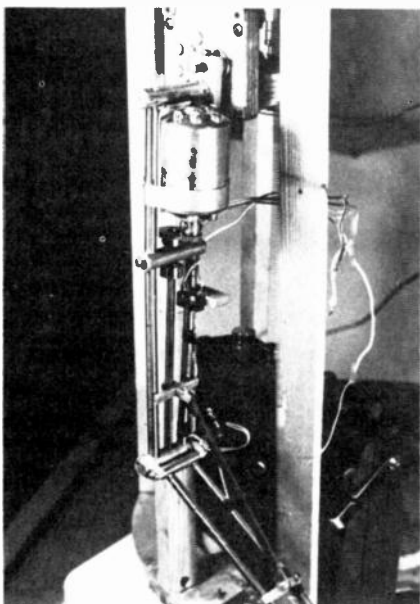

FIG. 34—SHOULDER MOTOR mounting plate is visible at very top of photograph. See Fig. 27 for body location.

the ability to bend his arms at the elbow and to open and close his hands. It would be useful to add another degree of freedom, which would allow the arms to be raised and lowered. That is easily accomplished with the same 22-RPM gearmotors we've already used.

A five-ohm, 20-watt resistor can be used to drop the motor's supply-voltage, thus slowing it down to a more suitable speed. (The same can be done for the body motor.)

The last cross-bar rod (at the shoulder hinge) on the manipulators has already been drilled to accept a shaft of the type found on these motors (refer back to Part 1, August 1980 issue). A simple bracket, shown in Fig. 27, allows the motor to be attached to the body. An actual installation of that sort is pictured in Fig. 34. Be sure that the mount is positioned so the surface of the gearmotor will be flush with the surface of the top bulkhead since, when the robot's skin is attached, a cutout will have to be made for the shoulder gearmotors, and their faces should be

flush with the skin's surface.

Again, the shoulder-motor wiring will be connected to a local terminal strip.

Alternatively, the manipulators may be affixed to .250-inch rods that are attached to the body frame, without motors. The motors can always be added later.

Bear in mind that, although the skin will be removable, as much interior work as possible should be completed before it is attached. Some of the things that remain to be added are:

1. "Local" terminal strips for motor wiring and connections from them to the master terminal strip in the mobility base.
2. Speaker and LED installation.
3. Installation of supports and brackets for radio control and/or computer equipment.

In the next section of this series, we'll complete the work described above and attach the skin. In addition, we'll describe the construction of the control box that will allow you to operate the robot by means of a cable running to the mobility base.

A BYTE OF POWER

Triacs are one way of switching alternating current. Because they are solid-state and operate from logic-level signals, they are well-suited to interfacing computers with electrical devices. Here are plans for an 8-channel board to do just that.

L. STEVEN CHEAIRS

WITH THE ADVENT OF MICROCOMPUTERS a whole new world has opened up wide for the home-electronics enthusiast. processing are but a few of the uses that have become routine. An often overlooked area, and one where microprocessors excel, is in household controllers. Those may be environmental controls, room-lighting sequencers, darkroom aids, fire alarms, burglar alarms, appliance controls, sprinkler system controls, etc.... The list is bounded only by your imagination. One common requirement for most of those controls is the need to switch household AC power. The circuit described in this article contains eight separate AC power switches—a byte of power.

Each switch is isolated from the other seven. All of them use triacs to provide true bidirectional current flow. By choosing the appropriate resistor/capacitor values, either sensitive ($I_{GT} < 15 \text{ mA}$) or non-sensitive ($15 \text{ mA} < I_{GT} < 50 \text{ mA}$) triacs may be used. (I_{GT} is the gate trigger-current.) Two of the eight power switches have all three triac lines brought out to the edge of the printed circuit card; that permits those on-board triacs to trigger two high-current triacs external to the PC board. The latter would be mounted on heat sinks and their terminals cabled to the printed-circuit board. The triacs are turned on or off with a logic gate—10 mA maximum current. The logic input is photo-optically isolated from the AC power-output stage.

About the circuit

As stated earlier, the printed-circuit card contains eight identical switching circuits. Figure 1-a shows the circuit to use for an inductive load with a sensitive-gate triac. Fig. 1-b provides

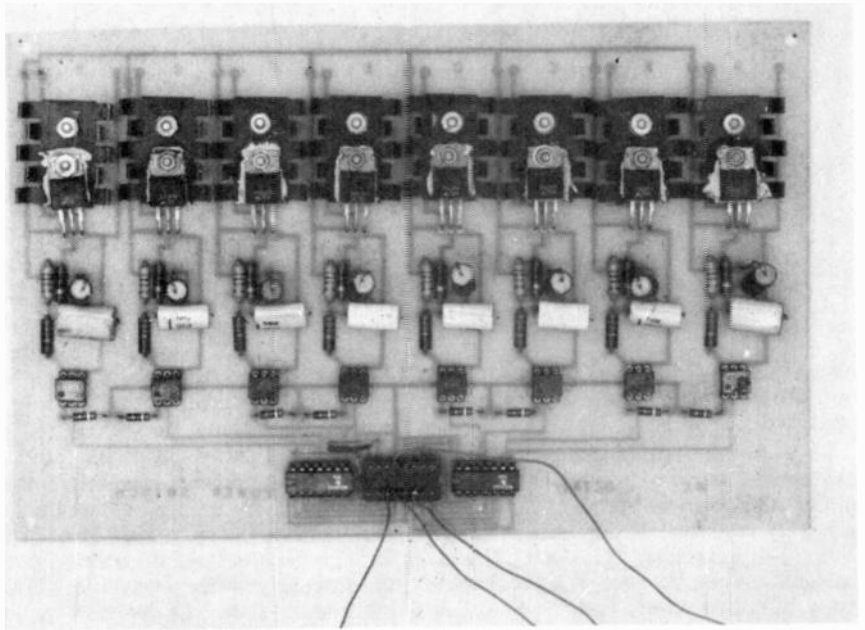

BYTE OF POWER AC CONTROLLER board uses eight optoisolator-driven triacs to provide computer control of "outside world" AC-operated devices.

the inductive load-configuration for the non-sensitive-gate triac, and Fig. 1-c illustrates the setup for resistive loads. Each triac is driven by a MOC3011 optically-isolated triac driver which, in turn, is driven by a 74125-type buffer acting on instructions from a computer.

The optically-isolated triac drivers are fabricated using a gallium-arsenide, infrared light-emitting diode that is optically coupled to a silicon bilateral switch. The electrical insulation is about 7500 peak volts. The LED trigger current required to latch the output is typically 5 mA; the maximum is 10 mA. Since the input is driven by a open-collector gate operating at +5 volts, then the value of resistor R1

is chosen to provide greater than 10 mA of current through the diode. The value calculated for that circuit was 390 ohms.

The output driver has a terminal voltage, off-state, of 250 volts. At 70°C, the on-state current (full-cycle 60 Hz) is 50 mA; at 25°C the on-state current is 100 mA. Resistor R2 sets the current level for the output driver. For the sensitive-gate inductive-load circuit in Fig. 1-b, resistor R3 has a value of 2,400 ohms and capacitor C1 is equal to 0.1 μf . For the nonsensitive inductive-load circuit, resistor R5 is 1.2 K and capacitor C1 is 0.2 μf . Resistor R4 and capacitor C2 are used to reduce false triggering due to line transients caused by the inductive load

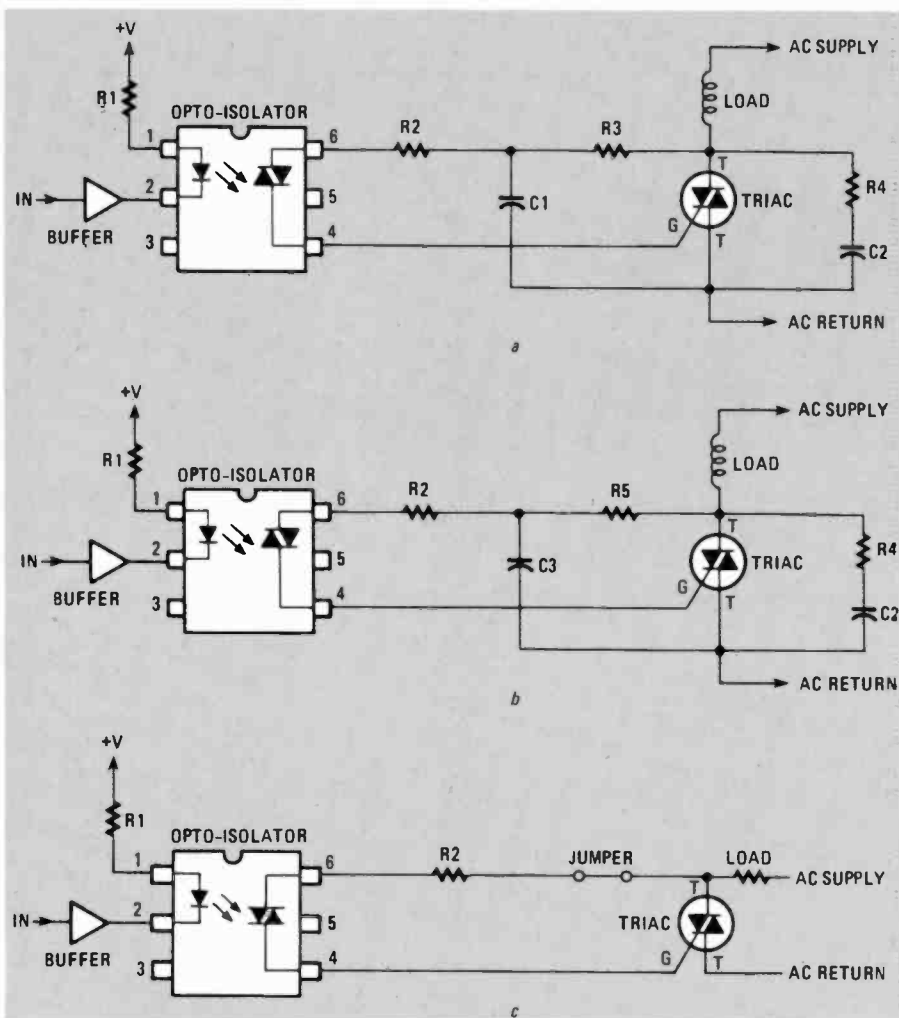

FIG. 1—USE THE TOP TWO CIRCUITS, a and b, with sensitive and non-sensitive-gate triacs, respectively, for inductive loads. Circuit c is for use with resistive loads.

element. A value of 10 ohms for R4 and 0.1 μ f for C2 seems to do the job quite well.

If a non-inductive load is to be switched, then the circuit can be simplified as shown in Fig. 1-c. Capacitor C2 and resistor R4 are not needed since no inductive "kick-back" will be seen. Also, resistor R3 and capacitor C1 are unnecessary. Place a jumper wire where resistor R3 would have been located.

Thermal considerations

On the printed-circuit board, space is provided for a small, 1 x 1-3/16-inch, TO-222-style heat sink. The maximum current that can be passed through the AC switch is a function of its power dissipation. That factor is defined by the thermal resistance between the silicon chip and its environment. Before beginning construction, one must decide the amount of power needed. If more power is needed for the load than can be handled by the triac and its heat sink, then a heavier-duty, off-card triac and heat sink must be connected to the board.

To determine how much current

can be passed through a triac, you must first determine the amount of power that can be dissipated by the silicon chip into its environment. Heat (power) can be removed by any of three means: conduction, convection, or radiation. Heat transfer by *conduction* is very effective in moving energy from the chip to the heat sink. *Convection* is the mode of transfer that transfers heat from the heat sink into the air. A portion of the heat is also *radiated* from the heat-sink fins.

Since most readers are familiar with the basics of electrical energy

flow, a comparable model will be used to illustrate heat flow. Electrical resistance is defined by Ohm's law. Ohm's law states that *resistance to the flow of an electrical current (in ohms) will equal the potential divided by the current ($R=E/I$)*.

The potential will be measured with reference to ground; that is, potential will be the difference in voltage available from the energy source and the ground level ($E = E_S - E_G$, where E is the potential, E_S is the potential level of the source, and E_G is the potential level at ground). Thus, an equation for the electrical resistance is $R = (E_S - E_G)/I$. Generally E_G will be zero since it is defined as system ground. Current flow is represented by I.

For thermal resistance, a similar equation exists: potential is the difference between the source temperature and the ambient temperature; energy flow is the power (heat) dissipation. Therefore, $\theta_{JA} = (T_J - T_A)/P_D$; where T_J is the junction temperature in degrees Celsius, T_A is the ambient temperature in degrees Celsius, P_D is the power dissipation in watts, and θ_{JA} is the thermal resistance from the silicon chip's junction to its environment in degrees Celsius per watt.

Heat must flow from the junction of the chip to the triac's case, then from the case to the heat sink, and then from the heat sink to the air. At each of those interfaces a certain amount of thermal resistance is encountered. If we were discussing electrical energy flow, a simple resistor network as seen in Fig. 2-a could be drawn. Let us use an analogous method to represent the thermal energy flow in Fig. 2-b. Three resistors, the thermal interfaces, are connected in series. One end is connected to the heat source and the other is the environment, which is at a lower energy potential. The first resistor would represent the thermal resistance from the chip's junction to the triac's case, θ_{JC} ; from Motorola's specification sheet for the 2N6349A triac, a value of

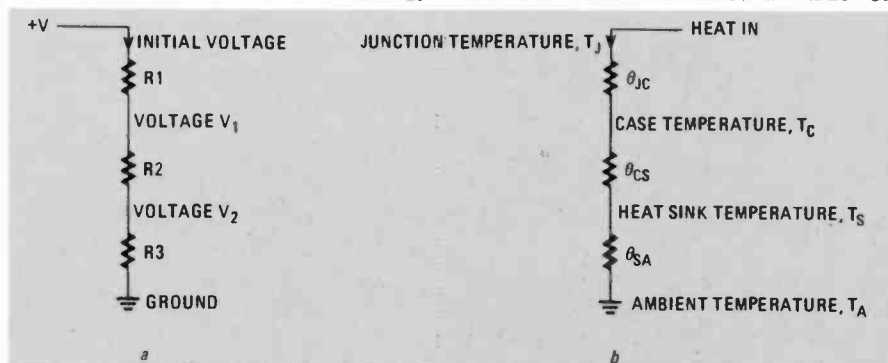

FIG. 2—JUST AS ELECTRICAL POTENTIAL (voltage) is referenced to ground (a), so can the temperature of a semiconductor junction be referenced to the temperature of the air in its vicinity (b).

$2^{\circ}\text{C}/\text{W}$ is given for θ_{JC} . The next resistor represents the thermal resistance between the 2N6349A's case and the heat sink. Assuming that thermal grease is used, the value of θ_{CS} is $0.8^{\circ}\text{C}/\text{W}$. The author used a heat sink with an θ_{SA} (thermal resistance from sink to environment) rating of $19^{\circ}\text{C}/\text{W}$. Therefore, the total thermal resistance is a sum of these three resistances: $\theta_{\text{JA}} = \theta_{\text{JC}} + \theta_{\text{CS}} + \theta_{\text{SA}}$. The value of θ_{JA} is $21.8^{\circ}\text{C}/\text{W}$.

If we assume a temperature of 60°C inside the cabinet that the printed circuit will be housed in, and use the maximum junction temperature from the thermal equation presented earlier, then the maximum power dissipation at the junction will be $2\frac{1}{4}$ watts. From the curve shown in Fig. 3, one can determine that the maximum current, I_{T} , at 60°C will be on the order of $2\frac{1}{2}$ amps. This means that, at 117 volts AC, devices up to about 290 watts can be switched. That is a *maximum* rating; For practical applications keep your current level to between $1\frac{1}{2}$ and two amps. If more current is required, use the triac off-card on a heat sink with a lower θ_{SA} rating. Note: Two of the eight switches have all three of the required lines brought out to the edge of

the card so that extra triacs and heat sinks can easily be employed.

Construction

Construction is relatively simple

because the circuit is so straightforward. On his prototype, the author used 2N6349A devices. Since the typical gate current (I_{GT}) for this triac can be as high as 25 mA, it is clas-

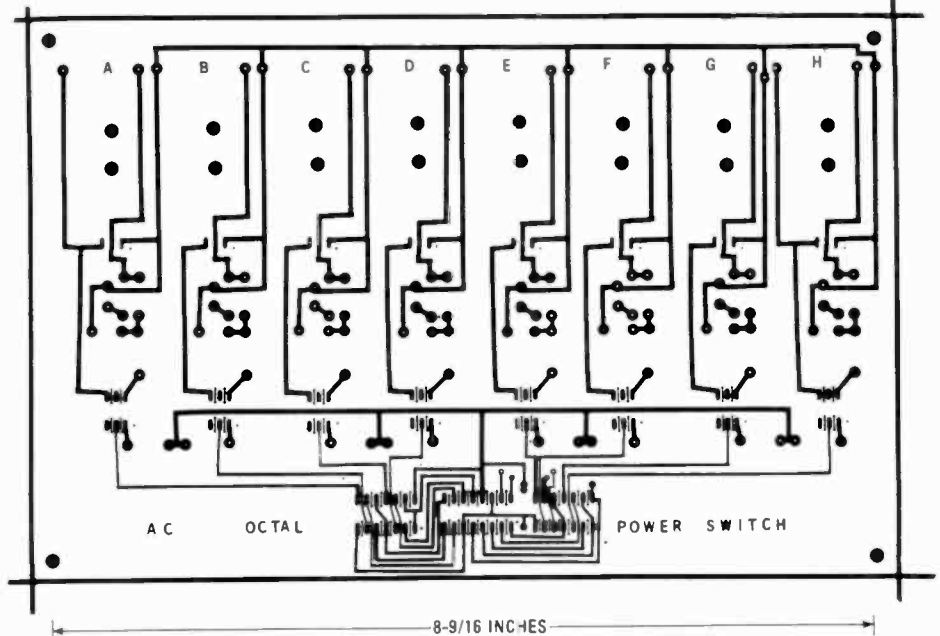

FIG. 4—AC CONTROLLER is built using an easily laid out PC board.

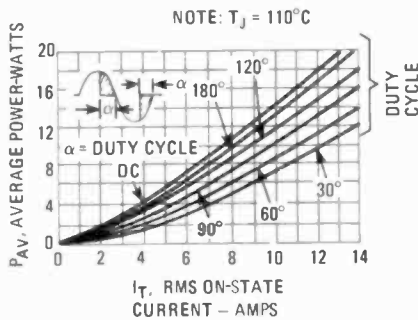

FIG. 3—POWER DISSIPATION plotted against current. Use DC curve for your calculations.

PARTS LIST—AC SWITCH

All resistors $\frac{1}{2}$ watt, 10%, unless otherwise noted

R1-R8—390 ohms, $\frac{1}{4}$ watt, 5%

R9-R16—180 ohms

R17-R24—2400 ohms or 1200 ohms (see note below)

R25-R32—10 ohms

Capacitors

C1-C8, C17— $0.1 \mu\text{F}$ or $0.2 \mu\text{F}$ (see note below)

C9-C16— $0.1 \mu\text{F}$

Semiconductors

IC1-IC8—MOC3011 optoisolated triac driver (Motorola)

IC9-IC16—2N6349A or equivalent triac

IC17, IC18—74125 quad bus buffer

Miscellaneous: PC board, heatsinks (8), hardware, etc.

Note: The part numbers above are related to those given in the text and in Fig. 1 as follows: R1-R8 = R1, R9-R16 = R2, R17-R24 = either R3 or R5, R25-R32 = R4, C1-C8 = either C1 or C3, C9-C16 = C2.

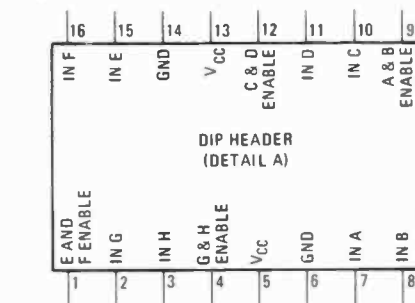
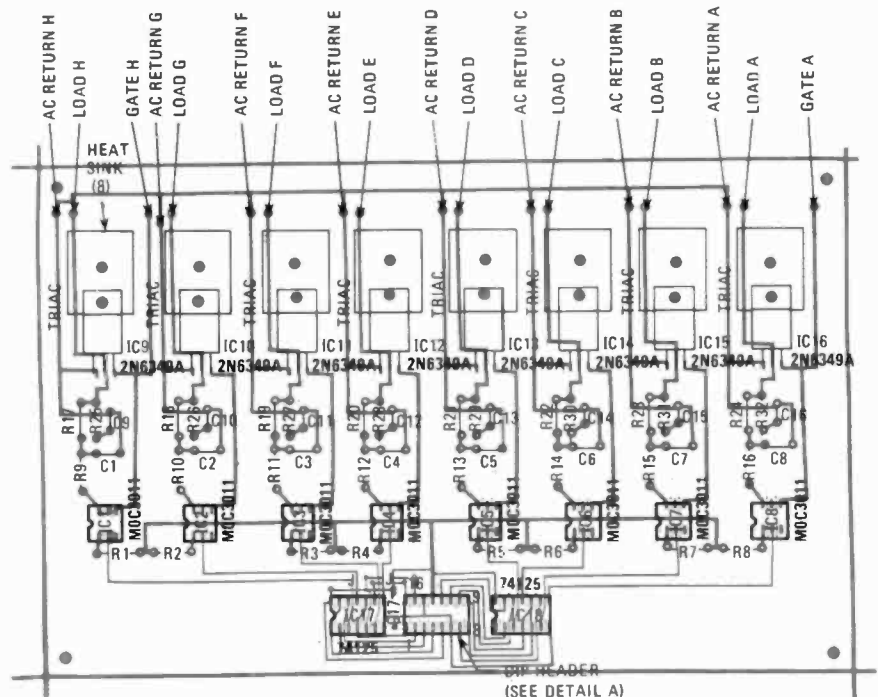

FIG. 5—ALL THREE LEADS of the outermost triacs are brought out to edge of board (see text). Detail "A" shows pinout of DIP header for connection to computer.

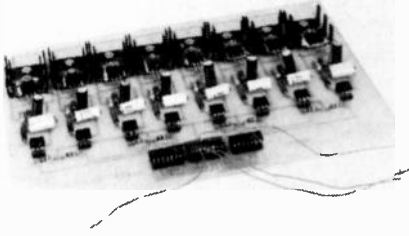

FIG. 6—CONNECTION to the AC controller is made through DIP header. Ribbon cable may be used instead of individual wires.

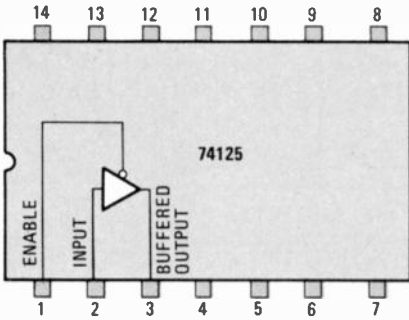

FIG. 7—ONE GATE of 74125 quad buffer. No output will be obtained unless both INPUT and ENABLE are at logic "0".

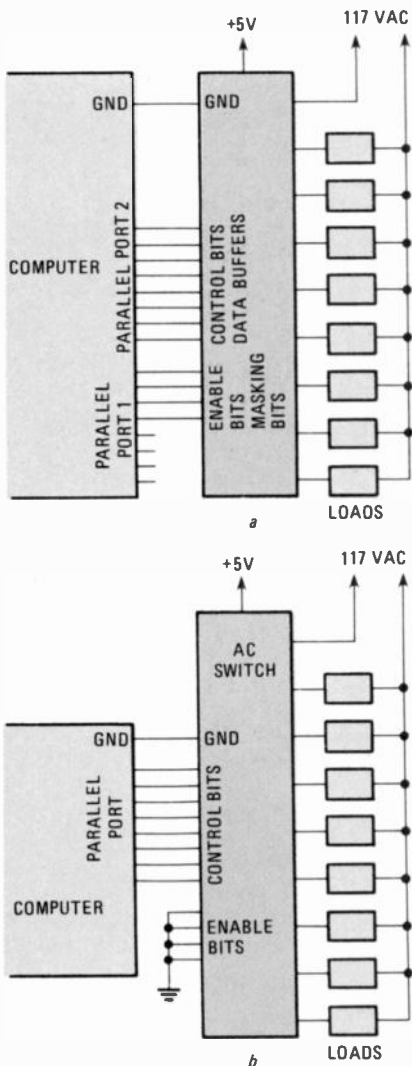

FIG. 8—IF SEVERAL PARALLEL PORTS are available at computer, use hookup shown in a; with only one port, use that in b.

sified as a non-sensitive gate type, and the circuit from Fig. 1-b was used.

If you have a sensitive-gate triac with similar pinouts (on the 2N6349A, pin 1 is main terminal 1, pin 2 is main terminal 2, pin 3 is the gate, and the tab is connected to pin 2), then use the resistor/capacitor values recommended for that gate-current range. (Refer back to Fig. 1-a.) And if only resistive loads—such as toasters, lamps, and coffee pots—are to be used, then you may omit capacitors C1 and C2 along with resistors R3 and R4 and install a jumper in place of resistor R3 as shown in Fig. 1-c.

The circuit uses a single-sided PC board, whose foil pattern is given in Fig. 4. It is quite simple to fabricate; but for those who don't have the facilities, a source for the etched board is given in the parts list.

When installing the triacs on the printed circuit card as per Fig. 5, use a liberal amount of thermal grease between the triac and its heat sink. Also, make sure that the fins of each heat sink clear the fins of its neighbor. The optoisolated triac drivers may be soldered to the board or plugged into sockets. Make sure they are oriented as shown.

After all the components have been installed and soldered into place perform a final inspection. Use Figs. 5 and 6 to check your work. Now connect a TTL driver, a 74125, to one of the input lines via the DIP header (refer to Fig. 5).

At the appropriate triac output connect the common AC line via a fuse to one wire of a line cord: from the other AC output line run a wire to an appropriate load. Connect the other terminal of the load to the remaining line-cord wire. Plug the line cord into an AC outlet. By toggling the input of the 74125 driver, the AC load should be turned on and off. Repeat that procedure for the other seven power switches. **Be careful—the output portion of this circuit has live 117-volt AC power!**

Interfacing to a computer output port

The AC switch is connected to the computer by means of the 16-pin DIP header located between the two 74125's. A control-bit input for each of the eight triacs is provided for, as well as four enable bits—one enable bit for each pair of triacs.

The reason for using two bits (control and enable) for each triac is, primarily, for the sake of security. Even if the computer outputs a control bit to turn on a given triac, the triac will not turn on until an enable signal is also sent. Figure 7 shows one section of a 74125 and Fig. 5 illustrates the DIP header configuration.

Figure 8-a shows the best way to control the AC switch, using two 8-bit

parallel ports. One port sends out the control (input) bits for the triacs you want to turn on, and half of the other is used to send the enable bits for those triacs.

If your computer has only a single parallel port, you'll have to do things somewhat differently. That port will

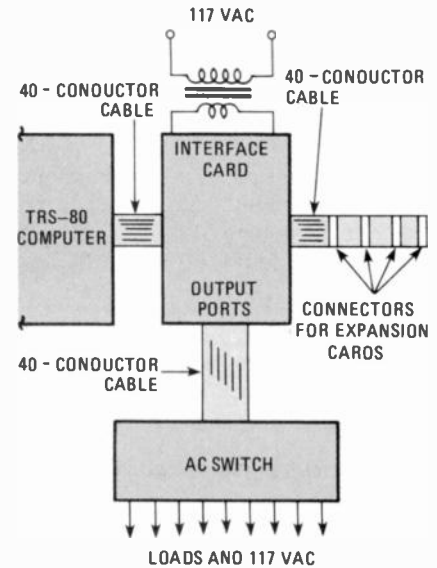

NOTES:

- +5 VOLT POWER FOR AC SWITCH IS ON PINS 37 & 39. OUTPUT PORT ENABLE LINES MUST BE GROUNDED

FIG. 9—INTERFACE CARD allows AC controller to be used with TRS-80 while providing buffering for addition of other boards.

PARTS LIST—TRS-80 INTERFACE

Resistors, 1/4 watt, 5%

- R1, R2—2200 ohms
- R3—100 ohms

Capacitors

- C1—100 μ F, 25 volts, electrolytic
- C2, C3—2.2 μ F, 20 volts, tantalum
- C4-C8, C10—.01 μ F
- C9—100 pF

Semiconductors

- D1-D4—1N4003
- IC1—74LS30
- IC2—7805 five-volt regulator
- IC3, IC5, IC6—74LS244
- IC4—74LS04
- IC7—74LS245
- IC8, IC9—74LS364
- IC10—74LS15
- IC11—74LS02
- IC12—74LS25

Miscellaneous: PC board, IC sockets, 40-pin ribbon-cable sockets (3), ribbon cable with connectors, hardware, etc.

The following are available from Quest-Star Electronics Co., 5412 Burntwood Way, Las Vegas, NV 89108: AC SWITCH: Kit of all parts \$115, PC board only \$14.95, MOC3011 \$5.50 each.

TRS-80 INTERFACE: Kit of all parts (except case and cables) \$102.75, PC board only \$21.95. Cables are about \$20 each—write for exact prices.

Please add \$1.75 for shipping and handling. Nevada residents add 3 1/2% tax.

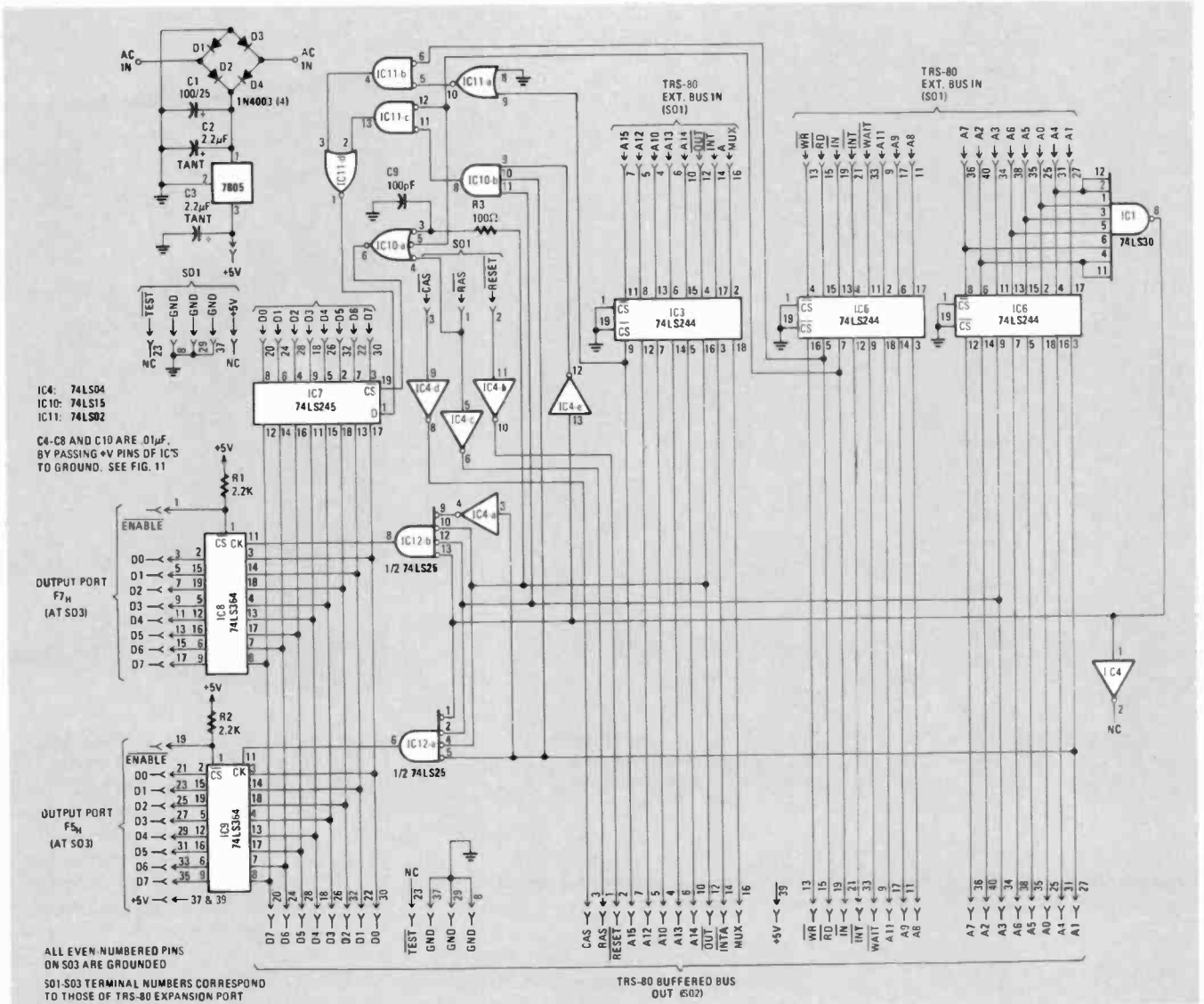

FIG. 10—BUFFERS on TRS-80 interface card prevent loading down computer's unbuffered port. Bars over signal designations indicate logic "0" control signals.

be used to send the control (input) bits, but all the triacs will be permanently enabled by tying the ENABLE lines at the DIP header to ground. (The 74125 will not pass a signal—such as a control bit—unless the ENABLE line is low.) Any bit-masking—making sure that only the bits you want the computer to output actually are—will have to be done in software, rather than through use of the ENABLE lines. That approach is illustrated in Fig. 8-b.

Interfacing the AC switch to a TRS-80

The Radio Shack TRS-80 computer has no external I/O ports to use for interfacing with the AC switch card, but it *does* have an external bus. Unfortunately, the bus is only rated for a single TTL load, but it's adequate if you only want to drive a single IC, and in our case we could do just that. You will probably want to use that bus for further expansion of the system, though. To accomplish that, you'll have to add output ports and buffer the external bus. Figure 9 shows how the final hookup would appear.

A schematic of the TRS-80 bus

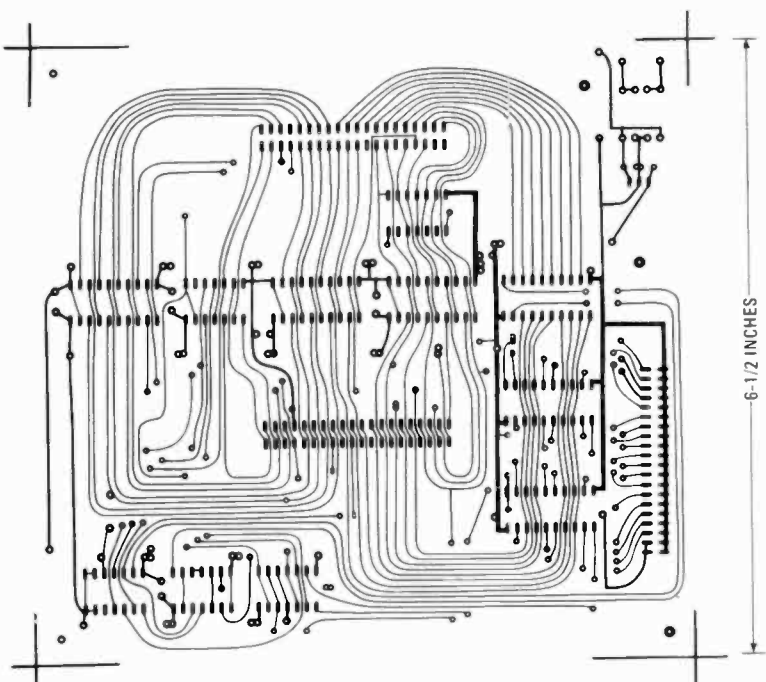

FIG. 11—SINGLE-SIDED PC BOARD is used for construction of TRS-80 buffered interface.

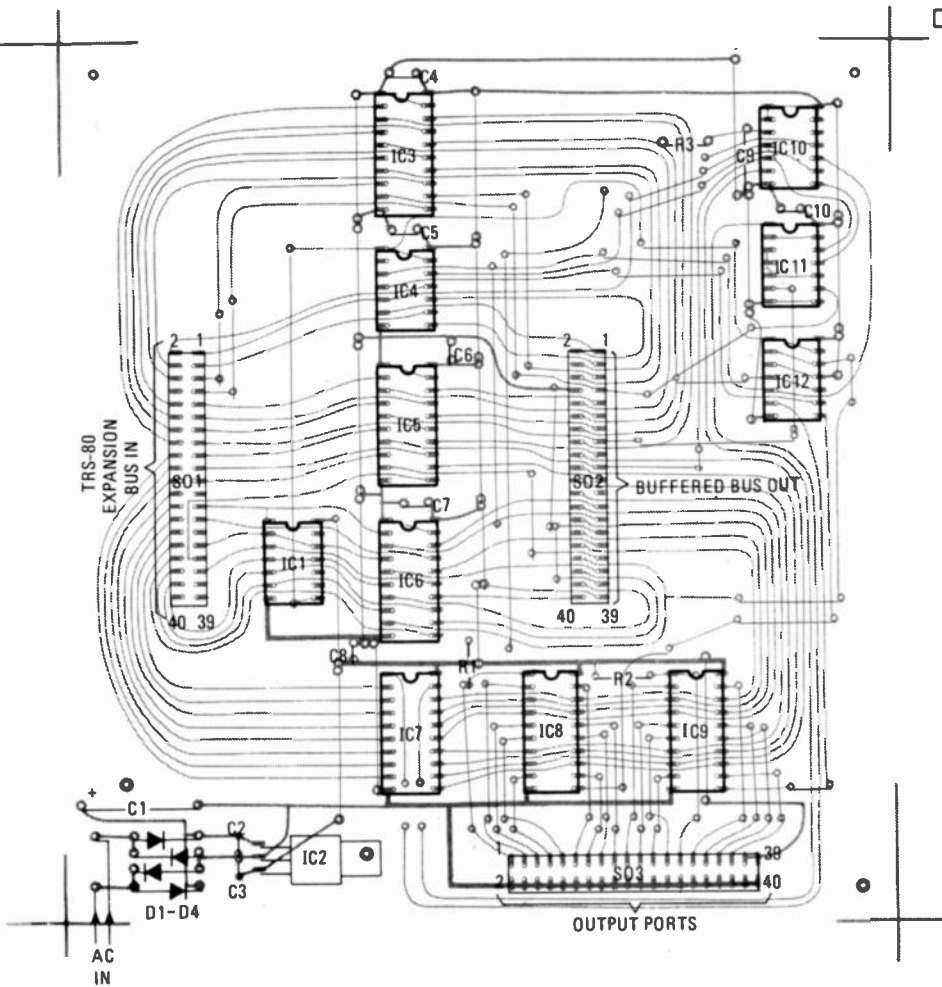

FIG. 12—EXTENSIVE USE OF JUMPERS makes single-sided design possible. They should be the first parts installed. One-ampere, 8 to 12-volt transformer is required.

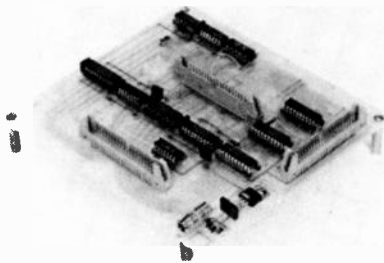

FIG. 13—USE THE TRS-80 INTERFACE as shown or, better, enclose it in a protective case for security.

buffer and output-port expansion circuit is presented in Fig. 10. It isn't as complex as it looks. Basically, each line coming in from the TRS-80 expansion port has a buffered counterpart leaving the interface board. The data lines are buffered bidirectionally, so that data can flow in both directions. Since the TRS-80 already uses the lower 32K of memory and I/O port FF (hex), the interface board is set up to permit only data transfers to and from the upper 32K of memory, and to use the remaining 255 I/O ports. The two output ports used for the AC switch are F5 and F7 (hex), using IC9 and IC8, respectively.

The foil pattern for that board is shown in Fig. 11, although an already-prepared board is available (see parts list). A parts-placement guide is given in Fig. 12. The board requires a number of jumpers, being single-sided, and those should be installed first. The IC sockets may then be mounted and, after that, the resistors and capacitors. When they have all been soldered in place, the three 40-pin ribbon-cable sockets can be installed. Finally, insert the IC's into their sockets and double-check everything.

You may want to add feet or legs to the board, or mount it in an aluminum chassis box, to prevent anything from shorting out on the bottom. The completed board should look like the one in Fig. 13. The board is powered by an out-board 8- to 12-volt transformer, rated at about one amp.

You will need three 40-conductor ribbon cables to attach the board to the computer and AC switch, and to provide expansion capabilities. Their connection is shown in Fig. 9, referred to earlier.

Whether you use this AC controller with a large computer, a TRS-80 or a single-board, dedicated control system, it will serve you well. **R-E**



MANY THINGS WITHIN A TV SET CAN INTERFERE with its picture. Unfortunately, there are several things that can interfere with the picture from *outside*, too! It won't help to tear down a set looking for trouble that's coming in from outside. You must be able to recognize outside interference when you see it.

Outside interference (TVI) is generally lumped under the term *noise*—random-frequency signals generated by electrical apparatus, or even power lines themselves. That is normally *radiated* into the TV antenna. It's possible for some to get in by way of the AC line cord (conduction), but that seldom happens; most of it is radiation.

Luckily there's a simple test that will separate internal from external noise. Just try another TV set. If you see the same symptoms on a second screen, the problem is definitely external. That is a useful test for sets on master-antenna systems in apartments, etc. As an alternative, check with neighbors to see if they're having the same kind of trouble.

A few interference problems can be caused by simultaneous troubles in and outside the set. Here again, a substitute TV set will help you separate them. The photos in this article show the typical appearance of each major noise source. Your picture may not look exactly like those, but if you check the basic *pattern* characteristics, you'll be a long way toward identifying the cause.

AC line noise

If the screen shows two lines of dots, which may float up or down, that means

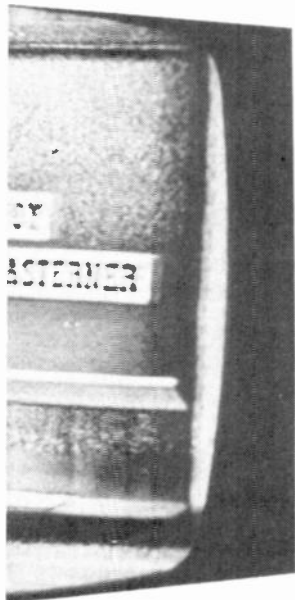

TV INTERFERENCE CAUSES and CURES

Nobody's immune to TVI. In most cases, though, there's a simple cure, if you know the cause. Some of the situations you're likely to encounter are described in this article, together with suggestions for combatting them.

JACK DARR
SERVICE EDITOR

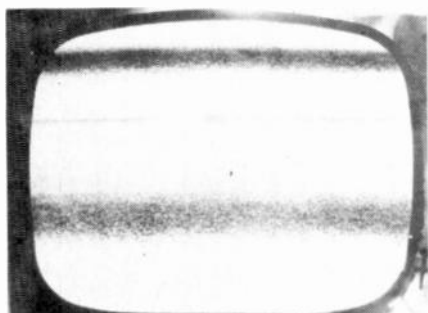

FIG. 1—DOUBLE LINES of hash indicate 120-Hz rate of AC power-line noise.

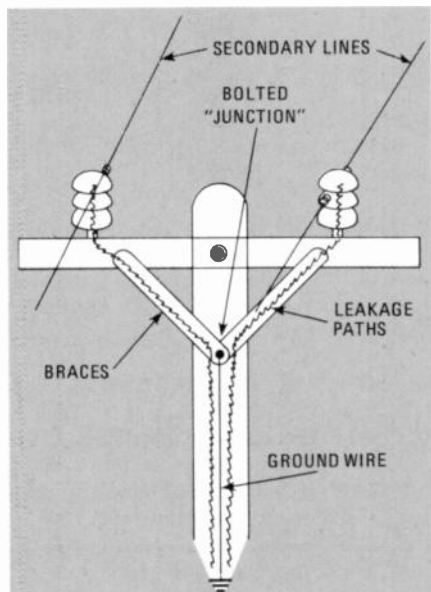

FIG. 2—LEAKAGE PATHS develop on line-pole hardware and generate RFI.

that the source is a 120Hz signal (see Fig. 1). That is often due to loose or faulty hardware on a pole carrying the

secondary AC lines. It's often called "line noise," but a more accurate name is "hardware noise."

Figure 2 shows the cause: A small leakage path has formed from the line, over or through the insulator, to the crossarm, and down the metal brackets to the ground wire. Industrial smog deposits, etc., with high carbon content can cause that. The plated metal hardware can oxidize and form tiny "rectifiers" at points where it is bolted together. That can cause noise by a form of "diode oscillation."

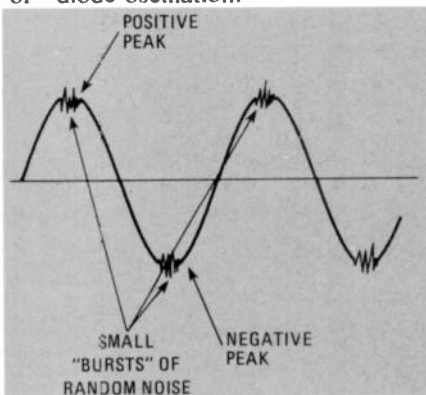

FIG. 3—RF BURSTS of random noise occur twice in each 60-Hz AC line cycle.

The 120-Hz pattern is due to the fact that leakage is greatest at the peak of each half-cycle. If you could see the waveform, it would look like Fig. 3. The small RF "bursts" on the peak of each half-cycle have frequency components in all bands up through the VHF TV bands.

For a quick check, disconnect the antenna. If the noise disappears, that's it.

If the set has a directional antenna with a rotator, turn it. You'll generally find one direction where the noise is stronger. If so, the antenna is aimed directly at the noise source. Two antennas like that, several blocks apart, get a very accurate bearing on the noise location. Draw lines on a map; where they cross, that's the source.

In cases of severe interference, use a car radio. Set the tuner to about 800 kHz, off station, and turn the volume up. Listen for a loud, buzzing roar. Cruise the area and when you find a place where that noise can be heard over the entire dial very loudly, you're very near the source. If the noise peaks at around 800 kHz, you're still quite a way off.

Report such interference to the power company. They will send a crew out to find the offending pole, clean it up and tighten the hardware. A second clue to that type of noise is that it will disappear or be drastically reduced in wet weather. The moisture provides a much lower resistance path for the leakage, and it doesn't generate so much RF hash. If that type of noise gets much worse in wet weather, there is a cracked insulator somewhere on a secondary line. The water makes a path through the crack, setting up a heavy arcing and generating strong RF interference. TVI like that has caused problems at distances of up to five miles.

Figure 4 shows a similar type of interference, often mistaken for hardware noise. Notice, however, that the pattern is different. That type of TVI is due to an old fluorescent lamp without RFI fil-

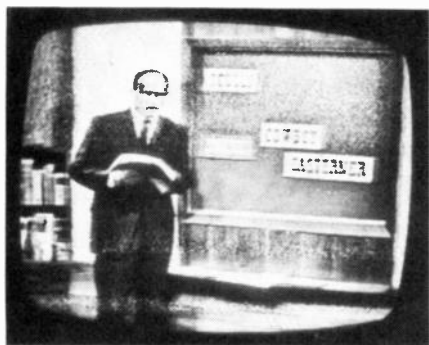

FIG. 4—FLUORESCENT LAMPS without filters can cause this type of problem.

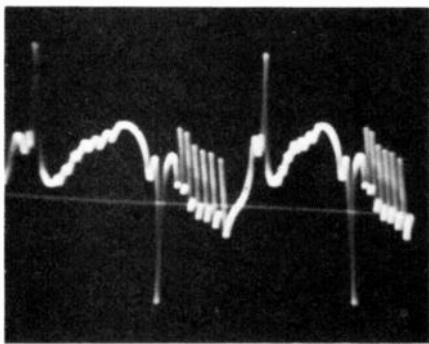

FIG. 5—SCOPE PROBE held near radiating lamp revealed this jagged waveform.

tering. The scope waveform in Fig. 5 shows why. It was picked up on a probe held *near* the bulb.

Interference often found if the antenna is near, or pointing across, a busy highway is shown in Fig. 6. That is ignition noise from old cars and trucks. It will show up as a jittering display of dashes, sometimes in heavy horizontal bars. The TVI will often be accompanied by a buzzing roar. Later-model cars with suppressors in the ignition will not cause that trouble.

If one of the lead-in interference filters on the market doesn't stop it, there's really only one cure: Move away from the highway! The noise is picked up by the *antenna*, not by the lead-in, so shielded cable won't help. A test was run on two antenna test towers. One tower had no antenna mounted at the time, only a lead-in all the way to the top. The tower with the antenna picked up the noise, but another TV set connected only to the lead-in didn't. Aiming the antenna directly away from the highway got rid of almost all noise.

Figure 7 shows a puzzling type of intermittent interference. There will be a high-frequency beat in the picture, usually jittering quite rapidly. This type of interference may also cause a color picture to (temporarily) revert to black-and-white. There may be squawks in the sound. That happens at irregular intervals and lasts only about 15—30 sec.

The cause is simple: You're picking up the high-powered FM transmitter of a passing police car. That signal is often in the 40—50-MHz band, and will be picked up directly, by the TV set's IF stages. In some cases, tuner cross-

modulation will cause beats to get through to the IF. Ordinarily, that will happen only when the police cruiser is transmitting within about ¼ mile of the antenna and in front of it. It doesn't happen often enough to be really annoying, but many viewers want an explanation.

A similar kind of interference can be generated by nearby CB or amateur radio transmitters. You'll also get a heringbone pattern, but the audio may be a littler clearer. A good high-pass filter installed at the TV set's antenna terminals will usually clear up the problem.

The Fake-Outs

A confusing kind of trouble can be caused by faulty power supplies in home antenna boosters, master antenna systems and even CATV line amplifiers. That is not, strictly speaking, "noise," but is due to hum-modulation of the RF signal. The same symptoms can be produced by a heater-cathode short in the RF amplifier, mixer tube, or even the



FIG. 6—IGNITION NOISE from vehicles without suppressors may cause this.

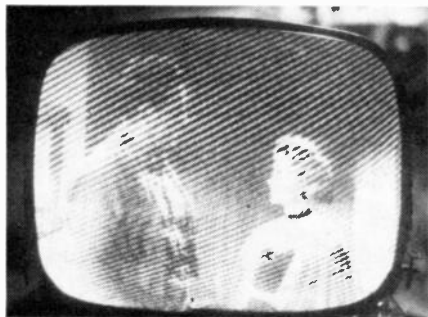

FIG. 7—FM TRANSMITTERS in police cars may cause occasional interference.



FIG. 8—S-BENDING in picture due to hum modulation of RF signal. Low-value capacitor in a booster caused distortion.

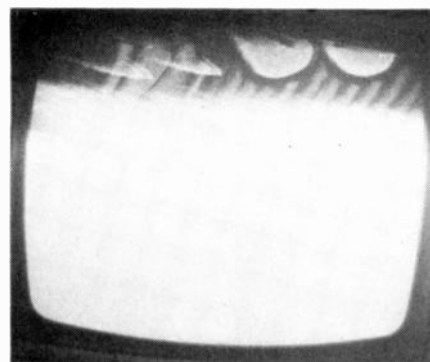

FIG. 9—WHITEOUT caused by severe hum modulation. An open-filter capacitor in antenna-booster power supply was source.

IF tubes. Also, AC ripple in the power supply to RF stages in transistor TV sets will cause that problem.

In mild cases, the picture will show severe S-bending, as in Fig. 8. If the hum is bad enough, half of the screen may be blacked out or whited out as in Fig. 9. Again, try a different TV set. If it shows the same symptoms, the trouble is in the input signal. Rabbit-ear antennas can be used in secondary areas, or any place where you can get even a bad picture on them. However, if the picture is clean with no hum bars, the trouble isn't in the set itself.

In some cases the picture will not show hum bars without an input signal; disconnecting the antenna leaves a clean raster. Of course, if you can see hum bars without the antenna, then the problem is definitely in the set.

Tube-type boosters generally have the power supply in the top unit. So, if it shows either 60-Hz or 120-Hz hum, lower the antenna. Solid-state boosters usually have the DC power supply in the bottom unit, making things much easier. Figures 8 and 9 were taken from sets with solid-state boosters. In Fig. 8, the filter capacitor was low in value; in Fig. 9, the capacitor was completely open.

Master-antenna systems, with full-wave bridge rectifiers or full-wave rectifiers in their DC power supply, can produce a 120-Hz ripple in the picture. At times, that will make two dark bars across the picture similar to hardware noise but quite a bit sharper and more distinct.

If the fault is in one of the line amplifiers, all TV sets fed from that amplifier will be affected. If the fault is in one of the head-end amplifiers at the antenna, all sets in the system will be affected. If tube amplifiers are still used, heater-cathode shorts in any of the amplifier tubes will cause a 60-Hz hum bar to appear on the screens of all sets after that amplifier.

When you see any of those particular symptoms in a TV picture, check out the antenna and any external noise. That can save hauling a set to the shop only to find it works perfectly. **R-E**

The Ins & Outs Of Interfacing System Components

If you're the owner of a stereo system using separate components, here's the way to get it all together.

LEONARD FELDMAN
CONTRIBUTING HI-FI EDITOR

THE ALL-IN-ONE HOME RADIO-PHONO-graph console began to give way to separate audio components just about 30 years ago; and today, almost anyone who wants a high-quality music reproduction system at home will select either a set of individual components or, at the very least, a group of components chosen by a single manufacturer and sometimes referred to as a compact system. For those who choose separate components, the number of possible combinations and choices is awesome. And even if the neophyte chooses a set of components in which each element is compatible with every other one, the problem of correct or optimum interface still looms.

System options

The simplest stereo component system, both in terms of hookup and in terms of ultimate use is one that uses an integrated receiver as its central component. The components of a basic system using a receiver are shown in Fig. 1. The receiver includes three basic sections, each of which might also have been purchased as a separate component: a tuner (usually AM and FM), a preamplifier control section (that combines the needed extra amplification required for phonograph record reproduction and the controls and switches required for program selection and signal processing), and a power amplifier that further steps up the signals to directly drive a pair of loudspeakers.

Since all three sections of a receiver can be built as separate components, it follows logically that another approach to component assembly would be to purchase a separate tuner and a separate integrated amplifier (which combines the preamplifier/control circuitry and

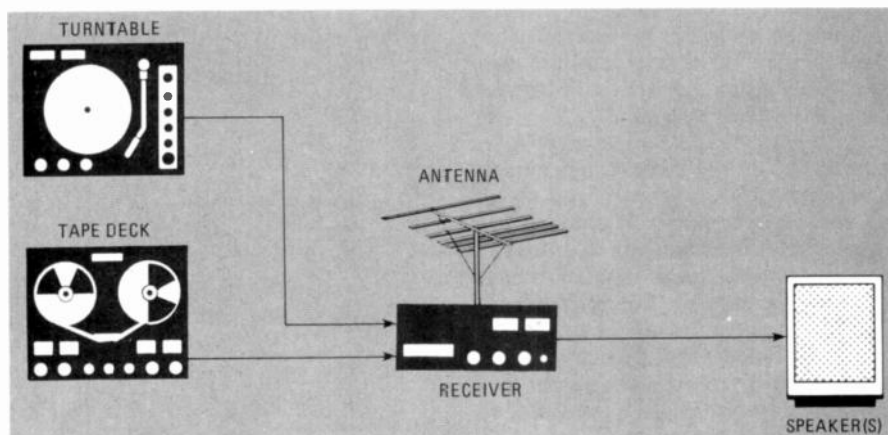

FIG. 1—BASIC HI-FI SYSTEM uses a receiver as its main component. The receiver contains the tuner, preamplifier, and power amplifier.

the power amplifier circuitry on a single chassis). A diagram illustrating the basic hookup using those two main components plus a variety of possible program sources is shown in Fig. 2.

Finally, the most elaborate approach to component-system assembly, shown in Fig. 3, uses a separate tuner, a separate preamplifier/control unit, and a separate power amplifier. Such systems generally cost the most (for a given level of system power and control features) but also offer a great degree of flexibility and the opportunity to upgrade one element of the system at a later date without having to discard all of the electronic componentry of the system.

Matching the electronics

In the case of a system that uses a receiver as its central component, there is little or nothing that the user need do about interface between the integrated sections of that receiver. You hope that the designers and manufacturers will have seen to it that when you switch

from one program source to another (e.g. from phono to tuner), loudness levels will not change dramatically, nor will signal-to-noise ratios or overall distortion levels. If, however, the system involves a separate tuner, plus an integrated amplifier (Fig. 2), or a preamplifier and amplifier (Fig. 3), it is advisable to consider the input-level/output-level relationships of the different components.

If the tuner is equipped with its own output-level control, then you can easily adjust the tuner output levels so that they match the input-level requirements of the integrated amplifier or the preamplifier. Let's illustrate with a couple of examples. Suppose that an integrated amplifier has a tuner-input sensitivity of 150 millivolts (stated in the specification sheet for the product) for rated output. This means that, with the volume control fully clockwise on the amplifier, a signal input of 150 millivolts applied to the tuner-input jacks will produce full rated power into the speakers connected to the amplifier.

Now suppose that the tuner being used is equipped with its own output-level control and that with that level control turned fully up, the tuner-signal output level will be 1.0 volt. If you were to operate the tuner with its control to maximum, the chances are very good that you would have to *lower* the master volume control on the amplifier to a point where other program sources, such as phonograph cartridge, would sound too quiet when switching over to them. On the other hand, if you turn *down* the level control on the tuner too far, you will find that you have to *turn up* the master volume control on your amplifier to too high a setting, thereby *increasing* residual noise and hum levels and again requiring readjustment (this time downward) of the control when switching to other program sources.

The ideal setting of the tuner's output-level control is somewhere between those two extremes, and a good way to determine just where that is to experiment by switching to the other most-often used program source (phono, in most cases) and adjusting the tuner's level control until the loudness level from records or FM broadcasts is virtually the same.

It follows that if the separate tuner you intend to buy is *not* equipped with a level control of its own, you should attempt to purchase a tuner whose rated output is not greatly in excess of, or less than, the rated input sensitivity of the associated amplifier or preamplifier. The same rule applies to the purchase of a tape deck, if such a deck is not equipped with its own output-level controls. Don't confuse record-level controls on a tape deck with output-level controls. The former are, of course, present on even the least expensive tape decks, while the output-level control is generally found only on medium to higher priced machines.

Phono cartridge selection

The most important, and most often used program source in any stereo high-fidelity system remains the phonograph record. To be sure, the LP vinyl record of today is but the forerunner of possible digitally recorded, optically tracked discs of the future; but for the moment, at least, selection and proper installation of a phonograph cartridge is of vital importance in assembling any hi-fi component system. And while choosing a phono cartridge to suit your system includes intelligent selection of its output-level rating, there are many other criteria by which a phono cartridge should be judged.

Let's take a look at the simpler problem of output levels first. Moving-magnet cartridges (the type most widely used in hi-fi systems) will have rated output levels ranging from about 1.0 to 5.0 millivolts or even a bit higher for a

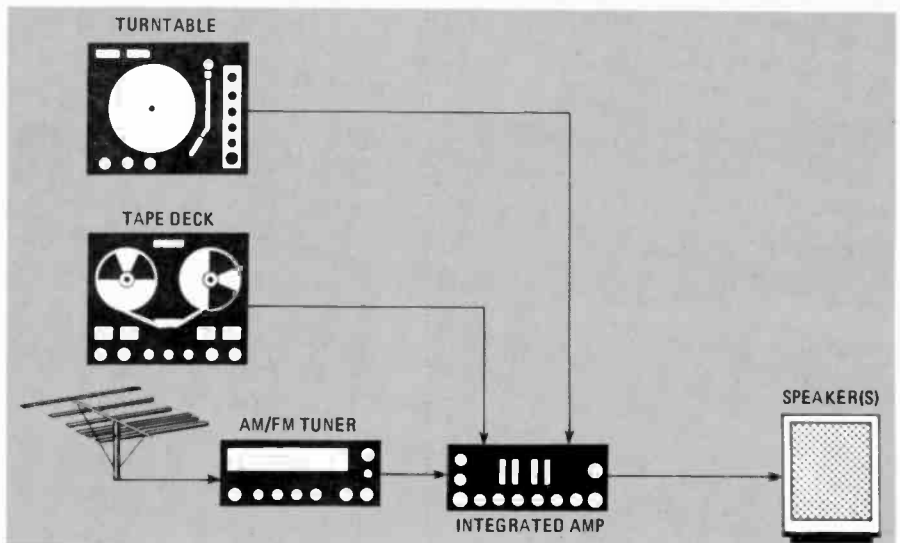

FIG. 2—INTEGRATED AMPLIFIER contains preamplifier and power amplifier. In this case, the tuner is an additional component.

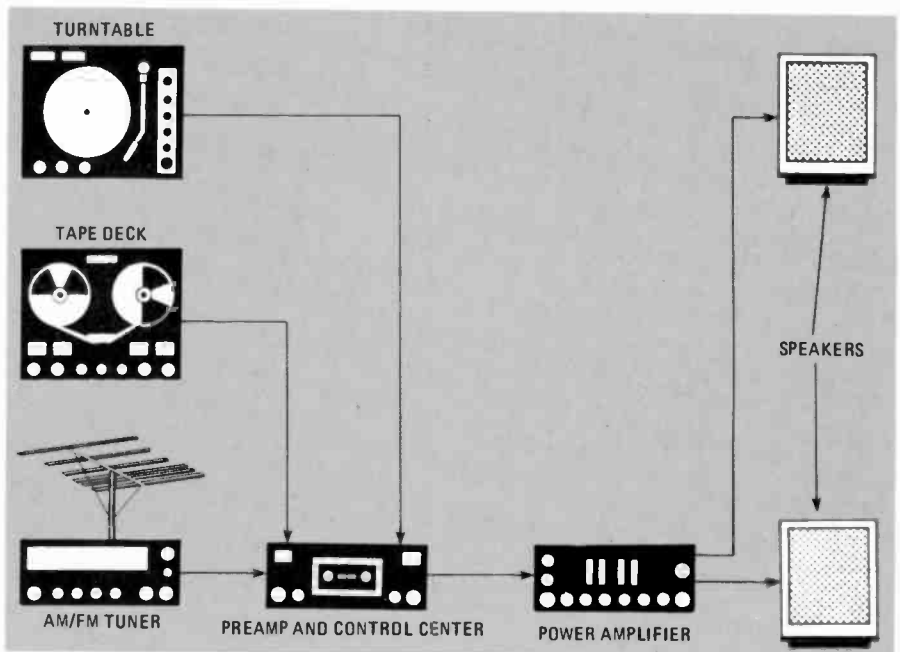

FIG. 3—THE MOST VERSATILE hi-fi system consists of a separate tuner, amplifier, and preamplifier. That approach lets you upgrade any individual portion of the system.

reference groove-modulation velocity of 3.54 cm-per-second. The specifications given for an integrated amplifier or a preamplifier will include a phono-input sensitivity. If that sensitivity is referenced to full output of the component, it may range from around 1.0 to 3.0 millivolts.

In choosing a phono cartridge, it is a good idea to choose one whose nominal output is somewhat higher than the rated sensitivity of the phono-input stage of the preamp or amplifier with which it will be used. If the nominal output of the selected cartridge is *less* than the rated input sensitivity of the component to which it is connected, you may have difficulty driving the system close to its rated output and may find yourself always turning up the master volume control of the amplifier close to its highest setting.

There is another aspect to this

matching problem that should be considered, and that is the matter of possible phono-stage overload. If you select a cartridge having an output that is too high, it is possible that when peaks in a musical selection are traced by the stylus, the output of the cartridge may be so great as to overload the low-level input stages of the preamplifier circuitry. Typically, the loudest moments in a recording may be 20 or more dB greater than the nominal levels of that same recording. With today's greater dynamic ranges of recordings recorded from digital master tapes, or by the popular direct-to-disc methods, the differences between average levels and peak levels may even be greater: 30 or 40 dB. A change in level of 30 dB represents a voltage difference of around 30 to 1, so that a cartridge having a nominal output rating of 3 millivolts may well deliver 90 to 100 millivolts

under these conditions. It is important that the preamplifier or amplifier selected for use with such a high-output cartridge be able to handle such high-input voltages without producing overload distortion.

More important than the level matching of a phono cartridge to its associated electronic equipment is the proper loading of that cartridge. Most phono-input stages provide a resistive termination for moving magnet cartridges of 47,000 ohms, a value that is perfectly suitable for 99% of currently available moving magnet pickups. However, that type of cartridge also requires a very specific amount of capacitance to be placed across each channel output pair of terminals. The value of that capacitance may range from a low of around 100 pF to a high of 600 pF or more per channel.

Although the manufacturer of the cartridge nearly always specifies the optimum value of capacitance with which his product should be loaded, few users bother to insure that the cartridge is properly loaded capacitively. Yet the variation in response, particularly at the high-frequency end

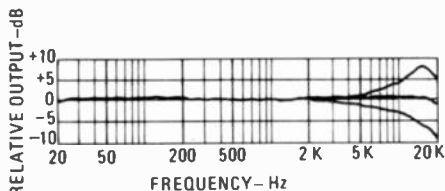

FIG. 4—A PHONO CARTRIDGE must be properly loaded to obtain optimum response. The frequency-response curve shows the effect of too little (top curve) and too much (bottom curve) load capacitance.

of the spectrum, that can occur because of errors in cartridge loading can be quite severe, as illustrated in the frequency-response plots of Fig. 4. The upper curve shows a severe peak in the high-frequency response of a cartridge that requires 500 pF of loading capacitance per channel but has only 100 or 150 pF of capacitance across its terminals. The center curve is for a properly terminated cartridge while the low curve, which shows a sharp attenuation of high frequencies, is for a cartridge which required only 200 pF of loading capacitance but which was loaded with more than 500 pF of capacitance per channel.

The audio cables normally supplied with turntable systems have a given number of picofarads (pF) of capacitance per foot, and most users of turntable/cartridge systems rely solely upon the cable-associated capacitance to properly load their cartridges. Capacitance per foot may vary greatly, however, from one type of shielded audio cable to another. More often than not, the retail salesperson will not be able to tell you how much capacitance is being contributed by the included audio cables, but that information is now more often found in the owner's manual that accompanies your turntable.

If the information cannot be obtained from the owner's manual or by writing a letter to the manufacturer of the turntable system, the only alternative is to purchase or borrow a low-cost capacitance meter. The Heath Company offers an inexpensive RLC Bridge, model IB-5281, in kit form for under \$40.00. Besides enabling you to read values of

capacitance from 10 pF to 10 μ F, it can also serve as an accurate bridge for measuring inductance and resistance.

To measure the capacitance of audio cables and internal pickup-arm wiring (the two must be considered together, as one overall loading value of capacitance) be sure to remove the cartridge from the pickup arm and make certain that there is no continuity between the outer shield and the inner conductor of the audio cable/pickup arm wiring. In most cases, the small amount of parallel capacitance that exists at the phono inputs of the amplifier or preamplifier can be ignored, but if you want to add that amount in to your calculations, this low value of parallel capacitance can be measured separately and added to the results obtained when measuring the combined audio cable/pickup arm wiring capacitance.

If the total capacitance-per-channel is less than the amount required for proper cartridge loading, it is a simple matter to wire a fixed capacitance across the input jacks of the preamplifier or amplifier to make up the difference. If the total capacitance measured is greater than that required for your cartridge, you may be able to obtain audio cables having lower capacitance-per-foot than the cables supplied, or you may be able to shorten the cable lengths between the turntable system and the phono inputs on your preamplifier or amplifier or receiver. If that is not possible, your only remaining alternative is to purchase a cartridge whose capacitance-loading requirements are consistent with the minimum loading capacitance which you are able to achieve with your existing cables and turntable.

Room for expansion—the tape-monitor switch

Originally intended as a simple circuit-interruption point so that a tape deck could be interposed in the signal path of a high-fidelity component system, the tape-monitor circuit on your amplifier, preamplifier or receiver has become an important access point to the system. It is at this access point that a growing variety of add-on components can be connected, thereby increasing the effectiveness of the system itself. In another article in this series, we will examine the many accessory items that can be connected to a hi-fi system via this useful circuit point and unscramble the mystery of which of the many signal processors goes ahead of which other ones. For the moment, however, it is important to understand just how a tape monitor in/out system works and where it is positioned in the signal path.

As shown in Fig. 5, the tape monitor-circuit or circuits (some receivers and amplifiers may have two or even three such complete circuits) is nothing more

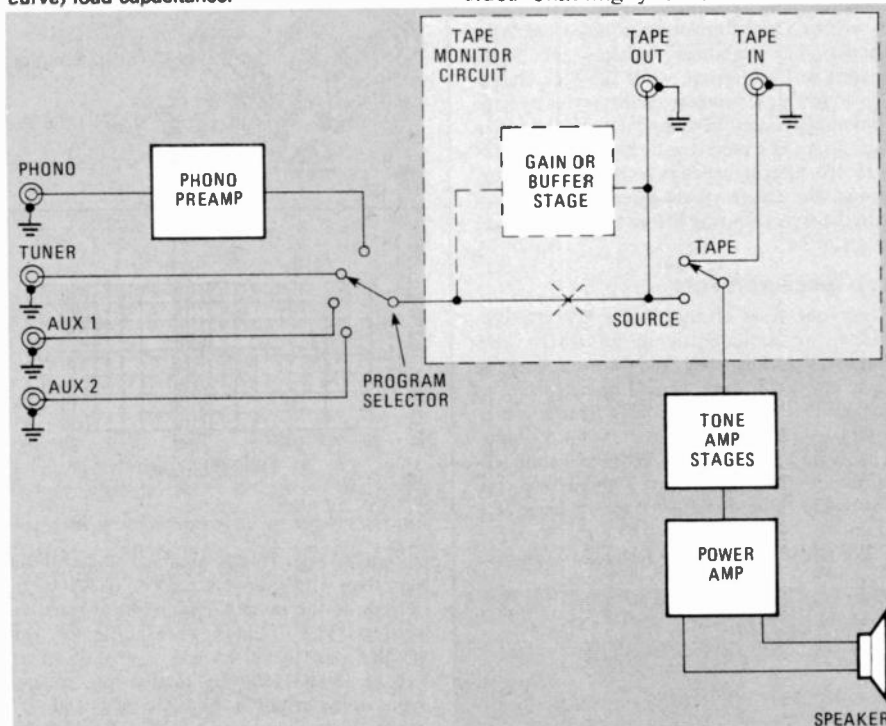
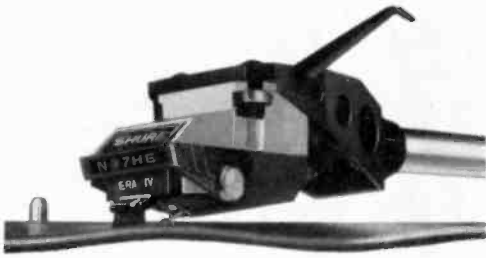

FIG. 5—THE TAPE-MONITOR CIRCUIT is actually a point of access to the signal path within the pre-amplifier. Although originally used for connecting a tape deck, many signal processors and add-on accessories are connected to the hi-fi system at this point.

continued on page 111

Shure Bros. Model M97HE Phono Cartridge



1 CIRCLE 108 ON FREE INFORMATION CARD

LEN FELDMAN
CONTRIBUTING HI-FI EDITOR

SINCE SHURE BROTHERS INTRODUCED THEIR popular *V-15 Type IV* cartridge a couple of years ago, the design innovations incorporated into that pickup have been praised by audio testers and consumers alike. That state-of-the-art cartridge now carries a suggested retail price of \$165.00—a price that even the affluent audiophile may find a bit beyond his reach.

More recently, Shure announced their *M97 ERA IV* series of more moderately priced cartridges. All the models in this series incorporate many of the design innovations previously found only in the company's *V15 Type IV*. The top cartridge in the new series is the model *M97HE*, shown in Fig. 1. Two of the features carried over from the *Type IV* design into all of the *M97* cartridges are a viscous-damped dynamic stabilizer (visible in the photo of Fig. 1) and a telescoped stylus-shank structure.

The viscous-damped dynamic stabilizer minimizes or completely eliminates record-warpage related problems such as fluctuating tracking force, groove skipping, cartridge bottoming, signal wow, and even amplifier or speaker overload, according to Shure Brothers. The entire stabilizer, suspended from two viscous bearings, acts much like a shock absorber to maintain a constant cartridge-to-record distance and uniform tracking force, even on severely warped records. In addition, the viscous-damped stabilizer tends to attenuate pickup-arm/cartridge resonance effects. A second benefit derived from the stabilizer is its ability to discharge static build-up on record surfaces while sweeping away dust particles. A line drawing of the dynamic stabilizer used in the cartridge is shown in Fig. 2.

A unique telescoped-stylus shank, as illustrated in Fig. 3, is standard on the *M97HE* cartridge. According to Shure, that telescoped-stylus shank structure reduces effective mass of the stylus assembly without sacrificing strength, and thereby helps to improve trackability in the mid- and high-frequency range.

The hyperelliptical stylus used in the *M97HE* is also carried over from the *V15 Type IV* design and, again according to Shure, is designed to provide an optimized contact area within the record groove to reduce both

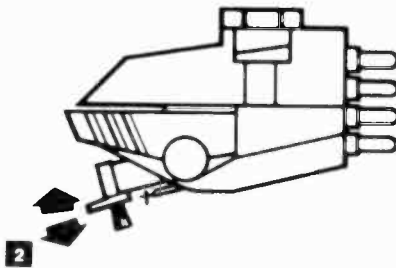

2

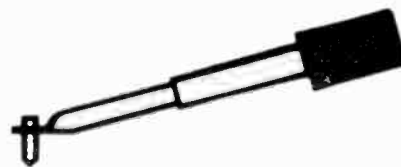

3

harmonic and intermodulation distortion.

Another new and important feature of all the *M97* Series cartridges is the stylus protection provided by the viscous-damped stabilizer, as well as a new development called the *Side-Guard*. The stabilizer protects the stylus against vertical impact, while the *Side-Guard*, shown in Fig. 4, protects against stylus damage sometimes caused by sliding a cartridge across the surface of a record or by hitting the edge of a record. If that happens to the *M97HE* cartridge, the entire stylus assembly withdraws into the stylus housing before the stylus is bent or distorted.

Lab measurements

For our tests of the Shure *M97HE* cartridge, we mounted it in an *SME 3009 Improved* pickup arm. We chose a tracking force of 1 gram but it should be noted that to achieve that downward tracking force it is necessary to calibrate the system for 1.5 grams. That is because the action of the dynamic stabilizer in effect subtracts 0.5 grams from the downward force, for a *net* tracking force of 1 gram.

We found that flattest frequency response

RADIO-ELECTRONICS AUDIO LAB
R.E.A.L. SOUND
RATES

SHURE M97HE
PHONO CARTRIDGE

SUPERB

Copyright © Gernsback Publications Inc., 1979

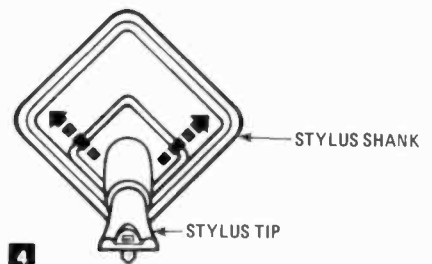

4

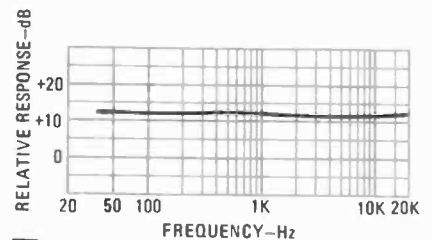

5

(shown in Fig. 5) was obtained under those conditions with a capacitance load of 300 pF in addition to the usual 47,000 ohms of resistive loading. The frequency response of the *M97HE*, as measured using a CBS Test Record (STR-130) was totally free of any major irregularities in the audio range and varied by no more than +0.5 dB and -1.0 dB from 20 Hz to 20,000 Hz.

Additional major performance measurements are listed in Table 1. Besides the mea-

MANUFACTURER'S PUBLISHED SPECIFICATIONS

Frequency Response: 20 Hz to 20 kHz (no tolerance given). **Channel Separation, 1 kHz:** Better than 20 dB. **Stylus Tip Type:** hyperelliptical. **Tracking Force Range:** 0.75 to 1.5 grams. **Output at 3.54 cm/sec, 1 kHz:** 4.0 millivolts. **Optimum Load Resistance:** 47,000 ohms. **DC Resistance:** 1550 ohms. **Inductance:** 700 millihenries. **Cartridge Weight:** 6.4 grams. **Suggested Retail Price:** \$112.50

surements shown, we were anxious to determine the benefits, if any, of the dynamic stabilizer. For those experiments, we used a CBS STR-120 test record. The M97HE cartridge was once again mounted in the SME pickup arm and, with that combination, arm/cartridge resonance occurred at around 8 Hz or so. When resonance was hit, it was clear that the arm/cartridge combination exhibited a significant amount of vertical oscillation (as would any arm/cartridge combination) when the dynamic stabilizer was pivoted out of the way and not used. When that section of the test record was played again, with the dynamic stabilizer in place, it was equally clear that the amount of vertical vibration of the arm/cartridge combination diminished considerably. Since it was not possible for us to measure those differences quantitatively we rely upon information supplied by Shure regarding the actual reduction of arm/cartridge resonance. Figure 6, supplied to us by Shure Brothers, shows what happens with and without the dynamic stabilizer. The lowered output (solid line) indicates that the dynamic stabilizer reduced the amplitude of oscillation at resonance. Conditions of the test were the same as those conducted in our own laboratory and, since we observed the same sort of improvement as is depicted in this graph, we are willing to accept Shure's results insofar as to the degree of improvement.

The trackability of an M97HE has also been plotted by Shure Brothers, as shown in Fig. 7, across the entire audio spectrum as well as in the sub-audible spectrum in terms of peak

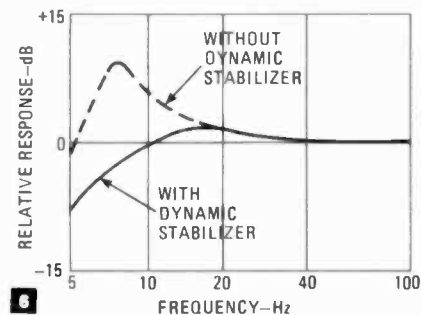

6

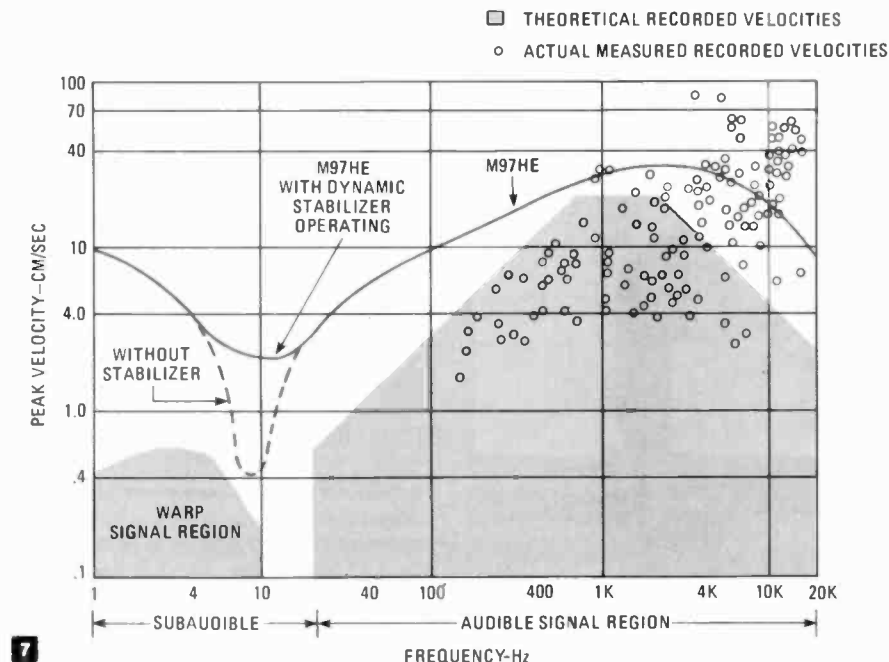

7

TABLE 1
RADIO-ELECTRONICS PRODUCT TEST REPORT

Manufacturer: Shure Brothers

Model: M97HE

PHONOGRAPH CARTRIDGE MEASUREMENTS

	R-E Measurement	R-E Evaluation
FREQUENCY RESPONSE (Hz-kHz, ± dB)	20-20, +0.5, -1.0dB See Fig. 5	Excellent
STEREO SEPARATION		
Separation, 1 kHz (dB)	25	Excellent
Separation, 10 kHz (dB)	25	Superb
Separation, 30 kHz (dB)	N/A	N/A
CHANNEL BALANCE, 1 kHz (dB)	0.5 dB	Excellent
TRACKABILITY MEASUREMENTS		
Stylus velocity at 1 kHz (cm/sec.)	30	Excellent
Stylus velocity at 10 kHz (cm/sec.)	N/A	N/A
COMPONENT MATCHING CHARACTERISTICS		
Output level, 1 kHz, 3.54 cm/sec. (mV)	4.0	
Optimum load impedance (ohms)	47K ohms, 300 pF	
Tracking force range (to grams)	0.75 to 1.5	
Cartridge weight (grams)	6.4	
OVERALL PHONO CARTRIDGE RATING		Excellent

TABLE 2

OVERALL PRODUCT ANALYSIS

Retail price	\$112.50
Price category	Medium/High
Price/performance ratio	Excellent
Styling and appearance	Excellent
Sound quality	Superb
Mechanical performance	Excellent

Comments: Since the M97HE cartridge is basically a "spin off" from Shure Brothers' higher-priced V-15 Type IV pickup, we were interested in finding out how the lower-priced unit compared, in terms of sound reproduction and mechanical characteristics, with the higher-priced predecessor. Frequency response characteristics proved to be virtually the same and, in blindfold listening tests we and our invited listening panel were hard-pressed to tell which cartridge was which. Only when we compared measured trackability did we find any substantial differences between the two cartridges. The V-15 Type IV, as might be expected, did a bit better in that regard, being able to handle higher velocities at 1.0 gram than the M97HE was able to do at 1.25 grams of downward tracking force. There are few records, however, where those differences would show up audibly. The fact that Shure was able to incorporate their dynamic stabilizer as well as their low-mass ultra-rigid stylus cantilever construction in this lower-priced cartridge makes it a very worthwhile investment for those audio enthusiasts who can't quite afford Shure's top-of-the-line unit.

velocity at the stylus tip. Trackability shown is for a downward tracking force of 1 gram. The ability to track high-recorded velocities is shown by the solid-line curve in the diagram. Theoretical and actual measured maximum recorded velocities are also shown and, at a 1-gram tracking force, it will be noted that there are still some high-energy high-frequency peaks that cannot be successfully tracked. As Shure points out, however, at slightly higher forces, (maximum recommended force is 1.5 grams), even more of those unusually high-velocity groove modulations can be successfully tracked.

Summary

In our listening tests, we were pleased with the uncolored and clean sound delivered by the Shure M97HE cartridge playing a wide variety of lately-made digitally mastered discs. The M97HE offers many of the benefits of the more expensive V-15 Type IV and the only sacrifice that seems to be inherent in choosing the lower-priced cartridge is somewhat lower ultimate trackability for a given downward tracking force. Our own evaluation of this new cartridge suggests that it merits an R.E.A.L. rating of Superb.

R-E

μ A783

AUDIO AMPLIFIER

Little IC's can solve big problems. This μ A783 is a dandy audio amplifier with a thousand-and-one applications.

JIM ESSEX

WHEN MANUFACTURERS ANNOUNCED the early "microamplifiers"—about 15 years ago—we thought the millenium had come. Yet, compared to today's offerings, they left a lot to be desired. I recall my first experiment, still, with some trepidation.

I had a huge heat sink whose giant fins literally leaped out in all directions; and although the "module" itself was about the size of a large overcoat button, we thought miniaturization had at last come. It would put out about 1½ watts at about the same figure of distortion (1½%), which jumped up to 5% if you pushed it for three watts!

The power supply was mounted on a separate chassis and left a lot to be desired, considering that extreme filtering was necessary with a hefty "back-up" in available power. When you considered—all that just to drive that seemingly insignificant "button"—you wondered if we were really heading in the best direction. Now we know. For, archaic as it first appeared, the button has given way to "chips", and the results are more than pleasing.

Look at Fairchild's μ A783 IC, for example. In one small, 12-pin, power package less than an inch long and quarter-inch wide and the thickness of a wafer, they've packed a 9-watt capability! And the total harmonic distortion is only 0.3%! What does this mean to music lovers? It means that compact record or tape players are within your reach, now!

For amateur musicians who play an instrument and have become tired of the perennial "pick-up" cord running from your guitar or whatever, you can have the whole package, conceivably, mounted in the instrument. The largest thing about it would be the "heat sink", and even that can be reduced to manageable proportions by using a good-quality

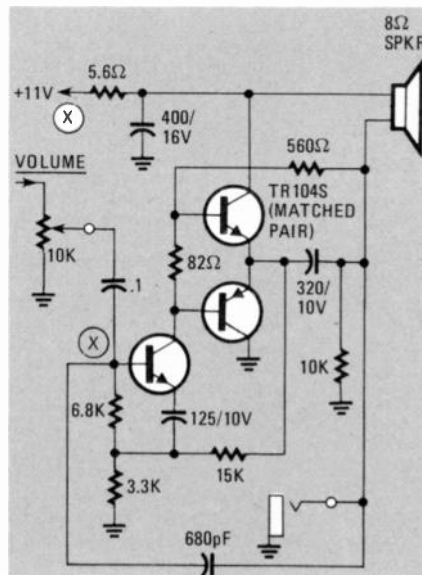

FIG. 1—TV AUDIO OUTPUT didn't deliver an adequate signal. I replaced it with the circuit in Fig. 2. Just clipped out the old and wired in the new at the X's.

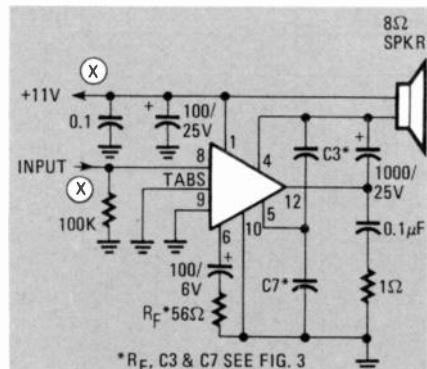

FIG. 2—SIMPLE AUDIO AMPLIFIER BUILT around the μ A783. It can also be used in children's phonographs and almost anywhere else a high-level input is available.

copper plate. Either form a "U" affixed to each tab, or bolt it to a frame as part of the PC-board support. (In TV chassis, I have seen ordinary aluminum plate—

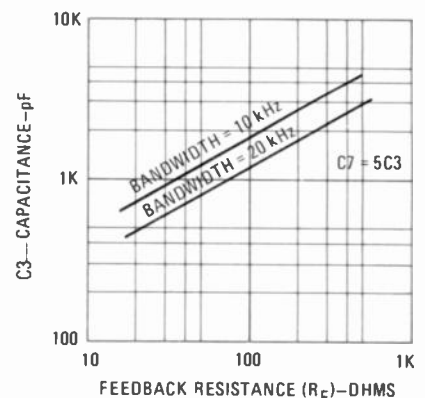



FIG. 3—USE THIS TABLE TO determine values for C3 and C7 in the circuit of Fig. 2.

about 1/16" thick—connecting the tabs to the chassis itself for an adequate heat sink.)

Be careful when soldering to the lugs. 260°C is maximum, and if the IC is wired, be sure to choose light wire. I had occasion to hook one up (similar to μ A783) in a portable B & W TV that was having difficulty delivering adequate output. I had had no experience with the new IC's, so I used available wire. It proved too "stiff" and, through vibration and handling, the input clip was soon broken. But the "heat sink" worked. That was made merely by bending the clip under a nearby screw. That dissipated the heat into the chassis adequately. The circuit replaced is shown in Fig. 1. I replaced it with the μ A783 circuit shown in Fig. 2.

With this versatile IC, other applications will no doubt come to mind. In my case, a once tired-sounding TV has been enhanced with a minimum of trouble. And I'll know what to do with that next portable record player which needs a "lift." Remember, existing loudspeakers can be used, as this IC works superbly into any standard 8- or 16-ohm speaker.

R-E

ADVANCE IS PROUD TO INTRODUCE
The  HITACHI Line of High Quality Oscilloscopes
All Hitachi Instruments
Are Backed by A Two-Year Warranty

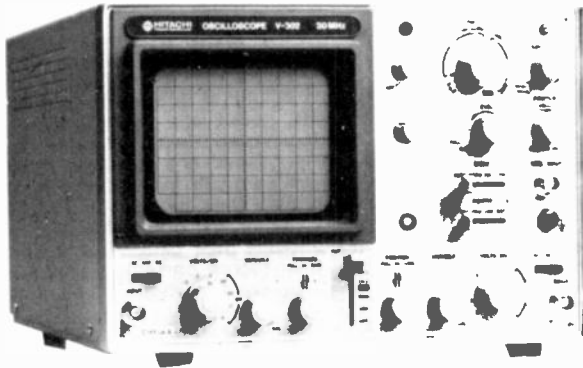

Hitachi Oscilloscope V-302
DC-30MHz dual-trace

- | | |
|-------------------------------------|--|
| 1. TV sync-separator circuit | 5. Sweep-time magnifier (10 times) |
| 2. High-sensitivity 1mV/div (5MHz). | 6. Trace rotation |
| 3. Signal delay line | 7. Z-axis input (Intensity modulation) |
| 4. X-Y operation | |

(Also available in single-trace)

- TV sync-separator circuit facilitates rapid video signal measurement.
- Extra-high sensitivity; vertical sensitivity of 1mV/div. now available.
- Built-in signal delay line for leading edge observation of quick-rising waveforms (V-301 and V-302).
- X-Y operation very convenient for measuring phase difference of two waveforms.
- Sweep-time magnifier effective for precise measurement; sweep time magnifying 10 times with one-touch operation.
- Trace rotation system for easily adjusting bright-line inclination caused by terrestrial magnetism.
- Z-axis input provided-possible to use as CRT display.
- 0.2 μ s~0.2s-wide sweep range setting.
- One-touch shifting waveform slopes.
- Five modes of vertical deflection operation (Type V-152 and V-302).
- Panel layout with color-coding of respective functions.

HITACHI V-302 & V-152

Put a proven Hitachi dual-trace oscilloscope on your bench for as little as \$695. Our V-152 15MHz model includes unprecedented sensitivity (1 mV/div)...10X sweep magnification...front panel XY operation...trace rotation...Z-axis input...and more. Need greater bandwidth? Our V-302 model is the only 30MHz dual-trace scope with signal delay line priced under \$1000, with all the above features, to make your testing operations fast, easy, and accurate. Reliability is exceptional too. (As you'd expect from a manufacturer with over 20 years of experience "outscoping" the competition.) So exceptional, in fact, that Hitachi quality is backed by a 2-year warranty...the longest in the industry. Whether you use it for teaching or repairs, for video, audio, or computer testing, you can't find more scope for your dollar than at Hitachi. Call for more details.

	Normal Price	
<input type="checkbox"/> V-152B 15 MHz Dual Trace	\$735*	Call For Special Introductory Price Offer
<input type="checkbox"/> V-302B 30 Mhz Dual Trace	\$995*	
*Probes included.		

Hitachi...The measure of quality.



Hitachi Oscilloscope V-152
DC-15MHz dual-trace

- | | |
|------------------------------------|--|
| 1. TV sync-separator circuit | 4. Sweep-time magnifier (10 times) |
| 2. High-sensitivity 1mV/div (5MHz) | 5. Trace rotation |
| 3. X-Y operation | 6. Z-axis input (Intensity modulation) |

(Also available in single-trace)



THE TEST EQUIPMENT SPECIALISTS
TOLL FREE HOT LINE
800-223-0474

54 WEST 45th STREET, NEW YORK, N.Y. 10036 212-687-2224

ADVANCE ELECTRONICS 



AUTOMATIC LIGHT CONTROLLER FOR CARPORT

MY WIFE WORKS EVENINGS AND GETS home well after dark. Because no one is at home to greet her upon her return, we used to leave the carport light on for many energy-wasting hours, just so she could avoid tripping over bicycles or stepping on the dog's tail when she returned in the evening.

To save my marriage—and conserve electricity—I devised the following circuit. It is simply a 555 timer IC, operating in the one-shot mode, that is triggered by light striking photoresistors. These normally have a resistance of several megohms but, in the presence of light, that resistance drops to several hundred ohms, permitting current from the six-volt source to flow in the circuit. The R-C combination shown gives an on-time of about two minutes. Photoresistors PC3 and PC4 are mounted at headlight-height on the carport wall (one for each of our two cars).

Now, when my wife pulls into the car-

port at night, the headlights illuminate the photoresistor, and the timer starts. That actuates a relay, RY1, in parallel with the carport light switch, and the lights are turned on long enough for her to get safely into the house. The lights are automatically turned off when the timer's two minutes are up.

We also have a push-button switch mounted inside the house and, when we go out at night, that allows us to turn on the outside lights to see our way out to the car, knowing they'll turn themselves off after we've left.

Photoresistors PC1 and PC2 are mounted on the outside of the house where they are in the sun much of the time. That keeps the timer from triggering during daylight hours. Resistors R1 and R2 establish the thresholds for proper on/off control.

My unit has been in service for over a year and has not given me any problems. I've also installed quite a few of these for friends, and they are pleased as can be.

All the components used are stock items.—Ronald Picard

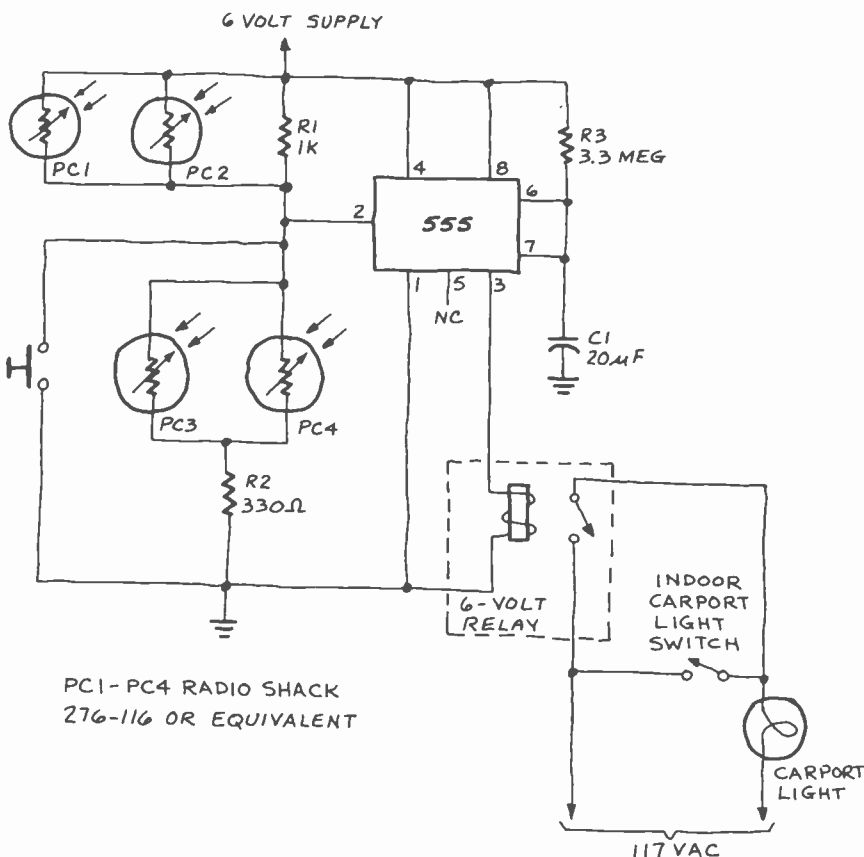
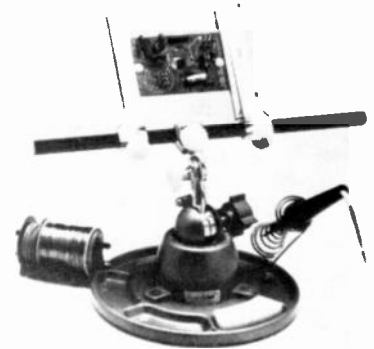

FIG. 1

NEW IDEAS

This column is devoted to new ideas, circuits, device applications, construction techniques, helpful hints, etc.

All published entries, upon publication, will earn \$25. In addition, Panavise will donate their model 324 Electronic Work Center, having a value of \$49.95. It combines their circuit-board holder, tray base mount, and solder station (see photo below). Selections will be made at the sole discretion of the editorial staff of **Radio-Electronics**.



I agree to the above terms, and grant **Radio-Electronics Magazine** the right to publish my idea and to subsequently republish my idea in collections or compilations of reprints of similar articles. I declare that the attached idea is my own original material and that its publication does not violate any other copyright. I also declare that this material had not been previously published.

Title of Idea		
Signature		
Print Name	Date	
Street		
City	State	ZIP

Mail your idea along with this coupon to: **New Ideas Radio-Electronics**,
200 Park Ave. South,
New York, NY 10003

NOW! A MINIATURE TELEPHONICS SYSTEM
EVEN MA BELL DOESN'T MAKE AVAILABLE.

FINGER FONE™

The unique Finger Fone brings you advanced solid-state wizardry, with total hands free conversation, speak and listen without lifting a finger. The total communications instrument for home and office.

Imagine you're a design engineer. You've just been assigned to come up with a smaller, simpler-to-use, more streamlined telephone with basic memory that can handle 99% of the ways people actually use a phone on a day-to-day basis.

You have a research laboratory with a support staff at your disposal. Plus access to the latest transistors, memory chips, and microprocessors. And you are given only one limitation: Keep the consumer's cost under \$100.

Now, since you're something of a maverick, your mind is not trapped in the right way/wrong way syndrome. And you were too independent to take that job with the Bell System a while back. Because you didn't want all your ideas to come out "Bell-shaped."

THE ANATOMY OF DESIGN

So you set to work — but not with wires, bells and whistles. Because your approach is different: You're going to discover how people actually use a telephone today and then design the instrument from the outside in, basing your conception around real communication needs in a way quite unlike anything ever before achieved.

INTRODUCING THE FINGER FONE

When you're finished, you realize you've come up with a minor revolution in design! Your new instrument is actually a miniature telephone: the entire unit measures a scant 2 3/4" wide, 8 3/4" long, and 2 3/4" high (at the speaker end), scarcely any bigger than the handset on an ordinary phone. Your Finger Fone has a nearly standard alphanumeric keyboard plus a couple of special benefits we'll get to in a minute. It also has an omnidirectional microphone, volume selector key, automatically control the volume of incoming voices, with four LED indicator lamps to display each volume level, and even a bright red on-off light.

What's more, it plugs into the new miniconnector Ma Bell provides for all its phones these days — with no additional wires for any other power source (which make the Finger Fone unlike those other multi-wire "speaker-phones" that sell for more but do less).



© MERCURY 1980

Finger Fone: modular, sophisticated, smarter than your present telephone. Comes with an ivory fascia.

WHY PICK A PHONE UP EVERY TIME IT RINGS?

Let's face it, your hands are often occupied when the phone rings. So to answer, you've got to stop at least half of what you're doing. With a Finger Fone, all you do is reach out and tap the "On" key with one finger. And since you needn't pick the instrument up, you can place it conveniently on a desk, counter, or table — or hang it on the wall.

MORE FINGERTIP CONVENIENCE

When Finger Fone announces an incoming call with its pleasant electronic chirp, tap the "On" key and begin speaking. If the caller is someone the whole family wants to hear, simply tap the volume control key and select one of the four sound levels and your caller's voice will be audible to everyone in the room. This benefit is great for the office as well, making it possible to replace an ordinary telephone, separate speaker-phone, and their complicated controls.

If you wish to speak with complete privacy, press the volume control key for low level volume. Yes, for strictly private calls you'll have to hold Finger Fone up to your ear. You won't mind, however, because the entire unit is a mere 11 1/4 ounces, just a featherweight more than ordinary telephone handsets.

YOU HEAR THEM, THEY DON'T HEAR YOU

Need to put your caller on "hold" for a moment? Easy. Tap "hold" key. All five LED indicator lamps will be blinking, indicating your caller is on hold. The other person won't be able to hear you, but you'll be able to hear him or her. We recommend you tell people about this so they don't make unguarded comments they think you can't hear. When you're ready to resume your call, simply tap "off" key, the LED lights will stop blinking, and you can continue.

BUSY SIGNAL? FORGET IT!

Because Finger Fone automatically remembers the most recently dialed "busy" number. When you want to call that number again, tap the "RE" (Recall) key once. Finger Fone dials the number for you, as often as needed until you get a clear line.

WHY WAIT FOR PUSH BUTTON DIALING?

Finger Fone is compatible in areas of the country where push-button dialing is already in use. But if you live in the 30% or so of the country where only rotary-dial phones can be used, wait no longer. Finger Fone automatically converts from musical tones to rotary-dial signals. This way, you can have the speed and advantages of push-button dialing without waiting for your local phone company to install central equipment.

NOW AVAILABLE AT INCREDIBLE LOW COST

Finger Fone costs only **\$79.95** compared with prices of similar-looking telephones (but not similar in performance) costing \$109, \$130 or more. Want two? Then it's only **\$74.95** each: Three? Save even more at **\$69.95** each. Add a \$2.50 charge to your total order for insured shipping, and if you live in New Jersey, include 5% tax.

MONEY-BACK GUARANTEE

You can try one or more Finger Fones in your own home for 30 days, protected by our unconditional money-back guarantee. If you're not satisfied with Finger Fone for any reason, simply return it (insured) for a full refund, no questions asked. Finger Fone is also covered by a 1-year parts and labor guarantee.

To order Finger Fone, call toll-free now. We're open 24 hours a day. You can charge it on Master Charge, Visa, American Express, Carte Blanche or Diners.

800-526-2801

800-257-7850

In New Jersey, Call: 800-322-8650

N.J. residents please add 5% sales tax. You can also mail your order with check or money order to:

M INTERNATIONAL SALES GROUP
MERCURY
THE IMAGINATION PEOPLE®

Dept. RE11
Mercury Bldg., 404 Madison Avenue
Lakewood, NJ 08701

CIRCLE 55 ON FREE INFORMATION CARD

hobby corner

How to modify the full-scale reading of an existing meter. Plus two new nifty catalogs.

EARL "DOC" SAVAGE, K4SDS, HOBBY EDITOR

SEVERAL OF YOU HAVE RAISED QUESTIONS recently about analog meters. It would seem that in these days of digital meters of all types, folks forget the basics of the old meters—how to use them, change their ranges, and so on. So perhaps it is time for a quick review. As we do that, keep in mind that the same principles apply equally to digital meters.

A *voltmeter* is a *high-resistance* device that measures the difference in voltage between two points. It is connected in parallel with the circuit as shown in Fig. 1-a. Note that if the voltmeter had a low resistance, most of the current would flow through it and not through the load—in the process it would probably burn out the meter.

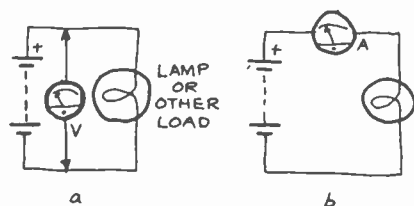

FIG. 1

An *ammeter* is a *low-resistance* device that measures the amount of current flowing through it. It is connected in *series* with the circuit as shown in Fig. 1-b—in other words, the circuit must be “broken” to insert the ammeter. Note that if it had a high resistance, it would “use up” most of the power, leaving little for the load.

So far, so good. Now let's see how to change the range or sensitivity on those meters. For our present purposes, we will keep it simple and not get involved with internal multipliers and shunts. We will do what we can without taking the meters apart.

First, consider the voltmeter. Compare Figures 1-a and 2-a and notice that we have added a resistor in series with the meter. One way of thinking of that circuit is that the resistor “uses up” some of the voltage. The higher the resistance, the lower the meter reading or, from the other viewpoint, the higher the full scale reading.

For example, suppose the resistor has a value equal to the resistance of the meter. It will “use up” half of the voltage; that

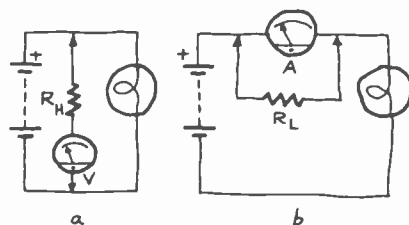

FIG. 2

is, the voltage drop across the resistor and the meter would be equal. If the applied voltage were 10 volts DC, the meter would read 5 volts (half the total). So, if that meter had a full-scale reading of 12 volts DC, the combination would indicate 24 volts DC at full scale.

In that way, the measurement range of a voltmeter can be extended.

Now, let's look at the ammeter—actually in our work it is usually a milliammeter or microammeter. Comparing Figs. 1-b and 2-b, you can see that a resistor has been placed in *parallel* with the meter. Recalling that a current meter has very low resistance, the resistor, too, must have a low value in this case. Part of the current flows through the meter and part through the resistor. Thus, the meter reading is less than the actual current flow in the circuit.

As an example, let's say that the resistor value is one-half that of the meter resistance. Twice as much current would go through the resistor and, so, only one-third of the total would go through the meter. (If the “twice as much” and “one-third” don't seem to match, think it over more carefully!) Thus, if the meter reads 30 mA, the load is actually drawing 90 mA from the battery.

Now we have extended the range of an ammeter. What about *decreasing* the

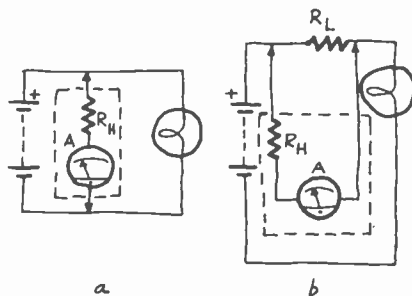

FIG. 3

range of meters? Without taking them apart, that cannot be done as easily. In fact, your best bet is to use an ammeter (milli- or micro-) for both voltage and current.

The circuit in Fig. 3-a shows a low-resistance ammeter in series with a high resistance. Resistor R_H protects the meter from the large current that otherwise would flow through it. It does pass a small current that the meter measures. What we have done, in effect, is to make a *voltmeter* inside the area in the dashed box in Fig. 3-a.

Remember that we are dealing with a DC circuit and the current and voltage are proportional: $E = I \times R$ (Ohm's law). For that reason, you can read the current, plug the values of I (current) and R (resistance) into the formula, and determine the voltage. If this is to be a permanent set-up, you can re-mark the meter scale in *volts* and thereafter read it directly.

Note that the full-scale reading can be made anything you wish simply by adjusting the value of resistor R_H . You can have a millivolt meter or a kilovolt meter or anything in between.

Next, let's make a very-low-range current meter. It can be done as shown in Fig. 3-b. A low resistance, R_L , is placed in series with the circuit and there is a small voltage drop across it. All we have to do is measure that voltage drop and apply the values to Ohm's law to find the current.

Since the purpose is to measure small currents with “big” meters, it is probable that you will be dealing with voltage drops in the millivolt range. If you have a suitable millivolt meter, use it, but likely you will have to build one as discussed above and shown in Fig. 3-a. Again, you can letter on an appropriate scale.

As you move into the changing of meters, be aware that there are formulas for determining meter and resistor values for any particular application. A word of caution: If you want to determine the resistance of a meter, **do not** slap an ohmmeter indiscriminately on the meter terminals. That is a good way to burn it out. Use indirect-measurement methods or trial-and-error experimentation for the external resistors. The latter method will work well if you keep in mind the fundamentals outlined above.

There are, of course, many other ways to change the range of meters. The most effective involve changing the resistors built into the meters themselves. That discussion will have to wait for another

continued on page 84

NOW SONY TEACHES YOU THE THEORY BEHIND VIDEO COLOR SYSTEMS AT THE TOUCH OF A BUTTON.

It's a whole new way of getting an education in color video technology—Sony-style. The classroom is home or shop. The seat—your most comfortable. The hours—your own. The method—five videocassettes and five accompanying booklets that make up a complete, self-paced learning program. With Sony teaching.

Called "Color Systems," this second course in Sony's Video Fundamental Series is designed for those who require a thorough background in all aspects of color theory as it applies to the video industry today.

You'll see clear demonstrations that unravel the mysteries of color circuitry—from cameras to CRT's. You will learn about the equipment and signals used for testing, plus useful techniques for troubleshooting color video systems. Each cassette comes with its own study booklet, whose self-review questions show you when you're on top of the material and ready to move on.

You can order a preview tape, individual tapes on a specific subject or the entire Color Systems course in Betamax or U-matic format.

Course Contents: 1. Properties of Color. 2. Color Camera Systems. 3. Video Display Systems. 4. Encoding NTSC Color. 5. Decoding NTSC Color.

Whether you own, sell or service video equipment, or have an overall electronics background, "Color Systems" will make you thoroughly at home in the world of color video technology.



SONY COLOR SYSTEMS COURSE

I'm interested in learning color video technology. Please send me:

COLOR SYSTEMS SERIES—COMPLETE

(5 cassettes/booklets, customized album and binder supplied)

Betamax 1 hr. 2 hr. \$295.00
Regular Price \$330.00

¾" U-matic \$355.00
Regular Price \$405.00

INDIVIDUAL LESSONS

(Price per cassette/booklet)

Betamax 1 hr. 2 hr. \$66.00

¾" U-matic \$81.00

Circle lesson # and indicate quantity desired in space provided.

1 ____ 2 ____ 3 ____ 4 ____ 5 ____

PREVIEW TAPE

Betamax 1 hr. 2 hr. \$12.50

U-matic \$28.00

Add appropriate sales tax and \$1.75 per cassette (\$8.75 for complete course) for handling and shipping. (UPS in continental U.S. If outside, add \$30.00 for Export Charges, plus Collect Freight Charges; special handling is extra.) For phone orders, call (213) 537-4300, x331, or visit your local SONY Video Products Dealer.

We honor VISA and MasterCard via phone or mail.

Name _____

Address _____

City _____ State _____

Zip Code _____ Phone # _____

VISA/MasterCard Number _____ Exp. Date _____

Signature _____

Mail to: Sony Video Products Company, Tape Production Services, 700 W. Artesia Blvd., Compton, California 90220.

Please send additional information.

NOTE: Tapes returnable if defective when received. Please allow two weeks for delivery.

SONY
Video Communications

Sony, Betamax and U-matic are registered trademarks of the Sony Corp.

CIRCLE 2 ON FREE INFORMATION CARD

VISA

MasterCard

BUILD A MASTERPIECE OF SOUND

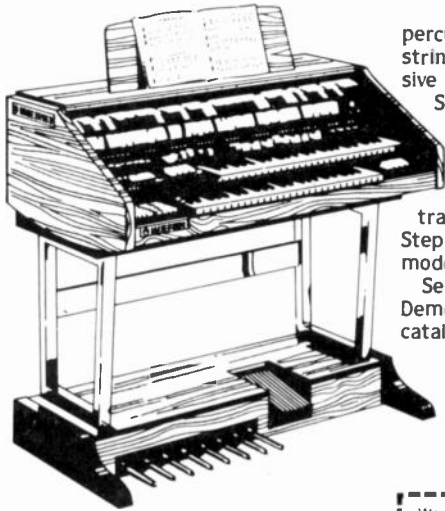

percussion and sustain. Wersi's famous string orchestra and bass guitar. Exclusive Sound Computer for 32-128 "One Stop Sounds" (total organ presets). Transposer. And lots more.

Build your own masterpiece of sound. No technical knowledge required. Just follow the clearly illustrated, easy to understand instructions. Step by step. Choose from at least 10 models. (Also factory assembled.)

Send \$6.00 with coupon for your Wersi Demo-Package (LP with 104-page color catalog).



Wersi has combined select features of the electronic music field, added its own creations and years of research by top engineers and musicians, to produce an incomparable line of organs.

Space-age technology. True-to-life voicing with full drawbar system. Polyphonic

Wersi Electronics, Inc Dept 21 1720 Hempstead Road Lancaster PA 17601	Wersi Organs & Kits Dept 21 14104 E Firestone Blvd Santa Fe Springs CA 90670
--	---

Enclosed is \$6.00 for my Demo-Package (LP with 104-page color catalog.)

Name _____
Address _____
City _____ State _____ Zip _____

CIRCLE 23 ON FREE INFORMATION CARD

In An Instant. YOU CAN SAFELY PLUG AWAY WITHOUT OVERLOADING OR COMING UP SHORT



You can do it thanks to SGL WABER® multiple outlet strips. There are over 100 versatile models with unsurpassed quality workmanship. Each exceeds National Electrical Code standards and is safety tested. Ideal for organizing your work area and having extra outlets *exactly* where you want them. Over 2,000 electronic distributors carry the SGL Waber line. Send for our free 24-page catalog, today!

SGL WABER Electric

A division of SGL Industries, Inc.
Dept. H—300 Harvard Avenue
Westville, New Jersey 08093
(609) 456-5400

IDEAL FOR
RACK MOUNTS

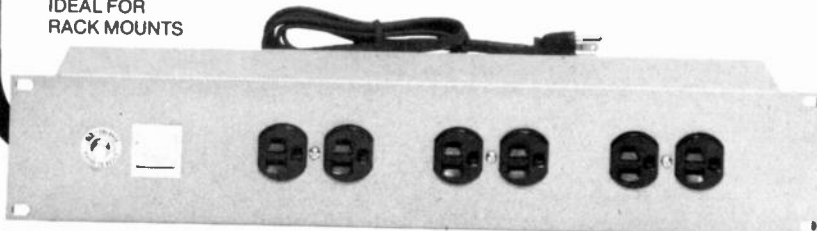

CIRCLE 30 ON FREE INFORMATION CARD

HOBBY CORNER

continued from page 82

time. For now the information provided is sufficient to enable you to modify meters to fit most applications.

For AC circuits, just put a diode in series with the meter but don't expect a linear scale to result.

What about digital meters? The same methods apply except that you will have *great* difficulty putting new scale markings on a digital meter!

Reader needs

A. P. Lingo of Dierks, AR is looking for a 4-switch circuit with corresponding LED indicator lights arranged to:

1. apply 12 volts DC to one of 4 circuits and light the LED for that circuit;
2. remove the 12 volts but leave the LED on when the switch is released;
3. turn off that LED when another switch is pressed to apply 12 volts to another circuit and turn on that LED;
4. and so on.

What is the minimum-component circuit, other than mechanical latching relays, that you can design to do the job? I'll pass it along to A.P., who will appreciate your help.

Recently available

"Instruments for Testing and Design"—this catalog from Global Specialties Corp., contains pictures, specifications and prices on their full line. If your test/design capability can stand improvement, you can get this catalog by calling 1-800-243-6077. Global even pays for the call!

General Catalog—Fuji-Svea Incorporated (P. O. Box 40325, Cincinnati, OH 45240) stocks a wide variety of parts and equipment. You'll find it all in their latest catalog. **R-E**



A LIFETIME GUARANTEE AND 11 OTHER REASONS TO BUY AN "OPTOELECTRONICS" FREQUENCY COUNTER

1. SENSITIVITY: Superb amplifier circuitry with performance that can't be matched at twice the price. Average sensitivity of better than 15 mV from 10 Hz to 500 MHz on every model and better than 30 mV from 500 MHz to 1.1 GHz on the Series 8010A and 8013.

2. RESOLUTION: 0.1 Hz to 12 MHz, 1 Hz to 50 MHz, 10 Hz over 50 MHz.

3. ALL METAL CASES: Not only are the heavy gauge aluminum cases rugged and attractive, they provide the RF shielding and minimize RFI so necessary in many user environments.

4. EXTERNAL CLOCK INPUT/OUTPUT: Standard on the 8010/8013 series and optional on the 7010 series is a buffered 10 MHz clock time base input/output port on the rear panel. Numerous uses include phase comparison of counter time base with WWVB (U.S. National Bureau of Standards). Standardize calibration of all counters at a facility with a common 10 MHz external clock signal, calibrate scopes and other test equipment with the output from precision time base in counter, etc., etc.

5. ACCURACY: A choice of precision to ultra precision time base oscillators. Our ± 1 PPM TCXO (temperature compensated xtal oscillator) and ± 0.1 PPM TCXO are sealed units tested over 20-40°C. They contain voltage regulation circuitry for immunity to power variations in main instrument power supply, a 10 turn (50 PPM) calibration adjustment for easy, accurate setability and a heavily buffered output prevents circuit loads from affecting oscillator. Available in the 8010 and 8013 series is our new ultra precision micro power proportional oven oscillator. With $\pm .05$ PPM typical stability over 10-45°C, this new time base incorporates all of the advantages of our TCXO's and virtually none of the disadvantages of the traditional ovenized oscillator. Requires less than 4 minutes warm-up time, small physical size and has a peak current drain of less than 100 ma.

6. RAPID DISPLAY UPDATE: Internal housekeeping functions require only .2 seconds between any gate or sample time

period. At a 1 second gate time the counter will display a new count every 1.2 seconds, on a 10 second gate time a new count is displayed every 10.2 seconds. (10.2 seconds is the maximum time required between display updates for any resolution on any model listed).

7. PORTABILITY: All models are delivered with a 115 VAC adapter, a 12 VDC cord with plug and may be equipped with an optional ni-cad rechargeable battery pack installed within its case. The optional Ni-Cad pack may be recharged with 12 VDC or the AC adapter provided.

8. COMPACT SIZES: State-of-the-Art circuitry and external AC adapters allowed design of compact easy to use and transport instruments.

Series 8010/8013: 3" H x 7-1/2" W x 6-1/2" D

Series 7010: 1-3/4" H x 4-1/4" W x 5-1/4" D

9. MADE IN U.S.A.: All models are designed and manufactured at our modern 13,000 square foot facility at Ft. Lauderdale, Florida.

10. CERTIFIED CALIBRATION: All models meet FCC specs for frequency measurement and provided with each model is a certificate of NBS traceable calibration.

11. LIFE TIME GUARANTEE: Using the latest State-of-the-Art LSI circuitry, parts count is kept to a minimum and internal case temperature is only a few degrees above ambient resulting in long component life and reliable operation. (No custom IC's are used.) To demonstrate our confidence in these designs, all parts (excluding batteries) and service labor are 100% guaranteed for life to the original purchaser. (Transportation expense not covered).

12. PRICE: Whether you choose a series 7010 600 MHz counter or a series 8013 1.3 GHz instrument it will compete at twice its price for comparable quality and performance.

MODEL 8010A/8013 1.1 GHz/1.3 GHz

MODEL 7010A 600 MHz



MODEL	RANGE (From 10 Hz)	10 MHz TIME BASE			AVG. SENSITIVITY		GATE TIMES	RESOLUTION			EXT. CLOCK INPUT/OUTPUT	SENSITIVITY CONTROL	NI-CAD BATTERY PACK
		STABILITY	AGING	DESIGN	10 Hz to 500 MHz	500 MHz to 1.1 GHz		12 MHz	60 MHz	Max. Freq.			
7010A	600 MHz	± 1 PPM	< 1 PPM/YR	TCXO*	15 mV	N/A	(3) 1, 1, 10 sec	1 Hz	10 Hz (600 MHz)	YES OPTIONAL	NO	YES OPTIONAL	
7010 1A		± 0.1 PPM											
8010A	1.1 GHz	± 1 PPM	< 1 PPM/YR	TCXO*	15 mV	30 mV	(4) 01, 1, 1, 10 sec	1 Hz	1 Hz	YES STANDARD	YES	YES OPTIONAL	
8010 1A		± 0.1 PPM											
8010 05A		$\pm .05$ PPM		OCXO**									
8013.1		± 0.1 PPM		TCXO*									
8013.05	1.3 GHz	$\pm .05$ PPM	< 1 PPM/YR	OCXO**	15 mV	30 mV	01, 1, 1, 10 sec	1 Hz	1 Hz	YES STANDARD	YES	YES OPTIONAL	

* TCXO = Temperature Compensated Xtal Oscillator

** OCXO = Proportional Oven Controlled Xtal Oscillator

SERIES 7010A

#7010A	600 MHz Counter - 1 PPM TCXO	\$199.95
#7010 1A	600 MHz Counter - 0.1 PPM TCXO	\$249.95
OPTIONS		
#70-H	Handle/Tilt Bail (not shown)	\$2.95
#Ni-Cad-701	Ni-Cad Battery Pack & Charging Circuitry Installed Inside Unit	\$19.95
#EC-70	External Clock Input/Output	\$35.00
#CC-70	Carry Case - Padded Black Vinyl	\$9.95

SERIES 8010A/8013

#8010A	1.1 GHz Counter - 1 PPM TCXO	\$399.00
#8010 1A	1.1 GHz Counter - 0.1 PPM TCXO	\$450.00
#8010.05A	1.3 GHz Counter - .05 PPM Oven	\$499.00
#8013.1	1.3 GHz Counter - 0.1 PPM TCXO	\$550.00
#8013.05	1.3 GHz Counter - .05 PPM Oven	\$599.00
OPTIONS		
#Ni-Cad-801	Ni-Cad Battery Pack & Charging Circuitry Installed Inside Unit	\$49.95
#CC-80	Carry Case - Padded Black Vinyl	\$ 9.95

ACCESSORIES

#TA-10G	Telescope antenna with right angle BNC	\$ 9.95
#P-100	Probe, 50 Ohm, 1X	\$ 3.95
#P-101	Probe, Lo-Pass	
	Audio Usage	\$16.95
#P-102	Probe, Hi-Z	
	General Purpose	\$16.95
#LFM:1110	Low Frequency Multiplier X 10, X 100, X 1000	\$119.95
	For High Resolution of Audio Freq.	



Optoelectronics inc

5821 N.E. 14th Avenue, Fort Lauderdale, Florida 33334

1-800-327-5912

FROM FLORIDA (305) 771-2051/2

CIRCLE 3 ON FREE INFORMATION CARD

TERMS: Orders to U.S. and Canada, add 5% for shipping, handling and insurance to a maximum of \$10.00. All other orders add 15%. C.O.D. collection fee \$2.00. Florida orders add 4% state tax. Personal checks must clear before goods are shipped.

Are YOU prepared for the ELECTRONIC EIGHTIES ...

... the decade that promises exciting advances in a still-young field?

Not many are. But you could be ... through ETI's advanced home study training methods. It's not an easy field but we make it easier to learn ... and easier on your bank account, too. We're a small school but we're BIG on service and our staff is dedicated to helping you IF you're ambitious, qualified and eager to learn.

Select from our basic courses, career programs or advanced courses. Mix and match to fit your needs and goals.

Send TODAY for our FREE catalog or for faster service, use the toll free telephone number below, day or night.

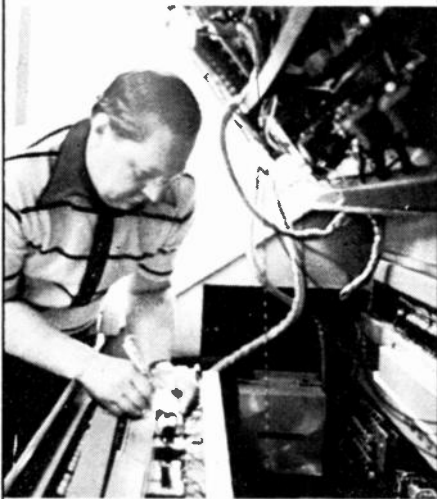

CALL FREE DAY OR NITE
1 800 621 5809
FROM ILLINOIS 800 972 5858



ETI

ELECTRONICS TECHNICAL INSTITUTE
Dept. 20110
153 West Mulberry St.
Lancaster, Ohio 43130

Ohio License
0683H

ETI Home Study, Dept. 20110
153 West Mulberry
Lancaster, Ohio 43130

Please rush FREE catalog on electronics opportunities and training I'm interested in

Basic Career Specialized
 Advanced

Name _____

Address _____

City/State/Zip _____

CIRCLE 56 ON FREE INFORMATION CARD

new products

More information on new products is available. Use the Free Information Card inside the back cover.

WIRE JUMPER KIT, model WK-1, designed for use in preparing circuits for solderless breadboards, is an assortment of insulated solid hook-up wire in 14 different color-coded lengths. The AWG No. 22 wire is pre-cut, prestripped, and the ends are bent 90 degrees, so no cutting, strip-

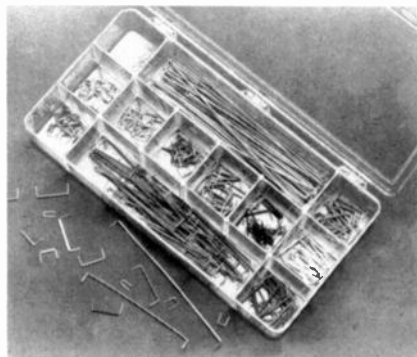

CIRCLE 151 ON FREE INFORMATION CARD

ping, or bending of the leads is necessary. The lengths are coordinated with the insulation color to provide standard jumper-length identification, and range in size from 0.1 to 4.0 inches. 25 pieces of each of the 14 lengths are sorted into compartments in a hinged-lid plastic case. Price is \$10.00.—Global Specialties Corp., 70 Fulton Terr., New Haven, CT 06509.

SOLDER, *Flowsolder Triple-Core Wire Solders*, for electronic hand soldering, feature a constant flux-to-metal ratio to eliminate flux voids. Requiring shorter iron dwell-time and lower idling temperatures, a thin solder wall permits faster

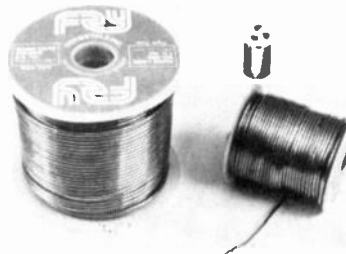

CIRCLE 152 ON FREE INFORMATION CARD

melting, flux flow, and thorough wetting. The solders are extruded and drawn to all standard diameters from .125 to .020 inches with flux percentages from .5% to 4%. Available in 1, 5, and 25 pound spools.—Fry Metals, Inc., 50 Sims Ave., Providence, RI 02909.

CARD GUIDES AND MOUNTING STRUTS, the *BR-20 Series*, is a line of press-in plastic card guides and extruded aluminum mounting struts designed for installing circuit boards within custom-designed enclosures. The guides support all 1/16-inch-wide cards up to 8-inches long and they have 60° entry channels on both ends so cards can be inserted from either end. The grooves are 0.072-inches wide by 0.1-inches deep and the guides bow slightly upward in the middle to stop the cards from vibrating.



CIRCLE 153 ON FREE INFORMATION CARD

For installation, the mounting pins are snapped into 0.156-inch diameter holes. A 0.1-inch diameter section on the pin allows easy alignment while a 0.163-inch knob secures the guides in place. The guides can be mounted directly on flat surfaces up to 0.125-inches thick. Alternately, the guides can be mounted on *TS-series* struts. The struts are pre-punched 0.292-inch thick by 1-inch wide. Made of flame-resistant nylon material, the guides are available in 3.42, 4.72, 5.42, 6.82, and 8.52-inch lengths. The T-struts are available in 8.12, 16.85, and 20.85-inch lengths. Prices for the card guides are from \$.27 to \$.34 each; the mounting struts are \$2.65 to \$4.60 each.—Vector Electronic Co., 12460 Gladstone Ave., Sylmar, CA 91342.

RF PROBE, the *DP750P*, allows the user to read the RMS voltage value of signals from 100 kHz to 750 MHz on a wide variety of DMM's and VOM's and provides a 1-volt DC output with a 1-volt RMS input for instruments having a 10-megohm input resistance. Features include a voltage range from 250 millivolts P-P to 100 volts P-P and has a break-resistant center conductor and a heavy-duty tip (BNC pin diameter).

Other features are retractable safety-sleeved banana plugs that fit standard banana jacks and a 200-volt (DC and peak AC) maximum input volt-

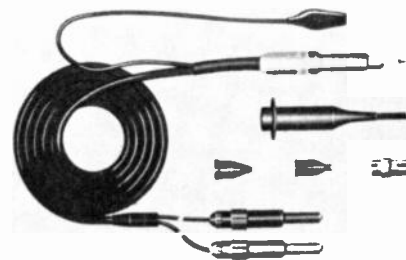

CIRCLE 154 ON FREE INFORMATION CARD

age. Insulated female/female adaptor sleeves are also available for use with instruments such as the Triplett model 630 VOM. The *DP750TP* comes complete with sprung hook, BNC adaptor, IC tip and insulating tip. Price is \$45.00.—Test Probes, Inc. P.O. Box 2113, La Jolla, CA 92038.

SOLAR-POWERED LCD CALCULATOR, *Stock No. 42,928*, operates on the power of normal light and never needs batteries. It works from the light of an ordinary light bulb and is on when the lights

continued on page 88

Good news for you and your customers. NESDA/ISCET rates RCA serviceability:

'Excellent'

"The RCA CTC 108 and CTC 109 chassis have earned the highest possible serviceability rating category...

Excellent... by incorporating serviceability features required in the ISCET Serviceability Rating Form.

"RCA's many years of cooperation with ISCET's Serviceability Committee has helped produce excellent results."

—Dean R. Mock, Chairman, NESDA/ISCET Serviceability Committee

ISCET's 92% (CTC 108) and 93% (CTC 109) ratings were good news to us. Because they mean that some of the most demanding critics in the industry agree that we've succeeded in de-

signing chassis that not only give your customers a first rate picture, but are easy to repair too. Here are some reasons why they think so:

All subassemblies plug into chassis. No tools are needed to remove chassis (main circuit board). Just remove the cabinet back, unplug subassemblies and the chassis is ready for removal.

Roadmapping on both sides of the board.

Although the XL-100 chassis use single-sided circuit boards, double road-mapping means you can easily trace circuits from either side.

Circuits and voltages directly identified. Major circuit areas as well as power supply source and key pulse voltages are labeled by name on the board. So you can find them fast.

That all means that when you do have to repair our new XL-100 chassis, in most cases you can fix them quickly and easily.

And you won't have to waste your valuable time trying to find out where to go to fix what you already know is wrong.

Because to us that's what really counts. Making your job easier and your customers happier.

RCA

**RCA IS MAKING
TELEVISION
BETTER AND BETTER.**



For your free subscription to RCA COMMUNICATOR our magazine of news and advice for service technicians, write: RCA, Dept. 1-453, 600 North Sherman Drive, Indianapolis, IN 46201.

BREAKTHROUGH In Transistor Testing

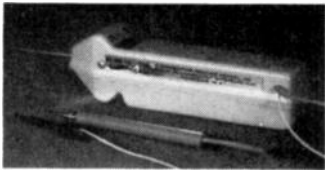

IN-CIRCUIT OUT-OF-CIRCUIT Transistor tester Model 3R ONLY \$49.95

FAST EASY TESTING OF BIPOLAR AND DARLINGTON TRANSISTORS FETs, SCRs, UJT's, LED's, DIODES and Continuity

- Positively identifies emitter, base and collector; Determines whether device is pnp or npn and silicon or germanium
- Completely portable with long battery life - use 4 "AA" cells.
- Will pulse CMOS logic

Terms We pay shipping on prepaid orders in the continental USA. COD, VISA/MASTER CHARGE welcome Phone (914) 423-7600.

Group Technology Systems, Inc.

44 Warburton Ave., Yonkers, NY 10701

Please send _____ model 3R transistor testers at \$49.95 each COD. Check enclosed or charge my VISA. Master Charge

Acc No _____ Exp Dt _____

Name _____

Address _____

City _____ State _____ Zip _____

New York State residents add applicable sales tax

CIRCLE 48 ON FREE INFORMATION CARD

TEST UP TO 100 WATTS/STEREO 200 WATTS/MONO



AUDIO POWER CONTROL TPC-100 \$140

Now test an amplifier or receiver's maximum power, crosstalk, distortion, and much more. The TPC-100's monitor output provides the interconnection between the amplifier and your test equipment. The TPC-100 distributes 2 channel audio signals into 4, 8, or 16 ohm dummy loads (which are MIL grade non-inductive), or to the external speakers.

To order, or for more information, contact:

testek

6010 HAYVENHURST AVENUE/VAN NUYS/CALIFORNIA 91406
213 796-6890

CIRCLE 9 ON FREE INFORMATION CARD

NEW PRODUCTS

continued from page 86

are on, so there is no worry of accidental release of power. Features include full memory function, full floating decimal point, and easy-to-read LCD digits. It adds, subtracts, multiplies, divides, and calculates percentages and square roots. The



CIRCLE 155 ON FREE INFORMATION CARD

calculator is a self-contained unit with a flip-up lid that houses a bank of ten solar panels. It measures only 3 1/4 X 2 1/2 inches and will fit into your shirt pocket. Price is \$29.88 plus \$2.50 packing and guaranteed delivery.—Edmund Scientific Corp., 2069-7082 Edscorp Bldg., Barrington, NJ 08007.

ELECTRONIC BLOOD-PRESSURE TESTER, i-Health Digital 8000, is a portable and easy-to-use instrument with three functions—systolic, diastolic, and pulse. The user attaches the cuff around the arm, switches on the indicator, and pumps air into the cuff with the rubber ball. The



CIRCLE 156 ON FREE INFORMATION CARD

large digital display will enable the user to read blood pressure and pulse quickly and accurately. This light, compact unit has a two-way power supply; either battery or AC adapter is required. Price is \$249 plus \$2 postage and insurance.—Advance Equipment Sales, Inc., 6418 Cambridge St., Minneapolis, MN 55426.

SMART DMM, model 8860A, is a 5 1/2-digit unit with standard multimeter functions, plus many more made possible by the addition of two microprocessors. One controls the analog circuitry, making the actual measurement. An optical coupler is used to pass the measurement to the outside processor, which then interfaces the analog function with the front panel, processes the measurement and displays the result.

The model 8860A features 2- and 4-terminal ohms-measurement capability, manual and auto-ranging, pushbutton DC, pushbutton ohms zero, and two measurement modes—continuous and single trigger. The microprocessor also provides special functions such as offset, limits, and

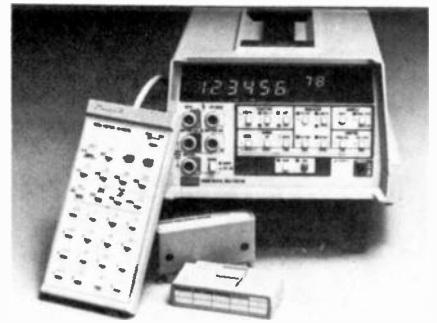

CIRCLE 157 ON FREE INFORMATION CARD

storing the highest and lowest measurement made. The unit is equipped with an IEEE-488 interface option that is fully programmable with a learning mode. It also has a calculating-controller option which is a keystroke-programmable calculator with plug-in memory modules. It has 100 fully merged steps and a complete set of algebraic, trigonometric, and logarithmic functions. Price is \$1,395.—John Fluke Mfg. Co., Inc., P.O. Box 43210, Mountlake Terrace, WA 98043.

SPEAKERPHONE, model KX-T1020, features a condenser microphone that picks up sound from all directions and an automatic switching circuit. It hooks up to a telephone, but may require an optional AC adaptor (KX-A01), depending upon the area. Other features are large-button con-



CIRCLE 158 ON FREE INFORMATION CARD

trols, a mute button that allows user to cut-off outgoing transmissions while still receiving incoming calls, an LED indicator for On and Mute, adjustable slide-volume control, and a simulated wood cabinet. Suggested retail price is \$69.95.—Panasonic, One Panasonic Way, Secaucus, NJ 07094.

FLAT CABLE HARNESS TESTER, Model 3650, is designed for production-line testing of flat cable harness assemblies. It can test a variety of Scotchflex brand and related harnesses—14 and 16-pin DIP connectors, Delta and Delta Ribbon series connectors, 20 through 50 contact card-edge connectors, 10 through 50 contact sockets and 26 through 50 contact PCB transition connectors. This portable, easy-to-use unit is housed in a rugged thermoformed case and is operated with a 9-volt battery. A test probe and LED read-out will identify troublesome shorted and open connectors to insure harness reliability. The test-

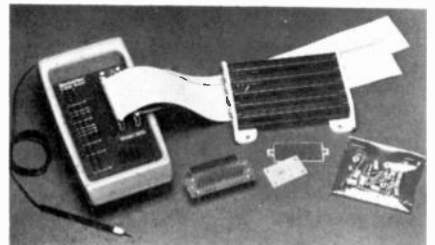

CIRCLE 159 ON FREE INFORMATION CARD

er comes complete with the module, the interface bed, 50 position card-edge interface board, 14/16-pin DIP interface board, and related accessories. Price is \$387.50.—3M, Dept. EP80-12, P.O. Box 33600, St. Paul, MN 55133. **R-E**

Start learning and computing for only **\$129.95** with a **Netronics 8085-based computer kit**. Then expand it in low-cost steps to a business/development system with 64k or more RAM, 8" floppy disk drives, hard disks and multi-terminal I/O.

THE NEW EXPLORER/85 SYSTEM

Special! Full 8" floppy, 64k system for less than the price of a mini! Only **\$1499.95!**

(Also available wired & tested, \$1799.95)

Imagine — for only \$129.95 you can own the starting level of Explorer/85, a computer that's expandable into full business/development capabilities — a computer that can be your beginner system, an OEM controller, or an IBM-formatted 8" disk small business system. From the first day you own Explorer/85, you begin computing on a significant level, and applying principles discussed in leading computer magazines. Explorer/85 features the advanced Intel 8085 cpu, which is 100% compatible with the older 8080A. It offers on-board S-100 bus expansion, Microsoft BASIC in ROM, plus instant conversion to mass storage disk memory with standard IBM-formatted 8" disks. All for only \$129.95, plus the cost of power supply, keyboard/terminal and RF modulator if you don't have them (see our remarkable prices below for these and other accessories). With a Hex Keypad/display front panel, Level "A" can be programmed with no need for a terminal, ideal for a controller, OEM, or a real low-cost start.



Level "A" is a complete operating system, perfect for beginners, hobbyists, industrial controller use. \$129.95



Full 8" disk system for less than the price of a mini (shown with Netronics Explorer/85 computer and new terminal) System features floppy drive from Control Data Corp., world's largest maker of memory storage systems (not a hobby brand!)



Level "A" With Hex Keypad/Display.

LEVEL "A" SPECIFICATIONS

Explorer/85's Level "A" system features the advanced Intel 8085 cpu, an 8355 RAM with 2k deluxe monitor/operating system, and an advanced 8155 RAM I/O... all on a single motherboard with room for RAM/ROM/PROM/EPROM and S-100 expansion, plus generous prototyping space.

PC Board: Glass epoxy, plated through holes with solder mask. • I/O: Provisions for 25-pin (DB25) connector for terminal serial I/O, which can also support a paper tape reader... cassette tape recorder input and output... cassette tape control output... LED output indicator on SOD (serial output) line... printer interface (less drivers)... total of four 8-bit plus one 6-bit I/O ports. • Crystal Frequency: 6.144 MHz. • Control Switches: Reset and user (RST 7.5) interrupt... additional provisions for RST 5.5, 6.5 and TRAP interrupts on-board. • Counter/Timer: Programmable, 14-bit binary. • System RAM: 256 bytes located at F800, ideal for smaller systems and for use as an isolated stack area in expanded systems... RAM expandable to 64k via S-100 bus or 4k on motherboard.

System Monitor (Terminal Version): 2k bytes of deluxe system monitor ROM located at F800, leaving 8000 free for user RAM/ROM. Features include tape load with labeling... examine/change contents of memory... insert data... warm start... examine and change all registers... single step with register display at each break point, a debugging/training feature... go to execution address... move blocks of memory from one location to another... fill blocks of memory with a constant... display blocks of memory... automatic baud rate selection to 9600 baud... variable display line length control (1-255 characters/line)... channelized I/O monitor routine with 8-bit parallel output for high-speed printer... serial console in and console out channel so that monitor can communicate with I/O ports.

System Monitor (Hex Keypad/Display Version): Tape load with labeling... tape dump with labeling... examine/change contents of memory... insert data... warm start... examine and change all registers

single step with register display at each break point go to execution address. Level "A" in this version makes a perfect controller for industrial applications, and is programmed using the Netronics Hex Keypad/Display. It is low cost, perfect for beginners.

HEX KEYPAD/DISPLAY SPECIFICATIONS

Calculator type keypad with 24 system-defined and 16 user-defined keys. Six digit calculator-type display, that displays full address plus data as well as register and status information.

LEVEL "B" SPECIFICATIONS

Level "B" provides the S-100 signals plus buffers/drivers to support up to six S-100 bus boards, and includes: address decoding for on-board 4k RAM expansion selectable in 4k blocks... address decoding for on-board 8k EPROM expansion selectable in 8k blocks... address and data bus drivers for on-board expansion... wait state generator (jumper selectable), to allow the use of slower memories... two separate 5 volt regulators.

LEVEL "C" SPECIFICATIONS

Level "C" expands Explorer/85's motherboard with a card cage, allowing you to plug up to six S-100 cards directly into the motherboard. Both cage and card are neatly contained inside Explorer's deluxe steel cabinet. Level "C" includes a sheet metal superstructure, a 5-card, gold plated S-100 extension PC board that plugs into the motherboard just add required number of S-100 connectors

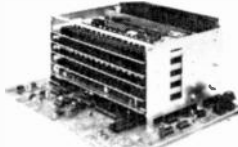

Explorer/85 With Level "C" Card Cage

LEVEL "D" SPECIFICATIONS

Level "D" provides 4k of RAM, power supply regulation, filtering/decoupling components and sockets to expand your Explorer/85 memory to 4k (plus the original

256 bytes located in the 8155A) The static RAM can be located anywhere from F000 to EFFF in 4k blocks

LEVEL "E" SPECIFICATIONS

Level "E" adds sockets for 8k of EPROM to use the popular Intel 2716 or the TI 2516. It includes all sockets, power supply regulator, heat sink, filtering and decoupling components. Sockets may also be used for 2k x 8 RAM IC's (allowing for up to 12k of on-board RAM).

DISK DRIVE SPECIFICATIONS

- 8" CONTROL DATA CORP professional drive
- LS controller
- Write protect
- Single or double density
- Data capacity 401,016 bytes (SD), 802,032 bytes (DD), unformatted
- Access time: 25ms (one track)

DISK CONTROLLER/I/O BOARD SPECIFICATIONS

- Controls up to four 8" drives.
- 1771A LSI (SD) floppy disk controller
- Onboard data separator (IBM compatible)
- 2 Serial I/O ports
- Autoboot to disk system when system reset
- 2716 PROM socket included for use in custom applications
- Onboard crystal controlled (IBM compatible) Onboard I/O baud rate generators to 9600 baud.
- Double-sided PC board (glass epoxy)

DISK DRIVE CABINET/POWER SUPPLY

- Deluxe steel cabinet with individual power supply for maximum reliability and stability

ORDER A COORDINATED EXPLORER/85 APPLICATIONS PAK!

Beginner's Pak (Save \$26.00!) — Buy Level "A" (Terminal Version) with Monitor Source Listing and AP-1 5-amp Power Supply; (regular price \$199.95), now at **SPECIAL PRICE: \$169.95** plus post. & insur.

Experimenter's Pak II (Save \$53.40!) — Buy Level "A" (Hex Keypad/Display Version) with Hex Keypad/Display, Intel 8085 User Manual, Level "A" Hex Monitor Source Listing, and AP-1 5-amp Power Supply; (regular price \$279.35), all at **SPECIAL PRICE: \$219.95** plus post. & insur.

Special Microsoft BASIC Pak (Save \$103.00!) — Includes Level "A" (Terminal Version), Level "B", Level "D" (4k RAM), Level "E", 8k Microsoft in ROM, Intel 8085 User Manual, Level "A" Monitor Source Listing, and AP-1 5-amp Power Supply; (regular price \$439.70), now yours at **SPECIAL PRICE: \$329.95** plus post. & insur.

ADD A TERMINAL WITH CABINET.

GET A FREE RF MODULATOR:

Save over \$114 at this **SPECIAL PRICE \$499.95** plus post. & insur.

Special 8" Disk Edition Explorer/85 (Save over \$104!) — Includes disk-version Level "A", Level "B", two S-100 connectors and brackets, disk controller, 64k RAM, AP-1 5-amp power supply, Explorer/85 deluxe steel cabinet, cabinet fan, 8" SD/DD disk drive from famous CONTROL DATA CORP. (not a hobby brand!), drive cabinet with power supply, and drive cable set-up for two drives. This package includes everything but terminal and printers (see coupon for them). Regular price \$1630.30, all yours in kit at **SPECIAL PRICE: \$1499.95** plus post. & insur. Wired and tested, only \$1799.95.

Special! Complete Business Software Pak (Save \$625.00!) — Includes CPM 2.0, Microsoft BASIC, General Ledger, Accounts Receivable, Accounts Payable Payroll Package; (regular price \$1325), yours now at **SPECIAL PRICE: \$699.95**.

Please send the items checked below:

- Explorer/85 Level "A" ktd (Terminal Version) \$129.95 plus \$3 post & insur
- Explorer/85 Level "A" ktd (Hex Keypad/Display Version) \$129.95 plus \$3 post. & insur
- 8k Microsoft BASIC on cassette tape: \$64.95 postpaid
- 8k Microsoft BASIC in ROM ktd (requires Levels "B", "D" and "E") \$80.95 plus \$2 post & insur
- Level "B" (S-100 ktd) \$48.95 plus \$2 post & insur
- Level "C" (S-100 6-card expander) ktd \$39.95 plus \$2 post & insur
- Level "D" (4k RAM) ktd \$80.95 plus \$2 post & insur
- Level "E" (EPROM/ROM) ktd \$5.95 plus 50¢ p&h
- Deluxe Steel Cabinet for Explorer/85 \$499.95 plus \$3 post & insur
- Fan For Cabinet \$15.00 plus \$1.50 post & insur
- ASCII Keyboard/Computer Terminal ktd: features a full 128 character set, 81 case, full cursor control, 75 ohm video output, convertible to baudot output, selectable baud rate RS232-C or 20 ma I/O, 32 or 64 character by 16 line formats and can be used with either a CRT monitor or a TV set (if you have an RF modulator) \$149.95 plus \$3.00 post & insur
- Deluxe Steel Cabinet for ASCII keyboard/terminal \$19.95 plus \$2.50 post & insur
- New! Terminal/Monitor: (See photo) Same features as above except 12" monitor with keyboard and terminal is in deluxe single cabinet, ktd \$399.95 plus \$7 post & insur
- Hazeltine terminals: Our prices too low to quote — CALL US
- Lear-Siegler terminals/printers: Our prices too low to quote — CALL US
- Hex Keypad/Display ktd \$89.95 plus \$2 post & insur

- AP-1 Power Supply ktd 2.8V @ 5 amps) in deluxe steel cabinet \$39.95 plus \$2 post & insur
- Gold Plated S-100 Bus Connectors \$4.85 each, postpaid
- RF Modulator ktd (allows you to use your TV set as a monitor) ... \$4.95 postpaid.
- 16k RAM ktd (S-100 board expands to 64k) \$109.95 plus \$2 post & insur
- 32k RAM ktd \$209.95 plus \$2 post & insur
- 48k RAM ktd \$309.95 plus \$2 post & insur
- 64k RAM ktd \$409.95 plus \$2 post & insur
- 16k RAM Expansion ktd (to expand any of the above in 16k blocks up to 64k) \$80.95 plus \$2 post & insur each
- Intel 8085 cpu Users' Manual \$7.50 postpaid
- 12" Video Monitor (10MHz bandwidth) \$139.95 plus \$5 post & insur
- Beginner's Pak (see above) \$109.95 plus \$4 post & insur
- Experimenter's Pak (see above) \$219.95 plus \$6 post & insur
- Special Microsoft BASIC Pak Without Terminal (see above) \$329.95 plus \$7 post & insur
- Same as above, plus ASCII Keyboard Terminal With Cabinet, Get Free RF-Modulator (see above) \$499.95 plus \$10 post & insur
- Special 8" Disk Edition Explorer/85 (see above) \$1499.95 plus \$26 post & insur
- Wired & Tested \$1799.95 plus \$26 post & insur
- Extra 8" CDD Floppy Drives \$499.95 plus \$12 post & insur
- Cabinet & Power Supply For Drive \$89.95 plus \$3 post & insur
- Drive Cable Set-up For Two Drives \$25 plus \$1.50 post & insur

- Disk Controller Board With I/O Ports \$109.95 plus \$2 post & insur
- Special! Complete Business Software Pak (see above) \$899.95 postpaid
- SOLD SEPARATELY**
- CPM 1.4 \$100 postpaid
- CPM 2.0 \$150 postpaid
- Microsoft BASIC \$325 postpaid
- Intel 8085 cpu User Manual \$7.50 postpaid.
- Level "A" Monitor Source Listing \$25 postpaid

Continental U.S.A. Credit Card Buyers Outside Connecticut
CALL TOLL FREE: 800-243-7428

To Order From Connecticut Or For Technical Assistance call (203) 354-9375

Total Enclosed (Conn res. add sales tax) \$ _____
Paid By _____
 Personal Check Cashier's Check/Money Order
 VISA Master Charge (Bank No. _____)
Acct. No. _____ Exp. Date _____
Signature _____
Print Name _____
Address _____
City _____
State _____ Zip _____

NETRONICS Research & Development Ltd.
333 Litchfield Road, New Milford, CT 06776

Why pay extra for the features and performance we may never use?

HERB FRIEDMAN, COMMUNICATIONS EDITOR

ONE OF THE GUIDING PRINCIPLES OF both American life and business is that "Bigger Is Better." Part of our greatness lies in that fact that we have always offered something better as a goal; whether it was in terms of lifestyle or a better ice-cube tray for the freezer. More important, people could make their own decision as to how much bigness they wanted. If somebody wanted to drive a basic Chevy but take photographs with a Hasselblad—which cost almost as much as the car when accessories were added into to the price of the camera—so be it. If a friend wanted an inexpensive shortwave receiver so he could use the cash he had left to entertain, or for any other purpose, that was also his prerogative.

The fact is, "trading up" was also the American way, whether it was education, jobs, household appliances, or whatever, we could always aspire to *more, bigger, or best*. At least we could do that until business discovered the MBA—the Master of Business Administration.

Taught to maximize business profits, the MBA's who now run American business no longer give us consumers

the option of starting small and "trading up" when the budget permits. Rather, we must purchase the whole kit and kaboodle whether we do or don't need maximized features and performance, for the MBA's simply phase out the lower-profit "basic" equipment.

A good illustration of what I mean is the *microprocessor*, the latest darling of those who manufacture consumer equipment. The microprocessor, which, to most, is synonymous with *computer*, is the consumer's latest toy. We build microprocessors into microwave ovens to "remember" cooking time—we could do the same with an ordinary mechanical timer that costs a lot less. We "computerize" FM receivers, providing features that few of us will ever need (but not necessarily better sound quality), and we computerize radio-telephone transceivers, again providing features we could just as well do without if given the option of trading off the features and saving a hundred or more dollars.

The problem is, we no longer get a choice. With rare exceptions, communications gear suffers from "kitchensinkitis", a contagious disease that

results in manufacturers incorporating every possible feature that can be extracted from a microprocessor. If the fictitious *Space Traveler 2-meter transceiver* has four memories, the next model from a competitor will have 10 memories, etc. Pity the poor amateur trying to squeeze modern gear into an inflation-restricted budget. He might like to have digital frequency selection and display, but maybe he doesn't need to pay extra for memory, or a *Touch Tone* keypad he'll never need. Must he pay for features he doesn't need? You bet he does, because the available computerized transceivers come only one way, with all the bells and whistles—"kitchensinkitis."

There is nothing wrong with selling equipment with every possible feature as long as a basic, and/or intermediate option is also available. For example, there is a computerized Bearcat VHF/UHF scanner that provides modest computerized features. Basically, it permits digital programming of a reasonable number of channels; the unit is essentially an "old fashioned", relatively low-cost scanner with a microprocessor controlling the frequency-determining device. For those who want, or need, additional features there is a model that will search a band of programmed frequencies, or specifically, the marine or aircraft frequencies. And for the serious VHF/UHF enthusiast there's the *model 300*, with 2000+ preprogrammed frequencies that can be searched in groupings such as police, telephone, forestry, etc. It has 50 user-programmable channels, and just about every other feature you can possibly imagine for a scanner. It also costs a bundle, but the point is that Bearcat provides a whole series representing a broad price range: You need purchase only what you need.

Bearcat is the exception to the rule. Few other manufacturers in any field give you the option of purchasing less than "the most expensive."

Consider test equipment for a moment: After many years of faithful service, my laboratory-grade AM signal generator expired. I still haven't been able to locate a replacement. Every model with suitable performance includes AM, FM, pulse, and SSB coverage into the gigahertz range, and costs

continued on page 92

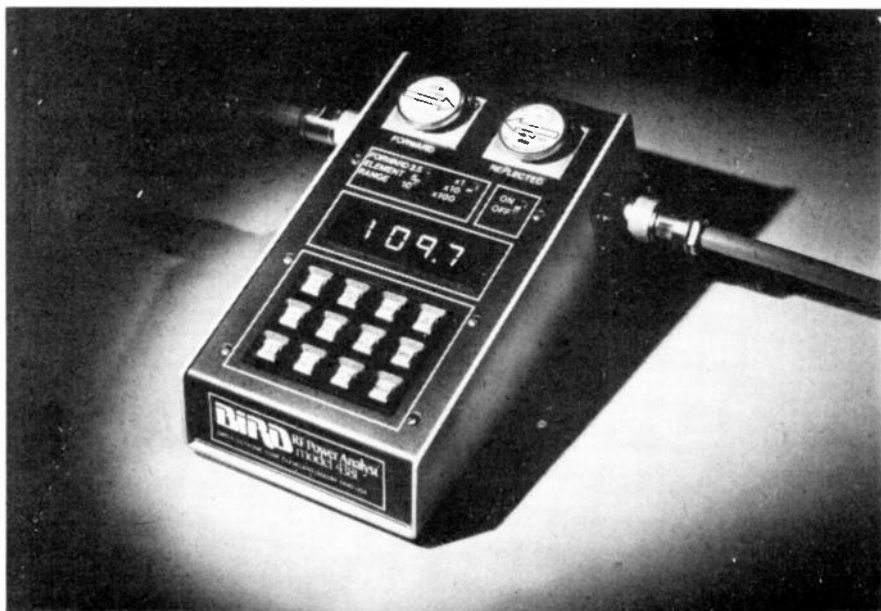

A MODERN INSTRUMENT FOR MODERN TRANSMITTERS. The Bird 4381 RF Power Analyst measures forward and reflected power for CW, AM, FM, and SSB (peak envelope power), automatically calculated VSWR, %-AM modulation, and return loss. It keeps track of maximum/minimum values, and identifies a rise or fall in measured values. Though jam-packed with features, just about all are a "must" for the modern service technician.

An in-depth look at the only "plug-in" remote control system you'll ever need for your home.

NOW AVAILABLE
DELUXE WALL
SWITCH MODULE
(Not shown) **\$18.95**

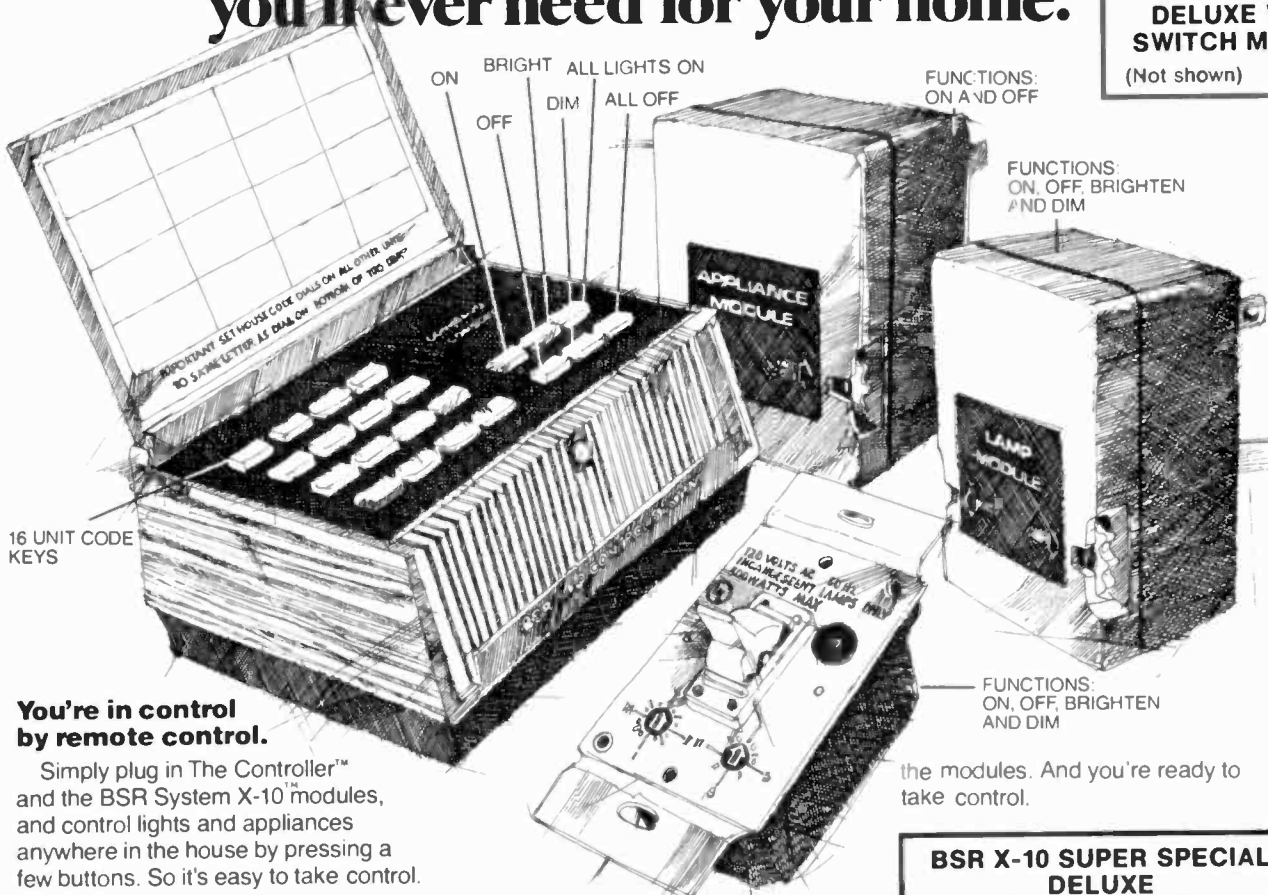

You're in control by remote control.

Simply plug in The Controller™ and the BSR System X-10™ modules, and control lights and appliances anywhere in the house by pressing a few buttons. So it's easy to take control.

There's no end to all of the control you've got.

You can turn on the TV, radio or stereo in the morning to help you wake up without getting up from bed. Or at night, turn on the lights before going downstairs so you don't have to fumble in the dark. Turn off unnecessary lights and help get your electric bill under control. Or, dim the lights and save energy, too.

And when it's time to turn in, just push a button and turn everything off. And sleep soundly. But, if you hear a strange noise in the middle of the night, you can press a button to turn on all the lights and scare the daylight out of an intruder.

The Controller is designed to control every room in the house.

By pressing the buttons on the Command Console keyboard, command signals are transmitted over

existing household wiring to the module of your choice. The Lamp Module turns on, off or dims any incandescent lamp up to 300 watts. The Appliance Module turns appliances like TVs, window fans or stereos on and off. And the Wall Switch Module is designed to turn on, off or dim any light or lamp up to 500 watts normally operated by a wall switch.

There's even a Cordless Controller that transmits signals to an Ultrasonic Command Console from up to 30 feet away. So there's plenty of control for everyone.

Simplicity is built into the system.

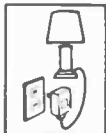

No special wiring is needed. Simply plug The Controller Command Console into any wall outlet in any room of the house.

Then plug your lamps and appliances into the appropriate modules. Plug in

the modules. And you're ready to take control.

BSR X-10 SUPER SPECIAL DELUXE ULTRASONIC CONSOLE

REGULARLY \$49.95
NOW \$29.95

With the purchase of three or more modules

Modules normally \$17.00 ea.

Modules of your choice

3 for \$47.95 6 for \$83.95

Ultrasonic Hand Unit

Normally \$24.95 Now \$18.95

Please add \$3.00 for shipping

TOLL FREE HOT LINE

800-223-0474

THE TIMER™ Automatically Programs Lights, Appliances. Just plug in The Timer and the BSR X-10 modules and you can program up to 8 lights and appliances to go On and Off up to twice a day. UL listed. \$74.95 if purchased separately. If purchased with 3 or more modules \$59.95

NEW



ADVANCE ELECTRONICS

54 West 45 Street, New York, N.Y. 10036 212-687-2224

slightly more than a new car. I don't need all that much performance and features. A few hundred dollars should give me what I need, but there just isn't a basic, low-cost lab generator made any more. It's as if all test gear was intended for a government job based on time and material costs.

How about shortwave receivers? Where is a basic .550- 30 MHz receiver at a price affordable by some young man saving up from his newspaper route? (That's the way many of us got started.) Today, we get the whole

kitchen sink: FM, perhaps *tuneable* public service (VHF) coverage (absolutely useless if tuneable), maybe a digital clock, AC, battery, and "auto" power source, and an assortment of tone controls that can't possibly do much with the sound coming out of an itty-bitty speaker. Get rid of all the excess garbage that's next to useless and it might turn out to be a decent receiver at a moderate price, but no one is eliminating the unnecessary features. The way the MBA's have it figured, everyone buys the high-profit item.

Of course, there are times when every feature possible through computerization is valuable, and probably

worth every penny. For example, consider bi-directional wattmeters for transmitter/antenna checks, tests, and installation. Below the power output used by most broadcasting stations, the Bird model 43 has been more or less accepted as the "standard of reference." It's a great meter, particularly for AM and CW transmitters. But it doesn't measure % modulation, or peak envelope power. For that, we call on the "computerized" Bird 4381 RF Power Analyst. That gem takes two power elements so you don't have to flip them around for forward and reflected measurements. Then, at the touch of a button, it gives a digital display of: the forward or reflected power from 1/10 watt to 10 kW in watts or dBm; automatically calculated VSWR; dB return loss; forward and reverse peak envelope power (SSB); percent AM modulation, and a *delta* function that identifies a rise or fall in displayed value(s). A minimum/maximum memory recalls optimum conditions during adjustments so you can tell if you are "tweaking" in the right direction. Frequency range is 0.5 to 2300 MHz using plug-in elements for 50-ohm lines.

Now all that is a lot of formidable features at an equally formidable price (about \$590), but the point is that the instrument provides precisely the functions needed for modern transmitter installations. There is not one unnecessary frill or a feature you could do without: If you're servicing communications gear you'll use them all. You will not be paying for "computerized" features for which you'll find that you have no use.

As far as purchasing computerized consumer and professional equipment is concerned, you'll get the maximum value at the lowest cost if you can take the time after being overwhelmed by the myriad features provided by space-age technology simply to ask the question: "Do I really have need for all this?" If your answer isn't an unqualified *yes*, then you probably don't really need it.

R-E

Pick your signal

VIZ means value... DC to 40 MHz



Pulse Generator WR-549A \$130

- Ideal for logic design or digital circuit trouble shooting
- Output 5 Hz to 5 MHz $\pm 5\%$, 0-15 V into 600 Ω , 0-6 V into 50 Ω
- Pulse width adj., 100 ns to 0.1 sec., rise and fall time 20 ns
- TTL and CMOS compatible, on and off time independently adj.



Function Generator WR-550B \$150

- Sine, sawtooth and square wave output, 1Hz to 1MHz
- Output 0-20 V peak to peak at 600 Ω plus 10 V adj. offset
- 10 to 1 freq. sweep with ext. sweep voltage of any wave form
- Freq. stability 200 ppm/ $^{\circ}$ C
- Accuracy to 100 kHz $\pm 5\%$ of dial. Above 100 kHz, $\pm 8\%$
- Separate fixed 4 VDC square/sawtooth wave outputs compatible with TTL and CMOS.



Audio Generator WA-504B/44D \$139

- Switch selectable sine or square wave output
- Output 20 Hz to 200 kHz in 4 ranges
- Stability better than $\pm 0.5\%$
- Voltage output 4 ranges .01 to 10 V at 600 Ω
- Sine wave harmonic distortion 0.15%
- Square wave rise and fall 150 nsec. Tilt 2%



RF Generator WR-50C \$130

- RF output tunable 85 kHz to 40 MHz in 6 ranges
- Special sweep output at 455 kHz and 10.7 MHz, plus external xtal
- RF output .05 V rms, 2 step 10 to 1 plus fine adj. attenuator
- Internal modulating freq. 600 Hz adj. to 80%
- Audio output 6 V rms across 15 k Ω load
- FET amplifier for rugged stability

See your VIZ distributor

VIZ VIZ Mfg. Co., 335 E. Price St., Philadelphia, PA 19144
Over 70 test instruments in the line



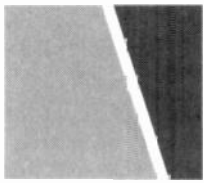

fact: you can choose your microphone to enhance your sound system.

Shure makes microphones for every imaginable use. Like musical instruments, each different type of Shure microphone has a distinctive "sound," or physical characteristic that optimizes it for particular applications, voices, or effects. Take, for example, the Shure SM58 and SM59 microphones:

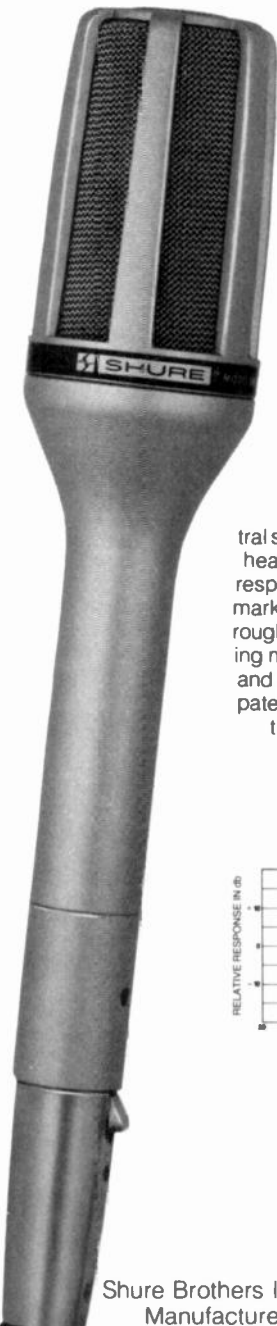

SM59

**Mellow, smooth,
silent...**

The SM59 is a relatively new, dynamic cardioid microphone. Yet it is already widely accepted as a standard for distinguished studio productions. In fact, you'll often see it on TV... especially on musical shows where perfection of sound quality is a major consideration. This revolutionary cardioid microphone has an exceptionally flat frequency response and neutral sound that reproduces exactly what it hears. It's designed to give good bass response when miking at a distance. Remarkably rugged — it's built to shrug off rough handling. And, it is superb in rejecting mechanical stand noise such as floor and desk vibrations because of a unique, patented built-in shock mount. It also features a special hum-bucking coil for superior noise reduction!

Some like it essentially flat...

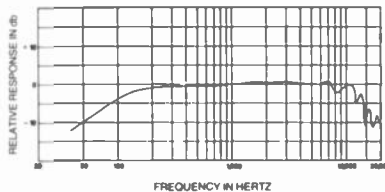

SM58

**Crisp, bright
"abuse proof"**

Probably the most widely used on-stage, hand-held cardioid dynamic microphone. The SM58 dynamic microphone is preferred for its punch in live vocal applications... especially where close-up miking is important. It is THE world-standard professional stage microphone with the distinctive Shure upper mid-range presence peak for an intelligible, lively sound. World-renowned for its ability to withstand the kind of abuse that would destroy many other microphones. Designed to minimize the boominess you'd expect from close miking. Rugged, efficient spherical windscreen eliminates pops. Lightweight (15 ounces!) hand-sized. The first choice among rock, pop, R & B, country, gospel, and jazz vocalists.

...some like a "presence" peak.

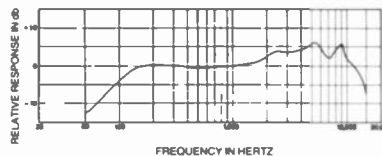

professional microphones...by



Shure Brothers Inc., 222 Hartrey Ave., Evanston, IL 60204, In Canada: A. C. Simmonds & Son Limited
Manufacturers of high fidelity components, microphones, sound systems and related circuitry.

CIRCLE 63 ON FREE INFORMATION CARD

FREE... Catalog of great gift ideas



You'll find the right gift for all the electronics buffs on your Christmas list - from clocks and radios to gas-saving car accessories to computers - all in easy-to-build, money-saving kits.



Prices start at under \$20.

This year, shop the fast, easy way in the Heathkit Catalog.

Heathkit®

If coupon is missing, write Heath Co., Dept. 020-712, Benton Harbor, MI 49022.

Send to: Heath Co., Dept. 020-712, Benton Harbor, MI 49022.

Send my free Heathkit Catalog now. I am not currently receiving your catalog.

Name _____

Address _____

City _____ State _____

CL-745 Zip _____

CIRCLE 26 ON FREE INFORMATION CARD

books

More information on new books is available. Use the Free Information Card inside the back cover

VIDEOCASSETTE RECORDERS, THE COMPLETE HOME GUIDE, by David Lachenbruch. Everest House, 1133 Avenue of the Americas, New York, NY 10036. 235 pp. 5 1/4" X 8 1/4" in. Softcover \$6.95.

This comprehensive guide tells you how and where to buy as well as operate a VCR. Written in nontechnical language, the book examines the history, operating principles and potential impact of VCR's, as well as the legal aspects. Some of the topics covered include how to shop for a VCR; how to install your own system and troubleshoot it; VCR accessories; and how to transfer home movies, make home tapes and do your own duplicating. The book contains many illustrations and an appendix listing available prerecorded programs.

CIRCLE 91 ON FREE INFORMATION CARD

MOTOROLA COMMUNICATIONS PARTS & DATA HANDBOOK. Motorola Communications & Electronics, Inc., 1313 E. Algonquin Rd., Schaumburg, IL 60196. 224 pp. 8 1/4" X 11 1/4" in. Hardcover \$14.95 (plus tax & shipping charges; slightly higher outside U.S.).

This book provides communications maintenance and installation technicians with the basic data (such as conversion and electronic formulas and test-equipment data) needed to service Motorola products. The book contains three sections: The first is a condensation of the elementary theory and practices required to modify circuits or systems. The second section contains parts lists and photographs of certain product lines. The third section provides a list of replacement components together with a description of their applications.

CIRCLE 92 ON FREE INFORMATION CARD

CALCULATING WITH BASIC, by Raymond Guido. SCELBI Publications, P.O. Box 133 PP STN, Milford, CT 06460. 80 pp. 8 1/4" X 10 1/4" inches. Softcover \$7.95. + 75¢ postage/handling.

This book provides routines and programs written in BASIC to assist students, engineers and hobbyists apply the BASIC computer language to practical problems. It presents typical problems in math, finance, statistics, mechanical engineering and electronics and provides suggested solutions. On the lighter side, two games

continued on page 96

Introducing... arkon's exclusive line!

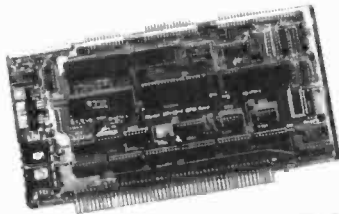

arkon kits

CP/IO-1

An S-100 system card, wired and tested that will outperform the mass market systems in versatility, price and speed. It has all the CPU (8080) disc control (1771) and IO (8255) needed for a disc based CPM system. Interfaces, to all common 8" and 5 1/4" drives. (Shugart, Memorex, BASF, Siemens, Wang). Also features EIA RS232 port (110 to 9600 baud), fully veared Interrupts (TMS5501), on board digital data separator, 2K bytes EPROM, 24 fully handshaked IO lines, dual mapped IO, cassette interface on board, fully buffered.....\$495.00

All ARKON kits are complete with PCB.
Logic Probe Kit, with case.....\$24.95
RS232 to TTL Converter Kit...\$ 9.95
VD-1 Video Modulator Kit.....\$ 8.95
ETI Sound Generator Kit.....\$44.95

ASC II KEYBOARD KIT

60 key complete ASCII character set. Highest commercial quality key switches. Uses a KR 2376 ST encoder IC. Output compatible with TTL. Caps lock for upper case alpha characters. Repeat key. Parity and/or data invertable. Positive and negative keypressed and strobe signals. Requires +5V to +30V at 100mA Complete kit all parts.....\$99.95

COLOR VIDEO MODULATOR

The ultimate APPLE II color modulator. Provides proper level shifting to clean up the familiar smearing effects of simpler modulators. Available at the same price.

Assembled and tested with die cast case.....\$49.95
Kit.....\$24.95

S-100 MOTHER BOARD

Exclusively ARKON's, the A6S100 6 slot mother board, designed for the system builder using modern boards where few slots are required. Provision for semi-active termination.

A6S100.....\$24.95
S-100 edge connector.....\$5. ea/6 for \$25.00.

SUPER S-100 XFORMER

Designed by ARKON, built by HAMMOND. A transformer that fits almost all requirements in building a computer power supply. Transformer no. 120165 uses standard line voltage and provides 3 outputs: 8V at 18A for +5V supply. 28Vct at 4.5A for ±15V supply. 22V at 4.5A for disc drives.

A unique value.....\$49.95

Send certified cheque, money order, ChargeX, Master Charge... include expiry date, card number and signature. We process only prepaid orders. Minimum order \$10.00 Add 5% (minimum \$2.00) for shipping and handling. Ontario residents add 7% sales tax. All prices subject to change. Dealer inquiries welcome.

409 Queen Street West, Toronto, Ontario Canada, M5V 2A5. Tel. (416) 868-1315.



CIRCLE 75 ON FREE INFORMATION CARD

NOW AVAILABLE!

WATT WIZARD™

POWER FACTOR CONTROLLER CUTS THE COST OF RUNNING ELECTRIC APPLIANCES BY AS MUCH AS 50% -- AND YOU CAN EVEN SEE THE SAVINGS!

For over a year now, in magazines and newspapers the world over, there have been enthusiastic write-ups on a remarkable new device that can cut your electric bill while helping the U.S. save huge quantities of fuel.

"The NASA/Nola power saver," wrote a *Popular Science* senior editor, "was developed by Frank Nola at NASA's Flight Center in a program to reduce power consumption in spacecraft motors. Nola calls it a PFC — power-factor controller. I prefer to call it a power saver, however, because that's what it does."

NASA TESTED IT

According to NASA documents, "The device has been tested at Marshall Center on over 40 types of motors, with power savings ranging up to 60%, depending on the loading. The motors tested were both single-phase and three-phase, ranging from 1/2 H.P. to 5 H.P. Most motors will show up to 40 — 50% savings when running lightly loaded or unloaded, and some will show 5-to-7% savings at rated load."

NASA's Technical Support Package showed that "The Power Factor Controller applies to induction type electric motors — the most commonly used type in all major home appliances and the most commonly used by industry."

HOW IT SAVES POWER

Popular Electronics explained it this way: "AC induction motors characteristically run at a nearly constant speed that's fixed by power-line frequency and independent of load and supply voltage. When heavily loaded, the motor draws line current that is nearly in phase with the applied voltage...Under light load conditions, the motor develops less torque by allowing more lag between the voltage and the current. This reduces the power factor while leaving the current essentially the same in magnitude.

"To minimize this waste, Nola's device monitors the motor's power factor and when it detects light load conditions, it reduces the supply voltage..... The current, now more nearly in phase with the voltage, therefore does as much useful work as before, but it and the voltage are smaller, resulting in a net savings of electric power."

THE SAVINGS CAN ADD UP

The cost of electric power keeps going up. In 1980-81 and beyond you'll pay more and more for the privilege of running your electric appliances.

Right now, the typical consumer pays about \$8 per month to operate a 16.5 cu. ft. frost-free freezer...\$10 to run a 17.5 cu. ft. frost-free refrigerator...and

*National Aeronautics and Space Administration
Patent No. 4,052,648*

about \$60 for an air conditioner used during summer months. That's what you're paying to run just one of these appliances per year.

Nola's power saver can soon pay for itself, then start reducing your electric bills. Until now, the device has not been available — except for industrial models priced at \$80 or more.

INTRODUCING THE WATT WIZARD

Cynex, an American manufacturer of electrical and electronic products and a prime contractor for the U.S. Army, has been licensed by NASA to manufacture Frank Nola's power saver. Cynex calls it the Watt Wizard.

The "Watt Wizard" says Ray Beauchea, the firm's *Marketing Director*, regulates the voltage fed into an induction motor making the motors run more efficiently and quieter, while lengthening motor life.

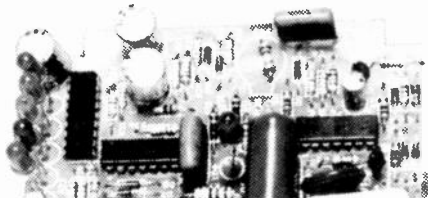

The Watt Wizard features a unique, constant power saving readout. So you can constantly monitor your energy savings.

SIMPLE TO USE

Cynex makes several models of the Watt Wizard (all with solid state design), including the 110 v. AC plug-in model we're offering. It's for single phase fractional H.P. motors (less than 1 H.P.) used in most freezers, refrigerators, fans, swimming pool pumps, vacuum cleaners, sewing machines, etc.

Simply plug the Watt Wizard into any electrical outlet, then plug the appliance into the Watt Wizard. There's no wiring required. Unlike some competitor's models (if and when available), the appliance does not have to be turned on before being plugged into the power saver. You can leave the appliance — whether on or off — plugged into the Watt Wizard all the time. Or you can move the Watt Wizard to various locations.

OTHER MODELS AVAILABLE

Air conditioners, washers and dryers require wire-in model. If you lack mechanical skill, you probably need an electrician to install it. We also offer it in 220 VAC single or three-phase.

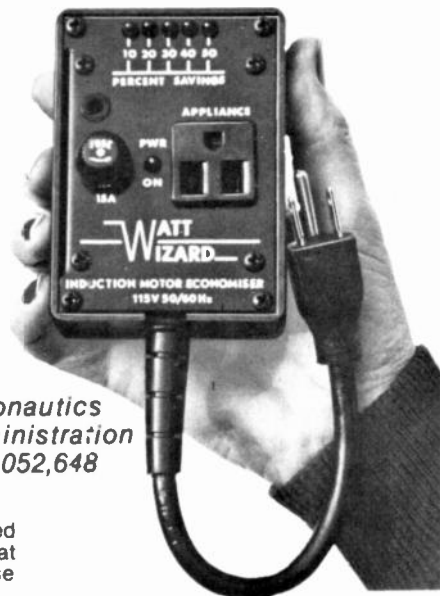

MERCURY 1980 ©

EXCLUSIVE ADVANCE FEATURES

The Watt Wizard also includes two more unique features which no competitor has. It's fused so if you accidentally overload the device, it won't burn out. Just change the fuse, which is available at any auto supply store.

And Watt Wizard features a unique LED readout, so you can actually tell, at any moment, exactly how much power you're saving — 10%, 20%, 30%, 40% or 50%. This feature is available only on the Watt Wizard.

There's a "power-on" light, too. And the Watt Wizard comes with the manufacturer's 1 year limited warranty.

LOW COST — AND A TAX CREDIT

We're offering the Watt Wizard for only \$39.95, with immediate delivery. Want two? Then its just \$37.95 each. Or splurge and get three at \$34.95 each. Wire-in models for heavy duty motors are \$6 more for each unit. Add just \$2.50 postage/handling for each order (not each unit).

And next year, when you fill out your tax return, you can deduct a full 15% energy tax credit - for additional savings.

30-DAY MONEY-BACK GUARANTEE

Try the Watt Wizard for up to 30 days. If not completely satisfied, return it (insured) for a full refund.

The sooner you send for the Watt Wizard, the more you can save on your electric bills. To order, send your check or money order to the address below. Or charge it to your Visa, MasterCharge, American Express, or Carte Blanche credit card. If using your charge card, you can also order via our toll-free phone number:

800-257-7850

(In New Jersey, Call: 800-322-8650)
N.J. residents, add 5% sales tax.

Or mail your order to:

INTERNATIONAL SALES GROUP
MERCURY
THE IMAGINATION PEOPLE®

Dept. RE11, Lakewood Plaza
Lakewood, New Jersey 08701

CIRCLE 51 ON FREE INFORMATION CARD

NEW 16K-RAM PERSONAL COMPUTER \$299

(What a smart Christmas present)

SPECIAL FACTORY PRICE!!

For \$299, you get new Interact Model "R" Computer, 16K-RAM, 2K-ROM, 8080A Microprocessor, color, sound, full 53 keyboard, high speed cassette deck, AC adapter, R.F. Modulator, Black Console Case, 90 day parts and labor warranty, owners guide, FCC approval, UL LISTED.

SPECIAL FACTORY PACKAGE PRICE \$399.

(Lists for over \$740.00)

Everything you get for \$299, plus: Level II Users Manual, Level II basic program tape, Level II command cards, Level II basic examples book. Two 8 axis action controllers. 3 program tapes. Diagnostic instruction program tape, Diagnostic manual, Service manual, Cassette head alignment tape, Schematics and parts list, Money saver service and warranty card. (everything you need to learn to operate, program and service your computer)

(15 DAY FREE TRIAL) - Return within 15 days complete and undamaged for refund of purchase price. Don't miss this sale - order now for Christmas!! Send certified check, money order, or personal check to PROTECTO Enterprises, Box 502, Franklin Park, IL 60131 (312/382-5244) Add \$15 for shipping and insurance via United Parcel. Illinois residents add 6% sales tax. WE SHIP C.O.D. AND HONOR VISA - MASTER CHARGE ORDERS.

CIRCLE 67 ON FREE INFORMATION CARD

Cover Story Kits

"Build this Audio Power Level Meter"
from 2/80 Radio
Electronics for
\$42

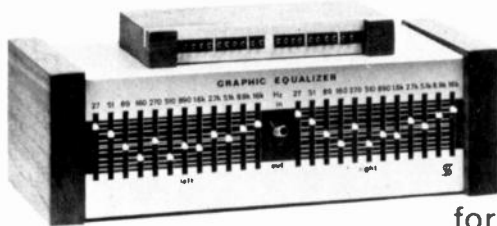

"Graphic Equalizer
for your stereo system"
from 5/78 Radio Electronics for
\$100/kit

(12 band/channel)

\$165 custom assembled, allow 60 days delivery.

Clever design and efficient packaging allow us to offer these attractive (SOLID unfinished walnut and brushed aluminum) high performance kits at unbeatable prices. Len Feldman reported on our equalizer's performance in the May 1978 issue: "excellent signal-to-hum-and-noise readings . . . THD measured .005% with a 1kHz input signal . . . Intermodulation distortion measured .009% . . . response was flat from 20Hz to 20kHz, within .5dB . . . offers graphic equalization capabilities of more expensive commercially built units at just a fraction of the cost."



SYMMETRIC SOUND SYSTEMS DEPT. R2, 912 KNOBCONE PLACE
LOVELAND, CO 80537
Phone Orders: (303) 669-1567



BOOKS

continued from page 94

are also presented—Space Capture and Hangman.

CIRCLE 93 ON FREE INFORMATION CARD

AUDIO AND VIDEO INTERFERENCE CURES, by Larry Kahaner. Hayden Book Company, Inc., 50 Essex Street, Rochelle Park, NJ 07662. 114 pp including index. 5 1/4 x 8 1/4 in. Softcover \$5.50.

This book covers all types of noise generators, both transmitter (radio stations, TV stations, amateur radio operators, etc.) and non-transmitter (hair dryers, washing machines, electric shavers, etc.) and provides information needed to stop the interference. Whatever the source of the noise may be, you will be given step-by-step instructions on how to find the offending source and cure the interference. Schematic wiring diagrams of filters for all types of receivers and transmitters are included. There are also simple filter designs which will eliminate radio and TV interference caused by motors, neon lights, etc. And if your particular trouble is especially difficult, there is a list of outside resources to assist you.

CIRCLE 94 ON FREE INFORMATION CARD

32 BASIC PROGRAMS FOR THE COMMODORE PET COMPUTER, by Tom Rugg and Phil Feldman. Dilithium Press, Box 92, Forest Grove, OR 97116. 267 pp. 5 1/4 x 8 1/4 in. Softcover \$15.95.

This book contains a wide variety of PET programs, ranging from computer games to mathematical applications. Programs include a road race, dice games, educational Flashcard and Vocab programs; plus Biorhythm and Checkbook. All programs can be run on 8K; some can run on 4K. The book also includes a bibliography to provide needed background information.

CIRCLE 95 ON FREE INFORMATION CARD

REFLECTOR ANTENNA ANALYSIS AND DESIGN, by P. J. Wood. Peter Peregrinus Ltd. (on behalf of the Institution of Electrical Engineers), Southgate House, Stevenage, Herts, SG1 1HQ, England. In USA: INSPEC, 445 Hoes Lane, Piscataway, NJ 08854. 221 pp + index. 5 1/4 x 8 1/4 in. Hardcover. \$35.00.

Volume 7 in the IEE Electromagnetic Waves Series, this book starts with a review of the geometrical optics, aperture field integral, induced current, plane-wave spectrum, GTD and integral-equation theories as applied to reflector antennas. The vector spherical wave expansion technique is then introduced as a vehicle for treating reflector scattering problems, incorporating measured pattern data and carrying out synthesis operations. Selected topics follow, more specifically oriented towards particular applications. They have in common a spherical wave analytic base. Topics include the characterization of the feed horn, vector representations appropriate to calculating polarization response, and a profile-synthesis procedure for dual reflector antennas. There are many diagrams, and some photos, illustrating each topic; in addition, numerical data taken from actual applications is included wherever feasible.

CIRCLE 89 ON FREE INFORMATION CARD

FROM TELEVISION TO HOME COMPUTER: THE FUTURE OF CONSUMER ELECTRONICS, Edited by Angus Robertson. Blandford Press; distributed by Sterling Publishing Co., Inc. 2 Park Avenue, New York, NY 10016. 323 pp. including index. 5 1/4 x 8 1/4 in. Hardcover \$19.95.

Edited by video expert Angus Robertson, this book covers the increasingly wide scope of today's consumer electronics: large-screen TV, VCR's and video discs, amateur and CB radio, television and electronic games, video program production, home computers, in-car entertainment, electronic watches and calculators, new advances in hi-fi, electronic home protection, world-wide cable TV, and further electronic marvels that are already visible on the horizon.

There are 300 photographs and drawings and a comprehensive glossary.

CIRCLE 90 ON FREE INFORMATION CARD

1234-240 p.—21 Custom Speaker Enclosure Projects You Can Build (\$12.95)

1066-882 p.—The Illustrated Dictionary of Electronics (\$19.95)

1113-182 p.—Understanding Electronics (\$8.95)

1167-168 p.—Electronic Music Synthesizers (\$9.95)

1222-266 p.—Advanced Radio Control, Including Rockets & Robots—2nd Edition (\$12.95)

21 CUSTOM SPEAKER ENCLOSURE PROJECTS YOU CAN BUILD

THE ILLUSTRATED DICTIONARY OF ELECTRONICS

161-504 p.—The GIANT Handbook of Computer Projects (\$15.95)

THE GIANT Handbook of Computer Projects

1146-504 p.—Radio Propagation Handbook (\$7.95)

RADIO PROPAGATION HANDBOOK

1225-322 p.—Master Handbook of Electronic Tables & Formulas—3rd Edition (\$14.95)

MASTER HANDBOOK OF ELECTRONIC TABLES & FORMULAS

1136-504 p.—Practical Electronics Math (\$15.95)

PRACTICAL ELECTRONICS MATH

1097-192 p.—All About Telephones (\$7.95)

ALL ABOUT TELEPHONES

8224-672 p.—The Complete Handbook of Radio Receivers & Transmitters (\$19.95)

THE COMPLETE HANDBOOK OF RADIO RECEIVERS & TRANSMITTERS

1199-476 p.—The Master IC Cookbook (\$15.95)

THE MASTER IC COOKBOOK

1119-434 p.—Color TV Trouble Factbook—Problems & Solutions—4th Edition (\$12.95)

COLOR TV TROUBLE FACTBOOK

806-420 p.—The Power Supply Handbook (\$12.95)

THE POWER SUPPLY HANDBOOK

1168-182 p.—How To Repair Clocks (\$9.95)

HOW TO REPAIR CLOCKS

1006-196 p.—Build-It Book of Solar Heating Projects (\$9.95)

BUILD-IT BOOK OF SOLAR HEATING PROJECTS

571-196 p.—Miniprocessors: From Calculators to Computers (\$9.95)

MINIPROCESSORS

106 EASY ELECTRONICS PROJECTS—Beyond the Transistor

106 EASY ELECTRONICS PROJECTS

THE COMPLETE SHORTWAVE LISTENER'S HANDBOOK—2nd Edition

THE COMPLETE SHORTWAVE LISTENER'S HANDBOOK

861-282 p.—Display Electronics (\$8.95)

DISPLAY ELECTRONICS

1059-448 p.—The Complete Handbook of Magnetic Recording (\$15.95)

THE COMPLETE HANDBOOK OF MAGNETIC RECORDING

887-244 p.—106 Easy Electronics Projects—Beyond the Transistor (\$8.95)

106 EASY ELECTRONICS PROJECTS

800-704 p.—Master Handbook of 1001 Practical Electronic Circuits (\$15.95)

MASTER HANDBOOK OF 1001 PRACTICAL ELECTRONIC CIRCUITS

1255-308 p.—The Complete Shortwave Listener's Handbook—2nd Edition (\$14.95)

THE COMPLETE SHORTWAVE LISTENER'S HANDBOOK

1212-504 p.—The Practical Handbook of Amateur Radio FM & Repeaters (\$15.95)

THE PRACTICAL HANDBOOK OF AMATEUR RADIO FM & REPEATERS

1196-280 p.—Adding Solar Heat To Your Home (\$12.95)

ADDING SOLAR HEAT TO YOUR HOME

An Extraordinary Offer to introduce you to the benefits of Membership in

ELECTRONICS BOOK CLUB

take **6** of these 24 unique electronics books **\$2.95** for **ALL SIX** (values to \$101.70) for only **2.95**

with a Trial Membership in the Book Club that guarantees to save you 25% to 75% on a wide selection of electronics books

Facts About Club Membership

- The 6 introductory books of your choice carry publisher's retail prices of up to \$101.70. They are yours for only \$2.95 for all 6 (plus postage/handling) with your Trial Membership.
- You will receive the **Club News**, describing the current Selections, Alternates, and other books, every 4 weeks (13x a year).
- If you want the Selection, do nothing, it will be sent to you automatically. If you do not wish to receive the Selection, or if you want to order one of the many Alternates offered, you simply give instructions on the reply form (and in the envelope) provided, and return it to us by the date specified. This date allows you at least 10 days in which to return the form. If, because of late mail delivery, you do not have 10 days to make a decision and so receive an unwanted Selection, you may return it at Club expense.
- To complete your Trial Membership, you need buy only four additional monthly Selections or Alternates during the next 12 months. You may cancel your Membership any time after you purchase these four books.
- All books—including the Introductory Offer—are fully returnable after 10 days if you're not completely satisfied.
- All books are offered at low Member prices, plus a small postage and handling charge.
- **Continuing Bonus:** If you continue after this Trial Membership, you will earn a Dividend Certificate for every book you purchase. Three Certificates plus payment of the nominal sum of \$1.95 will entitle you to a valuable Book Dividend of your choice which you may choose from a list provided Members.

May we send you your choice of 6 of these practical time-and-money-saving books as part of an unusual offer of a Trial Membership in Electronics Book Club?

Here are quality hardbound volumes, each especially designed to help you increase your know-how, earning power, and enjoyment of electronics. Whatever your interest in electronics, you'll find Electronics Book Club offers practical, quality books that you can put to immediate use and benefit.

This extraordinary offer is intended to prove to you through your own experience, that these very real advantages can be yours. That it is possible to keep up with the literature published in your areas of interest, and to save substantially while so doing. As part of your Trial Membership, you need purchase as few as four books during the coming 12 months. You would probably buy at least this many anyway, without the substantial savings offered through Club Membership.

To start your Membership on these attractive terms, simply fill out and mail the coupon today. You will receive the 6 books of your choice for 10-day inspection. **YOU NEED SEND NO MONEY.** If you're not delighted, return the books within 10 days and your Trial Membership will be cancelled without cost or obligation.

ELECTRONICS BOOK CLUB, Blue Ridge Summit, Pa. 17214

ELECTRONICS BOOK CLUB

Blue Ridge Summit, Pa. 17214

Please open my Trial Membership in ELECTRONICS BOOK CLUB and send me the 6 books circled below. I understand the cost of the books I have selected is only \$2.95 for all 6, plus a small shipping charge. If not delighted, I may return the books within 10 days and owe nothing, and have my Trial Membership cancelled. I agree to purchase at least four additional books during the next 12 months after which I may cancel my membership at any time.

800 806 861 887 971 1006 1059 1066
1097 1113 1119 1136 1146 1167 1168 1169
1196 1199 1212 1222 1225 1234 1255 8224

Name _____ Phone _____

Address _____

City _____

State _____ Zip _____

(Valid for new Members only. Foreign and Canada add 15% IRE-1180)

CIRCLE 11 ON FREE INFORMATION CARD

state of solid state

New high-efficiency photovoltaic solar panels brings everyday applications closer to reality.

KARL SAVON, SEMICONDUCTOR EDITOR

WOULDN'T IT BE NICE TO MAKE AN INVESTMENT of a few thousand dollars, say as part of your mortgage, and then sit back and know you had free electricity for 20 years or so? I'm afraid you can't do it today, but the idea may not be too far-fetched. Motorola's announcement of relatively high-efficiency solar panels in 10-, 20- and 40-watt sizes, although specifically aimed at a different market, brings such possibilities to mind.

The 40-watt unit is a matrix of 33, 4 × 4-inch square solar cells that account for almost 85% of the total 13.2-inch by 47.2-inch surface area. Equivalent round wafer designs use only 69% of the total available area. The type-304 stainless framed panels are 1.5 inches thick. Great emphasis was obviously placed on module

life—localized solar-cell failures do not significantly affect panel performance. Redundant interconnects and across-the-cell contacts keep the power flowing even when cracked cells break current paths.

The MSP43A40 has three rows of 11 cells that are wired in series to give a useful output-voltage level. At 28°C cell temperature, the open-circuit charging voltage is 19.5 volts. In typical silicon fashion, the voltage drops about 2 millivolts per cell for each degree of temperature rise. The output voltage is reduced to 16.4 volts at a 65°C cell temperature. The nominal 40-watt rating is specified at a 28°C cell temperature, and the power rating drops off to 27.1 watts at 65°C.

The Motorola solar modules are covered with a tempered *Solatex* 0.125-inch

cover glass; they're encapsulated with polyvinyl butyral, backed with aluminized *Tedlar* (polyvinyl fluoride) and are edge-sealed with butyl rubber. The frame has a insulation resistance of 1600 volts AC minimum.

The solar modules are designed to operate at ambient temperatures from -40°C to +60°C. They will withstand constant wind velocities of 100 mph and gusts to 125 mph.

The MSP13A10 10-watt module uses quarter-size cells and the MSP23A20 20-watt module uses half-size cells as shown in Fig. 1. All three modules use 33 series-connected cells to generate the same open-circuit voltage.

Suggested applications for the square-cell solar modules include village power supplies, remote communications equipment, and offshore and forestry equipment. Clearly, those applications have been selected where their special nature justifies the presently high solar-module prices.

The large-quantity price of the 40-watt module is \$476, or \$11.90 per watt. If we assume that the cells work for 12 hours a day at their full output, and that a kilowatt-hour costs 6 cents, it would take about 200,000 hours or 45 years to pay for the system—if it lasted that long. However, considering the present low-volume production and the still-improving technology, the future outlook for such a home-energy system is far from unimaginable.

The advantages of electric energy with clean, inverter-based, electronic-control systems, adds to the desirability of a solar-cell system. Such a system is not subject to leaks, nor to the antifreeze and overheating problems of the currently available hot water solar panels.

The three modules are available from stock and in hundred-quantities are priced at \$199, \$298, and \$476 each, which converts to \$19.90, \$14.90, and \$11.90 per watt, respectively. For more information, write to: Motorola Semiconductor Products Inc., P.O. Box 20912, Phoenix, AZ 85036.

Universal display driver

This is the age of the digital display. It is used in clocks, radios, temperature indicators, games, test equipment, and automotive products. Rapid drops in the cost of displays accounts for their popularity, and has caused a similar exponentially growing demand for display drivers.

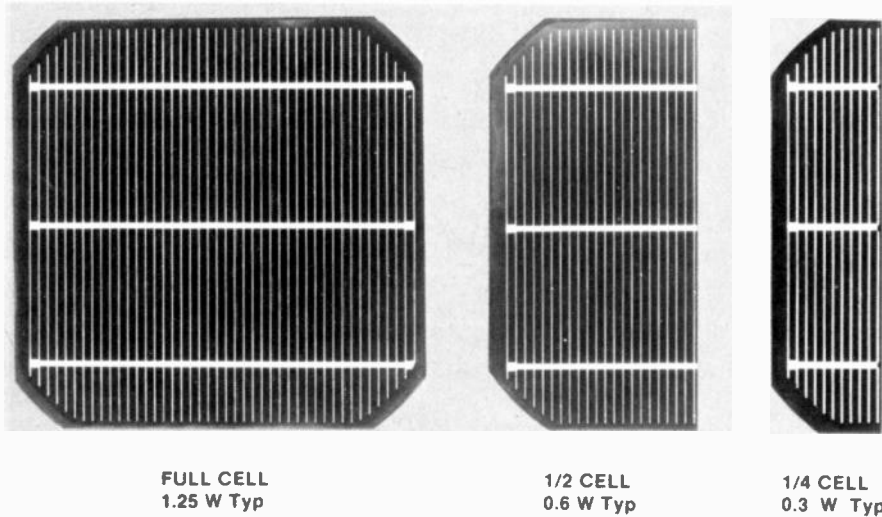

FIG. 1

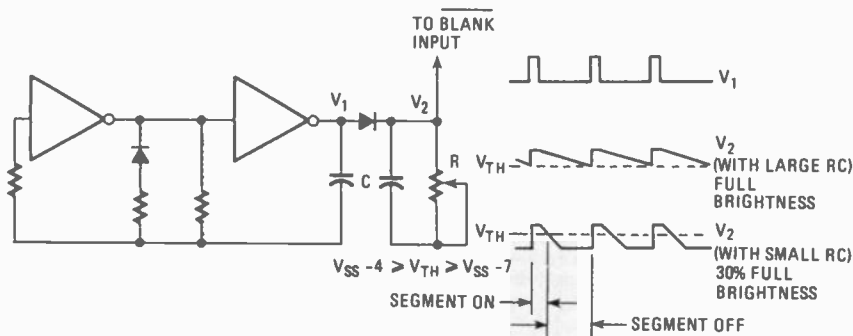
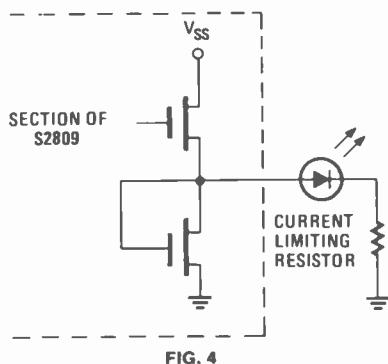
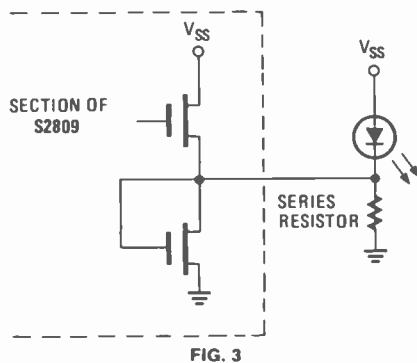

FIG. 2

American Microsystems' S2809 Universal Display Driver IC has 32 static, high-current outputs that can directly drive LED, LCD, and vacuum-fluorescent displays. The IC can source 1 milliamp at V_{SS} , 4 milliamps at 1 volt below V_{SS} , and 9 milliamps at 3 volts below V_{SS} . When used to drive four non-multiplexed 7-segment display digits, four outputs remain for single-element indicators.

The 40-pin AMI S2809 uses a serial-input format to load 32 bits of information through a shift register. The PMOS design includes circuitry that makes it possible to cascade two or more units to expand output capability. On-chip capacitors have been included to suppress RF interference generated by the clock and by other switching signals. Input logic signals can have either positive or negative sense, and are accommodated by using EXCLUSIVE OR gates on the parallel outputs to invert all 32 output signals when the invert control input is switched high. While data is being clocked in, the outputs are held at the same logic level as the invert-control input. The clock input must be high for at least 3 microseconds and low for 6.5 microseconds. Data is loaded when the chip-select input goes high.

The blanking-input pin can be used to control display brightness. If the pin is driven by a variable duty-cycle oscillator, the input waveform determines the output on-off ratio and the resulting average display intensity. The suggested circuit shown in Fig. 2 is an astable oscillator that feeds a peak-detector circuit with variable discharge-time control. If the discharge-time constant is relatively long,



the voltage (V_2) on the blanking pin never falls below the trigger threshold and full brightness is maintained. As the control's resistance is decreased, the voltage falls more rapidly and reaches the turn-off threshold, turning the output display off periodically and thus lowering the average display brightness.

The output drivers can drive a LED anode as shown in Fig. 3 by direct drive; the current is limited by the resistor in series with the LED. Since the output devices have unsymmetrical current capability, the cathode of a LED is driven by biasing the diode normally on with a series resistor as shown in Fig. 4. The upper, higher-current output device

drives the cathode high, cutting off the LED. In effect, the positive output current from the display driver takes over the current normally supplied to the series resistor through the LED. This configuration requires higher total circuit power since current is always flowing in the resistor, whether the display is on or off. For vacuum-fluorescent and liquid-crystal display drive, the display segment is driven directly from the output. The LCD backplane is returned to the invert signal which provides the AC drive necessary for liquid crystal displays.

For more information, you can write to: AMI, 3800 Homestead Road, Santa Clara, CA 95051. R-E

ADVANCE IS PROUD TO INTRODUCE the KEITHLEY Line of High Quality Digital Multimeters Featuring The New 130 Hand-Held DMM

Take a look at Keithley's new Model 130 measurement problem-solver.

Easy to use

- Two rotary switches instead of eight pushbuttons
- Large, easy to read 1.8cm (.6") LCD digits—larger and sharper than competitors'

Rugged

- High-impact ABS plastic case
- Shock-mounted LCD
- Tough polycarbonate plastic window and front panel

Performance Plus

- Convenient size and weight—only 10 oz. (7.0" x 3.1" x 1.5")
- 200 hour battery life
- Low battery annunciator
- Easy to maintain—all components on one board
- One-year guarantee on specifications
- Only one calibration adjustment, only once
- 25 Ranges and five functions: DC volts, AC volts, DC amps, ohms
- 100 μ V, 1 μ A, 0.1 Ω sensitivity
- 1000V DC, 750V AC, 10A and 20M Ω upper range limits



\$109

Case \$10.00
Shipping \$3.00

SPECIFICATIONS

	RANGE	ACCURACY
DC VOLTAGE	200mv, 2V, 20V, 200V, 1000V	.5%
AC VOLTAGE	200mV, 2V, 20V, 200V, 750V	1%
DC CURRENT	2mA, 20mA, 200mA, 2000mA, 10A	2%
AC CURRENT	2mA, 20mA, 200mA, 2000mA, 10A	3%
RESISTANCE	200 Ω , 2k Ω , 20k Ω , 200k Ω , 20M Ω	.5%



THE TEST EQUIPMENT SPECIALISTS
TOLL FREE HOT LINE
800-223-0474

44 WEST 45th STREET NEW YORK N.Y. 10036 212 687 2224

ADVANCE
ELECTRONICS

Sinclair Multimeters

Repeatable Quality at Unrepeatable Prices!
Take advantage of this super special offer of professional quality DMMs.

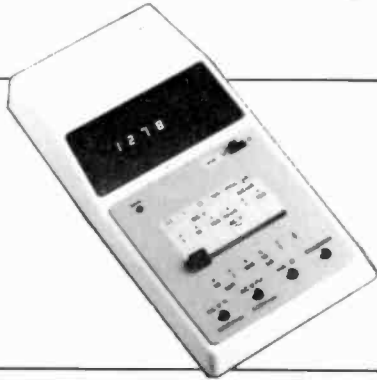

PDM35

\$39.95

Hand-held 3 1/2 digit LED Multimeter
1% basic DCV Accuracy
16 ranges: DC/AC Volts, DC Current, Ohms.
Resolution 1mV / 0.1nA / 1ohm
Ranges to 1000V / 100mA / 10M
Battery operated (PP3) or AC Adaptor
Complete with test leads and carrying pouch

DM235

Bench/Portable 3 1/2 digit LED Multimeter
0.5% basic DCV Accuracy
21 ranges: DC and AC Volts and Current, Ohms
Resolution 1mV / 1µA / 1ohm
Ranges to 1000V / 1A / 20M
Battery operated (4 'C' cells) or AC Adaptor
Complete with test leads

\$69.95

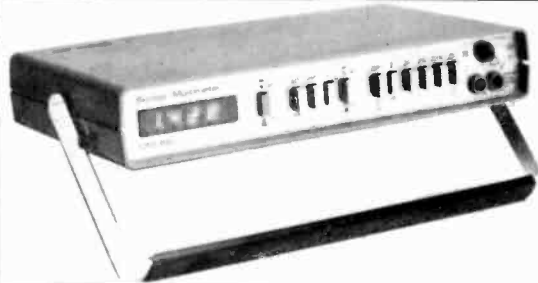
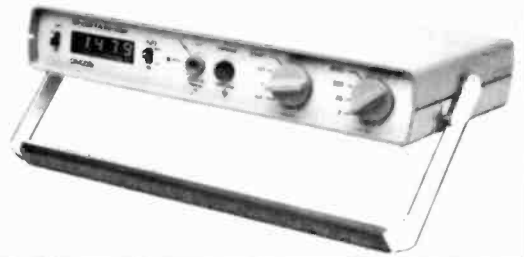

DM350

\$99.95

Bench/Portable 3 1/2 digit LED Multimeter
0.1% basic DCV Accuracy
34 ranges: DC and AC Volts and Current, Ohms
Resolution 100µV / 1nA / 0.1ohms
Ranges to 1200V / 10A / 20M
Battery operated (4 'C' cells) or AC Adaptor
Complete with test leads

DM450

Bench/Portable 4 1/2 digit LED Multimeter
0.05% basic DCV Accuracy
34 ranges: DC and AC Volts and Current, Ohms
Resolution 10µV / 0.1nA / 0.01 ohms
Ranges to 1200V / 10A / 20M
Battery operated (4 'C' cells) or AC Adaptor
Complete with test leads

\$129.95

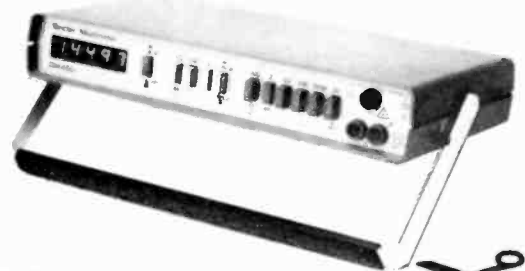

please send me

<input type="checkbox"/> PDM35 Hand-held DMM	@ \$39.95 each	: \$	_____
<input type="checkbox"/> DM235 Bench/Portable DMM	@ \$69.95 each	: \$	_____
<input type="checkbox"/> DM350 Bench/Portable DMM	@ \$99.95 each	: \$	_____
<input type="checkbox"/> DM450 Bench/Portable DMM	@ \$129.95 each	: \$	_____
<input type="checkbox"/> AC Adaptor for PDM35	@ \$4.95 each	: \$	_____
<input type="checkbox"/> AC Adaptor for DM235	@ \$4.95 each	: \$	_____
<input type="checkbox"/> AC Adaptor for DM350	@ \$4.95 each	: \$	_____
<input type="checkbox"/> AC Adaptor for DM450	@ \$4.95 each	: \$	_____
Shipping/Handling at single rate per order		: \$	5.00*
New Jersey residents add appropriate Sales tax:		: \$	_____
TOTAL :		: \$	_____

I enclose

Check Money Order Master Charge Visa
(Allow 2 - 3 weeks clearance time for personal checks)

Credit Card No. _____ Exp. Date _____

NAME _____

STREET _____

CITY _____ STATE _____ ZIP _____

SEND TO: NJS Technology Inc.
P.O. Box 8247
Haledon
New Jersey
07538

*Continental USA only **N.J. Residents and other inquiries call: (201) 790-3141**

Call Toll Free: 800-526-5311 (Orders Only)

Here are several hints from our mailbag. Maybe one of them will help you on your next "tough dog."

JACK DARR, SERVICE EDITOR

EVERY SO OFTEN I WIND UP WITH A GROUP of short items, none of them long enough to make a whole column, but important enough to be passed along. So, I've combined several of those items into this column.

The first is inspired by far too many letters saying, "I put in a new horizontal output transistor, turned it on and the new one blew!" (The following is a re-run of at least two previous columns, plus a couple of "memory-joggers".) So, when you find one of the big transistors blown out, especially the horizontal output, and replace it, don't slap the full line voltage on the set immediately. The odds are too great that the new one will go the same way.

Put a current-meter in series with the DC supply, in place of the fuse that should have blown, and/or a DC voltmeter on the B+ output as shown in Fig. 1. Now, plug the set into a variable-voltage line transformer, and bring the line up very slowly. Watch the current. If you see almost the normal rated current, and the line is only about 50%, look out!

Start looking for the overload. Check all the low-voltage power supplies taken from the flyback; the yoke; the high-voltage tripler (if used) and any and all loads

on this stage. A suitable variable voltage-line transformer costs about the same as one of those big power transistors! If you save only one of them, the transformer is a freebie.

Fast-recovery diodes

The second item deals with an unusual problem we recently ran into. This appeared in an SCR-type flyback circuit, such as RCA's. The commutating diode across the SCR was bad. It was replaced with a good fast-recovery diode, and the new diode blew out in a very short time! After quite a bit of head-scratching, and a couple of phone calls, we finally found one that would work. That is a new special RCA power-switching diode; the part number is 142569. It will hold up in this application.

The 142569 diode will work across either the trace or retrace SCR. Frankly, we have not been able to find out why a stock fast-recovery diode blew out so fast, though its ratings were ample. That one will do the job. Make a note of the number and put it up over your bench.

Admiral parts

We get quite a few letters asking about parts for Admiral TV sets, since they

closed up shop. We finally found out: They still have a parts depot, with a WATS line. The number is 1-800-447-8361. Be sure you have the correct Admiral part number, chassis number, and all other data needed at hand.

Vacuum tubes.

After printing a question from a reader needing an old-type vacuum tube, I got lots of letters from readers who had some, as well as some useful addresses. For the older tube types, try these companies:

Richardson Electronics, Ltd., 3030 North River Road, Franklin Park, IL 60131. They, too, have a WATS line: 1-800-323-6860. (Thanks to George J. Falckenbach for this one)

John L. Groezinger sends in this one: Thor Electronics Corp. 321 Pennsylvania Ave, P.O. Box 7070, Linden, NJ 07036. Phone numbers: NY Area, (212) 239-4510; NJ Area, (201) 486-3300. All others, 1-800-526-4052.

Doug Stevens of Hawaii, and several others, sent in this one, which surprised me a bit: Fair Radio Sales, Inc., 1016 East Eureka, P.O. Box 1105, Lima, OH 45802. This company deals in surplus radio and electronic equipment, but it turns out that they have quite a stock of the older tubes, at some very good prices.

Finally, although there were a few others, Edward J. Modie, 141 West Main St. Barnesville, OH 43713 says that he has a few RCA/Sylvania type 75 tubes, if anyone needs them.

Toshiba vacuum tubes

This is another re-run; it originally came up some time ago. A friend in California found the answer and told me. Problem is very short life of 23JS6 tubes used in Toshiba Chassis TAC-6410. The cure is using a 23JS6 tube manufactured by Toshiba. In this and similar chassis, the tube is subjected to a tremendous heater-to-cathode voltage. The US types will not withstand it, although they work perfectly well in all other sets, and are within spec! The Toshiba tubes are built with a very high heater-to-cathode breakdown voltage. Company address is: Toshiba America, Inc., 280 Park Ave, New York, NY 10017. If you can't locate the nearest Toshiba distributor, they can tell you where it is.

Here's a clarification of a statement made in this column, some time ago, about using the scope to check filter capacitors by looking for signs of hash on

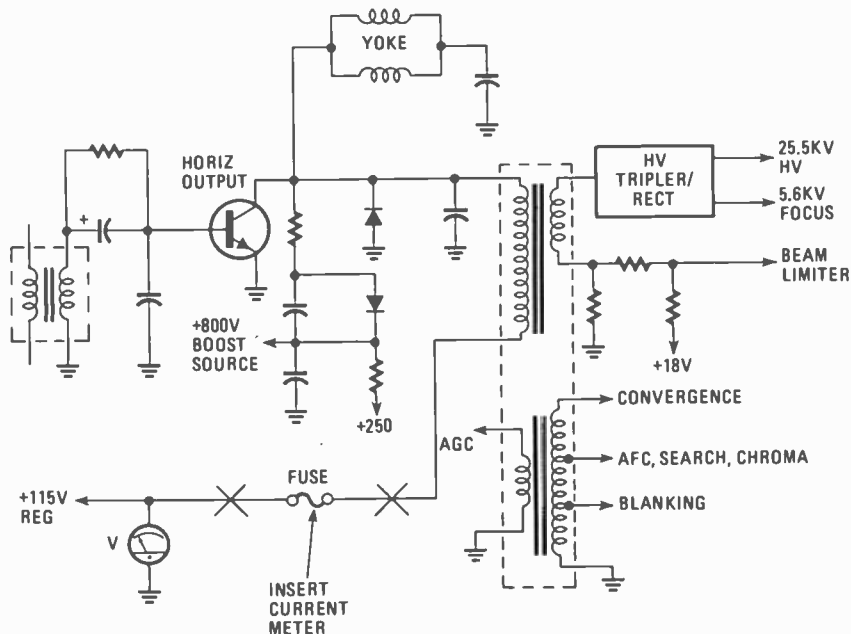

FIG. 1

SERVICE CLINIC
continued from page 101

the terminals. Reader wanted to know where his vertical gain should be set on the scope. In general, as high as possible, so that you'll catch even the smallest pulse or glitch on the B+.

However, some of the newer scopes are so dang sensitive that you see all kinds of stuff on the pattern even on good capacitors. That can be due to stray pickup, or even to having the probe ground on the wrong point (or leaving it off, which is one of my pet goofs!) I suppose that a good medium setting would be at a point that gives you almost full-screen when you are reading the ripple on the input filter; somewhere around 2-3 volts for full screen deflection. That should be sensitive enough to pick up anything that can cause troubles.

That's about it for this time. I hope that some of those items will be of at least a little help, and good luck. **R-E**

service questions

BAD FLYBACK

The question was about excess current and the horizontal output transistor blow-

ing in an RCA CTC-97. I suggested some checks to see that other things were OK. Reply was: "We found the answer and it was what you said! The new integrated-type flyback was bad. New one and new output transistor and it worked. Thanks!"

Thanks to J.T. Durland of Elk City, OK, for that one.

PICTURE TUBE GOES OUT

Here's a cutie! In this Motorola Quasar T938-A 16-1, the heater of the picture tube will light dimly in the OFF position. Turn the switch on, and the heater goes out! I've tried to trace out things on the switch, but I get lost. Sams shows 6 wires to T800 (Heater transformer) and the one in here has only four. I'm lost! Can you help—B.H., Modesto, CA.

I hope so! Quasar's CTV-8 manual shows the 4-lead transformer, which is T801 here (T800 in the Sams; different run, or something). That transformer does only one thing: In the OFF position, it feeds a low AC voltage to the heater of the picture tube for instant-on operation. The on/off switch has an SPDT switch in the secondary of this transformer. That switches the heater from the yellow lead of T801 over to pins 19 (common) and 20, on the JA panel. In normal operation, those are the picture-tube heater supply, derived from the flyback.

The brown lead from the heater goes to

the slider of the switch, the blue lead to pin 20 (hot). Check those.

HOT RESISTOR

Here's one I ran into in a Magnavox T991. If Q6 on the regulator board runs too hot and eventually self-destructs, check the waveform on the collector. Although that isn't shown in the service data, and should be, it's a square 150-volt P-P pulse about 20 microseconds in duration. If that pulse is distorted in any way, check the mating pins 11-12 on the mother board for possible bad solder joints. That prevents the full feedback pulse from T101 getting to where it must be to develop the proper bias on Q6. Must be a clean square pulse or it won't do!

(Thanks very much to John Gorman, of South Plainfield, NJ. I've run into a few similar cases, but not many. Problem is due to incorrect pulses on regulator stages, letting them go "out of control." One had the opposite symptom. The pulse was a squarewave, but should have been a sharp spike! Bad capacitors in differentiating circuit caused it. That waveform was not shown in the service data either!)

SHORT-LIVED BOOST CAPACITOR

First there was smoke, then narrow raster and finally no raster at all. Boost capacitor C111 was burned beyond recognition. New capacitor and replaced

LEADER
Instruments Corp.

Oscilloscopes

2 YEAR WARRANTY
Probes included on all scopes



20 MHz, TRIGGERED
• Single trace, automatic trigger for highly stable, bright display
• 17.5nSec rise time • 10mV/cm to 20V/cm Vertical Sensitivity • 11 steps



20 MHz, DUAL TRACE
• Add, subtract modes on CH-1 & CH-2 facilitate easy checkout for simultaneous pulses, signal levels, distortion & noise cancelling



30 MHz, VARIABLE DELAYED SWEEP, DUAL TRACE
• Built in variable delay circuitry — 1µSec to 5 Sec. • 5mV/Div. Vertical Sensitivity



35 MHz, FIXED DELAY, DUAL TRACE
• Dual trace, 35 MHz bandwidth
• 5mV/cm Vertical Sensitivity • 10.0 ns

COLOR BAR GENERATORS, BRIDGES, TESTERS.

NTSC Color Bar Pattern Generator

Model LCG-396



- NTSC color bars
- Provides full range QA, insertion, pull-in, control chroma and luminance
- Bright, high contrast, high purity and white balance color bar, green, white, black
- Dots and single line bars for convergence, raster and other alignment requirements
- 1000 lines, 1000 lines and 400 lines TV range color bars
- Equipped with phase locked to color sub carrier

Completely Portable, Battery Operated TV Color Analyzer

Model LCG-397

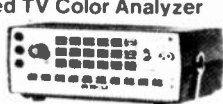

- 0V composite video outputs
- 0.00" variable color burst for easy chroma service
- 18 convergence patterns • 10 bar gated 3 bar gated and 5 noise patterns
- 3 dot patterns, 2 crosshatch patterns
- 3 vertical lines and 3 horizontal lines plus gray scale
- Oscilloscope trigger outputs
- Battery operated, 4 standard C cells, 1.5v each

Transistorized LCR Bridge

Model LCR-740



- Highly accurate 10 digit readout
- Max. resistance 1000Ω, Capacitance 0.1µF and Resistance 100Ω, Inductance 0.5mH
- Readouts variable with built in 10% overrange
- Q/S Factor scale D
- Operate on 1.5v battery or on built in AC adapter

FM Multiplex Stereo Generator

Model LSG-231



- 80% Composite and Audio Outputs
- Check's separation, balance and alignment in the field or on the bench
- 18Hz pilot signal • 2Hz accuracy
- 1kHz audio signal • 1% accuracy
- Composite stereo output 87MHz 5CA switch selectable
- 1 minute modulation capability
- Selectable pre emphasis

Order with Confidence and get the Fordham Advantage!

Call for our prices **TOLL FREE**
(800) 645-9518
in N.Y. State call (516) 752-0050

FORDHAM
855 Conklin St. Farmingdale, N.Y. 11735



- Master Charge
- BankAmericard
- VISA • COD
- Money Order
- Check
- COD's extra

weak output tube. Ran two days in shop and two weeks in the home. Came back, C111 burned up again! Tell me what the obvious solution is!—B.A., Lindenhurst, NY.

From the length of time the set did work well, it seems to me that the replacement capacitor must have been defective. Two things could have made this happen—one would be excessive pulse-voltage from the flyback. That would have shown up as high boost voltages, high voltage sweep, and so on. So, we don't have much left except for a bad capacitor.

Be sure you use a type that will withstand high RF currents. Polycarbonate dielectric and others. That capacitor gets quite a high pulse voltage, and from the symptoms, it suffered a gradual heating until it broke down. The original is rated for 6 kV. Be sure your new one has at least that much rating.

QUICK AND DIRTY FIX FOR ARCING

J.S. Belcher of Greenup, KY, sends along this hint for arcing between the grounding spring and bell of a CRT. He says it's a quick and dirty fix but it works! Just push a wad of aluminum foil between the ground strap and the dag coating of the tube. J.S. says he wrapped up a small plastic bag with the foil to give it more "spring," and it worked.

Thank you sir; suggestions are always welcome.

NO-COLOR PROBLEM

Thanks for the help on the RCA CTC-27X with the no-color problem. I finally located a 3.16 megohm resistor in the collector of the ACC transistor that was open. That caused the ACC stage to kill the color. Couldn't find that odd value, and it was a 1% type, so I used a 3.0 Meg and 160K in series, and it worked. It's R172 and it's among quite a bag of worms in that circuit! Had to take it all apart before I caught the open one.

Thanks to W. J. McLain of Phoenix, AZ, for the feedback. (That was a goodie!)

GRID DRIVE FLATTENING

This Motorola-Quasar TS929 chassis was working only fairly well. The 6LF6 horizontal-output tube was drawing over 350 mA. Boost voltage is quite low, and so on. The drive waveform looks odd, but I've noticed that lot of them do. Any ideas?—A.O., Adel, IA.

I told him to do the standard things. He replied: "I kept checking things and finally got it. For one thing, the drive waveform on the 6LF6 grid didn't look right. New tube did not help." (That was one of the stock tests, for possible grid emission in 6LF6, that I suggested.) "Got over into the horizontal oscillator stage. Voltages there off enough to be suspicious.

EQUIPMENT REPORTS

continued from page 44

ing system problems or in planning your own modifications.

The *Elf II* includes 256 bytes of memory; enough for elementary programming exercises. Using the 1802's DMA (Direct Memory Access) facility starts program loading at address 0000 with a minimum of hardware.

If you want greater convenience an additional \$39.95 buys the *Giant* board module that includes a ROM-based monitor. That monitor lets you examine and change any section of memory; you are no longer confined to starting at address 0. It also gives you an 8-bit input and an 8-bit output port to control external circuitry, a serial input/output port for connection to a printer or terminal, and a tape recorder interface to be used for saving and loading programs.

Netronics has a catalogue of expansion items, including a color and music board, a light pen, a prototyping board, 4K memory boards, and an ASCII keyboard and companion video-display board. Available software includes a disassembler, and the *Elfbug* monitor that lets you insert breakpoints into a machine language program. A cassette text editor is available to prepare mnemonic assembly language source programs that can be processed by the cassette assembler to produce executable machine code. Also available is a full BASIC interpreter.

While the *Elf II* is an excellent and inexpensive way to learn about the 1802 microprocessor, and processors in general, at their most fundamental level, other alternatives should be explored before beginning a large systems expansion.

Additional information is available from Netronics Research and Development Ltd., 333 Litchfield Rd., New Milford, CT 06776. R-E

"Resistors, etc. checked out OK. I tried a new 6BL8 oscillator tube. Voltages much closer to normal. Looked over at cathode-current monitor and it was down to normal 225 mA! DC voltages all back up to the right value! I didn't try a new 6BL8 earlier because it was almost new; I'd put it in only about 90 days ago!"

That is indeed a valuable hint. This is the first time that I've heard of a drive-flattening problem caused by the oscillator tube! There have been many cases like that, but till now, they've all been due to grid emission in the horizontal-output tube.

ODD RASTER

In this Philco black-and-white set, I needed a new deflection yoke—76-14170-1, or Thordarson Y-94. Put one of those in and got an odd raster, with about two inches of black on both sides. Checked everything else. No luck. Here's the answer. The magnets glued to the sides of the yoke were installed so the polarity was backwards. They opposed the sweep and distorted it! Taking both of them off cured the problem.

Thanks to John Conti, of Texas City, TX, for that oddball case. R-E

Get A GNOME

the original micro-synthesizer

Every day more people discover that PAIA's GNOME is the most versatile, cost effective special effects device on the market today.

John Simonton's time-proven design provides two envelope generators, VCA, VCO and VCF in a low cost, easy to use package. Use alone with its built in ribbon controller or modify to use with guitar, electronic piano, polytonic keyboards, etc.

The perfect introduction to electronic music and best of all, the Gnome is only \$59.95 in easy to assemble kit form. Is it any wonder why we've sold thousands?



PAIA 1020 W. Wilshire Blvd. Oklahoma City, OK 73116

Send GNOME MICRO-SYNTHESIZER Kit (\$59.95 plus \$2.00 postage)
 GNOME MICRO-SYNTHESIZER (Fully Assembled) \$100.00 plus \$2 postage
 Send FREE CATALOG

name _____
 address _____
 city _____ state _____ zip _____
 visa master card no. _____
 Dept. 11-R (405) 843-9626
 PAIA 1020 W. Wilshire Blvd. Oklahoma City, OK 73116

CIRCLE 16 ON FREE INFORMATION CARD

LEARN MICROPROCESSING on your own computer!

You Learn How To:

- Design & code micro-processor software
- Use logic & Bit Manipulation Techniques
- Enter & execute programs on your own computer
- Understand Microprocessor architecture & Support Chips
- Control Programmable Input/Output Ports
- Implement Real-Time Interrupt Handling & Data Transfer
- Design your own microcomputer



8085 MICRO-PROCESSOR TRAINING UNIT \$299.95

You Will Receive:

- A fully tested and assembled 8085A Microcomputer with 1K RAM 1K EPROM and 1K PROM Memory Programmable I/O Keyboard Unit CPU Card Display and Operating System 44 pin edge connector can be configured to any bus structure area on CPU Card for Custom wrap design or user defined interface circuitry completely expandable
- Complete Step-by-Step Instruction Manual
- Complete User's Manual with programs included
- 352 page 8085A Cookbook takes you from basic microprocessor concepts to actual design of an 8085A Microcomputer
- 44 page 8080/8085 Software Design Book 1 with over 190 executable program examples plus detailed examination of a 1244 Instructions and typical assembly language program for the 8080/8085 Microprocessor

Satisfaction Guaranteed. If not completely satisfied you may return the product within 30 days for a full refund.

RATED BEST VALUE BY INSTRUCTORS

PRCCOM CREDIT CARD ORDERS CALL TOLL-FREE
 14905 NE 40th Dept RE 111 REDMOND WA 98052 1-800-426-6254 EXT 111

YES! I want to start learning Microprocessors. Please rush me 8085 AAT Microprocessor Training Unit at \$299.95 plus \$3.00 P&H

NAME _____ VISA M/STCD
 ADDRESS _____
 CITY _____ ST _____ ZIP _____
 CARD NO _____ EXP. DATE _____
 SIGNATURE _____

CIRCLE 52 ON FREE INFORMATION CARD

VIZ LCD Digital Multimeter



Model WD-747

- Large 3½ digit 0.5" LCD readout.
- Side switches for easy one-hand use.
- Accuracy better than 0.8% DCV.
- Resolution down to 100µV, 100µA DC, 0.1Ω.
- Only DMM with built-in socket for transistor h_{FE} testing.
- 10MΩ input impedance, 10-amp DC range.
- Auto zero polarity. Full overload-protection.
- All functions color coded.
- Rugged orange-colored ABS plastic case.
- Complete with battery, deluxe test probes and spare fuse.

Power Supplies

WP-29 Monitor Isotap



- Supply line: 105 to 130V, 48 to 500Hz • Isolated output: 0 to 150V 48 to 500Hz • Leakage: Less than 0.1mA • Power rating (resistive load): 400VA • Meter: Taut band 3½" ±2% • Size: 3¾" x 8¼" x 8¾" • Weight: 14½ lb. • Comes with output cable.

WP-708 Triple Output



Two 0-20 VDC supplies, 0-2A full load. May be used in series to provide 0-40 VDC, 0-2A. One 5 VDC (0.4A full load) fixed supply. Two digital voltmeters 0-99.9 VDC with separate inputs on the front panel.

Order with Confidence and get the Fordham Advantage!

Call for
our prices **TOLL FREE**
(800) 645-9518

In N.Y. State call (516) 752-0050

FORDHAM

855 Conklin St. Farmingdale, N.Y. 11735



- Master Charge
- BankAmericard
- VISA • COD
- Money Order
- Check
- COD's extra

CIRCLE 37 ON FREE INFORMATION CARD

LEARN ELECTRONICS THE EASY WAY!

Unique, low-cost, home-study course prepares you for the electronic 80's!

Here's What You Learn!

Value-packed course teaches you the fundamentals of AC and DC electricity and power supplies, circuits and circuit assembly, amplifiers and oscillators, digital electronics and integrated circuits... plus you learn to solder, read schematics, read resistor color codes, know all the latest components, design circuit boards, use engineering Protoboards, assemble electronic projects and kits! It's a bonanza of everything you always wanted to know at an unheard of low price you can't afford to pass up!

Here's What You Get!

No other comparably priced home study course offers so much for so little! This amazing course, taught in U.S. Government, CETA-sponsored classrooms, includes 230 electronic components, which you use to perform 20 exciting, instructive training activities. In addition, you build six permanent projects, including highly useful 3-stage AC-DC power supply, LED blinker, component substitution board, audio amplifier, audible continuity tester and logic probe for use in digital electronics. All activities and projects are fully documented in four concise, easy-to-read, step-by-step activity manuals. Course-work is presented in four, thoroughly illustrated lesson manuals.

Moneyback Guarantee!

To prove to you there is no better value in electronics education anywhere we are offering you an unconditional, money-back guarantee! If you are not fully satisfied after examining your PPG Basic Electronics Course for ten days, just ship it back to us and we will refund your money, less only shipping charges.

How The Course Works

PPG's Basic Electronics Course is designed for home study. You learn step-by-step at your own pace. You read the lessons, do the activities, take the self-test quizzes provided. Then, if you need help, you contact PPG for assistance. Our training counselors will respond promptly and courteously with complete answers to your questions. You learn electronics the easy way!

Free Tool Offer

You've always wanted to know more about electronics. Well now's your chance



Complete course only \$169.95!

to do so without signing up for a costly, long-range program. This proven method covers it all from basic electricity to digital electronics and there's an excellent chance it will qualify for employer reimbursement where you work. Join the more than 50,000 students, hobbyists and technicians who yearly enjoy PPG electronic kits and courses. Place your order before October 31, 1980 and receive FREE needle-nose pliers and dikes as a bonus.

To Order your PPG Basic Electronics Course, send check or money order for only \$169.95 plus \$5.00 shipping charges; OR if you want to take advantage of our special 10-payment, Pay-As-You-Learn program, send only \$21.50 to receive your first packet of materials.

Name _____
Address _____
City _____ State _____ ZIP _____

VISA and Master Charge accepted. California residents add 6% sales tax.



Electronics Co., Inc.

14663 Lanark St. • Van Nuys, CA 91402
(213) 988-3525

This chip
changed
your
life.

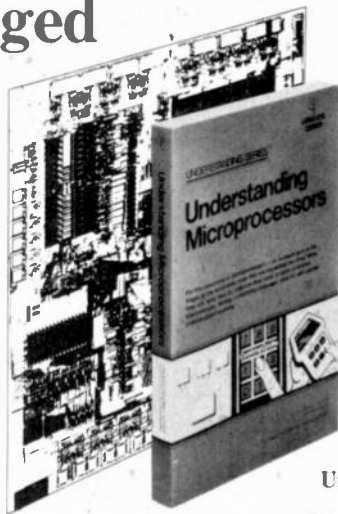

This book
tells you
how.
And why.

Understanding Microprocessors.
From the Texas Instruments
Learning Center. 288 pages. \$4.95.

Learn quickly and easily about the explosive impact microprocessors have had on electronics technology.

How the "miracle chip" works to make those things you use everyday — calculators, appliances, microwave ovens, stereos, tv, automobiles — even toys and games — do the remarkable things they do.

Understanding Microprocessors is the latest addition to the Texas Instruments Understanding Series™. All TI Understanding Series books are ideal for those who want to learn about today's technology — without having to devote years to the study.

* Written in bright, clear, down-to-earth language, and fully illustrated, you'll find these books to be invaluable tools for your personal entry into the microelectronics revolution. See coupon for all details.

© 1980 Texas Instruments Incorporated

- LCW8161 Basic Electricity and DC Circuits \$19.95
1026 pages. Building blocks for a thorough working knowledge of DC circuits.
- LCB3361 Understanding Solid-State Electronics \$3.95
270 pages — New 3rd edition. Individualized approach for learning microelectronic basics.
- LCB3311 Understanding Digital Electronics \$3.95
265 pages. The springboard for a look into the fascinating world of today's electronic logic devices, circuits and systems.
- LCB4023 Understanding Microprocessors \$4.95
288 pages. For the newcomer to microprocessors. What they are, what they do and how they work.
- LCB3321 Understanding Calculator Math \$3.95
224 pages. Unlocks the real power of your handheld calculator — loaded with practical applications.
- LCB4521 Understanding Communications Systems \$4.95
288 pages. Electronic Communications Systems — what they are, what they do, how they work.

Add sales tax, except AK, DE, MI, NH, OR.

Mail check or money order to Texas Instruments, P.O. Box 3640, M/S 84, Dallas, Texas 75285.

Orders in Continental U.S. shipped prepaid. Foreign orders: Prepaid in U.S. dollars only. Include shipping costs.

Prices subject to change without notice.



Name _____
Address _____
City _____ State _____ Zip _____

RE-1180

TEXAS INSTRUMENTS
INCORPORATED 801098

STAMP-IT ETCH-IT

MAKE PROFESSIONAL LOOKING P.C. BOARDS FAST AND EASY

• SENSATIONAL
• REVOLUTIONARY
• FANTASTIC

STAMP-IT ETCH-IT

Reduces Printed Circuit Board Art Work From 2 Hours to 10 Min. . . .
Simple as A.B.C.

Are you tired of the hours of small, detailed, eye-straining art work that goes into making printed circuit boards? "STAMP IT, ETCH IT" is introducing a NEW product called "STAMP IT, ETCH IT" Kit. This Kit will take the tedious art work and many tiresome hours out of printed circuit board preparation. In just a few short minutes you have a professional looking etched printed circuit board ready for drilling!

The "STAMP IT, ETCH IT" Kit is exactly as the name implies. Following the step by step simple instructions, you can have a printed circuit board and have saved hours of frustration. As easy as you use a rubber stamp to stamp messages on paper, you stamp your component connections on copper clad printed circuit boards.



AT LAST
COMPLETE LINE OF
STAMP-IT ETCH-IT DIP IC SOCKETS
A DREAM COME TRUE
No Previous PCB Experience Necessary

IC-40 "28P"	IC-36 "28P"	IC-28 "28P"
IC-24 "28P"	IC-18 "28P"	IC-16 "28P"
IC-14 "28P"	IC-8 "28P"	

PRICE EACH

IC-40	\$2.95	IC-14	\$2.95
IC-36	\$2.95	IC-16	\$2.95
IC-28	\$2.95	IC-18	\$2.95
IC-24	\$2.95	IC-8	\$2.95

FOR COMPLETE KIT ORDER SE-2 KIT \$29.95

A. Stamp Components on P.C. Board. B. Use Pen to Interconnect Lines. C. Etch Board

SE-2 KIT CONTAINS:

- CONNECTOR FINGERS
- 18 PIN DUEL IN LINE IC SOCKET
- 18 PIN ROUND IC SOCKET
- 8 PIN ROUND IC SOCKET
- TO-8 TRANSISTOR SOCKET
- TO-18 TRANSISTOR SOCKET
- LARGE & SMALL DONUT PAD
- RESIST INK
- INK PAD
- RESIST PEN

PLUS

ONLY \$9.95 PLUS 1 LB. POSTAGE

ADDITIONAL STAMPS:

Broad board stamps for all integrated circuits "Great" for experimenters.

Only \$2.95 each or all four \$9.95

- #1 DUEL INLINE
- #2 FLAT PACK
- #3 8-PIN ROUND
- #4 10-PIN ROUND

• RESIST INK . . . 95c per bottle
• RESIST PEN ea. 95c
• INK PAD ea. \$1.15
• Etching Containers . . . 10 for 95c

In your "STAMP IT, ETCH IT" kit we supply all component stamps shown in SE-2 Kit. In the SE-2 kit we also have resist ink enough for months and months of experimenting, ink stamp pad, resist pen, and etching containers. The most revolutionary item in your "STAMP IT, ETCH IT" Kit is . . . The Fool Proof System of etching your printed circuit boards.

With our kits and our etching containers, you are able to etch a printed circuit board as fast as bubble etching machinery and the results are as good or better.

RAINBOW INDUSTRIES
4994 Olympia Drive
Indianapolis, Indiana 46208

\$5.00 Minimum Order
PLEASE ADD POSTAGE



MASTER CHARGE PHONE
ORDERS WELCOME 317-297-2717

RAINBOW INDUSTRIES MADE UP A SE-2 400 KIT FOR THE PRINTED CIRCUIT BOARD MAKER WHO WANTS EVERYTHING . . . And Just For You . . .

One Complete Package Pictured Below

SE-2 KIT PLUS SE-D8 KIT

ONE COMPLETE SE-D8 KIT PLUS

ALL THESE EXTRAS

- 100 copies of kit manual and stamp transfer
- 100 extra etching containers
- 100 extra resist pen
- Printed Circuit Boards
- Stamp Pad
- Resist Ink
- Resist Pen

ALL FOR ONLY \$54.95 ASK FOR SE-2400 KIT

PRINTED CIRCUIT BOARDS

6-10 FIBERGLASS

Size	1 Side	2 Sided
2" x 4"	.25	.35
3" x 6"	.50	.65
4" x 6"	.65	.90
6" x 6"	.90	1.35
6" x 12"	1.50	2.50
12" x 12"	2.95	3.95

See March '79 "Radio-Electronics" Hobby Corner for additional information on Stamp It, Etch It Method.

CIRCLE 74 ON FREE INFORMATION CARD

NOVEMBER 1980

Put Professional Knowledge and a
COLLEGE DEGREE
 in your Electronics Career through
HOME STUDY

Earn Your DEGREE

by correspondence, while continuing your present job. No commuting to class. Study at your own pace. Learn from complete and explicit lesson materials, with additional assistance from our home-study instructors. Advance as fast as you wish, but take all the time you need to master each topic.

The Grantham electronics degree program begins with basics, leads first to the A.S.E.T. degree, and then to the B.S.E.T. degree. Our free bulletin gives complete details of the program itself, the degrees awarded, the requirements for each degree, and how to enroll. (We are located at 2500 S. LaCienega Bl., Los Angeles, Calif.) Write to our mailing address shown below for *Bulletin R-80*

Grantham College of Engineering
 P. O. Box 35499
 Los Angeles, California 90035
Worldwide Career Training thru Home Study

stereo products

More information on stereo products is available.
 Use the Free Information Card inside the back cover.

AXIAL DOME 2-WAY CAR SPEAKER, the model 4128, consists of a 4 X 10-inch woofer and a 1-inch Super Dome tweeter. The woofer boasts a 20-oz. ceramic magnet and 1-inch hi-temp voice

coil. The 4128 has a power handling capacity of 50 watts and a frequency response of from 70 to 15,000 Hz. —Heppner Mfg., Belvidere Rd., Round Lake, IL 60073



CIRCLE 131 ON FREE INFORMATION CARD

coiled connecting cord with a 3-circuit phone plug. It's packaged in a 3-color display carton. Suggested retail price of model 60A is \$14.95. —BP Electronics, 855 Conklin St., Farmingdale, NY 11735. **R-E**



CIRCLE 132 ON FREE INFORMATION CARD

STEREO HEADPHONE, model 60A, offers high quality sound at an affordable price. It features individual volume and balance controls, a sensi-

Electronics Paperback Book Club
 Quality Paperbacks at Affordable Prices
Buy two, get one free!

Select the books you want or join the club now. Either way you earn a free book and can qualify for discounts of up to 20% for the next year. Here are 5 great books to start your membership. Select the ones that you want to read.

ORDER FORM

CASH NOW

I've checked off three books that I want to buy. I've included payment for two of them at the full list price. I understand the third book is **FREE**.

\$15 for a 15% discount

I've checked off the book I want **FREE** and have included my \$15 membership fee. I understand that this fee makes me a member of your book club for one year and that during that time I can order as many books as I want and deduct 15% from the list price.

\$25 for a 20% discount

I've checked off the free book and have enclosed my \$25 membership fee. I understand that this fee makes me a member of your book club for one year and that during that time I can order as many books as I want and deduct 20% from the list price. I further understand that I can use my \$25 membership fee as a credit toward future purchases.

Signature _____

Name _____

Address _____

City _____

State _____

Zip _____

Title	Quantity	Total Price
<input type="checkbox"/> How To Build Your Own Metal & Treasure Locators \$2.95	_____	_____
<input type="checkbox"/> A Practical Introduction To Digital IC's \$2.95	_____	_____
<input type="checkbox"/> Electronic Calculator Users Handbook \$2.95	_____	_____
<input type="checkbox"/> Popular Electronic Projects \$3.50	_____	_____
<input type="checkbox"/> Electronic Music & Creative Tape Recording \$3.50	_____	_____
<input type="checkbox"/> \$15/15% Membership	_____	_____
<input type="checkbox"/> \$25/20% Membership	_____	_____
	Subtotal	_____
	Shipping (35¢ per book)	_____
	Sales Tax (NY State residents)	_____
	Total	_____

MAIL TO:

ELECTRONIC TECHNOLOGY TODAY INC.

17 Slate Lane Central Islip, NY 11722

No Canadian Orders

computer products

More information on computer products is available.
Use the Free Information Card inside the back cover.

ADAPTER/MOTHERBOARD, the *Basic 8100*, is designed to be used with the *TRS-80* computer. It provides an interface to the *S-100* Bus, with six *S-100* card slots and converts the *TRS-80* signals to *S-100* signals. The *Basic 8100* includes an extension connector for adding another motherboard. Each basic unit provides six connectors and card-guide sets. There is an options kit for the *Basic 8100* for providing both additional I/O and RAM capabilities. The RAM option includes support circuitry for eight 16K or 4K dynamic RAM chips, DIP switches, bypass capacitors, sockets for all IC's, and instructions. The options kit also provides either standard *RS-232-C* I/O interface or 20 mA serial teletype I/O interface. That option comes with everything needed for the interface circuitry—sockets, IC's, *DB-25* connector, parallel connector, and software. The *Basic*

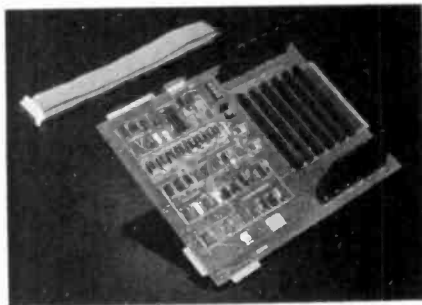

CIRCLE 121 ON FREE INFORMATION CARD

8100 features selectable odd, even, or no parity, and 5, 6, 7 and 8-bit word length with 1, 1½, or 2 stop bits. It is available either assembled and tested or in kit form. Suggested retail price is \$245.—California Computer Systems, 250 Caribbean Dr., Sunnyvale, CA 94086.

GRAPHICS INTERFACE, model *SDI*, is a high-resolution unit designed for Cromemco computer systems. It displays color or black-and-white images with up to 756 by 484 point resolution. Features include color-map selection, dual-page windowing function, automatic area fill mode, and NTSC broadcast compatibility. The *SDI* consists of two circuit boards that plug into the *S-100* bus of the system, and uses direct memory access to display the contents of display memory. Each pixel of the display can be mapped from one bit of

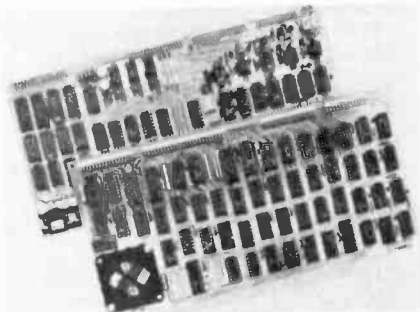

CIRCLE 122 ON FREE INFORMATION CARD

the display memory and 12K or 48K of memory can be used. In the nybble-mapped mode, any 16

of 4096 possible colors can be displayed in one picture. In the bit-mapped mode, any two colors can be displayed, and in black-and-white nybble-mapped mode there can be 16 shades of gray. The *SDI* has three separate analog output signals

to drive the Red, Green, and Blue guns of an RGB monitor and a composite sync signal is switch-selectable on any of the three outputs. Suggested retail price is \$595.—Cromemco, Inc., 280 Bernardo Ave., Mountain View, CA 94043. R-E

Nine Ways To Get A Precise Grip On Precision Jobs

Slender, perfectly mated jaws that give you a sure touch on fine work. Hand honed cutters sharp enough to cut a human hair. Precision machined joints with no loose side wobble. Blue dipped plastic comfort grips. Quality in every detail (at no premium in price). Little Champ Pliers by CHANNELLOCK. Be sure THAT trade name is on the pliers you buy.

CHAN NEL LOCK

Little Champ Precision Pliers
CHANNELLOCK, INC. • Meadville, Pennsylvania 16335
Meet The Rest Of The Family. Send For Our Free Catalog.

CIRCLE 24 ON FREE INFORMATION CARD

More information on new lit is available. Use the Free Information Card inside the back cover

RCA SK SOLID STATE REPLACEMENT GUIDE 1980 is 368 pages and offers 1,080 solid state replacement devices that replace more than 161,000 domestic and foreign types. There is a dual numbering system which shows both the SK stock number and the stock number in the systems used by EGC, REN, and TM.

There is information on RCA's full line of replacement transistors, rectifiers, thyristors, integrated circuits, and high-voltage triplers, including many MRO (Maintenance and Repair Operation), replacements. The guide also includes an index and a comprehensive data section with listings grouped according to the type of device. The price of the guide is \$1.50.—**RCA Distributor and Special Products**, PO Box 597, Woodbury, NJ 08096.

CIRCLE 141 ON FREE INFORMATION CARD

VIDEO/AUDIO SUPPLIES AND ACCESSORIES CATALOG, contains 80 pages describing hundreds of unique and innovative items for audio and video users. Featured products include custom cables, video cassettes, tape labels, hard-to-find connectors and adaptors, microphones, test charts, audio cassettes, tape cleaning supplies, cable markers, splicing kits, books and ser-

vice manuals, tool kits, storyboard pads, and many other items. The catalog also introduces the pocket cable tester and the Little. Name-brand items are offered, such as Memorex, Switchcraft, Belden, Maxell, Shure, Vaco, Brady, and many others.—**WIDL Video**, 5245 W. Diversey Ave., Chicago, IL 60639.

CIRCLE 142 ON FREE INFORMATION CARD

ALUMINUM SOLDERING GUIDE, *Alu-Sol Multicore Solder*, is a 4-page brochure that provides information on soldering aluminum using the multi-cored solder, *Alu-Sol 45D*. *Alu-Sol 45D* is a combination of a flux and silver-loaded tin-lead solder that contains no bismuth, zinc, cadmium or aluminum. The brochure provides complete applications, technical data, joint design recommendations and soldering techniques. Detailed performance information is also given including a table on the solderability of various wrought and cast aluminum alloys, different aluminum finishes as well as other metals and alloys using *Alu-Sol 45D*.—**Multicore Solders**, Westbury, NY 11590.

CIRCLE 143 ON FREE INFORMATION CARD

ELECTRONICS CATALOG, contains 80 pages crammed with hundreds of bargain-priced elec-

tronic parts and equipment. Listed are factory surplus items plus many unusual and hard-to-find parts. This catalog will be of interest to everyone in the field of electronics—teachers, students, hams, hobbyists, as well as technicians, dealers and manufacturers.—**Etco Electronics Corp.**, Dept. 113, Box 796, Plattsburgh, NY 12901.

CIRCLE 144 ON FREE INFORMATION CARD

KEYBOARD-SWITCH CATALOG, is a 4-color, 12 page catalog featuring the complete *Series T-5* line of mechanical contact keyboard switches. The catalog covers 12 basic switch types, electrical specifications, mechanical dimensions, PC-board layout and mounting requirements. It also covers dimensions, styles, and colors available of stock and custom keytops and lighted-switch lenses.—**MEI, Inc.**, Park Center, Sterling, VA 22170.

CIRCLE 145 ON FREE INFORMATION CARD

CROSS REFERENCE FOR VARIABLE TRANSFORMERS, *Interchangeability Chart*, is a six-page two-color guide covering over 400 models. The listing shows the equivalent catalog numbers for similar types made by other variable transformer manufacturers. The guide lists current ratings from 0.8 amps to 540 amps as well as model numbers.—**Staco Energy Products Co.**, 301 Gaddis Blvd., Dayton, OH 45403. R-E

CIRCLE 146 ON FREE INFORMATION CARD

BK PRECISION

Microcomputer-Controlled Autoranging DMM Model 2845

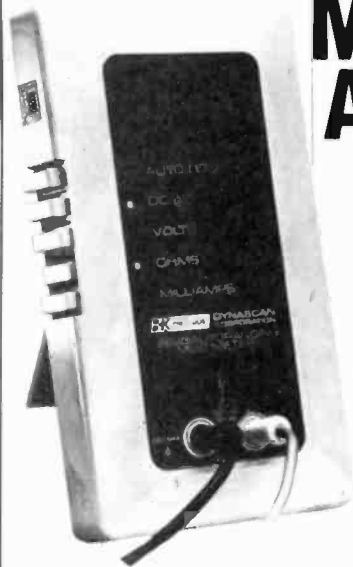

- **Computer stabilized accuracy to 0.1%**
- **Auto-perfection**
Selects range for maximum resolution
- **Audible continuity indicator**
Built-in audible tone generator
- **G-MOV overload protection**
Provides AC and DC voltage range protection to 1000 VDC or AC peak
- **Shielded In RF fields**
Accuracy maintained in RF fields
- **Long life, high reliability**
Four hermetically sealed reed relays perform range switching with virtually no contact wear.
- **Microcomputer intelligence**
Designed around 4-bit microcomputer. Analyzes stored data and range that provides greatest display resolution. Program memory capacity 1024 x 8 bits of ROM supported by 48 x 4 bits of data memory RAM

... in stock and available for immediate delivery.

Dual Trace 5" 30 MHz Triggered Scope Model 1479A



Sweep/Function Generator Model 3020

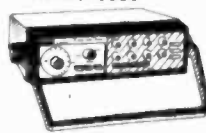

Semiconductor Transistor Tester Model 520B



Portable Digital Capacitance Meter Model 820



Order with Confidence and get the Fordham Advantage!

Call for our prices **TOLL FREE (800) 645-9518**

in N.Y. State call (516) 752-0050

FORDHAM

855 Conklin St. Farmingdale, N.Y. 11735



- Master Charge
- BankAmericard
- VISA ■ COD
- Money Order
- Check
- COD's extra

CIRCLE 33 ON FREE INFORMATION CARD

radio products

More information on radio products is available. Use the Free Information Card inside the back cover.

KILOWATT LINEAR AMPLIFIER, model 444 Hercules, features instant break-in and requires no tuning—the front panel uses just four switches (power, mode, meter, and band). Behind the black-out upper panel are two large meters that light up when AC power is turned on. One measures collector current, the other measures collector voltage or power (forward and reverse). There are also six status indicators with LED's that can show the following conditions: overdrive, improper control-switch setting, heat-sink temperature, SWR, overvoltage, and RF output balance. The amp will shut down when set limits are exceeded.

The model 444 uses two 500-watt push-pull transistor amplifier modules, operating at 45-volts DC at 22.2 amps, and providing 600 watts RF output. Frequency range is 1.8 MHz through 21.5 MHz, and input and output impedance is 50



CIRCLE 111 ON FREE INFORMATION CARD

ohms. The separate power supply provides 45 volts DC at 24 amperes and an automatic line-voltage correction circuit eliminates the possibility of applying too high a voltage to the final transistors. Price is \$1575.—TEN-TEC, Inc., Highway 411 E., Sevierville, TN 37862.

MARINE CB ANTENNAS, models MC277 and MC270, are designed for use on fiberglass, wood, plastic, or metal boats and recreational vehicles and do not require ground planes. Both antennas feature a molded, hinged base that locks in an upright position for transmission and folds 180° for out-of-the-way storage when not in use. Both include a prewired coax assembly sealed into the base for moisture protection. The model MC277 Sea King is a nine-foot fiberglass whip that pro-

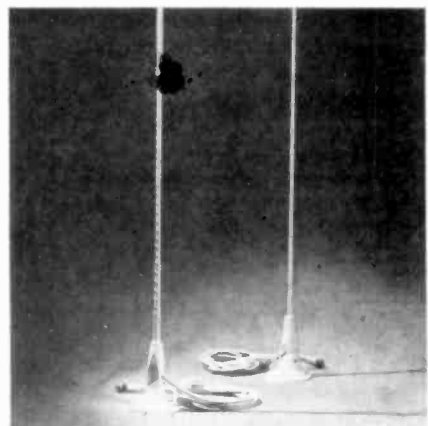

CIRCLE 112 ON FREE INFORMATION CARD provides maximum range and performance and is

priced at \$39.95. The model MC270 Sea Sprite is a loaded fiberglass stick-type that combines the convenience of short height (39 inches) with high-

performance characteristics. It is priced at \$31.95.—Antler Antennas, P.O. Box 40526, Fort Worth, TX 76140. R-E

The DR22-C Fully Synthesized General Coverage Receiver from McKAY DYMEK



FEATURES

- Shortwave, CB, ham radio, ships at sea, overseas phone calls, etc.
- High Impedance tuner output for Hi Fi System use.
- High level RF front end for excellent inter-modulation rejection and sensitivity.
- Crystal filters in first and second IF amplifiers, ceramic filter in third IF.
- Quartz crystal tuning accuracy at all frequencies, no crystals to buy.
- Built in power supply for 110-120 or 220-240 VAC switchable, 50-60 Hz.
- Low Phase Noise Synthesizer
- Solid state, phase locked, digital synthesis tuning.
- Extreme ease of tuning at all frequencies.
- No mechanical tuning dial error or backlash.
- Switch selectable 4 or 8 kHz RF bandwidth.
- Built in monitor speaker with external speaker connectors.
- Switchable impulse noise limiters for AM and SSB.

SPECIFICATIONS

- Frequency coverage: 50 kHz to 29.7 MHz, continuous. Digital synthesis in 5 kHz steps, fine tune for ± 5 kHz.
- Reception modes: AM, upper sideband, lower sideband, CW.
- Sensitivity for -10 dB S + N/N:

	100 kHz	200 kHz	400 kHz-20MHz	20MHz-29.7MHz
CW, SSB	5 μ V	1.5 μ V	0.5 μ V	C 75 μ V
AM	10 μ V	3.0 μ V	1.0 μ V	5 μ V
- Selectivity: 6dB @ ± 2 kHz or ± 4 kHz and -60dB @ ± 5 kHz or ± 14 kHz
- AM Harmonic distortion: 50% modulation = 0.6% THD, 90% modulation = 1.5% THD (1kHz modulation)
- Frequency stability: Within ± 40 Hz in any 8 hour period at a constant ambient of 25C, after 30 minute warm up
- Circuitry: 43 integrated circuits, 18 transistors, 16 FETs and 54 diodes.
- Dimensions & Wt.: (W x D x H) 17.5 x 14.5 x 5.1 inches. Shpg. Wt. 19 lbs. (8.7 Kg)



McKay Dymek Company
111 South College Avenue
PO Box 5000
Claremont, CA 91711



For more information write or call today
Toll Free
800/854 7769
Calif. 800/472-1783
TWX 910 581 4990
Local Tel 714/621-6711

CIRCLE 19 ON FREE INFORMATION CARD

Test computer terminal CRTs

with a
B&K-PRECISION
portable
CRT analyzer



Model 467
\$395

Now you can save time and reduce call-backs by field testing most any monitor or computer-terminal CRT. The B&K-PRECISION 467 CRT restorer/analyzer provide a definite "yes or no" answer to tube condition on an easy-to-read meter. It offers fast set-up and testing and measures true dynamic beam current. All CRTs are checked identically—including all color "in-line" and "one-gun" types. Checks virtually all types of terminal CRTs.

In addition, the 467 offers a powerful digitally controlled CRT restoration method so that you'll be able to extend the life of many "bad" CRTs and guarantee results.

- Exclusive multiplex technique tests all three guns of a color CRT simultaneously
- Exclusive circuit tests focus-electrode lead continuity
- Obsolescence proof: perpetual set-up charts available
- Improves profitability by reducing call-backs—repair a terminal in one trip instead of two!
- Entirely self contained; weighs only 10 pounds

For additional information and the name of your local distributor, call toll-free 800-621-4627.

BK PRECISION
DYNASCAN
CORPORATION

6460 West Cortland Street
Chicago, Illinois 60635 • 312/889-9087

Intl. Sls., 6460 W. Cortland St., Chicago, IL 60635
Canadian Sales: Atlas Electronics, Ontario

next month

DECEMBER 1980

■ Build This Hi-Fi Minispeaker

Complete construction plans for a low-cost sub-compact speaker system that delivers high-fidelity performance.

■ How To Build Your Own Robot

Part 5. Complete details on how to wire the body and build a remote control box.

■ How To Locate Faults in Coaxial Cables

Nifty troubleshooting method locates open or shorted conductors in hard to reach coaxial cables.

■ A Potpourri of Useful Information

Hints, tricks and circuits to help you troubleshoot and repair circuits. Included are actual case histories along with troubleshooting procedures.

PLUS:

Hobby Corner

Communications Corner

Service Clinic

Equipment Reports

and more . . .

ISO-TIP® for soldering control and convenience

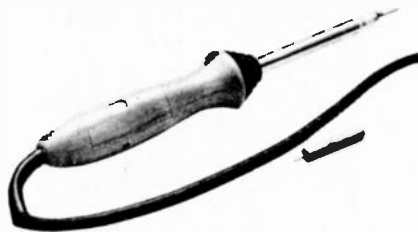

temperature control

50W iron maintains any temperature between 400-750°F with $\pm 2\%$ accuracy to solder delicate components without damage. Allen key for temperature adjustment included. Heats in 45 seconds, indicated by thermostatically controlled lamp. Production 50 — No. 7200

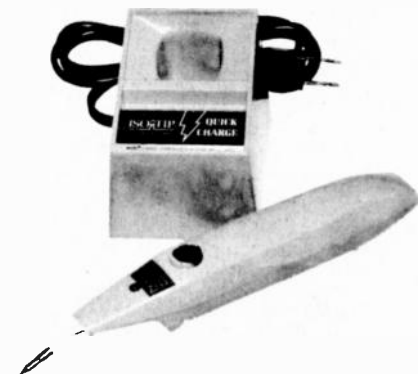

cordless convenience

High capacity nickel cadmium battery power lets you take low-voltage soldering anywhere! Complete recharge in 3-4½ hours. Partial recharge in less time. Isolated tip design with a wide range of "snap-in" tips available. Quick Charge — No. 7700

Available at most electronic parts distributors.

WAHL CLIPPER CORPORATION
ORIGINATORS OF PRACTICAL CORDLESS SOLDERING
Sterling, Illinois 61081 • (815) 625-6525
"Manufacturing Excellence Since 1919"

HI-FI STEREO

continued from page 75

than a switchable circuit-interruption point in the long signal path from program source to loudspeaker terminals. Usually, the tape-monitor interruption point occurs immediately after the program-source selector switch. In some components, an additional stage of gain or a stage used as a buffer amplifier may be added, as shown by the dotted lines of Fig. 5. In either case, the jack labelled "tape out" (only one channel is shown for convenience, but in a stereo component, the identical configuration would appear for the alternate channel) is intended for connection to the *input* of an accessory component or a tape deck, while the jack labelled "tape in", "monitor" or "tape play" connects to the *output* of either a tape recorder/deck or the output of one of the many auxiliary devices or accessories.

If nothing is connected to the tape-monitor circuit and the front-panel tape-monitor switch is depressed or moved to the "tape" setting, it is clear from Fig. 5 that the signal path will be completely broken or interrupted and nothing will be heard from the system's loudspeakers. On the other hand, if a tape deck (for example) is connected to the tape-monitor loop and the "tape" position of the front-panel tape-monitor switch is chosen, only the output of the tape deck will be fed to the succeeding amplification stages and ultimately to the loudspeakers, regardless of the setting of the main-program selector switch on the front panel of your receiver or amplifier.

Often, users forget those important facts and, when they turn on their systems and discover that no sound is coming from the loudspeakers, they panic and place a call to their local service technician. Only when he arrives and simply restores the tape-monitor switch to its "out" or "source" position do they realize that they have wasted a service call. **R-E**

Put your money where your Heart is.



Technicians— RCA Flameproof Film Resistors simplify your replacement problems.

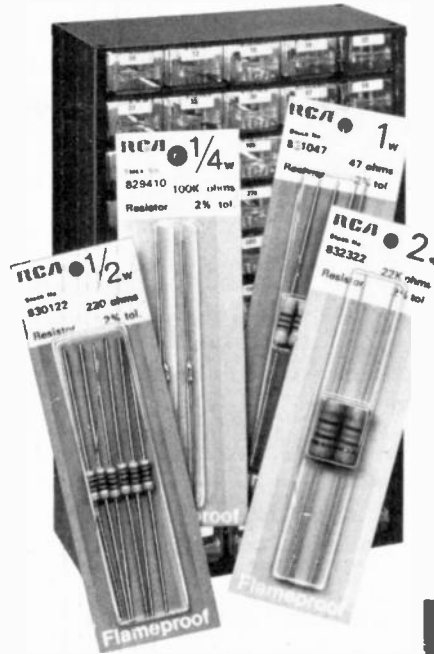

More and more technicians are switching to RCA Flameproof Film Resistors. Here are 4 important reasons why:

- Many of today's circuits require flameproof resistors.
- High quality service demands high quality replacement parts.
- They're available in the popular wattage ratings — 1/4, 1/2, 1 and 2 watts.
- Values run from 0.1 Ohm to 1.5 Megohms. Altogether there are 643 film resistors to choose from.

And, RCA's convenient, preloaded and pre-labeled Flameproof Resistor Kit makes it easy to store and locate your resistors.

See your RCA Distributor for details or write to RCA Distributor and Special Products Division, 2000 Clements Bridge Road, Deptford, NJ 08096.

RCA Flameproof Film Resistors

HIGH STABILITY CRYSTALS FOR FREQUENCY OR TIME
USE THE BEST BUY JAN CRYSTALS

- CB
- CB standard
- 2 meter
- Scanners
- Amateur Bands
- General Communication
- Industry
- Marine VHF
- Micro processor crystals

Send 10¢ for our latest catalog. Write or phone for more details.

Jan Crystals
2400 Crystal Drive
Ft. Myers, Florida 33907
all phones (813) 936-2397

easy to charge



CIRCLE 22 ON FREE INFORMATION CARD

CB, AMATEUR or COMMERCIAL COMMUNICATIONS

Hustler has the antenna you're looking for!

Mobile or base station. Whatever your needs, Hustler has the quality for exceptional mechanical and electrical performance. The result of unique engineering expertise and innovation, respected throughout the industry. For outstanding antenna quality, look to Hustler!

Clearly the choice of those who know quality.

See your dealer or write:



3275 North B Ave
Kissimmee, Florida 32741



CIRCLE 28 ON FREE INFORMATION CARD

market center

CLASSIFIED COMMERCIAL RATE (for firms or individuals offering commercial products or services), \$1.50 per word prepaid (no charge for zip code) . . . **MINIMUM 15 WORDS**. 5% discount for 6 issues, 10% for 12 issues within one year, if prepaid.

NON-COMMERCIAL RATE (for individuals who want to buy or sell a personal item) **85¢ per word prepaid** . . . no minimum.

ONLY FIRST WORD AND NAME set in bold caps. Additional bold face (not available as all caps) at 10¢ per word. All copy subject to publisher's approval. **ADVERTISEMENTS USING P.O. BOX ADDRESS WILL NOT BE ACCEPTED UNTIL ADVERTISER SUPPLIES PUBLISHER WITH PERMANENT ADDRESS AND PHONE NUMBER.** Copy to be in our hands on the 26th of the third month preceding the date of the issue (i.e., August issue closes May 26). When normal closing date falls on Saturday, Sunday, or a holiday, issue closes on preceding working day.

SATELLITE TELEVISION

ANTENNA azimuth and elevation for all Western Hemisphere geostationary satellites. \$4.00 and your latitude and longitude. Free sample SASE. **DAVID FREY**, Box 2591, Satellite Beach, FL 32937

AUTHORIZED **TRS-80®** DEALER A301
COMPUTER SPECIALISTS



Up to
15% Discount
on **TRS-80's**

26-1051 4K LEVEL I \$424.00

26-1056 16K LEVEL II \$670.00

1-800-841-0860 TOLL FREE

MICRO MANAGEMENT SYSTEMS, INC.
Downtown Plaza Shopping Center
115 C. Second Ave., S.W.
Cairo, Georgia 31728
(912) 377-7120 Ga. Phone No.

SATELLITE TV
FANTASTIC 80 TV CHANNELS

Better than Cable TV! A must for all homeowners and Do-it-yourselfers. Build a Video System the whole family can enjoy! No commercials, FREE movies, sports and Vegas Shows - worldwide, crystal clear reception connects to any TV set. 100 pages (8 x 11) loaded with photos, plans, kits—TELLS EVERYTHING! Satisfaction Guaranteed.
Send \$7.95 TODAY! Add \$2.00 for 1st class (air mail).
Or call our 24 hour C.O.D. rush-order line (305) 862-5068.
GLOBAL TV ELECTRONICS, P.O. Box 219-V, Maitland, FL 32751

FREE SATCORN KIT FOR HOME AS NO MORE

PLANS & KITS

SPEAKERS. Save 50%. Build your own speaker system. "Free catalog" write: **MC GEE RADIO**, RE 1901, McGee Street, Kansas City, MO 64108

PROJECTION TV . . . Convert your TV to project 7 foot picture. Results equal to \$2,500 projector. Total cost less than \$20.00. Plans & lens \$16.00. Illustrated information free. **MACROCOMGC**, Washington Crossing, PA 18977

DIGITAL multimeter kits handheld, best quality 0.1% accuracy. The lowest price in America \$67.50 write: **E. G. TRONICS**, 8254 Greenleaf Circle, Tampa FL 33615

Satellite TV

FOR THE HOME

Sick of Network TV?

Our receiver lets you get over 75 channels of television directly from earth-orbiting cable TV satellites: HBO, Showtime, super stations, sports and movies from around the world.



**We don't just sell information!
We Manufacture Hardware!**

Our 94-page catalog and information book tell the whole story! Inexpensive dishes, high proceeds, computer aiming software! Specs, kits and more! Send \$7.95 today!

24-hour C.O.D. Hotline
(305) 339-7600



SPACECOAST RESEARCH
Dept. T, P.D. Box 442, Altamonte Springs, FL 32701

PRINTED circuit boards from sketch or artwork. Kit projects. Free details. **DANOCINTHS INC.**, Box 261, Westland, MI 48185

TELEVISION alignment—in minutes—while observing revolutionary pattern on screen. Check RF, IF, video, instantly! So simple and inexpensive it's incredible. Complete plans—\$6.00. Free details. **JOHN KOZULKO**, Box 2702R, Clearwater, FL 33517

SAVE 90%. Build your own minicomputer. Free details. **DIGITRONICS CORPORATION**, 2723E W. Butler Dr., Phoenix, AZ 85021

NEW plans. Telephone memory dialer, negative ion generator, burglar alarm, \$3.00 each. Subscription television decoder, \$10.00. Plans include detailed instructions and circuit board patterns. **COLLINS ELECTRONICS**, Box 6424, San Bernardino, CA 92408

DECODE Morse and RTTY signals off the air with new Morse-a-Word or RTTY reader. Morse keyboard also available. Kits or factory wired. Send for details. **MICROCRAFT**, Box 513R, Thiensville, WI 53092 (414) 241-8144.

4 in kit • **CAPACITANCE METER** 1pF to 999KµF
• **FREQUENCY COUNTER** 35MHz
• **SQUARE WAVE GEN.** 1Hz to 99KHz-
• **OHMMETER** - 3.58MHz Xtal - Regulated PS - Five .8" Readouts - Low cost TTL Circuits - Automatic Decimal Placement - Be **AMAZED** - Build it for \$50 or less. | Purchase the plans, etched P.C. board 4-3/4" by 6-3/4" and front panel decal for \$15.29 | **BAGNALL ELECTRONICS**, Refund 179 May Street, Fairfield, Conn. 06430 any Kit

TELEPHONE calls recorded automatically, unattended, build yourself for less than \$10.00. Detail plans \$2.50. **GARRETT ELECTRONICS**, 6451 Imperial Avenue, San Diego, CA 92114

ELECTRONIC toys and games. Build your own and save. Plans for 10 toys \$5.00. **MICRON**, 210 E. Belcrest Road, Belair, MD 21014

CABLE TV descramblers and converters. Build or buy. For information send \$2.00. **C&D COMPANY**, POB 26, Hudsonville, MI 49426

BUILD electronic burglar alarm. Most versatile and practical home alarm available. Fantastic features. Build for \$130.00. Complete plans, schematics, parts lists \$12.00. Specifications sheet and photo \$1.00 (deductible when ordering plans). **BUSH ALARMS**, 501 Prada Dr., Milpitas, CA 95035

To run your own classified ad, put one word on each of the lines below and send this form along with your check for \$1.50 per word (minimum 15 words) to:

Radio-Electronics, 200 Park Avenue South, N.Y., N.Y. 10003

ORDER FORM

PLEASE INDICATE in which category of classified advertising you wish your ad to appear. For special headings, there is a surcharge of \$10.

() Plans/Kits () Business Opportunities () For Sale
() Education/Instruction () Wanted ()

Special Category: \$10

(PLEASE PRINT EACH WORD SEPARATELY, IN BLOCK LETTERS.)

1	2	3	4	5
6	7	8	9	10
11	12	13	14	15
16	17	18	19	20
21	22	23	24	25
26	27	28	29	30
31	32	33	34	35

PLEASE INCLUDE FOR OUR FILES YOUR PERMANENT ADDRESS AND PHONE NUMBER.



THE PERFECT CHRISTMAS GIFT. ORDER EARLY WHILE SUPPLIES LAST!

Are you receiving our mailers regularly? if not, Please return this form

Zilog

Z80-CPU	2.5 MHz	9.85	Z80-SIO/0	2.5 MHz	30.50
Z80A-CPU	4.0 MHz	12.05	Z80A-SIO/0	4.0 MHz	36.70
Z80-PIO	2.5 MHz	6.65	Z80-SIO/1	2.5 MHz	36.00
Z80A-PIO	4.0 MHz	8.00	Z80A-SIO/1	4.0 MHz	44.10
Z80-CTC	2.5 MHz	6.65	Z80-SIO/2	2.5 MHz	36.00
Z80A-CTC	4.0 MHz	8.00	Z80A-SIO/2	4.0 MHz	44.10
Z80-DMA	2.5 MHz	22.35			
Z80A-DMA	4.0 MHz	28.00			

1980 IC MASTER over 2700 PAGES

Complete integrated circuit data selector. Master guide to the latest I.C.'s including microprocessors and consumer circuits. 45,000 device types listed. 5,000 new device types added. Complete new section on MPU boards & Systems.

"VERY SPECIAL \$29.95"



NAME _____
 ADDRESS _____
 CITY _____
 STATE _____ ZIP CODE _____

OPTO SALE

L.E.D. LAMPS

LED209	T-1 2 mm Red	.09
LED211	T-1 3 mm Green	.19
LED212	T-1 3 mm Yellow	.14
LED220	T-1 1/4 5 mm Red	.11
LED222	T-1 1/4 5 mm Green	.24
LED224	T-1 1/4 5 mm Yellow	.18

DISPLAYS

FND357	.375" Common Cathode	.99
FND500	.500" Common Cathode	.99
FND507	.500" Common Anode	.99
DL704	.300" Common Cathode	1.29
DL707	.300" Common Anode	1.29
DL747	.630" Common Anode	2.29
DL1416		29.95

4 digit, 16 segment alphanumeric display 16" ht.

ISOLATORS

ILD74	Dual Opto Isolator	1500V	1.29
ILC74	Quad Opto Isolator	1500V	3.95
ILCT6	Dual Opto Isolator	1500V	1.29
TIL111	Opto Coupler	1500V	.54
4N26	Opto Isolator	2500V	.54
4N33	Opto Isolator	1500V	.65

CMOS

CD4000BE	.29	CD4021BE	.69	CD4046BE	.84	CD4082BE	.22	CD4527BE	1.85
CD4001BE	.29	CD4022BE	1.19	CD4047BE	.79	CD4085BE	.59	CD4528BE	.84
CD4002BE	.23	CD4023BE	.29	CD4048BE	.41	CD4086BE	.69	CD4531BE	.89
CD4006BE	.99	CD4024BE	.48	CD4050BE	.39	CD4093BE	.79	CD4532BE	1.09
CD4007BE	.39	CD4025BE	.27	CD4051BE	.78	CD4098BE	1.98	CD4539BE	.79
CD4008BE	.79	CD4026BE	1.79	CD4052BE	1.09	CD4104BE	1.99	CD4543BE	1.72
CD4009BE	.49	CD4027BE	.44	CD4053BE	1.09	CD4508BE	1.79	CD4553BE	2.89
CD4010BE	.49	CD4028BE	.54	CD4056BE	1.75	CD4510BE	.74	CD4556BE	.66
CD4011BE	.29	CD4029BE	.89	CD4068BE	.79	CD4511BE	.69	CD4558BE	1.99
CD4012BE	.27	CD4030BE	.42	CD4069BE	.25	CD4512BE	.69	CD4562BE	.48
CD4013BE	.39	CD4033BE	1.79	CD4070BE	.37	CD4514BE	1.95	CD4582BE	.88
CD4014BE	.64	CD4034BE	2.50	CD4072BE	.22	CD4515BE	1.95	CD4584BE	.48
CD4015BE	.64	CD4035BE	.94	CD4073BE	.34	CD4519BE	.49	CD4585BE	.86
CD4016BE	.39	CD4040BE	.89	CD4075BE	.29	CD4520BE	.69	CD4702BE	8.89
CD4017BE	.65	CD4042BE	.64	CD4076BE	.70	CD4522BE	.89		
CD4018BE	.57	CD4043BE	.89	CD4078BE	.34	CD4526BE	.99		
CD4019BE	.69	CD4044BE	.74	CD4081BE	.26				
CD4020BE	.84								

PLASTIC POWER TRANSISTORS

TIP29	39	NPN	1 AMP	100V
TIP30	39	PNP	1 AMP	100V
TIP31	42	NPN	3 AMP	100V
TIP32	43	PNP	3 AMP	100V
TIP41	59	NPN	6 AMP	100V
TIP42	64	PNP	6 AMP	100V
TIP115	59	PNP	2 AMP	60V
TIP120	64	PNP	5 AMP	60V
TIP127	74	NPN	5 AMP	100V
TIP125	74	PNP	5 AMP	60V
TIP127	85	PNP	5 AMP	100V
TIP2955	83	PNP	15 AMP	60V
TIP3055	70	NPN	15 AMP	60V
FT3055	59	NPN	10 AMP	60V

LINEAR I.C.'s

LM301AN-8	.34	LM324N	.54	LM741CN-8	.39
LM304CH	.89	LM339N	.54	LM*17CN-14	.59
LM307N-8	.29	LM338N-14	.99	LM*48CN-8	.39
LM308N-8	.89	LM339N-8	.79	LM1458N-8	.42
LM309CH	.95	LM555N-8	.32	LM1488N-14	.69
LM309K	1.29	LM556N-14	.49	LM1489N-14	.69
LM310HC	1.49	LM723CH	.89	LM3046N-14	.99
LM311N-8	.59	LM723CN-14	.49	LM3302N-14	.55
LM311T	1.49	LM725CN-8	1.75	LM3403N-14	.89
(TO-220)		LM733CN-14	1.59	LM3900N	.49
LM318N-8	1.45	LM739CN-14	1.29	LM4136N-14	.39
LM318CH	1.75	LM741CH	.65	ULN2003AN	.89

DUAL-IN-LINE — LOW PROFILE — I.C. SOCKETS

CONTACTS	PRICE	CONTACTS	PRICE
8 PIN	.07	22 PIN	.21
14 PIN	.11	24 PIN	.23
16 PIN	.13	28 PIN	.27
18 PIN	.17	40 PIN	.39
20 PIN	.19		

• LOWEST PRICES ANYWHERE FOR THE HIGHEST QUALITY AN UNBEATABLE COMBINATION.

TTL-Ls

ALL CIRCUITS IN STOCK FOR GUARANTEED IMMEDIATE DELIVERY.

74LS00N	.23	74LS20N	.27	74LS55N	.39	74LS95N	.64	74LS137N	.99	74LS161N	.89	74LS191N	1.29	74LS245N	2.75	74LS279N	.84	74LS348N	2.95	74LS379N	1.95
74LS01N	.21	74LS21N	.29	74LS73N	.45	74LS96N	.74	74LS138N	.69	74LS162N	.89	74LS192N	.68	74LS247N	.69	74LS280N	2.69	74LS352N	1.27	74LS390N	2.29
74LS02N	.34	74LS26N	.39	74LS74N	.49	74LS107N	.45	74LS139FN	.69	74LS163FN	.98	74LS193FN	.89	74LS248N	1.69	74LS283N	1.19	74LS353N	1.95	74LS393N	2.75
74LS03N	.23	74LS27N	.34	74LS75N	.49	74LS109N	.59	74LS145N	1.25	74LS164N	.64	74LS194N	.72	74LS249N	.99	74LS290N	.84	74LS362N	11.95	74LS395N	1.95
74LS04N	.29	74LS30N	.19	74LS76N	.39	74LS112N	.44	74LS147N	2.49	74LS165N	1.27	74LS195N	.68	74LS251N	2.25	74LS293N	.38	74LS365N	4.59	74LS447N	.37
74LS05N	.39	74LS32N	.49	74LS78N	.35	74LS122N	.54	74LS148N	1.49	74LS166N	1.87	74LS196N	1.12	74LS252N	.59	74LS295N	1.39	74LS366N	1.25	74LS490N	1.95
74LS08N	.34	74LS38N	.32	74LS83N	.94	74LS123N	.84	74LS151N	.49	74LS169N	12.85	74LS197N	.99	74LS257N	.95	74LS298N	1.19	74LS367N	1.98	74LS630N	85.00
74LS09N	.59	74LS40N	.24	74LS85N	.87	74LS124N	.99	74LS152N	.52	74LS170N	2.75	74LS221N	.88	74LS258N	.68	74LS299N	2.98	74LS368N	1.50	74LS631N	85.00
74LS10N	.23	74LS42N	.49	74LS86N	.74	74LS125N	.84	74LS155N	.94	74LS173N	.74	74LS224N	1.14	74LS259N	4.76	74LS320N	2.95	74LS373N	1.48	74LS669N	.98
74LS11N	.34	74LS47N	.69	74LS90N	.44	74LS126N	.52	74LS156N	1.45	74LS174N	.49	74LS2241N	1.35	74LS260N	1.00	74LS321N	3.86	74LS374N	1.48	74LS670N	2.65
74LS12N	.18	74LS48N	2.95	74LS91N	.79	74LS127N	.44	74LS157N	.98	74LS175N	.52	74LS242N	1.35	74LS262N	.69	74LS322N	4.95	74LS375N	2.98		
74LS13N	.27	74LS51N	.29	74LS92N	.74	74LS128N	2.85	74LS158N	.79	74LS181N	2.38	74LS243N	.79	74LS264N	.39	74LS323N	3.39	74LS377N	1.44		
74LS14N	.49	74LS54N	.24	74LS93N	.38	74LS136N	.65	74LS160N	1.60	74LS190N	1.25	74LS244N	1.35	74LS266N	4.95	74LS324N	1.38	74LS378N	1.30		

MOS MEMORIES

MOS Static RAM's

Part No.	Price
2102-25	1.75
1K (1K x 1) 250NS 16 PIN	
P2111-35	3.95
1K (256 x 4) 350NS 18 PIN	
P2112-35	3.45
1K (256 x 4) 350NS 18 PIN	
2114L	4.45
Low Power 4K (1024 x 4) 300NS	
4K (4K x 1) 55NS	16.95
2147	12.95
4K (4K x 1) 70NS	
UART's	
AY5-1013A	3.95
0 to 40K BAUD 40 PIN	
COM8017	Special 3.95
40 Khz Single 5V Supply	
1K CMOS RAM	
5101	54.95
1K (256 x 4) 450NS 22 PIN Low Power	
4K CMOS RAM	
P6504	12.95
4K (4K x 1) 550NS 18 PIN 110MW	
P6514	12.95
4K (1K x 4) 450NS 18 PIN 110MW	
SHIFT REGISTERS	
3341APC FIFO 1MHz	5.50
3342PC 64 Bit Shift Register	4.45
3347PC 80 Bit Shift Register	3.95
ECL RAM	
10410ADC/HM2106	Special 6.95
256 x 1 Bit Fully Decoded 15NS 16 PIN	

MICROPROCESSOR CHIP SETS

Part No.	Price	Part No.	Price	Part No.	Price
8080A	\$5.65	6800	\$6.50	6502	\$9.95
8085	11.95	6802	11.95	6504	9.95
				6505	9.95
8212	2.75	6810	3.75		
8214	3.95	6820	4.95	6520	6.95
8216	2.95	6821	3.75	6522	9.95
8224	3.45	6850	3.95	6532	13.95
8226	2.95	6582	3.75	6551	13.95
8228	4.98				
8238	4.98				
8251	6.95				
8253	10.95				
8255	6.95				
8257	10.95				
8259	12.95				

SCR's and TRIAC's

C106D	.34	SCR 5 amp 400V TO-220
TIC116B	.97	SCR 8 amp 200V TO-220
TIC126B	.99	SCR 12 amp 200V TO-220
TIC216B	.99	Triac 6 amp 200V TO-220
TIC226D	1.05	Triac 8 amp 400V TO-220
TIC236D	1.45	Triac 12 amp 400V TO-220
TIC246D	1.45	Triac 16 amp 400V TO-220

Bi-Fet OP AMPS

TL064CN	2.75	Quad low power	TL081CP	49	J-FET input
TL071CP	.99	Low noise	TL082CP	99	Dual J-FET input
TL072CP	1.19	Dual low noise	TL084CN	1.95	Quad J-FET input
TL074CN	2.35	Quad low noise			

LATEST IN TECHNOLOGY

"Memory Specials" EPROM'S

C2708	1K x 8 450 ns	\$ 5.95
TMS2532	32K (4096 x 8) 450 ns	\$ 36.00
TMS2716	16K (2K x 8) 450 ns (3 power supplies) T.J. Version	\$ 18.95
C2716/TMS2516	16K (2K x 8) 450 ns (Single 5V supply — Similar to Intel version)	\$ 10.45
TMS2564	64K (8K x 8) 450 ns	\$395.00

IN CANADA VISIT OUR NEW CALGARY LOCATION

Active Electronic Sales Corp.

P.O. BOX 1035 FRAMINGHAM, MASSACHUSETTS 01701

Over-the-counter sales, 12 Mercer Rd. Natick, Mass 01760
 Behind Zayres on Rte. 9
 Telephone Orders & Enquiries (617) 879-0077

MINIMUM ORDER \$10.00 + ADD \$3.00 TO COVER POSTAGE & HANDLING

Foreign customers please remit payment on an international bank draft or international postal money order in American dollars to our Montreal address.

VISA AND MASTER CHARGE ACCEPTED

IN CANADA

||
||
||

FREE KIT Catalog

FUNCTION GENERATOR KIT \$59.95
Auto-Ranging Cap-meter kit \$79.95
contains TEST & EXPERIMENTER'S EQUIP

Phone 415-447-3433

Write or Phone for FREE CATALOG.
Average 1 minute Saturday call is 21¢.

DAGE SCIENTIFIC INSTRUMENTS
BOX 1054R LIVERMORE CA 94550

PLANS & KITS

RECORD all telephone conversations automatically. Simple circuit starts your cassette recorder whenever your phone is in use. For construction plans send \$3.00 to: **BIX**, Dept. B1 17801 Devonshire, Northridge, CA 91325

KIRLIAN camera kit, dynamite photographs, amaze friends, science fair projects, anyone can assemble. Send \$5.00 plans, \$29.95 kit. **CREATIVE PHOTOGRAPHY** 403 Grand Blvd. Half Moon Bay, CA 94019

SUBSCRIPTION TV decoder circuits. Detailed plans \$4.60, **JOE** PO Box 61, Cumberland, RI 02864

SATELLITE spherical TV antenna easy to build from local parts for \$200.00. Detailed plans \$20.00. **GEMINI T.V.**, 183 Lamport Blvd., S.I., NY 10305

BUILD your own descrambler for pay TV circuit plans \$4.50. **DECODERCO**, Box 8930, Warwick, RI 02888

SOUND EFFECTS SYNTHESIZER. Uses voltage controlled oscillator and filter plus noise to make pure tones, wind, space-out sounds. Unlimited possibilities. Super model also makes bells, gunshots. Etched, drilled, bare board with complete plans. Regular model \$6.95. Super model \$9.95 or send SASE for information. **WAVEFORM PROCESSING**, 7 Bradford Ave, Pittsburgh, PA 15205

WANTED

RECEIVING tubes, old fashioned types, unused and boxed. **TSUTOM YOSHIMURA**, C1-105, Deguchi-cho 34, Suita, Osaka 564, Japan

URGENTLY needed: 12AP4 (1803-P4) picture tubes and parts for RCA pre-war television, call collect: (203) 521-5280

WANTED: pre-1928 radios and tubes, also pre-WWII televisions. **DAVID SMITH** Rt. 2 Box 698 Rustburg, VA 24588, 804-821-2068

HIGHLY PROFITABLE ONE-MAN ELECTRONIC FACTORY

Investment unnecessary, knowledge not required. sales handled by professionals. Ideal home business. Write today for facts! **Postcard will do. Barta-RE-1, Box 248, Walnut Creek, CA 94597.**

BIOPHYSICAL MONITORING

TELEMETRY transmitter detects arterial pulses with pressure sensitive transducer placed over wrist artery. Each detected pulse transmitted as audio tone, (beep), to standard FM radio. Flashing LED provides visual indication. Completely assembled. Transducer, wrist strap, and battery included. Size: 4.4" x 2.4" x 1.2". Order model BPT-17. \$39.50 plus \$2.00 shipping. **OMNI-TEK**, Box 1318, Longmont, CO 80501

Burglar-Fire Protection

Protect Your Life, Home, Business, Auto, etc.

- Our catalog shows how. Install your own alarm systems and devices and save \$\$\$\$.
- We offer FREE write-in engineering service.

FREE CATALOG Lowest Prices on Reliable, High Quality Alarm Systems and Devices

Burdex Security Co. Box 82802-RE Lincoln, Ne. 68501

1. 5 Volt, 3 amp, Regulated Power Supply. Great for TTL Projects.....\$19.50
2. EMM 4200A, 4K Static RAMs, Ceramic A local memory boards manufacturer closed. We bought the new memory boards and took these 4200A static RAMs out. They are tested and 90-day guaranteed 100% good. Prime tested 4200A 4K RAMs \$5.50 ea.
3. Super Saver. Micro PD411, Ceramic 4K x 1 dynamic RAMs..... 8 for \$10.00.

WE BUY SURPLUS ELECTRONIC INDUSTRIAL INVENTORIES DELTRONIKS

5151 BUFORD HIGHWAY
ATLANTA, GA 30340
404-458-4690

FOR SALE

SCANNER/monitor accessories—kits and factory assembled. Free catalog. **CAPRI ELECTRONICS**, Route 1R, Canon, GA 30520

FREE catalog, IC's, semi's, parts. **CORONET ELECTRONICS**, 6494 Notre Dame W., Montreal, Que., Canada H3C 1H8. U.S. inquiries.

SAVE up to 50% on name brand test equipment. Free catalog and price list. **SALEN ELECTRONICS**, Box 82-M, Skokie, IL 60077

GOVERNMENT surplus receivers, transmitters, sniperscopes, parts, fantastic 72 page catalog 25¢. **MESHNA**, Nahant, Mass. 01908

CABLE TV converters \$39.95. Incredible 96-page catalog free. **ETCO**, Box 762, Plattsburgh, NY 12901

GIANT communications guide. Info thru 1980. Worldwide LW- AM- FM- SW- RTTY- CW- Fax-satellite-VOLMET- marine- NOAA- QSL'S- etc. \$20.00 ppd. **GCG**, 11625 W. McKinley, Fresno, CA 93711

CONCORD

COMPUTER COMPONENTS

1971 SOUTH STATE COLLEGE ANAHEIM, CA. 92806

VISA MASTERCARD (714)937-0637 MINIMUM ORDER \$10.00
CHECK OR M/D ADD \$1.50 FOR FRT
NO C.O.D. We stock and will over 12,000 types of sem. conductors. CAL RES ADD 6¢

Freq	Application	price
1.00 Mhz	6800	\$4.50
1.8432	MC14411	4.50
2.00	G-8/17Vgms	4.50
2.01	TV gms	2.90
2.4576	34702baud	5.60
4.00	4004/4040	4.50
4.194304	8038	5.60
5.00	misc CPU's	4.50
5.0688	Com 5016	4.50
10.0	misc MPU's	4.50
13.0		4.50
14.31818		4.50
18.0	8080/8008	5.60
22.1184	8080A	5.60
27.0		5.60
32.0		5.60
32.768	MSM5832	\$3.85

TRS-80
16K Memory Add-On
\$46.66 KIT
with jumpers and instructions



EPROM'S
2708 . . . \$6.75
1Kx8 450NS
8 FOR \$48.50
2716 . . . \$14.95
16K(2Kx8) 450NS
8 FOR \$142.95
2732 . . . \$59.95
32K(4096x8)

74LS Series			
74LS00	.26	74LS155	1.15
74LS02	.26	74LS158	.75
74LS03	.26	74LS160	.95
74LS04	.26	74LS161	.85
74LS08	.28	74LS162	.95
74LS09	.26	74LS163	1.60
74LS10	.26	74LS164	.65
74LS20	.26	74LS165	.65
74LS21	.28	74LS170	1.75
74LS22	.26	74LS174	.75
74LS26	.49	74LS175	.75
74LS27	.26	74LS190	.75
74LS30	.28	74LS193	.95
74LS32	.32	74LS195	.95
74LS38	.32	74LS198	.85
74LS42	.65	74LS221	1.40
74LS48	.78	74LS240	1.65
74LS51	.25	74LS241	1.65
74LS54	.35	74LS243	1.45
74LS74	.38	74LS244	1.45
74LS75	.60	74LS245	2.25
74LS83	.44	74LS253	.95
74LS85	.95	74LS257	.95
74LS86	.95	74LS258	.95
74LS90	.89	74LS259	2.85
74LS93	.89	74LS279	.44
74LS107	.45	74LS283	1.00
74LS112	.38	74LS293	1.85
74LS113	.48	74LS298	1.20
74LS122	.48	74LS366	.95
74LS123	.95	74LS367	.55
74LS126	.69	74LS368	.55
74LS138	.69	74LS373	1.39
74LS139	.44	74LS374	1.39
74LS153	.44	74LS386	.65

80-COLUMN IMPACT PRINTER
LOWEST IN PRICE—HIGHEST IN PERFORMANCE

10 Lines per minute
114x280mm 80 or 96 cols
72, 80, 88, 100 or 120 characters/line
*Not net weight

Apply for **base2** Printer for 1980, 1981, 1982 and 1983
*10 Year Warrant in U.S.A.

\$649.00
base2, inc.

APPLE II Computer
with full 48K of memory!

\$1089.00

Plexiglass cover
as shown
\$24.95

SOROC
TECHNOLOGY, INC.

IQ120 \$699.00

FACTORY WARRANTY
One year unconditional on CRT and keyboard.
All else unconditionally warranted forever.

video 100

\$129.00

Leedex Corp.
12" BLACK & WHITE
LOW COST VIDEO
MONITOR

- With the purchase of the APPLE II 48K select from the below SPECIAL PRICING!
- FULL OPTION Base2 printer...\$599.00
 - Disk II w/cont.... 535.00
 - Disk II..... 475.00
 - Firmware Card. 149.00
 - UHF to RCA Cable. 5.00
 - PASCAL Card...399.00
 - Ser. Printer Cd... 179.00
 - SupRMd..... 23.00
 - 3way I/O Select.. 33.00
 - Video 100 12".... 119.00

APPLE EXPANSION KIT
16K Memory Add-On \$44.44

MEMORY ADD-ON KIT
INCLUDES INSTRUCTIONS

QUALITY stock and custom control panels and switch plates for computers, industry, home or auto. Free flyer. **CUSTOM CONTROLS**, 4 Fernandes Drive, So. Hadley, MA 01075

CAPACITOR kits: Direct from factory beats distributor costs. Aluminum, tantalum. Send \$3.00 for info and 3 samples. **STEELE INC.**, Box 422, McKenzie, TN 38201

MICROWAVE yagi antenna for MDS complete with hardware, type N connector \$49.95. **SIGNAL ELECTRONICS**, 4027 18th Avenue, Brooklyn, NY 11218

SATELLITE VISION

We manufacture the highest spec 3-meter data & video dish in the world 41db gain! We also sell direct. Immediate delivery or you pick up. Complete details including satellite TV information, aiming service and discount schedule. Send \$1.25 for postage & handling to:

TIGER TENNAS
P. O. Box 561
Casselberry, Florida 32707



SATELLITE television information—build or buy your own earth station \$3.00 U.S.—**SATELLITE TELEVISION**, R.D. 3, Oxford, NY 13830

RF spectrum analyzer, ASL model 8622, 10 to 1,000 MHz, 3-inch CRT, manual and application notes, weight 22 lbs. Excellent condition. \$895. **M.W. ROBERTS**, 3694 East Tompkins, Las Vegas, Nevada 89121. 702-451-3517.

LASER handbook with burning, cutting, Ruby Reds, Co's, complete plans, books, and parts. Send \$4.00 to **FAMCO**, dept re, box 1902, Rochester, NH 03867

RYDER'S radio manuals pre-WWII no's 2 to 14. Best offer. **CHARLES ZENTS**, Rt 3, 1950 Rock Rd., Mansfield, OH 44903

PRINTED circuit boards: Your artwork, quick delivery, reasonable. Quantity discounts. **ATLAS CIRCUITS**, Box 974, Waynesville, NC 28786. (704) 456-3739

39.95
ADD \$2.50 FOR POSTAGE

30 CHANNEL CABLE TV CONVERTER

FREE!
UNUSUAL 96 PAGE ELECTRONIC PARTS & IDEAS CATALOG!

ORDER No. 171AE047

ENCO ROUTE 9N, PLATTSBURGH, N.Y. 12901 Tel.: (518) 561-8700.

GET MORE CB CHANNELS AND RANGE! Frequency expanders, boosters, speech processors, interference filters, how-to books, plans. Catalog \$1. **CB CITY**, Box 31500 RE, Phoenix, AZ 85046

TELEVISION downconverters and decoders \$99.95 up. Details for stamp. **GW ELECTRONICS**, POB 688, Greenwood, IN 46142

PRINTED circuit board—double sided epoxy, approximately 2.5 sq. ft., min. size 6"x12", \$5.00 plus \$2.00 postage and handling; send certified cheque or money order: **CYCLOPS ELECTRONICS LTD.**, P.O. Box 4089, Vancouver, R.C. Canada V6B-3Z6 **TEST** equipment lowest prices B&K Leader, Hitachi, Viz, Beckman, OK Tool, Blonder Tongue, RCA parts transistors others, write call collect L. I. **Electronics**, 981 Sunrise Highway, Bay shore, NY 11706. 516-666-7360

AMAZING ELECTRONIC PROJECTS and PRODUCTS: Lasers Super Powered, Burning Cutting, Rifle, Pistol. Pocket. See in Dark—Shotgun Directional Mike—Unscramblers—Giant Tesla—Stunwand—TV Disrupter—Energy Producing, Surveillance, Detection, Electrifying, Ultrasonic, CB, Auto and Mech. Devices. Hundreds More—All New Plus INFO UNLTD PARTS SERVICE Catalog \$1. Information Unlimited, Dept. R8 Box 716 Amherst, N.H. 03031.

RATIOTRANS Gertsch RTIR \$316.00 Mod. 241, equiv., RT 9R, \$466.00, ST248, equiv., ST200, \$90.00, or make offer. Call 813-867-5300.

BEARCAT scanners. Dealer prices. Big savings. Free price list. **RADIO SALES**, 3462 Oakland, Oshkosh, WI 54901

ATV Research ...specialists in CCTV and computer monitors!

Video monitors - color & B/W • TV Cameras, kits, parts & plans • Video-to-RF modulators • Free catalog. Phone or write. (402) 987-3771

13-RE Broadway Dakota City, NE. 68731

TEST equipment, new and used. Catalog \$1.00. **PTI**, Box 8756, White Bear Lake, MN 55110

VIDEO recorder and camera with zoom lens. Use for surveillance, closed circuit monitoring etc. Accessories including movies are available—both recorder and camera for only \$325.00—supply limited. **MEDIA ASSOCIATES**, 616 National Ave, Mt. View, CA 94043 415/968-2444

GET YOUR COLLEGE DEGREE IN ELECTRONICS

at home in your spare time

Now you can train for a money-making career in electronics and get your College Degree. No need to quit your job. No time wasted on subjects you don't need...or traveling to class. Learn electronic measurements, circuitry, instrumentation—everything you need to qualify for a degree in electronics. Instructors are as close as your phone...and we pay the bill. No obligation. No salesman will call. **MAIL COUPON TODAY.**

ICS Center for Degree Studies, Dept. P090
ICS College Center, Scranton, PA 18515

Yes! Rush me free facts telling how I can train for a career in electronics and get my college degree at home in spare time.

Name _____ Age _____
Address _____
City/State/Zip _____

MAKE MONEY in Electronics

LOGIC PROBE KIT \$17.95

HOME STUDY COURSE ON CASSETTE

SH-INTRODUCTION TO MICROPROCESSORS \$29.95
S2-PROGRAMMING MICROPROCESSORS \$29.95

THE COMPUTIKS ARE COMING!

MC1330AIP \$1.60
MC1350P 1.15
MC1358P 1.50
LM380N 1.75
NE565N 1.25
MC1458P .50

MSM5832 MICROPROCESSOR

REAL-TIME CLOCK/CALENDAR

GENERAL DESCRIPTION

The MSM5832 is a monolithic, metal gate CMOS integrated circuit that can store on a single 5V supply a calendar for use in microprocessor systems. The unit stores 12 bits of real-time information including day of the week, month, year, and time of day. It also includes a 10-bit binary counter and a 10-bit shift register. Other features include a 10-bit shift register, a 10-bit shift register, and a 10-bit shift register.

The MSM5832 normally operates from a 5V supply. It is a low-power device with a typical supply current of 100 microamps. It is available in an 8-pin DIP package.

\$745

MPD 117 is the low-cost solution to your power distribution problems.

The MPD 117 has a high-performance EMI filter, built-in circuit breaker, two direct and six switched outlets, illuminated "on/off" switch for switched outlets, and is built with rugged UL-approved components and housing in an all-steel chassis with convenient mounting flanges.

VOLTAJE REGULATORS

NEGATIVE POSITIVE

7905(5V)	7805(5V)	7815(15V)
7908(8V)	7806(6V)	7818(18V)
7915(15V)	7808(8V)	7824(24V)
7918(18V)	7812(12V)	

75¢

2114L

1024 x 4 Static RAM

450 ns \$4.50

200ns \$5.50

2102A

1Kx1 SaticRAM

AMD 89¢

555 Timer

27¢

Logic Probe

1980 "IC" Master

\$47.95

TASA's Solid State Micro Proximity Keyboards

Full 128 position 8 bit ASCII output plus continuous strobe parity select

Completely solid state washable sealed construction

55 micro proximity sensor positions three color coded to function

infinite to static charge or external noise

Low power requirement: 18V DC 35mA/0.65 watt built in regulator

Additional TASA Model 55 Keyboard Features

- High performance surface mounted components fully assembled
- Built-in electronic shut-off and test key feature
- Electronic hardware for full size
- Signal activation time approximately 1 millisecond "no bounce"
- Parallels output. Active pull down (select TTL compatible) (one side) open collector load
- CMOS compatible with pull-up resistor
- Continuous strobe and LED's data output for use with any computer

General Description

The TASA Model 55 and all other TASA keyboards are truly solid state touch-activated systems combining the best advantage of electronic keyboards with fully integrated single chip circuitry for a durable, reliable, and long life keyboard. The Model 55 is a 55 ASCII keyboard providing full function capability in an 80-pin package. For linear (serial) keyboard applications, the Model 55 is available in a 40-pin package. All components are hand processed and distributed through a contract manufacturer to a system integrator.

\$7500 FROM STOCK

S-100 16K ADD-ON BARE BOARD

WITH DOCUMENTATION AND DETAILED INSTRUCTOR BOOK \$28.95

8038C

VCO Waveform Generator

\$2.55

APPLE GAME PORT REMOTE PLUG-IN EXPANDER with SELECTOR!

Allows continuous connection of any three of the Apple game port options.

\$39.95

TTL

SN7400N .20	SN7482N 1.05
SN7402N .22	SN7492N .50
SN7404N .22	SN7493N .48
SN7408N .24	SN7495N .60
SN7410N .22	SN7496N .70
SN7412N .28	SN74122N .39
SN7413N .35	SN74136N .95
SN7414N .49	SN74141N .69
SN7416N .29	SN74151N .65
SN7417N .29	SN74153N .65
SN7423N .28	SN74154N 1.25
SN7425N .25	SN74155N .80
SN7430N .23	SN74157N .69
SN7437N .29	SN74160N .95
SN7438N .24	SN74161N .85
SN7440N .22	SN74163N .85
SN7442N .57	SN74164N .87
SN7443N .75	SN74165N .87
SN7445N .78	SN74174N .96
SN7451N .20	SN74175N .69
SN7454N .20	SN74180N .75
SN7474N .32	SN74181N 1.15
SN7475N .32	SN74393N 1.69

BUSINESS OPPORTUNITIES

MECHANICALLY inclined individuals desiring ownership of Small Electronics Manufacturing Business—without investment. Write: **BUSINESS-ES**, 92-R, Brighton 11th, Brooklyn, NY 11235

PROJECTION TV . . . Make \$200.00+ per evening assembling projectors . . . Easy . . . Results equal to \$2,500 projectors . . . Your total cost less than \$15.00 . . . Plans, lens & dealer's information \$14.00 . . . Illustrated information free . . . **MACROCOMGX**, Washington Crossing, PA 18977

\$700 per month earnings possible filling out income tax forms at home or tax office during tax season. We show you how. Simple, quickly learned. Details mailed free. No salesmen. Hurry. Big demand. **FEDERATED TAX**, 2015 Montrose, Chicago, IL 60618

EDUCATION & INSTRUCTION

UNIVERSITY degrees by mail! Bachelors, Masters, Ph.D's . . . Free revealing details. **COUNSELING**, Box 317-RE11, Tustin, CA 92680

SWITCHING power supplies, learn how they operate, send 2.95 plus 50¢ handling. Calif. residents add 6%. **SDG Research**, 3947 Delta, Rosemead, CA 91770

COMPUTERS/DP

COMPUTERS/DATA PROCESSING clearly explained. Cassette learning seminar presented by consultant/college instructor. Listen while driving or relaxing. Send \$19.95 (plus \$2.00 shipping) for learning module R-10. Receive first module and capsule summary of complete series plus booklet. Contains 2 hours informative and practical instruction. **CAREER ENHANCEMENT INSTITUTE**, 361 Virginia Street, Crystal Lake, IL 60014

MUSIC PUBLICATIONS

ELECTRONIC musicians: For monthly reviews, schematics, equipment modifications and more, read **DEVICE!** Now in 2nd year. \$15/12 issues (USA); sample \$1.50. **DEVICE**, Dept. RE, 1085 Broadmoor, Napa, CA 94558

DON'T FORGET



USE
YOUR
READER
SERVICE
CARD

4Kx16 MEMORY BOARD with 64 IC chips (2102) in sockets. Super deal at \$50 the complete board.

\$29 AUTO SECURITY SYSTEM alarm system \$7.00

SPACE MAN toy module PC board w/musical IC synthesizer chip. ROM has 5 programs, wierd noises blinking LEDs \$3.00 each

DATA STATION CONSOLE w/keyboard, 9 inch monitor, power supply. Logic boards broken. \$80
Send for details on this one.

Computer video monitor chassis 9 inch, 12 volt used \$40
Computer video monitor chassis 12 inch, new \$50
Hy Gain CB chassis, trunk mount \$9.00



Govt surplus walky talky, used cond. 47-55.4 mc range. Ant. \$5 each extra. With data.

\$25 ea 2 for \$45
AN/PRC-6

SEE IN THE DARKNESS

IR viewer, portable, new with choice of one lens...close up, telephoto or gen. purpose.

Requires 6 volt DC btry. \$250

Parallel ASCII-II Keyboard

Unused \$50.00

Red LED's large 10/\$1.00

Shipping extra on all merchandise

Meshna Inc., PO Box 62, E. Lynn, Mass. 01904



CIRCLE 15 ON FREE INFORMATION CARD

BULLET ELECTRONICS

PO Box 401244R
Garland TX 75040

NPN HIGH VOLTAGE 1.59

VCEO = 450 VDC IC = 3A (5A Peak)
FOR TV HORIZONTAL SECTIONS, HIGH VOLTAGE REGULATORS
REPLACES: 2N5076, 2N5077, 2N5838, 2N5665, BDY94, BU126, 2SC2121, 2N5840, 2SC1046, 2N5466, TIP556 AND MANY OTHERS

LM3046	(CA3046) Transistor Array	.75
RCA 40430	400V 6A TRIAC TO-66	.75
CA3086	RCA Transistor Array	.80
LM567	Tone Decoder	.99
CD4046	PLL CMOS	.99
LM3302	Quad Comparator	.89
2SC1849	High Freq NPN TO-92	6/1.00
MPS A20	NPN GEN PUR	8/1.00

Sound Effects Kit \$18.50

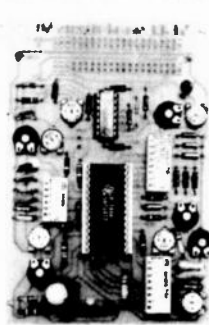

The SE-01 is a complete kit that contains all the parts to build a programmable sound effects generator. Designed around the new Texas Instruments SN7477 Sound Chip, the board provides banks of 10 DIP switches and pots to program the various combinations of the SLF Oscillator, VCO, Noise, One Shot and Envelope Controls. A Quad Op Amp IC is used to implement an Adjustable Pulse Generator, Level Comparator and Multiplex Oscillator for even more versatility. The 3 1/2" x 5" PC Board features a prototype area to allow for user added circuitry. Easily programmed to duplicate Explosions, Phaser Guns, Steam Trains, or almost an infinite number of other sounds. The unit has a low price includes all parts, assembly manual, programming charts and detailed 76477 chip specifications. It runs on a 9V battery (not included). On board 100mW amp will drive a small speaker directly, or the unit can be connected to your stereo with incredible results! (Speaker not included)

* 76477 CHIP IS INCLUDED. EXTRA CHIPS \$3.15 EACH

AY3-8910 PROGRAMMABLE SOUND GENERATOR

The AY3-8910 is a 40 pin LSI chip with three oscillators, three amplitude controls, programmable noise generator, three mixers, an envelope generator, and three D/A converters that are controlled by 8 BIT WORDS. No external pots or caps required. This chip hooked to an 8 bit microprocessor chip or Buss (8080, Z80, 6800 etc.) can be software controlled to produce almost any sound. It will play three note chords, make bangs, whistles, sirens, gunshots, explosions, bleets, whines or grunts. In addition, it has provisions to control its own memory chips with two IO ports. The chip requires +5V @ 75ma and a standard TTL clock oscillator. A truly incredible circuit.

\$14.95 w/Basic Spec Sheet (4 pages)

60 page manual with S-100 interface instructions and several programming examples, \$3.00 extra.

1/2W RESISTOR ASSORTMENT

A good mix of 5% and 10% values in both full lead and PC lead devices. All new, first quality

(Ass't) 200 pieces 2.00

7 WATT AUDIO AMP KIT

SMALL SINGLE HYBRID IC and COMPONENTS FIT ON A 2" x 3" PC BOARD (INCLUDED) RUNS ON 12VDC GREAT FOR ANY PROJECT THAT NEEDS AN INEXPENSIVE AMP LESS THAN 3% THD @ 5 WATTS COMPATIBLE WITH SE-01 SOUND KIT \$5.95

ULTRASONIC RELAY KIT

INVISIBLE BEAM WORKS LIKE A PHOTO ELECTRIC EYE. USE UP TO 25 FT. APART. COMPLETE KIT. ALL PARTS & PC BOARDS. \$21.50



THE PERFECT TRANSFORMER

117VAC primary, 12VAC secondary @ 200ma Great for all you CMOS, or low power TTL projects. PC board mount. 99¢ ea. 3/\$2.50 Size: 1.5" W x 1.25" D x 1.25" H

XAN SUPER DIGITS

.6" JUMBO LED RED
6920 COMMON CATHODE .99 7 SEGMENT
6640 COMMON ANODE

NOW A SUPER READOUT AT A SUPER BUY! These are factory fresh prime LED readouts, not seconds or rejects as sold by others. Compare our price and send for yours today, but hurry, the supply is limited! SPECIFY: COMMON ANODE OR COMMON CATHODE

NEW! MUSIC FOR YOUR EARS

Bullet's Electronic Music Maker™ Kit has a single 28 Pin Microprocessor Chip with ROM that has been programmed to play the first 16 to 10 notes of the 25 popular tunes listed below. Each tune can easily be addressed individually or played sequentially at the push of a button. The 3 chime sequences are activated at any time by separate switch closures so when used as a doorbell, one door can play songs while two others will play different chimes. The unit has a 5 watt audio Amp and will run on either 12VAC or 12VDC. Optional 117VAC transformer is available. Construction is very simple, works with any 8 or 16 ohm speaker, or horn speaker. (Not Included) Tunes can be remotely programmed using a single rotary switch, (not included), if desired.

Complete Kit \$16.95 Transformer \$1.35
(For operation on 117VAC)

Tunes: Tossador * William Tell * Hallelujah Chorus * Star Spangled Banner * Yankee Doodle * America, America * Deutschland Lied * Wedding March * Beethoven's 5th and 9th * Hell's Bells * La Vie En Rose * Star Wars Theme * Clementine * Augustine * Jingle Bells * God Save The Queen * Colonel Bogey * Marcelline * O Sole Mio * Santa Lucia * The End * Blue Danube * Brahms Lullaby * Westminster Chime * Simple Chime * Descending Octave Chime.

PARTS

TL490	Bar/Graph Driver	2.50
7805	5V 1A Regulator	.99
78M05	1/2A TO-5 Reg. 5V (Hse #)	.60
LM3911	Temp Transducer	1.10
555	Timer IC	.49
723	Voltage Reg. 14 Pin Dip	.50
7812	1A 12V Reg.	.99
2N6028	P.U.T. W/Specs	.50
IL-1	Opto Isolator W/Specs	.60

- NO C O D 'S
- SEND CHECK M O OR CHARGE CARD NO
- PHONE ORDERS ACCEPTED ON VISA AND MASTERCHARGE ONLY (214) 278-3553
- ADD 5% FOR SHIPPING
- TX RES ADD 5% STATE SALES TAX
- FOREIGN ORDERS ADD 10% (EXCEPT CANADA) (20% AIRMAIL) U.S. FUNDS ONLY

catalog free on request

A Microcomputer for everyone at a Micro Price

The **MicroAce** - a new generation of miniature computers
A COMPLETE COMPUTER for \$149.00 for 1K Kit
 Post and Packing FREE



(Add 6% Tax for Shipments inside California)

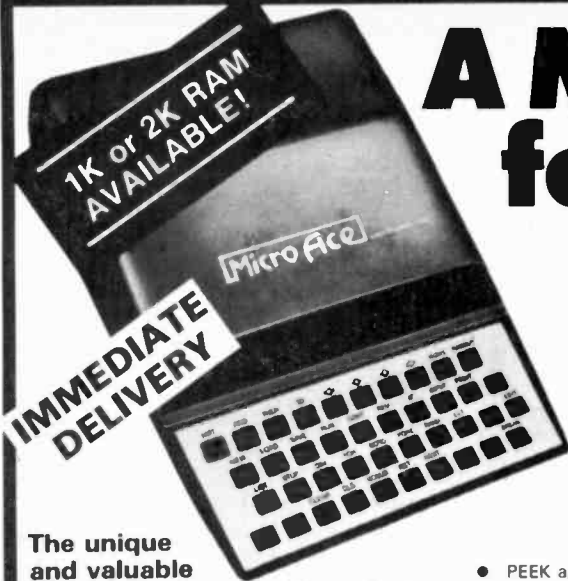

The unique and valuable components of the MicroAce

The MicroAce is not just another personal computer. Quite apart from its exceptionally low price, the MicroAce has two uniquely advanced components: the powerful BASIC interpreter, and the simple teach yourself BASIC manual.

The unique versatile BASIC interpreter offers remarkable programming advantages:

- Unique 'one-touch' key word entry: the MicroAce eliminates a great deal of tiresome typing. Key words (RUN, PRINT, LIST, etc.) have their own single-key entry.
- Unique syntax check. Only lines with correct syntax are accepted into programs. A cursor identifies errors immediately. This prevents entry of long and complicated programs with faults only discovered when you try to run them.
- Excellent string-handling capability — takes up to 26 string variables of any length. All strings can undergo all relational tests (e.g. comparison). The MicroAce also has string input — to request a line of text when necessary. Strings do not need to be dimensioned.
- Up to 26 single dimension arrays.
- FOR/NEXT loops nested up to 26.
- Variable names of any length.
- BASIC language also handles full Boolean arithmetic, conditional expressions, etc.
- Exceptionally powerful edit facilities, allows modification of existing program lines.
- Randomise function, useful for games and secret codes, as well as more serious applications
- Timer under program control.

- PEEK and POKE enable entry of machine code instructions,USR causes jump to a user's machine language sub-routine.
- High-resolution graphics with 22 standard graphic symbols.
- All characters printable in reverse under program control.
- Lines of unlimited length.

'Excellent value' indeed!

For just \$149.00 (excluding handling charge) you get everything you need to build a personal computer at home... PCB, with IC sockets for all ICs; case; leads for direct connection to a cassette recorder and television (black and white or color); everything!

Yet the MicroAce really is a complete, powerful, full-facility computer, matching or surpassing other personal computers at several times the price.

The MicroAce is programmed in BASIC, and you can use it to do quite literally anything, from playing chess to managing a business.

The MicroAce is pleasantly straightforward to assemble, using a fine-tipped soldering iron. It immediately proves what a good job you've done: connect it to your TV ... link it to the mains adaptor ... and you're ready to go.

Fewer chips, compact design, volume production-more power per Dollar!

The MicroAce owes its remarkable low price to its remarkable design: the whole system is packed on to fewer, newer, more powerful and advanced LSI chips. A single SUPER ROM, for instance, contains the BASIC interpreter, the character set, operating system, and monitor. And the MicroAce 1K byte

RAM (expandable to 2K on board) is roughly equivalent to 4K bytes in a conventional computer — typically storing 100 lines of BASIC. (Key words occupy only a single byte.)

The display shows 32 characters by 24 lines.

And Benchmark tests show that the MicroAce is faster than all other personal computers.

No other personal computer offers this unique combination of high capability and low price.

The MicroAce teach-yourself BASIC manual.

If the features of the BASIC interpreter mean little to you—don't worry. They're all explained in the specially-written book *free* with every kit! The book makes learning easy, exciting and enjoyable, and represents a complete course in BASIC programming—from first principles to complex programs. (Available separately—purchase price refunded if you buy a MicroAce later.) A hardware manual is also included with every kit.

The MicroAce Kit:
\$149.00 with 1K COMPLETE
\$169.00 with 2K

Demand for the MicroAce is very high: use the coupon to order today for the earliest possible delivery. All orders will be despatched in strict rotation. If you are unsuccessful in constructing your kit, we will repair it for a fee of \$20.00, post and packing FREE. Of course, you may return your MicroAce as received within 14 days for a full refund. We want you to be satisfied beyond all doubt — and we have no doubt that you will be.

Z80 A microprocessor chip, widely recognised as the best ever made.

Sockets for TV, cassette recorder, power supply.

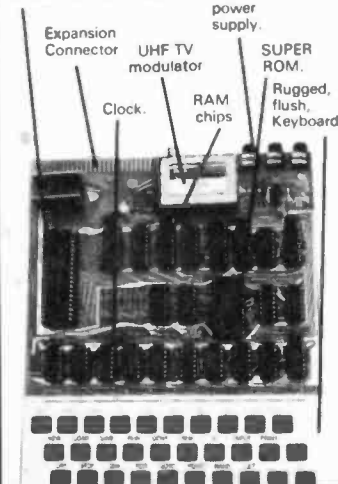

Your MicroAce kit contains...

- Printed circuit board, with IC sockets for all ICs.
- Complete components set, including all ICs—all manufactured by selected world-leading suppliers.
- New rugged keyboard, touch-sensitive, wipe-clean.
- Ready-moulded case.
- Leads and plugs for connection to domestic TV and cassette recorder. (Programs can be SAVED and LOADED on to a portable cassette recorder.)
- Mains adaptor of 600 mA at 9VDC nominal unregulated.
- FREE course in BASIC programming and user manual.

JOIN THE REVOLUTION - DON'T GET LEFT BEHIND - ORDER YOUR MICRO ACE NOW!!

Send Check, Money Order or quote your Credit Card No. to:
MicroAce 1348 East Edinger, Santa Ana, California, Zip code 92705.
 or phone (714) 547 2526 quoting your Credit Card Number.

Quantity	Description	Unit Price	TOTAL
	MicroAce Kit 1K	\$149.00	
	MicroAce Kit 2K	\$169.00	
	Manual	\$10.00	
	1K Upgrade Kit	\$29.00	
Shipments inside California add 6% TAX		TOTAL	

- Amex.
- Diners
- Check
- Money Order
- Master Charge
- Visa

Card No. _____

Exp. Date _____

Name _____

Address _____

City _____ State _____ Zip _____

100W CLASS A POWER AMP KIT

Dynamic Bias Class "A" circuit design makes this unit unique in its class. Crystal clear, 100 watts power output will satisfy the most picky fans. A perfect combination with the TA-1020 low T.I.M. stereo pre-amp.

Specifications:

- Output power: 100W RMS into 8-ohm
125W RMS into 4-ohm
- Frequency response: 10Hz - 100 KHz
- T.H.D.: less than 0.008%
- S/N ratio: better than 80dB
- Input sensitivity: 1V max.
- Power supply: $\pm 40V$ @ 5 amp

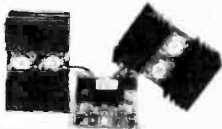

TA-1000 KIT
\$51.95
Power transformer
\$15.00 each

PROFESSIONAL 10 OCTAVE STEREO GRAPHIC EQUALIZER!!



Graphic equalizer have been used for years in sound studios and concert arenas but were too expensive to be considered for home use. Now we offer you the facility at an affordable price. This unit can extend your control of your HI-FI system by minimizing the non-linearities of the combined speaker/room system. Fantastic features as follows:

- 10 double slide controls for two channels
- Cut out rumble, surface noise and hiss
- Minimizes speaker/room non-linearities
- Frequency response from 30Hz to 16KHz
- 10 tone controls plus defeat, monitor and tape selector.
- Control range $\pm 12dB$ in 10 octaves (30Hz, 60Hz, 120Hz, 240Hz, 500Hz, 1KHz, 2KHz, 4KHz, 8KHz, 16KHz.)
- Operating voltage 117V 50/60Hz.

FACTORY ASSEMBLED UNIT, NDT A KIT
SPECIAL PRICE \$69.50 ea.

SUB MINI SIZE FET CONDENSER MICROPHONE



Specification:
Sensitivity: $-65dB \pm 3db$
FREQ. Response: 50 Hz - 8 KHz
Output Impedance: 1K ohm max.
Polar Pattern: Omni-directional
Power Supply: 1.5V - 10V D.C.
Sound Pressure Level: Max. 120dB
EM4RP \$2.50 ea. or 2 for \$4.50

NEW MARK III 9 Steps 4 Colors LED VU

Stereo level indicator kit with arc-shape display panel!!! This Mark III LED level indicator is a new design PC board with an arc-shape 4 colors LED display (change color from red, yellow, green and the peak output indicated by rose). The power range is very large, from $-30dB$ to $+5dB$. The Mark III Indicator is applicable to 1 watt - 200 watts amplifier operating voltage is 3V - 9V DC at max 400 MA. The circuit uses 10 LEDs per channel. It is very easy to connect to the amplifier. Just hook up with the speaker output!

IN KIT FORM \$18.50

2 WATT AUDIO AMP

Pre assembled units. All you need is to hook up the speaker and the volume control. Supply voltage from 9V - 15V D.C. measures only 2" x 3 1/2", making it good for portable or discrete applications. Comes with hook up data.



BUY 2 FOR
\$4.99

MARK IV 15 STEPS LED POWER LEVEL INDICATOR KIT

This new stereo level indicator kit consists of 36 4-color LED (15 per channel) to indicate the sound level output of your amplifier from $-36dB$ to $+3dB$. Comes with a well-designed silk screen printed plastic panel and has a selector switch to allow floating or gradual output indicating. Power supply is 6V - 12V D.C. with THG on board input sensitivity controls. This unit can work with any amplifier from 1W to 200W!

Kit includes 70 pcs. driver transistors, 38 pcs. matched 4-color LED, all other electronic components, PC board and front panel.



MARK IV KIT \$31.50

NEW MARK V 15 STEPS LED POWER OUTPUT INDICATOR KIT

All functions same as Mark IV but this is with heavy duty aluminum front plate and case. Can be easily slot into the front panel of your auto, truck or boat. Operates on 12V D.C.



\$41.50 EACH KIT

BATTERY POWERED FLUORESCENT LANTERN

MODEL 888 R



\$10.50 EA

FEATURES

- Circuitry: designed for operation by high efficient, high power silicon transistor which enable illumination maintain in a standard level even the battery supply drops to a certain low voltage.
- 9" 6W cool/daylight miniature fluorescent tube.
- 8 x 1.5V UM-1 (size D) dry cell battery.
- Easy sliding door for changing batteries.
- Stainless reflector with wide angle increasing lamination of the lantern.

30W + 30W STEREO HYBRID AMPLIFIER KIT

It works in 12V DC as well! Kit includes 1 PC SANYO STK-043 stereo power amp. IC LM 1458 as pre amp, all other electronic parts, PC Board, all control pots and special heat sink for hybrid. Power transformer not included. It produces ultra hi-fi output up to 60 watts (30 watts per channel) yet gives out less than 0.1% total harmonic distortion between 100MHz and 10KHz.



\$32.50 PER KIT

5W AUDIO AMP KIT

2 LM 380 with Volume Control
Power Supply 6 18V DC
ONLY \$6.00 EACH



PROFESSIONAL PANEL METERS



All meters white face with black scales. Plastic cover.

SPECIAL 0.5" LED ALARM CLOCK MODULE

ASSEMBLED! NOT A KIT!
Features: • 4 digits 0.5" LED Displays • 12 hours real time format • 24 hours alarm audio output • 59 min. countdown timer • 10 min. snooze control.



ONLY \$7.00 EACH
SPECIAL TRANSFORMER FOR CLOCK
\$2.50

DIGITAL AUTO SECURITY SYSTEM

4 DIGITS PERSONAL CODE!!

SPECIAL \$19.95



- proximity triggered
- voltage triggered
- mechanically triggered

This alarm protects you and itself! Entering protected area will set it off, sounding your car horn or siren you add. Any change in voltage will also trigger the alarm into action. If cables within passenger compartment are cut, the unit protects itself by sounding the alarm.

3-WAY PROTECTION!!

All units factory assembled and tested - Not a kit!

SANYO HYBRID AUDIO POWER AMPLIFIER I.C.



Typical ratings
Operating case temp. 85°C.
T.H.D. = 0.5% f = 20~20KHZ
Input resistance $P_o = 0.1W$ 30K Ω
Power band width 20HZ~20KHZ
Freq. response 10HZ~100KHZ
Output resistance = 8 Ω
With built in protection circuit.

PART	OUTPUT (W)	SUPPLY VOLTAGE	PRICE
STK040	10W+10W Stereo	$\pm 16V$ D.C.	\$14.50
STK041	15W+15W Stereo	$\pm 20V$ D.C.	\$18.50
STK043	20W+20W Stereo	$\pm 22V$ D.C.	\$22.50
STK054	23 WATTS	$\pm 23V$ D.C.	\$13.50
STK056	30 WATTS	$\pm 22V$ D.C.	\$18.50
STK050	50 WATTS	$\pm 35V$ D.C.	\$26.50
STK070	70 WATTS	$\pm 42V$ D.C.	\$32.50
STK1050	100 WATTS	$\pm 50V$ D.C.	\$40.50

PROFESSIONAL FM WIRELESS MICROPHONE

TEC model WEM-16 is a factory assembled FM wireless microphone powered by an AA size battery. Transmits in the range of 88-108MHz with 3 transistor circuits and an omni-directional electric condenser. Element built-in plastic tube type case, mike is 6 1/4" long. With a standard FM radio, can be heard anywhere on a one-acre lot; sound quality was judged very good.

\$16.50



FLASHER LED

Unique design combines a jumbo red LED with an IC flasher chip in one package. Operates directly from 5V-7V DC. No dropping resistor needed. Pulse rate 3Hz @ 5V 20mA.

2 for \$2.20



BIPOLAR LED RED/GREEN

2 colors in one LED, green and red, changes color when reverse voltage supply. Amazing!
2 FOR \$1.60

LCD CLOCK MODULE!

• 0.5" LCD 4 digits display • X'tal controlled circuits • O.C. powered (1.5V battery) • 12 hr. or 24 hr. display • 24 hr. alarm set • 60 min. countdown timer • On board dual back-up lights • Dual time zone display • Stop watch function.

NIC1200 (12 hr) \$24.50 EA.

NIC2400 (24 hr) \$26.50 EA.



SANYO UHF VARACTOR TUNER

For UHF CH 14~83
Tuning voltage + 1V ~ + 28V/D.C. Input impedance 75 OHM. I.F. band width 7~16 MHz. Noise figure 11.5 dB MAX. Size 2 3/4" x 1 1/4" x 3/8". Supply voltage 15V D.C. Sound I.F. = 58.0 MHz. Video I.F. = 62.5 MHz

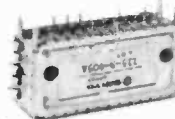

All units are brand new from Sanyo.
MODEL 115-B-405A
\$35.00 EACH

FLUORESCENT LIGHT DRIVER KIT



With Case Only
\$6.50 Per Kit

12V DC POWERED
Lights up 8 ~ 15 Watt Fluorescent Light Tubes. Ideal for camper, outdoor, auto or boat. Kit includes high voltage coil, power transistor, heat sink, all other electronic parts and PC Board, light tube not included!

SUPER FM WIRELESS MIC KIT — MARK III



FMC-105
\$11.50 PER KIT

This new designed circuit uses high FET transistors with 2 stages pre amp. Transmits FM Range (88-120 MHz) up to 2 blocks away and with the ultra sensitive condenser microphone that comes with the kit, allows you to pick up any sound within 15 ft. away! Kit includes all electronic parts, OSC coils, and P.C. Board. Power supply 9V D.C.

PRESS-A-LIGHT SELF GENERATED FLASHLIGHT

EXCLUSIVE!! \$3.95 ea
Model F-179



Never worry about battery, because it has none! Easy to carry in pocket and handy to use. Ideal for emergency light. It generates its own electricity by squeezing grip lever. Put one in your car, boat, camper or home. You may need it some time!

ELECTRONIC DUAL SPEAKER PROTECTOR



KIT FORM
\$8.75 EA.

Cut off when circuit is shorted or over load to protect your amplifier as well as your speakers. A must for OCL circuits.

"FISHER" 30 WATT STEREO AMP



Super Buy
Only \$18.50

MAIN AMP (15W x 2)
Kit includes 2 pcs. Fisher PA 301 Hybrid IC all electronic parts with PC Board. Power supply \pm 16V DC (not included). Power band with (KF 1% \pm 3dB). Voltage gain 33dB. 20Hz - 20KHz.

SPACE WAR SOUND GENERATOR BOARD



Brand new preassembled module for a toy factory. The board gives out 6 different selectable space sound with LED light effect. Sounds include UFO take-off, space gun blast, wave, and space chime. 7 LED on the board will work with the sound. Requires 9V battery to operate. Speaker not included. SPECIAL \$3.99 EACH SPEAKER \$1.25 EACH

ELECTRONIC PIEZO BEEP BUZZER



Unique surplus $\frac{3}{8}$ " Dia. piezo ceramic disc on circuit board gives a distinct high freq. buzz. Unit contains an I.C., 2 caps, 6 resistors and is already preassembled. Requires 9V battery to operate. SPECIAL 2 FOR \$2.99

2 BIT COUNTER, WARBLE PULSE ALARM BOARD

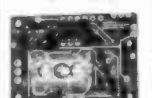

This new assembly easily converts to a counter, stop watch, warble and pulse alarm generator by adding a few components. We supply the data and typical applications. Requires 9V battery to operate. SPECIAL 2 FOR \$1.99

PUSH-BUTTON SWITCH



N/Open Contact
Color: Red, White, Blue, Green, Black
3/\$1.00
N/Close also Available
50c each
LARGE QTY. AVAILABLE

HEAVY DUTY CLIP LEADS



10 pairs — 5 colors Alligator clips on a 22" long lead. Ideal for any testing.
\$2.20/pack

BATTERIES

PK/\$10.00
2 PK/\$19.00
ILLUSTRATED
LESS COVER

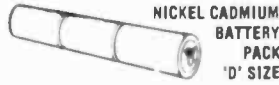

Output: 3.6 Volts @ 3.0 Amp/Hour. Consists of three each, 1.2 Volt "D" size Nickel Cadmium Cells stacked and plastic film encapsulated. Tabs are provided at each end for electrical connections. The individual cells can be cut apart if desired. Rated recharge rate is 30 mA, 14-18 hours. Size: $1\frac{1}{4}$ " dia. x 7" long. New. Shpg. Wt. each pack, 1 lb.

"C" SIZE BATTERY PACK



10 C size ni-cd battery in dng pack, gives out 12.5V D.C. 1.8 amp per hour. All fresh code, pull-out from movie cameras. Can be disconnected to use as single c cells. Hard to find \$15.00 per pack of 10 batteries

NI-CD BATTERY SALE



12V Pack 450 MZ/HR Size 3" x 1" x 2"
\$8.00 PER PACK
4 AA Pack 450 MA/HR
\$3.50 PER PACK

All above batteries are used but late date code and we guarantee to take back all bad ones for exchange.

ELECTRONIC PIN BALL MACHINE



That sounds and plays like the real thing. All units are brand new but without the case. Functions of the game include double flipper control, kicker control, 1-4 players, 3 speed ball control, tilt switch, automatic score, extra bonus cave and many more. All solid state with LED panel, no moving parts. Requires 9V battery to operate, speaker not included.

A perfect gift for yourself or friends.
SPECIAL \$8.99 EACH
SPEAKER \$1.25 EACH

ULTRASONIC SWITCH KIT



Kit includes the Ultra Sonic Transducers, 2 PC Boards for transmitter and receiver. All electronic parts and instructions. Easy to build and a lot of uses such as remote control for TV, garage door, alarm system or counter. Unit operates by 9-12 DC. \$13.50

COMPLETE TIME MODULE



0.3" digits LCD Clock Module with month and date, hour, minute and seconds. As well as stop watch function!! Battery and back up light is with the module. Size of the module is 1" dia. Ideal for use in auto panel, computer, instrument and many others! \$8.95 EACH

SOUND ACTIVATED SWITCH



All parts completed on a PC Board SCR will turn on relay, buzzer or trigger other circuit for 2 - 10 sec. (adjustable). Ideal for use as door alarm, sound controlled toys and many other projects. Supply voltage 4.5V 9V D.C. 2 for \$3.00

FM WIRELESS MIC KIT



It is not a pack of cigarettes. It is a new FM wireless mic kit! New design PC board fits into a plastic cigarette box (case included). Uses a condenser microphone to allow you to have a better response in sound pick-up. Transmits up to 350 ft.! With an LED indicator to signal the unit is on #FMM2 KIT FORM \$7.95

REGULATED DUAL VOLTAGE SUPPLY KIT

\pm 4 30V DC 800 MA adjustable, fully regulated by Fairchild 78MG and 79MG voltage regulator I.C. Kit includes all electronic parts, filter capacitors, I.C., heat sinks and P.C. board.



\$12.50 PER KIT

AA SIZE NI-CD RECHARGEABLE BATTERIES

SPECIAL SALE 4 FOR \$6.00
LIMITED QUANTITY AVAILABLE

SUB MINIATURE TOGGLE SWITCH 6 AMP 125V A.C.

SPDT	\$1.20	
SPDT MOMENTARY	\$1.40	
DPDT	\$1.80	
DPDT MOMENTARY	\$1.80	
DPDT (CENTER OFF)	\$2.20	
3PDT	\$2.20	
3PDT (CENTER OFF)	\$2.50	
4PDT	\$2.80	
4PDT (CENTER OFF)	\$3.80	

POWER SUPPLY KIT

0-30V D.C. REGULATED
Uses UA723 and ZN3055 Power TR output can be adjusted from 0-30V, 2 AMP. Complete with PC board and all electronic parts. Transformer for Power Supply, 0-30 Power Supply 2 AMP 24V x 2 \$8.50 \$10.50 each

I.C. TEST CLIPS

Same as the E-Z clips \$2.75
With 20" Long Leads
In Black and Red Colors per pair



SOUND GENERATOR I.C.

Creates almost any type of sound — gun shot, explosion, train, car crash, star war, birds, organ ext. A built-in audio amplifier provides high level output. Operates from one 9V battery, 28 pin dip; we supply the datas. \$2.90 EACH

ELECTRONIC SWITCH KIT

CONDENSER TYPE
Touch On Touch Off
uses 7473 I.C. and
12V relay
\$5.50 each



1 WATT AUDIO AMP

All parts are pre-assembled on a mini PC Board. Supply Voltage 6 9V D.C. SPECIAL PRICE \$1.95 ea.



LOW TIM DC STEREO PRE-AMP KIT TA-10 20

Incorporates brand-new D.C. design that gives a frequency response from 0Hz — 100KHz \pm 0.5dB! Added features like tone defeat and loudness control let you tailor your own frequency supplies to eliminate power fluctuation!
Specifications: • T.H.D. less than .005% • T.I.M. less than .005% • Frequency response: DC to 100KHz \pm 0.5dB • RIAA deviation: \pm 0.2dB • S/N ratio: better than 70dB • Sensitivity: Phono 2MV 47K/Aux. 100MV 100K • Output level: 1.3V • Max. output: 15V • Tone control: bass \pm 10dB @ 50Hz/treble \pm 10dB @ 15Hz • Power supply: \pm 24 D.C. @ 0.5A
Kit comes with regulated power supply, all you need is a 48V C.T. transformer @ 0.5A
ONLY \$44.50
X'former \$4.50 ea.

SOLID STATE ELECTRONIC BUZZER

Mini size 1" x $\frac{3}{4}$ " x $\frac{3}{4}$ "
Supply voltage 1.5V - 12V
Ideal for Alarm or Tone Indicator \$1.50 each



FORMULA INTERNATIONAL INC.

11/80
SHIPPING AND HANDLING CHARGES
Under \$40.00 Purchase 1.00 Over \$40.00 Purchase 2.00
Outside California (Includes Mexico & Canada) 3.00
Outside USA 5.00
Minimum Order: \$10.00/Call. Residents Add 6% Sales Tax
Phone Orders Accepted on Visa or MC ONLY. NO C.O.D.'s/Store Hours 10-7 Mon. thru Sat.
12603 CRENSHAW BLVD., HAWTHORNE, CA 90230
PHONE: (213) 972-1821 • (213) 678-5162

Send \$1.00
For Detailed
Catalogue

LONG PLAY 10 HOUR TAPE RECORDER

Top quality AC-DC cassette recorder, modified to provide 5 continuous hours of recording and playback of true fidelity, distortion-free sound on each side of cassette for a total of 10 hours. Unit has many special built-in features. TDK D-C180 cassette supplied.



ONLY \$125.00*

PHONE RECORDING ADAPTER

Record incoming and outgoing calls automatically with this all solid state unit connected to your telephone jack and tape recorder. Starts recording when phone is lifted. Stops when you hang up, making a permanent record. Easily installed. No monthly charges. FCC APPROVED



\$24.50*

VOX VOICE ACTIVATED CONTROL SWITCH

Solid state. Self contained. Excellent adjustable sensitivity. Voices or other sounds activate and control recorder. Uses recorder mike or remote mike.



2 1/4 x 1 3/4 x 3/4" \$24.95*

Phone call Adapter \$24.50*, VOX \$24.95* (* plus \$1.00 ea. shipping & handling), 10 hr. Recorder \$125.00* (* plus \$4.00 shipping & handling). California residents add tax. Mail Order, VISA, M/C, cod's okay, quantity discounts available. Money back guar. Free data.

AMC SALES, Dept. 19 9335 Lubec St., Box 928
Downey, CA 90241, Phone (213) 869-8519

CIRCLE 4 ON FREE INFORMATION CARD

SOCKETS & SEMIS SPECIAL

You come out ahead with our specials... just look at these great prices and stock up your lab!

SOLDERTAIL SOCKETS
8 pin 100/\$5.95
14, 16, & 18 pin 50/\$4.95
20 pin 40/\$4.95
24, 28 pin 30/\$4.95
40 pin 20/\$4.95

SEMICONDUCTORS

Gen purp signal diodes 50/\$2
GT5306 NPN darlington 100/\$8.95
NPN sim 2N3904 100/\$7.95
PNP sim 2N3906 100/\$8.95
4N28 opto-isol. 5/\$2
SN76477 sound IC 1/\$2.50
MA1003 12V DC clock module \$14.95

16K DYNAMIC RAM 8/\$39!

Expand memory in TRS-80-I and -II, as well as machines made by Apple, Exidy, Heath H89, newer PETs, etc. Low power, high speed (4 MHz). Add \$3 for 2 dip shunts plus TRS-80 conversion instructions.

DC ROBOT MOTOR

DC fractional horsepower motor runs on about 1 to 5V. Not a servo motor by any means, but good for experimenting with robots, toys, games, etc. 10/\$2.95

FREE CATALOGUE: Find out more about our product line.

TERMS: Cal res add tax. Allow 5% for shipping, excess refunded. Orders under \$15 add \$1 handling. VISA/Mastercard orders (\$25 min) call (415) 562-0636, 24 hrs. Please include street address for UPS delivery. Sale prices good through cover month of magazine. Other prices subject to change without notice. ©1980 is a trademark of the Tandy Corporation.

GODBOUT

GODBOUT ELECTRONICS
Bldg. 725, Oakland Airport, CA 94614

CIRCLE 8 ON FREE INFORMATION CARD

Poly Paks[®] Quality Electronics INC. For Less!

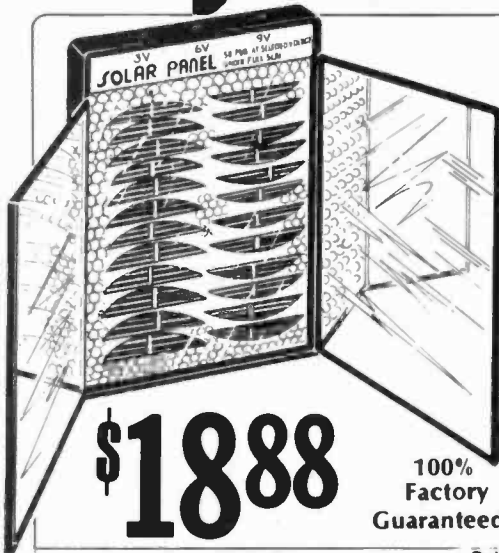

\$1888

100%
Factory
Guaranteed!

SELECTABLE VOLTAGE SOLAR PANEL UNIQUE!

- Snap-On Reflectors
- 1st Multiple Voltage Solar Power Supply!
- Excellent Battery Substitute 3, 6, or 9 VDC @ 50 mA!

Cat. No. 92CUG413

Attractive 4 1/4 x 5 1/4 x 1 1/2" black plastic case houses 24 crescent shaped silicon silvers, arranged under a plastic faceplate consisting of 100s of bubble magnifiers which enhance the light and insure optimum cell performance. In addition, two 4 x 5" reflector panels fit on either side of the case, (similar to a tanning mirror) thus providing maximum light collection and panel efficiency. Three miniature mm. jacks are top mounted and labeled 3V, 6V, and 9V. Just plug into the voltage you need! Delivers 50 mA @ all voltages, (under full sun). Excellent battery substitute in transistor radios, small motors & lamps, etc. Comes w/min plug with 18" insulated wire leads. For Less! Wt: 5 oz.

Send For Our FREE Catalog Today!

Featuring the Largest Selection and the Lowest Prices on a wide variety of quality electronic products, including: Computer Peripherals, Solar Devices, Speakers, Audio Equipment, and much much more! Take advantage of our 25 years as America's foremost supplier of discount electronics.



For Faster Service
Order By Phone
1-617-245-3828



COMPLETE COUPON AND MAIL TO-
P.O. BOX 942, RE 11 SOUTH LYNNFIELD, MA. 01940
Send me Solar Panels @ \$18.88 ea.
Plus \$3 each for Postage & Handling

NAME _____
ADDRESS _____
CITY _____
STATE _____ ZIP _____
Enclosed is CHECK, MONEY ORDER
Charge my MASTERCARD VISA
ACCT. # _____ EXP. DATE _____
 Send me your FREE catalog

CIRCLE 42 ON FREE INFORMATION CARD

FLASHING L.E.D.

Litronix FRL-4403

diffused red led with built in flashing unit
7 1/4 package
pulse rate 3Hz in 5v 20 ma.
2 for \$1.70

AXIAL ELECTROLYTIC CAPACITORS

8,000 MFD 15VDC \$1.50 ea.
3/78" long x 1-1/16" diameter
800 MFD 100 VDC \$1.00 ea.
2-1/16" long x 1" diameter
4,700 MFD 15 VDC 2 for \$1.50
2" long x 1" diameter

DUAL 50K SLIDE POT

linear taper \$1.50 each

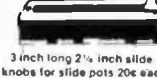

3 inch long 2 1/2 inch slide
knobs for slide pots 20c each

50K SLIDE POT 75c Each

Knobs for Slide
Pots 20c each audio taper



• 3-1/2 inch long • 2-3/4 inch slide

TRANSFORMERS

115 volt primaries



3 VOLTS @ 200MA. \$1.25
6 VOLTS @ 250MA. \$1.25
12.6 VOLTS C.T. @ 250MA. \$1.50
12.6 VOLTS C.T. @ 1 AMP. \$2.75
16.5 VOLTS @ 3AMP \$6.50

COMPUTER GRADE CAPACITORS

ALL ARE BRAND NEW

1,700 MFD. \$2.00
150 VDC. 2 1/2 in. dia. x 4 1/2 in.
3,000 MFD. \$2.00
150 VDC. 3 in. dia. x 4 1/2 in.
6,400 MFD. 60 VDC. \$2.50
1-3/8 in. dia. x 4 1/2 in.
22,000 MFD. 15 VDC. \$2.50
2 in. dia. x 2 1/2 in.
22,000 MFD. 50 VDC \$3.50
3 in. dia. x 4 1/2 in.
CLAMPS TO FIT CAPACITORS 50c ea.

POTTER BRUMFIELD 4 PDT RELAYS

• 14 pin style
• 3 amp contacts
• 24 volt d.c. or
• 120 volt a.c. coil
• Used but fully tested

\$1.50 each
specify coil voltage
LARGE QUANTITIES AVAILABLE

22/4 EDGEBOARD CONNECTOR

TIN SOLDERTAIL .156" x .200"



LARGE QUANTITIES AVAILABLE
\$1.35 each 10 for \$12.50

PHOTO - FLASH CAPACITOR

1100 MFD 330 VOLTS

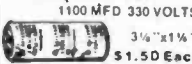

3 1/4" x 1 1/4" \$1.50 Each

3x5" OAKTRON SPEAKER

3 oz. Magnet
8 OHM Impedance

\$2.50 each
LARGE QUANTITIES AVAILABLE

ALL ELECTRONICS CORP.

905 S. Vermont Ave. SEND FOR OUR FREE CATALOG

Los Angeles, CA 90006

(213) 380-8000

Store & Warehouse Hours

9 AM - 5 PM

Monday thru Friday

Saturday

10 AM - 3 PM

TERMS

- Quantities Limited
- Min. Order \$10.00
- Add \$2.00 Shipping USA
- Calif. Res. Add 6%
- Prompt Shipping

CIRCLE 69 ON FREE INFORMATION CARD

FREE ELECTRONICS CATALOG!

Over
1,500,000
Parts in Stock!

- No minimum order
- Volume discounts
- Orders shipped same day
- 100% money-back guarantee
- Phone orders accepted

We carry semiconductors, capacitors, resistors, switches, potentiometers, transformers, hardware, and much, much more.

WRITE OR CALL TODAY for
your FREE CAL WEST catalog!
Collect Calls Accepted!

(213) 889-2209

- Mastercharge
- Visa
- BankAmericard



31320 Via Colinas, Suite 105
Westlake Village, CA 91361

CIRCLE 79 ON FREE INFORMATION CARD

Why Wait for Mail Order Delivery? Make The Shack® Your Parts Place!

Dual Gate MOSFET NEW!

159
Case
TO-72



High performance at a low price! RF amp, mixer or oscillator to 450 MHz. Low noise — ideal for the converter you're planning. Vbs: 27V. Diss.: 360 mW. 276-2045 1.59



NEW!
100% Prime
13⁹⁵

16K Dynamic RAM
Type MMS290-055/4116. For microprocessor projects. 16,384x1 bits in 16-pin DIP. Access time: 250 nanoseconds. 1 millisecond refresh. Requires +5, +12, -5VDC. TTL compatible. 276-2505 13.95

Auto-Range 3½-Digit LCD Multimeter

NEW!
99⁹⁵ • 10-Megohm Input
• Easy to Read
0.4"-High Display

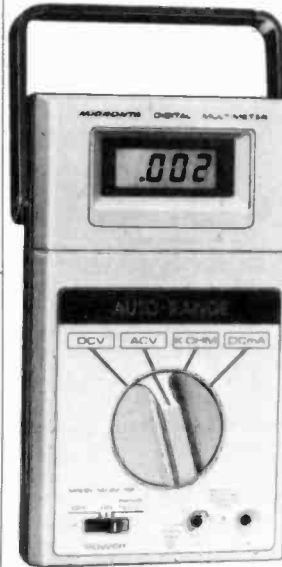

You need DCV, ACV, K-Ohms or DC mA, this Micronta® tester selects the correct range and polarity, automatically! Measures to 1000V DC, 500V AC, 200 mA DC and 2 megohms resistance. Overload protected. Range hold overrides auto-range when desired. With leads, instructions. Req. 9V battery or AC adapter. 22-196 99.95
AC Adapter. U.L. listed. 273-1431 4.95

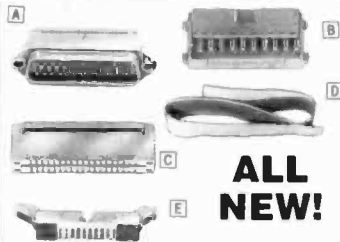

**ALL
NEW!**

Computer Connectors and Ribbon Cables

- A** 20-Pin Header with Ejectors. Mounts on perforboard with .100x.100" centers. Polarized. 276-1556 2.69
- B** 20-Pin Cable Connector. Reusable insulation-displacement type. Mates with above. 276-1557 3.49
- C** 40-Pin Card Edge Connector. Insulation-displacement type. Mounts at ends or along cable. 276-1558 5.95
- D** 20-Conductor Ribbon Cable. 5 ft. 278-770 3.95
- 40-Conductor Ribbon Cable. 5 ft. 278-771 6.95
- E** DBM 25 Connector. Insulation-displacement type, mounts on end or along cable. 276-1559 4.99

VMOS Power FETs

- A** VN10KM. Fast switching time, hi-Z input. Ideal for TTL- or CMOS-to-high current interface. 1W. TO-92 case. 276-2070 1.59
- B** VN67AF. Great for RF amps and power switching. 15W. TO-202AA case. 276-2071 2.49

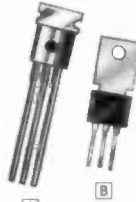

NEW!
Low As **159**

Mini DPDT Switch

Save 27% Reg. 2.19
159

Rated 6A @ 125V

Mini DPDT. Ideal for PC board mounting. Positions: On-Center Off-On. 1/2x1/2x3/4" body. Includes nut and washers for panel mounting. 275-668 Sale 1.59



350 ¼W Resistors

99⁵
Pkg. of 350



5% Tolerance. Popular values, 10 ohms to 10 megohms. Includes \$1.99-value see-through box, color-code chart and list of values. Ideal for builders, experimenters and service technicians. \$27.30 individual parts value! 271-602 Pkg. of 350/9.95

Disc Capacitors

99⁵
Pkg. of 150



50WVDC Ceramics. Fifteen .005 µF. 10 each of: 100, 220, 470 pF, .001, .002, .01, .02, .05, 1 µF. Five each of: 5, 47, 68, 330 pF plus 25 other popular values. See-thru box included. \$22.75 individual parts value! 272-601 Pkg. of 150/9.95

Digital Logic Probe

Detects one-shot, low rep rate pulses scopes may miss (up to 1.5 MHz). Detects logic levels high, low or pulsed, with a minimum detectable pulse width of 300 nanoseconds. Features an easy-to-interpret 3-LED readout, built-in over-voltage and reverse-polarity protection. Powered from circuit under test. 6 3/8x3/4x1 1/16". 22-300 26.95



Multi-Logic Compatible, 5-15VDC

26⁹⁵

- 36" Power Leads
- Illustrated Manual

10 Small-Signal Diodes

Pkg. of 10 **99¢**



- 1N914/4148**. Silicon switching diodes. 100% prime. 75 PRV. 1.0 VF. 276-1122 Pkg. of 10/99¢
- 1N34A**. General purpose germanium. 60 PRV. 1.0 VF. 100% prime. 276-1123 Pkg. of 10/99¢

Photoresistor

119

Hi Sensitivity to Yellow-Green Light (2870°K)



Cadmium sulfide photoresistor. 5 megohms in darkness to 100 ohms in bright light. 200 mW at 170V. maximum. 1/2" dia. x 1/4". 276-116 1.19

Mini DPDT Switch

Save 26%

Reg. 2.29 **169** 6A @ 125VAC



Mini DPDT. Solder lugs, ideal for panel mounting in 1/4" dia. hole. Positions: On-None-On. 1/2x1/2x1/2" body. With hardware. 275-669 Sale 1.69

Adjustable Voltage Regulators

Low As **89¢**



- A** LM723. Adjustable from 0 to 40VDC output. 14-pin DIP. 276-1740 Each 89¢
- B** LM317K. Adjustable from 1.2 to 37VDC output at 1.5 Amps. TO-3 case. 276-1777 4.99
- C** LM317T. Positive regulator. Adjustable 1.2 to 37VDC. 1.5 A. TO-220 case. 276-1778 3.99
- LM337T. Negative regulator. Adjustable -1.2 to -37VDC. 1.5 A. TO-220 case. 276-1779 3.99

3" Silicon Solar Cell

High Efficiency

999
Each



Easy to solder cell converts sunlight into electrical power. Delivers up to 0.45V at 1 Amp. Use several in series/parallel for higher voltage/current. 276-123 9.99

LOW PRICES AND NEW ITEMS EVERY DAY!
IN STOCK NOW AT OUR STORE NEAR YOU

Come In for Your FREE Copy of Our 1981 Computer Catalog RSC-4

Prices may vary at individual stores and dealers

Radio Shack®

A DIVISION OF TANDY CORPORATION • FORT WORTH, TEXAS 76102
OVER 7000 LOCATIONS IN 40 COUNTRIES

7400

SN7400N	19	SN74123N	89
SN7401N	22	SN74125N	39
SN7402N	22	SN74126N	44
SN7403N	22	SN74128N	59
SN7404N	22	SN74132N	69
SN7405N	22	SN74133N	95
SN7406N	23	SN74139N	69
SN7407N	23	SN74141N	69
SN7408N	26	SN74142N	295
SN7409N	23	SN74143N	295
SN7410N	23	SN74144N	295
SN7411N	20	SN74145N	62
SN7412N	20	SN74147N	195
SN7413N	39	SN74148N	120
SN7414N	59	SN74150N	99
SN7415N	29	SN74151N	87
SN7417N	20	SN74152N	87
SN7420N	22	SN74153N	87
SN7421N	35	SN74154N	117
SN7422N	29	SN74155N	82
SN7423N	29	SN74156N	89
SN7425N	29	SN74157N	89
SN7426N	29	SN74158N	165
SN7427N	29	SN74160N	95
SN7429N	45	SN74161N	95
SN7430N	45	SN74162N	99
SN7432N	29	SN74163N	87
SN7437N	29	SN74164N	97
SN7438N	29	SN74165N	97
SN7439N	29	SN74166N	120
SN7440N	24	SN74167N	195
SN7441N	70	SN74170N	169
SN7442N	57	SN74172N	595
SN7443N	79	SN74173N	79
SN7444N	79	SN74174N	89
SN7445N	79	SN74175N	89
SN7446N	79	SN74176N	85
SN7447N	59	SN74177N	85
SN7448N	79	SN74179N	180
SN7450N	23	SN74180N	75
SN7451N	23	SN74181N	175
SN7453N	23	SN74182N	75
SN7454N	23	SN74184N	195
SN7459N	29	SN74185N	195
SN7460N	23	SN74186N	995
SN7470N	36	SN74190N	115
SN7473N	36	SN74191N	115
SN7474N	36	SN74192N	85
SN7475N	36	SN74193N	85
SN7476N	45	SN74194N	85
SN7478N	45	SN74195N	85
SN7480N	49	SN74196N	85
SN7481N	110	SN74197N	85
SN7482N	110	SN74198N	139
SN7483N	39	SN74199N	139
SN7485N	65	SN74221N	139
SN7486N	39	SN74251N	95
SN7489N	175	SN74273N	105
SN7490N	39	SN74279N	89
SN7493N	55	SN74283N	390
SN7494N	55	SN74284N	390
SN7495N	55	SN74285N	390
SN7496N	55	SN74286N	390
SN7497N	55	SN74287N	390
SN7498N	55	SN74288N	390
SN7499N	55	SN74289N	390
SN7500N	55	SN74290N	125
SN7501N	55	SN74291N	95
SN7502N	55	SN74292N	95
SN7503N	55	SN74293N	95
SN7504N	55	SN74294N	95
SN7505N	55	SN74295N	95
SN7506N	55	SN74296N	95
SN7507N	55	SN74297N	95
SN7508N	55	SN74298N	95
SN7509N	55	SN74299N	95
SN7510N	55	SN74300N	95
SN7511N	55	SN74301N	95
SN7512N	55	SN74302N	95
SN7513N	55	SN74303N	95
SN7514N	55	SN74304N	95
SN7515N	55	SN74305N	95
SN7516N	55	SN74306N	95
SN7517N	55	SN74307N	95
SN7518N	55	SN74308N	95
SN7519N	55	SN74309N	95
SN7520N	55	SN74310N	95

74LS00

74LS00N	35	74LS164N	119
74LS01N	28	74LS165N	89
74LS02N	28	74LS166N	248
74LS03N	28	74LS168N	189
74LS04N	39	74LS169N	189
74LS05N	39	74LS170N	199
74LS06N	39	74LS173N	99
74LS09N	39	74LS174N	99
74LS10N	28	74LS175N	99
74LS11N	39	74LS181N	220
74LS12N	39	74LS182N	115
74LS13N	47	74LS181N	115
74LS14N	125	74LS182N	98
74LS15N	39	74LS193N	98
74LS20N	26	74LS194N	115
74LS21N	36	74LS195N	95
74LS22N	36	74LS196N	89
74LS26N	39	74LS197N	89
74LS27N	39	74LS221N	149
74LS28N	39	74LS240N	195
74LS30N	35	74LS241N	190
74LS32N	39	74LS242N	195
74LS37N	79	74LS243N	195
74LS38N	39	74LS244N	185
74LS40N	26	74LS245N	495
74LS42N	79	74LS247N	110
74LS47N	79	74LS248N	110
74LS48N	79	74LS249N	169
74LS51N	26	74LS281N	179
74LS54N	36	74LS253N	98
74LS55N	36	74LS257N	98
74LS57N	45	74LS258N	98
74LS57AN	59	74LS259N	295
74LS57BN	68	74LS260N	68
74LS57CN	68	74LS261N	249
74LS58N	45	74LS262N	175
74LS59N	99	74LS273N	189
74LS59SN	119	74LS275N	440
74LS58N	45	74LS279N	59
74LS59N	75	74LS283N	110
74LS59AN	75	74LS284N	129
74LS59BN	75	74LS285N	195
74LS59CN	88	74LS295N	110
74LS59DN	98	74LS296N	129
74LS59EN	45	74LS324N	175
74LS59FN	45	74LS325N	195
74LS59GN	45	74LS326N	195
74LS59HN	45	74LS327N	195
74LS59IN	45	74LS328N	195
74LS59JN	45	74LS329N	195
74LS59KN	45	74LS330N	195
74LS59LN	45	74LS331N	195
74LS59MN	45	74LS332N	195
74LS59NN	45	74LS333N	195
74LS59ON	45	74LS334N	195
74LS59PN	45	74LS335N	195
74LS59QN	45	74LS336N	195
74LS59RN	45	74LS337N	195
74LS59SN	45	74LS338N	195
74LS59TN	45	74LS339N	195
74LS59UN	45	74LS340N	195
74LS59VN	45	74LS341N	195
74LS59WN	45	74LS342N	195
74LS59XN	45	74LS343N	195
74LS59YN	45	74LS344N	195
74LS59ZN	45	74LS345N	195
74LS59AN	45	74LS346N	195
74LS59BN	45	74LS347N	195
74LS59CN	45	74LS348N	195
74LS59DN	45	74LS349N	195
74LS59EN	45	74LS350N	195
74LS59FN	45	74LS351N	195
74LS59GN	45	74LS352N	195
74LS59HN	45	74LS353N	195
74LS59IN	45	74LS354N	195
74LS59JN	45	74LS355N	195
74LS59KN	45	74LS356N	195
74LS59LN	45	74LS357N	195
74LS59MN	45	74LS358N	195
74LS59NN	45	74LS359N	195
74LS59ON	45	74LS360N	195
74LS59PN	45	74LS361N	195
74LS59QN	45	74LS362N	195
74LS59RN	45	74LS363N	195
74LS59SN	45	74LS364N	195
74LS59TN	45	74LS365N	195
74LS59UN	45	74LS366N	195
74LS59VN	45	74LS367N	195
74LS59WN	45	74LS368N	195
74LS59XN	45	74LS369N	195
74LS59YN	45	74LS370N	195
74LS59ZN	45	74LS371N	195
74LS59AN	45	74LS372N	195
74LS59BN	45	74LS373N	195
74LS59CN	45	74LS374N	195
74LS59DN	45	74LS375N	195
74LS59EN	45	74LS376N	195
74LS59FN	45	74LS377N	195
74LS59GN	45	74LS378N	195
74LS59HN	45	74LS379N	195
74LS59IN	45	74LS380N	195
74LS59JN	45	74LS381N	195
74LS59KN	45	74LS382N	195
74LS59LN	45	74LS383N	195
74LS59MN	45	74LS384N	195
74LS59NN	45	74LS385N	195
74LS59ON	45	74LS386N	195
74LS59PN	45	74LS387N	195
74LS59QN	45	74LS388N	195
74LS59RN	45	74LS389N	195
74LS59SN	45	74LS390N	195
74LS59TN	45	74LS391N	195
74LS59UN	45	74LS392N	195
74LS59VN	45	74LS393N	195
74LS59WN	45	74LS394N	195
74LS59XN	45	74LS395N	195
74LS59YN	45	74LS396N	195
74LS59ZN	45	74LS397N	195
74LS59AN	45	74LS398N	195
74LS59BN	45	74LS399N	195
74LS59CN	45	74LS400N	195

16K UPGRADE ONLY
\$49.95
SPECIAL COMPUTER

NEW!
We Now Have The
Apple Silentype
IN STOCK

With Apple Intelligent Interface Card. Reg. \$598.00
Interface Card Has All Software For Hi-Res. Graphics & Pascal Use.

BEGMAN
Digital Multimeters
MODELS TECH 300 AND TECH 310

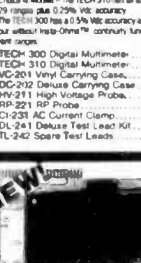

AS LOW AS **\$100.00**

NEW!
MUSIC MACHINE 9
WITH 9 VOICES!



AM/FM stereo surrounds and fills your body with sound. No earplugs. You wear it!

FLOPPY DISK DRIVES

Model LB-1 5 1/4" 40 tracks 279.00
Shugart SA400 5 1/4" 35 tracks 295.00
Shugart 800/801R 8" 5 tracks 475.00
Sanyo Shugart Compatible Model FDD-120-80 429.00
PERCSI Model 277 Dual 1195.00
WANG/SIEMENS 5 1/4" Drive 280.00
MPI 802 5 1/4" Dual 348.00
WANG/SIEMENS 282 Dual 5 1/4" 395.00
WANG/SIEMENS 82 290.00

CONTINENTAL SPECIALTIES
Model LB-3 40-channel Logic Monitor 585.00
Model LB-1 Logic Monitor 50.00
Model LB-2 Logic Monitor 147.00
MAX-100 10MHz Portable Frequency Counter 149.00
Model LP-1 Digital Logic Probe 50.00
Model LP-2 Economy Logic Probe 28.00
Model LP-3 High Speed Logic Probe 77.00
Model LP-4 Logic Probe Kit 21.95
Model LTC-1, LTC-2 Logical Analysis Kits 220/250

Proto Clips
14-Pin Clip PC-14 \$ 4.25
18-Pin Clip PC-18 \$ 4.50
24-Pin Clip PC-24 \$ 5.50
40-Pin Clip PC-40 \$19.95

Proto Boards
PB-100 14x95 14.95
PB-101 14x95 21.00
PB-102 14x95 28.00
PB-103 14x95 34.00
PB-104 14x95 40.00
PB-203A 14x95 47.00
PB-203B 14x95 54.00

ADVANCED COMPUTER PRODUCTS

Apple II. 16K or Apple II. Plus \$990
DISK SYSTEM SPECIAL
Apple II Plus w/48K Supermod Video Modulator
Disk II w/Controller Integer Based ROM Card
Reg. \$2,220.00, ACP Price \$1819.00, SAVE \$401.00

Hi-Speed Serial I/O	\$189.00	DS65 Dup-Sector	\$349.00	Integer ROM Card	\$189.00
Centronics Printer I/O	180.00	Apple Graphics Tablet	675.00	Photo Card	21.95
Accessories II Firmware	189.00	D.C. Hayes Modem II	349.95	M & R Modulator	29.95
Apple Clock	269.00	Disk II w/Controller	559.00	Sanyo Cassette	54.95
Introl X-10 System	179.95	Disk II	459.00	16K Upgrade Kit	54.95
Introl X-10 Controller	269.95	Parallell Lang System	150.00	Desktop Plan	58.00
AI Music Synthesizer	239.95	Parallell Printer Card	165.00	H. Floppy Controller	350.00
16 Ch. Analog Input	249.95	Communications Card	189.00	Hi-Speed SpeechKit	179.00
2 Ch. Analog Output	164.95	Business Software Pkg.	625.00	Romulac +	169.00
13-Key Keypad	119.95	Corvus 10 Megabyte Drive		SuperTalker	279.00
View Calc	125.00			Cashier	250.00

ATARI 800 & 400
Personal Computer System
ATARI 800 \$825.00
ATARI 400 \$449.00

ATARI 800 includes: Computer Console, BASIC Lang. Cartridge, Education System Master Cartridge, BASIC Language Programming Manual, 800 Operator's Manual w/Notebook, ATARI 410 Program Recorder, 16K RAM Module, Power Supply, TV Switch Box.

Personas	599.00	Education System Console Program	35.00	Spelling	35.00
Disk Drive	299.00	U.S. History	35.00	Basic Algebra	35.00
Printer	149.00	U.S. Government	35.00	Basic Trigonometry	35.00
Program Recorder	69.00	Supremacy Skills	35.00	Basic Business Program Console	18.00
Software - 800 Cartridge		World History	35.00	Guide to BASIC Programming	18.00
Education System Master Cartridge	289.00	Basic Accounting	35.00	BASIC Game Programs	19.00
Math BASIC	59.00	Accounting Procedures	35.00	MPI-B BASIC	110.00
Assessment Diag.	55.00	Principles of Accounting	35.00	IBM RAM Memory Module	125.00
Personal	42.00	Physics I	35.00	IBM RAM Memory Module	125.00
Math BASIC	59.00	Great Classics (English)	35.00	Reference	18.00
Super BASIC™	42.00	Business Communications	35.00	Bare Bones	18.00
Music Composer	59.00	Basic Psychology	35.00	Disk File Manager	18.00
Computer Chess	58.00	Effective Writing	35.00	Assembly Cardsets	18.00
Home Printer	50.00	Auto Mechanics	35.00	Driving Controller Pak	18.00
		Principles of Economics	35.00	Pages Computer Pak	18.00

TEXAS INSTRUMENTS
INCORPORATED
99/4 PERSONAL COMPUTER
Superior Color, Music,

FREE PREMIUMS

Free Soldering Iron with any order totalling \$25 to \$99.
Free Speaker Kit K350D6 with any order totalling \$100 to \$249.
Free Speaker System B300C10 with any order totalling \$250 or more.
Above premiums are listed in this ad.

TUBES

78% OFF Sleeves of 5. International Servicemaster Brand
Send for Complete Range of 2,000 Receiving, Industrial and Antique Types.

Type	Net Ea.	Type	Net Ea.	Type	Net Ea.
1V2	1.09	6EJ7	1.55	6X8	2.30
2AV2	1.33	6E7	1.55	6X8Z	1.72
3AV2	1.69	6E7C	1.53	6L8B	3.40
3AV3	1.69	6F7	1.28	6L8F	3.37
3B2	1.69	6G7	1.28	6M4G	3.37
3AT2B	1.65	6G7A	2.24	6U10	1.74
30B3	1.86	6GH8A	1.30	8Z10	2.56
3C3	1.86	6GJ7	1.52	6J10	2.56
30J3	1.79	ECF801	1.52	8FQ7	1.28
3HM5	1.62	6GM6	1.77	8CG7	1.28
3HA5	1.62	8GU7	1.76	12AT7	1.44
5GH8A	1.99	8HB7	1.65	EC81	1.44
6AQ5AV	1.14	8HM5	1.63	12AU7A	1.30
6GM5	2.04	8HA5	1.63	EC82	1.30
68A11	1.48	8HZ6	1.34	12AX7	1.33
68K4C	3.15	8JBS	2.02	EC83	1.33
6EL4A	3.15	8HE5	2.02	12BY7A	1.51
68L8	1.19	6JCS	2.82	12BY7	1.51
6CF8	1.19	6JCA	1.86	12CD7	1.51
6CQ3	1.58	6JEC	3.53	12HG7	2.35
6CE3	1.58	6L06	3.83	12GN7	2.35
6C03	1.58	6J56C	3.14	17JZ8	1.80

SEMIS - Japanese

Item	Net Ea.	Item	Net Ea.
1N34	.11	25C710	.25
1N60	.11	25C756	1.60
2SA473	.50	25C799	1.00
2SA509	.35	25C807	2.00
2SA564	.25	25C1014	.64
2SA634	.40	25C1018	.65
2SA673	.38	25C1096	.55
2SA678	.35	25C1168R	.27
2SA725	.30	25C1172	3.40
2SA733	.25	25C1173	.50
2SB324	.30	25C1239	2.50
2SB405	.30	25C1306	1.45
25C372	.23	25C1878	1.25
25C394	.23	25C1973	.75
25C454	.30	25D235	.70
25C458	.25	25R19GR	.55
25C509	.40	25K34	.64

For quantities under 5 add 10% to above prices.

Send for our complete range of semiconductors

SPEAKERS

SYSTEMS*

B450T10

3-WAY

• Electronic Crossover • 4" air suspension woofer • 2" mid-range • 1 1/2" tweeter • Mtg. Bkt. • Input Power: 50 watts max.



\$115.95 pr.

B300C10

2-WAY MINI

• 3" 5 oz. acoustic suspension woofer • 2" cone type tweeter • Input Power: 30 watts max. • Mtg. Bkt.



\$44.95 pr.

B400C10

2-WAY

• Variable brilliance control • Mtg. Bkt. • 4" woofer 2" tweeter



\$74.95 pr.

- * INCLUDE
- Two enclosures
- Heavy duty hook-up wires
- All mounting brackets & hardware
- Installation instructions

KITS*



DELUXE 3-WAY

Item	Qty	Net Ea.	Single Unit
K6X9T20	6" x 9"	20 oz.	\$32.00
K4X10T20	4" x 10"	20 oz.	\$32.00
K500T10	5"	10 oz.	\$28.95
K525T20	5 1/2"	20 oz.	\$28.95
K5X7T20	5" x 7"	20 oz.	\$28.95

CO-AXIAL

Item	Qty	Net Ea.	Single Unit
K400C10	4"	10 oz.	\$18.95
K525C20	5 1/2"	20 oz.	\$20.95
K6X9C20	6" x 9"	20 oz.	\$27.75
K4X10C20	4" x 10"	20 oz.	\$27.75

DUAL CONE

Item	Qty	Net Ea.	Single Unit
K350D6	3 1/2"	6 oz.	\$ 8.95
K400D10	4"	10 oz.	\$13.95
K525D10	5 1/2"	10 oz.	\$11.95
K6X9D10	6" x 9"	10 oz.	\$17.00
K4X10D10	4" x 10"	10 oz.	\$16.50

* Includes: 2 speakers, grilles, hardware, wiring, instructions

SEND FOR COMPLETE RANGE OF PROFESSIONAL/DEM & MINIATURE TYPES

COMPONENT KITS

Experimenter/Technician



\$7.95 ea.
in plastic box

Send for complete range



Service/MRO

\$24.95 ea.
in 9-drawer cabinet

TD-1S 25 in kit	Mini Axial Lead Alum. Electrolytic Capacitors 1 to 470 MFD 16 to 50 VDC	TD-1M 75 In kit	
PD-S 25 in kit	Mini Radial Lead Alum. Electrolytic Capacitors 1 to 1000 MFD 16 to 35 VDC	PD-M 75 In kit	
RM25-S 300 in kit	Carbon Fixed Resistors 1/4 watt ± 5% to 10% 10 Ohms to 10 MEGOHMS	RM25-M 1000 in kit	
RM50-S 300 in kit	Carbon Fixed Resistors 1/2 watt ± 5% to 10% 10 Ohms to 10 MEGOHMS	RM50-M 1000 in kit	

RESISTOR SPECIAL
500 1/4 watt 5 & 10% Resistors in Poly bag
\$3.95

30-watt Soldering Iron
Lightweight • Ideal for P.C. work and kits • 250° tip
A-PS30
\$2.75

STEVEN PRODUCTS

P.O. Box 698, Melville, N.Y. 11747

To order call collect
(516) 752-0060

Add for Shipping & Insurance	
to \$250.00	\$ 3.50
\$251.00 to \$500.00	5.00
\$501.00 to \$750.00	7.50
\$751.00 to \$1000.00	10.00
Over \$1000.00	12.50
C.O.D.'s extra	

• VISA • MASTER CHARGE
• CHECK • MONEY ORDER
N.Y. STATE RESIDENTS
ADD APPROPRIATE SALES TAX

CIRCLE 64 ON FREE INFORMATION CARD

CFR Associates EXCLUSIVE! SURPLUS COMPUTER BARGAINS

8 INCH FLOPPY DRIVES

Used, removed from systems. Mid. by MPI Division of Control Data. These are the CDC floppy includes schematics & I/O data. Sold "As-Is" but complete and whole! An incredible BARGAIN, easy to interface with most commercial controllers. Features "hard" sectoring.

Special Price Only **\$229.00**
Buy 3 and SAVE BIG!! **3/\$599.00**
Plus Shipping



DAISY TERMINALS featuring the DIABLO HyType Daisy Printer. This exciting terminal features: RS232C ASCII, 110-1200 Baud, KSR operation plus fantastic PLOTTER mode with bi-directional horiz. & vert! movement, 1/60"H & 1/48"V increments, 15" platen, prints at 10, 15 & 30 cps! Uses plastic printwheel and has many more exciting features. Includes operator's manual & schematics. Used & refurbished.

Now Only **\$1499.00**
Add \$30.00 for Shipping Crate. Pay Shipping On Delivery

* SELECTRIC Typewriter Terminals

USED, off-lease. Features IBM Selectric Printer RS232 I/O. Takes BCD code type elements. Whole and complete. "AS-IS" (may need some adjustments). SEE OUR QCT. 1980 ADVERTISEMENT in this magazine. 15" carriage, type ball included. 110 VAC includes power supply, I/O and printer circuits and more.

Only **\$469.00**
Add \$18.00 for Shipping Crate. Pay Shipping On Delivery
Maintenance Manuals Available. \$25.00



*IBM Trademark

GET YOUR COPY OF OUR LATEST FLYER!
Circle the Bingo Card Number or Send a 1st Class Stamp for a Free Copy.

CFR ASSOCIATES, INC.
18 Granite Street
Haverhill, Mass. 01830

617-372-8536
Phone Orders
Welcome



CIRCLE 32 ON FREE INFORMATION CARD

INTERNATIONAL ELECTRONICS UNLIMITED

IMMEDIATE DELIVERY OF QUALITY RESISTORS

CARBON FILM RESISTORS 1/4 & 1/2 watt

CARBON FILM 55s	total quantity ea	PRICING
1/watt (R, Ohm R25)	pk-10	pk-100
.095" dia x .250" long (body)	1-999	\$1.00
1/2watt (R, Ohm R50)	1000-	.10
.146" dia x .354" long (body)	5000-	.10
	10000-	.10

25 or more resistors - not individually packaged - mixed - specify any assortment of values \$1.00ea

.5	3.9	16	68	300	1.2K	5.1K	22K	91K	390K	1.6M	*6.2M
1.0	4.3	18	75	330	1.3K	5.6K	24K	100K	430K	1.8M	*6.8M
1.1	4.7	20	82	360	1.5K	6.2K	27K	110K	470K	2.0M	*7.5M
1.2	5.1	22	91	390	1.6K	6.8K	30K	120K	510K	2.2M	*8.2M
1.3	5.6	24	100	430	1.8K	7.5K	33K	130K	560K	2.4M	*9.1M
1.5	6.2	27	110	470	2.0K	8.2K	36K	150K	620K	2.7M	*10M
1.6	6.8	30	120	510	2.2K	9.1K	39K	160K	680K	3.0M	*11M
1.8	7.5	33	130	560	2.4K	10K	43K	180K	750K	3.3M	*12M
2.0	8.2	36	150	620	2.7K	11K	47K	200K	820K	3.6M	*13M
2.2	9.1	39	160	680	3.0K	12K	51K	220K	910K	3.9M	*15M
2.4	10	43	180	750	3.3K	13K	56K	240K	1.0M	3.3M	* 1/2z only
2.7	11	47	200	820	3.6K	15K	62K	270K	1.1M	4.7M	
3.0	12	51	220	910	3.9K	16K	68K	300K	1.2M	5.1M	
3.3	13	56	240	1.0K	4.3K	18K	75K	330K	1.3M	5.6M	
3.6	15	62	270	1.1K	4.7K	20K	82K	360K	1.5M		

METAL FILM RESISTORS.

METAL FILM 51s	total quantity ea	pk-10	pk-25	pk-100	pk-250
RM60 (R, Ohm R60F) 1/watt	1-999	\$25	1.00	2.00	7.50
Low temp coef - 50ppm/°C	1000-	.20	.80	1.80	7.00
.138" dia x .355" long (body)	5000-	.20	.85	1.70	6.50
color banded	10000-	.20	.80	1.55	6.00

10 or more resistors - not individually packaged - mixed - specify any assortment of values \$1.50ea

Standard 1 metal film values from 10 ohm to 475K ohm											
10.0	12.1	14.7	17.8	22.6	27.4	33.2	40.2	48.7	59.0	71.5	88.7
10.2	12.4	15.0	18.2	23.2	28.0	34.0	41.2	49.9	60.4	73.2	90.9
10.5	12.7	15.4	18.7	23.7	28.7	34.8	42.2	51.1	61.9	75.0	93.1
10.7	13.0	15.8	19.1	24.3	29.4	35.7	43.2	52.3	63.4	76.8	95.3
11.0	13.3	16.2	19.6	24.9	30.1	36.5	44.2	53.6	64.9	80.6	97.6
11.3	13.7	16.6	20.0	25.5	30.9	37.4	45.3	54.9	66.5	82.5	
11.5	14.0	16.9	20.5	26.1	31.6	38.3	46.4	56.2	68.1	84.5	
11.8	14.3	17.4	22.1	26.7	32.4	39.2	47.5	57.6	69.8	86.6	

and multiples of 10 of the above values to 475K
i.e. 10.0 100 1.0K 10.0K 100K etc (total 448)

VOLTAGE REGULATORS	10% OFF ON \$25.00	15% OFF ON \$50.00
M320T-5	Negative 5 V reg (7905)	1.19
M320T-12	Negative 12 V reg (7912)	1.19
M320T-15	Negative 15 V reg (7915)	1.19
M340T-5	Positive 5 V reg (7805)	1.19
M340T-8	Positive 8 V reg (7808)	1.19
M340T-12	Positive 12 V reg (7812)	1.19
M340T-15	Positive 15 V reg (7815)	1.19

2N3904	NPN TO-92	10/\$1.50	1N4148	400mw
--------	-----------	-----------	--------	-------

ramsey

the first name in Counters !



9 DIGITS 600 MHz \$129⁹⁵ WIRED

PRICES:

CT-90 wired, 1 year warranty	\$129.95
CT-90 Kit, 90 day parts warranty	
AC-1 AC adapter	109.95
BP-1 Nicad pack + AC Adapter/Charger	3.95
OV-1 Micro power Oven time base	12.95
External time base input	49.95
	14.95

The CT-90 is the most versatile, feature packed counter available for less than \$300.00! Advanced design features include: three selectable gate times, nine digits, gate Indicator and a unique display hold function which holds the displayed count after the input signal is removed! Also, a 10MHz TCXO time base is used which enables easy zero beat calibration checks against WWV. Optionally, an internal nicad battery pack, external time base input and Micro-power high stability crystal oven time base are available. The CT-90, performance you can count on!

SPECIFICATIONS:

Range:	20 Hz to 600 MHz
Sensitivity:	Less than 10 MV to 150 MHz Less than 50 MV to 500 MHz
Resolution:	0.1 Hz (10 MHz range) 1.0 Hz (60 MHz range) 10.0 Hz (600 MHz range)
Display:	9 digits 0.4" LED
Time base:	Standard: 10,000 mHz, 1.0 ppm 20-40°C Optional: Micro-power oven-0.1 ppm 20-40°C
Power:	8-15 VAC @ 250 ma

7 DIGITS 525 MHz \$99⁹⁵ WIRED



SPECIFICATIONS:

Range:	20 Hz to 525 MHz
Sensitivity:	Less than 50 MV to 150 MHz Less than 150 MV to 500 MHz
Resolution:	1.0 Hz (5 MHz range) 10.0 Hz (50 MHz range) 100.0 Hz (500 MHz range)
Display:	7 digits 0.4" LED
Time base:	1.0 ppm TCXO 20-40°C
Power:	12 VAC @ 250 ma

The CT-70 breaks the price barrier on lab quality frequency counters. Deluxe features such as: three frequency ranges - each with pre-amplification, dual selectable gate times, and gate activity indication make measurements a snap. The wide frequency range enables you to accurately measure signals from audio thru UHF with 1.0 ppm accuracy - that's .0001%! The CT-70 is the answer to all your measurement needs, in the field, lab or ham shack.

PRICES:

CT-70 wired, 1 year warranty	\$99.95
CT-70 Kit, 90 day parts warranty	
AC-1 AC adapter	84.95
BP-1 Nicad pack + AC adapter/charger	3.95
	12.95



7 DIGITS 500 MHz \$79⁹⁵ WIRED

PRICES:

MINI-100 wired, 1 year warranty	\$79.95
MINI-100 Kit, 90 day parts warranty	
AC-Z Ac adapter for MINI-100	59.95
BP-Z Nicad pack and AC adapter/charger	3.95
	12.95

Here's a handy, general purpose counter that provides most counter functions at an unbelievable price. The MINI-100 doesn't have the full frequency range or input impedance qualities found in higher price units, but for basic RF signal measurements, it can't be beat! Accurate measurements can be made from 1 MHz all the way up to 500 MHz with excellent sensitivity throughout the range, and the two gate times let you select the resolution desired. Add the nicad pack option and the MINI-100 makes an ideal addition to your tool box for "In-the-field" frequency checks and repairs.

SPECIFICATIONS:

Range:	1 MHz to 500 MHz
Sensitivity:	Less than 25 MV
Resolution:	100 Hz (slow gate) 1.0 KHz (fast gate)
Display:	7 digits, 0.4" LED
Time base:	2.0 ppm 20-40°C
Power:	5 VDC @ 200 ma

8 DIGITS 600 MHz \$159⁹⁵ WIRED



NEW READ RECEIVER FREQUENCY

SPECIFICATIONS:

Range:	20 Hz to 600 MHz
Sensitivity:	Less than 25 mv to 150 MHz Less than 150 mv to 600 MHz
Resolution:	1.0 Hz (60 MHz range) 10.0 Hz (600 MHz range)
Display:	8 digits 0.4" LED
Time base:	2.0 ppm 20-40°C
Power:	110 VAC or 12 VDC

The CT-50 is a versatile lab bench counter that will measure up to 600 MHz with 8 digit precision. And, one of its best features is the Receive Frequency Adapter, which turns the CT-50 into a digital readout for any receiver. The adapter is easily programmed for any receiver and a simple connection to the receiver's VFO is all that is required for use. Adding the receiver adapter in no way limits the operation of the CT-50, the adapter can be conveniently switched on or off. The CT-50, a counter that can work double duty!

PRICES:

CT-50 wired, 1 year warranty	\$159.95
CT-50 Kit, 90 day parts warranty	
RA-1, receiver adapter kit	119.95
RA-1, wired and pre-programmed (send copy of receiver schematic)	14.95
	29.95

DIGITAL MULTIMETER \$99⁹⁵ WIRED



PRICES:

DM-700 wired, 1 year warranty	\$99.95
DM-700 Kit, 90 day parts warranty	
AC-1, AC adapter	79.95
BP-3, Nicad pack + AC adapter/charger	3.95
MP-1, Probe kit	19.95
	2.95

The DM-700 offers professional quality performance at a hobbyist price. Features include: 26 different ranges and 5 functions, all arranged in a convenient, easy to use format. Measurements are displayed on a large 3 1/2 digit, 1/2 inch LED readout with automatic decimal placement, automatic polarity, overrange indication and overload protection up to 1250 volts on all ranges, making it virtually goof-proof! The DM-700 looks great, a handsome, jet black, rugged ABS case with convenient retractable tilt bail makes it an ideal addition to any shop.

SPECIFICATIONS:

DC/AC volts:	100uV to 1 KV, 5 ranges
DC/AC current:	0.1 uA to 2.0 Amps, 5 ranges
Resistance:	0.1 ohms to 20 Megohms, 6 ranges
Input impedance:	10 Megohms, DC/AC volts
Accuracy:	10.1% basic DC volts
Power:	4 °C cells

AUDIO SCALER

For high resolution audio measurements, multiplies UP in frequency.

- Great for PL tones
- Multiplies by 10 or 100
- 0.01 Hz resolution!

\$29.95 Kit \$39.95 Wired

ACCESSORIES

Telescopic whip antenna - BNC plug	\$ 7.95
High impedance probe, light loading	15.95
Low pass probe, for audio measurements	15.95
Direct probe, general purpose usage	12.95
Tilt bail, for CT 70, 90, MINI-100	3.95
Color burst calibration unit, calibrates counter against color TV signal.	14.95

COUNTER PREAMP

For measuring extremely weak signals from 10 to 1,000 MHz. Small size, powered by plug transformer-included.

- Flat 25 db gain
- BNC Connectors
- Great for sniffing RF with pick-up loop

\$34.95 Kit \$44.95 Wired

ramsey electronics, inc.

BOX 4072 • ROCHESTER, NY 14610



PHONE ORDERS
CALL 716-586-3950

TERMS

Satisfaction guaranteed - examine for 10 days if not pleased, return in original form for refund. Add 5% for shipping - insurance to a maximum of \$10. Overseas add 15%. COO add \$2. Orders under \$10, add \$1.50. NY residents, add 7% tax.

CIRCLE 39 ON FREE INFORMATION CARD

8 Instruments in 1

- Out-of-Circuit Transistor Analyzer
- Dynamic In-Circuit Transistor & Radio Tester
- Signal Generator
- Signal Tracer
- Voltmeter
- Milliammeter
- Battery Tester
- Diode Checker



Model
Transistor Analyzer 212
Factory Wired & Tested — **\$39.94**
Easy-to-Assemble Kit — **\$26.61**

Now you can pinpoint defective transistors and their circuit troubles speedily with a single, feature-packed instrument instead of a costly elaborate set-up. Performance-proven by thousands! Checks all transistor types, hi or low power, for DC current gain (beta) to 200 in 3 ranges, and leakage.

Universal test socket accepts all base configurations. Identifies NPN or PNP transistors. Dynamically tests all transistors (oscillator check) and AF, IF, RF circuits.

No external power needed. Measures DC currents to 80 ma. Complete with test leads, instruction manual and transistor listing.

Write for FREE catalog of the world-famous EMC line of test instruments.

EMC ELECTRONIC MEASUREMENTS CORP.
625 Broadway, New York, NY 10012

ELECTRONIC DESIGN LAB CA-16

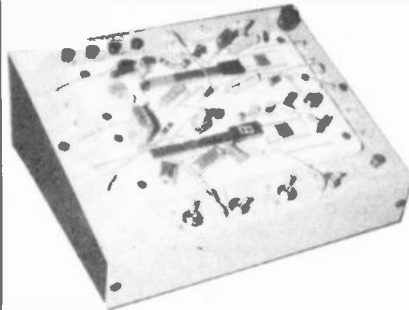

Components not included

- Variable function generator 1 Hz to 100 KHz TTL, CMOS logic levels
- Six regulated supply voltages, all short circuit proof, including 5 volt 1 amp
- Four logic indicators and debounce switches
- Two CMOS to TTL converters
- Two large breadboards, all point to point connections—no soldering

Everything is at the users finger tips. Our Design Lab will soon pay for itself in time and component savings. An excellent aid for engineers, technicians, students, and hobbyists. \$99.95.

Free brochure

CASCADE LABS

4156 South Alder Avenue
Freeland, Washington 98249 (206) 221-7483

CIRCLE 18 ON FREE INFORMATION CARD

XENON STROBE TUBE & TRIGGER COIL STROBE LIGHT SCHEMATICS INCLUDED C24081 \$1.75	LED Flasher Kit Simple to build kit with the popular 955 timer IC to demonstrate high speed pulsed LED. Complete with all parts including the PC board. 10V battery is not included. C2389 \$2.49
--	--

SOUND EFFECTS GENERATOR BASIC KIT

Now it's possible to build your own sound effects generator without spending a fortune. We supply you with the 1176477 sound chip plus an etched and drilled glass epoxy PC board with schematic and layout instructions. This board makes it simple to build a generator capable of phaser sounds, locomotive, sirens, airplanes, clocks, etc. Does not require DIP switches or other expensive/unusual components. You supply a few standard resistors, capacitors, switches, pots, speaker, 2N2222 transistor and 9V battery.

C23883 BASIC KIT CONTAINING 1176477, PC BOARD AND INSTRUCTIONS. ONLY **\$5.95**

2N2222 TRANSISTOR FOR ABOVE C23884 .39 EACH

ELECTRONIC WARNING FLASHER KITS

Warning system which gives you a choice of 3rd and 4th order filter. 1 per second rate. Complete with all parts & PC board. (Low supply)

3VDC MODEL C23207 \$6.95	6VDC MODEL C23808 \$8	12VDC MODEL C23978 \$10.95
------------------------------------	---------------------------------	--------------------------------------

ELECTRONIC STROBOSCOPE KIT

THEMATIC KIT FOR TROUBLESHOOTING OR DEMONSTRATING OPTICAL PHENOMENA. OPTICALLY STOP MOTION OF FANS, WHEELS, PULLEYS, FLYWHEELS, ETC. THE STROBOSCOPE OPERATES FROM STANDARD 117VAC and FEATURES BRIGHT XENON FLASH TUBE AND IC DESIGN. CONTINUOUSLY VARIABLE FLASH RATE FROM 100-5000RPM. THE KIT COMES WITH ALL COMPONENTS INCLUDING PC BOARD, WIRE CORD AND HOUSING. DOES NOT INCLUDE CASE. SIZE OF BOARD: 3 1/2" W x 1 3/4" L.

C24070 **\$29.95**

120 VAC Xenon Strobe Kit Complete variable rate strobe light kit. Contains all parts. PC board, wire and instructions. C23871 \$7.50	Wheel of Fortune Passive game device uses LED's to produce a "W" or "X" to give the effect of a wheel that spins and has numbers. Hand crank mounted and set apart & ready to play on a number of all parts. Includes & PC board. C23855 \$8.99
---	--

CHANEY electronics inc.

Minimum order \$5.00
Please include \$1.00 for postage
Visa, MC and COD accepted
Phone orders are welcome

P.O. BOX 27038, DENVER, CO. 80227 (303) 781-5750

Send for our free giant catalog of unique items!!!

CIRCLE 13 ON FREE INFORMATION CARD

Announcing

KITS • KITS •

NEW . . . PRE-DRILLED PCB'S FOR ALL KITS

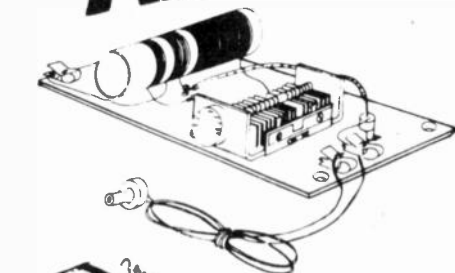

CRYSTAL RADIO KIT

A self powered radio which uses a resonant circuit and detector for AM radio reception. An ideal project for the beginner.

Model # EK80CR001 **PRICE \$8.95**

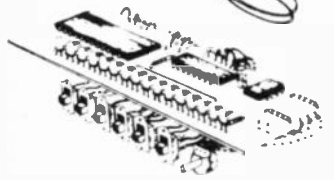

STROBE LITE KIT

Fantastic for special effects. Variable speed Xenon flash gives you a "STILL MOTION" effect. A real attention getter.

Model # EK80SL001 **PRICE \$21.95**

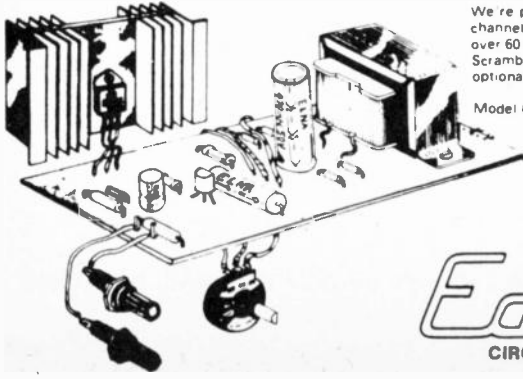

16 CHANNEL LED CHASER KIT

A very familiar sight seen at discos, department stores, and on neon signs. 16 LED's flash in sequence up down or alternate. Adaptable to 120 vac. I Extra.

Model # EK80LC016 **PRICE \$22.95**

16 CHANNEL MULTI-MODE LED CHASER KIT

We're proud to add this to our line. It's similar to our 15 channel led chaser but with many extra features. There are over 60 selectable modes. A few are Up, Down, Skip, Pulse, Scramble, Single Pulse, Multi Pulse and many more. An optional 120 vac board is available. I Extra.

Model # EK80LCM16 **PRICE \$32.95**

Edu-Kit Ltd.
P.O. Box 147
Niagara Square Station
Buffalo, N.Y., 14201

EduKit LTD.
CIRCLE 61 ON FREE INFORMATION CARD

1.5 to 24v POWER SUPPLY KIT

A variable Power Supply suitable for many digital and linear applications. Delivers up to output current of 100ma from 1.5v to 15v and 500ma from 16v to 24v.

MODEL # EK80PS024 **PRICE \$24.95**

POWER SUPPORT 120

A 120 volt power board which allows you to connect regular lamps to our LED Chaser Kits. 8 channels are supplied per board with 150 watts per channel. They can be easily interfaced for 16 channels.

Model # EK80PLC120 **PRICE \$24.95**

0-28 VOLT POWER SUPPLY KIT

A true 0 to 28 volts capable of delivering 1 amp continuous. Full wave rectification, filtering and capacitance multiplication provides a clean dc source for sensitive audio and digital work. An ideal supply for the experimenter.

Model # EK80PS028 **PRICE \$39.95**

5 WATT IC AUDIO AMPLIFIER KIT

A general purpose 5 watt amplifier with Thermal Overload and Short Circuit Protection. Because of its low operating voltage and high power output, it allows the user to use it as an add on amplifier for car stereo.

Specifications
Frequency Response 40Hz to 15KHz B1-3dB
Power Output 5 watts at 4ohms
7 watts at 2ohms
Distortion 5% at 7 watts at 2ohms
Load Impedence 2 to 16ohms
V Supply 12 to 15vdc

Model # EK80A005 **PRICE \$19.95**

National Semiconductor Clock Modules

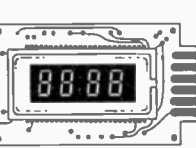

12VDC AUTOMOTIVE/INSTRUMENT CLOCK

APPLICATIONS:

- In-dash autoclocks
- After-market auto/RV clocks
- Aircraft-marine clocks
- 12VDC oper. Instru.
- Portable/battery powered instruments

Features: Bright 0.3" green display. Internal crystal timebase ± 0.5 sec./day accur. Auto. display brightness control logic. Display color filterable to blue, blue-green, green & yellow. Complete—just add switches and lens.

MA1003 Module \$16.95

MA1023 7" Low Cost Digital LED Clock Module 8.95
MA1026 7" Dig. LED Alarm Clock/Thermometer 18.95
MA5036 3" Low Cost Digital LED Clock/Timer 6.95
MA1002 5" LED Display Dig. Clock & Xformer 9.95



National Semiconductor RAM SALE

MM5290J-2 (MK4116/UPD418) . . . \$6.95 each
 16K DYNAMIC RAM (150NS)
 (8 EACH \$49.95) (100 EACH \$650.00/lot)

MM5298J-3A \$3.25 each
 8K DYNAMIC RAM (LOW HALF OF MM5290J) 200NS
 (8 EACH \$23.95) (100 EACH \$250.00/lot)

MM2114-3 \$5.95 each
 4K STATIC RAM (300NS)
 (8 EACH \$43.95) (100 EACH \$450.00/lot)

MM2114L-3 \$6.25 each
 4K STATIC RAM (LOW POWER 300NS)
 (8 EACH \$44.95) (100 EACH \$475.00/lot)

EPROM Erasing Lamp



- Erases 2708, 2716, 1702A, 5203Q, 5204Q, etc.
- Erases up to 4 chips within 20 minutes.
- Maintains constant exposure distance of one inch.
- Special conductive foam liner eliminates static build-up.
- Built-in safety lock to prevent UV exposure.
- Compact — only 7-5/8" x 2-7/8" x 2"
- Complete with holding tray for 4 chips.

UVS-11E \$79.50

Jumbo 6-Digit Clock Kit

- Four .630" ht. and two .300" ht. common anode displays
- Uses MM5314 clock chip
- Switches for hours, minutes and hold functions
- Hours easily viewable to 30 feet
- Simulated walnut case
- 115VAC operation
- 12 or 24 hour operation
- Includes all components, case and wall transformer
- Size: 6 3/4" x 3-1/8" x 1 3/4"

JE747 \$29.95

6-Digit Clock Kit

- Bright .300 ht. comm. cathode display
- Uses MM5314 clock chip
- Switches for hours, minutes and hold modes
- Hrs. easily viewable to 20 ft.
- Simulated walnut case
- 115 VAC operation
- 12 or 24 hr. operation
- Incl. all components, case & wall transformer
- Size: 6 3/4" x 3-1/8" x 1 3/4"

JE701 \$19.95

Regulated Power Supply

Uses LM309K. Heat sink provided. PC board construction. Provides a solid 1 amp @ 5 volts. Can supply up to ±5V, ±9V and ±12V with JE205 Adapter. Includes components, hardware and instructions. Size: 3 1/2" x 5" x 2 1/4"

JE200 \$14.95



ADAPTER BOARD
 —Adapts to JE200—
 ±5V, ±9V and ±12V

DC/DC converter with +5V input. Toroidal hi-speed switching XMFR. Short circuit protection. PC board construction. Piggy-back to JE 200 board. Size: 3 1/2" x 2" x 9/16"

JE205 \$12.95

MICROPROCESSOR COMPONENTS

8080A/8080A SUPPORT DEVICES

INS4882A	CPU	6.30
DP8212	8-Bit Input/Output	3.25
DP8214	Priority Interrupt Control	1.50
DP8216	8-Directional Bus Driver	1.50
DP8218	Clock Generator/Driver	3.00
DP8225	Bus Driver	3.00
DP8228	System Controller/Bus Driver	4.00
DP8238	System Controller	6.00
INS4243	I/O Expander for 48 Series	9.00
INS4250	Asynchronous Comm. Element	16.00
DP8811	For Common I/O (USART)	7.00
DP8813	Prog. Interval Timer	14.00
DP8815	Prog. Paraphase I/O (PPI)	14.00
DP8817	Prog. DMA Controller	14.00
DP8819	Prog. Interrupt Control	14.00
DP8827	Prog. CRT Controller	49.00
DP8829	Prog. Keyboard/Display Interface	18.00
DP8830	Octal Bus Receiver	6.00
DP8832	System Timing Element	6.00
DP8834	8-Bit Bi-Directional Receiver	3.00
DP8837	8-Bit Bi-Directional Receiver	3.00
DP8838	8-Bit Bi-Directional Receiver	3.00

8080/8800 SUPPORT DEVICES

MC6680	MPU	14.00
MC6880CP	MPU with Clock and RAM	18.00
MC6880AP	128-Byte Static RAM	1.00
MC6821	Peripheral Inter. Adapter (MC6820)	7.43
MC6820	Priority Interrupt Controller	10.00
MC6818	8080/88-Bit DMA (MC6818A)	10.00
MC6816	Asynchronous Comm. Adapter	6.00
MC6812	Synchronous Serial Data Adapter	10.00
MC6810	8-Bit/10-Bit Digital MUX/DEM	10.00
MC6802	8080/88 Microcontroller	10.00
MC6800A	Quad 3-State Bus Trans. (MC6728)	2.28

MICROPROCESSOR CHIPS

Z80 (80C)	CPU (MK3800A)	13.50
Z80A (780-1)	CPU (MK3800A)	15.00
CDP1802	CPU	20.00
3850	MPU	35.00
LD4201ADC	CPU—8-Bit Slice (Com. Temp. Grade)	19.00
MC5802	MPU w/Clock (8K Bytes Memory)	11.00
INS4201A-4	MPU—8-Bit (84Hz)	16.00
INS4201A-6	CPU—Sp. Chip 8-Bit (128 Bytes RAM)	19.00
INS4201A-4	CPU (256 Byte RAM)	24.00
INS4201A-6	CPU (64 Bytes RAM)	24.00
PM08	CPU	19.00
INS4200	CPU—16-Bit	29.00
TM5900JL	MPU—16-Bit	39.00

SHIFT REGISTERS

MM5820H	Dual 20-Bit Dynamic	.50
MM5821H	Dual 16-Bit Dynamic	.50
MM5821H	Dual 16-Bit Static	.50
MM5820H	Quad 8-Bit Accumulator	.50
MM5802	256-Bit Dynamic (MC6818A)	14.00
MM5803	1024-Bit Dynamic/Accumulator	1.00
MM5804H	512-Bit 1511 Dynamic	.80
MM5803H	Octal 80-Bit	5.00
MM5804H	Octal 80-Bit	5.00
256V (MOMA)	1024-Bit Dynamic	3.00
3518H	Hex 32-Bit Static	4.00
3520V	Dual 132-Bit Static	2.00
3521V	512-Bit Dynamic	.99
3522V	1024-Bit Dynamic	2.00
3523V	Dual 256-Bit Static	2.00
3524V	Quad 256-Bit Static	4.00
3525V	Quad 256-Bit Static	2.00
3526V	Quad 256-Bit Static	2.00
3518PC	Fifo (Dual 80)	6.00

DATA ACQUISITION

AF100-1CN	Universal Active Filter 2.5%	5.00
AF121-1CJ	Touch Tone Low Pass Filter	18.00
AF122-1CJ	Touch Tone Low Pass Filter	18.00
LM324H	Super Gain Op. Amp.	1.00
LM33Z	Constant Current Source	1.30
LM33Z	Temperature Transducer	1.10
JFET1	JFET in Op. Amp.	1.10
LF398N	Sample & Hold Amplifier	1.10
LM399H	Temp. Comp. Prec. Ref. (3ppm/C)	4.00
AD620BLCN	8-Bit A/D Converter (1.5Bit)	1.00
DAC2008LCN	8-Bit D/A Converter (0.7% Lin.)	2.25

DATA ACQUISITION (CONTINUED)

ADC0809CCN	8-Bit A/D Converter (8-Ch. Multi.)	5.00
DAC1208LCN	8-Bit D/A Conv. Micro. Comp. (0.5% Lin.)	12.00
DAC1028LCN	10-Bit D/A Conv. Micro. Comp. (0.20% Lin.)	8.00
DAC1028LCN	10-Bit D/A Converter (0.5% Lin.)	8.00
DAC1028LCN	10-Bit D/A Converter (0.20% Lin.)	11.00
CD4051N	8-Channel Multiplexer	1.00
AY-1013	38K BAUD UART	5.00

RAM'S

1101	256x1 Static	1.49
1103	1024x1 Dynamic	3.00
2101 (0101)	256x1 Static	3.00
2102	1024x1 Static	1.75
2103	4096x1 Static	3.00
2111 (0111)	256x1 Static	3.00
2112	256x1 Static MOS	4.00
2116	1024x1 Static 4096x1 Low Power	6.00
2116-3	1024x1 Static 300ns	7.00
2114-1-3	1024x1 Static 300ns Low Power	7.00
2114-1-3	38.5Kbit Dynamic 500ns (House marked)	9.00
MM2147J	4096x1 Fast 70ns	19.00
5101	256x1 Static	2.00
MM5811	1024x1 Dynamic Fully Coded	5.00
MM5812	2Kx1 Dynamic	.25
MM5820/207	4096x1 Dynamic	.25
MM5821/21	16Kx1 Dynamic (UPD418)	6.00
MM5821A-3A	8K Dyn. 200ns (lower of MM5820)	1.00
7489	16K Static	4.00
UPD418/1A/1024	8K Dynamic 16-pin	4.00
TM5404A-8N/L	1024x1 Static	4.00
TM5405	1024x1 Static	4.00

PROMS/EPROMS

1702A	2K UV Erasable PROM	5.00
2708	2K EPROM	5.00
TM5273A	16K EPROM (+5V, +5V, +12V)	17.00
2716 (161)	16K EPROM (Simple +5V)	11.00
2721 (161)	20K EPROM	49.00
2708	1K EPROM (60ns) (Simple +5V)	7.00
5203	2048 PROM	14.00
5202 (M0180)	2048 PROM (Open Collector)	4.00
62611A	4096 Bipolar PROM	25.00
62521 (H5308)	2Kx1 Tri-State Buffer PROM	4.00
62518	8K PROM	29.00

ROM'S

1813 (2401)	Character Generator (Upper Case)	9.00
2513 (2021)	Character Generator (Lower Case)	9.00
3516N	Character Generator	9.00
MM5202A	2048 Bit Read Only Memory	1.00

NMOS READ ONLY MEMORIES

MM5811P	128x16 ASCII Smitted w/Driver	13.00
MM5810P	128x16 ASCII Smitted w/Driver	13.00
MM5870P	128x16 Alpha Control Char. Gen.	13.00

MICROPROCESSOR MANUALS

M-280	User Manual	7.50
MC-CP1802	User Manual	7.50
MC-3800	User Manual	7.50

SPECIAL FUNCTION

D8402CN	Dual MOS Clock Driver (M/Z)	2.50
D8405CN	Dual MOS Clock Driver (M/Z)	1.00
INS1171N-1	Floppy Disk Controller	30.00
INS1263N	Communication Chip	10.00
MM5817N	Microprocessor Real Time Clock	10.00
MM5811N	Microprocessor Compatible Clock	11.00
COM49N	Microcontroller with 8-Digit RAM and Direct LED Drive	6.00
COM69N	Microcontroller with 8-Digit RAM & Direct LED Drive w/8-Bit Bus Int.	7.00
COM49N	38-Seg. VAC. Fluor. Driver (20-pin pkg.)	1.00

TELEPHONE/KEYBOARD CHIPS

AY-1010	Push Button Telephone Dialer	14.00
AY-1011	Rotary Dialer	14.00
AY-1012	CMOS Clock Generator	4.00
AY-1013	Keyboard Encoder (86 keys)	11.00
AY-1014	Keyboard Encoder (16 keys)	7.00
AY-1015	Keyboard Encoder (16 keys)	7.00
AY-1016	Keyboard Encoder (26 keys)	7.00
AY-1017	Push Button Pulse Dialer	7.00
MM5100N	16-Key Serial Keyboard Encoder	8.00

COMPUTER CUBE™



COMPUTER CRT MONITDR & ACCESSORY CASE

- One piece heavy duty molded construction
- Painted to match Apple II & III (Lt. beige, textured finish)
- Smoke colored acrylic front cover (removable)
- Built-in shelf holds CRT and allows room for 2 Apple II disk drives below shelf
- Three 2 1/2" holes provided in bottom of case for addition of fan if needed
- Fan hole positioned above Apple motherboard location.
- Hookup cables can be run through other 2 holes.
- Case accommodates most 8" and Color uncase CRT monitors made by Motorola, Ball Bros., Zenith, Sanyo, Panasonic, Hitachi, etc. or any monitor that will fit into 10 3/8" H x 14 3/4" W x 1 3/4" D space.
- Size: 15" x 15" x 15" O.D., 14 3/4" H x 14 3/4" W x 1 3/4" I.D.
- Weight: approximately 12 lbs.
- CRT monitor fan and disk drives not included.

CUBE-1 \$99.95

TRS-80 16K Conversion Kit

Expand your 4K TRS-80 System to 16K.
 Kit comes complete with:

- 8 each MM5290-2 (UPD418) (16K Dynamic Rams) (200NS or less)
- Documentation for conversion

TRS-16K \$49.95

JE610 ASCII Encoded Keyboard Kit

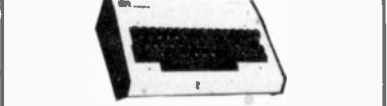

The JE610 ASCII Keyboard Kit can be interfaced into most any computer system. The kit comes complete with an industrial grade keyboard switch assembly (82-keys), IC's, sockets, connector, electronic components and a double-sided printed wiring board. The keyboard assembly requires +5V @ 150mA and -12V @ 10 mA for operation. Features: 80 keys generate the 128 characters, upper and lower case ASCII set. Fully buffered. Two user-definable keys provided for custom applications. Caps lock for upper-case only alpha characters. Utilizes a 2376 (40-pin) encoder read-only memory chip. Outputs directly compatible with TTL/DTL or MOS logic arrays. Easy interfacing with a 16-pin dip or 18-pin edge connector.

JE610 (Case not included) \$79.95

K62 (Keyboard only) \$34.95

JE610 ASCII Encoded Keyboard Kit

Compact desk-top enclosure: Color-coordinated designer's case with light tan aluminum panels and molded end pieces in mocha brown. Includes mounting hardware. Size: 3 1/2" H x 14 3/4" W x 8 3/4" D.

DTE-AK \$49.95

SPECIAL: JE610/DTE-AK PURCHASED TOGETHER (Value \$129.90) \$124.95

JE600 Hexadecimal Encoder Kit

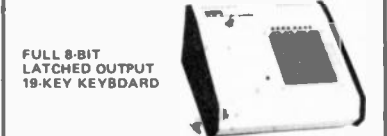

The JE600 Encoder Keyboard Kit provides two separate hexadecimal digits produced from sequential key entries to allow direct programming for 8-bit microprocessor or 8-bit memory circuits. Three additional keys are provided for user operations with one having a bistable output available. The outputs are latched and monitored with 9 LED readouts. Also included is a key entry strobe. Features: Full 8-bit latched output for microprocessor use. Three user-definable keys with one being bistable output. Debounce circuit provided for all 19 keys. 9 LED readouts to verify entries. Easy interfacing with standard 16-pin IC connector. Only +5VDC required for operation.

JE600 (Case not included) \$59.95

K19 (Keyboard only) \$14.95

JE600 Hexadecimal Keyboard Kit

Compact desk-top enclosure: Color-coordinated designer's case with light tan aluminum panels and molded end pieces in mocha brown. Includes mounting hardware. Size: 3 1/2" H x 8 3/4" W x 8 3/4" D.

DTE-HK \$44.95

SPECIAL: JE600/DTE-HK PURCHASED TOGETHER (Value \$104.90) \$99.95

DESIGNER'S SERIES Blank Desk-Top Electronic Enclosures

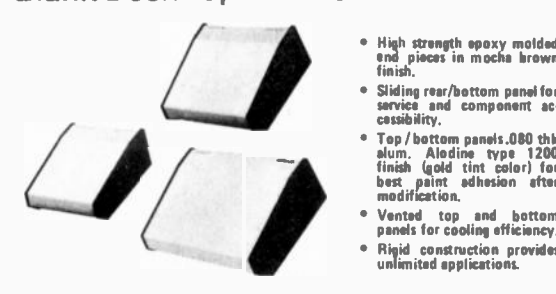

CONSTRUCTION:
 The "DTE" Blank Desk Top Electronic Enclosures are designed to blend and complement today's modern computer equipment and can be used in both industrial and home. The end pieces are precision molded with an internal slot (all around) to accept both top and bottom panels. The panels are then fastened to 1/4" thick tabs inside the end pieces to provide maximum rigidity to the enclosure. For ease of equipment servicing, the rear/bottom panel slides back on dotted tracks while the rest of the enclosure remains intact. Different panel widths may be used while maintaining a common profile outline. The molded end pieces can also be painted to match any panel color scheme.

Enclosure Model No.	Panel Width	PRICE
DTE-8	8.00"	\$29.95
DTE-11	10.65"	\$32.95
DTE-14	14.00"	\$34.95

\$10.00 Min. Order — U.S. Funds Only
 Calif. Residents Add 6% Sales Tax
 Postage — Add 5% plus \$1 Insurance (if desired)

Spec Sheets — 25¢
 1981 Catalog Available — Send 41¢ stamp

Jameco ELECTRONICS
 PHONE ORDERS WELCOME
 (415) 592-8097

MAIL ORDER ELECTRONICS — WORLDWIDE
 1355 SHOREWAY ROAD, BELMONT, CA 94002
 PRICES SUBJECT TO CHANGE

7400	
SN7400N	.25
SN7401N	.25
SN7402N	.25
SN7403N	.25
SN7404N	.25
SN7405N	.25
SN7406N	.25
SN7407N	.25
SN7408N	.25
SN7409N	.25
SN7410N	.25
SN7411N	.25
SN7412N	.25
SN7413N	.40
SN7414N	.40
SN7416N	.25
SN7417N	.25
SN7418N	.25
SN7419N	.25
SN7420N	.25
SN7421N	.25
SN7422N	.45
SN7423N	.45
SN7424N	.25
SN7425N	.25
SN7426N	.25
SN7427N	.25
SN7428N	.25
SN7429N	.25
SN7430N	.25
SN7431N	.25
SN7432N	.25
SN7433N	.25
SN7434N	.25
SN7435N	.25
SN7436N	.25
SN7437N	.25
SN7438N	.25
SN7439N	.25
SN7440N	.25
SN7441N	.25
SN7442N	.25
SN7443N	.25
SN7444N	.25
SN7445N	.25
SN7446N	.25
SN7447N	.25
SN7448N	.25
SN7449N	.25
SN7450N	.25
SN7451N	.25
SN7452N	.25
SN7453N	.25
SN7454N	.25
SN7455N	.25
SN7456N	.25
SN7457N	.25
SN7458N	.25
SN7459N	.25
SN7460N	.25
SN7461N	.25
SN7462N	.25
SN7463N	.25
SN7464N	.25
SN7465N	.25
SN7466N	.25
SN7467N	.25
SN7468N	.25
SN7469N	.25
SN7470N	.25

J608 PROGRAMMER

2708 EPROM PROGRAMMER



3 separate Display Registers: 8128 or 16K Hex Bytes, 1018 (8" Q") for Address Register and 8112 for Data Memory Register. The Data Memory Register displays the contents from the EPROM. The Data Memory Register is development of microprocessor systems by means of a ribbon cable from the program point test socket to the EPROM socket on the microprocessor board.

Repeat check-verify of programmed data changes.

Use only static data from a master to RAM's or write into RAM's with keyboard control.

Always connect programming connections (pin and data) at any address location.

Based on the EPROM Programmer operating at 1.5V Hex Bytes, Keyboard Programmable Programmer Board assembly with 1 power supply and a LED/OT Buffer Panel Board assembly. The Test Register Board is available for Power requirements: 115VAC, 60Hz, 800mA.

Compact desk-top unit with a standard 40-pin connector, one with light test socket and test points in a standard form. Size 3 1/2" x 11 1/2" x 9 1/2" Height 8 1/2" Depth.

The J608 EPROM Programmer is a completely self contained unit which is independent of computer control and requires no additional systems for its operation. The EPROM can be programmed from the Hexadecimal Keyboard or from a pre-programmed EPROM. The J608 Programmer can emulate a program EPROM by the use of its internal RAM control. This will allow the user to test or pre-program a program for a system prior to programming the actual EPROM. The J608 Programmer contains a Program Buffer Board with 25 IC's and including power supplies of -5V -5V +12V and +26V. The Hexadecimal Keyboard and LED Test Socket Panel Board are separate assemblies within the system.

J608 KIT \$399.95
J608A Assembled and tested \$499.95

DISCRETE LEDs

XC556R 200' red	5/51	MV50 .088' red	6/51	XCL11R .100' red	5/51
XC556G 200' green	4/51	XC209R .125' red	5/51	XCL11R .100' green	4/51
XC556Y 200' yellow	4/51	XC209G .125' green	4/51	XCL11Y .100' yellow	4/51
XC556C 200' clear	4/51	XC209Y .125' yellow	4/51	XCL11C .100' clear	4/51
XC22R 200' red	5/51	XC526R .185' red	4/51	INFR-RED LED Flat	
XC22G 200' green	4/51	XC526G .185' green	4/51	1/4" x 1/4" x 1/8" Flat	
XC22Y 200' yellow	4/51	XC22Y .185' yellow	4/51	IRL - 5/51	
MV108 .170' red	4/51	XC526C .185' clear	4/51		

DISPLAY LEADS

C.A. - Common Anode			C.C. - Common Cathode		
Type	Polarity	Ht Price	Type	Polarity	Ht Price
MAN 1	C.A.-red	.270 2.95	DL71	C.A.-red ± 1	.630 1.25
MAN 2	5x7 D.M.-red	.300 4.26	DL76	C.C.-red ± 1	.630 1.49
MAN 3	C.C.-red	.125 .25	DL77	C.C.-red	.600 1.49
MAN 4	C.C.-green	.300 1.25	OL50	C.C.-red	.600 1.49
MAN 54	C.C.-green	.300 1.25	DL33B	C.C.-red	.110 .35
MAN 71	C.A.-red	.300 .75	FN270	C.C.	.250 .69
MAN 72	C.A.-red	.300 .75	FN286	C.C. ± 1	.387 .75
MAN 74	C.C.-red	.300 1.25	DL78	C.C.-red	.600 1.49
MAN 82	C.A.-yellow	.300 .49	FN203	C.C.	.500 .99
MAN 84	C.C.-yellow	.300 .99	FN207	C.A. (FN2050)	.500 .99
MAN 3820	C.A.-orange	.300 .49	H05P-3401	C.A.-red	.400 1.50
MAN 3820	C.A.-orange ± 1	.300 .99	H05P-3603	C.C.-red	.400 1.50
MAN 3640	C.A.-green	.300 .99	XC22-7513	C.C.,R.H.D.-red	.300 1.25
MAN 4610	C.A.-orange	.400 .99	5082-5020	C.A.,L.H.D.-yel.	.300 1.25
MAN 6610	C.A.-orange-DO	.560 .99	5082-7623	C.C.,R.H.D.-yel.	.300 1.25
MAN 6630	C.A.-orange ± 1	.560 .99	5082-7720	C.A.,L.H.D.-red	.300 .99
MAN 6640	C.C.-orange-DO	.560 .99	5082-7721	C.A.,R.H.D.-red	.300 1.25
MAN 6650	C.C.-orange ± 1	.560 .99	5082-7750	C.A.,L.H.D.-red	.430 1.75
MAN 6660	C.A.-orange	.560 .99	5082-7751	C.C.,R.H.D.-red	.430 1.75
MAN 6710	C.A.-red-DO	.560 .99	5082-7860	C.C.,R.H.D.-red	.430 1.75
MAN 6750	C.C.-red ± 1	.560 .99	5082-7820	overly dig. R.H.O.	.400 22.00
MAN 6780	C.C.-red	.500 1.25	5082-7304	ext. sig. dig. L.H.O.	.400 19.95
DL70	C.C.-red	.300 1.25	LIT-1	Photo Xistor Opto-Isol.	.69
DL72	C.C.-red	.500 1.49	MOC3010	Optically Isolated Triac Driver	1.25

74LS

74LS00	.29	74LS192	1.15
74LS01	.29	74LS193	1.15
74LS02	.29	74LS194	1.15
74LS03	.29	74LS195	1.15
74LS04	.29	74LS197	1.15
74LS05	.29	74LS221	1.15
74LS07	.29	74LS240	1.15
74LS09	.29	74LS241	1.15
74LS10	.29	74LS242	1.15
74LS11	.29	74LS244	1.15
74LS12	.29	74LS245	1.15
74LS13	.29	74LS246	1.15
74LS14	.29	74LS247	1.15
74LS15	.29	74LS248	1.15
74LS16	.29	74LS249	1.15
74LS17	.29	74LS250	1.15
74LS18	.29	74LS251	1.15
74LS19	.29	74LS252	1.15
74LS20	.29	74LS253	1.15
74LS21	.29	74LS254	1.15
74LS22	.29	74LS255	1.15
74LS23	.29	74LS256	1.15
74LS24	.29	74LS257	1.15
74LS25	.29	74LS258	1.15
74LS26	.29	74LS259	1.15
74LS27	.29	74LS260	1.15
74LS28	.29	74LS261	1.15
74LS29	.29	74LS262	1.15
74LS30	.29	74LS263	1.15
74LS31	.29	74LS264	1.15
74LS32	.29	74LS265	1.15
74LS33	.29	74LS266	1.15
74LS34	.29	74LS267	1.15
74LS35	.29	74LS268	1.15
74LS36	.29	74LS269	1.15
74LS37	.29	74LS270	1.15
74LS38	.29	74LS271	1.15
74LS39	.29	74LS272	1.15
74LS40	.29	74LS273	1.15
74LS41	.29	74LS274	1.15
74LS42	.29	74LS275	1.15
74LS43	.29	74LS276	1.15
74LS44	.29	74LS277	1.15
74LS45	.29	74LS278	1.15
74LS46	.29	74LS279	1.15
74LS47	.29	74LS280	1.15
74LS48	.29	74LS281	1.15
74LS49	.29	74LS282	1.15
74LS50	.29	74LS283	1.15
74LS51	.29	74LS284	1.15
74LS52	.29	74LS285	1.15
74LS53	.29	74LS286	1.15
74LS54	.29	74LS287	1.15
74LS55	.29	74LS288	1.15
74LS56	.29	74LS289	1.15
74LS57	.29	74LS290	1.15
74LS58	.29	74LS291	1.15
74LS59	.29	74LS292	1.15
74LS60	.29	74LS293	1.15
74LS61	.29	74LS294	1.15
74LS62	.29	74LS295	1.15
74LS63	.29	74LS296	1.15
74LS64	.29	74LS297	1.15
74LS65	.29	74LS298	1.15
74LS66	.29	74LS299	1.15
74LS67	.29	74LS300	1.15
74LS68	.29	74LS301	1.15
74LS69	.29	74LS302	1.15
74LS70	.29	74LS303	1.15
74LS71	.29	74LS304	1.15
74LS72	.29	74LS305	1.15
74LS73	.29	74LS306	1.15
74LS74	.29	74LS307	1.15
74LS75	.29	74LS308	1.15
74LS76	.29	74LS309	1.15
74LS77	.29	74LS310	1.15
74LS78	.29	74LS311	1.15
74LS79	.29	74LS312	1.15
74LS80	.29	74LS313	1.15
74LS81	.29	74LS314	1.15
74LS82	.29	74LS315	1.15
74LS83	.29	74LS316	1.15
74LS84	.29	74LS317	1.15
74LS85	.29	74LS318	1.15
74LS86	.29	74LS319	1.15
74LS87	.29	74LS320	1.15
74LS88	.29	74LS321	1.15
74LS89	.29	74LS322	1.15
74LS90	.29	74LS323	1.15
74LS91	.29	74LS324	1.15
74LS92	.29	74LS325	1.15
74LS93	.29	74LS326	1.15
74LS94	.29	74LS327	1.15
74LS95	.29	74LS328	1.15
74LS96	.29	74LS329	1.15
74LS97	.29	74LS330	1.15
74LS98	.29	74LS331	1.15
74LS99	.29	74LS332	1.15

RADIO CONTROL CIRCUITS

Ideal for remote control systems which use pulse amplitude modulation (toy cars, boats, tanks, etc.) Features: five function control; adjustable steering angle, suitable for 27 and 47MHz bands and low power consumption.

NEW!

KB-4428 TRANSMITTER
 Abs. max. rating (TA895C): Supply volt.: Vcc: 12VDC. Power Dissip.: PD: 300mW; Temp. range: Oper. 0-50°C. Storage -30-125°C. Rec. oper. volt.: 7-11V. Crystal or C.R. Oscillation circuit acceptable.

KB-4429 RECEIVER
 Abs. max. rating (TA895C): Supply volt.: Vcc: 11V. Vcc2: 7.5V. Power Dissip.: 800mW; Temp. range: Oper. 0-50°C. Rec. oper. volt.: VOPI 7-11V - VOPE 3-4V.

LOW PROFILE (TIN) SOCKETS

1-24	25-49	50-100
8 pin LP	.17	.35
14 pin LP	.20	.19
16 pin LP	.22	.21
18 pin LP	.22	.27
20 pin LP	.27	.26
22 pin LP	.31	.30
24 pin LP	.35	.37
28 pin LP	.48	.44
36 pin LP	.60	.58
40 pin LP	.63	.61

SOLDERTAIL STANDARD (TIN)

1-24	25-49	50-100
8 pin ST	.38	.35
14 pin ST	.46	.40
16 pin ST	.49	.46
18 pin ST	.59	.50
20 pin ST	.64	.61
22 pin ST	.75	.69
24 pin ST	.84	.80
28 pin ST	1.19	1.14
36 pin ST	1.65	1.46
40 pin ST	1.75	1.59

SOLDERTAIL (GOLD) STANDARD

1-24	25-49	50-100
8 pin SG	.39	.36
14 pin SG	.46	.41
16 pin SG	.49	.44
18 pin SG	.59	.53
20 pin SG	.64	.61
22 pin SG	.75	.69
24 pin SG	.84	.80
28 pin SG	1.19	1.14
36 pin SG	1.65	1.46
40 pin SG	1.75	1.59

WIRE WRAP SOCKETS (GOLD) LEVEL #3

1-24	25-49	50-100
8 pin WW	.54	.49
14 pin WW	.69	.63
16 pin WW	.72	.67
18 pin WW	.82	.76
20 pin WW	.99	.90
22 pin WW	1.19	1.08
24 pin WW	1.49	1.38
26 pin WW	1.79	1.68
28 pin WW	1.69	1.53
36 pin WW	2.19	1.99
40 pin WW	2.29	2.09

1/4 WATT RESISTOR ASSORTMENTS - 5%

ASST. 1	5 ea.	10 Ohm	12 Ohm	15 Ohm	18 Ohm	22 Ohm	27 Ohm	33 Ohm	39 Ohm	47 Ohm	56 Ohm	68 Ohm	82 Ohm	100 Ohm	50 pcs.	\$1.95		
ASST. 2	5 ea.	180 Ohm	220 Ohm	270 Ohm	330 Ohm	390 Ohm	470 Ohm	560 Ohm	680 Ohm	820 Ohm	1K	1.2K	1.5K	1.8K	2.2K	2.7K	50 pcs.	\$1.95
ASST. 3	5 ea.	3.3K	3.9K	4.7K	5.6K	6.8K	8.2K	10K	12K	15K	18K	22K	27K	33K	39K	47K	50 pcs.	\$1.95
ASST. 4	5 ea.	22K	27K	33K	39K	47K	56K	68K	82K	100K	120K	150K	180K	220K	270K	330K	50 pcs.	\$1.95
ASST. 5	5 ea.	150K	180K	220K	270K	330K	390K	470K	560K	680K	820K	1M	1.2M	1.5M	1.8M	2.2M	50 pcs.	\$1.95
ASST. 7	5 ea.	1M	1.2M	1.5M	1.8M	2.2M	2.7M	3.3M	3.9M	4.7M	5.6M	6.8M	8.2M	10M	50 pcs.	\$1.95		

ASST. 8 ea. Includes Resistor Asssts. 1-7 (350 pcs.) \$10.95 ea.

\$10.00 Min. Order - U.S. Funds Only
 Calif. Residents Add 6% Sales Tax
 Postage - Add 5% plus \$1 Insurance (if desired)

Spec Sheets - 25¢
 1981 Catalog Available - Send 41¢ stamp

Jameco ELECTRONICS

PHONE ORDERS WELCOME (415) 592-8097

MAIL ORDER ELECTRONICS - WORLDWIDE
 1355 SHOREWAY ROAD, BELMONT, CA 94002
 PRICES SUBJECT TO CHANGE

INTERSiL

Part No.	Function	Price
7065IP1	CMOS Precision Timer	14.95
7065VK1*	Stopwatch Chip, XTL	22.95
7106CP1	1/4 Circuit A/D (LCO Drive)	16.95
7106EV/K1*	1/4 Circuit Buffer, Display	34.95
7107CP1		

GET IT ALL! Subscribe today, and don't miss a single issue.

When you subscribe to the best electronics magazine of all—Radio-Electronics—you're making sure that you'll get all the news of electronics you want, every month from now on. Issue after issue, you'll get equipment news, test reports, projects to build, computer technology, servicing tips and more, including regular columns on computers, solid state, hi-fi, hobbies and servicing. And every one is written by the experts, the outstanding authorities in the most exciting, fastest-growing field in the world today—electronics.



And...you save money, too, as much as \$5. off the newsstand price of Radio-Electronics when you select one of the subscription offers listed on the handy coupon. More important—you'll be assured of having your copy reserved, even if it runs out on the newsstands. You save money and time. Make sure you get all the excitement of every issue of Radio-Electronics, every month, by filling in and mailing the coupon, today.

GET THE BEST!—Radio-Electronics

- 1 Year—12 issues ONLY \$13.00**
(You save \$2.00 off newsstand price.)
- 2 Years—24 issues ONLY \$25.00**
(Save More! \$5.00 off newsstand price.)
- Payment enclosed
- Bill me

Extra Shipping: Canada \$3.00 per year. all other countries \$5.00 per year.

40LO

(please print)

Name _____
Address _____
City _____
State _____ Zip Code _____

Mail to: Radio Electronics SUBSCRIPTION DEPT., P.O. BOX 2520, BOULDER, COLO 80322

C/MOS DIODE CLAMPED

4001	35	4027	45	4081	35	74C74	50
4002	35	4028	45	4082	45	74C76	70
4003	110	4029	85	4083	45	74C78	130
4007	27	4030	35	4084	35	74C80	140
4009	45	4031	75	4085	35	74C82	140
4010	45	4032	75	4086	35	74C84	140
4011	35	4040	45	4087	35	74C86	140
4012	35	4042	45	4088	35	74C88	140
4013	40	4043	50	4089	35	74C90	140
4014	130	4044	300	4090	35	74C92	140
4015	130	4046	300	4091	35	74C94	140
4019	45	4048	75	4092	35	74C96	140
4017	105	4050	45	4093	35	74C98	140
4018	80	4051	110	4094	35	74C100	140
4019	45	4052	110	4095	35	74C102	140
4020	110	4053	110	4096	35	74C104	140
4021	110	4054	70	4097	35	74C106	140
4022	110	4055	70	4098	35	74C108	140
4023	35	4071	35	4099	35	74C110	140
4024	35	4072	35	4100	35	74C112	140
4025	35	4073	35	4101	35	74C114	140

PRINTED CIRCUIT BOARD

4" x 6" DOUBLE SIDED EPOXY BOARD 1/16" thick
\$.60 ea. 592.60

EPOXY glass vector board
1/16" thick with 1/10" spacing 4 1/2" x 6 1/2" \$1.95

74500	30	74520	40	745153	110
74502	30	74530	40	745151	125
74508	45	74532	40	745157	125
74508	40	74589	130	745158	125
74511	35	745112	85	745174	150
74515	40	745140	100	745257	150

TRANSISTOR SPECIALS

2N1303 PNP GE TO-18	\$1.00
2N1307 PNP GE TO-18	\$1.00
2N4004 PNP GE TO-18	\$1.00
2N4004A PNP GE TO-18	\$1.00
2N4007 NPN GE TO-18	\$1.00
2N4007A NPN GE TO-18	\$1.00
2N4010 NPN GE TO-18	\$1.00
2N4010A NPN GE TO-18	\$1.00
2N4013 NPN GE TO-18	\$1.00
2N4013A NPN GE TO-18	\$1.00
2N4017 NPN GE TO-18	\$1.00
2N4017A NPN GE TO-18	\$1.00
2N4020 NPN GE TO-18	\$1.00
2N4020A NPN GE TO-18	\$1.00
2N4022 NPN GE TO-18	\$1.00
2N4022A NPN GE TO-18	\$1.00
2N4024 NPN GE TO-18	\$1.00
2N4024A NPN GE TO-18	\$1.00
2N4027 NPN GE TO-18	\$1.00
2N4027A NPN GE TO-18	\$1.00
2N4030 NPN GE TO-18	\$1.00
2N4030A NPN GE TO-18	\$1.00
2N4033 NPN GE TO-18	\$1.00
2N4033A NPN GE TO-18	\$1.00
2N4035 NPN GE TO-18	\$1.00
2N4035A NPN GE TO-18	\$1.00
2N4037 NPN GE TO-18	\$1.00
2N4037A NPN GE TO-18	\$1.00
2N4040 NPN GE TO-18	\$1.00
2N4040A NPN GE TO-18	\$1.00
2N4042 NPN GE TO-18	\$1.00
2N4042A NPN GE TO-18	\$1.00
2N4045 NPN GE TO-18	\$1.00
2N4045A NPN GE TO-18	\$1.00
2N4047 NPN GE TO-18	\$1.00
2N4047A NPN GE TO-18	\$1.00
2N4050 NPN GE TO-18	\$1.00
2N4050A NPN GE TO-18	\$1.00
2N4052 NPN GE TO-18	\$1.00
2N4052A NPN GE TO-18	\$1.00
2N4055 NPN GE TO-18	\$1.00
2N4055A NPN GE TO-18	\$1.00
2N4057 NPN GE TO-18	\$1.00
2N4057A NPN GE TO-18	\$1.00
2N4060 NPN GE TO-18	\$1.00
2N4060A NPN GE TO-18	\$1.00
2N4062 NPN GE TO-18	\$1.00
2N4062A NPN GE TO-18	\$1.00
2N4065 NPN GE TO-18	\$1.00
2N4065A NPN GE TO-18	\$1.00
2N4067 NPN GE TO-18	\$1.00
2N4067A NPN GE TO-18	\$1.00
2N4070 NPN GE TO-18	\$1.00
2N4070A NPN GE TO-18	\$1.00
2N4072 NPN GE TO-18	\$1.00
2N4072A NPN GE TO-18	\$1.00
2N4075 NPN GE TO-18	\$1.00
2N4075A NPN GE TO-18	\$1.00
2N4077 NPN GE TO-18	\$1.00
2N4077A NPN GE TO-18	\$1.00
2N4080 NPN GE TO-18	\$1.00
2N4080A NPN GE TO-18	\$1.00
2N4082 NPN GE TO-18	\$1.00
2N4082A NPN GE TO-18	\$1.00
2N4085 NPN GE TO-18	\$1.00
2N4085A NPN GE TO-18	\$1.00
2N4087 NPN GE TO-18	\$1.00
2N4087A NPN GE TO-18	\$1.00
2N4090 NPN GE TO-18	\$1.00
2N4090A NPN GE TO-18	\$1.00
2N4092 NPN GE TO-18	\$1.00
2N4092A NPN GE TO-18	\$1.00
2N4095 NPN GE TO-18	\$1.00
2N4095A NPN GE TO-18	\$1.00
2N4097 NPN GE TO-18	\$1.00
2N4097A NPN GE TO-18	\$1.00
2N4100 NPN GE TO-18	\$1.00
2N4100A NPN GE TO-18	\$1.00
2N4102 NPN GE TO-18	\$1.00
2N4102A NPN GE TO-18	\$1.00
2N4105 NPN GE TO-18	\$1.00
2N4105A NPN GE TO-18	\$1.00
2N4107 NPN GE TO-18	\$1.00
2N4107A NPN GE TO-18	\$1.00
2N4110 NPN GE TO-18	\$1.00
2N4110A NPN GE TO-18	\$1.00
2N4112 NPN GE TO-18	\$1.00
2N4112A NPN GE TO-18	\$1.00
2N4115 NPN GE TO-18	\$1.00
2N4115A NPN GE TO-18	\$1.00
2N4117 NPN GE TO-18	\$1.00
2N4117A NPN GE TO-18	\$1.00
2N4120 NPN GE TO-18	\$1.00
2N4120A NPN GE TO-18	\$1.00
2N4122 NPN GE TO-18	\$1.00
2N4122A NPN GE TO-18	\$1.00
2N4125 NPN GE TO-18	\$1.00
2N4125A NPN GE TO-18	\$1.00
2N4127 NPN GE TO-18	\$1.00
2N4127A NPN GE TO-18	\$1.00
2N4130 NPN GE TO-18	\$1.00
2N4130A NPN GE TO-18	\$1.00
2N4132 NPN GE TO-18	\$1.00
2N4132A NPN GE TO-18	\$1.00
2N4135 NPN GE TO-18	\$1.00
2N4135A NPN GE TO-18	\$1.00
2N4137 NPN GE TO-18	\$1.00
2N4137A NPN GE TO-18	\$1.00
2N4140 NPN GE TO-18	\$1.00
2N4140A NPN GE TO-18	\$1.00
2N4142 NPN GE TO-18	\$1.00
2N4142A NPN GE TO-18	\$1.00
2N4145 NPN GE TO-18	\$1.00
2N4145A NPN GE TO-18	\$1.00
2N4147 NPN GE TO-18	\$1.00
2N4147A NPN GE TO-18	\$1.00
2N4150 NPN GE TO-18	\$1.00
2N4150A NPN GE TO-18	\$1.00
2N4152 NPN GE TO-18	\$1.00
2N4152A NPN GE TO-18	\$1.00
2N4155 NPN GE TO-18	\$1.00
2N4155A NPN GE TO-18	\$1.00
2N4157 NPN GE TO-18	\$1.00
2N4157A NPN GE TO-18	\$1.00
2N4160 NPN GE TO-18	\$1.00
2N4160A NPN GE TO-18	\$1.00
2N4162 NPN GE TO-18	\$1.00
2N4162A NPN GE TO-18	\$1.00
2N4165 NPN GE TO-18	\$1.00
2N4165A NPN GE TO-18	\$1.00
2N4167 NPN GE TO-18	\$1.00
2N4167A NPN GE TO-18	\$1.00
2N4170 NPN GE TO-18	\$1.00
2N4170A NPN GE TO-18	\$1.00
2N4172 NPN GE TO-18	\$1.00
2N4172A NPN GE TO-18	\$1.00
2N4175 NPN GE TO-18	\$1.00
2N4175A NPN GE TO-18	\$1.00
2N4177 NPN GE TO-18	\$1.00
2N4177A NPN GE TO-18	\$1.00
2N4180 NPN GE TO-18	\$1.00
2N4180A NPN GE TO-18	\$1.00
2N4182 NPN GE TO-18	\$1.00
2N4182A NPN GE TO-18	\$1.00
2N4185 NPN GE TO-18	\$1.00
2N4185A NPN GE TO-18	\$1.00
2N4187 NPN GE TO-18	\$1.00
2N4187A NPN GE TO-18	\$1.00
2N4190 NPN GE TO-18	\$1.00
2N4190A NPN GE TO-18	\$1.00
2N4192 NPN GE TO-18	\$1.00
2N4192A NPN GE TO-18	\$1.00
2N4195 NPN GE TO-18	\$1.00
2N4195A NPN GE TO-18	\$1.00
2N4197 NPN GE TO-18	\$1.00
2N4197A NPN GE TO-18	\$1.00
2N4200 NPN GE TO-18	\$1.00
2N4200A NPN GE TO-18	\$1.00
2N4202 NPN GE TO-18	\$1.00
2N4202A NPN GE TO-18	\$1.00
2N4205 NPN GE TO-18	\$1.00
2N4205A NPN GE TO-18	\$1.00
2N4207 NPN GE TO-18	\$1.00
2N4207A NPN GE TO-18	\$1.00
2N4210 NPN GE TO-18	\$1.00
2N4210A NPN GE TO-18	\$1.00
2N4212 NPN GE TO-18	\$1.00
2N4212A NPN GE TO-18	\$1.00
2N4215 NPN GE TO-18	\$1.00
2N4215A NPN GE TO-18	\$1.00
2N4217 NPN GE TO-18	\$1.00
2N4217A NPN GE TO-18	\$1.00
2N4220 NPN GE TO-18	\$1.00
2N4220A NPN GE TO-18	\$1.00
2N4222 NPN GE TO-18	\$1.00
2N4222A NPN GE TO-18	\$1.00
2N4225 NPN GE TO-18	\$1.00
2N4225A NPN GE TO-18	\$1.00
2N4227 NPN GE TO-18	\$1.00
2N4227A NPN GE TO-18	\$1.00
2N4230 NPN GE TO-18	\$1.00
2N4230A NPN GE TO-18	\$1.00
2N4232 NPN GE TO-18	\$1.00
2N4232A NPN GE TO-18	\$1.00
2N4235 NPN GE TO-18	\$1.00
2N4235A NPN GE TO-18	\$1.00
2N4237 NPN GE TO-18	\$1.00
2N4237A NPN GE TO-18	\$1.00
2N4240 NPN GE TO-18	\$1.00
2N4240A NPN GE TO-18	\$1.00
2N4242 NPN GE TO-18	\$1.00
2N4242A NPN GE TO-18	\$1.00
2N4245 NPN GE TO-18	\$1.00
2N4245A NPN GE TO-18	\$1.00
2N4247 NPN GE TO-18	\$1.00
2N4247A NPN GE TO-18	\$1.00
2N4250 NPN GE TO-18	\$1.00
2N4250A NPN GE TO-18	\$1.00
2N4252 NPN GE TO-18	\$1.00
2N4252A NPN GE TO-18	\$1.00
2N4255 NPN GE TO-18	\$1.00
2N4255A NPN GE TO-18	\$1.00
2N4257 NPN GE TO-18	\$1.00
2N4257A NPN GE TO-18	\$1.00
2N4260 NPN GE TO-18	\$1.00
2N4260A NPN GE TO-18	\$1.00
2N4262 NPN GE TO-18	\$1.00
2N4262A NPN GE TO-18	\$1.00
2N4265 NPN GE TO-18	\$1.00
2N4265A NPN GE TO-18	\$1.00
2N4267 NPN GE TO-18	\$1.00
2N4267A NPN GE TO-18	\$1.00
2N4270 NPN GE TO-18	\$1.00
2N4270A NPN GE TO-18	\$1.00
2N4272 NPN GE TO-18	\$1.00
2N4272A NPN GE TO-18	\$1.00
2N4275 NPN GE TO-18	\$1.00
2N4275A NPN GE TO-18	\$1.00
2N4277 NPN GE TO-18	\$1.00
2N4277A NPN GE TO-18	\$1.00
2N4280 NPN GE TO-18	\$1.00
2N4280A NPN GE TO-18	\$1.00
2N4282 NPN GE TO-18	\$1.00
2N4282A NPN GE TO-18	\$1.00
2N4285 NPN GE TO-18	\$1.00
2N4285A NPN GE TO-18	\$1.00
2N4287 NPN GE TO-18	\$1.00
2N4287A NPN GE TO-18	\$1.00
2N4290 NPN GE TO-18	\$1.00
2N4290A NPN GE TO-18	\$1.00
2N4292 NPN GE TO-18	\$1.00
2N4292A NPN GE TO-18	\$1.00
2N4295 NPN GE TO-18	\$1.00
2N4295A NPN GE TO-18	\$1.00
2N4297 NPN GE TO-18	\$1.00
2N4297A NPN GE TO-18	\$1.00
2N4300 NPN GE TO-18	\$1.00
2N4300A NPN GE TO-18	\$1.00
2N4302 NPN GE TO-18	\$1.00
2N4302A NPN GE TO-18	\$1.00
2N4305 NPN GE TO-18	\$1.00
2N4305A NPN GE TO-18	\$1.00
2N4307 NPN GE TO-18	\$1.00
2N4307A NPN GE TO-18	\$1.00
2N4310 NPN GE TO-18	\$1.00
2N4310A NPN GE TO-18	\$1.00
2N4312 NPN GE TO-18	\$1.00
2N4312A NPN GE TO-18	\$1.00
2N4315 NPN GE TO-18	\$1.00
2N4315A NPN GE TO-18	\$1.00
2N4317 NPN GE TO-18	\$1.00
2N4317A NPN GE TO-18	\$1.00
2N4320 NPN GE TO-18	\$1.00
2N4320A NPN GE TO-18	\$1.00
2N4322 NPN GE TO-18	\$1.00
2N4322A NPN GE TO-18	\$1.00
2N4325 NPN GE TO-18	\$1.00
2N4325A NPN GE TO-18	\$1.00
2N4327 NPN GE TO-18	\$1.00
2N4327A NPN GE TO-18	\$1.00
2N4330 NPN GE TO-18	\$1.00
2N4330A NPN GE TO-18	\$1.00
2N4332 NPN GE TO-18	\$1.00
2N4332A NPN GE TO-18	\$1.00
2N4335 NPN GE TO-18	\$1.00
2N4335A NPN GE TO-18	\$1.00
2N4337 NPN GE TO-18	\$1.00
2N4337A NPN GE TO-18	\$1.00
2N4340 NPN GE TO-18	\$1.00
2N4340A NPN GE TO-18	\$1.00
2N4342 NPN GE TO-18	\$1.00
2N4342A NPN GE TO-18	\$1.00
2N4345 NPN GE TO-18	\$1.00
2N4345A NPN GE TO-18	\$1.00
2N4347 NPN GE TO-18	\$1.00
2N4347A NPN GE TO-18	\$1.00
2N4350 NPN GE TO-18	\$1.00
2N4350A NPN GE TO-18	\$1.00
2N4352 NPN GE TO-18	\$1.00
2N4352A NPN GE TO-18	\$1.00
2N4355 NPN GE TO-18	\$1.00
2N4355A NPN GE TO-18	\$1.00
2N4357 NPN GE TO-18	\$1.00
2N4357A NPN GE TO-18	\$1.00
2N4360 NPN GE TO-18	\$1.00
2N4360A NPN GE TO-18	\$1.00
2N4362 NPN GE TO-18	\$1.00
2N4362A NPN GE TO-18	\$1.00
2N4365 NPN GE TO-18	\$1.00
2N4365A NPN GE TO-18	\$1

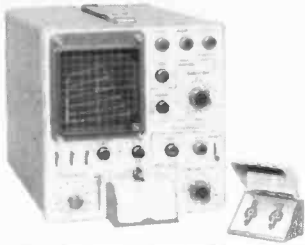

CT71 Curve Tracer, Versatile Tracer, Curves, Transistors, Fets, Diodes and more. Reg. 1495.00/Now 1200.00.

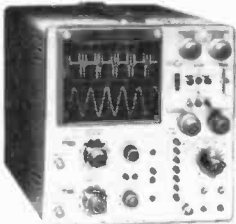

DM64 Oscilloscope 10 MHz Storage Single Shot. Reg. 1495.00/Now 1295.00.

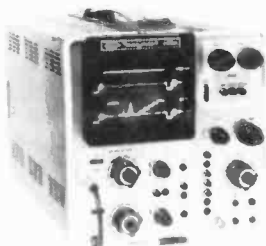

D66A 25 MHz Dual Trace Scope 20Ns Div. Reg. 1095.00/Now 795.00.

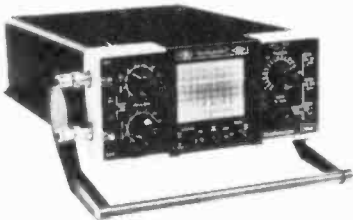

Model D34 Scope Battery Operated Dual Trace 15 MHz and more. Reg. 1295.00/Now 700.00.

BUY NOW. Savings From 200.00 To 300.00 and more ...

That's right. We purchased the entire Tektronix Telequipment inventory and will pass the savings along to you. Single and Dual Trace models. Frequencies from 5-30 MHz, portable battery operation to storage models, as well as curve tracers.



D32 Oscilloscope Battery Operated Dual Trace. Reg. 995.00/Now 599.00.

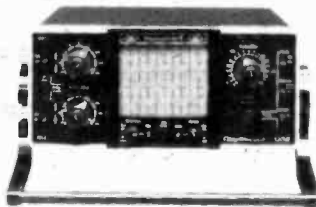

D67A General Purpose Scope 25 MHz Dual Trace. Reg. 1400.00/Now 1095.00.

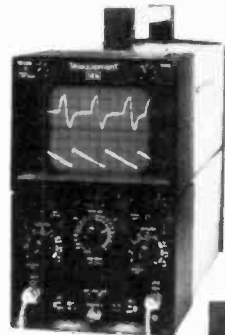

S61/D61 5 or 10 MHz Single or Dual Trace. Single Trace Reg. 400.00/Now 265.00. Dual Trace Reg. 600.00/Now 350.00.

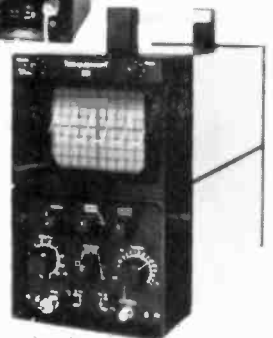

D1015 Oscilloscope 15 MHz Dual Trace Rise time 23Ns and so much more. Reg. 800.00/Now 650.00.

Matching accessories include: X10 Probes, Scope Carts, Carrying Cases, Cameras and much more. All models operate on 120/220 Volts 40-60 Hz. All come with a full one year warranty. Remember CTG has NLS, Gould, Hewlett-Packard, Tektronix, B&K, Leader, Hameg, Kikusui, Hitachi, Phillips, Hickok, RCA, Lectrotech, and so much more. Come in, call or write for free brochures. Export inquiries invited.



Communications
Technology
Group, Incorporated®

448 Merrick Road, Oceanside, N. Y. 11572 U.S.A. (516) 536-5724
Communications for Worldwide Use

SPECIAL

AN 214Q 1.45
TA 7205P 1.70
2SQ 1308K 2.50
 MIN. 10 PIECES PER TYPE

EXACT REPLACEMENT TO ECG

1-9		1-9		1-9		1-9	
100	1.00	169	1.50	258	3.50	336	25.00
101	1.00	170	3.90	259	2.70	337	15.00
102	1.10	171A	0.90	260	4.70	338	16.00
102A	0.75	172A	0.40	261	1.40	339	23.00
103	1.10	173BP	6.00	262	1.40	340	1.90
103A	0.80	175	1.30	263	1.60	373	1.45
104	2.00	176	1.00	264	2.00	374	1.55
105	2.20	177	0.25	265	1.00	375	1.80
106	0.40	178MP	0.50	266	0.90	376	2.30
107	0.60	179	5.00	267	1.00	380	3.60
108	0.75	180	4.00	268	1.20	381	3.60
109	0.30	181	2.90	269	1.30	396	2.10
110MP	0.50	182	2.50	270	3.30	397	2.30
111	1.20	183	3.00	271	4.50	409	1.30
112	0.80	184	1.00	272	0.80	416	1.10
113A	0.80	185	1.20	273	1.20	428	0.80
114	0.80	186	0.90	274	2.60	519	0.40
115	0.80	186A	1.20	275	3.00	524	1.50
116	0.30	187	1.10	276	7.75	551	1.60
117	0.30	187A	1.30	277	9.80	601	0.25
118	1.30	188	1.50	278	2.50	703A	1.20
119	1.00	189	1.40	279	5.00	708	1.50
120	0.90	190	1.80	280	3.40	709	2.60
121	2.70	191	2.00	281	4.60	710	2.60
122	4.00	192	0.45	282	3.10	712	1.80
123	0.60	193	0.45	283	6.00	713	1.50
123A	0.55	194	0.45	284	4.20	714	2.80
123AP	0.70	195A	1.90	285	5.70	715	3.00
124	1.60	196	1.20	286	5.50	718	1.50
125	0.30	197	1.30	287	0.60	719	1.50
126	1.20	198	1.40	288	0.70	720	1.50
127	4.00	199	0.40	289	0.60	722	1.50
128	0.85	209	0.30	290	0.60	723	1.50
129	1.00	210	0.85	291	1.30	724	2.60
130	1.30	211	1.00	292	1.50	731	3.80
131	1.00	213	10.00	293	0.80	737	3.50
132	0.60	218	2.70	294	1.00	738	4.10
133	0.55	219	3.50	295	0.60	740A	2.20
134A	0.50	220	1.60	297	0.90	742	3.90
135A	0.50	221	1.50	298	1.00	743	3.30
136A	0.50	222	1.50	299	0.75	748	2.00
137A	0.50	223	3.00	300	0.70	780	2.50
138A	0.50	224	3.00	302	1.30	783	3.00
139A	0.50	225	4.50	306	1.30	788	2.80
140A	0.50	226	1.80	307	0.60	790	2.60
141A	0.50	226MP	4.90	308	6.80	791	2.80
142A	0.50	228A	1.00	309K	3.20	801	2.00
143A	0.50	229	0.60	310	6.50	807	3.20
144A	0.50	230	4.20	311	2.00	917	2.90
145A	0.50	231	3.80	312	0.60	955M	1.20
146A	0.50	232	0.60	313	1.90	977	1.20
147A	0.50	233	0.50	314	7.50	1002	1.30
148A	0.50	234	0.45	315	0.90	1003	1.20
149A	0.50	235	1.50	316	2.50	1006	2.00
150A	0.50	236	4.90	317	26.00	1009	2.15
151A	0.50	237	2.40	318	20.00	1010	2.15
152	0.90	238	3.30	319	1.10	1011	2.20
153	1.00	239	2.70	321	3.60	1014	2.20
154	1.40	241	2.00	322	1.90	1015	2.60
155	2.20	242	2.00	323	2.20	1016	2.20
156	0.45	243	2.10	324	2.50	1019	1.20
157	1.10	244	2.20	325	29.20	1020	2.90
158	0.90	245	3.00	326	0.90	1024	4.20
159	0.60	246	4.20	327	17.00		
160	1.80	247	4.00	328	9.00		
161	0.90	248	4.00	329	3.70		
162	4.60	249	7.00	330	12.80		
163A	5.60	250	7.00	330W	10.00		
164	3.20	251	5.00	331	1.90		
165	3.30	252	7.00	332	2.00		
166	0.70	253	1.30	333	20.00		
167	0.95	254	1.50	334	20.00		
168	1.00	257	1.80	335	25.00		

FOR 10 PIECES AND UP, SEE CATALOG
 PARTIAL LIST, ASK FOR OUR FREE CATALOG

1500 TYPES ORIGINAL
 JAPANESE TRS & ICS ✓

1000 TYPES
 ECG REPLACEMENT ✓

OTHER ELECTRONIC
 PARTS FOR TV, STEREO,
 CB, CAR STEREO ✓

ELECTRONIC PARTS SUPPLY

TOLL FREE: 800 227-0104
 IN CALIFORNIA (415) 532-2711
 P.O. BOX 5356 BERKELEY,
 CALIFORNIA 94705
 VISA, M/C, PREPAID, COD, M/O

CIRCLE 14 ON FREE INFORMATION CARD

ADVERTISING INDEX

RADIO-ELECTRONICS does not assume any responsibility for errors that may appear in the index below.

Free Information Number Page

4	AMC Sales	120
12	AP Products, Inc.	38
—	ATV Research	115
65	Active Electronics	113
10,68	Advanced Computer Products	124-125
—	Advanced Electronics	15,42-43,79,91,99
69	All Electronics	120
5	American Antenna	Cover 4
70	Ancrona	121
75	Arkon Electronics Ltd.	94
29	B & K Precision Dynascan Corp.	110
—	Bagnall Electronics	112
—	Karel Barta	114
77	F.W. Bell	32
—	Bullet Electronics	116
—	Burdex Security	114
32	CFR Associates	126
69	Cal West Supply Co.	120
18	Cascade Labs.	128
13	Chaney Electronics	128
24	Channelock	107
—	CIE—Cleveland Institute of Electronics	18-21
—	Command Productions	134
60	Communications Electronics	2
78	CTG—Communications Technology Group Inc.	133
71	Concord—Computer Components	114-115
58	The Cooper Group—Electronic Division	Cover 2
—	Dage Scientific	114
—	Deltroniks	114
35	Digi-Key	123
27	Discwasher	Cover 3
61	Dominion Radio Electronics	128
—	EMC—Electronic Measurements	128
—	ETCO	115
11	Electronics Book Club (TAB)	97
14	Electronic Parts Supply	134
56	Electronics Technical Institute	86
—	Electronic Technology Today	106
72	Fluke	7
33,34,36,37	Fordham Radio Supply	22,102,104,108
6,7	Formula International	118-119
66	Global Specialties	46
—	Global TV Electronics	112
8	Godbout Electronics	120
—	Grantham College of Engineering	106
48	Group Technology Systems	88
25,26,62	Heath	13,33,94
28	Hustler, Inc.	111
—	ICS	115
—	Information Unlimited	115
49	International Electronics Unltd.	126
—	JS & A	1,5
20,21	Jameco Electronics	130-131
22	Jan Crystal	111
53	Jimi-Pak	40-41
45	Key-Stone Electronics Corp.	26
19	McKay Dymek	109
57	Media Marketing	24
51,54,55	Mercury International	45,81,95
15	Meshna	116
—	Micro-Ace	117
—	Micro Management Systems	112
81	NJS Technology Inc.	100
—	NRI—National Radio Institute	8-11
—	National Technical Schools	28-31
31	Netronics	89
46,47	Non—Linear Systems	25,27
40	O.K. Machine & Tool	23
3	Optoelectronics	85
16	Paia	103
—	PPG, Inc.	104
52	Pac-Com	103
41	Panasonic	39
42	Poly Paks	120
67	Protecto Enterprises	96
17	Quest	129
73	RCA	36-37,87,111
59	Radio Shack	122
74	Rainbow Industries	105
39	Ramsey Electronics	127
—	Sabtronics	34,35
30	SLG Waber	84
63	Shure Brothers	93
43	Solid State Sales	132
2	Sony	83
—	Spacecoast Research	112,115
76	A.W. Sperry Instruments Inc.	17
38	Sprague	44
64	Steven Products	126
—	Symmetric Sound Systems	96
9	Testek	88
—	Texas Instruments	105
44	VIZ Mfg. Co.	92
80	Wahl Clipper	110
23	Wersi Electronics	84

PASS FCC EXAMS

The Original FCC Tests-Answers exam manual that prepares you at home for FCC First and Second class Radiotelephone licenses. Newly revised multiple choice exams cover all areas tested on the actual FCC exam. Plus "Self Study" Ability Test. Proven! \$9.95 postpaid. Moneyback Guarantee.



COMMAND PRODUCTIONS
 Radio Engineering Division

P.O. Box 26348
 San Francisco, CA 94126

DISCWASHER D4 SYSTEM

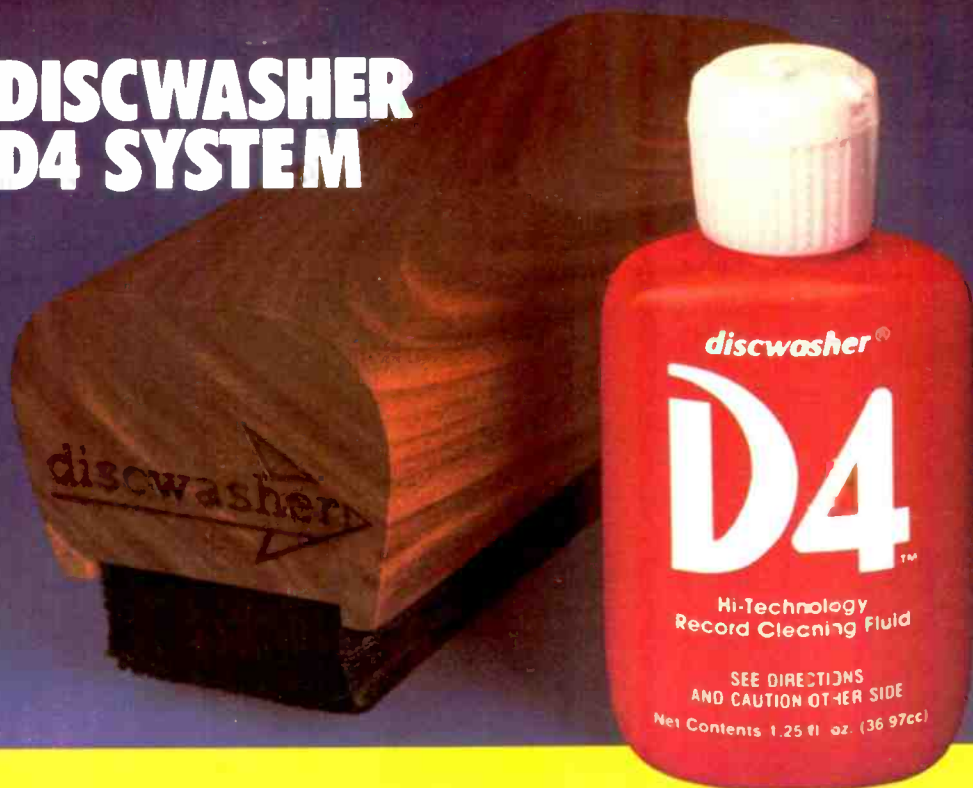

A NEW STANDARD OF RECORD CARE

NEW D4 FLUID

Inherently more active against record contamination. Inherently safe for record vinyl. Preferentially absorptive formula carries all contamination off the record.

NEW D4 FABRIC

Unique directional fibers preferentially remove fluid and contamination. D4 fabric results in clearly better cleaning, better drying and ultimately residue-free surfaces.

UNMATCHED VALUE

The Discwasher D4 System is enhanced by the durability and aesthetics of the hand-finished walnut handle. Included in the D4 System are the DC-1 Pad Cleaner and new instructions.

discwasher[®]
PRODUCTS TO CARE FOR YOUR MUSIC

Discwasher, Inc., 1407 N. Providence Rd., Columbia, MO 65201

CIRCLE 27 ON FREE INFORMATION CARD

In one year our **K40** antenna has become the largest selling CB antenna in the world!

1. It's more expensive ...

\$42.50 suggested retail

And when you pay more, you expect more!

MORE PERFORMANCE:

The K40 is guaranteed to transmit further or receive clearer than any antenna it replaces. We know it will. We've tested it with 771 CB'ers just like you for one year.

MORE FLEXIBILITY:

You can fit your K40 to any mounting surface. It will fit any vehicle you'll ever own! That includes choppers, dune buggies, gutters, mirror mounts, luggage racks, trunks, hatchbacks, through roofs, semis, pick ups and RV's.

MORE QUALITY:

It's not imported. It's not made in Taiwan, Korea or Japan. It's American made in an American town. It's made with better materials that cost more and by professional people we pay more. And we designed it right here in the U.S.A.

*Including optional mounts at extra cost.

...This Antenna is so DYNAMITE you receive a ...

DOUBLE GUARANTEE

GUARANTEE I: The K-40 will transmit farther and receive more clearly than the antenna it replaces or the customer will receive a prompt and full refund from the Registered K-40 Dealer who installed and tuned it.

GUARANTEE II: Unconditionally guaranteed for 12 months. Guaranteed against cracking, chipping, or rusting. Guaranteed against mechanical failure. Guaranteed against electrical failure. Guaranteed against accidental breakage. No exclusions. No gimmicks. For a full 12 months.

2. It's made better...

3. It's proven best!

...Here's what the leading CB publications said.

CB TIMES: "... it's not often that a product bursts onto the market scene, dominates and improves CB'ing for everyone. American Antenna and the K40 are doing it—repeated tests showed the K40 could out-perform the major competitive brands."

RADIO-ELECTRONICS: "The results of our tests showed that, in three different positions of the monitoring receiver, the model K40 equaled or out-performed the competitive antenna. Apparently, American Antenna's advertising is not merely Madison Avenue showmanship."

PERSONAL COMMUNICATIONS: "... an impressive 95% of the trials, the K40 out-performed the existing mobile antennas. We had to try one for ourselves. ... in every case, the K40 either equaled or out-performed its competitor."

"No ifs, ands, or buts! The K40 Antenna from American Antenna would have to be just about the best antenna around."

CB MAGAZINE: "Introduced in November, 1977, the K40 quickly became the top seller and in mid 1978, became the number one selling antenna in the nation."

...Here's what CB'ers all across the country said.

ANTENNA SPECIALISTS: "... truck driver and CB'er for 10 years ... 50% further than my M410 'Big Momma'."

—J.H. Coilett, 207 McFee, Bastrop, LA

AVANTI: "I'm an electronic technician with a Second Class FCC license ... I was able to transmit 70% further and tune the SWR 75% lower than my Avanti."

—H.R. Castro, VRB, Monserrante D-67, Salinas, Puerto Rico

PAL: "... 20% better in transmission and reception than my 5/8 wave Pal Firestick."

—John A. Blum, Box 446, Zeilenople, PA

SHAKESPEARE: "... I've been a CB'er for three years and the K40 is the best I've ever had. Better in reception and transmission than my Shakespeare."

—H. Bachert, Jr., 15 King Rd., Park Ridge, NJ

HUSTLER: "Compared to my Hustler XBLT-4, the K40 can consistently transmit 40% further and the reception was better. The K40 is the perfect way to complete a CB system."

—Jerome R. Brown, 7800 S. Linder, Burbank, IL



GOOD STUFF FOR PROS ONLY!



(SPECIAL NOTE) IF YOU'RE A BEGINNER:

Our K40 Dealers will be happy to sell you any of the older style and less expensive antennas that are great bargains for any beginning CB'er.

AMERICAN ANTENNA
ELGIN, IL 60120

©COPYRIGHT AMERICAN ANTENNA 1979

K40
POWER!

... Sold exclusively by 3500 American K40 Dealers throughout the U.S. & Canada.

CIRCLE 5 ON FREE INFORMATION CARD