

Radio-Electronics®

A
GERNSBACK
PUBLICATION

How To Fix Bad Color



FOR MODEL RR Electronic Throttle

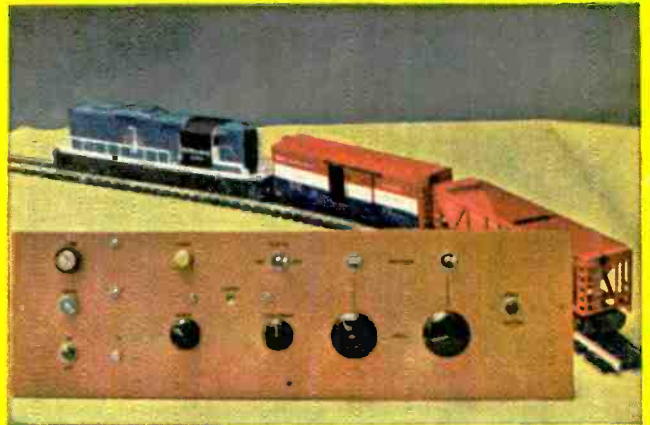

Experimenters Now Build R-E's One-IC Radio

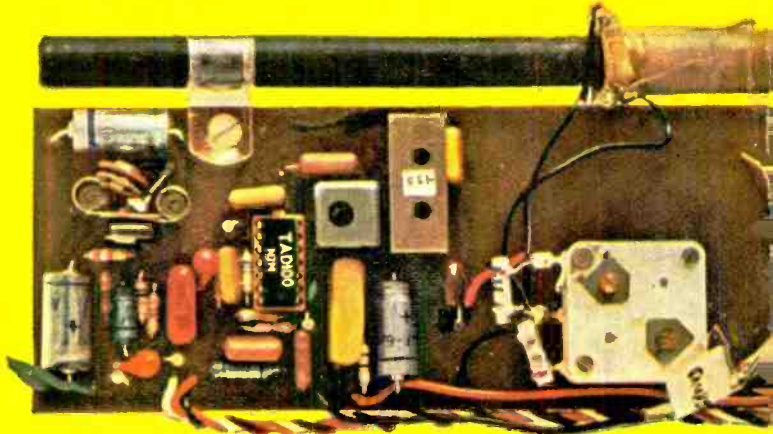

Dazzle your friends with lightworks.



Sound n' Color®

The *now* dimension to music pleasure. EICO All Electronic Solid-State Audio-Color Organs transform sound waves into moving synchronized color images. Connect easily to speaker leads of hi-fi or radio. From \$29.95.



Translators

The electronics you need to create audio-stimulated light displays to your own imagination. Actuates: Light Display Units, Strobe Lites, any lamp configuration (Xmas trees, patio lights, etc.). From \$24.95 kit, \$39.95 wired.



Strobe Lites

High-intensity bursts of white light from Xenon tube flash in cadence with each beat of audio. From \$24.95 kit, \$39.95 wired.

Build the Stereo Kits praised by experts.

All amplifier power ratings according to IHF standards. Cortina® designed and manufactured in U.S.A. and guaranteed by EICO.

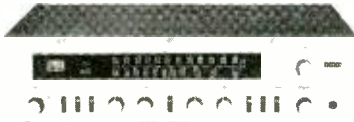

70-Watt AM/FM Stereo Receiver including cabinet. Cortina 3770, \$189.95 kit, \$279.95 wired.

70-Watt FM Stereo Receiver including cabinet. Cortina 3570, \$169.95 kit, \$259.95 wired.



150-Watt Silicon Solid-State Stereo Amplifier, including cabinet. For the audio perfectionist. Cortina 3150, \$149.95 kit, \$225 wired.

70-Watt Silicon Solid-State Stereo Amplifier, including cabinet. Cortina 3070, \$99.95 kit, \$139.95 wired.



FM Stereo Tuner including cabinet. Cortina 3200, \$99.95 kit, \$139.95 wired.



EC-1100
FM WIRELESS MIKE \$9.95

Build for fun and use with Eicocraft® jiffy project kits.

The newest excitement in kits. 100% solid-state and professional. Expandable, interconnectable. Excellent as introductions to electronics. No technical experience needed. Finest parts, pre-drilled etched printed circuit boards, step-by-step instructions. 36 kits to select from, \$2.50 to \$9.95. Just released: EC-2600 "Super Snooper" \$8.95; EC-2700 Police & Fire Converter



(lo band) \$7.95; EC-2800 Aircraft Converter \$7.95; EC-2900 Police & Fire Converter (hi band) \$7.95; EC-3100 2-Station Intercom (with cases) \$10.95; EC-3200 "Do-It-Yourself" PC Etching Kit \$4.95; EC-2300 Audio Preamplifier \$8.95; EC-2400 Bullhorn \$8.95; EC-2500 Fuzzbox \$8.95.



EC-1900 TREASURE FINDER \$9.95

Shape up your own car/boat with EICO Engine Analyzer

For all 6V/12V systems; 4, 6, 8-cyl. engines. Now you can keep your car or boat engine in tip-top shape with this solid-state, portable, self-powered universal engine analyzer.

Completely tests your *total* ignition/electrical system. Complete with comprehensive Tune-up & Trouble-shooting Manual. EICO 888, \$49.95 kit, \$69.95 wired.



Be a technocrat with EICO® solid-state test equipment

Only EICO brings you laboratory precision and long life at lowest cost.



EICO 240 Solid-State FET-TVOM \$49.95 kit, \$69.95 wired



EICO 379 Solid-State Sine/Square Wave Generator \$54.95 kit, \$74.95 wired

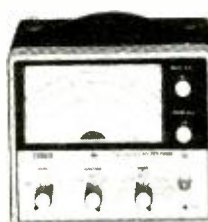

EICO 242 Solid-State Deluxe FET-TVOM \$59.95 kit, \$79.95 wired.

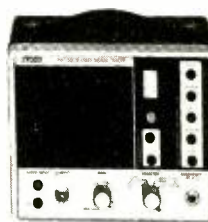

EICO 150 Solid-State Signal Tracer \$49.95 kit, \$69.95 wired



EICO 330 Solid-State RF Signal Generator \$59.95 kit, \$79.95 wired

You save up to 50% with EICO Kits. Since 1945, Best Buys in Electronics. Over 3 Million EICO Instruments Now in Use.

FREE 1969 CATALOG

Send me FREE catalog describing the full EICO line of 200 best buys, and name of nearest dealer.

EI-11



EICO Electronic Instrument Co., Inc.
283 Malta Street, Brooklyn, N.Y. 11207
Available In Canada

Name _____

Address _____

City _____

State _____

Zip _____

Here's More Alarming News From The Alarmists!

Dialtronic Automatic Telephone Communicator Model DT-1000



Radar Sentry Alarm announces a new powerful way to stop crime . . . "Dialtronic"

Radar Sentry Alarm announces a new powerful way to fight crime. Imagine a security system that automatically and silently delivers any emergency message for which it is programmed. Dialtronic adds a new dimension to your security needs. Advanced concepts in technology and design bring you a new level of security. Providing unlimited application, the Dialtronic uses solid state circuitry to bring help immediately. Use it with existing alarm systems or any other sensing device. Dialtronic is the ideal personal protection for anyone who is vulnerable to intruders. Dialtronic will perform with never a lapse in security . . . You are assured of highly reliable protection.

Also used to protect premises while they are being occupied, the Radar Dialtronic gives push button protection to businesses and home owners alike. This system is triggered by a hidden push button or portable transmitter. Once set into action, it automatically dials the phone—delivering any pre-recorded message for which it is programmed without the would-be-thiefs' knowledge. In effect, the Dialtronic gives you a direct line to police, fire departments, in-plant security, key personnel . . . whoever you designate.

Dialtronic's built-in programmer lets you magnetically store "error free" messages on cassette type tape cartridges. Stored information is instantly available to notify proper officials, delivering correct message in each case.

Advantages of Dialtronic Telephone Communicator

- Eliminates costly leased telephone lines.
- Simultaneously stores up to ten separate messages on magnetic tape.
- Automatically dials the right people and delivers the correct message in each case.
- Battery operated (optional) Rechargeable "Nic/Cad" batteries with built-in charger.
- Converts existing local alarm to central station system. Easily and quickly installed.
- Silent "on premises hold up alarm with the ability to get the facts out" instantly.
- Can be used with optional wireless control.
- Home prowler alarm, fire alarm, emergency alarm for invalids. Can be programmed for any emergency.

The Crimebusters Want You! . . . Now!



. . . To make the biggest profits of your career—filling ready-made demand for the dramatic new RADAR SENTRY ALARM systems. Get started NOW as dealer or distributor—step into five-figure income at once, with unlimited potential and wide-open opportunity to grow as you go! MAIL COUPON AT ONCE!

← Circle 8 on reader service card

RADAR DEVICES MFG. CORP.
22003 Harper Avenue
St. Clair Shores, Michigan 48080

- Send me the alarming details.
 Also send me booklet outlining available dealerships.

Name

Address

CityStateZip

Circle 9 on reader service card

AGING IMPROVES LEAD BATTERY



MURRAY HILL, N.J.—

The conical grid held next to this new cylindrical lead-acid battery is a key element for doubling battery life to 30 years over the 15-year life of present batteries. The new Bell Labs design causes the battery to improve with age.

The circular grid is made with pure lead instead of commonly used lead alloys that corrode more rapidly. A special energy-producing paste with an interlocking crystal structure is also used. The cylindrical design causes the grid to expand evenly as the lead corrodes. This, unlike normal batteries, keeps the rings in contact with the paste constantly. Eventually, corrosion effectively increases the amount of paste, which improves the battery capability.

The Bell System uses about \$15 million worth of batteries a year as an emergency power source. Although not designed for car batteries, the principle will probably be applied in the automobile market.

IN THIS ISSUE

Experimenters note: They've packed most of the elements for a radio on an IC chip. Learn how you can use it on page 49.

BRUSHLESS MOTOR

TOKYO—Use of the Hall effect for a brushless dc motor has been announced by Pioneer Electronic Corp. for portable and car tape recorders. The motors, which do not need commutators or brushes, reportedly provide noise free operation with very low rumble, wow and flutter.

With the Hall effect, a voltage is developed across a conductive material when it is placed in a vertical magnetic field. Pioneer uses IC's in conjunction with the Hall device to electronically operate the motor.



ELECTRON BEAMS REDUCE IC SIZE

PITTSBURGH—A new technique that uses electron beams instead of light to make integrated circuits can make possible "the next generation of miniaturized electronic circuitry," according to Westinghouse.

With the technique, some 4 million three-element electronic devices can be squeezed onto a postage stamp size area. A Westinghouse scientist said circuit components 100 times smaller than those available for large-scale integration IC's today will be possible.

To make the masks used to fabricate the LSI wafers, the drawings are digitized and put on magnetic tape. A computer then uses the information to control a scanning electron microscope, which traces an exact-size mask pattern into a sensitized metal plate. The stencil-like, light-sensitive masks are then placed one after another at the cathode of an image tube. When light is shined on the masks they eject electrons toward the anode of the tube. A sensitized silicon wafer at the anode records the pattern of each mask.

The photo shows a TV display of one of the masks used to form the LSI circuit on the wafer being held.

LOOKING AHEAD

by DAVID LACHENBRUCH
CONTRIBUTING EDITOR

Entertainment via EVR

The first group of entertainment programs for Electronic Video Recording (EVR) players has now been announced, perhaps foreshadowing a new type of "television" service to the home. EVR is the TV cartridge-film system developed by CBS Laboratories. Initial black-and-white EVR players will be made next year by Motorola for educational use, with home color players scheduled in 1971.

The EVR entertainment cartridges are part of a service being offered by Motorola initially to hospitals and nursing homes for playing through their TV distribution systems. They include films on professional football, great prizefights, Laurel & Hardy classics, children's cartoons. In offering these entertainment cartridge to hospitals (in addition to health films, such as "How to Stop Smoking"), Motorola reasons that bedridden patients are entitled to daytime visual entertainment other than the normal telecast fare of soap operas.

Even more significant, however, is the entry of Motorola—currently the exclusive U.S. producer of EVR—into the EVR software field. It could be that this is a test to prepare for the eventuality of a huge home market for entertainment and educational video recordings.

Brighter & costlier

Those new super-bright color tubes announced by almost all television manufacturers are going to be reflected in the cost of the sets they go into. Initial indications are that most or all of the manufacturers will compensate for the increased cost by raising prices of sets with the new tubes about \$20. Some, however, will avoid an outright increase by using the new tubes only in yet-to-be-introduced models, rather than phasing them into existing models. Either way, the tubes cost more, and the buyer will pay more.

R-E

(continued on page 12)

Radio-Electronics

November 1969 • Over 60 Years of Electronics Publishing

BUILD ONE OF THESE

- Electronic Throttle Control 42 Henry Mierlak**
Run model trains just like the real ones
- One-IC Radio 49**
Take an IC, add two transistors, and . . .
- Perfect Electronic Keyer 69 W. O. Hamlin, W6ENU**
Dots and dashes accurately and almost automatically

TELEVISION

- Automatic Tint Control Is Here 4 Robert F. Scott**
Here's how that new Magnavox circuit operates
- In The Shop 14 Jack Darr**
Transistor testing—what with?
- Kwik-Fix™ 37 Forest Belt**
6HS8 noise-cancelling, sync/age stage
- How To Fix Bad Color 52 Matt Mandl**
What you can do to put better pictures on your screen
- Service Clinic 90 Jack Darr**

FOR THE EXPERIMENTER

- MOSFETs—How They Work 33 Tom Haskett**
The inside story on these new semiconductors
- Using Electronic Breadboards 62 Jim Ashe**
Experimenting with new circuits can be easy

ELECTRONICS TODAY

- Looking Ahead 2 Dave Lachenbruch**
Current happenings with future overtones
- All About Tools 44 Tom Haskett**
This month we examine the screwdriver
- Chemical Tools—Secret Weapon in Your Shop 60 J. Merino y Coronado**
Use chemicals to do a better job faster
- Channel Separation Nomograph 73 Max H. Applebaum**
- Equipment Report 78 Jack Darr**

DEPARTMENTS

- | | | |
|------------------------------------|------------------------------------|-------------------------------|
| Correspondence 22 | New Literature 91 | Technotes 94 |
| New & Timely 2 | New Products 87 | TTO's 98 |
| Reader Service 85 | | |

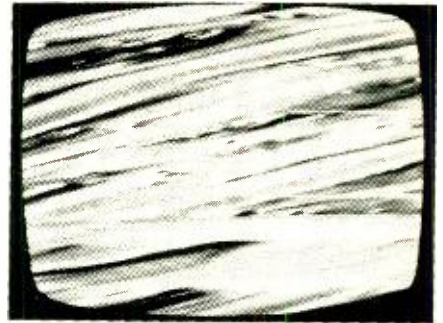

Got this on the screen? If the sync circuit uses a 6HS8, Kwik-Fix can be the solution. [see page 52](#)

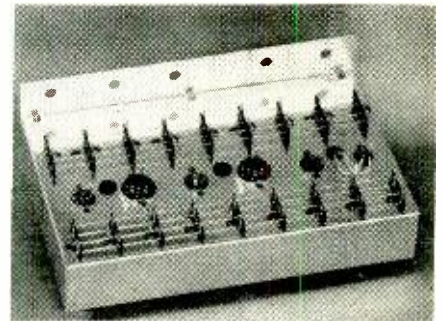

Breadboards have changed. See how the new ones can help you set up trial circuits fast and easy. [see page 62](#)

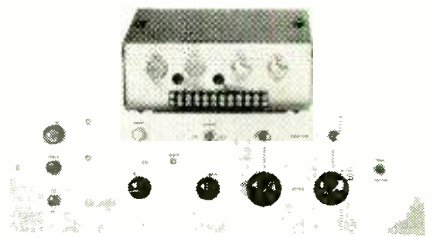

Model Railroaders! Here's a throttle control that makes those model trains operate like the real ones. [see page 42](#)

RADIO-ELECTRONICS, NOVEMBER 1969, Vol. 46, No. 11
Published monthly by Gernsback Publications, Inc., at Ferry St., Concord, N. H. 03302
Editorial, Advertising, and Executive offices: 200 Park Ave. S., New York, N.Y. 10003. Subscription Service: Boulder, Colo. 80302.
Second-class postage paid at Concord, N. H. Printed in U.S.A. One-year subscription rate: U.S. and possessions, Canada, \$6.
Pan-American countries, \$7.50. Single copies, 60¢. ©1969, by Gernsback Publications, Inc. All rights reserved.
POSTMASTER: Notices of undelivered copies (Form 3579) to Boulder, Colo. 80302.



Radio-Electronics is indexed in *Applied Science & Technology Index* (formerly *Industrial Arts Index*)

AUTOMATIC TINT CONTROL FOR COLOR TV

By ROBERT F. SCOTT

SENIOR TECHNICAL EDITOR

An innovation in some 1970 Magnavox color TV receivers is certain to make life simpler for the viewer and will, no doubt, accelerate the growth and popularity of color TV. This new development, called *automatic tint control* or *atc*, keeps flesh-tones relatively constant and eliminates the need to adjust the set's tint and color controls after program changes or when switching channels. It keeps flesh-tones just as you want them, even when the station switches cameras on live programs or switches to film or tape. For now, we'll take a look at the basic operation of automatic tint control operation and will leave a detailed circuit analysis for later.

Each color produced on a TV screen is the result of a definite phase difference between the 3.58-MHz burst and the 3.58-MHz sinewave chroma signal. The color wheel (below) shows that

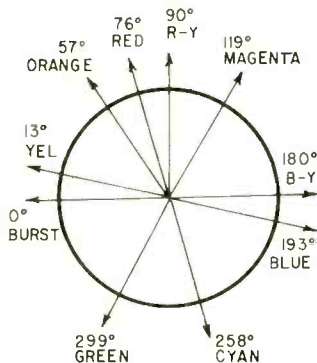

when the burst is taken as a reference point, all colors lag the burst by varying degrees.

Flesh-tones and all other impure colors are the mixture of the two pure colors (red-blue, blue-green or green-red) that lead and lag them in phase. Small phase errors occurring during the transmission of colors such as magenta and cyan are seldom detected or are not objectionable be-

cause these colors occupy relatively wide areas between red and blue and blue and green, respectively. Too, a viewer may not detect the error if the magenta coffee can he sees on the TV screen is a little too red or too blue.

On the other hand, the viewer likes flesh-tones confined to a very narrow sector occupying a few degrees above and below 57 degrees. If the phase lag of the chroma signal is less than 57 degrees, the face takes on a greenish hue. A transmission error causing the 57-degree or "I" vector to shift toward 90 degrees produces red faces.

The Magnavox scheme, called Total Automatic Color or TAC, is a combination of automatic fine tuning, automatic chroma control and automatic tint control. Aft and acc are needed for satisfactory operation of the atc circuit. A block diagram of the atc circuit is shown below. The chroma amplifier, red and yellow gates and the 3.58-MHz switch are transistors.

The output of the band-pass amplifier is tapped off the arm of the color control and fed to the input of the chroma amplifier. It is also fed through a 3-position switch (FULL-PARTIAL-OFF) directly to the yellow gate and through a 90-degree phase-shift network to the red gate.

The red and yellow gates are set up somewhat like gated or keyed age amplifiers with their emitters returned to ground through the collector-emitter circuit of the 3.58-MHz switch. The npn gates can conduct only when their bases are forward-biased by the positive portions of the chroma signal and only during the periods when the switch is closed (turned on) by the positive half-cycles of the 3.58-MHz reference signal

from the color oscillator.

The reference signal has a phase of 90 degrees. The phase-shift network and PREFERENCE control can vary the phase of this reference signal fed to the 3.58-MHz switch. The normal phase for the sample or gating time is 13 degrees. The PREFERENCE control permits the gating time to be varied plus or minus 30 degrees. The precise setting of the control produces the desired flesh-tones.

The "on" time of the gates is very short because the switch closes only on the positive peaks of the 3.58-MHz reference signal. Chroma signals between yellow and magenta are positive-going during the gating time and produce correction voltages at the gate outputs. Chroma signals such as blue, cyan and green are negative-going and cannot produce correction voltages.

Maximum output is obtained from the yellow gate when a yellow chroma signal is fed to its input. The 13-degree yellow chroma signal is at its positive peak when the gate closes at 13 degrees. The yellow signal produces

very little output from the red gate. When the red gate is keyed on at 13 degrees from the reference oscillator, the chroma signal—advanced 90 degrees to 283 degrees—is passing through zero and cannot forward-bias the keyer's base.

The red gate produces maximum output from a chroma signal of 103 degrees. This signal is advanced (moved back toward zero) 90 degrees to 13 degrees so it is at its peak when the gate is keyed on. The yellow gate produces little or no output at this time because it is passing through zero when the keying pulse hits its emitter.

The correction voltage from the yellow gate is delayed 90 degrees and the red-gate output is advanced 30 degrees before the two correction voltages are fed in parallel to the base of the chroma amplifier. Both signals are then inverted 180 degrees by the chroma amplifier.

The chroma signal from the color control is fed to the chroma amplifier emitter. The ultimate phase of the yellow correction voltage is 103 de-

(continued on page 41)

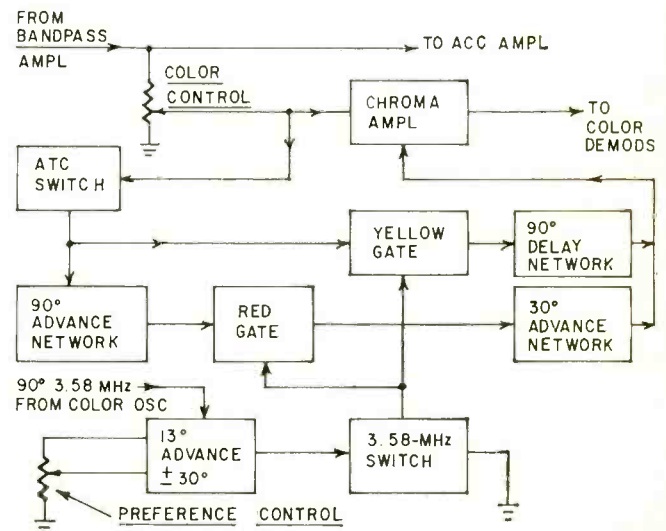

Now is the time to get into TV Repair—and \$99 is all it takes to do it !

...with a program that wins enthusiastic approvals like these!



"Overjoyed with the program!"*



"Highly recommend it!"*



"Best!"*

This is a TV Repair program that anyone with normal intelligence can learn.

A program that anyone can afford. *The cost is actually under \$100.* And backed by the reputation of ICS.

A program so thorough, so beautifully organized and presented, that it can easily be completed in six months. And win enthusiastic approvals like those quoted above. As well as the complete approval of National Electronic Associations.

A program that requires no special location. And no special equipment beyond an old TV set to work on, and a few inexpensive tools.

A step-by-step program so effective, so practical, that you should be able to repair 70% of what goes wrong with TV sets *after only a few weeks of study.* Black-and-white or color.

A program that trains you to move confidently into this booming field in any way you choose—as a hobby, a part-time money-maker, full-time apprentice, even your own business. *And what a future can be yours!*

A program that leads to membership in the ICS TV Repair Institute, and a coveted ICS diploma to *prove your qualifications.*

And you don't have to take our word for any of it—or even the word of the men who have taken it and pronounced it terrific. If, after you look the course over for 10 days, you decide it's not for you—*your money back.*

Now the only question is—what are you waiting for? For full information, send the coupon—today!

*Actual comments, from the ICS files.

ICS International Correspondence Schools
Division of Intext
Clip coupon here—mail to ICS, Scranton, Pa. 18515.

ICS, Scranton, Pa. 18515		E2513K
Rush me <i>free</i> information on TV servicing! I understand there is no obligation.		
NAME	(please print)	
ADDRESS		
CITY		
STATE	ZIP	

Circle 10 on reader service card

PHONE LINES CARRY HIGH GRADE CCTV

RIVER FOREST, ILL.—Closed circuit TV signals are being transmitted over a pair of 22-gauge, voice-grade phones between a bank and police station in River Forest. Although the experimental security-monitor circuit is only 1000 feet long, according to a recent *Electronic News* report, tests by the Canadian Broadcasting Co. with similar equipment suggest quality (875-line) images can be sent 15,000 feet.

Costs with the CCTV system are only 5% of the customary coaxial cable system, according to Hiatt Electronics, Inc., a US franchiser for West Germany's Grundig, who make the system.

A scramble/unscramble technique is used in which the camera signal is split and transmitted in two 180° out-of-phase halves. Grundig reportedly plans simultaneous voice transmission over a single pair and color TV capability over 22 wire pairs within a year.

Bell System's Picturephone service, now being put into operation, uses a 6-wire loop with amplifiers for two-way transmission.

ATOMIC CLOCK FOR EXPO '70

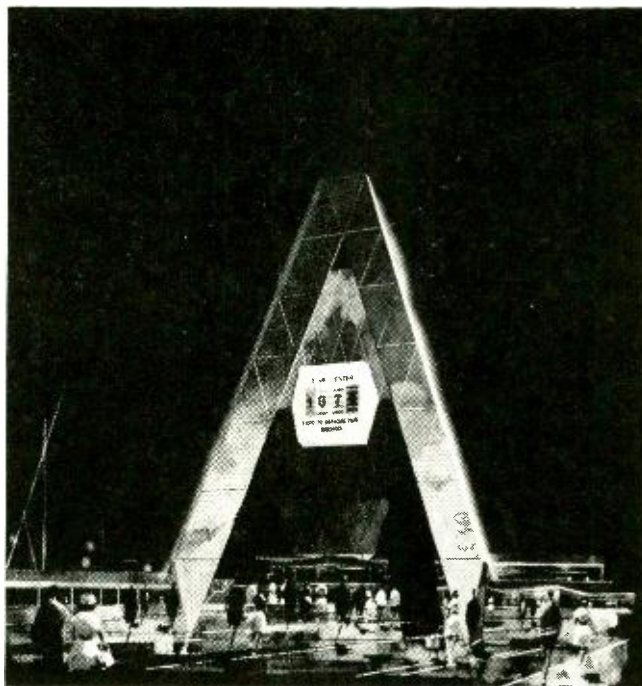

OSAKA, JAPAN—Visitors to Japan's world fair, Expo '70, will be sure of having the right time handy. Some 110 standard and digital clocks throughout the fairgrounds are being equipped with uhf receivers.

An atomic-regulated master clock installed in a time center (see drawing) will transmit super accurate time signals to the receivers

operating with each clock.

The master clock uses a crystal oscillator system that is in turn regulated by an atomic frequency standard. The system is designed to vary in accuracy by only one or two seconds in several thousand years.

Seiko of Japan, a watch manufacturer and official time keeper for the world exposition, is preparing the system.

NEW X-RAY STANDARDS SET FOR COLOR TV

WASHINGTON—A gradual tightening of standards to cut X-ray emission from color TV was approved by a Department of Health, Education and Welfare technical committee in August.

According to the three-part proposal, by January 1970, sets must be built so that radiation does not exceed 0.5 milliroentgens per hour about 2 inches from any point when power supply voltages exceed normal levels. By June 1970, this 0.5 mR could not be exceeded even if viewers tried to readjust controls.

Finally, effective in 1971, the new rules call for limiting X-radiation to below the 0.5 mR level even if the set malfunctions.

SEMICONDUCTORS MAY BOOST REPAIR RATES

CHICAGO—The National Alliance of Television Electronics Service Assn. went on record against extended warranties again, and members were told solid-state components and warranties might require service rate increases to offset parts profits decline. **R-E**

Radio-Electronics

HUGO GERNSBACK (1884-1967)
founder

M. HARVEY GERNSBACK,
editor and publisher

LARRY STECKLER, managing editor

Robert F. Scott, W2PVG
senior technical editor

John R. Free, associate editor

Jack Darr, service editor

I. Queen, editorial associate

Matthew Mandl, contributing editor

David Lachenbruch, contributing editor

Vincent P. Cicenja, production manager

Elizabeth Shincel, production assistant

H. Matysko, circulation

Cover by Harry Schlack

RADIO-ELECTRONICS is published by Gernsback Publications, Inc. 200 Park Ave. South New York, N.Y. 10003 (212) 777-6400

President: M. Harvey Gernsback
Secretary: Bertina Baer

ADVERTISING REPRESENTATIVES

EAST
John J. Lamson, Eastern Sales Mgr.

MIDWEST
Robert Pattis, the Bill Pattis Co., 4761 West Touhy Ave., Lincolnwood, Ill. 60646 (312) 679-1100

W. COAST/Texas/Arkansas/Oklahoma
J. E. Publishers Representative Co., 8380 Melrose Ave., Los Angeles, Calif. 90069. (213) 653-5841; 420 Market St. San Francisco, Calif. 94111, (415) 981-4527

SOUTHEAST
E. Lucian Neff Associates 25 Castle Harbor Isle Fort Lauderdale, Florida 33308 (305) 566-5656

SUBSCRIPTION SERVICE: Send all subscription orders and correspondence to RADIO-ELECTRONICS, Subscription Department, Boulder, Colo. 80302.

MOVING? For change of address, allow six weeks, furnishing both the old and new addresses and if possible attaching label from a recent issue below. Otherwise please print clearly your name and address exactly as it appears on your label.

ATTACH LABEL HERE

name (please print)

address

city state zip code

Mail to: RADIO-ELECTRONICS
SUBSCRIPTION DEPT., BOULDER, COLO. 80302

Circle 11 on reader service card →

**JFD is ready!... 20 million homes are ready!...
Get ready... get set... go with new**

JFD Home Entertainment Program Center Kits

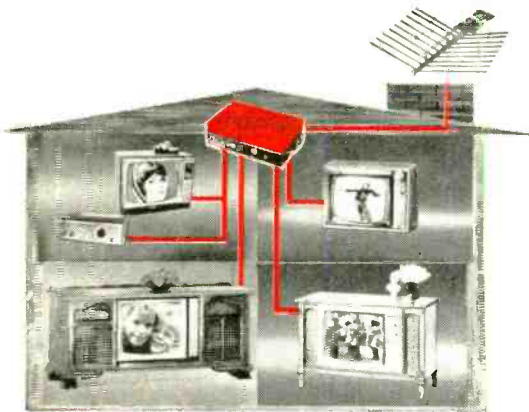

- ★ Provide up to 4 TV sets with *different* programs — from 1 antenna.
- ★ Beautifully packaged in *full-color carry-home* display carton.
- ★ Distribution amplifier powerful enough to drive up to 12 sets — with additional splitters.

Whether you install it yourself or sell it over-the-counter, the unique JFD Home Entertainment Program Center Kit gets you in on the ground floor of a lucrative new untapped market — 20 million households with two or more sets that can use a distribution system.

Make every home an entertainment center!

Thousands of old home owners, new home owners, contractors, and builders in your area are ready-to-buy prospects for (4) JFD Program Center Kits

**Easy to sell!
Easy to install!**

SEE YOUR DISTRIBUTOR
OR WRITE FOR OUR PROMOTION KIT



JFD ELECTRONICS CORP.

SUBSIDIARY OF RIKER-HANSON CO. INC.

10 AVENUE AT 66 STREET, BROOKLYN, NEW YORK 11216

JFD (INTERNATIONAL), 9200 SHAWNEE DRIVE WESTBURY, N.Y. 11590 / JFD CANADA LTD., ONTARIO, CANADA

JFD DE VENEZUELA, S. A., AVENIDA LOS HATICOS 125-97, MARACAIBO, VENEZUELA

© 1966 JFD

Discover the ease and excitement of learning Electronics with programmed equipment NRI sends you

When you train at home with NRI, you train with your hands as well as your head. You learn the WHY of Electronics, Communications, TV-Radio the NRI pioneering "3-Dimensional" way. NRI training is the result of more than half a century of simplifying, organizing, dramatizing subject matter, and providing personal services unique for a home study school. You get the kind of technical training that gives you priceless confidence as you gain experience equal to many, many months of training on the job.

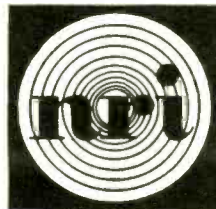

NRI—The 53 Year Leader in Electronics Training

APPROVED UNDER NEW GI BILL

If you served since January 31, 1955, or are in service, check GI line in postage-free card.



*Earn \$5 or more an hour
spare or full time in*

TV-RADIO SERVICING

Color Television has arrived. Sales are soaring, along with the continuing popularity of other home entertainment equipment like portable radios, tape recorders, hi-fi sets, phonographs and auto radios. TV-Radio servicing is one of your best routes to spare-time earnings, a good paying job or a business of your own. NRI not only trains you quickly and expertly, but also shows you how to get started in Servicing soon after you enroll, earning as you learn. NRI trains you in today's methods of installing and repairing all Electronic equipment for the home—including booming Color TV. You even build, experiment with and keep to enjoy your own solid-state radio and your choice of black-and-white or Color TV receiver. Like thousands of others, you can be earning \$5 or more an hour extra in spare time starting soon.

*There's money and
success awaiting you in*

BROADCASTING— COMMUNICATIONS

The experience you gain from intensely practical NRI training in Complete Communications equals as much as two years of training on the job. With NRI, you can train for a choice of careers ranging from mobile, marine and aviation radio to TV broadcasting and space communications. You learn how to install, maintain and operate today's remarkable transmitting and receiving equipment by actually *doing* it. You build and experiment with test equipment, like a VTVM you keep. You build and operate amplifier circuits, transmission line and antenna systems, even build and use a phone-cw transmitter suitable for transmission on the 80-meter amateur band. Whichever of five NRI Communications courses you choose, you prepare for your FCC License exams, and you must pass your FCC exams or NRI refunds your tuition in full.

*Move ahead in America's
fast growing industry as*

ELECTRONICS TECHNICIAN

Electronics touches everyone's lives. This vast field of opportunity is open to you with NRI training. Industrial/Military Electronics training—like all NRI courses—prepares you quickly, thoroughly the practical "hands on" way. You build with, and learn to understand the functions of, today's miracle solid-state components like printed circuits, diodes and transistors. You build and experiment with Electronic circuitry used in automation, data processing, ultrasonics, telemetry. Whatever your interest in Electronics, NRI training can fill your needs. Prove to yourself what nearly a million NRI students could tell you . . . that you get more for your money from NRI. Check the postage-free card and mail it today for your FREE NRI Color Catalog. No salesman will call. NATIONAL RADIO INSTITUTE, Electronics Division, Washington, D.C. 20016.

YOU GET MORE FOR YOUR MONEY FROM NRI — Build, test, explore, discover. Everything you see here is included in one NRI course—including Color TV. Other courses equally complete. And you'll be surprised at the low tuition costs. Text for text, kit for kit, dollar for dollar—you get more for your money from NRI.

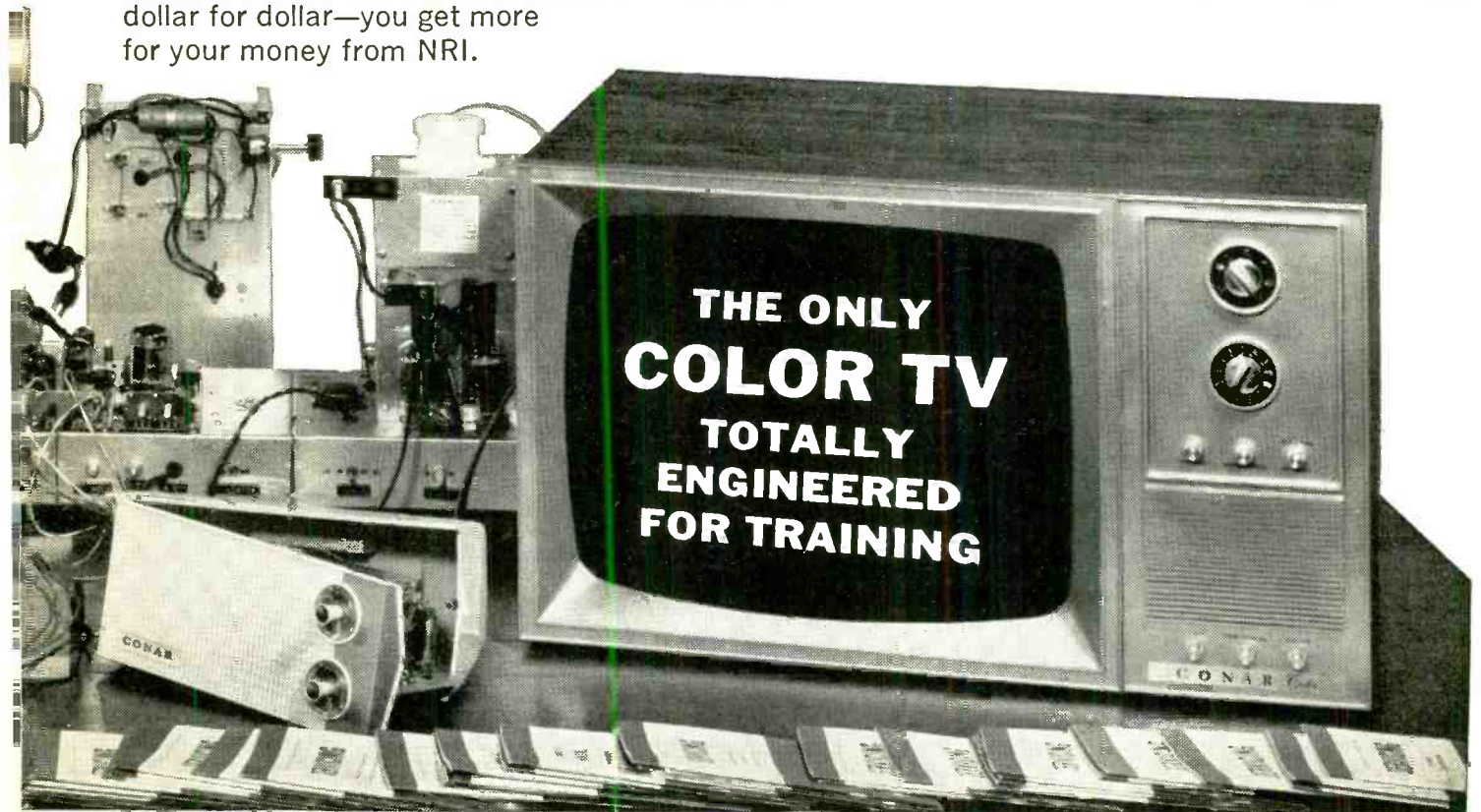

THROW AWAY THE SOLDER OR MY DADDY USES CUSS WORDS

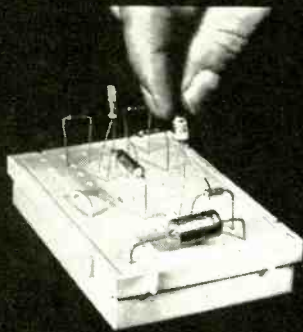

Some years ago two men, Mr. S. and Mr. deC had an idea. Wearing white hats they dutifully offered it to the giant electronics conglomerate under whose roof they laboured. He sneered so they left and developed it on their own.

It's a solderless breadboard and the secret lies in a precision clip of firm grasp and low resistance. These clips are leafspring contacts of phosphor bronze or silverplate.



As with all good things customers came up with more ideas using S-DeCs than the originators believed possible and the demand for added flexibility resulted in a box with two interlocking S-DeCs known as DeCSTOR, (pronounced Deck-Store). Not content with this, users circuits outgrew the DeCSTOR and so a 4-DeC kit was created for the man with ideas bigger than his breadboard. Today there is a whole range of DeC solderless breadboards covering conventional and integrated circuit requirements.

So, if you need to throw away the solder, keep the skin on your fingers and the black words buried down below, write to us for more information, or better still send us a check.

INTRATEC

399 Jefferson Davis Highway
Arlington, Virginia 22202

Please send me postage paid:

..... S-DeC's @ \$ 6.75 each
..... DeC STOR's @ \$13.75 each
..... 4-DeC's @ \$23.25 each

I enclose a check/money order for \$.....
Va. residents add 4% sales tax

I am interested in the IC versions. Send literature and prices.

Name

Address

City

State Zip Code

Box RE

Circle 13 on reader service card

LOOKING AHEAD

(continued from page 2)

Pictures from FM stations

The FCC has been asked to authorize tests of TV picture transmission from an FM station in a trial of a special educational service. The pictures would be sent by slow-scan techniques (no motion could be shown) on a 5-kHz subcarrier of a Flint, Mich., educational FM outlet. Other subcarriers of the same station would transmit audio educational material, while the main channel would carry the station's normal programming. Educating Systems, Inc., which has requested the test, would supply specially modified television receivers for the TV-FM broadcasts. Pushbuttons on the receiver would permit students to answer questions asked by the instructor. The various subcarriers, selected by the pushbuttons, would tell students whether their replies were correct or incorrect, and why.

SCA receiver ban

The FCC, in a surprise action, has banned the sale of SCA (multiplex) receivers by a retail and mail-order chain to general consumers. Armed with a Justice Department opinion, the Commission obtained agreement by Lafayette Radio to stop selling radios designed to receive Subsidiary Communications background music subcarrier transmissions. The Justice Department said that unauthorized use of private transmissions was illegal when the listener derives a "gain" from it—the "gain" in this case presumably being enjoyment of music. Previous FCC advisory opinions had indicated that the Commission saw no law violation in consumer reception of SCA transmissions.

FM dominates radio

The dream that frequency modulation some day would be the dominant force in radio has finally been realized. For the first time in history, Americans are buying more FM-equipped than AM-only radios. In this year's second quarter, the crossover became apparent. Of 8.9 million table, clock and portable radios sold in the United States, 4.6 million (or 51.9%) had FM.

Thus the common garden variety home and portable radio has now joined the more sophisticated component tuner and the radio-phonograph or TV combination in converting to FM. The only radio field which is still a virtual AM monopoly is auto radio—but even this is gradually changing. In 1968, about 11% of car radios sold had FM. The share inched up to 13% in the first half of this year.

Government X-ray standards

Agreement has been reached between the government's Bureau of Radiological Health and a government-industry-public advisory committee on standards for radiation for color sets, involving a progressive tightening of permissible limits. As of next Jan. 1, no receiver may radiate more than 0.5 milliroentgens per hour (mR/hr.) as measured at 5 centimeters (about 2 inches) from any surface of the outside of the set with line voltage at 130 and all user controls set for maximum radiation.

Beginning June 1, the same limits will apply, but with service controls set so as to produce maximum radiation. And, as of June 1, 1971, the 0.5-mR limit will be enforced with receivers doctored to simulate failure of components or circuits (shunt regulator, etc.) to increase radiation. Television set manufacturers, now concentrating on introducing such fail-safe components as solid-state high-voltage rectifiers, feel that they can meet this schedule.

The next X-ray standard to be propounded by the Bureau is expected to set limit on radiation of receivers during servicing, for the protection of technicians.

R-E



DELTA will tell you *everything!* — Complete Specs including schematics!

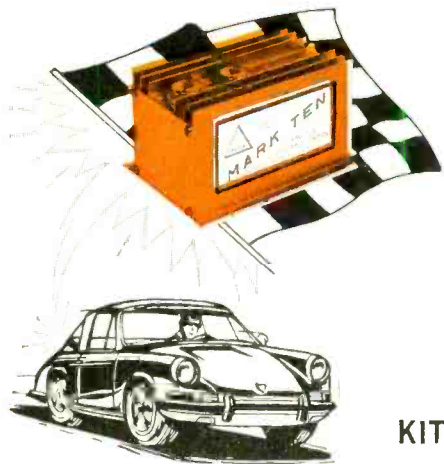

MARK TEN® SCR

CAPACITIVE DISCHARGE IGNITION SYSTEM

Now discover for yourself the dramatic improvement in performance of your car, camper, jeep, truck, boat — any vehicle. Delta's remarkable electronic achievement saves on gas, promotes better acceleration, gives your car that zip you've always wanted. Find out why even Detroit has finally come around. In five years of proven reliability, Delta's Mark Ten has set new records of ignition benefits. No re-wiring! Works on literally any type of gasoline engine.

- ▲ Dramatic Increase in Performance and in Fast Acceleration
- ▲ Promotes More Complete Combustion
- ▲ Points and Plugs Last 3 to 10 Times Longer
- ▲ Up to 20% Mileage Increase (saves gas)

KIT FORM **\$29⁹⁵**
12V ONLY

ASSEMBLED ONLY **\$44⁹⁵**
ppd.

MODEL 3000 FET VOM

Delta now offers a compact, versatile, and extremely sensitive VOM which combines FETs and ICs for extreme accuracy. Compact (6½"W x 8"H x 3½"D), portable. Wt. 3¾ lbs.

IN KIT FORM: Feedback network with pre-selected components to eliminate all final calibration. Ready to use when assembled!

NEW DELTA FEATURES:

- ▲ Mirror scale 200 A D'Arsonval meter
- ▲ Integrated circuit (IC) operational amplifier for extreme accuracy
- ▲ FET input stage with current regulator
- ▲ Two stage transistor current regulator and Zener diode on OHMS for absolute stability and accuracy
- ▲ Voltage clippers for protection of input stage

- ▲ Fully temperature compensated for low low zero drift
- ▲ Ten turns ZERO and OHMS adjust potentiometers
- ▲ Epoxy glass circuit boards and metal case
- ▲ Enclosed switches
- ▲ Uses readily available type AA cells
- ▲ Uses standard test leads for maximum flexibility and ease of measurement
- ▲ 10 Megohms input impedance

ONLY **\$74⁹⁵**
ppd.

Only **\$59⁹⁵**
ppd.

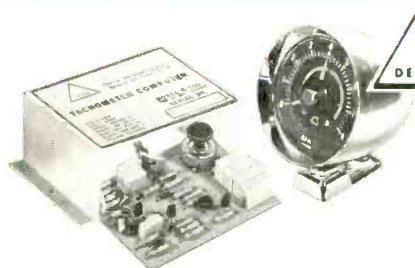

COMPUTACH®

Delta, pioneers in CD ignition who produced the fabulous MARK TEN®, now offer a precise computer-tachometer which obsoletes any type tachometer on the market today! You achieve unbelievable accuracy in RPM readings due to the advanced, solid-state electronic matched components used in the computer, coupled with the finest precision meter in the world. Works on all 2, 3, 4, and 6 cylinder 2 cycle and with 4-6-8 cylinder—4 cycle 12 volt engines.

- ▲ C-8000 RPM range
- ▲ Perfect linearity — zero parallax
- ▲ Adjustable set pointer
- ▲ Wide angle needle sweep
- ▲ Translucent illuminated dial
- ▲ Chrome plated die-cast housing
- ▲ A-1-angle ball & socket mounting
- ▲ Use it with ANY ignition system
- ▲ Meter: 3½" dia. X 3¾" deep
- ▲ Calibration kit included, no test eqpt. needed.

*An exclusive computer-tachometer for precise RPM measurement in easy-to-build Kit form!

\$29⁹⁵
ppd.

KIT FORM ONLY

DELTA: Please send me literature immediately.

I am enclosing \$_____ for items checked.

- Mark Ten SCR Kit Assembled
 Model 3000 FET VOM Kit Assembled
 Computach (Kit only)

Please ship immediately.

Name _____

Address _____

City/State _____ Zip _____

*My car is (Model) _____ (Year) _____

Write today for complete literature packet



DELTA PRODUCTS, INC.

P.O. BOX 1147 • GRAND JUNCTION, COLORADO 81501

Circle 14 on reader service card

SKINNY, YES.

undernourished?

HARDLY!

This QUAM speaker is thinner and lighter than most, but there's nothing scrawny about its sound or emaciated about its performance.

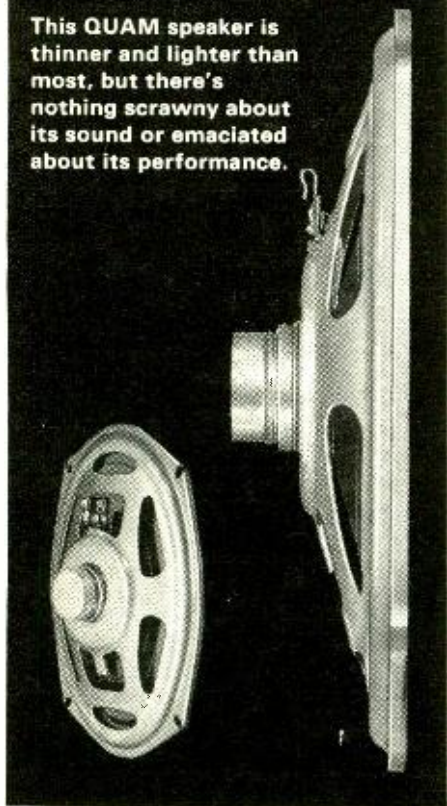

It's one of 25 models in the Quam line that's being fed a special diet . . . an exclusive new high energy magnet material we call Q/8.

Q/8 provides more gap energy for less weight, so a .65 ounce magnet gives you the same performance as a full ounce of Alnico V. Ideally suited to Quam's high density cup-pot structure, Q/8 slims the speaker down in contour as well as weight—while delivering full, robust sound.

Q/8 magnets are exclusively available today on Quam speakers—part of our ongoing program of nourishing our customers first with the finest.

QUAM

—always the
Quality Line,
for every
speaker need.

QUAM-NICHOLS COMPANY
234 East Marquette Road
Chicago, Illinois 60637

Circle 15 on reader service card

In the Shop . . . With Jack

By JACK DARR
SERVICE EDITOR

TRANSISTOR TESTING: WHAT WITH?

ONE FELLOW SAYS "AN OHMMETER'S not worth a darn for transistor testing! I like a curve-tracer."

Another one says, "Nay, nay. In-circuit beta-tester is the only thing that'll give you good results!"

The truth of the matter is that almost *any kind* of test equipment will give you some results in transistor testing. It depends on how you use it and how you interpret the results. There's no such thing as a Universal Tester for solid-state stuff.

Plain old ohmmeter

The first and probably the most frequently used is the ohmmeter. You can get a lot of dope in a hurry with an ohmmeter. The No. 1 test is strictly a "bang-bang" check on any medium-resistance range. Take a reading from any element to any other; then reverse the prods. This reverses the polarity of the ohmmeter battery (Fig. 1). So you get a low resistance reading (forward-biased junction) one way, and a high-resistance reading (back-biased junction) the other.

Due to the wide variation of transistor resistances, and the difference in ohmmeter battery voltages, there's no such thing as a standard resistance. So, all you need to look for is "High one way, Low the other." Very low or zero resistance both ways—it's shorted. OR! There is something shunted across it, in the circuitry under test.

Check the schematic, if available. If not, yank the transistor out and recheck. If you get this kind of reading out-of-circuit, *it IS shorted*.

Don't set the ohmmeter on too high a range. The X100 scale is a good compromise setting. On a batch of typical transistors, I got low readings from 1,000 ohms to 5,000 ohms, and 15,000 ohms up to 50-60,000 ohms on high. You hear repeated warnings about using an ohmmeter on transistors, for fear of blowing the transistor with the ohmmeter battery voltage. I won't say it can't happen, but it has never happened to me. Possibly the series resistance inside the ohmmeter limits the current to a very low value. It's *current* which blows transistors.

One thing you do need to know is the polarity of your ohmmeter battery. In many older vom's and some vtvm's, the red lead was always negative. Most late models have the red lead positive. If you know which is which, you can find out the sex of any transistor with a simple test.

Put the ohmmeter negative lead on the base. If this is a pnp device, you'll read a low resistance to both collector and emitter. Reversing the

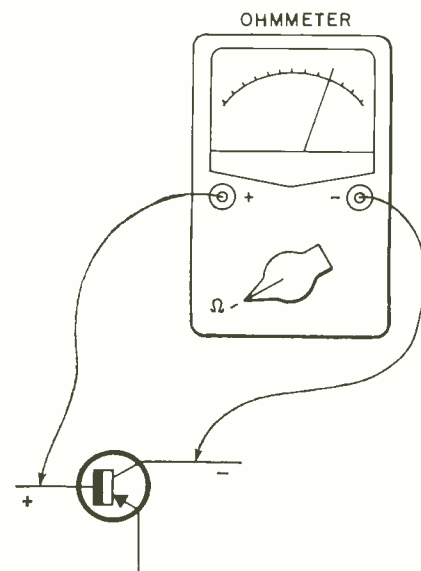

prods: high resistance to both. If it's an npn, putting the positive lead to the base will give you low resistance to collector and emitter. Reverse the prods; both high. You automatically check for internal shorts at the same time, of course.

Measuring leakage

Now comes the real bugaboo—leaky transistors. In germanium transistors, a small amount of leakage is OK. With silicons, so popular now in rf, i.f. and even af stages—none. Zero!

Leakage must be read with the transistor out-of-circuit and on an accurate leakage-tester. Any of the better modern in-circuit out-of-circuit transistor testers will read it.

Leakage problems show up in TV agc; agc-controlled i.f.'s; direct-

(continued on page 16)



Just one little mistake... and you're washed up!

That's the way it is at Channel Master.

If a color picture tube's screen doesn't pass precision inspection in 1-2-3 order...green, blue, and red...it's sent back for a complete acid wash-up.

We'll start all over again.

Even our new extra bright gadolinium rare earth phosphors at \$120 a pound go right down the drain when a color screen isn't up to standard.

Regardless of cost, we protect Channel Master's

reputation for producing Color CRTs that equal or exceed industry standards.

That's just one of the reasons why you find Channel Master CRTs in some of today's finest new color sets. It's also why you can point with pride to the Channel Master name on replacement color tubes.

Call your Channel Master Distributor. He's your complete Picture Tube Headquarters.

At Channel Master YOUR Reputation is OUR Business.

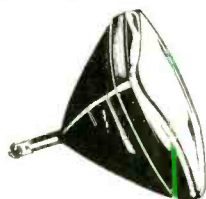

CHANNEL MASTER[®]

DIVISION OF AVNET, INC., ELLENVILLE, NEW YORK 12428

Circle 16 on reader service card

NOW—**ALL** CHECK **TRANSISTORS** IN OR OUT OF CIRCUIT ...

Flick function switch to left to check all regular transistors.

Flick function switch to right to check any FET.

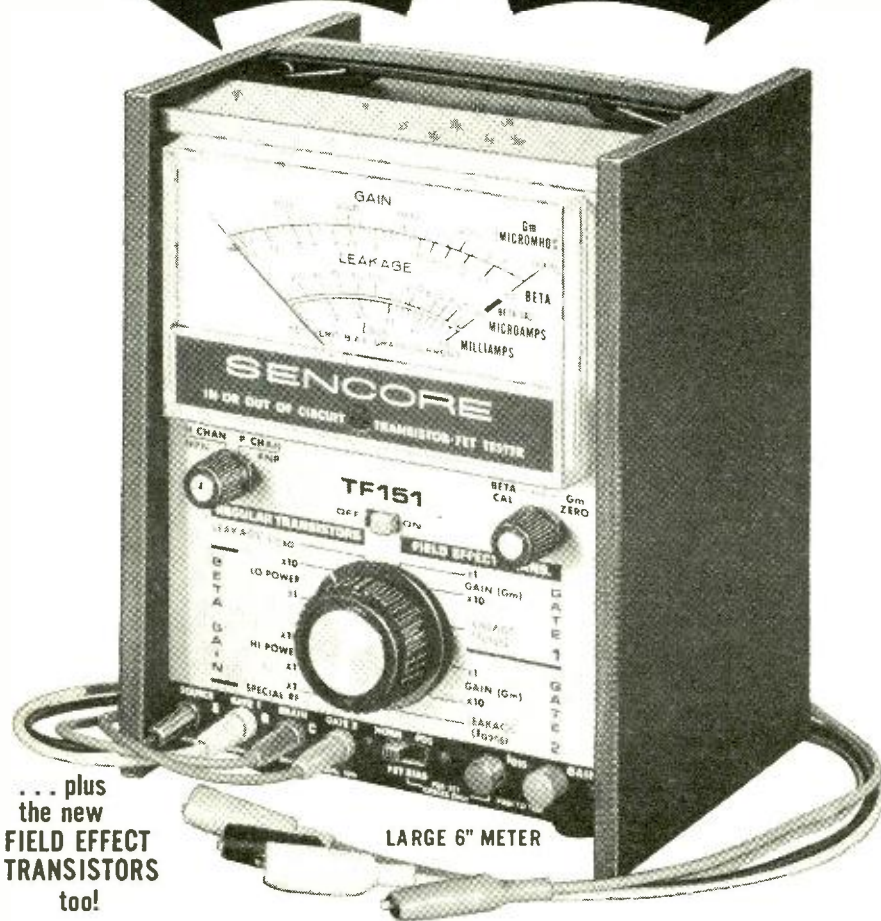

... plus the new **FIELD EFFECT TRANSISTORS** too!

LARGE 6" METER

You won't be stopped when you run into the new FETs that are wired into the latest hi-fi, newest TV receivers and nearly every other new device coming on the market. For the very first time, you can check them all, in or out of circuit. The TF151 works every time using tried and proven signal injection techniques. New, improved tests on special RF transistors and the latest high power transistors, mean that the TF151 is the only up-to-date transistor tester on the market. A new, exclusive setup book in rear compartment guides you to every test for over 12,000 transistors and FETs. The book is not needed for general service troubleshooting. Regular transistors are checked for beta gain and I_{cbo} leakage. FETs are checked for transconductance and I_{gss} leakage. **only \$129⁵⁰**

NEW SENCORE TF17 compact in and out of circuit transistor FET tester. Same as TF151 except in new Sencore Handi case and with 4-1/2" meter. . . \$109.50



SENCORE
NO. 1 MANUFACTURER OF ELECTRONIC MAINTENANCE EQUIPMENT

426 SOUTH WESTGATE DRIVE, ADDISON, ILLINOIS 60101

Circle 17 on reader service card

IN THE SHOP

(continued from page 14)

coupled audio amplifiers: rf amplifiers, and so on. Transistor bias is always critical, but there seem to be quite a few stages where it's super-critical. And if you think 10-mA leakage isn't a heck of a lot, put one with this much leakage into an age stage and watch the fur fly!

Back to the good old days

You should never grab a transistor tester, ohmmeter or anything like that and jump in checking transistors at random. This is a waste of time. As far as I can see from quite a bit of bench-testing of test-methods, we're probably going to have to go back to signal tracing!

This started in the late 1930's. There were quite a few specialized test instruments built for just this purpose. In fact, if you happen to have an old Hickok Trace-Ometer or Meissner Analyst under your bench, blow the dust off it.

The idea of this is very simple. We need to know *where the signal stops*. That's where we start our testing. The part causing trouble is either in this stage or one of the stages which control it.

This brings up another highly useful instrument—the oscilloscope. Using it, and any kind of signal source—even a broadcast signal—you can get into the area of the trouble in far less time than with any other test instrument. You can feed any kind of identifiable signal into the input of the device and literally go "bang-bang-bang" through the circuit until you find the point where the signal stops.

Any kind of signal is useful. You can check out a video amplifier stage with a record player and an audio test-record if you want to.

One good quick-check for normal operation, very useful in places like transistor i.f. stages, and any stage using the popular common-emitter circuit, is the emitter *voltage*. There will almost always be an emitter resistor, and the voltage drop across this is a good clue.

If the emitter voltage is normal, the transistor is conducting normally. Zero emitter voltage means the transistor is either cut off or completely open. Abnormally high emitter voltage means the transistor is either conducting very heavily, or is shorted. Either one means trouble. **CAUTION:** *In stages where the bias varies quite a bit with an input signal, be sure to check the schematic to see exactly how this voltage is measured—with signal or no-signal. This can make a great difference in age, i.f., sync or even audio stages.* **R-E**

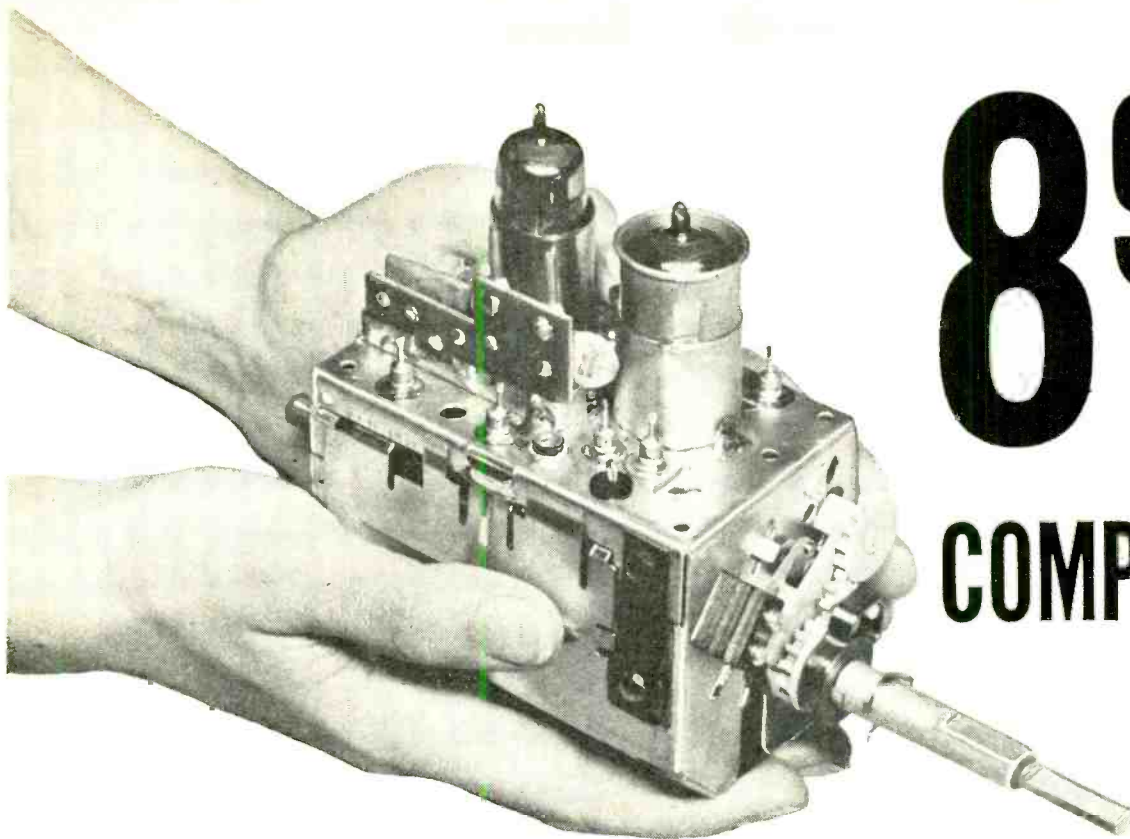

895 COMPLETE

Castle, the pioneer of television tuner overhauling, offers the following services to solve ALL your television tuner problems.

● **OVERHAUL SERVICE** — All makes and models.

- VHF or UHF tuner \$9.95
- UHF-VHF combination (one piece chassis) \$9.95
- TRANSISTOR tuner \$9.95
- COLOR tuner \$9.95
(Guaranteed color alignment . . . no additional charge)

Overhaul includes parts, except tubes and transistors.

Simply send us the defective tuner complete; include tubes, shield cover and any damaged parts with model number and complaint. Your tuner will be expertly overhauled and returned promptly, performance restored, aligned to original standards and warranted for 90 days.

UV combination tuner must be single chassis type; dismantle tandem UHF and VHF tuners and send in the defective unit only.

And remember—for over a decade Castle has been the leader in this specialized field . . . your assurance of the best in TV tuner overhauling.

● **CUSTOM REPLACEMENTS**

Exact replacements are available for tuners that our inspection reveals are unfit for overhaul. As low as \$12.95 exchange. (Replacements are new or rebuilt.)

● **UNIVERSAL REPLACEMENTS**

Prefer to do it yourself?

Castle universal replacement tuners are available with the following specifications.

STOCK No.	HEATERS	SHAFT		I.F. OUTPUT		PRICE
		Min.*	Max.*	Snd.	Pic.	
CR6P	Parallel 6.3v	1¾"	3"	41.25	45.75	8.95
CR7S	Series 600mA	1¾"	3"	41.25	45.75	9.50
CR9S	Series 450mA	1¾"	3"	41.25	45.75	9.50
CR6XL	Parallel 6.3v	2½"	12"	41.25	45.75	10.45
CR7XL	Series 600mA	2½"	12"	41.25	45.75	11.00
CR9XL	Series 450mA	2½"	12"	41.25	45.75	11.00

*Selector shaft length measured from tuner front apron to extreme tip of shaft.

These Castle replacement tuners are all equipped with memory fine tuning, UHF position with plug input for UHF tuner, rear shaft extension and switch for remote control motor drive . . . they come complete with hardware and component kit to adapt for use in thousands of popular TV receivers.

Order universal replacements out of Main Plant (Chicago) only.



CASTLE TV TUNER SERVICE, INC.

MAIN PLANT: 5715 N. Western Ave., Chicago, Illinois 60645

EAST: 41-96 Vernon Blvd., Long Island City, N.Y. 11101

Circle 18 on reader service card

We pack your electronics course with kits to make your training fast. You'll enjoy every minute of it.

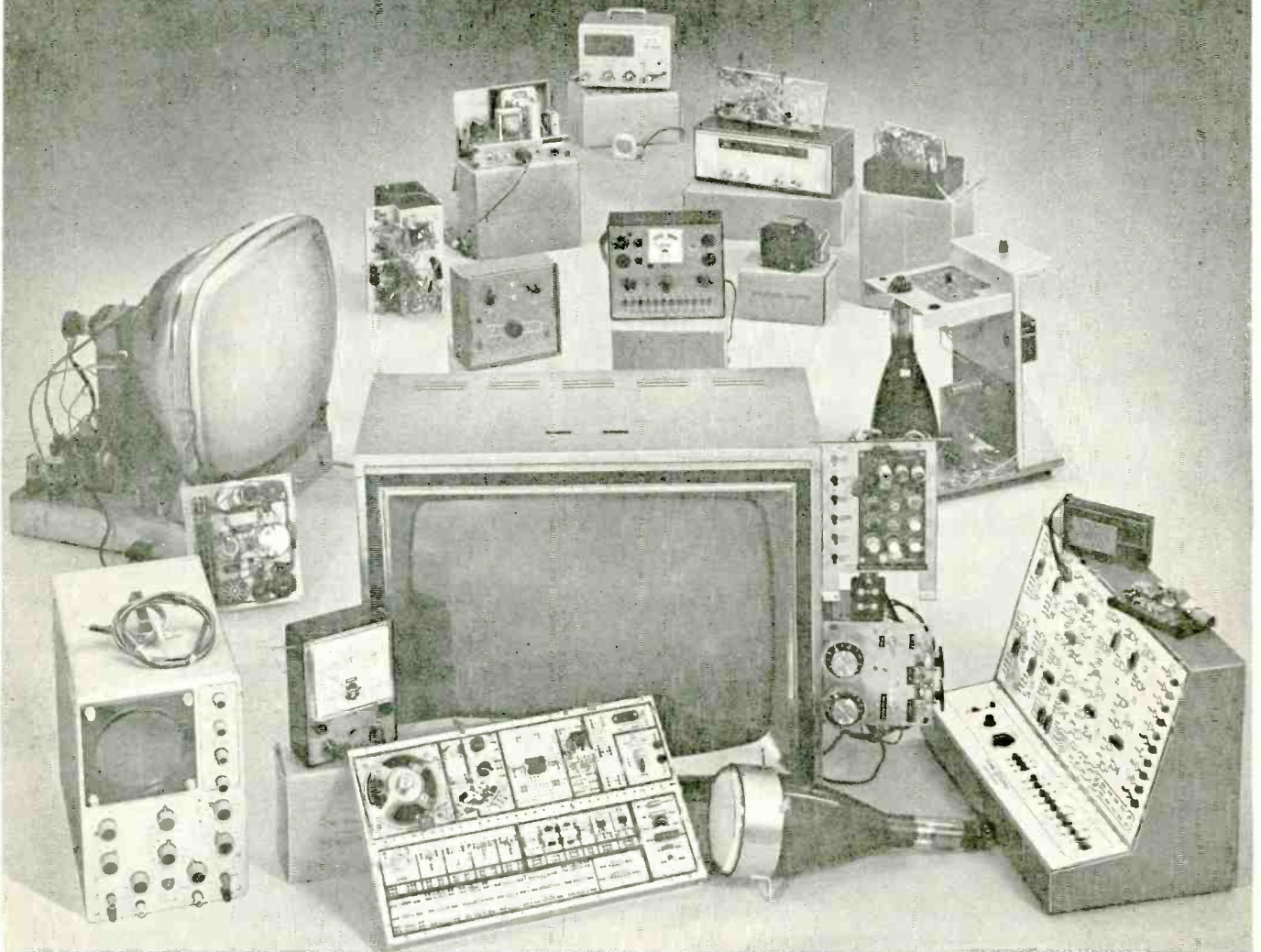

Your NTS success package

Choose a career in electronics: Computers. Color TV Servicing. Automation. Communications. Whatever the field, NTS has a complete home-study package to get you to the top *faster*. 10 thorough training courses. Each includes *everything* to give you the *working* knowledge required of successful technicians.

NTS Project-Method Training is the practical way to learn elec-

tronics. It's a proven combination of lessons and the best professional kit equipment available. NTS provides the *biggest selection of kits ever offered in home-study . . . all at no extra cost*. You'll construct these exciting kits to fully understand electronic circuits, components, and concepts. Our Project-Method lets you build skills by putting theory into practice . . . by working with your hands, as well as your head.

The NTS "learn and practice" approach makes training at home really easy. All it takes is a few hours a week . . . whether you're starting from scratch or in advanced courses. This is the all-inclusive success package that put thousands of men into the best paying jobs . . . or into their own business. If "just a living" isn't good enough for you, now is the time to get something better going for you!

NTS COMPUTER ELECTRONICS

This is the future. And it's happening now. The number of computers will *increase many times* in the next few years.

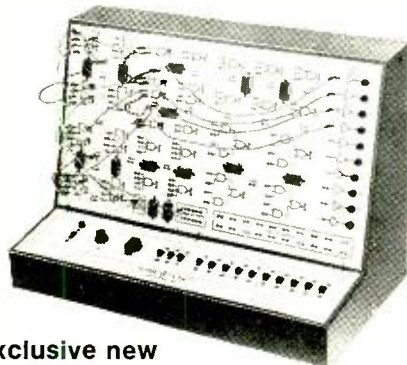

Exclusive new Compu-Trainer®

NTS offers a solid grounding in computer operation, wiring, data processing and programming. One of the 10 important kits included is our exclusive Compu-Trainer®. It's a fully operational computer logic trainer — loaded with integrated circuits — the first ever offered in home study. It introduces you quickly to how, what, when and why of computers . . . from theory to practical servicing techniques. This unit is capable of performing 50,000 operations per second. And it's sent at no extra cost.

NTS COLOR TV SERVICING

This is a broad, easily understood

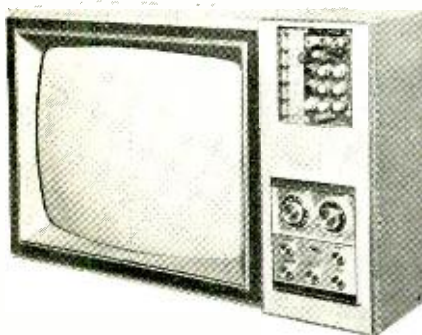

COLOR TV 295 SQ. IN. PICTURE

program designed to make you a complete home-entertainment service technician. Included, at no extra cost, is a color TV that has more features than any

set on the market. You also learn all about stereo, hi-fi, multiplex systems, and become a specialist in Color TV Servicing. Kits also include AM-SW radio, solid-state radio, field-effect transistor volt-ohmmeter, electronic tube tester,

NTS AUTOMATION/ INDUSTRIAL ELECTRONICS

You're trained in the "push-button" electronics that keep industry going and growing . . . from relay type controls to highly advanced systems essential to production. You receive 16 kits including a 5" wide band oscilloscope, and the new NTS electronics lab: a fascinating NTS exclusive experimental laboratory. A complete workshop which makes you familiar with solid-state, miniature, and integrated circuits.

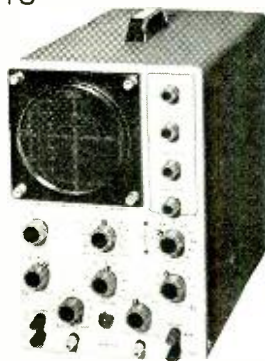

5"
Oscilloscope

NTS ELECTRONIC COMMUNICATIONS

The use of 2-way radio systems in private and commercial applications is skyrocketing. NTS prepares you for the big-money opportunities in the field of transmitting and receiving equipment. *Your tuition will be refunded in full if you cannot pass the FCC exam for a 1st Class Commercial Radio-Telephone License within*

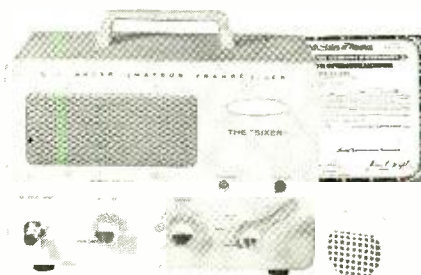

5 Watt AM Transmitter & Receiver

six months after successfully completing this course. You build valuable kits including Amateur-Phone 6 Meter VHF Transceiver, solid-state Radio, and a field-effect transistor volt-ohmmeter.

CLASSROOM TRAINING AT LOS ANGELES

You can take classroom training at Los Angeles in sunny Southern California. NTS occupies a city block with over a million dollars in facilities devoted exclusively to technical training. Check box in coupon.

NATIONAL TECHNICAL SCHOOLS

World-Wide Training Since 1905

4000 South Figueroa Street
Los Angeles, Calif. 90037, U.S.A.

APPROVED FOR VETERANS

Accredited Member: National Association of Trade and Technical Schools, National Home Study Council.

**TODAY, MAIL
COUPON
FOR FREE
COLOR
CATALOG
AND SAMPLE
LESSON.**

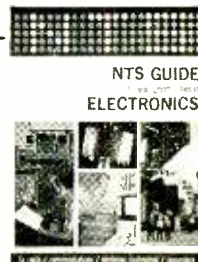

NATIONAL TECHNICAL SCHOOLS
4000 S. Figueroa St., Los Angeles, Calif. 90037

Please rush Free Color Catalog and Sample Lesson, plus information on field checked below. No obligation. No salesman will call.

- MASTER COURSE IN COLOR TV SERVICING
- COLOR TV SERVICING
- MASTER COURSE IN TV & RADIO SERVICING
- PRACTICAL TV & RADIO SERVICING
- MASTER COURSE IN ELECTRONIC COMMUNICATIONS
- FCC LICENSE COURSE
- MASTER COURSE IN ELECTRONICS TECHNOLOGY
- INDUSTRIAL AND AUTOMATION ELECTRONICS
- COMPUTER ELECTRONICS
- BASIC ELECTRONICS

Name _____ Age _____

Address _____

City _____ State _____ Zip _____

Check if interested in Veteran Training under new G.I. Bill.

Check if interested ONLY in Classroom Training at Los Angeles. Dept. 206-119

Clever Kleps

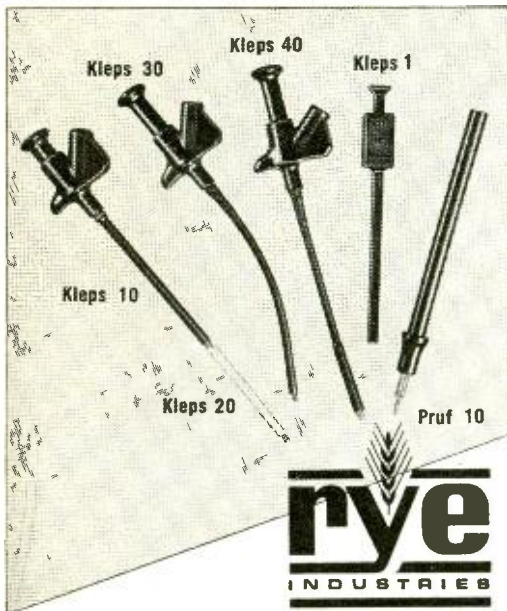

Test probes designed by your needs—
Push to seize, push to release (all Kleps spring loaded).

Kleps 10. Boathook type clamp grips wires, lugs, terminals. Accepts banana plug or bare wire lead. 4¾" long. **\$1.19**

Kleps 20. Same, but 7" long. **\$1.39**

Kleps 30. Completely flexible. Forked-tongue gripper. Accepts banana plug or bare lead. 6" long. **\$1.47**

Kleps 40. Completely flexible. 3-segment automatic collet firmly grips wire ends, PC-board terminals, connector pins. Accepts banana plug or plain wire. 6¾" long. **\$2.39**

Kleps 1. Economy Kleps for light line work (not lab quality). Meshing claws. 4½" long. **\$.99**

Prof 10. Versatile test prod. Solder connection. Molded phenolic. Doubles as scribing tool. "Bunch" pin fits banana jack. Phone tip. 5½" long. **\$.79**

All in red or black — specify.

For additional information, write for our complete catalog of — test probes, plugs, sockets, connectors, earphones, headsets, and miniature components.

Available through your local distributor, or write to:
RYE INDUSTRIES, INC.
130 Spencer Place, Mamaroneck, N.Y. 10543

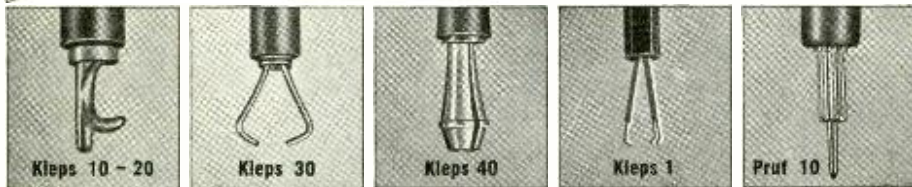

Circle 20 on reader service card

America's Top-Rated Stereo Kits Now a Best Buy!*



*LT-112B-1
FM Stereo Monitor Tuner Kit:
Now \$149.95

LK-60B
160-Watt Stereo Amplifier Kit:
Now \$149.95

LR-88
135-Watt AM/FM Stereo Receiver Kit:
Now \$299.95

SCOTT

Write for new Scott Kit Catalog.
H. H. Scott, Inc., 111 Powdermill Road,
Maynard, Mass. 01754. © 1969, H. H. Scott, Inc.

POPULAR SCIENCE SAYS:

"... How does it perform? In a word, flawlessly; stereo performance is superb, and the set's sensitivity will cope with the deepest fringe-area reception conditions... I rate the LT-112B as one of the finest FM tuners available — in or out of kit form."

STEREO REVIEW SAYS:

"We measured the IHF sensitivity of the Scott LT-112B tuner as 1.4 microvolts, which certainly makes it one of the most sensitive tuners we have encountered."

AMERICAN RECORD

GUIDE SAYS:

"Scott LT-112B tuner must be placed in the very top echelon of today's components."

AUDIO SAYS:

"Here's a stereo FM/AM receiver kit with a real hot front end, fairly high power output, low distortion, and excellent operating flexibility... The Scott LR-88 offers a most competent design at a price well below that for an equivalent factory-assembled unit."

ELECTRONICS

ILLUSTRATED SAYS:

"One of the finest examples of solid-state integrated-amplifier kit design, packaging and performance we have seen in the Scott LK-60."

HIGH FIDELITY SAYS:

"... an unprecedented high sensitivity, one which surprised even us... This is certainly a tuner for use in the most difficult of reception areas; stations seem to pop in all across the tuner dial."

Circle 100 on reader service card

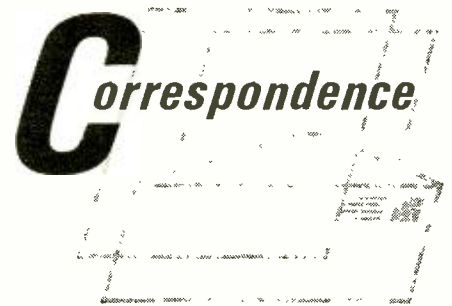

REPAIR VS. DESIGN

In your August issue Jack Darr, in his "In The Shop . . . With Jack" article, indicates that technicians should be called "service engineers" because "they do engineering work." He goes on to describe the work of a TV repairman.

The author makes a big mistake in comparing the two professions. Nowhere in his article does he indicate that the repairman does any engineering work. Instead, he is busy comparing what he finds (trouble) with the indications he should find, and isolates the problem. This is not engineering.

The work of an engineer is to do the original circuit design. It is the engineer who tells the technician what the circuit should do in the first place.

If the technician feels that he has enough knowledge to design a TV set, let him do it and be titled "engineer." There is enough need in industry today for engineers that any qualified applicant will be accepted. But let those who repair and fix be called by the time-honored title, "technician." In this time when the title "engineer" is being abused by so many people, let those who should know better refrain from this practice.

JOHN PRITCHETT,
Electronic engineer,
Altec Lansing

WANTS MORE DARR

I've been reading Jack Darr's "In The Shop . . . With Jack" for several years, and think he does an excellent job of making difficult servicing problems easy to understand for beginners like myself. Does he have any books published, and could you give me all the titles?

N. VELEZ-CASANOVA
Mayaguez, P.R.

Mr. Darr begins his 10th year with us in January simplifying tough problems on a regular basis. Listing all his books, though, might take more room than we have here. Instead, for a starter, write: Howard W. Sams & Co., Inc., 4300 W. 62 St., Indianapolis, Ind. 46206; or, TAB Books, Blue Ridge Summit, Pa. 17214.

(continued on page 24)

smooth

RCA WP-700A, 702A, 703A and 704A constant voltage dc power supplies are all solid-state. A negative feedback circuit maintains constant output voltage with low ripple—regardless of varying line. In fact, at rated load, these supplies are so smooth that “they hardly cause a ripple.”

They are versatile bench-type units—ideally suited for use in circuit design, servicing, industrial, and educational applications.

Output voltage of the WP-700A and WP-702A is continuously adjustable from 0 to 20 volts at current levels up to 200 mA.

Output voltage of the WP-703A is continuously adjustable from 0 to 20 volts at current levels up to 500 mA.

Output voltage of the WP-704A is continuously adjustable from 0 to 40 volts at current levels up to 250 mA.

All four power supplies have built-in electronic short-circuit protection—and a front panel overload-indicator that signals approach to maximum rated current level.

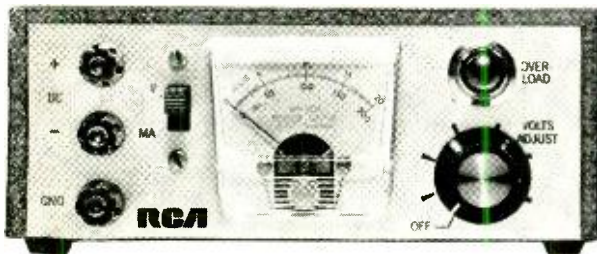

WP-700A: \$40.00* (five or more) \$48.00* (less than five)

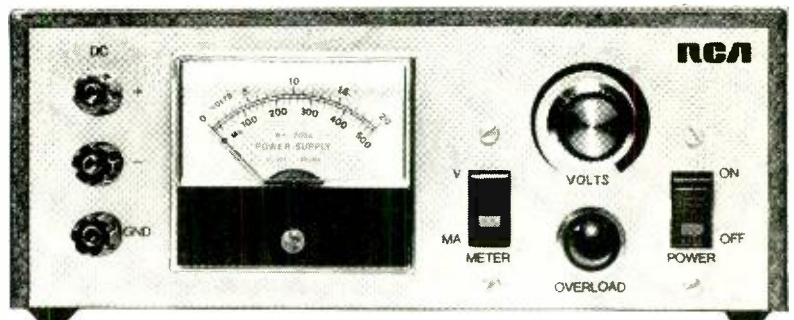

WP-703A: \$49.00* (five or more) \$58.00* (less than five)

WP-704A: \$49.00* (five or more) \$58.00* (less than five)

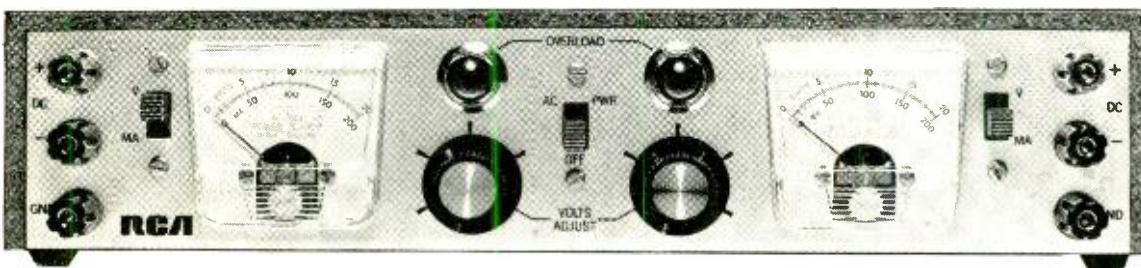

*Optional Distributor Resale Price.

WP-702A: Siamese Twins of WP-700A, but electrically isolated \$73.00* (five or more) \$87.00* (less than five)

For further information write: RCA Electronic Components, Commercial Engineering, Department K39W, Harrison, N. J. 07029.

[Look to RCA for instruments to test/measure/view/monitor/generate](#)

Circle 22 on reader service card



You never saw a scope like this for twice \$229.

Leader's five-inch LBO-53B has a bandwidth running from DC to 10MHz. (About twice the bandwidth of any other scope in the same price range.)

Its sensitivity rating is 10 mv/cm or better. (About half-again the sensitivity of any other scope in the same price range.)

It has FET vertical and horizontal inputs, directly coupled with push-pull amplifiers for no-distortion display. (You won't find that on any other scope

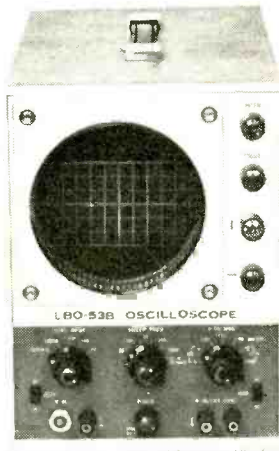

for the money.)

It's the perfect test companion for Leader's LCG-388 color bar generator. The only one that's perfectly stable, the instant you turn it on.

The LBO-53B: only \$229, and now you know what we mean about never seeing a scope like it for twice the price.

At your distributor's, along with the LCG-388 and other Leader test instruments. For the distributor nearest you, just drop a line or call.

Seeing is believing.

LEADER INSTRUMENTS CORP.

24-20 Jackson Avenue, Long Island City, N. Y. 11101 (212) 729-7411

Circle 23 on reader service card

Build this pipelike Schober Recital Organ for only \$1850!*

You couldn't touch an organ like this in a store for less than \$4,000—and there never has been an electronic instrument with this vast variety of genuine pipe-organ voices that you can add to and change any time you like! All four families of formal pipe tones are present in variety to delight players of classic and religious music. Yet you can change the entire organ for popular and theatrical sounds, or plug in special voices for baroque, romantic, or modern repertoires. If you've dreamed of the sound of a large pipe organ in your own home, if you're looking for an organ for your church, you'll be more thrilled and happy with a Schober Recital Organ than you could possibly imagine—kit or no kit.

You can learn to play it—and a full-size, full-facility instrument is easier to learn on than any cut-down "home" model. And you can build it, from Schober Kits, world famous for ease of assembly without the slightest knowledge of electronics or music, for design and parts quality from the ground up, and—above all—for the highest praise from musicians everywhere.

Send right now for the full-color Schober catalog, containing specifications of all five Schober Organ models, beginning at \$499.50. No charge, no obligation. If you like music, you owe yourself a Schober Organ!



*Includes finished walnut console. (Only \$1446 if you build your own console.) Amplifier, speaker system, optional accessories extra.

Circle 24 on reader service card

The Schober Organ Corp., Dept. RE-72
43 West 61st Street, New York, N.Y. 10023

- Please send me Schober Organ Catalog and free 7-inch "sample" record.
- Enclosed please find \$1.00 for 12-inch L.P. record of Schober Organ music.

NAME _____

ADDRESS _____

CITY _____ STATE _____ ZIP _____

CORRESPONDENCE (continued from page 22)

DOUBTFUL DIGITS

Somehow I doubt if many of your readers will rush to construct that \$250 IC digital clock described in your September issue. I would say that article is the zenith (or perhaps nadir) of expensive absurdity in construction articles. I just can't see the advantage of such a clock in view of the mechanical numeral clocks on the market that do the same thing for one-tenth the cost.

Surely a simpler and less expensive clock with numeral readout tubes could be constructed using inexpensive clock and timing motors driving low-friction rotary switches to activate the tube circuits.

KEN GREENBURG
Chicago, Ill.

We felt many of our readers would like to tackle such a project. Ken, so we asked for comments in an April 1969 article (page 23). Based on the hundreds of enthusiastic requests, we decided to run it. We'd still like to have other opinions.

There's no doubt about your second point, but we preferred an electronic to an electromechanical version—they're considerably more reliable.

TV CAMERA ERRORS

I discovered the following mistakes while going over the TV camera article in your July issue:

Resistor R52 is 222K in the parts list and 220K on the schematic. Isn't 220K the correct value?

The parts list indicates C39 as a 0.1 μ F, 400V. It's marked 1000 μ F on the schematic, which I believe circuit specifications call for. Right?

You have two C45's listed: one in the horizontal scan and one in the video amplifier. I discovered the horizontal scan C45 is in reality C43.

Incidentally, I've found an old Army ammo can is perfect for the chassis. I was all set to suggest such a project, and I thank you for the opportunity to build such a camera.

FRANCIS E. FULLER
Fort Monmouth, N.J.

You're right on all counts. Francis. Also, there should be a dot indicating a connection between C30, C31, C29 and Q16's collector. R-E

NEXT MONTH

The new solid-state antenna rotators are described in November by R-E's technical editor. Find out how they work to help pull in better signals for TV.

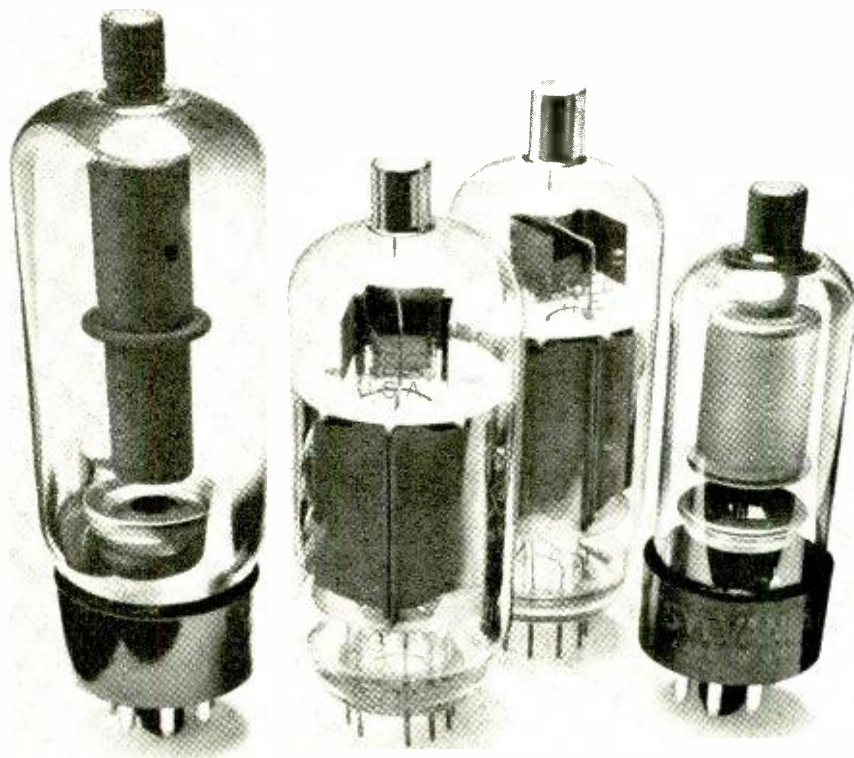

Our hot ones are the last to go.

The last thing you need is to be called back a day or two after you've replaced the sweep or high voltage tubes in somebody's color TV.

But, they're usually the first to go. Because they get so hot.

So we figured out how to cool them. Now, they last a lot longer.

Take our 6JE6C/6LQ6, for example. It's the horizontal deflection tube that takes such a beating when the set gets hot.

Well, we've given it special patented radiator fins that first absorb the heat and then radiate it out of the tube.

Now it runs cooler and lasts longer. Same for our 6JS6C.

Or take our 6BK4C/6EL4A. That's the shunt regulator that eliminates runaway high voltage. We gave this one a whole new anode and shield design to improve heat transfer and stability.

Circle 25 on reader service card

Now it also runs cooler and lasts longer.

Or take our 3A3B high voltage rectifier. This one's got leaded glass for added protection. And it lasts longer too.

So next time you have to replace any of the hot ones, just cool it. You'll both last longer.

SYLVANIA
GENERAL TELEPHONE & ELECTRONICS

Excelsior!*

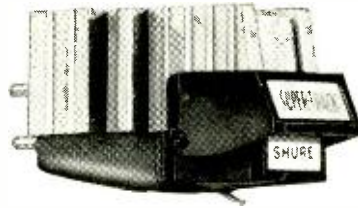

We couldn't leave well enough alone

We have improved the trackability of the V-15 Type II in the bass and mid-range registers — without affecting its redoubtable treble. Result: where, in the past, you may have been required to increase tracking forces to track heavily modulated bass drum, tympani, organ pedal, bassoon, tuba, or piano passages . . . you can now play these passages *without* increasing tracking force, without bass flutter or IM distortion . . . and significantly increase record and stylus tip life. Only \$67.50 for the world's highest trackability cartridge.

* Latin: always upward

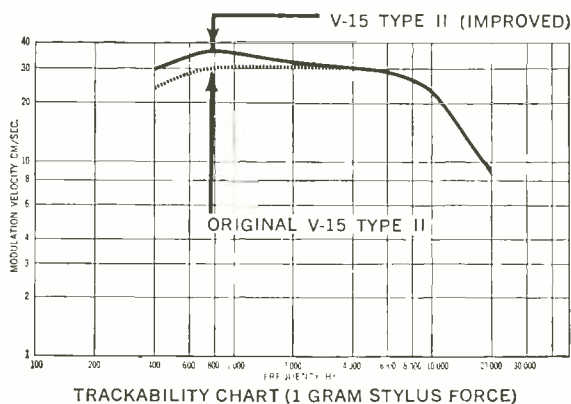

YOU CAN MODIFY YOUR PRESENT V-15 TYPE II . . .

You may attain this higher bass and mid-range trackability by installing the IMPROVED VN15E stylus at \$27.00. Look for the word "Shure" in red letters on the stylus grip.

NEW

SHURE

V-15 TYPE II (IMPROVED)

SUPER TRACKABILITY PHONO CARTRIDGE

© 1969, Shure Brothers Inc., 222 Hartrey Ave., Evanston, Illinois 60204

Circle 26 on reader service card

Earn Your DEGREE in Electronics!

Grantham School of Engineering offers an educational program leading to the Degree of Associate in Science in Electronics Engineering — the ASEE. *Beginners in electronics* must take resident classes in Hollywood, Calif., or in Washington, D.C. However, *experienced electronics technicians* may complete the entire degree program by home study, except for the final two weeks which must be taken in Hollywood. There are three different ways the program is offered, referred to as *Daytime-Residence*, *Supplemented-Correspondence*, and *Home Study*. Each method is discussed below.

Daytime-Residence

The Daytime-Resident program is designed for *beginners*. You may enroll in Hollywood or Washington. Classes meet five days per week, and each semester is 16 weeks long. Three semesters are offered each year. Upon satisfactory completion of the five-semester program (about 20 months), you are awarded a Diploma in Electronics Engineering Technology. Then, to complete the requirements for the ASEE Degree, you must attend the associate-degree seminar—a two-week period of review, consultation, and evaluation.

This seminar is held, for Hollywood and Washington students, at the main School in Hollywood. For Washington students the School pays the round-trip (to and from Hollywood) airline transportation charges, so that all the graduating students in both schools may participate in each seminar together.

For those who wish to continue their engineering studies beyond the ASEE Degree level, Grantham offers a BSEE Degree program in Hollywood. The Grantham ASEE Degree or other equivalent background is prerequisite to enrollment in the BSEE Degree program.

Supplemented-Correspondence

The Supplemented-Correspondence program is designed for *beginners*. You take the correspondence lessons from the main school in Hollywood, but the supplementary resident classroom and laboratory sessions, one evening per week, may be taken in either Hollywood or Washington. The main part of the program is divided into five semesters, each semester being slightly less than six months long, so that you normally complete the five semesters in 2½ years. Upon completion of this five-semester program, you are awarded a Diploma in Electronics Engineering Technology. Then, to complete the requirements for the ASEE Degree, you must attend the associate-degree seminar—a two-week period of review, consultation, and evaluation—in Hollywood, the same as is explained under “Daytime-Residence” above. Seminar round-trip airline transportation for Washington students is paid by the School.

Grantham School of Engineering

Specializing in Electronics since 1951

1505 N. Western Ave.
Hollywood, Calif. 90027

or

818 18th Street, N.W.
Washington, D.C. 20006

Telephone:
(213) 469-7878

Telephone:
(202) 298-7460

NOVEMBER 1969

Home Study

In the ASEE Degree program offered to *experienced electronics technicians*, the entire educational program leading to the Diploma in Electronics Engineering Technology is conducted by home study. It consists of 370 home study lessons, divided into five “correspondence semesters”. The prerequisite for enrollment is high school graduation (or equivalent) and at least one year of fulltime experience as an electronics technician.

Upon completion of the 370 home-study lessons (five semesters) and receipt of your EET Diploma, you are then eligible to attend the associate-degree seminar—a two-week period of review, consultation, and examination—in Hollywood, as the final requirement for your ASEE Degree.

This *accredited* ASEE Degree program offered to experienced technicians, begins with a review of electrical and electronic principles and systems, and then continues with applied engineering mathematics (including algebra, trigonometry, analytic geometry, and calculus), classical and modern physics, technician writing, computer systems, electrical network design, and semiconductor circuit design.

Accreditation, and G.I. Bill Approved

Grantham School of Engineering was established in Hollywood, California in 1951, and the Eastern Extension Division of the School was opened in Washington, D.C. in 1955.

The School is *approved* in California by the California State Department of Education, is *approved* in the District of Columbia by the D.C. Board of Education, is *approved* under the “Cold War G.I. Bill” to offer resident courses in Hollywood and Washington and correspondence courses from Hollywood, is *accredited* by the Accrediting Commission of the National Home Study Council, and is *authorized* under the laws of the State of California to grant academic degrees.

Grantham School of Engineering RE-11-69

1505 N. Western Ave., Hollywood, Calif. 90027

Please mail your free Bulletin, which explains how the Grantham educational program can prepare me for my Associate in Science Degree in Electronics Engineering.

Name _____ Age _____

Address _____

City _____ State _____ Zip _____

I am interested in: Daytime-Residence
 Supplemented-Correspondence, Home-Study

Can you solve these two basic problems in electronics?

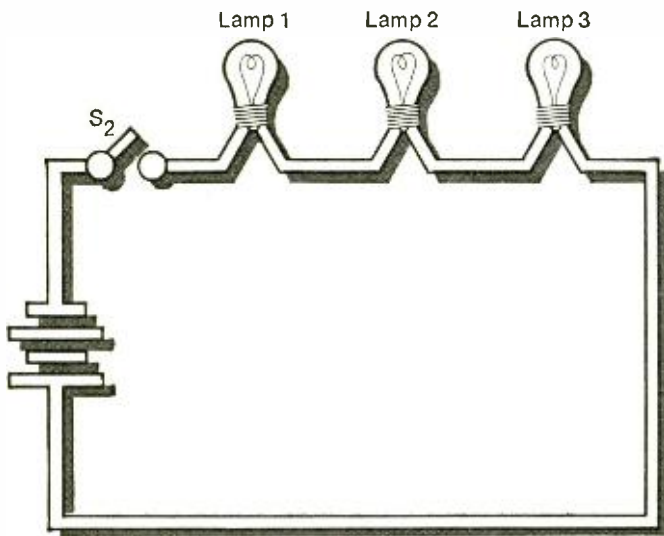

This one is relatively simple:

When Switch S_2 is closed, which lamp bulbs light up?

Note: If you had completed only the first lesson of any of the RCA Institutes Home Study programs, you could have solved this problem.

ANSWERS: Problem 1—they all light up
Problem 2—20 Volts (p-p)

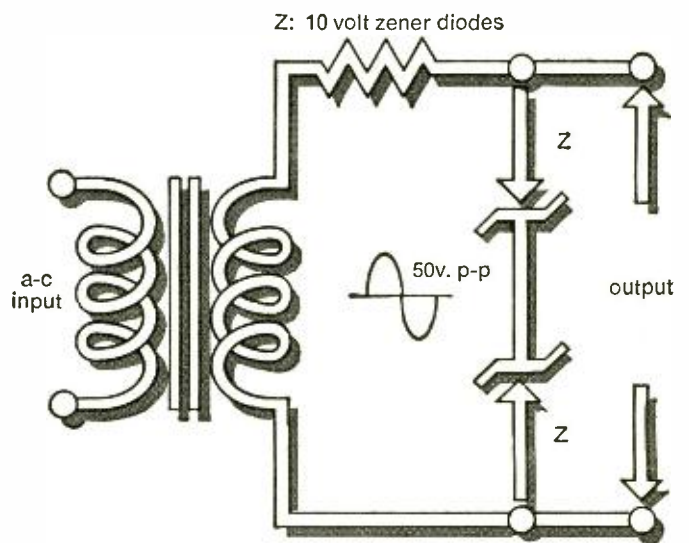

This one's a little more difficult:

What is the output voltage (p-p)?

Note: If you had completed the first lesson in the new courses in Solid State Electronics, you could have easily solved this problem.

These new courses include the latest findings and techniques in this field. *Information you must have if you are to service today's expanding multitude of solid state instruments and devices used in Television, Digital, and Communications Equipment.*

If you had completed an entire RCA Institutes Home Study Course in Semiconductor Electronics, Digital Electronics, or Solid State Electronics, you should now be qualified for a good paying position in the field you choose. Send for complete information. Take that first essential step now by mailing the attached card.

RCA Institutes Autotext learning method makes problem-solving easier... gets you started faster towards a good-paying career in electronics

Are you just a beginner with an interest in electronics? Or, are you already making a living in electronics, and want to brush-up or expand your knowledge? In either case, RCA has the training you need. And Autotext, RCA Institutes' own method of Home Training will help you learn more quickly and with less effort.

Wide Range of Courses

Select from a wide range of courses. Pick the one that suits you best and check it off on the attached card. Courses are available for beginners and advanced technicians.

Electronics Fundamentals
Black & White Television Servicing
(Transistorized TV Kit Available)
Color Television Servicing (Color TV Kit Available)
FCC License Preparation
Automatic Controls
Automation Electronics
Industrial Electronics
Nuclear Instrumentation
Electronics Drafting
Computer Programming

Plus these new up-to-the-minute courses

Semiconductor Electronics
Digital Electronics
Solid State Electronics
Communications Electronics

Prepare for good paying positions in fields like these

Television Servicing
Telecommunications
Mobile Communications
CATV
Broadcasting
Marine Communications
Nuclear Instrumentation
Industrial Electronics
Automation
Computer Programming
Solid State
Electronics Drafting



Build and keep this valuable oscilloscope.

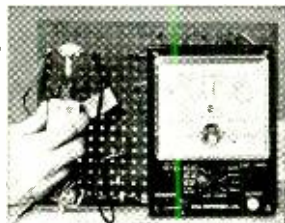

In the new program on Solid State Electronics you will study the effects of temperature and leakage characteristics of transistors.

RCA

Variety of Kits—Yours to Keep

A variety of RCA Institutes engineered kits are included in your program of study. Each kit is yours to keep when you've completed the course. Among the kits you construct and keep is a working signal generator, a multimeter, a fully transistorized breadboard superheterodyne AM receiver, and the all-important oscilloscope. These 4 kits are at no extra cost. Compare this selection with other home study schools.

Two Convenient Payment Plans

Pay for lessons as you order them. No contract obligating you to continue the course. Or, you can take advantage of RCA's convenient monthly payment plan. No interest charges!

Classroom Training Also Available

RCA Institutes operates one of the largest technical schools of its kind. Day and evening classes. No previous training is required. Preparatory courses are available. Classes start four times a year.

Job Placement Service, Too!

Companies like Bell Telephone Labs, GE, Honeywell, IBM, RCA, Westinghouse, Xerox, and major radio and TV networks have regularly employed graduates through RCA Institutes' own placement service.

All RCA Institutes courses and programs are approved for veterans under the new G.I. Bill.

Send Attached Postage Paid Card Today. Check Home Study or Classroom Training.

Accredited Member National Home Study Council.

IF REPLY CARD IS DETACHED, SEND THIS COUPON

RCA Institutes Inc.

Home Study Dept. REN-9
320 West 31 Street
New York, N. Y. 10001

Please send me FREE illustrated career catalog.

Name _____ Age _____
(please print)

Address _____

City _____ State _____ Zip _____

Go on a quality kick

You can afford it with these Outperformers

You give up nothing — except a high price — when you buy these quality performance Pioneer hi-fi units. Designed for the discriminating budget-minded buyer, they contain advanced engineering features and looks that put them in the class of much more expensive stereo components.

SA-500 INTEGRATED STEREO AMPLIFIER — The perfect starter unit for a stereo system, the all solid state SA-500 produces 44 watts of music power. Even at the highest crescendo, distortion is less than 0.5%. Four inputs plus outputs for speakers, tape recording, loudness contour and a headset jack make it tops in versatility. \$99.95

TX-500 AM-FM TUNER — All solid state, its multiplex circuitry provides wide channel separation with excellent frequency response. An FET front end, combined with years-ahead design, assures high sensitivity and superb image

rejection. Containing advanced features that place it on a par with more expensive units, it is priced at \$99.95.

SR-202 REVERBERATION AMPLIFIER — The most dramatic new component in years! No matter what your system is, the SR-202 adds dimension and greater realism to your stereo sound than you can realize. The SR-202 increases the natural quality of your recordings and tapes. Reverberation can be added to an audio amplifier using one or two tape recorders, a record player, or a tuner. In fact, a total of 15 equipment combinations are possible. \$95.00

These three Pioneer Outperformers are each housed in a handsome cabinet with brushed chrome facing and Brazilian rosewood end pieces. Hear them in action at your local Pioneer dealer.



PIONEER®

PIONEER ELECTRONICS U.S.A. CORPORATION, 140 Smith Street, Farmingdale, N.Y. 11735 • (516) 694-7720
West Coast: 1335 W. 134th St., Gardena, Calif. 90249 (213) 323-2374 & 321-1076 • Canada: S. H. Parker Co., Prov. Ontario

Circle 29 on reader service card



By THOMAS R. HASKETT

IN A PREVIOUS ARTICLE ("THE JFET Story," RADIO-ELECTRONICS, May 1969) you learned how the junction field-effect transistor (JFET) works, and how to use it in circuits. Now you're going to find out about the other type of field-effect transistor—the MOSFET. (Its name will be explained later.)

As you know, the JFET has an input impedance much like that of a vacuum tube, and higher than that of an ordinary transistor. The MOSFET has an even higher impedance (10^9 ohms for the JFET, 10^{14} ohms for the MOSFET). Because it has such a very high impedance, the MOSFET also has very low input leakage. And it has a higher gain-bandwidth product than the JFET.

Of course, both MOSFET's and JFET's share certain advantages over other amplifying devices. As a dc amplifier, a FET has a zero temperature coefficient; it doesn't drift. As a general-purpose amplifier, it has the high power gain of a vacuum tube and less noise than either tube or transistor. As a vhf mixer, the FET has less noise and cross-modulation than either a tube or an ordinary transistor.

Other FET features: higher frequency response than most ordinary transistors; nearly constant current-output characteristic (flat drain-current/drain-voltage curve): almost completely unilateral gain function excellent input-output isolation.

Chief disadvantage of the MOSFET is that it's noisy at low frequencies. Thus it's poorly suited for a dc or audio preamp. Of course, like the JFET, the MOSFET cannot produce much power output.

Though expensive a few years ago, the MOSFET is now priced comparably to conventional transistors and vacuum tubes.

Depending on physical construction, an FET can operate in one of three ways—with reverse bias (or in the *depletion mode*, called *type A*), with zero bias (in the *depletion-enhancement mode*, called *type B*) and with forward bias (in the *enhancement mode*, called *type C*).

To refresh your memory, Fig. 1 shows an n-channel JFET, a type-A device. (Type-A devices are usually JFET's, although a few type-A MOSFET's have been made.) Two p-type junctions are diffused into the sides of a bar of n-type material. These junctions are connected internally to form the *gate*, while the ends of the bar form the *drain* and *source*. If a battery is connected to the JFET (positive terminal to the drain, negative terminal to the source) much

current flows from source to drain (Fig. 1-a). Another battery connected with its negative terminal to the gate and its positive terminal to the source reverse-biases the gate. This bias voltage establishes electric fields or *depletion regions* around the gate junctions. The more negative the gate, the wider the depletion regions, and the less source-to-drain current flow (Fig. 1-b). When gate bias is great enough, drain current is almost completely pinched off or cut off. This value of gate bias is known as *pinch-off voltage*. It's obvious that gate bias controls drain current (Fig. 1-c). This is how an n-channel JFET operates. (A p-channel JFET is made of a bar of p-type material, with n gate junctions.)

Now look at Fig. 2, which shows the operation of a type-B device. (Type-B devices are usually MOS-

through the channel (Fig. 2-a). If the gate is biased negative with respect to the source, the channel is *depleted* by a field (Fig. 2-b) just as in the JFET.

Keep in mind that as long as the JFET gate junction is reverse-biased, its impedance is high—because it draws no current from the channel. Should the JFET gate become forward-biased (positive with respect to the source in an n-channel type), the gate junction draws current and its impedance goes down drastically.

Fig. 2-c shows what happens when the gate of a type-B MOSFET is forward-biased; the existing channel is *enhanced* by the gate field, and *more* current flows from source to drain. As Fig. 2-d shows, the type-B MOSFET can operate with both negative and positive gate bias without

MOSFET'S

Part 1—What they are. How they work

FET's, since JFET's don't operate too well in this mode.) Two junctions of n-type semiconductor material are diffused into and near the ends of a bar of p-type material, forming drain and source terminals. (The p-type material is called the *substrate*, *body*, *bulk* or *base*, depending on manufacturer. It's merely used as a base for the other terminals. The substrate is usually connected to the source, either internally or externally.) Between the drain and source terminals is diffused a channel of n-type material. Above the channel is placed a layer of oxide insulating material, and atop this layer is deposited a thin strip of metal, forming the gate terminal.

From this construction comes the device name: metal (gate electrode) oxide (insulator) semiconductor (the bar of p-type material with n-type junctions) field-effect transistor, or MOSFET. Since the gate is insulated from the semiconductor (instead of being a junction, as in the JFET) the device is also called an *insulated-gate field-effect transistor*, or IGFET. The oxide insulator is very thin and the gate and substrate act as the plates of a capacitor.

If the drain is made positive with respect to the source, current flows

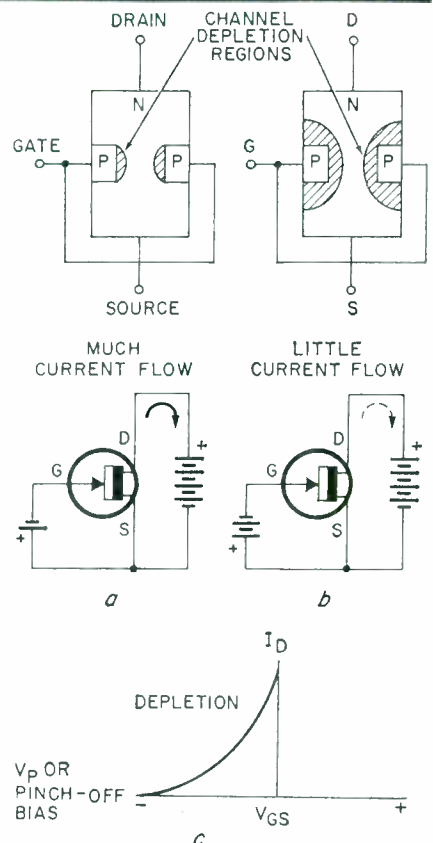

Figs. 1-a, b—Increased bias in type-A JFET. c—Depletion region JFET operation.

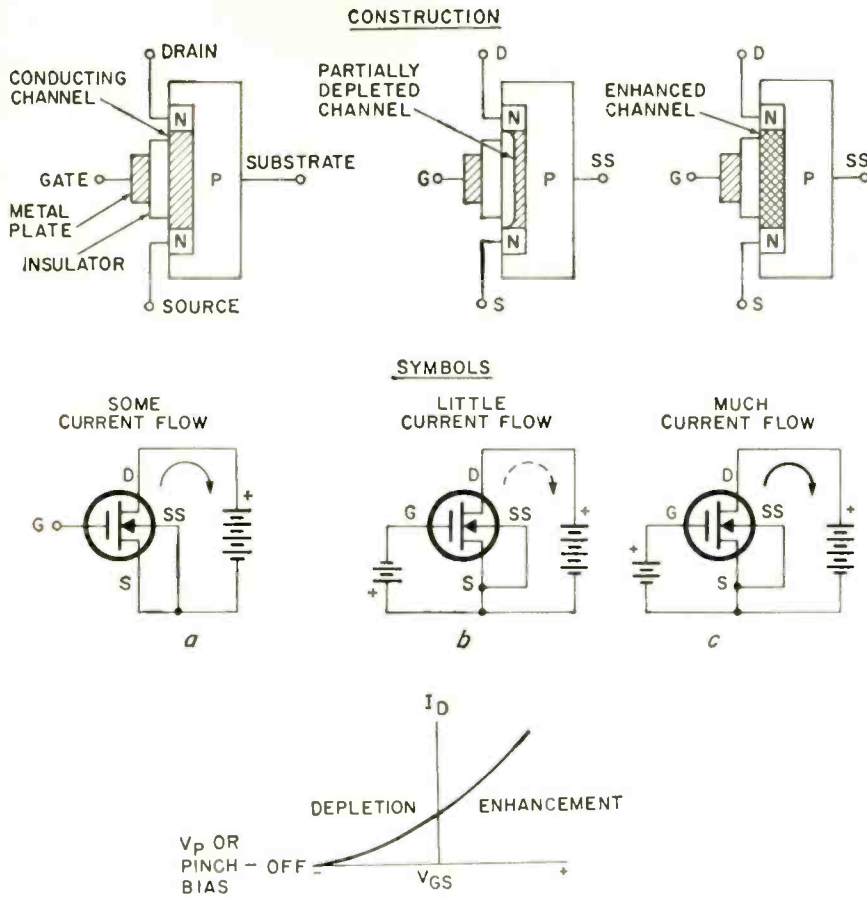
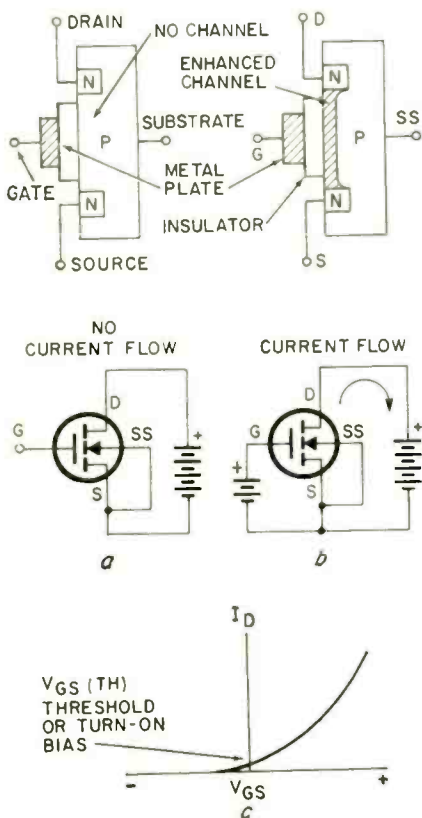

Fig. 2-a-d shows increasing gate bias in type-B MOSFET and its operating curve.

Fig. 3-a-d—Applying bias to type-C MOSFET and the enhancement mode curve.



drawing gate current. The device operates in both depletion and enhancement modes.

The type-B MOSFET, then, is a normally *on* device. It can be turned *off* by reverse gate bias, or channel depletion. It can also be turned *more on* by forward gate bias, or channel enhancement. A hybrid, the type-B MOSFET, acts like both a vacuum tube and a conventional transistor.

Fig. 2 shows the operation of an n-channel type-B MOSFET. Its substrate is p-type material and the channel, drain, and source terminals are n-type material. Type-B MOSFET's are also made in p-channel versions: all materials and supply voltages are of opposite polarities.

Type-C FET

In Fig. 3 you see the operation of a type-C device. (All type-C devices are MOSFET's.) Normally there is no channel between the drain and source terminals; make the drain positive with respect to the source (in the n-channel version shown) and no current flows (Fig. 3-a). Only when the gate is forward-biased (made positive with respect to the source, in this case) does current flow. A channel has been *enhanced*, or formed, by the action of the voltage field placed by

the gate between drain and source. See Fig. 3-b.

As Fig. 3-c shows, the type-C MOSFET operates only when the gate is forward-biased; it's an enhancement-mode-only device. The type-C device, then, is normally *off* and must be turned on by forward bias or channel enhancement. In this respect, the type-C FET operates like a bipolar transistor.

Fig. 3 illustrates operation of an n-channel type-C FET. P-channel devices are also made, in which semiconductor materials and supply voltages are of opposite polarities.

Some MOSFET's are made with symmetrical geometry, as are most JFET's. Thus it makes no difference which end of the bar (or channel) you call the drain or source. Current flows in either direction. Fig. 4-a shows an alternate symbol for the symmetrical type-B MOSFET.

Many MOSFET's, however, are nonsymmetrical. In Figs. 4-b, c, and d you see alternate symbols for type-B nonsymmetrical MOSFET's. Note that in the symbol of Fig. 4-d the substrate is tied internally to the source. An alternate symbol for a nonsymmetrical type-C MOSFET is shown in Fig. 4-e.

All symbols in Fig. 4 represent n-channel devices. Since the symbols for FET's haven't yet been standardized, a few manufacturers show the arrowhead pointing the other way.

Bipolar and unipolar devices

Once again, to refresh your memory: Conventional transistors are now called *bipolars*, to distinguish them from FET's. A bipolar transistor uses both majority and minority carriers. In an npn version, for instance, electrons flow from emitter to collector and are the majority carriers. Holes flow the other way and are the minority carriers. In a pnp version, the opposite is true. Bipolars are also called *injection* transistors, because of electron-hole injection into the base.

The FET, on the other hand, is a *unipolar* device. It uses only majority carriers—electrons in the n-channel version, holes in the p-channel version. And because the gate of a MOSFET is insulated from the channel, neither holes nor electrons are injected into the channel.

Operating characteristics

In most respects, the MOSFET operates like the JFET. To illustrate, Fig. 5-a shows transfer characteristic curves (drain voltage vs drain current for various gate bias values) for a type-A MOSFET. As drain-to-source voltage is increased from zero, current flows through the channel. Channel current is approximately propor-

tional to drain-source voltage—up to a point. This portion of the curve is known as the *ohmic region* because the channel resistance is varied linearly by the current flowing through it. It's also called the *triode region* because the curve looks like that of a triode tube. (Near the bottom of the ohmic region of the curve, channel resistance is several megohms in a typical MOSFET.)

At the knee of the curve the current has become so great that it sets up a reverse bias along the channel which acts the same as external gate bias—it depletes the channel. The curve flattens out because additional increase in drain-source voltage has little effect on drain current. (The channel resistance has decreased to about 1000 ohms.) Since this action resembles pinch-off voltage at the gate, this portion of the curve is known as the *pinch-off region*. The channel is saturated with current flow, so this part of the curve is also known as the *saturation region*. And since the curve is flat, like that of a pentode vacuum tube, this area is also called the *pentode region*.

By operating the MOSFET in the pinch-off region, with drain-source voltage between about 6 and 18 (referring to Fig. 5-a), small changes in gate voltage produce large changes in drain current. Thus the MOSFET is useful as an amplifier.

Beyond the pinch-off region is the *avalanche or breakdown region*. It's similar to the breakdown region in a bipolar transistor, and if total device power dissipation is not limited to a safe value, the MOSFET will be permanently damaged.

A simple amplifier stage is shown in Fig. 5-b to illustrate MOSFET operation. The device is an n-channel type A operating in the depletion mode as a common-source amplifier. Input signal is fed through coupling capacitor C_{c1} to the insulated gate, which is returned to ground through resistor R_G . This resistor is typically several megohms, depending on the desired input impedance. Drain-source current flowing through resistor R_D produces a voltage drop which provides sufficient negative bias at the gate to operate the MOSFET in the middle of the pinch-off region of its transfer curve. Bypass capacitor C_S allows R_S to act as a voltage dropper for dc but not for ac.

The substrate is connected to the source. It may also be grounded. (In some devices, it is internally connected to the source.) Drain-source current through load resistor R_D produces a voltage drop which is taken off through coupling capacitor C_{c2} and fed to the next stage.

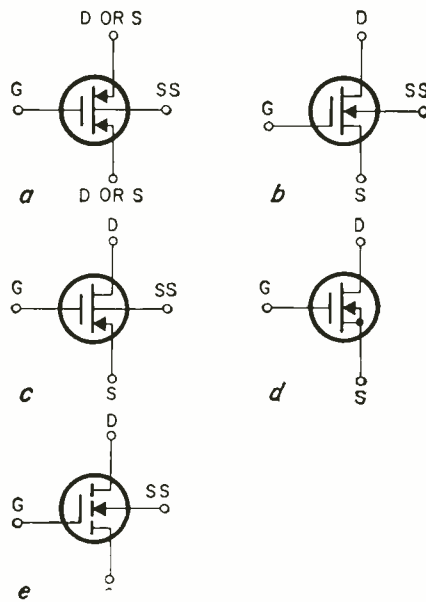

Fig. 4—Symbols used for MOSFET's. All devices shown are the n-channel type.

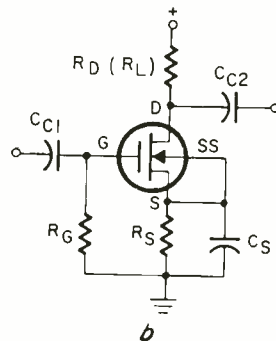
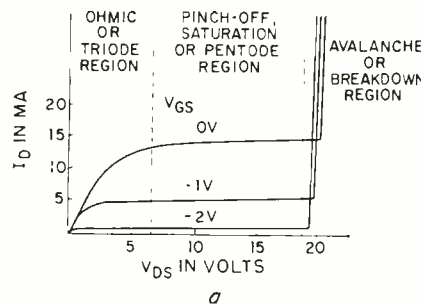

Fig. 5-a—Type-A MOSFET transfer curves. b—Typical common-source amplifier.

The MOSFET in Fig. 5-b is operating in the common-source (gate-drive) mode. This is similar to the bipolar common-emitter (base-drive) mode and the vacuum-tube common-cathode (grid-drive) modes. The MOSFET can also be operated in the common-gate (source-drive) mode, or the common-drain (source-follower) mode. And, of course, if the device were a p-channel type, supply-voltage polarity would be reversed.

The type-B MOSFET, you'll recall, operates in both depletion and enhancement modes. Fig. 6-a shows drain-current/drain-voltage curves for an n-channel version of this device. They are similar to the curves of Fig. 5-a, but notice that the gate varies

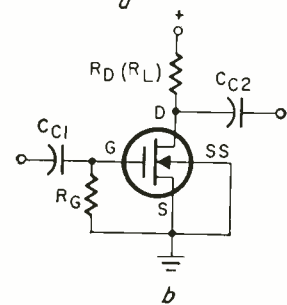
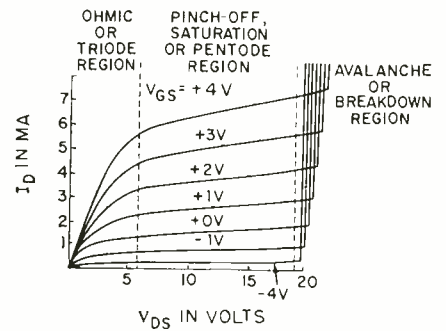

Fig. 6-a—Type-B MOSFET transfer curves. b, c—Zero bias and reverse-bias.

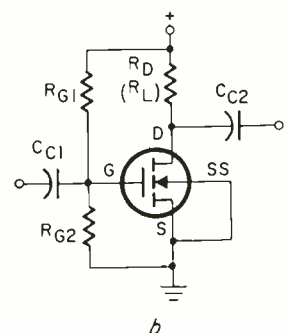
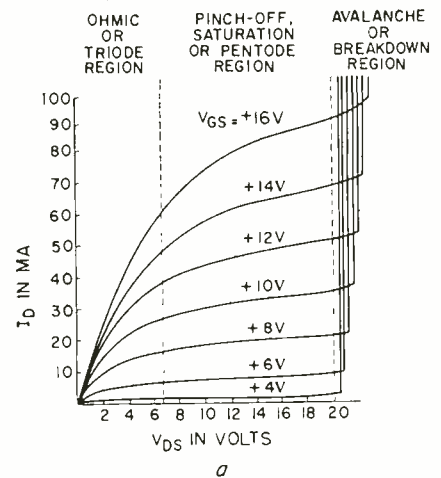

Fig. 7-a—Type-C MOSFET transfer curves. b—Common-source amplifier.

from negative to positive with respect to the source.

The circuits of two typical n-channel type-B MOSFET stages are shown in Figs. 6-b and c. At Fig. 6-b, the stage is operated with zero bias, so the source is grounded. Sometimes a very high value of R_{G1} is used (22 megohms, for instance) and a certain amount of gate bias is developed therefrom.

Not all type-B MOSFET's operate well at zero bias, however. Many work best when reverse-biased, even though the input (ac) signal drives the gate positive on alternate half-cycles. Thus the circuit of Fig. 6-c shows several methods of such reverse bias. One system is self-bias furnished by source resistor R_S and bypass C_S , as in the type-A stage. Another system

omits source components, using gate resistors R_{G1} and R_{G2} as a voltage divider across the supply. This is known as constant-current biasing, and useful because it allows the gate to go both positive and negative.

Even if zero bias is desired, the MOSFET gate must not be allowed to float—it *must* have a dc return to ground. Otherwise, the gate may build up a high potential from stray coupling. Such a high potential can puncture the insulator between gate and channel, destroying the device.

A p-channel stage, of course, would be the same except for supply-polarity reversal.

Curves for an n-channel type-C (enhancement-only) MOSFET are shown in Fig. 7-a; they look more like those of a bipolar transistor than of a vacuum tube. This is not surprising, as the enhancement-type MOSFET is normally *off* and must be turned *on*, just like a bipolar.

Typical biasing of a type-C MOSFET is shown in Fig. 7-b. Since only forward biasing is used, the source-resistor scheme cannot be used, and bias is usually obtained from a divider across the supply. Sometimes only a single resistor— R_{G1} —is used. A p-channel version would, of course, operate the same, but with reversed supply polarity.

In the previous article, differences between n- and p-channel JFET's were mentioned. These differences also apply to MOSFET's. The mobility of electrons, you will recall, is greater than that of holes. Since electrons are the majority carriers (which are all FET's use) in n-channel devices, they are better than their p-channel counterparts in several respects. N's have more gain (for a given input capacitance) than p's; they also have lower *on* resistance and lower noise figures.

Dual-gate MOSFET's

You learned about dual-gate or tetrode JFET's in the previous article. MOSFET's are also available with two gates, and they are also useful as mixers, converters and in agc applications. Some are also used as stereo FM and color TV demodulators—and they would probably work well as product detectors in SSB receivers. Three symbols for dual-gate MOSFET's are shown in Fig. 9. All are nonsymmetrical type-B devices, and in each the substrate is connected internally to the source.

Handling precautions

Because the MOSFET gate has such high impedance, it's extremely sensitive to static voltages that may be discharged through it during handling and installation. The oxide insulator

between gate and channel may easily be punctured by such a static voltage. It's common for the human body to build up a static charge of thousands of volts by walking across a rug, for instance. Though only a small current may flow when this charge is discharged to ground, the MOSFET's high impedance makes it so sensitive that the oxide insulator may be punctured. This causes permanent damage to the device.

To avoid damage to a MOSFET, you should observe three precautions while handling them.

1. Retain the shorting ring or wire around the MOSFET leads which is supplied with the device. If no shorting ring is supplied, the manufacturer usually tapes the leads together. Don't remove or unshort the leads until the device has been soldered or otherwise installed in a circuit. (I'll explain an exception to this rule later.)

2. Be sure the power is *off* before installing or replacing a MOSFET.

3. Ground yourself and the tip of the soldering iron or gun while soldering a MOSFET in a circuit. One way is to place the circuit on a grounded metal plate, and rest your elbows on that sheet during installation. Use a clip lead from the soldering tip to the sheet.

In an attempt to protect the gate from accidental static-voltage damage, some manufacturers fabricate MOSFET's with integral gate-protection networks. That covers the theory portion of this series. Next month we'll present some practical construction projects using low-cost MOSFET's, and show where the various types are best used.

(TO BE CONTINUED)



"I'm no engineer, but I think our physics department just lost a patent."

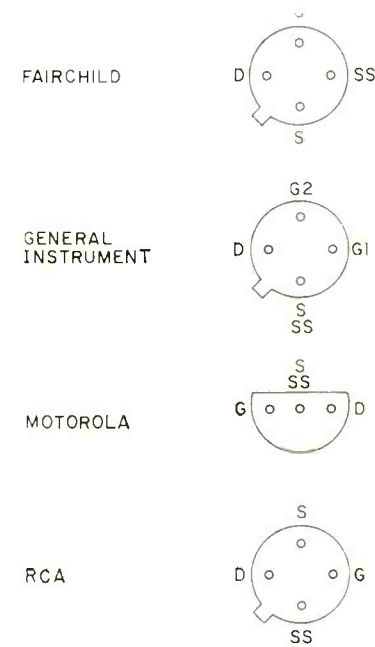

Fig. 8—Base terminals above for MOSFET's are the configurations used by some manufacturers.

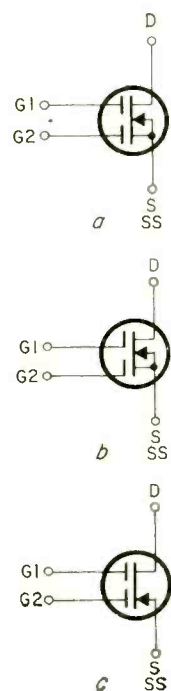

Fig. 9—Dual-gate or tetrode MOSFET symbols are illustrated on the left. All are type-B.





NEW R-E EXCLUSIVE

Kwik-Fix™ picture and waveform charts

by Forest H. Belt & Associates*

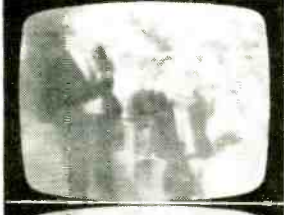
SCREEN SYMPTOMS AS GUIDES

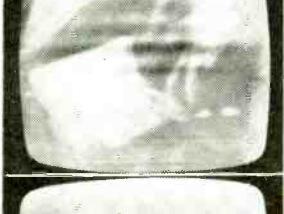
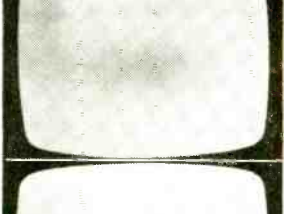
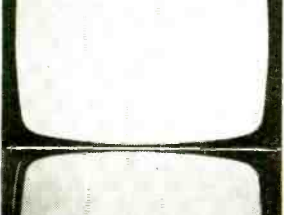
WHERE TO CHECK FIRST

SYMPTOM PIC	DESCRIPTION	VOLTAGE	WAVEFORM	PART
	Agc overload, no sync, sound buzz	cathode-pin-1 screen-pin-2	WF1 WF2	R8 C5
	Weak picture, sync okay	G1-pin-7	WF2	R6 R7
	Weak picture, sync poor	G1-pin-7 plate-pin-3	WF1	C2
	Weak picture, bending and flagwaving	G3-pin-6	not much help	R1 R2
	Whiteout, sound remains	G1-pin-7	WF2	R7
	Whiteout, no sound	not much help	WF1 WF3	R4 and most others
	Agc overload, sync fairly normal, sound buzz	screen-pin-2 G3-pin-6	WF1	R2 R9 R10

NOTES:

Use this guide to help you find which key voltage or waveform to check first.

Study the screen and the action of the Agc and Noise Gate controls.

Most helpful clues to the fault are found at the key test points indicated.

an Easy Read™ feature by FOREST H. BELT & Associates © 1969

Make voltage or waveform checks as indicated for screen symptoms.

Use the VOLTAGE GUIDE and WAVEFORM GUIDE to analyze results.

For a quick check, test or substitute the parts listed as the most likely cause of the symptoms.

THE CIRCUITS

THIS KEYED AGC STAGE IS POPULAR, ESPECIALLY IN color sets. Tube has special twin-pentode construction, with some elements common to both sides—cancels noise for both sync separation and automatic gain control action. This issue of *Kwick-Fix™*, number 6, covers keyed age; next issue, number 7, covers other half of tube—sync separator.

Grids 1 and 2 and cathode are common to both sections, terminated in pins 7, 2, and 1, respectively. Age section has its own separate G3 and plate, pins 6 and 3 (pins 8 and 9 are plate and grid 3 for sync separator section). Grid 1 is noise-canceling grid for both sections. Grid 2 is screen grid for both; constant positive voltage there affects general conditions of conduction for entire tube.

SIGNAL BEHAVIOR

Video-and-sync signal from video amplifier is applied through compensating network R1-C1-R4 to age grid (pin 6). Sync pulses in WF1, which are positive-going, exercise strong control over conduction in this section of tube. *when* tube can conduct. Thus, amplitude of WF1 sync pulses determines amount of conduction.

At same time, video signal with negative-going sync is applied to noise-canceling grid at pin 7. Bias is enough on grid-pin-7 that any signal of higher amplitude than sync pulses (such as noise) drives tube way into cutoff. No noise pulse can therefore be amplified, even if it reaches grid-pin-9, because same noise impulse (but in opposite polarity) is cutting this vacuum tube off at grid-pin-7.

Meanwhile, high-amplitude keying pulse from flyback is applied to plate-pin-3 of tube through C3. Pulse is positive-going, acts as short-duration plate voltage for tube. Is large enough in value to make tube conduct, provided that, at same time, positive sync pulse in WF1 is present on grid-pin-6 and no noise in WF2 is cutting off tube at grid-pin-7. Amount of plate current is determined mainly by strength of positive-going sync pulse on grid-pin-6.

Noise or any other signal disturbance between sync pulses can't affect age voltage developed, because keying assures no plate voltage except during retrace (and horizontal sync pulse) time.

Capacitor C4 decouples screen grid from B-plus, using cathode-bypass capacitor C5 as an easy signal path to ground.

DC DISTRIBUTION

Plate voltage for age section of 6HS8 is pulse from flyback transformer (from horizontal output plate in some receivers). Exists only during sweep retrace in yoke. Result: tube acts as grid-controlled rectifier of keying pulse. Steady negative dc voltage develops on plate-pin-3, value controlled by amplitude of sync pulses in video-and-sync signal on grid-pin-6. Output decoupling network (not shown) distributes age voltage to rf and i.f. stages, after filtering it. There, it controls gain, compensating for variations in signal strength.

Bias between cathode and grid 1 of tube is set by controls R7 and R8. Noise gate sets level of operation for G1. Control is set for dc voltage level just below tips of incoming sync pulses, so pulses won't quite overcome dc voltage. Age control R8 adjusts cathode voltage—thus sets grid-cathode bias. Determines conduction for any particular amplitude of signal applied to grid 3 (pin 6). That, in turn, determines level of age voltage.

Resistor R9 from cathode-pin-1 to plate-pin-3 applies slight positive bucking voltage to delay age, and is input load for keying pulse. Constant screen voltage is applied from 250-volt line by R10.

QUICK TROUBLESHOOTING

Overloading in i.f. and rf stages of receiver, caused by too much or too little age voltage, can confuse troubleshooting attempts. Leaves no proper video to operate age stage. First step, always, is to clamp age at whatever value lets video through the screen.

Don't apply too much clamp voltage. Just clip variable dc bias supply to i.f. age line and turn up voltage until picture is visible. May be out of sync, but that's okay. Leave age and noise gate set at center of rotation.

Then, *with video on screen*, go ahead with waveform and dc voltage checks. Use scope first. Plenty of faults cause very little dc change, yet warp waveforms noticeably. Check output of video amplifier before analyzing WF1; it is source for that waveform. Likewise, check video detector output before condemning WF2. NOTE: If waveform display is shaky or jittery on scope, adjust receiver hold controls for as steady a TV picture as you can get.

Also, see next *Kwick-Fix™*, number 7, which is companion to this one—shows sync-separator side of stage. (WAVEFORM CHARTS ON NEXT THREE PAGES)

R-E

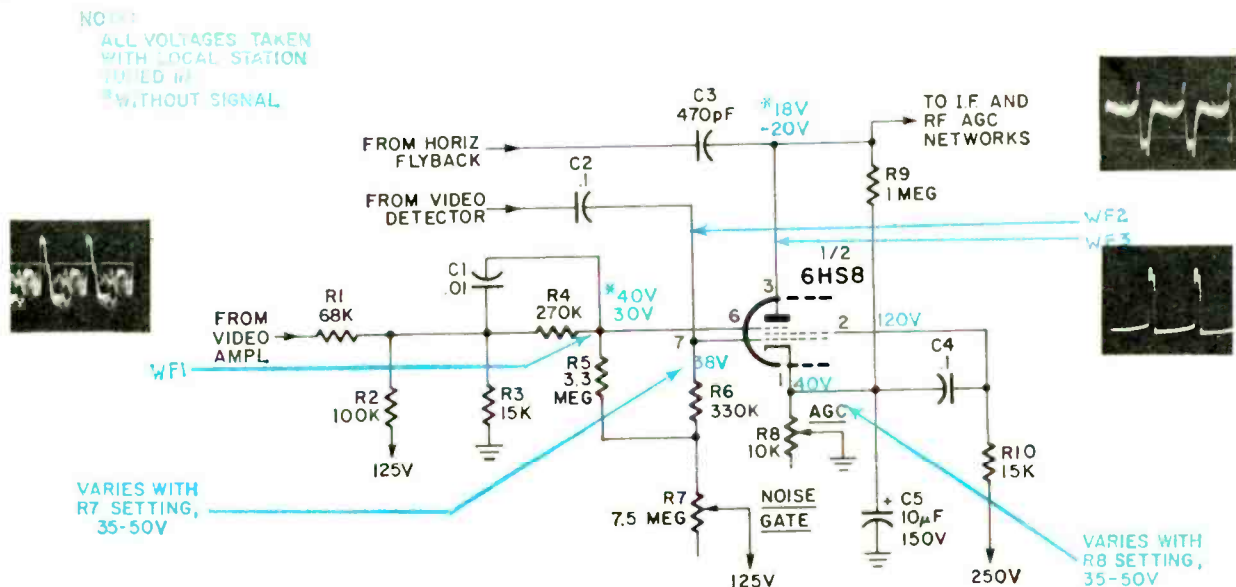

DC VOLTAGES AS GUIDES

Voltage change	to zero	very low	low	slightly low	slightly high	high
cathode-pin-1 Normal 40 V Varies from 35 to 50 volts with setting of R8. Develops as result of average plate conduction in tube.	R10 open C5 short	R7 open	R10 high C2 leaky C5 leaky		C2 open C4 leaky	R8 open R10 low C2 open
screen-pin-2 Normal 120 V Is applied through R10 from 250-volt line.	R10 open C4 shorted	C4 shorted C5 shorted	R10 high C4 leaky C5 leaky	C4 leaky	R6 open C2 open	R5 low R7 open R8 open R10 low C2 leaky
plate-pin-3 Normal —15 V to —30 V Depends on how much video/sync reaches grid-pin-6. I-f agc line should be clamped for testing.	R2 open R3 low R8 open ¹ R9 low ¹ R10 open R10 low ¹ C3 open ¹ C4 leaky	R1 open R2 open R3 low	R1 high	R7 open C2 open	R5 low R6 open	R2 low R3 open, high R10 high C2 leaky C5 leaky C5 shorted
G3-pin-6 Normal 30 V Varies with amplitude of input video signal. Developed by grid-leak action across R5.			R1 open R2 open R3 low R10 high C2 leaky C5 leaky	R6 open R7 open	R8 open C2 open	R2 low R3 open
G1-pin-7 Normal 38 V Varies from 35 to 50 volts with setting of R7. Comes through R7 from 125-volt line. ¹ Voltage goes positive	R6 open R7 open R10 open	R6 high	R5 shorted R10 high C2 leaky C5 leaky	C2 open	C4 leaky	R8 open R10 open

NOTES:

Use this guide to help you pinpoint the faulty part. **BE VERY SURE** to clamp i-f agc line as described in text; indications in this chart are valid only under those conditions. Measure each of the five key voltages with a vtvm.

For each, move across to the column that describes the change you find.

Finally, notice which parts are repeated in the combination of changes you find.

Test those parts individually for the fault described.



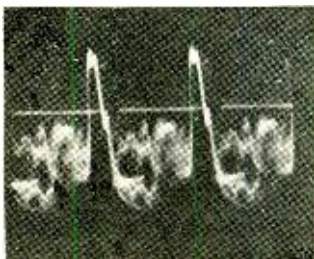







WAVEFORMS AS GUIDES



WF1 Normal 15 V p-p

Taken at G3-pin-6, this is high-amplitude signal containing video and positive-going sync pulses. Has been amplified and inverted by video amplifier before being applied to input network R1-C1-R4. Effect of compensating network is to sharpen leading edges of video signal—result of frequency peaking. Amplitude of sync pulses is what determines how much dc agc voltage is developed at plate-pin-3 and fed to i.f. and rf stages of receiver.

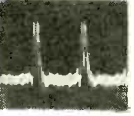
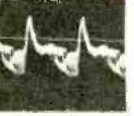
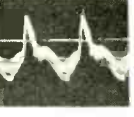



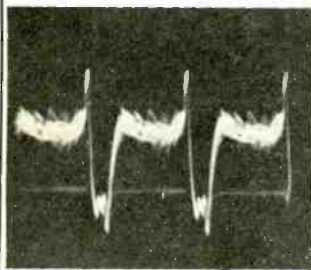





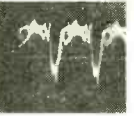
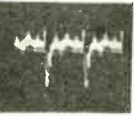

WAVEFORMS AS GUIDES

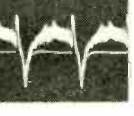
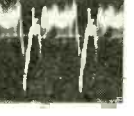
<p>V p-p low</p> <p>R3 low C5 leaky</p>	<p>V p-p high</p> <p>R1 open R1 high</p>	<p>V p-p zero</p> <p>R2 v. low C2 leaky</p>	 <p>10 V p-p R1 low</p>	 <p>3 V p-p R1 open</p>	 <p>6 V p-p R2 low</p>	 <p>10 V p-p R3 high</p>	 <p>10 V p-p R5 low</p>
			 <p>3.5 V p-p R7 open</p>	 <p>10 V p-p R8 open</p>	 <p>7 V p-p C1 open</p>	 <p>2 V p-p C2 leaky</p>	 <p>12 V p-p C3 open</p>
			 <p>12 V p-p C5 open</p>	 <p>2 V p-p C5 leaky</p>	 <p>15 V p-p C7 open</p>		



WF2 Normal 0.6 V p-p

Taken at G1-pin-7, noise-canceling grid, this is video-and-sync signal directly from video detector. Sync pulses normally point negative. No compensating network at input, just dc-blocking capacitor C1. Note trailing edge is sharp, rather than leading edge as in WF1. This signal doesn't affect operation of tube much unless there is noise accompanying signal. In that case, noise pulse blocks conduction momentarily to keep noise from appearing in agc output (which is dc at plate-pin-3).

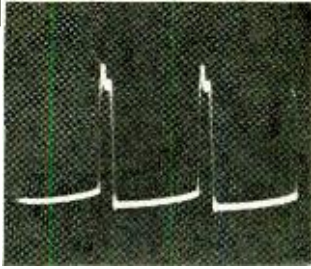

<p>R1 low R2 low C2 open</p>	<p>R8 open R9 low C4 leaky C5 open</p>	<p>C2 open</p>	 <p>2 V p-p R1 open</p>	 <p>0.4 V p-p R2 low</p>	 <p>0.5 V p-p R3 high</p>	 <p>2.5 V p-p R5 low</p>	 <p>2 V p-p R7 open</p>
			 <p>3 V p-p R8 open</p>	 <p>4 V p-p R9 low</p>	 <p>0.4 V p-p R10 open</p>	 <p>0.4 V p-p C2 open</p>	 <p>2 V p-p C2 leaky</p>
			 <p>0.3 V p-p C3 open</p>	 <p>2 V p-p C5 open</p>	 <p>0.6 V p-p C7 open</p>	 <p>2 V p-p C7 shorted</p>	 <p>0.6 V p-p C5 leaky</p>

WAVEFORMS AS GUIDES



WF3 Normal 200 V p-p

Taken at plate-pin-3. Don't misconstrue this as output pulse, however. This waveform is high-amplitude, short-duration, positive plate voltage for tube. When this voltage is applied to plate at time that coincides with positive sync pulse at G3-pin-6, tube can conduct. If WF3 is missing or inverted, check wiring from C3 all way back to flyback transformer, or to whatever source supplies keying pulse.

V p-p low	V p-p high	V p-p zero	 0.4 V p-p C3 open	 2 V p-p R9 low	
C3 open		C3 open C9 short			

NOTES:

Use this guide and the Voltages Guide to help you pin down fault possibilities. ALWAYS clamp the i-j age line at whatever voltage lets video reach the TV screen, even if sync remains poor. All waveform symptoms shown in this chart are taken under those conditions (see text).

With the direct probe of the scope, check the three key waveforms. The scope should be set at H or about 5 kHz, to show three cycles of waveform. Note amplitude. If it's low or high, check parts under those descriptions. Note waveshape. If there's a change from normal, check the parts indicated.

AUTOMATIC TINT CONTROL FOR COLOR TV (continued from page 4)

greens at the chroma amplifier. The phase of the red correction voltage at this point is 343 degrees—leading the burst by 17 degrees.

When fleshtones shift from 57 degrees toward yellow, the correction signal produced at 103 degrees combines vectorially with the original chroma signal to produce a 57-degree resultant. (This assumes that the ATC switch is at FULL and the chroma error doesn't exceed 30 degrees.) When the fleshtone shifts toward red, the 343-degree correction signal adds to the chroma signal to produce a 57-degree resultant signal.

When the ATC switch is set at FULL, all colors between a yellowish-orange and a bright red are combined to produce a 57-degree orange in the fleshtone orange. Thus, a vectorscope pattern of a modulated color bar will show variations in the area between zero and 90 degrees, depending on the position of the ATC switch. When it is OFF, pulses

representing ten color bars will appear 30 degrees apart; starting from the burst at zero degrees.

The first petal or pulse represents the yellowish-orange bar at 30 degrees; the second represents the orange bar at 60 degrees and the third is a bright red bar at 90 degrees. When the switch is in the PARTIAL position, the 90-degree pulse moves counterclockwise to around 78 degrees and the 30-degree pulse moves clockwise to about 45 degrees. Throwing the switch to FULL, causes the first three petals to overlap at 57 degrees and the fourth petal moves around to about 87 degrees. Thus, with full atc correction, all colors transmitted with phase angles between 30 and 90 degrees will reproduce as 57 degree fleshtones. Naturally, this correction causes shifts in some background colors between yellowish-orange and red but, generally, this is not as easy to detect nor as annoying to the viewer as an equal phase error in

fleshtones without atc correction.

(A few weeks with the Magnavox T940 chassis with atc proved that automatic tint control does have disadvantages under some conditions. One evening my wife called to me, "Come and see the invisible singer on TV." All I could see was an almost solid orange screen with a pair of eyes, lips, the faint outline of a nose, gloved

hands and shoes. My heart kicked up as it occurred to me that the picture tube had failed. When I regained my composure, I flipped the atc switch from FULL to OFF. Now, we could see a beautiful honey blonde in a light orange dress against an orange-red background. The atc circuit had converted nearly all colors in the scene to fleshtone-orange so the gal was nearly invisible.) **R-E**



OH-OH

FOR MODEL RR

Electronic

Throttle

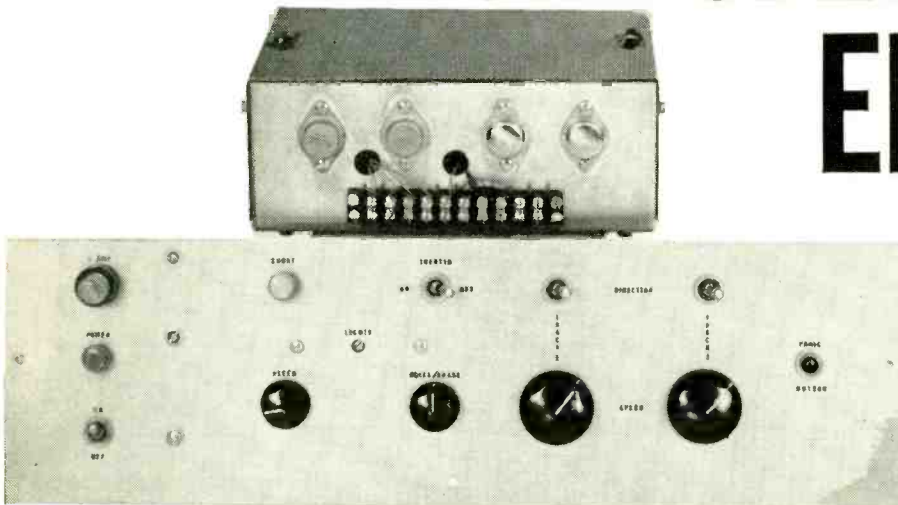

Solid-state features include dual variable-speed and inertia controls, automatic-latching tripout and panic button

by HENRY J. MIERLAK

MODEL RAILROADING RECEIVED A mild "shot in the arm" with the introduction of N gauge. About half the size of the popular HO gauge, complex N-gauge layouts occupy much less space than any other gauge model railroad. But complex layouts (anything greater than a single-track circuit) fall flat in performance and enjoyment unless versatile control of train traffic can be achieved.

The dual throttle unit described here will give the hobbyist stability and versatility for a two-circuit layout with these features:

- Two 0-14-volt variable-speed outputs regulated up to 1 amp each.
- Ac accessory output (20 volts).
- Variable dc output for lighting.
- Variable inertia control. Trains accelerate and brake at a selectable rate.
- Automatic-latching tripout with indicator to remove all track circuit power when an overload occurs.
- Panic button to stop all track action in case of a collision course requiring quick action.

If some of the features are not desirable, a simpler and more economical throttle can be built. Simplifying the throttle unit will be described later and is accomplished by deleting sections of the unit. Before we start drilling and soldering, let's

look at the circuit of the electronic throttle by sections (see Fig. 1).

Power-supply section

Transformer T1 supplies two rectifier systems: one full-wave for the track circuits and one half-wave for the lighting circuit. The full-wave dc line has a 750- μ F filter (C1 and C2) as the minimum value for good speed regulation and stable operation of the tripout circuit. The lighting circuit receives unfiltered half-wave dc since regulation is not required here. The pilot light and ac accessory outputs are tapped from a 20-volt side of the transformer secondary.

The filtered dc line is fed to two series-control transistors (Q5 and Q8) through the tripout relay contacts, and to the reference-voltage source (D4 and Q2). Darlington amplifiers permit use of low values of control current from the control section.

Control section

Zener diode D4 and R5 hold Q2's emitter at 17 volts, and Q2 offers isolation and current gain between this Zener and the control transistors. Capacitor C3 is used for RFI (rf interference) suppression. Transistors Q9 and Q10 are controlled directly from the wiper of R7. The lighting output voltage is about 1½ volts less than the wiper arm value of R7 due to base-emitter voltage drops. Up to ten 6-volt miniature lamps can

be used to light up your model railroad layout.

Track circuits 1 and 2 are identical, so only the description of track 1's circuit is necessary. When S3 is in its shown position (INERTIA OFF), Q3's base is tied to the reference voltage source through R9. The track voltage is determined by the settings of R8 and R13, and it follows the speed control position as in any conventional throttle unit. When S3 is in the INERTIA ON position, R8, R9, R10 and C4 set up an RC delay for any change in R8's wiper position, thus the inertia or delayed-action effect. Pot R10 has a delay range of about 7 to 30 seconds for completion of the train's gradual response to the resetting of R8.

Bleed pot R13 maintains a dc potential on the tracks, and is set to the point where the engine(s) is just about to move. This gives the speed pots control over the full range of rotation, and train movement therefore begins during the first few degrees of rotation of the speed pots.

Tripout section

This section offers protection for the unit and warns of trouble on the tracks. When either track circuit draws more than 1 amp for any reason, the relay (RY1) activates and removes all dc from the two series pass transistors (Q5 and Q8). Relay RY1 is latched through its contacts;

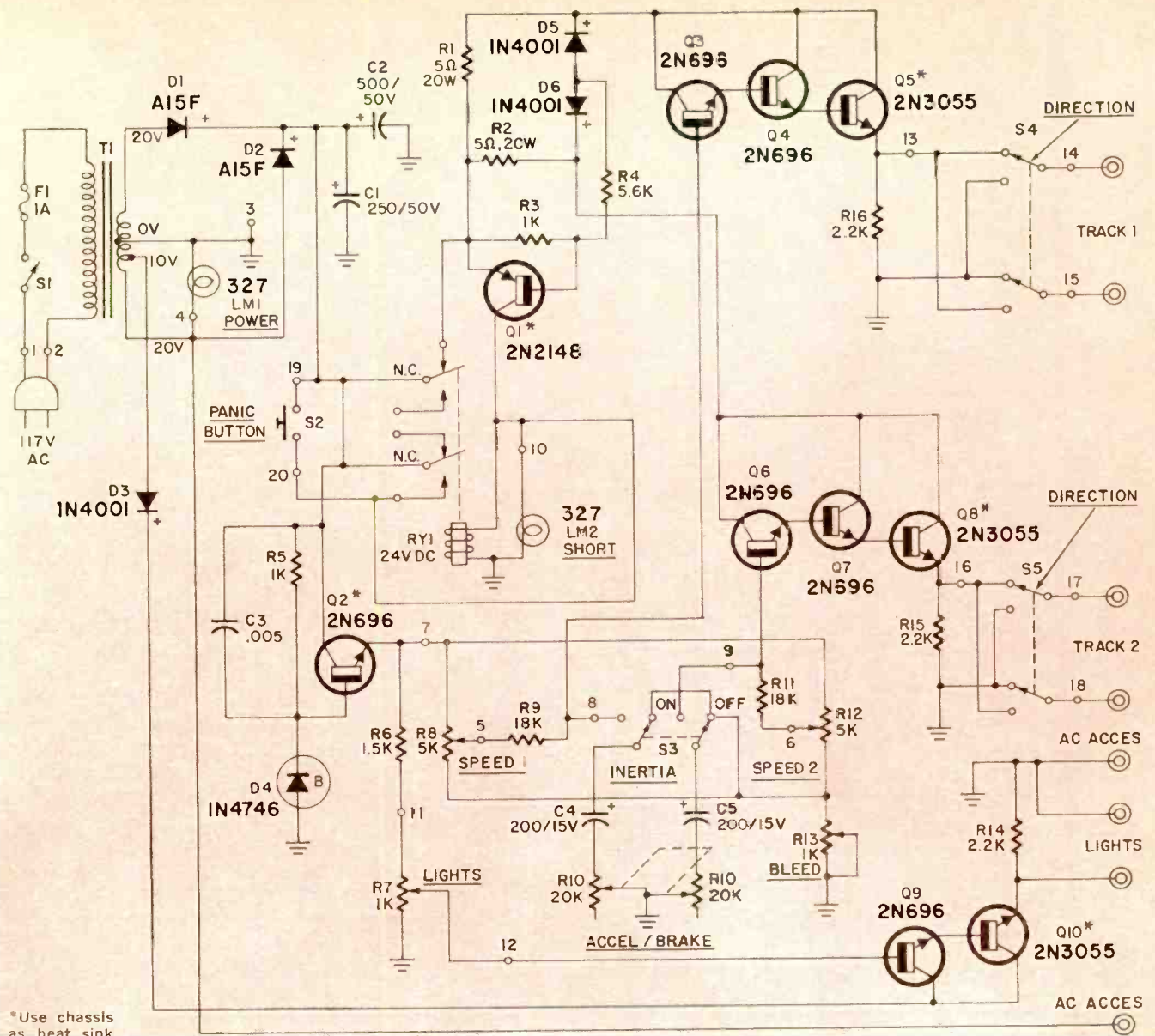

*Use chassis as heat sink

PARTS LIST

Capacitors

- C1—250- μ F, 50V, electrolytic
- C2—500- μ F, 50V, electrolytic
- C3—0.005- μ F, 100V ceramic or mylar
- C4, C5—200- μ F, 15V, electrolytic

All resistors 10% or better

- R1, R2—5-ohm, 20-watt wirewound
- R3, R5—1000-ohm, $\frac{1}{2}$ W
- R4—5600-ohm, $\frac{1}{2}$ W
- R6—1500-ohm, $\frac{1}{2}$ W
- R7, R13—1000-ohm, 2 or 4-watt, linear wirewound potentiometer
- R8, R12—5000-ohm, 2 or 4-watt, linear wirewound potentiometer
- R9, R11—18,000-ohm, $\frac{1}{2}$ W
- R10—20,000-ohm, dual linear potentiometer
- R14, R15, R16—2200-ohm, $\frac{1}{2}$ W

Semiconductors

- D1, D2—50 PIV, 3A, silicon diode (G.E. A15F or equal)
- D3, D5, D6—50 PIV, 1A, silicon diode (1N4001 or equal)
- D4—18-volt, 1-watt, 10% Zener diode (1N4746 or equal)
- Q1—2N2148 transistor
- Q2, Q3, Q4, Q6, Q7, Q9—2N696 transistor
- Q5, Q8, Q10—2N3055 transistor

Other parts

- T1—40-volt center tapped with 10-volt tap power transformer (Triad types F-92A or R-204A)
- RY1—24-volt, dpdt-contact relay (P&B type KA11DY or equal)
- S1—spst toggle switch
- S2—momentary-contact pushbutton switch
- S3, S4, S5—dpdt toggle switch
- MISC—prepunched board, terminal strip, T05 clip-on heat sink, knobs, cable, chassis

Use Fig. 1 above to wire an electronic throttle like the author's or any of the variations described in the text. Numbered circles above are connections to a control panel. Photo shows U-chassis and L subchassis used in this version.

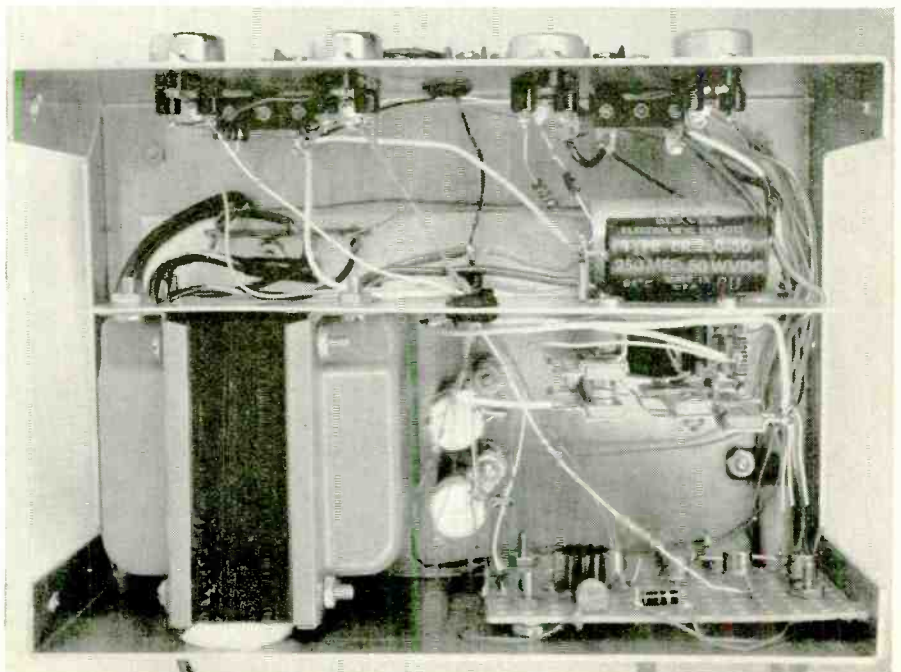

the ac power switch must be switched off and back on to unlatch it. When pressed, PANIC BUTTON S2 simply activates RY1. Transistor Q1 is normally off and R3 and R4 are selected to turn Q1 and RY1 on when either R1 or R2 drops 5 volts or more due to currents of 1 amp or greater. Lamp LM2 visually indicates the overload or short condition of the tracks.

Construction tips

Use whatever component layout your railroad calls for. I housed the controls and switches on a panel and the remaining components in a deep U chassis. A 20-conductor cable was used between the panel and chassis. Numbered circles on the conductors in Fig. 1 show where I used a cable between the two subassemblies. All small components (except C3 and

C4) were mounted in the chassis. Parts T1, RY1, D1 and D2 are mounted on an L subchassis. A screw-type barrier strip was used for the output terminals. Transistors Q1, Q5, Q8 and Q10 are TO3-style devices, and since their maximum dissipation ratings far exceed circuit dissipation, the chassis was used as a suitable heat sink. Use silicone compound and a chassis 1/16 inch or thicker. Dry transfer letters were used for labeling the functions and a brush coating of clear nailpolish protects the labels.

Design considerations

Wirewound controls should be used for R7, R8, R12 and R13, and 2N3055's should be used for Q5, Q8 and Q10. The rest of the components are not critical and appropriate sub-

stitutions can be made. Component layout is not critical, and the aluminum-plate heat sink for the four power transistors should be at least 8x4x1/16 inches. A chassis side may be used for heat sinking. A push-on heat radiator for Q2 is required.

If regulation of the lighting output is desired, add a 500- μ F, 25-V electrolytic capacitor between Q10's collector and ground. If an adjustable tripout is desired, add a 5000-ohm pot between R3 and R4 and connect the wiper to Q1's base. Also change R4 to a 1000-ohm resistor. You can then set the tripout point to your needs. Delay time of the inertia feature can be increased or decreased by changing the values of C4 and C5.

By deleting portions of the unit, a simpler and cheaper throttle unit can be built. If the panic button and tripout feature are not desired, RY1, LM2, S2, Q1, R1, R2, R3, R4, D5 and D6 can be deleted. Just return the collectors of Q2, Q5 and Q8 to the positive ends of C1 and C2. To eliminate the inertia features, omit R9, R10, R11, C4, C5 and S3. Connect R8's wiper directly to Q3's base, and R12's wiper to Q6's base. To omit the lighting circuit, remove D3, R6, R7, R14, Q9 and Q10. A tapped transformer would not be a requirement for the unit now. **R-E**

Behind author's control panel. A 20-conductor cable ties controls to the chassis.

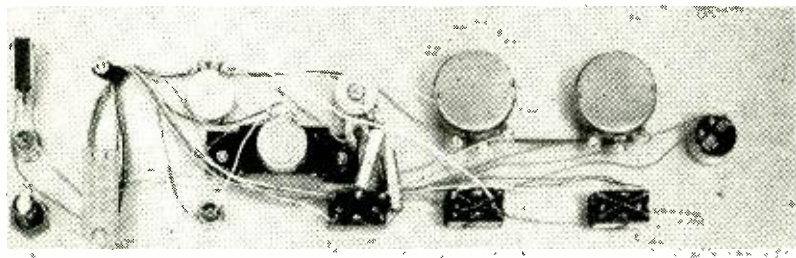

TOOLS FOR ELECTRONICS

by TOM HASKETT

Hand tools are vital to working in electronics. In the past two months we have presented a complete picture of how and when to use what kind of pliers. This month we continue our series with a complete rundown on screwdrivers. In the months to come many other kinds of tools, including wrenches, screwdrivers, alignment tool, power tools, etc. Each section will become a handy, practical addition to your R-E Reference Manual.

For those of you who have vainly tried to assemble the first two installments of this series, we offer our apologies. Our printer, in both issues, carefully turned the backup pages upside down, making this an impossible task. As soon as we have ironed out a method for providing you with corrected pages we'll let you know.

MAKE AN R-E REFERENCE MANUAL

If you wish you can purchase a special hardcover binder to keep your Reference Manual pages together. It has a dark blue fabric cover and is gold stamped Radio-Electronics Reference Manual. The cost is \$1.00, postpaid. Order from N. Estrada, 17 Slate Lane, South Hauppauge, N. Y.

SCREWDRIVERS

IF YOU WORK OR PLAY IN ELECTRONICS, YOU PROBABLY HAVE TO turn screws many times each day. The screwdrivers you use are designed to handle only a few sizes of screws, and therefore you can't get by with merely a couple of drivers; you have to have an assortment on hand. As with other tools, specialized drivers permit precise, safe and more efficient work. This article will describe the many kinds of screwdrivers available today, and how they can make your job easier and speed up your work.

The basic screwdriver

Probably no tool is more used and misused than the common screwdriver. As shown in Fig. 1, it's a simple tool, consisting of three parts—the **tip** (also known as the **bit** or **point**), the **blade** (also called **shank** or **shaft**) and the **handle**. A screwdriver is used to apply torque to a relatively small area—the head of a screw.

The common screwdriver has a thin steel blade anchored in a larger handle. The blade is forged from tool steel or other tough, resilient metal, which is then tempered. The tip is flat, hot-forged to size and heat-treated. The handle is made of wood or plastic, often fluted or ridged for a good grip. The blade is anchored in the handle by two or more tongs or wings on the end of the blade, which prevent the blade from turning in the handle.

Driver tips and screwheads

There are at least seven different kinds of screwheads and driver tips. Each of these screws and drivers comes in several sizes. To drive a screw properly, you must match the driver tip to the screwhead.

The most common type of screw has a **slotted head**, and two types



Fig. 1—Four standard slotted-head type screwdrivers. Top left, is Upson GC. Top right is Stanley 1006, bottom left Xcelite R5166. Bottom right, Crescent 94.

of driver tips are made to turn it. The keystone bit shown in Fig. 1 is most common and simple to make, but has the disadvantage that you

electronics, and requires its own driver, shown in Fig. 5. The recess in the screw head looks somewhat like a figure "8." The driver, known as a **Type G clutch head**, is made in six tip sizes: 3/32 inch, 1/8 inch, 5/32 inch, 3/16 inch, 1/4 inch, and 5/16 inch.

Developed in Canada, **Scrulox** (or **Robertson**) screws are making



Fig. 5—G-type clutch-head is still another tip style. This time only two such screwdrivers are shown. Left, Xcelite 3164; right, Ocatonna CH 6.

their way into the US, and require a square-tipped driver (Fig. 6). Drivers are available with five tip sizes, from No. 00 to No. 3.



Fig. 6—Square-tipped screwdriver comes in five tip sizes. Unit shown here is Vaco driver model R10.

Two kinds of hexagonal recessed screwheads are in common use in electronics—often as control-knob setscrews. The **Allen head** is a

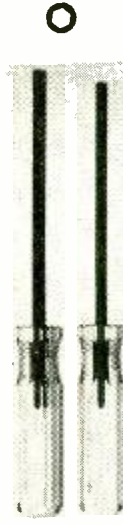

Fig. 7—Hexagon recessed screwheads require still another type driver. Here are two sizes, both by Proto. Model 6589 (top) and 6588 (bottom).

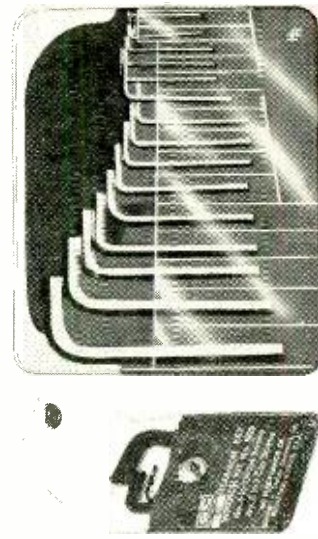

Fig. 8—Allen-head wrenches take all shapes and sizes. Three different sets are illustrated. Left, G-C 5029; center, Peer 41-565; right, Shelton 8-way.



can't work it into a recessed hole. The cabinet tip (Fig. 2) is straight-sided and far more useful, since no part of the blade is wider than the



Fig. 2—Straight-sided cabinet tip gets into tighter corners, but costs more. Top left, Stanley 1016; top right, Vaco A316-6; bottom left, Crescent 9.

tip, permitting you to work recessed screws. A keystone-tip driver is often called a mechanic's screwdriver; the type with a cabinet tip is often called an electrician's screwdriver.

Two kinds of cross-slot screw heads are in general use. More common is the Phillips (Fig. 3), which is sometimes called a U slot. Phillips



Fig. 3—Phillips head or U-slot screwdrivers come in a variety of tip sizes. Top left, Channellock 102-P; Top right, Xcelite RP 102; bottom left, Stanley 2912.

screwdrivers are made in five tip sizes, from No. 0 to No. 4, to fit the various sizes of screws.

The other type of cross-slot screw is called Reed & Prince or Frearson, and has a head with a V slot, different from the Phillips U slot (see Fig. 4) R&P drivers are made with tip sizes from No. 1 through No. 4. You cannot use a Phillips driver on an R&P screw, or vice versa.



Fig. 4—Clutch-head or V-slot looks like a Phillips but isn't. Tool at the left is the Vaco model F-710 screwdriver.

The clutch head (or butterfly) screw is becoming more common in

hexagonal flat-sided recessed type, which can be turned with Allen drivers (Fig. 7) or L-angle Allen wrenches (Fig. 8). A unique variation is Hunter's T-handle Allen driver (Fig. 9), which is available in several sizes. Most Allen drivers and wrenches are available in kits which cover the most common screw sizes.

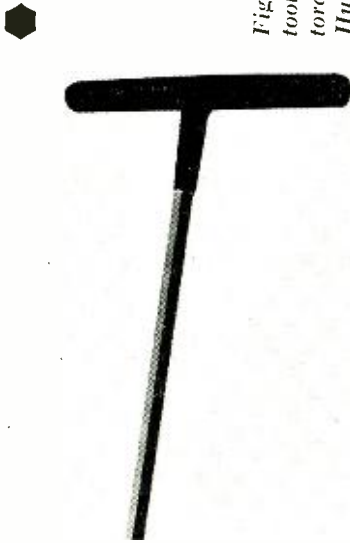

Fig. 9—T-handle Allen driver is a tool that provides high starting torque when required. It's made by Hunter as their model 3TH6.

The other kind of hexagonal recessed screwhead is called Bristo spline. You can turn it with Bristo drivers (Fig. 10) or L-angle wrenches (Fig. 11). Both are available in kits.

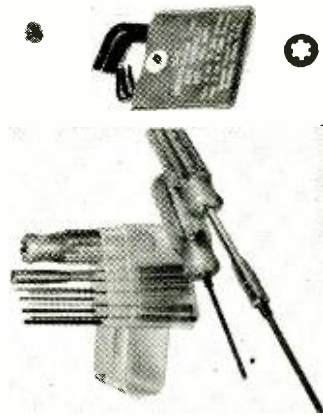

Fig. 10—Bristo-spline heads can be turned with drivers too. Set on the left is Xcelite model 99PS-60.

Fig. 11—Another way to handle the Bristo-spline head is with L-angle wrenches. The set on the right is the General-Cement model 5070.

Blade types

To perform specific jobs, screwdriver blades are made in various lengths and widths. The length of a blade tells you the size of a screwdriver; that is, a 4-inch screwdriver has a 4-inch blade.

The most common type of driver has the **round blade** shown previously. (A cabinet-tip driver always has a round blade.) Also, drivers with Phillips, Reed & Prince, clutch and Scrulox tips usually have round blades.

Square blades (Fig. 12) are found only on longer keystone-tip drivers for slotted-head screws. There is more steel in a square cross-



Fig. 12—A square cross section, such as on the Xcelite S148 (left) and Armstrong 3062 (right), provides more steel in these square blades and delivers more torque. Design lets you lock on a wrench or pliers for more leverage.

section than in a round, so a square-bladed driver delivers more torque to a screwhead. Also, you can slip a right-angle wrench around the square blade to provide more leverage on hard-to-work screws.

The size of the screw to be turned determines the tip size, which in turn determines the length and thickness of the blade and the size of the handle. In general, the larger the screw, the larger and longer the screwdriver blade and handle. This is necessary to permit comfortable grasping, so that the proper amount of torque may be applied easily. If the handle is too small, you can't apply enough torque to turn the screw. If the handle is too large, you may be able to apply too much torque, stripping the screw threads or damaging the screwhead and/or the driver tip.

As you can see, there's a common-sense relationship between tip width and blade length, determined by the need for just so much torque and no more. For example, a rough kind of size progression might go like this (tip width vs blade length, both in inches): $3/32 \times 3$, $1/8 \times 4$, $5/32 \times 5$, $3/16 \times 6$, $1/4 \times 8$, $5/16 \times 10$, $3/8 \times 12$. This is no hard-and-fast rule, though. It is more applicable to keystone-tip drivers, in which the blade gets longer as the tip gets wider. You can buy cabinet-tip drivers in $3/16$ -inch or $1/8$ -inch widths with blade lengths from 2 inches to 12 inches.

For a given tip width, you can buy long- and short-bladed drivers, which are useful in certain situations. You should be aware of the general rule that the wider the tip, the longer the blade, and remember the need for only so much torque.

Probably the two most useful sizes of screwdrivers for slotted-

from the cabinet front. Of course, such drivers are also useful in other hard-to-reach locations. You have to be careful, though, not to use too much torque or you'll strip threads or damage heads.

The **right-angle** or **offset** screwdriver lets you work a screw in tight quarters, where the long blade of a conventional driver wouldn't fit. The double-tipped type (Fig. 15) has two bits—often one is slotted and one Phillips. Another type (Fig. 16) has four bits and is often called a **four-way** offset driver. Both kinds are about 4 or 5 inches long.

Fig. 16—Right-angle or offset arrangement lets you operate in cramped places. This General 808 offset has four bits for added versatility.



Some screwdrivers are made with insulation over the blade (Fig. 17). Only the tip is exposed metal, and thus the driver can be used on a



Fig. 17—Insulated-blade drivers, like the Crescent 2401-4 (left) or Klein 620 (right), have only the tip exposed, which simplifies working around dangerous voltages.

live circuit. You might find this one useful in some alignment and setup procedures.

Occasionally you may have to work a screw around a corner, which is impossible with most drivers. Several flexible-shaft screwdrivers which use a spring-steel wire blade permit work around corners and in nearly inaccessible places.

Another flexible screwdriver approach is the Allen driver (Fig. 18). As you can see, the tip is a hex ball which fits into Allen screws from several angles.

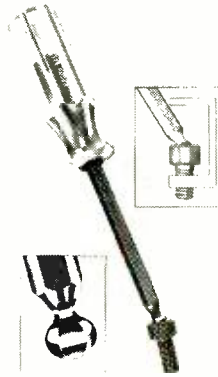

Fig. 18—Tightening or loosening a screw around a corner is made easier with the approach used by Upson: their ball-end, hex-allen driver has a hex ball for adjusting Allen screws easily.

head screws and bolts commonly used in electronics are these:

A 6-7-inch driver with a 1/4-inch tip (for 6-32 screws).

A 4-5-inch driver with a 1/8-inch tip (for 4-40 screws and set-screws).

A **stubby** screwdriver generally has a blade about 1 1/2 inches long, and a short, thick handle (Fig. 13). This tool is useful when you have



Fig. 13—Stubby screwdrivers are great in tight corners. Here are three of them. Left, Utica 90062; middle, Proto model 9651; right, Upson Stubby.

to work in tight quarters where a longer driver won't fit. The blade is often square; you can therefore use a right-angle wrench to obtain more torque. You can get stubby drivers with slot, Phillips, Reed & Prince, clutch and Scrulox tips.

Very useful in TV service is the long, slim-blade screwdriver shown in Fig. 14. This type has a 10-inch or 12-inch blade and a 1/8-inch or



Fig. 14—Long slim blades are extra handy in TV repair. The unit shown here is ideal for this application. It's an Xcelite R-810.

3/16-inch tip. Most have slot tips, but some have Phillips. There are very-long-blade Phillips drivers which are useful for working through the back of a TV cabinet to screws mounted on the inside front panel. Vaco's PP202 and Xcelite's X-2020 each have a 20-inch blade. A long, slim, slot-tip driver is useful for loosening frozen tuner oscillator slugs



Fig. 15—Offset screwdrivers are also handy. They come as Phillips or slotted. Left, Omega offset; right, Utica U-90185.

Handle types

Carpenters' screwdrivers are usually made with wooden handles, but plastic handles are more useful in electronics, as plastic is a better insulator than wood. Some drivers are available with **rubber-** or **vinyl-plastic grips** over the handles (Fig. 19). Rubber is more comfortable and makes the driver easier to use, reducing fatigue and increasing your job efficiency.



Fig. 19—Plastic grips can make a screwdriver a lot more comfortable to use. Here's what they look like on a Klein 620. Worth looking for.

A midget screwdriver often has a clip attached so you can carry it in your pocket (Fig. 20). This is useful if you often adjust setscrews or



Fig. 20—Miniature units with a clip are handy for carrying in your pocket. Many types are available. At the left is Upson AU2; right, Xcelite R-181.

meter-zero screws around a broadcast station or industrial plant.

The size of a screwdriver handle, as pointed out before, is proportional to tip width and blade length, for proper torque. In medium and large tip sizes, however, drivers are available with somewhat larger than usual handles (Fig. 21). The usual driver with a blade 1/4 ×

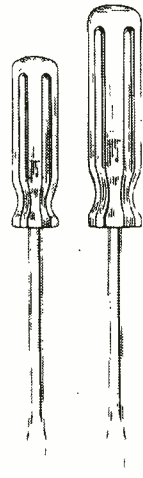

Fig. 21—Oversize handles improve torque ratio, makes it easier to handle tight screws. Both tools shown here are from Vaco. Top is standard model; bottom has oversized handle.

6 inches has a handle about 1 × 3 3/4 inches. The larger handle measures about 1 1/8 × 4 inches.

Experiment With—

By LUCIJAN AUER &
HARRY THANOS*

THE TAD100 IS A MONOLITHIC INTEGRATED CIRCUIT THAT INCORPORATES ALL THE ACTIVE STAGES FOR A PORTABLE AM BROADCAST RECEIVER.

It is designed for use with either a 6 or 9-volt supply, and features 4- μ V sensitivity and a signal-to-noise ratio of 23 dB. The agc range is 10 dB maximum for a 60 dB rf change, and the output power of 50 mW is sufficient to drive an Amperex complementary transistor pair to an output of 1.5 watts.

Circuit operation

The rf signal is picked up by the ferrite antenna and applied via the secondary winding between the base of Q1 and the oscillator feedback winding. Optimum antenna source impedance presented to the mixer is 2500 ohms in the 535-1620-kHz frequency range.

Transistors Q1 and Q2 constitute a long-tail pair mixer. Oscillator injection is through dc coupling between Q2's base and the emitter of local oscillator Q3. Because of slightly increased V_{BE} on Q2 due to oscillator injection, some oscillator voltage, in addition to its regular dc bias, is supplied to Q1 through C1 so that the current in Q1 and Q2 are equal.

This connection also provides a low-impedance return to ground for the "cold" end of the antenna secondary. Another benefit of this connection is the in-phase feedback for variation in the dc operating points of the two transistors due to variation in oscillator injection voltage. Any change in oscillator injection on Q2's base is accompanied by a corresponding change in Q1, thus tending to maintain the currents of Q1 and Q2 equal.

Mixing occurs in the long-tail pair, and the i.f. signal is taken from the collector of Q2. This prevents "bottoming" oscillation in the mixer when the antenna is tuned to frequencies near the integral harmonics of the i.f.—for example, 910 or 1365 kHz. The emitter network which connects to pin 3 is designed to bias the mixer to provide 30 dB conversion gain and a uniform gain slope over a wide range of frequencies.

Oscillator, i.f. ampl, detector

A conventional grounded-base oscillator is used, but with several added features to improve circuit performance. The oscillator base bias is supplied from a dc-stabilized line in the i.f.-detector section. This insures negligible variation of oscillator amplitude with battery voltage. Additional oscillator amplitude stabilization is obtained from

ONE-IC RADIO

New radio on a chip provides an unusual approach to portable AM receiver design

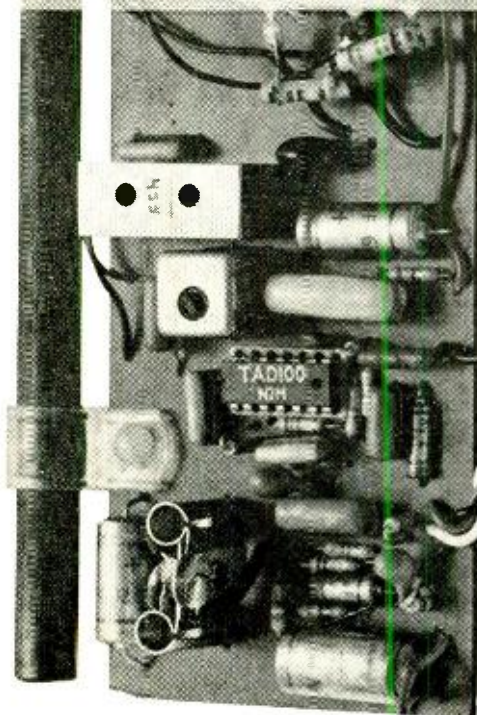

paralleled-back-to-back diodes, which are across the feedback winding. (currently available TAD100's do not include the diodes. You must add R17 across the oscillator transformer primary or install ordinary silicon diodes between IC terminals 2 and 12.)

With the use of these two techniques, the oscillator activity, as well as the injection voltage, are maintained over optimum conversion gain for the mixer over a wide range of frequencies, supply voltage and temperature variations. Ideally, the oscillator injection voltage at pin 13 should be about 100 mV rms.

Several departures from conventional circuit techniques are used with the TAD-100. For example, all the i.f. selectivity is in "front" of the i.f. amplifier. This prevents oscillator feed-through to the detector causing spurious beats, and permits use of a pre-aligned selective unit having any

EDITOR'S NOTE:

THE OSCILLATOR TRANSFORMER (T2) is shown with three windings, a 100-turn tuned primary, a 2-turn feedback winding in the collector circuit and a 10-turn winding to couple energy into the emitter circuit. You can use the more conventional transistor oscillator transformer with a tap on the tuned winding for the emitter circuit.

The tuning capacitor in this set has a maximum capacitance of 280 pF per section. A fixed padder (C18) is used to limit the maximum capacitance of the oscillator section. Most subminiature oscillator transformers are designed for a maximum oscillator tuning capacitance of 78-110 pF. This makes it necessary to change the value of padder C18 or replace it with an adjustable type with a maximum value of around 400 pF. As an alternate, you might try a

matched set including the antenna and oscillator transformers and tuning capacitor. One such set is the J. W. Miller 2108 capacitor, 2069 oscillator transformer and 2009 antenna transformer. With matched sets, padder C18 may have to be eliminated. See the maker's specifications and instruction sheet.

Ideally, the oscillator injection voltage fed to the mixer should be 100 mV rms. If it is too high, the oscillator voltage may get into the audio circuit and cause distortion and other troubles. If it is too low, it will adversely affect mixer operation.

Once you get your TAD100 receiver operating, we would like to hear from you. Performance might be improved with an added rf stage, and we'd like to learn about any modifications that make your receiver smaller and more sensitive.

PARTS LIST

Capacitors

- C1—2-section, 280-pF—section, variable
- C2, C4, C6—.047 mica
- C3, C9—.01- μ F mica
- C5—10- μ F, 2.5V electrolytic
- C7—.047 μ F mica
- C8—.047 ceramic
- C10, C11—200 μ F, 6.4V electrolytic
- C12—.002 μ F ceramic
- C13—320 μ F, 6.4V electrolytic
- C14—32 μ F, 4V electrolytic
- C15, C20—.002 μ F, ceramic disc
- C16—6.8 pF tubular or disc ceramic NPO750
- C17—1.5-pF tubular or disc ceramic NPO750
- C18—300-pF mica (see text)
- C19—.01 μ F mica

Note: Electrolytic voltage and capacitance ratings are European standards. Use next higher available voltage and capacitance ratings.

- R1, R2—8200 ohms
- R3—56 ohms
- R4—560 ohms
- R5—330,000 ohms
- R6—390 ohms
- R7—100-ohm, subminiature (PC) linear trimmer potentiometer
- R8—50-ohm NTC thermistor (Amperex No. 2322 610 11509)*
- R9—390 ohms
- R10—1000 ohms
- R11—4700-ohm log. potentiometer and spst switch combination
- R12—68 ohms
- R13—10,000 ohms
- R14—27 ohms
- R15—3900 ohms
- R16—4700 ohms
- R17—100,000 ohms

- R18—10,000 ohms
 - R19—27 ohms
 - R20—3900 ohms
 - R21—4700 ohms
 - R22—100,000 ohms
 - All resistors $\frac{1}{4}$ W, 5%
 - Q12, Q13—2N4105, 2N4106 transistors
 - IC—TAD100 (Amperex)
 - T1, T2—(see text)
 - T3—ceramic i.f. filter (Amperex No. 822 410 42010)
 - MISC—6-volt battery, 4-ohm speaker, 14-pin IC socket
- An etched, drilled epoxy PC board is available for \$1.75 ppd. (Part No. E-119) from Blakesley Electronics, Box 686, Syracuse, Indiana 46567.

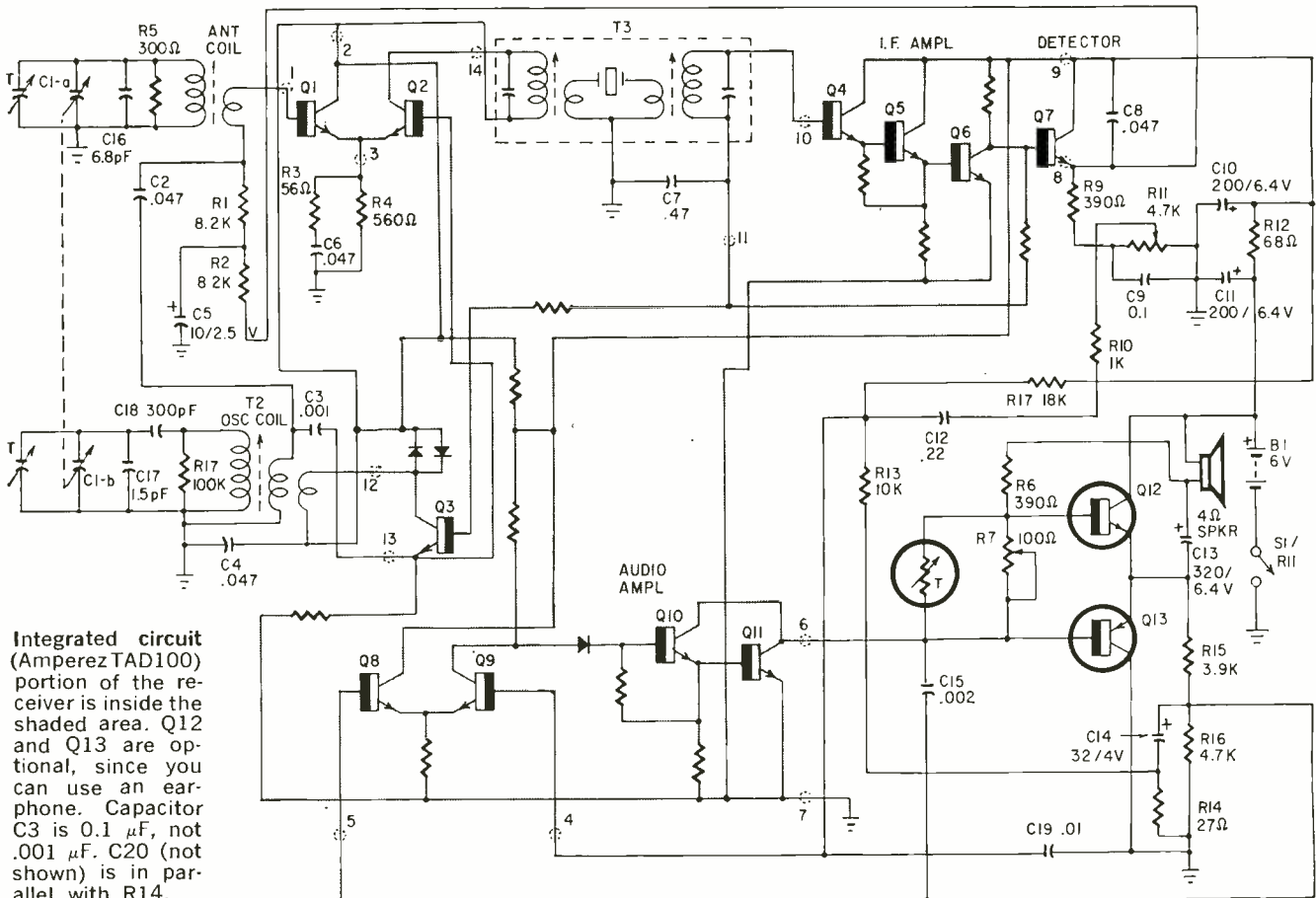

Integrated circuit (Amperex TAD100) portion of the receiver is inside the shaded area. Q12 and Q13 are optional, since you can use an earphone. Capacitor C3 is 0.1 μ F, not .001 μ F. C20 (not shown) is in parallel with R14.

desired bandpass characteristic. A third advantage is that the i.f. amplifiers can be a series of dc-coupled transistors with the proper gain and phase characteristics for excellent stability.

The i.f. amplifier consists of Q4, Q5 and Q6 arranged in a dc feedback circuit (pins 10 and 11 connected), which maintains a constant collector voltage on Q6. Bias is also provided to the base of local oscillator Q3 from pin 11 as a stabilized voltage reference source.

The input impedance of the amplifier is very high (greater than 500K) due to the two emitter followers, Q4 and Q5. This arrangement eliminates the need for a tap and is highly stable. The power gain is approximately 70 dB.

The output of the last i.f. transistor, Q6, is dc coupled to Q7, which function as the detector. The volume control and bypass capacitor are connected to pin 8 and the demodulated audio appears across them. An additional RC filter is included to reduce further any residual 455 kHz signal that might appear across the volume control.

The capacitor on pin 8 must be connected back to the positive line and not to ground since Q7 is being driven between base and collector.

Audio amplifier stages

The basic IC audio amplifier consists of predrivers Q8 and Q9 and drivers Q10 and Q11. Transistors Q8 and Q9 form a long-tailed pair, and drive is taken from Q9's collector through D3 to Darlington pair Q10-Q11 which drives the output stage.

Choice of audio output circuitry depends upon the particular application. A battery-operated portable could use a complementary symmetry pair such as the 2N4107 yielding 1.5 watts with about 10% distortion with a 9-volt supply.

An ac only line-operated radio could use an "off-the-line" single-ended audio output operated Class A and delivering 1-watt with about 10% distortion.

In the battery-operated version, dc feedback is taken from the emitters of the output pair (the midpoint) to pin 5 by the voltage divider R12-R13. R-E

Actual-size PC pattern for the TAD100 receiver is shown with a component-side diagram next to it. The odd "notch" in the ground foil pattern is to prevent spurious signals from entering the i.f. stage of the sensitive TAD100.

*R8 MOUNTED ON Q12-Q13 COMMON HEAT SINK
 **LEAD ATTACHED TO Q12-Q13 HEAT SINK
 ***ON COPPER SIDE OF BOARD

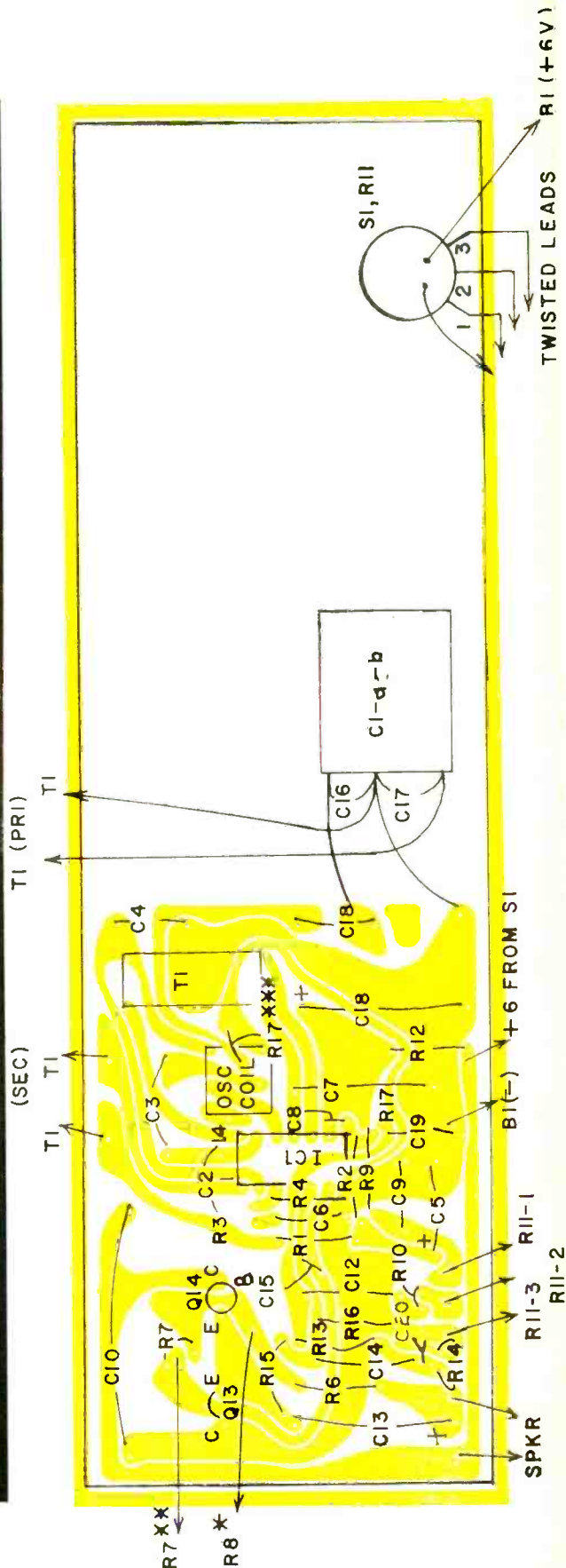

How would you like a nice new color TV?



**How would you like a nice new color TV
and a new car?**



**How would you like a nice new color TV
and two cars?**

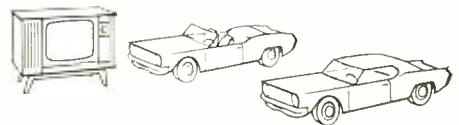

**How would you like a nice new color TV
and two cars
and a new house?**

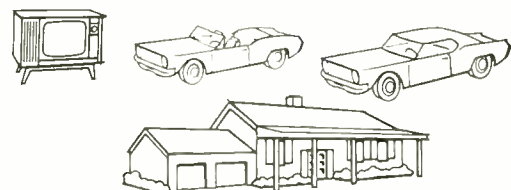

YOU WOULD?

**Then turn the page and read
a story that could start you on the
road to getting them...**



"CIE training helped pay for my new house," says Eugene Frost of Columbus, Ohio

Gene Frost was "stuck" in low-pay TV repair work. Then two co-workers suggested he take a CIE home study course in electronics. Today he's living in a new house, owns two cars and a color TV set, and holds an important technical job at North American Aviation. If you'd like to get ahead the way he did, read his inspiring story here.



IF YOU LIKE ELECTRONICS—and are trapped in a dull, low-paying job—the story of Eugene Frost's success can open your eyes to a good way to get ahead.

Back in 1957, Gene Frost was stalled in a low-pay TV repair job. Before that, he'd driven a cab, repaired washers, rebuilt electric motors, and been a furnace salesman. He'd turned to TV service work in hopes of a better future—but soon found he was stymied there too.

"I'd had lots of TV training," Frost recalls today, "including numerous factory schools and a semester of advanced TV at a college in Dayton. But even so, I was stuck at \$1.50 an hour."

Gene Frost's wife recalls those days all too well. "We were living in a rented double," she says, "at \$25 a month. And there were no modern conveniences."

"We were driving a six-year-old car," adds Mr. Frost, "but we had no choice. No matter what I did, there seemed to be no way to get ahead."

Learns of CIE

Then one day at the shop, Frost got to talking with two fellow workers who were taking CIE courses... pre-

paring for better jobs by studying electronics at home in their spare time. "They were so well satisfied," Mr. Frost relates, "that I decided to try the course myself."

He was not disappointed. "The lessons," he declares, "were wonderful—well presented and easy to understand. And I liked the relationship with my instructor. He made notes on the work I sent in, giving me a clear explanation of the areas where I had problems. It was even better than taking a course in person because I had plenty of time to read over his comments."

Studies at Night

"While taking the course from CIE," Mr. Frost continues, "I kept right on with my regular job and studied at night. After graduating, I went on with my TV repair work while looking for an opening where I could put my new training to use."

His opportunity wasn't long in coming. With his CIE training, he qualified for his 2nd Class FCC License, and soon afterward passed the entrance examination at North American Aviation. "You can imagine how I felt," says Mr. Frost. "My new job paid \$228 a month more!"

Currently, Mr. Frost reports, he's an inspector of major electronic systems, checking the work of as many as 18 men. "I don't lift anything heavier than a pencil," he says. "It's pleasant work and work that I feel is important."

Changes Standard of Living

Gene Frost's wife shares his enthusiasm. "CIE training has changed our standard of living completely," she says.

"Our new house is just one example," chimes in Mr. Frost. "We also have a color TV and two good cars instead of one old one. Now we can get out and enjoy life. Last summer we took a 5,000 mile trip through the West in our new air-conditioned Pontiac."

"No doubt about it," Gene Frost concludes. "My CIE electronics course has really paid off. Every minute and every dollar I spent on it was worth it."

Why Training is Important

Gene Frost has discovered what many others never learn until it is too late: that to get ahead in electronics today, you need to know more than soldering connections, testing circuits, and

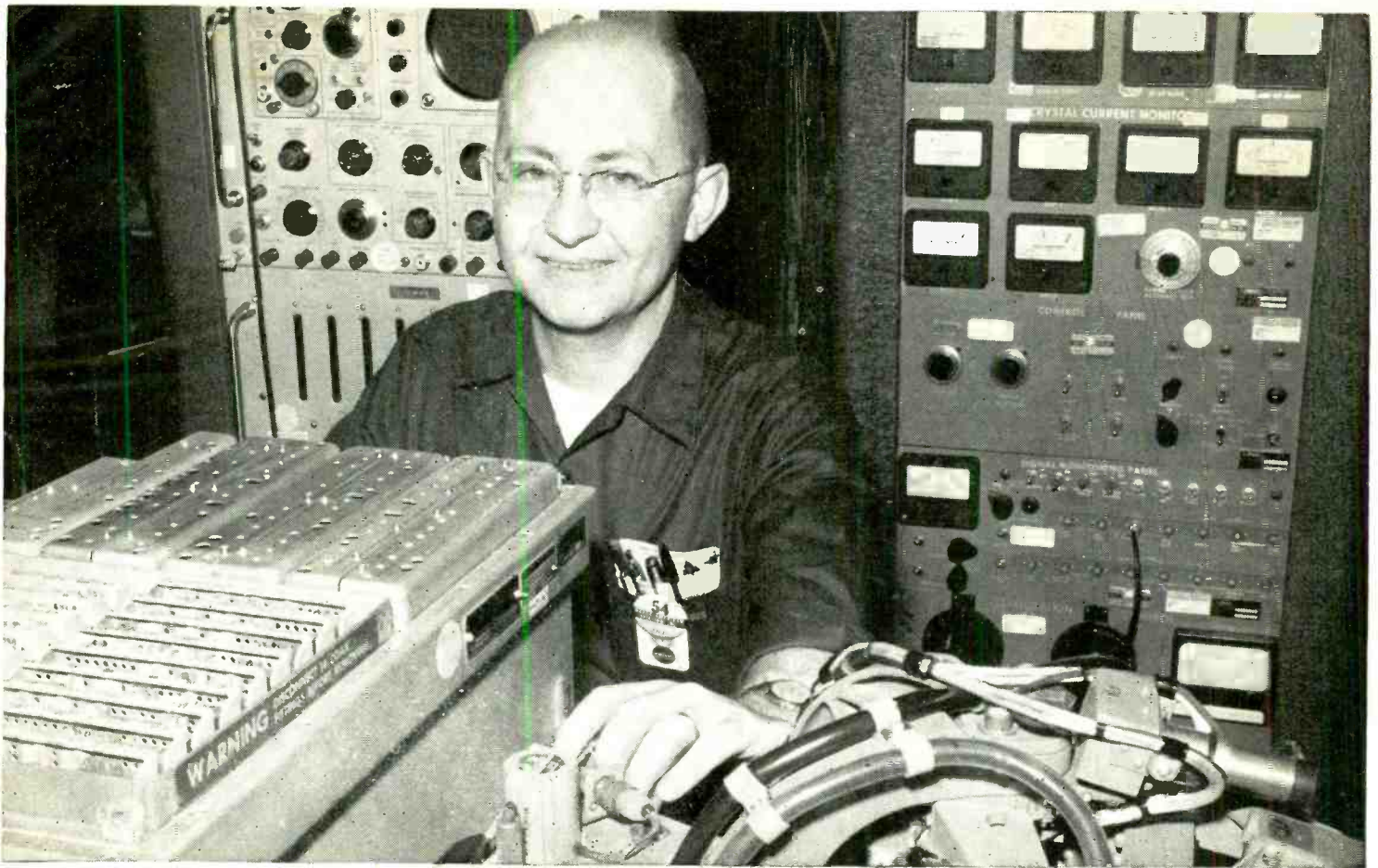

replacing components. You need to really know the fundamentals.

Without such knowledge, you're limited to "thinking with your hands" ... learning by taking things apart and putting them back together. You can never hope to be anything more than a serviceman. And in this kind of work, your pay will stay low because you're competing with every home handyman and part-time basement tinkerer.

But for men with training in the fundamentals of electronics, there are no such limitations. They think with their heads, not their hands. They're qualified for assignments that are far beyond the capacity of the "screw-driver and pliers" repairman.

The future for trained technicians is bright indeed. Thousands of men are desperately needed in virtually every field of electronics, from 2-way mobile radio to computer testing and troubleshooting. And with demands like this, salaries have skyrocketed. Many technicians earn \$8,000, \$10,000, \$12,000 or more a year.

How can you get the training you need to cash in on this booming demand? Gene Frost found the answer in CIE. And so can you.

Send for Free Book

Thousands who are advancing their electronics careers started by reading our famous book, "How To Succeed In Electronics." It tells of the many electronics careers open to men with the proper training. And it tells which courses of study best prepare you for the work you want.

If you'd like to get ahead the way Gene Frost did, let us send you this 44-page book free. With

it we'll include our other helpful book, "How To Get A Commercial FCC License." Just fill out and mail the attached card.

If the card is missing, use the coupon below.

ENROLL UNDER G.I. BILL

All CIE courses are available under the new G.I. Bill. If you served on active duty since January 31, 1955, or are in service now, check box on reply card for G.I. Bill information.

CIE Cleveland Institute of Electronics
1776 East 17th Street, Cleveland, Ohio 44114

NEW
COLLEGE-LEVEL CAREER COURSE FOR MEN WITH PRIOR EXPERIENCE IN ELECTRONICS
ELECTRONICS ENGINEERING... covers steady-state and transient network theory, solid state physics and circuitry pulse techniques, computer logic and mathematics through calculus. A college-level course for men already working in Electronics.

Cleveland Institute of Electronics
1776 East 17th Street, Cleveland, Ohio 44114

Please send me without cost or obligation:

1. Your 44-page book "How To Succeed In Electronics" describing the job opportunities in Electronics today, and how your courses can prepare me for them.

2. Your book on "How To Get A Commercial FCC License."

I am especially interested in:

- | | | |
|--|---|--|
| <input type="checkbox"/> Electronics Technology | <input type="checkbox"/> Broadcast Engineering | <input type="checkbox"/> First Class FCC License |
| <input type="checkbox"/> Electronic Communications | <input type="checkbox"/> Industrial Electronics | <input type="checkbox"/> Electronics Engineering |

Name _____ (Please Print)

Address _____

City _____ State _____ Zip _____

Check here for G.I. Bill information.

RE-66

Circle 30 on reader service card

proper high voltage the brilliancy control may have to be backed down slightly and the chroma control regulated so the regulator tube can function properly. With proper adjustments, pastel scenes to highly vivid ones should cause no blooming, shrinkage or blurs.

The high voltage can be measured at the cap of the shunt regulator tube or at the high-voltage clip where it enters the receptacle on the picture-tube side. High-voltage test points are usually provided in sets with the pulse-feedback type of regulation. If the high-voltage varies several thousand volts with color-contrast changes, try a new regulator tube. Don't set the high voltage above that specified in the service notes, and make sure your high-voltage probe is calibrated properly.

High-voltage probes use a special high-megohm resistor in series with the probe lead as shown in Fig. 4. These can be replaced, when defective, by unscrewing the double section making up the body of the assembly.

Since such probe resistors may have a value of 1090 megohms for some vtvm units, or 480 megohms for 20,000-ohms-per volt meters, they are too high in value to be made up by stringing together common

resistors. Most meter manufacturers, however, furnish the proper resistor for their particular model. If you are in doubt regarding the resistance value necessary, the following will be of help.

If, for instance, you have a 20,000 ohms-per-volt meter the current through the meter at full-scale deflection is 50 μ A. For a 30-kV reading on the 6000-volt scale we need to read an additional 24,000 volts: (30,000 - 6000 = 24,000).

Since we require an additional 24,000 volts at 20,000 ohms per volt, the resistance required is $24K \times 20K = 480$ megohms.

In one instance only a 1090-megohm resistor was available (formerly used on a vtvm on the 300-volt scale. This was used with a 20,000 ohms-per-volt meter to increase the scale to approximately 60,000 volts. For a 60-kV scale, we require an additional 54-kV range on the existing 6000-volt meter scale.

Thus, $20K \times 54K = 1080$ megohm which is sufficiently close to the 1090 megohm to give fairly accurate results.

When the shunt regulator fails to keep the high voltage within bounds or the voltage can't be adjusted properly with the control, circuit components must be tested. Most of the modern regulating systems have sim-

plified circuitry, as shown in Fig. 5 for the Magnavox T932 receiver. After the receiver has been shut off, discharge the h-v charge and test the resistor values.

The H-V ADJUST should have a smooth change in resistance as the control is adjusted. Also make sure the series 1-megohm resistor has not changed value. Be sure the proper low voltage is applied to the cathode circuit. For the receiver mentioned, test points on the rear control board (printed circuit) can be reached without having to remove the chassis.

Make sure there are no h-v arcs from leads to chassis. Observe the chassis in a darkened room while the set is in operation. Clean off dust and dress high-voltage leads away from metal parts. Anti-corona spray is available for critical areas or sets operated in high-humidity locations.

Antenna system impedances

In areas where stations are not all from the same direction, an antenna rotator is a virtual necessity, even in strong signal areas. Pinpointing the antenna orientation does much for good color reception. Sometimes, however, even the best motorized antenna system can give some trouble because of lead-in length.

In theory, a 300-ohm antenna is to be attached to a 300-ohm lead-in, and this to a 300-ohm input tuner. If these three match in impedances, no trouble occurs. Input impedances of the tuner, however, may not be constant when changing stations (and also because of slight variations from 300 ohms in a given line or antenna). A mismatch at the tuner can cause rejection of some signals arriving at it. These are reflected back along the line and re-enter the tuner later. Such standing waves can reduce picture sharpness and provide ghosts closely spaced to the primary picture. Sometimes this only occurs for one station, leading the technician to believe receiver tuning is at fault.

In a recent installation in the Trenton, N. J., area, color reception was perfect for channels 3, 6 and 10 from Philadelphia, but weak for New York stations. A high-gain antenna was installed and a rotor used for precise pinpointing. Now excellent reception was obtained for the New York stations, but channel 6 from Philadelphia was poor in detail, even though contrast was good. Sharp details showed faint repeat areas which gave the appearance of a blurry picture.

Having run across this symptom before, the servicing technician added a short 16-inch section to the lead-in.

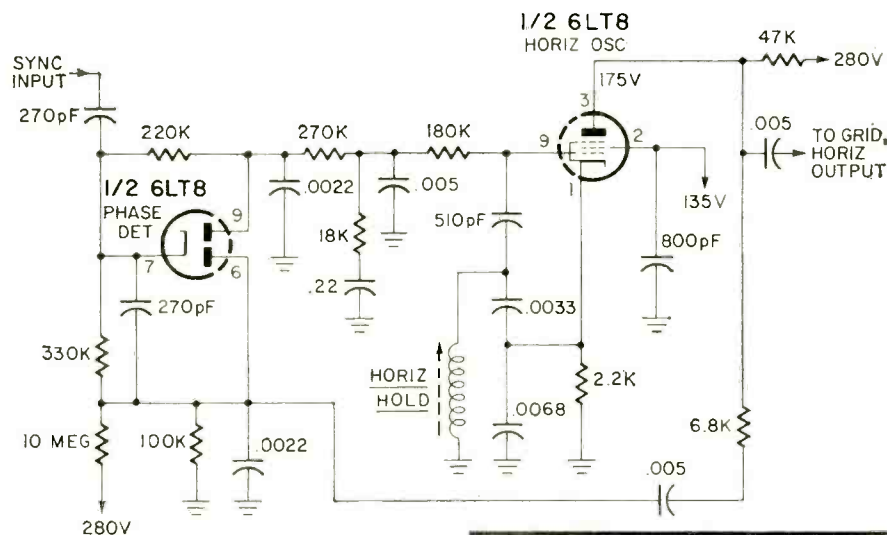

Fig. 2—Another phase detector arrangement, using the diode section of a 6LT8 instead of matched solid-state diodes. ment, using the diode section of a 6LT8

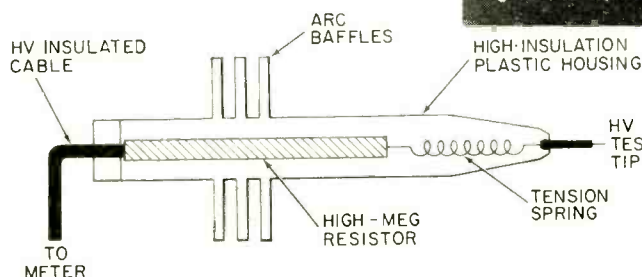
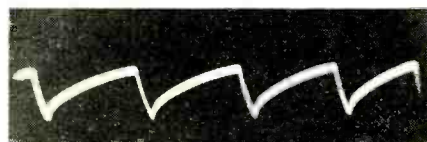

Fig. 4—High-voltage probe with built-in high-meg resistor. Units can often be separated to replace defective resistors.



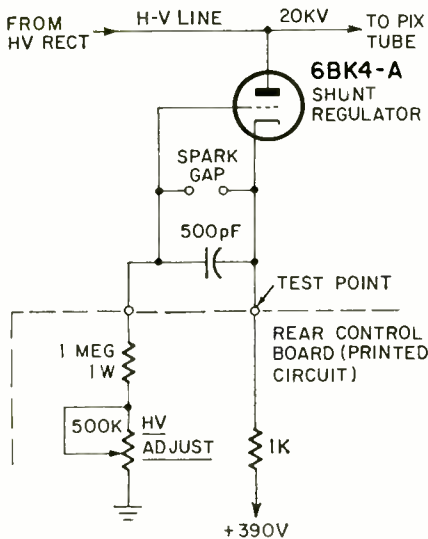

Fig. 5—Shunt-regulator circuit used in the Magnavox T932 TV receiver.

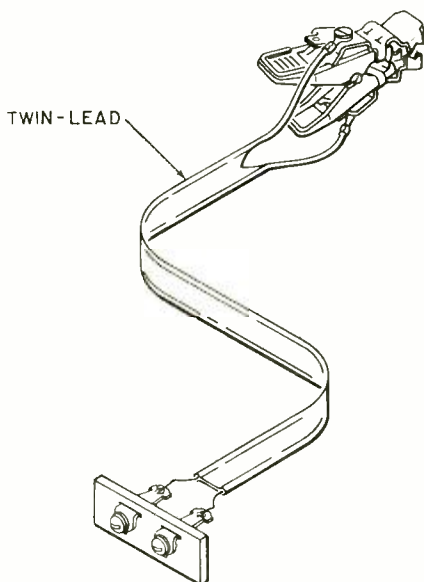

Fig. 6—Several lengths of twin lead can help solve lead-in length problems.

The result was complete restoration of picture excellence. This technique may be challenged by the newcomer who hasn't experienced this problem before. Many oldtimers, however, have long recognized the difficulties that specific lead-in lengths can cause. Often the experienced technician will carry several lead-in test sections of the type shown in Fig. 6. These vary in length from 6 inches to 2 feet, since a particular length is often best for a given installation.

Once the right length has been found, reception is rechecked on other channels, because the added length to the lead-in may alter reception on one or two other channels. When this happens, the added section may have to be increased or shortened in length to reach a compromise for the affected stations. Once the optimum length has been established, a section of proper length is soldered to the lead-in permanently.

R-E

BESTSELLING SAMS BOOKS

for every electronics interest

1-2-3-4 Servicing Automobile Stereo

The "1-2-3-4 Method" is a simple, logical step-by-step process which helps do the servicing job in the easy way and the right way. This book first applies the Method to both mechanical and electrical equipment, and then proceeds to cover the electronic and mechanical principles of automobile stereo, fm multiplex, and tape cartridge systems. Finally, the book shows how to apply the "1-2-3-4 Method" to auto stereo systems. Includes a wealth of schematics, charts, and illustrations. Order 20737, only.....\$3.95

Closed-Circuit Television Handbook. 2nd Ed.

Explains in practical terms the basic concepts of CCTV systems. Describes the versatile applications of closed-circuit television, and the equipment used. Subjects include cameras, monitors, video recorders, lighting, and signal transmission. Completely updated to include latest information. Order 20726, only.....\$5.95

Antennas and Transmission Lines

A readily understandable text and reference on the theory of antennas and transmission lines, using technician-level mathematics. The book opens with basic antenna theory, including point and array sources, wave interference, standing waves, collimators, lenses, apertures, and simple radiators. It then proceeds to transmission lines and their design factors. The final third of the text covers a broad variety of antenna topics. An ideal book for home study and reference. Order 20716, only.....\$7.95

Record Changer Servicing Guide

This book provides a complete understanding of record changers, how they operate, and the various systems employed. Provides detailed instructions on how to track down troubles encountered in record changers and how to repair them in the fastest and most effective way. Order 20730, only.....\$3.95

Auto Radio Servicing Made Easy. 2nd Ed.

Explains the circuitry of both new and old auto radios, covering each of the tube and transistor stages. Provides step-by-step troubleshooting and repair details; explains how to eliminate noise and interference, how to set the bias on output transistor stage without breaking circuit, how to determine correct bias on transistor stages, what to do about AVC trouble in transistor radios, etc. Order 20719, only.....\$3.95

ALL-NEW EDITION OF THE FAMOUS

Audio Cyclopedia

Completely revised 2nd Edition by the renowned authority, Dr. Howard M. Treman. This is the most comprehensive work on audio—virtually a complete reference library in a single volume. Fully covers every phase of the subject, including all the latest developments, right down to the newest solid-state and integrated circuits. Contains authoritative, concise explanations of thousands of topics in the fields of acoustics, recording, and reproduction; covers basic principles, components and devices, film recording, studio techniques, motion picture equipment, audio installation techniques, audio measurements, etc. Each subject is located instantly through a unique chapter and paragraph numbering system. Supported by over 1600 illustrations. This is truly the master reference work on the audio art. Order 20675, only.....\$29.95

NEW 5TH EDITION OF THE WORLD-FAMOUS Reference Data for Radio Engineers

Now contains 50% more data to cover the developments of the past 12 years. Prepared by outstanding engineers, professors, and experts, under the direction of the International Telephone and Telegraph Corporation staff. Provides comprehensive data on all basic phases of electronics, including tables, formulas, standards, and circuit information—PLUS—all-new data on micro-miniature electronics, navigation aids, reliability and life testing, international telecommunication recommendations, switching networks and traffic concepts, and quantum electronics. Over 1350 illustrations 1196 pages. Order 20678, only.....\$20.00

Amateur Tests and Measurements

This new E & E book shows how to perform virtually all tests on amateur transmitters, receivers, and antennas, and how to make required adjustments. An invaluable book for the amateur who wants to maintain top operating efficiency. Order 65072, only.....\$5.50

101 Questions & Answers About Amateur Radio

A handy and practical reference source providing the answers to the most frequently asked questions about ham radio. An invaluable book for both the newcomer and the old-timer. Order 20731, only.....\$2.95

Transistor Specifications Manual. 3rd Ed.

Updated to include the latest 1969 transistors. Contains the electrical and physical parameters for virtually all of the transistors now in use. Electrical parameters include maximum collector-to-base, emitter-to-base, and collector-to-emitter voltages; maximum collector current; power dissipation; and maximum operating temperature. Also lists frequency gain and leakage parameters. Order 20707, only.....\$4.25

Fundamentals of Digital Computers

An excellent introductory text to the general field of electronic computing. It enables anyone to acquire a good basic understanding of what computers do and how they do it. The book begins with a discussion of various types of computer applications and surveys the history and evolution of computers. Then, it discusses in detail subjects such as the functional organization of a computer, the individual components of a computer system, data preparation, storage devices, input and output peripheral devices, conversion units, and the central processor. A comprehensive glossary of computer terms is included. Order 20714, only.....\$5.50

SPACE AGE TECHNOLOGY SERIES

Prepared under the guidance of *Training and Retraining, Inc.*, this series of five books holds unusual interest for anyone who desires to learn about the application of electronics to space progress, and the vital role it plays in that technology. All texts are programmed-type.

Inertial Guidance Systems.
Order 20605, only.....\$4.95

Controlled Guidance Systems.
Order 20573, only.....\$4.95

Synchros and Servos.
Order 20533, only.....\$4.95

Lasers and Masers.
Order 20559, only.....\$4.95

Microminiature Electronics.
Order 20562, only.....\$5.75

SPECIAL OFFER! All 5 Volumes at a savings, in beautiful slip case. Order 20724, only.....\$24.95

HOWARD W. SAMS & CO., INC.

Order from any Electronic Parts Distributor, or mail to Howard W. Sams & Co., Inc., Dept. RE-11
4300 W. 62nd St., Indianapolis, Ind. 46268

Send books checked at right. \$_____enclosed.

Send FREE 1970 Sams Book Catalog

Name _____
FLIASE, PRINT

Address _____

City _____ State _____ Zip _____

- | | |
|--------------------------------|--------------------------------|
| <input type="checkbox"/> 20737 | <input type="checkbox"/> 20707 |
| <input type="checkbox"/> 20726 | <input type="checkbox"/> 20714 |
| <input type="checkbox"/> 20716 | <input type="checkbox"/> 20605 |
| <input type="checkbox"/> 20730 | <input type="checkbox"/> 20573 |
| <input type="checkbox"/> 20719 | <input type="checkbox"/> 20533 |
| <input type="checkbox"/> 20675 | <input type="checkbox"/> 20559 |
| <input type="checkbox"/> 20678 | <input type="checkbox"/> 20582 |
| <input type="checkbox"/> 65072 | <input type="checkbox"/> 20724 |
| <input type="checkbox"/> 20731 | |

Circle 31 on reader's service card

CHEMICALS—

The Secret Weapon In Your Shop

Cements, Cleaners, Lubes, and Solvents are

Tools. Use the Right One For Speed and Efficiency.

by J. MERINO Y CORONADO*

IT SOUNDS STRANGE TO SPEAK OF "chemical tools" in electronics, but dozens of them are in use. Knowing when to use the proper chemical tool for a job can be just as important as selecting the right mechanical tool. We'll look at some of the important "groups" of chemical tools that make our work easier and more efficient.

Using lubricants

Let's begin with lubricants. A can of a good *light machine oil* is a must for general lubrication and to prevent rust in fine tools. So is a can of *medium machine oil*, the kind you use in your car. Next time you change the oil, buy a can for the shop.

Lubriplate is useful for tape recorders and record changer parts, and so is *Tuner Lube* for TV tuners.

Ordinary *grease* can be used to prevent corrosion on battery terminals. This type of grease, or grease containing graphite (used for bicycle chains) is useful for gears, provided temperature does not run very high. *Fiber grease* should be used for high-temperature conditions.

A box of *paraffin* or household wax is useful to prevent tool rust, as a humidity seal for some types of coils and i.f. transformers or to secure ferrite tuning slugs in place. Heat from a soldering iron held near the coil for a minute or two softens this wax, allowing the core to be adjusted as desired.

Silicone grease provides a heat-transferring bond when mounting power transistors.

If you service organs, *piano grease* must be kept in stock to lubricate keyboards and pedal lever systems. Never let oil or grease fall on the delicate switching system. If you do, clean it off with a camel-hair

brush and solvent. Of course, ordinary and graphite grease may be used to lubricate keyboards and pedaliers; many technicians do use them, but it's better to use the right chemical tool.

A type of penetrating oil is called *chemical wrench* or *Liquid Wrench*. Rusted bolts in antennas or towers may be loosened two or three minutes after applying it.

Very fine instruments such as the movements of some medical electronic instruments (phonocardiographs, electroencephalographs and the like) are lubricated with *watchmakers' oil*. You don't need this special lubricant unless you service this kind of equipment.

Cleaners and solvents

Of course, every shop has the best cleaner and solvent there is—water. But plain water is not enough. Glass dial covers and TV tubes may be cleaned with it, but it's better to use first a neutral soap and a soft-rubber or foam sponge—then water.



There are many *glass cleaners* on the market, but when the tube or dial cover is covered with dirt, it's better to start with soap and water and then use the glass cleaner. Of course, you may use *detergents*, but

some strong types may attack glass and fog it. Many glass cleaners and strong detergents can fog plastic. Fortunately several good glass and plastic cleaners are on the market. If you don't have time to experiment, better use them.

Acetone is a good solvent for speaker cement. Applied to a speaker-cone dust cover, it softens the cement so the cover may be removed with tweezers to be used again. *Amyl acetate*, a solvent used to remove nail polish, is much stronger than acetone but more volatile.

Before soldering a break in a printed circuit, a solvent must be used to remove the silicone resin or protective cover used on it. *Print Kote Solvent* is useful for the purpose, as is the *ordinary thinner* solvent used by painters. Both are applied with a camel-hair brush, and several sizes of brush should be at hand.

Ordinary *gasoline* is the best solvent for grease and oil on screws, bolts and other heavy-duty parts. But don't forget it contains tetraethyl lead, a poisonous compound. After using ethyl gasoline wash your hands. In some places gasoline without lead may be obtained.

Carbon tetrachloride or "tet" is an excellent cleaner and solvent. Several manufacturers specify it for cleaning tape heads and capstans. Some kinds of rubber dissolve in tet, so be sure to note equipment manufacturer's warnings.

A word of caution: continuous breathing of carbon tetrachloride fumes can produce serious, permanent damage to internal organs. Be sure to use it only with plenty of ventilation.

There are several good *tape-head cleaners* on the market that do not contain tet. They may be used on most heads without danger, and a bottle is a good investment. So is *isopropyl alcohol* for the same pur-

*Research Physicist, University of Mexico Professor of Acoustics, Polytechnic Institute of Mexico



pose. Avoid use of *methyl alcohol*: it is dangerous to your eyes. And don't forget ordinary alcohol is denatured. This means a chemical has been added to make it unsuitable for drinking.

A can or small bottle of *contact cleaner* should also be available. Unlike carbon tetrachloride, most contact cleaners contain a lubricant and an anticorrosive. Applied with a long, curved eyedropper or a spray extensor into a volume control, the chemical will saturate the inside and clean the sliding contact. Cleaning is especially important in the expression-pedal controls of electronic organs. Located near the floor, they are subject to severe "dust storms." Volume controls used in expression pedals, unlike those in radio or TV sets, are moved many times per minute while playing a tune.

Insulating coatings

There are many brands of liquid tape" for low voltages up to 1000 volts. Some technicians brush a coating or two on tools as a protection against electric shock. But if you're working with voltages of 400 or over no liquid tape is a safe substitute for rubber, bakelite or plastic insulation. Don't take chances, especially if you're working on or near a damp or wet area.

Red insulating varnish forms a good coat over solder connections. It also serves for sealing adjusting screws in i.f. transformers, organ tuning coils, etc. For this last purpose, a drop of nail polish is good enough.

In the old days electricians used a plain solution of shellac in alcohol as insulating varnish. (This solution may also be used to cover up cabinet scratches). When brushed over wires or printed circuits it takes at least 20 minutes to dry. For this reason, most

technicians prefer to use a *silicone resin coating* to restore the protective coating on printed circuits after a repair. Print Kote is one trade name for this silicone resin.

Cement types

A good general-purpose and speaker cement can be made by dissolving clean celluloid or acetate film from old negatives in a solvent made with 50% acetone and 50% amyl acetate. A drop is useful for fixing knots in dial cords, loose coil windings, or to secure pointers on a dial cord. Don't use all-purpose cement to repair broken plastic or wooden cabinets. *Plastic cement*, *bakelite cement* or carpenter's glue are better choices.



For very strong joints, *epoxy cement* can be used. Epoxy will bond practically anything to any surface.

Dentists use a very strong cement that can be molded to practically any shape. Used for mending broken dental plates, this cement is made with a resin and catalyst and can withstand severe temperature and humidity. It is transparent, but may be easily colored. For neat work, dentist's cement is a good choice, but it's quite expensive.

Loose rubber objects may be fastened with any *rubber-to-metal*

cement. (Loose drivers or wheels that must be fastened to shafts, for example.)

Wood glue is useful for repairing wooden cabinets, or for most wood-to-wood bonding. Many wood glues can not stand severe humidity.

Miscellaneous chemical tools

Many other chemicals are useful in any shop. Some are used daily; others seldom used—depends on the work you have.

For instance, *sodium bicarbonate* or ordinary baking soda is a must if you handle car batteries. A saturated tap-water solution helps in cleaning the terminals and boxes of batteries, and stops corrosion by neutralizing the sulfuric acid of any electrolyte which spills from the battery cells. When a drop of acid falls on the floor or your hands, use the solution liberally as a neutralizer, followed by plenty of water.

Ordinary *muratic* or *hydrochloric acid* is used for some types of soldering, but its main use is for cleaning porcelain and porcelainized fixtures. Remember that any strong acid is dangerous to your skin and very dangerous for your eyes. Use rubber gloves when handling strong acids.

A few words of caution: always remember to keep these chemical tools in clean, clearly labeled containers. Acids, denatured alcohol, carbon tetrachloride and any chemical you do not know is harmless should be labeled POISON in big letters. Alcohol, gasoline, solvents and the like must be kept only in small quantities and labeled HIGHLY INFLAMMABLE, or KEEP AWAY FROM OPEN FLAME.

As we have seen, there are many useful chemical tools for daily use. There are many others of minor or infrequent use, but all of them simplify and speed our work.

R-E

ABC's of Circuit Breadboarding

Avoid costly mistakes with your electronic projects by modeling them first. You'll learn circuit theory better, spot troubles and develop design improvements

by **JIM ASHE**

IF YOU DON'T BREADBOARD CIRCUITS AND PROJECTS BEFORE you build the real things, you may be losing time and money. A few minutes spent breadboarding some new design or part of a construction project will familiarize you with the circuit theory, spot bugs, suggest improvements and develop your knowledge of electronics.

The cost of breadboarding even a complex circuit is usually pennies, since the components can be reused. And with careful work a forbidding new pulse, signal or control circuit becomes a familiar friend. Engineers breadboard their designs time and again.

Why don't you?

Maybe it's because you haven't come across a good description of what it's all about. Breadboarding is simply another kind of modeling, and many examples in other fields come to mind.

Electronic modeling

The architect's model costs a few dollars but shows new perspectives on a building that will cost millions. The car stylist's clay model finally appears in thousands of real duplicates, but only after a long and sometimes painful

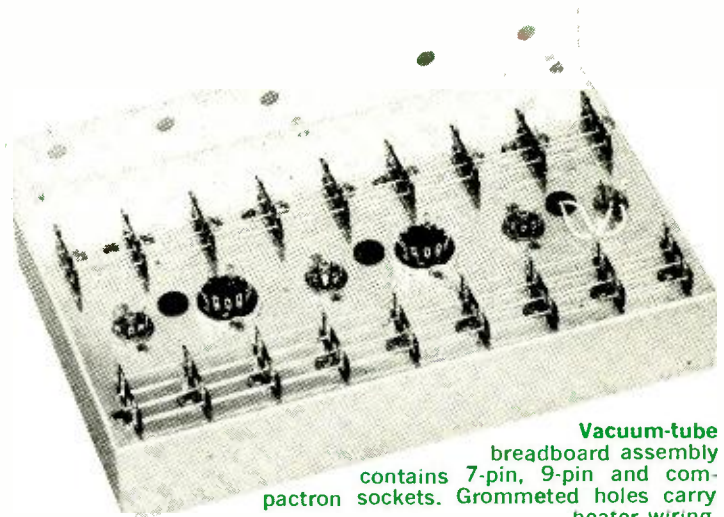

Vacuum-tube breadboard assembly contains 7-pin, 9-pin and compactron sockets. Grommeted holes carry heater wiring.

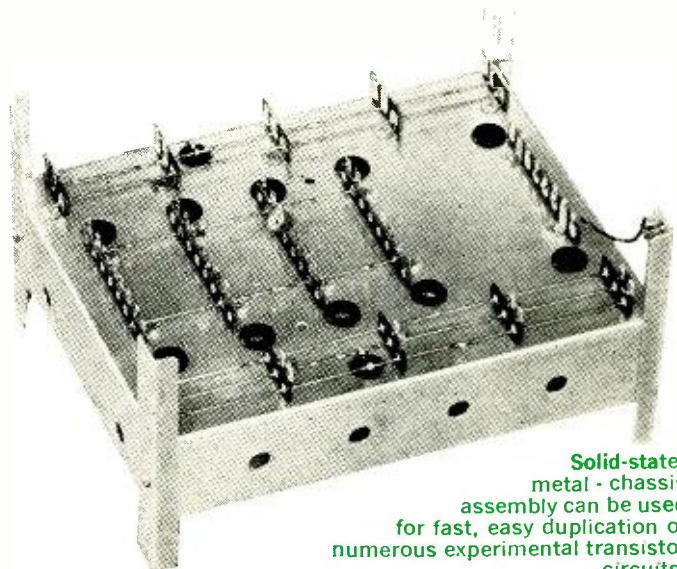

Solid-state, metal-chassis assembly can be used for fast, easy duplication of numerous experimental transistor circuits.

evolution. Can you imagine building a complete new car to check out each styling or mechanical design idea?

Yet this same modeling concept seems to be pretty rare in ham radio, experimenter, hi-fi and other popular electronics fields. Let's look at this breadboarding idea from the special perspective of somebody interested in electronics.

Pick an electronic instrument, box or machine. It could be a standard vtm, or if you're more ambitious you might choose a radio receiver or an oscilloscope. Only a glutton for punishment would choose a computer. Now open it and look inside. There are resistors, capacitors, transistors, IC's and perhaps vacuum tubes. There's also a lot of sheet metal, mounting hardware, pots, meters and other mechanical or electromechanical structures.

But most of it is of secondary importance. In there somewhere is the *circuit*, the collection of interconnected resistors, capacitors, inductors and active devices that actually does whatever it is we say the box does. This circuit is the real heart of the electronic gear and in a very real sense the rest—perhaps 80% or more by weight—is simply extra trimming.

If you're thinking about building something new, it's not good planning to invest time and money in hardware and mechanical work until you are reasonably certain the result will be acceptable. And if you are a student or trying to upgrade yourself in your field, a good practice is to avoid routine mechanical construction work. It consumes time and money but does little for your mastery of new and all-important knowledge.

This key point seems to be almost invisible in popular and technical electronics, although most professional engineers, who are great breadboarders, see it clearly. When an idea or design is proved reliable, the most economical procedure is to work directly from the design to the finished product. But proven reliability is one part skilled design, one part appropriate testing and one part understanding—a not very common mix. Sometimes the idea-to-product process is good policy, but in real life the procedure in Fig. 1 has compelling advantages.

The original idea is modeled or breadboarded, and after observing the results we may change our thinking and try again. We may go around this loop several times for new work, but finally the ideas and design come into focus. We step out of the loop with a finished product, and from there we sometimes go to a real physical project. And if all we needed was a finished *idea* we've saved ourselves the time and expense of a hardware project. Fig. 1 illustrates the approach we use in breadboarding, and on many other occasions too.

Practical breadboards

Once we have lowered our sights and set a limited goal of testing and understanding circuits rather than constructing hardware, our work becomes much simpler. Costs are reduced, too.

Elaborate circuit-construction kits have appeared on the market for this kind of work, but they do not seem to last long. Perhaps it's because kit designers have to overdo to have anything to sell. A breadboard that looks like a candidate for the junk pile will do as well as a commercial assembly, and though many of us will choose the better-looking gear, we will gain little from the additional expense. A sample breadboard arrangement is shown in Fig. 2.

This is a piece of plywood with two three, or four short rows of tacks or nails driven into it. Two lengths of bus wire or strips of tin along the outer rows serve as supply and grounding lines. A bracket or brackets are provided to mount controls that are too heavy or that require too much torque to be left lying on the board or hanging in midair. Construction of a circuit on this bread-

board is very simple and results in a neat job.

To breadboard a one-transistor circuit, solder the collector resistor to the supply line, add the transistor to the end of it (socket optional) and tack in the emitter resistor on the other side. Two additional resistors are the base bias network, and a couple of capacitors stick out the ends or sides for input and output.

There are no fixed input, output or supply terminals. Connections as required are carried in by clip leads, avoiding fussing around with mating connectors that add nothing to the progress of the work. When a wire doesn't reach, tack on a bit of hookup wire. Used parts, if they are known to be good, are excellent for practice, saving much money.

At radio frequencies some positioning of parts may be needed, but usually the distances provided by leads will reduce coupling to levels as low or lower than can be expected in a finished circuit assembly.

This style of construction has proved adequate for a variety of circuits. One was a remarkably successful regenerative detector project, which did not seem to suffer from any of the disadvantages that appear unavoidable in this open, nonrigid construction. Evidently some old perspectives about circuit construction need rearranging in the light of today's tiny solid-state electronics.

Careful construction is necessary to avoid an effect like that of a collection of springs. No soldered joint should carry appreciable stress or things will fly apart upon resoldering. Bend wires as needed to achieve contact, and then solder for electrical connections only. You will quickly develop an easy familiarity with this style of construction.

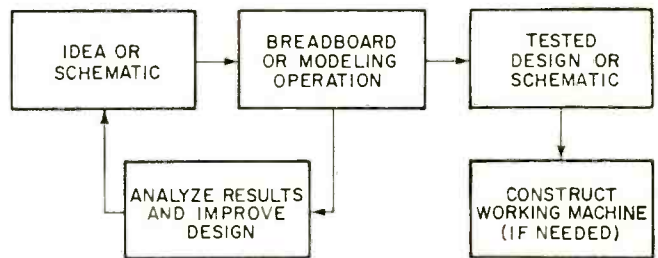

Fig. 1—Smart approach to project building calls for first building a model instead of a direct idea-to-product process.

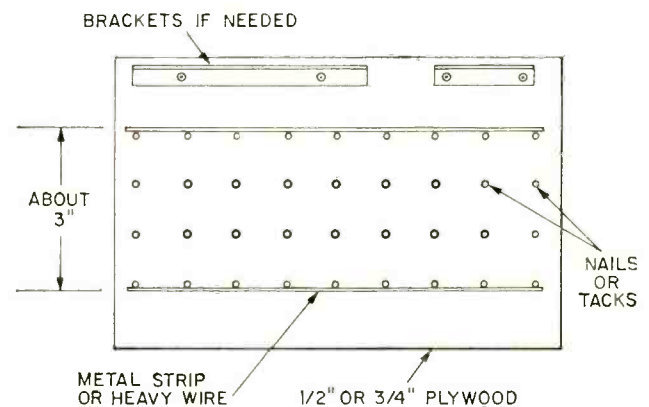
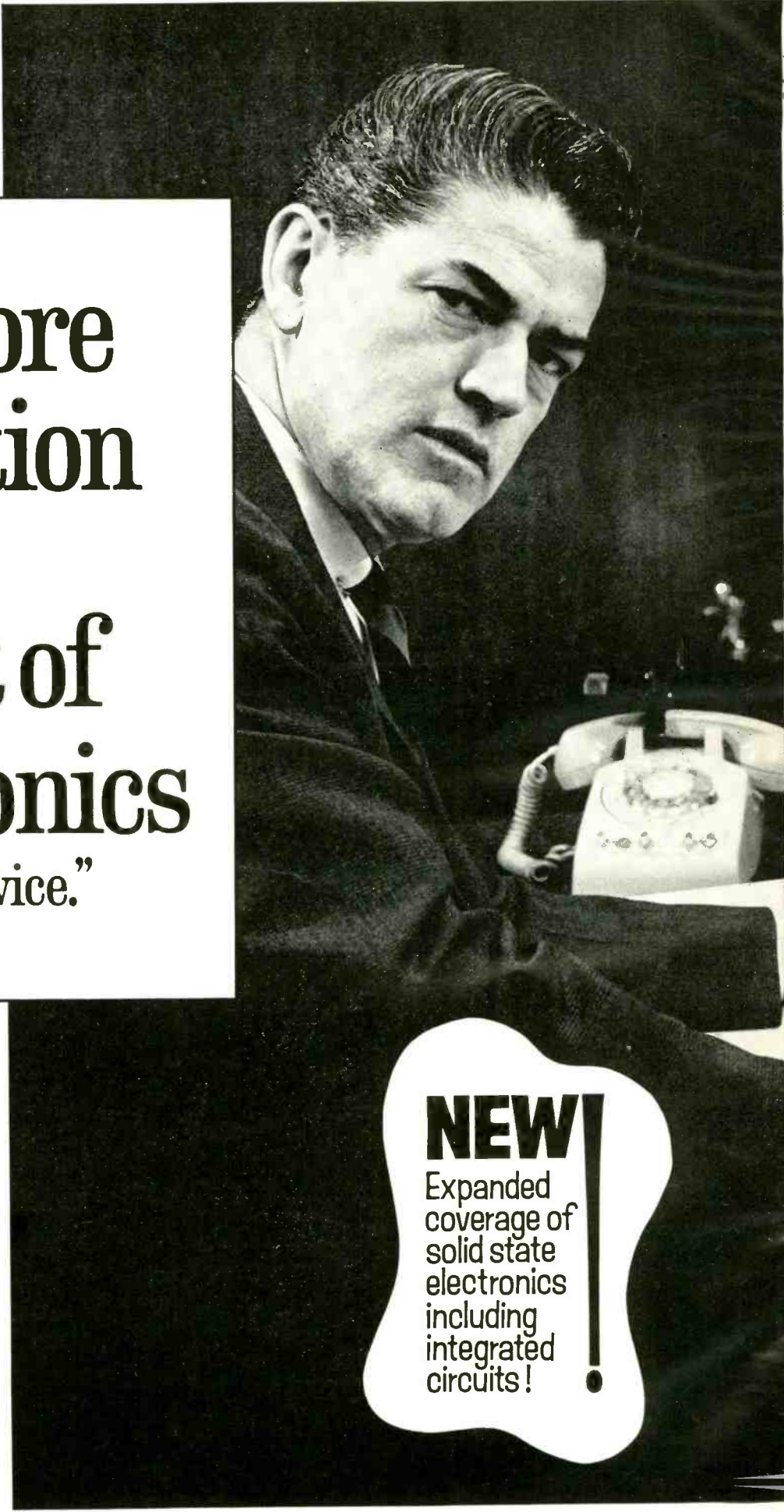

Fig. 2—Breadboard setups can be simple, like this plywood with nails, or more elaborate like the photos on the left.

Table I—Batteries for Breadboarding

Ever-ready Number	Voltage and recommended current	Size (inches)	Catalog Price
1015	1.5V, 25 in A	35/64 dia x 1 31/32 long	\$0.17 Pencil
1050	1.5V, 150 in A	1 21/64 dia x 2 25/64 long	\$0.20 Std. D cell
276	9V, 30 in A	2 9/16 x 2 x 3 5/32	\$1.36
731	6V, 500 in A	5 3/8 x 2 7/8 x 4 15/16	\$1.96
732	12V, 250 in A	5 3/8 x 2 7/8 x 4 15/16	\$1.96



**“Get more
education
or
get out of
electronics
...that’s my advice.”**

NEW!

Expanded
coverage of
solid state
electronics
including
integrated
circuits!



Ask any man who really knows the electronics industry.

Opportunities are few for men without advanced technical education. If you stay on that level, you'll never make much money. And you'll be among the first to go in a layoff.

But, if you supplement your experience with more education in electronics, you can become a specialist. You'll enjoy good income and excellent security. You won't have to worry about automation or advances in technology putting you out of a job.

How can you get the additional education you must have to protect your future—and the future of those who depend on you? Going back to school isn't easy for a man with a job and family obligations.

CREI Home Study Programs offer you a practical way to get more education without going back to school. You study at home, at your own pace, on your own schedule. And you study with the assurance that what you learn can be applied on the job immediately to make you worth more money to your employer.

You're eligible for a CREI Program if you work in electronics and have a high school education. Our FREE book gives complete information. Mail postpaid card for your copy. If card is detached, use coupon below or write: CREI, Dept. 1411H, 3224 Sixteenth Street, N.W., Washington, D.C. 20010.



**CREI, Home Study Division
McGraw-Hill Book Company
Dept. 1411H, 3224 Sixteenth Street, N.W.
Washington, D.C. 20010**

Please send me FREE book describing CREI Programs. I am employed in electronics and have a high school education.

NAME _____ AGE _____

ADDRESS _____

CITY _____ STATE _____ ZIP CODE _____

EMPLOYED BY _____

TYPE OF PRESENT WORK _____ G.I. BILL

I am interested in

Electronic Engineering Technology Computers

Space Electronics Nuclear Engineering Technology

NEW! Digital Communications **NEW!** Industrial Automation

APPROVED FOR TRAINING UNDER NEW G.I. BILL

Assemblies like that of Fig. 2 can be made up from chassis and lug strips, as shown in the photos. They look better—perhaps electrically they are better—and they cost more. One is a solid state, the other a vacuum-tube breadboarding assembly.

Around the breadboard

If you automatically reach for an ac power supply every time you think of a circuit experiment, you're missing the best part of the whole idea. Batteries have come back into style and are ideal for breadboarding work.

Their simplicity, isolation from power lines, general availability, electrical properties and stability are all well suited to breadboarding. You can assemble some batteries into a small box with switch and terminals, or choose a few handy sizes such as the larger transistor batteries. Avoid miniatures. The ultra-tiny penlight cells and general-purpose 9-volt radio batteries may seem attractive but they have no capacity. Look for lantern batteries or others of rather hefty construction.

Alkaline energizer batteries are nice if you are working with heavy loads and high currents. This is unusual in most breadboarding, and they probably are not worth the extra cost. Some suggested batteries available at economical prices are shown in Table I.

If you really have your mind set on power supplies, there should be a couple of them, or else one power supply and some batteries on your workbench.

Typical breadboards will contain somewhat less than all of an electronic system. Working on a receiver design, you may breadboard the tunable oscillator, simulate the age system, test the audio amplifier, or do other tests on only a part of the overall system. This excellent engineering practice has a couple of very important, unavoidable bits of theory connected with it.

The first is that electronic circuits and their inputs frequently interact. If you duplicate the interaction, the breadboarded part of a circuit cannot detect the difference between your setup and the real thing. Driving or input sources typically have a source resistance and reactance, which can usually be duplicated by a little additional circuitry on the breadboard.

For example, suppose you are breadboarding a tape playback pickup circuit. How do you match the properties of the head? Simply by adding the equivalent circuit of the head to the breadboard (Fig. 3).

Similar arguments apply at the output side of the circuit. A loudspeaker is easily simulated by a resistor, but if you are checking an i.f. amplifier stage you may want to include the transformer as shown in Fig. 4. Some careful thinking will usually enable you to reconstruct real circuit conditions with reasonable accuracy.

A convenient arrangement for breadboarding operations is to set your generators, meters and other test gear about 4 inches above the working surface of the bench. A simple shelf assembly will achieve this. The fronts of the instruments become far more accessible, and the hazards of dragging a shirt sleeve across all the loose ends projecting from the breadboard are nearly eliminated.

Breadboarding tips

The purpose of a breadboarding project is to test your thinking, not to replace it. Good breadboarding is a fairly cerebral activity, one of the reasons for its low cost. The first requirement is a goal, or purpose, for building the breadboard. This is expressed most effectively by a schematic of the circuit, carrying notes about the circuit's anticipated performance. Results can usually be added to the schematic and corrections made as indicated.

Later a fresh schematic is drawn, giving a clear, concise summary of your results and finished design. The breadboard is dismantled, scrap materials and paper dis-

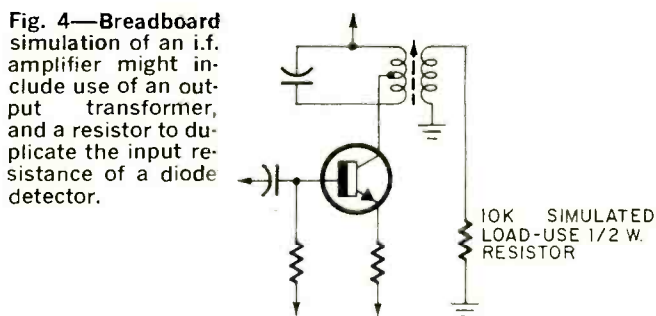
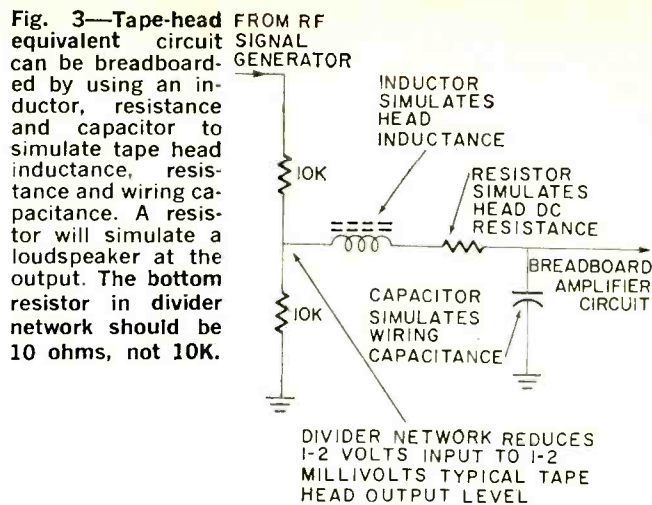

carded, and the deck is cleared for your next job.

When you have your breadboarded circuit assembled on the bench, can you find your way around it easily? A bit of memorization will enable you to work more rapidly, and direct your attention to the problem rather than annoying details of color charts and data books. Memorize the color code in Table II, and learn how it is applied to resistors, capacitors and inductors.

Table II Color Codes		Table III The Magic Number Sequence	
Color	Number	Number	Sequence
Black	0	1.0	
Brown	1	1.2	
Red	2	1.5	
Orange	3	1.8	
Yellow	4	2.2	
Green	5	2.7	
Blue	6	3.3	
Violet	7	3.9	
Gray	8	4.7	
White	9	5.6	
(Silver)	10%	6.8	
(Gold)	5%	8.2	
		(10)	

Since you may be breadboarding elaborate circuits once you've collected some materials and experience, you soon begin to appreciate being able to spot instantly that 3900-ohm (orange-white-red) resistor the schematic shows in the second transistor's collector circuit. Memorize the basic transistor lead configuration, too: emitter-base-collector, seen from top, goes clockwise.

Another handy bit of memory work is the series of magic numbers appearing in Table III. These are the same 12th roots of 10 numbers used for 10% values of resistors, capacitors and inductors. Compare this sequence with the resistor, capacitor and inductor values in catalogs. Another 12 values are added to this sequence to specify all standard 5% values. Perhaps in a few years all R, C and L values will be in this system.

R-E

BUILD— Perfect Electronic Keyer

An automatic Morse code keyer loaded with IC-controlled features.

by **W. O. HAMLIN, W6ENU**

THE PERFECT ELECTRONIC KEYSER CAN GIVE YOU PRECISE, fully automatic Morse code operation. Dashes are always three times longer than dots, and the design features self-completing dots and dashes, making it unnecessary to hold the key closed until either is completed.

Closing one set of contacts on the double-contact key generates a string of dots as long as the position is held, and the other contacts provide dashes. Operating speed is controlled by a potentiometer. When both contacts are

Fig. 1—Dual two-input gate, the 914 IC, is shown below with its base diagram on top. PEK uses both NOR and NAND circuits.

Fig. 2—Cross coupling of 914 provides a freerunning multivibrator (top, right) or a "memory" flip-flop.

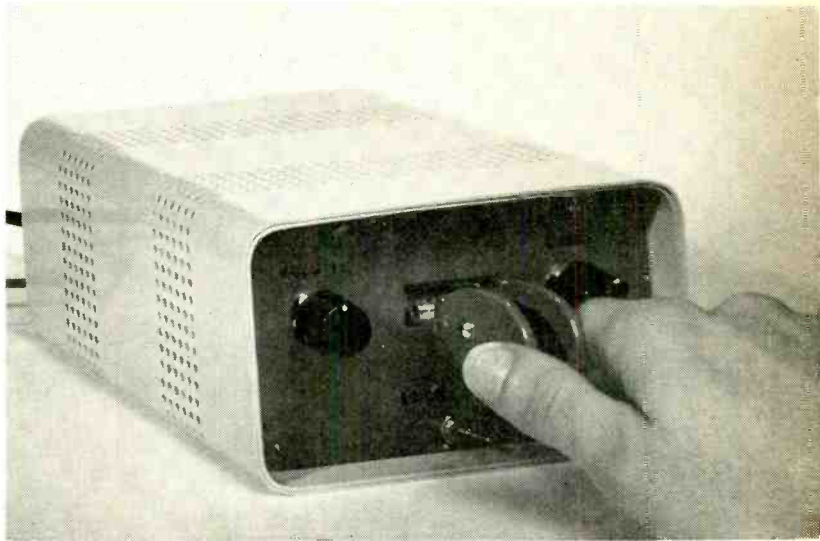
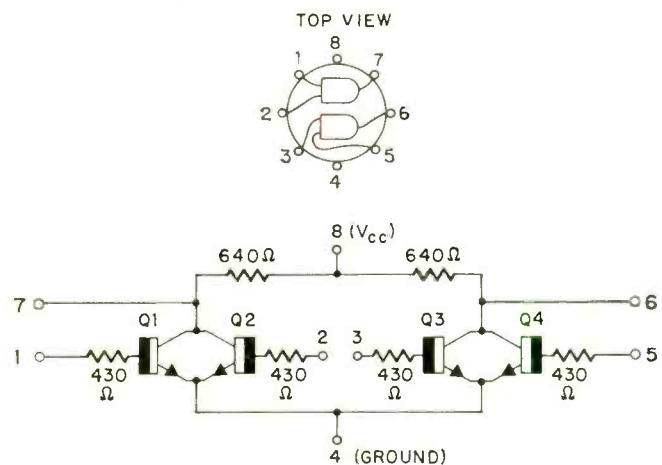

PEK FEATURES

- Character and space memory (completes if key is released)
- Dashes always three times longer than dots.
- Squeeze keying gives dot-dash or dash-dot continually when both sides of key are closed. (Start depends on which side is closed first.)
- Loudspeaker and side-tone monitor jack for connection into receiver audio.
- Keying relay output for connection into any transmitter keying circuit.
- Lock-key to short across relay for transmitter tune up.
- Logarithmic speed control for linear change at fast and slow ends.

held, a string of alternating dots and dashes (or dashes and dots) is formed. This makes it easy to form common letters such as C.

Unlike earlier keyer designs, a dot or dash is started the instant the contacts are closed—not at some indefinite time later. The PEK's built-in tone monitor is optional, since many ham rigs have side-tone monitors.

Building the PEK is a snap. Since 95% of the PEK's circuitry is inside the 11 inexpensive integrated circuits (IC's) used, even a novice can wire the PC board in about one hour.

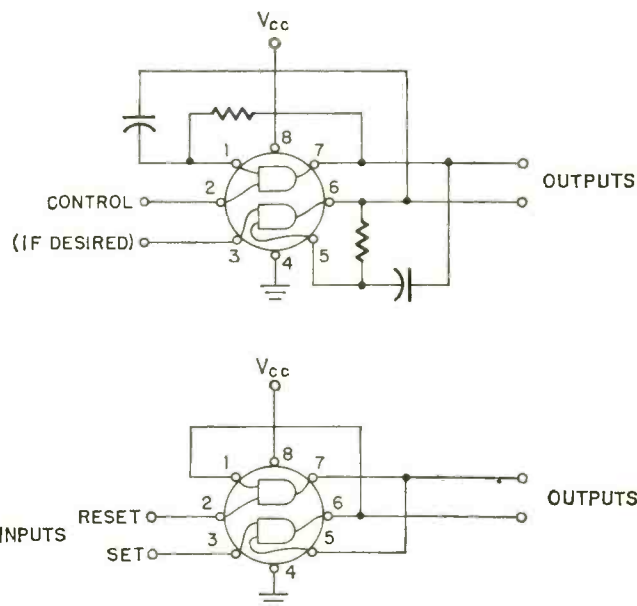

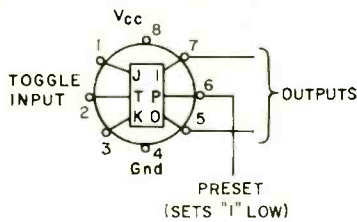

J	K	I	O
HIGH	LOW	HIGH	LOW
LOW	HIGH	LOW	HIGH
LOW	LOW	CHANGES STATES	
HIGH	HIGH	NO CHANGE	

Fig. 3—JK flip-flop used in PEK, the 923, is shown in a top view. Unit is strobed at its input to change its states. Truth table for 923 JK flip-flop, shows all logic conditions. High is a positive voltage, low is near-zero.

Fig. 4—Complete schematic diagram of the PEK keyer. IC's and a printed circuit board simplify construction. Note that the IC just to left of Q1 is IC-1, not IC-2.

PARTS LIST

- C1, C2, C3—0.22 μ F capacitor
- C4—100- μ F, 10V capacitor
- C5, C6—10- μ F, 5V capacitor
- C7-C10—0.003 μ F capacitor
- C11, C12—0.01 μ F capacitor
- C13—10,000- μ F, 10V electrolytic capacitor (Sprague 39D 109G016JT4 or equivalent)

All fixed resistors 1/2 watt, 10%

- R1, R11—470 ohms
- R2, R3, R9, R13, R18—3300 ohms
- R4—18,000 ohms
- R5—33,000 ohms
- R6—220 ohms
- R7—1000 ohms
- R8, R16, R17—820 ohms
- R10—330 ohms
- R12—(see text)
- R14, R15—1500 ohms
- R19—5000-ohm linear potentiometer

- R20—10,000-ohm, CCW logarithmic potentiometer

Semiconductors

- D1-D4—1N2069 diodes or equivalent
- Q1—2N5134 transistor
- Q2—2N3565 transistor
- Q3—2N3566 transistor
- Q4—2N3638 transistor
- IC1-IC4, IC6, IC7, IC10, IC11—914 dual RTL gate integrated circuit (Fairchild or ITT)
- IC5, IC8, IC9—923 JK flip-flop integrated circuit (Fairchild or ITT)

MISC—Hathaway G-PIA6 relay (distributed by Compar.) Key: Brown Bros. UTL (without base) or BTL with base. Box: LMB model CO-3. Box: LMB model CO-3.

A set of two PC boards for building the keyer, a keying relay and a complete set of transistors and IC's is available for \$24.95 post-paid. A Brown UTL key is \$11.95. Write: Solid-State Services, 1720 Kimberly Drive, Sunnyvale, Calif. 94087 (Atten: W6ENU).

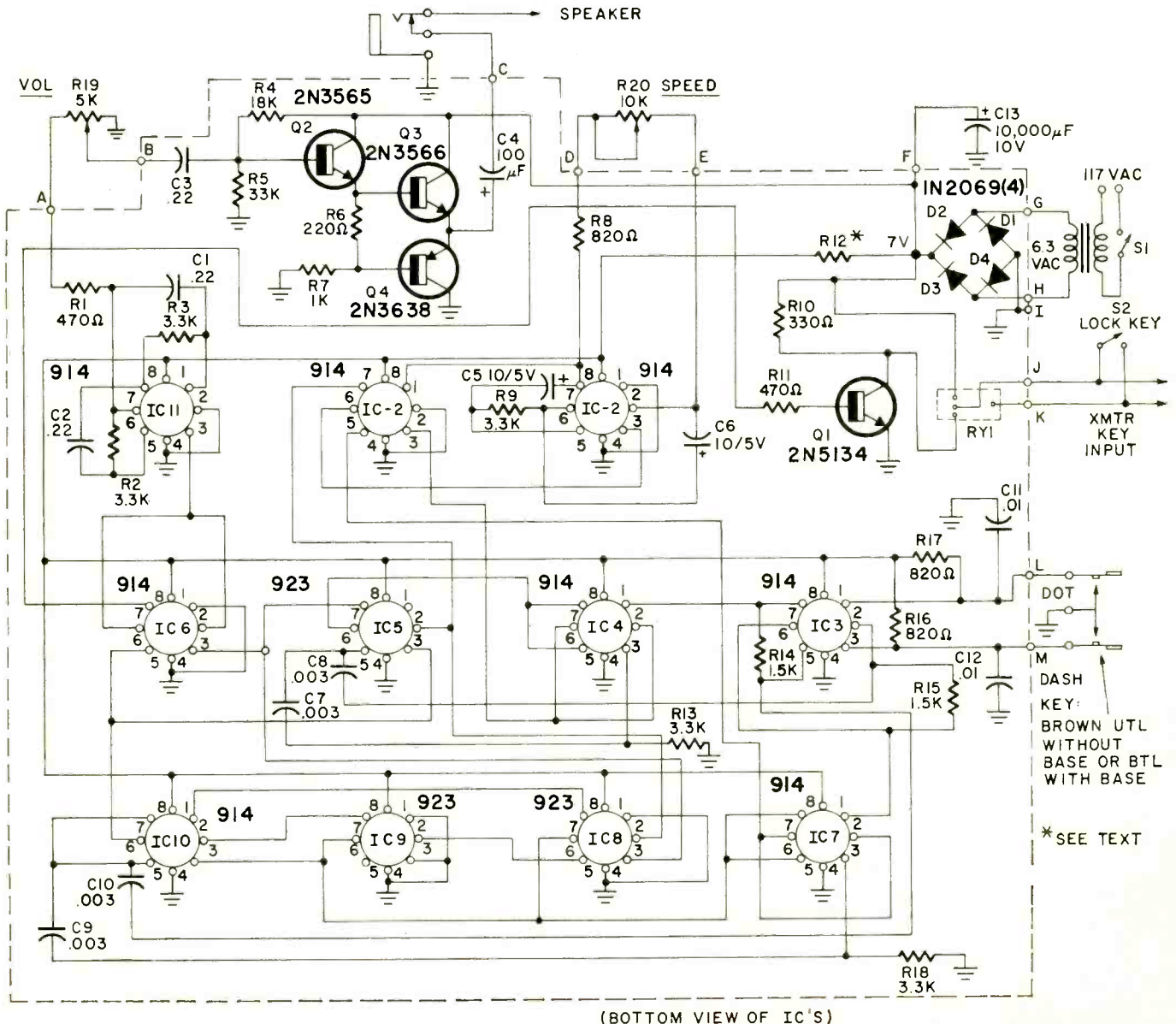

*SEE TEXT

(BOTTOM VIEW OF IC'S)

Keyer logic elements

First, let's look at the IC logic elements that make up the PEK. Two types are used: 914 dual two-input gates, and 923 JK flip-flops. Fig. 1 shows the dual-gate circuit and its basing diagram. Transistors Q1-Q2 form one gate and Q3-Q4 form the other. Because resistors as used for loads and at the transistor inputs, these are called RTL (resistor-transistor-logic) circuits.

The basic circuit is called a NOR gate when the input is a positive signal. NOR means "not OR." By definition, an OR gate gives an output signal (voltage) when there is a signal at either input (either input *or* both inputs). The *not* OR situation arises when a positive input voltage causes a gate transistor to conduct so that the output voltage is a negative (inverted) signal. Since either transistor can produce the same output results, the OR definition is satisfied.

In computer logic terminology, the opposing type of circuit is the AND circuit. Both one *and* the other input must have signals to obtain an output. The NOR circuit can satisfy this definition by operating in reverse, and with inverting output it is called the NAND circuit. There is no output when both inputs are positive. That is, both transistors are conducting and the output voltage is low. One transistor *and* the other must be turned off before the output level changes. Notice that the change in definition of NOR to NAND requires a change in signal definition

from a high to a low voltage level. The PEK uses both NOR and NAND logic concepts, as we'll describe later.

A dual-gate IC such as the 914 can be cross-coupled to form a bistable flip-flop as shown in Fig. 2. In a flip-flop, when one side is on the opposite side is always forced off. Since a bistable flip-flop stays in one of these states until forced to change by an external signal, it can be used for a "memory."

If the gates are cross-coupled with capacitors and dc bias is applied to the transistor bases, the on-off condition cannot be sustained. Instead, the two sides go on and off alternately, or oscillate. This is called an astable, or free-running, multivibrator. In the PEK, it is used for the timing oscillator and side-tone monitor.

The logic and base diagram for the 923 JK flip-flop is shown in Fig. 3. The device gets its name from the function of its J and K inputs. It must be "strobed" at the J input by a fast fall-time wave to trigger (change states). The truth table shows all logic conditions possible. "High" is a positive voltage; "low" is a near-zero voltage. For example, when the J input is high and the K input low, the output is a high voltage and the 0 output is a low voltage after the toggle input has been strobed. The JK's outstanding feature is that when both inputs are low it changes state each time it is strobed. This results in a frequency division of the strobing signal.

Note that in either type of flip-flop, when one output is high the other must be low, and vice versa. The preset "P" always sets the flip-flop the same way: when it is high the "1" output is low and the "0" output is high. Using these principles, the JK flip-flop in the PEK is used for frequency dividing to set the dot, dash and space relationships.

How the keyer works

The complete schematic of the PEK is shown in Fig. 4, and the waveforms in Fig. 5 help explain its operation. Keying pulses originate in the clock oscillator, IC1. Dots and dashes are generated independently from the same clock by the divider circuits: IC5 for dots, and IC8 and IC9 for dashes. Both portions of the circuit work identically, except the dash portion has an additional divider and decoding gate to make the dash three times longer than the dot.

Here's the circuit operation: IC3 is the input gate connected to the key. When the key is in neutral, the outputs of both gates (pins 6 and 7) are low. When the key is moved to the dot position, pin 1 is grounded, causing the output at pin 7 to go high. This sets the upper half of IC4 so that its pin 7 goes low. This removes the preset voltage on pin 6 of IC5, a JK flip-flop, permitting it to divide the clock signal. It also sets the input to the lower IC4 gate low, and its output (pin 6) goes high. This voltage is inverted in IC2 so that pin 3 in IC1 goes low, thus starting the "clock" oscillator. Therefore the lower half of IC2 acts as a clock control.

The output of the clock (IC1, pin 7) first goes negative and is inverted in IC2. This applies a positive signal to the toggle input (IC5, pin 2). When clock IC1 switches to the alternate cycle, its output goes positive, so that input to IC5 goes negative. This causes the JK flip-flop IC5 to change states, and its output at pin 7 goes from a low to high voltage, remaining high until the input action repeats itself.

Because IC5 flips only on positive-going signals of the clock, in effect it is dividing the clock frequency by one-half. This is the period of the dot. Pin 5 of IC5, which was low during the dot, goes high on the second flip of IC5 and sends a positive-going pulse through C7 and R13. This resets IC4 to its off state if the key has been opened, so that pin 7 is driven high. Thus, IC4 controls the dot

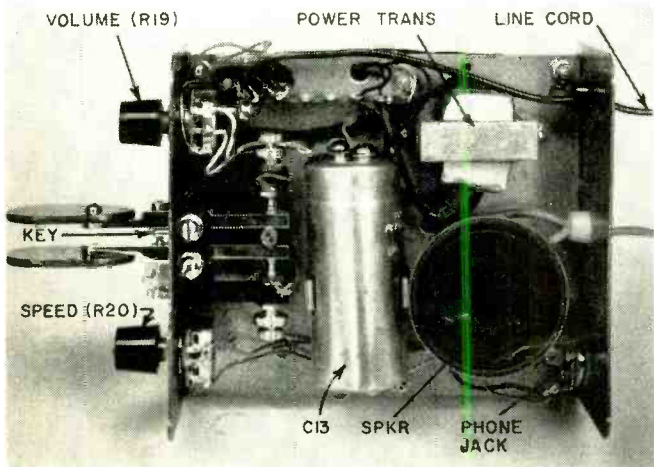

Top view of the PEK shows positioning of speaker, transformer and filter capacitor used. A crutch tip holds the speaker.

Printed circuit boards or perf-board arrangement can be mounted on lower side of the cabinet. Layout is not critical.

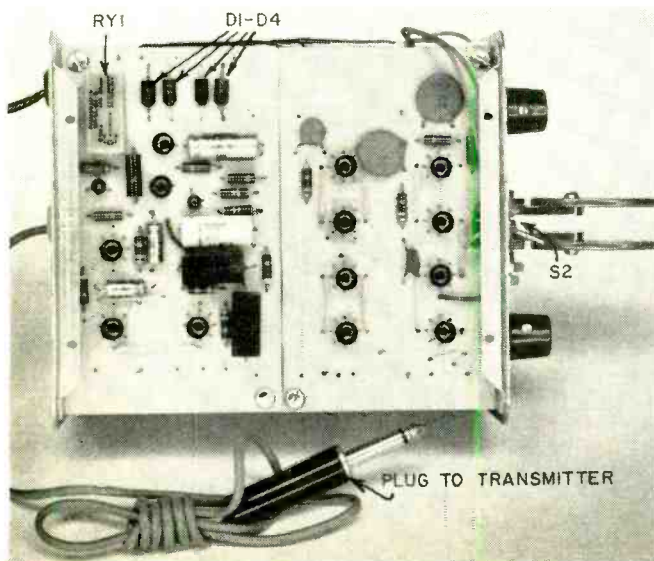

circuitry. As long as pin 7 is high, dots will be turned off, and when low they will be turned on.

Dash dividers IC8 and IC9 and the clock are controlled by IC7 in the same manner that IC4 controls dots. The clock waveform is divided twice, so the output of IC9 is one-quarter the clock frequency. The wave from IC9 is connected to an OR gate, the top half of IC10, along with the output of the first dash divider, IC8. The resulting output is shown in Fig. 5. IC10 therefore acts to decode the outputs of IC8 and IC9 into a dash.

Since independent circuits are used for dot and dash generation, dot-dash memory is inherent in the system. One problem exists, however: dot and dash dividers IC5 and IC8 would start dividing immediately after a dot or dash is selected by the key, since their toggle inputs are tied to gether.

This is prevented by a dash-signal inhibit connection from the dash output of IC10 to pin 3 of IC5, and a dot inhibit connection from the dot output of IC5 to pin 3 of IC8. These connections are analagous to an interlock.

"Squeeze keying" is accomplished by feedback from C8 and C10. When a dot is completed, the positive reset pulse through C8 holds off any dot generation at IC3 (pin 3), but feeds through R15 to start a dash on pin 1 of IC7. Likewise, C10 performs the same function at the completion of a dash by holding off more dashes at pin 5 of IC3, but starts a dot by feeding through R14 at pin 1 of IC4. Therefore, continuous alternation of dots/dashes will occur as long as pins 1 and 4 of IC3 are held at ground by the key contacts.

The function of IC6 is to mix the outputs of the dot and dash generators and invert them so both a plus and a minus code signal is available to interface with transmitter circuits. The addition of a transistor amplifier and keying relay is the simplest way to meet any keying requirement.

Assembling a PEK

A pair of PC boards are available, along with the IC's and transistors used (see parts list). Pegboard construction can be used since the layout is not critical, but wiring runs should be kept as short as possible.

It may be necessary to shield the circuit from transmitter rf fields. Frequency response of the IC transistors exceeds 100 MHz, but induced rf signals over a few hundred millivolts can cause spurious triggering. Place the unit in an aluminum box, and bypass the leads going to and from the box with the capacitor values shown in Fig. 4. The monitor speaker is a 2¼-inch transistor radio type, pushed into a chassis-mounted crutch tip (available in drug or hospital supply stores).

An inexpensive 6.3-volt filament transformer is used with a bridge rectifier for the power supply. (The 6.3 volts may be available from an accessory plug on your equipment.) The 3.6 volts required by the IC's is obtained by dropping the rectified 6.3 volts through a resistor. Current drain is about 125 mA.

The value of dropping resistor R12 will vary according to the transformer's internal resistance or the source resistance in the equipment. For a low-resistance source, the dropping resistor should be about 21 ohms. Measure the output voltage with the circuit drawing current to set it between 3.2 and 4 volts; decrease resistance for less than 3.2 volts measured and increase resistance for more than 4 volts.

Testing and troubleshooting

With the dc supply voltage adjusted as described above, and the key in the neutral position, the relay should be open. Moving the key so that pin 1 of IC3 is grounded should produce a string of dots, and grounding pin 3 of

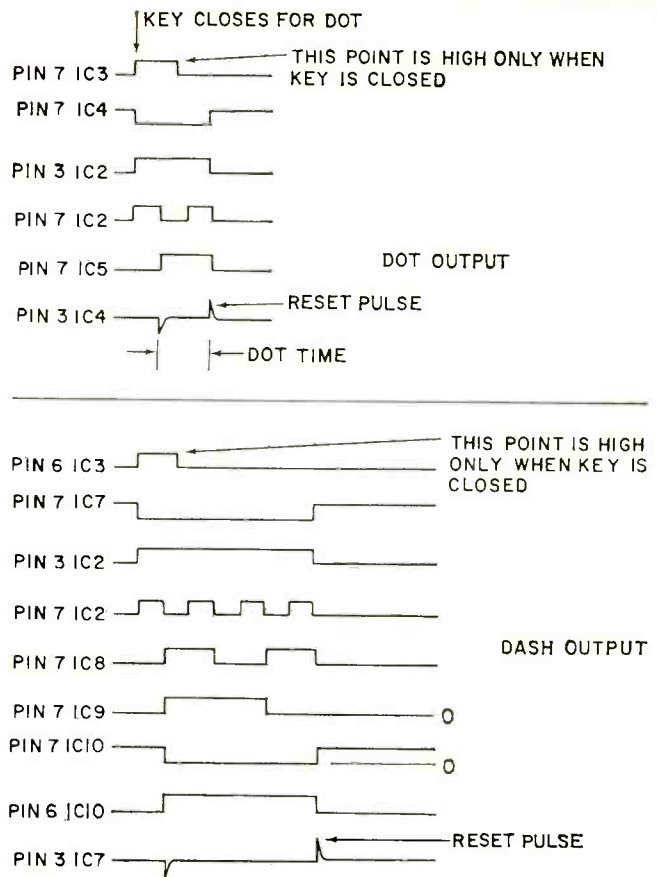

Fig. 5—Dot output for various IC's is shown on top above and the dash output below the line.

VOLTAGE READING CHART				
IC	PIN NUMBER	KEY POSITION		
		NEUTRAL	DOT	DASH
2	3	L	H	L
	5	L	L	H
	6	H	L	L
3	1	H	L	H
	3	H	H	L
	6	L	L	H
	7	L	H	L
4	2	L	H	L
	3	L	L	L
	5	H	L	H
	6	L	H	L
7	1	L	L	H
	2	L	L	H
	3	L	L	L
	5	H	H	L
6	6	L	L	H
	7	H	H	L

Fig. 6—Voltage chart can be used to check correct operation of the circuit. Value of H varies with supply loading.

L: LESS THAN 0.3V H: MORE THAN 0.6V

IC3 should generate a string of dashes. Potentiometer R20 varies the PEK speed. If the operation seems improper, check the chart of Fig. 6, which gives circuit test-point voltage readings. An L on the chart stands for a low voltage and indicates readings for a saturated collector. This L voltage should be less than 0.3. An H stands for high voltage (collector of a transistor which is off). The H voltage should be between 0.6 and the power supply voltage, depending upon the resistance loading at that point.

R-E

Channel Separation Nomogram

By MAX H. APPLEBAUM

WHEN A STEREO-FM RECEIVER is working properly, channel separation should be equal to or greater than the 30 dB the FCC requires of stations. Here is a nomogram you can use to measure and calculate separation.

Manufacturers often use the following method to measure separation:

1. Feed a stereo signal (left or right channel only) into the antenna input of the receiver. The input signal should be about 1,000 μ V.

2. Adjust the receiver loudness control to obtain 0.5 volt measured with a vtvm connected across the speaker terminals.

3. Switch the signal, at the generator, to the other channel. Keep rf at 1,000 μ V.

4. Read the resultant output level, on the vtvm, across the *original* speaker terminals.

The separation in dB, for that channel, is $20 \log_{10}$. This is a ratio of the output level of the desired channel to the output level of the undesired channel. It is simply the ratio of the voltage measured in step 2 to that of step 4.

A simpler method is to feed in the signal as described in step 1 and measure the channel separation directly, without decoding the composite stereo signal. You can do this by viewing the waveform on a dc scope connected to the receiver second detector.

Fig. 1 shows the ideal composite signal with the 19-kHz pilot carrier removed. Such a waveform indicates infinite separation. In practice, however, this is impossible to obtain. Fig. 2 shows the signal which you'd normally see at the second detector. The amplitude of a signal of the *left* channel due to an input of the *left* channel only is represented by A. B represents the amplitude of a signal on the *right* channel due to an input on the *left* channel only.

Since these dimensions (A and B) are directly proportional to the voltages they represent, you can calculate the separation with this formula:

$$\text{Separation} = 20 \log_{10} A/B$$

Referring to the nomo, the cal-

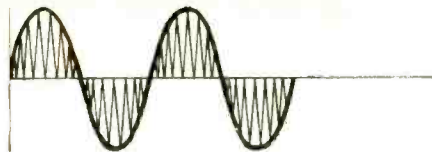

Fig. 1

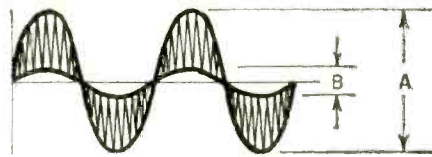

Fig. 2

ulation is now completed by extending a straightedge from the value of A on its column to the value of B on its column. The separation in dB is found where the straightedge crosses the center column.

In the example shown, $A = 2$, $B = .05$ and the separation is found to be 32 dB.

R-E

NOTE: The nomogram may also be used to calculate separation when the measurements are taken as described at the beginning of this article. Remember that scales A and B must always be in the same units.

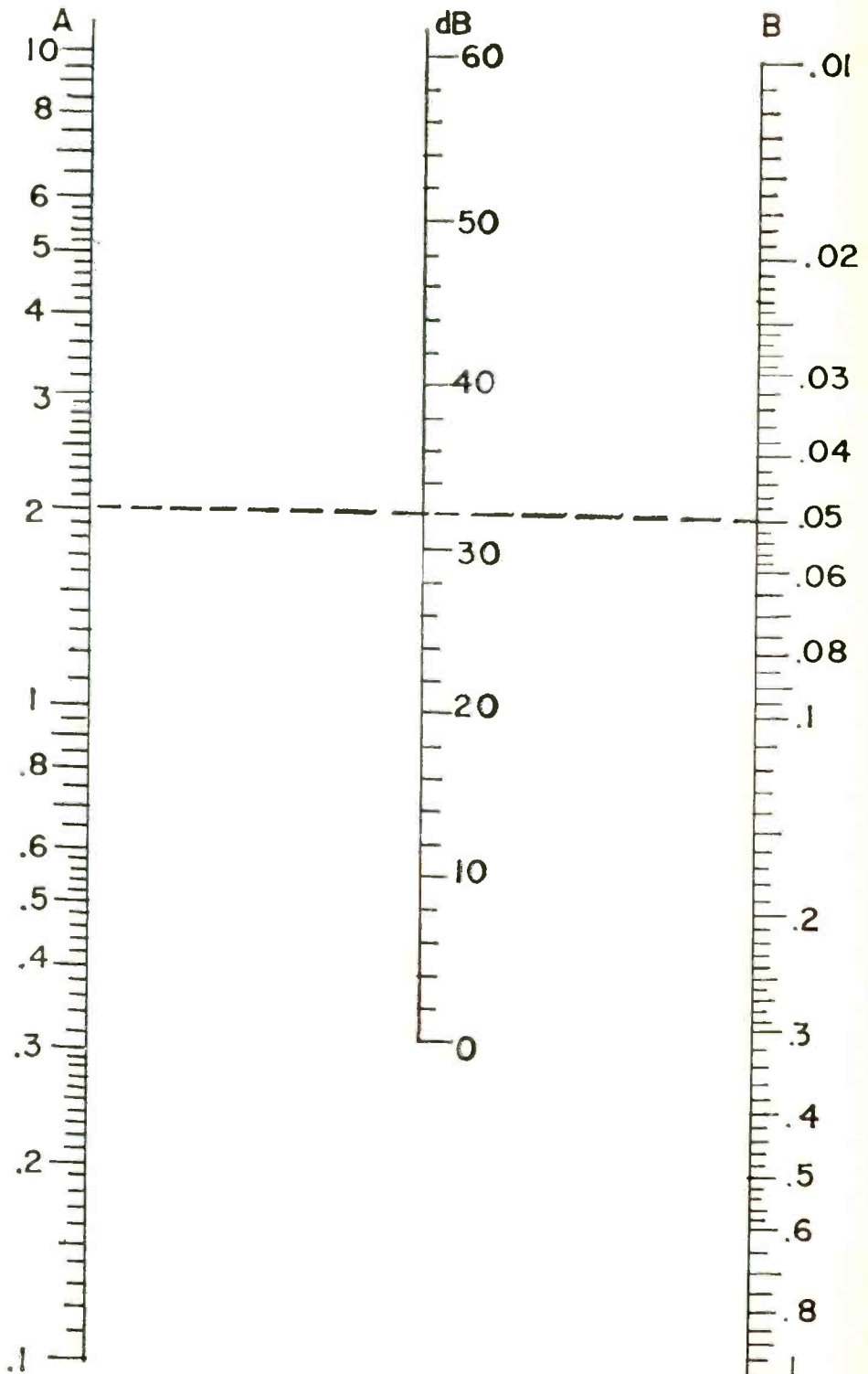

Exciting New Kits For Home & Hobby

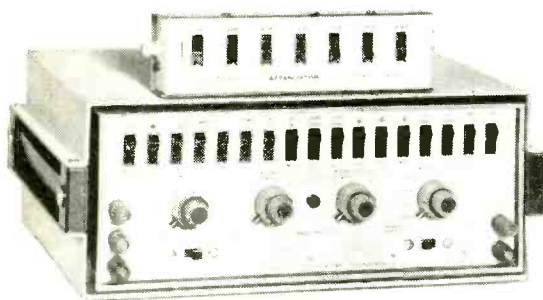

NEW Kit IG-57A

\$135⁰⁰*

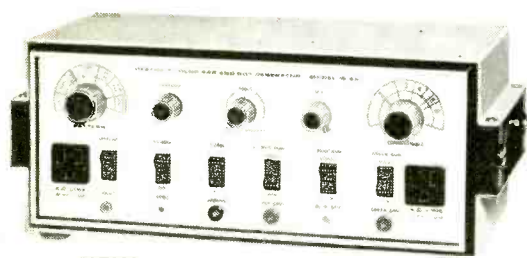

NEW
Kit IG-28

\$79⁹⁵*

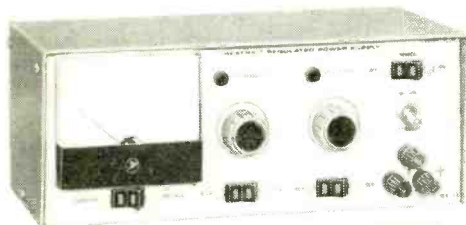

NEW
Kit IP-28

\$47⁵⁰*



NEW
Kit GR-78

\$129⁹⁵*



NEW
Kit GD-209A

\$149⁹⁵*

NEW, Improved Heathkit IG-57A Solid-State Post Marker/ Sweep Generator . . . Now With Built-In Video Sweep Modulator

Now align virtually every color and B&W TV set on the market with the new Heathkit IG-57A. New built-in Video Sweep Modulation eliminates the need for external equipment—the IG-57A and a scope are all you need to check the overall frequency response from the antenna terminals thru the tuner, IF strip, video detector to the color bandpass amplifier outputs. And you don't have to worry about video detector diode load. Another new feature is the addition of two individually adjustable 15 volt bias supplies with switchable polarity. Additional features: 15 crystal-controlled markers for color bandpass, TV sound, IF frequencies between 39.75 & 47.25 MHz and picture & sound carriers for channels 4 & 10 . . . switchable retrace blanking . . . adjustable phase control . . . trace reverse function for proper display . . . built-in switchable 400 Hz modulator . . . Zener regulated power supply . . . external attenuator for 1, 3, 6, 10 & 20 dB steps up to 70 dB . . . complete with all test leads, cables, connectors & plugs. Put complete servicing facilities on your bench now, with the new Heathkit IG-57A. 14 lbs.

NEW Heathkit Color Bar-Dot Generator . . . Advanced Integrated Circuitry Produces 12 Patterns Plus Clear Raster, Eliminates Divider Chain Instability Forever

The new IG-28 is the signal source for all color and B&W TV servicing. No other instrument at any price will give as much stable, versatile TV servicing capability. Its solid-state circuitry produces dots, cross hatch, vertical and horizontal bars, color bars, and shading bars in the familiar 9x9 display . . . plus exclusive Heath 3x3 display of all these patterns . . . plus a clear raster that lets you adjust purity without upsetting AGC adjustment. Fifteen J-K Flip-Flops and associated gates count down from a crystal controlled oscillator, eliminating divider chain instability and adjustments. And for time-saving convenience the IG-28 has variable front panel tuning for channels 2 through 6. Plus & minus going video signals at the turn of a front panel control . . . for sync, in-circuit video or chroma problems, use the front panel sync output. Two front panel AC outlets for test gear, TV set, etc. Built-in gun shorting circuits and grid jacks too. Add any service-type scope with horizontal input and you have vectorscope display capability as well. Fast, enjoyable circuit board-wiring harness construction. You can't beat the Heathkit IG-28 for versatility or value . . . put it on your bench now. 8 lbs.

NEW Heathkit 1-30 VDC Solid-State Regulated Power Supply

The new modestly priced IP-28 is an excellent power supply for anyone working with transistors. Compact Heathkit instrument styling with large, easy-to-read meter . . . two voltage ranges — 10 V., 30 V. . . two current ranges — 100 mA, 1 A. External sensing permits regulation of load voltage rather than terminal voltage. Adjustable current limiting prevents supply overloads and excessive load current. Convenient standby switch. Fast, easy assembly with one circuit board and wiring harness. Order yours today! 9 lbs.

NEW Heathkit GR-78 Solid-State General Coverage Receiver . . . Tunes 190 kHz To 30 MHz In Six Bands

The new GR-78 combines wide coverage, superior performance and portability with sharp styling to provide a remarkable value in general coverage receivers. Tunes AM, CW & SSB signals from 190 kHz to 30 MHz in six switch-selected bands. The all solid-state circuit employs modern FET's in the RF section and 4 ceramic filters in the IF to deliver maximum sensitivity and sharp selectivity. Bandspread Tuning is built-in, and can be calibrated for either Shortwave Broadcast or Amateur Bands. Completely portable . . . comes with a nickel-cadmium rechargeable battery pack and built-in charger that operates from 120 or 240 VAC and 12 VDC. Many built-in features . . . 500 kHz crystal calibrator . . . switchable Automatic Noise Limiter . . . switchable Automatic Volume Control . . . Receiver Muting . . . Headphone Jack and many more. Order yours today. 14 lbs.

NEW Heathkit Deluxe Radio-Controlled Screw-Drive Garage Door Opener Semi-Kit

The next best thing to a personal doorman. The "wireless" factory assembled transmitter operates up to 150 feet away. Just push the button and your garage door opens and the light turns on . . . and stays on until you're safely inside your home. The giant 7 ft. screw mechanism coupled with the 1/4 HP motor mean real power and reliability and the adjustable spring-tension clutch automatically reverses the door when it meets any obstruction . . . extra safety for kids, pets, bikes, even car tops. Assembles completely without soldering in just one evening. Easy, fast installation on any 7' overhead track (and jamb & pivot doors with accessory adapter). Order yours now. 66 lbs.

Adapter arm for jamb & pivot doors, Model GDA-209-2, \$7.95*

From The Leader



NEW Heathkit Ultra-Deluxe "681" Color TV With AFT . . . Power Channel Selection & Opt. RCA Hi-Lite Matrix Tube

The new Heathkit GR-681 is the world's most advanced Color TV with more built-in features than any other set on the market. Automatic Fine Tuning on all 83 channels . . . power push button VHF channel selection, built-in cable-type remote control . . . or you can add the optional GRA-681-6 Wireless Remote Control any time . . . plus the built-in self-servicing aids that are standard on all Heathkit color TV's. Other features include high & low AC taps to insure that the picture transmitted exactly fits the "681" screen, automatic degaussing, 2-speed transistor UHF tuner, hi-fi sound output, two VHF antenna inputs, top quality American brand color tube with 2-year warranty. With optional new RCA Matrix picture tube that doubles the brightness, Model GR-681MX only \$535.00.

GRA-295-4, Mediterranean Cabinet shown . . . \$124.95*

Heathkit "295" Color TV

With Optional RCA Matrix Tube . . . with the same high performance features and built-in servicing facilities as GR-681 above . . . less AFT, VHF power tuning and built-in cable-type remote control. You can add the optional GRA-295-6 Wireless Remote Control at any time. New optional RCA Matrix tube doubles the brightness, Model GR-295MX, \$485.00.

GRA-295-1, Contemporary Walnut Cabinet shown . . . \$64.95*

Both the GR-681 and GR-295 fit into the same Heath factory assembled cabinets; not shown Early American style at \$109.95*

NEW Deluxe Heathkit "581" Color TV With AFT

The new Heathkit GR-581 will add a new dimension to your TV viewing. Brings you color pictures so beautiful, so natural, so real . . . puts professional motion picture quality right into your living room. Has the same high performance features and exclusive self-servicing facilities as the GR-681, except with 227 sq. inch viewing area, and without power VHF tuning or built-in cable-type remote control. The optional GRA-227-6 Wireless Remote Control can be added any time you wish. And like all Heathkit Color TV's you have a choice of different installations . . . mount it in a wall, your own custom cabinet, your favorite B&W TV cabinet, or any one of the Heath factory assembled cabinets.

GRA-227-2, Mediterranean Oak Cabinet shown . . . \$109.95*

Heathkit "227" Color TV

Same as the GR-581 above, but without Automatic Fine Tuning . . . same superlative performance, same remarkable color picture quality, same built-in servicing aids. Like all Heathkit Color TV's you can add optional Wireless Remote Control at any time (GRA-227-6). And the new Table Model TV Cabinet and roll around Cart is an economical way to house your "227" . . . just roll it anywhere, its rich appearance will enhance any room decor.

GRS-227-5, New Cart and Cabinet combo shown . . . \$54.95*

Both the GR-581 and GR-227 fit into the same Heath factory assembled cabinets; not shown, Contemporary cabinet \$64.95*

NEW Heathkit Deluxe "481" Color TV With AFT

The new Heathkit GR-481 has all the same high performance features and exclusive self-servicing aids as the new GR-581, but with a smaller tube size . . . 180 sq. inches. And like all Heathkit Color TV's it's easy to assemble . . . no experience needed. The famous Heathkit Color TV Manual guides you every step of the way with simple to understand instructions, giant fold-out pictorials . . . even lets you do your own servicing for savings of over \$200 throughout the life of your set. If you want a deluxe color TV at a budget price the new Heathkit GR-481 is for you.

GRA-180-1, Contemporary Walnut Cabinet shown . . . \$49.95*

Heathkit "180" Color TV

Feature for feature the Heathkit "180" is your best buy in color TV viewing . . . has all the superlative performance characteristics of the GR-481, but less Automatic Fine Tuning. For extra savings, extra beauty and convenience, add the table model cabinet and mobile cart. Get the value-packed GR-180 today.

GRS-180-5, Table Model Cabinet & Cart combo . . . \$42.50*

Both the GR-481 and GR-180 fit the same Heath factory assembled cabinets; GRA-180-2, Early American Cabinet \$94.95*

Add the Comfort And Convenience Of Full Color Wireless Remote Control To Any Rectangular Tube Heathkit Color TV . . . New Or Old!

Kit GRA-681-6, for Heathkit GR-681 Color TV's . . . \$64.95*

Kit GRA-295-6, for Heathkit GR-295 & GR-25 TV's . . . \$69.95*

Kit GRA-227-6, for Heathkit GR-581; GR-481 & GR-180

Color TV's . . . \$69.95*

Now There Are 6 Heathkit® Color TV's To Choose From

2 Models In 295 Sq. Inch Size

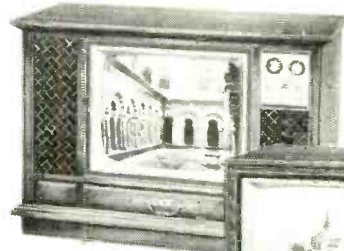

NEW
Kit GR-681
With AFT
\$499.95*
(less cabinet)

Kit GR-295
\$449.95*
(less cabinet)



2 Models In 227 Sq. Inch Size



NEW
Kit GR-581
with AFT
\$419.95*
(less cabinet)

Kit GR-227
NOW ONLY
\$379.95*
(less cabinet
& cart)

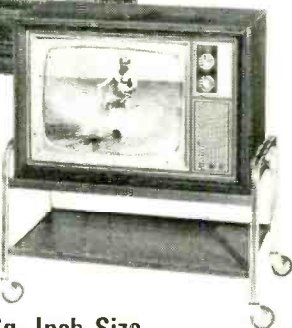

2 Models In 180 Sq. Inch Size

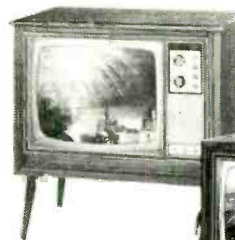

NEW
Kit GR-481
with AFT
\$359.95*
(less cabinet)

Kit GR-180
NOW ONLY
\$329.95*
(less cabinet & cart)

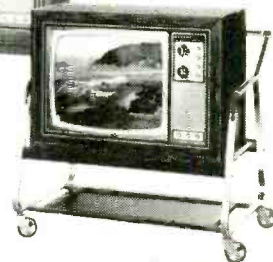

Reception Is Simulated
On All Sets Shown



NEW

FREE 1970 CATALOG!

Now with more kits, more color. Fully describes these along with over 300 kits for stereo/hi-fi, color TV, electronic organs, electric guitar & amplifier, amateur radio, marine, educational, CB, home & hobby. Mail coupon or write Heath Company, Benton Harbor, Michigan 49022.

HEATH COMPANY, Dept. 20-68
Benton Harbor, Michigan 49022

Enclosed is \$ _____, plus shipping.

Please send model (s)

Please send FREE Heathkit Catalog. Please send Credit Application.

Name _____

Address _____

City _____

State _____

Zip _____

*Mail order prices; F.O.B. factory. Prices & specifications subject to change without notice.

CL-368

Circle 33 on reader service card

THE CALECTRO

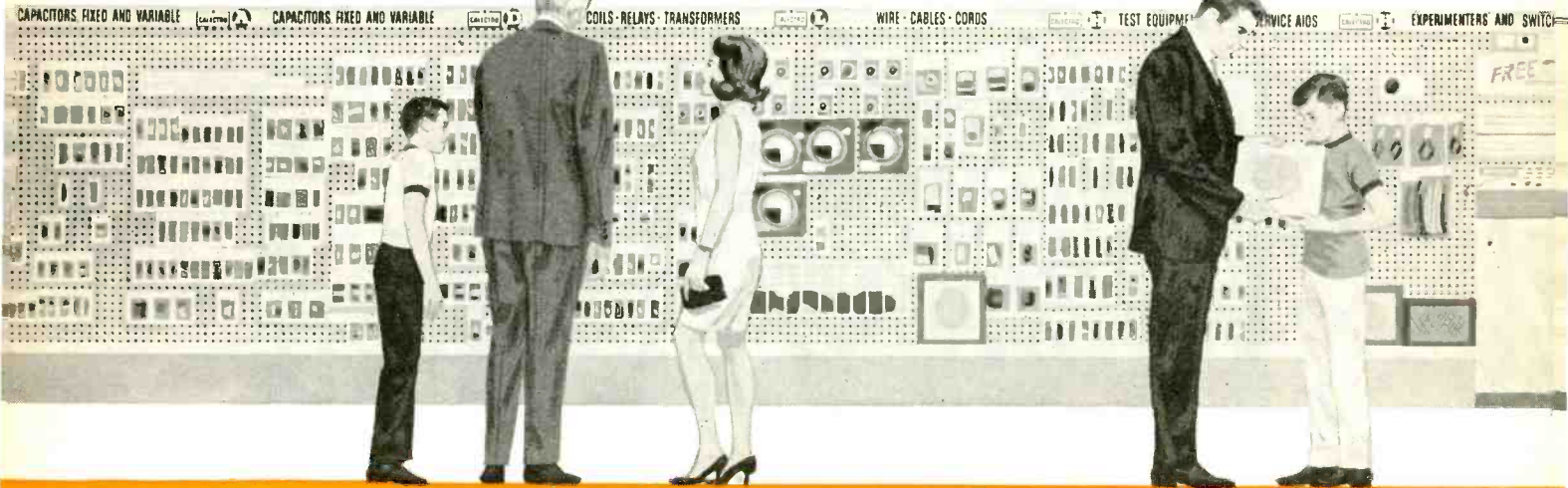

EVERYTHING IN ELECTRONICS!

Over 800 popular, new Calectro products for every household use!
 Now at each location, hundreds and hundreds of items for everyone
 hobbyist, enthusiast, amateur, executive, homeowner, do-it-yourselfer.
 See the SELF-SERVICE G.C. Calectro display
 at your Calectro SUPERMARKET TODAY.

VARIABLE BALANCE STEREO HEAD PHONE
 Unique "Sound Level" control on each earpiece permits adjustment.
 Frequency range: 20 to 20,000 cps.
 6 1/2' cord with stereo plug. Impedance 4 to 16 ohms.
 Cat. No. Q4-132 \$17.95 Net



"C" (FLASHLIGHT) TYPE CELL HOLDER
 Holds 4, 6-volt "C" cells; connect with wires
 Cat. No. F3-064 \$6.62 Net

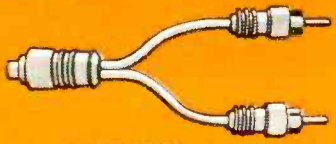

AUDIO ADAPTORS
 "Y" Audio Adaptor has a phono pin jack on one end and dual phono pin plugs on the other.
 Cat. No. Q4-288 \$3.99 Net

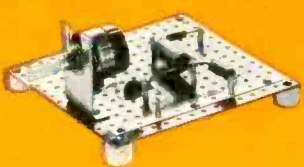

EXPERIMENTER'S CIRCUIT BOARD KIT
 Contains a 3 1/2" x 4" perforated board, 15 terminals (No. J4-636) and 4 mounting feet w/screws. Build small circuits, hobby and science projects, etc.
 Cat. No. J4-660 \$8.98 Net



TWO STATION WIRELESS INTERCOM
 Just plug into any electrical outlet. Completely portable. Expand system anytime with additional units. Two unit system complete in display pack.
 Cat. No. H4-110 \$34.95 Net



2 CONDUCTOR PHONE PLUG
 Plug has black or red plastic handle w/solder lug and clamp.
 Cat. No. F2-816 (black) \$4.43 Net
 Cat. No. F2-817 (red) \$4.43 Net

MINIATURE LAMPS



Type PR2 - 2.5 volt - 0.50 amp - Cat. No. E2-430 - Pkg. of 2 \$2.29 Net
 Type PR3 - 1.6 volt - 0.50 amp - Cat. No. E2-431 - Pkg. of 2 \$2.29 Net



Type 12 - 6.3 volts - 0.15 amp - Cat. No. E2-435 - \$3.39 ea. Net



Type 40 - 6.3 volt - 0.15 amp - Cat. No. E2-437 - Pkg. of 2 \$2.29 Net
 Type 46 - 6.3 volt - 0.25 amp - Cat. No. E2-441 - Pkg. of 2 \$2.29 Net



TV WIRE STANDOFF HOLDERS
 Wood screw type, 3/4" long. Insulator fits "flat-line" foam and co-ax cable.
 Cat. No. 32-050 Pkg. of 4 \$3.42 Net
 Same as above, but 7/8" long
 Cat. No. 32-054 Pkg. of 3 \$3.71 Net
 Snap-on type, fits on 1 1/4" masts. Universal insulation for all types of cable.
 Cat. No. 32-062 Pkg. of 2 \$3.58 Net

RESISTORS

Attractively packaged 2 per pack, showing values, color codes and formulas.

Type	Rating	Sizes Available	Price	Unit
Carbon	1/2 Watt	10 Ohm - 10 Meg	\$3.19	Pkg. of 2
Carbon	1 Watt	10 Ohm - 1 Meg	.19	Ea.
Carbon	2 Watt	10 Ohm - 100K	.25	Ea.
Wire	10 Watt	10 Ohm - 15K	.36	Ea.



STANDARD 1000 VOLT CAPACITOR

High quality, compact and reliable. Minimum capacity change with varying temperature. Rating: 1000 volts; tolerance: 20%.

Cat. No.	Description	Net	Unit
A1-060	220pF	\$2.25	Pkg. of 2
A1-061	330pF	.25	Pkg. of 2
A1-062	470pF	.25	Pkg. of 2
A1-063	680pF	.25	Pkg. of 2
A1-064	0.001uF	.19	Ea.
A1-065	0.005uF	.19	Ea.
A1-066	0.01uF	.19	Ea.



SUPERMARKET

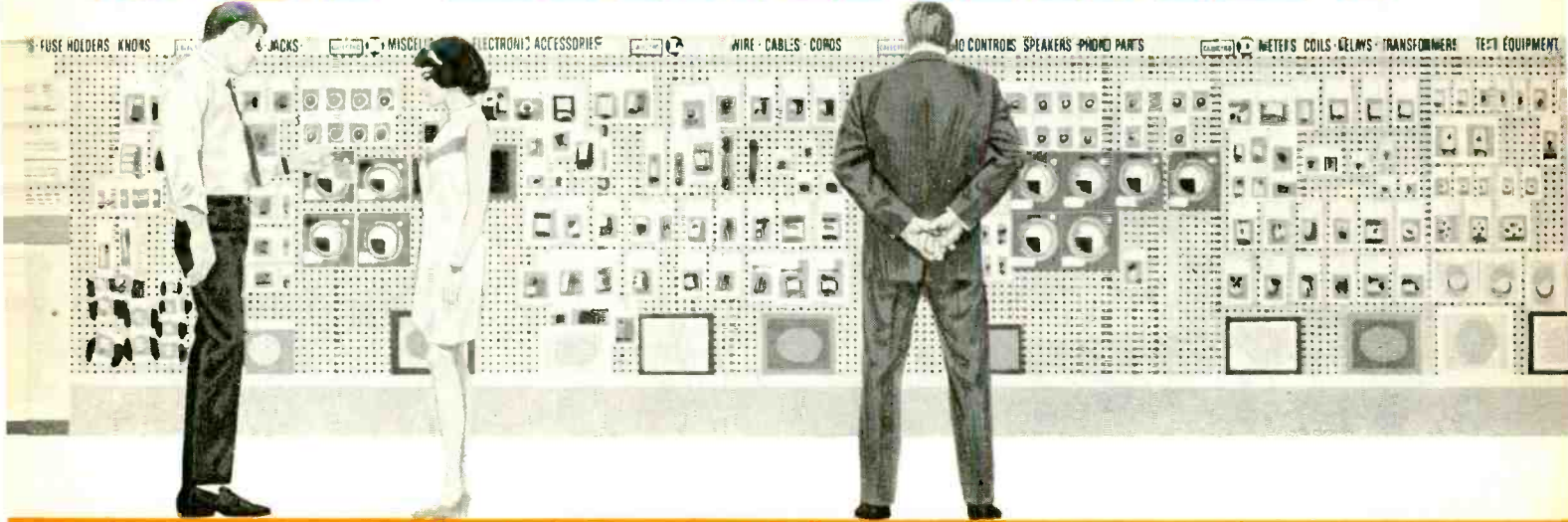

"HOBBY-PACK" SEMICONDUCTORS



PNP-GNL. PURPOSE Audio/RF Silicon Transistor - TO-5 case - typ. gain-60 - max. operat. volt-12 - freq. to 2MHz.
Cat. No. K4-501 Pkg. of 3 \$3.99 Net



PNP-35 POWER Germanium Transistor - TO-3 case - typ. gain-50 - max. operat. volt-25 - max. power 35W.
Cat. No. K4-520 \$3.99 Ea.



HOBBYIST'S SOLDERING AND TOOL KIT

Diagonals, long nose pliers, soldering iron and solder, solder aid tool, heat-sink, and screwdriver.
An ideal gift item.

Cat. No. H3-378 \$7.95 Net.

PRECISION PANEL METERS

Economical, high quality, dependable meters give 2% accuracy. Hand calibrated - Linear dial scales - D'Arsonval movement with jeweled bearings. Clear cover. DC Current Types ... DC Volt Types ... AC Volt Types ... also available in VU Meter and "S" Meter.

See Calectro Handbook page 38 for prices and specifications.



PICTURE TUBE BRIGHTENERS

Restores brightness and contrast. Corrects low emission problems or internal shorts. Just plugs in in parallel or series circuits.

Cat. No.	Description	Net
M4-035	For 110° B/W Tubes	\$2.95
M4-036	For 90° B/W Tubes	2.85
M4-037	For Round Color Tubes	6.95
M4-038	For Rect. Color Tubes	7.75



TAPE RECORDER MICROPHONE

Outstanding performance on music and speech for the price. Low impedance matches late model solid state recorders. Removable desk stand. 4 1/2' cord with dual plugs that fit most models. Freq. Response: 100-8k Hz. Output - 77 dB. Impedance: 200 ohms.
Cat. No. Q4-146 \$4.95 Net



CIGARETTE LIGHTER PLUG

Connects C9 Sets, warning lights, bottle warmers, etc. to auto dash receptacle.

Cat. No. M4-029 \$3.75 Net

PHONE JACK

Chassis mount jack for open or closed circuit.

Cat. No. F2-842 \$2.25 Net



The "GC Calectro Hobbyist Handbook" is available at your nearest Calectro Electronic Supermarket. One is located near you. WRITE TODAY and we'll rush you the name and address of your nearest Calectro Supermarket.

700 locations all over the country and Canada. See your electronic parts distributor and SAVE.

CALECTRO

G-C ELECTRONICS

400 SO. WYMAN ST. ROCKFORD, ILLINOIS 61101



A DIVISION OF
HYDROMETALS, INC.

Olson
ELECTRONICS
FREE
Catalog

Fill in coupon for a FREE One Year Subscription to OLSON ELECTRONICS Fantastic Value Packed Catalog — Unheard of LOW, LOW PRICES on Brand Name Speakers, Changers, Tubes, Tools, Stereo Amps, Tuners, CB, Hi-Fi's, and thousands of other Electronic Values. Credit plan available.

NAME _____
ADDRESS _____
CITY _____ STATE _____
GIVE ZIP CODE _____

If you have a friend interested in electronics send his name and address for a FREE subscription also.

OLSON ELECTRONICS
512 S. Forge Street, Akron, Ohio 44308

Circle 39 on reader service card

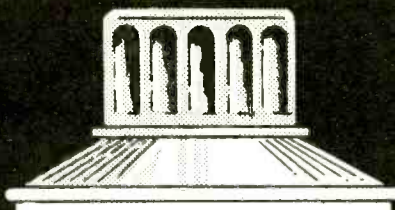

More and More Technicians Say:
"We've tried cheaper substitutes . . . now
WE'RE BACK TO
DEPENDABLE, RELIABLE
"NO NOISE"

World's No. 1 TRUSTED NAME BRAND

- VOLUME CONTROL & CONTACT RESTORER
- TUNER-TONIC with PERMA-FILM
- EC-44 FOR ELECTRICAL CONTACTS
- TAPE-RECO HEAD CLEANER
- FRIGIO-AIR CIRCUIT COOLER

All Guaranteed Non-Flammable, No Carbon Tet, Non-Toxic, Non-Drift Tuner Cleaner And Guaranteed Not To Affect Plastics.

The Only Brand Perfect For Color TV and Black & White

FREE extender assembly for pinpoint application supplied with ALL NO-NOISE PRODUCTS.

Electronic Chemical Corp.

813 Communipaw Ave. / Jersey City, N. J. 07304

Circle 40 on reader service card

Use
Christmas Seals.
It's a matter of
life and breath.



Christmas Seals
fight emphysema,
tuberculosis,
and air pollution.



Space contributed by the publisher as a public service.



SNAKEBIT?

using a
conventional
staple gun
on wire?

No shocking recoil action . . . no short circuits when wires and cables are fastened with an Arrow Staple Gun!

SAFE! Grooved Guide positions wire for proper staple envelopment! Grooved Driving Blade halts staple at right depth of penetration to prevent damaging wire or cable jacketed insulation!

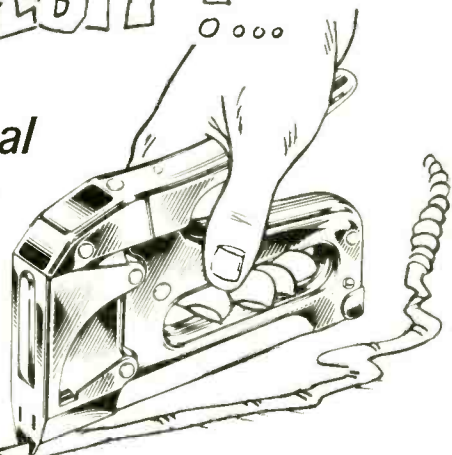

ARROW

Wire and Cable **STAPLE GUNS**

Model T-18



Fits any low voltage wire up to 3/16" in diameter.

Model T-25

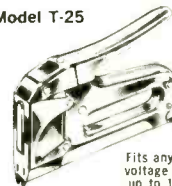

Fits any low voltage wire up to 1/4" in diameter.

Model T-75

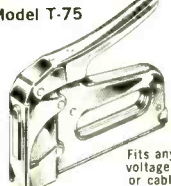

Fits any low voltage wire or cable up to 1/2" dia.

ARROW FASTENER COMPANY, INC.

271 Mayhill Street, Saddle Brook, N. J. 07663

Circle 41 on reader service card

← Circle 38 on reader service card

NEW PRODUCTS

More information on new products is available from the manufacturers of items identified by a Reader Service number. Use the Reader Service Card at the left and circle the numbers of the new products on which you would like further information. Detach and mail the postage-paid card.

ENGINE ANALYZER KIT, Model KG-303, uses a full-sized 2½" meter which has 4 rpm ranges from 0-6000 rpm, two dwell-angle ranges from 0-60°, plus a 0-16V voltmeter range. It may be used on 4-, 6- and 8-cylinder engines with



6- or 12-volt positive or negative ground ignition. This analyzer is able to test points, distributor and spark advance, and fuses. It can also be used as a continuity tester, 6½" high, 3½" wide and 2½" deep. \$19.95.—Allied Radio Corp., Chicago, Ill.

Circle 46 on reader service card



CASSETTE RECORDER, Model RK-99, offers 117-Vac and battery operation as well as complete record and playback facilities. Features include piano keyboard controls, record safety interlock (preventing accidental tape

erasures), and cassette "pop up" removal. Ac bias recording system with automatic level control permits distortion-free recording. Input for radio, phono or tape recorder; output for external speaker or earphone. Recording time: 2 hours. \$49.95.—Lafayette Radio Electronics Corp., Syosset, N.Y.

Circle 47 on reader service card

POWER SUPPLY, Model 1025, all-transistor power source with built-in meters to provide continuous monitoring of both output current and voltage. Output voltage is variable from 0 to 30 volts. Max continuous load current is 150 mA in the 0-12V range, 200 mA from 12 to 24 V, and 300 mA from 24 to 30 V. Maximum ripple at full load is

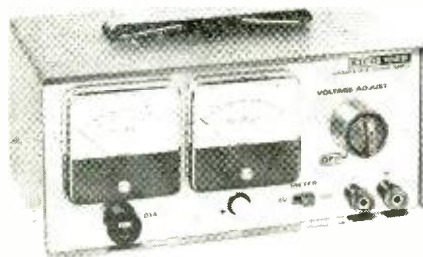

0.005%. Power supply is fuse-protected against short circuits. Kit is \$34.95; factory-wired \$49.95.—EICO Electronic Instrument Co., Inc., Brooklyn, N.Y.

Circle 48 on reader service card

AUTO TUNE-UP METER, Model ID-29, weighs 2½ lb in polypropylene case; is completely portable. This meter uses no batteries and measures dwell, rpm's and dc volts on any 4-cycle, 3-,



4-, 6- or 8-cylinder engine with standard ignition. Signal and power received directly from engine under test. \$29.95.—Heath Co., Benton Harbor, Mich.

Circle 49 on reader service card

INTEGRATED AMPLIFIER, Model AS-200, is designed specifically for tape recording. It allows simultaneous recording and monitoring with three tape

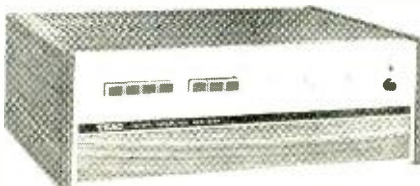

decks and facilities for playback from five tape decks. The differential amplifier (a computer type circuit) eliminates output capacitors and their distortions. This amplifier delivers 50 watts per channel at 8 ohms, and 60 watts per channel at 4 ohms. Harmonic distortion is 0.5%. Features include: two loudspeaker outputs for main and remote stereo speaker systems, tone-control selector switch, pushbutton input selectors, and high and low filters. \$299.50.—TEAC Corp. of America, Santa Monica, Calif.

Circle 50 on reader service card

AC LEAKAGE TESTER, Model 229, designed for testing 117-V/ac appliances and electrical equipment. Performance comes within ±1.0 dB of normal perception curve, and leakage currents as



small as 5 mA can be measured. Built for use on production lines and "in-field" service applications. Ac ranges cover 0-0.3, 1, 3, 10 mA; and ac voltage from 0 to 150 volts.—Simpson Electric Co., Chicago, Ill.

Circle 51 on reader service card

TAPE ERASER, Model 30-140, can be used by hand or as table model. Hand-



held, the eraser is passed over the tape reel in a circular motion. As a table

BURGLAR ALARM

Series 6000 solid state microwave Doppler Radar Systems in the UHF Range provide complete wall-to-wall, floor-to-ceiling protection for an area of up to 2500 feet per sensor.

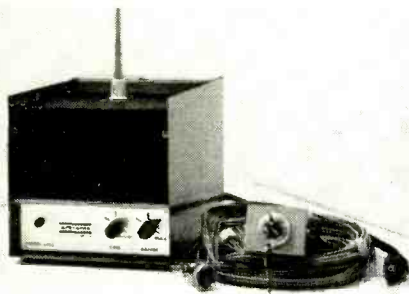

- Stable operation, with two alarm stages.
- Transistorized design, low power consumption. (less than 3 watt).
- Compatible with all other types of burglar alarm equipment.
- Modular construction, adaptable to every installation.
- Automatic, variable reset of alarm conditions, from 5 sec. min. to 10 min. plus.
- Low cost, only 5¢ to 15¢ per protected sq. ft., depending on final systems configuration.
- Designed for continuous, indoor operation and easy installation.

artronix

SURVEILLANCE

716 Hanley Industrial Ct. St. Louis, Mo. 63144
Area Code 314 Phone: 644-2456

Circle 106 on reader service card

model, tape reel is placed on the post and rotated. Can also be used for cassette recorders. Includes momentary switch and cord. \$18.30.—GC Electronics, Rockford, Ill.

Circle 52 on reader service card

C-B TRANSCEIVER, Model 14-523, portable, 5-watt, 23-channel unit. Double superhet receiver has mechanical filter, an S and rf meter on the



rubber safety front panel. Final-stage efficiency is 65% delivering over 3.2 watts rf. Sensitivity is 0.5 mV. Variable squelch. ANL. age. Weight: 3½ lb.—Claricon, Elizabeth, N.J.

Circle 53 on reader service card

METRIC HAND TOOLS, in size ranges from 3 mm to 17 mm. The line includes 18 midget, regular and hollow-shaft fixed-handle nutdrivers particularly useful in the assembly and servicing of European and other foreign-designed equipment. Two compact, pocket-size sets are available: *Set No. 99-PS-41-MM* contains 7 hex socket, interchangeable blades with hex sizes from 1.27 mm to 5 mm, plastic handle and 4" exten-

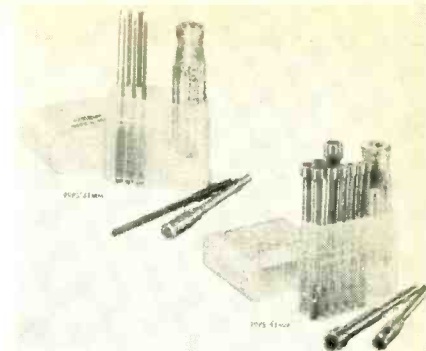

sion. *Set No. 99-PS-51-MM* consists of 10 interchangeable nutdriver shanks with hex openings from 4 mm to 11 mm; handle and 4" extension.—Xcelite Inc., Orchard Park, N. Y.

Circle 54 on reader service card

STEREO BACKGROUND MUSIC SPEAKER Model AP-9C. Flush-mounting ceiling speakers eliminate space and

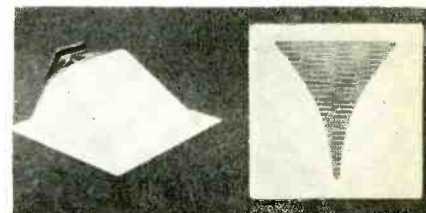

decor problems. Each speaker sends sound forward in a broad pattern providing even tonal quality throughout a

EVERYTHING PRICED RIGHT

Our TREMENDOUS BUYING POWER & PURCHASING EXPERIENCE make is possible. We invest Thousands of Dollars (in just a single item) to create a good DOLLAR BUY, resulting in the AMAZING & EXCITING OFFERS that follow:

FREE \$1 BUY WITH EVERY 10 YOU ORDER Only applies to "S1" Buys **FREE GIFT WITH EVERY ORDER**

- TRANSISTOR RADIO *asst type* \$1.50
good, bad, broken, as-is, potluck
- TAPE RECORDER — assorted types
good, bad, broken, as-is, potluck ... \$4
- 32' — TEST PROD WIRE \$1
deluxe quality, red or black
- HEARING AID AMPLIFIER \$1
Incl. 3 Tubes, Mike, etc. (as is)
- COLOR POWER TRANSFORMER — Good for most sets 201150 List Price—\$36.75 \$6.95
- 10 — STANDARD TRANSISTORS \$1
NPN & PNP 2N404, 2N414, etc.
- 10—ASSORTED DIODE CRYSTALS \$1
1N34, 1N48, 1N60, 1N64, etc.
- 6 — TRANSISTOR RADIO EARPIECES wired complete with plug \$1
- S20—SHURE M-7D DIAMOND NEEDLE exact replacement ... \$3
- \$15.00 TELEVISION PARTS \$1
"JACKPOT" best buy ever
- 10 — SETS PHONO PLUGS & PIN JACKS RCA type ... \$1
- 10 — SURE-GRIP ALLIGATOR CLIPS 2" plated ... \$1
- 50 — ASSORTED PRINTED CIRCUIT SOCKETS best types ... \$1
- 10 SETS — DELUXE PLUGS & JACKS asst. for many purposes ... \$1
- 70—BRASS FAHNESTOCK CLIPS \$1
popular type & size
- 3' JUMPER CABLES Male RCA \$1.19
Type Plug on Both Ends, 2 for

- 300 — ASST. ½ W RESISTORS \$1
Top Brand, Short Leads, Excellent Selection
- 100—ASST ¼ WATT RESISTORS \$1
stand. choice ohmages, some in 5%
- 100—ASST ½ WATT RESISTORS \$1
stand. choice ohmages, some in 5%
- 70 — ASST 1 WATT RESISTORS \$1
stand. choice ohmages, some in 5%
- 35 — ASST 2 WATT RESISTORS \$1
stand. choice ohmages, some in 5%
- 50 — PRECISION RESISTORS \$1
asst. list-price \$50 less 98%
- 20 — ASSORTED WIREWOUND RESISTORS, 5, 10, 20 watt ... \$1
- 4 — TOGGLE SWITCHES \$1
SPST, SPDT, DPST, DPDT
- 10—ASSORTED SLIDE SWITCHES \$1
SPST, SPDT, DPDT, etc.
- TV TUNER — asst. all new standard makes. Less Tubes ... \$1
- TV TUNERS asst. all new standard makes, including Tubes ... \$3
- WESTINGHOUSE STANDARD TUNER #470V120H01 — (6G5 — 6CG8 Tubes) ... \$4
- UHF TUNER — TRANSISTOR TYPE Used in all TV Sets ... \$3.95
- 48 — #3AG FUSES 10 AMP. \$1
popular type

- COLOR-TV RECTIFIER — Used in most color sets—6500 kv 3 for \$1.95
- 2—MOTOROLA HEP-170 RECTIFIER 2½ AMPS and 1000V PIV) Covers all 600MA to 2500MA Units Voltage ranging from 50PIV to 1000 PIV ... \$1
- 50 — ASSORTED TRANSISTORS \$1
big factory scoop—sold as-is
- METER SENTRY—SOLID STATE Protects meter movements up to 25 amps surge ... 99¢
- 15 — ASST. ROTARY SWITCHES \$1
all popular types \$20 value
- 3 — TOP BRAND 35W4 TUBES \$1
- 15 — G.E. #NE-2 TUBES \$1
Neon Glow Lamp for 101 uses
- 150' — BUSS WIRE #20 tinned for hookups, special circuits, etc. \$1
- 8 — ASST. LUCITE CABINETS \$1
hinge cover, handy for parts
- 20—PENLITE BATTERIES 1½v ... \$1
- 15—BATTERIES C-cell similar 935 ... \$1
- 10—BATTERIES D-cell similar 950 ... \$1
- 5—BATTERIES (Transistor) similar 216 ... \$1
- 100 — FINEST NYLON DIAL CORD best size, .028 gauge ... \$1
- 3—ELECTROLYTIC CONDENSERS \$1
C.D. 500 mfd—200 volts
- 3—ELECTROLYTIC CONDENSERS \$1
C.D.—250 mfd—350 Volts

- ### MARKET SCOOP COLUMN
- 12" OXFORD SPEAKER, Top Quality ... Large Magnet ... \$4
 - 10" PHILCO SPEAKER — Top Quality ... Large Magnet ... \$2.69
 - 8" QUAM SPEAKER — Large Magnet — Special Buy ... \$1.94
 - 2½" x 4" SPEAKER — Special Buy ... 69¢
 - 3½" — ROUND SPEAKER — Special Buy ... 59¢
 - 25 — 3900-OHM-7w RESISTOR 10% Corning Glass ... \$1
 - 20 — 47-600V CONDENSERS White Ceramic C.D. American ... \$1
 - SPECIAL TUBE BUY 3CB6, 3DT6, 4CS6, 12AU7, 12BH7, Each ... 49¢
 - 10 — ASST. RADIO & TV TUBES \$1
Every Tube a good number
 - 3—PRINTED CIRCUIT IF TRANSFORMERS 4-Lug, 456 KC ... \$1
 - 5" UNIVERSAL TWEETER \$1.29
1 Oz. Magnet
 - UNIVERSAL 5½" PM SPEAKER \$1
Alnico 3 magnet, quality tone
 - UNIVERSAL 4" PM SPEAKER \$1
Alnico 5 magnet, quality tone
 - 3—ELECTROLYTIC CONDENSERS \$1
G.E.—200/30/4/10mfd—350 volts

IMMEDIATE DELIVERY . . . Scientific light packing for safe delivery at minimum cost. HANDY WAY TO ORDER: Pencil mark or write amounts wanted in each box, place letter F in box for Free \$1 BUY. Enclose with check or money order, add extra for shipping. Fearsheets will be returned as packing slips in your order, plus lists of new offers.

Minimum Order \$3.00

Please specify refund on shipping overpayment desired: CHECK POSTAGE STAMPS MERCHANDISE (our choice) with advantage to customer

BROOKS RADIO & TV CORP., 487 Columbus Ave., New York, N. Y. 10024 212-874 5600 TELEPHONE

room. Can be used with home stereo systems; only one moderately powered stereo amplifier is needed.—Karlon Research and Mfg., W. Hempstead, N.Y.

Circle 55 on reader service card

SOLID STATE VOLT-OHMMETER, Model 116, is 5 1/2" x 6 1/2" x 2 1/2". This volt-ohmmeter achieves low loading (de input is 11 megohms; ac input impedance is 1 megohm) as well as a sensitivity



that is 500 times as great as a standard 20,000-ohms-per-volt volt-ohmmeter. The solid-state circuitry and 4 1/2" 200-MA meter are protected against burn-out. Peak to peak voltage ranges: 0 to

3.3, 33, 330, 1200 volts. Rms ac voltage ranges: 0 to 1.2, 12, 120, 1200 volts. Dc voltage ranges: 0 to 1.2, 12, 120, 1200 volts. Resistance ranges: 0 to 1,000, 0 to 100,000, 0 to 10 meg., 0 to 1000 meg. Kit is \$29.95; wired model \$39.95.—Electronic Measurements Corp., New York, N. Y.

Circle 56 on reader service card

COLOR GENERATOR, Model CG18, is an unusually compact unit providing 10 RCA color bars, full-line crosshatch, dots, and individual vertical and horizontal lines. The timer controls are on the front



panel, and range has been doubled to prevent the timers from jumping time. Special features include: interlace control to stop dot bounce, crystal-controlled 4.5-MHz sound carrier for adjusting fine tuning, and automatic shut-off when lid is closed.—Sencore Inc., Addison, Ill.

Circle 57 on reader service card R-E

WHY PAY MORE?

You can buy for LESS at Edlie's

Be sure to send for our

FREE MONEY SAVING CATALOGUE

HERE ARE JUST A FEW OF OUR SPECIAL

BUYS

CARBON MIKE

Brand new—used for C. B., ship-to-shore, mobile, etc. American Made. push button type uses Western Electric FI Carbon Mike element. PRICE ONLY \$2.95 ea; 6 for \$20.95

TRANSDUCER 200 K. C.

Made by Brush. Brand new. For use with Marine Depth Finder Equipment or experimental purposes. PRICE ONLY \$2.95

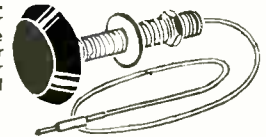

S. C. R. BOARDS

Type A contains the following:

1-12A, 200 P.I.V. S.C.R.; 1-transistor; 4 resistors; 2-diodes. PRICE 99¢ ea; 6 for \$5.00

Type B contains the following:

1-12A, 200 P.I.V. S.C.R.; 3-transistors; 1-100 ohm trimpot; 10-resistors; 2-diodes. Price —\$1.39

Paco ST-26 FM TUNER-AMP. KIT

Comes complete with a 66 page assembly and operating Manual for building this fine kit. Complete with 6 tubes and all major parts. It is complete in every detail except for a few minor parts such as miscellaneous hardware which can be easily obtained. Has output for stereo multiplex adaptor. Price for this FM tuner & amplifier kit only \$14.95 Cabinet not included.

WESTINGHOUSE solid state MULTIPLEX ADAPTERS \$3.95

Terms of sale: Full payment or 20% with order. Minimum order \$2.00

Write for FREE 1969 Catalog.

EDLIE ELECTRONICS INC. Dept. RE-11
2700 Hempstead Tpke., Levittown, N.Y. 11756

Circle 107 on reader service card

CANADIANS: Ordering is easy — we do the paperwork — try a small order

IBM COMPUTER SECTIONS
8 assorted Units we sell for \$1 are loaded with over 150 valuable parts.
Incl. — Transistors, Condensers, Resistors, Heat Sinks, Diodes, Etc.
8 for \$1
100 for \$10

WESTINGHOUSE ALL TRANSISTOR HOME/OFFICE MESSAGE CENTER

Leaves messages for other for replay... Built in speaker/microphone for talk-into convenience... Records up to 3 minutes of messages... Illuminated signal shows when a message is waiting. Control adjusts playback volume without affecting recording volume... Capstan Drive; BRAND NEW \$10
SOLD AS IS

RCA 110° FLYBACK TRANSFORMER



We scooped the Market Latest type — standard for all 110° TVs
RCA's design of large Coil produces 18KV — assuring adequate width
Incl Schematic Diagram, application for any TV
List price \$13.90
Your price .. \$3
10% off in lots of 3

110° TV DEFLECTION YOKE

for all types TV's Incl schematic .. \$3

"COMBINATION SPECIAL" RCA 110° FLYBACK plus 110° DEFLECTION YOKE \$5

90° FLYBACK TRANSFORMER for all type TV's Incl schematic .. \$2

90° TV DEFLECTION YOKE for all type TV's Incl schematic .. \$2

70° FLYBACK TRANSFORMER for all type TV's Incl schematic .. \$2

70° TV DEFLECTION YOKE for all type TV's Incl schematic .. \$2

2 — TV CIRCUIT BREAKERS \$1.19 Rated 4.2 TO 5.0 AMPS, etc. .

70° COLOR YOKE For all Round color CRT's .. \$10.95

90° COLOR YOKE For all Rectangular 19 to 25" Color CRT's .. \$10.95

- 1000 — ASST. HARDWARE KIT screws, nuts, washers, rivets, etc. \$1
- 300 — ASSORTED HEX NUTS 2/56, 4/40, 5/40, 6/32, 8/32 .. \$1
- 250 — ASST. SOLDERING LUGS best types and sizes .. \$1
- 250 — ASST. WOOD SCREWS finest popular selection .. \$1
- 250 — ASST. SELF TAPPING SCREWS #6, #8, etc. .. \$1
- 150 — ASST. 6/32 SCREWS and 150 6/32 HEX NUTS .. \$1
- 150 — ASST. 8/32 SCREWS and 150-8/32 HEX NUTS .. \$1
- 150 — ASST. 2/56 SCREWS and 150-2/56 HEX NUTS .. \$1
- 150 — ASST. 4/40 SCREWS and 150-4/40 HEX NUTS .. \$1
- 150 — ASST. 5/40 SCREWS and 150-5/40 HEX NUTS .. \$1
- 500 — ASSORTED RIVETS most useful selected sizes .. \$1
- 500 — ASSORTED WASHERS most useful selected sizes .. \$1
- 100 — ASST. RUBBER BUMPERS for cabinet bottoms & other uses .. \$1
- 100 — ASSORTED RUBBER GROMMETS best sizes .. \$1

- 2 — G.E. PIECES OF EQUIPMENT stocked with over 200 useful parts \$1
- 50 — ASSORTED MYLAR CONDENSERS popular selected types .. \$1
- 3 — TOP BRAND SILICON RECTIFIERS 1 amp, 1000 PIV .. \$1
- 20 — ASST. PILOT LIGHTS #14, 46, 47, 51, etc. .. \$1
- 50 — ASSORTED #3AG FUSES Popular ampere ratings .. \$1
- 4 — 50' HANKS HOOK-UP WIRE assorted colors .. \$1
- 100' — SPOOL SPEAKER WIRE 2 cond, mini zip, clear, 101 uses .. \$1
- 5 — I.F. COIL TRANSFORMERS 456-kc for Transistor Radios .. \$1
- 5 — AUDIO OUTPUT TRANSFORM Sub-min for Trans Radios .. \$1
- 5 — PNP TRANSISTORS general purpose, TO-5 case .. \$1
- 5 — NPN TRANSISTORS general purpose, TO-5 case .. \$1
- MOTOROLA HEP KIT—INTEGRATED CIRCUITS INCLUDES —One J-K flip flop, One Dual Buffer, One 4-input Gate, Two Dual 2-Input Gates, All Five .. \$3.95
- MOTOROLA EXPERIMENTER KIT HEK-2—9 Projects, instructions enclosed. Includes 2-FET, 2-Transistors, *Tips on using FET's* & Cross-reference Guide. .. \$3.95
- 100' — TV TWIN LEAD-IN WIRE 300 ohm, deluxe heavy duty, clear .. \$2
- UNIVERSAL TV ANTENNA Back of set mounting .. \$1.98
- 5 section rods .. \$1.98

SHANNON MYLAR RECORDING TAPE

2 1/2" — 225' .. \$.17	7" — 2400' .. \$1.79
3" — 225' .. \$.19	7" — 3600' .. \$ 2.95
3" — 300' .. \$.27	CASSETTE 60 minutes .. \$.89
3 1/4" — 600' .. \$.58	CASSETTE 90 minutes .. \$ 1.54
5" — 600' .. \$.62	CASSETTE 120 minutes .. \$ 1.97
5" — 900' .. \$.80	
5" — 1200' .. \$.97	2 1/2" TAPE REEL .. \$.04
5" — 1800' .. \$ 1.49	3" TAPE REEL .. \$.05
7" — 1200' .. \$.77	3 1/4" TAPE REEL .. \$.06
7" — 1800' .. \$ 1.12	5" TAPE REEL .. \$.12
	7" TAPE REEL .. \$.14

- BONANZA "JACKPOT" not gold, not oil, but a wealth of Electronic Items—Money-Back-guarantee .. \$5
- ALL AMERICAN TUBE KIT 12B6, 12BE6, 12AV6, 50C5, 35W4—total list \$9.70 .. \$2
- UNIVERSAL MICROPHONE regular/remote/single & dual plug .. \$2
- CRYSTAL LAPEL MICROPHONE high impedance, 200 6000 cps .. \$5.95
- STEREO HEADPHONES Hi-Fi Quality .. Complete with Stereo plug .. \$5.95
- 50 — TUBE CARTONS (colored) assorted sizes for Popular Tubes .. \$1
- 4 — TV ALIGNMENT TOOLS most useful assortment .. \$1
- 50 — ASST. TERMINAL STRIPS all types, 1-lug to 6-lug .. \$1
- 25 — INSTRUMENT POINTER KNOBS selected popular types .. \$1
- 1 — LB SPOOL ROSIN-CORE SOLDER 40/60 top quality .. \$1
- 7 — TV ELECTROLYTIC CONDENSERS desirable types .. \$1
- 5 — 6' LINE CORDS #18 Stranded Copper Wire .. \$1
- MOTOROLA PWR TRANSFORM 110v, CT 150/150v, 6.3v .. \$1
- 10 — TRANSFORMERS assorted Audio Outputs, Chokes, I. F. 's, etc. .. \$1
- 4 — 36" Hi-Fi CABLES RCA Molded Phone plug at one end stripped and tinned leads on other end .. \$1
- 3 — ELECTROLYTIC CONDENSERS most popular number 50/30—150v .. \$1

Circle 108 on reader service card

FAST

COMPLETE SERVICE ON ALL MAKES OF TV TUNERS

Maximum Time In Shop 24 Hrs.

[90-Day Warranty]

(WE SHIP C.O.D.)
YOU PAY SHIPPING
\$9.95



Black &
White
or Color

VHF or
UHF

UV Combo's \$16.50

Price includes all labor and parts except Tubes, Diodes & Transistors. If combo tuner needs only one unit repaired, disassemble and ship only defective unit. Otherwise there will be a charge for a combo tuner. When sending tuners for repair, remove mounting brackets, knobs, indicator dials, remote fine tuning arrangements and remote control drive units.

All tuners must have remote control units and/or mounting brackets removed before tuner can be cleaned and repaired. Please remove these accessories before shipping as we will not be responsible for loss or damage.



All tuners are serviced by **FACTORY TRAINED TECHNICIANS** with years of experience in this specialized field. All tuners are **ALIGNED TO MANUFACTURER'S SPECIFICATION** on crystal controlled equipment and air checked on monitor before shipping to assure that tuner is operating properly.

GEM CITY TUNER REPAIR SERVICE

Box 6E Dabel Station
2631 Mardon Drive
Dayton, Ohio 45420

Circle 109 on reader service card

Service Clinic

By **JACK DARR**
SERVICE EDITOR

Horizontal phase vs color

Why does the adjustment of the horizontal-hold control affect the color while still holding the picture? I've seen this on a couple of sets.—E. K., Woodland Hills, Calif.

Color burst is taken from a keyed stage, and works exactly like keyed agc and sync separators. Unless the keying pulse from the flyback is exactly in phase with the color

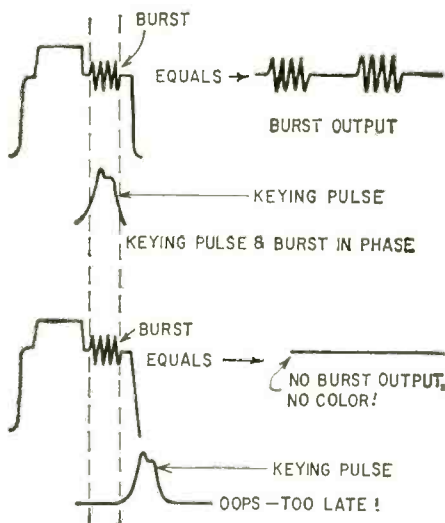

burst, you won't get any burst output, and away goes the color.

The horizontal hold has a far wider "hold range" than does the burst. Burst itself is actually only about 2-3 μsec wide, sitting on the back porch of the horizontal sync, which itself is only 15 μsec . You've got to be right on the nose with your gating pulse, or the burst will find the "gate" slammed shut in its face!

Adding Speakers

I need some information. I want to add a speaker to a transistor amplifier, and the specs call for a 30-32-ohm impedance. Only one speaker like this is listed, and it's a 4-incher. I need a bigger one, preferably 12-15 inches.

What's a safe hookup, using regular speakers?—F. B., Tacoma, Wash.

There are several ways you can do this: four 8-ohm speakers in series, two 16-ohm speakers in series, etc. Anything that will add up to the 32 ohms you need.

If you can't find a big speaker, here's a sneaky way to do it. Use

four 8-inch, 8-ohm speakers in either of these arrangements. The "in-line" layout will give you something like a

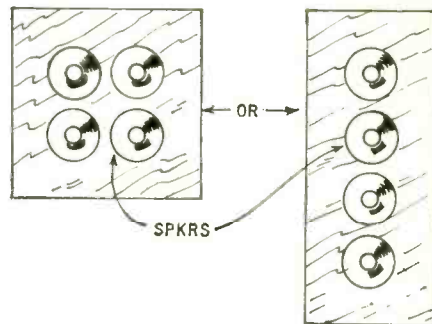

sound column, and the square layout will work almost like one 16-inch speaker. All voice coils must be in phase, of course.

Scope intensity-control burnout

I have an old Knight scope that I've overhauled. It keeps burning out the intensity control! What do you think?—A.B. No. Miami Beach, Fla.

Here's a partial schematic of the voltage-supply network of a Knight 83YU144. Note the high negative voltage applied to the cathode and

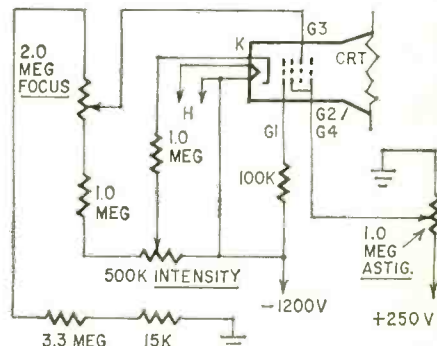

heater, and the positive voltage applied to the screen (G2/G4).

Your intensity control will be in either the cathode—as it is here—or the control grid. In some scopes, there are bypass capacitors around this network; look for one. Otherwise, I'd suspect a heater-cathode short in the tube, or a wiring short if it's an old instrument. Try using a heavier wattage pot, say 2-3 watts for this particular control. **R-E**

This column is for your service problems—TV, radio, audio or general and industrial electronics. We answer all questions individually by mail, free of charge, and the more interesting ones will be printed here.

If you're really stuck, write us. We'll do our best to help you. Don't forget to enclose a stamped, self-addressed envelope. Write: Service Editor, Radio-Electronics, 200 Park Ave. South, New York 10003.

NEW LITERATURE

All booklets, catalogs, charts, data sheets and other literature listed here with a Reader's Service number are free for the asking. Turn to the Reader's Service Card facing page 87 and circle the numbers of the items you want. Then detach and mail the card. No postage required!

AUDIO EQUIPMENTS. mono/stereo, including phonographs in the *AVT Series* and *EDT Series* plus headphones and listening center kits are illustrated in non-technical terms with photos in a 20-page catalog entitled "NEWCOMB". Items featured are useful especially for classroom purposes.—**Newcomb Audio Products Co.**, Sylmar, Calif.

Circle 61 on reader service card

STEREO CARTRIDGE PLAYERS, 8-track, come in 5 models: all with a tape speed of 3¾ ips, frequency response, 40-15,000 Hz and signal-to-noise ratio, 50 dB. Three models feature power outputs of 10 watts and two include two 5¼" high-compliance speakers. Full description and specs of these units are described in *Form CU-2174*, 4 pages.—**Telex Communications Div.**, Minneapolis, Minn.

Circle 62 on reader service card

OUTLET PLATES, UHF/VHF/FM include *Magna-Grip* that holds antenna wire snug under pressure to assure proper lead contact for better signal reception. While wire cannot be pulled from plug, plug can be pulled from wall socket at any angle without damage to the wire or wall plate. Five models in the *Colortap Rotortap Series* are described in Catalog "Get A Grip on A Profitable Market," 4 pages.—**Blonder-Tongue**, Newark, N. J.

Circle 63 on reader service card

U.S. GOV'T ELECTRONIC SURPLUS

Nationally Known-World Famous SURPLUS CENTER offers finest, most expensive, Government Surplus electronic units and components at a fraction of their original acquisition cost.

ORDER DIRECT FROM AD or WRITE FOR CATALOGS

COMPUTER TRANSISTORS ON HEAT SINKS

IBM Computer Quality Units

• (#22-928) -- Unit consists of one 150-watt power transistor on heavy, ribbed, aluminum heat sink. Many experimental uses. (1 lb.)

Cost Gov't Over \$10.00 **\$1.99**

• (#22-915) -- Unit consists of two 150-watt power transistors, 3 pos., several diodes, capacitors, resistors, etc. on heavy, ribbed aluminum heat sinks. Ideal for use as motor speed control. (4 lbs.)

Cost Gov't Over \$35.00 **\$4.91**

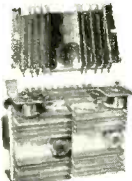

RUNNING TIME METER

• (#DX-104) -- Use to record number of operating hours of electric lights and electrical devices such as refrigerators, furnaces, etc. Records total hours, tenths and hundredths up to 9,999.99 hours. For 115-volt, 60-cycles. Size 4¼" x 3" x 2½". Shipping weight 2 lbs.

\$5.69 Cost Over \$29.00



12 and 24-VOLT TRANSFORMER

• (#15-920) -- General Electric 115-volt, 60-cycle to 12 and 24-volt @ 250-watts. Capacity 42-amps. @ 24-volts, 64-amps. at 12-volts. Useful for battery chargers, running DC motors, etc. 7" x 5" x 3". (18 lbs.)

Cost Gov't Over \$35.00 **\$16.72**



EXPANDED SCALE 0 - 15 DCVM

• (#21-900) -- Brand new, expensive voltmeter reads 0.5 to 15-volts DC and 3 to 8-volts. Very useful for automotive and aircraft battery charge indicator, etc. D'Arsonval movement, black phenolic case. 7" x 5" x 2½". (3 lbs.)

List \$32.50 **\$12.95**



SURPLUS TELETYPEWRITERS

Orig. Cost

Over

\$1500.00

SPECIAL

\$249.50

• (ITEM #22-535) -- Used but excellent teletypewriter, Model 15 complete with A.S., C.O. data-com. Prints using teletypewriter over regular long distance communication. Complete with AC power supply, control telephone, etc. Wt. 140 lbs. Size 22" x 22" x 42".

• Also have limited number Model 19 Teletypewriter with perforator, Data-Com, etc. Write for sale price.



SEND 25¢ COIN OR STAMPS FOR CATALOGS
All Items FOB Money Back Guarantee

SURPLUS CENTER

DEPT. RE 119 LINCOLN, NEBR. 68501

the new SANSUI AU555



The AU555 by Sansui is an outstanding, professional control amplifier. 60 watts (IHF) of music power, bandwidth from 20 to 30,000 Hz and a distortion factor of less than 0.5% assure you of clean sound reproduction. The Sansui AU555 offers almost unlimited versatility with its pre- and main amplifier sections designed for independent usage, 2-adjustable speaker damping factors, 4-position speaker selector switch, 4-outputs and 7-inputs, and much, much more . . . At your franchised Sansui dealer. \$159.95.

Sansui®

SANSUI ELECTRONICS CORP. Woodside, New York, 11377 • Los Angeles, California, 90007
SANSUI Electric Co., Ltd., Tokyo, Japan • European Office Frankfurt a.M., West Germany
Circle 111 on reader service card

MODEL

4000



FIELD EFFECT METER

COMBINES THE FINEST FEATURES OF THE
VTVM & VOLT-OHMS MILLIAMMETER



- .300 V. FULL SCALE DC
- LARGE 6" METER
- AC and BATTERY OPERATED
- HIGH IMPEDANCE (11 MEGS DC)
- 5 DC CURRENT RANGES

Solid State — so there's
NO WARM UP! • NO DRIFT!
• NO INTERNAL HEAT
TO UPSET STABILITY!
• ISOLATION FROM
AC LINE!

ONLY
79⁹⁵
WIRED

Includes: AC-OHMS/DC Probe
Power Requirements: 115 V 50/60 Hz, 3W
7½ x 6½ x 4 — 3 lbs.

All Mercury Test Equipment Guaranteed For One Full Year!
Write for complete catalog of Mercury Test and Repair
instruments, and name of your nearest dealer.

MERCURY ELECTRONICS CORPORATION
315 Roslyn Road • Mineola, N.Y. 11501 • (516) 742-5400
CANADA: William Cohen Corp. • 8900 Park Avenue • Montreal-11

Circle 112 on reader service card

NOVEMBER 1969

91

UNEXCELLED! THE UVM ANTENNA

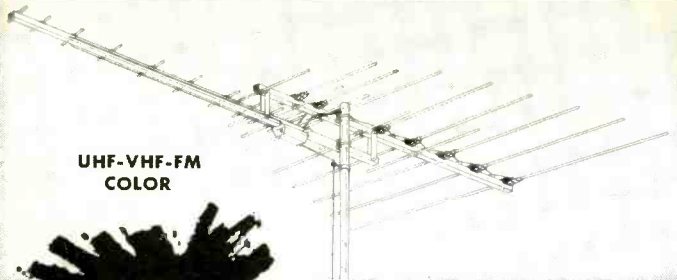

UHF-VHF-FM
COLOR

**COMPLETELY
NEW!**

Combination
UHF-VHF-FM Antennas

for superior performance.

Tuned and engineered featuring a LOG PERIODIC VHF section incorporating a PATENTED MAGNETIC WAVE design for UHF. Discriminate between desired signal and unwanted noise. An absence of minor lobes and extremely high front to back ratio are characteristics of these antennas. Mechanical features include all new fittings and special alloy aluminum tubing for added strength. Six models available.

Write or phone for complete information.

S & A ELECTRONICS, INC.

210 W. Florence St. Phone (419) 693-0528 Toledo, Ohio 43605

Circle 113 on reader service card

NEW COAX MATCHING TRANSFORMER

For UHF/VHF
Color/B&W TV

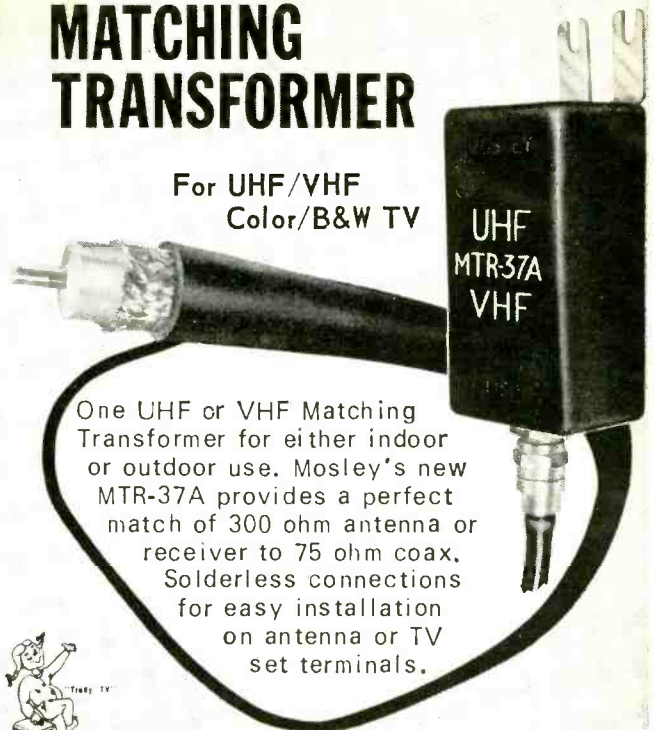

One UHF or VHF Matching Transformer for either indoor or outdoor use. Mosley's new MTR-37A provides a perfect match of 300 ohm antenna or receiver to 75 ohm coax. Solderless connections for easy installation on antenna or TV set terminals.



Write Dept. 160A for FREE detailed brochure.

Mosley Electronics Inc. 4610 N. Lindbergh Blvd.,
Bridgeton Missouri 63042

Circle 114 on reader service card

It's yours free

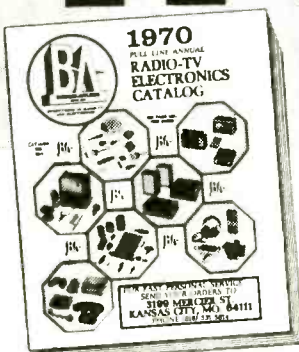

for the
asking!

**GIANT 274 PAGE
1970
RADIO-TV
ELECTRONICS
CATALOG**

YOUR BUYING GUIDE FOR . . .

TV's, Radios, Recorders, Phonos, Amateur and CB equipment, electronic parts, tubes and test equipment . . . featuring B-A's famous big bargain packed section!

Write to:

**BURSTEIN-APPLEBEE CO.,
DEPT. RE-K 3199 MERCIER ST.,
KANSAS CITY, MO. 64111**

Name _____

Address _____

City _____

State _____

Zip Code _____



Accuracy like a VTVM... Convenience like a VOM...

NEW BATTERY-OPERATED FET
SOLID-STATE VOLT-OHMMETER #116

Easy-to-build KIT

\$29⁹⁵ #116K

Factory-Wired & Tested

\$39⁹⁵ #116W

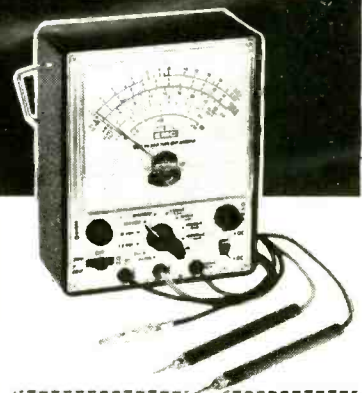

Now you can get all the benefits of a VTVM (laboratory accuracy, stability and wide range) but with its drawbacks gone: no plugging into an AC outlet, no waiting for warm-up, no bulkiness. New Field Effect Transistor (FET) design makes possible low loading, instant-on battery operation and small size. Excellent for both bench and field work.

Compare these valuable features:

- High impedance low loading: 11 meg-ohms input on DC, 1 megohm on AC
- 500-times more sensitive than a standard 20,000 ohms-per-volt VOM
- Wide-range versatility: 4 P-P AC voltage ranges: 0-3.3, 33, 330, 1200V; 4 RMS AC voltage ranges: 0-1.2, 12, 120, 1200V; 4 DC voltage ranges: 0-1.2, 12, 120, 1200V; 4 Resistance ranges: 0-1K, 0-100K, 0-10 meg., 0-1000 meg.; 4DB ranges: -24 to +56DB.

Sensitive easy-to-read 4 1/2" 200 micro-amp meter. Zero center position available. Comprises FET transistor, 4 silicon transistors, 2 diodes. Meter and transistors protected against burnout. Etched panel for durability. High-impact bakelite case with handle useable as instrument stand. Kit has simplified step-by-step assembly instructions. Both kit and factory-wired versions shipped complete with batteries and test leads. 5 1/4" H x 6 3/4" W x 2 7/8" D. 3 lbs.

Send FREE catalog of complete EMC line and name of nearest distributor. RE-11

Name _____

Address _____

City _____

State _____

Zip _____

EMC

ELECTRONIC MEASUREMENTS CORP.
625 Broadway, New York, N.Y. 10012
Export: Pan-Mat Corp. 1270 B way N. Y. N.Y. 10001

COMING

NEXT

MONTH

DECEMBER 1969

■ Automatic Antenna Rotators

The new breed uses solid-state electronics to make them do a better job. See how they work.

■ Transistor Curve Tracer

Want to know the characteristics of that unknown bargain-basement semiconductor? Use this instrument with your scope to find out. Build it with ICs.

■ Programmed Course

Automatic-fine-tuning is here today in many of the new color sets. Here's a painless way to see how it works and how to keep it working.

■ Fuzz Box

Another add-on for your guitar amplifier. Use it to add another dimension to your electric music.

Who needs a tuner wash? Save your money and use
QUIETROLE

The product that cleans while it lubricates. Zero effect on capacity and resistance. Harmless to plastics and metals. Keeps color and black and white on the beam.

Non-flammable.



manufactured by
QUIETROLE CO.
Spartanburg, South Carolina

Circle 117 on reader service card

ARTISAN ALL TRANSISTOR ORGANS



CLASSICAL and THEATER styling for all CHURCH-HOME-PROFESSIONAL applications.

ARTISAN tonal concepts, consoles and related mechanics are completely "TRADITIONAL" in design.

Individually keyed oscillators and independent sets of tone generators with separate amplifiers and speakers assure the finest sound.

Distinctive voiced solo stops that blend in grand ensemble. Assemble your own organ and save 40% — 2 models in KIT or assembled form. In addition, we custom build to your specifications.

Tuner your own sound with PLUG-IN adjustable voices, variable VIBRATOS and TREMOLOS, sustain, reverberation and REAL PERCUSSIONS.

For descriptive literature and address of your nearest dealer:



Write
ARTISAN ORGANS
1372 E. Walnut Street
Pasadena, California 91106
213 449-0814

Circle 118 on reader service card

MODEL
1101C



NEW GRID-CIRCUIT ANALYZER TUBE TESTER

QUICKLY PINPOINTS BAD, WEAK AND GASSY TUBES

Built-in vacuum tube voltmeter circuit cuts through wasted motions to two un-failing tests; cathode emission and gas, grid emission and grid leakage — to pinpoint trouble sources. Reveals gas content as low as 0.5 sources.



ONLY
49⁹⁵ KIT
\$69.95 WIRED

Self-contained in handsome luggage type scuff-proof carrying case.

• Latest phosphor-bronze contact type sockets • All sockets identified • All up-to-date pin straighteners • Wide angle rugged meter with special Gas/Grid Leakage Arc • Heavy Gauge 2-color anodized aluminum panel • Grid Leakage and Gas Test • 12 button, 3 position Switching System reduces the obsolescence problem to the vanishing point!

TUBE DATA is not only up-to-date, but is kept up-to-date on a year in year out basis! Data for over 3000 tubes is constantly reviewed and enlarged year after year!

All Mercury Test Equipment Guaranteed For One Full Year!

MERCURY ELECTRONICS CORPORATION

315 Roslyn Road • Mineola, N.Y. 11501 • (516) 742-5400
CANADA: William Cohen Corp. • 8900 Park Avenue • Montreal-11

Circle 119 on reader service card

TECHNOTES

G-E KE COLOR TV CHASSIS

Whenever power supply diodes CR109 or CR110 fail, shunt a 0.001- μ F, 1-kV capacitor (G-E part ET-22X58) across each diode. The capacitors provide added protection against possible damage by voltage surges.—*G-E Service Talk*

GENERAL ELECTRIC KC-KD CHASSIS

Raster shading where the right half of the raster appears substantially

darker than the left may be observed during periods of no video modulation (camera changes, etc.). This shading may be accompanied by a retrace "snake." In either case make the following changes.

1. Change diode CR102 to a G-E type ET57X40. Move the anode (ground) end of CR102 to the positive terminal of C132-B (the unencoded lug of electrolytic C132).

2. Disconnect the end of R153 from the junction of C136 and C138

and connect it to lug 8 of jack J101. If vertical retrace lines appear,

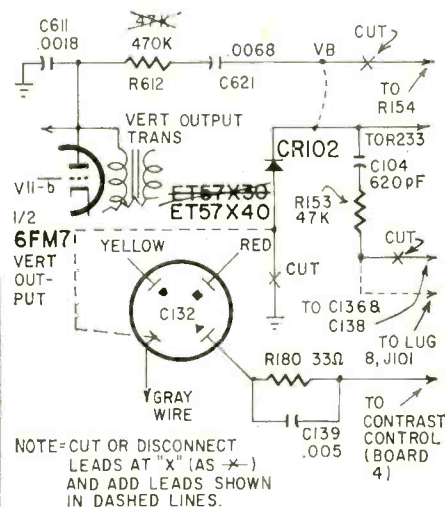

make the following changes.

1. Change R612 from 47,000 to 470,000 ohms, 1/2 watt. Disconnect the wire going from circuit-board terminal VB (or C612) to R154. (R154 is now excess and may be removed.)

2. Reconnect wire from VB to the cathode end of CR102.—*G-E Techni-talk*

R-E

easy answers to common color complaints

Perma-Power puts back Color TV Quality!



Puts back brightness

Color-Brite Picture Tube Briteners

Color-Brite brings out lost sharpness and details of fading color picture tubes. Provides increased filament voltage to boost electron emission, returns full contrast and color quality.

MODEL C-501 for round tubes
Dealer Net.....\$5.85

MODEL C-511 for rectangular tubes
Dealer Net.....\$5.85



Puts back black-and-white

Color-Brite Isolation Briteners

No Boost. Corrects for cathode-to-filament short causing loss of black and white video drive. Isolates the short, restores the black and white information that gives the color picture its quality.

MODEL C-502 for round tubes
Dealer Net.....\$7.25

MODEL C-512 for rectangular tubes
Dealer Net.....\$7.25



Puts back full voltage

Automatic Voltage Regulator

Automatically boosts voltage 10 volts when line voltage drops below 110 volts. Eliminates shrinking, loss of brightness, loss of convergence. Combats poor line voltage regulation, overloaded circuits.

MODEL D-210 for appliances rated up to 400 watts
Dealer Net.....\$14.95

Put Back Profit—Use Perma-Power Briteners

Free technical literature on request

Perma-Power COMPANY

Division of Chamberlain Manufacturing Corp.
5740 North Tripp Ave. Chicago, Ill. 60646
Phone: (312) 539-7171

Circle 120 on reader service card

SOLVE YOUR TV REPAIR PROBLEMS WITH TV TECH AID

A monthly TV publication of actual repairs, and troubles encountered in **OUR** business. The information will be gathered from technicians, field reps, and all the leading manufacturers.

TV TECH AID will present up to 40 different trouble shooting cases each month. Each manufacturer will have its own page. Each symptom will have a clearly marked schematic of the particular faulty stage. The faulty components, and corrections will be listed to aid in repair. No guess work.

It will contain current models, older models, circuit changes and modifications on various models as they occur.

The days of "Trial and Substitution" are over.

Time means money. Don't forfeit those valuable profits.

ONE repair is worth more than four times the investment.

Each monthly issue will contain a series of timely sheets and the cost to you is only \$7.95 for a full years subscription.

TV TECH AID
P.O. BOX 603
KINGS PARK, L. I.
NEW YORK 11754
ENCLOSED IS A CHECK OR M.O. FOR \$7.95 PLEASE SEND 12 ISSUES OF TV TECH AID
TO:
NAME _____
ADDRESS _____
CITY _____
STATE _____ ZIP _____

Circle 121 on reader service card

RADIO-ELECTRONICS

NEW BOOKS

RCA TRANSISTOR, THYRISTOR, & DIODE MANUAL, SC-14 Commercial Engineering, RCA Electronic Components, Harrison, N.J. 07029. 8 x 5 1/4 inches, 656 pp. Soft cover, \$2.50.

A useful volume for anyone working with semiconductors. Some 200 pages of text explain solid-state fundamentals clearly and in detail; chapters cover numerous device applications—TV, linear systems, power, switching and more. The technical data section provides detailed data and design curves for some 900 devices. Circuits section presents circuits and parts list for 38 solid-state devices—from code oscillator to FM stereo multiplex decoder.

FEEDBACK AMPLIFIERS AND OSCILLATORS, by Robert E. Senti and Robert A. Bartowiak. Holt, Rinehart and Winston, Inc., 383 Madison Ave., New York, N. Y., 10017. 6 x 9 in., 218 pages, soft cover, \$3.95.

This is another in the Electronics Technology Series slanted toward technical institutes and junior colleges. Requires a good grounding in electronic fundamentals and math. The various types of feedback and factors influencing feedback are described in the first three chapters. Other chapters analyze most types of oscillators, including crystal, negative-resistance, RC, LC and uhf and microwave oscillators. **R-E**

The brand for all reasons



BSR McDonald 600

Every BSR McDonald automatic turntable is precision made in Great Britain to the most exacting specifications. Upon their arrival in the U.S., every model is unpacked and re-tested under actual playing conditions. That's why BSR service calls are the lowest in the industry—and perhaps that also explains why BSR sells more turntables than anyone else in the world.



McDONALD

P
BSR (USA) LTD.
BLAUVELT, N.Y. 10913

Please send FREE detailed literature on all BSR McDonald automatic turntables.

Name _____

Address _____

City _____

State _____

Zip _____

Circle 123 on reader service card

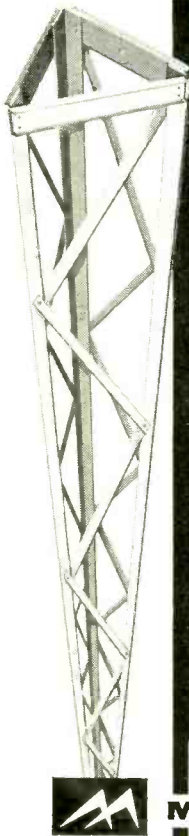

AL SERIES ALUMINUM TOWERS for uhf - vhf

Ideal for mounting industrial, commercial, citizens band, amateur, or television receiving antennas. Exceptional strength in proportion to weight qualities. Easy access to equipment mounted on the Microflect top mast extension. Other features are:

- 10 to 120 feet high in easy to erect 10 foot sections.
- Available factory assembled or in kit form.
- Lightweight, all aluminum, 10 foot sections weigh only 12 1/2 lbs.
- Low maintenance, will never rust or require painting.
- Staggered ladder treads for easy climbing.
- Can be used for direct radiator at HF.
- Wide variety of mounting brackets and accessories available.

DISTRIBUTOR INQUIRIES INVITED

MICROFLECT

3575 25TH STREET
SALEM, OREGON 97302
AC 503-363-9267 TWX 510-599-0107

Circle 122 on reader service card

NOVEMBER 1969

MODEL 3000



NEW VECTORSCOPE 5" OSCILLOSCOPE

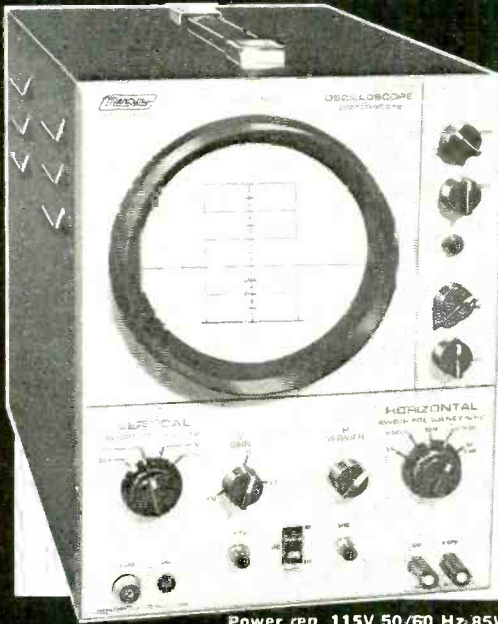

5 MHz HIGH SENSITIVITY WIDE BAND SCOPE PLUS Input-Compensated VECTORSCOPE

- Direct reading Graticule, instantly removable (2 supplied) plus special V input circuit
- Peak-to-Peak readings as easy as reading VOM or VTVM
- Vertical amplifier, 4.6 Mv RMS/Cm usable to 10 MHz for truly high sensitivity . . . 10 Hz to 5 MHz \pm 3Db . . . 0.08 Microsecond rise time

JUST **109⁹⁵** KIT

179.95 WIRED, probes optional.

Power req. 115V 50/60 Hz 85W. 11 x 9 x 16, 22 lbs.

- Horizontal amplifier, 5 Hz to 500 KHz
- Internal, external and line synch.

All Mercury Test Equipment Guaranteed For One Full Year!

The Model 3000 is perfect for general purpose waveform observation applications, meeting all the requirements of technical schools, industry, electronic experimenters and development engineers.

Write for complete catalog of Mercury Test and Repair Equipment, and name of your nearest dealer.

MERCURY ELECTRONICS CORPORATION
315 Roslyn Road • Mineola, N.Y. 11501 • (516) 742-5400
CANADA: William Cohen Corp. • 8900 Park Ave. • Montreal-11

This BOOK is a 'must'! "Servicing Color TV With The Vectorscope" \$2.95



Circle 124 on reader service card

INTRODUCE

YOURSELF

to a line of products new in the U.S.
from a new supplier

AUDIONICS, INC. Presents SINCLAIR

SINCLAIR is England's leading manufacturer of budget audio and experimenter devices. Audionics Inc is quite pleased to be the US distributor for Sinclair Ltd.

IC-10. The Sinclair IC-10 is a monolithic integrated circuit high fidelity amp and pre-amp. It has a peak power output of 10 watts. As an audio amplifier, the IC-10 requires only the addition of volume and tone controls with related circuitry. No other transistors are required to complete the operating requirements of the IC-10. The IC-10 may also be used as a servo amplifier as it is d.c. coupled in both sections. Each IC-10 is fully tested and is supplied with complete instructions including a 32 page applications manual. The frequency response of the IC-10 is flat within one decibel from 5hz to 100kHz. With a power gain of 110 db, an output of 5 watts rms and a distortion figure of only one percent, the IC-10 offers exceptional performance. \$12.00 postage paid.

The PZ4 Stabilized power supply is designed for use with the IC-10 or the Z-12 amplifier. The PZ4 comes preset for 18 VDC but is adjustable from 0 to 30 VDC. The PZ4 may be used with either 110 or 220 VAC. Ripple is less than 20 mv at any output up to 1.5 amps. Regulation is within 3%. The PZ4 is fully transistorized for stability and is an outstanding value at \$13.95 postage paid.

The Z-12 Integrated amplifier is a high fidelity unit measuring only 3" x 1-3/4" x 1-1/4". The Z-12 will operate satisfactorily from 6 to 20 VDC. It may be used in numerous home and commercial applications due to its wide range and low distortion combined with an unusual amount of output. The Z-12's frequency response within one decibel ranges from 15hz to 50kHz. The Z-12's power response is within two decibels from 50hz to over 20kHz with less than one per cent distortion. The Z-12 is direct coupled and is suitable for use with speaker systems ranging from 1.5 ohms to 16 ohms. Measured at 3 ohms with a 20 volt supply the Z-12 will produce 13 watts of power, rms. This figure nearly doubles when used with a 1.5 ohm load. The Z-12 weighs 3 oz. and comes fully assembled and tested. \$13.95 postage paid.

The Stereo 25 pre-amplifier and control unit is designed to be used with a pair of Z-12's and the PZ4 supply. It may be used, however, with any high quality basic amplifier. Controls are provided for bass and treble boost and cut, stereo balance, volume and input switching. A tape output is provided. Frequency response is flat within one decibel from 25hz to 30kHz and down only three decibels at 100 kHz. RIAA equalization is correct within one decibel. The unit is finished in brushed aluminum with black trim and solid aluminum knobs. Tested and shipped postage paid \$28.95

The complete system consisting of the Stereo 25, two Z-12's, and a PZ-4 may be purchased for \$59.95.

Quantity users are advised to write Audionics Inc. for pricing.

Send today for a descriptive brochure giving complete specifications of the entire group of Sinclair products including stereo tuners, amplifiers, and speakers.

Dealer inquiries invited.

WRITE TODAY
FOR FREE DETAILS
OF THE ENTIRE
SINCLAIR-AUDIONICS
LINE.

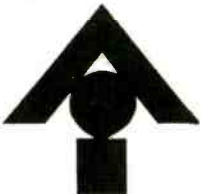

AUDIONICS, INC.
9701 S.E. Mill, Portland, Oregon 97216

NAME _____
ADDRESS _____
CITY _____
STATE _____ ZIP _____

Circle 125 on reader service card

TRY THIS ONE

COILED-CORD TEST LEADS

Delicate test instruments may suffer severe damage when their lengthy leads snag on tools or equip-

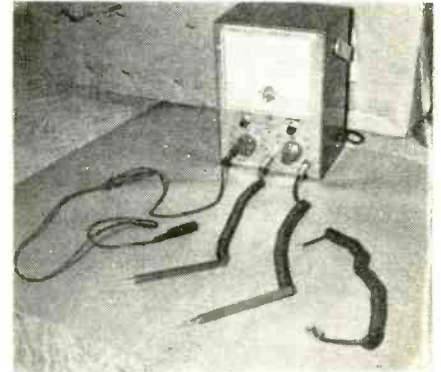

ment on test benches and land on the floor.

A partial cure for this hazard is to replace the regular-length test leads

SAVE ON EVERYTHING IN ELECTRONICS!

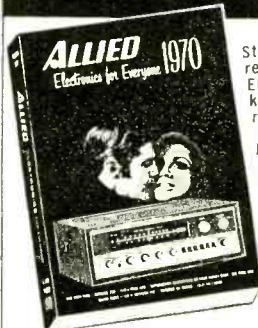

Stereo hi-fi • Tape recorders & tape • Electronic & hobby kits • CB 2-way radios • Radios • Shortwave • Phonographs • Amateur gear • Automotive electronics • Tools & hardware • Tubes, transistors, parts, batteries, books and more! . . .

FREE 552-PAGE ALLIED 1970 CATALOG

Right off the press and crammed with values—our biggest catalog ever! Huge selections, low prices, fast service. Mail coupon below for your free copy. Hurry, while they last!

ALLIED RADIO, Dept. 538 Please
P.O. Box 4398, Chicago, Ill. 60680 Print

NAME First Middle Last _____
STREET ADDRESS or ROUTE & BOX NO. _____
CITY _____
STATE _____ ZIP _____

Circle 126 on reader service card

RADIO-ELECTRONICS

Enjoy Relaxing Background Music at Home with NO COMB



with the much shorter, coiled leads used on camera flash units. The coiled leads stretch out to where they're wanted, then retract out of harm's way. Should they lose their spring, re-winding the coiled turns in the opposite direction restores their springiness.—Harry J. Miller

STOWING LINE CORDS

Are you at a loss as to what to do with a dangling power cord when storing or moving a piece of test equipment? A simple remedy is to install a cabinet drawer handle on the rear panel of the test equipment. The

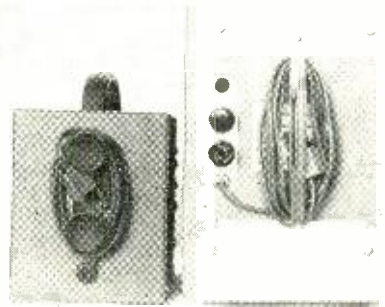

power cord is then neatly wrapped out of the way around the handle. The drawer handles, which can be purchased at any hardware store, come in various shapes, sizes, and colors. The photo shows two types of handles that are easy to use.—Harry Gondo

NEW LIFE FOR OLD PHONO IDLER

When the life goes out of a rubber idler wheel in a phonograph, and the drive surface becomes glazed and slips, clean the drive surface with a service cleaner, then give it a couple of coats of rubber paint—the kind used for refinishing the surface of rubber mats, tires, etc. When this is dry, it will give the idler sufficient "tack" to drive the turntable without slipping, while a new idler is on order. It isn't recommended as a more permanent cure since, when life goes out of the idler's rubber, it loses resilience, and consequently, tends to transmit more and more motor noise to the turntable.—Frank H. Tooker R-E

TRY THIS ONE'S WANTED

Have you developed a new tool, a new use for an old tool, or a new or simpler way of doing a job around your shop or service bench? Your fellow readers can profit from your experience. We need good how-to-do-it hints for our Try This One column. Line drawings and photos make your item worth more.

There's no substitute for SUCCESS...



JAMES WONG—Research Engineer Heald Engineering College Graduate

or IN-CLASS INSTRUCTION!

In electronics, it's the training that makes the difference. Employers require well-trained men and the first thing checked is where you gained your knowledge.

HEALD GRADUATES have many job offers with starting salaries often in excess of \$10,000 per year. AND advancement is rapid.

GET STARTED NOW. Be a DRAFTSMAN—12 months
TECHNICIAN—15 months
ENGINEER (B.S. Deg.)—36 months
ARCHITECT (B.S. Deg.)—42 months
YOU are eligible for HEALD ENGINEERING COLLEGE if you have a high school education or the equivalent.

Increased income starts with success—success starts with your move to Heald. Send now for FREE brochures with more information on Heald in San Francisco and your future in Engineering.

FREE LIFETIME PLACEMENT SERVICE
VETERAN APPROVED



WRITE TODAY FOR DETAILS

HEALD Engineering College

1215 Van Ness Ave., San Francisco, California 94109

Please send me information about:

- ARCHITECTURE
 - ENGINEERING: Civil Electrical Electronic Mechanical
 - TECHNOLOGY: Electronic Engineering Technician (FCC) Radio-Television Technician (FCC)
 - DRAFTING: Mechanical Electrical Structural
- I am interested in Day Evening courses
Also send an application.

NAME _____ AGE _____
ADDRESS _____
CITY _____
STATE _____
ZIP _____ PHONE _____

Circle 129 on reader service card

...makes possible reception of local programming, transmitted by 400 FM stations around the country. YOUR FM tuner or receiver can recover this "hidden" music with the simple addition of an SCA-1. Hook-up in minutes—full instructions supplied. SCA-1 is self powered . . . uses all solid-state circuitry (FET'S, IC's, NPN's). Works with any quality FM Tuner or receiver.

Send check or m.o. for either . . .
SCA-1 (Wired, ready to use) \$64.50
SCA-1K (Kit, all needed parts) \$49.95
Etched, drilled P.C. Board plus special IC plus full construction plans \$12.50

One year parts guarantee
Free national SCA station list supplied with every order.

SOLD FOR HOME USE ONLY

SCA Services Co., Inc.

Box 601 Port Washington, N.Y. 11050

Circle 127 on reader service card



AMAZING OFFER

RADIO & TV SERVICE DATA

Your best, complete source for all needed RADIO and TV diagrams and helpful servicing data. Most amazing values. Only \$2.50, \$3, \$4, per giant volume. Cover all important makes, models of all periods. Use this entire ad as your no-risk order form.

NO-RISK ORDER COUPON

TELEVISION SERVICE MANUALS

Supreme TV manuals are best for faster, easier TV repairs. Lowest priced. Factory data on practically all sets. Complete circuits, all needed alignments facts, wiring board views, waveforms, voltages, production changes, and double-page schematics. Only \$3 and \$4 per large annual manual. Check volumes wanted, send entire advertisement as your order form.

- New 1969 COLOR TELEVISION Manual, only \$4.
- 1969 TV, \$4. 1968 TV, \$4. 1967 TV, \$4.
- 1966 TV, \$3. Additional 1965 TV, \$3.
- 1965 TV, \$3. 1964 TV, \$3. 1963 TV, \$3.
- Additional 1962 TV, \$3. 1962 TV, \$3.
- 1961 TV Manual, \$3. Early 1962 TV, \$3.
- Additional 1959 TV, \$3. Early 1959 TV, \$3.
- 1958 TV Manual, \$3. Additional 1957 TV, \$3.
- 1955 TV, \$3. 1954 TV, \$3. 1951 TV, \$3.
- Master Index to all TV & Radio Manuals, 25¢

RADIO DIAGRAM MANUALS

Here are low-priced radio manuals that simplify repairing. Cover everything you may need from recent radios to pre-war old-timers; all type radios, stereo, combinations, transistor portables, FM-AM, and auto sets. Large schematics, all needed alignment facts, printed boards, voltage data, dial stringing, hints. Volumes are big, 8 x 11", about 190 pages, each

\$2.50

- 1966, 1965, 1964, 1963, 1962, 1961, 1960, 1959, 1958, 1956, 1955, 1954, 1953, 1952, 1951, 1950, 1948, 1946, 1942, 1941, 1940, 1926-38, EACH, \$2.50

SUPREME PUBLICATIONS

1760 Balsam Road, Highland Park, ILL., 60035

Rush today TV and Radio manuals checked in no-risk order form of this ad. Send postpaid. I am enclosing full price. You guarantee my complete satisfaction or my money back.

Name: _____
Address: _____
City: _____ State: _____

Circle 128 on reader service card

MARKET CENTER

ELECTRONICS

SPECIAL CLEARANCE SALE: Rectifiers, transistors, and many other electronic parts. Lowest prices! Free catalog. **GENERAL SALES COMPANY**, 254 Main, Clute, Texas 77531

SELL DIGITAL VOLTMETER: Nixie readout, like new, sacrifice. Send for data, **J. RIDER**, Box 301, Prospect Heights, Illinois 60070

Ultra-sensitive and powerful **METAL DETECTORS** join the many who are finding buried coins, minerals, relics and artifacts. Don't buy till you see our free catalog of new models. Write **JETCO**—Box 132-RE, Huntsville, Texas 77340

RADIO & TV TUBES 33¢ each. One year guaranteed. Plus many unusual electronic bargains. Free catalog. **CORNELL 4217-E University**, San Diego, California 92105

COLOR ORGAN KIT \$7.50. Power Supplies \$3.98. Catalog. **MURPHY**, 204 Roslyn Ave., New York, 11514.

MR. SCA OPERATOR

NEED A RELIABLE SOURCE FOR HIGH QUALITY, LOW COST SCA RECEIVERS, OR SCA DEMODULATOR UNITS?

A new and proven sub-carrier demodulation scheme using old established principles is now practical due to recent component developments and mass production. The resultant reduction in cost is passed on to you.

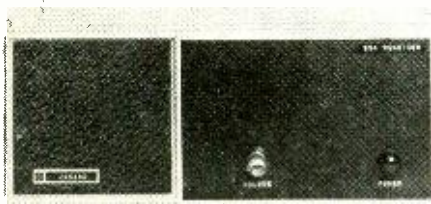

MODEL SCA-6137 SINGLE FREQUENCY FM RECEIVER. Size: 12" x 5½" x 1½". Price: \$69.95 (Quantity 1-9)

SCA-6137 FM Receiver Features:

- Range: 88 to 108 MHz • Frequency Field Adjustable • All Solid State Devices • RF Stage • 3 IF Stages • Automatic Frequency Control • Two 67 KHz Amplifier Stages • 67 KHz Ratio Detector • Adjustable Muting • Main/Sub-Carrier Switch • One Watt Audio Output • 1" Monitor Speaker • Provision for External Speaker • 117 Volt AC Operated.

Also available: SCA-3 sub-carrier demodulator PC Card with muting control. Size: 2½" x 3" x ¼". Operates on 6 to 12 Volts DC at 6 ma. Available from stock. Price: \$39.95 (Quantity 1-9)

Quantity discounts and detailed specifications are available to SCA operators.

Send orders and inquiries to:

**JanZac Company; P.O. Box 177;
Stamford Conn. 06904**

**KenZac Company; P.O. Box 66251;
Houston, Texas 77006**

OSCILLOSCOPE IMPROVEMENT KITS. High speed Triggersweep eliminates sync problems. Dual trace FET switch displays two wave-forms together. **SOLID-STATE SERVICES**, P.O. Box 901, Cupertino, California 95014.

INTEGRATED CIRCUIT KITS: computer, audio, others. New catalog free. **KAY ENGINEERING**, Box 3932-D, Long Beach, California 90803.

SCHEMATICS, DIAGRAMS, old radios, TVs, \$1.50. **GORDIES TV**, Hustisford, Wis. 53034

COLOR T.V. IS TERRIFIC with TERADO VOLTAGE ADJUSTERS ACCURATE A.C. VOLTMETER
CORRECTS HIGH OR LOW VOLTAGE TO NORMAL CAP. 300 to 500 watts

SATURN (shown) Model no. 50-172 List \$26.95
POLARIS (w o meter) Model no. 50-204 List \$16.50

FULL DEALER DISCOUNTS
See your Electronics Parts Jobber, or write

terado CORPORATION
1053 Raymond Ave., St. Paul, Minn. 55108

LATEST ARCTURUS SPECIALS

- Color focus rectifiers, 14,000 P.I.V. at 1 MA, 99¢ each. 6.5 KV—79¢

- Color TV yokes 70° & 90° types. Fit almost all sets \$10.95.

- 1700 Transistor types—39¢

- DS-501, 2N278 power transistor types. Cat. #349, 69¢

- HEP170, Motorola HV/Current epoxy silicon rectifiers, 2.5 amps at 1,000 PIV, 49¢

- Fully transistorized UHF tuners. Fit most sets. Cat. #UHF567, \$4.95 each.

- UHF tuners, 1 tube type. Fit most sets. Cat. #UHF3, \$3.95 each.

Complete listings of electronic items at similar bargain prices are available. Write for our latest catalog. Minimum order \$5.00, plus postage.

ARCTURUS ELECTRONICS CORP.

502-22nd St., Union City, N.J. 07087

Dept. MRE

Phone: 201-864-5568

Circle 136 on reader service card

RADIO-ELECTRONICS
responsibility for
appear in the index

READER SERVICE CARD NO.

126	Allied Radio Corp.	13
41	Arrow Fastener Co., Inc.	13
118	Artisan Organ	13
106	Artronix	13
125	Audionics, Inc.	13
34	B & K (Division of Dynascan Corp.)	13
108	Brooks Radio and TV Corp.	13
123	BSR USA Ltd.	13
115	Burstein-Applebee Co.	13
18	Castle TV Tuner Service, Inc.	13
16	Channel Master	13
30	Cleveland Institute of Electronics	53-57
35	Concord Electronics Corp.	79
149	Cornell-Dubilier	Cover III
	CREL Home Study Division of McGraw-Hill Book Co.	64-67
14	Delta Products, Inc.	13
107	Edlie Electronics, Inc.	89
40	Electronic Chemical Corp.	84
8	EICO Electronic Instrument Co., Inc.	Cover II
	EMC Electronic Measurement Corp.	92
38	GC Electronics	82-83
109	Gem City Tuner	90
	Grantham School of Electronics	27
129	Heald Engineering College	99
33	Heath Co.	74-77
10	International Correspondence Schools	5
148	International Crystal Mfg. Co.	104
13	Intratec	12
11	JFD Electronics Corp.	7
	Lafayette Radio Electronics	95-96
23	Leader Test Instruments	24
112	Mercury Electronics Corp.	91
119	Mercury Electronics Corp.	93
124	Mercury Electronics Corp.	97
122	Microlect, Inc.	97
114	Mosley Electronics, Inc.	92
	National Radio Institute	8-11
	National Technical Schools	18-21
39	Olson Electronics, Inc.	84
120	Perma-Power	94
29	Pioneer Electronics	32
15	Quam-Nichols Co.	14
117	Quietrol Co.	93
9	Radar Devices	1
	RCA Institutes	28-31
	RCA Electronic Components	
37	Semiconductors	81
	Tubes	Cover IV
22	RCA Test Equipment	23
20	Rye Industries, Inc.	22
113	S & A Electronics	92
31	Sams and Co., Inc., Howard W.	59
111	Sansui Electronics Corp.	91
127	SCA Services Corp.	99
24	Schober Organ	24
100	Scott, Inc., H. H.	22
17	Sencore	16
26	Shure Bros.	26
128	Supreme Publications	99
	Surplus Center	91
25	Sylvania (Subsidiary of General Telephone & Electronics)	25
121	TV Tech Aids	94
36	Wen Products, Inc.	80
	MARKET CENTER	100-103
	Aleo Electronic Products, Inc.	
136	Arcturus Electronics Corp.	
	Bele Electronics	
138	Edmund Scientific Co.	
	Fair Radio Sales	
	Kenzac Co.	
	McGee Radio Co.	
140	Park Electronic Products	
139	Poly Paks	
	Relco	
137	Solid State Sales	
	Technical Materials Co.	
	Terado	
	Varitron	
	Viking Detectors	
	SCHOOL DIRECTORY	103
	Tri-State College	
	Valparaiso Technical Institute	

RADIO-ELECTRONICS

TUBES—LOWEST PRICES in the world. Hard to get British, German, foreign and American obsolete and present day special purpose transmitting tubes. Send for giant tube and parts catalog. **UNITED RADIO CO.**, Dept. R-56, Ferry St., Newark, N.J. 07105

RECEIVING & INDUSTRIAL TUBES, TRANSISTORS, All Brands—Biggest Discounts. Technicians, Hobbyists, Experimenters—Request FREE Giant Catalog and SAVE! **ZALYTRON**, 469 Jericho Turnpike, Mineola, N.Y. 11501.

Discharge IGNITION, PHOTOFLASH. Free catalog parts, kits. **TRANSPARK**, Carlisle, Mass. 01741

WANTED

QUICK CASH . . . for Electronic EQUIPMENT, COMPONENTS, unused TUBES. Send list now! **BARRY**, 512 Broadway, New York, N. Y. 10012, 212 WALKER 5-7000.

INVENTIONS & PATENTS

FREE "Directory of 500 Corporations Seeking New Products." For information regarding developments, sale, licensing of your patented/unpatented invention. Write: **RAYMOND LEE ORGANIZATION**, 230-U Park Avenue, New York City 10017.

INVENTORS: protect your ideas! Free "recommended procedure". **WASHINGTON INVENTORS SERVICE**, 422X Washington Building., Washington, D.C. 20005

INVENTIONS WANTED. Patented; Unpatented. **GLOBAL MARKETING**, 2420-AE 77th Ave., Oakland, Calif. 94605

EDUCATION/ INSTRUCTION

ELECTRONICS ENGINEERING. Day or evening classes. Bachelor of Science Program evenings. Associate in Science Program day or night. If you are married or if you must work for a living while obtaining your education, this is the college for you. Approved for Veterans. **WESTERN STATES COLLEGE OF ENGINEERING**, 970 West Manchester Avenue, Inglewood, California 90301.

FCC First Class License in six weeks—nation's highest success rate—approved for Veterans Training. Write **ELKINS INSTITUTE**, 2603E Inwood Road, Dallas, Texas 75235

NO TUITION, RENT. Memorize, study—Command's "1969 Test-Answers" for FCC first class license. Plus Command's "Self-Study Ability Test." Proven. \$5.00. **COMMAND PRODUCTION**, Box 26348-E, San Francisco, Calif. 94126

FREE TV TUNER REPAIR tricks. Plans, details, complete courses. **FRANK BOCEK**, Box 833 Redding, Calif. 96001

AUDIO — HI-FI

Tapemates makes available to you ALL 4-TRACK STEREO TAPES. All labels—postpaid to your door—at tremendous savings. For free brochure write: **TAPEMATES CLUB**, 5280 RE West Pico Blvd., Los Angeles, Calif. 90019.

TAPE RECORDER SALE. Brand new nationally advertised brands. \$10.00 above cost. Amazing discounts on stereo components. **ARKAY ELECTRONICS**, 1028-E Commonwealth Avenue, Boston, Mass. 02215

WRITE for highest discounts on components, recorders, tapes, from franchised distributors. Send for FREE monthly specials. **CARSTON**, RFD #3, Route 7, Brookfield, Conn. 06804

RENT 4-track open reel tapes—all major labels—3,000 different—free brochure. **STEREO-PARTI**, 55 St. James Drive, Santa Rosa, Ca. 95401

NOVEMBER 1969

INTEGRATED CIRCUITS & RECTIFIERS SEMICONDUCTORS & TRIACS

TRIACS

PVR	5 AMP	10A
100	.90	1.20
200	1.40	1.75
300	1.75	2.25
400	2.25	2.75
500	2.60	3.25

ER900 TRIGGER DIODES. These bidirectional trigger diodes are one of the best and cheapest methods to trigger SCR's and triacs 3/\$1.00

UNIUNCTIONS!

Similar to 2N2419. RBB of 5-7 stand off ratio of .6 and Ip of 12 with data sheet SPECIAL \$1.00

ZENERS 750 milliwatt 7-68V \$4.00
10 Watt 7-180V \$7.50

MOUNTING HARDWARE KITS.

These kits are used to mount our SCR's Zeners and Rectifiers etc.
6x32 stud (3, 12 amp rectifiers,
7A SCR's) 6 sets/\$1.00
1/4x28 stud (30 amp. rectifiers,
20 amps SCR's.) 4 sets/\$1.00

2N1163 a TO-3 PNP GERMANIUM TRANSISTOR rated at 35v and a gain of 50 at 25 amps. \$1.75

N-CHANNEL FET'S TO-18 plastic units, low noise, low leakage, 25 volts source to gate, 50 ma gate current Gain to 9000 μ mho's. \$.80

NEON LIGHT OR NIXIE TUBE DRIVERS. An NPN, TO-18, S1 Transistor. With a VCBO of 120 3/\$1.00

Silicon Power Rectifiers

PRV	3A	12A	30A
100	.09	.30	.50
200	.16	.50	.80
400	.20	.70	1.20
600	.30	1.00	1.50
800	.40	1.25	1.80
1000	.50	1.50	2.20

Terms: FOB Cambridge, Mass.

Send Check or Money Order. Include Postage. Average Wt. per package 1/2 lb. No C.O.D.'s. Minimum Order \$3.00

WE LEAD THE WAY IN SERVICE AND QUALITY

Send for our latest catalog featuring Transistors and Rectifiers; 325 Elm St., Cambridge, Mass.

OLID TATE ALES

Post Office Box 74D

Somerville, Mass. 02143

Tel. (617) 547-4005

Circle 137 on reader service card

UNUSUAL
BARGAINS
BY MAIL

SHOPPING MART

A selection of products available by mail for readers of Radio Electronics. All merchandise sold on money-back guarantee. Order by No. Send check or M.O.

EXCELLENT
for
XMAS
GIFTS!



BRIGHT IDEAS in UNIQUE LIGHTING
Big, new 100-page handbook packed with facts, loaded with illustrations. All latest developments, applications, equipment. Covers strobes, sources, black light, projectors, crystal and organic slides, color organs, mirrors, polarized color, screens, light boxes, MusicVision, etc. Rare find for business, home, hobby. Ideal for display houses, conchas, experimenters, hobbyists. 8 1/2" x 11" looseleaf paper punched to fit 3 ring binder. Add new developments as they happen.
Stock No. 9109EH \$3.00 Ppd.



ROTATING MULTI-COLORED LIGHT
Dazzling colors stream endlessly from constantly rotating light. Faceted, transparent globe has lowered drum inside with red, green, blue & yellow stars. Bulb heat rotates drum which projects flickering star points on walls, ceilings, etc. while individual globe facets present constantly changing array of brilliant colors. 9 1/2" star approx. 12" high on bell-shaped base. Place on table, TV, fireplace—top of Christmas tree or display.
Stock No. 71,000EH . . . \$6.00 Ppd.



3" ASTRONOMICAL TELESCOPE
See moon, stars, orbits—stars, phases of Venus, planets close up. 60 to 180 power—famous ML Palomar reflecting type. New, improved aluminized & overcoated 3" diameter f/10 primary mirror, ventilated cell. Equipped with 60X eyepiece and mounted SX finder scope, hardwood tripod. FREE: "STAR CHART," "HANDBOOK OF HEAVENS," "HOW TO USE YOUR TELESCOPE" book.
Stock No. 85,050EH \$29.95 Ppd.
1 1/2" REFLECTOR TELESCOPE
Stock No. 85,105EH \$94.50 FOB
6" REFLECTOR TELESCOPE
Stock No. 85,086EH \$239.50 FOB

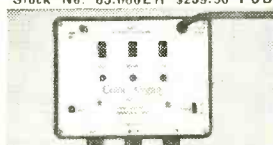

3-CHANNEL COLOR ORGAN BARGAIN
Create tremendous variety of unusual & beautiful lighting effects with this low-cost top quality, 1500 Watt unit (500 W. per channel). Compares with others selling for twice the price. Has pilot light, plus individual lights. Can operate ten 150 W. "spots" or 200 Xmas lights. Uses reg. house current—attaches to audio source w/ RCA-type phono plug. 5 1/2" x 6 3/4" x 2 1/4". 2 1/2 lbs. Thermal setting plastic case. 6 ft. cord. Incl. compl. instruct.
Stock No. 71,223EH . . . \$34.95 Ppd.

9030 8 BIT MEMORIES . . . \$3.95

LINEAR CIRCUITS

CA 3011 FM-IF AMPLIFIER . . . \$.90
702C WIDE BAND DC AMPL. . . \$1.75 ea.
709C OPERATIONAL AMPL. . . \$1.75 ea.
710C HI SPEED DIFF. AMP. . . \$1.75 ea.
711C DUAL COMPARATOR \$1.75 ea.

DIGITAL RTL CIRCUITS

2-914 QUAD 2 input gates . . \$1.25
900 Buffer . . . \$.75
925 Dual 2 input gate expander . . \$.75
923 JK flip flop . . . \$1.00
2-923 Dual JK flip flop . . . \$1.50

Controlled Avalanche or Epoxy Rectifiers 1 AMP.

PRV	PRV
100	.07
200	.09
400	.12
600	.18
800	.22
1000	.35

Silicon Control Rectifiers

PRV	3A	7A	20A	70A
50	.35	.45	.70	1.00
100	.50	.65	1.00	4.00
200	.70	.95	1.30	8.00
300	.90	1.25	1.70	
400	1.20	1.60	2.10	12.00
500	1.50	2.00	2.50	
600	1.80	2.40	3.00	16.00
700	2.20	2.80		

Send for our latest catalog featuring Transistors and Rectifiers; 325 Elm St., Cambridge, Mass.

OLID TATE ALES

Tel. (617) 547-4005

Circle 137 on reader service card

EDMUND SCIENTIFIC CO. 300 EDSCORP BUILDING BARRINGTON, NEW JERSEY 08007

Circle 138 on reader service card

FREE Catalog Of The WORLD'S
FINEST GOV'T
SURPLUS ELECTRONIC BARGAINS

Now **BIGGER** and
BETTER Than Ever!

---MAIL THIS COUPON NOW---

NAME: _____
ADDRESS: _____
CITY: _____ STATE: _____ ZIP: _____

For your FREE copy, fill out coupon and mail. Dept. RE
FAIR RADIO SALES
1016 E. EUREKA • Box 1105 • LIMA, OHIO • 45802

WRITE NOW FOR FREE 1970 CATALOG
McGEE RADIO COMPANY
1001 BARGAINS IN SPEAKERS—PARTS
TUBES—HIGH FIDELITY COMPONENTS
RECORD CHANGERS—TAPE RECORDERS—KITS
EVERYTHING IN ELECTRONICS
1901 McGee St., Kansas City RE, Missouri 64108

MARKET CENTER

TREASURE
Find buried gold, silver,
coins, treasures.
5 Powerful models.
Write for free catalog



DEPT. **\$19.95** UP
RELCO D-149
BOX 10839, HOUSTON, TEX. 77018

TRANSISTORIZED C. B. RADIOS: Repaired cost estimated by return mail. Shipped complete without batteries; we will return via C.O.D. 90 day warranty on all repaired units. A & M ELECTRONICS, 2937 Broadway, Riviera Beach, Florida 33404

GOVERNMENT SURPLUS

JEEPS Typically From \$53.90 . . . Trucks From \$78.40 . . . Boats, Typewriters, Airplanes, Multimeters, Oscilloscopes, Transceivers, Electronics Equipment, Used, 100,000 Bid Bargains Direct From Government Nationwide. Complete Sales Directory and Surplus Catalog \$1.00 (Deductible First \$10.00 Order). SURPLUS SERVICE, Box 820 REL, Holland, Michigan 49423

GENERAL

TREASURE HUNTERS! PROSPECTORS! Relco's new instruments detect buried gold, silver, coins. Kits, assembled models. Transistorized. Weighs 3 pounds. \$19.95 up. Free catalog. RELCO-A25, Box 10839, Houston, Texas 77018

CUSTOMIZED KEY TAGS: Choice of resistor or disc capacitor embedded in transparent, shock-resistant plastic. Distinctive! Smart! Chain included. \$1.00. PLASTECH, 2258 Portal Way, San Jose, Calif. 95122

JAPANESE NEW PRODUCTS MONTHLY! \$1.00. Refundable. DEERE, 10639 Riverside, North Hollywood, Calif.

HOBBYISTS, EXPERIMENTERS, TECHNICIANS, INVENTORS, NOW YOU CAN HAVE YOUR BLACK AND WHITE TELEVISION CONVERTED TO COLOR, BY MEANS OF A NEW PATENTED CIRCUIT. COMPLETE INSTRUCTIONS AND BLUE PRINTS, WRITE, BELE ELECTRONICS CORP. 121 S.E. FIRST ST. MIAMI, FLORIDA. 33131

CONTROL CENTERS
Switch Speakers!



For Stereo, Input Mixing, Monitoring!

1st Time!

Alco Control Center allows your choice of up to 6 stereo speaker systems to be selected simultaneously. Push-on & push-off switches enable you to optionally select your choice of speaker pairs. Easy access rear panel connectors to match your particular system. No external power required; no impedance match problems. Useable with low or high impedance circuits. Leather-styled black metal with brushed aluminum trim. 5 1/2" x 2 1/8" x 3 1/16". For home or professional use.

Model No.	Prs.	Connector Type	Each
CC4RCA	4	RCA	\$19.95
CC4PHM	4	Phone (Miniature)	21.95
CC4PHS	4	Phone (Standard)	22.95
CC6RCA	6	RCA	26.95
CC6PHM	6	Phone (Miniature)	28.95
CC6PHS	6	Phone (Standard)	29.95

ORDER BY MAIL—CHOICE OF 6 MODELS

ALCO Buy Direct: BOX 1348RE LAWRENCE, MASS. 01842
We ship shipping when check accompanies order.

PRE XMAS SALE!

DOUBLE BONUS \$25

WORTH OF
• Transistors
• Diodes
• Rectifiers
• Knobs
• Condensers
• Coils, etc.

ADD 25¢ FOR HANDLING

BOTH BLIS-DOR "GIFTS" FREE WITH \$10.00 ORDERS

CHOOSE ANY **\$1** BLIS-DOR PAK FOR FREE

1¢ SALE!

EPOXY SILICON TRANSISTORS

Imagine—buy 1 BLIS-DOR PAK at our bargain price and get the 2nd one for ONLY 1¢

2 BLIS-DOR PAKS for \$1.01

Type	Sale
2N2222	5 for \$1
2N2368	5 for \$1
2N2711	5 for \$1
2N2368	5 for \$1
2N3396	5 for \$1
2N3565	5 for \$1
2N3568	5 for \$1
2N3638	5 for \$1
2N3641-3	5 for \$1
2N3645	5 for \$1
2N3662	5 for \$1
2N3683	5 for \$1
2N3793	5 for \$1
2N4248	5 for \$1
2N4284-5	5 for \$1
2N4288-9	5 for \$1
2N4290	5 for \$1

2N1906 HIGH-POWER GERMANIUM PNP

\$1.98 (Watts) 115
BY CBO 100
(AMP) 15

400 mc

2.99 ea

2N3632
23W, 3A.

RECTIFIERS

5 — 1 AMP 1000 PIV	5 for \$1
6 — 1 AMP 800 PIV	6 for \$1
4 — 2 AMP 1000 PIV	4 for \$1

BLIS-DORS

In the new RE-USABLE BLIS-DOR PAK

\$25 SURPRISE PAK: transistors, rect. diodes, etc.	\$1
50 GERMANIUM GLASS DIODES, 1N34, 1N48 no test	\$1
40 TOP HAT SILICON RECTIFIERS, no test/asst values	\$1
25 EPOXY RECTIFIERS, silicon asst, no test	\$1
40 PRECISION RESISTORS, 1/2-2W, 1% asst values	\$1
30 TRANSISTORS, rf, if, audio, osc, no test	\$1
60 TUBULAR CONDENSERS, to .5mf to 1KV, asst	\$1
50 DISC CONDENSERS, to .05mf npo, temp coef, asst	\$1
30 POWER RESISTORS, to 25 watts, to 24K ohms	\$1
10 VOLUME CONTROLS, to 1 meg, switch too!	\$1
10 ELECTROLYTICS, to 100mf, tubular too, asst	\$1
50 RADIO & TV KNOBS, asst colors & styles	\$1
10 TRANS-TOR ELECTROLYTICS to 100mf, asst values	\$1
50 COILS AND CHOKES, if, rf, ant, osc, peaking, etc	\$1
65 HALF WATTERS, to 1 meg, 5% popular values too	\$1
2 FIELD EFFECT TRANSISTORS, n channel, hobby	\$1
10 PANEL SWITCHES, toggle, slide, micro, rotary	\$1
5 "IBM" COMPUTER BOARDS, many trans, diodes	\$1
40 "MICRO" CONDENSERS, for transistor circuitry	\$1
50 TERMINAL STRIPS, 1 to 8 lug types	\$1
4 PHOTO ELECTRIC CELLS, hi. imp., schematic	\$1
40 "TINY" RESISTORS, 1/10W, 5% too! to 1 meg	\$1

COUNTING DIGITAL "ICs"

No.	similar	Description	\$5.95
958	SN7490N	Counter	3 for \$15
959	SN7475N	Memory	
960	SN7441N	BCD-to-Decoder	

SALE ON FAIRCHILD "ICs"

Fairchild No.	Function	\$1.19 ea.
900	Buffer	
914	Dual Two Input Gate	
923	JK Flip Flop	
927	Quad Inverter	

3 for \$3

POLY PAKS

Giant 'XMAS' CATALOG ON: Parts, Rectifiers, Transistors, SCRs, I.C.'s, Equipment. 10¢

P.O. BOX 942 R LYNNFIELD, MASS 01940

LOWEST PRICES ON LINEAR AMPLIFIERS

Guaranteed! With Spec. Sheets!

\$2.22 3 for \$6

"BLISTER" PACKED

Type	Use
702	D.C. Amplifier
709	Operational Amp
710	Differential Comparator
711	Sense Amplifier

Circle 139 on reader service card

MAGNETS. All types. Specials-20 disc magnets, or 2 stick magnets, or 10 small bar magnets, or 8 assorted magnets, \$1.00. MARYLAND MAGNET COMPANY, 5412-G Gist, Baltimore, Maryland 21215.

CONVERTING CONVERGENCE YOKES

I just got a Zenith color test jig from my distributor. I'd like to use the same jig for checking out other makes. I'm pretty confused about this. Aren't all convergence yokes about the same?—P. A., Sharon, Mass.

Welcome to The Confused Club. I checked schematics and connections on two or three convergence-yoke and board assemblies. They are functionally the same—they do the same things—but they do it in different ways. I traced out the circuits and kept meeting myself coming back.

I doubt if we'll ever be able to use convergence assemblies from one make on sets of another through the use of an adapter plug, etc. It's often confusing enough changing models of the same make on a test jig.

Minor differences upset things. One make will use a small transformer to feed certain pulses into the convergence circuits; another will feed them through a capacitor. Some use two shaper diodes, others use four, and so on.

So, while this sounds like a good idea, I'm sorry to say I don't see how you can make it work. If any readers have found a solution to this, we'll be happy to hear about it.



FUNCTION GENERATOR

- SQUARE, TRIANGLE, SINE
- ONE BAND, 20HZ TO 200,000HZ
- LEFT, RIGHT, VARIABLE SYMMETRY
- BATTERY OPERATED, PORTABLE
- FLAT RESPONSE
- LESS THAN \$100.00

Varitron CORPORATION

P.O. BOX 2294 • ST. LOUIS, MISSOURI 63116

TREASURE & COIN DETECTOR MONEY BACK GUARANTEE

New electronic detector penetrates deep into earth to locate gold, silver, coins, minerals. More penetrating power than ever before. Sensitive enough to locate a single coin or small nugget. Works through earth, wood, vegetation, water, rock, etc. Not a "probe" type but a fully electronic detector that is guaranteed to have at least twice the detection ability of any detector in this price range or return in 10 days for refund. Uses inexpensive 9V battery. Fully transistorized. Weighs only 2 pounds. Loudspeaker signals when object is detected. Has plug-in earphone for treasure hunting in privacy. NOTHING ELSE TO BUY!



2995 POST PAID

Comes complete, ready for operation. Shipping container has compartments for detector and all accessories, serves as a carrying case. Send only \$29.95 check, cash or M.O. for postpaid shipment or \$2.00 and pay \$27.95 plus small C.O.D. when delivered. Viking Detectors, Dept. V-30, Box 10880, Houston, Tex. 77018

RECHARGEABLE EVEREADY NI-CAD BATTERIES

9V (8.75V) 1/2 amp. hr. cap., size 2 1/2" long x 1 1/2" diam. Made of 7-N38 or BH 500 button cells. Suitable to power cameras, elect. flash, phonos, radios, exp. power supplies, many other uses. Retail value \$12.00 ea. A fortunate purchase permits selling these life time batteries on a money back guarantee basis at a fraction of cost. Postpaid at \$2.95 ea. (6 for \$15.00)

Miniature Swiss, permanent magnet precision motor, reversible, (escap) 1-6 volts D C with reduction gear 50 rpm. High torque \$1.95 ea.

TECHNICAL MATERIALS COMPANY
769 Inwood Road — Union, N.J. 07083
Phone 201-687-9172 — 201-687-5171

CLASSIFIED COMMERCIAL RATE (for firms or individuals offering commercial products or services). 70¢ per word . . . minimum 10 words.
NON-COMMERCIAL RATE (for individuals who want to buy or sell personal items) 30¢ per word . . . no minimum.
Payment must accompany all ads except those placed by accredited advertising agencies. 10% discount on 12 consecutive insertions, if paid in advance. Misleading or objectionable ads not accepted. Copy for February issue must reach us before November 10.

CLASSIFIED ADVERTISING ORDER FORM

1	2	3	4	5
6	7	8	9	10
11	12	13	14	15
16	17	18	19	20
21	22	23	24	25
26	27	28	29	30
31	32	33	34	35

No. of Words { @ .30 Non-Commercial Rates } = \$
 { @ .70 Commercial Rate }

Total Enclosed \$

Insert _____ time(s)

Starting with _____ issue

Payment must accompany order unless placed through accredited advertising agency

NAME _____

ADDRESS _____

CITY _____ STATE _____ ZIP _____

SIGNATURE _____

MAIL TO: RADIO-ELECTRONICS, CLASSIFIED AD DEPT., 200 PARK AVE. SOUTH, NEW YORK, N.Y. 10003

SCHOOL DIRECTORY

GET INTO ELECTRONICS

V.T.I. training leads to success as technicians, field engineers, specialists in communications, guided missiles, computers, radar and automation. Basic & advanced courses in theory & laboratory. Electronic Engineering Technology & Electronic Technology curricula both available. Associate degree in 29 mos. B.S. also obtainable. G.I. approved. Graduates in all branches of electronics with major companies. Start Sept., Feb. Dorms, campus. High school graduate or equivalent. Catalog.

VALPARAISO TECHNICAL INSTITUTE
Dept. C, Valparaiso, Indiana 46383



distinguished graduates

hold important engineering and business administration posts throughout U.S. Professionally-oriented college with outstanding placement record. Four-quarter year permits degree in three years. Fine faculty. Modern labs. Small classes. 300-acre campus. Accredited. Approved for vets. Moderate costs. Enter Jan., March, June, Sept. For Catalog, write Adm. Director.



TRI-STATE COLLEGE
2119 College Avenue, Angola, Indiana 46703

PEP'S Dollar Sale \$1 Money Back guarantee \$1

- 1 Amp Silicon Rectifier choice of package
 - Bullet—Miniature Glass-Metal
 - 5-800V units \$1.00
 - 4-1000V units \$1.00
 - 3-1200V units \$1.00
 - 3 AMP Epoxy Package
 - 10-100V units \$1.00
 - 5-400V units \$1.00
 - 2-1000V units \$1.00
 - 5 AMP Epoxy Package
 - 8-100V units \$1.00
 - 6-200V units \$1.00
 - 3-800V units \$1.00
- SILICON STUD MOUNT 12 AMP
 - 5-100V units \$1.00
 - 2-800V units \$1.00
 - 1-1000V units \$1.00
- SILICON STUD MOUNT 20 AMP
 - 3-100V units \$1.00
 - 1-1000V unit \$1.00
- SILICON STUD MOUNT 40 AMP
 - 3-50V units \$1.00
 - 2-100V units \$1.00
- SILICON STUD MOUNT 60 AMP
 - 2-50V units \$1.00
 - 1-1000V unit \$1.00
- SILICON GLASS DIODES DO-7
 - 10-100V units \$1.00
- SPECIAL INTEGRATED CIRCUITS
 - Dual 4 Input NAND Gate Digital \$1.50
 - Quad 2 Input NAND Gate Digital \$1.50
 - J-K Flip Master Slave Digital \$1.75
 - Linear I-C Operational Amp 709C Type . . . \$1.75
- POWER TRANSISTOR 85 Watt Similar to 2N-212-1724-1208
 - 1 Unit \$1.00
- SCR Silicon Controlled Rectifier
 - TO-5 Package
 - 5-40V units \$1.00
 - 4-100V units \$1.00
 - 3-200V units \$1.00
 - 2-400V units \$1.00
 - 7 AMP SCR
 - 4-50V units \$1.00
 - 3-100V units \$1.00
 - 2-200V units \$1.00
 - 1-800V units \$1.00
 - 20 AMP SCR
 - 2-50V units \$1.00
 - 1-300V unit \$1.00
- Gen Purpose PNP Germ Transistor Similar to 2N404
 - 8 For \$1.00
- ZENER DIODES 3 Watt
 - 10 Volts
 - 3 units \$1.00
- ZENER DIODES 1 Watt
 - 1 EA 4V-6V-8V-10V
 - 4 units \$1.00
- GERM GLASS DIODES DO7 GEN PURPOSE
 - 20 Units \$1.00
 - Replaces 1N-34 1N-60 1N-64 1N-295
- Zener Diodes 250 to 400 Milliwatt
 - 1 EA 2V-4V-6V-8V-10V
 - 5 units \$1.00
- Power Transistors
 - 2N-155
 - 3 units \$1.00
 - 2N-176
 - 2 units \$1.00
- RADIATION FREE TUBE FOR COLOR TV
 - 50,000 Volts Replaces RCA 3A-3A or Equivalent. Guaranteed for life of set or 5 years. Eliminates heat to prolong life of other tubes. \$8.99 each

PARK ELECTRONIC PRODUCTS

P. O. Box 78 N. Salem, N. H. 03073
Tel. (603) 893-0276

Circle 140 on reader service card

For The Experimenter!

International EX Crystal & EX Kits

OSCILLATOR / RF MIXER / RF AMPLIFIER / POWER AMPLIFIER

Type EX Crystal

Available from 3,000 KHz to 60,000 KHz. Supplied only in HC 6/U holder. Calibration is $\pm .02\%$ when operated in International OX circuit or its equivalent. (Specify frequency)



\$395

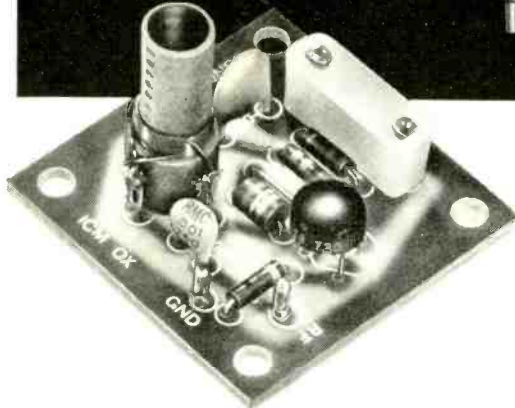

OX OSCILLATOR

Crystal controlled transistor type.
Lo Kit 3,000 to 19,999 KHz
Hi Kit 20,000 to 60,000 KHz
(Specify when ordering)

\$295

MXX-1 Transistor RF Mixer \$3.50

A single tuned circuit intended for signal conversion in the 3 to 170 MHz range. Harmonics of the OX oscillator are used for injection in the 60 to 170 MHz range.

Lo Kit 3 to 20 MHz Hi Kit 20 to 170 MHz
(Specify when ordering)

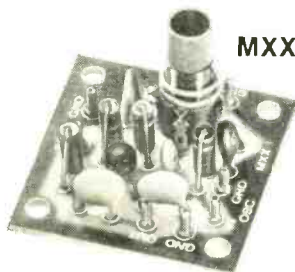

MXX-1



SAX-1

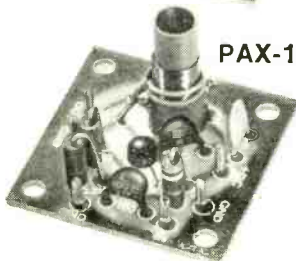

PAX-1



BAX-1

SAX-1 Transistor RF Amplifier \$3.50

A small signal amplifier to drive MXX-1 mixer. Single tuned input and link output.

Lo Kit 3 to 20 MHz
Hi Kit 20 to 170 MHz
(Specify when ordering)

PAX-1 Transistor RF Power Amplifier \$3.75

A single tuned output amplifier designed to follow the OX oscillator. Outputs up to 200 mw can be obtained depending on the frequency and voltage. Amplifier can be amplitude modulated for low power communication. Frequency range 3,000 to 30,000 KHz.

BAX-1 Broadband Amplifier \$3.75

General purpose unit which may be used as a tuned or untuned amplifier in RF and audio applications 20 Hz to 150 MHz. Provides 6 to 30 db gain. Ideal for SWL, Experimenter or Amateur.

Write for complete catalog.



CRYSTAL MFG. CO., INC.
10 NO. LEE • OKLA. CITY, OKLA. 73102

Circle 148 on reader service card

Circle 149 on reader service card ➔



Put your parts in order.

All it takes is genius to arrive at simplicity. This new display stand is deceiving. It's more than a display stand. It's set up to operate like a store within your store for instant servicing.

Here, within this unit, is a complete stock of all the wide range twist prongs you'll need plus micas, miniature electrolytics, ceramics, wide range tubulars and dipped paper Mylar.* The selection was based on an extensive study of all capacitors used in the replacement market. Now, with the Re-Place, you're in the capacitor

replacement business. The Re-Place only takes 2' x 5' in space and you have all your parts in order.

Interested? Write for our new catalog on The Re-Place™ capacitor line. "The Replacers" — the most complete line of replacement capacitors in the smallest possible package.



COMING YOUR WAY FOR CHRISTMAS '69 RCA'S

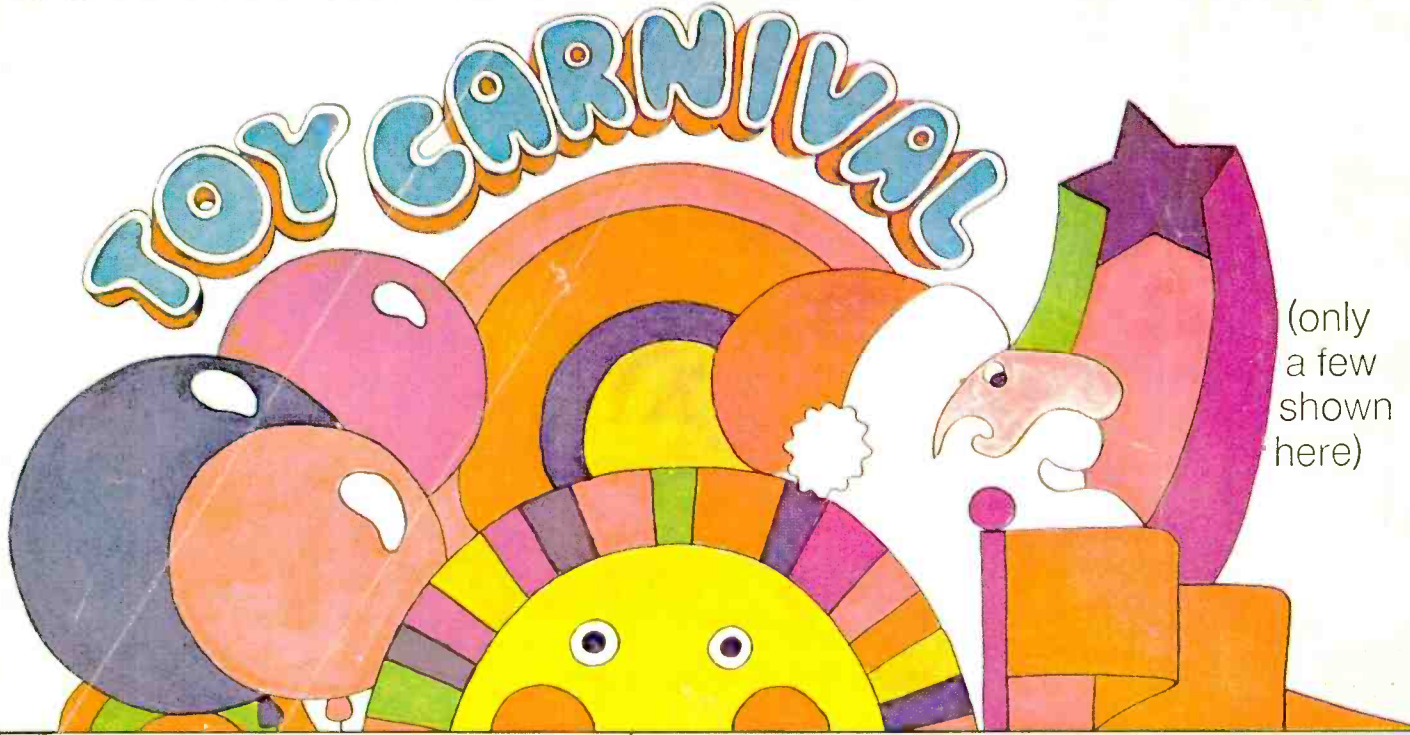

(only a few shown here)

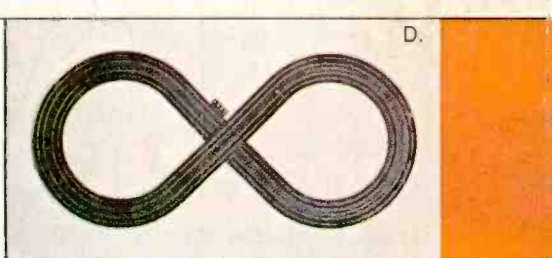
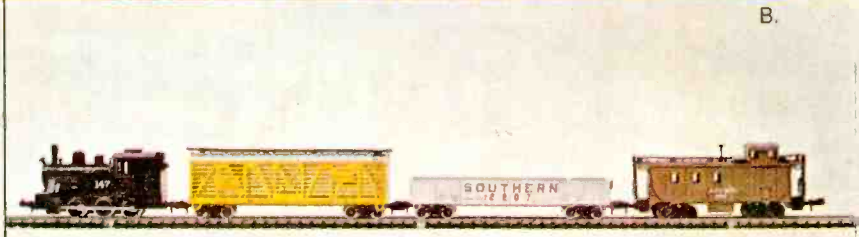
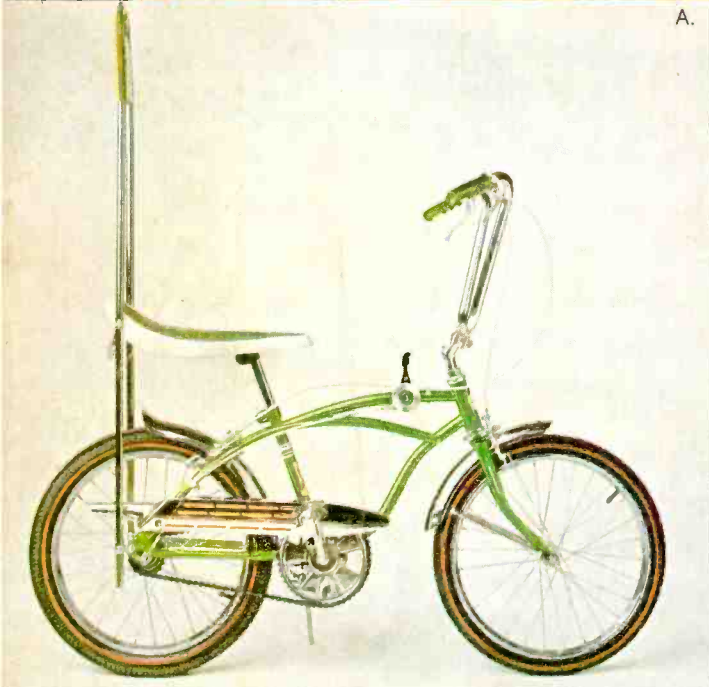

* 17 wondrous toys (only a few shown here) to light up the eyes of children of all ages!
 * available with purchases of RCA Entertainment Receiving Tubes and Picture Tubes from your local participating RCA Tube Distributor.



- A. HUFFY BOY'S BICYCLE "DRAG-STER III"—TC-2044—3 speeds
- B. ATLAS N-GAUGE READY-TO-RUN TRAIN SET—TC-69364—complete
- C. PLUSH DOG—TC-2262—cute-as-a-button beagle type
- D. ATLAS ROAD RACING-SET—TC-1202—complete with power supply
- E. PARKER "QUBIC" GAME—TC-400—3-dimensional Tic-Tac-Toe
- F. COLLECTOR'S SET AMERICAN SPACE PROGRAM BY REVELL—TC-1839—3 ready-to-assemble models
- G. HORSMAN "BABY BUTTERCUP" DOLL—TC-5301—drinks and wets
- H. MIGHTY-TONKA DUMP TRUCK—TC-3900—a kid can ride it
- I. HORSMAN "BABY TWEAKS"—TC-2570—18" tall, she "coos"

See your participating RCA Tube Distributor for details

RCA Electronic Components, Harrison, N.J. 07029

