

Radio Electronics

50c

SEPT. 1966

TELEVISION

HIGH FIDELITY

HUGO GERNSEBACK, Editor-in-Chief

A GERNSEBACK PUBLICATION

CB/COMMS SECTION!

**CB TRANSCEIVER FAILURES
TOUGH DOG TWO-WAY
CALIBRATOR FOR CITIZENS BAND**

... and ...
New build-it projects
Computer circuit talk

**Free-lance
Communi-pac**

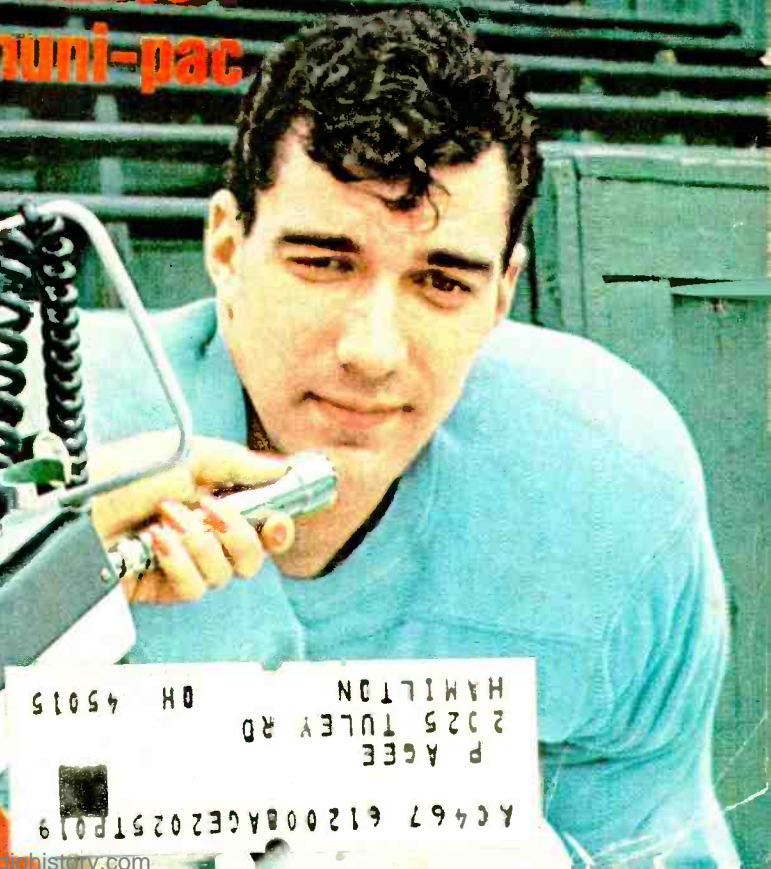
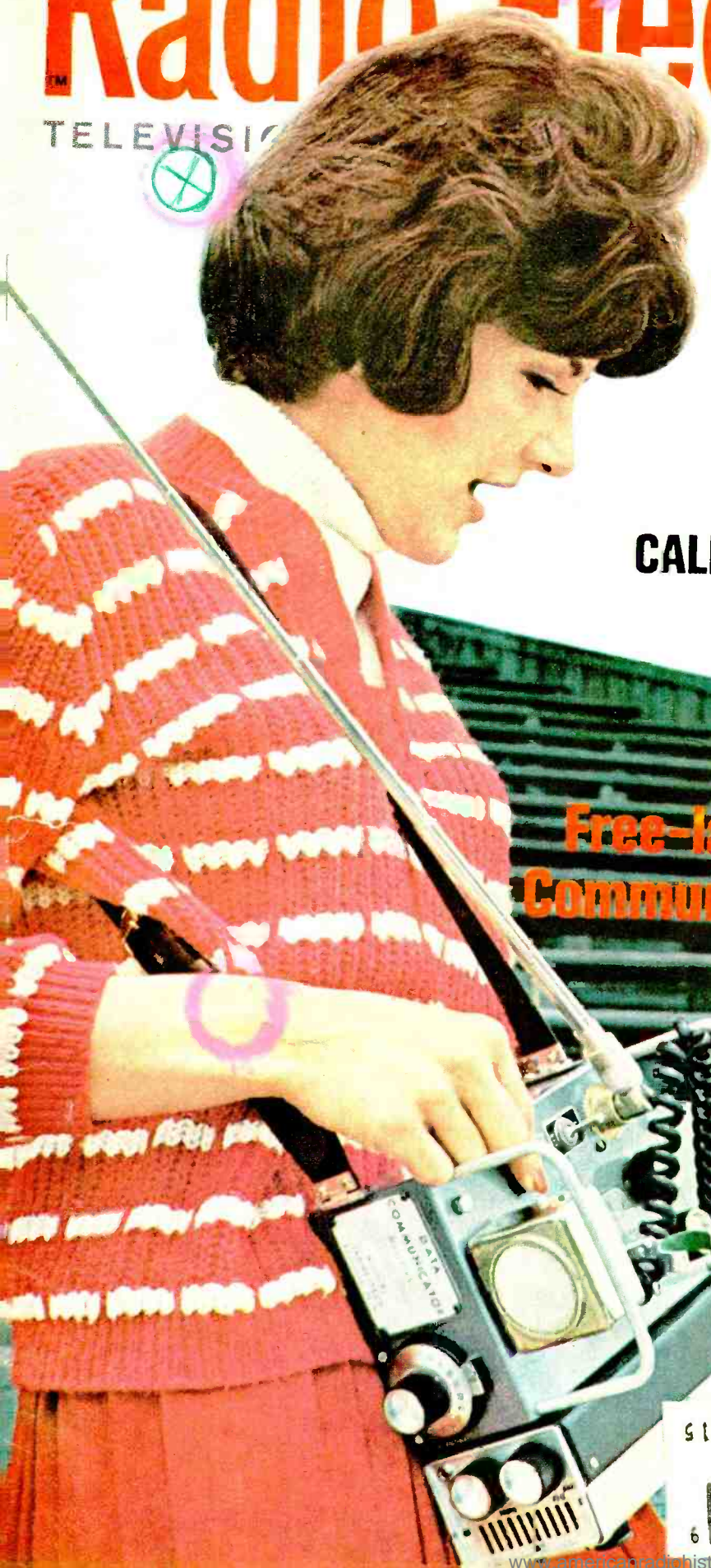

AC467 61200BAGE2025TP019
P AGEE
2025 TULEY RD
HAMILTON OH 45015

If you think
all replacement tubes are alike,
you've got a surprise coming

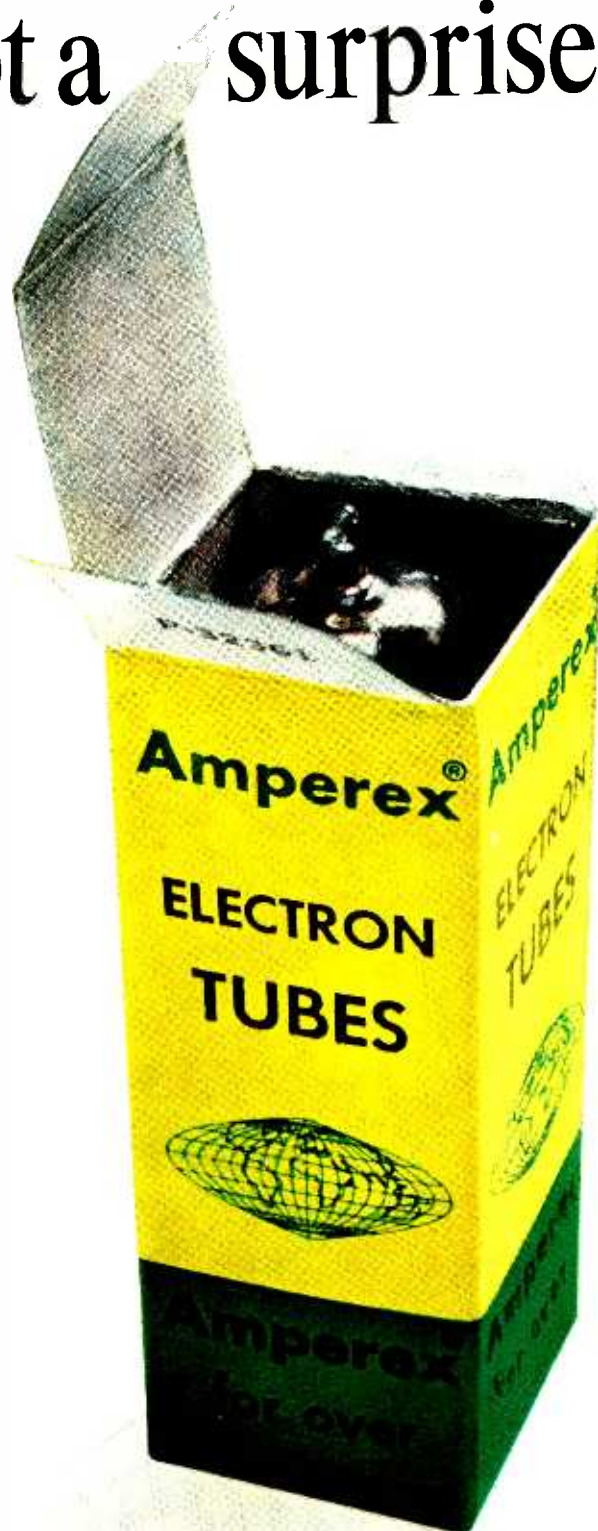

© 1966, AMPEREX ELECTRONIC CORP., HICKSVILLE, L. I., NEW YORK 11802
Circle 7 on reader's service card

A New Electronics Slide Rule with Self-Training Course

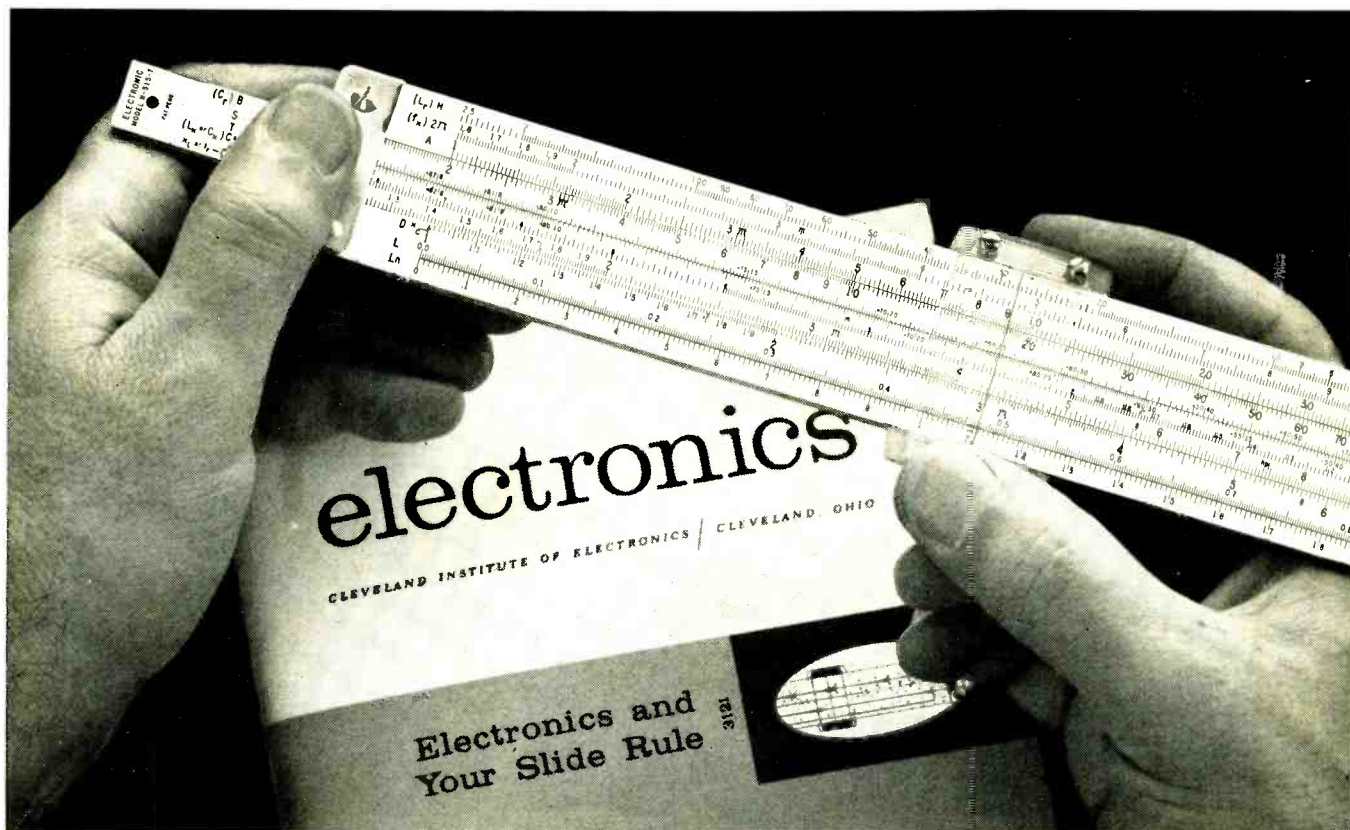

Why didn't someone think of this before?

Here's a great *new* way to solve electronic problems accurately . . . easily. The Cleveland Institute Electronics Slide Rule* is the only rule designed specifically for the exacting requirements of electronics computation. It comes complete with an illustrated Instruction Course consisting of four AUTO-PROGRAMMED* lessons . . . each with a short quiz you can send in for grading and consultation by CIE's expert instructors. With this personal guidance, you'll soon be solving complex electronics problems in seconds while others still struggle along with pad and pencil.

Here's what Mr. Joseph J. DeFrance, Head of the Electrical Technology Dept., New York City Community College, has to say about it:

"I was very intrigued by the 'quickie' electronics problem solutions. It is an ingenious technique. The special scales should be of decided value to any technician, engineer, or student. The CIE slide rule is a natural."

See for yourself. Learn how to whip through all kinds of reactance, resonance, inductance, AC and DC circuitry problems in seconds . . . become a whiz at conventional computations too!

This all-metal 10" rule is made to our tough specs by Pickett, Inc. . . . comes complete with top grain leather carrying case and Instruction Course. A \$50 value for less than \$25. Send coupon for FREE illustrated booklet and FREE Pocket Electronics Data Guide. Cleveland Institute of Electronics, 1776 E. 17th St., Dept. RE-127, Cleveland, Ohio 44114.

*TRADEMARK

GET BOTH FREE!



Send coupon
today →

Cleveland Institute of Electronics

1776 E. 17th St., Dept. RE-127 • Cleveland, Ohio 44114

Please send FREE Electronics Slide Rule Booklet.
SPECIAL BONUS: Mail coupon promptly . . . get FREE Pocket Electronics Data Guide too!

Name _____ (Please Print)
Address _____ County _____
City _____ State _____ Zip _____

A leader in Electronics Training . . . since 1934

Circle 8 on reader's service card

Universe The World of Communications

On the editorial page this month, in this our first CB & Communications Special, I planned to talk to you about the most spectacular communications event to date. No earth-shattering commentary, just a chat about how it was accomplished and what it might mean to your future and mine.

So I picked the most recent big event. But . . . no . . . that wasn't really the most important. The most important was . . . No, wait a minute . . . how about . . . ?

You get the idea. With so many events linked in one way or another to communications, how could I possibly pick out one that is the most important? Obviously, I couldn't.

The news media played up the triumph of Surveyor I, our "TV station" on the moon. Now, *there's* a TV show for you—live, from outer space! Not only did Surveyor manage a gentle landing, controlled by its own internal computer, but shortly set to work with its movable-mirror television camera telecasting back to earth thousands of sparkling pictures of the moon's surface. All through the 270°F temperature of the moon "day," the tough little moon photographer worked, and then settled into stillness to wait out the —280°F lunar "night."

Then, 14 earth-days later, when the sun rose again over the lonely lunar landscape, earth-based scientists sent out hopeful little electronic suggestions that Surveyor should wake up and look around again. And, with a slow but encouraging stretch of electronic muscles, Surveyor did wake up, healthy as ever, soaked up a hearty breakfast of solar energy to replenish its now-thawed batteries, and went willingly to work again pouring information about the moon down those telemetry and television beams to exulting scientists at receiving stations back on earth.

Then there's that other miracle of space commu-

nications—Mariner 4—which has become the earth's most traveled former denizen. Not satisfied with sending the world's first closeup pictures of Mars last year, this marvelous interstellar traveler obligingly sent back an answer to our most recent electronic question—sent it back from 749 million miles away in space. Talk about communications! It took more than 2 hours for the messages to make the round trip to Mariner and back.

All this activity in outer space overshadows less flashy happenings down here within a few hundred miles of earth. A worldwide system of communications is ready to serve the military. Navigation satellites are edging toward the launch pads. Some experts predict we'll have direct satellite-to-home TV in a few years; others deny it. (Rest assured; if we don't, the reason won't be technical.) And orbiting observatories are an accomplished but little publicized fact.

Right here on the solid earth, imaginative ways of multiplexing more messages on existing facilities are being put into operation. In labs, lasers are opening new avenues of speculation about handling the mounting volume of future communications traffic.

No spot is untouched by the innovators. New means for undersea communication are being tried out, while we're still finding new ways to send more messages over those old standby's, the undersea cables.

So, you see, I picked too broad—if not impossible—a subject. One short editorial can't cover it.

But, in working at it, I decided one thing I can pass along and hope will affect your future thinking about communications: No longer can any of us talk of, think about, or plan for *world* communications. From the briny depths of the ocean to yet-unfathomed reaches of outer space, we now must plan our communications systems in terms of the *universe*.

—Forest H. Belt

Radio-Electronics

SEPTEMBER 1966 VOL. XXXVII No. 9
Over 55 Years of Electronic Publishing

EDITORIAL

- 2 The Universe of Communications** Forest H. Belt

CB/COMMS SPECIAL SECTION

- 22 Service Clinic** Jack Darr
Transmitting antennas
- *32 Communi-Pac For the Free Lance** John J. Borzner
Build this do-everything recorder-receiver-transmitter
- 34 Let the Lasers Do the Talking** H. Dale Belt
An answer to bandwidth problems for future communications
- 37 Analyzing CB Failures** E. F. Rice and Andrew J. Mueller
Review of new transceiver circuits — with helpful case histories
- 40 Two-Way Radio Has Its Tough Dogs, Too!** Don Dudley
FM circuitry keeps the technician alert and wary
- 42 Xtal + Oscillator = Citation??** Will Connelly
You can't always depend on your stated crystal frequency!
- 48 Making Modulation Easy to Understand** ... Norman H. Crowhurst
An explanation that centers around vectors
- 52 CB'ers Crystal Calibrator** Lyman E. Greenlee
Identifies any CB channel quickly, accurately
- 58 An RF Wattmeter for UHF** Harold Balyoz
A simple route to CB, ham or industrial power checks

ELECTRONICS

- 46 "And/Or... Nand/Nor" ... Computer Talk** Irwin Math
It isn't strange at all. See logic circuits you can use
- 54 Seismic Amplifier Tops Out at 1 Hz!** Earl T. Hansen
And it works down to .01 Hz!

AUDIO-HIGH FIDELITY-STEREO

- 44 Quick-Change PA System Saves \$\$** William Darragh
A fast switch and a basic unit does this job

GENERAL

- 36 Zeners as Hi-Cap Variable Capacitors** Rufus P. Turner
Try this ingenious way of tuning audio filters
- 59 Heavy-Duty 5-Amp Supply — With Regulation** Allan W. Crowell
Dependable for two-way and auto-radio testing
- 66 Equipment Report: Knight-Kit KG-625 VTVM; Sencore MX11 Channelizer**
- 78 Is Color a TV-Man Job?** Wallace Waner
Your customer may think not; check to see if you agree
- 92 CB Troubleshooter's Casebook** Andrew J. Mueller
Servicing tips based on shop experience
- 91 Fix Your Burned-Out Ohmmeter Ranges** Wayne Lemons
How to find and replace the bad part

THE DEPARTMENTS

- | | |
|---|---------------------------------|
| 14 Correspondence | 106 Noteworthy Circuits |
| 107 New Books | 96 Technotes |
| 90 New Literature | 98 Try This One |
| 85 New Products | 53 What's Your EQ? |
| 72 New Semiconductors, Microcircuits & Tubes | 53 50 Years Ago |
| 4 News Briefs | 82 Reader's Service Page |



p 40—2-WAY TOUGH DOGS

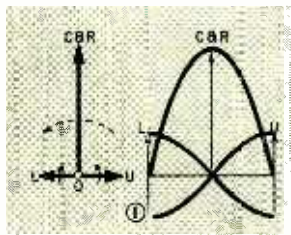

p 48—PHASE MODULATION

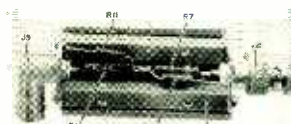

p 58—A UHF WATTMETER

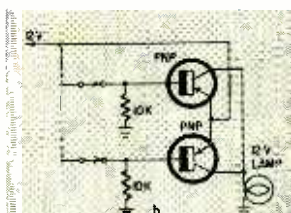

p 46—COMPUTER LOGIC



p 54—QUAKE DETECTOR

p 59—A 5-AMP SUPPLY

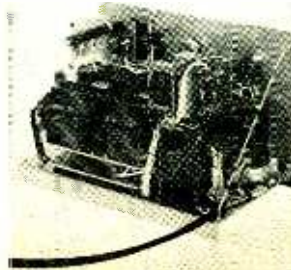

RADIO-ELECTRONICS, September 1966, Volume XXXVII, No. 9. Published monthly by Gernsback Publications, Inc., at Ferry St., Concord, N. H. 03302. Editorial, Advertising, and Executive offices: 154 West 14th Street, New York 10011. Circulation Office, Boulder, Colo. 80302.

Second-class postage paid at Concord, N. H. Printed in U.S.A. One-year subscription rate: U. S. and possessions, Canada, \$5. Pan-American countries, \$6. Other countries, \$6.50. Single copies: 50c. © 1966, by Gernsback Publications, Inc. All rights reserved. POSTMASTERS: Notices of undelivered copies (Form 3579) to Boulder, Colo. 80302.

*COVER FEATURE



p 32—For interviews and for reporting, this multi-purpose gadget can make the life of the free lance easier. It can be built by almost anyone.

LASER COMMUNICATIONS



p 34—In outer space and for earthbound communications, the laser seems to be an answer to the expected congestion.



Member,
Institute of High Fidelity.
Radio-Electronics is indexed in
Applied Science & Technology
Index (formerly *Industrial Arts Index*)

NEWS BRIEFS

HUGO GERNSBACK HONORED BY INTERNATIONAL PRESS GROUP

The International Union of the Radiotechnical and Electronics Press (L'Union internationale de la Presse radiotechnique et électronique) has elected Hugo Gernsback a Member of Honor of the association. "in recognition of his outstanding services in the fields of radiotechnical and electronic journalism."

L'Union internationale de la Presse
radiotechnique et électronique
has elected

Hugo GERNSBACK

to be a

MEMBER OF HONOUR

in recognition of his outstanding services in the fields
of radiotechnical and electronic journalism

The President:



The General Secretary:



May 1966

Mr. Gernsback was notified of the honor in a letter by Eugene Aisberg, president of the Union, old-time friend, and publisher of five magazines in the field of electronics in France:

"Dear Friend Gernsback:

I am very happy to address you this witness of affection and admiration from your confreres of the world electronic press."

The Union is composed of editors of publications in the electronics field and includes leading publishers and editors in a large number of countries and languages.

TV DIRECT FROM SATELLITES

NOT LIKELY, SAYS COMSAT HEAD

Dr. Joseph V. Charyk, president of the Communications Satellite Corp., does not believe that television broadcasts are likely to be relayed direct to homes from satellites. Instead, he thinks broadcasts will go from space to ground stations and then be distributed by existing television networks.

Direct satellite transmission would create a propaganda broadcast prob-

lem, and many governments might object to their citizens receiving material the satellites might broadcast. There would also be a serious economic problem, as existing television networks would probably object to any type of broadcast that would bypass them and possibly terminate the reason for their existence.

NEW LASER "RADAR" HAS ELECTRIC SCANNING

An electrically scanned laser is the first that can relocate a rocket momentarily lost in the clouds; mechanically scanned lasers cannot move fast enough to rediscover a moving target once it is lost. The new laser, by General Telephone & Electronics Corp., can pinpoint a rapidly moving target to within 12 inches at a height of 8 miles.

The optical-beam deflector consists of 20 movable and 8 stationary mirrors. The 20 movable mirrors are attached to piezoelectric prisms activated by alternating current and direct the beam to 2,000 locations within a half-second after contact with the target is lost. As soon as the beam strikes the target and is again reflected, the ground receiver shuts off the deflector and locks the system onto the moving target.

CHRONIC PAIN RELIEVED BY DC OR RF NEEDLE

Direct current or high-frequency ac, from a needle inserted into the upper spinal column, is now being used to relieve persistent pain. Relief is immediate and continues for a period measurable in months. Dr. Sean Mulla of the University of Chicago School of Medicine, who described the technique to the American Medical Association's 115th annual convention, said that the method had been used chiefly on advanced cases of cancer, but has value in treating persistent pain from other causes. The problem of drug addiction does not arise, and treatments can be given under a local anesthetic. The dc method is used where the doctor does not wish the effects to persist, since treatment with rf produces longer-lasting effects.

STANDARDIZED TAPE CARTRIDGES WITH "MUSICASSETTE" SYSTEM?

North American Philips says 39 major manufacturers of tape recording equipment have adopted the Philips compact cassette (cartridge) system. This may foreshadow a standardized cartridge tape system.

The new tape is less than 1/4 inch

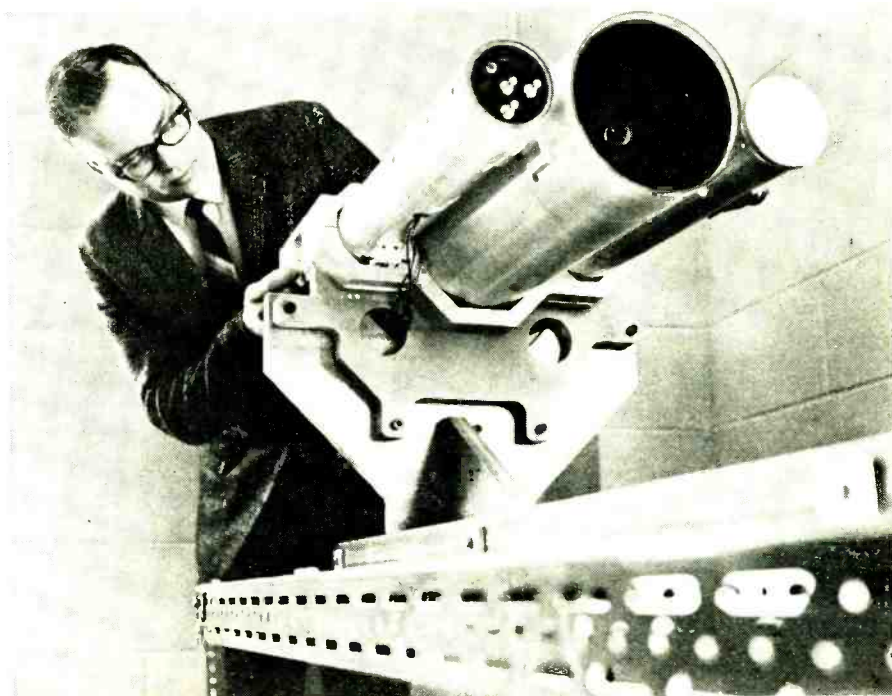

Sylvania engineer Robert Johnson inspects beam reflector (left tube), tracking telescope (center tube) and receiving unit (right tube) of the electrically scanned laser system.

DEVRY TECH NOT ONLY TRAINS YOU... BUT HELPS YOU GET STARTED AT NO EXTRA COST IN THE **BIG-MONEY FIELD** OF

ELECTRONICS!

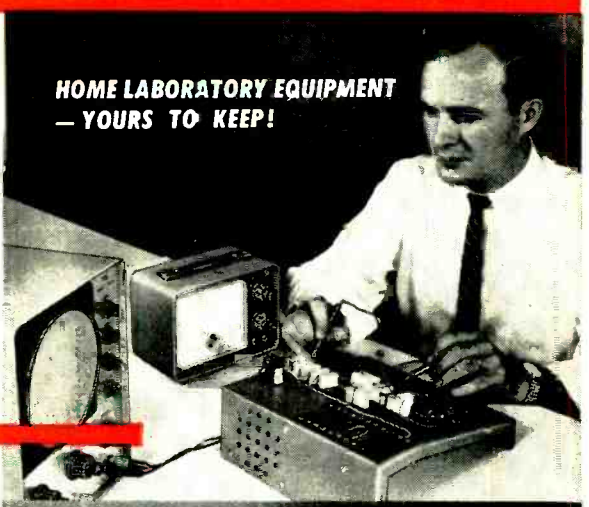

HOME LABORATORY EQUIPMENT — YOURS TO KEEP!

✓ PREPARE AT HOME

Whether you want to prepare for a good-paying new job or for advancement in Electronics with your present employer, DeVry Tech offers specialized educational programs designed to meet your needs. You set up your own HOME LABORATORY and work over 300 construction and test procedures to develop on-the-job type skills. You build a quality Transistorized Meter, a 5-inch Oscilloscope and a special Design Console. DeVry also includes modern "programmed" texts, instructive motion pictures, Consultation Service. Effective? Yes!

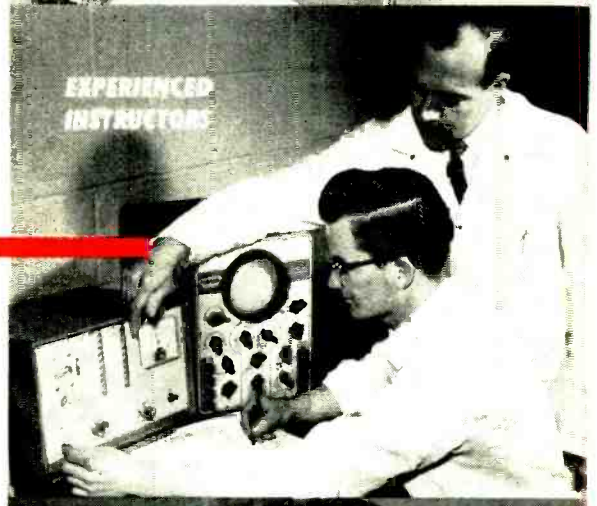

EXPERIENCED INSTRUCTORS

✓ RESIDENT SCHOOL

If you prefer you may get all of your training in DeVry's U.S. or Canadian resident schools under the close guidance of friendly, experienced instructors. You work with a wide variety of commercial equipment similar to that actually used in industry as you prepare in our laboratories for a technician's job in Communications, Microwaves, Radio-Television, Automation, Radar, Computers, or other branch of Electronics. DeVry even provides part-time job placement service to those who wish to earn extra money while attending day or evening classes.

✓ PLACEMENT SERVICE

Meet W. E. Bartz, who has helped thousands of DeVry men toward exciting, profitable careers in Electronics. When YOU complete your program, he will help you too. As Placement Manager in touch with business and industry across the nation, Bartz knows the employer demand for DeVry-trained men. He has cooperated in placing our graduates with thousands of firms!

Men 18-45, start preparing NOW for this vast opportunity field. Soon you should be ready for DeVry's valuable employment help!



MAIL COUPON TODAY!

No Advanced Education or Previous Technical Experience Needed to Get Started

Your ambition and desire to succeed are more important! DeVry guides you every step of the way toward success.

Free

Send coupon for these two actual booklets NOW!



DeVRY TECHNICAL INSTITUTE
 4141 Belmont Avenue, Chicago, Ill., 60641 Dept. RE-9-W
 Please give me your two free booklets, "Pocket Guide to Real Earnings" and "Electronics in Space Travel"; also include details on how to prepare for a career in Electronics. I am interested in the following opportunity fields (check one or more):

<input type="checkbox"/> Space & Missile Electronics	<input type="checkbox"/> Communications
<input type="checkbox"/> Television and Radio	<input type="checkbox"/> Computers
<input type="checkbox"/> Microwaves	<input type="checkbox"/> Broadcasting
<input type="checkbox"/> Radar	<input type="checkbox"/> Industrial Electronics
<input type="checkbox"/> Automation Electronics	<input type="checkbox"/> Electronic Control

Name _____ Age _____
 Address _____ Apt. _____
 City _____ State _____ Zip Code _____

Check here if you are under 16 years of age.
HOME STUDY AND RESIDENT SCHOOL TRAINING AVAILABLE IN CANADA

DEVRY TECHNICAL INSTITUTE
 4141 Belmont Avenue • Chicago, Illinois 60641
 Accredited Member of National Home Study Council



The new Norelco compact cassette stereo recorder with its speakers and a set of the "musicassettes." Cartridges aren't interchangeable with all the other systems.

wide and moves at 1 7/8 inches per second. Unlike some earlier cartridges, this one can be used to record as well as play back. It is fully compatible and interchangeable for playback on all machines using the Philips compact cassette system.

The musicassettes play for 60 minutes. There is also a version using a thinner tape for 90 minutes of play.

PHONE CALL DIRECT-DIALED FROM US TO SWITZERLAND

Just 90 years after Alexander Graham Bell demonstrated the telephone at the Philadelphia Centennial Exposition, a direct-dial telephone call was made between Philadelphia and the continent of Europe. Lowell Wingert, vice president of the Long Lines Department of AT&T, made the call at a session of the International Communications Conference. He dialed 200-2-33-10-11. The 200 is the international "area code." The 2 routed the call to Switzerland, and the other six digits are the telephone number of Jean Rouviere of the International Telegraph and Telephone Consultative Committee, Geneva. Mr. Wingert told the meeting that direct customer dialing between selected central offices in New York City and several European cities would be introduced on an experimental basis next year.

NEA PROPOSES NATIONAL TECHNICIAN CERTIFICATION

As part of its training and upgrading program, the National Electronic Associations has for some time proposed certification of electronic service technicians on a national basis. It has developed and tested written and practical examinations designed to lead to such certification.

The first NEA test was an essay type, with 115 questions, covering test equipment, antennas, color and black-

and-white TV theory, audio and general questions. After trying the test in Indianapolis, Kansas City, Des Moines and Wichita, NEA analyzed the test and defective or ambiguous questions were deleted. The revised test was then brought out in multiple-choice form.

Most capable technicians, says NEA '65-'66 president Dick Glass of Indianapolis, appear to be in favor of certification, and consider the certificates valuable in their customer relations. A certificate also is useful to a prospective employer, as at least a minimum gauge with which to judge a potential employee. Some objections to the program have been voiced, generally by persons with little or no technical training. Approximately 65% of those who have taken the test have passed. An opportunity was provided for a later test for those who failed the first time, and most of them passed on the second try.

The tests are being discussed at the association's national convention (Aug. 18-21) together with plans for putting the certification plan into effect nationally.

ITT SCIENTIST FORECASTS NEW MICROWAVE GENERATORS

Traveling-wave tubes, klystrons, and even varactors may soon be outmoded as microwave generators. Robert Caruthers of International Telephone & Telegraph Corp. (ITT) told the 1966 IEEE International Communications conference.

"Where 2 years ago suppliers were pessimistic about the chances of power transistors ever exceeding 600 MHz, now even greater power output devices are being developed at 1 GHz. Fifteen watts at 1 GHz will soon be a reality and several watts are forecast at 2 GHz by the end of this year.

"The literature is now stressing Gunn-effect, silicon-controlled avalanche (SCAT) and metal-base transistors. With the Gunn device, watts and even kilowatts are forecast at microwave. We can anticipate their use in pulse-type operation, replacing klystron radar transmitters. There is less publicized information on the progress in SCAT, metal-base, and other exotic transistors, but all researchers seem to believe that powers of 5 watts or more are possible through 6 GHz using these devices as transmitting amplifiers," Caruthers concluded.

GENERAL SARNOFF PROPOSES AN INTERNATIONAL PATENT SYSTEM

A global patent system, using satellite communications and electronic data processing, would be an important step in spreading technology more

continued on page 12

Radio-Electronics

154 WEST 14TH STREET
NEW YORK 10011

HUGO GERNSBACK, *editor-in-chief*

M. HARVEY GERNSBACK, *publisher*

FOREST H. BELT, *editor*

Bruce Ward, *production manager*

Robert F. Scott, W2PWG, *technical editor*

Jack Darr, *service editor*

I. Queen, *editorial associate*

Wm. Lyon McLaughlin,
technical illustration director

Nancy Gitchel, *editorial assistant*

Patricia Mitchell, *production assistant*

G. Aliquo, *circulation manager*

Joseph L. Bund, *newsstand director*

Cover by Harry Schlack

RADIO-ELECTRONICS is published by Gernsback Publications, Inc.

Chairman of the Board: Hugo Gernsback

President: M. Harvey Gernsback

Vice President-Secretary: G. Aliquo

Vice President-Treasurer: Charles A. Raible

ADVERTISING REPRESENTATIVES

EAST

John J. Lamson, Eastern Sales Manager, RADIO-ELECTRONICS, 154 West 14th Street, New York 10011, 212-255-7755

MIDWEST

P. H. Dempers Co., 5555 N. Lincoln Ave., Chicago, Ill. 60625, 312-561-0220

WEST COAST

J. E. Publishers Representative Co., 8380 Melrose Ave., Los Angeles, Calif. 90069, 213-653-5841; 420 Market St., San Francisco, Calif. 94111, 415-981-4527

UNITED KINGDOM

Publishing & Distributing Co., Ltd., Mitre House, 177 Regent St., London W.1, England

SUBSCRIPTION SERVICE: Send all subscription correspondence and orders to RADIO-ELECTRONICS, Subscription Department, Boulder, Colo. 80302. For change of address, allow six weeks, furnishing both the old and new addresses and if possible enclosing label from a recent issue.

MOVING? Or writing about subscription? Be sure to fill out form below.

For FASTEST service on address change, missing copies, etc., attach old mailing label in first space below. Otherwise please print clearly your address as we now have it.

OLD ADDRESS (Attach old label if available)

Name

Address

City State

Zip Code

NEW ADDRESS

Name

Address

City State

Zip Code

Mail to: RADIO-ELECTRONICS
Subscription Dept. Boulder, Colo. 80302

RADIO-ELECTRONICS

E. F. JOHNSON

...The finest name in CB radio

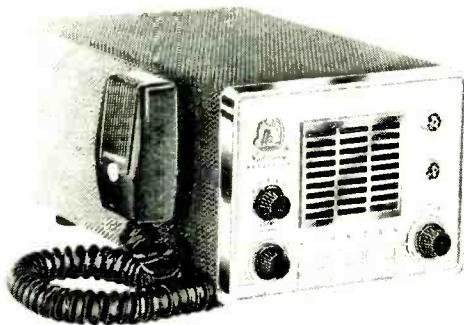
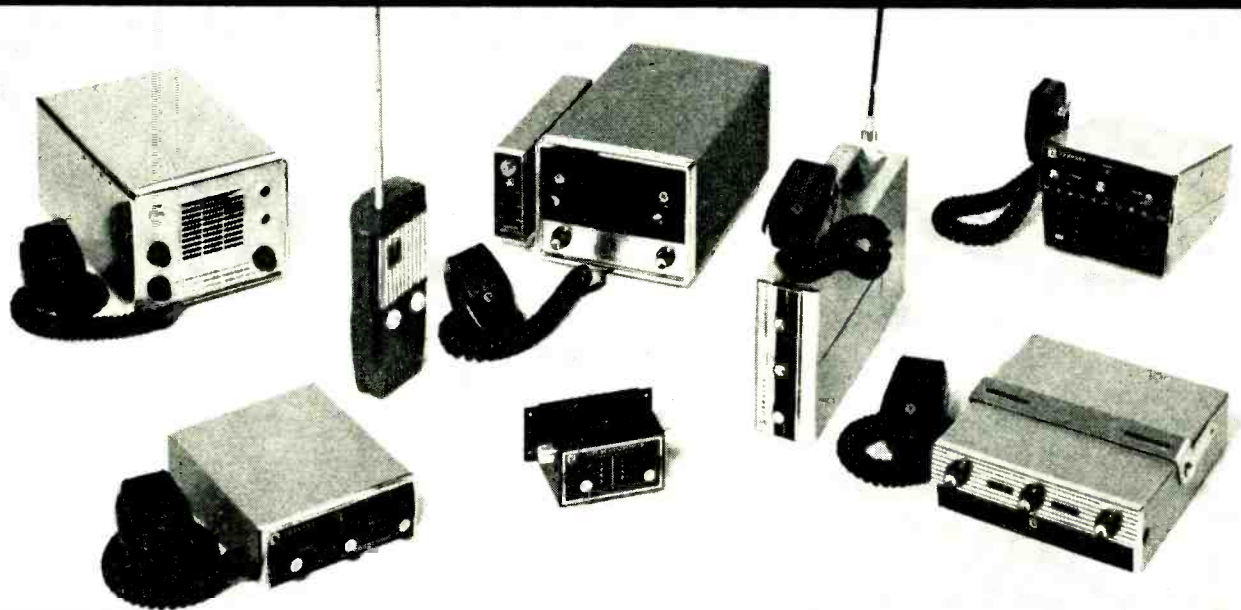

MESSENGER

A best seller for years. Five crystal controlled channels. For 115 Volt AC and 6 or 12 Volts DC.

\$9995 NET

Johnson sets the standards for performance and reliability and lives up to them. It's all a result of manufacturing excellence and engineering superiority.

Johnson brings you the most complete line of CB transceivers and accessories ever offered. Take advantage of the new low prices on three popular Messengers and move up to Johnson.

The most reliable name in communications



E. F. JOHNSON COMPANY

2349 10th AVE. S.W. • WASECA, MINN. 56093

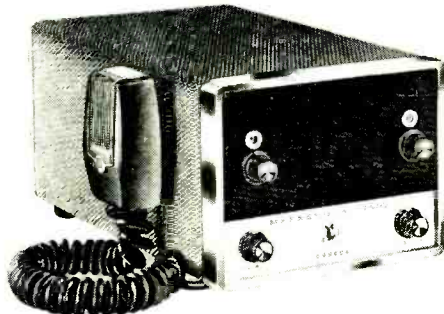

MESSENGER TWO

Ten channels and tunable receiver. Excellent selectivity.

\$14995 NET

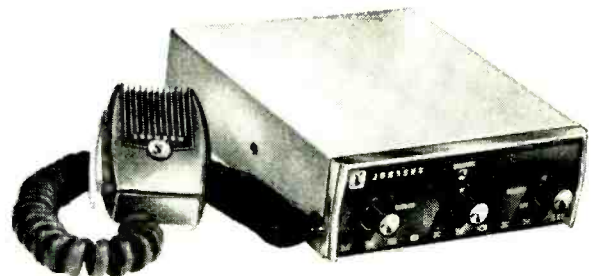

MESSENGER III

Perfect for base, mobile or portable. All solid state design throughout.

\$15995 NET

Circle 10 on reader's service card

Electronics comes alive with NRI Training Kits

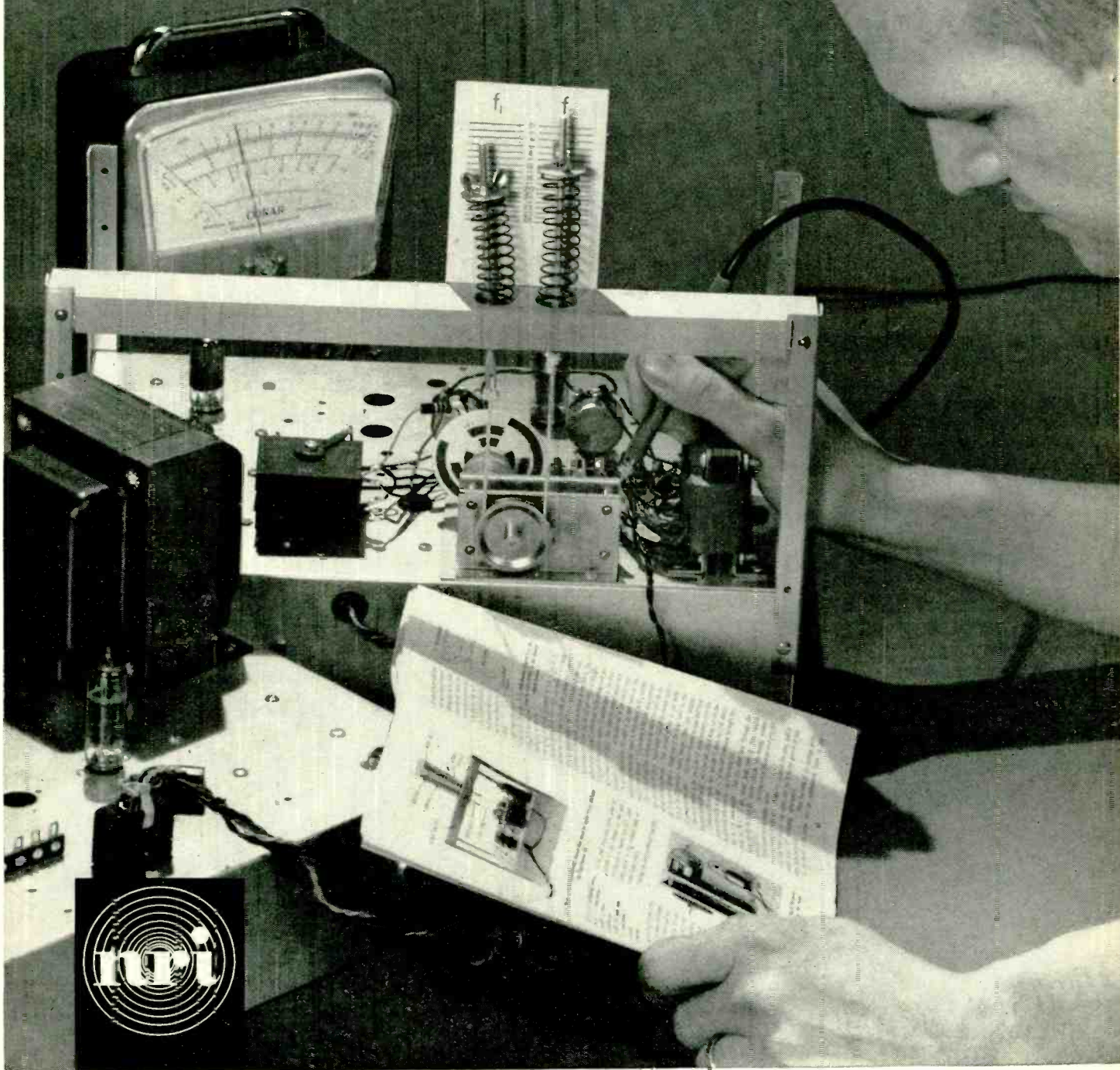

DISCOVER THE EASE AND EXCITEMENT OF TRAINING AT HOME THE NRI WAY

New Achievement Kit—Custom Training Kits—"Bite Size" Texts

Only NRI offers you this pioneering method of simplified "3 Dimensional" home-study training in Electronics, TV/Radio and Broadcasting/Communications. It's a remarkable teaching idea unlike anything you have ever encountered, the result of more than half a century of simplifying, organizing and dramatizing learning-at-home techniques. If you are an ambitious man—regardless of your education—you can effectively learn the Electronics field of your choice the NRI way.

NRI has *simplified* Electronics by producing "bite size" lesson texts averaging only 40 pages each. Dozens of illustrations open wide a picture window through which you'll see and understand practical uses of Electronics. You start out with NRI's exclusive Achievement Kit, containing everything you need to get started fast. (Illustrated at right.)

NRI has *organized* Electronics training to take you step-by-step from the first stages into more intriguing areas. Once you know the fundamentals thoroughly, it's easy to grasp more advanced theory and techniques. You move with confidence and enthusiasm into a new adventure filled with the excitement of discovery.

NRI has *dramatized* Electronics through the careful development of special training equipment that is *programmed* into your training systematically . . . beginning with your first group of lessons. Things you read about come alive in your hands as you build, experiment, purposely cause "problems" in circuits—and solve them. You learn to use test equipment, to build radios and TV sets, transmitter, or computer circuits. It's the priceless "third dimension" in NRI training . . . practical experience.



YOU GET MORE FOR YOUR MONEY FROM NRI

Mail postage-free card now for your free NRI catalog. Then, compare. You'll find—as have thousands of others—NRI training can't be beat. Read about the new Achievement Kit sent the day you enroll; about "bite-size" texts and custom designed training equipment. See why NRI gives you more value. Whatever your reason for wanting more knowledge of Electronics, NRI has an instruction plan for you. Choose from major programs in TV/Radio Servicing, Industrial Electronics and Complete Communications. Or select from special courses to meet specific needs. Check the course of interest to you on postage-free card and mail today for free NRI catalog. Nosaesman will call. NATIONAL RADIO INSTITUTE, Electronics Div., Washington, D.C. 20016.

Available Under NEW GI BILL

If you served since January 31, 1955, or are in service, check GI line in postage-free card.

More than 50 years of leadership
in Electronics Training



Career? Part-Time Earnings? Hobby? Choose From 10 Training Plans

1. TELEVISION-RADIO SERVICING

Complete training from basic fundamentals of electricity to home entertainment equipment. You learn how to fix radios, hi-fi and stereo sets, black-and-white and color TV, PA systems, etc. A profitable field full or part-time.

2. COMPLETE COMMUNICATIONS*

Designed to teach and provide you with actual practice in operation, service and maintenance of AM, FM and TV broadcasting stations. Also covers marine, aviation, mobile radio, facsimile, microwave, radar.

3. INDUSTRIAL-MILITARY ELECTRONICS

From basic principles to computers. A comprehensive training plan that teaches you the fundamentals, then takes you into such modern-day miracles as servos, telemetry, multiplexing, pulse circuitry, data processing, other career-building subjects.

4. FCC LICENSE*

Specifically designed short course to prepare you for your First Class FCC Radio-telephone License examinations. You begin

with a thorough background in fundamental Electronic principles, advance to required subjects covering equipment and procedures.

5. BASIC ELECTRONICS

A concise course to teach modern Electronics terminology and components. A wealth of practical, useful information to help you better understand the field, to give you some technical knowledge. For anyone who wants a basic understanding of Radio-TV Electronics.

6. MATH FOR ELECTRONICS

A brief course for engineers and technicians who need a quick review of the essential mathematics used in industry, in communications, in government jobs. Basic arithmetic review, short-cut formulas, modern digital numbers systems, much, much more.

7. ELECTRONICS FOR AUTOMATION

This course not for beginners. Offered for men with some fundamental knowledge of Electronics who want a better understanding of Automation in current use. Covers process control, ultrasonics, telemetering and remote control, electromechanical measurements, other key subjects.

8. AVIATION COMMUNICATIONS*

This course prepares you to install, maintain, service aircraft communications equipment. Covers direction finders, ranges, markers, Loran, Shoran, radar, landing systems. Earn your First Class FCC License with Radar Endorsement.

9. MOBILE COMMUNICATIONS*

Learn to install and maintain mobile equipment and associated base stations. Covers transmitters and receivers used by police and fire departments, public utilities, construction projects, taxis, etc. Prepares you for a First Class FCC License.

10. MARINE COMMUNICATIONS*

Covers transmitters, direction finders, depth indicators, radar, Sonar, other equipment used on commercial ships and thousands of pleasure boats. Prepares you for your First Class FCC License with Radar Endorsement.

* You must pass your FCC License exam (any Communications course) or NRI refunds in full the tuition you have paid.

WHY risk your reputation with "just-as-good" capacitors?

When you pay little or no attention to quality in tubular replacement capacitors, you leave yourself wide open for criticism of your work . . . you risk your reputation . . . you stand to lose customers. It just doesn't pay to take a chance on capacitors with unknown or debatable performance records when it's so easy to get guaranteed dependable tubulars from your Sprague distributor!

There's no "maybe" with these 2 great SPRAGUE DIFILM® TUBULARS!

The ultimate in tubular capacitor construction. Dual dielectric . . . polyester film and special capacitor tissue . . . combines the best features of both. Impregnated with H₂CX®, an exclusive Sprague synthetic hydrocarbon material which fills every void in the paper, every pinhole in the plastic film *before it solidifies*, resulting in a rock-hard capacitor section . . . there's no oil to leak, no wax to drip. Designed for 105°C (220°F) operation without voltage derating.

DIFILM® ORANGE DROP® Dipped Tubular Capacitors



A "must" for applications where only radial-lead capacitors will fit . . . the perfect replacement for dipped capacitors now used in many leading TV sets. Double-dipped in rugged epoxy resin for positive protection against extreme heat and humidity. No other dipped tubular capacitor can match Sprague Orange Drops!



DIFILM® BLACK BEAUTY® Molded Tubular Capacitors

The world's most humidity-resistant molded capacitors. Tough, protective outer case of non-flammable molded phenolic . . . cannot be damaged in handling or installation. Black Beauty Capacitors will withstand the hottest temperatures to be found in any TV or radio set, even in the most humid climates.

For complete listings, get your copy of Catalog C-616 from your Sprague distributor, or write to Sprague Products Company, 81 Marshall Street, North Adams, Massachusetts.

SPRAGUE®
THE MARK OF RELIABILITY

WORLD'S LARGEST MANUFACTURER OF CAPACITORS

65-6110

Circle 12 on reader's service card

equitably around the world, General Sarnoff stated to the Patent, Trademark & Copyright Research Institute of George Washington University.

"The fragmented array of national patent systems," said the RCA chairman, "inhibits the swift and equitable worldwide distribution of patent benefits. When we can transmit an idea around the world in less than 1/7 second, why must years elapse before that idea can be validated within or outside the country of origin?"

"The instruments for such a system include the coming worldwide array of high-capacity satellites and the emerging generation of high-speed electronic data processing and information storage systems."

NEW UNDERSEA CABLE SYSTEM FIRST TO USE TRANSISTORS

Bell Telephone Laboratories' new undersea telephone cable system can carry nearly six times as many two-way conversations as any present US undersea cable. The new SF system, as it is called, provides for 720 two-way channels, compared to 128 two-way circuits in the previous SD system.

Transistor amplifiers, used for the first time, help broaden the bandwidth and therefore increase the number of voice channels. The transistors are expected to have an even longer life than the estimated 25 years of tubes previously used in such amplifiers. The amplifiers will be spaced 10 nautical miles apart, and each will provide a gain of about 40 dB.

The first cable used in the new system is expected to be a 1,250-mile stretch between Jacksonville, Fla., and St. Thomas, Virgin Islands.

CALENDAR OF EVENTS

NEA (National Electronic Associations, Inc.), August 18-21; Sheraton Motor Inn, Winston-Salem, N. C.

WESCON (Western Electronic Show and Convention), August 23-26; Sports Arena, Los Angeles, Calif.

NATESA (National Alliance of Television and Electronic Service Associations) Convention, August 25-28; Sherman House, Chicago, Ill.

IEEE 16th Broadcast Symposium, September 22-24; Mayflower Hotel, Washington, D. C.

New York Hi-Fi Music Show, September 22-October 2; New York Trade Show Building, New York, N. Y.

Radio-Electronics Adopts Hertz

RADIO-ELECTRONICS is now using the term *hertz* in place of cycles in all references to frequency. Hz, kHz and MHz, abbreviations for hertz, kilohertz and megahertz, are replacing cycles, kc and mc in all recently edited material.

RADIO-ELECTRONICS

we looked into your future, then created the "little corporal," a most remarkable CRT tester.

B & K has done it again . . . put you a "jump ahead" by looking into your future . . . your problems, *your* needs. This is the "Little Corporal," the CRT Rejuvenator and Checker, designed to provide maximum obsolescence protection by providing continuously variable voltages for all CRT elements. You can make the most accurate possible tests, even on future CRT types, because the heater

voltage is metered and is continuously variable from 0 to 13 volts with any tube heater current. And, using the required adaptors, you can test and correct all tube, transistor or integrated circuit black and white and color picture TV tube troubles (including GE 11" color and imported color tubes) in a few minutes . . . in the home or on the bench . . . without removing tubes from the TV set.

You can give new life to weak or inoperative picture tubes—prove to your customers their need for new tubes.

The "Little Corporal," another product of B & K electronic innovation, carries the B & K Professional Servicing Equipment emblem, your assurance . . . your customers' assurance . . . that you use the finest equipment made.

Model #465, Net: \$89.95.



A Division of
Dynascan Corporation
1801 W. Belle Plaine
Chicago, Illinois 60613

Export: Empire Exporters, Inc.
123 Grand Street
New York, NY., 10013



A Division of Dynascan
Where Electronic Innovation
Is A Way of Life

Circle 13 on reader's service card

Then,
it takes a lot
of know-how to
be a UNIVAC
field engineer?



One reason we're leaders in the commercial computer industry is the kind of people we have working for us and the kind of training we give them as they go along.

In the case of our field engineers we give them plenty. So much, in fact, that they don't need a college degree to get started with us. If you have a good grasp of electronic and electro-mechanical fundamentals and a more than ordinary amount of ambition, we'll see to it that you get all the training you can handle on our various computers... And we'll pay you while in training.

After that you'll be on your way up as one of our career field engineers—installing and maintaining our equipment. We have field offices all across the nation and overseas as well. You'll be assigned to one of them.

Sound good? Wait until you hear about UNIVAC's expense allowances, fringe benefits, and advancement policies.

**Interested candidates are invited to write
Manager of Field Administration, UNIVAC,
P.O. Box 8100, Philadelphia, Pa.
Dept. 60J**

UNIVAC
DIVISION OF SPERRY RAND CORPORATION

An Equal Opportunity Employer

Want to know
how you can
learn while we're
paying you?



METAL LOCATOR QUERIES

Dear Editor:

I am building the underwater metal locator described in your June issue. Please explain how I can make the set's i.f. amplifier oscillate or publish the circuit of a separate bfo.

E. WILHELM

Islip, N. Y.

Many transistor i.f. amplifiers are relatively unstable and it doesn't take much to make them oscillate. Connect a short piece of insulated hookup wire to the base of the i.f. input transistor and a second piece to the collector of the i.f. output stage. Twist the two leads together (a "gimmick") and the circuit should oscillate so that you hear a whistle when you tune a station. Twist the leads just enough to get a faint whistle. Don't overdo it, or you'll decrease the set's sensitivity.

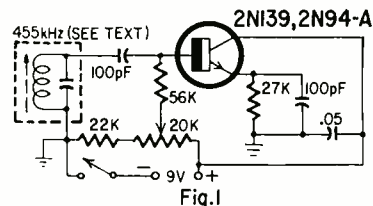
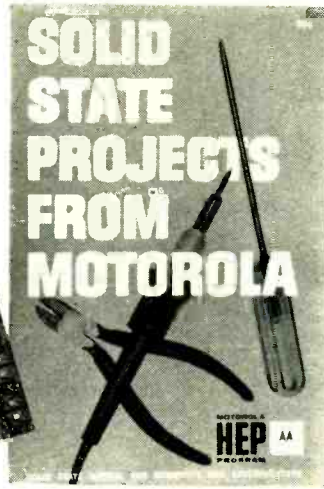
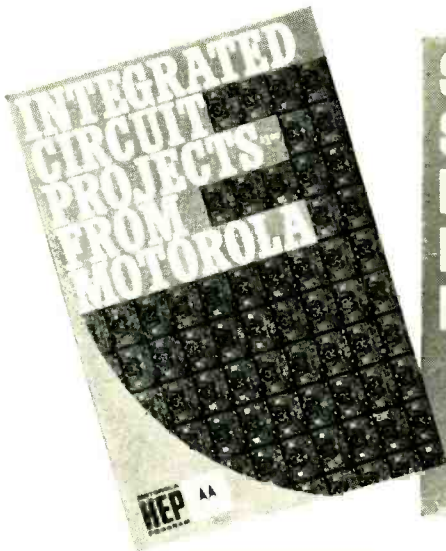

Fig. 1

A separate bfo as in Fig. 1 allows more control over the strength of the beat note. The 455-kHz circuit may be the primary of a replacement-type transistor i.f. transformer. The 20,000-ohm pot adjusts the strength of oscillation. You may have to connect a small capacitor—about 10 pF or so—between the transistor base and emitter for reliable oscillation within the range of the pot. Use the tiniest available parts and you'll probably be able to build the bfo in the case with the receiver. Otherwise, build it in a small box you can fasten to the outside of the set. You may have to use a "gimmick" or tiny capacitor to couple the top end of the bfo coil to the set's detector circuit.

Some readers haven't been able to purchase the 75-ohm ribbon-type transmission line specified for the search coil. This cable is made by several firms but is not readily available. In most cases, it only comes in 100-foot and longer rolls. This type wire was recommended simply because it is easier to thread two turns through 1/2-inch tubing and con-

NOW FIELD EFFECT TRANSISTOR and INTEGRATED CIRCUIT PROJECTS



IN 3 HEP SOLID-STATE PROJECT BOOKS FROM MOTOROLA

Motorola's HEP program provides you with the latest in quality semiconductors and offers proven projects incorporating these new devices. These project books, prepared for beginner and expert, contain easy-to-follow text and illustrations that make construction as easy as "electronics by the numbers." These books open new vistas for using semiconductors in test equipment, computers, musical instruments and fun circuits.

The first Integrated Circuit Project Book for hobbyist and experimenters contains eight chapters, 96 pages, including a basic introduction to integrated circuits. Build your own completely portable square wave generator featuring a 10 nanosecond rise time, and frequency response from 6 Hz to 60 kHz in four ranges. For fun you can build an I/C 4-octave organ with separate voicing controls. Other projects include a gliditone, binary computer, oscillator, electronic string guitar etc. Price **\$1.00**

Ten chapters, including a basic description on semiconductor fundamentals. Projects include a regulated power supply, intercom, motor speed control, 6-meter converter, minifi amplifier, signal generator and other circuits. Price **\$.50**

Another HEP first—a project book full of circuits utilizing the field effect transistor (FET), 96 pages. Projects include a high impedance DC Voltmeter (22 mega-ohms) with a scale of accuracy of $\pm 2\%$ that requires no zeroing when changing ranges; a four-input audio-mixer with a flat frequency response of 20 Hz to over 100 kHz, as well as such projects as a timer, crystal calibrator, vibrato preamp etc. Price **\$1.00**

On sale at all Motorola HEP franchised outlets, the books are also available by sending the coupon below, with the appropriate amount, plus 10 cents for handling, to HEP, Box 955, Phoenix, Arizona 85001.

HEP

DEPT. RE96
BOX 955,
PHOENIX, ARIZ.
85001

Gentlemen:

Please send the following HEP project books:

- Integrated Circuit Projects From Motorola\$1.10
- Field Effect Transistor Projects\$1.10
- Solid-State Projects From Motorola\$.60

Enclosed is _____



MOTOROLA
Semiconductor
Products Inc.

Name _____

Address _____

City _____

State _____ Zip code _____

nect the leads in series to make a 4-turn coil than it is to thread 4 turns of single-conductor wire. You can use any ribbon-type wire. A convenient and readily available substitute is ordinary POSI lamp cord.

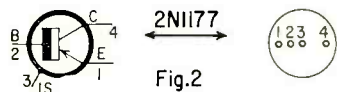

One reader was puzzled by the "extra" lead on the base of the 2N1177 transistor. This transistor has an internal shield connected to a separate lead—see Fig. 2.

CORRECT ADDRESS

Dear Editor:

My thanks to John F. Cleary for his mention of my book "Electronic Musical Instruments" on page 45 of the June issue. Readers and book stores will have better luck obtaining it, however, with the publisher's correct address:

Radiofile
43 West 61 St.
New York, N. Y. 10023
Price, by the way, is \$7.50.

RICHARD H. DORF

New York, N. Y.

READER'S RESULT

Dear Editor:

Enclosed is a photo of the supply we built from Mr. Rogers' article "All Silicon Regulated Power Supply" in the June 1966 issue. We service several dozen transistor amplifiers in the language lab of a local college, and the power supply we had just wasn't large

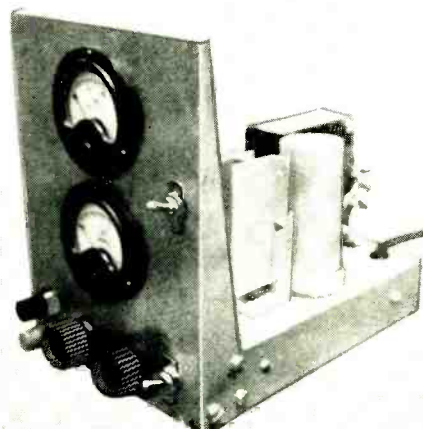

enough to handle them. We made the chassis, the front panel, punched and drilled them, calibrated some 1-mA (0-3V scale) meters we acquired, and put the unit together. You can see the result. We believe this one will fill our requirements. Thanks for this timely article.

E. PAUL HUNT

Liberty, Mo.

SE . . . WHAT?

Dear Editor:

Leslie's article on the European squabble (July 1966 RADIO-ELECTRONICS, page 68) is OK. However, SECAM comes from *SE*quential *C*ouleur *A* Memoire, no matter how the French *qu* is pronounced.

Incidentally, direct reports from some English friends who have seen SECAM in operation say (not a direct quote): "Bloody Awful!"

J. WALLINGFORD

Little Rock, Ark.

END

TESTING CAMERA SHUTTERS WITH YOUR OSCILLOSCOPE

Did you know that you can turn an ordinary service scope into a device that will measure how long the shutter remains open? Edward F. Rice explains how you can do this in the October issue.

RADIO-ELECTRONICS

Also see the special section on Industrial Electronics

DEEPCUT
 ANTENNAS
 EXPENSE
 FREE

MEET ALL CRITICAL DEMANDS WITH TARGET ANTENNAS

MODEL PW
UHF-VHF-COLOR-FM
PASSIVE WAVE
ANTENNA

S & A easily satisfies your most demanding specifications for sharp brilliant reception.

- **MODEL PW ANTENNAS**
Passive Wave combined with the best features of Log Periodic construction produce a new design unequalled in overall operation. Wave guide element system in combination with frequency independent drive effects a new breakthrough in a high gain channel 2 through 83 antenna. UHF section provides director action at VHF high band frequencies in addition to wave guide control at UHF frequencies.
- **MODEL FID ANTENNAS**
Eliminate the need for two antennas by using this new VHF-FM Color antenna incorporating frequency independent drive. (Log Periodic Construction.) Features a new phase angle control director system which provides a triple function, greatly increasing performance obtainable with ordinary dual band systems. Assures VHF and color plus FM listening at their finest.

PAT. PENDING

MODEL FID
FREQUENCY
INDEPENDENT
DRIVE ANTENNA
VHF-FM-COLOR

... manufacturers of the TARGET ANTENNA

S & A Electronics Inc.

210 W. FLORENCE ST. • TOLEDO, OHIO 43605

Phone: 419-693-0528

Circle 16 on reader's service card

not all
cardioid microphones
are alike . . .

only the

SHURE UNIDYNE III

TRUE CARDIOID UNIDIRECTIONAL DYNAMIC
MICROPHONE SOLVES ALL THESE
COMMON MICROPHONE PROBLEMS!

MODEL 545S

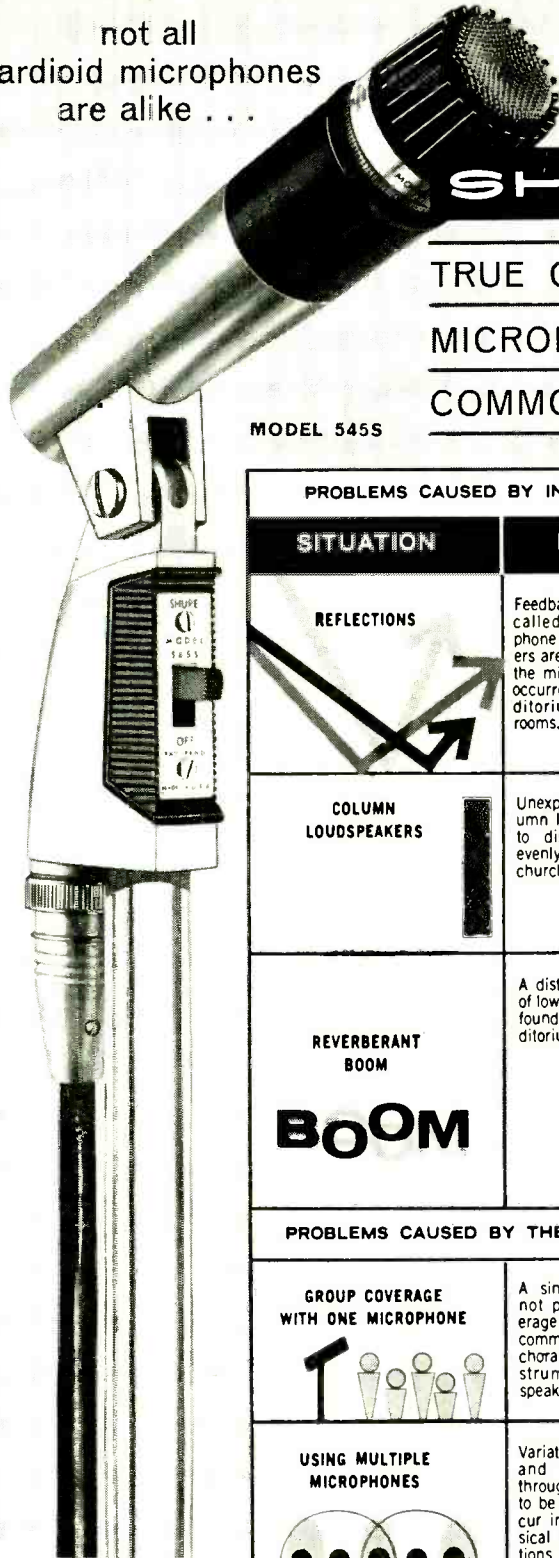

SHURE
BROTHERS, INC.

222 Hartrey Ave.
Evanston, Illinois

PROBLEMS CAUSED BY INEFFICIENT REJECTION OF UNWANTED SOUNDS BY THE MICROPHONE			
SITUATION	PROBLEM	CAUSES	SOLUTION
<p>REFLECTIONS</p>	<p>Feedback occurs where a so-called "cardioid" microphone is used and the speakers are placed to the rear of the microphone. A common occurrence in churches, auditoriums, and meeting rooms.</p>	<p>Sound bounces off hard surfaces on the walls, floor and ceiling, in and around the audience area and the microphone used is not effective in rejecting these sounds at all frequencies, and in all planes about its axis.</p>	<p>The Unidyne III eliminates this problem because of effective rejection of sound at the rear of the microphone with uniformity at all frequencies. Sounds bouncing off the floor or other reflective surfaces that reach the rear of the Unidyne III are rejected.</p>
<p>COLUMN LOUSPEAKERS</p>	<p>Unexplained feedback. Column loudspeakers are used to distribute sound more evenly to the audience in churches and auditoriums.</p>	<p>While column speakers direct the sound toward the audience, they also have side and rear sound lobes which may reach the microphone. Feedback occurs when the rear and side sound lobes of the speakers coincide with the rear and side lobes of a so-called "cardioid" microphone.</p>	<p>The Unidyne III solves this problem because it has no rear or side lobes. Thus it rejects the side and rear lobes of the sound column speakers.</p>
<p>REVERBERANT BOOM</p> <p>BOOM</p>	<p>A disturbing, echoing effect of low frequency sound often found in churches, large auditoriums, and arenas.</p>	<p>The particular "cardioid" microphone used fails to retain its unidirectional characteristics with low frequencies. In addition, its front response tends to accent low frequencies of the desired sounds. These factors result in pickup and reinforcement of the low frequency reverberation and boominess characteristic of many halls.</p>	<p>Using the Unidyne III Microphone will solve the problem because it maintains a uniform pattern of sound rejection in all frequencies, even as low as 70 cps. The frequency response also has a controlled roll-off of the low end. This prevents reinforcement of the low frequency reverberation and diminishes the effect of a boomy hall.</p>
PROBLEMS CAUSED BY THE MICROPHONE'S INEFFECTIVENESS IN PICKING UP THE DESIRED SOUND			
<p>GROUP COVERAGE WITH ONE MICROPHONE</p>	<p>A single microphone does not provide uniform coverage of a group. This is commonly experienced with choral groups, quartettes, instrumental combos, and speaker panels.</p>	<p>The particular "cardioid" microphone used lacks a uniform pickup pattern, so that persons in different positions within the general pickup area of the microphone are heard with varying tonal quality and volume.</p>	<p>The Unidyne III affords uniform pickup of the group with a resulting consistency in volume and sound quality among the members of the group.</p>
<p>USING MULTIPLE MICROPHONES</p>	<p>Variation in the pickup level and tonal quality exists throughout the broad area to be covered. This may occur in stage pickup of musical and dramatic productions, panels and audience participation events.</p>	<p>The pickup pattern of the microphones used is too narrow, causing "holes" and "hot spots". The off-axis frequency response of the microphones also varies.</p>	<p>The Unidyne III permits a smoothness in pickup as the true cardioid pattern gives broad coverage with uniformity throughout the coverage area. This eliminates "holes", "hot spots", and the variations in sound quality and permits blending many microphones with ease.</p>
<p>DISTANT PICKUP</p>	<p>Too much background noise or feedback results when working with microphone at desired distance from sound source.</p>	<p>So-called "cardioid" and particularly long range microphones being used are less directional with lower frequencies. In addition, they have lobes or hot spots that pick up sound at the rear, resulting in the background noise or feedback problem.</p>	<p>Use the Unidyne III to gain relatively long range with effective rejection of sound at all frequencies at the rear of the microphone.</p>

Circle 17 on reader's service card

The "Chip"

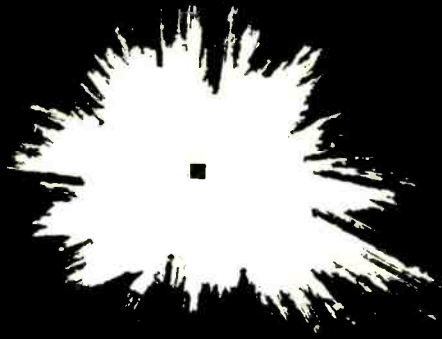

**...will it make or break
your job future?**

THE DEVELOPMENT OF INTEGRATED CIRCUITRY is the dawn of a new age of electronic miracles. It means that many of today's job skills soon will be no longer needed. At the same time it opens the door to thousands of exciting new job opportunities for technicians solidly grounded in electronics fundamentals. Read on the facing page what you need to know to cash in on the gigantic coming boom, and how you can learn it right at home.

TINY ELECTRONIC "CHIPS," each no bigger than the head of a pin, are bringing about a fantastic new Industrial Revolution. The time is near at hand when "chips" may save your life, balance your checkbook, and land a man on the moon.

Chips may also put you out of a job ...or into a better one.

"One thing is certain," said *The New York Times* recently. Chips "will unalterably change our lives and the lives of our children probably far beyond recognition."

A single chip or miniature integrated circuit can perform the function of 20 transistors, 18 resistors, and 2 capacitors. Yet it is so small that a thimbleful can hold enough circuitry for a dozen computers or a thousand radios.

Miniature Miracles of Today and Tomorrow

Already, as a result, a two-way radio can now be fitted inside a signet ring. A complete hearing aid can be worn entirely inside the ear. There is a new desk-top computer, no bigger than a typewriter yet capable of 166,000 operations per second. And it is almost possible to put the entire circuitry of a color television set inside a man's wrist-watch case.

And this is only the beginning!

Soon kitchen computers may keep the housewife's refrigerator stocked, her menus planned, and her calories counted. Her vacuum cleaner may creep out at night and vacuum the floor all by itself.

Money may become obsolete. Instead you will simply carry an electronic charge account card. Your employer will credit your account after each week's work and merchants will charge each of your purchases against it.

When your telephone rings and nobody's home, your call will automatically be switched to the phone where you can be reached.

Doctors will be able to examine you internally by watching a TV screen while a pill-size camera passes through your digestive tract.

New Opportunities for Trained Men

What does all this mean to someone working in electronics who never went beyond high school? It means the opportunity of a lifetime—if you take advantage of it.

It's true that the "chip" may make a lot of manual skills no longer necessary.

But at the same time the booming sales of articles and equipment using integrated circuitry has created a tremendous demand for trained electronics personnel to help design, manufacture, test, operate, and service all these marvels.

There simply aren't enough college-trained engineers to go around. So men with a high school education who have mastered the fundamentals of electronics theory are being begged to accept really interesting, high-pay jobs as engineering aides, junior engineers, and field engineers.

How To Get The Training You Need

You can get the up-to-date training in electronics fundamentals that you need through a carefully chosen home study course. In fact, some authorities feel that a home study course is the best way. "By its very nature," stated one electronics publication recently, "home study develops your ability to analyze and extract information as well as to strengthen your sense of responsibility and initiative." These are qualities every employer is always looking for.

If you do decide to advance your career through spare-time study at home, it makes sense to pick an electronics school that specializes in the home study method. Electronics is complicated enough without trying to learn it from texts and lessons that were designed for the classroom instead of correspondence training.

The Cleveland Institute of Electronics has everything you're looking for. We teach only Electronics—no other subjects. And our courses are designed especially for home study. We have spent over 30 years perfecting techniques that make learning Electronics at home easy, even for those who previously had trouble studying.

Your instructor gives your assignments his undivided personal attention—it's like being the only student in his "class!" He not only grades your work, he analyzes it. And he mails back his corrections and comments the same day he gets your lessons, so you read his notations while everything is still fresh in your mind.

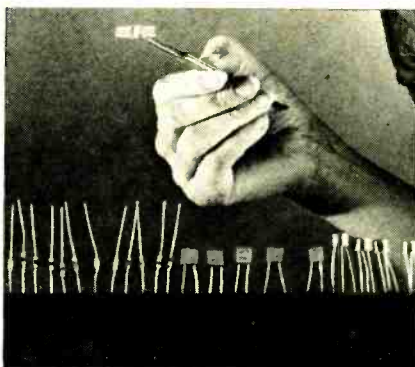

50 FUNCTIONS IN A SINGLE CHIP. The functions of these 50 separate transistors, diodes, resistors and capacitors can now be formed by the tiny dot in the center of the integrated circuit held by the tweezers.

Always Up-To-Date

Because of rapid developments in electronics, CIE courses are constantly being revised. Students receive the most recent revised material as they progress through their course. This year, for example, CIE students are receiving exclusive up-to-the-minute lessons in Microminiaturization, Logical Troubleshooting, Laser Theory and Application, Single Sideband Techniques, Pulse Theory and Application, and Boolean

Algebra. For this reason CIE courses are invaluable not only to newcomers in Electronics but also for "old timers" who need a refresher course in current developments.

Praised by Students Who've Compared
Students who have taken other courses often comment on how much more they

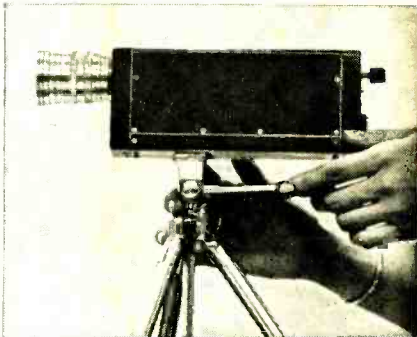

TINY TV CAMERA for space and military use is one of the miracles of integrated circuitry. This one weighs 27 ounces, uses a one-inch vidicon camera tube, and requires only four watts of power.

learn from CIE. Mark E. Newland of Santa Maria, California, recently wrote: "Of 11 different correspondence courses I've taken, CIE's was the best prepared, most interesting, and easiest to understand. I passed my 1st Class FCC exam after completing my course, and have increased my earnings \$120 a month."

Get FCC License or Money Back

No matter what kind of job you want in Electronics, you ought to have your FCC Commercial License. It's accepted everywhere as proof of your education in Electronics. And no wonder—the Government licensing exam is tough. So tough, in fact, that without CIE training, two out of every three men who take the exam fail.

But better than 9 out of every 10 CIE-trained men who take the exam pass...on their very first try!

This has made it possible to back our FCC License courses with this famous Warranty: you *must* pass your FCC exam upon completion of the course or your tuition is refunded in full.

Mail Card For Two Free Books

Want to know more? The postpaid reply card bound in here will bring you free copies of our school catalog describing today's opportunities in electronics, our teaching methods, and our courses, together with our special booklet on how to get a commercial FCC License. If card has been removed, just send us your name and address.

VETERANS

If you had active duty in any branch of the Armed Forces after January 31, 1955, you may be entitled to Government-paid tuition for any CIE course.

CIE Cleveland Institute of Electronics
1776 E. 17th St., Dept. RE-23, Cleveland, Ohio 44114
Accredited Member National Home Study Council • A Leader in Electronics Training... Since 1934

COMPLETE TUNER OVERHAUL

ALL MAKES—ONE PRICE

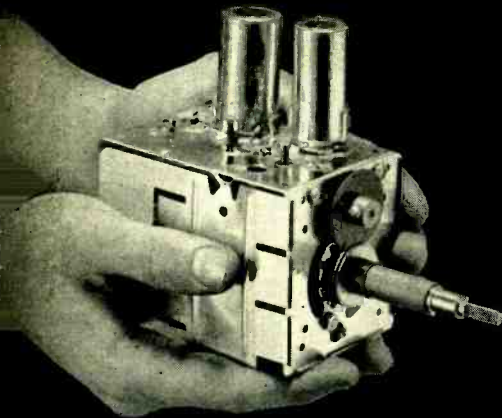

ALL LABOR AND PARTS (EXCEPT TUBES & TRANSISTORS)*

9.95



VHF



UHF



COLOR



UV



COLOR TUNERS



TRANSISTOR

Guaranteed Color Alignment—No Addit. Charge

Simply send us the defective tuner complete; include tubes, shield cover and any damaged parts with model number and complaint. Your tuner will be expertly overhauled and returned promptly, performance restored, aligned to original standards and warranted for 90 days.

UV combination tuner must be single chassis type; dismantle tandem UHF and VHF tuners and send in the defective unit only.

Exact Replacements are available for tuners unfit for overhaul. As low as \$12.95 exchange. (Replacements are new or rebuilt.)

Pioneers in TV Tuner Overhauling

CASTLE

TV TUNER SERVICE, INC.

MAIN PLANT: 5715 N. Western Ave., Chicago 45, Illinois
 EAST: 41-96 Vernon Blvd., Long Island City 1, N.Y.
 IN CANADA: Castle Television Services, Ltd. . . .
 Nation-wide service

*Major Parts are additional in Canada

SERVICE CLINIC

By JACK DARR Service Editor

TRANSMITTING ANTENNAS

WHAT IS THE MOST IMPORTANT THING in a mobile radio installation? The rf power of the transmitter? FM or AM? CB or commercial band? No. It's the antenna. No matter how much power output you get, unless you have the proper antenna, properly *tuned*, you aren't going to reach very far! The antenna is the *load* on a transmitter. Unless you can deliver the rf power to the load, you have no output to speak of.

A proper antenna is a resonant circuit and obeys all the laws and formulas for resonance. A piece of straight wire can form a resonant circuit, and does in this case—the only single-ended tank circuit in electronics! Power flows up the wire and disappears. Or does it? Certainly not. What happens is simple once you understand it.

One wave of current leaves the transmitter, travels to the far end of the wire, and finds there an infinite impedance—an open circuit. So, it bounces. It comes back to the transmitter, where it finds another high impedance. If the length of the antenna is exactly right, it also finds another wave of rf current just leaving. The two have the same polarity, so they join and form a bigger wave, which again goes off toward the other end.

If the antenna isn't the right length, the first wave will not get back to the transmitter at the right time. Then the second wave won't be of quite the same polarity, and will *cancel* part of the first. You get *less* energy than the transmitter is putting out.

With the right antenna, the resonant process builds up the waves each time, until they get so strong they leave the antenna and fly into space. Well . . . almost, anyway.

An antenna is an inductance. Energy in an inductor is stored in the form of magnetic fields in the surrounding

space. When the circulating (bouncing) rf currents in a resonant antenna grow big enough, some of the magnetic fields can't get back into the wire, so they leave the antenna. This is antenna *radiation*.

What you have to do to get the most out of any transmitting antenna—from CB to commercial-communication types—is to make sure the wire (or *radiator*) is resonant—that it is properly *tuned*. Transmitters have coils or capacitors for tuning the output stage to make the whole antenna circuit resonant at the carrier frequency.

To check for peak resonance, you need a detector of some sort. The simplest type is a short pickup wire with a diodes in series. If you hook a vom across the diode, you can read the rf strength as a small dc voltage or current. An 18-inch rod with a diode, set up about 10 feet from a CB antenna, will read up to 1 or 2 mA, which will give you a good-sized peak on a 0-3-mA meter.

You can tune a mobile antenna circuit with the pickup on the ground nearby or on top of the car, and a pair of leads running to the vom in the front seat or wherever the transmitter is mounted. You can even tune up base-station antennas with the dc meter leads run as far as 100 feet! All you need to watch for is a peak reading while you make the antenna-tuning adjustments. How much the reading is counts for very little; the actual meter current can be down into the microampere range. What you want is that *peak*.

This procedure applies only to the *antenna* tuning and loading adjustments, not to oscillator or plate-tank tuning. Unless you have an FCC license, you're not supposed to touch those. However, you can legally adjust the antenna tuning on CB radios, for that adjustment can't cause the transmitter to exceed FCC power-output limits in a properly designed CB transmitter.

Maximum meter reading from your simple field-strength meter means maximum energy is being radiated from the antenna. This means that for this antenna and transmitter combination you have made the antenna circuit resonant and are getting maximum efficiency.

If you have some standard to measure against, you can even check transmitters to see if they've lost any rf output strength. Set the pickup at a certain distance from the antenna when the set is first installed and tuned up, and

This column is for your service problems—TV, radio, audio or general and industrial electronics. We answer all questions individually by mail, free of charge, and the more interesting ones will be printed here.

If you're really stuck, write us. We'll do our best to help you. Don't forget to enclose a stamped, self-addressed envelope. Write: Service Editor, Radio-Electronics, 154 West 14th Street, New York 10011.

← Circle 19 on reader's service card

RADIO-ELECTRONICS

ADD MILES TO RECEPTION

range of CB & FM receivers

by reducing ignition noise with HALLETT SIGNAL SAVERS*

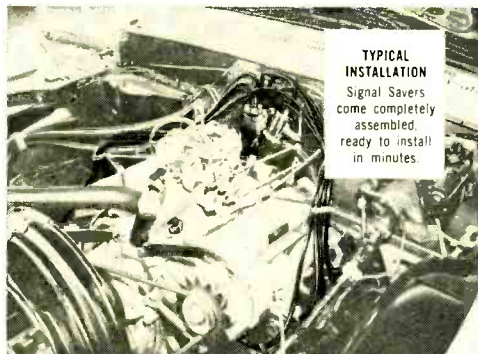

**TYPICAL
INSTALLATION**
Signal Savers
come completely
assembled,
ready to install
in minutes



HERE'S WHY SIGNAL SAVERS INCREASE RECEPTION RANGE

Your receiver has a given operating range, depending on the type, power and frequency of the base station equipment, your mobile equipment, and local conditions. However, all gasoline-spark type ignition engines create ignition noise that interferes with your reception. And as your vehicle moves further from your base station the signal becomes weaker, the ratio of ignition noise to signal strength increases, and eventually the noise interference overrides your signal. Thus, noise interference limits your communications range.

But by grounding noise interference so it doesn't "clobber" the incoming signal, you can extend your reception range. Even double it. That's how *Signal Saver* works. It places a noise blanketing shield around the sources of the noise — the distributor, coils, spark plugs and high tension leads. In short, *Signal Saver keeps the noise out, lets the message in.*

*Signal Saver is a trademark of Hallett Manufacturing Company



There's a Signal Saver to fit practically every internal combustion engine

**NOW, EASY-TO-INSTALL SIGNAL SAVER KITS ARE AT LEADING
ELECTRONIC DISTRIBUTORS INCLUDING THOSE LISTED ON THIS PAGE!**

CALIFORNIA

Alameda Radio Shack
1201 Lincoln Avenue
Alameda

Pacific Electronics Inc.
2801 Shattuck Avenue
Berkeley

California Electronics Supply
1911 Armacost Avenue
Los Angeles

Radio Product Sales
1501 South Hill
Los Angeles

Alcom Electronics
2025 East Middlefield
Mountain View

Quement Electronics
1000 South Bascom Avenue
San Jose

CANADA

A.C. Simmonds & Sons Ltd.
100 Merton Street
Toronto, Ontario

ILLINOIS

CB Center of America
5207 North Milwaukee Avenue
Chicago

Crawford Electronics
301-303 West Main Street
Genoa

Schacht TV & Communications
316 West Park Drive
Lombard

IOWA

Marcusen's
2027 Nash Drive
Des Moines

NEW JERSEY

B & G Electric
50 Huyler Road
Somerville

TENNESSEE

Pat's Heating & Cooling &
Electronics
Linden

TEXAS

Butler Electronics
6609 Hillcrest
Dallas

Sherman Electronics
722 San Pedro
San Antonio

WASHINGTON

Pringle Electronic Inc.
2101 Colby Street
Everett

Cascade Electronic Supply
6125 202nd Street
Lynnwood

Carrington Company
91 South Columbia
Seattle



HALLETT MANUFACTURING CO. Dept. RE-9, 5910 Bowcroft St. • Los Angeles, Calif. 90016

Circle 20 on reader's service card

note the reading. You can use this as a standard later on to check power output. On commercial FM two-way radios, you can set the pickup at a certain place on the truck or car body, note the reading, and then later check for any rf loss very quickly.

A piece of insulating board of some kind, with a small magnet glued to it, makes a handy mount for the rf pickup. The diode and pickup wire or rod can be mounted on the same board, with a pair of binding posts for the meter leads. You can stick the magnet any place on the car and it'll stay there.

What's a chiff?

I've been listening to a very expensive electronic organ that belongs to one of my friends. There's a stop on it marked CHIFF. It gives an interesting effect to the note, something like a click, or like the mallet of a marimba striking the note.

Investigating inside the organ, I found that this consists of a relay circuit with a diode, a capacitor and a resistor for each note "chiffed". Too many wires; so I can't follow the circuit, but I'd like to know what it does.—M. J. R., Los Angeles, Calif.

This is a percussion circuit. What it does, by means of a wave-envelope shaping network (the diode, resistor and capacitor), is give each note a very fast rise time, with perhaps just a wee bit of overshoot. This gives it a very fast "attack", and the percussion effect.

The word "chiff" is used by organists to describe the sharp, short noise caused by the inrush of air into an organ pipe when its key is pressed. For many kinds of music, it's very desirable.

Adding tuning meter to FM tuner

I want to add a tuning meter to my FM tuner. What kind of meter, and where do you connect it?—J. F. S., Islington, Ont.

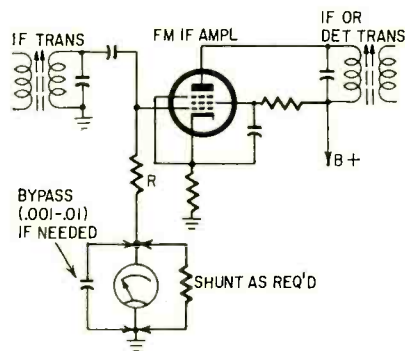

Basic tuning-meter arrangement that can be found in many FM tuners and receivers.

Almost any kind of meter, depending on where you put it. In AM radios, the tuning meter is a milliammeter in the plate circuit of avc-controlled rf or i.f. amplifier stages. The increase in avc voltage with a strong signal reduces the plate current: so, you tune for a minimum meter reading (a dip).

A good tuning meter in an FM receiver would be a microammeter in series with the ground end of one of the late (third or fourth) i.f. grid resistors. This will read the grid current developed by the stage, which increases as the signal strength increases. The diagram shows how to connect a meter.

When you add a tuning meter to some old or not-so-good FM tuners, you may find that maximum signal strength (as indicated on the i.f. or limiter grid meter) doesn't correspond with best sound. This generally means that the discriminator or ratio detector is not aligned with the i.f. stages, or that the i.f.'s are badly out of line—or both.

RF Pickup Between Recorders

I have an old wire-recorder and a tape recorder. I was transferring some recordings from wire to tape, monitoring with earphones. Sounded good while recording, but when I played the tape back, I had two recordings—one from

who says an old picture tube has to be DULL?

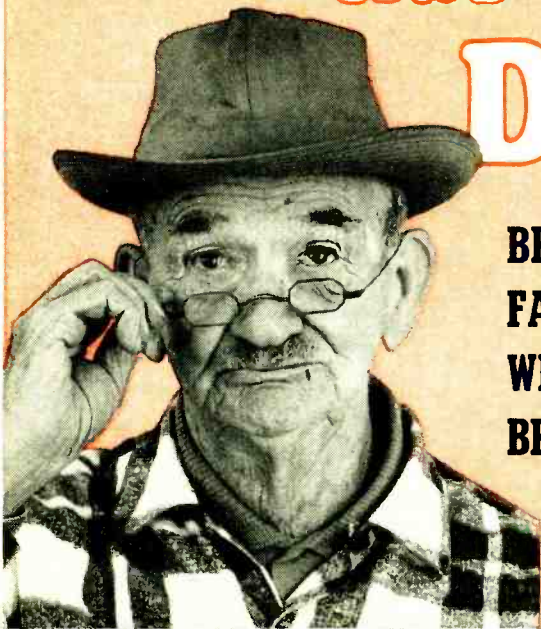

**BRIGHTEN UP THOSE
FADING PICTURES
WITH PERMA-POWER
BRITENERS!**



SQUINTING customers are unhappy customers. When aging picture tubes get dull, it's time for Tu-Brite. Tu-Brite instantly brings back like-new sparkle, and builds good will for you, even with the grouchiest old curmudgeon. *The right voltage is a cinch. If the base is right, the boost is right. No other britener gives you this assurance or ease of selection.*

Make sure you have all three models in stock.

Model C-202 for duodecal base CRT's.	Net	
Model C-212 for 110° button base CRT's.		\$2.25
Model C-222 for 110° shell base CRT's.		each

Handsomely packaged for customer acceptance, color coded by base type for instant selection.

Write for free Britener Selector Chart, your guide to the base type of every picture tube now in the field.

PERMA-POWER COMPANY

5740 North Tripp Avenue • Chicago, Illinois 60646
Phone: 539-7171 (Area Code 312)

Circle 21 on reader's service card



ONLY \$10 PER MONTH Brings You 20% MORE PHOTOFAC Coverage!

JOIN THE NEW PHOTOFAC® OF-THE-MONTH CLUB!

**MORE CURRENT MODEL COVERAGE
EACH MONTH TO KEEP YOU AHEAD
AND YOU SAVE OVER \$60 PER YEAR!**

As a PHOTOFAC-OF-THE-MONTH CLUB member you get 6 new PHOTOFAC Sets every month packed with the time-saving, profit-boosting servicing help you need. To stay ahead, to save money (individually purchased Sets now sell for \$2.50 each)—join the PHOTOFAC-OF-THE-MONTH CLUB now!

**HERE'S THE KIND OF PHOTOFAC COVERAGE
YOU GET IN A TYPICAL MONTHLY "PACKAGE"**

(6-Set release, September 1966)

20% MORE COVERAGE THAN EVER BEFORE:

- 8** COLOR TV FOLDERS
- 13** B & W TV FOLDERS
- 31** OTHER FOLDERS

(AC-DC, FM-AM, Stereo Hi-Fi,
Record Changers, Phonographs)

**COMPLETE CURRENT COVERAGE OF
AT LEAST 50 CHASSIS EACH AND
EVERY MONTH FOR ONLY**

20¢ per folder!

(less than 1¢ per page of
invaluable servicing know-how)

**TRY A THREE-MONTH SUBSCRIPTION!
USE THIS HANDY ORDER FORM**



**A great monthly "package"
exclusively for Photofact
of-the-Month Club Members...**

You get your 6 new PHOTOFAC Sets every month in sturdy new file folders sealed in factory carton to ensure perfect condition and completeness—easier-than-ever to file and use. Now you get 20% more coverage and save over \$60 per year with a PHOTOFAC-OF-THE-MONTH CLUB membership!

TRY A THREE-MONTH SUBSCRIPTION

save on Photofact—watch it boost your earnings

See your Sams Distributor or send Membership Form below:

**HOWARD W. SAMS & CO., INC. Dept. REF-9
4300 W. 62nd St., Indianapolis, Ind. 46206**

Enroll me for a 3-month membership in the Photofact-of-the-Month Club. I agree to pay \$10 per month, and understand I will receive 6 current Photofact Sets monthly for 3 months to be delivered by my Sams Distributor (named below).

Name _____

Shop Name _____

Address _____

City _____ State _____ Zip _____

My Sams Distributor is: _____

Signed: _____

Circle 22 on reader's service card

the wire, the other from WABC! How did this get in there, and, more important, how can I get rid of it?—F.J.C., Wood-Ridge, N. J.

I can tell you *what* the trouble is, but not exactly *where*. It is undoubtedly rf pickup in the input of the tape recorder, or even in the input circuits of the wire recorder. The rf is being detected and mixed with your recording, so, you hear two different programs at the same time.

The only way to pin this down is by isolation. Hook up both recorders exactly as they were. Turn on the tape re-

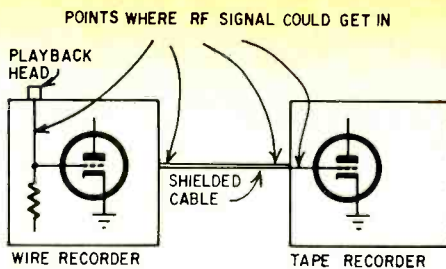

recorder, but leave the wire recorder amplifier off. Record a few feet of tape and play it back to see if the WABC signal

is there. If it is, then the pickup is in the input of the tape recorder, or in a poor ground in your shielded cables somewhere.

If the interference doesn't show up on this test, turn the wire recorder amplifier on, set it to playback (no wire on the machine) and repeat the test. By this process of elimination you can find out where the unwanted rf signals are getting in.

If the trouble does turn out to be in the input of one of the amplifiers, you can check shielding, or, as a last resort, add very small rf bypass capacitors from grid to ground, or even small rf chokes in series with the grid leads.

Intermittent 5U4, Philco 9L41

The filament of the 5U4 goes dark intermittently. I think it's in the power transformer. Can I replace it with a filament transformer?—E. L. Baltimore, Md.

Check carefully before you do any thing that drastic. First, make sure the tube itself hasn't been so hot that it's melted the solder on the ends of its base-pins. This has happened, in this very model. Next, be sure the socket contacts are tight and clean. While it is possible that there is a broken wire inside the power transformer, it's fairly unlikely; the filament wire is heavy, and is usually brought out of the transformer as is, without splicing a separate lead onto it. For a check, try pulling and moving the filament wires, watching the tube; if you can make it go on and off, then it may actually have an internal intermittent.

As a last resort, you could always add a small 5-volt filament transformer on the chassis, or a 6-volt one with a small dropping resistor; there should be room on the chassis. Suggestion: how about replacing the 5U4 with a silicon rectifier plug-in replacement?—No filament at all! END



Where the action is you'll find the hot new . . . Hallicrafters CB-20 "Reacter"—\$99.95!

Yours today—the ruggedest, cleanest, most powerful basic CB transceiver that ever rode the range!

You get Hallicrafters' field-proven, solid-state design—compact, fool-proof. You get high-order modulation, superb sensitivity and built-in noise suppression. You get five-channel convenience.

In short—you get performance equal to that of equipment more than double the price.

Quality through craftsmanship is the whole idea at **hallicrafters**

Export: International Division,
Canada: Available through Gould Sales Co.

5th & Kostner Aves., Chicago, Ill. 60624

Get the full story from your
Hallicrafters authorized
CB outlet today!



hallicrafters



My remote control unit keeps turning on my neighbor's garbage disposal.

Circle 23 on reader's service card

Circle 24 on reader's service card →

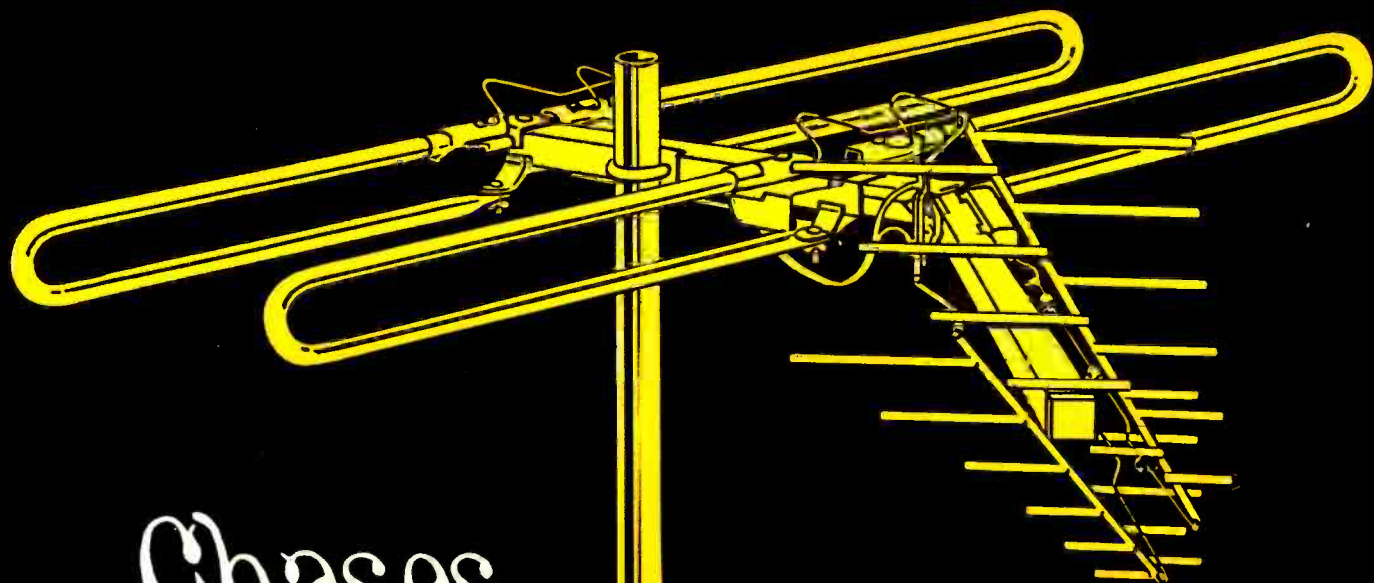

Chases
ghosts
out of
town

In the city you don't need a very powerful antenna. Generally, your problem is too many signals rather than not enough. But strong signals bouncing off tall buildings cause multiple images, commonly known as ghosts. Faint ghosts may not bother black-and-white pictures much, but they're intolerable in color.

Jerrold Metrocolor antennas are especially engineered to solve the problem of metropolitan reception. They reject reflected signals and minimize standing waves. Metrocolor antennas are as effective in preventing ghosts and color smears as many of the bulkiest, most expensive fringe-type antennas. Also, they're made to match Coloraxial cable, a must for color TV.

There are two Metrocolor models: Model MCX-82, covering all UHF-VHF and FM channels, lists for \$29.95; Model MCX-13, for VHF and FM only, lists for \$16.95. Cash in on the BIG city antenna market with Metrocolor antennas. They chase the ghosts right out of town, and leave the profits for you. Talk to your Jerrold distributor today, or write Distributor Sales Division.

NEW JERROLD

metrocolor™

82-CHANNEL ANTENNAS

FROM JERROLD ELECTRONICS CORPORATION, 401 WALNUT ST., PHILADELPHIA, PA. 19105



RCA'S new career book can be your success story.



The Most Trusted Name in Electronics

Home Training

Find out about...

- RCA Institutes Career Programs.
TV Servicing • FCC License Preparation • Automation Electronics • Automatic Controls • Digital Techniques • Telecommunications • Industrial Electronics
- Nuclear Instrumentation • Solid State Electronics • Electronics Drafting.
- How RCA's "Autotext" programmed instruction teaches electronic fundamentals—the faster, easier, way to technical learning.
- RCA Institutes' liberal tuition plan—the economical way to learn electronics.
- The prime quality electronics kits students receive at no extra cost.
- How RCA Institutes Home Training has helped its students enter profitable electronics careers and continually advance in their fields.
- For your free copy of RCA Institutes 1966 Home Study Career Book, just mail the attached postage-paid card today.



*All RCA Institutes
programs and courses are
approved for veterans
under the new G.I. Bill.*

Classroom Training

- Located in New York City, RCA Institutes is one of today's largest of its kind, and provides excellent classroom and laboratory facilities.
- Previous technical training is not required... special preparatory classes are available for students who have not completed high school.
- Day and evening coeducational programs start four times a year.
- Free placement service has in recent years placed 9 out of 10 graduating students.
- Complete descriptive catalog free on request... check classroom training on attached card.

Both Home Training and Classroom Training programs are also available in Spanish. Check Spanish on attached card and appropriate information will be rushed to you.

RCA INSTITUTES, Inc., Dept. ZRF-96 A Service of Radio Corporation of America,
350 West 4th Street, New York, N.Y. 10014

Communi-Pac For the Free Lance

CB
COMMUNICATIONS

A universal communications system for the free-lance reporter, photographer or writer. Start with recorder and CB radio and add other radios if you need them

By JOHN J. BORZNER

THE FREE-LANCER'S COMMUNI-PAC IS A communications center. Mine was built to suit my own needs whenever I go out chasing a story—to the track, to the stadium, to the docks. You can assemble one to suit your individual needs. Rather than lug several separate pieces of equipment, I devised the Communication-Pac as a single package that contains the specific instruments.

My unit, shown in the photos, contains a Citizens-band transceiver, a tape recorder and an AM-FM radio. A later version includes a marine-band receiver. You may want to use an AM-FM-marine model. An aircraft-tower receiver is to be added to a modification I have planned. Each subunit is transistorized. I picked them so that all have the same voltage requirements, thus the completed unit can use a single battery.

Assembling a Communi-Pac like this one is not at all difficult if the components are carefully chosen for size and weight. Decide on a complete packaging plan before you start construction. The

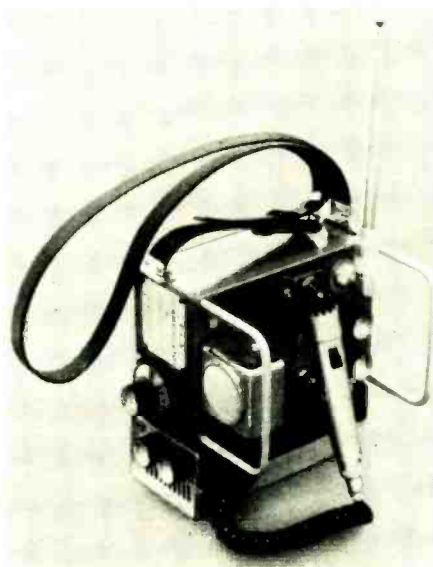

Three-quarter view of the Communi-Pac. Custom-built, the basic set consists of tape recorder, Citizens-band transceiver and an AM-FM radio for monitoring. Inexpensive sets and accessories make professional unit.

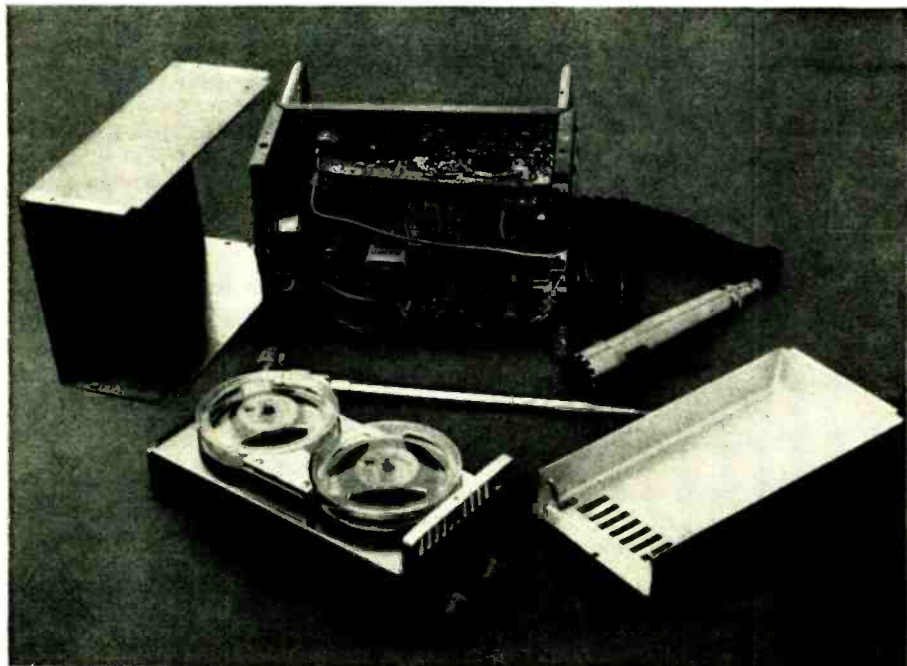

Interior view of the Communi-Pac. Note that the Citizens-band transceiver and the AM-FM receiver are removed from cabinets. New controls and speakers were added.

CB transceiver I chose is a Lafayette HA-70A. It has a continuous-tuning superregenerative type receiver. It was selected because its broad tuning covers several channels simultaneously. This is useful for listening at football games or racetracks where several channels are being used. You know where the action is all the time without constantly flipping a channel switch. This feature is also helpful for listening in a moving car where constant tuning is not practical. (The Communi-Pac once picked up two billboard poster men, each analyzing the other's work from opposite sides of a busy four-lane highway.)

The marine-band radio was selected because of my proximity to the fishing fleets. I frequently get my first inkling of a good story listening to the boats pass "the news" to one another.

The AM radio is a natural addition. Considering the small size and low power needs of transistor AM-FM receivers, it seemed logical to pick a combination unit.

Aircraft, fire, public works or other bands of specific interest to you can be substituted. Caution should be used if you plan to add a police-band receiver. Local laws vary on restrictions, but mobile reception of police bands is prohibited in most localities.

The tape recorder is probably the handiest addition. You can record any event you happen to be receiving on the other components, for an audible record. Or, it can be extremely useful for interviews, or simply for taking notes on the scene of a story. Many recorders are suitable. Mine is a Lloyd.

After you have selected the parts, construction of the Communi-Pac is mainly a matter of bolting them together. You can see from the photos and assembly diagram how the unit is built. You can vary the location of the controls, but they should all be kept where they can be adjusted "blind." Also, they should be placed so that they don't interfere with body movements.

I recommend using two speakers. I used the rear-seat auto speaker because the CB transceiver has no squelch control on the receiver and the constant "rush" sound is annoying; with a separate speaker, I can turn it down and still hear the other receivers. A small speaker for listening to both the AM-FM receiver and the marine-band radio is mounted in the rear of the main cabinet. You can see it in the photo showing the unit disassembled.

The U-shaped "crash" bars make convenient pickup handles. They were handy in the construction phase and make good supports during troubleshooting. They also offer protection to the unit during field trips.

The collapsible antenna is the one that is supplied with the transceiver. It was force-fitted into a standard PL-259 coaxial connector, then attached to a right-angle Amphenol rf connector or equivalent. The AM-FM receiver is also coupled to this antenna. A small trimming capacitor is connected between the antenna and all the radios for best matching, and the transmitter is peaked for use with the same antenna, extended halfway. A Hammarlund type-HFA (or equivalent) 4.3-50-pF capacitor is used.

The transceiver speaker can be switched to use as a microphone, of course, and the tape recorder comes with its own mike. However, for convenience, an inexpensive microphone was bought and connected into the Communi-Pac. The one I'm using (you can see it in the photo) is a crystal type that cost \$3.95. A clip holds it conveniently on the front of the set, out of the way but easy to reach. How the mike is hooked up depends on what tape recorder and CB set you select.

One dress-up detail is the nameplate, which can be glued on using contact cement, or screwed on. I made mine up very inexpensively, and you can do the same. Cut out magazine type in any style you like and spell out the unit's name or your name and address, reward, etc. Glue the letters and words on card stock. Then shoot a Polaroid picture of the label you have put together, making sure it comes out the final size you desire. RADIO-ELECTRONICS has made up a couple of nameplates that you can use. Cut them out and type in your name and address. Take them to a plastics laminator and have them encased in plastic. The ones on my Communi-Pac cost 50¢ for laminating.

That's about all there is to the Communi-Pac. The units included in mine will be handy no matter what you use the Communi-Pac for. With the "guy on the roof" and the "guy at the set" trying to adjust the antenna in a tough-ghost spot, communication via Citizens band is a distinct advantage. After a climb down a rickety ladder, two and a half stories over the rose bed, your partner's assurance that the picture is perfect had better be good. You can have the evidence on tape. END

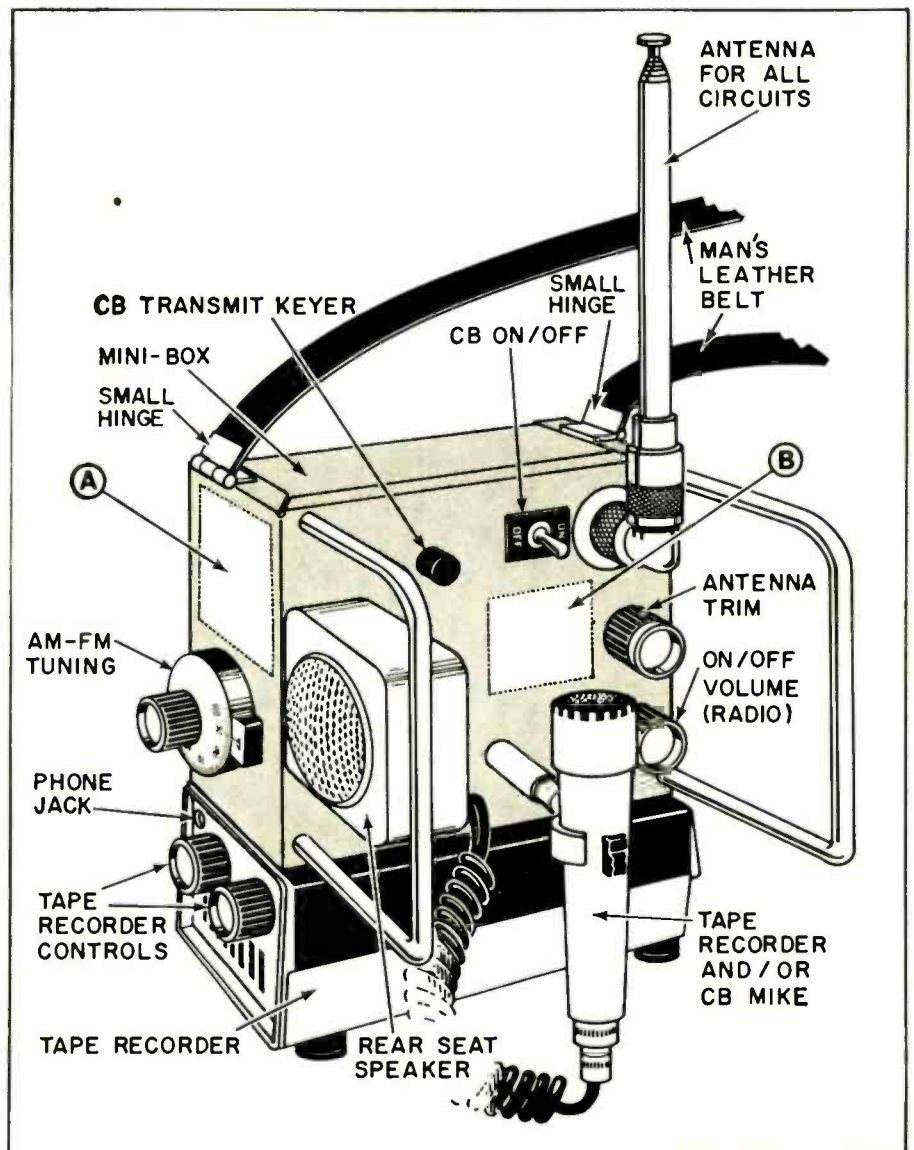

A detailed exterior of the Communi-Pac. Note the construction and convenience features that go a long way toward providing good professional performance and reliability.

Radio-Electronics FREE-LANCE COMMUNI-PAC

NAME _____

ADDRESS _____

REWARD FOR RETURN IF FOUND

Radio-Electronics FREE-LANCE COMMUNI-PAC

NAME _____

ADDRESS _____

REWARD FOR RETURN IF FOUND

Nameplates for your Communi-Pac. Cut out and laminate in plastic. The large one goes at A and the smaller at B in drawing above.

LET THE LASERS DO THE TALKING

Coherent light beams are the communications carrier of the future

By H. DALE BELT

CB
COMMUNICATIONS

AS GEMINI 7 PASSED high over Kauai, Hawaii, in its record-setting flight last December, a tiny beam of blue-green light shot up from the island. Astronauts Frank Borman and James Lovell saw the blinking light as it intercepted their spacecraft, and moved into action. With a hand-held unit they sent their own tiny ray toward the earth. Unfortunately, during the few minutes the island was within range for the experiment, the return signal was not detected on the ground. If his signal had been received, Lovell would have switched his unit to a special mode of transmission and sent his voice down the beam to establish the first laser communication between men on earth and men in space.

While our astronauts were looping their way around and around the earth, scientists in Russia were busy testing another laser communication system. They were using a laser beam to connect a telephone exchange office with a tall building at Moscow University. It worked. The system they developed is to be used to transmit large numbers of voice and television channels between two telephone exchanges in Moscow.

In this country, the laser is being put to similar communications uses. In 1963 a laser beam carried a CBS television network program across a table to a receiver where it was detected and sent out to viewers all over the country. Garry Moore cut his program off the air by placing his hand in the beam.

Voices have now been transmitted by lasers thousands of times. Laser light recently carried signals to an Explorer satellite in orbit; the satellite returned them to earth by specially constructed reflecting devices. Today, hundreds of laboratories throughout the United States are experimenting with ways to generate, amplify, modulate and detect

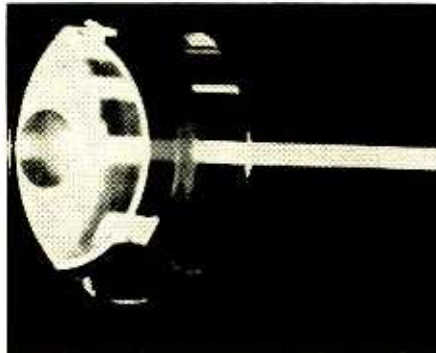

Extreme intensity of laser beam, combined with lack of spreading, makes it especially suitable for line-of-sight communications. One such beam has even reached the moon.

laser light, with an eye to its future in communications.

What is the laser (pronounced layzer)? How does it produce its revolutionary new light, and why does it hold so much potential for communications?

The term *laser* is an acronym for *Light Amplification by Stimulated Emission of Radiation*. The laser draws energy from the excited molecules of certain materials and emits that energy as a *coherent* beam of light. (Webster: *cohere*—to hold together firmly as parts of the same mass.) The laser beam is coherent in three ways: in direction, in frequency and in phase. This is illustrated in Fig. 1, where a highly directional light beam is represented as many waves, all exactly the same frequency and in perfect phase. This is in contrast to noncoherent light from conventional sources (fluorescent, incandescent and arc lamps, the sun, etc.) which is emitted as a jumble of many wavelengths in every direction and with all possible phase relations. It is the coherency of laser light that makes it so useful and its future so bright.

The laser was proposed by A. L. Shawlow and C. H. Townes in 1958, and

a working model was built by Theodore Maiman only 2 years later. (Townes shared the Nobel prize in 1964 for maser and laser work, and early this year Maiman received the Buckley prize.)

Both the maser and laser—as their names imply—operate on the principle of *stimulated emission*. This process is in contrast to the way ordinary light is produced, which is by *spontaneous emission*. In a lamp filament, for example, atoms absorb electrical energy in the form of heat. This causes each atom to undergo internal structural changes that leave it in an excited state. Almost immediately the atom changes back to an unexcited state by spontaneously emitting the absorbed energy as a pulse of energy. This pulse-release process is being repeated billions of times a second by the huge number of atoms the lamp filament contains. The frequency of occurrence of these energy pulses is the frequency of light. Because they are spontaneously emitted, the pulses (called quanta) are random in phase and direction and consist of a wide range of frequencies—from infrared all the way through the visible-light spectrum.

Stimulated emission, on the other hand, is a much more orderly process. Atoms in a carefully prepared environment are raised to an excited state (a process called pumping) but do not spontaneously emit light. Instead, they remain in this condition long enough for a light beam of preselected frequency to be introduced. In response to this light, all the excited atoms are stimulated to release their quanta simultaneously and in the same direction as the original beam.

Fig. 2 shows how the light stimulation is introduced, by flash tubes around the laser rod. The ends of the rod are mirror-finished for reflectivity, but one end is left slightly translucent. The coherent light generated in the rod is bounced back and forth between the ends many times until it grows to an intensity great enough to penetrate one of the reflectors. The result is an intense ray of light with very precise frequency. This is laser light.

The laser has found many applications in the few years since its discovery. It can be focused to provide extremely narrow beams more intense than light from the surface of the sun. Such narrow beams have been used for precise welding, drilling, and machining operations.

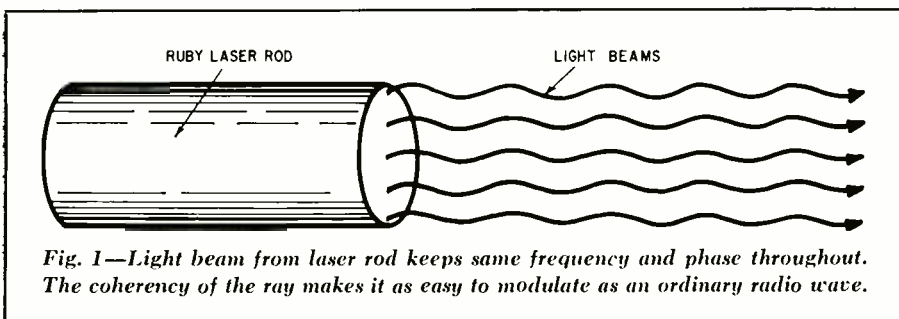

Fig. 1—Light beam from laser rod keeps same frequency and phase throughout. The coherency of the ray makes it as easy to modulate as an ordinary radio wave.

In medicine a laser beam has been used to destroy a tumor in a human eye and shows potential in cancer treatment, dermatology and other procedures where its tiny, powerful beam can pinpoint and affect individual cells. The monochromatic feature of the laser's light has contributed to the design of a gyroscopic leveling device with no moving parts. Lasers have also been put to work in various ranging and tracking devices of hitherto unbelievable precision and accuracy.

A listing of laser applications would take many pages. And new uses are found regularly. All take advantage of the unique property of laser light—its coherency. This is also the basis for its value in communications, which may hold the greatest potential for laser application.

In communications the very frequency of the laser emission is of primary importance. The bandwidth needs of a signal increase as the modulating frequency increases. This has been one of the forces directing engineers to higher and higher frequencies over the history of electromagnetic communications. Also, the trend toward more complex groups of information to be transmitted requires wider bands. Voices can be transmitted with bandwidths of only a few thousand hertz. But television channels need a band several million hertz wide.

In modern communication systems, multiplexing makes possible several television channels or thousands of voice channels on one carrier, for economy in long-distance transmission. Such a carrier must have a very wide bandwidth and high frequency if it is to keep these multiple signals independent of each other. To achieve this, transmitting devices were pushed into the microwave region during World War II. Now, microwave radio-relay systems carry most of our communications traffic between cities.

Communication needs grow at a faster rate than the population. In the decades ahead, these needs will put an increasing strain on present systems of communication. However, attempts to extend electronically generated frequency bands above microwave values met with many difficulties. New waveguide technology has produced useful rf systems in the millimeter range; but, until the appearance of the laser, scientists looked helplessly at the infrared and visible portions of the electromagnetic spectrum—which they knew to contain tremendous bandwidths. Now, thanks to the laser, it is becoming possible to utilize this rich region. In the visible portion of the spectrum alone, a single laser beam could carry all the communications of the world at one time. Properly utilized, it could simultaneously carry



Laser beams for communications are able to be bent around corners by periscope devices. Here, a small prism is used as a passive relay device that changes the direction of the highly concentrated laser beam.

several million television programs with room to spare. When the much broader infrared region—where the laser also functions—is included, the almost limitless capacity of the laser becomes evident.

Conventional light sources also emit light at these high frequencies, so why have they not been used for communication? Conventional light is incoherent, which renders it difficult to be systematically modulated and demodulated. The laser, because of its controlled emission, is like electronically produced radio waves and microwaves, carefully monochromatic and in phase. Laser waves, then, like radio waves, can be modulated with information signals.

Much experimental work is under way to find new and more effective ways to modulate and detect these laser light beams. Because there are many different types of lasers (crystal, gas, solid-state), this study is developing on many fronts and with considerable success. It seems evident that when the other elements of a laser communications system are ready, the modulation problem will have been solved.

There is another drawback to ordi-

nary light; it travels in every direction from its source. This property causes its intensity to decrease rapidly with distance. Searchlights overcome this difficulty by using focusing reflectors, and telescopes use lenses. The beam from a laser has the advantage that it does not diverge in this manner. It maintains its direction and strength for great distances, spreading only a few inches in a mile. Such a narrow beam was sent half a million miles on a round trip to the moon and back in 1962. The reflection from the moon's surface was strong enough to be recorded in the laboratory, and was only 2 miles in diameter on the moon's surface—239,000 miles away.

For communication purposes this narrow spread of the laser's light is of prime importance, because it delivers such a large proportion of the original signal compared to other transmitters. Microwave-radio relay systems derive much of their utility from the directionality and minimal spreading of their beams. Even so, spreading and other attenuations usually reduce the microwave signal to a hundred-thousandth of its transmitted strength in the 20 or 30 miles between relay stations. The narrow laser beam could traverse the same distance with only a tiny fraction of these losses, because it spreads so little.

While spreading losses are almost negligible, losses due to atmospheric attenuation are not. This is one of the major problems confronting laser-communications engineers. Air itself is not the chief difficulty here, but what the air may contain. Rain, snow, fog or haze would cut off a laser beam over even a relatively short distance. Light cannot penetrate these obstructions in the manner that radio and radar can. Since most communications require continuous operation without gaps or interference, this imposes a severe limitation on laser systems.

Of course, outside the atmosphere, in space, this problem does not exist. For that reason, laser communication will play an important role in our future

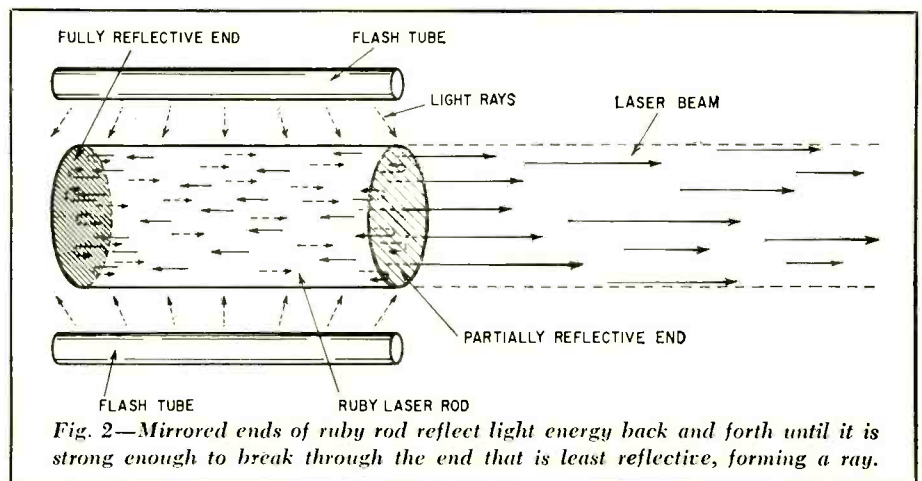

Fig. 2—Mirrored ends of ruby rod reflect light energy back and forth until it is strong enough to break through the end that is least reflective, forming a ray.

space programs. Their huge data-carrying capacity and miniscule beam spreading are compulsory qualities for interplanetary communication where distances are vast and data rates from manned and unmanned exploration craft will be very high.

Atmosphere problems are unimportant in another area where laser communications will play a significant role. Great volumes of information are transferred through the various sections of computers, especially to and from memory storage units. In large computers the hugeness of this exchange is beginning to strain the wires that must handle it. Here the laser may be able to handle the job, again using its ability to carry almost infinite data loads. It could also be used for information transfer between computers—a practice that is becoming increasingly attractive as computers grow in size and cost.

Scientists are presently studying ways to avoid atmospheric interference in earth-bound laser-communication systems. One workable solution may involve some method of enclosing the laser beam in a pipe or tube from which the air can be excluded. Lenses spaced at intervals in the tubes could re-focus the laser light and prevent its spreading. Experiments have shown that power losses are slight in the lenses that could accomplish this, especially with the new gas lenses that have been developed.

As in microwave-radio links, these systems must pass around the curvature of the earth for long-distance usefulness. This means that additional lenses or repeater units will be needed. If the tubes are underground or attached to the surface, they will have to be able to withstand earthquake and other geological stresses without altering transmission. The close tolerances necessary in the lens systems envisioned will provide a considerable challenge to engineers.

A tube laser-communications network will involve high installation costs in addition to its other difficulties. However, the huge quantities of information that a single system could carry should offset these shortcomings. Properly modulated, one laser beam could conceivably handle all communications between two large metropolises for decades to come, even though channel needs increase many times.

Major communications companies are investing money and manpower to develop this young genie. Laser systems are not needed today because our microwave and coaxial-cable systems so far can handle the volume of traffic. However, in the next decade, in our burgeoning space-age society, existing systems may not be sufficient to handle the information explosion. By that time, laser communication systems should be ready to carry the load.

Zeners as Hi-Cap Variable Capacitors

Reasonably priced diodes exhibit high reverse-bias capacitance

By RUFUS P. TURNER

SOME ZENER DIODES HAVE HIGH JUNCTION capacitance, which can be varied by a negative dc voltage applied to the anode—the higher the voltage, the lower the capacitance will be. You can use this phenomenon to provide a solid-state voltage-variable capacitor with a value higher than is obtainable with regular capacitive diodes. Such high capacitance is useful in audio-frequency tuned circuits and filters, for which a plate-type variable capacitor is not practical. Only a few microamperes of current are required to vary the capacitance, so the value is essentially voltage-controlled.

I tested a number of Zener diodes rated at various wattages and breakdown voltages, and found their zero-dc capacitance to range from 200 pF to .0086 μ F. Capacitance, however, is a secondary property in a Zener diode: it is not deliberately engineered into the device. Consequently, its value may vary widely in different diodes of identical type and voltage rating. For this reason, you may have to check several Zeners to find one yielding a capacitance near a desired particular value. Be sure the bridge or capacitance meter you use to test them places no more than 0.1 volt rms across the diode. A good sampling may be bought without spending much money; one mail-order house recently offered a dozen Zeners for less than \$2.

Fig. 1-a shows a circuit in which

you can use the dc-variable Zener-diode capacitor. The dc control voltage, which may be supplied by a simple battery-and-potentiometer combination (Fig. 1-b), is applied to the dc input terminals. External connections are made to terminals X and Y in the same way as to any conventional capacitor. In Fig. 1-a, 1-meg $\frac{1}{2}$ -watt resistor R serves as a current limiter for diode D and also acts somewhat like a choke, isolating the dc supply from any ac that exists in the external circuit connected to the capacitance terminals. C is a 1- μ F blocking capacitor (a 200-volt metallized paper tubular is fine) that keeps an external circuit from shorting the dc control voltage and protects the diode from any high dc voltage in the external circuit. The capacitance of C is so high with respect to the diode capacitance that the capacitance "seen" at terminals X and Y is essentially that of reverse-biased Zener diode D.

Fig. 2 charts how capacitance varies with dc input voltage, from .004 to .0086 μ F, in a particular 1N1604 10-volt 10-watt Zener diode. The test was made with the combined circuits of Fig. 1. Larger changes seem to be afforded by diodes having lower maximum capacitance. For example, in one 27-volt 500-mW diode, the capacitance varied from 65 to 240 pF as the control voltage was reduced from 22½ volts to zero.

END

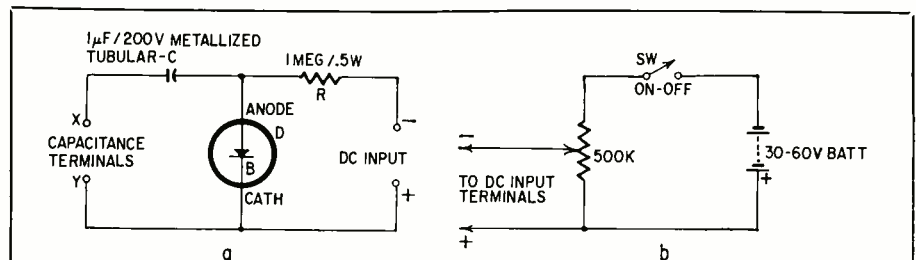

Fig. 1—With reverse bias applied through resistor, Zener diode is capacitor.

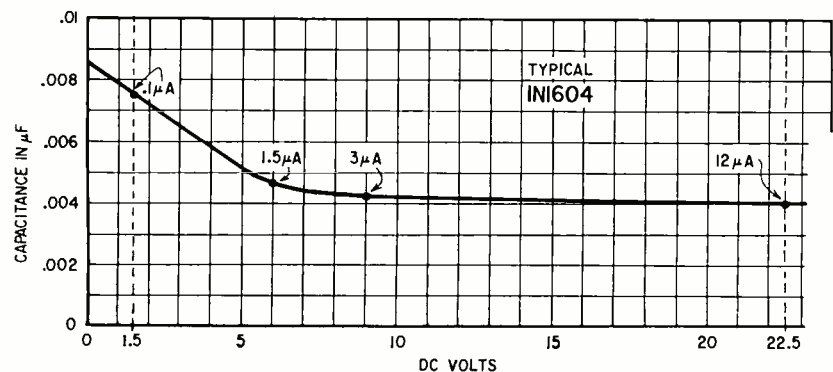

Fig. 2—Capacitance values exhibited by diode picked from low-cost group.

ANALYZING CB FAILURES

If new CB circuits find you in a fog, here's your way out on a course that will guide you to top-notch CB efficiency

By E. F. RICE and
ANDREW J. MUELLER

COMMUNICATIONS

THE CITIZEN'S-BAND transceiver is no longer a toy. It's a compact, 23-channel, solid-state unit with very sophisticated transmitter circuitry that may include electronic switching of the antenna from the transmitter to the receiver. Many units have crystal-controlled dual-conversion receivers using a frequency synthesizer. Since a typical transceiver may carry a price tag over \$200, the CB user wants his unit to be repaired by an expert technician, and there is a growing need for such experts in the service industry. This article describes some of the newer and possibly unfamiliar circuits and offers servicing tips in the form of brief case histories.

An example of up-to-date solid-state design is the Pearce-Simpson Director, a block diagram of which is shown in Fig. 1. The receiver section audio-output stage doubles as the modulator for the transmitter, but the low-level speech amplifiers are separate from the receiver audio amplifiers. Tracing the modulated B+ line from the audio output, you'll see that both the driver and the final rf amplifier are modulated. At the upper left of the diagram is the receiver front end which has two agc systems and employs dual conversion. As we noted before, the modern CB mobile unit is mighty refined.

How frequency synthesizers work

The stages that make up the frequency synthesizer in Fig. 1 are shown within the broken lines. The beauty of a

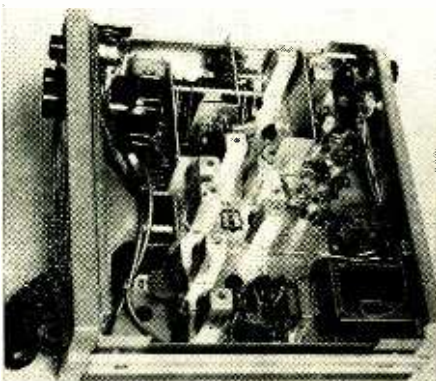

The modern CB transceiver is a precision-crafted instrument demanding highly developed troubleshooting and technical skills.

synthesizer is that, by using a master oscillator to feed both transmitter and receiver, the total number of crystals required to transmit and receive on all 23 channels is much less than the 46 required when separate transmitter and receiver crystals are used for each channel. The Director uses 14; others use only 11. The transmitter and receiver sections have their own separate oscillators which heterodyne the signal supplied by the master oscillator. A little arithmetic will illustrate the basic principle: To transmit on channel 1 (26.965 MHz), the master-oscillator frequency is 33.000 MHz. Subtract the transmitter oscillator frequency (6.035 MHz), and the difference is 26.965 MHz, which is

fed through the rf section to the antenna.

To receive on channel 1, the master oscillator frequency remains 33.000 MHz. Subtract the incoming signal frequency (26.965 MHz), and the difference is 6.035 MHz, which is fed to the 2nd mixer to be heterodyned by the receiver oscillator. Receiver oscillator frequency is 6.490 MHz; subtract the first i.f.—6.035 MHz—and you have 0.455 MHz, or 455 kHz, the second i.f.

Fig. 2 shows how the same master-oscillator crystal is used to obtain the first four channels. The transmitter and receiver crystals are chosen so that the correct beat frequencies are produced at the buffer and i.f. stages. For channels 5 through 8, a different master-oscillator

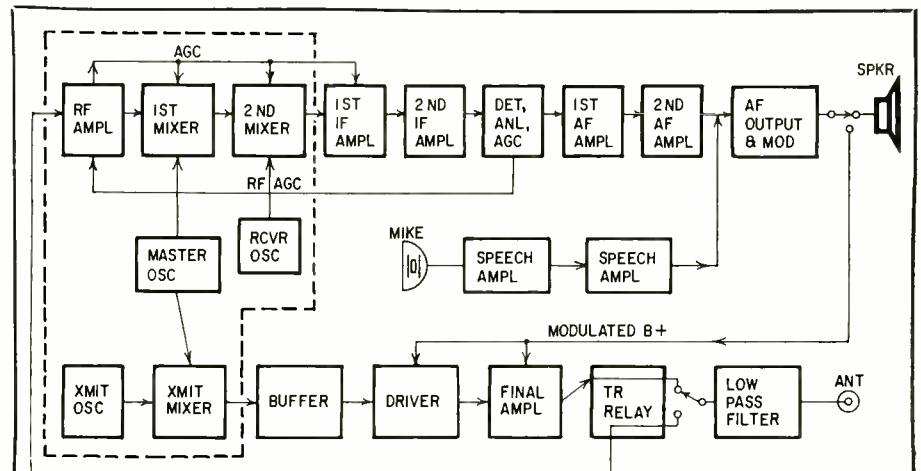

Fig. 1—As in the case of most service-bench problems, CB transceiver problems can best be sorted out by examining overall functions on a block diagram, then pinpointing the trouble to a specific stage that can be serviced using old familiar techniques.

Fig. 2—This chart and a basic understanding of heterodyne frequency mixing will go a long way toward removing the glazed look from the service technician's eyes.

XTAL FREQ	CHANNEL																						
	1	2	3	4	5	6	7	8	9	10	11	12	13	14	15	16	17	18	19	20	21	22	23
XMIT OSC																							
6,035 (MHz)																							
6,025																							
6,015																							
5,995																							
MASTER OSC																							
33,000 (MHz)																							
33,050																							
33,100																							
33,150																							
33,200																							
33,250																							
RCVR OSC																							
6,490 (MHz)																							
6,480																							
6,470																							
6,450																							

frequency is employed, and the same transmitter and receiver crystals are used over again. In this manner, all 23 channels are covered by combinations of the 14 crystals listed in the chart.

This ingenious method of obtaining the needed frequencies can lead to some peculiar symptoms when something goes wrong. If one of the receiver crystals fails, for example, or if the channel switch makes a poor contact on one position, reception will be lost on every fourth channel. The same thing happens in the case of a defective transmitter crystal. But if a master-oscillator crystal fails, four adjacent channels will be dead on both *transmit* and *receive*. These situations become even more confusing when some would-be repairman has swapped the crystals around.

Component failures in the oscillator stages produce a different effect and are easier to localize. A failure of 680-ohm emitter-resistor R10 in the master-oscillator circuit of Fig. 3, for example, disables both transmitter and receiver on all channels. A defective R15 in the transmitter oscillator, however, disables only the transmitter on all channels, while an open R13 in the receiver oscillator renders the receiver inoperative on all channels.

Output-transistor failures

Rf output transistors are easily damaged by wrong voltages or improperly loaded antennas. One stubborn case was finally cured by sending the owner to an auto mechanic. The unit was a

Hallcrafters CB-12, mounted in a 1965 Ford. The first time the set came in for repairs, the output transistor was shorted. It was replaced, and the rig seemed OK when operated on the service bench, so it was installed in the car.

A few hours later the car was returned, and the owner complained that the transmitter was out again. Examination showed the output transistor was shorted once again. After replacing the second transistor, the unit was installed in the car, and collector voltage was measured with the transmitter operating and the engine running at a fast idle—the meter read 18 volts. This could mean only one thing: The output transistors had failed because a defective voltage regulator in the car allowed the alternator to supply 18 volts.

When replacing output transistors, it's important to use the exact transistor recommended by the manufacturer. This is one place where the so-called "universal" replacements don't work. Be sure to check whether a later modification of the unit might use a different transistor from the original; the new one may have higher ratings. Remember to replace the silicone grease and the radiating fins when they are used.

Another case involving an output transistor is illustrated in Fig. 4 and shows a common-collector output stage used in the Lafayette HB-500. The unit had no rf output and the following steps were taken: A milliammeter inserted at point X revealed that there was no collector current. A milliammeter at point

Y indicated normal 50-mA collector current in the driver. With the trouble isolated to the output circuit, the voltages in this stage were checked—11.5 volts on both the base and collector indicated the output transistor was shorted.

The reason for the original transistor failure was not discovered until the technician installed a new one and attempted to load the unit into a dummy antenna; there still was no output. It is standard practice to begin the tuneup procedure with about 8 volts on the output collector, and in this case the technician had inserted a 10-ohm 2-watt resistor in series with the collector. The precaution paid off, because the input capacitor (C2) in the pi-section antenna-coupling circuit was shorted. This removed the output-load impedance and caused excessive collector current, enough to have destroyed the new transistor if full voltage had been applied during the final check.

Another interesting aspect of the output circuit shown is the use of *negative* bias on the base of an npn transistor. We usually expect to find *positive* or forward bias on the base of an npn, but in this case reverse bias on the base is used to keep the stage well beyond cutoff so the amplifier operates in class C.

The reverse-bias voltage is developed like grid-leak bias in vacuum-tube amplifiers. The base of Q1 is driven positive enough at the peak of the input-drive signal to cause a flow of electrons through the emitter-base junction to the right side of C1. Following the positive peak of the input cycle, these electrons leak from the right side of C1 through R1 to the left side, producing a 1-volt bias across R1 and also across the base-emitter junction. This results in a net voltage of -0.62 from base to ground, as indicated on the schematic.

TR-switch failures

Fig. 5 illustrates a typical TR-switch circuit used in many CB units. The receiver-section rf amplifier is coupled to the antenna through C1. During receiver operation, D and C2 have very little effect on the signal. During transmission, the mike switch places a positive voltage on the anode of D, thereby lowering its resistance and effectively shorting the base of the receiver-section rf stage to ground through C2. C1 has enough reactance at the transmitter frequency that it causes only slight attenuation.

The diode is likely to fail in these circuits, and if it shorts, the receiver is disabled permanently. An open diode might not be noticed until the rf-amplifier transistor is destroyed.

The transmitter would not be affected by TR-circuit failures unless C1 were shorted. This condition would probably lead to replacement of the di-

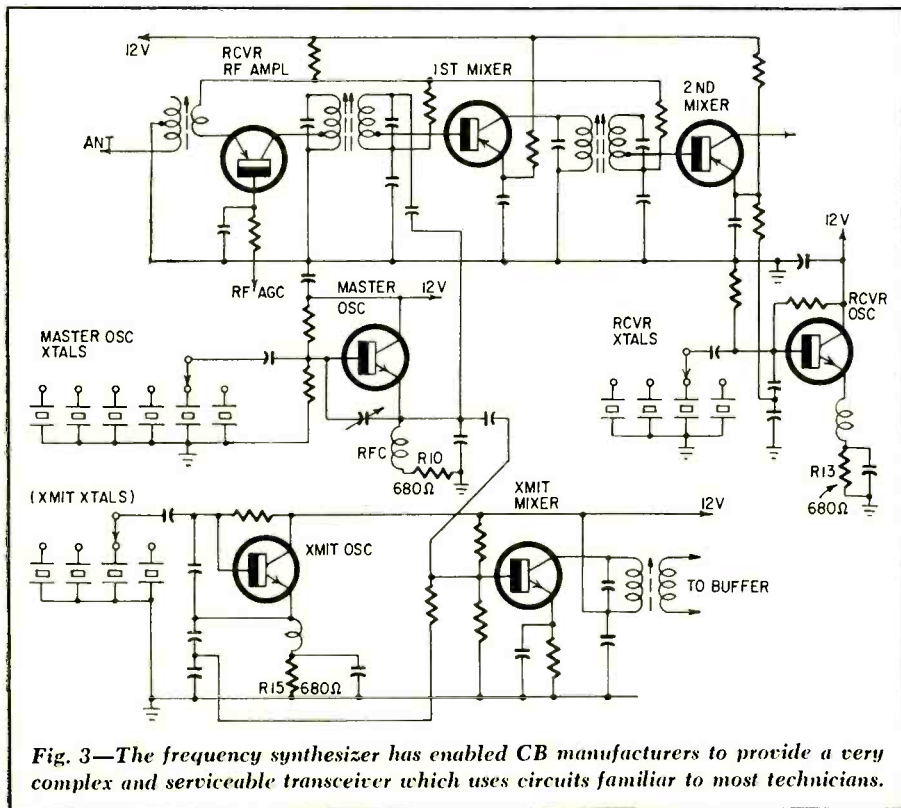

Fig. 3—The frequency synthesizer has enabled CB manufacturers to provide a very complex and serviceable transceiver which uses circuits familiar to most technicians.

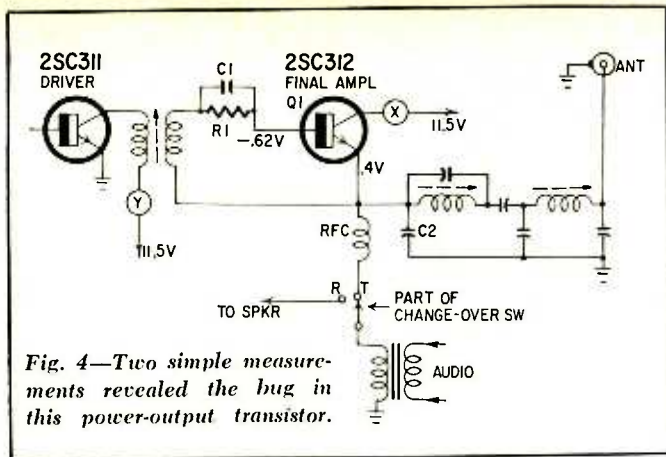

Fig. 4—Two simple measurements revealed the bug in this power-output transistor.

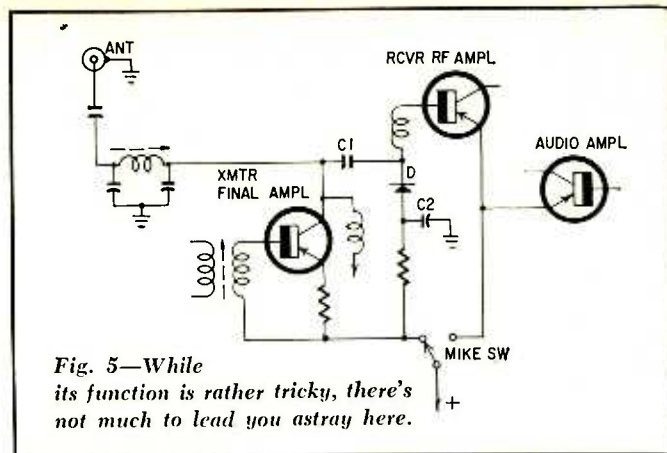

Fig. 5—While its function is rather tricky, there's not much to lead you astray here.

ode and the rf-amplifier transistor in the receiver section.

Relay-type TR switches also develop defects, but the result is usually intermittent operation in transmit or receiver modes, or in both. A typical case is the Johnson Messenger II, which has a plastic cover over the relay that frequently causes the contacts to jam. This failure causes considerable consternation because the unit usually begins to work again after it has been removed from the cabinet, and the unsuspecting technician doesn't know where to begin.

Some tuneup tips

Receiver alignment is pretty straightforward, and you'll find that most manufacturers' instructions are essentially the same. The first step is to feed 455 kHz to the input of the mixer stage (the second mixer in the case of dual-conversion receivers) and tune the i.f. transformers for maximum agc voltage. Then connect an antenna and tune up the rf stage (and the first mixer if there is one) on a signal from another transmitter or from a signal generator loosely coupled to the receiver. Try to make an adjustment which gives the best overall sensitivity on all channels.

The FCC requires that persons adjusting the frequency-determining circuits of CB transmitters must hold at least a Second-Class Radiotelephone Operator License. When making adjustments of the transmitter which might affect the frequency, keep this FCC requirement in mind.

To tune the transmitter, some kind of output meter is needed. Fig. 6 shows one you can make in an emergency, but a calibrated power-output meter such as the Electronic Communications, Inc. Portalab or EICO model 715 CB Tester will do a much better job. The best result will be obtained when following the manufacturer's instructions exactly. If this is not possible, you can do a good job by following the general procedure outlined here.

Start with reduced voltage on the collector of the rf output stage, unless

you're sure the transmitter circuits are already close to resonance, then connect a dummy antenna or rf power meter. Measure the dc bias voltage developed at the base of the final rf amplifier and tune the buffer stages and the input tank of the final amplifier for the highest reading on a channel in the middle of the band. Retouch the alignment of these circuits at the high and low ends to be sure the drive voltage does not fall off considerably. Remember that drive voltage will be reverse bias—that is, *negative* voltage when the output transistor is an npn.

Next come adjustments to the final tank and antenna-coupling circuit. Some manufacturers recommend using a scope connected to the final tank to facilitate tuning for maximum rf voltage. A vtvm with an rf probe is simpler to use, and in many cases the point of maximum power output is easier to determine. The scope and vtvm do not actually measure output power; they provide only relative indications, permitting you to adjust for maximum. To determine exactly how much power output this maximum is, you need a commercial dummy load and a calibrated rf power meter.

Final touchup of antenna tuning must be done "on the air," using the regular station antenna. If your earlier adjustments have been made carefully, it will not be necessary to make long test transmissions. The FCC requires that tests on the air be as brief as possible, during a time when the channel is not being used. You also must give the station call sign and identify the transmission as a test.

There are two ways to check the fi-

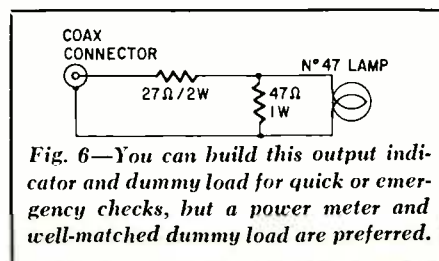

Fig. 6—You can build this output indicator and dummy load for quick or emergency checks, but a power meter and well-matched dummy load are preferred.

nal adjustments: Monitor the signal on the S-meter of a receiver located a few blocks away and have another operator at that position report on the results of each adjustment. Or, use an swr bridge between the transmitter and the antenna and simply tune the antenna-coupling circuit for maximum forward power with the least possible reflected power. The latter is the easiest and more accurate method. Remember to check the signal on several channels and obtain the best compromise.

Shaping up the whip

Here are some suggestions for getting the best results from mobile-style whip antennas: Some whips, when obtained from the manufacturer, are longer than an electrical ¼-wave and must be trimmed to the correct length as determined by the specific characteristics of the installation. In some cases, the swr of a mobile whip can be as high as 4:1 before it is trimmed, and this represents more than 60% reflected power. With base-loaded whips, cut ¼-inch sections from the base end until an swr of less than 2:1 is obtained. With center- and top-loaded whips, cut off about ⅓ inch at a time.

In areas where salt is used on the streets in the winter, it's a good idea to clean the antenna coil and the spring mounting regularly to improve the swr as well as to prevent corrosion.

Check the button at the tip of the whip when the receiver seems to have excessive noise. If the button is missing, a static charge builds up on the antenna and can cause severe interference.

Repairing CB units is really no different from repairing any other electronic equipment; it takes a combination of theoretical knowledge and practical skill. But, most of all, it takes a lot of common sense. If your CB customers feel you are technically competent and interested in helping them get the best out of their rigs, they will tell their friends, both in person and on the air, and you will be assured of plenty of service business on CB equipment.

END

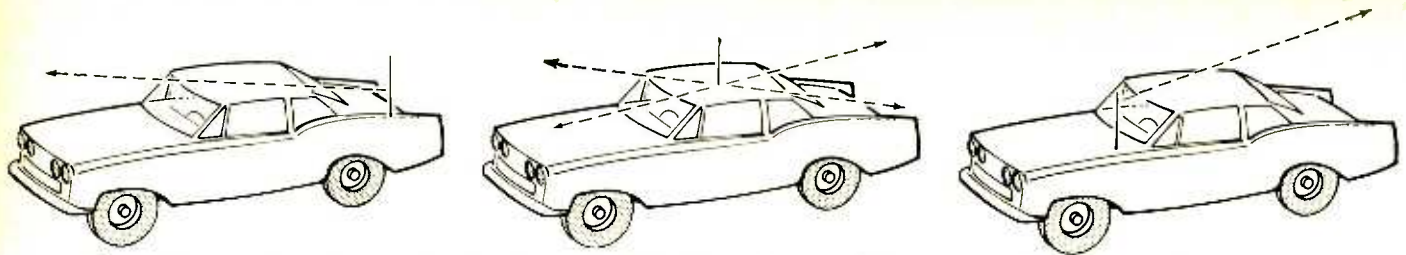

Fig. 1—Arrows show antenna directivity. Top-mounted antenna has greatest range as well as most uniform coverage.

Two-Way Radio Has Its Tough Dogs, Too!

A practical technician gives a few hints direct from his mobile service experience

By **DON DUDLEY**



I BEGAN TO HEAR THE term "tough dog" first in TV service; but, believe you me, we've had 'em in mobile FM two-way communications for years—those unique problems that make any kind of servicing challenging to technicians.

Many obscure troubles can be traced to an ineffective antenna. No matter how powerful the transmitter is or how sensitive the receivers, a defective or poorly installed antenna can block both completely. To be an effective radiator, the antenna must use the car for its ground plane. So the best place to mount the antenna is in the middle of the largest expanse of horizontal metal—the roof of the car (Fig. 1). Any other position will give you a weaker signal. With the antenna mounted on the left rear fender, the lobe will be aimed across the car as shown. In fringe areas, take advantage of this and instruct the user to aim the car if he is having trouble getting through to the base station.

Three types of antennas are generally used in the low band: the full-size quarter-wave whip, the disguised antenna, and the glass-fiber helical-wound type.

The braid inside the spring used on the full-sized whip often breaks after long use. Any resistance then between the coils on the spring will allow the spring to act as a base load. The resulting load and increased standing-wave ratio (SWR) reduce the working range. This shows up more with the vehicle in motion.

The disguised antenna has a shorted stub on the antenna feed line to make up for the reduced antenna height. If the stub is not properly placed, it can cause some head scratching. A unit came into the shop with "poor reception." The receiver was gone over and found normal. The antenna was then suspected, but an SWR check read normal for that type of antenna, thank goodness. The officer casually mentioned that the technician who installed his radio did not know if the stub should be shorted or left

open. Not wishing to place a short across the feed line, he left it open and then pruned it till he had good loading. A proper length of shorted stub licked the poor-reception problem. Apparently the open stub allowed the transmitter to tune up OK, but soaked up the receiving frequency.

It is sometimes hard to get a good ground with the disguised antenna. As with the open braid, trouble will show up mainly when the car is moving. A squad car came into the shop with the complaint that the operator heard arc-

ing in his transmitted signal. It turned out that the convex half-moon washer was touching the rubber gasket. The rf had completed a carbon path and was arcing to ground across it when transmitting.

The helical-wound antenna is pretty sturdy, but trouble can occur with it, also. A squad car with a helical-wound antenna reported he could not transmit. The unit would not load the antenna. An SWR meter showed as much power coming back as was going out. No breaks could be seen in the plastic sheath. At the shop, a little of the plastic was cut back at the top to expose some wire. A resistance check then indicated the antenna was open. The officer said his children had bent the antenna and let it spring back a few times. Most likely the constant vibration broke the wire lead.

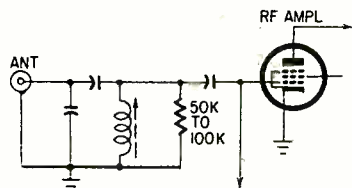

Fig. 2—The resistor improves matching.

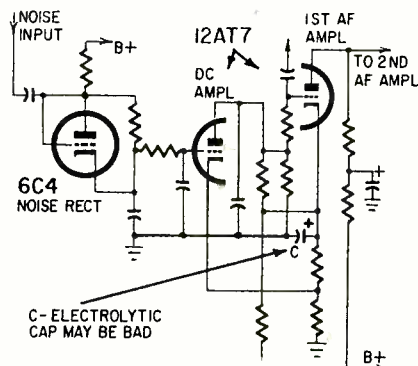

Fig. 3—Bad capacitor kills squelch.

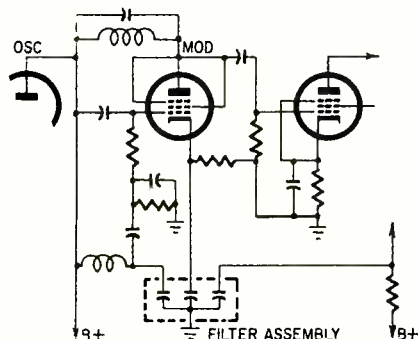

Fig. 4—Source of the many harmonics was found in the least expected place.

Oscillations and oscillators

Oscillation in the receiver—as indicated by squealing and an abnormally high limiter reading—can be caused by a too high impedance stepup between the antenna and the grid circuit of the tube. This can happen if the antenna impedance becomes lower—which is highly possible with the vertical whip—or if the grid circuit impedance increases. If you don't care to detune the front end of the receiver, place a 50,000 to 100,000-ohm resistor across the grid circuit of the rf tube (Fig. 2). It will improve the impedance match.

Sometimes the oscillations are in the second i.f. circuit. In that case tubes are generally at fault. Pulling the antenna and even the rf tube won't stop oscillations in the second i.f. The squelch will be dead, the same as with rf oscillation, and the discriminator will be off zero. A unit with these symptoms came in for repairs. The tubes were carefully checked and even the border-line ones were replaced, but the oscillations continued. The second i.f. tubes were replaced one by one and left in the circuit, with no results. Finally, second i.f. tubes of a different make were used. That did it! Apparently the internal capacitance

of that particular run of tubes was too high for that circuit.

In some makes of two-way equipment, the front-end crystals are oven-heated to maintain their frequency. Off-frequency operation reduces sensitivity and increases motor noise in the receiver. However, in a few cases frequency shift has been traced to the oven itself. If you have a unit under contract and must supply the parts, a little money may be saved by checking on this item. The thermostat contacts on the oven heater may short together, applying continuous heat and ruining both crystal and oven. In suspected cases, place a voltmeter across the oven heater. The voltage abruptly increases and decreases slightly as the heater kicks on and off. If there is more than one heater, remove them, as they mask the suspected one. You can save the cost of a new crystal if you catch it in time.

In newer Motorola units, the first audio-squelch grid has a high resistance, and a high-resistance short in the squelch tube will cause loss of squelch control. A short tester will have to be very good to be able to pick it out. If you find you are replacing this tube more often than seems necessary, try replacing the electrolytic connected to the cathode of the audio-squelch tube (Fig. 3). If the capacitor shorts, squelch control is lost. If it opens, the audio level drops. Pulling out and replacing the audio-squelch tube (12AT7) often heals the capacitor, giving the illusion the tube repaired the fault.

Harmonic radiations

We had a complaint from another source that the base transmitter was not only on its own frequency but on several others as well. The tubes and the crystals were replaced and the unit re-tuned, but to no avail. Further checking and some head scratching revealed a bad filter capacitor assembly in the cathode circuit of the modulator (Fig. 4). Replacing it kept the transmitter on its own frequency only.

The same trouble showed up in a fairly new walkie-talkie. A bench check indicated no defective part, tube or crystal. After a lot of work, we started to go over it with the idea that the fault had come from the factory. The unit was checked part by part against the parts lists. Sure enough, we came up with the wrong tripler coil. The identification mark on the coil did not match the one in the parts list for that frequency.

Some people around the base station complained they were picking up our police calls on the FM tuners. A borrowed FM tuner revealed that the second harmonic of the assigned frequency was causing the trouble. After the usual checks, replacing tubes, tuning, and replacing the crystal, the trou-

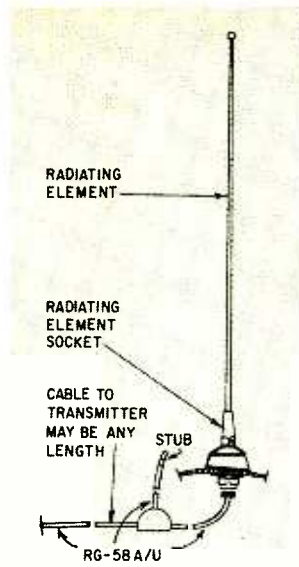
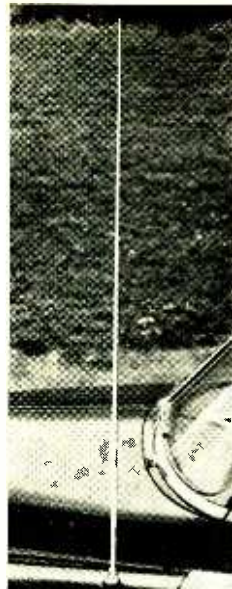

Photos courtesy C/P Corp. Drawing courtesy Communication Products Co.

Two-way mobile antennas. Disguised antennas are at left and center. The one on the right may be quarter-wavelength long. This type is usually on bumper to reduce height.

ble turned out to be in the second-harmonic filter in the output circuit of the transmitter. Replacement of this one-in-a-hundred fault took the police out of the entertainment field.

Some manufacturers have both primary and secondary tuning slugs on the transmitter accessible from the top of the chassis. Others have one on top and the other on the bottom. I wonder how many technicians made the same mistake I did in the beginning, trying to decide why some of the meter readings were getting low, while forgetting to tune the slug from underneath?

Resistable fuses

Some fuses are good, some are bad, and a few others oddly enough, develop into resistors. While troubleshooting in a two-way unit, I accidentally touched the fuse and discovered it was quite warm. It had turned into a resistor and current through it made it hot. We now measure for a voltage drop across all fuses. A few wrong-gos have been found before they could cause any trouble. The main A-plus fuse, usually located under the hood, may also develop a voltage drop due to rust and dirt which becomes wedged between the fuse and the fuse holder. Many cases of intermittent operation and low sensitivity and power output have been traced to this fault. The battery voltage drops too low for proper operation.

Transistor trials and troubles

A unit came into the shop with a shorted power transistor in the power supply. It was checked out and the transistor replaced, only to have the unit come back a few days later. As nothing could be found wrong, and as only one

of the pair was replaced the first time, both were now replaced. A few days later the unit came back. We then checked the generator output with the motor running fast, as we should have done in the first place. The 18 to 22 volts and maybe more the generator was putting out on a high-speed chase was burning out the transistors. A repair on the car's electrical system stemmed the run on my transistor supply.

Low B-plus or no B-plus may often be traced to the silicon rectifiers. In one case, the front-to-back ratio in all rectifiers was checked and found to be normal. The transmitter was held on for a few seconds. Then the old reliable finger meter was used to see if a hot one could be found. Sure enough, there it was! The rectifier would turn bad only under a current drain.

A transistor checker did not pick out the bad power transistor in the case of low-B-plus in a transistorized power supply. The mystery was that, with the transmitter energized, the B-plus to the final was half its normal value but was higher than the receiver B-plus, which is added to the high-voltage supply for the transmitter. The high-voltage circuit and the current drain of the final were checked and nothing found wrong. As the same two power transistors supplied the ac for both the receiver and the high-voltage power supplies, they were not checked till last. Despite what the transistor checker indicated, we replaced them and the high voltage went back to normal. The transistor checker could not tell that the transistors could no longer carry high current. So the old rule "Don't always believe what your tube checker tells you" applies to semiconductors too!

END

Xtal + Oscillator = Citation?

The number stamped on your crystal can may not always be the frequency at which your CB equipment is actually operating

By WILL CONNELLY, W6QID, N0TLJ, KXX0973

COMMUNICATIONS
CB

MANY CB'ERS HAVE HAD PROBLEMS WITH crystals. Sometimes they won't oscillate. Sometimes they oscillate so far off frequency that the fact is brought to their attention by other CB'ers (or worse, by the FCC!). There is a strong tendency in these cases to think unkind thoughts about the crystal maker or the set manufacturer; but the truth is that both the set and the crystal are probably all right.

Before the manufacturer installs it in its mounting, encloses it in a can, fills the can with an inert gas and solders the case shut, every crystal is tested extensively for frequency, activity and stability. The frequency stamped on the crystal can is (with rare exceptions) a precise and accurate statement of the crystal's frequency in the oscillator circuit for which it was designed.

The overtone crystal

Crystals are classed as *fundamental* or *overtone*. These terms define the type of mechanical vibration within the crystal structure. Put two hands together with palms facing each other and rub: the flattened hands represent the crystal blank and the rubbing shows the *single thickness shear vibration* of a *fundamental* crystal. Add a third hand (your own or someone else's) between the others. Keep all three flat and in contact, then move the outer hands in one direction while the inner hand moves in the opposite direction. Reverse directions. This demonstrates the *multiple thickness shear vibration* of a third-overtone crystal. Other modes of vibration can be set up in crystals, but these are the ones used in crystals ground for CB.

A fundamental crystal can often be made to oscillate at the third overtone. A third-overtone crystal can *always* be made to oscillate at the fundamental. For example, a crystal marked 27.105 MHz will operate at either 27.105 MHz, in the third overtone mode, or at *approximately* 9035 kHz as a fundamental crystal. (The actual fundamental of a crystal calibrated at the overtone frequency will be slightly lower than one-third of the calibrated frequency—closer to 9031 kHz than 9035 kHz.)

The same crystal can also be operated in either a *parallel-resonant* (high-impedance) or *series-resonant* (low-impedance) condition. The parallel-resonant frequency of a crystal is 1 to 2 kHz higher than its series-resonant frequency. For any given crystal, then, *four frequencies* may be possible (two each at the fundamental and at the third overtone), depending on variables in the operating mode. In the proper

oscillator circuits, that third-overtone channel-12 crystal can probably be made to oscillate at 9029, 9031, 27099 and 27105 kHz.

It should now be clear that the numbers stamped on a crystal case refer to the frequency when the crystal is operated in the specific mode for which it was calibrated. But even this is not the whole story. The oscillator circuit must be identical to the oscillator in which it was calibrated. For crystals operated parallel-resonant, good frequency correlation depends on making the load capacitance into which the crystal works identical with the load capacitance for which it was calibrated.

Fundamental crystals are seldom ground for frequencies above 20 MHz, and even here they are but a few thousandths of an inch thick. For operation at 27 MHz, then, it is necessary to use either a third-overtone crystal with output at 27 MHz, or to use a fundamental crystal with output at 27 MHz, or to use a fundamental crystal at 13.5 MHz and double the frequency.

Another characteristic of crystals is temperature sensitivity. Crystals *do* vibrate at different frequencies at different temperatures. And, by the very act of vibrating, crystals heat themselves. So, keep the drive level to a crystal as low as possible. Moderate overdrive causes frequency drift—greatly excessive overdrive will fracture the crystal.

Crystal oscillator circuits

Five circuits predominate in CB equipment: the Miller, the Pierce, the electron-coupled Pierce, the Colpitts and the series-resonant Colpitts. Each is good when used as intended by its inventor, but the first three have serious disadvantages, though they were popular with early CB set designers.

The Miller (Fig. 1) presents a high-impedance load to the crystal, which accordingly oscillates at one of its parallel-resonant frequencies. It can be used at the fundamental or at overtone frequencies if the plate tank is adjusted to the desired frequency. The "plate tank" circuit may be a parallel coil and capacitor or a slug-tuned coil alone (the distributed capacitance of the coil plus the output capacitance of the tube serve as the required capacitor). For CB use, the Miller circuit almost always uses a third-overtone crystal.

Bear in mind that parallel-resonant crystals are calibrated into a specific load capacitance. The capacitance the crystal "sees" in this circuit is the stray wiring capacitance which may consist of socket capacitance plus the interelectrode capacitance of the tube and the capacitance of the crystal

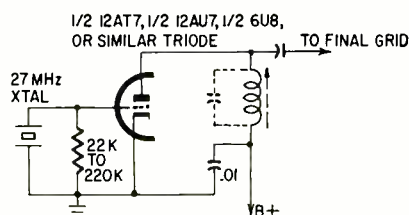

Fig. 1—The Miller circuit, common in the earlier Citizens-band equipment.

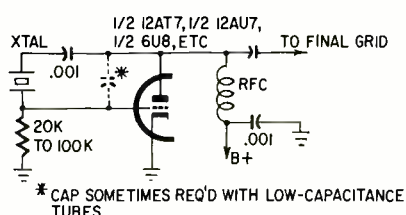

Fig. 2—The Pierce oscillator works well when lightly loaded by circuit after.

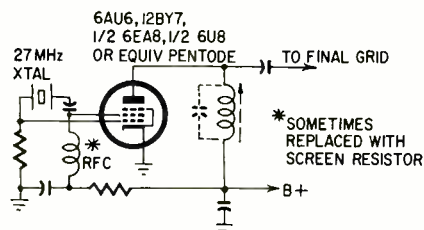

Fig. 3—Electron-coupled Pierce, an improvement over Fig. 2, is more stable.

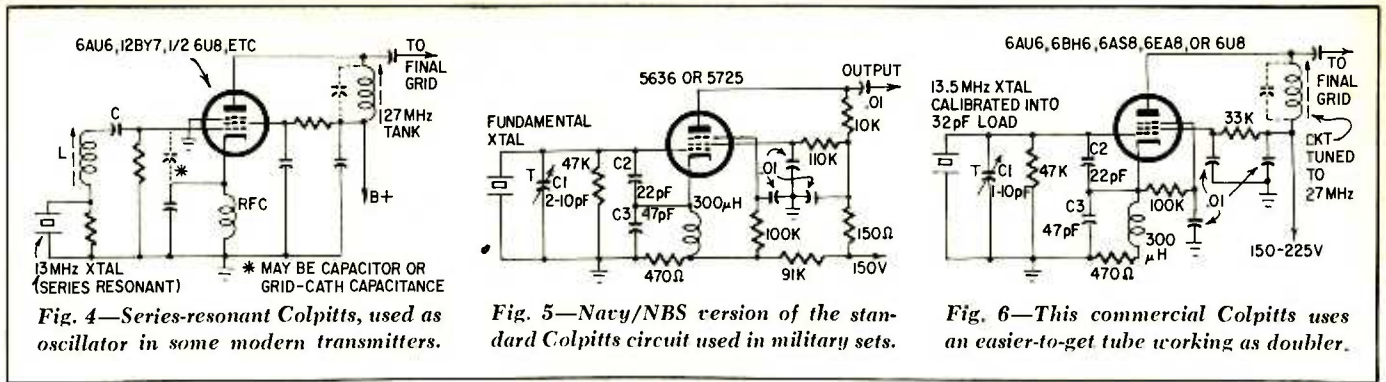

Fig. 4—Series-resonant Colpitts, used as oscillator in some modern transmitters.

Fig. 5—Navy/NBS version of the standard Colpitts circuit used in military sets.

Fig. 6—This commercial Colpitts uses an easier-to-get tube working as doubler.

switch (if used). Any change in plate-circuit tuning affects the capacitances the crystal "sees" as well as the drive to the crystal. The crystal frequency can be "bent" over 5 or 6 kHz—several times the allowable tolerance—by shifting the plate tank.

In fairness, when the Miller circuit is lightly loaded and operated at a point well below maximum output, it is as stable as any other oscillator.

The "lightly loaded" consideration is all-important. The Miller oscillator is not meant to provide power to the next stage. It is intended to establish an accurate frequency, not to act as a driver. It is very satisfactory as a local oscillator for receivers. For transmitter applications, it should be followed by a buffer (driver) stage.

Another popular third-overtone oscillator using parallel resonance is the Pierce, shown in Fig. 2. (The rf choke is often replaced by a tuned circuit in CB equipment.) It is an improvement over the Miller from the standpoint of frequency stability (there is no adjustment) but has the same faults: inadequate drive to the final unless overdriven, and susceptibility to oscillation with any crystal plugged into its socket. The drive problem can be solved by using the electron-coupled Pierce (of Fig. 3). But, unless the tube has an independent suppressor operated at rf ground, the infamous plate tank can once again affect the output frequency. Either Pierce circuit is fine for receiver crystal control.

Note that several new CB transceivers use crystal synthesizers. Miller and Pierce oscillators are entirely proper and satisfactory in these sets, because: first, the oscillators are very lightly loaded, as they were intended to be; and, second, there is no crystal-frequency correlation problem since all crystals are installed by the manufacturer.

A fourth oscillator, this time operating at fundamental series resonance, is the series-resonant Colpitts, shown in Fig. 4. It is apparently used only in Johnson equipment. Coil L is adjusted at the factory, and with C transforms from the very low impedance of the crystal to the high impedance the tube wants to "see." The circuit uses electron coupling. While the crystals actually oscillate at around 13 MHz, the frequency is doubled in the plate tank circuit (which has no effect on the crystal operating frequency). Ample drive is provided to the final amplifier. Crystals may be ordered from any crystal manufacturer by specifying "series-resonant fundamental" and the desired frequency (which is one-half the actual output frequency). This is an excellent, stable oscillator.

The parallel-resonant Colpitts

The Colpitts oscillator is supplanting the Miller in newly designed CB sets. The crystal operates at the fundamental, and the frequency is doubled in the plate tank. Although the crystal is operated parallel-resonant, the Miller oscillator's extreme sensitivity to external circuit changes is eliminated by the heavy capacitance loading across the crystal itself. A circuit change of a picofarad or two—disastrous in a

Miller circuit—will seldom move the Colpitts out of tolerance. The very fact that the crystal is capacitively loaded permits a major standardization for the crystals.

The Colpitts oscillator is widely used in military equipment. Preferred circuit PC 102 (from Supplement No. 2 to the Navy's *Handbook of Preferred Circuits*, NAVAER 16-1-519, available from the Superintendent of Documents, Washington, D.C. 20025) is an electron-coupled Colpitts for use from 800 kHz to 20 MHz. It was designed for the Navy by the National Bureau of Standards. The design recognizes a long-existing commercial and military standard for crystals: frequency calibration with the crystal operated into a 32-pF load capacitance. The Navy circuit in Fig. 5 is untuned and delivers its output at the fundamental frequency. The circuit values are for operation from 5-20 MHz. A modified version (Fig. 6) uses a commercial tube and includes a plate tank tuned to the second harmonic of the 13-MHz crystals with which it is used.

Once the load capacitance (C1, C2, C3), the stray wiring capacitances and the capacitance of the crystal holder are established, any crystal specified for a 32-pF load may be plugged into the crystal socket with every confidence that the crystal manufacturer will have done an excellent job of frequency calibration. Crystals may be specified as MIL type CR-18. This specification defines a crystal in an HC-6/U holder (the usual CB type) with a frequency tolerance of .005% (as required by the FCC) and calibrated into 32 pF. With the usual stray wiring capacitances, the load capacitance can be adjusted with C1. Plug in one crystal, adjust C1 to zero-beat with a commercial frequency standard (or have the frequency measured with a freqmeter while adjusting C1 to precisely the desired frequency) and all additional crystals ordered to spec will be on frequency.

The closest commercial equivalent to the 5636 sub-miniature tube used in the Navy is the 6AS6. Excellent results will be obtained with 6AU6 seven-pin or 6AS8 nine-pin tubes in the circuit of Fig. 6. In each case, the independent suppressor grid permits the suppressor to operate at rf ground but at the same dc potential as the cathode. This helps reduce or eliminate frequency variation resulting from plate-circuit loading or tuning variations.

Many new CB sets are adopting the parallel-resonant Colpitts design. One manufacturer (International) of both crystals and CB gear has been using Colpitts oscillators in its transmitters since its earliest design and has ground all its crystals for a 32-pF load. When set builders do adopt the standard suggested by the best engineering minds in the country, the frequency and "pink QSL" problem should be solved permanently for all future CB set production, and users will benefit from universally interchangeable crystals.

For the solid-state fraternity, the Navy and the National Bureau of Standards have created a new line of transistorized preferred circuits. The Colpitts oscillators appear in Supplement No. 1, Vol. II of the *Preferred Circuits Handbook*. END

Quick-Change PA System Saves \$\$

A multipurpose system that didn't strain a small-town budget

By WILLIAM DARRAGH

EVERYBODY WAS TALKING AT ONCE. "I need a PA system for meetings and banquets," said the Chamber of Commerce.

"I've gotta have sound at the rodeo arena and out on the fair midway for paging," said the Fair Committee.

"We've got to have a sound system in the sale barn," said the Cattlemen's Association.

"We could use better sound at the football stadium," said the Athletic Association.

"How about the beauty contests and talent shows?" asked the Jaycees.

At that point, they all bent over, dragged me out from under the conference table, and demanded, "Well, how about it?"

Badly outnumbered, I got out my little pad and pencil. "OK. OK." I said resignedly. "Just tell me what you want at each place." The co-channel interference started again—all yakking at once.

I got them calmed down, and then made a list of requirements and a hasty exit, swearing I'd never make *that* mistake again—attending meetings, that is.

Back at the ranch, I sorted out all the demands and began figuring. This was, of course, one of those "just get us what we want but don't spend any money" jobs, standard in municipal and civic-society work. So, I had to figure out maximum usage with minimum equipment.

Well, Bill, start with a medium-powered amplifier; got to have that. Say about 30 watts—ample power for these jobs. Now, how to spread this out as thin as possible. Fortunately, none of the activities take place at the same time. Rodeo at nights, cattle sales in the afternoons, no football games during rodeo time, and so on. So, here's an idea: maybe use the same amplifier for all of 'em!

Maybe. But what about that most important part—speakers? The first thing that comes to mind is a pair of portable speakers. No. You simply can't

cover big crowds like at rodeo arenas and football games, where three or four thousand people are on both sides of a big arena, with portable speakers.

Hey! How about putting up the *right* speakers at each place, and then just lug the amplifier back and forth. Now, that idea looks promising.

Let's see. Four small paging-horn speakers at the rodeo arena, mounted on the light poles so they spread the sound out over the crowd (like in Fig. 1). Already have two horns at the football field, but the amplifier there is old enough to draw Social Security, and not big enough, anyway. Could work out a fixed-speaker system for the bull barn. Finally, a pair of small cone speakers in cabinets for the banquets where we won't need much power output. That ought to do it.

So what'd I do? Well, I started with the rodeo arena. We have rodeos in the fall and spring and, at fair-time, high-school beauty contests, talent shows and so on. For these, they put a portable

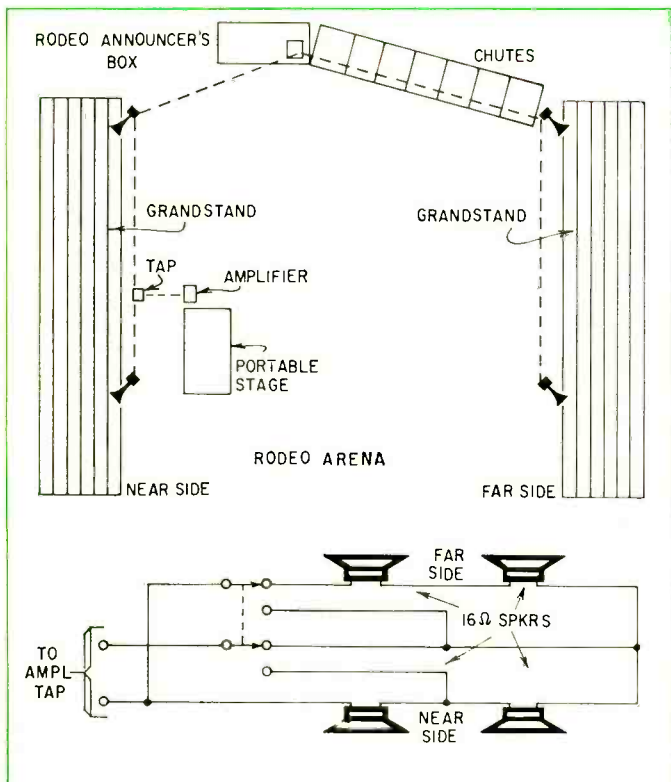

Fig. 1—Dpdt switch in announcer's box opens line to far-side speakers to silence them during such events as beauty contests.

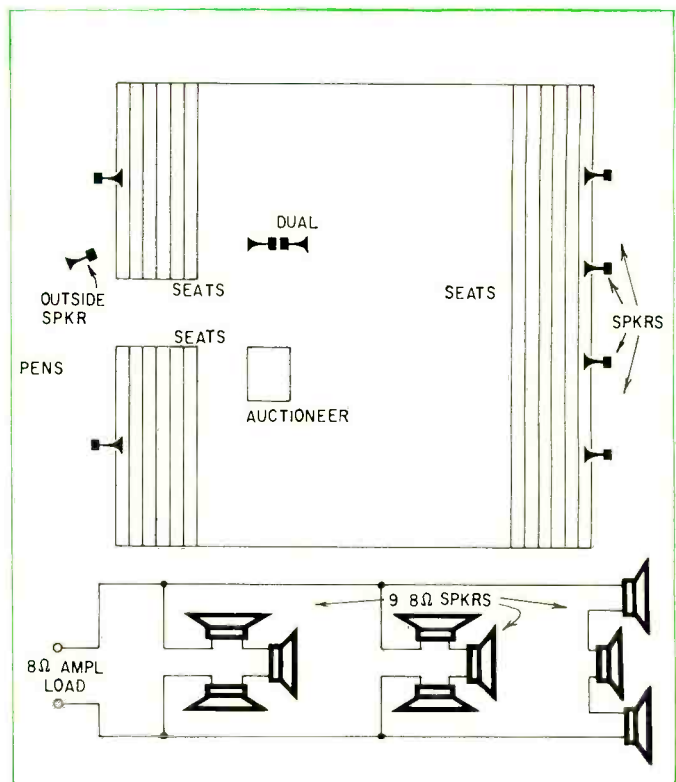
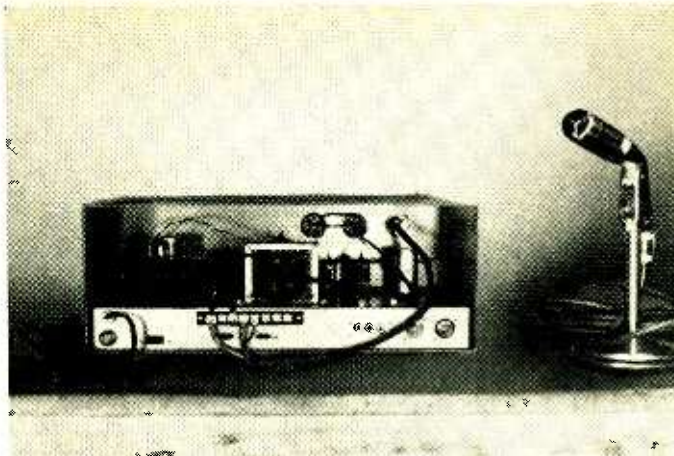
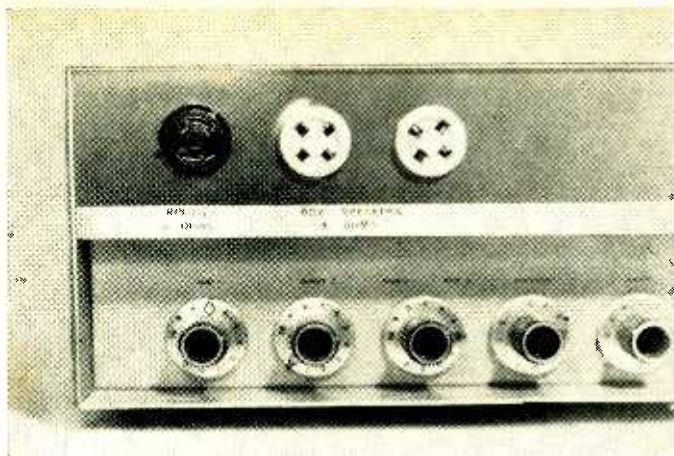

Fig. 2—Speaker system in the bull barn uses nine speakers wired in series-parallel to provide a proper impedance match.



Mounting speaker sockets on the front and color-coding them makes the system easier to use. Sockets are wired to terminal strip on back apron. Mike connector was moved to front panel after this photo was taken.

stage at one side of the arena, and use one side of the rodeo grandstands. To cover the whole crowd, I used four 16-ohm 15-watt paging-horn speakers. Connected the speakers on each side in series, then connected the two in parallel, and I had a neat 16-ohm impedance. The lines were terminated in a terminal block, with wing nuts, at the rodeo announcer's box. A switch was added here, to disconnect (short out) the "farside" circuit. Tell you why in a minute.

To save trouble, I ran a drop down the center light pole, as you can see in Fig. 1. Another terminal block there, for the speaker lines. Also, an ac outlet, wired into the arena light circuit.

When they set up the stage for the beauty contest, we put the amplifier on the ground and connected it to the speakers on one side of the arena, then threw the switch in the announcer's box since we didn't need the farside speakers. This gave us a nice 8-ohm pair on this side.

The speakers were about 100 feet apart, and I wanted to run low-impedance for simplicity. So I used solid No. 12 wire for the speaker lines so that it would be self-supporting over those long spans. Also, saved quite a bit on transformers. The heavy wire avoids line drop on long runs.

Football field: no problem. Already had two nice big horns here that I'd put up some time ago. Both were 16-ohm, in parallel, so I had another 8-ohm set.

Banquet speakers: Got a pair of new 8-inch 16-ohm speakers and had boxes made for them. I fixed them so they buckled together: that made a handy carrier for the amplifier and mike.

Now the worst of all: the bull barn. This is a sheet-metal building about 50 x 50 feet, with seats on both sides and the auctioneer's rostrum down on the sale floor. The acoustics are about as poor as you'd expect, and I was going to have some background noise (an understatement, with the bulls and auctioneer

bawling at the same time!). If I tried to brute-force it, all I'd get would be the grandfather of feedback howls from those tin walls. So, I decided to use the "sprinkle" method, which had worked before in similar situations.

I got nine small speakers, 8-inch medium-power jobs (5 watts) and built them into little boxes. Then, we scattered them around all over the place, as in Fig. 2. Just for luck, I put two boxes back-to-back, and hung them well up toward the ceiling over the sale floor. One more was weatherproofed and hung on the outside of the building so the auctioneer could call people out in the holding pens and so on.

Here again I got an 8-ohm impedance. These were 8-ohm speakers, so I hooked three in series, and then paralleled three series groups to get my 8 ohms back again.

With comparatively low sound level in each speaker, I got a good average sound level over the whole area without having to use so high a level that I got bounces and feedback from the metal walls. Works very well, too.

Since the bull barn is at one end of the fair midway, I mounted another outdoor horn—a 16-ohm 20-watt job—on the roof, aimed down the midway. That was the paging horn. The main use is finding out where the county agent is, so somebody can chew him out about something.

A shelf was mounted on the wall behind the auctioneer's stand, and another near the front door. The first holds the amplifier during sales; the other is for paging while the fair is going on.

That took care of the coverage. To finish the job, I had to set this thing up so it would not only be foolproof but "dang-fool proof." too. So, I modified.

The amplifier originally had small, delicate-looking speaker plugs on the back apron. Usable, but they didn't look strong enough to stand up under the abuse they'd get from the amateur

soundmen around here! I could have used the multiple-impedance terminal strip on the back, but that would require tools and the ability to figure the right impedance: so that was out. This system had to be automatic!

The front panel was nice and blank above the controls, so I punched three holes and put in heavy 4-hole sockets. I ran heavy wires to the terminal strip on the back of the amplifier. To make it easy for anyone using the system, I used a black socket for 16 ohms and two white sockets for 8 ohms.

At each "speaker system" location, of course, I ran a heavy pair of flexible wires and put on a heavy-duty shell-type 4-pin plug. The 16-ohm system plugs were left black, and the shells of the 8-ohm plugs were painted white. Now, all they have to do is match the colors.

A rugged semicardioid dynamic mike is used with this system. It gives excellent speech reproduction and is good for music as well. With a desk stand for the bull barn, banquets and rodeo announcer—plus a floor stand for the beauty contests and talent shows—we were in business. A short mike cable, about 15 feet, is used for most applications, and a 50-foot extension mike cable takes care of anything else that is needed.

By "designing for use," we came out with a multiple-application sound system that works like a horse. Of course, extra amplifiers permanently installed at each location can be added whenever the boys get up the money. However, this flexible system of mine is one way to get full sound coverage of all kinds of events.

There was only one small hitch in the way it worked. When someone wanted to use the amplifier, it took 2 or 3 hours to find out who had it. We finally solved that by making the county agent responsible for it all the time. Whenever anyone takes it, they sign a log. At least we know where to start looking! END

"And/Or...Nand/Nor"...Computer Talk

Logic circuits aren't confined to computers. Here they are in everyday guise

By IRWIN MATH, WA2NDM

AUTOMATIC INDUSTRIAL CONTROL SYSTEMS, complex computers, and a host of other "thinking" machines use pre-planned programs to dictate their operations. These programs tell the machine exactly what to do at each stage of an operation. Such a program, besides commanding each step of a process, entails logical step-by-step evaluation of exactly what effect each event has on following events.

Special circuits, called *logic circuits*, perform comparisons and make decisions. Four of the elementary logic circuits are the *and* circuit, the *or* circuit, the *nand* circuit, and the *nor* circuit. These circuits are the building blocks of complex computers. If you know how they work, you are on your way to understanding computers. In discussing applications, however, you'll see that these logic devices are used in more everyday ways than you might think.

Fig. 1-a is a simple *and* circuit or *and gate* as it is usually called. Switches and a relay are shown, to make the principle easy to understand. Switch A energizes the lamp circuit, and switch B the relay coil. You can see that only when switches A and B are closed can the relay close and light the lamp. Neither switch can light the lamp alone. If you consider the *act* of closing a switch to be an energy input, and the lighted lamp to be a result of output, you can visualize the underlying operating principle of the *and* circuit: both input A and input B must be present for an output.

Fig. 1-b is a semiconductor version of the *and* gate. Again, switch A must be closed to supply collector voltage to the transistor, and switch B must be closed to bias the transistor into conduction, before current can flow through the lamp.

This idea can be expanded to produce an *and* gate with any number of inputs. Fig. 1-c shows a four-input *and* gate. For the lamp to light (an output) all four of the series-connected transistors must conduct. This requires that all switches be closed (all inputs be present) — 1 and 2 and 3 and 4. If any one (in-

put) is missing, there is no output. You can make the output (lamp lighting) depend on as many inputs as you like.

Fig. 2-a is a simple *or* gate. In this circuit input A or B must be present before you get an output. Since the two switches are in parallel, either one will energize the relay and light the lamp. When you examine the solid-state version in Fig. 2-b, you'll see that B+ is always supplied to the transistor so it is ready to conduct all the time. All that is required for an output (make the lamp light) is that any switch be closed, biasing the transistor into conduction. Expanding the number of *or*-gate inputs is simply a matter of adding more switches in parallel with the ones already present.

Up to this point, closing a switch has represented an input. In the next example, you'll see situations where it is desirable to produce an output by opening a switch (removing an input). These characteristics, basically the opposite of the circuits just described, are called *not-and* (or *nand*) and *not-or* (*nor*) logic.

The *not-and* or *nand* circuit will produce an output only when inputs A and B are *not* present. For instance, consider Fig. 3-a. Assume that *opening* a switch constitutes an input. It is obvious that only when *both* switches are open will the relay contacts close and the lamp light. The same function with semiconductors (Fig. 3-b) takes a pnp transistor. When both switches are closed, the transistor base is essentially tied to the emitter. With no base-to-emitter bias the transistor is cut off. Opening both switches (*not* input A and *not* input B) removes this short and the transistor conducts, lighting the lamp.

The *nor* gate (Fig. 4-a) produces an output when either switch A or switch B is opened. When either is opened, the corresponding relay drops out, its con-

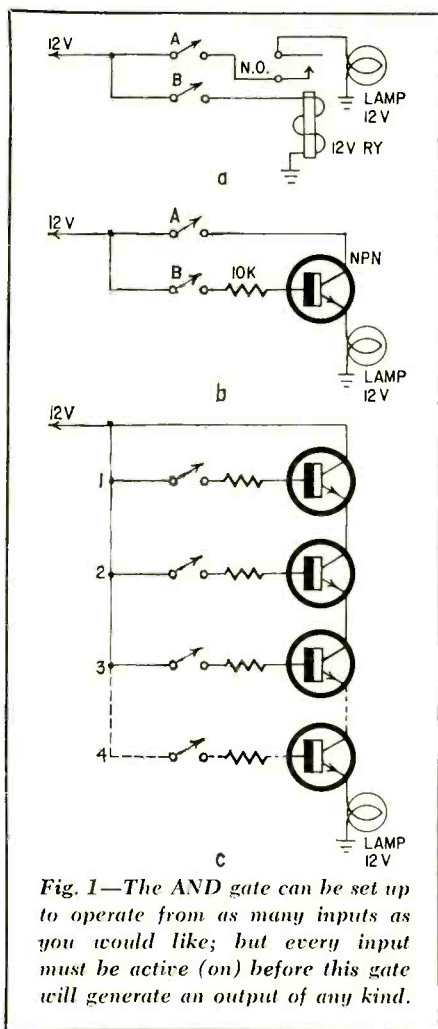

Fig. 1—The AND gate can be set up to operate from as many inputs as you would like; but every input must be active (on) before this gate will generate an output of any kind.

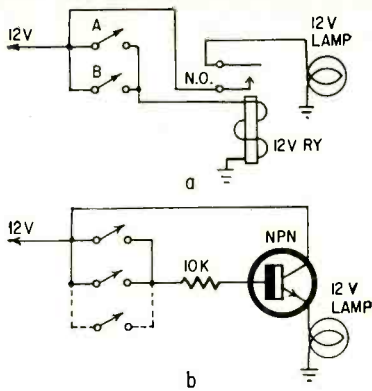

Fig. 2—In the OR gate, you can have any number of inputs; in this logic circuit, however, an output will be produced if any one of the inputs becomes active (or turns on).

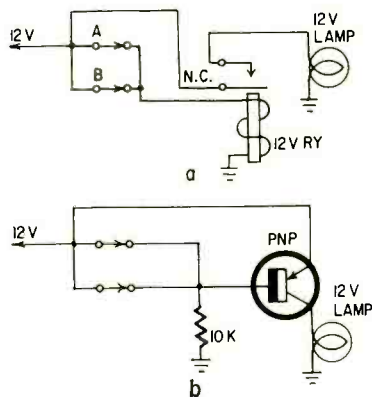

Fig. 3—NAND gate circuit depends on inputs becoming inactive (turning off or being removed). However, every input must be inactivated before an output will be produced.

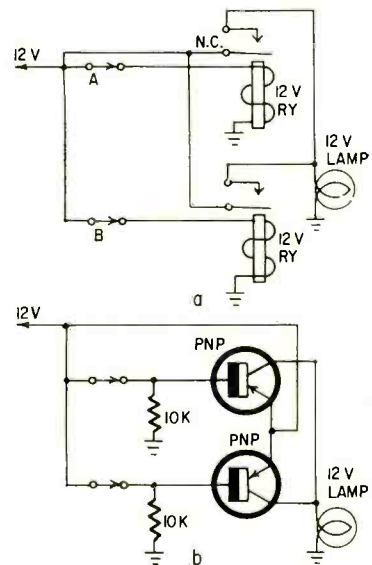

Fig. 4—The NOR gate depends on removal of a single input. Can have as many as is necessary, but losing just one of them is enough to cause the gate to produce output "pulse."

tacts close, and current flows to the lamp. The semiconductor version does the same thing. With neither switch open, the bases of the pnp transistors are at emitter potential and the transistors are cut off. When a switch is opened, however, its transistor is biased on, current flows and the lamp lights.

While the operation of these circuits has been explained using the action of closing and opening switches as inputs and the action of lighting lamps as outputs, most computer circuits are more sophisticated. The usual logic circuit responds to either voltage-level changes or to pulses of some sort.

A typical example of such a logic circuit is given in Fig. 5. This *and* gate is part of one type of punchcard reader. The transistors are biased into cutoff by the base resistors: the resistance of the photocells is very high. When a card moves into place and the two holes on the card reach the right position, light shines through them, illuminating the photoconductive cells. Their resistance drops to a point where the two transistors are switched on. Current flows through the transistors and the 1K load resistor, producing a voltage across it. This voltage pulse is fed to the next logic circuit where it produces another action, and so on. Whenever the specific two holes on a card are in that particular position, there is an output from the *and* gate. By selecting positions for lamps and photocells, you make the many holes on a card represent specific data. The computer "reads" this data as each card moves into position.

Now think about a simple but useful logic-type warning device. Consider this situation: If you leave your automobile with the motor off and the headlights on, the battery will discharge. How about an alarm to warn you before you leave the car? Plan it so the passengers can leave the car without sounding the alarm. The sources of information (inputs) can be: the ignition switch, which we will call A; the headlight switch, B, and the door switches, C. The alarm should sound only if A is open and B and C are closed. Any other condition should not trigger the alarm.

Fig. 6 shows the relay approach. RY1 forms a *nor* gate with switch A as the input, while RY2 forms an *and* gate with B and C as the input. The buzzer sounds only when the headlights are on *and* one of the doors is open. B and C are closed and A is open. The solid-state version (Fig. 7) operates in exactly the same manner. B applies base bias for Q2, but Q2 can conduct only if Q1 does. C applies emitter voltage to Q1, but it can conduct only if a door is open. So, with the headlights on *and* a door open, Q1 and Q2 are both ready to conduct—except that a closed A holds the base of Q1 at the same potential as

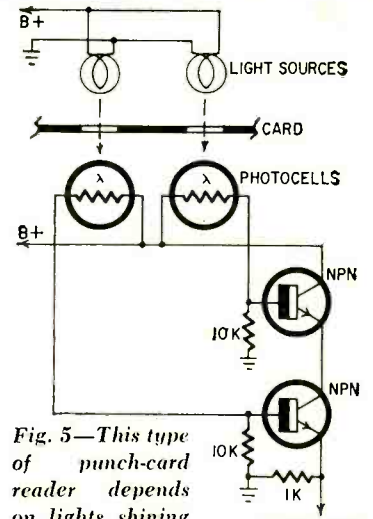

Fig. 5—This type of punch-card reader depends on lights shining through the holes.

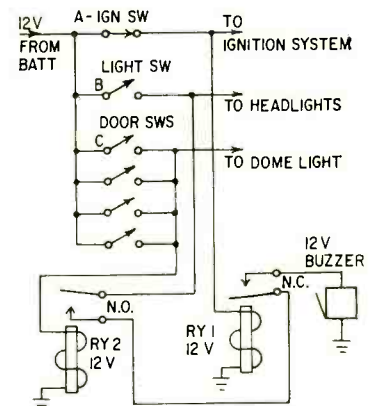

Fig. 6—Headlight alarm shows how logic circuits can be turned to everyday use. This setup takes one AND gate and one OR gate to turn on.

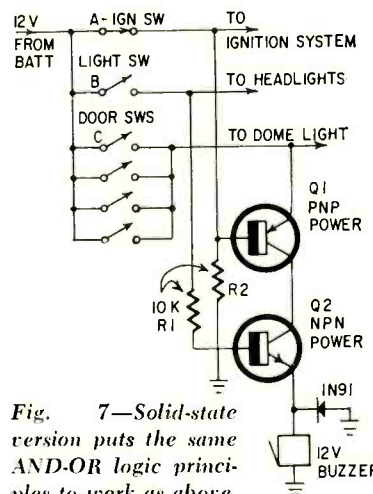

Fig. 7—Solid-state version puts the same AND-OR logic principles to work as above.

the emitter and keeps it cut off. Turn off the ignition switch and you add the final input that sets off alarm. The diodes across the buzzer coil prevent voltage spikes generated by the buzzer coils from damaging Q1 or Q2.

By thinking along these lines, you can construct similar and even more complex control circuits for whatever special application you may have. END

Making Modulation Easy to Understand

This sequel to "Vectors Show How Circuits Work" proves the point

By **NORMAN H. CROWHURST**

IN THE JULY ISSUE, I SHOWED YOU HOW VECTORS CAN HELP you understand circuit operation. In this followup article, I'm going to show you how to uncover some of the mysteries of modulation through the use of vectors. Take a quick look through the first article (page 58 July RADIO-ELECTRONICS) if you've forgotten any of the fundamentals I brought out there. Then proceed, and see how vectors truly do help you understand circuit operation.

Amplitude modulation

You may recall that amplitude modulation can be represented by a carrier and two sidebands. You can graph this by laboriously adding the sine waves that represent these three frequencies, point by point. *Once you realize that vectors "work", you can do the same thing much more easily from a simple vector diagram.*

You're probably familiar with the convention that a vector rotates *counterclockwise* at the frequency it represents. If we have three *different* frequencies, such as a carrier and two sidebands, then we shall have three vectors, each rotating counterclockwise at a rate determined by its frequency.

With vectors that represent a circuit working at only one frequency, we examine relationships in only one position of

the vectors, to make the drawing easier. We imagine, in effect, that we're going around with the vectors, so they appear stationary to us. Or, if you imagine the vectors being driven around by some sort of motor, they could be viewed as stationary by using a strobe light operated at the same frequency. We "stop" them all at a particular point in their travel.

Now, when we imagine the amplitude-modulation vector diagram, we work the strobe light at the carrier frequency. The carrier vector will now appear stationary. The lower sideband will appear to rotate clockwise, and the upper sideband vector will appear to rotate counterclockwise, each at the frequency by which it differs from the carrier frequency.

Completing the analysis, we can show the vector diagrams at different points through the modulation cycle, and show that the resultant vector, made up by adding the carrier and its two sidebands, is always in phase with the carrier (never at an angle to it) and is of varying amplitude, to represent true amplitude modulation (Fig. 1).

In this diagram, C is for carrier, L for lower sideband and U for upper sideband, with R for resultant. We also see a half cycle of all three frequencies at points marked 1, 2 and 3 on the modulation envelope, to demonstrate how the waves themselves add up at the corresponding points on the modulation wave.

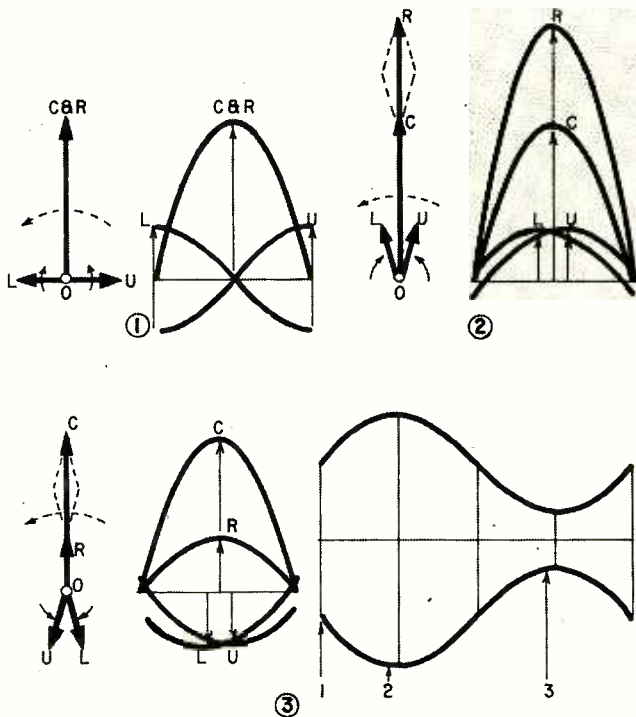

Fig. 1—Vector representation of amplitude modulation. Comparing with sine-wave equivalents shows how the vectors are developed. Sine waves show instantaneous phase relationships.

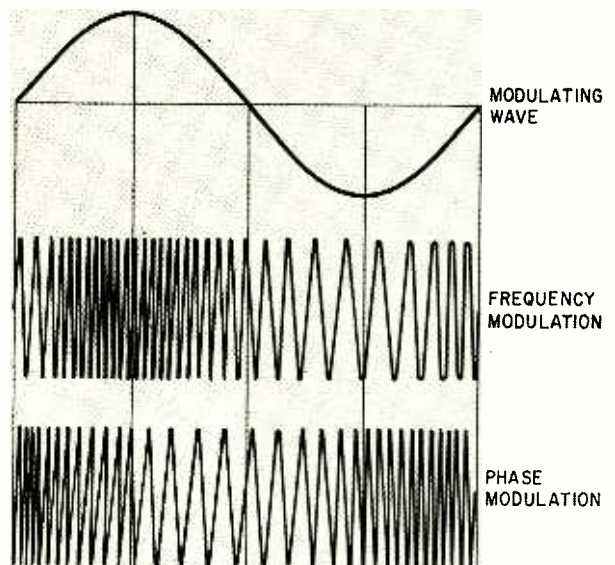

Fig. 2—FM alters frequency of the carrier with modulation; PM (phase modulation) affects the phase of each cycle of carrier. Compare the modulation envelopes of the PM and FM signals.

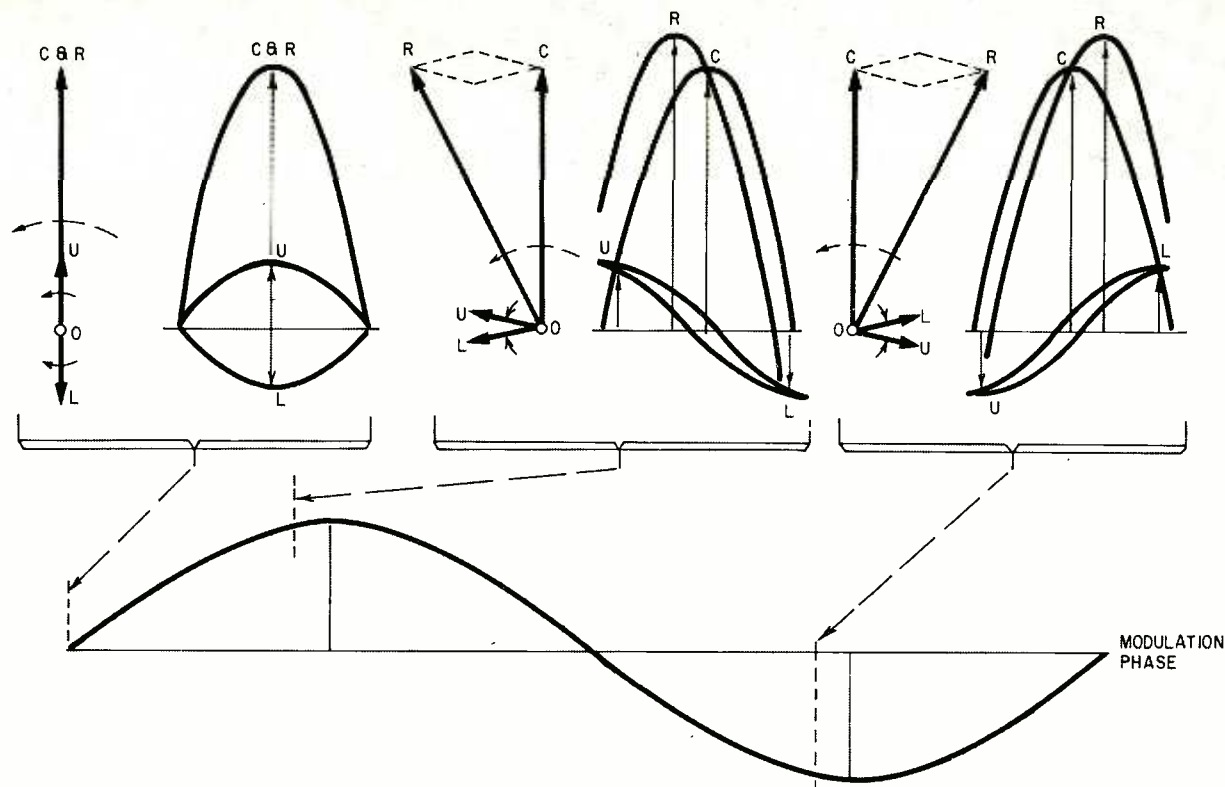

Fig. 3—At center frequency, resultant coincides with carrier. During modulation, the resultant lags, then leads the carrier vector.

Frequency or phase modulation

So far, so good. Now we turn to frequency or phase modulation. For any one modulating frequency, these two types of modulation come out to the same thing. The distinction between them shows up when we consider impressing a complex wave, or a complete program on the carrier, and then determine the relationship between the modulating waveform and the carrier deviation it produces. Frequency modulation changes the *frequency* to match the instantaneous amplitude of the modulating waveform; phase modulation changes the carrier *phase* (Fig. 2).

For our analysis, at one modulating frequency the methods are identical: linear frequency modulation is also linear phase modulation, and vice versa.

Linear amplitude modulation makes the amplitude of the carrier fluctuate in faithful replica of the modulating waveform. It also keeps the carrier frequency or phase constant, as shown by the fact that the resultant wave is always in phase with the carrier. The object of frequency (or phase) modulation is to have the frequency or phase of the resultant vary in faithful replica of the modulating wave, while keeping its amplitude constant.

Frequency or phase modulation is developed by using circuits that modulate the carrier in one of these ways. This modulation must add sidebands to achieve the desired effect. For other reasons (connected with bandwidth and interference), the number and magnitude of the sidebands must be restricted.

What limitation on performance do these restrictions impose? Some discussions imply that nothing is really lost by clipping off some of the sidebands. Even the best explanations have left the matter somewhat hazy. To examine why sidebands are necessary and what they contribute to overall per-

formance quality, we will examine them as if they are added consecutively, in pairs, as required. Then we will analyze just what can be done with successive limited numbers of sideband pairs.

The first step is to add the first pair of sidebands in a different phase relationship from that used for amplitude modulation (Fig. 3). These sidebands have equal amplitude, and start 180° out of phase with each other. Now the resultant swings forward and backward in phase, as well as changing amplitude much less than in Fig. 1 (and at twice the frequency, being minimum at zero and increased at both extremes of the modulating wave). As long as the phase deviation is small, this looks good: the resultant swings on alternate sides of the carrier, and its magnitude doesn't change too much.

But as soon as we step up the amount of modulation a little more, the amplitude starts to change more rapidly than the phase. Before the phase swing can reach 90° in each direction from center, amplitude goes up to infinity. This is why frequency or phase modulation must add further sidebands. First we add another pair, called second-order sidebands. Their frequency of contrarotation, relative to the carrier, is double that of the first pair (Fig. 4). These new sidebands "b" start out in phase with each other. Their amplitudes are equal.

If the second-order sidebands augment the carrier at the zero-modulation (center) point, they will neutralize one another at the half-phase (45°) points, where the first-order sidebands produce a resultant 0.707 of the maximum deviation. At maximum deviation (90°) of the modulating wave, the second-order sidebands will oppose the carrier by as much as they augmented it at the zero point.

Now we can examine how the resultant changes at these three positions (five positions, if we consider positive and

negative phase excursions, which are identical). Each deviation point considered is analyzed into in-phase (zero-angle) and quadrature (right-angle) components. For the zero-phase point, the resultant is the carrier plus twice the individual second-order magnitude. For the maximum deviation point (90° and 270°), the in-phase component is carrier *minus* twice the second-order magnitude, while the quadrature component is twice the first-order magnitude.

Using *C* for carrier, *a* for first-order magnitude and *b* for second-order magnitude, we can write expressions for the resultant, *R*, using the Pythagorean theorem. We equate those expressions, to represent the condition that the magnitude is the same at zero and maximum deviation points. (Actually, we equate *R*², to make the algebra simpler: if *R*² is equal at both points, *R* will be also). Then we derive an expression for second-order magnitude, in terms of carrier and first-order magnitude.

We want to know two more things: Does the amplitude stay constant, because we've made it the same at the middle and extremes. Is the phase movement linear with the modulating signal it represents?

To answer the first: making the extremes equal to the middle position magnitude required the value of the resultant at each to satisfy $R = C + 2b$, or $R^2 = C^2 + 4Cb + 4b^2$. Substituting the condition that yields this equality, the intermediate value of *R*² (at the 45° point) becomes $R^2 = C^2 + 2a^2$ (which it is regardless, but by substitution) = $C^2 + 4Cb$. In this last form, it is obviously less than *R*² at the middle and extremes, by $4b^2$.

So the bigger *b* becomes, the more the amplitude fluctuates at the intermediate modulation point.

The phase-linearity test involves a little trig, but this is

fairly simple if we use different reference angles. At the 30° phase-modulation points, deviation (measured as an angle) should be half the maximum, because $\sin 30^\circ = 0.5$. So now we have different relationships at the intermediate phase point, although the middle and extremes are the same as before (Fig. 5).

The first-order sidebands will have half their maximum quadrature value in the resultant. The second-order sidebands will be half their maximum value, in-phase-augmenting the carrier (they augmented it by twice this in the zero or middle position).

To check what happens now, we make the half-phase deviation precisely half the maximum deviation, using the tangent formula

$$\tan 2\phi = \frac{2\tan\phi}{1 - \tan^2\phi}$$

Making the proper substitutions, $\tan \phi$ (the half-angle vector) is its quadrature component divided by its in-phase component, or $\frac{a}{C + b}$, while $\tan 2\phi$ is the same ratio for the full-angle vector, or $\frac{2a}{C - 2b}$. Equating the two values for $\tan 2\phi$

(one from its vector and the other from the formula using $\tan \phi$) and simplifying by ordinary algebra (not shown in detail) yields the condition $a^2 = 3(Cb + b^2)$.

As the expression for the zero-phase amplitude does not include any quadrature component (component with *a* in it) and those for half-phase and full-phase amplitudes both do, we can substitute for *a*² in each of the latter, to get the same form, so amplitude variation is more apparent. Now

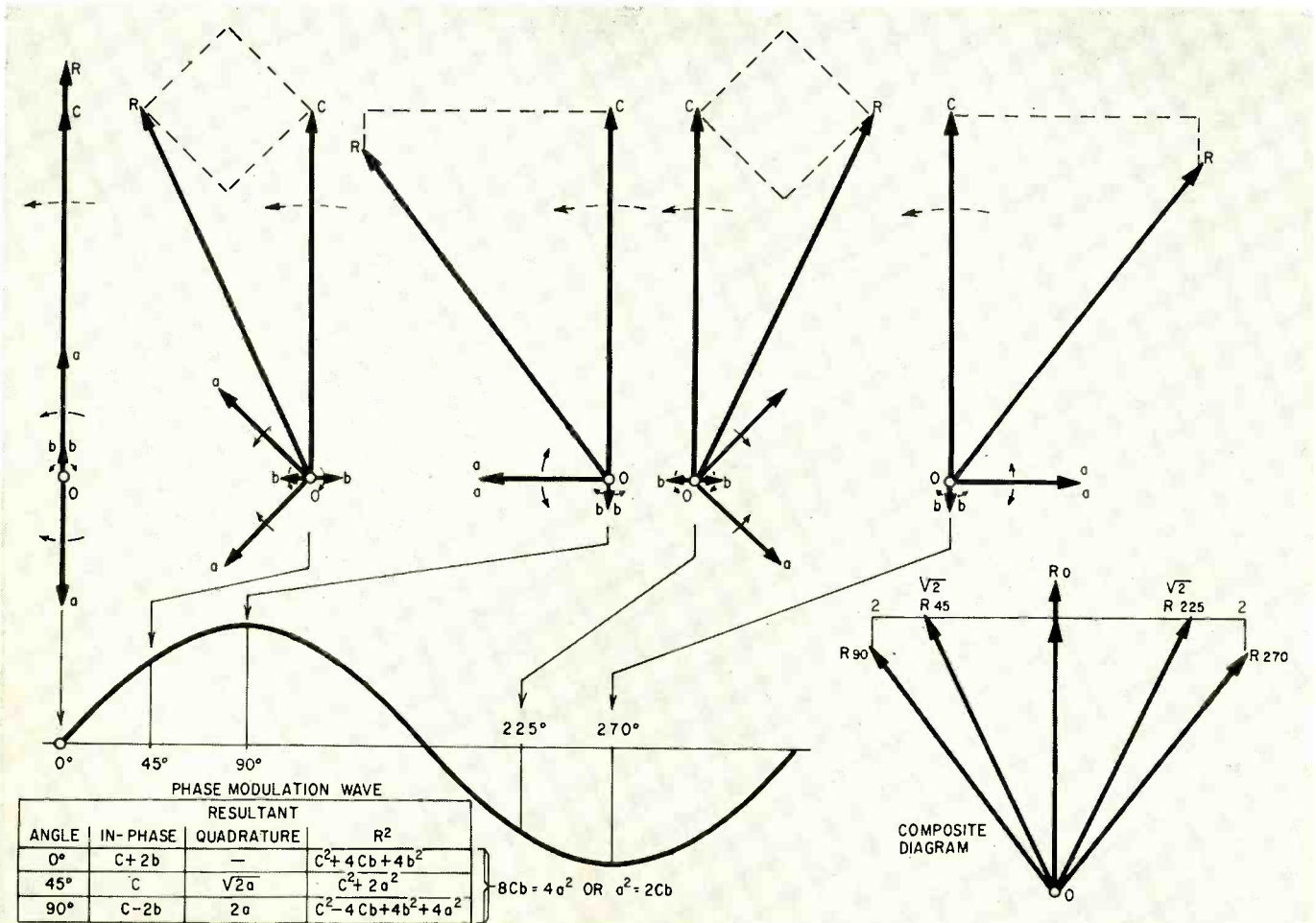

Fig. 4—Modulation increased. Vectors associated with different points on the modulating wave show why more sidebands exist.

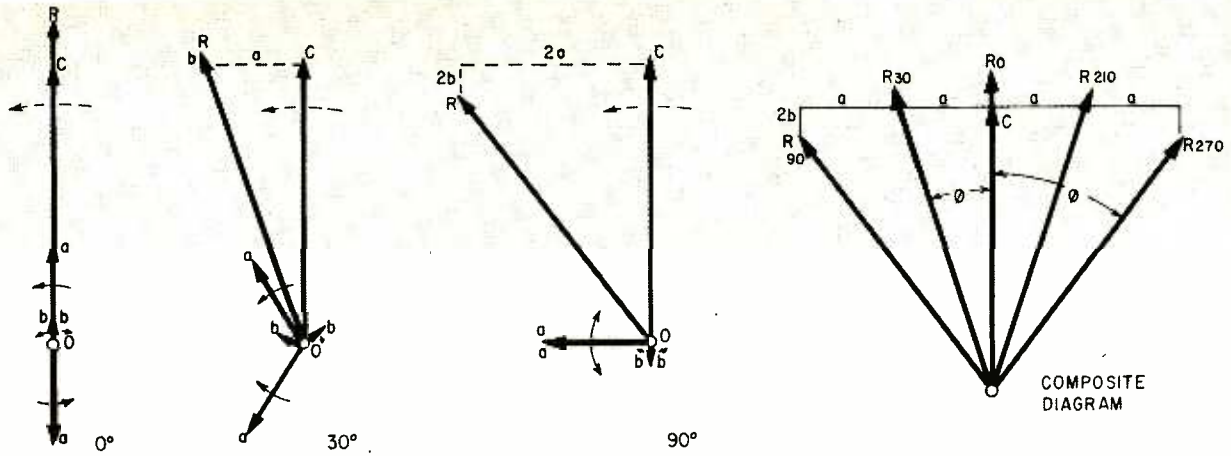

Fig. 5—Vectors here resemble those in Fig. 4 to some extent. The 90° vectors are exactly the same, intermediate points differ.

the expressions are

$$\text{For zero phase, } R^2 = C^2 + 4Cb + 4b^2$$

$$\text{For half phase, } R^2 = C^2 + 5Cb + 4b^2$$

$$\text{For full phase, } R^2 = C^2 + 8Cb + 16b^2$$

The value substituted for a^2 , in terms of C and b , makes the half-phase point true. Maintaining linearity of phase modulation makes the amplitude vary even more than it does when zero and maximum-phase amplitudes were made equal, because half-phase and full-phase values of R^2 are both greater than the zero-phase value.

From this point, we can add the third-order sidebands and see what they yield. This has been done, qualitatively, in Fig. 6. The math to go with it gets a little more involved.

The point to emphasize is that, as each sideband is added, vector analysis provides a complete picture of what happens, which cannot readily be gained from the analysis using pure math involving Bessel functions. Adding this third sideband pair enables both the constant-amplitude and the phase-linearity conditions to be preserved more closely.

As deviation is increased, fourth-order sidebands are needed to keep phase linearity.

What FM sidebands do

In summary, the first-order sidebands change their amplitude before they show appreciable nonlinearity of phase

modulation. The second-order sidebands primarily correct the variation in amplitude, but in doing so fail to maintain phase linearity. The third-order sidebands enable phase linearity to be preserved further, but again leave amplitude deviating a little more. The fourth-order sidebands correct this, and so on, back and forth, as wider overall deviations become possible.

We can see that the first difference between amplitude and phase modulation is in the phasing of the same first-order sidebands. From this it can be shown that a phase shift here will transfer some modulation energy from amplitude to phase, or vice versa (Fig. 7).

The successive magnitudes of the carrier and the different sidebands can be shown for different magnitudes of maximum deviation.

The carrier gets smaller and smaller and eventually passes through zero and reverses its phase, relative to the rest of the family. Further study would show that all the sideband amplitudes go through cyclic variation of magnitude and phase, as deviation is increased, to preserve the same constant resultant magnitude.

This is an interesting and enlightening way to study frequency modulation. It shows "what has to give," from a performance viewpoint, to maintain linear modulation and constant amplitude. We can use vectors, as we said, to show how various other electronic circuits work. In later articles, if we find you're interested, we can take up some of them. END

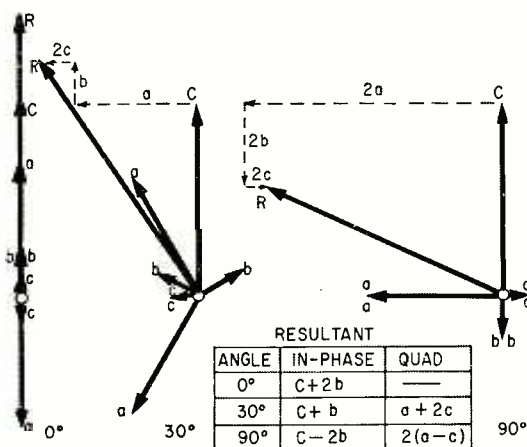

Fig. 6—More sideband pairs added, third-order this time. By vectors, we see proof that adding sidebands preserves linearity. Math required for the analysis is involved but is not difficult.

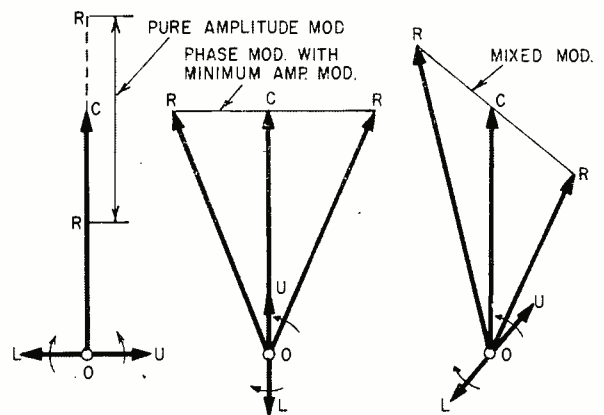
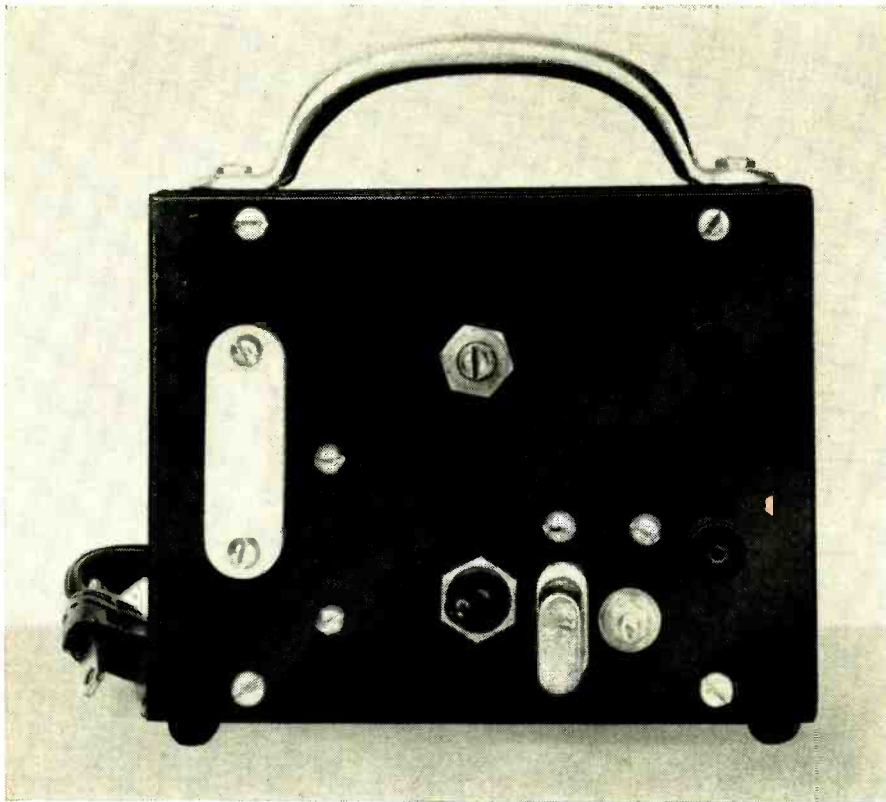

Fig. 7—Showing the effects of mixed modulation on transmitter output. Resultants at equidistant points vary radically in amplitude, thus indicating presence of undesired modulation products.



Although a specialized kind of signal generator, this CB calibrator is useful for a variety of other purposes around the CB owner's workbench and for repair technicians as well.

CB'ers Crystal Calibrator

COMMUNICATIONS
CB

This 23-channel calibrator makes channel identification as simple as plugging in an overtone crystal

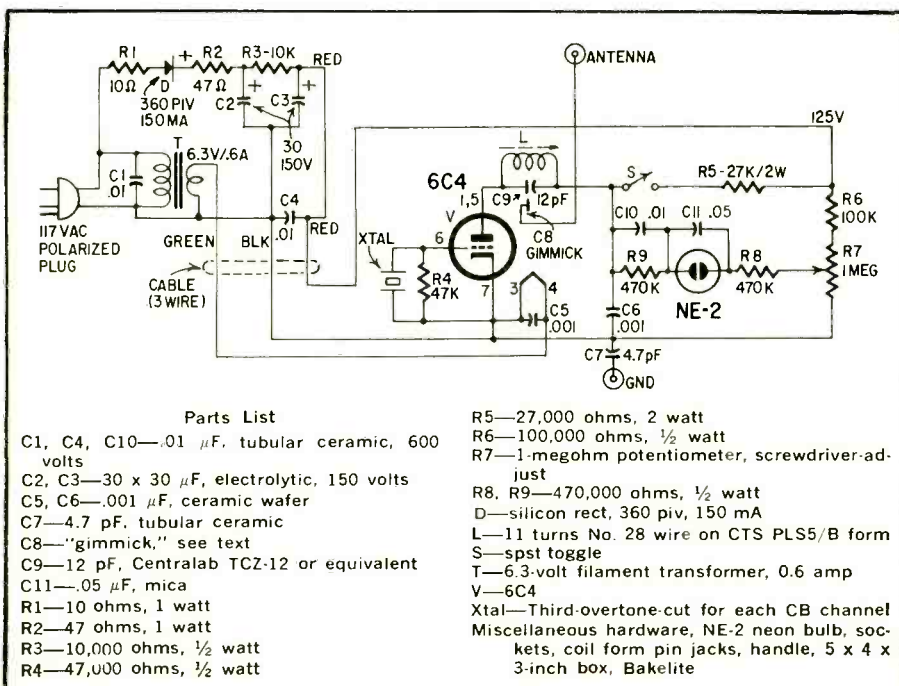

By LYMAN E. GREENLEE

ALTHOUGH THE SIGNAL GENERATOR found on the average workbench may be adequate for servicing AM radios, it's of very little use in locating Citizens-band channels. About all you can depend on is that it will locate the 27-MHz band. To locate individual channels, a crystal calibrator is almost essential.

The calibrator shown in the photo will pinpoint all CB channels, using a separate plug-in overtone crystal for each frequency. Cost of the unit is moderate, and construction is simple. Power-supply components are mounted to the rear metal panel of a 5 x 4 x 3-inch metal utility cabinet, and the 6C4 oscillator and its associated rf components are assembled on a Bakelite front panel. There is no chassis.

Construction tips

Resistors R1 and R2 limit the initial charge to C2 and also serve as slow-acting fuses to protect the instrument in case of a shorted rectifier or filter capacitor. The power supply is connected to the rf section on the front panel through a 3-wire cable, so that both front and rear panels are easily removable for adjustment or service.

The rf section is quite straightforward and uses a neon lamp to indicate the intensity of oscillation (crystal activity). The tank coil is wound on a CTC PLS5/B coil form with a 12-pF capacitor in parallel. Any small slug-tuned coil resonant at 27 MHz should work equally well.

Parts should be mounted on the front and back panels as shown in the photographs. The front panel is 4 x 5 x $\frac{1}{8}$ -inch Bakelite or similar material drilled to accept the various oscillator components. The 6C4 socket is mounted on a small bracket made from a scrap of sheet aluminum. The crystal socket and oscillator coil are mounted close to the 6C4 socket to keep leads as short as possible. Arrangement of the other components is not critical.

When winding the tank coil, it's a good idea to add a couple extra turns of wire that may be removed later if necessary, to center the slug's tuning range in the center of the 27-MHz band. A grid-dip meter, if available, will be most useful for tuning the coil. Otherwise, use a mid-band crystal and set the slug halfway into the coil form. Tune by removing a turn at a time from the coil, or by substituting different values of fixed capacitance. A ceramic trimmer (4–30 μ F) may be used in place of fixed capacitor C9 to simplify tuning the coil to cover the band. However, the trimmer will not be as stable as the drift-corrected fixed capacitor.

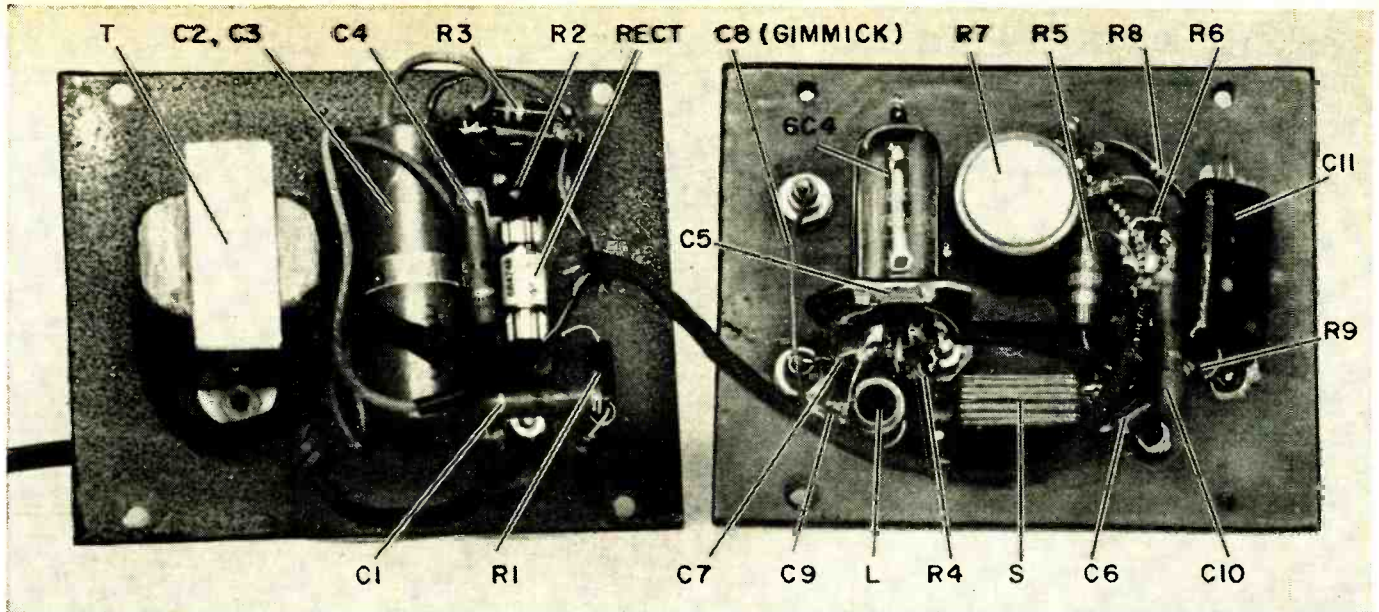

Current-limiting resistors R1 and R2 reduce the current surge as C2 charges and act as fuses to protect against short circuits.

Leads of oscillator-section components are kept as short as possible for best results. Inductor L is tuned from the front panel.

Insert a 27-MHz crystal in the socket, allow the 6C4 to warm up, then adjust the tuning slug for maximum rf signal as indicated by the neon lamp. Adjust R7 so the neon indicator is fired by the rf signal (not by the dc power supply). Once the potentiometer has been set to respond to an active crystal, it will not need to be readjusted.

When L is correctly tuned, crystals for all channels will function with only minor adjustment of the tuning slug.

A short piece of wire may be inserted into the "antenna" pin jack if the signal level at the receiver is too low. The oscillator tank coil is coupled to the antenna jack through a "gimmick," a short piece of insulated hookup wire run-

ning from the pin jack through the center of tubular ceramic capacitor C9. This short piece of wire may be fastened in place with coil dope.

Note that the "ground" connection is made through capacitor C7. A POLARIZED AC-LINE PLUG AND SOCKET ARE REQUIRED to maintain the common (white) lead and the cabinet at ground potential at all times.

To check crystal activity, use a field-strength meter, adjusted to read half-scale, as an indicator. By substituting various crystals cut to the same channel, it is easy to make a relative evaluation of their activity. Weak, erratic signals indicate crystals of low activity. Mechanical instability can be checked

by lightly tapping the crystal case with a pencil. Defective or weak crystals should be replaced.

The most useful application of the Crystal Calibrator is to pinpoint the various CB channels on a tunable receiver dial. The calibrator may be left plugged in at all times so that the 6C4 is heated, and it will be ready for instant use simply by applying the plate voltage. Any channel can be instantly and exactly spotted on the receiver by plugging in the correct crystal. No direct connection between calibrator and receiver is needed, and you can be sure of being tuned exactly to the channel without having to wait for a transmission to check the tuning. END

WHAT'S YOUR EQ?

Conducted by E. D. CLARK

Remote-Control Circuit

Using 60-Hz current and single-pole switching, how many independent relay-controlled circuits can you operate from a two-conductor line? Only one load circuit is energized at a time. —E. A. Johnson

Three puzzlers for the student, theoretician and practical man. Simple? Double-check your answers before you say you've solved them. If you have an interesting or unusual puzzle (with an answer) send it to us. We will pay \$10 for each one accepted. We're especially interested in service stinkers or engineering stumblers on actual electronic equipment. We get so many letters we can't answer individual ones, but we'll print the more interesting solutions—ones the original authors never thought of.

Write EQ Editor, Radio-Electronics, 154 West 14th Street, New York, N. Y. 10011.

Answers to this month's puzzles are on page 101.

Bridge Resistance

The diagram shows the familiar bridge circuit. What value will the ohmmeter read with S1 open? With S1 closed?—Joseph Kish Jr.

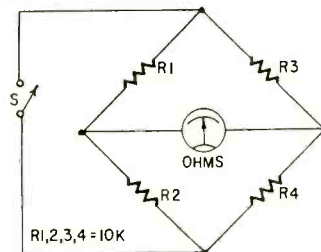

All 1-Ohm

The black box in the diagram has 9 terminals. Using only 9 resistors (same value), how can one connect them in such a way as to have a value of 1 ohm appear between any two terminals?—Robert G. Donnell

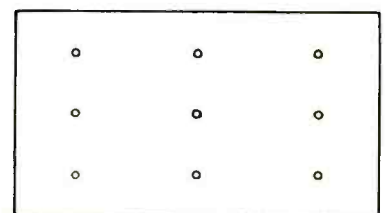

BLACK BOX

50 Years Ago

In Gernsback Publications
In September 1916
Electrical Experimenter

Why not Have the President Talk
Simultaneously to All the People?
Engineering as a Vocation
Tickers for Undamped Signals
Making Selenium Cells

SEISMIC AMPLIFIER TOPS OUT AT 1 Hz!

With an upper limit well below the bottom of many "low-frequency" amplifiers, this instrument has uses impossible to other equipment

By EARL T. HANSEN

THIS AMPLIFIER WITH HIGH GAIN AND ultra-low-frequency response was designed to amplify the output from a moving-coil seismometer and apply it to a pen recorder. The purpose is to record distant earth disturbances. The amplifier can also be used for other geophysical or biomedical applications. Total cost of components is about \$50.

Other features include a balanced differential input with good common-mode rejection, a variable high-fre-

quency response may be compared to a similar need in a magnetic phono preamplifier. The velocity of the needle (or seismo coil) decreases with frequency, and therefore the amplifier requires low-frequency boost to maintain a flat overall response.

If you have a use for an amplifier of this kind with flat response, replace C15 and C16 with jumper wires. Switching them in and out is not practical, since R43 must be readjusted each time for correct transistor bias.

For the present application, more than adequate gain is available without R35 (infinite resistance). For very-high-gain applications it may be necessary to short out C15 and C16 to prevent objectionable noise in the ultra-low-frequency region.

The preamplifier uses four transistors in a direct-coupled push-pull circuit. R12 is a dc balance adjustment to equalize the collector voltages on Q7 and Q8. C2, C3, C4 and C5 attenuate high frequencies. This reduces the possibility of saturating the preamp with rf or other high-amplitude unwanted signals before they can be rejected by the variable low-pass filters.

The preamp, designed for maximum gain and signal-to-noise ratio, does not have a high input impedance. The input impedance is further lowered by R9 and R10, which are a damping load for the seismometer coil. The transistor dc operating levels are stabilized by dc feedback from common-emitter load R19 to the common input return of Q5 and Q6.

The preamp is ac-coupled through two low-leakage tantalum electrolytic capacitors, C7 and C8, to the first section of the R-C low-pass filter and the attenuator. The R-C filter attenuates the signals 6 dB per octave for frequencies above the cutoff point selected by S1. The attenuator switch, S2, was used instead of a dual control, to reduce noise and to make settings repeatable. There are 10 steps, approximately 2.5 dB (25% change) each, and an off position.

The high-impedance equalizing amplifier is designed to sacrifice gain in favor of very high input impedance, and stability of gain. It boosts the low frequencies with the help of feedback via R41 and R42. The dc operating point is stabilized by obtaining the bias to Q9 and Q10 from common-emitter load R43.

This amplifier is ac-coupled through the second variable R-C filter section to the output amplifier. The 6-dB-per-octave attenuation of the second filter, combined with that of the first filter section, provides 12-dB-per-octave attenuation above the frequency selected by S1.

The output amplifier section sacrifices voltage gain in favor of high input impedance and current gain. Q13 and Q15 are emitter followers, direct-coupled to the push-pull output stage. R54 and R55 allow degeneration in the emitter for stability. R56 is an adjustment for zeroing the output to the recorder.

Regulator power supply

The power supply is regulated. At the normal operating current of 18 mA, line voltage changes of 20% cause less than 1-mV change in the supply voltage,

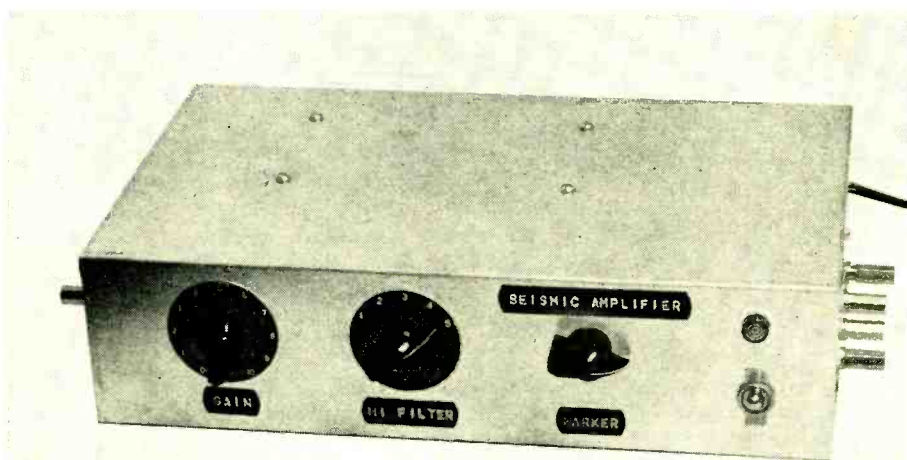

The amplifier looks conventional, but don't try it on your phonograph!

quency filter, a step attenuator, provision for external marker, very low power consumption, and a long reliable life.

The frequency range (Fig. 1) of the amplifier extends from below .01 to about 1 Hz (cycle per second). For seismic use, upper-frequency rolloff must begin between 1 and 10 Hz. This aids in rejecting manmade earth disturbances. The amplifier has a variable two-section, five-position R-C filter (selected by S1 in Fig. 2) to adjust the upper cutoff frequency, from 1 to 5 Hz. Attenuation is 12 dB per octave above the selected cutoff point. For frequencies below 0.3 Hz there is a gradual increase in gain at 6 dB per octave to .02 Hz.

With the output unloaded, the attenuator on position 5, and R35 omitted, the voltage gain is approximately 5,000 at 0.5 Hz. With R35 reduced to zero, and the attenuator on position 1, the voltage gain is over 150,000. (Since the amplifier is to be used with a pen recorder which responds to *current*, the voltage gain is not really significant.) The internal impedance is approximately 1,500 ohms, and voltage may be converted to current on this basis. An open-circuit voltage of 5, when short-circuited, would produce an output current of 3.3 mA ($5 \div 1500 = .0033$). The value of R35 can be selected between zero and infinity to obtain the desired gain.

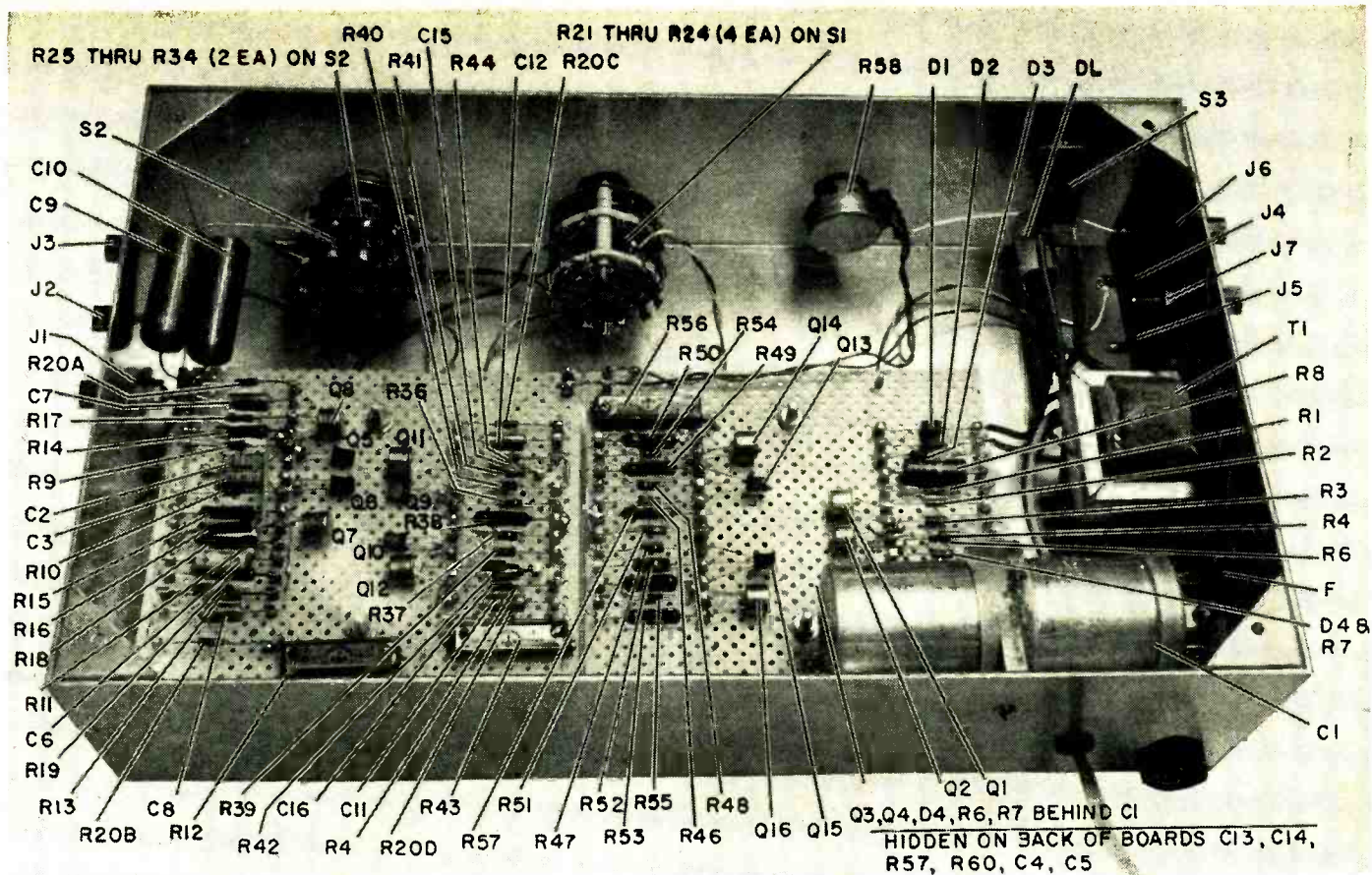

Underchassis view of the seismic amplifier shows perforated boards used to mount components in "military" order.

and have no effect on the amplifier output. Short-circuit current is limited by R8, so the power supply will not be damaged by a short. Q1, D3 and R2 form a constant-current source for series regulator Q2 and the difference amplifier Q3 and Q4. D4 is a Zener reference element. R3 compensates for any line-voltage change which might otherwise be passed by the regulator.

Construction hints

In building the amplifier, mount small components on perforated boards with push-through terminals. All circuitry should be in a metal enclosure, preferably with a *minimum* of vents, for best thermal stability. I used a standard chassis and cover.

If the 2N3391-A transistors are not already painted black, paint them. At low currents they are quite sensitive to light. Light variations could cause unwanted outputs from the amplifier. Input resistors in the preamp must be metallized-film or deposited-carbon type for minimum noise. The coupling capacitors (C7, 8, 11, 12, 15, 16) must be tantalum. Normal electrolytics have far too much leakage.

Complete the power supply first and check it for proper operation before connecting it to the other circuitry. The output voltage should be 12 ± 0.5 . Since Zener diodes vary considerably

between units, some adjustment will probably be necessary. If the voltage is too high, shunt R4 with some additional resistance (47,000 ohms will change it about 10%). If it is too low, shunt R5.

Complete the amplifier except for the coupling capacitors, C7, 8, 11, 12. Apply power and adjust R12 for equal collector voltages within 0.5 volt on Q7 and Q8, measured to ground. These should be between 8 and 10 volts. Decrease R13 if the voltage is too low. Set the attenuator (S2) about midway. Adjust R43 so collector voltages of Q11 and Q12 are between 7.5 and 9.5.

If there is excessive spread in the collector voltages of Q11 and Q12, it may be necessary to match Q9 and Q10 more closely. Allow several minutes for the voltages to stabilize after adjusting R43. If C15 and C16 are shorted out to flatten out the low-frequency response, R43 will require readjustment.

In balancing and adjusting the stages, be careful not to cause a momentary thermal imbalance by touching or blowing on transistors. Adjust R56 for zero voltage across output terminals J4 and J5. (If you can't zero the output, you may have to match Q13 and Q15

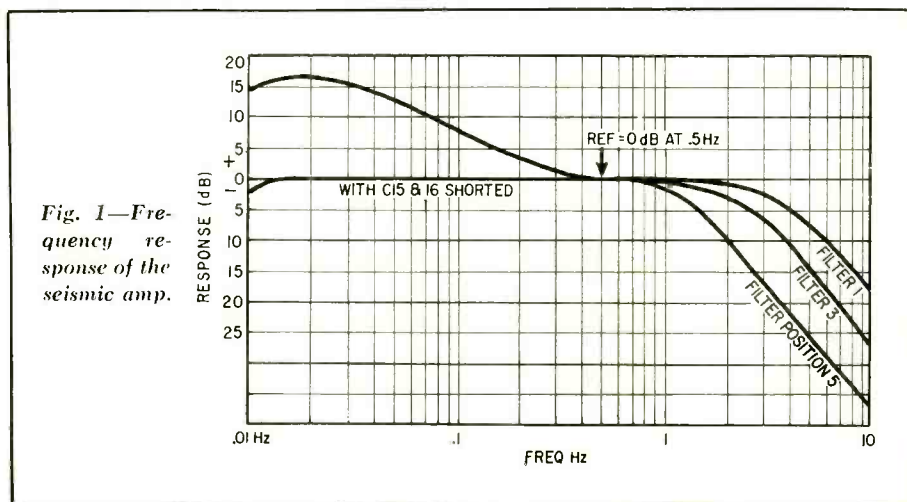
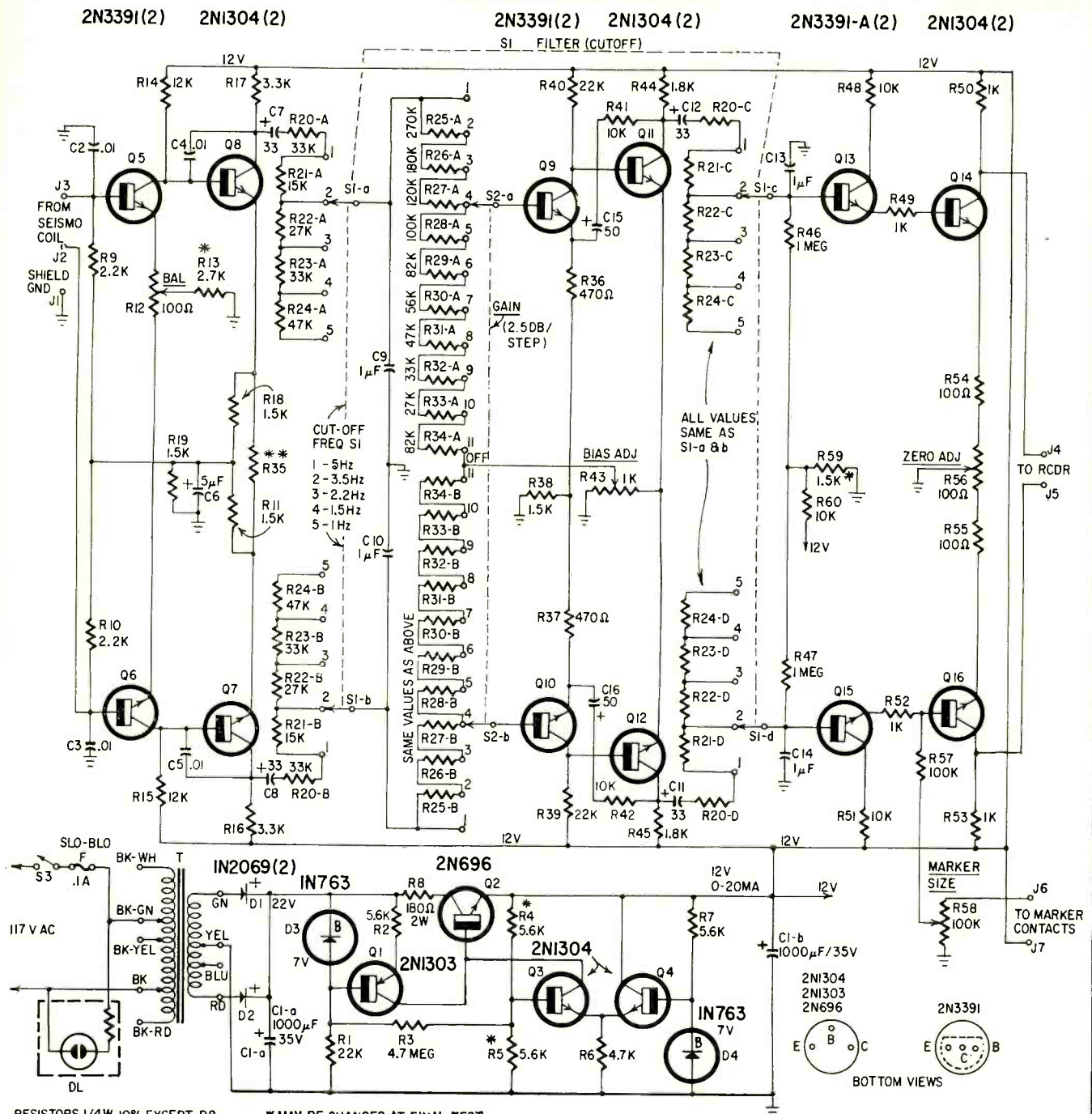

Fig. 1—Frequency response of the seismic amp.

SOLID STATE SEISMIC AMPLIFIER



RESISTORS 1/4W, 10% EXCEPT R8

* MAY BE CHANGED AT FINAL TEST
 ** SELECT FOR DESIRED OVERALL GAIN

Fig. 2—The seismic amplifier has an all push-pull circuit, with differential input and a 4-transistor power supply.

All resistors 1/4 or 1/2 watt except R8. All ± 10%, except where noted. Total needed shown parenthesis.

- | | | | |
|--|---|---|--|
| <p>R1, R39, R40—22,000 ohms
 R2, R4, R5, R7—5,600 ohms
 R3—4.7 megohms
 R6—4,700 ohms
 R8—180 ohms, 2 watts
 R9, R10—2,000 ohms, 5% carbon film
 R12, R56—100 ohms (Bourns E-Z-Trim pot, or equivalent)
 R13—2,700 ohms
 R14, R15—12,000 ohms, 5% carbon film
 R16, R17—3,300 ohms
 R11, R18, R19, R38, R59—1,500 ohms
 R20, R23, R43 (10)—33,000 ohms
 R21 (4)—15,000 ohms
 R22, R33 (6)—27,000 ohms
 R24 (4)—47,000 ohms
 R25 (2)—270,000 ohms
 R26 (2)—180,000 ohms</p> | <p>R27 (2)—120,000 ohms
 R28, R57 (3)—100,000 ohms
 R29, R34 (4)—82,000 ohms
 R30 (2)—56,000 ohms
 R31 (2)—47,000 ohms
 R35—see text
 R36, R37—470 ohms
 R43—E-Z trim pot, 1,000 ohms
 R44, R45—1,800 ohms
 R46, R47—1 megohm
 R41, R42, R48, R51, R60—10,000 ohms
 R49, R50, R52, R53,—1,000 ohms
 R54, R55—100 ohms
 R58—pot, 100,000 ohms
 C1—1,000-1,000 μF, 35V, dual electrolytic
 C2, C3, C4, C5—.01 μF, paper or ceramic, 100 volts or more
 C6—5 μF, 6 volts or more, electrolytic</p> | <p>C7, C8, C11, C12—33 μF, 10 volts, tantalum electrolytic
 C9, C10, C13, C14—1 μF, paper or ceramic, 10 volts or more
 C15, C16—50 μF, 10 volts, tantalum electrolytic
 T—Pri, 117 volts, sec. 34V, center tapped, .035 amp (Knight 64G 731, Triad F94-X, or equivalent)
 J1, J2, J3, J4, J5, J6, J7—5-way binding posts
 F—.01-amp fuse and holder
 DL—dial lamp, neon with resistor (optional)
 D1, D2—IN2069 or equivalent, silicon rectifiers
 D3, D4—IN763 or equivalent 7-volt ±20% Zener diode, 250 mW
 Q1—2N1303 p-n-p germanium</p> | <p>transistor
 Q2—2N696 n-p-n silicon transistor
 Q3, Q4, Q7, Q8, Q11, Q12, Q14, Q16—2N1304 n-p-n germanium transistor
 Q5, Q6, Q9, Q10, Q13, Q15—2N3391-A n-p-n silicon planar transistor
 S1—4-pole 5-position, shorting, rotary switch (Centralab PA-2010 or equiv.)
 S3—spst toggle switch (optional)
 Misc: ac power cord, wire knobs, and small hardware
 Perforated circuit boards (Vector 85 G 24 or equiv.)
 Insertion terminals .062 in. (Vector T-28 or equiv.)
 7 x 13 x 2 in. chassis, with cover</p> |
|--|---|---|--|

more closely.) Measure this voltage to ground, J1. It should be between 6 and 8 volts. If necessary, change R59 to meet this requirement, and rezero R56.

Temporarily connect the four coupling capacitors across the 12-volt supply (watch polarity). By re-forming the tantalum capacitors before installing them, the initial stabilizing time can be greatly reduced and we lessen the possibility of circuit damage. After about 5 minutes, remove the capacitors and discharge them by shorting. Install them and apply power to the amplifier.

Because of the long time constants (33 seconds) in the amplifier, several minutes may be necessary for it to stabilize. This is not normally a problem since operation is usually continuous. After stabilization, none of the voltages should be appreciably different from what they were without the capacitors. A slight readjustment of R56 may be needed to rezero the output.

The amplifier was designed for isolated input and output coils. *These external circuits must not be returned to the amplifier ground.*

In using the amplifier, let it stabilize each time you change the gain switch. The filter switch can be varied without creating disturbances since there is no dc at the contacts.

The seismometer and the recorder shown in the photographs are both home-constructed. In the seismometer, the mass is mechanically coupled to a 500-ohm coil moving in a dense magnetic gap. The natural resonant period of the mass is approximately 30 seconds. The recorder has a 500-ohm coil and a full-scale sensitivity of 5 mA. A synchronous clock type motor rotates the drum once an hour. A screw on the drum

axis moves the drum laterally as it rotates, making the recording in the form of a long spiral. Approximately 48 hours may be recorded with only a single change of paper.

Timing marks are recorded every minute and hour. This is done by an electric clock modified to include contacts on the second and minute hands, at the 12 o'clock position. The contacts are connected to the marker terminals on the amplifier. (A following article will give construction details on these instruments.)

Fig. 3 is a typical recording made with the amplifier, seismometer and recorder combination, at Covina, Calif. It shows an unidentified earth disturbance, recorded twice—once as conducted through the earth, and again as the surface wave. The time difference between the two displays was about 9 hours.

I measured frequency response with a Hewlett-Packard 202A low-frequency function generator, a dc scope, and lots of patience waiting for the cycles to stabilize. END

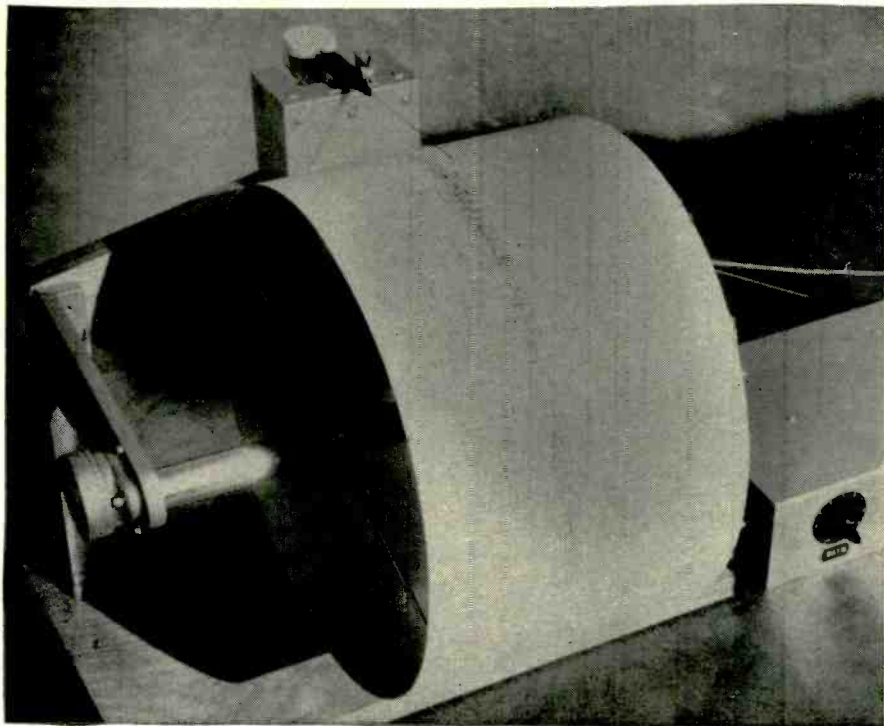

This recorder is the output device that the low-low-frequency amplifier works into.

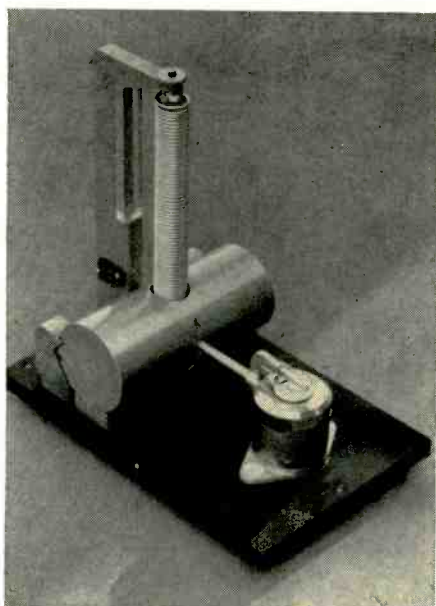

The home-built seismograph recorder for which this low-Hz amplifier was designed.

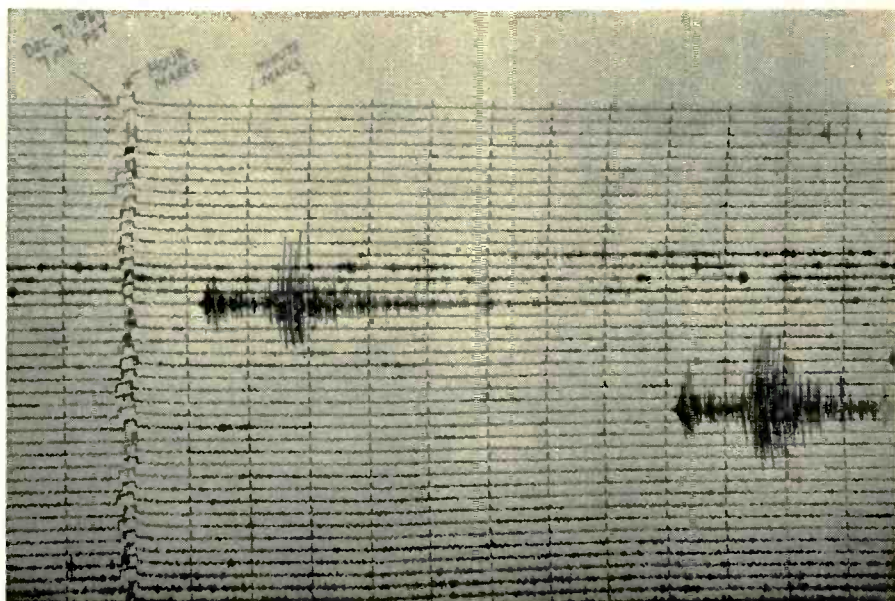

Fig. 3—Typical recording as produced by the amplifier and its associated equipment. Timing pulses recorded each minute and hour show the time and the duration of shocks.

An RF Wattmeter for UHF

By HAROLD BALYOZ

COMMUNICATIONS

WITH A RESPONSE ACCEPTABLY flat from 2 MHz to at least 500 MHz, the instrument described here will indicate full-scale power levels of 30 or 100 mW. Using the separate 10-dB 50-ohm pad between transmitter and wattmeter, the ranges expand to 300 mW and 1 watt. Similar pads of adequate power-handling capability can further extend the two full-scale ranges.

Construction

The heart of the wattmeter is the assembly shown in the schematic (Fig. 1-a) and in Fig. 2. All components should be assembled exactly as pictured to insure a response flat to 500 MHz.

Begin construction by mounting J1 in the case to be certain it will slip in easily after all components are attached to it. Using a hot soldering iron and resin-core solder, tin the connector flange at four points between the mounting holes. Be absolutely certain to use heat-sink clips (Hunter 51G or equivalent on all leads when soldering resistors R1 through R4 and diodes D1 and D2 to the connector flange. Excess heat will destroy the diodes and alter the values of the resistors.

Solder one lead of each resistor to the pretinned spots on J1, then solder

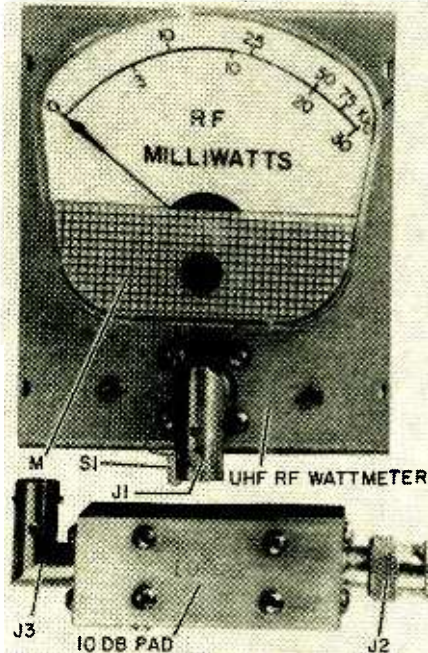

Use of BNC connectors throughout insures good efficiency in coupling the wattmeter and 10-dB pad to transmitter under test.

Table I

Volts	mW	Volts	mW
0.39	3.0	1.24	30.0
0.71	10.0	1.60	50.0
1.00	20.0	1.94	75.0
1.12	25.0	2.24	100.0

the other end of each resistor and one lead from each diode (watch the polarity) to the center conductor of J1. Finish the assembly by soldering button capacitors C1 and C2 to the diodes (and capacitors C3 and C4 if you want a flat response as low as 2 MHz).

Insert the basic assembly into the predrilled box and mark the holes to be used for mounting the button capacitors. Remove the assembly, drill the holes, then mount the assembly and the remaining components. The placement of the other parts is not critical.

Remove the meter scale and glue a piece of white paper or cardboard to it and reassemble the meter. Later you can mark the appropriate divisions lightly in pencil, then fill them in using India ink.

Calibration

Two calibration methods are feasible. If you can beg or borrow a commercial rf wattmeter or a calorimetric power meter like the Hewlett-Packard Model 434A, you can calibrate directly against it. Otherwise, use an rf voltmeter to measure the input voltage developed at J1 by a signal fed from an rf signal generator, marking the scale ac-

ording to Table I. For the low end, an audio vvm like the Ballantine Model 310A is accurate to 2 MHz. If you include capacitors C3 and C4 in your instrument, you will be able to calibrate at that frequency using a 2-MHz audio or rf signal generator as a source.

First select values for R5 and R6 so the full-scale ranges of 30 and 100 are set accurately (30 mW equals 1.24 volts—see Table I.) R5 will be around 620 ohms and R6 around 1,400 ohms. If you'd rather use pots instead of fixed-value units, R5 can be 1,000 ohms and R6, 2,500 ohms. Merely set them for proper full-scale deflections at the correct input voltages. Their adjustments should not be accessible from outside the case to avoid their being turned accidentally during use.

The 10-dB pad

Construct the pad (Figs. 1-b and 3) by connecting R7 and R8 in series, then to the center conductors of connectors J2 and J3. The connector flanges should be 2³/₁₆ inches apart. Solder resistors R9 through R12 as shown, two to one flange and two to the other. As before, pretinning the inside surfaces of each connector flange will simplify construction. Finally, drill and tap four round or square pieces of 1/4-inch aluminum stock to fit snugly between the two flanges.

When the instrument is finished, it can be used in many helpful ways. A two-turn link around the tank coil of a small crystal oscillator or rf amplifier stage, for example, will enable you to check the activity of various crystals or the performance of tubes, transistors, or various other circuit elements by comparing power outputs. Few instruments can be as varied in test-bench applications as a wattmeter. Top efficiency for rf circuits demands a means for measuring power levels, and this instrument provides that means at reasonable cost.

END

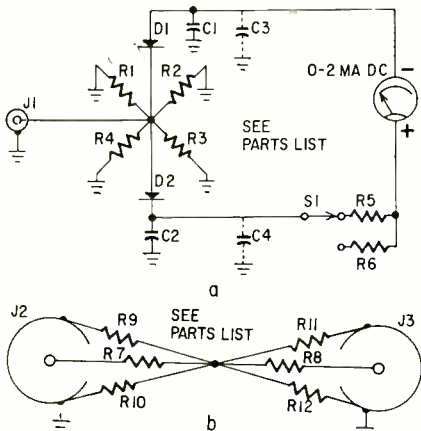

Fig. 1—Deceptively simple schematically, the wattmeter (a) and attenuator (b) require careful attention to minor construction details. Follow layouts in Figs. 2 and 3.

PARTS LIST

J1—UG-290/U or UG-535/U BNC connector
 J2—Avien 165-540 or equivalent BNC connector
 J3—UG-290/U BNC connector
 R1, R2, R3, R4—200 ohm, 1/4 watt, 5%
 R5—Meter multiplier, see text
 R6—Meter multiplier, see text
 R7, R8—27 ohm, 1 watt, 5%
 R9, R10, R11, R12—150 ohm, 1/2 watt, 5%
 D1, D2—1N82A, flex-lead style
 C1, C2—1,000 pF (Erie 662-003 102K or equivalent)
 C3, C4—.01 μ F disc ceramic (optional, see text)
 MA—dc milliammeter, 2-mA full-scale movement
 S1—spdt toggle switch
 Chassis box, 3³/₄ x 3 x 2¹/₂ inches (LMB 135 or equivalent)
 Heat-sink clips, Hunter 51G or equivalent (6 required)

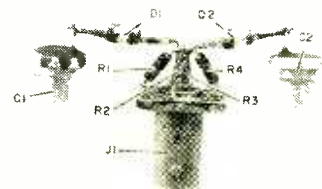

Fig. 2—Basic assembly requires careful construction to assure good uhf response.

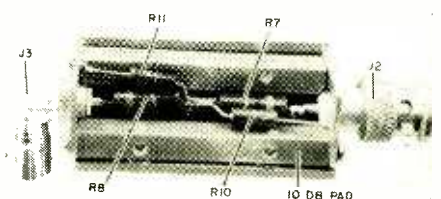

Fig. 3—Simply built attenuator extends wattmeter's power-handling capabilities.

Heavy-Duty 5-Amp Supply—With Regulation

Up to 30 volts that will take care of tests in mobile 2-way radios

By ALLAN W. CROWELL

FOR A GROWING VARIETY OF WORK-bench applications, especially for troubleshooting and repairing Citizens-band and business/industrial radiotelephone equipment, a heavy-duty regulated power source is a basic tool. For those who have lots of extra bucks or who can anticipate enough business activity to justify the cost, there are several excellent commercially built supplies. They are expensive—several hundreds of dollars, as a rule. The supply described here will provide 5 amps of dc power continuously variable over a 7-to-30-volt range, and its total cost is far below the commercial equivalents. A quick look at the SPECIFICATIONS box on this page reveals performance capabilities generous enough to satisfy most technicians and home builders.

All operating controls are conveniently arranged on the front panel of the utility-box cabinet, and a direct-reading meter can be switched to monitor load current or output voltage. A chassis-mounted fan provides sufficient air circulation across the heat sinks for the power transistors.

General component arrangement can be seen quite clearly in Figs. 1 and 2. The differential amplifier and driving cir-

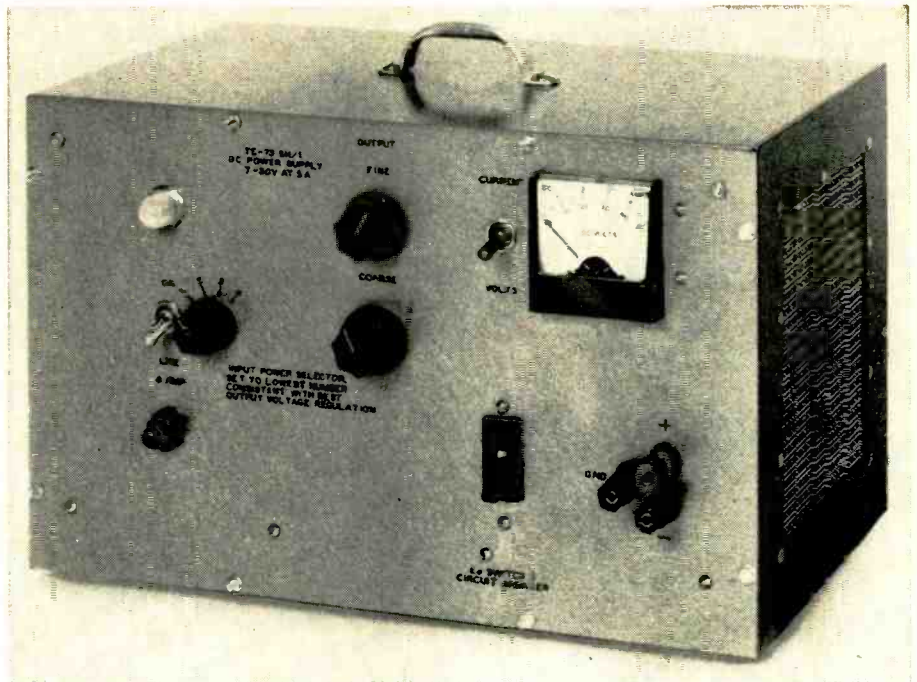

cuitry for the pass transistors are mounted on the vertical phenolic board at the left of the panel, and 5-volt and 33-volt transformers with their related components are mounted on a second subpanel assembly bolted to the power transformer main frame at the right side of the chassis. The mechanical sub-

assembly, consisting of heat sinks for the pass transistors and the diode-bridge rectifiers with their associated spacers, takes up most of the central chassis.

The mechanical assembly

While the schematic clearly shows the electronic circuitry, the mechanical

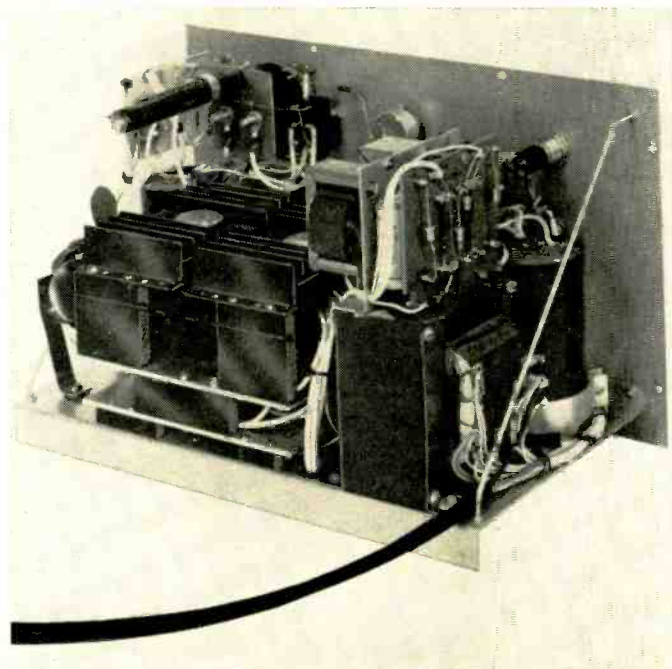

Fig. 1—Right-rear view of power supply. The low-voltage supplies are mounted on subpanels fastened to the power transformer.

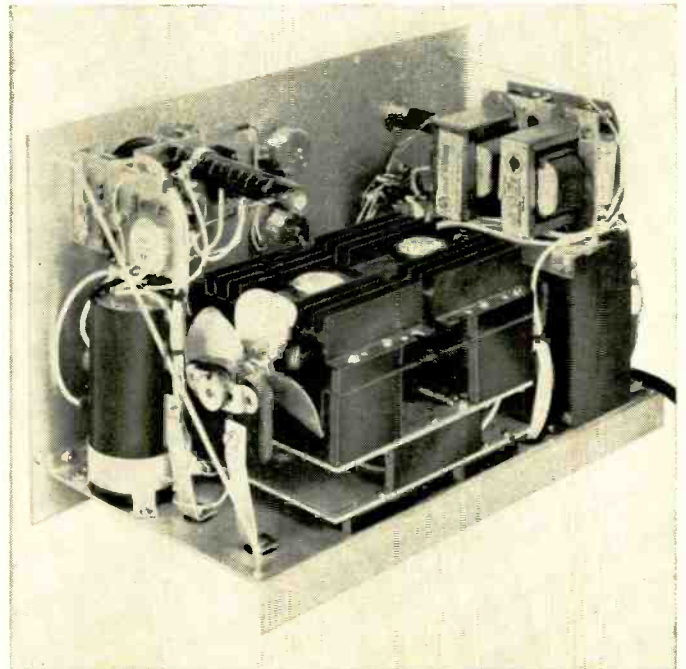

Fig. 2—Power supply as seen from the left-rear. Fan and control transistors are on circuit board fastened to the front panel.

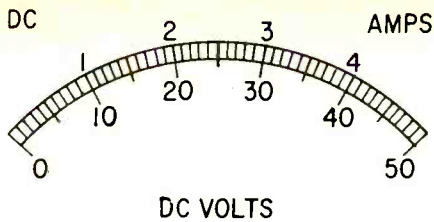

Fig. 5—Drawing of the meter scale.

The diode bridge (D1 through D4) consists of two Motorola type MR-323 and two type MR-323R diodes mounted on the two 1/8-in. heat-sink plates. Each pair can be pressed into 1/2-inch holes in its heat sink, because the 323's have their *cathodes* connected to the case and the 323R's have their *anodes* connected to the case. Two diodes are mounted on each plate, spaced 2 inches from each of two opposite corners along a connecting diagonal. The top sink contains the two MR-323R diodes. The insulated heat sinks permit mounting the diodes directly into the metal, resulting in the greatest possible heat dissipation. Mount the plates so they face on opposite diagonals to avoid shorting the diode leads.

The diodes are designed for a force-fit in 1/2-inch mounting holes. *Press* them into the holes with a drill press (turned off!). *Do not hammer* or otherwise shock them into place. You may change their characteristics or completely ruin them.

If a preinsertion check shows that a diode will not fit snug, place the heat sink on an anvil or other solid surface and tap around the edges of the holes with a ball-peen hammer. This spreads the metal and insures a snug fit when the diodes are forced into place.

Construction is straightforward

All wiring can be No. 20 stranded wire, except for those circuits which carry the 5-amp load. These include T1's secondary, the diode bridge, the collector and emitter circuits of Q1-Q4, the four equalizing resistors (R13-R16), the circuit breaker, resistor R11, and all wiring to the two 5-way output terminals. The wiring in these circuits should be No. 10 or 12. Be sure that wire is used to carry all current. Do not depend on frames, chassis or panels; such practice is extremely unreliable in the long run. A plastic cable clamp secures the line cord against damage.

Adequate ventilation is provided by a 4 1/2 x 6-inch cutout at each end of the cabinet and a 6 x 11 1/2-inch cutout in the back panel, cut using a nibbling tool available at most parts-supply houses. The openings are covered with perforated sheet aluminum, mounted inside the cabinet and secured with aluminum rivets.

Four rubber feet are installed at the corners to prevent scratching. A 10-32 screw passes up through the bottom

of the cabinet into a tapped hole at the rear of the baseplate to secure the entire assembly within the cabinet. Be sure this screw does not extend near enough to the bottom diode sink to ground it out.

The original meter scale was removed using a medium-hard eraser. Then the 0-50 scale and the designation DC VOLTS were inked in with a Wrico VCN120 lettering guide as in Fig. 5. The ampere scale was added above the voltage scale as was the designation DC AMPS. The 0 and 5 were omitted to avoid crowding. If 1% or 2% voltmeter accuracy is desired, select R10 (the meter multiplier) for 49,900 ohms, since the meter itself has a 100-ohm movement.

Calibration

After setting up the voltmeter circuitry, calibrate the current scale by connecting a 10-ohm 50-watt load resistor across the supply output and adjusting the resistance of R11 until the meter reads 2 amps when 20 volts ($I = E/R = 20/10 = 2$ amps) is applied across the load. Be sure to remove the load before making any adjustments, because the slider on the resistor invariably will open-circuit during movement, resulting in all current going through the meter itself, with damaging results.

The value of R12 can be altered if required to obtain acceptable meter accuracy in conjunction with R11 when the best slider position falls between two adjacent turns. Power-supply circuitry is isolated from ground (chassis) so that either positive or negative terminals can be connected to ground. The three 5-way output terminals, 2 black and 1 red, are labeled as indicated on the schematic. They are mounted on 3/4-inch centers to permit use of dual banana-plug connectors.

Operation

The line switch has an associated 4-position rotary switch for selecting combinations of T1 primary windings for best output power regulation vs input line voltage. In use, set the switch to the lowest number consistent with best output-voltage regulation. Before switching, momentarily rotate the COARSE output-voltage control maximum counterclockwise to reduce line transients, avoiding the possibility of blowing the line fuse. The output-voltage control is adjusted conveniently close to the desired value with the COARSE control, then set to the exact value with the FINE control.

Because most experimenters and technicians who will build this supply will rely on their stock of on-hand spare parts, no two units built will likely be identical. Following the schematic faithfully and not straying too far from the suggested mechanical construction and parts layout, however, should provide good results.

END

NEW SAMS BOOKS

101 Ways to Use Your Oscilloscope — New Edition



by Robert G. Middleton. This popular, newly revised working handbook shows latest methods for faster, more proficient servicing using the scope. Explains how to make waveform tests and how to analyze waveforms produced by defective circuits. Includes new material on use of wide-band and triggered-sweep scopes. Covers detailed testing of various sections of both b/w and color TV sets. Describes use of square waves to evaluate circuits and components. Each test described includes information on equipment needed, proper connections, test procedure and evaluation. Heavily illustrated. 192 pages; 5 1/2 x 8 1/2".

Order TEM-2A, only \$795

Design & Operation of Regulated Power Supplies

by Irving Gottlieb. Newly revised to provide a full understanding of the design and operation of these increasingly important power supplies. Describes dozens of methods and circuits for controlling power supply outputs; details design, operating principles, uses, and variations in design parameters. Includes many diagrams of open-loop regulated supplies, closed-loop regulators, and open-loop circuits using zener diodes. 144 pages; 5 1/2 x 8 1/2".

Order RPS-2, only \$325

ABC's of Electronic Test Probes

by Rudolf F. Graf. Shows you how to get the most from your test equipment through the proper use of the many probes required for testing radio, TV, and other electronic equipment. Tells how to select the right probe to get accurate measurements for troubleshooting. Includes full information on the construction, basic function, and application of most of the common types of probes in use today. 128 pages; 5 1/2 x 8 1/2".

Order APG-1, only \$225

Direct Readout Meters

by John D. Lenk. An ideal new text for student technicians and a training tool for the experienced technician who wants to enter the industrial field. Fully explains in basic terms a wide variety of digital, differential, and analog meters; provides technician-level circuit descriptions for the most widely used types. Also covers laboratory meters in logical progression, following signal sequence, wherever possible, from pickup devices, through the processing circuits, to the display functions. Provides the information required by technicians to qualify as laboratory meter specialists. 154 pages; 5 1/2 x 8 1/2".

Order DRM-1, only \$325

Electronic Cable Handbook

by Engineering Staff, Belden Mfg. Co. The first comprehensive handbook on electronic cable. Explains in detail the design, construction, handling, and installation of various types of modern electronic cable. Provides full information on latest cable design, specifications, and applications. Special sections on cable for intercom, hi-fi, home entertainment systems, f-m, two-way radio, etc. Covers military and nonmilitary specifications. Includes many useful tables and a glossary. An easy-to-understand, complete guide to electronic cable. 224 pages; 5 1/2 x 8 1/2".

Order ECH-1, only \$395

Applications Handbook for Electrical Connectors

by John D. Lenk. The authoritative book on connectors, their uses and selection. Discusses basic design considerations; provides detailed descriptions of connector parts, configurations, construction details, assembly methods, etc. Describes various environmental conditions to which connectors are subjected; explains tests used to check connectors under special conditions. Absolutely invaluable and much-needed data on the entire subject of connectors. 160 pages; 5 1/2 x 8 1/2".

Order ECL-1, only \$325

HOWARD W. SAMS & CO., INC.

Order from your Sams Distributor today, or mail to Howard W. Sams & Co., Inc., Dept. RE-9, 4300 W. 62nd Street, Indianapolis, Ind. 46206

Send me the following books:

- TEM-2A APG-1 ECH-1
 RPS-2 DRM-1 ECL-1

Send FREE Sams Booklist. \$_____ enclosed

Name _____

Address _____

City _____ State _____ Zip _____

My Distributor is _____

Circle 29 on reader's service card

“He’s a good worker.
I’d promote him right now
if he had more
education in
electronics.”

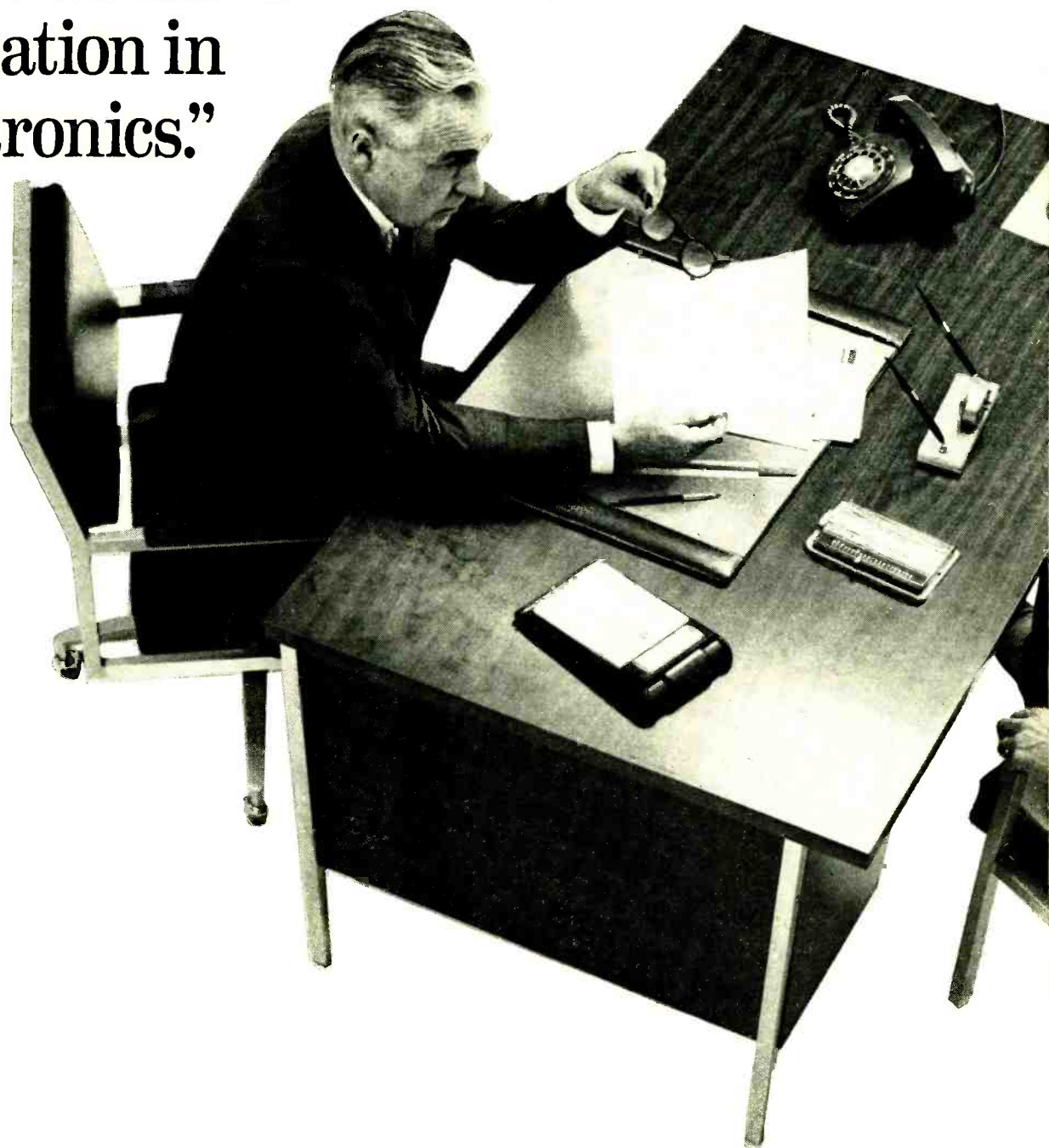

Could they be talking about you?

You'll miss a lot of opportunities if you try to get along in the electronics industry without an advanced education. Many doors will be closed to you, and no amount of hard work will open them.

But you can build a rewarding career if you supplement your experience with specialized knowledge of one of the key areas of electronics. As a specialist, you will enjoy security, excellent pay, and the kind of future you want for yourself and your family.

Going back to school isn't easy for a man with a full-time job and family obligations. But CREI Home Study Programs make it possible for you to get the additional education you need without attending classes. You study at home, at your own pace, on your own schedule. You study with the assurance that what you learn can be applied to the job immediately.

CREI Programs cover all important areas of electronics including communications, servo-mechanisms, even spacecraft tracking and control. You're sure to find a program that fits your career objectives.

You're eligible for a CREI Program if you work in electronics and have a high school education. Our FREE book gives complete information. Airmail postpaid card for your copy. If card is detached, use coupon below or write: CREI, Dept. 1419-D, 3224 Sixteenth Street, N.W., Washington, D.C. 20010.



NOW!
2 NEW PROGRAMS!

- Industrial Electronics for Automation
- Computer Systems Technology



The Capitol Radio Engineering Institute
Dept. 1419-D, 3224 Sixteenth Street, N.W., Washington, D.C. 20010

Please send me FREE book describing CREI Programs. I am employed in electronics and have a high school education.

NAME _____ AGE _____

ADDRESS _____

CITY _____ STATE _____ ZIP CODE _____

EMPLOYED BY _____

TYPE OF PRESENT WORK _____ GI BILL

I am interested in Electronic Engineering Technology
 Space Electronics Nuclear Engineering Technology
 NEW! Industrial Electronics for Automation
 NEW! Computer Systems Technology

EQUIPMENT REPORT

Knight-Kit KG-625 6-inch VTVM

Circle 26 on reader's service card

One of the newest vtvm kits, this instrument has two outstanding features: a 0.5-volt full-scale dc range, and separate internal calibration pots for the 0.5- and 1.5-volt dc ranges.

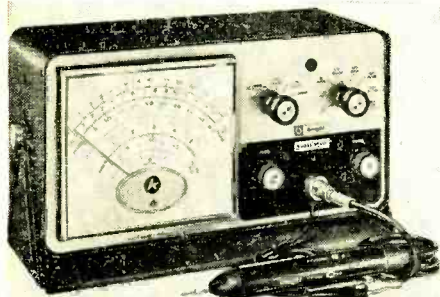

If you have done any experimental work with transistors, you know that their base-to-emitter potentials can be fractions of a volt. It takes a 0.5-volt scale to allow them to be read easily and accurately. The KG-625 also has direct peak-to-peak voltage scales, important in TV servicing.

The Knight-Kit vtvm seems to reflect good electrical and functional design. The scales on the 6-inch meter have 100° arcs. Two colors are used, red for peak-to-peak (which matches the red

panel markings at the function and range selectors) and black for the rest. All lettering is large and bold.

The front-panel controls are the same as on most vtvm's: range selector, function selector, zero-adjust and ohms-adjust. The pilot light is a neon lamp, shining through a red bull's-eye on the panel. A screw-on microphone-type cable connector is the input for all ranges, and provides complete shielding, a must for high usable sensitivity.

The case is steel, as is the swinging gimbal mount. That gimbal mount is a nice idea. With it you can tilt the instrument to any angle on the workbench, mount it against a wall or under an overhanging shelf. The front panel is aluminum, with an etched finish lithographed in charcoal gray and red. The bottom of the case has a trap door for access to the ohmmeter battery. Four holes on the side of the case are for getting at internal adjustments. They are identified on the case.

The circuit is standard for better vtvm's. A 12AU7-A dual-triode is a balanced bridge, with a 200- μ A meter connected from plate to plate. The tube is an aged Mullard Master 10M series, with a 10,000-hour guaranteed life, matched for equal characteristics in each section. A 6AL5 develops peak-to-

peak readings on ac. Range resistors are all 1%. Input resistance on dc is 11 megohms, with 1 meg of that in the probe. A single, switchable probe is used for all functions, and a removable alligator clip is supplied with it. The separate ground lead has an alligator clip on its end.

The function switch throws a short across the meter movement when it is in the OFF position. This damps the meter and prevents wild needle bounce when the instrument is carried around.

Assembly and wiring was fairly easy. There is lots of room to work, because of the 7 $\frac{3}{4}$ x 5 $\frac{1}{2}$ x 12-inch size and the use of a large U-bracket, which holds all the parts except those on the front panel. All wiring is point-to-point. Two multiconductor, multicolor cables are supplied, plus a variety of different-colored hookup wires, already cut to size and skinned.

The four internal-adjustment pots and the separate low-range ac scales on the meter make it possible to set up a very accurate instrument, if you have accurate voltage standards to start with. The adjustment instructions recommend using mercury batteries (1.354 volts) for the dc range adjustments. The 1.5-volt dc range is adjusted before the 0.5-volt range. Then a pot is connected across the battery and turned down to read 0.5 on the 1.5-volt range. This becomes the standard for the 0.5-volt range. Ac calibration adjustments are made from the 120-volt line. Greater accuracy is possible if you can determine what the exact line voltage is, of course. I was fortunate to have a lab-type ac meter which told me my line voltage was 123 at the time.

The kit comes with two manuals: one for assembly and wiring, and one for permanent use afterward, as an operator's manual. The operator's manual contains calibration, service and detailed how-to-use information. A circuit description and schematic diagram are in the back. An added feature is a graph for reading dB from voltage across a 600-ohm load, and a chart for straight-edge conversion of the ratio of any two voltages to dB.—*Louis M. Dezettel*

MANUFACTURER'S SPECIFICATIONS

Input resistance: 11 megohms on dc
Accuracy: dc: $\pm 3\%$ of full scale
 ac: $\pm 5\%$ of full scale
Dc ranges: 0-0.5-1.5-5-15-50-150-500-1500 volts full scale (to 25,000 volts with accessory high voltage probe)
Ac ranges: rms: 0-1.5-5-15-50-150-500-1500 volts full scale
 P-P: 0-4.2-14-42-140-420-1400-4000 volts full scale
Frequency response: ± 1 dB, 30 Hz to 3 MHz. (To 250 MHz with accessory rf probe.)
Ohmmeter ranges: 0-1000-10,000-100,000 ohms; 0-1-10-100-1000 megohms
 Center scale: 10, 100, 1000, 10,000, 100,000 ohms, 1 and 10 megohms
Battery: 1 $\frac{1}{2}$ volt, "C" size
Tubes: 12AU7-A pre-aged, matched; 6AL5.
Price: \$39.95 kit, \$59.95 wired
Allied Radio Corp., 100 No. Western Ave., Chicago, Ill. 60680

END

NEW-7 Pattern Displays For Color TV Servicing

Precise's "Green Line"
Model 660

SOLID STATE COLOR GENERATOR



\$12495 net

1. Clear Raster: automatically provides sync and quieting when performing purity adjustments.
2. Shading Bars: special gray scale pattern (4 levels of brightness) for gun tracking adjustments.
3. White Dots: 140 fine, high definition dots permit extremely accurate convergence adjustments.
4. Crosshatch Pattern: 10 fine vertical lines and 14 equally fine horizontal lines.
5. Vertical lines only.
6. Horizontal lines only.
7. Color Bars: ten sharply defined keyed rainbow color bars.

The Precise Model 660 is the complete answer to all the rigid, no-compromise requirements for the seven signal sources so vital for color convergence, sync adjustments, gray-scale-tracking and troubleshooting of color TV circuits.

FEATURES—All solid-state design, for instant warmup and maximum stability. Crystal-controlled circuitry and advanced-design highly stable counters insure sharp, locked-in, trouble-free displays with unusually high contrast and stability. Continuously variable chroma level control on front panel. Panel includes 4.5mc sound carrier switch in addition to three color gun killer switches. RF output adjustable to channels 3, 4, or 5. (factory-set to channel 3)

The compact, lightweight Model 660 is ideal for in-home color adjustments as well as year-in and year-out service use in the shop. In addition to meeting all the requirements for today's color servicing work, the Model 660 also anticipates color set servicing of tomorrow.

See the complete Green Line—power instruments, scopes, VTVMs, signal generators, tube testers, decade boxes, probes—at your local distributor, or write direct for full information and specs.



PRECISE ELECTRONICS

76 East Second Street, Mineola, L.I., New York

ENGINEERED EXCELLENCE IN TEST EQUIPMENT

Circle 27 on reader's service card

Sony has developed the world's finest audio transistors...

here's the proof



Many manufacturers have made fairly good transistor amplifiers. Until now nobody has made a great one. And everybody knows the reason: distortion. Unfortunately, most transistor amplifiers distort in a very special way. Not so much at top power, but rather more at normal listening levels where it hurts most.

The Sony TA-1120 integrated amplifier and TA-3120 power amplifier are the first high-powered transistor units to really overcome the problem of distortion. At all power levels, at all frequencies distortion is kept below that of the finest tube amplifiers. The TA-1120 and TA-3120 both provide 120 watts IHF at 8 ohms, both channels operating. Distortion, at rated output, is 0.1%. And at normal listening levels it is even less, 0.05% at 1/2 watt. In addition, they have achieved an extraordinarily high damping factor, better than 70 at 1000 cps to assure clear, low-frequency power response. Frequency response is practically flat from 10 to 100,000 Hz (+0 db/-1 db). For safety's sake, an SCR (silicon controlled rectifier) protects the power transistors against accidental shorts and other overloads.

The integrated amplifier, the TA-1120 features a sensible arrangement of the front-panel controls for the greatest versatility and ease of operation.

We believe that these are the first great transistor power amplifiers. How can Sony do what other manufacturers couldn't? Sony is a pioneer in transistors. With first after first. Such as the tunnel diode. Transistor television. And the all transistor videocassette recorder. The point is that Sony knows transistors. To the nth degree. And designed new, advanced types especially for the driver and output stages of these amplifiers. And silicon transistors are used throughout. They are the most stable. The TA-1120 integrated amplifier, \$399.50. A handsome off-finish walnut enclosure is optional. The power amplifier TA-3120, \$249.50.

Visit your Sony high fidelity dealer and make him prove that Sony is worth the money. Make him compare it with the finest tube amplifiers. We think you'll end up with a Sony. For a free brochure write:

SONY All prices suggested list.
® Corp. of America, 47-37 Van Dam St.,
Long Island City, N.Y. 11101 Dept. H

You earn your FCC First Class License

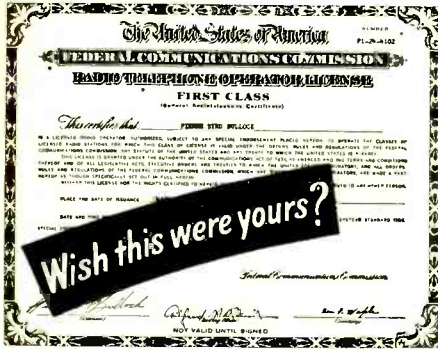

or your money back!

**THERE'S A WORLD OF OPPORTUNITY
FOR THE MAN WITH AN FCC LICENSE**

All it takes is a few spare hours a week and NRI's FCC License Course to open the way to increased opportunities in Communications. With an FCC License, you're ready to operate, service and install transmitting equipment used in aviation, broadcasting, marine, mobile and Citizens-Band communications.

What does it take? Men with absolutely no training or experience in Electronics complete the course in 10 months. A Technician or man with some background can easily cut that time in half. And because NRI has a greater enrollment than any other school of its type, training costs you less than comparable courses offered by other schools. Further, **YOU MUST PASS** your FCC exams or **NRI refunds your tuition in full.**

Get full details about NRI FCC License Course plus other home-study plans offered by NRI, oldest and largest school of its kind. Mail coupon. No obligation. No salesman will call. **NATIONAL RADIO INSTITUTE, Washington, D. C. 20016.**

**AVAILABLE UNDER
NEW GI BILL.** If you
served since January 31,
1955, or are in service,
check GI line in coupon.

**MAIL FOR
FREE
CATALOG**



NATIONAL RADIO INSTITUTE
Electronics Division
Washington, D.C. 20016 30-096

Please send me complete information on FCC License Training and other NRI courses, as checked below. (No salesman will call.)

- | | |
|---|---|
| <input type="checkbox"/> Television-Radio Servicing | <input type="checkbox"/> Electronics for Automation |
| <input type="checkbox"/> Industrial Electronics | <input type="checkbox"/> Aviation Communications |
| <input type="checkbox"/> Complete Communications | <input type="checkbox"/> Marine Communications |
| <input type="checkbox"/> FCC License | <input type="checkbox"/> Mobile Communications |
| <input type="checkbox"/> Math for Electronics | <input type="checkbox"/> Electrical Appliance Repairs |
| <input type="checkbox"/> Basic Electronics | <input type="checkbox"/> Electronics for Printers |
| <input type="checkbox"/> CHECK FOR FACTS ON NEW GI BILL | |

Name _____ Age _____
PLEASE PRINT

Address _____

City _____ State _____ Zip _____
Code _____
Accredited Member National Home Study Council

Sencore MX11 Channelizer FM-Stereo Signal Generator

Circle 31 on reader's service card

A TEST INSTRUMENT IS VALUABLE IF IT will do something none of your other test equipment will do and do it faster and easier. The Sencore MX11 Channelizer FM stereo generator does both, at least in my shop. FM stereo is growing by leaps and bounds, and it does require a very special type of signal generator.



With isolated meters and rf stereo signal, battery-powered unit can be used to align multiplex receivers fairly close if your sweep generator happens to be unavailable.

The MX11 is in a case only 3 inches high and about 10 inches square, with a carrying handle. All-transistor and powered by self-contained dry batteries, it's ready to go whenever you are. Clips on the back keep the cables wound up out of the way. Soft rubber feet let you set the unit on even the finest cabinet.

The MX11 delivers a 3,000- μ V signal. This is set at 100 MHz but can be returned to any frequency between 90 and 105. The FM multiplex signal has both L and R signals at 1,000 Hz, plus the standard 10%-modulation 19-kHz pilot carrier. The rf output cable, with 300-ohm impedance, can be connected directly to the antenna terminals of an FM tuner. You can also take the composite signal without the rf carrier from a pair of tip jacks on the front panel.

The MX11 is easy to operate. There are only four switches on the front panel: ON-OFF, RIGHT SIGNAL, LEFT SIGNAL and PILOT MODULATION-PERCENTAGE SELECTOR.

A crystal-controlled Pierce oscillator produces a 76-kHz signal which is shaped and used to control a 38-kHz bistable multivibrator. The 38-kHz signal takes the form of two symmetrical square waves, 180° out of phase. These

control the L (left) and R (right) switching transistors.

A 1,000-Hz phase-shift oscillator generates a sine-wave audio signal. The output of this is coupled to both L and R panel switches, then through a pair of emitter followers to the switching transistors. They are activated by alternate halves of the 38-kHz square wave. The L signal joins during one excursion, the R signal during the other, producing a multiplex L-R sideband signal. Filters correct any phase shift and take out any 114-kHz (third harmonic of 38 kHz) component of the signal before it reaches the modulator.

The 19-kHz pilot oscillator is a Colpitts, timed by a pulse from one side of the 38-kHz square wave. The 19-kHz output goes through the PILOT switch to the modulator and its attenuators.

From the modulator another composite multiplex signal goes to the STEREO-SIGNAL jacks on the front panel, and also to the rf oscillator—another Colpitts. The modulator frequency-modulates the composite signal onto this carrier. Rf output is through a coaxial cable terminated in a resistive pad to match the 300-ohm input on FM tuners.

The power supply for the MX11 is eight C-cells, hooked up as two 6-volt sources—one positive and one negative. Normal current drain is 12 mA from each, so battery life should be good. The batteries can run down to a level of about 5 volts before replacement is necessary.

One feature is handy in a lot of ways besides the one for which it's intended: a pair of output meters! They are not connected in any way to the MX11 circuitry; each has its own cable on the back panel, plainly marked. Each meter has an 8-ohm 5-watt load resistor and a diode rectifier. Hooked across the speakers of a stereo system, these meters measure audio output level. If you run into a transistor system with an odd speaker impedance—like 100 ohms—add a blocking capacitor in series with each meter.

Each is a 3-volt rms-reading ac voltmeter. The scales are marked HI-GOOD-LOW and in dB. If one meter is at full scale and the other is at the HI mark, this indicates a 20-dB separation between

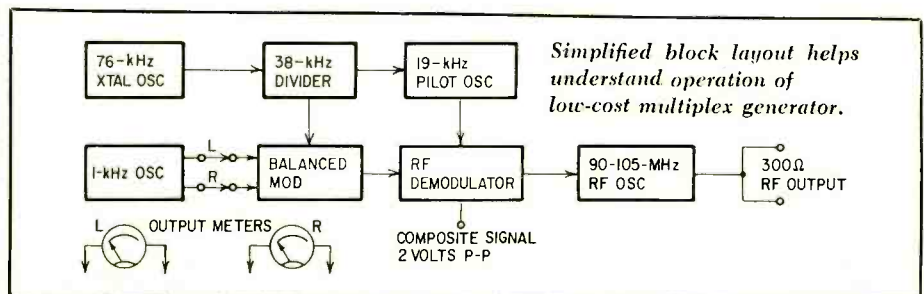

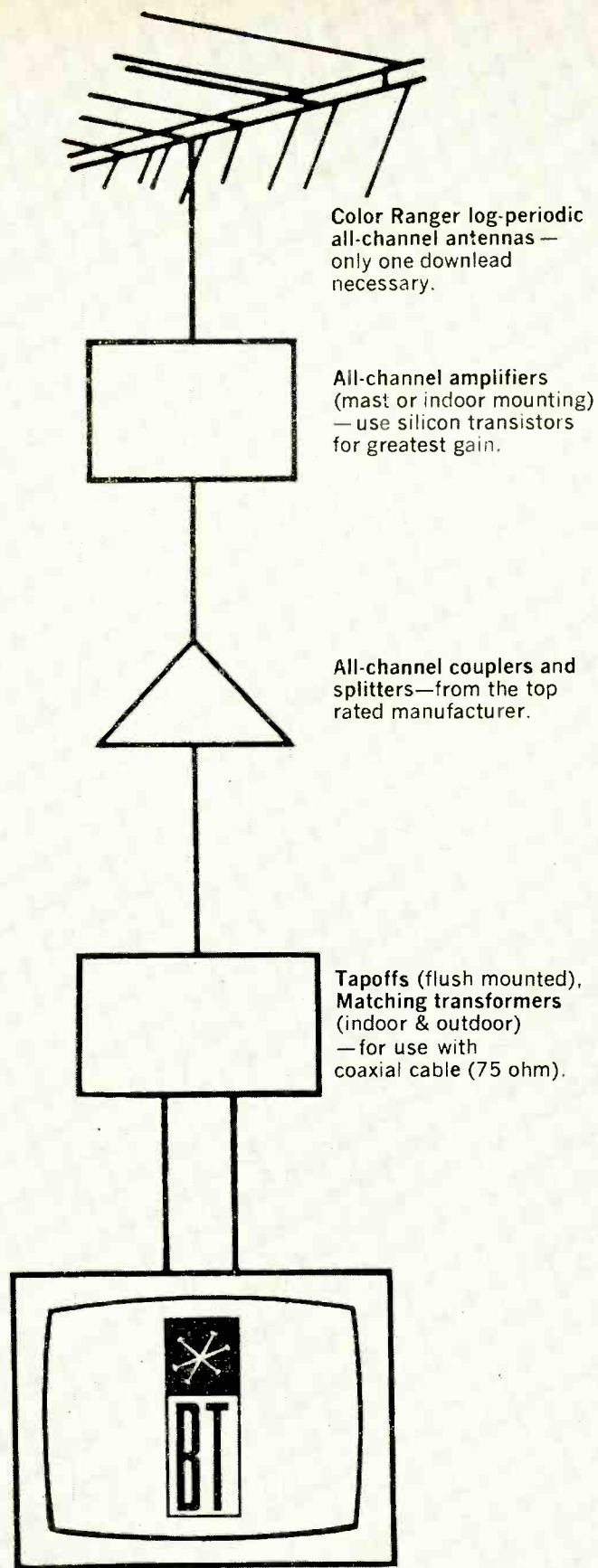

Color Ranger log-periodic all-channel antennas — only one downlead necessary.

All-channel amplifiers (mast or indoor mounting) — use silicon transistors for greatest gain.

All-channel couplers and splitters—from the top rated manufacturer.

Tapoffs (flush mounted), Matching transformers (indoor & outdoor) — for use with coaxial cable (75 ohm).

GO ALL CHANNEL ALL DOWN THE LINE WITH BLONDER TONGUE

From the tip of the antenna to the TV set terminals matched components engineered for the all-channel and color TV era. Sold by leading distributors. Write for catalog of all-channel, color approved products. **Blonder-Tongue Laboratories, Inc.,** 9 Alling Street, Newark, N. J.

Circle 30 on reader's service card

enter now!!!
SIMPSON 260® VOM
APPLICATIONS CONTEST

Grand Prize: One week at the famous Tropicana in Las Vegas.
Other Prizes: A Goof-Proof VOM a month, for six months. Diode Meter Protectors for all entrants.



Send in your ORIGINAL test application for Simpson's famous 260 VOM . . . an application NOT ALREADY described in our new book, "1001 Uses for the 260 . . ." Copies available from your Electronic Distributor; list price, \$1.00. He also has entry rules. Contest ends December 31, 1966.

SIMPSON ELECTRIC COMPANY
 5219 W. Kinzie, Chicago, Ill. 60644

WE DON'T CLAIM
OUR ELECTRONIC
IGNITION SYSTEM
IS BEST . . .



OUR
CUSTOMERS DO!

WRITE TODAY FOR FREE LITERATURE

JUDSON

RESEARCH AND MFG. CO.
 CONSHOHOCKEN, PA., U.S.A.



Circle 32 on reader's service card

channels or signals being compared.

You can make a lot of tests very quickly with the MX11. To check channel separation in FM stereo receivers, connect the rf cable to the input and the meter cables to each speaker terminal. Tune in the signal, set the volume control for full-scale deflection of one meter, turn the balance control for equal readings. If the 1,000-Hz tone annoys you, disconnect the speakers (the built-in load resistors will protect the amplifier.)

Set the PILOT switch to 10% and turn off either L or R. The corresponding meter reading should drop, while the other stays where it was. Channel separation is read directly in dB from the scale that dropped. Repeat the test for the other channel. This test can catch a lot of troubles. For instance, if you turn off the R signal and the L meter drops, something's wrong! (Be sure you've hooked the meter clips to the correct speaker terminals.) The mpx adapter could be misaligned so that the output is 'way out of phase.

If you find a system with poor separation, the mpx section can be aligned with the MX11. Feed the composite signal directly into the multiplex input or FM detector output point. If this shows good separation, the trouble must lie in the FM tuner circuits. Incorrect alignment or defective parts can cause the tuner bandpass to become too narrow for the full multiplex signal. Tuner rf and i.f. stages can be aligned roughly with the MX11 signal. The meters are used as output meters, a full stereo signal applied at the input, and the receiver circuits tuned for maximum indication on both meters.

In the shop, the MX11 can be used with a scope for checking multiplex detector and pilot carrier. If the trouble seems to be in the pilot carrier or the doubler, hook the scope across the mpx detector and peak the 19-kHz and 38-kHz stages for maximum amplitude.

For the service technician who is going into the profitable field of FM stereo work, the MX11 will make his jobs simpler. Best of all, it's really in the right price range.—*Jack Darr*

Price: \$99.50

END

FREE! HOW TO
IMPROVE YOUR
TWO-WAY RADIO!

The right communications microphone may double the talk power of even the finest transmitters! Learn how unwanted noise can be eliminated—reliability improved—intelligibility increased by proper microphone selection. Write for our helpful free booklet today!



Electro-Voice
 SETTING NEW STANDARDS IN SOUND

.....
 ELECTRO-VOICE, INC., Dept. 962E; 613 Cecil St.
 Buchanan, Michigan 49107
 Please send the free E-V booklet on choosing communications
 microphones. I am interested in the following areas of two-way
 radio: Amateur Aviation CB Business.
 NAME _____
 COMPANY _____
 ADDRESS _____
 CITY _____ STATE _____

THE MANY USES OF
CRYOGENICS

Many miracles can be performed at low temperatures. Discover how supercooling is used for industrial research and development. Coming in October.

RADIO-ELECTRONICS
 In the special section on
Industrial Electronics

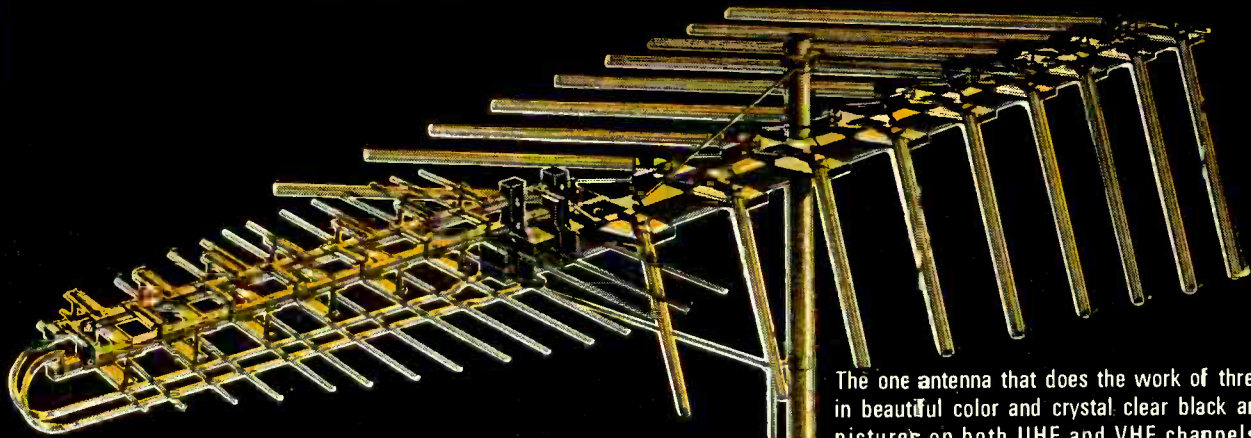

FINCO ALL-BAND UHF-VHF-FM ANTENNA
75 OHM Model CX-UVF-24 \$72.10 List

FINCO ALL-BAND UHF-VHF-FM ANTENNA
300 OHM Model UVF-24 \$59.95 List

The one antenna that does the work of three! Pulls in beautiful color and crystal clear black and white pictures on both UHF and VHF channels... plus the finest stereophonic and monophonic FM sound reproduction.

300-ohm models for normal reception areas from \$18.50 to \$59.95

75-ohm models for poor reception areas from \$42.65 to \$72.10

FINCO

introduces / 75-ohm COLOR VE-LOG ANTENNAS
FOR UHF-VHF-FM RECEPTION

Finco's Swept-Element Antenna challenges all competition. Its unique design assures the finest color and black and white TV reception—plus superb FM and FM Stereo tone quality.

300-ohm models for normal reception areas from \$16.95 to \$54.50

75-ohm models for poor reception areas from \$18.55 to \$62.80

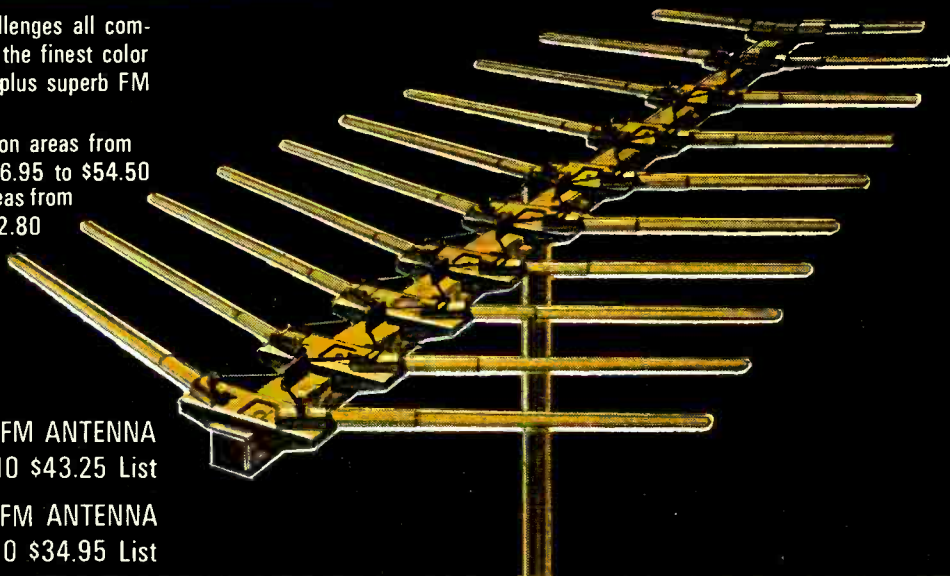

FINCO SWEPT-ELEMENT VHF-FM ANTENNA
75 OHM Model CXVL-10 \$43.25 List

FINCO SWEPT-ELEMENT VHF-FM ANTENNA
300 OHM Model VL-10 \$34.95 List

FREE! ALL FINCO CX-VL, CX-UVF AND UVF ANTENNAS COME WITH A FREE INDOOR SET-MOUNTED TRANSFORMER, VHF-UHF TRANSFORMER SPLITTER OR VHF-UHF SPLITTER.



THE FINNEY COMPANY

34 WEST INTERSTATE STREET, DEPT. RE, BEDFORD, OHIO

**Buy the BEST!
Buy in KIT form!**



MARK[®]TEN

SCR CAPACITIVE DISCHARGE
IGNITION SYSTEM

ONLY \$ **29⁹⁵** PPD.!

Why settle for less in motor vehicle ignition systems when you can buy the very BEST from Delta, the originators, the leaders in capacitive discharge (SCR) systems. Delta pioneered this electronic marvel. Thousands have installed this remarkable electronic system. Now YOU can purchase at low, LOW cost, and in easy-to-build kit form, the king of them all, the DELTAKIT. Low price due simply to high production levels at no sacrifice in peerless Delta quality.

**Operate Any Motor
Vehicle More Efficiently**

Compare these proven benefits:

- ▲ Up to 20% Increase in Gasoline Mileage
- ▲ Installs in Only 10 Minutes on any Car or Boat
- ▲ Spark Plugs Last 3 to 10 Times Longer
- ▲ Instant Starts in all Weather
- ▲ Dramatic Increase in Acceleration and General Performance
- ▲ Promotes More Complete Combustion

Literature and complete technical information sent by return mail.

BETTER YET — ORDER TODAY!



DELTA PRODUCTS, INC.

P.O. Box 1147 RE, Grand Junction, Colo. 81501

Enclosed is \$_____. Ship prepaid.

Ship C.O.D.

Please send:

Mark Tens (Assembled) @ \$44.95

Mark Tens (Delta Kit) @ \$29.95

SPECIFY— Positive Ground Negative Ground
6 or 12 Volt

Car Year _____ Make _____

Name _____

Address _____

City/State _____ Zip _____

DP 6-2

Circle 35 on reader's service card

72

NEW SEMICONDUCTORS, MICROCIRCUITS & TUBES

This month's developments are highlighted by several advanced transistor types, switches and FET's. The A477 and A473 are new silicon planar epitaxial transistors for TV video i.f. amplifier service. Their unusually low feedback capacitance—150 fF (femtofarads or thousandths of a picofarad, sometimes called millipicofarads or mpF) and 220 fF (0.220 pF), respectively—make it possible to design an unneutralized three-stage video i.f. amplifier with an overall minimum gain of 90 dB.

Typical f_T is 350 MHz for the A467 and 400 MHz for the A473. Both types have high breakdown voltages. V_{CEO} is 30 and 35 volts, respectively. The transistors are in TO-18 cases. TV i.f. circuits, application notes and detailed specifications can be obtained from Amperex Electronic Corp., Semiconductor and Special Purpose Tube Div., Slatersville, R. I. 02876.

The 2N4127 and 2N4128 are new high-power rf transistors for use in 25-volt mobile and aircraft applications. The 2N4127 has a power output of 13.5 watts at 175 MHz with 8 dB gain. The 2N4128 delivers 25 watts with 9 dB gain at the same frequency. These TRW Semiconductors transistors are in low-profile molded silicone packages with stud mounts. The high-power unit costs \$45 in quantities less than 100 and the low-power unit \$24. Prices can be expected to drop as more applications are developed. They should be ideal for portable and mobile amateur radio vhf applications.

The type 8643 tube is another new product that should find its way into amateur mobile gear. It is an Amperex twin diode with a revolutionary type of cathode designed for relative immunity to variations in heater supply voltage. The cathode delivers 90% of rated power with heater voltages ranging from 10 to 16.

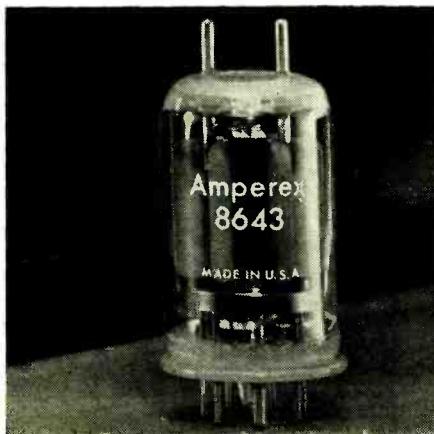

The 8643 is designed for rf amplifier, oscillator and frequency multiplier applications up to 175 MHz. Rated for PTTS (push-to-talk service—maximum duty cycle: 1 minute on, 4 minutes off) at 175 MHz, it delivers up to 135 watts output with less than 4 watts drive as a push-pull FM amplifier. Under ICAS conditions, it delivers 123 watts with 3.5 watts of drive.

Two new developmental RCA npn transistors (TA2669 and TA2669A) are especially suited for switching-control amplifiers, power gates, switching regulators, converters and inverters, and rf amplifiers and power oscillators. The 0.5 μ sec (max) turn-on time makes them useful as switches handling up to 15 amps. Both can dissipate up to 140 watts at case temperatures of 25°C.

Characteristics are:

	TA2669	TA2669-A
V_{CEO}	120	150 volts
V_{CEV} (sus)	120	150 volts
V_{CER} (sus)	80	110 volts
V_{GEO}	60	90 volts
V_{EBO}	7	7 volts
I_C	20	20 amps
I_B	10	10 amps



Philco's Solid-State Products Operation at Spring City, Pa. has developed a high-speed germanium diode capable of demodulating the output of lasers used in optical communications systems in the 0.5—1.8-micron range.

The L-4250 optical-detecting, photomixing diode is expected to find greatest use with 1.06-micron neodymium and 1.15-micron helium-neon lasers. It has a peak spectral response at 1.4 microns, a .03 sq. mm. light-sensitive area and a cutoff frequency of 1.5 GHz. The diode is most efficient with 6 volts or more of reverse bias. Cost is \$135 in quantities of 1 to 9.

G-E has introduced the D13D1 SUS (Silicon Unilateral Switch) and D13E1 (Silicon Bilateral Switch). The former is a diode thyristor with electrical characteristics approaching the ideal four-

RADIO-ELECTRONICS

FREE *ALLIED* 1967 CATALOG

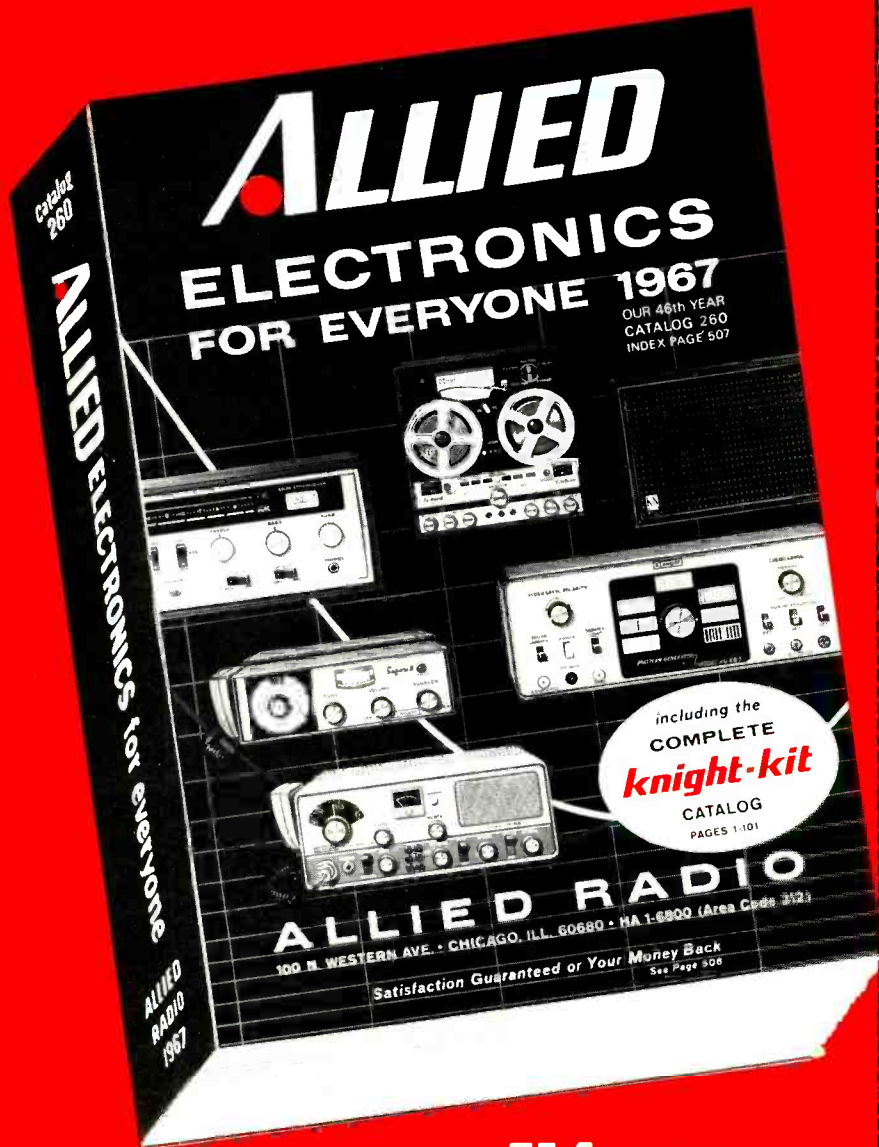

NEW 514-PAGE *ALLIED* CATALOG

**TOP SAVINGS ON THE BEST
IN ELECTRONICS FOR EVERYONE...**

- Famous Knight-Kits • Stereo Hi-Fi • Tape Recorders & Tape
- CB 2-Way Gear • 'Walkie-talkies • FM-AM & AM Radios
- Short Wave Radios • Portable TV • Phonographs, Accessories
- Amateur Gear • Intercoms & P.A. • Automotive Electronics
- Test Instruments • TV Antennas & Tubes • Power Tools • Parts
- Hardware • Tubes • Transistors • Batteries • Books

NO MONEY DOWN-24 MONTHS TO PAY!
Low Monthly Payments to fit your budget.

DO A FRIEND A FAVOR—give him this card to send for his FREE ALLIED CATALOG



TO:
ALLIED RADIO
P. O. BOX 4398
CHICAGO, ILLINOIS 60680

PLACE
STAMP
HERE

**RUSH
THIS CARD
TODAY**

FREE

NEW 1967

ALLIED CATALOG

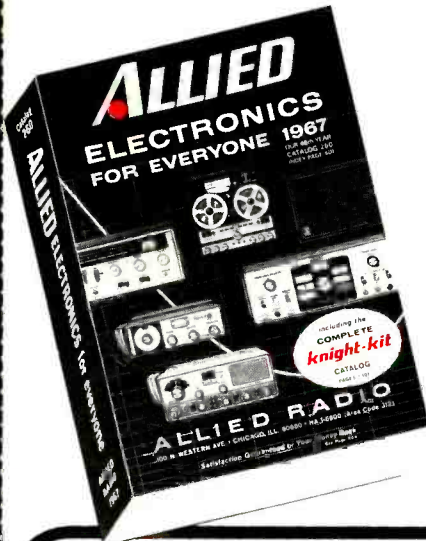

514 pages! See everything new in electronics... featured first at Allied, the world's largest electronics headquarters!

New! for the audiophile...



Knight-Kit® Deluxe Stereo FM-AM Tuner. Easy-to-build solid-state design.

New! for the ham operator...



Knight-Kit® 6-Meter Amateur Transceiver with universal solid-state power supply.

New! for the CB user...



KNIGHT® 2-Way Radio. Compact solid-state design at amazingly low cost!

New! for the serviceman...



Knight-Kit® Portable Solid-State Color/Bar Pattern Generator. A top value!

New! for everyone...



Ampex 6200 HVR Home Videotape Recorder. Make videotapes at home!

New! for TV and FM owners...

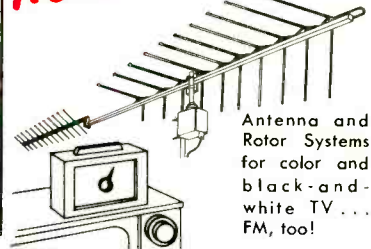

Antenna and Rotor Systems for color and black-and-white TV... FM, too!

Plus hundreds more new and exclusive items, and scores of special Allied values!

NO MONEY DOWN!

Enjoy the things you want now, while you take 24 months to pay for them on the Allied easy-on-the-budget Credit Fund Plan.

ALLIED RADIO

P.O. BOX 4398
CHICAGO, ILLINOIS 60680

DO A FRIEND A FAVOR—give him this card to send for his FREE ALLIED CATALOG

NAME—PLEASE PRINT _____

ADDRESS _____

CITY _____

STATE

2J

ZIP _____

**FREE
ALLIED
1967
CATALOG**

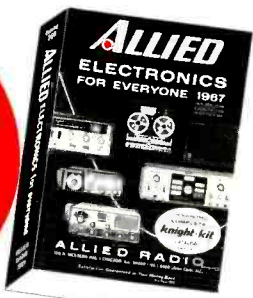

CHOOSE FROM THE WORLD'S LARGEST SELECTION IN ELECTRONICS... AND SAVE!

Buy from the world's largest electronics supplier. Use the Allied Credit Fund Plan to enjoy what you want NOW—no money down, 24 months to pay.

RUSH THIS CARD NOW!



**Every time
you sell an RCA
TV antenna
you buy
customer confidence.**

Customers feel better about buying from you, when they know you sell antennas with the first name in color and black & white TV.

Your profit is assured, too, when your antennas have the RCA Mark of Quality. That's because you sell a brand, rather than a price. And, the RCA brand identifies the leader in TV station equipment, TV receivers, and TV satellite equipment for outer space. Therefore, the customer expects *this* brand to identify outstanding TV antenna performance. It does.

There's an RCA antenna for every reception area. For maximum profit and performance, sell the top of RCA's complete line. RCA COLOR-SCAN outdoor antennas bring all VHF, UHF and FM signals to suburban and fringe areas. The RCA COLOR-MARK II is unsurpassed in indoor antenna performance (VHF, UHF and FM) — and its styling is in a class by itself.

Have your RCA Distributor give you the profit picture on RCA antennas. It's as beautiful as the TV picture your customer gets when he buys them.

RCA PARTS AND ACCESSORIES, DEPTFORD, N. J.



The Most Trusted Name
in Electronics.

3 new

Winegard

Distribution Amplifiers

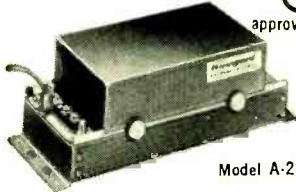

Model A-215

to run 2 sets, 200 or MORE!

- Designed for color and FM stereo—have flat frequency response, no phase distortion, full gain to top of FM band.
- Lowest Noise—use All high transconductance, low noise triodes—no pentodes.
- Easiest to Service—All jacks, controls, switches, and connections accessible from top of chassis.
- Extended Band Pass—Allows cascading without clipping the end channels.
- Fully Ventilated Top and Sides—dissipate heat for longer life.
- For complete information contact your distributor or write Winegard today.

LIST PRICES:

- Model A-845 (8 tube, 45 db gain, drives up to 100 sets) **\$159.95**
- Model A-430 (4 tube, 30 db gain, drives up to 52 sets) **\$84.95**
- Model A-215 (2 tube, 15 db gain, drives up to 10 sets) **\$44.95**

Winegard Company
3000 Kirkwood • Burlington, Iowa

Circle 38 on reader's service card

Enjoy the "music-only" programs now available on the FM broadcast band from coast to coast.

- NO COMMERCIALS •
- NO INTERRUPTIONS •



It's easy! Just plug Music Associated's Sub Carrier Detector into multiplex jack of your FM tuner or easily wire into discriminator. Tune through your FM dial and hear programs of continuous commercial-free music you are now missing. The Detector, self-powered and with electronic mute for quieting between selections, permits reception of popular background music programs no longer sent by wire but transmitted as hidden programs on the FM broadcast band from coast to coast. Use with any FM tuner. Size: 5½" x 6". Shipping weight approx. 7 lbs.

KIT \$49.50

(with pre-tuned coils, no alignment necessary)

WIRED \$75.00 (Covers extra \$4.95 ea.)

Current list of FM Broadcast stations with SCA authorization \$1.00

MUSIC ASSOCIATED

65 Glenwood Road, Upper Montclair, N. J.
Phone: (201)-744-3387

Circle 39 on reader's service card

layer diode. Designed for monostable and bistable circuitry such as telephone switching, SCR triggering, and a variety of memory and logic applications. The D13E1 is a silicon planar multijunction device with a symmetrical negative-resistance characteristic, designed for stable switching characteristic over a wide temperature range. A gate lead (see diagrams) gives access to the Zener and p-n-p base node. Suitable for half- and full-wave triggering in low-voltage SCR and Triac phase control circuits. Pertinent characteristics are:

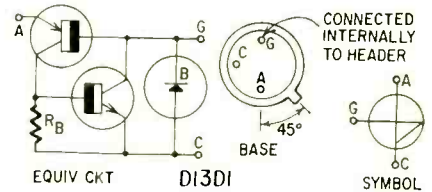

D13D1

Forward switching voltage, V_s
6 volts (min)
10 volts (max)

Forward switching current, I_s
500 μA

Reverse current,
 $V_R = -30, T_A = 25^\circ C$
0.1 μA

Forward current,
 $V_F = 5, T_A = 25^\circ C$
1.0 μA

Forward voltage drop,
 $I_F = 200 \text{ mA}$ 1.75 volt

Turn-on time, t_{on} 1.0 μsec

Turn-off time, t_{off} 25.0 μsec

Capacitance,
(0 volt, $f = 1 \text{ MHz}$)
2.5 pF

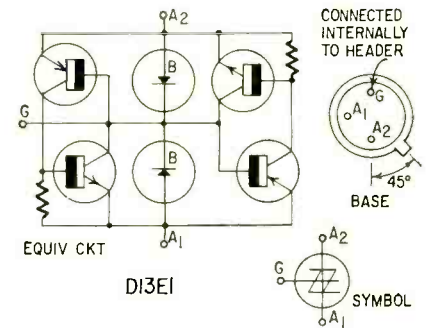

D13E1

Switching voltage, V_s
6 volts (min)
10 volts (max)

Switching current, I_s
500 μA

Absolute switching voltage,
($V_{S2} - V_{S1}$) 0.5 volt

Absolute switching current,
($I_{S2} - I_{S1}$) 50 μA

Holding current, I_H 1.5 mA

Current (off state when
 $V_F = 5, T_A = 25^\circ C$)

1.0 μA

Turn-on time, t_{on} 1.0 μsec END



Your new copy is waiting

FREE! For fun and pride in assembly, for long years of pleasure and performance, for new adventures in creative electronics mail the coupon below and get Conar's brand new catalog of quality do-it-yourself and assembled kits and equipment. Read about items from TV set kits to transistor radios . . . from VTVM's to scopes . . . from tube testers to tools. And every item in the Conar catalog is backed by a no-nonsense, no-loopholes, money-back guarantee! See for yourself why Conar, a division of National Radio Institute, is just about the fastest growing entry in the quality kit and equipment business.

CONAR

MAIL THIS COUPON NOW

CONAR 3939 Wisconsin Ave., Washington, D.C. 20016 JC6C

Please send me your new catalog.

Name _____

Address _____

City _____ State _____ Zip _____

Code _____

How The New Heath DC Triggered Sweep Oscilloscope Up-Dates The Value Standards For All Lab Oscilloscopes

Kit
IO-14
\$299⁰⁰
Assembled
IOW-14
\$399⁰⁰

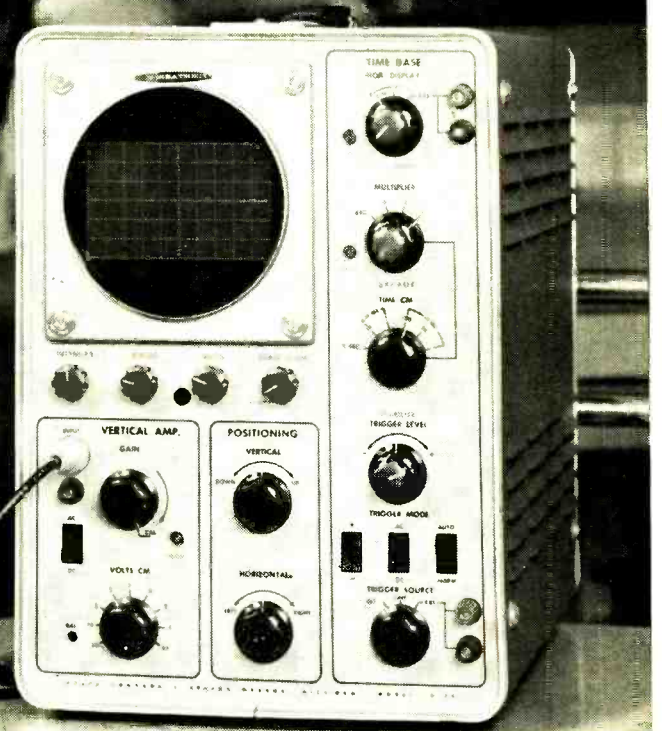

THE NEW HEATH IO-14 OSCILLOSCOPE OFFERS TRULY SOPHISTICATED CAPABILITIES. It features a high-quality flat-face 5" CRT with an accurately-ruled 6 x 10 cm graticule • DC to 8 MHz bandwidth with 40 nanosecond rise time • 0.25 microsecond vertical signal delay through high-linearity delay line circuitry • 3% calibrated vertical attenuation — from 0.05 v/cm to 20 v/cm • 3% calibrated time base — from 0.2 microseconds/cm to 0.5 seconds/cm • Forced air cooling for the toughest industrial applications • Input for Z axis modulation • Input for direct access to vertical deflection plates • Highly-stable fiberglass circuit board construction • Wiring options for 115/230 volt, 50-60 hertz operation • The IO-14 is designed with modern circuitry, engineered with high-quality close-tolerance components, and capable of satisfying the most critical demands upon its performance specifications.

THE HEATH IO-14 INCLUDES ENGINEERING FEATURES YOU EXPECT ONLY IN HIGH-PRICED OSCILLOSCOPES. For example, switches are ball-detent type; all major control potentiometers are precision high-quality sealed components; all critical resistors are 1% precision; and vertical signal delay is provided through precision coaxial delay lines — circuitry considered by all knowledgeable electronic engineers to be the most desirable for high linearity and maximum frequency response.

THE HEATH IO-14 PROVIDES THE ULTRA-STABLE LOW-NOISE PERFORMANCE DEMANDED FOR TRULY PROFESSIONAL INDUSTRIAL, ACADEMIC, ELECTRONICS-ENGINEERING, AND BIO-MEDICAL REQUIREMENTS. Here's what engineer Adam L. Keller of Swiss Controls & Research Inc., Michigan City, Indiana says about the IO-14: "May I take this opportunity to congratulate your company on the fine job you have done on your new IO-14 oscilloscope kit. In my opinion there is not a scope on the market which can compare with your fine new product, at least until you start talking 4 or 5 times the price. We are most satisfied with the instrument in every respect ... your IO-14 is probably the finest kit you have ever put on the market, bar none." **WE AT HEATH AGREE.**



FREE! 1967 Heathkit Catalog

108 pages ... many in full color ... describe over 250 Heathkits for the lab, hobbyist, and industry.

HEATH COMPANY, Dept. 20-9
Benton Harbor, Michigan 49022

Please send more information on _____ (product)

Name _____

Address _____

City _____ State _____ Zip _____

Prices & Specifications subject to change without notice.

TE-150

Circle 41 on reader's service card

?

What's the difference in loudspeakers that makes Quam so special?

All loudspeakers look pretty much alike, and may even sound pretty much alike—yet Quam speakers are different—in a way that's very important to you who sell them!

?

the difference lies in PERFORMANCE RELIABILITY

When it's a Quam speaker—you sell it and forget it. Quam speakers are built to give long, trouble-free performance. Return time would eat up your profit—but Quam speakers don't come back!

Quam's factory is a manufacturing plant, not merely an assembly shop. By making our own speaker parts, we can guarantee the quality of the materials that go into them. Our voice coils are centered precisely; each and every speaker is thoroughly tested; the product you get meets the standards we have insisted on for almost forty years.

Quam Quality Line speakers are enameled in gold—and while the color has no effect on performance characteristics, it symbolizes the quality and reliability that's built into every Quam speaker.

ASK FOR

QUAM

THE QUALITY LINE
for all your speaker needs

QUAM-NICHOLS COMPANY

234 East Marquette Road • Chicago 37, Ill.

Circle 42 on reader's service card

Is Color a TV-Man Job?

Customers, dealers, technicians all still have serious doubts about color television. This article should lay many of them to rest

By WALLACE WANER

IT USED TO BE SAID THAT INSTALLING A black-and-white TV set called for no particular knowledge, skill or equipment—but that installing a color receiver was something that could be done only by a competent technician with adequate equipment.

This may no longer be strictly true. Self-degaussing receivers *can* be put in without special equipment, and possibly without too much skill. But there is still a lot of difference between black-and-white and color receivers. The average user doesn't notice slight imperfections in a black-and-white set. The picture width and height may be overextended a little; contrast and brilliancy levels somewhat off; focus may not be even over the entire picture area; and the linearity can be far from perfect. These weaknesses get by anyone but the trained technician, a critical observer or the finicky customer.

Color adds further problems: Is the purity good? How about convergence? Is the antenna system good enough for color? These factors are prominent, together with a few not-so-obvious items.

How does a competent technician meet those problems? He is likely first to inspect the antenna system to see if it looks like one that will pick up color, and that there are no loose connections, broken rods, or corroded terminals. He may immediately decide that it will not handle color. Some high-gain antennas clip sidebands. The effect cannot be noticed on a black-and-white set with a bandwidth of 2.5 to 3.2 MHz. It might be entirely useless for color reception where the bandwidth has to be 4 MHz.

A color technician might also consider a rotator for ghost elimination, which shows up much worse on color than on black-and-white. For the lower-priced sets it is still necessary to demagnetize (degauss) the receiver when installing it and on later service calls.

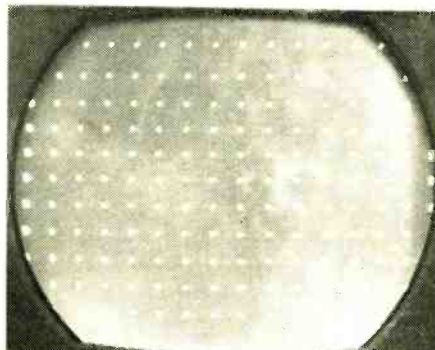

A typical dot pattern is used for preliminary adjustments and for dc convergence.

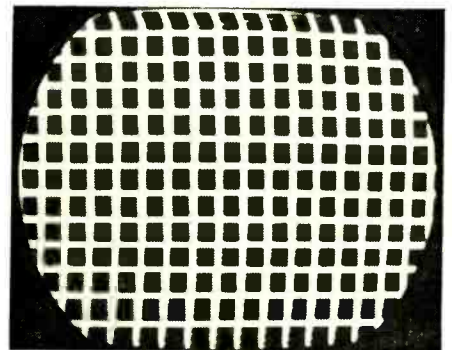

Crosshatch patterns like the one above are used to adjust dynamic convergence.

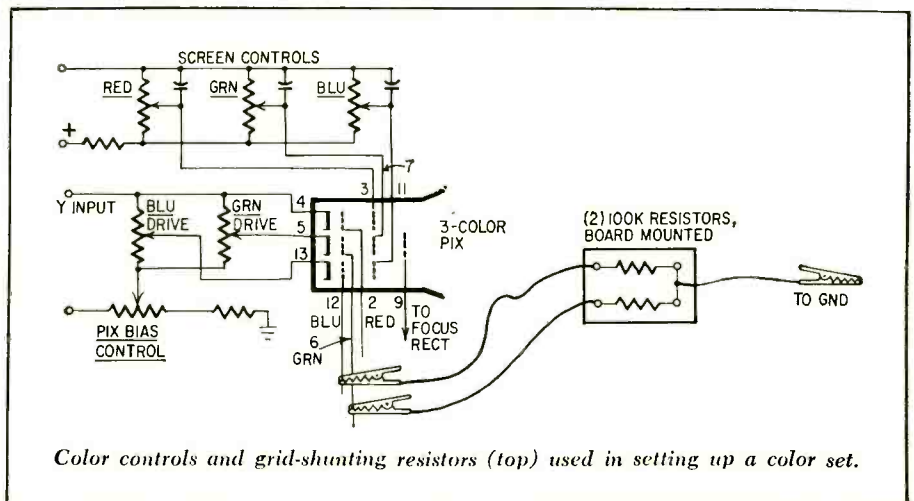

Color controls and grid-shunting resistors (top) used in setting up a color set.

In an age when time is of the essence, thousands of people have spent 50 to 70 hours building their own Heathkit®/Thomas Organ



Savings

It is a proven fact that significant savings can be realized. Savings amounting to several hundreds of dollars. This, indeed, is strong motivation for all.

Superior Performance

Building your own Heathkit organ permits you to stretch your budget to afford the purchase of a superior instrument at the cost of an ordinary one. And Thomas organs are renowned for their excellent voicing, fine mechanical construction, and advanced electronic circuitry.

Challenging Fun

If you haven't tried it, you cannot realize the exhilarating fun of constructing as complex an instrument as an organ. Yet, you need no special skills or knowledge to accomplish it. We show you how, completely. No unanswered questions, no technical jargon. Just one of the most satisfying do-it-yourself activities ever!

Like To Hear Them Perform?

A 7", 33-1/3 rpm demonstration record is available for each organ. Use the handy coupon below, include 50¢ to cover postage and handling, and ask for record no. GDA-325-1 (GD-325B Color-Glo organ), or GDA-983-2 (GD-983 organ). You'll convince yourself.

Deluxe Heathkit/Thomas "Coronado" ... 17 Voices, Chimes, Full Features

Just touch a tab and you create any one of 17 rich organ voices ... Saxophone 8', French Horn 8', Violin 8', English Horn 8', Oboe 8', Flute 8', Cello 8', Bass Clarinet 16', Trumpet 16', Bourdon 16', Flute D' Amour 4', Quint 5-1/3' and Diapason 16' and 8'. And you'll soon learn combinations to produce additional voices like the hawaiian guitar, vibraharp, harpsichord, zither, calliope, bagpipes, etc. It's like having an entire orchestra at your fingertips.

Its professional features also include 28 notes of chimes — worth \$500 to \$2000 as an extra on other organs; 2-speed rotating Leslie speaker plus 2-unit main speaker system; two 44-note keyboards; 13-note bass pedals; attack and repeat percussion; handcrafted walnut cabinet and bench; all-transistor circuit.

Kit assembly takes around 70 hours, and you enjoy savings up to \$350. Liberal credit terms available on both Heathkit/Thomas organs.

Kit GD-983, organ & matching bench,
245 lbs. \$849.00

Low-Cost Heathkit/Thomas "Artiste" ... Instant-Play COLOR-GLO And 10 Voices

Thanks to exclusive Color-Glo, you and every member of your family can play melody, harmony and bass notes instantly. Just match up the colors with your left hand, the letters with your right ... and you play complete songs ... even if you've never played an organ before!

And when you're finished, just flip a switch and the Color-Glo key lights disappear, leaving a beautiful spinet organ. Other features include 10 organ voices; two 37-note keyboards; 13-note bass pedals; variable repeat percussion; all-transistor circuitry; 12" speaker; plus handsome walnut cabinet and bench.

The assembly takes about 50 hours, and you save up to \$150 over a comparable factory-built model.

Discover how easy a Heathkit/Thomas organ is to build and play ... mail coupon below for FREE Heathkit catalog.

Kit GD-325B, 171 lbs. ... organ & matching bench \$394.90

HEATHKIT 1967

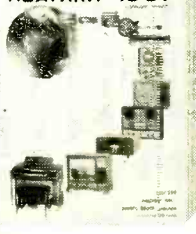

FREE! World's Largest Electronic Kit Catalog!

108 pages ... many in full color ... describe these and over 250 easy-to-build kits for stereo/hi-fi, amateur radio, shortwave, color TV, test, marine, CB, educational. Mail coupon or write Heath Company, Benton Harbor, Michigan 49022

HEATH COMPANY, Dept. 20-9
Benton Harbor, Michigan 49022

Enclosed is \$ _____, plus shipping.

Please send model _____

Please send FREE Heathkit Catalog.

Name _____

Address _____

City _____

State _____

Zip _____

Prices & specifications subject to change without notice.

CL-253



Circle 41 on reader's service card

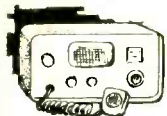

The Heart
of your
Radio
is Its



INSIST ON
CQC*

* Controlled Quality Crystals available only from Texas Crystals dealers. Extensive precision testing throughout manufacture enables Texas Crystals to unconditionally guarantee their frequency control crystals. Use of Texas Crystals in space program and by other governmental agencies is evidence of the quality you can count on.

If your dealer can't supply your needs, send his name with your request for catalog to our plant nearest you.



**TEXAS
CRYSTALS**

Division of Whitehall Electronics Corp.

1000 Crystal Drive Fort Myers, Fla. 33901
4117 W. Jefferson Blvd. Los Angeles, Calif. 90016
Phone: 813-936-2109 Phone: 213-731-2258

Circle 43 on reader's service card



**EFFICIENT!
SAFE!
FAST!**

AUTOMATIC STAPLE GUNS



For Fastening Any
Inside or Outside

Wire Up to 1/2" in Diameter

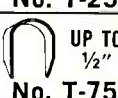
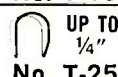
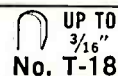

- Telephone wire
 - Intercom wire
 - Bell wire
 - Thermostat wire
 - Radiant heating wire
 - Hi-Fi, Radio & TV wires
- Tapered striking edge gets into close corners!

Available in:
Brown, Ivory, Beige,
Monel, Bronze, Natural

ARROW FASTENER COMPANY, INC.

SADDLE BROOK, N. J. 07663

Circle 44 on reader's service card

On these same sets it will be necessary to degauss whenever the set is moved, and occasionally when it has been exposed to strong magnetic fields. Turning a vacuum cleaner off or on when near the receiver, for example, is an excellent way to magnetize the tube.

On sets with self-degaussing circuits (automatic color purifiers, etc.) the set is degaussed every time it's turned on, or in some sets any time the owner wants to push the button.

Purity and convergence adjustments are a great improvement over what they were a few years ago. But proper adjustment still requires the correct equipment, and is helped a great deal by the experience of the technician. It is possible to check the purity without any more equipment than a pair of 100,000-ohm grid-shunting resistors. The blue and green grids are shunted to leave only red. If the purity is not good, adjustments can often be made, following the instructions given by the manufacturer in the manual for that particular set.

After the red field is checked, the blue and the green ones can be handled in the same way. Red is usually the critical color, especially on the older, low-efficiency picture tubes.

Some jobs demand equipment

Convergence is one job for which you must have the proper tools—a dot-bar generator or equivalent. A grid-test generator is also very useful, especially for dynamic convergence. The cross-hatch pattern indicates overscan, linearity defects, etc. Some modern generators, of course, supply all these together with single lines or assembling point.

Of course, if the set is not picking up any black-and-white well, it will not receive color. It's a good idea to go on to black-and-white and adjust the controls for good highlights in white areas—in other words make sure that you're getting a good black-and-white picture. Newer receivers have a setup or NORMAL-SERVICE switch, that cuts vertical sweep and sets picture-tube bias at a predetermined level for gray-scale tracking. The screen controls are then adjusted so that each one just barely produces a horizontal line.

There is a great deal you can do to a color set without dragging in several pieces of equipment. **END**

Radio-Electronics Is Your Magazine!

Tell us what you want to see in it. Your suggestions may make it a better magazine for the rest of the readers as well as yourself. Write to the Editor, RADIO ELECTRONICS, 154 West 14th St., New York, N. Y. 10011.

EVERY 8 MINUTES...



SOMEONE BUYS A NEW SENCORE CG10 LO-BOY STANDARD COLOR BAR GENERATOR

It's time you too switched to Sencore and saved \$100.00 in the bargain. The new compact LO-BOY is a solid Sencore value that outperforms the highest priced generators—and is already selling at the rate of one every 8 minutes.

Compare these features:

- Ten standard RCA licensed color bars plus all patterns found on more expensive generators.
- New patent pending counting circuits using silicon transistors. Crystal controlled timers for the utmost in stability.
- New front mounted timer controls for quick adjustment if they should ever jump. Absolutely eliminates timer instability.
- All solid state. Battery powered by long life "C" cells.
- HI in performance — LO in price. . . . (Less than the cost of a kit.) . . .

only \$89.50

SENCORE CG138 LO-BOY—Just like CG10 except AC operated, 4.5 mc crystal controlled signal recommended for troubleshooting. . . .

only \$109.50



SENCORE

NO. 1 MANUFACTURER OF ELECTRONIC MAINTENANCE EQUIPMENT

426 SOUTH WESTGATE DRIVE, ADDISON, ILLINOIS 60101

Circle 45 on reader's service card

How To Get A \$570 Stereo Recorder For \$400

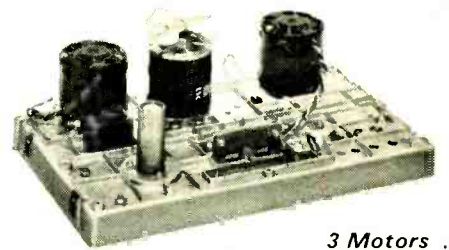

3 Motors . . .
Solenoid Operated . . .
Die-cast Main-plate, Flywheel
& Capstan Shaft Housing

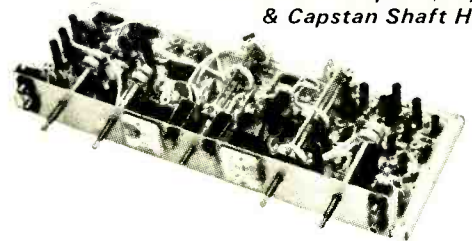

All Solid-State Electronics . . . Record
4-Track, Stereo-Mono, Sound-On-
Sound, Sound-With-Sound & Echo!

Build The New Heathkit®/Magnecord® 1020!

You Save \$170!

Thanks to Heath, you can now save \$170 on the new Magnecord 1020 4-Track Transistor Stereo Tape Recorder by building it yourself. And the only difference between this Heathkit version and the original is the \$170 you save (think of all the tape you can buy with that!).

All parts are made at the Magnecord factory . . . under a quality control system that meets the demanding requirements of the National Aeronautics & Space Administration (NASA).

Add to this Magnecord's years of pioneering and developing tape equipment for the broadcasting and recording industries, and you have a sophisticated recorder that will give you years of professional quality and reliability.

Professional Recording Facilities

With the 1020, you can record "live" from microphones, or from auxiliary sources like tuners, phonographs, TV's, etc., and playback . . . in 4-track stereo or mono at either 7½ or 3¼ ips. And you can make sound-on-sound, or sound-with-sound (mixing) recordings, or create interesting echo effects.

Professional Tape Transport

The tape transport is powered by 3 separate motors. The hysteresis synchronous capstan motor has a dynamically balanced flywheel and a ballbearing inertial stabilizer mount for constant, accurate speed. Two permanent split-capacitor type motors drive

the reels. With the convenient push-button controls, you can change operational modes instantly and gently with the touch of a button. Compliance arms insure correct tape tension at all times.

The military-type differential band brakes are solenoid operated for instant, gentle stops. And when the tape runs out an automatic switch shuts off all motors and retracts the tape pressure roller eliminating unnecessary motor wear and prevents deformation of rollers. The tape gate and pressure roller also are solenoid-operated for positive action.

3 Professional Tape Heads

Selectable ¼ track erase, record and play. Engineered and lapped to a precise hyperbolic curve for smooth low frequency response . . . made with a deep gap, deposited quartz for high frequency response and long life. Removable shields afford double protection against external magnetic fields. Protective, snap-mounted head covers provide easy access for cleaning and de-magnetizing. And for quick, accurate editing, there are center-line marks.

Other Professional Features

All parts mount on a thick, die-cast main-plate that won't warp, reduces wear, provides rigid support and stable alignment. Two V.U. meters for visual monitoring of signal levels from either tape or source . . . allows quick comparison of source with re-

corded signal. Inputs for microphones and outputs for headphones are all front-panel mounted for easy access. Digital counter with push button reset. Low impedance emitter-follower outputs deliver 500 millivolts or more to amplifier inputs. Individual gain controls for each channel. And all solid-state circuitry . . . 21 transistors and 4 diodes . . . your assurance of cool, instant operation, long reliable life.

Famous Heathkit Know-How Speeds Assembly

Simple step-by-step instructions with generous use of giant pictorials guide you every step of the way. You just wire two circuit boards and do the easy mechanical mounting for the transport components.

And to make construction even easier, the connecting wires and shielded cables are pre-cut, stripped, and marked . . . even the connectors are installed where necessary; just plug them in! The only soldering you do is on the circuit board! Total assembly time is around 25 hours . . . that's like getting \$7 an hour for your efforts.

Get today's best buy in a professional stereo tape recorder . . . order the Heathkit version of the Magnecord 1020 now!

Kit AD-16, deck & electronics, 45 lbs. . . . \$399.50
ADA-16-1, walnut base, 8 lbs. . . . \$19.95
ADA-16-2, adapter ring for cabinet or wall mounting, 2 lbs. . . . \$4.75
ADA-16-3, slides, (combine with walnut base for tape drawer), 7 lbs. . . . \$9.95

FREE!

World's Largest Kit Catalog

108 pages! Describes this and over 250 kits in stereo hi-fi, color TV, organs, ham, test, CB, marine, home and hobby. Mail coupon, or write Heath Company, Benton Harbor, Michigan 49022.

Heath Company, Dept. 20-9, Benton Harbor, Michigan 49022

Enclosed is \$ _____, plus shipping. Please send model (s) _____

Please send FREE Heathkit Catalog.

Name _____

Address _____

City _____ State _____ Zip _____

Prices and specifications subject to change without notice.

HF-194

Circle 41 on reader's service card

The following free advertising material is available through

RADIO-ELECTRONICS READER'S SERVICE

- ALLIED RADIO CORP.** (Pg. 89) **Circle 111**
Details on Knight-Kit solid-state Color Bar/Pattern Generator.
- AMPEREX ELECTRONIC CORP.** (Second Cover) **Circle 7**
List of replacement tubes.
- AMPLIFIER CORP. OF AMERICA** (Pg. 106) **Circle 127**
Booklet "Flutter" and literature on Flutter Meter
- ARROW FASTENER CO., INC.** (Pg. 80) **Circle 44**
Information on staple guns and fasteners.
- B & K MANUFACTURING CO.** (Pg. 13) **Circle 13**
Literature and technical data on the "Little Corporal" CRT tester.
- BLONDER-TONGUE** (Pg. 69) **Circle 30**
Catalog of all-channel color approved products.
- BROOKS RADIO & TV CORP.** (Pg. 98-99) **Circle 122**
Information sheets and price lists of tubes and parts.
- BROWNING LABORATORIES, INC.** (Pg. 96) **Circle 120**
Details on operating a franchised Browning CB Radio Equipment Sales and Service Center.
- CASTLE TV TUNER SERVICE, INC.** (Pg. 22) **Circle 19**
Information on complete tuner overhaul by mail.
- CLEVELAND INSTITUTE OF ELECTRONICS** (Pg. 1) **Circle 8**
Booklets describing Electronics Slide Rule and Electronic Data Guide.
- CORNELL ELECTRONICS CO.** (Pg. 110) **Circle 131**
Catalog and price list of tubes and parts.
- DELTA PRODUCTS, INC.** (Pg. 72) **Circle 35**
Literature and complete technical data on Mark Ten SCR capacitive discharge ignition system.
- DE VRY TECHNICAL INSTITUTE** (Pg. 5) **Circle 9**
Free booklets, "Pocket Guide to Real Earnings," and "Electronics in Space Travel."
- ELPA MARKETING INDUSTRIES, INC.** (Pg. 90) **Circle 113**
Information on Editabs splicing method.
- FINNEY CO.** (Pg. 71) **Circle 34**
Information on Finco 75 ohm Color Ve-Log Antenna.
- GRANTHAM SCHOOL OF ELECTRONICS** (Pg. 107) **Circle 129**
Information on FCC licence preparation.
- HALLETT MANUFACTURING CO.** (Pg. 23) **Circle 20**
Complete guide for adding noise-free miles to the reception range of CB and FM receivers through use of Hallett "Signal Savers," which shield all ignition noise.
- HALLICRAFTERS** (Pg. 26) **Circle 23**
Information on Hallicrafters CB-20 transceiver.
- HEALD'S ENGINEERING COLLEGE** (Pg. 101) **Circle 125**
Catalog and registration application.
- HEATH COMPANY** (Pg. 77, 79, 81) **Circle 41**
Catalog.
- INTERNATIONAL CRYSTAL MFG. CO., INC.** (Pg. 112) **Circle 148**
Complete Catalog of equipment.
- INTERNATIONAL RADIO EXCHANGE** (Pg. 90) **Circle 114**
Complete list of equipment in stock.
- JENSEN MANUFACTURING DIVISION** (Third cover) **Circle 149**
Information on the new X-40 ultra compact loud-speaker system.
- JERROLD ELECTRONICS CORP.** (Pg. 27) **Circle 24**
Literature on Metro Color 82 channel antennas.
- JOHNSON, E. F.** (Pg. 7) **Circle 10**
Literature on complete line of CB transceivers and accessories.
- JUDSON RESEARCH & MFG. CO** (Pg. 70) **Circle 32**
Literature on electronic ignition system.
- LAFAYETTE RADIO ELECTRONICS** (Pg. 93-94) **Circle 118**
Catalog.
- LAMPKIN LABORATORIES INC.** (Pg. 87) **Circle 108**
Booklet "How to Make Money in Mobile Maintenance" and information on Lampkin meters.
- MERCURY ELECTRONICS CORP.** (Pg. 95) **Circle 119**
Information on Model 801A CRT color tester-reactivator.
- MUSIC ASSOCIATED** (Pg. 76) **Circle 39**
Information on Music Associated sub carrier detector for "Music only" programs on FM Broadcast Band.
- NOVA-TECH** (Pg. 88) **Circle 110**
Booklet on 4-band 12-transistor portable with direction finder for airplane, airport, police, shortwave and marine broadcast bands as well as standard AM.
- OLSON ELECTRONICS, INC.** (Pg. 90) **Circle 112**
Catalog.
- PERMA-POWER CO.** (Pg. 24) **Circle 21**
Britener Selector Chart for base type of every picture tube.
- POLY PAKS INC.** (Pg. 111) **Circle 132**
Catalog on Semiconductors, Poly Paks and Parts.
- PRECISE ELECTRONICS** (Pg. 66) **Circle 27**
Information and technical data about the complete line of power instruments, scopes, VTVM's, signal generators, tube testers, decade boxes, probes.
- PYRAMID ASSOC., INC.** (Pg. 86) **Circle 107**
List of tubes.
- QUAM-NICHOLS CO.** (Pg. 78) **Circle 42**
Literature on speakers.
- QUIETROLE CO.** (Pg. 101) **Circle 124**
Literature on lubricants and cleaners for electronic applications.
- RADIO SHACK** (Pg. 102-105) **Circle 126**
Radio Shack Catalog.
- RCA INSTITUTES, INC.** (Pg. 28-31) **Circle 25**
Home Study Career Catalog.
- READING IMPROVEMENT PROGRAM** (Pg. 99) **Circle 123**
Booklet on "How to Read Faster and Retain More."
- RIDER PUBLISHING, INC., JOHN F.** (Pg. 91) **Circle 115**
Book catalog.
- RYE SOUND CORP.** (Pg. 92) **Circle 117**
Information on "Clever Kliips 30" test probe.
- S & A ELECTRONICS, INC.** (Pg. 16) **Circle 16**
Information on Target Antennas.
- SAMS & CO., INC., HOWARD W.** (Pg. 61) **Circle 29**
Booklist.
- SAMS & CO., INC., HOWARD W.** (Pg. 25) **Circle 22**
Information on Photofacts-of-the Month.
- SEMITRONICS** (Pg. 92) **Circle 116**
Information on Semitronics Transistor Tester and Set Analyzer.
- SENCORE** (Pg. 80) **Circle 45**
Literature and technical data on the CG10 "LO-BOY" standard color bar generator.
- SHURE BROS. INC.** (Pg. 17) **Circle 17**
Literature on the "Unidyne III" true cardioid unidirectional dynamic microphone.
- SONY CORP. OF AMERICA** (Pg. 67) **Circle 28**
Brochure on transistorized TA-1120 integrated amplifier and TA-3120 power amplifier.
- SPRAGUE PRODUCTS COMPANY** (Pg. 12) **Circle 12**
Catalog C-616 on Difilm Orange Drop Dipped Tubular Capacitors and Difilm Black Beauty Molded Tubular Capacitors.
- TEXAS CRYSTALS** (Pg. 80) **Circle 43**
Catalog on Controlled Quality Crystals.
- UNITED RADIO CO.** (Pg. 109) **Circle 130**
Parts Catalog.
- UNIVERSITY SOUND (DIV. OF LTV LING ALTEC, INC.)** (Pg. 88) **Circle 109**
Catalog on Progressive Speaker Expansion.
- WARREN ELECTRONIC COMPONENTS** (Pg. 106) **Circle 128**
Information on silicon rectifiers.
- WELLER ELECTRIC CORP.** (Pg. 97) **Circle 121**
Literature on dual heat soldering guns and kits.
- WINEGARD CO.** (Pg. 76) **Circle 38**
Literature on distribution amplifiers.

Here's how you can get manufacturers' literature fast:

1. Tear out the post card on the facing page. Clearly print or type your name and address.
2. Circle the number on the card that corresponds to the number appearing at the bottom of the New Products, New Literature or Equipment Report listing in which you are interested. For literature on products advertised in this issue circle the number on the card that corresponds to the number appearing at the bottom of the advertisement in which you are interested, or use the convenient checking list in the column at the left.
3. Mail the card to us (no postage required in U. S. A.)

NEW PRODUCTS

More information on new products is available free from the manufacturers of items identified by a Reader's Service number. Turn to the Reader's Service Card facing page 82 and circle the numbers of the new products on which you would like further information. Detach and mail the postage-paid card.

Hz = hertz = cycle per second; kHz = kilocycles; MHz = megacycles

WOW AND FLUTTER METER, models ME-101/102. Power: 110-125/220-240 volts, 40-60 Hz. Oscillator unit: measuring frequency 3,150 Hz (constant 1×10^3 after warm-up period); output voltage approx. 0.4Vrms at test output connector, 20mV at auxiliary calibrating output. Measuring unit: input voltage 30mV to 30 V, 3,150 Hz $\pm 5\%$; input impedance 10,000 ohms; measuring ranges, ME-101:



± 0.2 to $\pm 0.5\%$ and ± 0.1 to $\pm 2.5\%$, ME-102: ± 0.01 to $\pm 0.15\%$ and $\pm .05$ to $\pm 0.75\%$. Frequency response of tone fluctuation: linear position: 0.50 to 500 Hz (-3-dB points); weighted position according to CCIR standard with external filter as required. Drift indication max. $\pm 4.5\%$. Auxiliary output: 20 volts peak-to-peak at 22,000 ohms. 7 x 8 x 11 1/2 in., 11 lb.—Gotham Audio Corp.

Circle 46 on reader's service card

12-CHANNEL CB TRANSCEIVER, the Hallmark SS, uses prealigned plug-in circuit modules. Receiver uses germanium transistors, has crystal-controlled oscilla-



tor, linear if amplifier. 95% to 100% modulation; 3.7 watts if power output for maximum talk power. Regulated power supply available.—Hallmark Instruments

Circle 47 on reader's service card

DUAL-TRACK CAPSTAN-DRIVE MONAURAL TAPE RECORDER, Aiwa portable model TP-719. 3 speeds; holds 7-inch reels. Ac bias recording and erase system. Less than 0.25% wow and flutter at 7 1/2 ips. 5 x 3-in. PM oval speaker. 1.5



watts output. Power source: 8 D-cell batteries; 117 volts, 60 Hz; 12-volt car battery. Accessories: earphone, mike, batteries, car battery adapter, ac cord, 7-in. supply reel with tape, 7-in. takeup reel. 16 1/2 x 13 x 3 3/4 in., 16 lb, 8 oz.—Selectron International

Circle 48 on reader's service card

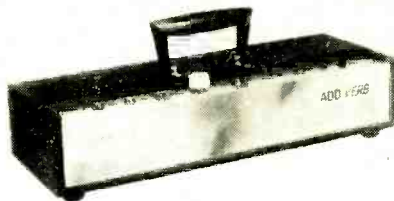

REVERBERATION ACCESSORY, the Add-Verb II, has 4-transistor circuit and a Hammond reverberation unit. Includes 1 mike input, 2 instrument inputs, mixer control, foot switch jack, input jack, pilot light, permanently connected output cable for connection to any instrument amplifier, phonograph or tape recorder. 17 x 1 1/2 x 6 in., less than 5 lb.—Gregory Amplifier Corp.

Circle 49 on reader's service card

120-WATT SOLID-STATE STEREO RECEIVER, model LR-1200T. Amplifier response ± 1 dB, 20-50,000 Hz at 1 watt. Harmonic distortion less than 1% at full output; 0.125% at 1 watt. Power bandwidth: 11 Hz to 38 kHz. Phono sensitivity: 2, 5, 12 mV; aux.: 275 mV; tape monitor: 370 mV. Hum and noise: -58 dB on phono, tape head; -78 dB auxiliary. Equalization: phono RIAA; tape head, NAB. Output impedance: 4-16 ohms. Tuner IHF FM sensitivity: 1.5 μ V. Image rejection: -70 dB. FM signal-to-noise ratio: -65 dB. FM distortion: 0.5% at 100% modulation. Capture ratio: 2.2 dB.



TV TECHNICIANS Does Your Present Job Offer These RCA Benefits?

- Working with new advanced technologies in color TV, solid-state circuitry, closed-circuit TV, sound systems and other related electronic products.
- A sales commission program that puts extra money into your pocket.
- Regular pay increases.
- Paid Hospital-Surgical and Major Medical Program for you and your family.
- Paid Life Insurance; Paid vacations and holidays.
- Liberal retirement plan.
- Company-supplied tools, vehicle and test equipment.

You owe it to yourself to investigate positions open at the RCA TV Service Branch in *your* area, or at 160 other Branches throughout the U.S.

Trainee positions also available for individuals with a basic knowledge of electron theory. No related work experience necessary.

Just fill out the coupon and mail to:

Mr. D. A. Giordano
Dept. YC-35
RCA Service Company
Building 201-1
Camden, New Jersey 08101

An Equal Opportunity Employer M & F



**The Most Trusted Name
in Electronics**

Name _____
Address _____
_____ Phone _____
Years of technical schooling: _____
Military _____ Civilian _____
Years of TV Technician Experience _____

PYRAMID YOUR PROFITS!

NEW

NEW

\$

70 + 5
OFF

Name brand tubes, individually boxed, date stamped. Unlimited 1 year guarantee assures top quality. Prices are 70 + 5 off Mar. '66 sugg. list. Qty's 50 or more. Just check off your order and send us a check.

Type	Asst'd.* 50 or More	Type	Asst'd.* 50 or More	Type	Asst'd.* 50 or More
074	.68	6BN6	.86	6SL7GT	.96
1B3 1G3GT	.79	6BN8	.90	6SN7GTB	.70
1G3GT	.79	6B05/EL84	.66	6SQ7GT	1.02
1K3	.79	6B06GA	.67	6T8A	.91
1R5	.91	6CU5	1.17	6U8A	.88
1U4	.76	6B06GTB/	1.17	6V6GT	.59
1U5	.87	6CU6	1.17	6W4GT	.66
1V2	.63	6B07A	1.07	6W6GT	.77
1X2B	.83	6BR8A	.64	6X4	.46
2AF4B	1.08	6FV8A	1.10	6X5GT	.60
2B94A	.79	6B58	1.07	6X8A	.86
2CY5	.87	6BU8	.97	7AU7	.70
3A3 3AW3	.91	6BY8	.77	8AW8A	1.00
3AU6	.63	6B26	.60	8C07	.67
3AW3	.91	6B27	1.07	8F07	.67
3C5/3CE5	.70	6C4	.50	10D67	.91
3B6	1.03	6C86A	.60	12AD6	.74
3B76	.62	6C06GA	1.57	12CA6	.50
3C6	.62	6CE5	.65	12AT6	.82
3CE5	.70	6CF6	.79	12AU6	.57
3CY5	1.07	6CG7	.67	12AU7	.68
3D6A	1.17	6C88A	.88	12B6	.46
3D76A	.67	6C8	1.08	12B6A	.46
3GK5	1.10	6CL8A	1.07	12AV5GA	1.28
3V4	.74	6CM7	.79	12AV6	.46
4BC8	1.10	6CN7	1.14	12AV7	.97
4B07	1.19	6CQ8	.94	12AX4GTB	.73
4B26	.60	6C56	.70	12AX7/ECC83	.68
5AM8	1.16	6CS7	.80	12AX7A	.68
5AN8	1.27	6CUS	.77	12AZ7A	.82
5A05	.68	6C06	1.17	12B4A	.87
5AT8	1.08	6CUB	1.25	12B6	.46
5BR8A	1.20	6CW4	1.22	12BE6	.48
5CG8	.90	6CX8	1.22	12BH7A	.83
5CL8A	1.10	6CY5	.99	12BL6	.82
5T8	1.20	6CY7	.87	12B06GTB/	1.20
5U4GB	.56	6CZ5	1.17	12CU6	.87
5UB	.88	6DA4A	.87	12BY7A	.79
5X8	1.07	6DE4	.68	12C5/12CU5	.82
5Y3GT	.46	6DE7	.76	12CA5	.79
6A84	.70	6DE7	.65	12C06	1.20
6AF3	.88	6DK6	.65	12C06B	1.13
6AF4	1.07	6DN7	.96	12D05	.88
6AF4A	1.07	6DQ5	2.24	12G6A	.74
6AG5	.82	6DQ6B	1.11	12G7GT	1.25
6AH4GT	.93	6DR7	1.17	12K7GT	1.14
6AH6	1.25	6DT6A	.59	12SN7GT	.73
6AK5	1.28	6DWA4	1.00	12SQ7GT	1.07
6AK6	.85	6EA7	1.48	12V6GT	1.07
6AL5	.50	6EA8	.86	12W6GT	1.07
6AM8A	.93	6EB8	1.25	12W6GT	1.07
6AN8A	1.07	6E17/EF184	1.02	13EM7/	1.39
6AQ5A	.57	6EM5	.91	15EA7	1.39
6AS5	.79	6EM7	1.37	16AQ3	.77
6A8	1.14	6ER5	1.02	17AX4GT	.87
6AT8A	1.14	6EVS	.82	17D4A	.87
6AU4GTA	.97	6EW6	.67	17DQ6B	1.13
6AU6A*	.56	6FG7	1.02	17I2B	1.02
6AU8A	1.25	6FHS	.90	19AU4GT	1.02
6AV6	.46	6F07	.67	19T8	1.05
6AW8A	1.00	6FV8A	1.10	22D4	.97
6AX3	.73	6GF7	1.39	25B06GTB/	1.25
6AX4GTB	.71	6GH8A	.86	25C06	1.64
6AY3A	.83	6GK5	1.10	25C06B	1.25
6B10	.96	6GM6	.79	25D6	1.70
6B6	.54	6GH8	1.17	25L6GT	.79
6B8A	1.14	6GU7	.91	35C5	.57
6BC5/6CE5	.45	6GV6	.74	35L6GT	.70
6BC8	1.07	6HS8 6KFB	1.02	35W4	.30
6BE6	.60	6J5GT	1.05	35Z5GT	.56
6BG6GA	1.74	6J6A	.76	50C5	.57
6BH6	.79	6JB6	1.67	50EHS	.63
6BH8	1.14	6JE6	2.42	50L6GT	.73
6B16	.79	6JH6	.70	ECC82	.67
6BK4A	2.16	6JUB	.96	ECC83	.68
6BK5	1.00	6K6GT	1.02	ECF80	1.02
6BK7B	1.02	6KFB	1.27	EF184	1.02
6B17GTA	1.25	6L6G	.68	EL84	.66
6B18/ECF80	1.07	654A	.68		
6BNA4	.97	65J7GT	1.11		

*Less than 50 assorted, 60% off list.
TERMS: Minimum order \$5.00 exclusive of postage. Orders for 200 or more tubes shipped prepaid.

FREE: Send for special list of private brand, fully guaranteed new tubes at special discounts up to 80% off Mar. '66 suggested list.

CHECK OR MONEY ORDER — NO C.O.D.
LIMITED TIME WITH YOUR ORDER

POPULAR NAME BRAND AC-DC KIT	3 — 35W4 3 — 50C5 2 — 12BE6 1 — 12AV6 1 — 12BA6	ONLY \$3.45
------------------------------	---	-----------------------

TOTAL 10 TUBES

PYRAMID ASSOC., INC.
16565 N.W. 15th Ave. Miami, Florida 33169

Circle 107 on reader's service card

AM suppression: 53 dB on FM. Stereo mpx separation: 40 dB at 400 Hz. FM antenna impedance: 300 ohms balanced. AM sensitivity: 15 μ V at 1,000 kHz.—Lafayette Radio Electronics

Circle 50 on reader's service card



MARINE RADIOTELEPHONE, the MRT-50. 50 watts, 12 FM channels, with automatic deviation limiting circuit to keep operator's transmission within FCC bandwidths. Transmitter cutoff switch reduces battery power requirements while permitting channel monitoring. All-angle mounting bracket on slide rail. 11 1/2 x 4 3/4 x 10 1/2 in., 20 lb. Vhf antenna less than 2 ft. tall.—Pearce-Simpson, Inc.

Circle 51 on reader's service card

PORTABLE SOLDERING TOOL, consists of Microflame gas welding torch plus new soldering-tip adapter. Torch uses self-contained miniature oxygen and

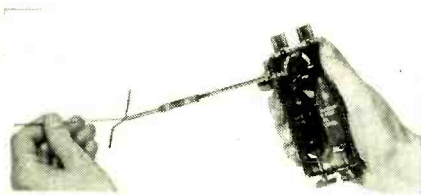

butane compressed gas cylinders to produce pin-point flame of over 5,000° F. This heats soldering tip, held in on-off adapter.—Microflame, Inc.

Circle 52 on reader's service card

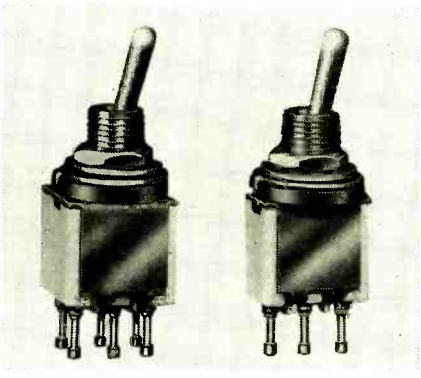

SWITCHES, E series. Waterproof, rated 6 amps at 125 Vac. Life cycle: 100,000 on-off operations (spdt). Temperature range -50°C to 150°C for 1 hour. Voltage breakdown: 1,000 Vac between terminals and case ground for one minute. Wide silver contacts bonded on silver-plated copper turret terminals. Double high-voltage barriers.—Alco Electronic Products, Inc.

Circle 53 on reader's service card

PORTABLE TV CAMERA, model HV-50, has on-off trigger in a foldaway handle (10 in. long, 3-in. diameter, 3 lb) that remotely controls operation of any



equipment associated with a camera, such as video tape recorder, video monitor, home TV receiver. Features: all silicon transistors, stabilized electric eye, accommodation for all C-mount lenses, both video and rf outputs. Not shown in photo: camera control unit, 6 x 7 x 2 3/4 in., 3 lb.—Shibaden Corp. of America

Circle 54 on reader's service card

TRANSCIEVERS: model HA-460 for 6 meters, model HA-410 for 10 meters. Dual-conversion receiver with crystal-controlled second converter. Nuvistor rf amplifier combines with SCR-controlled noise limiter. 20-watt (dc plate input) transmitter features built-in vfo, low-pass

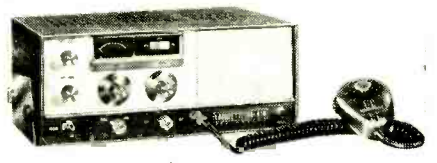

filter. Oscillator can be crystal-controlled with standard 8-MHz crystals. Built-in 117-Vac and 12-Vdc power supplies. Frequency coverage: HA-460, 50-52 MHz; HA-410, 28-29.7 MHz. Receiver sensitivity: 1 μ V for 10-dB signal-to-noise ratio. Selectivity: 35 dB at 8 kHz. 12 1/8 x 5 1/8 x 3 3/4 in., 22 lb.—Lafayette Radio Electronics Corp.

Circle 55 on reader's service card

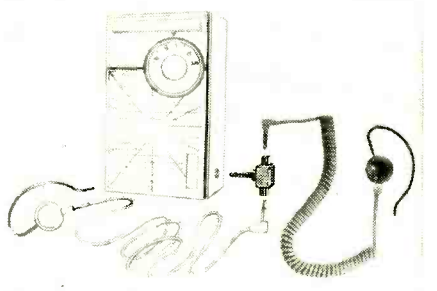

EARPHONE JACK ADAPTER, the Tini-Tee, enables two people to enjoy car-phone listening. Plugs into phone jack.—Switchcraft, Inc.

Circle 56 on reader's service card

TRANSCIEVER, the Citi-Fone II, uses car radio for second i.f. and audio, crystal-controlled; 5 watts input, 3 watts output; capable of 100% amplitude modulation; double-pi rf output circuit. Receiver: tuned rf amplifier; crystal-controlled oscillator/mixer; sensitivity 1/2 μ V for 10 dB s+n/n ratio. Use with standard broadcast set results in 8 tuned circuits. 9 silicon transistors, 2 diodes.



Power: 12 volts dc; receive, .03 amp; transmit, 1.5 amps. 4 $\frac{3}{4}$ x 1 $\frac{1}{2}$ x 5 $\frac{3}{4}$ in., 3 lb.—Multi-Elmac Co., 21470 Coolidge, Oak Park, Mich.—48237

Circle 57 on reader's service card

TEST-LEAD TERMINALS, *Tes-Con-Ects*, for fast makeup of test leads with terminations needed to match any equipment under test. Terminals snap on

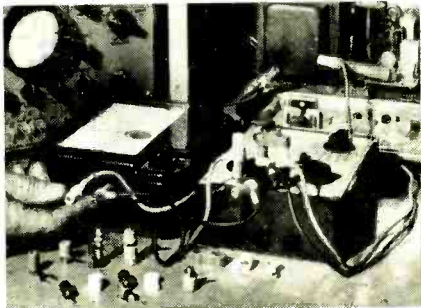

and off instantly. Types include alligator clips, spade tongue, phono and banana jacks, etc. Available with color coding.—Waldom Electronics, Inc.

Circle 58 on reader's service card

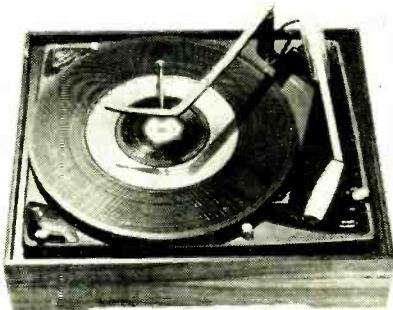

AUTOMATIC TURNTABLE, the *Crown Princess*, model RCD-6, 4-speed automatic/manual stereo with low-mass tone arm, full range of stylus pressure settings. Built-in stylus brush, automatic locking tone arm, 11-in. turntable with anti-static rubber mat, 4-pole dynamically balanced motor. Two audio cables and line cord.—RFS Industries, Inc.

Circle 59 on reader's service card

VIDEO TAPE RECORDER, model VX-1100, uses cross-field bias-head longitudinal modulation system. Records at 30 ips on $\frac{1}{2}$ -inch audio magnetic tape, 7- or 10 $\frac{1}{2}$ -in. reel; 100 minutes on 10 $\frac{1}{2}$ -in. reel of 7,200 feet. Video band-width: 60 Hz to 1 MHz \pm 6 dB. Signal-to-noise ratio more than 34 dB. TV signal: input and output 1.4 Vpp sync-negative 75 ohms. Audio (direct recording system) bandwidth: 50 Hz to 10 kHz. Signal-to-noise ratio more than 40 dB. Input and impedances: 600 ohms, 0 dB; 20K, -50 dB.



Output: 600 ohms, 0 dB. Power: 100, 110, 120, 200, 220, 240 volts switchable by variable transformer. 17 $\frac{3}{4}$ x 16 $\frac{3}{4}$ x 10 $\frac{1}{4}$ in., 45 lb.—Akai Electric Co., US agent Califone/Roberts Electronics

Circle 60 on reader's service card

VIDEO TAPE RECORDER, the VTR-600, uses helical-scan recording system with dual rotating heads; $\frac{1}{2}$ -in. tape at 12 ips, 7-in. reel. Recording time: 40 min. for 2,400 ft. Resolution better than 250

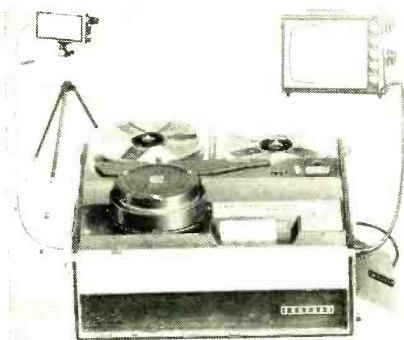

lines. Power: 80 watts. 10 x 17 x 16 $\frac{1}{2}$ in., 52 lb. VTR-600 augmented by camera MTC-12 and TV monitor MR-600.—Concord Electronics Corp.

Circle 61 on reader's service card



STEREO HEADPHONES, model PH-98, feature air-filled headband for long periods of use. Ear cups padded with foam rubber which contains an air pocket. Impedance: 8 ohms. Response: 40-12,000 Hz.—Olson Electronics, Inc.

Circle 62 on reader's service card

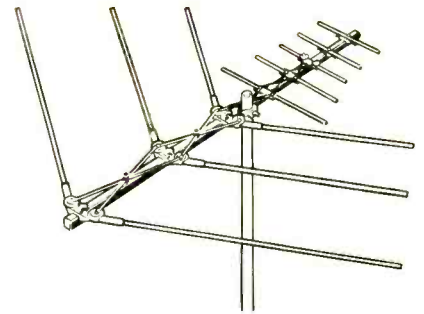

VHF/UHF/FM LOG PERIODIC ANTENNA, the LPV-VU5, for urban use. 45-in long, response flat within \pm $\frac{1}{2}$ dB on any channel. Sharp forward lobe in polar pattern for unidirectional pickup and high

Earn Extra Income
in **MOBILE-RADIO**
MAINTENANCE!



CITIZENS BAND
AIRCRAFT . . . MARINE
. . . PUBLIC SAFETY . . .
BUSINESS AND INDUSTRIAL
RADIO

961,000 new transmitters added
last year, with the curve still
going upward!

MEASURE FREQUENCY with the LAMPKIN 105-B

- Just this ONE instrument . . . with no extra crystals or factory adjustments . . . will measure ALL channels from 100 KC to 175 MC. Only \$295.00.
- Ample accuracy for all mobile transmitters except for split-channels above 50 MC—for these use inexpensive accessory PPM Meter.
- Pin-point signal generator for receiver final alignment.
- Internal quartz crystal standard . . . correctable to WWV.

MEASURE FM DEVIATION with the LAMPKIN 205-A

- Just this ONE meter measures all mobile channels, 25 MC to 500 MC.
- Reads instantaneous true peak swing due to FM modulation.
- Set selective-calling tone signals using 0-1.25 KC or 0-2.5 KC ranges of 205-A Quad Scale, \$340.00. Dual Scale model, 12.5 KC and 25 KC ranges, only \$290.00.
- Oscilloscope jack for true wave form.
- 3-inch meter indicates directly in peak KC.



105-B

205-A

FREE BOOKLET!
Send for "HOW TO MAKE
MONEY IN MOBILE-RADIO
MAINTENANCE".

MAIL COUPON TODAY!

At no obligation to me, please send free booklet and information on Lampkin meters.

Name _____

Address _____

City _____ State _____ Zip _____

LAMPKIN LABORATORIES, INC.
Dept. 26, Bradenton, Fla. 33505

Circle 108 on reader's service card

Plan and build your speaker system of tomorrow today!

The P.S.E. Way

University's PSE — Planned Speaker Expansion is a master blueprint for better stereo speaker systems. See your University Dealer today, or write for your FREE PSE Technigrams.



UNIVERSITY SOUND
A DIVISION OF LTV LING ALTEC, INC.

Dept. 1-69 P.O. Box 1056, Oklahoma City, Okla.

Name _____

Address _____

City _____

State _____ Zip _____

Circle 109 on reader's service card



RADIO AND FINDER: With this 4-band, 12-transistor portable, you can pick up standard broadcasts, planes in flight, airport towers, police calls, short wave and the complete marine band. Its rotating antenna and null meter also combine to make it an accurate radio direction finder for your boat. The 2-lb., 8" x 5" x 2" unit can operate 4 ways—from internal batteries, external dry cell, house current or sun power from a solar cell bank. Write for FREE booklet: *Nova-Tech*, Dept 49, Manhattan Beach, California.

Circle 110 on reader's service card

front-to-back ratio on all channels. Indoor splitter included. Gold-coated aluminum. —JFD Electronics Corp.

Circle 63 on reader's service card

WIDE-ANGLE PACING/TALK-BACK SPEAKER, the *APC-30T*. Built-in transformer and screwdriver-adjustable watts/impedance switch. Power up to 30

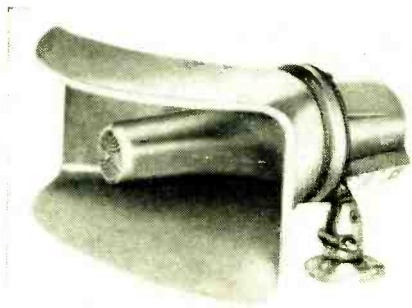

watts continuous. Power, equalized to frequencies above horn cutoff, 40 watts. Response 250–14,000 Hz. Sound level 123 dB measured 4-ft on axis at 30 watts input. Dispersion, 120° x 60°. 6 x 14 x 12½ in., 6 lb.—Atlas Sound

Circle 64 on reader's service card



SOLID-STATE PORTABLE TAPE RECORDER, the *RK-142T*, more than 4 hours recording on long-play ½-mil 2,400-ft tape reel at 3¾ ips. Positive-acting lever-type record/playback motor control. 4 x 6-in. permanent-magnet speaker. Heads: ½-track lamination type record/play, ½-track double-gapped high efficiency erase. 7.5 and 3.75 ips speeds. Signal/noise ratio —40 dB or better at 7.5. Record playback response essentially flat with tone at max treble. Wow and flutter less than 0.25% rms at 7.5, less than 0.35% at 3.75. Power output ±2 watts. Power supply 117 volts, 60 Hz ac. 11¾ x 6½ x 10¼ in., 16 lb.—Lafayette Radio Electronics Corp.

Circle 65 on reader's service card

2-WAY FM RADIO, the *Motrac*, for uhf-band operation with up to 70 watts output power. Receiver sensitivity: 0.3 mV for 20 dB of quieting, with —65-dB intermodulation protection. Frequency stability ±5 parts per million with standard channel elements. Interchangeable plug-in channel-element option gives stability of ±2 parts per million. 5 watts audio output

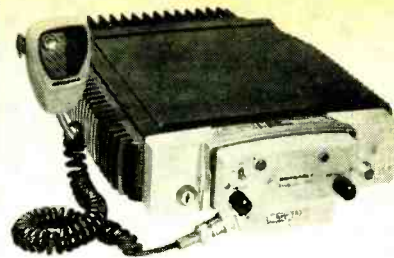

with less than 5% distortion.—Motorola Communications Div.

Circle 66 on reader's service card

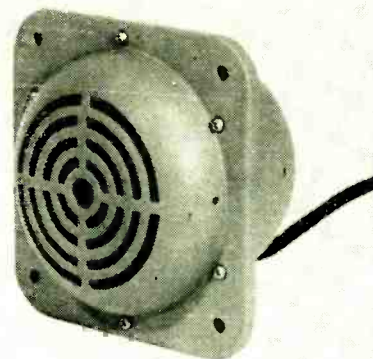

UNDERWATER LOUDSPEAKER, *UL-3*, provides music while you swim. Dynamic range: 50–20,000 Hz. Operational to depth of 16½ feet, temperature range 14° to 140°F.—Pioneer Electronics U.S.A. Corp.

Circle 67 on reader's service card



PUSH-TO-TALK MICROPHONES, No. *M-2* (250 ohms) and No. *M-3* (45,000 ohms). Sensitivity 1.2 mV/microbar; response 80–12,000 Hz. Microphone switch has positive lock action to hold circuit closed. High-impact rubber case. 2-in. dia.—Audio Div. American Gelsco Electronics, Inc.

Circle 68 on reader's service card

SAVE MONEY ON PRINTED CIRCUIT BOARDS

Be up-to-date with PC boards, which are much simpler and neater looking than the old, bulky handwired construction. Illuminating advice on where to buy surplus PC boards for next-to-nothing prices and how you can adapt them for your own projects.

October issue of **RADIO-ELECTRONICS**
Also see the special section on Industrial Electronics in the October issue.

NEW
FROM
ALLIED

knight-kit® PORTABLE SOLID-STATE COLOR BAR/PATTERN GENERATOR

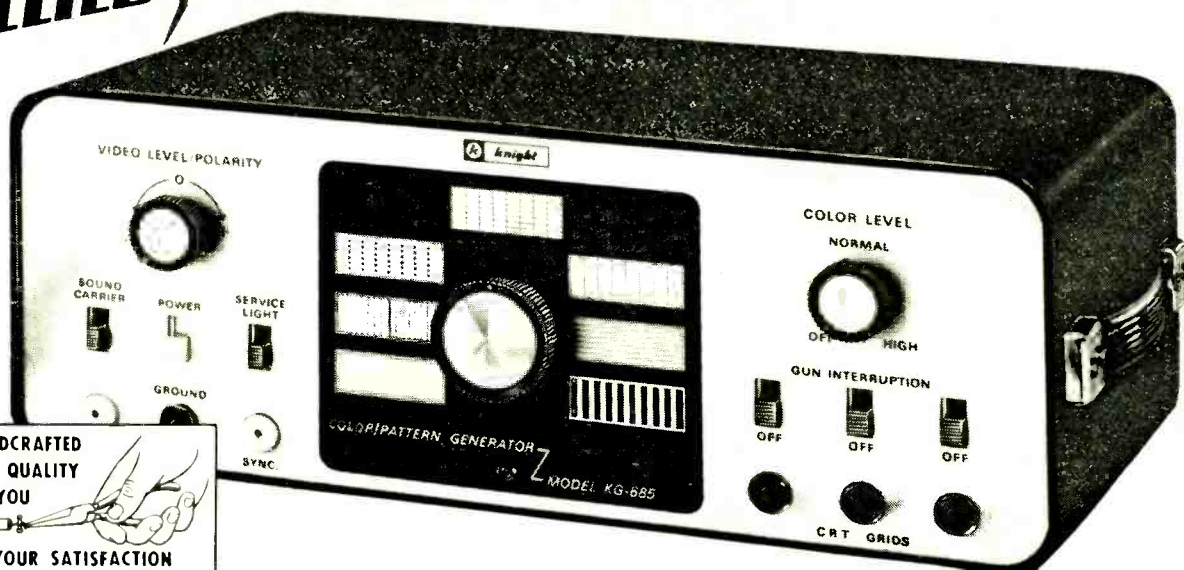

**HANDCRAFTED
FOR QUALITY
BY YOU**

**— YOUR SATISFACTION
GUARANTEED BY ALLIED**

GIVES YOU 7 ACCURATE, STABLE, CRYSTAL-CONTROLLED PATTERNS
for speedier, easier, more accurate convergence and color adjustments



Purity Adjustment



Ten Color Bars



Small Dot Pattern



Exclusive 6-Position Gray Scale



Horizontal Lines



Vertical Lines

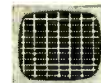

Crosshatch Pattern

You get the most for your money—outstanding performance, rock-like stability, plus day-in, day-out solid-state reliability with this great new Knight-Kit Color Bar/Pattern Generator. It's the perfect choice for both on-the-bench and in-the-home color TV servicing.

Generates 7 patterns—all displays needed for complete color set adjustments. Special 2-volt output for Zenith color sets. Every display is well-defined with extremely low background noise. Pattern for purity adjustments does not require usual tube removal or other quieting "tricks." Unique gray scale pattern provides 6 discreet levels of brightness for gun tracking adjustments. Horizontal display elements are only one raster line thick for ultimate definition. Crystal-controlled patterns eliminate any need for synchronization with TV set. Lead-piercing clips on gun interrupters allow fast, safe connection to receiver under test. Solid-state design provides instant operation.

Shaded light source on 3-ft. cable has handy clip mount for service adjustments in darkened room. Highly polished service mirror conveniently stores under bottom of case. Special power transformer with extremely low external field eliminates magnetic effects on color CRT. Rugged steel case measures 4 5/8 x 9 5/8 x 12". All parts, cables, instructions and 32-page \$89.95 operator's manual for just

COMPLETE KIT \$ 89⁹⁵
Including 32-page
Operator's Manual

Read this unique money-back guarantee...
exclusive in the industry:

KNIGHT-KIT GUARANTEE

Build a Knight-Kit in accordance with our easy-to-follow instructions. When you have completely assembled the kit, you must be satisfied or we will return your money, less transportation charges, under the Allied guarantee of satisfaction.

ALLIED RADIO

MODEL KG-685 SPECIFICATIONS

7 Displays: purity, tracking, dots, crosshatch, vertical lines, horizontal lines, and color bars. *RF Output:* 10,000 microvolts minimum, tunable to channels 3, 4 or 5. *Composite Video Output:* ± 2 volts peak-to-peak. *Composite Sync Output:* -2 volts. *Master Oscillator:* 189 kc, crystal controlled. *Color Oscillator:* 3.56 mc, crystal controlled. *Sound Subcarrier Oscillator:* 4.5 mc, crystal controlled. *Front-Panel Controls and Jacks:* Display Selector Switch, Sound Carrier On/Off Switch, Power On/Off Switch, Service Light On/Off Switch, Gun Interruption On/Off Switches (3—red, blue and green); Color Level Control (off through high, continuously variable); Video Level/Polarity (continuously variable level and choice of polarity); 6 Pin Jacks (3 signal output and 3 CRT grids). *Rear Panel:* Channel Tuning; Vertical Intensity (screwdriver adj.); Timing (5 screwdriver adj.); 6-circuit Test Jack. *Cables:* RF Output, 4-ft. long with alligator clips; Gun Interrupter, 4-ft. with lead-piercing, color-coded, alligator clips and ground lead; Service Light, 3-ft. with insulated mtg. clip, hi-intensity lamp and shade; Composite Video and Sync, 4-ft. with alligator clips and ground. *Power Requirements:* 110-130 v., 60 cycle AC. *Fuse:* Internal, 1/4 amp quick blow. *Power Consumption:* approx. 10 watts.

Rush the coupon below for full details and
Special Introductory Offer on the KG-685

Allied Radio, Knight-Kit Div., Dept. 2-JJ
P.O. Box 4398, Chicago, Ill. 60680

Please rush full details and Introductory Offer on the new
Knight-Kit Color Bar/Pattern Generator.

Name: _____ PLEASE PRINT
Address: _____
City: _____ State: _____ Zip: _____

Circle 111 on reader's service card

Olson

FREE

Fill in coupon for a FREE One Year Subscription to OLSON ELECTRONICS' Fantastic Value Packed Catalog—Unheard of LOW, LOW PRICES on Brand Name Speakers, Changers, Tubes, Tools, Stereo Amps, Tuners, CB, Hi-Fi's, and thousands of other Electronic Values. Credit plan available.

NAME _____
 ADDRESS _____
 CITY _____ ZONE _____ STATE _____

If you have a friend interested in electronics send his name and address for a FREE subscription also.

OLSON ELECTRONICS, INC.

503 S. Forge Street Akron, Ohio 44308

Circle 112 on reader's service card

MEND, SPLICE, SAVE Your Hi-Fi tapes with EDItabs

The MEND+AID* Splicing Method that works like a "Band-Aid"

GET A QUICK DEMONSTRATION
AT YOUR HI-FI DEALER'S.
PACKAGE OF 50—ONLY \$1.50

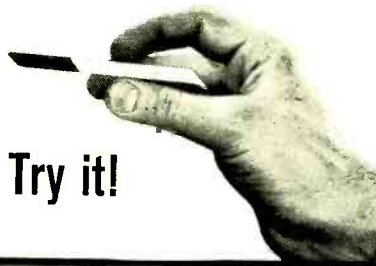

Try it!



*A mark of Elpa Marketing Industries, Inc.

Circle 113 on reader's service card

ATTENTION! CB OPERATORS

save on citizens radio equipment

Discontinued Models From International Radio Exchange

Select that extra transceiver for mobile or base installation, or equip a new station. Our stock includes International types as well as other makes.

Write Today for A
Complete List of
Equipment in Stock



RADIO EXCHANGE
18 NO. LEE, OKLA. CITY, OKLA. 73102
Division Of International Crystal Mfg. Co.
Dealing In Used Citizens
Radio Equipment



90

Circle 114 on reader's service card

NEW LITERATURE

All booklets, catalogs, charts, data sheets and other literature listed here are free for the asking with a Reader's Service number. Turn to the Reader's Service Card facing page 82 and circle the numbers of items you want. Then detach and mail the card. No postage required!

MATV SYSTEM BROCHURE, "Don't Get Caught in the TV Traffic Jam," describes system components which give any MATV system full 82-channel uht/vhf/FM capability. Architects' and engineers' specifications.—Blonder-Tongue

Circle 69 on reader's service card

SOUND COLUMN TECHNICAL & INSTALLATION MANUAL, describes, with diagrams, methods of installation and arrangement of sound-column speakers in public-address systems.—American Gelo Electronics Inc.

Circle 70 on reader's service card

COLOR TV ELECTROLYTIC CROSS REFERENCE, Form CTVX-651, lists every color TV manufacturer's electrolytic part number and corresponding Aerovox exact replacement or equivalent. 14 pages, pocket size.—Aerovox Corp.

Circle 71 on reader's service card

PROFESSIONAL SERIES LOUDSPEAKERS CATALOG, No. 1070-E, 24 pages, photos, specs of line of speakers in applications from low power to superpower; hi-fi to maximum efficiency types.—Jensen Mfg. Div./Muter Co.

Circle 72 on reader's service card

TRANSISTOR RADIOS FLYER, Standard brand, including what is described as world's smallest radio (2 x 1 1/2 x 13/16 in.). Illustrated.—Mini-tronics

Circle 73 on reader's service card

COIL CROSS-REFERENCE CATALOG, No. 103, 42 pages, looseleaf-punched, exact replacements for all manufacturers' TV and radio coil and transformer part numbers, available at most electronics distributors.—Workman Electronics Products, Inc.

Circle 74 on reader's service card

POLYESTER TAPE BROCHURE, 4 loose-leaf punched pages, contains property tables on 10 Scotch polyester tapes, plus info on two capacitor-taping machines designed to use polyester tape.—3M Co.

Circle 75 on reader's service card

PERSONAL RADIO PAGING SYSTEM BROCHURE, No. 90-57, 14-page illustrated fold-out explains how personal paging differs from public-address paging; gives many applications.—Motorola Communications & Electronics, Inc.

Circle 76 on reader's service card

WIRELESS MICROPHONE, the Vega-Mike, brochure, data sheet and accessory information on one-piece microphone/transmitter and companion FM receiver.—Vega Electronics Corp.

Circle 77 on reader's service card

COMPACTRONS FOR COLOR TV, Bulletin ETD-4359, 12 pages with attached chain for hanging, is guide to selection of multifunctional compactrons for color and b-w TV. Charts, specs, diagrams, special features of compactrons.—General Electric Co.

Circle 78 on reader's service card

RADIO-ELECTRONICS

Fix Your Burned-Out Ohmmeter Ranges

By **WAYNE LEMONS**

DO YOU HAVE AN OHMMETER THAT READS the same on the $R \times 1$ scale as it's supposed to on the $R \times 100$ or $R \times 1,000$ scale? This trouble is usually caused by putting the ohmmeter leads on a circuit carrying several volts. What happens is more apparent if you check a typical circuit as shown in the diagram. (Perhaps you have hesitated to dig into it because the circuitry shown in the instruction booklet is in a form all its own.)

Note that meter ranges are changed by switching shunts across the test leads. These shunts bypass part of the current so that the meter becomes less sensitive. The meter will then read lower resistances more accurately, and on an expanded scale on the low-ohms ranges.

These shunts are always comparatively low resistances. When you attempt to read a rather large voltage with the vom switched to the ohms position, a heavy current passes through the shunt and often burns it out. When this happens, the effect is the same as if you had switched to a higher ohms range. Whatever range the shunt opens on will automatically take on the sensitivity of the highest ohms scale on the meter, and you will be misled about the value of resistance you're measuring if you don't realize the shunt is open.

How to find the trouble

When you remove the back of almost any vom and see all the multiplier and shunt resistors you may at first despair of ever finding the one you're looking for. Don't give up—it isn't difficult. What you are looking for is usually just one open resistor. Since it is a shunt resistor it will be a low value, usually less than 100 ohms and maybe below 10. Fortunately, most vom manufacturers label the resistors with their values. All you need do is ferret out all the low-value resistors and check them with another ohmmeter—right in the circuit!

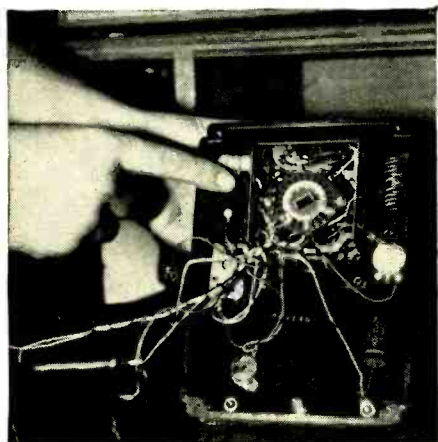

Somewhere in this mess is a burned-out resistor. Now you can find out which one!

Don't worry if you're not sure just which resistor you are looking for, check them all. You should be able to do that in 2 minutes or so. When you find the open one, you've found the trouble. It's usually best to switch the vom you're testing to a dc volts scale so you can't get any false shunt readings.

In some meters the shunts may be bobbin-wound and not marked. If so, and you can't determine the value of the resistor from the schematic or otherwise, find the open one with an ohmmeter. Then take a small carbon or wirewound potentiometer or a rheostat of about 50 ohms and connect it in the circuit in place of the open resistor. Set the range

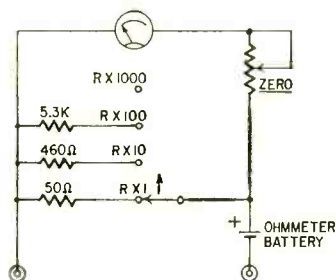

Simplified typical ohmmeter circuit. The shunt values here don't belong to any particular meter—they're just representative.

switch on the vom to the defective scale and, with the test leads, measure a resistor of known value (a 1% resistor in another meter, for example). Adjust the pot until the meter pointer of the defective vom reads the correct value.

If there's room, you can just leave the pot in the circuit; if not, measure its value and replace it with an equivalent fixed resistor.

Using standard resistors

The ohmmeter resistors won't often be standard values, but with a little ingenuity you won't have to order one from the factory.

Let's suppose the correct value is 9.3 ohms. You won't have much trouble finding in a group of four or five a 10-ohm carbon resistor that will measure very close to the correct value. Sometimes you might use a slightly larger resistor, say 12 ohms, and shunt it with larger resistors (around 100 ohms) until you get the calibration close enough for practical purposes. I've never failed to find a standard resistor or network of them that will hold the calibration as good as or better than that of a factory-wound unit.

Next time your lower ohms scales get too sensitive, dive into your vom and check the low-value resistors—you'll save yourself time and money—and feel like an expert in the bargain. **END**

Radio Books From Hayden

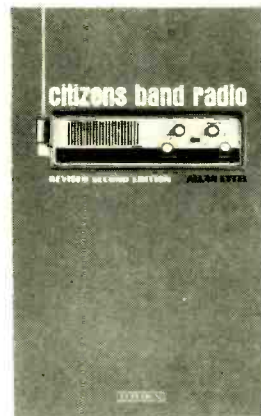

a newly revised edition of CITIZENS BAND RADIO

by Allan Lytel

featuring a special section on single side-band operation. Especially useful for judging and comparing different types of CB equipment, the book analyzes typical CB models and covers CB history, FCC regulations, installation and repair. #5737, \$3.95

also available:

Getting Started In Amateur Radio

by Julius and Jack Berens

Two experts show how to become a "ham." This revised edition gives basic electronic theory, FCC regulations, Morse Code. #0708, \$2.95

Space Communications

by Stanley Leinwoll

Fully explains "space listening" — how the "ham" can monitor satellite-earth communications. Includes principles and applications. #0384, \$3.95

Radio Operator's License Q & A Manual

by Milton Kaufman

Supplement No. 3, newly released, brings this famous study guide up to date to prepare you for the FCC Examinations in use now. #0130 (standard text), \$7.10; #0731 (Supplement No. 3), \$2.60

Dept. RE-9 Hayden Book Co., Inc.
116 W. 14 St., N.Y., N.Y. 10011

Please send me: 5737, 0708, 0384, 0130, 0731 for a free examination. After ten days I will remit payment plus postage or return the books. Check here if payment enclosed. Publisher pays postage with same return guarantee.)

Name _____

Address _____

City _____ State _____ Zip _____

Check here for free copy of our latest catalog.

Circle 115 on reader's service card

FROM THE LEADERS IN SEMICONDUCTOR REPLACEMENTS

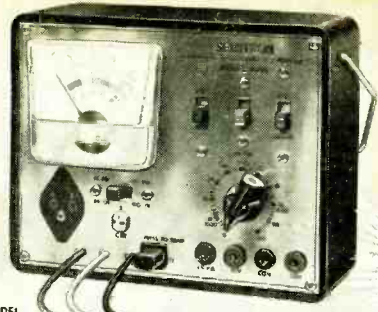

NEW!
from
Semitron

ONLY
\$34⁹⁵

Factory wired
and tested

TRANSISTOR TESTER and SET ANALYZER

You don't need a bench full of instruments to test transistor radios! All the equipment needed to check the transistors themselves — and the radios or other circuits — have been engineered into this compact analyzer. It's the transistor radio troubleshooter with all the features found only in more expensive units. Find defective transistors and circuit troubles, speedily, with this single, streamlined instrument.

It's actually 8 Analyzers in 1 Unit!

• Transistor tester • diode tester • voltmeter • ammeter • signal generator • in-circuit tester • battery tester • A.C. and D.C. beta tester.

Checks germanium and silicon transistors, power transistors, RF, IF and audio transistors, p-n-p and n-p-n types, diodes.

Use the new Semitron Model 1000 to check all transistor types — high or low power. Check DC current gain to 400. Check leakage. Universal test socket for various bases. Identifies unknown transistors as npn or pnp. Dynamic test for all transistors, in or out of circuit. Supplies test signal for AF, RF or IF circuits. Signal traces all circuits. Measures supply voltages on 20-volt scale. Measures circuit current drain to 100 ma. Supplied with three external leads for in-circuit testing. Comes complete with free instruction manual and transistor listing.

See your distributor or write to:

Semitronics Corp., 265 Canal Street, New York, N. Y. 10013

Circle 116 on reader's service card

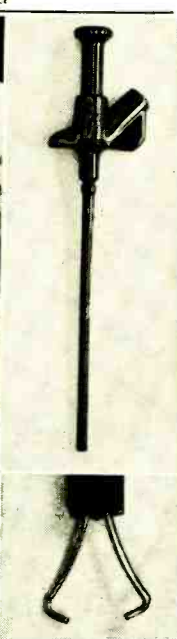
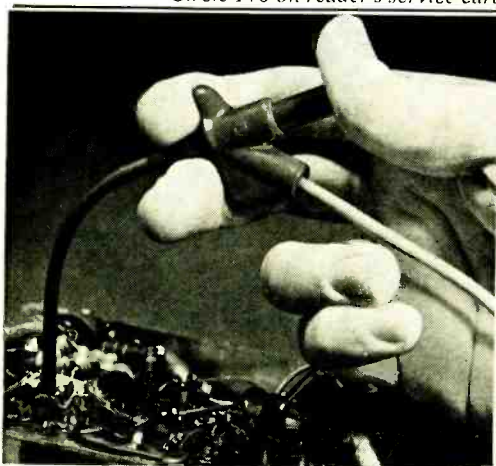

Clever Kleps 30

Push the plunger. A spring-steel forked tongue spreads out. Like this  Hang it onto a wire or terminal, let go the plunger, and Kleps 30 holds tight. Bend it, pull it, let it carry dc, sine waves, pulses to 5,000 volts peak. Not a chance of a short. The other end takes a banana plug or a bare wire test lead. Slip on a bit of shield braid to make a shielded probe. What more could you want in a test probe?

\$1⁴⁷



Available through your local distributor, or write to:

RYE INDUSTRIES INC.

123 Spencer Place, Mamaroneck, N.Y. 10543

Circle 117 on reader's service card

CB Troubleshooter's Casebook

Compiled by
Andrew J. Mueller

Case 1: Receiver oscillator drifts; sometimes cuts off altogether.

Common to: E.C.I. Fleet Courier

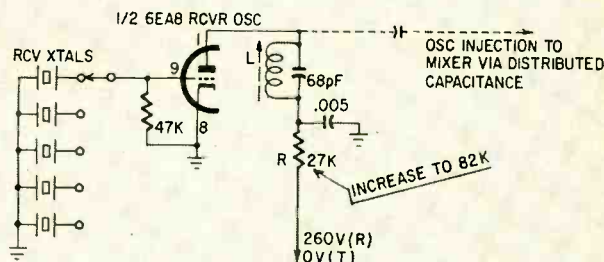

Remedy: Try new 6EA8 and receiver crystal. Realign coil L. If that fails, increase R to 82K.

Reasoning: In some of these units, there is too much plate voltage on the local oscillator. The grid bias is not enough to keep the stage in class-C operation and the stage becomes unstable. Increasing R reduces plate voltage and keeps oscillator well within class C instead of near the edge.

Case 2: Intermittent receive, transmit, or both.

Common to: Johnson Messenger I and II

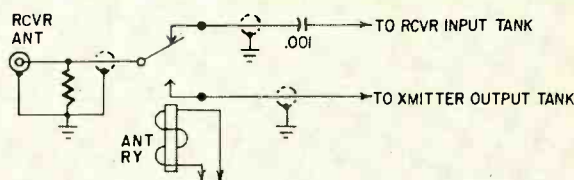

Remedy: Check plastic cap on antenna change over relay. Clean with paper or burnishing tool.

Reasoning: In late production runs, the plastic cap on the relay sometimes causes the contacts to stick. In older models, the relay contacts get dirty and need frequent cleaning.

Case 3: Does not transmit; receives OK. Clicks when the mike button is pushed.

Common to: Pearce-Simpson Companion II

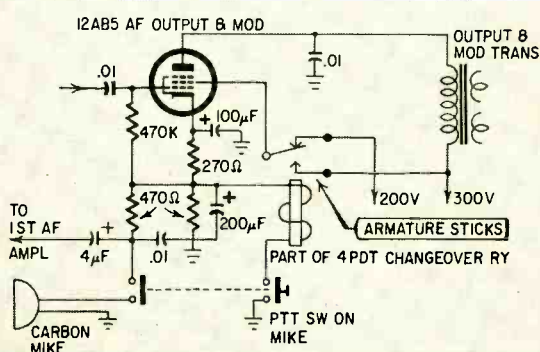

Remedy: Replace the TR (change over) relay.

Reasoning: These encapsulated relays sometimes jam or "hang up," and the unit will not switch to transmit. Since they are sealed, relay replacement is the easiest solution and almost always preferable.

continued on page 95

FREE!

LAFAYETTE

1967 Catalog 670



Now BETTER THAN EVER

Over 500 Pages

Featuring Everything in Electronics for

- HOME
 - INDUSTRY
 - LABORATORY
- from the

"World's Hi-Fi & Electronics Center"

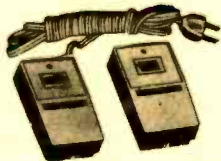

New! Wireless Remote Control for Lamps, TV, Hi-Fi, Appliances



New! 100,000 ohms/volt Lab Tester



New! Police-Aircraft FM Receiver—Model HA-520



New! Complete Line of Lafayette Mikes for Recording, PA

Use Lafayette's Easy-Pay Budget Plan No Money Down... Up to 24 Months to Pay

Satisfaction Guaranteed or Money Refunded

LAFAYETTE Radio ELECTRONICS
Dept. JI-6 P.O. Box 10
Syosset, L.I., N.Y. 11791
Send me the Free 1967 Lafayette Catalog 670

Name _____
Address _____
City _____ State _____
Zip _____
(Please Give Your Zip Code No.)

STORE LOCATIONS

NEW YORK

Bronx
Brooklyn
Jamaica
Manhattan
Scarsdale
Syosset

NEW JERSEY

Newark
Paramus
Plainfield

MASSACHUSETTS

Saugus
Boston
Natick

WASHINGTON, D.C. (Area)

Falls Church, Va.
Mt. Rainier, Md.

PENNSYLVANIA

Pittsburgh

CONNECTICUT

Hamden
W. Hartford

Mail the Coupon
Today for Your
FREE 1967
Lafayette
Catalog 670

Mail This Card Today for Your Friend's

FREE!

1967 Lafayette Catalog 670



Friend's
Name

Address

City

State

Zip

(Please Give His Zip Code No.)

Dept. JI-6

Live Better Electronically With

LAFAYETTE RADIO ELECTRONICS

Mail The Card Today for Your

FREE!

1967 Catalog 670

Shop At The
"World's Hi-Fi &
Electronics Center"
For Widest Selection,
Low Prices

Stereo Hi-Fi • Citizens Band •
Ham Gear • Tape Recorders
• Test Equipment • TV and Radio
Tubes and Parts • Cameras •
Auto Accessories • Musical In-
struments • Tools • Books

Everything In Electronics for Home • Industry • Laboratory

Exclusively Yours at Lafayette

A Complete Assortment
of Musical Instruments



25-Channel, Solid-
State C.B. Transceiver
with Business Band,
Model HB-600



New! Criterion Hi-Fi
Bookshelf Speakers

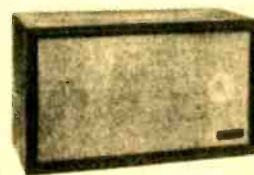

No Money Down • Up to 24 Months to Pay

New! 65-Watt AM-FM
Solid-State Stereo Re-
ceiver, Model LR-900T



New! 2-Channel 6-Trans-
istor Walkie - Talkie
Model HA-62

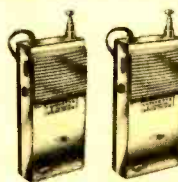

New! All Solid - State
Tape Recorders and
Decks—Model RK-830



Satisfaction Guaranteed or Money Refunded

Lafayette
Mobil-Ade™
12-Channel Solid-State
CB Transceiver,
Model HB-555



50-Watt Solid-State
Stereo Amplifier, Model
LA-248



New! Complete Line of
Lafayette TV Antennas

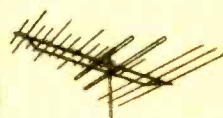

Do A Friend A Favor...

Have a friend interested in hi-fi or electronics? Send us his name and address and we will send him his own personal copy of the 1967 Lafayette Catalog 670.

FREE

MAIL THE CARD TODAY!

LAFAYETTE RADIO ELECTRONICS
P.O. BOX 10
SYOSSET, L.I., N.Y. 11791

PLACE
STAMP
HERE

Sales-wise, profit-wise and otherwise, you'll do very well with Browning CB radio equipment.

Many territories available for Franchised Browning Sales and Service Centers. Sell the nationally advertised Eagle CB base station and Raven mobile unit in your exclusive territory. Complete sales aids and technical assistance furnished. Get all the facts now and cash in on the top selling Browning CB line.

Browning Laboratories, Inc.
Department E2
1269 Union Avenue, Laconia, New Hampshire

Please send me information on Franchised Browning Sales and Service Centers.

NAME _____
ADDRESS _____ ZIP CODE _____
CITY _____ STATE _____



MAIL THIS COUPON TODAY!

browning
LABORATORIES, INC.

1269 Union Avenue, Laconia, New Hampshire 03246

Circle 120 on reader's service card

Designed and manufactured in U.S.A.

**NEVER
A BURNOUT**
IN 6 EMC DIODE-PROTECTED VOMS

NOBODY ELSE BUT EMC DESIGNS IN SO MUCH VALUE!
Professional quality and versatility • Lifetime protection against electrical abuse • No meter burn-out, needle damage, or fuse replacement

VOLOMETER

Model 109A Factory Wired & Tested \$28.95
Model 109AK Easy-to-Assemble Kit \$21.15
20,000 Ω/v DC sens. 10,000 Ω/v AC sens. $4\frac{1}{2}''$, 40 μ a meter. High impact bakelite case. 5 DC voltage ranges: 0-6-60-300-600-3000v. 5 AC voltage ranges: 0-12-120-600-1200-3000v. 3 DC current ranges: 0-6-60-600ma. 3 AC current ranges: 0-30-300ma; 0-3A. 3 resistance ranges: 0-20K, -200K, -20 megs. 5 db ranges: -4 to +67db. With carrying strap. $5\frac{1}{4}''$ W x $6\frac{3}{4}''$ H x $2\frac{7}{8}''$ D.

VOLOMETER

Model 103A Factory Wired & Tested \$20.75
Model 103AK Easy-to-Assemble Kit \$16.80
 $4\frac{1}{2}''$, 2% accurate, 800 μ a D'Arsonval type meter. One zero adjustment for both resistance ranges. High impact bakelite case. 5 AC voltage ranges: 0-12-120-600-1200-3000v. 5 DC voltage ranges: 0-6-60-300-600-3000v. 5 db ranges: -4 to +64db. 5 AC current ranges: 0-30-150-600ma. 4 DC current ranges: 0-6-30-120ma; 0-1.2A. 2 resistance ranges: 0-1K, 0-1 meg. $5\frac{1}{4}''$ W x $6\frac{3}{4}''$ H x $2\frac{7}{8}''$ D.

POCKET SIZE VOLOMETER

Model 102A
Factory Wired & Tested \$16.95
Model 102AK Easy-to-Assemble Kit \$14.40
 $3\frac{1}{2}''$, 2% accurate 800 μ a D'Arsonval type meter. One zero adj. for both res. ranges. High impact bakelite case. 5 AC voltage ranges: 0-12-120-600-1200-3000v. 5 DC voltage ranges: 0-6-60-300-600-3000v. 3 AC current ranges: 0-30-150-600ma. 4 DC current ranges: 0-6-30-130ma; 0-1.2A. Resistance: 0-1K, 0-1 meg. $3\frac{3}{4}''$ W x $6\frac{1}{4}''$ H x $2''$ D.



EMC, 625 Broadway, New York 12, N.Y.

Send me FREE catalog of the complete value-packed EMC line, and name of local distributor.

NAME _____ RE-9

ADDRESS _____

CITY _____ ZONE _____ STATE _____

EMC

ELECTRONIC MEASUREMENTS CORP.
625 Broadway, New York 12, New York
Export: Pan-Mar Corp., 1270 B'way, N.Y. 1

TECHNOTES

KCS83 CHASSIS: DOUBLE TROUBLE

At first, this chassis had hum symptoms, so I replaced bad filter capacitor C119.

When the new capacitor was in, the picture was just a little snowy. Not too bad, but something was still wrong. There must have been at least two troubles.

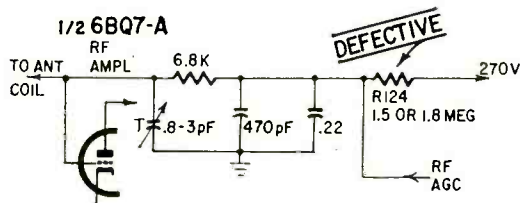

The antenna coils checked good, and so did tubes in the tuner and i.f. stages. Voltages in the tuner seemed close to what they should be. But the agc voltage, off-station, read 5 to 6 volts. With a station tuned in, the voltage rose to 9.

R124 resistance had doubled. A good 1.5 meg resistor was soldered in place, and the picture same back to normal.
—Homer L. Davidson

REGISTER CONTROL

If a General Electric CR 7515 Register Control is inoperative, the electron-ray tube does not flicker and the two neon indicator lamps are both brightly lit, check first for lack of screen voltage on the 6J7 tube in the scanner head. Loss of this voltage is usually due to an opening in the 5,000-ohm divider.

If screen voltage is present, the trouble is probably a defective coupling capacitor between the plate of the 6J7 and the sensitivity control.—R. C. Roetger

KORTING MT1585 STEREO RECORDER

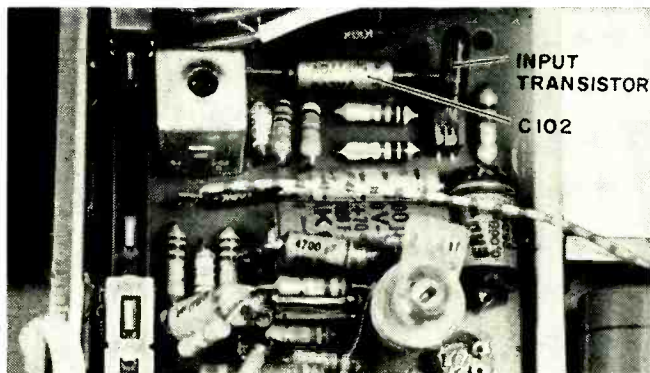

Symptom: Low volume on left-channel recording and playback.

Fault: C102, base blocking capacitor, shorted or leaky. Check transistor for possible damage before reassembling unit. Chassis is released by retainer located at top end near motor and swings out for easy service. Photo shows location of defective capacitor on PC board.—Steve P. Dow

ERRATIC PERFORMANCE, G-E CB CHASSIS

A poor ground on the pulse winding of the flyback transformer in General Electric 21-inch CB chassis has caused unusual and erratic symptoms, the factory reports. The

pulse winding supplies the burst gate, so intermittents in it can cause several defects:

Colored horizontal bars (sometimes intermittent)

No color

Intermittent color

Greenish cast in lower part of picture

Neon lamp N701 lights intermittently or not at all

To correct the trouble, put a ground lug under the self-tapping screw that secures the flyback to the chassis. (This is at the bottom rear of the high-voltage cage.) Install a short wire between this lug and the eyelet that secures the end of the pulse winding. Solder well at both ends.—*G-E Service Talk*

KEEP MAGNETS AWAY FROM FERRITE ANTENNAS

The speaker magnets in small transistor portables are often very powerful for their size. If you should have to disassemble such a radio, don't let the ferrite-core antenna come too near the speaker magnet. The field can reduce the permeability of the core, and hence the inductance of the antenna. That reduces the radio's sensitivity and may make it difficult to "track" the set properly during alignment.—*Siemens "Werkstatt Praxis"*

THE SWIFT-KICK APPROACH TO TV SERVICE

This RCA CTC7 would lose horizontal sync, then the horizontal oscillator would drop out and the horizontal output tube plates would get red hot. I checked and replaced everything from sync to flyback that seemed leaky or off-value. The set worked beautifully for 2 days, then the trouble started again.

My 4-year-old daughter gave me the clue. When her favorite cartoon showed lost sync, she would swat the set a good one. Bingo! Back in sync. I pulled the chassis again, looked everything over, put it back again. Same trouble.

Quite by chance, as I happened to be looking into the back of the set, I noticed the 6CG7 horizontal oscillator tube heater brighten noticeably when I rapped the cabinet. Turned out the pins were making poor contact—not poor enough to kill the heater, but just enough to affect a/c and oscillation. Embarrassing!—*Charles Berold*

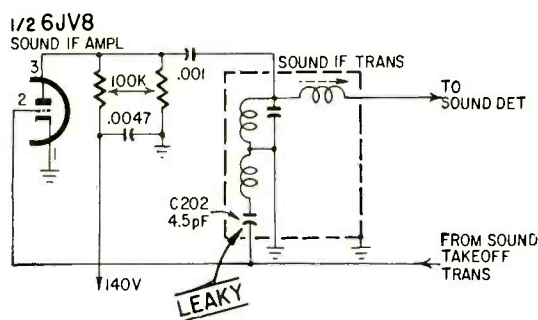

ADMIRAL 21C5-14C CHASSIS: SOUND TROUBLE

Sound and picture would not track properly. The picture had intermittent hum. The fine-tuning control just didn't do its job. A complete sound alignment didn't help.

Voltages in the sound stages were close enough. Sometimes the trouble looked like age, but I had the feeling that it was in the sound circuits. All resistors and capacitors were checked; C202 measured 2,000 ohms. Sure enough, this was the culprit.

To get at C202 is a job: the video output coil shield must be removed. The small capacitor lies down tight against the etched board.—*Homer Davidson* END



TWO TRIGGER POSITIONS



GIVE HIGH AND LOW HEAT

(Only Weller Soldering Guns have it)

This exclusive Dual Heat feature permits instant switching to either of two soldering temperatures. There's low heat for most of your electronic soldering, yet high heat is immediately available when you need it.

Weller guns also reach full soldering temperature up to 40% faster than other guns. They deliver more heat per rated watt, resulting in the greatest soldering efficiency.

This is why professionals insist on Weller. Be sure you do, too.

Weller Dual Heat Guns and Kits come in wattage ranges from 100 to 325, priced from **\$6.95** to **\$12.95** list.

Weller[®]

WELLER ELECTRIC CORP., EASTON, PA.

In England: Horsnam, Sussex.

WORLD LEADER IN SOLDERING TECHNOLOGY

Circle 121 on reader's service card

TRY THIS ONE

ADAPT EXTENSION CORD FOR CLAMP-ON AMMETER

SHORT UNUSED AMPLIFIER INPUTS FOR LOWER NOISE

Most commercial hi-fi amplifiers have selector switches designed to short unused inputs to ground. As long as only the desired input is "hot," there can be no irritating feedthrough, or crosstalk, from the switched-out sources.

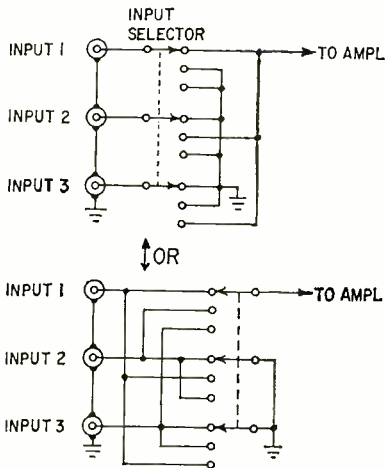

Selector switches designed to short unused inputs to ground usually have a section that is exactly the "inverse" of

the normal selector section. Instead of a ring connected to the amplifier input with a tab on it that contacts only one point at a time, this shorting section is a grounded ring with a notch in it, and it ungrounds only one point at a time. Contact sections like that are available as replacement items, but they are not always easy to get for home construction, nor always tailored to a particular application.

There is a way around, though. If you wire a switch as shown in the diagrams, you will have exactly the same thing, with only slightly more wiring and space. Note that you need as many switch poles as you have inputs. The number of poles may look extravagant, but single-section switches with up to three poles cost only very little more than single-pole switches with the same number of positions.

You can figure out schematics for four, five or any number of poles by remembering only this: Only one input must be ungrounded and connected to the amplifier at any one switch setting. All others are disconnected from the amplifier and grounded.—Peter E. Sutheim

When servicing in the field, the idea is to take as few tools and instruments as possible to do as many jobs as possible.

A neat hook-on ammeter adapter can be made from an extension cord (see photo) by splitting the cord and inserting the ratio turns in one wire. The ratio turns are made up of enameled solid wire (the type used in motor winding). After winding the correct number of turns for the ratio desired, wrap the turns with cotton tape and then with

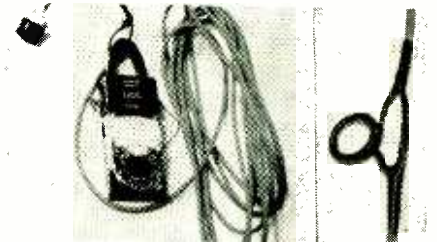

plastic electrical tape. The wire size for the ratio turns should be the same as that in the extension cord. Several ratio coils could be connected in series if several ratios are desired.

For a direct reading of the current, the meter can be clamped around the single separated conductor of the extension cord. To read small currents clamp the meter into the ratio coil.—T. L. Bartholomew

"MOVING-IN PARTY" YOU-HELPED US BUILD A BIG INVENTORY! THESE AMAZING BUYS-ARE YOUR DIVIDENDS

FREE \$1 BUY WITH EVERY 10 YOU ORDER Only applies to "\$1" Buys FREE GIFT WITH EVERY ORDER

- | | | | | | | | | | | | | | | | | | | | | | | | | | | | | | | | | | | | | | | | | | | | | | | | | | | | |
|---|---|---|--|--|---|--|---|---|--|---|--|---|--|---|---|---|--|--|--|--|--|--|--|---|--|---|--|--|---|--|--|--|--|---|---|---|--|---|--|---|---|--|--|--|--|--|---|---|---|---|---|
| <input type="checkbox"/> 8 - ASST LUCITE CABINETS \$1
hinge cover, handy for parts . . . | <input type="checkbox"/> 3 - TOP HAT SILICON RECTIFIERS \$1
750ma-600v top quality . . . | <input type="checkbox"/> 100 - MIXED DEAL "JACKPOT" \$1
Condensers, Resistors, Surprises . . . | <input type="checkbox"/> 1 - SQ. YARD GRILLE CLOTH \$1
most popular brown & gold design | <input type="checkbox"/> 20 - EXPERIMENTER'S COIL \$1
"JACKPOT" assorted for 101 uses | <input type="checkbox"/> 20-ASST. PILOT LIGHTS \$1
#44, 46, 47, 51, etc. | <input type="checkbox"/> 50 - ASST. DISC CERAMIC CONDENSERS \$1
popular numbers . . . | <input type="checkbox"/> 10 - ASST. RADIO ELECTROLYTIC CONDENSERS \$1 | <input type="checkbox"/> 50 - ASST. TUBULAR CONDENSERS \$1
.001 to .17 to 600v . . . | <input type="checkbox"/> 20 - STANDARD TUBULAR CONDENSERS \$1
.047-600v | <input type="checkbox"/> 3-1/2 MEG VOLUME CONTROLS \$1
with switch, 3" shaft | <input type="checkbox"/> 10 - ASST. 4 WATT WIRE-WOUND CONTROLS \$1 | <input type="checkbox"/> CLEAN UP THE KITCHEN" JACKPOT" \$1
Big Deal
only one to a customer | <input type="checkbox"/> 5 - ASSORTED TRANSFORMERS \$1
Radio, TV and Industrial | <input type="checkbox"/> BONANZA "JACKPOT" not gold, not oil, but a wealth of Electronic Items—Money-Back-guarantee . . . \$5 | <input type="checkbox"/> 75' - MINIATURE ZIP CORD \$1
2 conductor, serves 101 uses . . . | <input type="checkbox"/> 10-ASSORTED SLIDE SWITCHES \$1
SPST, SPDT, DPDT, etc. | <input type="checkbox"/> 10 SETS - DELUXE PLUGS & JACKS \$1
asst. for many purposes . . . | <input type="checkbox"/> 10 - SETS PHONO PLUGS & PIN JACKS \$1
RCA type | <input type="checkbox"/> 10 - SURE-GRIP ALLIGATOR CLIPS \$1
2" plated | <input type="checkbox"/> 4-50' SPOOLS HOOK-UP WIRE \$1
4 different colors | <input type="checkbox"/> 50 - RADIO & TV SOCKETS \$1
all type 7 pin, 8 pin, 9 pin, etc. . . | <input type="checkbox"/> 200'-BUSS WIRE #20 tinned for hookups, special circuits, etc. . . \$1 | <input type="checkbox"/> 100 - STRIPS ASSORTED SPAGHETTI handy sizes \$1 | <input type="checkbox"/> 100-ASSORTED RUBBER GROMMETS \$1
best sizes | <input type="checkbox"/> 50-ASSORTED PRINTED CIRCUIT SOCKETS \$1
best types | <input type="checkbox"/> 20-ASSORTED VOLUME CONTROLS \$1
less switch | <input type="checkbox"/> 7-ASSORTED VOLUME CONTROLS \$1
with switch | <input type="checkbox"/> 5 - ASST. SELENIUM RECTIFIERS \$1
65ma, 100ma, 300ma, etc. . . . | <input type="checkbox"/> 4 - TV ALIGNMENT TOOLS \$1
most useful assortment | RCA 110° FLYBACK TRANSFORMER

We scooped the Market Latest type — standard for all 110° TV's
RCA's design of large Coil produces 18KV—assuring adequate width Inel Schematic Diagram application for any TV
List price \$13.90
Your price . . . \$3
10% off in lots of 3 | <input type="checkbox"/> 110° TV DEFLECTION YOKE \$3
for all type TV's Inel schematic . . | <input type="checkbox"/> 90° FLYBACK TRANSFORMER \$1
for all type TV's Inel schematic | <input type="checkbox"/> 70° FLYBACK TRANSFORMER \$1
for all type TV's Inel schematic | <input type="checkbox"/> 70° TV DEFLECTION YOKE \$1
for all type TV's Inel schematic | <input type="checkbox"/> 20-ASSORTED TV COILS \$1
I.F. video, sound, ratio, etc. . . . | <input type="checkbox"/> 40-ASSORTED TV KNOBS \$1
all standard types, \$20 value . . | <input type="checkbox"/> 20-ASSORTED GRID CAPS \$1
for 1B3, 1X2, 6BG6, 6BQ6, etc. . . | <input type="checkbox"/> 100 - ASSORTED TV PEAKING COILS \$1
all popular types | <input type="checkbox"/> 2 - TV VERT OUTPUT TRANS \$1
universal 10:1 ratio for all TV's . . | <input type="checkbox"/> DELUXE MULTIPLE WIRE CABLE \$1
5 conductor, Jacket, color coded, any length to 500' 20' for | <input type="checkbox"/> 20 - ELECTROLYTIC CONDENSERS \$1
25mf-6v, top quality | <input type="checkbox"/> 1 - LB SPOOL ROSIN-CORE SOLDER \$1
40/60 top quality | <input type="checkbox"/> 10 - G.E. SAPPHIRE NEEDLES \$1
4G, VR-11, etc. (\$25.00 value) . . | <input type="checkbox"/> 20 - ITT SELENIUM RECTIFIERS \$1
65ma for Radios, Meters, Chargers, Transistors, Experiments, etc. . . . | <input type="checkbox"/> 7 - ASST. TV ELECTROLYTIC CONDENSERS \$1
popular selection | <input type="checkbox"/> \$15.00 TELEVISION PARTS \$1
"JACKPOT" best buy ever | <input type="checkbox"/> 50 - G.E. FLASHLIGHT BULBS \$1
#PR-9, 2.7 volts | <input type="checkbox"/> 15 - G.E. #NE-2 TUBES \$1
Neon Glow Lamp for 101 uses . . . | <input type="checkbox"/> 2 - G.E. PIECES OF EQUIPMENT \$1
stacked with over 200 useful parts | <input type="checkbox"/> 10-ASSORTED DIODE CRYSTALS \$1
1N34, 1N48, 1N60, 1N64, 1N82 | <input type="checkbox"/> 10-TOP BRAND TRANSISTORS \$1
NPN & PNP 2N104, 2N414, etc. . . |
|---|---|---|--|--|---|--|---|---|--|---|--|---|--|---|---|---|--|--|--|--|--|--|--|---|--|---|--|--|---|--|--|--|--|---|---|---|--|---|--|---|---|--|--|--|--|--|---|---|---|---|---|

IMMEDIATE DELIVERY . . . Scientific light packing for safe delivery at minimum cost. HANDY WAY TO ORDER: Pencil mark or write amounts wanted in each box, place letter F in box for Free \$1 BUY. Enclose with check or money order, add extra for shipping. Tearsheets will be returned as packing slips in your order, plus lists of new offerings.

Name
Address
Cost of goods
Shipping
estimated
TOTAL

Please specify refund on shipping overpayment desired: CHECK POSTAGE STAMPS MERCHANDISE (our choice) with advantage to customer

Circle 122 on reader's service card

MAGNETIC "THIRD HAND"

Here's a small-parts grabber that eliminates burned fingers and frazzled nerves from trying to solder small parts together.

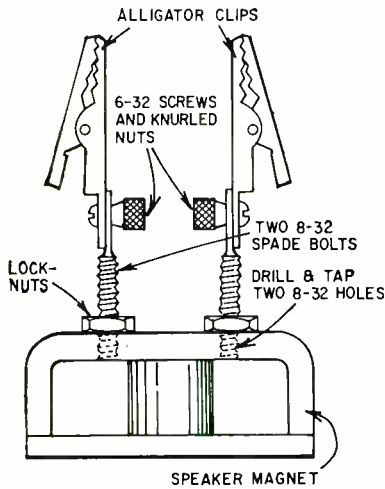

Drill and tap two 8-32 holes in the back of the magnet assembly of an old PM speaker. Run nuts up onto two 8-32 spade bolts and fasten an alligator clip (the kind with a screw) to each as shown in the drawing. Hold the clip-spade-bolt assemblies into the holes in the speaker frame and tighten the lock nuts. The magnet will hold fast to any



iron or steel surface, including a tool-box lid, and the clips can be rotated in various directions to accommodate all sorts of small parts.—Peter Legon END

Would You Like To Earn Big Money?

Read about the Installers, another feature in our Career Series. A successful group of installation and maintenance technicians who contract the big jobs are interviewed in

The October issue RADIO-ELECTRONICS

Why Do You Read So Slowly?

A noted publisher in Chicago reports there is a simple technique of rapid reading which should enable you to double your reading speed and yet retain much more. Most people do not realize how much they could increase their pleasure, success and income by reading faster and more accurately.

According to the publisher, anyone, regardless of his present reading skill, can use this simple technique to improve his reading ability to a remarkable degree. Whether reading stories, books, technical matter, it becomes possible to read sentences at a glance and entire pages in seconds with this method.

To acquaint the readers of this publication with the easy-to-follow rules for developing rapid reading skill, the company has printed full details of its interesting self-training methods in a new booklet, "How to Read Faster and Retain More" mailed free to anyone who requests it. No obligation. Send your name, address, and zip code to: Reading, 835 Diversy Parkway, Dept. 4486, Chicago, Ill. 60614. A postcard will do.

Circle 123 on reader's service card

CANADIANS: Ordering is easy . . . we do the paperwork . . . try a small order

SARKES TARZIAN TV TUNER 41mc



Latest Compact Model—good for all 41 mc TV's. BRAND NEW—MONEY BACK GUARANTEE

Best TUNER "SARKES TARZIAN" ever made—last word for stability, definition & smoothness of operation. An opportunity—to improve and bring your TV Receiver up-to-date.

COMPLETE with Tubes & Schematic . . . \$7.95

HIGHWAVE AM-FM PORTABLE RADIO

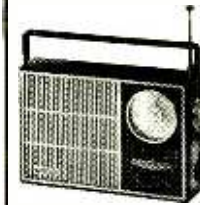

Elegance in Ebony & Chrome
14 Transistors — A Powerhouse of Quality Reception with AFC Operates on 4 "C" Cells
22" Telescoping FM Antenna & Personal Listening attachment
Money refund — if not better than any Known Brand selling for even twice the price
8"x5 1/4"x2 1/4" — 4 lbs

COMPLETE . . . \$19.50

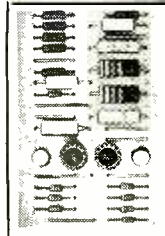

IBM COMPUTER SECTIONS

8 assorted Units we sell for \$1 are loaded with over 150 valuable parts. Incl. — Transistors, Condensers, Resistors, Heat Sinks, Diodes, Etc.

8 for \$1
100 for \$10

LUCKY 13 HARDWARE KITS

This month only pay for 11, get 2 Free. + Gift

- 1000—ASST. HARDWARE KIT \$1
screws, nuts, washers, rivets, etc.
- 300 — ASSORTED HEX NUTS \$1
2/56, 4/40, 5/40, 6/32, 8/32 . . .
- 250—ASST. SOLDERING LUGS \$1
best types and sizes
- 250—ASST. WOOD SCREWS \$1
finest popular selection
- 250 — ASST. SELF TAPPING SCREWS \$1
#6, #8, etc.
- 150—ASST. 6/32 SCREWS and 150 6/32 HEX NUTS
- 150—ASST. 8/32 SCREWS and 150—8/32 HEX NUTS
- 150—ASST. 2/56 SCREWS and 150—2/56 HEX NUTS
- 150—ASST. 4/40 SCREWS and 150—4/40 HEX NUTS
- 150—ASST. 5/40 SCREWS and 150—5/40 HEX NUTS
- 300 — ASSORTED HEX NUTS \$1
150-6/32 and 150-8/32
- 500—ASSORTED RIVETS \$1
most useful selected sizes
- 500—ASSORTED WASHERS \$1
most useful selected sizes

- HEARING AID AMPLIFIER \$2
Incl. 3 Tubes, Mike, etc. (as is)
- UNIVERSAL 2" PM SPEAKER 29¢
Alnico 5 magnet, quality tone
- UNIV. 3" x 5" PM SPEAKER 75¢
Best type for Radios, TV, Etc.
- UNIVERSAL 4" PM SPEAKER 69¢
Alnico 5 magnet, quality tone
- 3 — AUDIO OUTPUT TRANSFORMERS \$1
50L6 type
- 10 — SPEAKER PLUG SETS \$1
deluxe type, 2 conductor
- CHAPT ZU DI MITZIA "JACK-POT" \$1
"double your money back if not completely satisfied
- 300 — ASST. 1/2 W RESISTORS \$1
Top Brand, Short leads, excellent
- 100 — ASST. RUBBER & FELT FEET FOR CABINETS \$1
best sizes
- 5 — I.F. COIL TRANSFORMERS \$1
sub-min for Transistor Radios
- 5 — AUDIO OUTPUT TRANSFORMERS \$1
Sub-min for Trans Radios
- 4 — TOGGLE SWITCHES \$1
SPST, SPDT, DPST, DPDT
- 15 — ASST. ROTARY SWITCHES \$1
all popular types \$20 value

- 100 — ASST. CERAMIC CONDENSERS \$1
Some in 5%
- 100 — ASST. MICA CONDENSERS \$1
some in 5%
- 100—ASST 1/4 WATT RESISTORS \$1
stand. choice ohmages, some in 5%
- 100 — ASST 1/2 WATT RESISTORS \$1
stand. choice ohmages, some in 5%
- 70 — ASST 1 WATT RESISTORS \$1
stand. choice ohmages, some in 5%
- 35 — ASST 2 WATT RESISTORS \$1
stand. choice ohmages, some in 5%
- 50 — PRECISION RESISTORS \$1
asst. list-price \$50 less 98%
- 20 — ASST'ED WIREWOUND RESISTORS, 5, 10, 20 watt
- 50 — ASST. TERMINAL STRIPS \$1
all types, 1-1ug to 6-1ug
- 25 — INSTRUMENT POINTER KNOBS \$1
selected popular types
- 50 — ASST. RADIO KNOBS \$1
all selected popular types
- 5 — PNP TRANSISTORS \$1
general purpose, TO-5 case
- 5 — NPN TRANSISTORS \$1
general purpose, TO-5 case
- 2 — POWER TRANSISTORS No. 1 \$1
Replace 2N155, 2N176, 2N301, etc.
- 10 — ASST DUAL CONTROLS \$1
for Radio, TV, Hi-Fi, Stereo, etc.

- 50 — ASSORTED MYLAR CONDENSERS \$1
popular selected types
- TELEPHONE JACK OR PLUG \$50¢
make any telephone portable ea
- TELEPHONE RECORDING DEVICE \$1
place it under telephone
- CRYSTAL LAPEL MICROPHONE \$1
high impedance, 200-6000 cps
- 25' — MICROPHONE CABLE \$1
deluxe, 2 conductor, shielded
- TAPE RECORDER — assorted types \$4
good, bad, broken, as-is, potluck
- TRANSISTOR RADIO asst type \$1.50
good, bad, broken, as-is, potluck
- 4 — TRANSISTOR RADIO EARPIECES \$1
wired complete with plug
- \$15.00 RADIO PARTS "JACK-POT" \$1
handy assortment
- 50 ASSORTED TUBE CARTONS \$1
all the 4 important sizes
- 10 — ASSORTED TUBES \$1
Radio, Television and Industrial
- ALL AMERICAN TUBE KIT \$2
Top Standard Brand — 12BA6, 12BE6, 12AV6, 50C5, 35W4
- 5 — RCA 1U4 TUBES brand new \$1
boxed, also serves as a 1T4

BROOKS RADIO & TV CORP., 487 Columbus Ave., New York, N. Y. 10024

TELEPHONE 212-874 5600

What you don't know about TV, Transistors & Test Instruments, may be costing you a promotion or a pay raise!

Here is an extraordinary offer to introduce you to Gernsback Library's famous Electronics Book Club, specially designed to help you increase your know-how and earning power.

WHY SHOULD YOU JOIN!

Whatever your interest in electronics—radio and TV servicing, audio and hi-fi, industrial electronics, communications, electronics as a hobby—you'll find that the Electronics Book Club will help you get the job you want, keep it, improve it, or make your leisure hours more enjoyable. By broadening your knowledge and skills, you'll build your income and electronics enjoyment as well.

WHAT BOOKS ARE OFFERED?

From Gernsback Library and other leading publishers come the country's most respected books in the field of electronics. All are deluxe, hard-covered books of permanent value, offered at considerable cash savings to members, regardless of higher retail prices.

HOW THE CLUB WORKS

The Electronics Book Club will send you, every other month, the News Bulletin describing a new book on a vital area of electronics. As a member, *you alone* decide whether you want a particular book or not. You get 3 books now for \$1.99 and need take only 4 more within a year, from a wide selection to be offered. And the Club *saves you money* on the books you take, regardless of higher retail prices.

HOW TO JOIN

Simply mail the coupon today. You will be sent your three handbooks—BASIC TV COURSE, FUNDAMENTALS OF SEMICONDUCTORS and THE OSCILLOSCOPE (regular retail price \$15.55). We will bill you \$1.99 (plus a few cents postage). If you are not pleased with the books, send them back within 10 days and membership will be cancelled. Otherwise you will enjoy these benefits:

- ★ Get three books immediately for \$1.99 (regular \$15.55 value).
- ★ Free 10-day examination privilege.
- ★ Continuous cash savings.
- ★ Free charts and reports given with many books.
- ★ You alone decide which books you want. Books are returnable.
- ★ Club Books are practical working tools, written by experts.

Get these three income-boosting books... a \$15.55 value

\$1.99
only

by joining the Electronics Book Club today!



BASIC TV COURSE

By George Kravitz. Perfect introduction to TV, in clear, non-mathematical language. Starting with the forming of the picture, the book shows how the picture tube works, the television signal, the television receiver, antennas and tuners, how the video IF works, the video detector and AGC, the video amplifier at work, how the sync section works, horizontal output and high voltage supply, how the sound section works, how transistor portable TV's work. 224 pages, completely illustrated. Retail Price \$5.75.

FUNDAMENTALS OF SEMICONDUCTORS

By M. G. Scroggie. Provides a complete background in semiconductor devices, beginning with basic facts on electrical conduction through transistors, rectifiers, photoelectric devices, thermistors, varistors, diodes, cryosars, etc. Supplies enough theory in a simple way to make it possible to understand more advanced literature. Also explains how the special properties of semiconductors are being applied in many kinds of useful devices. Dozens of charts, diagrams and photos. 160 pages. Retail Price \$4.60.

THE OSCILLOSCOPE

By George Zwick. (Revised Edition). Teaches you how to operate the scope, how to use it for alignment and shows you how to solve every type of service testing problem you are likely to encounter. Demonstrates how to interpret waveforms correctly, how to use scope probes, how to measure low input voltages, how to perform specific experiments using the oscilloscope, etc. 224 illustrated pages. Retail Price \$5.20.

Gernsback Library, Inc., Electronics Book Club, Dept. RE 96
154 West 14th Street, New York, N.Y. 10011

Please enroll me in the Electronics Book Club and send me the 3 income-boosting handbooks: BASIC TV COURSE; FUNDAMENTALS OF SEMICONDUCTORS; THE OSCILLOSCOPE. Bill me only \$1.99 plus shipping (for this \$15.55 value). If not pleased, I may return the books in 10 days and this membership will be cancelled.

As a member, I need only accept as few as 4 additional books a year—and may resign any time after purchasing them. All books will be described to me in advance, every other month, in the Club Bulletin, and a convenient form will always be provided for my use if I do not wish to receive a forthcoming book. You will bill me the special Club price for each book I take (plus a few cents postage)—regardless of higher retail prices. Offer good in U.S.A. and Canada only.

Name (Please Print)

Address

City State Zip Code

SAVE: Enclose your \$1.99 now with this coupon and we will pay postage. Same return guarantee privilege; prompt refund if not satisfied.

WHAT'S YOUR EQ?

These are the answers. Puzzles are on page 53.

Remote-Control Circuit

With the switch in position 1, only RY1 is energized (via D1 and D2). In position 2, only RY2 is energized (via D3 and D4). In position 3, ac is fed to the line, energizing both relays. In position 4, neither relay is energized. Since there are four different combinations, appropriate contacts may be selected to operate four independent circuits.

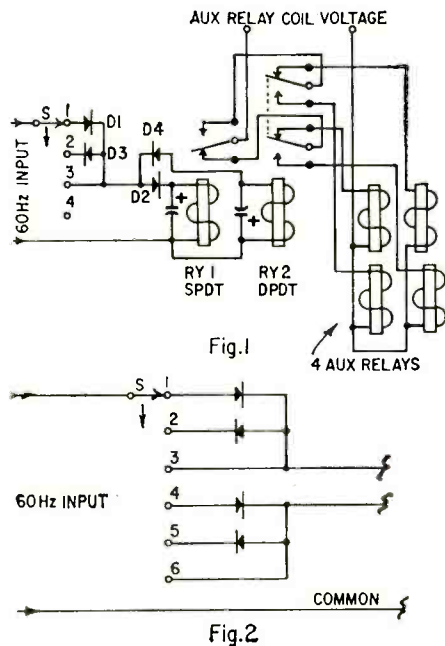

Fig. 2

By duplicating this setup and using a three-conductor line (add a shield), six independent circuits may be controlled. (Fig. 2) The switch position in which neither relay is energized is eliminated as is one auxiliary relay. Otherwise, it is possible to have two load circuits energized simultaneously.

Bridge Resistance

The ohmmeter reads 10,000 ohms in both switch positions. As shown redrawn

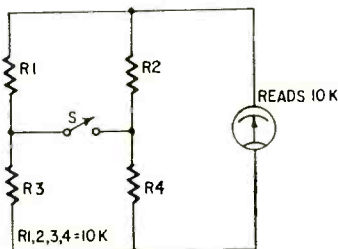

Fig. 1

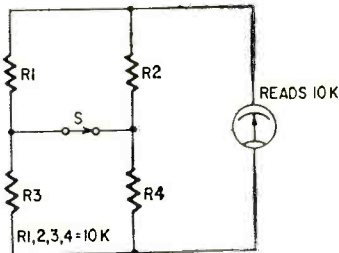
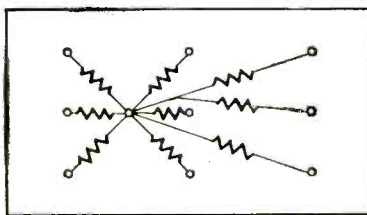

Fig. 2

with S1 open (Fig. 1), the meter sees the four resistors in series-parallel—two 20K series legs in parallel totaling 10K.

With S1 closed (Fig. 2), the meter sees R1 and R2 paralleled to 5K in series with R3 and R4 paralleled to 5K for a total of 10K.

All 1-Ohm



ALL RESISTORS 1/2Ω

Simply connect one end of each 1/2-ohm resistor to a different terminal and connect the 9 free ends together. END

Color or Black & White TV respond to QUIETROLE like magic!

- Lubricates & Cleans
- Non-inflammable . . . Non-conductive . . . Non-corrosive
- Easy Spray or Dropper Application
- Nearly 20 Years of Outstanding Leadership
- Harmless to Plastics & Metal — Zero Effects on Capacity & Resistance

Acknowledged leadership by both manufacturers and servicemen. Silences noisy TV and radio controls with minimum attention. Mark-II for tuners . . . Spray-Pack for controls and switches . . . Silitron for general use.

Ask your distributor for Quietrole by name.



manufactured by QUIETROLE CO. Spartanburg, South Carolina

Circle 124 on reader's service card

ELECTRONICS



Engineering-Technicians

Bachelor of Science Degree, 30 Months Save Two Years' Time

- Radio-Television Plus Color Technician (12 Months)
- Electronics Engineering Technology (15 Months)
- Electronics Engineering (B.S. Degree)
 - Electrical Engineering (B.S. Degree)
 - Mechanical Engineering (B.S. Degree)
 - Civil Engineering (B.S. Degree)
 - Architecture (B.S. Degree) (36 Months)

Electronic Technicians, Radio TV Technicians is at an all time high. Heald Graduates are in demand for Preferred High Paying Salaries. Train now for a lucrative satisfying lifetime career.

Approved for Veterans

DAY AND EVENING CLASSES

Write for Catalog and Registration Application. New Term Starting Soon.

HEALD'S

ENGINEERING COLLEGE

Est. 1863—103 Years
Van Ness at Post, RE
San Francisco, Calif.

Your Name

Address

City

State

Circle 125 on reader's service card

RADIO SHACK'S NEW AMERICAN-MADE TRANSCEIVER FEATURES 24 CRYSTAL CHANNELS *plus* DX BOOST

Our Realistic "Americana 23-Plus" is CB's New Standard of 2-Way Radio Value!



All Crystals Supplied! Astatic Noise-Cancelling Mike!

Radio Shack puts you "on the air" in style with our exclusive REALISTIC transceiver. The "Americana" pulls 'em in where others fail with dual-conversion superhet reception, a DX range switch for greater sock, and unique hard-access transmitter tuning control. Switchable noise limiter; squelch control; bandspread tuning for channels slightly off frequency. Extra-power tube circuit with Realistic "Lifetime" tubes—replaced FREE forever! #21-023.

Made
in
U.S.A.

169⁹⁵
NO
MONEY
DOWN!

Radio Shack PACER Special!



- 8 Crystal-Controlled Channels!
- 23-Channel Tunable Receiver!
- Dual 117 VAC/12 VDC Supply!
- Illuminated S/RF Meter!

**SPECIAL
LOW
PRICE!**

89⁹⁵
NO
MONEY
DOWN

MADE IN U.S.A.

This famous-make CB rig outperforms models costing dollars more! Features a positive-acting squelch control; spotting switch; superhet receiver with tuned RF stage. Solid 100% modulation. Pi-net circuit for efficient antenna matching. Provision for external crystal. Has 3.4 watts RF output; 3.5 watts audio. With mounting bracket; ceramic push-to-talk mike with coiled cable; receive and transmit crystals for Channel 11. #21-019.

The Only Completely New Line of 100% Reliable Walkie Talkies!

Dual-Channel 100 Milliwatt
With Tuned RF Stage for Extra Range!

29⁹⁵
Ea.

2 for
\$59.00

- Send, Receive up to 2 Miles!
- License-Free Operation!

TRC-22: 10 transistors plus crystal-controlled dependability! Has push-to-talk switch with "lock-on" feature; rugged die-cast case. With crystals for Channel 11, earphone, battery. #21-904

Dual-Channel 100MW with Squelch
More "Plus" Features; Range to 3 Miles!

39⁹⁵
Ea.

2 for
\$79.00

- Separate Microphone & Speaker!
- Big 13-Transistor Performance!

TRC-33: re-designed for even better performance and value! Squelch cuts out background noise. Battery level indicator gives advance warning of power loss. Tuned RF stage for extra range! Die-cast. With crystals for Channel 11, batteries. #21-906

Dual-Channel 1 Watt Powerhouse
Dependable Communications up to 5 Miles!

59⁹⁵
Ea.

2 for
\$119.00

- Separate Jacks for External Power Supply, Mike & Antenna

TRC-44: features separate built-in mike and speaker; battery level meter; squelch control. #21-1137. 2-Watt model TRC-88: peak power, 15 transistors, long 10-mile range, and noise limiter in addition to features above. \$79.95 ea. #21-188

MAIL CARD TODAY for FREE 1967 RADIO SHACK CATALOG! 1,000's OF VALUES! EASY CREDIT!

Now Over 90 Radio Shack Stores Coast to Coast!

- ARIZONA**
PHOENIX — 3905 East Thomas Rd., 273-1722
- CALIFORNIA**
ANAHEIM — 507 East Kabela Ave., 776-9540
BAKERSFIELD — 1308 19th St., 322-8448
LA HABRA — 1511 West Whittier Blvd., 697-6707
LONG BEACH — 3976 Atlantic Ave., 426-7514
LOS ANGELES:
Downey — Stonewood Shop, Ctr., 923-1709
Ladera Shop, Ctr. — 5305 Centinela Ave., 776-5268
Mission Hills — 10915 Sepulveda Blvd., 365-9118
Reseda — 19389 Victory at Tampa, 881-3142
Torrance — 22519 Hawthorne Blvd., 373-1984
West Covina — 2516 East Workman Ave., 339-1227
West L.A. — Pico Blvd. at Overland, 810-6152
OAKLAND (San Leandro) — Bay Fair Shop, Ctr., 278-5200
SACRAMENTO — 600 Fulton Ave., 483-2707
SAN BRUNO — 481 El Camino Real
SAN DIEGO (La Mesa) — Grassmont Shop, Ctr., 465-4062
SANTA ANA — Bristol Plaza Shop, Ctr., 546-5700
- COLORADO**
DENVER:
758 South Santa Fe Dr., 733-7833
Westland Shopping Center, 238-6323
- CONNECTICUT**
HAMDEN — Hamden Mart Shop, Ctr., 288-7911
MANCHESTER — Manchester Shopping Parkade, 649-5247
NEW HAVEN — 230 Crown St., 787-1721
NEW LONDON — New London Shop, Ctr., 442-0522
STAMFORD — 29 High Ridge Rd., 325-4371
WEST HARTFORD — 38 St. Main St., 236-5441
- GEORGIA**
ATLANTA — Greenbriar Shopping Center
ATLANTA — No. DeKalb Shopping Center
- ILLINOIS**
CHICAGO — Evergreen Plaza at 95th St., 636-9796
- KANSAS**
WICHITA — Parklane Shopping Center
- MAINE**
PORTLAND — Pine Tree Shop, Ctr., 773-7071
- MARYLAND**
LANGLEY PARK — Hampshire-Langley Shop, Ctr., 439-6689
- MASSACHUSETTS**
BOSTON:
167 Washington St., 523-4719
594 Washington St., 426-3431
110 Federal St., 426-3997
BRINTREE — South Shore Plaza, 643-9200
BROCKTON — Westgate Mall, 588-5327
BROOKLINE — 730 Commonwealth Ave., 734-1000
CAMBRIDGE — Fresh Pond Shop, Ctr., 491-2925
FRAMMINGHAM — Shoppers World, 672-6558
LOWELL — Central Shop, Plaza, 455-5469
SAUGUS — N. E. Shop, Ctr., 233-5350
WEST SPRINGFIELD — Century Shop, Ctr.
WORCESTER — Lincoln Plaza, 757-8030
- MINNESOTA**
MINNEAPOLIS — 1121 Nicollet Ave., 339-3515
ST. PAUL — 473 North Snelling, 645-2063
- MISSOURI**
ST. LOUIS:
1125 Pine St. (Walter Ashe Div.), 241-1125
South County Shopping Center, 892-1800
Northland Shopping Center, 381-5190
- NEW HAMPSHIRE**
MANCHESTER — 1247 Elm St., 659-1303
- NEW MEXICO**
ALBUQUERQUE — 6315 Lomas, N.E., 268-5722
- NEW YORK**
BINGHAMTON (Vestal) — Vestal Shopping Plaza, 729-1525
BUFFALO (Cheerilee) — Transfair Shop, Ctr., 632-7111
NEW YORK — 1128 Ave. of the Americas, 687-4882
SCHENECTADY (Rotterdam) — Shoporama Ctr., 355-9740
SYRACUSE:
3057 Erie Blvd. East, 446-4990
Fairmount Fair Shop, Ctr., 468-0211
- OHIO**
CINCINNATI — 852 Swifton Ctr., 631-4570
- OKLAHOMA**
OKLAHOMA CITY — Mayfair Shop, Ctr., 943-8491
TULSA — 2730 Southward, 742-2255
- OREGON**
PORTLAND — 1928 N.E. 42nd St., 281-4842
- PENNSYLVANIA**
PHILADELPHIA:
23270 Cottman Ave., Rosevelt Mall, 338-4711
1128 Walnut St., 923-2188
PITTSBURGH — 309 So. Hills Village, 343-5800
- RHODE ISLAND**
PROVIDENCE — 355 Reservoir Ave., 467-3990
EAST PROVIDENCE — Shoppers Town, 434-5672
- TENNESSEE**
MEMPHIS — Southland Mall, 396-7762
- TEXAS**
ABILENE — 2810 North First St., 673-8169
ARLINGTON — Collins at Park Row, 277-3151
AUSTIN — Hancock Shopping Center, 454-3090
BROWNSVILLE — 847 S.E. Elizabeth St., 546-6156
- DALLAS:**
Medallion Center, 363-6236
125 Wynnwood Village, 948-3201
Plymouth Park Shop, Ctr., 253-6811
- FORT WORTH**
1515 So. University Dr., 335-4705
900 East Berry St., 927-7828
3524 Denton Highway, 831-1951
2615 West 7th St., 336-4684
- HOUSTON:**
7900 Katy Rd.
8458 Gulf Freeway, 643-4731
322 Northline Mall, 697-7914
Beairste — 4759 Bissonnet, 667-5190
- MILWAUKEE**
MILWAUKEE — South 'B' Meta Drive
- SAN ANTONIO:**
150 Wonderland Shop, Ctr., 735-9161
684 S.W. Military Drive, 924-4851
SHERMAN — 1620 Highway 7 North, 892-6553
WACO — 1016 Austin Ave., 752-7739
- UTAH**
SALT LAKE CITY — Cottonwood Mall, 277-3064
- VIRGINIA**
ARLINGTON — Parkington Shop, Ctr., 524-5422
VIRGINIA BEACH — Pentrose Mall Shop, Ctr., 497-9211
- WASHINGTON**
SEATTLE:
2028 Third Ave., 682-5280
837 N. E. 110th St., 364-8670
Burien Plaza, 242-3637

Radio Shack Tape Special!

Super-Strength MYLAR at a Below-Acetate Price!

99¢ Each

In Lots of 3 or More Reels

- Full 7-in. Reels! 1200 Ft.!
- Made by Top U.S. Manufacturer!

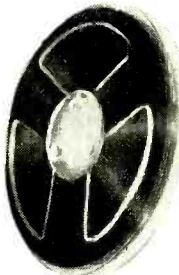

Another \$-saving Radio Shack special purchase from one of America's kingpin tape makers! Certified defect-free. Super-strength, quality and fidelity! Not a so-called "white box" tape! #44-755

Made for People Who Fly!

Exclusive Aircraft and AM Portable!

21⁹⁵

- 2 Bands! 10 Transistors!
- Hear Exciting Aircraft Transmissions!

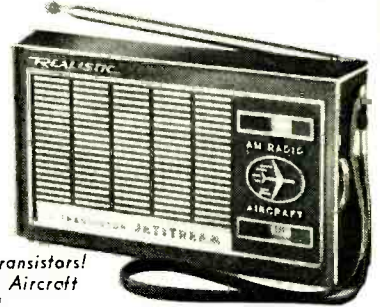

Fabulous new "Jetstream" — great for pilots, VHF fans, travelers, GI's. AM radio. 2 antennas. 5/8 x 3 3/8 x 1 1/4". With batteries. # 12-626.

We're Famous For Stopwatches!

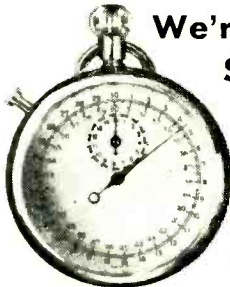

9⁹⁹

- Traditional Swiss Accuracy!
- 7-Jewel Sports Model

1/10 second divisions. Outer dial registers up to 30 seconds; hand counts to 15 minutes. Crown controls with zero-reset button. #63-639.

Our Fabulous FE-103 Speaker

Free: Plans for building Special Hi-Fi Enclosure!

7⁹⁵

- New 4" Acoustic-Suspension Speaker!
- Massive Ceramic Magnet!



Unique design handles 15 watts music power; 30-17,000 cps response; 8Ω impd. High performance. 8 3/4 x 8 x 6 1/8". #40-1197.

Wireless Solid State Intercom

29⁹⁵ PAIR

- Up To 1 Mile Range!
- Save Time, Steps, Money!

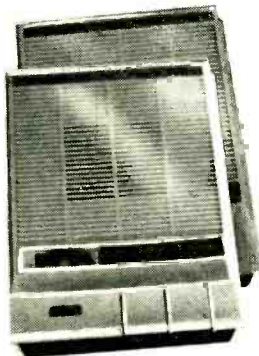

No installation — plug into regular household outlet. Easy push-to-talk operation, volume control. Dictation, monitoring lock. Pilot light. #43-210.

5 Dukes of Dixieland 12" Stereo LP's

Special purchase!

5 for 8⁰⁰



Audio Fidelity Records — Demo Quality Stereo. 16-25,000 CPS.

Build up your music library with these 5 great LP bargains: Minstrel Time; Mardi Gras Time; On Campus; Circus Time; Up the Mississippi. #50-5893.

FILL OUT THIS HANDY ORDER COUPON AND MAIL TODAY

RE-966

RADIO SHACK CORPORATION,

730 Commonwealth Ave., Boston, Mass. (Eastern Customers)

1515 So. University Dr., Fort Worth, Texas (Western Customers)

- | | | |
|---|--|---|
| <input type="checkbox"/> Americana 23-Plus, #21-023 | <input type="checkbox"/> TRC-44, #21-1137 | <input type="checkbox"/> Stopwatch, #63-639 |
| <input type="checkbox"/> Pacer CB Transceiver #21-019 | <input type="checkbox"/> TRC-88, #21-188 | <input type="checkbox"/> FE-103 Speaker, #40-1197 |
| <input type="checkbox"/> TRC-22, #21-904 | <input type="checkbox"/> Mylar Tape (3 Reels), #44-755 | <input type="checkbox"/> Wireless Intercom, #43-210 |
| <input type="checkbox"/> TRC-33, #21-906 | <input type="checkbox"/> Aircraft/AM Radio, #12-626 | <input type="checkbox"/> 5-Record LP Set, #50-5893 |

Please send me the items I have checked above. I enclose \$_____ plus \$1.00 to cover handling and postage anywhere in the U.S.A.; I understand any excess payment will be refunded promptly.

Name _____

Street _____

City _____ State _____ Zip _____

Circle 126 on reader's service card



Assure 100% COMPLETE ERASURE of Recorded Tape ON THE REEL

Use the **Magneraser**[®]
— the Original and still the best!

Quickly erases a reel of magnetic tape or sound film of any size or type. Erasure is 100% complete even on severely overloaded tape. Lowers background noise level of unused tape 3 to 6 db. Also demagnetizes record-playback and erase heads. Only \$24.00. Two-Year Guarantee. Available at your dealer's or write us.

New ULTRA-SENSITIVE FLUTTER METER



With built-in Three-Range Filter, 3 kc Test Oscillator, High Gain Preamplifier and Limiter. Filter Ranges: 0.5 to 6 cps; 0.5 to 250 cps; 5 to 250 cps.

Designed for rapid visual indication of flutter and wow. Meets standards set by the IEEE... Condensed Specs.: Input Voltage, 0.001 to 300 Volts; Ranges, 0.01 to 3%; Limiter Range, 20 db.; Oscillator (built-in), 3000 cycles; Net Price, \$495.00... Write for complete specifications and free 12-page booklet on Flutter.

AMPLIFIER CORP. of AMERICA
75 Frost St., Westbury, N. Y. 11590 • (516) 333-9100
Circle 127 on reader's service card

SILICON RECTIFIER SALE

IMMEDIATE DELIVERY
FULLY GTD NEWEST TYPE
AMERICAN MADE FULLY TESTED

750 MA-SILICON "TOPHAT" DIODES
LOW LEAKAGE FULL LEAD LENGTH

PIV/RMS 50/35 .05 ea.	PIV/RMS 100/70 .07 ea.	PIV/RMS 200/140 .10 ea.	PIV/RMS 300/210 .12 ea.
PIV/RMS 400/280 .14 ea.	PIV/RMS 500/350 .19 ea.	PIV/RMS 600/420 .21 ea.	PIV/RMS 700/490 .25 ea.
PIV/RMS 800/560 .30 ea.	PIV/RMS 900/630 .40 ea.	PIV/RMS 1000/700 .50 ea.	PIV/RMS 1100/770 .70 ea.

ALL TESTS AC & DC & FWD & LOAD

SILICON POWER DIODE STUDS

D.C. AMPS	50 PIV 35 RMS	100 PIV 70 RMS	150 PIV 105 RMS	200 PIV 140 RMS
.3	.08 ea.	.12 ea.	.16 ea.	.22 ea.
12	.25	.50	.65	.75
35	.65	1.90	1.25	1.40
50	1.00	2.35	1.50	1.75
100	1.60	2.00	2.40	3.00

D.C. AMPS	300 PIV 210 RMS	400 PIV 280 RMS	500 PIV 350 RMS	600 PIV 450 RMS
.3	.27 ea.	.29 ea.	.37 ea.	.45 ea.
12	.90	1.30	1.40	1.65
35	2.00	2.35	2.60	3.00
50	2.20	3.25	3.50	4.00
100	3.60	4.50	5.25	7.00

"SCR" SILICON CONTROLLED RECTIFIERS "SCR"

PRV AMP	7 AMP	16 AMP	25 AMP	PRV AMP	7 AMP	16 AMP	25 AMP
.25	.50	.75	1.00	250	1.75	2.15	2.50
50	.60	.90	1.25	300	2.00	2.40	2.75
100	.80	1.25	1.50	400	2.40	2.75	3.25
150	.90	1.60	2.00	500	3.20	3.40	3.80
200	1.25	1.80	2.25	600	3.40	4.00	4.50

SPECIALS! SPECIALS!
Westinghouse 160 AMP, 500 PIV SILICON HI-POWER STUD RECTIFIER IN1666. Limited quantity. \$5.10 ea. 10 for \$45.00

100 Different Precision Resistors 1/2—1—2 Watt 1/2%—1% TOL \$1.25

Asst transistor Kit. P.N.P.—N.P.N. All popular types. Unchecked 100 for \$2.95 500 for \$9.95

Computer Grade Condenser 15,500 MFD 12 VDC American Mfg. .75 ea.

Type IN34 DIODE GLASS .07 ea 100 for \$5

Money Back guarantee. \$2.00 min. order. Include additional \$ for postage. Send check or money order. C.O.D. orders 25% down.

Warren Electronic Components
230 Mercer St., N. Y., N. Y. 10012 • 212 OR 3-2620

Circle 128 on reader's service card

NOTEWORTHY CIRCUITS

ADJUSTING SCOPE ATTENUATORS

Compensating capacitors on oscilloscope input attenuators are commonly adjusted with a square-wave input. If you do not have a square-wave generator, you can get the same results by us-

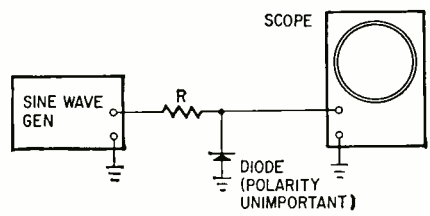

Fig.1

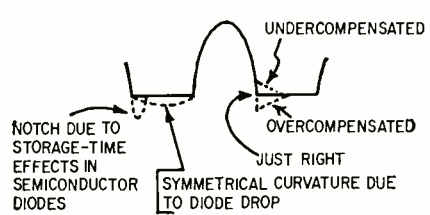

Fig.2

ing rectified sine waves from an audio oscillator. The sine waves can be obtained from the circuit shown in Fig. 1, using a semiconductor or vacuum-tube diode. Resistor R is not critical. It must be large enough not to load down the generator or put excessive current through the diode, and yet small enough not to be shunted appreciably by stray

capacitances. Values between 10K and 100K are satisfactory.

The waveform obtained is shown in Fig. 2. (It may be inverted, depending on diode polarity.) If the bottom of the wave is perfectly flat, the compensation is just right. Departures from correct compensation will give rise to asymmetrical curvature as shown.

The correct frequency to use depends on the R-C product of the attenuator. If the frequency is too low, the curvature will not be visible. (Moreover, extraneous curvature may be introduced by coupling capacitors in the scope amplifier.) If the frequency is too high, adjusting the trimmers will primarily vary the height of the complete waveform, and the changes in curvature will again be less noticeable. About 10 kHz was found to work well for a typical scope input attenuator, and 400 Hz was satisfactory for a typical attenuator probe.

Diode voltage drop can also give rise to curvature as shown, but this curvature is symmetrical and is readily distinguished from miscompensation. Storage-time effects in semiconductor diodes will produce notches, as shown, at high frequencies.

This technique is useful for adjusting or checking any video amplifier employing capacitive or inductive compensation.—Charles Erwin Cohn

AUTOMATIC RECORD-LEVEL CONTROL

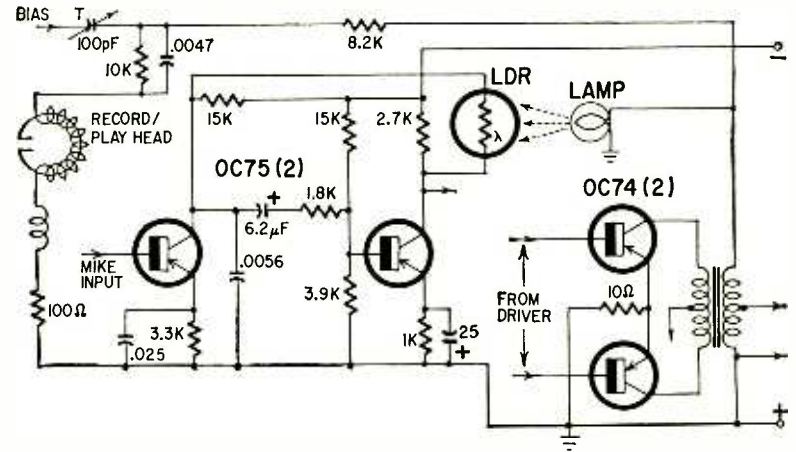

Many of the newer tape recorders—particularly those designed for dictating and conferences—feature automatic recording-level controls. The diagram shows the basic circuit in the Philips EL3582 dictating machine. The important elements are the lamp across the output transformer and a photoresistor (LDR) in a feedback loop between the collectors of the first two pre-amplifier stages. (The LDR is a photoresistive, also called photoconductive,

photocell whose resistance varies with the intensity of light falling on it. Typical of this type are the cadmium sulphide and cadmium selenide cells.)

Light intensity tends to rise as the input signal level increases. This light falls on the photocell and decreases its resistance. This decrease in resistance limits circuit gain through degenerative feedback and keeps the recording level fairly even. The time constant is suitable for speech.—Steve P. Dow END

NEW BOOKS

COMPUTERS AND THE HUMAN MIND, by Donald G. Fink. Doubleday & Co., Inc., 277 Park Ave., New York, N. Y. 10017. 4 x 7 in., 301 pp. Paper, \$1.45

A masterfully written work, describing the how of computers and their languages, in terms readily understandable by the layman, but at a level that makes the book interesting to the engineer. The last chapters are devoted to the human brain, to human and nonhuman intelligence, and the question "Can machines create?"

SEMICONDUCTOR JUNCTIONS AND DEVICES: THEORY TO PRACTICE, by Dr. William B. Burford 3d and Dr. H. Grey Verner. McGraw-Hill Book Co., 330 W. 42 St., New York, N.Y. 10036. 6 x 9 in., 316 pp, Cloth, \$12

Discusses the formation and behavior of junctions, and the principles of transistor circuits. Covers single and multi-junctions, point contacts, and transistor applications.

BASIC ELECTRICITY, by Gilbert L. Rainey. Holt, Rinehart & Winston, 383 Madison Ave., New York, N. Y. 10017. 8½ x 11 in., 180 pp. Paper, \$3.95

One volume in a "Basic Industrial Electronic Series." All these are laboratory textbooks and are put together like workbooks. Each experiment is on some basic fundamental of electricity. Does not get into electronics in this basic text.

BASIC MICROWAVES, by Bernard Berkowitz, Hayden Book Co., Inc., 116 W. 14 St., New York, N. Y. 10011. 6 x 9 in., 168 pp. Paper, \$3.95, cloth \$5.95

Covers nature of microwaves, antennas and theory. Transmission lines and components. Fairly well-illustrated. Includes quite a bit of math, but understanding isn't entirely predicated on understanding the mathematics. Not for the beginner, but not at the engineering level either. END

SCHOOL DIRECTORY

LEARN ELECTRONICS

Get Your F.C.C. LICENSE and A.S.E.E. DEGREE

Move up. Take advantage of the good pay and security now offered by an electronics career. Grantham can train you quickly, in resident classes or by correspondence.

We offer the following courses—all of which are approved under the new *G.I. Bill*. Select the course you are interested in, and write or phone for free details.

- Electronics Engineering Technology* (resident course, which leads to the A.S.E.E. degree)
- Basic Electronics Engineering Technology* (correspondence course, which covers the first 1/3 of the EET course listed above, and credit for which can be applied toward the A.S.E.E. degree)
- Communications Electronics* (resident course, which leads to the FCC first class license and trains you to be a communications technician)
- F.C.C. License Course* (correspondence course, which leads to the FCC first class license)
- Radio & Television Servicing* (resident course, which trains you to be a service technician)

For complete information without obligation, write or telephone the School at any of the addresses listed below, and indicate the course you are interested in.

Dept. 67-P

Grantham School of Electronics

1505 N. Western Ave., Hollywood, Cal. 90027
Phone: (213) 469-7878
408 Marion Street, Seattle, Wash. 98104
Phone: (206) MA 2-7227
818-18th St., NW, Washington, D.C. 20006
Phone: (202) 298-7460

Circle 129 on reader's service card

start your career here

Tri-State graduates hold important engineering and business administration posts throughout the U. S. Tri-State is a small professionally-oriented college in the beautiful lake section of NE Indiana. Excellent faculty . . . well-equipped labs . . . new library and residence halls . . . 300-acre campus . . . small classes . . . rich tradition. Fully accredited. Modest costs. Four-quarter year permits degree in three years. One-year Drafting-Design Certificate program. For Catalog, write Director Admissions indicating career interest. Graduate placement outstanding!



TRI-STATE COLLEGE

2496 College Avenue, Angola, Indiana

LEARN Electronics Engineering AT HOME

Fix TV, design automation systems, learn transistors, complete electronics. College level Home Study courses taught so you can understand them. Earn more in the highly paid electronic industry. Computers, Missiles, theory and practical. Kits furnished. Over 30,000 graduates now employed. Resident classes at our Chicago campus if desired. Founded 1934. Catalog.

AMERICAN INSTITUTE OF ENGINEERING AND TECHNOLOGY

1139 W. Fullerton PKY., Chicago, Ill. 60614

GET INTO ELECTRONICS

V.T.I. training leads to success as technicians, field engineers, specialists in communications, guided missiles, computers, radar and automation. Basic & advanced courses in theory & laboratory. Electronic Engineering Technology and Electronic Technology curricula both available. Assoc. degree in 29 mos. B.S. also obtainable. G.I. approved. Graduates in all branches of electronics with major companies. Start Sept., Feb. Terms, campus. High school graduate or equivalent. Catalog.

VALPARAISO TECHNICAL INSTITUTE

Department C, Valparaiso, Indiana



Learn Electronics for your SPACE-AGE EDUCATION at the center of America's aerospace industry

No matter what your aerospace goal, you can get your training at Northrop Tech, in sunny Southern California.

COLLEGE OF ENGINEERING. Get your B.S. degree in engineering in just 36 months by attending classes year round. Most Northrop Tech graduates have a job waiting for them the day they're graduated!

A & P SCHOOL. Practical experience on real aircraft. One-year course prepares you for F.A.A. A & P certificate. WRITE TODAY FOR CATALOG.

NORTHROP INSTITUTE OF TECHNOLOGY

1199 W. Arbor Vitae, Inglewood, Calif.



COMING NEXT MONTH IN RADIO-ELECTRONICS INDUSTRIAL ELECTRONICS SPECIAL SECTION

CRYOGENICS: Discover what miracles can be performed at low temperatures! How supercooling is used for industrial research and development: superconductivity, space studies and environmental research.

THE INSTALLERS: A Career Series interview with an extremely successful group of installation and maintenance technicians who contract the big jobs, such as installing a radar system or an instrumentation system in a factory, or even a CATV system!

TESTING CAMERA SHUTTERS WITH YOUR SCOPE: An informative feature for technician-photographers explains how to take an ordinary service scope and turn it into a device that will measure how long the shutter remains open.

MANY MORE INTERESTING FEATURES

In the October issue on Sale September 20 at Newsstands and Parts Distributors

ADVERTISING INDEX

MARKET CENTER

BLACK/WHITE OR COLOR

THE ONLY SAFE NON-DRIFT TV TUNER CLEANERS

AVAILABLE AT ALL DISTRIBUTORS

CHEMTRONICS

BROOKLYN, N. Y. 11236



FREE CATALOG!

148 PAGES • NEARLY 4,500 BARGAINS

OPTICS • SCIENCE • MATH

Completely new 1966 edition. New items, categories, illustrations. Dozens of electrical and electromagnetic parts, accessories. Extensive selection of Astronomical Telescopes, Microscopes, Binoculars, Magnifiers, Mirrors, Lenses, Prisms. Many war surplus items for hobbyists, experimenters, workshop, factory. Write for catalog "EH".



CLIP AND MAIL COUPON TODAY

EDMUND SCIENTIFIC CO., Barrington, N. J. 08007
PLEASE SEND ME FREE CATALOG "EH"

Name

Address

City

State

ZIP

BIG CATALOG

World's "BEST BUYS" in GOV'T. SURPLUS Electronic Equipment

FULL OF TOP QUALITY ITEMS—

Transmitters, Receivers, Power Supplies, Inverters, Microphones, Filters, Meters, Cable, Keys, Phones, Antennas, Chokes, Dynamotors, Blowers, Switches, Test Equipment, Headsets, Amplifiers, etc., etc. **SEND 25¢** (stamps or coin) for **CATALOG** and receive **50¢ CREDIT** on your order. Address Dept. RE.

FAIR RADIO SALES

P.O. Box 1105 • LIMA, OHIO • 45802

CLASSIFIED COMMERCIAL RATE (for firms or individuals offering commercial products or services): 60¢ per word . . . minimum 10 words.

NON-COMMERCIAL RATE (for individuals who want to buy or sell personal items): 30¢ per word . . . no minimum.

Payment must accompany all ads except those placed by accredited advertising agencies. 10% discount on 12 consecutive insertions, if paid in advance. Misleading or objectionable ads not accepted. Copy for November issue must reach us before September 10th.

WORD COUNT: Include name and address. Name of city (Des Moines) or state (New York) counts as one word each. Zone or Zip Code numbers not counted. (We reserve the right to omit Zip Code if space does not permit.) Count each abbreviation, initial, single figure or group of figures or letters as a word. Symbols or groups such as 8-10, COD, AC, etc., count as one word. Hyphenated words count as two words. Minor over-wordage will be edited to match advance payment.

GENERAL

CONVERT ANY TELEVISION to sensitive Big-Screen Oscilloscope. Only minor changes required. No electronic experience necessary. Illustrated plans \$2.00. **RELCO-A25**, Box 10563, Houston 18, Texas.

TV SERVICE ORDER BOOKS for use with your rubber stamp. Duplicate or triplicate. Low cost. Write for **FREE 32 PAGE CATALOG** and Special Rubber Stamp Offer. **DELRIK PUBLICATIONS**, 6556 W. Higgins, Chicago, Ill. 60656.

FREE ELECTRONICS (new and surplus) Parts catalog. We repair multimeters. **BIGELOW ELECTRONICS**, Bluffton, Ohio 45817

PRINTING PRESSES. Type, Supplies. Lists 5¢. **TURNBAUGH SERVICE**, Mechanicsburg, Pa.

VIDEO TAPE exchange correspondence, pen pal type with anyone, anywhere using Ampex 1" tape system. **ED CUSHMAN**, Eniwetok, M.I. APO, San Francisco 96333

New scientific transistor instrument detects buried coins, treasures. Will detect gold, silver, copper, iron, etc. \$19.95 up. Free catalog. **RELCO-A-25**, Box 10563, Houston 18, Texas.

WANTED

QUICK CASH . . . for Electronic EQUIPMENT, COMPONENTS, unused TUBES. Send list now! **BARRY**, 512 Broadway, New York, N. Y. 10012, 212 WALKER 5-7000.

MERCURY, platinum, gold, silver. **FREE** circular. **MERCURY REFINERS**, Norwood, Mass.

INVENTIONS WANTED. Financial Assistance. Free protection forms, information. Contact: **INTERNATIONAL INVENTION INSTITUTE**, Dept. 29, 160 Broadway, New York, New York 10038

WANTED: Radar Equipment AN/TPS-10D, APT-9, SCR-584, AN/GPG-1, M-33 etc., **P. J. PLISHNER**, 550 Fifth Avenue, N. Y. Tele: 212 JU 6-4691

18 Volt Dynamotors Wanted. Must have shaft at both ends. **NELSON BROS.**, PO Box 7275, Phoenix, Ariz. 85011

RADIO-ELECTRONICS does not assume responsibility for any errors which may appear in the index below.

Allied Radio Corp.	73-74, 89
Amperex Electronic Corp.	Second Cover
Amplifier Corp. of America	106
Arrow Fastener Co., Inc.	80
B & K Manufacturing Co., (Div. of Dynascan Corp.)	13
Blonder-Tongue	69
Brooks Radio & TV Corp.	98-99
Browning Laboratories, Inc.	96
Capitol Radio Engineering Institute, The ..	62-65
Castle TV Tuner Service, Inc.	22
CLASSIFIED	108-111
Cleveland Institute of Electronics	I, 18-21
Conar (Div. of National Radio Institute) ..	76
Cornell Electronics Co.	110
Delta Products, Inc.	72
DeVry Technical Institute	5
Electro-Voice, Inc.	70
Electronic Measurement Corp. (EMC)	96
Elpa Marketing Industries, Inc.	90
Finney Co.	71
Gernsback Library Inc.	100, 109
Hallet Manufacturing Co.	23
Hallcrafters	26
Heald's Engineering College	101
Heath Company	77, 79, 81
International Crystal Mfg. Co., Inc.	112
International Radio Exchange	90
Jensen Manufacturing Division (The Muter Company)	Third Cover
Jerrold Electronics Corporation (Distributor Sales Division)	27
Johnson, E. F.	7
Judson Research and Mfg. Co.	70
Lafayette Radio Electronics	93-94
Lampkin Laboratories Inc.	87
Mercury Electronics Corporation	95
Motorola Semiconductor Products, Inc.	15
Music Associated	76
National Radio Institute	8-11, 68
Nova-Tech	88
Olson Electronics, Inc.	90
Perma-Power Company	24
Poly Paks	111
Precise Electronics & Development (Div. of Designatronics, Inc.)	66
Pyramid Assoc., Inc.	86
Quam-Nichols Co.	78
Quietrol Co.	101
Radio Shack	102-105
RCA Components & Devices Tubes	Fourth Cover
RCA Institute, Inc.	28-31
RCA Parts and Accessories	75
RCA Service Corp.	85
Reading Improvement Program	99
Rider Publishing, Inc., John F. (Div. of Hayden Book Co., Inc.)	91
Rye Sound Corporation	92
S & A Electronics Inc.	16
Sams & Co., Inc., Howard W.	25, 61
Semitronics	92
Sencore	80
Shure Bros.	17
Simpson Electric Company	70
Sony Corp. of America	67
Sprague Products Company	12
Texas Crystals (Div. of Whitehall Electronics Corp.)	80
United Radio Co.	109
University Sound (Div. of LTV Ling Altec, Inc.)	88
Univac (Division of Sperry Rand Corporation) ..	14
Warren Electronic Components	106
Weller Electric Co.	97
Winegard Co.	76
MARKET CENTER	108-111
Chemtronics	
Edmund Scientific Corp.	
Fair Radio Sales	
SCHOOL DIRECTORY	107
American Institute of Engineering & Technology	
Grantham School of Electronics	
Northrop College of Science & Engineering	
Tri-State College	
Valparaiso Technical Institute	

MARKET CENTER

HI FI Equipment At Dealer. Wholesale Cost. Catalog. **MACALESTER CORPORATION**, 355 Macalester, Saint Paul, Minnesota 55105.

BUSINESS AIDS

JUST STARTING IN TV SERVICE? Write for **FREE 32 PAGE CATALOG** of Service Order books, invoices, job tickets, phone message books, statements and file systems. **OELRICH PUBLICATIONS**, 6556 W. Higgins, Chicago, Ill. 60656. New Hyde Park 5, N.Y.

1,000 Business Cards, "Raised Letters" \$3.95 postpaid. Samples. **ROUTH RE12**, 2633 Randleman, Greensboro, N. C. 27406.

GOLD EMBOSSED Business Cards. Samples. **MTL PRINTCRAFT**, Box 947, Chicago 60690

BUSINESS OPPORTUNITIES

INVENTIONS-IDEAS developed: Cash/Royalty sales. Member: **UNITED STATES CHAMBER COMMERCE**, Raymond Lee, 130-U W. 42nd, New York City 10036

ELECTRONICS

BARGAINS in Canadian Electronic equipment and surplus. Send \$1.00 for giant catalogs. **ETCO**, Dept. R, 520 Fifth Avenue, New York 36, N.Y.

TRANSISTOR ignition kits, components. Free diagrams. **ANDERSON ENGINEERING**, Epsom, N.H. 03239

DIAGRAMS, service information. Radio \$1.00. Television \$2. **BEITMAN**, 1760 Balsam, Highland Park, Illinois 60035

PROFESSIONAL ELECTRONICS PROJECTS — Organs, Timers, Computers, etc.—\$1 up. Catalog 25¢. **PARKS**, Box 25565, Seattle, Wash. 98125.

TUBES. "Oldies", latest. Lists free. **STEINMETZ**, 7519 Maplewood, Hammond, Indiana, 46324.

FREE Catalog. Electronic parts, tubes. Wholesale. Thousands of items. Unbeatable prices. **ARCTURUS ELECTRONICS RE**, 502-22 St., Union City, N. J. 07087

BEFORE You Buy Receiving Tubes, Transistors, Diodes, Electronic Components & Accessories — send for **Giant Free Zalytron Current Catalog**, featuring all **STANDARD BRAND TUBES** all Brand New Premium Individually Boxed. One Year Guarantee—all at **BIGGEST DISCOUNTS** in America! We serve professional servicemen, hobbyists, experimenters, engineers, technicians. **WHY PAY MORE? ZALYTRON TUBE CORP.**, 469R Jericho Turnpike, Mineola, N. Y. 11502

TV CAMERAS, transmitters, converters, etc. Lowest factory prices. Catalog 10¢. **VANGUARD**, 196-23 Jamaica Ave., Hollis, N.Y. 11423.

SURPLUS PARTS CATALOG. Send for free catalog listing hundreds of up-to-date electronic components at down-to-earth prices. **ELECTRONIC CONTROL DESIGN COMPANY**, P.O. Box 1432-P, Plainfield, N.J. 07061.

NEON AC/DC ELECTRIC TESTER
FOR HOME AUTO SHOP
Special! 59¢

Special!
With every \$10 Order
25¢ per tube
No Limit! from this list
6AG5 6SN7
6AQ5 6CB6 6S4
6AU6 6J6 6W4

CORNELL TUBES

1 YR. GUARANTEED

Mutual Conductance Lab-tested, Individually Boxed, Branded and Code Dated, Tubes are new, or used and so marked.

21 PICTURE TUBES
1 1/2 yr. Guaranteed
Eliminated No C.O.D.'s on Picture Tubes

all purpose ELECTRONIC CLEANER
89¢ plus 30¢ shipping
ELECTRONIC CLEANER
LUBRICATES AND STORES
TUBES - CORNELL

33¢ PER TUBE

100 TUBES OR MORE: **30¢ PER TUBE**

024	6A55	6CD6	6K6	6X4	12BF6
1B3	6AT6	6CF6	6K7	6X8	12BH7
1J3/1K3	6AT8	6CG7	6Q7	7A7	12BL6
1H5	6AU4	6CG8	6S4	7AB	12BY7
1L4	6AU5	6CM7	6SA7	7B6	12C5
1T4	6AU6				12CA5
1U4	6AV6				12CN7
1X2	6AW8				12SQ7
3BZ6	6AX4				25L6
3DG4	6BA6				25Z6
5U4	6BC5	6CZ5	6SH7	7C5	35W4
5UR	6BD6	6D6	6SJ7	7N7	35Z3
5V4	6BG6	6DA4	6SK7	7Y4	50L6
5Y3	6BJ6	6DE6	6SL7	12AD6	24
6A6	6BL7	6DG6	6SN7	12AE6	27
6A8	6BN4	6EA7	6SQ7	12AF6	77
6A84	6BN6	6EM5	6SR7	12AT7	78
6AC7	6BQ6	6F6	6U7	12AU7	84/6Z4
6AG5	6BQ7	6G8	6U8	12AX7	5687
6AK5	6BZ6	6GH8	6V6	12BA6	6350
6AL5	6C4	6H6	6W4	12BD6	6463
6AN8	6C6	6J5	6W6	12BE6	7044
6AQ5	6CB6	6J6			

Other tubes at low prices—send for free list

NO SUBSTITUTIONS WITHOUT YOUR PERMISSION

NEW! EASY TO USE! RADIO-TV TUBE TESTER
TEST and REPAIR TV & RADIO SETS APPLIANCES
\$2.89 plus 30¢ shipping

11,000 TUBE SUBSTITUTES
1.25

ABC COLOR TV \$100
GET AHEAD OF THE FIELD

PICTURE EXPANDER
99¢

SOLDERING GUN
2.99

CORNELL ELECTRONICS CO.

Dept RE 9 4217 University Ave., San Diego, Calif. 92105

TERMS: Add 3c per tube shipping. Orders under \$5.00 add 3c per tube shipping plus 50c handling. Canadian orders add approximate

postage. Send 25% deposit on C.O.D. orders. No C.O.D. orders under \$5.00 or to Canada No 24 hr. free offer on personal check orders

5-DAY MONEY BACK OFFER

MESHNA CONVERTER KITS, converts car radio for shortwave reception. Police, fire, marine. 30-50mc, 100-200mc, marine. Any kit \$5.00. Completely wired for use \$15.00. MESHNA, Lynn, Mass. 01904.

RADIO & TV TUBES 33¢ each. One year guaranteed. Plus many unusual electronic bargains. Free catalog. CORNELL 4217-E University, San Diego, California 92105

TRANSISTORS-DIODES — Components. Large selection. Write for FREE catalogue. ELECTRONIC COMPONENTS CO. Box 2902B, Baton Rouge, La. 70821

FOR SALE: one RCA AVR11 Radio Receiver, 150 KC-550 KC, 550KC thru 22MC, one RCA AR88 Radio Receiver, with meter same as new, one Westinghouse TCE-1 Transmitter less power supply, with all plug-in units. Best cash offer. W2YXW, 904 Morgan Ave., Palmyra, New Jersey. (609) 829-3027

SOLID STATE CONVERTERS, 50-54 mc input. Crystal controlled, 2.5 db noise figure. Wired and tested. \$25 pbd. SYNTELEX, 39 Lucille, DuMont, N. J. 07628

BUILD A CODETYPER. Transistorized electronic computer-typewriter for Morse teaching or keying your rig with fb fist. For schematic, parts list and technical dope send \$2 to COMPUTRONICS ENGINEERING, Box 6606 Metropolitan Station, Los Angeles, 90059

BEGINNERS, BUILDERS' Giant catalog—25¢, refundable. LABORATORIES, 993-B, Redwood City, California 94064

New Soldering efficiency-remarkable one hand gun; Guaranteed free information. VALVE PRODUCTS Dept. D, Box 208, Hamilton, Montana 59840

TV CAMERA KITS including printed circuit and transistor models \$18.95 up! Send 10¢ for 1966 catalog. ATV RESEARCH, Box 396-R, So. Sioux City, Nebr. 68776

GOVERNMENT SURPLUS

72 page illustrated Government Surplus Radio, Gadgeteers Catalog 25¢. MESHNA, Nahant, Mass.

EDUCATION/ INSTRUCTION

LEARN ELECTRONIC ORGAN SERVICING. New home study course covering all makes electronic organ including transistors. Experimental kits—schematics—trouble-shooting. Accredited NHSG-1 Approved. Write for free booklet. NILES BRYANT SCHOOL, 3631 Stockton Blvd., Dept. F, Sacramento 20, Calif.

FCC LICENSE in 6 weeks. First Class Radio Telephone. Results Guaranteed. ELKINS RADIO SCHOOL, 2603E Inwood, Dallas, Tex.

SLEEP LEARNING. Hypnotism! Tapes, records, books, equipment. Details, strange catalog FREE. RESEARCH ASSOCIATION, Box 24-RD, Olympia, Wash.

BROADCASTING, Communications Electronics taught quickly—resident classes; correspondence. Free details. Write: Dept. 4, GRANTHAM SCHOOLS, 1505 N. Western, Hollywood, Calif. 90027

REI First Class Radio Telephone License in (5) weeks Guaranteed. Tuition \$295.00. Job placement free. RADIO ENGINEERING INSTITUTE, 1336 Main Street, Sarasota, Fla.

ENGINEERING and Electronics—send \$1.00 for 100 page Career Opportunities. C.I.S.T., Suite 655, 263 Adelaide Street West, Toronto, Canada.



DOUBLE BONUS
\$25
 WORTH OF
 TRANSISTORS
 RECTIFIERS
 RESISTORS
 CONDENSERS
 DIODES & ETC.
 Add 25¢ for handling
BOTH FREE WITH ANY \$10 ORDER

PLUS
 CHOOSE ANY
\$1.00
 ITEM
 FREE

SALE
FIELD-EFFECT TRANSISTORS
2\$1
 For experimental & shop use.
 N-channel
 P-channel
 TO-5

FACTORY TESTED SEMI-KON-DUCTORS

- 2 Bidirectional Transistors 2N1641 ... \$1
- 4 2N170 TRANSISTORS, by GE, npn for gen'l use \$1
- 1 IGNITION SWITCHING TRANSISTORS, 10 AMP \$1
- 4 2N336 NPN SILICON transistors, Transistron \$1
- 10 ZENERS REFERENCES stud, asst types ... \$1

WELL KNOWN MAKE 1. AMP 800 PRV SUBMINIATURE 4 FOR RECTIFIERS \$1

SILICON POWER STUD RECTIFIERS

AMPS	25 PIV	50 PIV	100 PIV	200 PIV
3	5¢	7¢	12¢	19¢
15	15¢	22¢	40¢	65¢
35	39¢	50¢	75¢	1.19

AMPS	400 PIV	600 PIV	800 PIV	1000 PIV
3	25¢	35¢	45¢	69¢
15	90¢	1.35	1.59	1.79
35	1.90	2.50	2.75	2.95

10 FAMOUS CK722 TRANSISTORS, npn no test \$1

- 5 2N107 TRANS'RS, by GE, npn, pop, audio pak \$1
- 2 40W NPN SILICON MESA 2N1648, 2N1048 \$1
- 25 ZENERS GLASS SILICON DIODES, no test ... \$1
- 5 SUN BATTERIES TO 1 1/2" sizes, lite sensitive \$1
- 2 2N718 NPN SILICON PLANARS, by Fairchild . \$1
- 4 2N213 TRANSISTORS, mixer-convt, TO22 ... \$1
- 10 MICRODIODE STABILIZERS, epoxy, silicon ... \$1
- 3 2N706 500MW, 300MC NPN PLANAR, TO-18. \$1
- 10 PHILCO MAT HI-FREQ. TR'SISTORS, untested. \$1
- 4 2N255 POWER TRANSISTOR EQUALS, TO3 cases \$1
- 2—500MC, 2N708 NPN Silicon planar TO46 ... \$1
- 3 2N711 300MW, 300 MC, PNP MESA, TO18 ... \$1
- 15 1AMP 200V epoxy rectifiers, made by Sylvania \$1
- 25 "EPOXY" SILICON DIODES, untested ... \$1
- 4 ZENER REFERENCES, 1N429, 6-volt, silicon . \$1
- 2 "TINY" 2N1613 2W, 100MC, TO18 case, npn \$1
- 4 500MC TRANS'RS; 2N964, mesas, npn, TO18 \$1
- 1 85W SILICON PWR TRANSTR, npn, like 2N1212 \$1
- 4 2N43 OUTPUT TRANSISTORS, by GE, npn, TO5 \$1
- 4 2N333 NPN SILICON transistors, by GE, TO5 \$1

FOR OUR "FALL" BARGAIN CATALOG ON:

Semiconductors Poly Paks Parts

10¢

POLY PAKS

TERMS: send check, money order, include postage—avg. wt. per pak 1 lb. Rated, net 30 days. CODs 25%.

P. O. BOX 942R
 SO. LYNNFIELD, MASS.
 "PAK-KING" OF THE WORLD

WORLD'S MOST POPULAR \$1 PARTS PAKS

- 3 INFRA-RED DETECTORS, with leads ... \$1
- \$25 SURPRISE PAK: transistors, rect, diodes, etc. \$1
- 40 PRECISION RESISTORS, 1/2, 1, 2W; 1% values \$1
- 30 CORNING "LOW NOISE" resistors, 5% too! \$1
- 60 TUBULAR CONDENSERS, to .5mf, to 1Kv, asst \$1
- 40 DISC CONDENSERS, 27mf to .05mf to 1KV \$1
- 60 TUBE SOCKETS, receptacles, plugs, audio, etc. \$1
- 30 POWER RESISTORS, 5 to 50W, to 24 Kohms. \$1
- 50 MICA CONDENSERS, to .1mf, silvers too! \$1
- 10 VOLUME CONTROLS, to 1 meg, switch tool . \$1
- 10° ELECTROLYTICS, to 500mf, asst FP & tubulars \$1
- 50 RADIO & TV KNOBS, asstd. colors & styles . \$1
- 10 TRANSISTOR ELECTROLYTICS: 10mf to 500mf \$1
- 50 COILS & CHOKES, if, rf, ant, osc, & more ... \$1
- 35 TWO WATTERS, asst incl: A.B., 5% too! ... \$1
- 75 HALF WATTERS, asst incl: A.B., 5% too! ... \$1
- 60 HI-Q RESISTORS, 1/2, 1, 2W, 1% & 5% values \$1
- 10 PHONO PLUG & JACK SETS, tuners, amps ... \$1

ZENER VOLTAGE REGULATORS 1 WATT

3 For \$1

Volts	Volts	Volts	Volts	Volts	Volts	Volts	Volts
<input type="checkbox"/> 10	<input type="checkbox"/> 15	<input type="checkbox"/> 22	<input type="checkbox"/> 33	<input type="checkbox"/> 47	<input type="checkbox"/> 58	<input type="checkbox"/> 100	<input type="checkbox"/> 150
<input type="checkbox"/> 11	<input type="checkbox"/> 16	<input type="checkbox"/> 24	<input type="checkbox"/> 36	<input type="checkbox"/> 51	<input type="checkbox"/> 75	<input type="checkbox"/> 110	<input type="checkbox"/> 160
<input type="checkbox"/> 12	<input type="checkbox"/> 18	<input type="checkbox"/> 27	<input type="checkbox"/> 39	<input type="checkbox"/> 56	<input type="checkbox"/> 82	<input type="checkbox"/> 120	<input type="checkbox"/> 180
<input type="checkbox"/> 13	<input type="checkbox"/> 20	<input type="checkbox"/> 30	<input type="checkbox"/> 43	<input type="checkbox"/> 62	<input type="checkbox"/> 91	<input type="checkbox"/> 130	<input type="checkbox"/> 200

10 TUBULAR ELECTROLYTICS, to 500 mf ... \$1

- INFRA-RED PHOTO DETECTOR TRANSDUCER ... \$1
- INFRA-RED PARABOLIC REFLECTOR & FILTER ... \$1
- 40 WORLD'S SMALLEST COND., to .05mf ... \$1
- 4 TRANSISTOR TRANSFORMERS, asst. worth \$25 \$1
- 2 CLAIREX PHOTO ELECTRIC CELL, CL607 ... \$1
- 60 CERAMIC CONDENSERS, discs, npn's, to .05 \$1
- 40 "TINY" RESISTORS, 1/10W, 5% too! ... \$1
- 10 TRANSISTOR SOCKETS for npn-npn transistors \$1
- 30 MOLDED COND'S, mylar, pore, black beauty \$1
- 10 2-6Amp RECT's, studs, silicon, 50 to 400V ... \$1
- 3 -25-AMP SILICON STUD RECTIFIERS ... \$1
- 3 2-WATT PLANAR TRANS'RS, 2N697, 100mc \$1
- 4 2N35 TRANSISTORS, npn, by Sylvania, TO22 ... \$1

FIRST TIME IN U.S.A! "ONE PRICE" SCRS!

Imagine 7-amp, 16-amp and 25-amp at one price! Just check the proper amp and PRV blocks.

7-Amps 16-Amps 25-Amps

PRV	Sale	PRV	Sale	PRV	Sale
<input type="checkbox"/> 200	1.35	<input type="checkbox"/> 600	3.50	<input type="checkbox"/> 1000	5.75
<input type="checkbox"/> 400	2.50	<input type="checkbox"/> 800	4.50		

750 MIL TOP HAT AND EPOXIES

PIV	Sale	PIV	Sale	PIV	Sale
50	5¢	600	19¢	1400	95¢
100	7¢	800	29¢	1600	1.10
200	9¢	1000	51¢	1800	1.35
400	13¢	1200	69¢	2000	1.50

Circle 132 on reader's service card

If You Service Citizens Radio Transceivers...

you should have

AN INTERNATIONAL

C-12B

FREQUENCY METER

Four Instruments In One

The C-12B is more than a frequency standard — it measures power output, measures AM modulation, and is a signal generator . . . all self contained in one convenient unit.

check these features!

- **Frequency Measurement** — Range 26.965 mc to 27.255 mc. Frequency stability $\pm .0025\%$ 32°F to 125°F; $\pm .0015\%$ 50°F to 100°F.
- **Power Measurement** — 0 to 5 watts, accuracy $\pm 1/4$ watt.
- **Counter Circuit** — Frequency range 0 to 3 kc. Residual error 100 CPS @ zero beat.
- **AM Modulation Measurement** — Range 0 to 100%. Accuracy 3% @ 400 CPS @ 80% modulation.
- **Signal Generator** — Frequency range 26.965 mc to 27.255 mc. Low output 1 microvolt through special pick-off box furnished with meter. High output 100 microvolts through output jack.



- **Panel Controls** — Channel selector, 24 positions • "Hi-Lo" frequency adjust • RF level control • Modulation set • Power • Meter calibration adjust • Function selector, 7 positions • Modulation • RF • Deviation • Calibration • Battery Test "A" • Battery Test "B" • Battery Test "C".
- **Battery Power Required** — 1½ vdc @ 60 ma, 67½ vdc @ 5 ma, 9 vdc.

The C-12B is capable of holding 24 crystals and comes with 23 crystals installed. Everything you need including connecting cable, PK box, dummy load, and batteries.

Cat. No. 620-101 \$300.00

Manufacturers of precision electronic products for home, industry and aerospace needs.

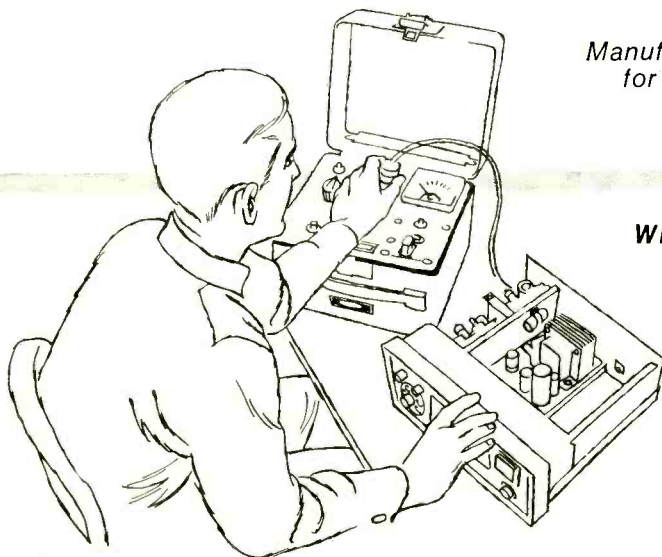

WRITE FOR COMPLETE CATALOG



CRYSTAL MFG. CO., INC.
18 NO. LEE • OKLA. CITY, OKLA. 73102

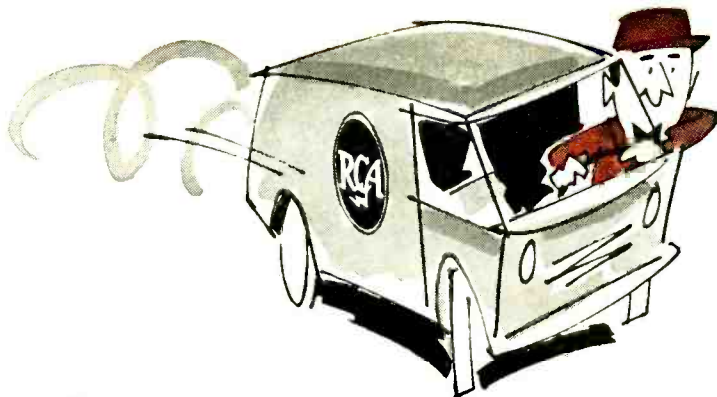

Poor convergence?



...check the horizontal and vertical output stages first

Sometimes the problem of misconvergence can be due to changes of characteristics in the horizontal and vertical output circuits. If the set has poor convergence here's a short check list of preliminary steps that may save you some valuable time. So, take a few moments and follow these easy steps...

1. Check the raster to see that it fills the entire screen. If it does not, check the height and width adjustments, the vertical and horizontal-output tubes, and the high-voltage section.
2. Measure the high voltage with your RCA VTVM or VOM, and high voltage probe. Rotate the brightness control and check voltage at various levels. Voltage should hold at all settings. If it does not, check the high voltage regulator circuit.
3. With your convergence-pattern generator, set up a crosshatch pattern. Then check and adjust linearity, if required. The crosshatch rectangles should be of uniform size. If not, adjust the vertical and horizontal linearity until you get a uniform effect.
4. Re-check items 1, 2, and 3.
5. Check color purity. If required, degauss the set and reset purity.

If these checks do not clear up the misconvergence, then make convergence adjustments as described in the service data.

For more satisfied customers, you'll find your local RCA Distributor your best source for top quality RCA receiving tubes for color TV.

RCA ELECTRONIC COMPONENTS AND DEVICES, HARRISON, N. J.



The Most Trusted Name in Electronics