

Radio-Electronics

JULY 50c

TELEVISION · SERVICING · HIGH FIDELITY

A
GERNSBACK
PUBLICATION

**New Tricks With a
Different Photocircuit**

**Sweep-Aligning
The TV I. F.**

**Resistor Decade Box
Handles High Wattage**

HUCO GERNSBACK, Editor-in-chief

**Ten Tubes in One —
New Klystron Puts Out
40 Kw at 8.4 Gigacycles**

See page 4

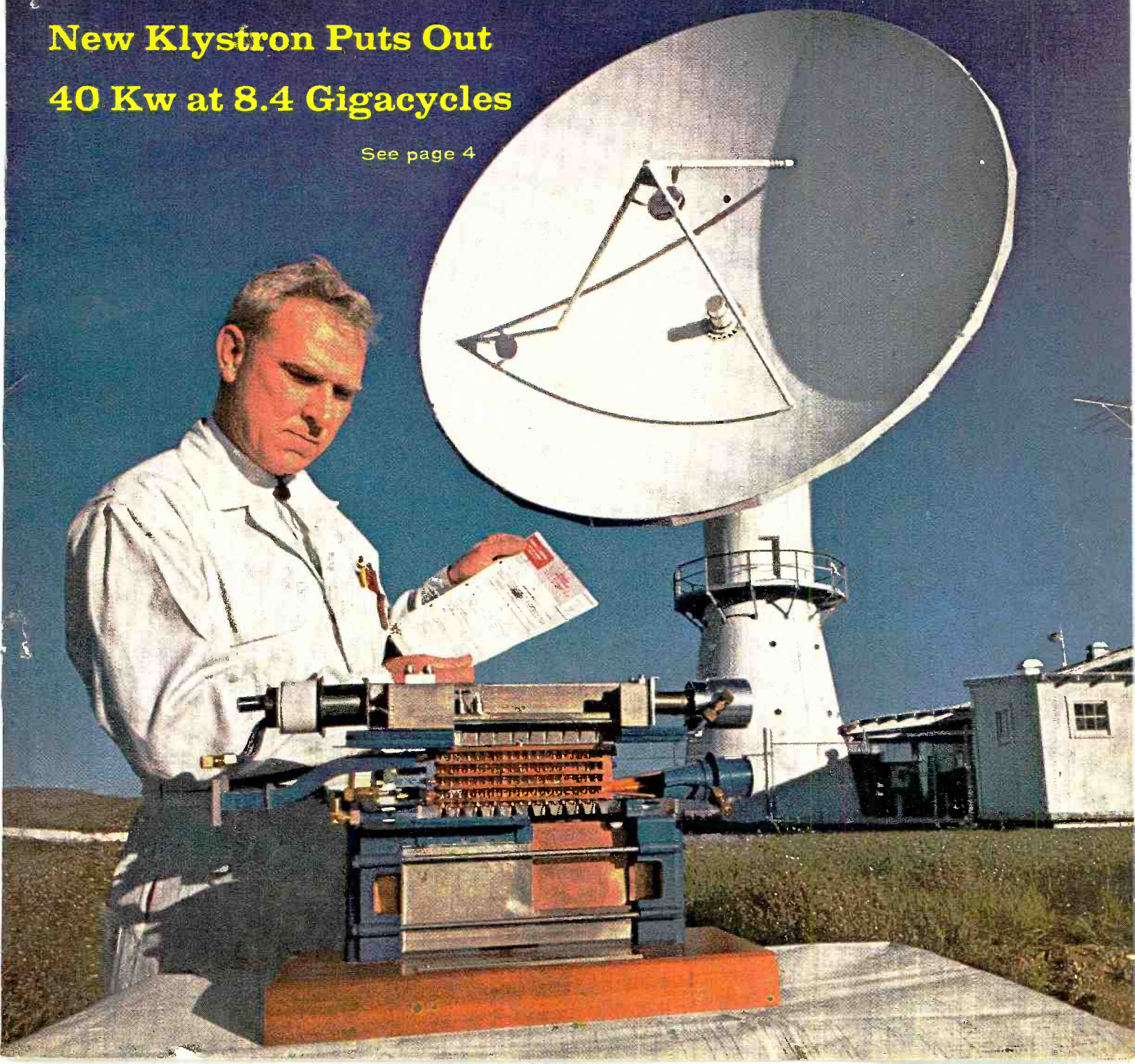

are you replacing
top quality tubes
with identical
top quality tubes
?

Now you can carry the identical tubes that you find designed into most of the quality TV sets you service. Chances are, you were not aware that these TV sets were designed around special Frame Grid tubes originated by Amperex and that even more tube types originated by Amperex are being designed into the sets you'll be handling in the future. Amperex frame grid tubes provide 55% higher gain-bandwidth, increase TV set reliability by simplifying circuits and speed up your servicing because their extraordinary uniformity virtually eliminates need for re-alignment when you replace tubes.

Tubes introduced by Amperex, currently used by major TV set makers include:

Frame Grid				Others	
2GK5	4GK5	6GK5	6EH7	6AL3	9A8
2ER5	4EH7	6ES8	6EJ7	6BL8	15CW5
3GK5	4EJ7	6ER5	6HG8	6BQ5	16AQ3
3EH7	4ES8	6FY5	7HC8	12AX7	27GB5

For optimum satisfaction for your customers and a better profit operation for yourself, make room in your caddy now for these matchless-quality tubes. Next time you visit your distributor, look for the green-and-yellow boxes and enjoy confidence in your work such as you never have before. Amperex Electronic Corporation, Hicksville, L. I., New York.

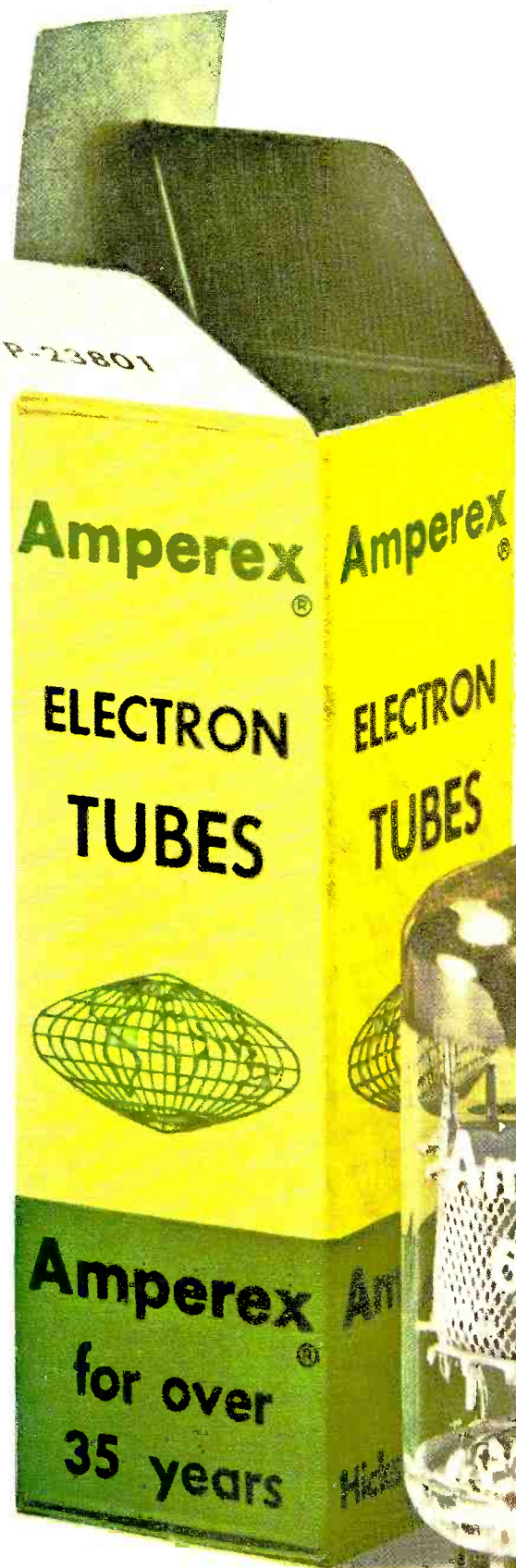

NOW 10 WAYS Pick Your Electronics Field and Train at Home with the Leader

Which field of Electronics is for you? NRI's 10 specialized instruction plans give you a choice of ways to go within the amazing Electronics field. Mail coupon for full information.

1 TELEVISION-RADIO SERVICING

Learn to fix black-and-white and color sets, AM-FM radios, stereo hi-fi, etc. A profitable part or full-time business of your own.

2 INDUSTRIAL-MILITARY ELECTRONICS

Learn Principles, Practices, Maintenance of Electronic equipment. Covers computers, servos, telemetry, multiplexing, other subjects.

3 COMPLETE COMMUNICATIONS

Comprehensive training for broadcasting or mobile, marine, aviation communications. Learn to operate, maintain transmitting equipment. Prepares for FCC License.

4 FCC LICENSE

Prepares you quickly for First Class License exams. Every communications station must have licensed operators. Also valuable for Service Technicians.

5 MATH FOR ELECTRONICS

A short course of carefully prepared texts from basic arithmetic to graphs and electronics formulas. Quick, complete, low in cost.

6 BASIC ELECTRONICS

26-lesson course covering Automation-Electronics, TV-Radio language, components, principles. Ideal for salesmen, hobbyists, others.

7 ELECTRONICS FOR AUTOMATION

For the man with a knowledge of basic electronics who wants to learn process control, ultrasonics, telemetering and remote control, electromechanical measurement, others.

8 AVIATION COMMUNICATIONS

For a career in and around planes. Covers direction finders, ranges, markers, loran, shoran, radar, landing system transmitters. Prepares for FCC License.

9 MARINE COMMUNICATIONS

Learn to operate, repair transmitters, direction finders, depth indicators, radar, other Electronic equipment used on commercial and pleasure boats. A growing, profitable field. Prepares for your FCC License.

10 MOBILE COMMUNICATIONS

Learn to install, operate, maintain mobile equipment and associated base stations as used by police, fire departments, taxi companies, etc. Prepares for FCC License.

NOTE: You must pass your FCC License exam (Communications courses) or NRI refunds in full the tuition you have paid.

NRI CUSTOM-DESIGNED TRAINING KITS MAKE LEARNING EXCITING, FAST

Tens of thousands of hours have been invested by NRI engineers and technicians in testing, changing, retesting and improving NRI training kits. Their aim: to simplify and speed your training, make it absorbing, exciting, fun to learn. Unlike other schools, "stock" or "standard" equipment has never been good enough. NRI custom-designs equipment exclusively for training. It demonstrates the theory you read about in clearly written, well illustrated lesson texts. It brings to life circuit action, defects, end-results. You learn operation, maintenance, trouble-shooting, by the exciting "discovery" method.

50 YEARS OF LEADERSHIP IN ELECTRONICS TRAINING

Fifty years of leadership in home-study Radio-TV, Electronics training is behind the NRI instruction plan you select. A half century has been devoted to simplifying and perfecting training to make home-study easier, more interesting, more meaningful. Whatever your reason for wanting knowledge in Electronics (hobby, part-time earnings, retirement income or full career) . . . whatever your education, you'll find an NRI plan to fit your needs. Before you consider enrolling with any school, you owe it to yourself to see what NRI offers you. Mail coupon for catalog. No salesman will call. National Radio Institute, Washington, D.C. 20016.



BUILD ACTUAL TRANSMITTER

Complete your Communications course by building an actual phone-CW transmitter with components NRI sends. Complies with FCC regulations. Can be put on the air.

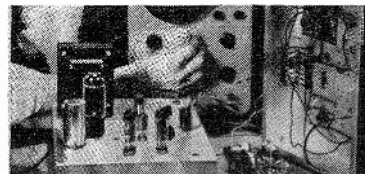

BUILD COMPUTER CIRCUITS

In NRI's Electronics course you solve mathematical problems with analog computer circuits you build yourself. One of 10 training kits you get.

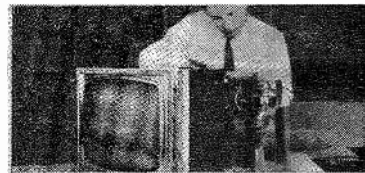

BUILD YOUR OWN TV SET

As part of NRI's Servicing course you get everything to build this complete attractive set from "the ground up." What better way to learn, than to do it?

MAIL NOW

3-74



NATIONAL RADIO INSTITUTE
WASHINGTON, D.C. 20016

I have checked the field(s) of most interest to me. Please send me your catalog. (No salesman will call.) Please PRINT.

- | | |
|--|---|
| <input type="checkbox"/> TV-Radio Servicing | <input type="checkbox"/> Basic Electronics |
| <input type="checkbox"/> Industrial Electronics | <input type="checkbox"/> Electronics For Automation |
| <input type="checkbox"/> Complete Communications | <input type="checkbox"/> Aviation Communications |
| <input type="checkbox"/> FCC License | <input type="checkbox"/> Marine Communications |
| <input type="checkbox"/> Math For Electronics | <input type="checkbox"/> Mobile Communications |

Name _____ Age _____

Address _____

City _____ State _____ Zip _____ Code _____

ACCREDITED MEMBER NATIONAL HOME STUDY COUNCIL



Radio-Electronics

JULY 1964 VOL. XXXV NO. 7

Over 55 Years of Electronic Publishing

EDITORIAL

- 26 Electronics' Future *Hugo Gernsback*

AUDIO-HIGH FIDELITY-STEREO

- 30 Notes From A Tape Recorder Service Book *Steve P. Dow*
Valuable hints for the audio technician
- 48 Center Bass Channel for Stereo *Robert F. Scott*
Cost and space-saving manufacturers' methods can be adapted to your own small system
- 57 Equipment Report: KLH Model Sixteen and Heath AJ-33
Transistor audio amplifier and all-transistor AM-FM-stereo tuner

ELECTRONICS

- 38 Try a Selective Photocircuit *Tom Jaski*
A what?
- 50 Tachometers for Speed Control *Matthew Mandl*
How the two basic types operate
- 53 Transistors Keep a Roof On *J. K. Bach*
- 62 Re: Transistors Save Your Breaker Points

GENERAL

- 43 What's New?
Pictorial reports of new developments
- 44 Decibels Debugged *H. R. Holtz*
Make db calculations in seconds with only simple arithmetic
- 45 What's Your EQ?
- 47 Junk Parts Go to the Devil

RADIO

- 32 Private-Brand Sets—Who Makes 'em? *L. A. James*
How and where to get information on house brands
- 37 Equipment Report: Knight C-555 CB Transceiver *Elmer C. Carlson*
Long range with low power in this little set

- COVER STORY 40 Multiple-Beam Klystron Pushes Back Microwave Frontiers *Eric Leslie*

TELEVISION

- 34 Sweep-Aligning TV I.F.'s *Jack Darr*
The elegant way of lining up the video i.f.
- 52 Versatile Converters for the UHF
- 54 Service Clinic *Jack Darr*
Radio-controlled garage doors

TEST INSTRUMENTS

- 28 Decade Box Uses Power Resistors *Joseph H. Sutton*
Easily built, this box will pinch-hit for burned bleeders, etc.
- 42 Align-and-Find Meter *Bill Hutchison*
- 46 Simple Inductance Bridge Checks Unknown Coils *John A. Dewar*
Inexpensive instrument will find many uses in your shop
- 59 Equipment Report: Lafayette TE-60 and Mercury 501
30,000-ohm-per-volt multimeter and a component substitutor

THE DEPARTMENTS

- 61 Correction
16 Correspondence
78 New Books
62 New Literature

- 76 New Patents
66 New Products
61 New Semiconductors & Tubes
6 News Briefs

- 72 Noteworthy Circuits
70 Technicians' News
63 Technotes
74 Try This One
71 50 Years Ago



Member,
Institute of High Fidelity
Radio-Electronics
is indexed in
Applied Science
& Technology Index
(Formerly
Industrial Arts Index).

HUGO GERNSBACK, *editor-in-chief and publisher.* M. HARVEY GERNSBACK, *editor.* Fred Shunaman, *managing editor.* Robert F. Scott, W2PWG, *technical editor.* Peter E. Sutheim, *associate editor.* Jack Darr, *service editor.* I. Queen, *editorial associate.* John J. Lamson, *eastern sales manager.* Wm. Lyon McLaughlin, *technical illustration director.*

GERNSBACK PUBLICATIONS, INC., 154 W. 14 St., N.Y. 10011. AL 5-7755. Board Chairman Hugo Gernsback, President M. Harvey Gernsback, Secy. G. Aliquo, Treas. Charles A. Raible

A NEW WORLD OF OPPORTUNITY AWAITS YOU WITH N.T.S. ALL-PHASE HOME TRAINING IN ELECTRONICS

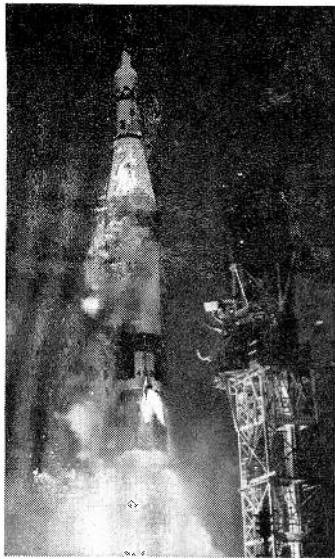

You can install and maintain electronic circuitry in missiles and rockets ... specialize in micro-waves, radar and sonar.

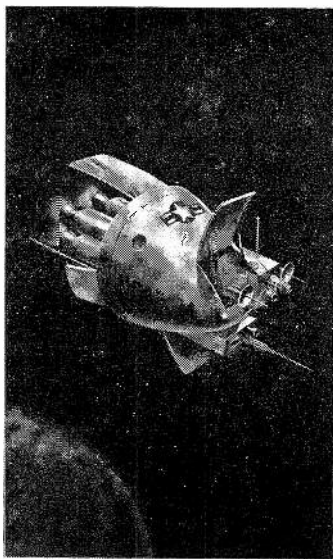

You can succeed in TV-Radio Communications ... prepare for F.C.C. License, service advanced satellites for industry and defense.

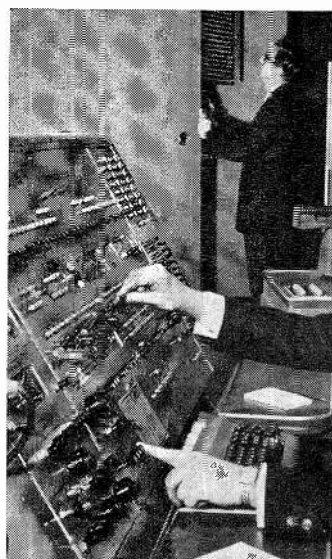

You can service and repair the electronic "brains" of industry — computers, data processing, and other automation equipment.

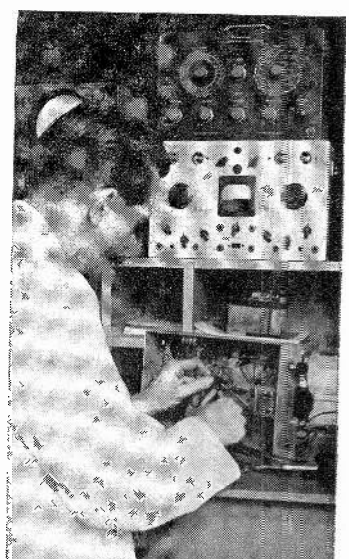

You can become a highly-paid TV-Radio Technician, an electronics field engineer, or succeed in your own sales & service business.

The N.T.S. Master Course enables you to do more, earn more in ELECTRONICS • TELEVISION • RADIO Yet N.T.S. Training costs no more than other courses for less complete

There's a good reason why N.T.S. Master-Training opens a wide new world of opportunity for you in Electronics, Television, Radio.

Everything you learn, from start to finish, can be applied directly to all phases of the Electronics Industry.

As a result, the N.T.S.-Trained Technician can move ahead faster, in any direction — from TV-Servicing to Radio Communications to Space-Missile Electronics and Automation for industry and defense. You can go wherever pay is highest and opportunity unlimited.

Electronic circuitry, for example, is one of science's miracles that is basic to the entire field of Electronics. It is used in satellites, computers and space capsules as well as in today's television sets and high fidelity equipment. N.T.S. shows you how to service and repair electronic circuitry for all electronic applications.

You work on many practical job projects. You build a short-wave, long-wave superhet receiver, plus a large-screen television set from the ground up. N.T.S. training kits contain all the parts you need ... at no extra cost. (See box at right.) You also receive a professional Multitester to use during training and on the job.

ONE LOW TUITION. You need training related to all phases of Electronics. Industry demands it. Only N.T.S. provides it ... in ONE Master Course at ONE low tuition.

RESIDENT TRAINING AT LOS ANGELES

If you wish to take your Electronics-TV-Radio training in our famous Resident School in Los Angeles — the oldest and largest school of its kind in the world — write for special Resident School catalog and information, or check coupon.



NATIONAL TECHNICAL SCHOOLS

WORLD-WIDE TRAINING SINCE 1905
1000 So. Figueroa St., Los Angeles, Calif 90037

Accredited Member N.H.S.C.



YOU ENROLL BY MAIL AND SAVE MONEY. No salesmen means lower costs for us, lower tuition for you.

START NOW. A whole new world of opportunity awaits the man with Electronic Home-Training from National Technical Schools — a recognized leader in technical training for 58 years.



19 BIG KITS
YOURS TO KEEP



MAIL COUPON NOW FOR FREE BOOK AND ACTUAL LESSON!

NO OBLIGATION.
NO SALESMAN WILL CALL.

NATIONAL TECHNICAL SCHOOLS

WORLD-WIDE TRAINING SINCE 1905

National Technical Schools, Dept. RG-74
4000 South Figueroa Street, Los Angeles, California 90037

Please Rush FREE Electronics-TV-Radio "Opportunity" Book and Actual Lesson. No Salesman Will Call.

Name _____ Age _____

Address _____

City _____ Zone _____ State _____

Check if interested ONLY in Resident Training at L.A.

High school home study courses also offered. Check for free catalog.

NEWS BRIEFS

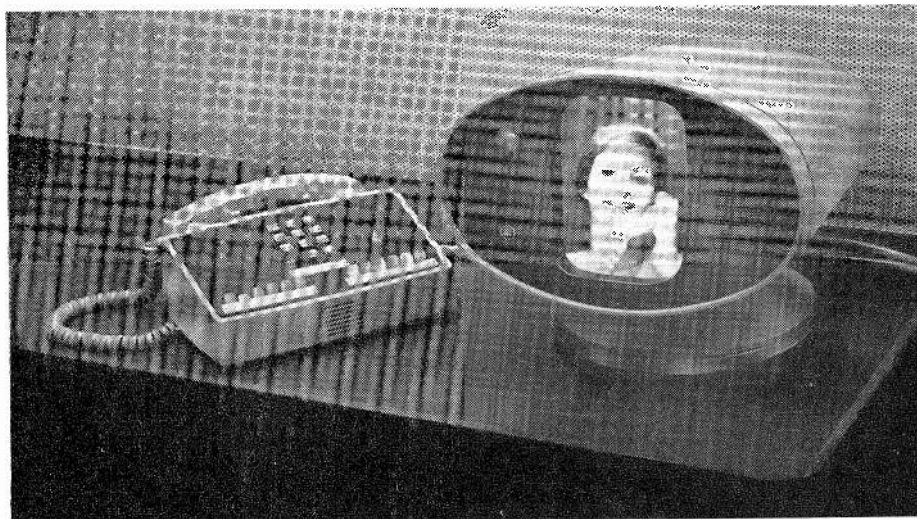

A person using AT&T's new Picturephone can push buttons to control whether he wants to be seen, see himself, see the other person, or nothing at all. Vidicon lens is small circle at upper left of screen. Speaker is behind grill to right. Control set uses no dial, but new "Touch-Tone" pushbutton calling system.

New York to California "Picturephone" Scores Hit at World's Fair

"See-as-you-talk" telephone was demonstrated publicly across the country for the first time at the opening of the New York World's Fair. West Coast reporters at Disneyland in southern California participated in a coast-to-coast press conference, asking questions of Bell System executives in New York via "Picturephone" hookup.

The installation in the American Telephone & Telegraph pavilion at the fair has been drawing great crowds. Soundproofed booths equipped with Picturephones have been set up, allowing visitors to talk with each other and with a telephone operator nearby. At occasional intervals throughout the day, a long-distance Picturephone call is placed to a waiting participant at Disneyland.

Callers sit about 3 feet from the instrument's screen, housed in a compact desktop set. Normal room illumination is sufficient for the tiny vidicon tube, next to the receiving screen, to generate a good picture. The caller has his choice of a view of himself, or of the party he's talking with or no picture at all.

Picture size is $4\frac{3}{8} \times 5\frac{3}{4}$ inches, with a scanning rate of 275 lines per frame, 30 frames (60 fields) per sec-

ond. The bandwidth required is about 500 kc (equivalent to about 125 telephone circuits). Each Picturephone set has three pairs of wires—one for the audio signal and two for the four-wire video transmission.

Vlf Signal Puzzle Near Solution

The strange behavior of very-low-frequency (vlf) radio signals, which may be received better in one direction than in the other when transmitted between two points, may be near explanation, according to Douglass D. Crombie of the National Bureau of Standards.

Radio signals do not travel equally well in opposite directions, and a number of theories have been proposed to explain this anomaly. Crombie believes that the cause may be magnetically caused changes in the radio waves' coefficients of reflection or transmission at the ionosphere. In other words, the difference is due to the earth's magnetic field. Greater signal loss on reflection in one direction is probably due to increased transmission out through the ionosphere.

RCA Stockholders Meet 2,500 Miles Apart

The first stockholders' meeting ever held by RCA outside New York City was also the first transcontinental meeting ever held by any company by two-way closed circuit color television. Increasing profits and a jump in color TV were reported to the "most broadly based annual meeting yet devised" in a meeting room "about 2,500 miles wall-to-wall."

President Engstrom said electronics has now passed the \$15 billion annual sales level, and is on the way to an anticipated \$22 billion annually by the end of the decade.

Other highlights of the meeting: color TV set sales for the first quarter of 1964 are 65% ahead of the same period in '63; black-and-white sales are up 21%. The RCA Service Co. is now making more on installation and maintenance of color TV than from black-and-white. A production line has been set up for the new 25-inch 90° rectangular color TV tube, and some will be sold during 1964. Color tubes made in Canada will also come on the market during the summer.

General Sarnoff reported that the first quarter of 1964 is the 13th consecutive quarter of increasing profits for RCA and, despite some cutbacks in government business, increasing consumer demands indicate that the upward trend will continue through the year.

Advertising Representatives:

EAST	MIDWEST
John J. Lamson	P. H. Dempers Co.
Eastern Sales Manager	740 North Rush Street
Radio-Electronics	Chicago, Illinois 60611
154 West 14th Street	(312) Michigan 2-4245
New York, N.Y. 10011	
(212) ALgonquin 5-7755	

SOUTHEAST

Neff Associates	J. Sidney Crane, Assoc.
15 Castle Harbor Isle	22 Eighth St., N.E.
Fort Lauderdale, Fla.	Atlanta 9, Ga.
(305) LOgan 6-5656	(404) TRinity 2-6720

WEST COAST/SOUTHWEST

Husted-Coughlin, Inc.	Husted-Coughlin, Inc.
1830 W. 8th Street	444 Market Street
Los Angeles 57, Calif.	San Francisco 11, Calif.
(213) 389-3132	(415) GARfield 1-0151

UNITED KINGDOM

Publishing & Distributing Co., Ltd., Mitre House,
177 Regent St., London W.1, England.

Subscription Service: Address form 3579 and correspondence to Radio-Electronics, Subscriber Service, 154 West 14th Street, New York, N.Y. 10011. When requesting a change of address, please furnish an address label from a recent issue. Allow one month for change of address.

Men 17-55

**JOB OPPORTUNITIES!
EXCITEMENT!
MONEY!**

All this
can be
Yours as a trained

Electronics

TECHNICIAN

**OVER 6,000 FIRMS HAVE EMPLOYED
DeVRY TECH GRADUATES!**

Thousands of companies in the United States and Canada who have employed DeVry Tech men prove two most important facts: (1) Electronics is one of the biggest, fastest growing opportunity fields of our time; and (2) DeVry Tech graduates are "WANTED" MEN.

Whether DeVry Tech prepares you in spare time at home or in its modern Chicago or Toronto Laboratories, your training is designed to get you ready to meet the exacting standards of industry. You get practical training that not only helps to fit you for a job or a service shop of your own — but also gives you a foundation for a career that can be profitable the rest of your life.

You work over 300 learn-by-doing experiments at home, using DeVry Tech's exclusive Electro-Lab method. You build and KEEP valuable equipment. With another DeVry Tech exclusive, you have the benefit of training movies that you can show over and over again until basic points are crystal clear. Special texts guide you every step of the way as well.

HOW DeVRY TECH CAN "BLUEPRINT" YOUR CAREER!

DeVry's faculty not only know how to teach Electronics, but they also understand men. They most likely know the type of problems you face. From this staff you get help, advice and understanding. It is this "human" side of DeVry's program that has caused many of our graduates to say: "DeVry Tech not only trains you for a job, they actually help you blueprint a profitable future!"

NO ADVANCED EDUCATION NEEDED!

Why don't you write for FREE FACTS today? Learn how you TOO can be a member of the great fraternity of DeVry Tech graduates across the continent . . . men who were properly trained, encouraged, appreciated and understood! SEND IN COUPON NOW!

EFFECTIVE EMPLOYMENT SERVICE

DeVry Tech's effective Employment Service is available to all graduates without additional cost.

**2 FREE BOOKLETS!
Send Coupon Today!**

"One of North America's Foremost Electronics Training Centers"

DeVry TECHNICAL INSTITUTE

Accredited Member of National Home Study Council

CHICAGO • TORONTO

Let DeVry help you to
prepare and
blueprint a
Solid Career
in this fast-
Growing Field!



TELEVISION



COMPUTERS



MICRO-WAVES



RADAR



BROADCASTING



DeVRY TECHNICAL INSTITUTE
4141 Belmont Ave., Chicago, Ill. 60641, Dept. RE-7-U

Please give me your two free booklets, "Pocket Guide to Real Earnings" and "Electronics in Space Travel"; also include details on how to prepare for a career in Electronics. I am interested in the following opportunity fields (check one or more):

- | | |
|--|---|
| <input type="checkbox"/> Space & Missile Electronics | <input type="checkbox"/> Communications |
| <input type="checkbox"/> Television and Radio | <input type="checkbox"/> Computers |
| <input type="checkbox"/> Microwaves | <input type="checkbox"/> Broadcasting |
| <input type="checkbox"/> Radar | <input type="checkbox"/> Industrial Electronics |
| <input type="checkbox"/> Automation Electronics | <input type="checkbox"/> Electronic Control |

Name _____ Age _____

Address _____ Apt. _____

City _____ Zone _____ State _____

Check here if you are under 16 years of age.
Canadian residents: Write DeVry Tech of Canada, Ltd.
2075-A 970 Lawrence Avenue West, Toronto 19, Ontario

TUNER REPAIRS

Includes ALL parts (except tubes)...
ALL labor on ALL makes for complete overhaul.

\$95.00

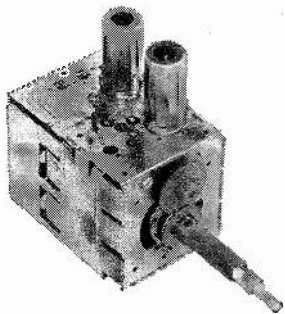

FAST, 24-HOUR SERVICE
with FULL YEAR WARRANTY

Sarkes Tarzian, Inc., largest manufacturer of TV and FM tuners, maintains two completely-equipped Service Centers, offering fast, dependable tuner repair service. Tarzian-made tuners received one day will be repaired and shipped out the next. More time may be required on other makes. Every channel checked and realigned per manufacturer's specs. Tarzian offers full, 12-month guarantee against defective workmanship and parts failure due to normal usage. Cost, including all labor and parts (except tubes), is only \$9.50 and \$15 for UV combinations. No additional costs. No hidden charges. You pay shipping. Replacements at low cost are available on tuners beyond practical repair.

Always send TV make, chassis and Model number with faulty tuner. Check with your local distributor for Sarkes Tarzian replacement tuners, parts, or repair service. Or, use the address nearest you for fast factory repair service.

S **SARKES TARZIAN, INC.**
TUNER SERVICE DIVISION

Dept. 200
537 South Walnut St.,
Bloomington, Indiana
Tel: 332-6055

Dept. 200
10654 Magnolia Blvd.,
North Hollywood, Calif.
Tel: 769-2720

New Color TV Sets Degauss Automatically

A color TV receiver that can be rotated on its stand for better viewing or moved from room to room was demonstrated by RCA in its recent showing of new products in New York City. Previously a color set had to be degaussed by the service technician when installed, to neutralize the effects of the earth's magnetic field. If moved, it had to be degaussed again.

The new set has a built-in degaussing coil, which operates every time the set is turned on. There is an initial surge of current in a cold set. This current energizes the degaussing coil. As the set warms up, the current through the coil decreases, reducing the magnetic effect much as the service technician does as he backs away from the screen. Once the set is warm the circuit through the degaussing coil is cut off with a thermistor.

The new 25-inch 90° rectangular picture tube, with 300 square inches of viewing space, and 4½ inches shorter than previous color tubes, was also demonstrated.

National Bureau of Standards Broadcast Changes

Transmitting clocks for stations WWV, WWVH, WWVB (and also Navy stations) were retarded 100 milliseconds April 1 because of change in the speed of the earth's rotation.

As of April 1, WWVB and WWVL began broadcasting continuously from 1630 UT (Universal Time) Wednesdays to 2230 Fridays. Saturday, Sunday and Monday they broadcast from 1630 to 2230 UT; they alternate on successive Tuesdays.

Geophysical alerts are broadcast on WWV and WWVH in International Morse code (7 words per minute) during the first half of the 19th minute on WWV, and on WWVH during the first half of the 49th minute past each hour:

GEO-MMMMM (Magnetic storm)

GEO-NNNNN (Magnetic quiet)

GEO-CCCCC (Cosmic ray event)

GEO-SSSSS (Solar activity)

GEO-QQQQQ (Solar quiet)

GEO-WWWWW (Stratospheric warning)

GEO-EEEE (No geolert issued)

By agreement with the Naval Observatory, WWV and WWVH started broadcasting on May 1 daily corrections to the regular time signals to enable users to obtain a very accurate value of UT2. During the last half of the 19th minute of each hour on WWV and the last half of the 49th minute of each hour on WWVH, code signals will be broadcast as follows: UT2 (space) AD or SU (space) three digits. UT2 is obtained by adding or subtracting (as indicated) the number of milliseconds indicated by the last 3 digits to the time as broadcast. The symbols will be revised on a daily basis, the new value appear-

ing for the first time during the hour after midnight UT, and continuing for the following 24-hour period.

Radio Pioneer Passes



Melville Eastham, as he appeared in the early days of General Radio.

Melville Eastham, known to many old-timers through the Clapp-Eastham equipment of the early years of the century, died May 7 at 79.

After a number of years with Clapp-Eastham, he founded the General Radio Co. in 1915. He was its president till 1944, continued as chief engineer till 1950, when he retired.

During World War II Mr. Eastham served in the Office of Scientific Research and Development, playing a leading role in the development of Loran navigational guidance.

Mr. Eastham was a pioneer in industrial relations as well as in electronics. General Radio started with a 40-hour work week and paid vacations in 1915.

Trans-Moon Communications

Lunar communications over 600 miles or more with frequencies around 350 kc may be possible, according to Prof. Newbern Smith of the University of Michigan.

Speaking at the US National Committee of the International Scientific Radio Union, Professor Smith suggested that a "solar wind" consisting of electrons and protons constantly streaming from the sun would create the equivalent of a lunar ionosphere. This would refract or bend radio waves in the same way that our ionosphere bends waves on the earth. Thus radio waves could be received at greater ranges over the moon's surface than previously thought possible.

Range and quality would, of course, be sensitive to variations in the ionosphere, which depends on solar activity, as well as the time of the lunar day. Communications over distances even greater than 600 miles may be possible with elevated antennas, Smith stated.

Get Your First Class Commercial F.C.C. License In a Hurry — Or at Your Own Pace!

Is the Course Proven?

A high percentage of Grantham *resident* students get their 1st class FCC licenses in the short period of 12 or even 8 weeks from the time they start the course. Many others choose *home study*, completing the course and getting their licenses at their own convenience.

Is the Course Complete?

Not only does the Grantham course cover all required subject matter completely; it grows and changes and expands in phase with change and expansion in the electronics field generally. With the Grantham course, you are assured of modern, up-to-the-minute instruction.

Is the Course "Padded"?

The streamlined Grantham course is designed specifically to prepare you to pass FCC examinations and examinations given by electronics firms. What you need to know to achieve these goals, you are taught completely and in detail. The course is not "padded" with information you will not need.

Is It a "Coaching Service"?

The weakness of the "coaching service" or "Q & A" method employed by some schools and individuals is that it presumes the student already has a knowledge of basic electronics.

The Grantham course is presented from the viewpoint that you have no prior knowledge of the subject; nothing is taken for granted where your training is concerned. We "begin at the beginning" and progress in a logical, step-by-step manner from one point to another, with the necessary math taught as an integral part of the course. Every subject is covered simply and in detail; the emphasis is on making the subject easy to understand.

With each lesson you receive an FCC-type test so that you can discover after each lesson just which points you do not understand and clear them up as you go along. In addition to the lesson tests, ten comprehensive Review Exams are given throughout the course.

For further details concerning F.C.C. licenses and our training, send for our FREE booklet

GRANTHAM SCHOOL OF ELECTRONICS

Los Angeles Division

1505 N. Western Ave., Los Angeles, Calif. 90027

Phone:
HO 7-7727

South Gate Division

9320 Long Beach Blvd., South Gate, Calif. 90280

Phone:
564-3421

Seattle Division

408 Marion Street, Seattle, Wash. 98104

Phone:
MA 2-7227

Kansas City Division

3123 Gillham Road, Kansas City, Mo. 64109

Phone:
JE 1-6320

Washington Division

821 — 19th Street, N.W., Washington, D.C. 20006

Phone:
ST 3-3614

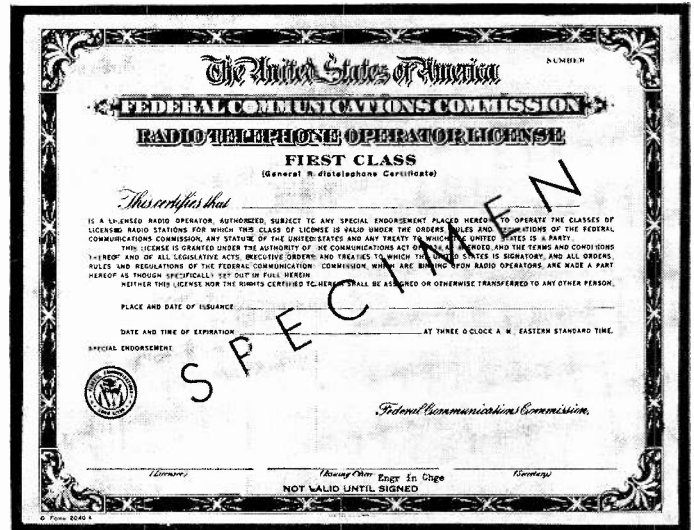

Is the School Accredited?

Grantham School of Electronics is accredited by the Accrediting Commission of the National Home Study Council.

Is It a "Memory Course"?

Grantham School has never endorsed the "memory" or "learn by rote" approach to preparing for FCC license exams. This approach may have worked in the early days of broadcasting, to the extent that a man could get his license that way; but, Heaven help the employer who expected this man to be able to demonstrate abilities implied by possession of the license!

Fortunately for all concerned, it is no longer possible for a man to pass FCC exams by spilling out memorized information which is essentially meaningless to him. Advances in the field of electronics—and the desire of the FCC to have the license really mean something — have caused upgrading of the exams to the point where only the man who is able to *understand* and *reason* electronics can acquire the 1st class FCC license.

Learn to thoroughly understand basic electronics from the school whose graduates are successfully employed by virtually every major electronics firm in the United States. Why not join them through Grantham training?

(Mail in envelope or paste on postal card)

TO: GRANTHAM SCHOOL OF ELECTRONICS
NATIONAL HEADQUARTERS OFFICE
1505 N. Western Ave., Hollywood 27, Calif.

Gentlemen:

Please send me your free booklet telling how I can get my commercial F.C.C. license quickly. I understand there is no obligation

Name _____ Age _____

Address _____

City _____ State _____

I am interested in:

Home Study, Resident Classes 44-K

EXCITING
NEW LINE!
EXCITING
NEW SOUND!

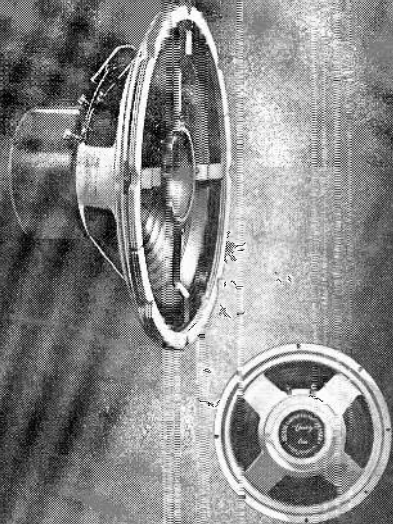

QUAM

FULL FIDELITY HI-FI SPEAKERS

Slim-line styling! Ceramic magnets! Superb reproduction over the full audio spectrum! Complete choice: coaxials, extended range, tweeters, woofers! The new Quam hi-fi line is as modern as tomorrow—and it's designed to offer the *serviceman* a top-quality product at a *list* price that's lower than others' "audiophile net." (Quam never advertises net prices—to protect your mark-up!)

Use Quam Hi-Fi Speakers in new systems, as extension speakers in existing hi-fi systems, and as replacement improvements in stereo consoles. They'll open your way to exciting new sales!

Write for your free copy of the new Quam Hi-Fi Catalog HF-64.

QUAM-NICHOLS COMPANY
234 East Marquette Road • Chicago, Ill. 60637

Cockroaches Key to Computer Problems?

The nervous system of the lowly cockroach may hold the answer to electrical circuit problems that frustrate computer designers. Two professors at Purdue University, Lawrence L. Ogborn and Daniel Shankland, are using microscopes and electrical test instruments in a research project on cockroach sensors, nervous systems and reflexes. They feel that nature has installed special circuitry to insure reliability, among other things, and that they may learn something about why nature's transducers are more efficient than many of the man-made devices used to measure such things as position, velocity and temperature.

Radio Signals from Jupiter Show Strange Variation

Observation of radio signals from four places on Jupiter gives rise to the suggestion that this largest of all the planets has abruptly changed its speed of rotation. This suggestion was offered by University of Florida radio astronomer Prof. Alex G. Smith.

The radio signals from the four Jovian radio sources sweep through space like the beams of a lighthouse, and have been measured accurately for some years. A short time ago, an abrupt change was noted in the rotational rate of the radio sources. Measurements

indicated that the rotation had slowed by 1.3 seconds.

If the signals are coming from some solid part of the planet, says Dr. Smith, "the implication is strong that the planet itself, or at least a portion of the interior, has suddenly altered its rate of spin."

The change in rotational rate would be 1.3 seconds in every 10-hour rotation of Jupiter, something mechanically almost inconceivable for such a large planet. Dr. Smith points out, however, that a nearly identical shift occurred in the rotational speed of the Great Red Spot, the one permanent marking of Jupiter's that is visible to astronomers.

Satellite Discovers Huge Ray Zone

An 188-pound paddle-wheel satellite called Imp (for Interplanetary Monitoring Platform), launched Nov. 26 from Cape Kennedy, has discovered an energetic radiation zone that engulfs the Van Allen belt. It also confirmed that the earth is enveloped in a turbulent shock wave of streams of energetic particles from the sun traveling at speeds up to 300 miles a second, giving a new clue to the source of the particles making up the Van Allen belt.

When the sunlit side of the earth collides with this shock wave (as close as 40,000 miles from the earth), it creates an ever-broadening wake that stretches as far as the moon.

SUNSPOT CYCLE NEARLY OVER

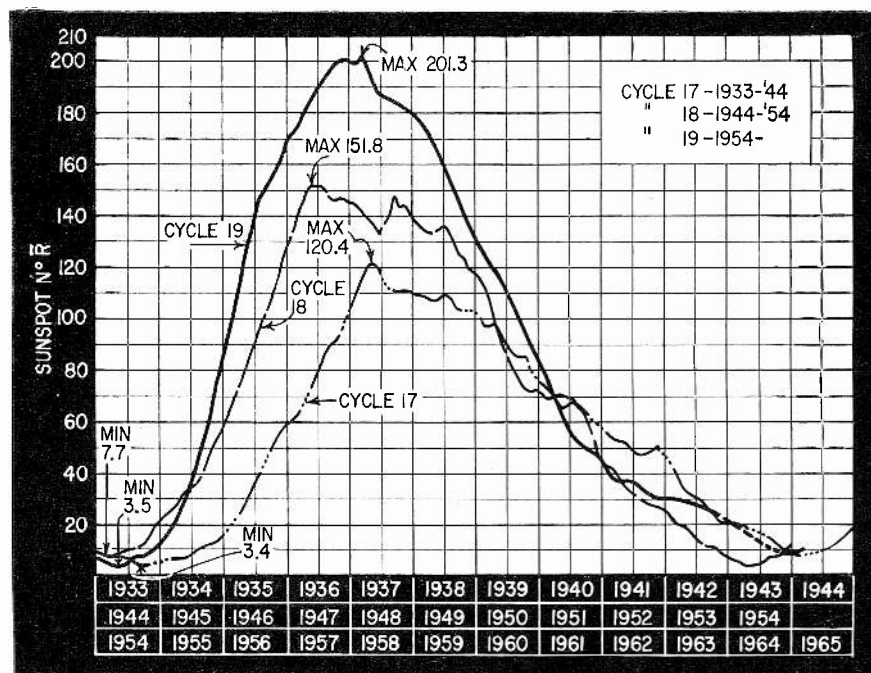

The present sunspot cycle No. 19 (the heavy solid curve on the chart) is approaching its end. Current estimates are that cycle 19 will bottom out somewhere between November, 1964 and April, 1965. (The curve is dashed from November 1963 on since exact information is not available beyond that date). The two previous sunspot cycles (17 and 18) are shown for comparison. The peaks of cycles 18 and 19 were the highest measured in the nearly 200 years of recorded sunspot history.

Chart courtesy of the BBC.

Pick the course for your career...

Electronics Technology

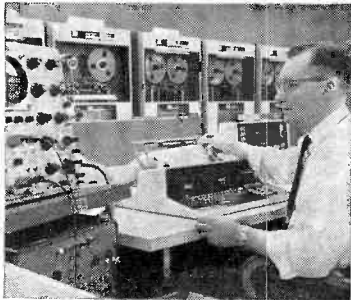

A comprehensive program covering Automation, Communications, Computers, Industrial Controls, Television, Transistors, and preparation for a 1st Class FCC License.

Electronic Communications

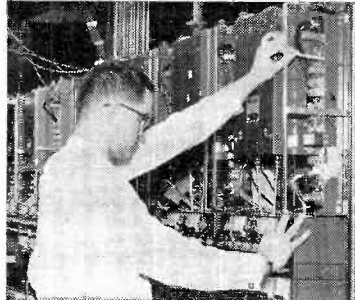

Mobile Radio, Microwave and 2nd Class FCC Preparation are just a few of the topics covered in this "compact" program . . . Carrier Telephony too, if you so desire.

First Class FCC License

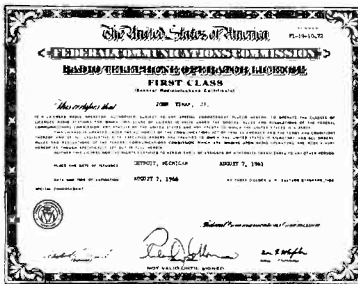

If you want a 1st Class FCC ticket quickly, this streamlined program will do the trick and enable you to maintain and service all types of transmitting equipment.

Broadcast Engineering

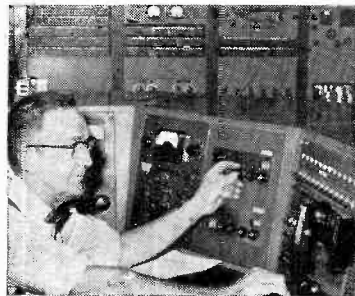

Here's an excellent studio engineering program which will get you a 1st Class FCC License and teach you all about Program Transmission and Broadcast Transmitters.

Get A Commercial FCC License ... Or Your Money Back!

A Commercial FCC License is proof of electronics skill and knowledge. Many top jobs require it . . . every employer understands its significance. In your possession, an FCC Commercial Ticket stamps you as a man who knows and understands electronics theory . . . a man who's ready for the high-paid, more challenging positions.

Cleveland Institute home study is far and away the quickest, most economical way to prepare for the FCC License examination. And that's why we can make this exclusive statement:

The training programs described above will prepare you for the FCC License specified. Should you fail to pass the FCC examination after completing the course, we will refund *all* tuition payments. You get an FCC License . . . or your money back!

Before you turn this page, select the program that fits your career objective. Then, mark your selection on the

Cleveland Institute of Electronics

1776 E. 17th St., Dept. RE-93
Cleveland, Ohio 44114



Accredited Member

coupon below and mail it to us today. We'll send you . . . without obligation . . . complete details on our effective Cleveland Institute home study. Act NOW . . . and insure *your* future in electronics.

Mail Coupon TODAY For FREE Catalog

Cleveland Institute of Electronics

1776 E. 17th St., Dept. RE-93
Cleveland, Ohio 44114

Please send FREE Career Information prepared to help me get ahead in Electronics, without further obligation.

CHECK AREA OF MOST INTEREST—

- | | |
|---|--|
| <input type="checkbox"/> Electronics Technology | <input type="checkbox"/> First Class FCC License |
| <input type="checkbox"/> Industrial Electronics | <input type="checkbox"/> Electronic Communications |
| <input type="checkbox"/> Broadcast Engineering | <input type="checkbox"/> Advanced Engineering |

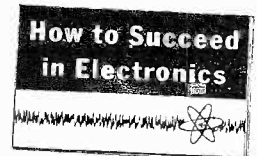

Your present occupation _____

Name _____ Age _____
(please print)

Address _____

City _____ State _____ Zip _____

Approved for Veteran's Training under Korean GI Bill. RE-93

you get **PRODUCT PLUS** *from your Sylvania Distributor*

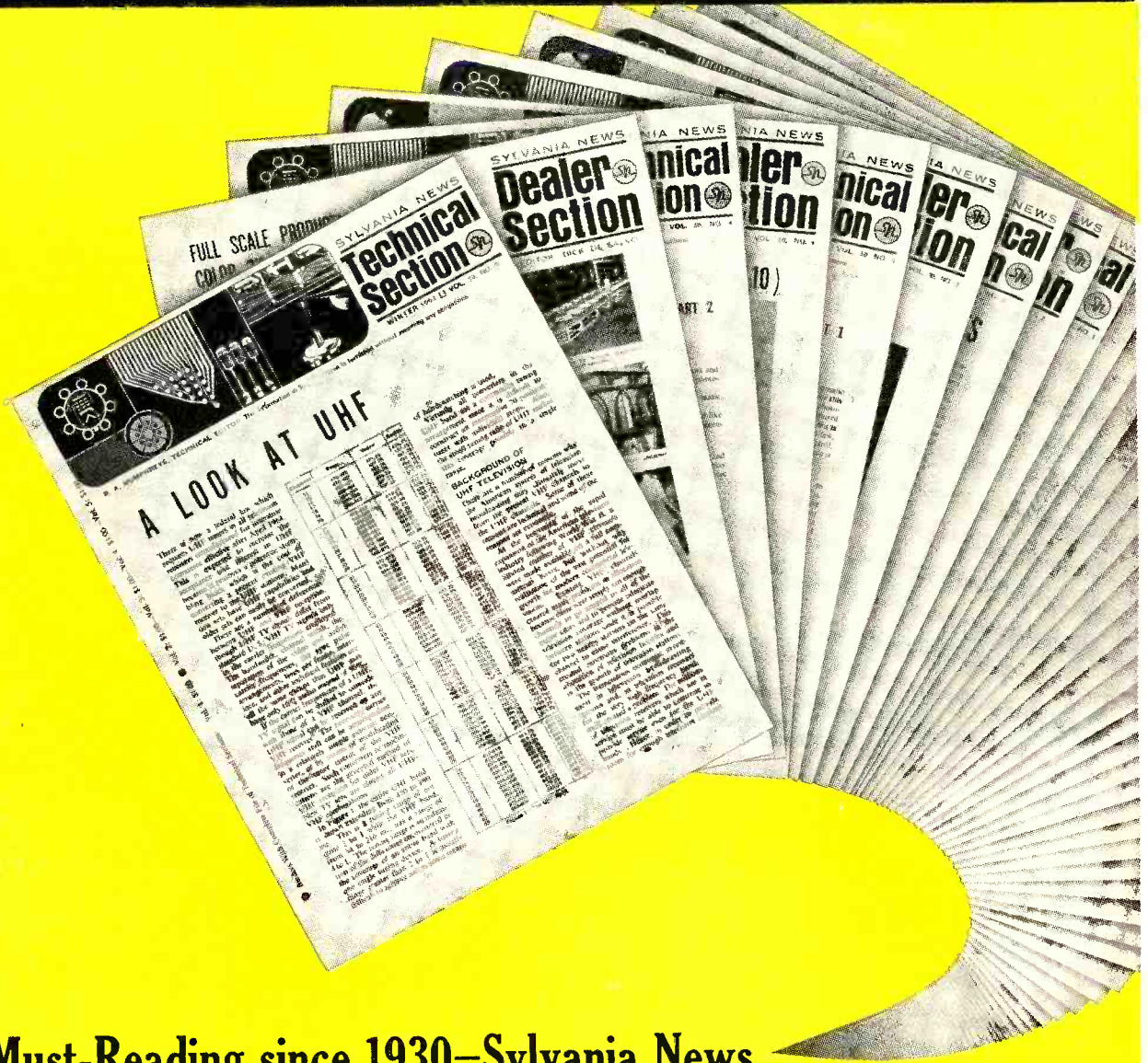

Must-Reading since 1930—Sylvania News

Sylvania and its distributors have long known that it pays to keep their customers informed. That's why 35,000 dealers today receive, read and depend on Sylvania News for useful information. Now in its 35th year of continuous publication, the News is still one of the most important dealer publications in the industry. ■ Dealers aren't the only ones who read Sylvania News—it also serves some 70,000 distributors, engineers and technical service men. Are you getting your copy? It's free. You can request it by asking your Sylvania distributor or dropping a line to: Editor, Sylvania News, 1100 Main Street, Buffalo, N. Y. 14209.

SYLVANIA
SUBSIDIARY OF
GENERAL TELEPHONE & ELECTRONICS **GTE**

MICROELECTRONICS — Medium-size ant dwarfs integrated semiconductor circuit (black square) containing 8 transistors, 12 resistors.

Photo courtesy of *Business Week*.

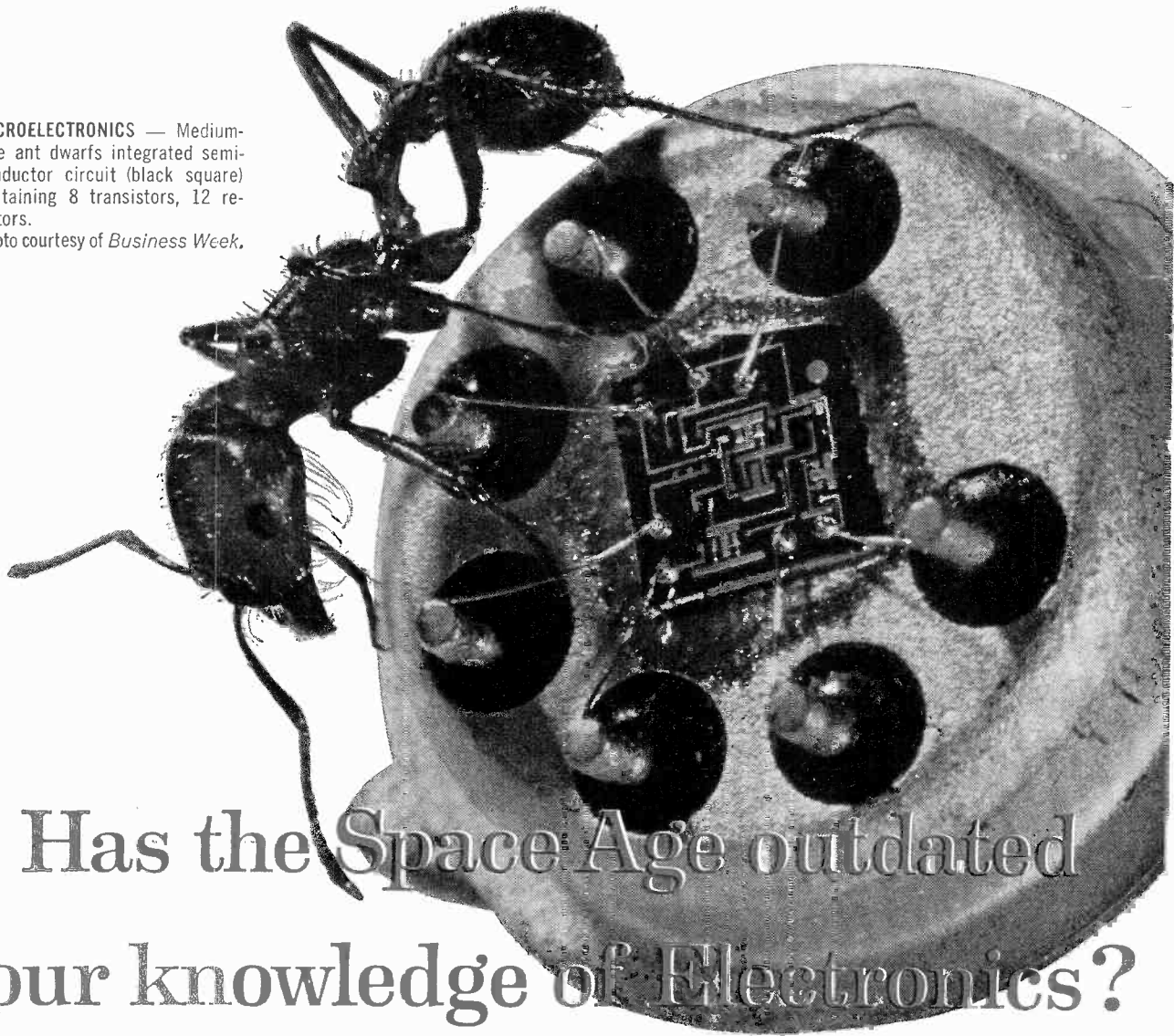

Has the Space Age outdated your knowledge of Electronics?

The photo above shows just one of the dramatic technical breakthroughs of the space age. Each day new developments are out-dating conventional systems and components—and are out-dating electronics men who can't measure up to more demanding employment requirements. Protect your career by supplementing your education with a CREI Home Study Program. CREI offers you specialized knowledge in every field of advanced electronics including new program in Space Electronics which covers Space Data Systems, Space Tracking Systems, Spacecraft Guidance and Control. If you work in electronics and have a high school education, mail coupon for FREE book or write: Dept. 1407-B, 3224 16th St., N.W., Washington, D. C. 20010.

Accredited Member of the National Home Study Council



SEND FOR FREE BOOK

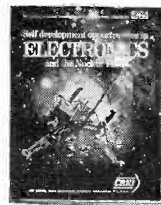

THE CAPITOL RADIO ENGINEERING INSTITUTE
Dept. 1407-B, 3224 Sixteenth St., N.W.
Washington, D. C. 20010

Please send me FREE book describing CREI Home Study Programs including new Program in Space Electronics. I am employed in electronics and have a high school education.

Name _____ Age _____

Address _____

City _____ Zone _____ State _____

Employed by _____

Type of Present Work _____

Check: Home Study Residence School G. I. Bill

E-3

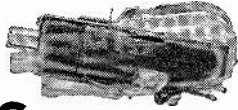

This one is twice as safe.

When Sonotone designs a retractable cartridge, you can be sure it offers something extra. Like other retractable cartridges, the new Sonotone "21TR" withdraws into the safety of the arm to avoid bumps and bruises. Further, it has "bottoming" buttons which act as shock absorbers between the needle assembly and the record. Unlike other retractables, the "21TR" features the exclusive Sono-Flex® stylus, which can be dropped or mauled and still continue to provide superior performance. The high-output "21TR" is a direct replacement for the thousands of record players requiring a quality retractable cartridge.

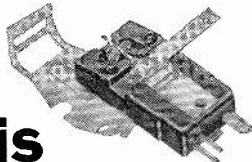

This one is twice as safe and twice as compliant.

The new Sonotone "23T" offers performance specifications never before available in a budget-priced ceramic cartridge—plus record protection. High compliance of 10; channel separation of 24 db; output voltage of 0.38; low tracking force of 2 to 4 grams make it the ideal replacement in quality stereo phonographs. Performance is only half the story of the "23T". This new cartridge features "bottoming" buttons and the flexible Sono-Flex® needle. Another Sonotone cartridge, the "22T," offers the high performance of the "23T" with a slightly higher output. Both feature the Sono-Flex plus a unique snap-in mounting bracket, for rapid replacement without tools.

Both are direct replacements for popular makes

...and themselves.

SONOTONE
audio products

Sonotone Corp., Electronic Applications Div., Elmsford, New York
Cartridges • Speakers • Microphones • Headphones • Hearing Aids • Batteries

CALENDAR OF EVENTS

San Fernando Valley Radio Club Hamfest and Picnic, June 21; Sunset Farms, Sylmar, Calif.

Statewide CB Jamboree, Naugatuck Valley CB Radio Club, June 21; Lake Quassapaug Pavilion, Route 6-A, Middlebury, Conn.

Conference on Precision Electromagnetic Measurements, June 23-25; National Bureau of Standards Laboratories, Boulder, Colo.

International Conference on Magnetic Recording, July 6-10; London, England.

First Radar Contacts by AIO With Mercury in April

The Arecibo Ionospheric Observatory, discussed in *RADIO-ELECTRONICS'* June editorial and in the February cover story, made its first radar contacts with the planet Mercury on April 7 and 8.

Gordon Pettengill, associate director of the observatory, said Mercury was about 90,000,000 miles from the earth at the time of the contacts. Signals would have been about 10 times stronger April 30, when Mercury was at its nearest point to the earth this year. Round trip time for each radar signal was about 14.5 minutes. Radar pulses travel at the speed of light, or about 186,000 miles per second.

Such contacts may provide accurate information on Mercury's orbit, and the nature and density of the planet's surface.

Electronic Vein Eraser Tested at U. of Minnesota

Medtronic, Inc. has devised a vein eraser which can disintegrate varicose veins, eliminating the need for multiple surgical incisions, dissections and chemical injections.

The unit is a 12-pound generator with plug-in electrode handle and probe, and has been tested for the last 2 years in the surgery department of the University of Minnesota.

Brief Briefs

An all-channel, all-transistor uhf-vhf TV receiver with a 9-inch screen has been introduced by Sony Corp. of America. The set operates from a 12-volt battery, weighs 9 lb.

RCA reports that color sets accounted for 3 out of every 10 set sales during the first part of 1964.

An experimental portable electronic organ has been developed for the Army's Chaplain Corps, for use in services in the field.

High-speed experimental data communications system developed by Bell transmits black-and-white facsimile 16 pages per minute, with 100-line-per-inch definition. Present transmission systems send 1 page in 6 minutes. END

INTERNATIONAL'S **NEW** EXECUTIVE 750-H CITIZENS BAND TRANSCEIVER... FOR PEOPLE WHO EXPECT THE **VERY BEST***



The International **Executive 750-H** introduces a transceiver that is quickly adaptable to all types of mobile or base installations.

The remote console, which is normally installed under the auto dash, has a new companion speaker console. It may be combined with the remote unit or mounted separately. The speaker makes a perfect base when the remote console is used on a desk. Provision has also been made for adding an S/meter.**

What's more, the Executive 750-H is loaded with extra performance features; such as, 23-crystal controlled channels, illuminated channel selector dial, a new speech clipper, increased selectivity, new connections for easy cabling.

The Executive 750-H is complete with crystals, mounting rack for the remote console, trunk mounting rack for the set, push-to-talk microphone, power cable kit, plus all necessary connecting cables. Operates on 6 vdc, 12 vdc, or 115 vac.

Your International dealer has a liberal trade-in plan. **Step up to an Executive 750-H today!**

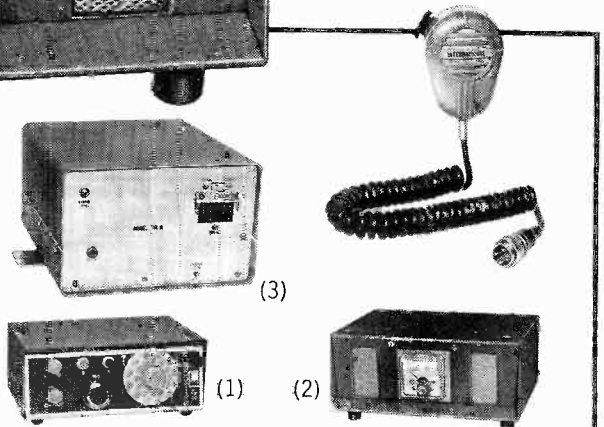

The Executive 750-H consists of three units: (1) the remote console, which turns the set (in the trunk) on or off, adjusts speaker volume and squelch; (2) the speaker console; (3) the main set which houses all other transmitting and receiving components.

*Performance—Construction—Design—Components
**S/meter available as an accessory item.

WRITE TODAY FOR OUR 1964 CATALOG.



18 NORTH LEE • OKLAHOMA CITY, OKLA.

for peanuts, we'll build any of the 115 products shown in this catalog...



but, why miss all the fun?

Kit building is lots of fun. Besides it enables you to enjoy the best equipment available at a substantial savings. The new 1964 EICO catalog opens the door to kit building enjoyment. Browse through it and you'll find superb values in high fidelity and mono components like the new Classic stereo FM MX receivers, amplifiers and tuners 4-track stereo tape decks test instruments for bench, tube caddy & ham shack economically-priced speaker systems new CB radio kit and ham gear.

For free 1964 catalog, use coupon:

EICO Electronic Instrument Co., Inc.
 131-01 39th Avenue, Flushing, N.Y. 11352
 Please send new 32-page 1964 catalog.

C-7

Name _____

Address _____

City _____

Zone _____ State _____

Roburn Agencies, 431 Greenwich St., N.Y. 13, N.Y.

Correspondence

Matching and Splicing "G-Line"

Dear Editor:

The many inquiries on my "G-Line" article (February issue) are gratifying, but the questions asked make it apparent that I goofed in two phases of the description:

1. The matching transformer and its connection to the surface-wave line.
2. Ways of splicing the G-line itself.

The launcher, one terminal of the G-line system, and the surface-wave conductor itself, the other electrical terminal, are physically different and therefore present different capacitances to earth ground. This means that different amounts of rf will be present in the launcher and in the line. It is also common practice to ground the launcher and, when this is done, clearly all rf potential appears on the surface-wave conductor.

Whether or not the launcher is grounded, the G-line is electrically unbalanced. This unbalance makes the G-line compatible with coaxial lines since they are normally operated with grounded outer conductors. Direct connection to coax could be made except for one thing: the impedance range of commonly available coaxial lines is 50 to 95 ohms and does not match the 300-ohm nominal impedance of the G-line. A transformer is required. If connection to a balanced line such as a 300-ohm ribbon lead is desired, the G-line must be isolated to prevent unequal currents in the balanced conductors.

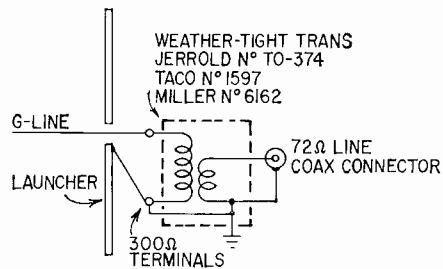

CONN FOR 72Ω OPERATION (CATCHER OR LAUNCHER)

Fig. 1

If the currents in parallel-conductor transmission lines are not equal, magnetic-field cancellation will not be maximum and radiation losses from the line will increase markedly. Although the nominal impedance of the G-line closely matches that of the ribbon, balanced-to-unbalanced conversion must be made. The schematics (Figs. 1 and 2) illustrate both transitions.

Splicing is not as ticklish as you might suppose, so long as the discontinuities caused by splicing are a small fraction of a wavelength and do not occur too often. I have made temporary twisted splices as an electrician might, without measurable electrical changes. However, many excellent splices for conductors are manufactured, and I recommend them instead.

Graybar Electric Co. has a full line of splices for all sizes of conductors. Their catalog No. AL61 is a splice for No. 6 solid aluminum. It is a slim, double-tapered cylinder with axial holes in each end to receive the conductors. To make the splice, simply push the conductors in from each end as far as they will go. They won't come out.

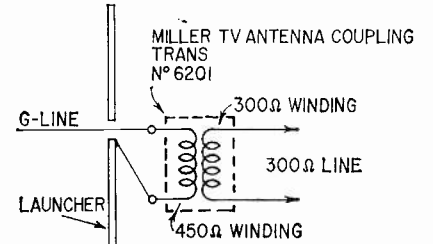

CONN FOR 300Ω BALANCED LINE (CATCHER OR LAUNCHER)

Fig. 2

Similar tension splices, as they are called, are made for copper. If you have a friend in the electrical business, you may be able to borrow a crimping tool that will enable you to use compression splicing sleeves. They are available for both aluminum and copper conductors, solid or stranded, and are preferable to the tension splices because they are smaller in diameter and much cheaper. After the splice is made, wrap polyethylene or polyvinyl tape over the splicing device to restore the all-important dielectric.

OWEN G. PATRICK

Carmel, Calif.





This *Weller*[®]
Heavy Duty Soldering Kit

has a professional
 240/325 WATT

Dual Heat Gun

No other soldering set offers you such versatility. The heavy duty Weller gun is the same professional tool used by technicians. Two trigger positions let you switch instantly to either 240 or 325-watt heat. In this single tool you have a choice of heat to suit the job, and tip temperature high enough to handle the tough ones. Instant heat saves time and current.

Kit includes 3 different tips for soldering, cutting, sealing and smoothing; tip-changing wrench and supply of solder. Everything is in a sturdy plastic carrying case. **\$12.95** LIST
 Model D-550PK. Weller Electric Corp., Easton, Pa.

FOR HOBBIES, HOMECRAFT AND MONEY-SAVING REPAIRS

Hi-fi kit building

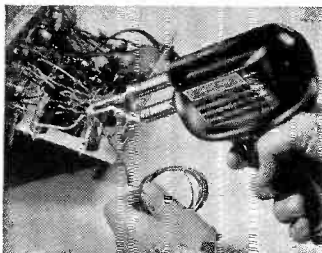

Electrical work



Repairing plastics

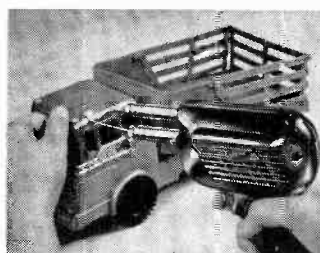

Sealing plastic bags

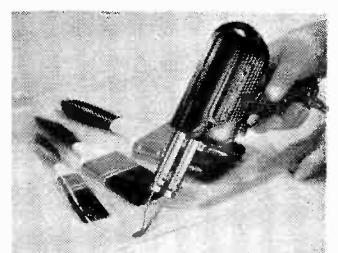

Appliance repairs

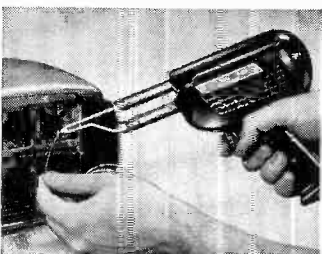

Metal work



Model RR connections

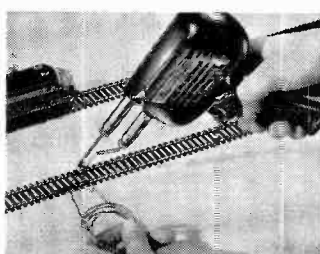

Cutting plastic tile



Winegard COLORTRON Antenna



The Colortron Antenna's "BALANCED DESIGN" is the Winegard secret of superior color reception!

It takes a combination of high gain, accurate impedance match, complete band width and pinpoint directivity to make the perfect color antenna. Only the Winegard Colortron gives you all 4 with **BALANCED DESIGN**.

What is Balanced Design? It's not enough to design an antenna for high gain alone and expect good color reception. A high gain antenna without *accurate impedance match* is ineffective. Or an antenna with *good band width* but *poor directivity characteristics* is unsuitable for color. The Winegard Colortron is the one antenna with *balanced design*, excellence in *all* the important characteristics that a good color antenna requires.

For example:

Gain and Bandwidth—A superior color antenna must have high gain and complete bandwidth as well. But the response must be *flat* if it is to be effective. Peaks and valleys in the curve of a high gain antenna can result in acceptable color on one channel and poor color on another.

No all-channel VHF-TV antenna has more gain with complete bandwidth across each and every channel than the Colortron. Look at the Colortron frequency response in this oscilloscope photo.

Note the consistent high gain in *all* channels. Note the absence of suck-outs and roll-off on end channels. The flat portion of the curve extends on the low band from the channel 2 picture carrier past the channel 6 sound carrier. On the high band, it is flat from the channel 7 picture carrier to the channel 13 sound carrier. There is less than $\frac{1}{2}$ DB variance over any channel.



Impedance Match—the two 300 ohm "T" matched Colortron driven elements have far better impedance match than *any* antenna using multiple 75 ohm driven elements. The Colortron transfers *maximum* signal to the line without loss or phase distortion through mismatch. Winegard's "T" matched driven elements cost more to make, but we know the precision results are well worth the added manufacturing expense . . . because a mismatched antenna causes loss of picture quality which *might* get by in black & white, but becomes highly disturbing in color.

The oscilloscope photo here shows the Colortron VSWR curve (impedance match). No current VHF-TV antenna compares with it across all 12 channels.

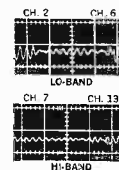

...made for color!

Directivity—Equally important for superior color pictures is freedom from interference and ghosts. Therefore, an antenna with sharp directivity and good signal-to-noise characteristics is necessary. Extraneous signals picked up at the back and sides produce objectionable noise and ghosts in black and white reception . . . frequently ruin color reception.

Winegard's Colortron has the most ideal directivity pattern of any all channel VHF antenna made. It has no spurious side or large back lobes . . . is absolutely dead on both sides. Colortron does not pick up extraneous signals, and even has a higher front-to-back ratio than a single channel yagi.

Look at this Colortron polar pattern. No other VHF-TV antenna has sharper directivity on a channel-for-channel comparison.

BALANCED DESIGN COLORTRONS HAVE SUPERIOR MECHANICAL FEATURES, TOO!

Every square inch of the Colortron has been engineered for maximum strength, minimum weight and minimum wind loading. Even the insulators are designed for low wind resistance. The result

is a streamlined, lightweight antenna that stays stronger longer. Colortrons have been wind tested to 100 mph.

Colortrons are simpler to put up, too. Easier to carry up a ladder and mount on a high mast. No extra weight and bulk to frustrate the antenna installer.

And, you can see the difference in quality when you examine a Winegard COLORTRON. The GOLD ANODIZED finish is bright weather-proof gold that *won't fade*, rust or corrode. It's the same finish specified by the Navy for military antennas. Full attention is paid to every detail.

Winegard Helps You Sell—does more national advertising than all other brands combined. When you sell Winegard, you sell a brand your customer knows . . . backed by a *written factory guarantee of satisfaction*.

It's not surprising that Winegard leads the field in the number of antennas installed with color sets. And Colortrons have been installed by the hundreds of thousands for black and white sets too—for the antenna that's best for color is best for black and white as well. Why don't you try a *balanced design* Colortron and see for yourself?

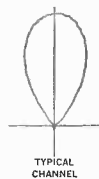

COLORTRON ANTENNA
Model C-44 • Gold Anodized • \$64.95

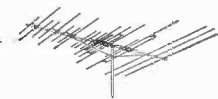

COLORTRON ANTENNA
Model C-43 • Gold Anodized • \$51.90



COLORTRON ANTENNA
Model C-42 • Gold Anodized • \$34.95



COLORTRON ANTENNA
Model C-41 • Gold Anodized • \$24.95



Winegard Co.

3013-G KIRKWOOD • BURLINGTON, IOWA

Coming Next Month in Radio-Electronics

NEED A LITTLE DICTATOR?

It is easy to modify one of the cheap tape recorders now being sold in large quantities, and make it a very efficient little dictating machine, complete with foot-pedal, start-stop, etc. The same techniques can be used on a standard recorder, too, of course.

WATCH THOSE SHIFTY RESISTORS

This article explains how thermistors and varistors work, with some hints about practical applications.

ANTENNA ROTATOR REPAIR

Mechanical troubles always give the service technicians more problems than electronic ones. But the antenna rotator is not a difficult device to repair if you understand it, and understand a few good techniques. Homer Davidson explains both the "how" and the "how to."

DESIGN YOUR SPEAKER ENCLOSURE

Have you ever had a speaker of a given size and supposed frequency response, and wondered what to do with it? This article tells you exactly what: covers the important questions of enclosure size, shape ducting and other features.

You'll find these and many other articles, features and regular departments in next month's RADIO-ELECTRONICS.

AUGUST ISSUE
(on sale July 16)

Another (Ultra-) Sonic Burglar Alarm

Dear Editor:

"Ultrasonics Stops Burglars" (RADIO-ELECTRONICS, May 1964) seems to go a long way around to solve a relatively simple problem. Since sound travels at about 1100 ft/sec, and a burglar would move at only 1 to 2 ft/sec, the Doppler shift in frequency would amount to only 0.1 to 0.2%, a pretty difficult job for discrimination devices. Since only a minute portion of the total sound energy is so modulated in frequency, there is another difficult job for amplitude discrimination between the direct, fixed frequency and the intruder-modulated frequency.

A much simpler and more direct method, which also uses ultrasound, relies on a standing-wave system which shifts about with the motion of any sizable objects in the room, the opening of a door or window, etc. It involves only an ultrasonic (or sonic) variable-frequency oscillator and reproducer and a receiver, which may be untuned, whose output is rectified to operate an alarm device.

After vacating the room and locking all entrances, the owner, having already switched on the apparatus, adjusts the transmitter frequency from an outside control until the receiver's sound field reaches a maximum of intensity in the standing-wave system of the room. This holds the alarm relay open until that system is shifted by intrusion, power failure or tampering, thus providing fail-safe operation.

Anyone who has run an audio oscillator into a speaker will recall how the sound level varies greatly as the frequency is changed (especially at frequencies of several kc) or, when steady, as the operator moves his head about, and most if he holds a finger over one ear.

If the frequency used is several kc, any intruder would have ample warning that he would surely be caught, so that forced-entry damages might be avoided. Yet the sensitivity would still be ample.

For those who may care to set up such an alarm system, its details can be found in my patent No. 2,071,933, issued Feb. 23, 1937, and sold to the Radio Corporation of America. It is of course now 10 years expired.

B. F. MIESSNER

Miami Shores, Fla.

Author Fasal Replies

Dear Editor:

The principle Mr. Miessner cites would be very promising were it not for one neglected detail that suggests that the system has never been tried in practice:

The standing-wave pattern in an enclosure can never be considered as an invariable sound field whose intensity at a given point is constant. The velocity of sound in a medium determines the wavelength of the sound wave, and this velocity depends on temperature, hu-

midity, barometric pressure and other, uncontrollable, factors. Therefore, the wavelength of the sound wave, and with it the standing-wave pattern, is continually changing. These changes are great enough to vary considerably the amplitude of the sound field at a given point.

A relatively stable pattern could be expected only in an enclosure whose dimensions do not exceed a few wavelengths—at most a few feet, at the frequencies being considered here. Also, the field intensity depends on not just one reflection but on an infinite number of superposed reflections, which result in an average value over time and over the surface of the receiving transducer.

Thus the proposed adjustment of the receiver to maximum output by changing the radiated frequency would not last long. False alarms would be inevitable. This automatic variation of the standing wave pattern in a room is undesirable, and circuits to compensate for it had to be designed into the unit described in my article.

Using audible sound for room protection is not too good an idea. At those frequencies, doors, windows, etc., act as diaphragms and permit the sound energy to penetrate to the outside. There, they protect not only the intended room but also the busy hallway outside, and the neighboring premises. The result would be an infinity of false alarms!

In addition, warning an intruder encourages him to prepare his job better for the next attempt. And the audible protection would drive the neighbors crazy!

May I ask, if Mr. Miessner's system is so much simpler, better, less expensive, more reliable, why his 1937 patent has never been used? It is apparently completely unknown to interested alarm manufacturers. And why is the Kidde Ultrasonic Alarm, based on the Doppler effect as described in my article, accepted as the most efficient and dependable room protection?

JOHN H. FASAL

*Walter Kidde & Co., Inc.
Alarms Div.
Clifton, N. J.*

Electronic Organ Debate: Round 2

Dear Editor:

I have just read Mr. Brounstein's letter in the May issue of RADIO-ELECTRONICS. My experience has mainly been with Baldwin organs, but I do not agree with Mr. Brounstein on several points.

Baldwin has a set of 12 tuning forks for tuning their organs. These should work well on any frequency-divider type organ. Procedure is to connect the organ output to a pair of headphones, hold the base of the vibrating tuning forks against the shell of the headphones, and adjust the organ tuning for zero beat.

Several manufacturers do provide service manuals for owners.

Only the harmonics in a Hammond

FASTATCH II CONTROL SYSTEM
MORE CONVENIENT AND
VERSATILE THAN EVER!

now
Centralab
gives you

SINGLE SHAFT CONTROLS

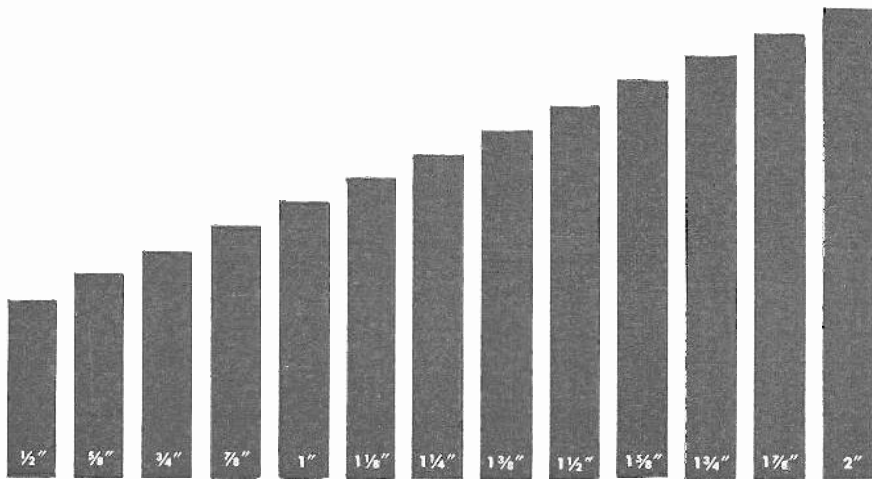

with exact length shafts



Need a control with a flat shaft—or split knurled—or screwdriver slot?

Maybe you need it with—or without—an attached line switch.

But two things are sure: You need a certain *exact* shaft length—and your Centralab distributor can supply it!

Centralab's new exact length solid shafts provide exact replacements for ALL your single control requirements, as well as twins for stereo, triples, and quads.

If you have the FRK-100 Fastatch II Kit, you can add these exact length shafts as you need them; they snap right into place on the Fastatch II front controls. Or, you can always get the exact control you need, instantly, from your Fastatch II distributor.

For a complete catalog on the Fastatch II Control System, write to Centralab or contact your distributor.

The Electronics Division of Globe-Union Inc.
P. O. Box 591 Dept. 92F, Milwaukee, Wisc. 53201
In Canada: Centralab Canada Ltd., P. O. Box 400, Ajax, Ontario

B-6420

JULY, 1964



21

Outperforms Finest Vacuum Tube Units

NEW SCOTT 312 SOLID STATE FM TUNER

... yet it's only \$259.95!

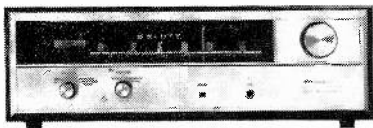

Scott announces a top-performing solid-state FM stereo tuner at a modest price... a no-compromise tuner that exceeds the performance of conventional tube units... it's factory-guaranteed for 2 full years. Not just a redesigned unit, the Scott 312 incorporates an entirely new approach to tuner circuit design:

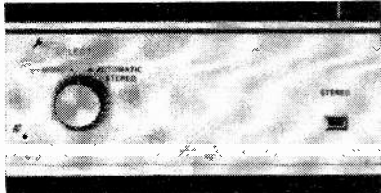

Exclusive "Comparatron" provides foolproof silent automatic stereo switching. Momentary changes in signal strength will not cause stereo to switch in and out as do ordinary automatic devices.



"Flat-Line Limiting" circuits assure quiet, noise-free FM reception, impervious to outside electrical interference. There's actually less than 1 db difference in tuner output whether you listen to a strong local station or a weak distant one.



H. H. SCOTT, INC. Dept. 570-07
111 Powdermill Road, Maynard, Mass.

Please rush me complete information and specifications on the new Scott 312 FM solid-state tuner, plus Scott's full-color 24-page Guide to Custom Stereo for 1964.

Name _____

Address _____

City _____

State _____ Zip _____

Export: H. H. Scott International, 111 Powdermill Road, Maynard, Mass. Cable HIFI Canada: Atlas Radio Corp., 50 Wingold Avenue, Toronto

are not tempered-scale. A Hammond can be played with other tempered-scale instruments, so tape-recorded notes should be accurate enough for tuning, if the tape recorder has sufficient accuracy.

In addition to the Conn Strobotuner, the Schober Organ Co. has a portable, relatively inexpensive stroboscopic tuner.

Mr. Brounstein is right about the limited need for full-time organ technicians. When I was doing installation and repair work for two dealers, I spent only about 3 or 4 days a month in organ work. I believe that electronics organ work is a good means of diversifying an electronic technician's work in locations where part-time work is available. Smaller organ dealers have told me it is very hard to find a technician well-grounded in electronics and interested in learning organ work on a part-time basis.

W. J. STILES

Humphreys, Mo.

Implosion when

Dear Editor:

I read with interest the article about implosion and explosion on page 48 of the April RADIO-ELECTRONICS.

Just recently there was an article in one of the trade magazines about a group of scientists who made a study of the sound made by an implosion. After much research and experiment they arrived at the conclusion that an implosion goes "GNAB."

H. L. SINGLETARY

Engineering Dept., WEAR-TV
Pensacola, Fla.

More on Patents

Dear Editor:

Couldn't help noticing in the Correspondence column the comment entitled "Our Patent System Not So Bad?" by Ronald Klett.

I am not going to try to argue whose patent system is best, since I am not fully versed in the various systems.

But, I would like to take exception to Mr. Klett's comment in paragraph 5 about the difficulty in invalidating an American patent. In some circumstances it is difficult and expensive but, in the majority, cheap and dirty.

This sounds like a strong accusation, but let us turn to Alexander Graham Bell who in numerous articles mentioned his complete financial loss defending his patents. The same is true of Lee de Forest (R-E, September 1961, page 33, paragraphs five and six).

With that issue of R-E in hand, I asked for and was granted an interview with the Senate Committee on Patents and Trade Marks in October 1961, with the hopes of creating interest in this direction.

In the interview I pointed out the Bell and de Forest situations. The committee agreed that it was most unfortunate. The conversation then drifted to

other individual inventors and it was agreed that many an inventor had lost his patent by not being financially able to answer an infringement suit, the plaintiff winning by default. It was also pointed out that it is nearly impossible legally to prove dishonorable intentions of a plaintiff even though they may be quite evident. It was estimated that about \$50,000 would be required to follow an infringement suit through the courts. The committee acknowledged the situation but expressed little interest.

A patent law that will permit the outstanding inventors of our time to be driven into poverty in defending their rights definitely needs revision. It is certainly no incentive for other inventors.

THOMAS L. BARTHOLOMEW

Silver Spring, Md.

Capacitive-Discharge Ignition

Dear Editor:

Mr. Palmer's letter, published in your January 1964 issue on page 47, was informative but did not go quite far enough for a good system comparison.

First, let me state that the classical polarity problem stems from the belief that a negative-going plug voltage fires the gap more easily than a positive-going one. In a slow-rise-time system this is true to some extent, because the plug center electrode is hotter, thereby capable of emitting electrons more easily, which in turn causes an earlier gap ionization or breakdown. The difference in voltage, positive or negative, is small so that in a fast-rise-time system it matters little.

My own developments in the capacitor discharge system have come far from my original description in July 1955 and my more recent description in the July 1962 issue of RADIO-ELECTRONICS. In fact, a complete SCR capacitor discharge system with a true ignition pulse transformer can be built at a cost less than that of a good transistor switched system, and draws less than 0.3 amp starting current.

As Mr. Palmer pointed out, the ignition coil today is the limiting factor in all systems that use it. With one exception, all ignition coils are wound on a low-cost iron-wire core but in a unique manner—for two very good reasons. The winding nearest the core is the high-voltage secondary. In fact, the core is itself tied to the high-voltage end of the winding, making an inside-out configuration. The reason for this is that it's easier to insulate from inside out to the metal can. The primary is the last (outermost) winding nearest the metal container, and can dissipate primary heat immediately to the can. This is extremely important, particularly in transistor systems, which draw from 3 to 16 amps and result in coil primary heat genera-

Exclusive with **RCA** ...

AUTOTEXT

new, faster, easier way toward a career in electronics

EXCLUSIVE WITH RCA. "AUTOTEXT", developed by RCA and introduced by RCA Institutes, Inc. is a system of programmed instruction, a method of learning proved with thousands of students. This beginning course in electronics is accurately planned so that as you read a series of statements, questions, and answers, you learn almost without realizing it. It's fast! It's easy! It's fun!

BEGIN NOW WITH RCA "AUTOTEXT". Now you can start your home training the amazing new RCA "AUTOTEXT" way. And, you get a complete set of theory lessons, service practice lessons, experiment lessons, and all the kits you need. Because "AUTOTEXT" has been designed to help you master the fundamentals of electronics more quickly, more easily—almost automatically—you'll be ready to go on to advanced training in electronics sooner than you ever thought possible.

STUDENT PROVED. Prove it to yourself as others throughout the country are now doing. An interest or inclination in electronics is all you need. RCA "AUTOTEXT" helps you to do the rest. The future is unlimited. The jobs are available! The important thing is to get started now.

FREE OFFER!

We'll send you complete information on amazing new RCA "AUTOTEXT", along with a free sample of a home training lesson in Electronics Fundamentals to prove to you how easy it is to learn this new way. Check Electronics Fundamentals and information will be rushed to you.

Classroom Training Available in New York City, and Cherry Hill (near Camden) New Jersey.
Check "Classroom Training" and we will rush information.



RCA INSTITUTES, INC., Dept. ZRE-74
A Service of Radio Corporation of America 350 West 4th St., New York 14, N. Y.

The Most Trusted Name in Electronics

Complete Selection of Home Training Courses.

- Electronics Fundamentals (also available in Spanish)
- TV Servicing
- Color TV
- Transistors
- Communications Electronics
- FCC License Preparation
- Mobile Communications
- Drafting
- Computer Programming
- Automation Electronics
- Industrial Electronics
 - Automatic Controls
 - Industrial Applications
 - Nuclear Instrumentation
 - Digital Techniques

All RCA Institutes Home Training Courses are complete step by step easy-to-understand units. You get prime quality equipment in the kits furnished to you to keep and use on the job. In addition, RCA's liberal tuition plan affords you the most economical possible method of home study training. You pay for lessons only as you order them. If you should wish to interrupt your training for any reason, you do not owe one cent. Licensed by the N.Y. State Department of Education. Approved for Veterans.

RCA Institutes, Inc. Dept. ZRE-74
350 West 4th St., New York, N.Y. 10014

Please rush me FREE illustrated book with information checked below. No obligation. No salesman will call.

Electronics Fundamentals _____

Other Home Training (choice of courses) _____

Classroom Training (choice of city) _____

Name _____ Age _____

Address _____

City _____ Zone _____ State _____

CANADIANS: Take advantage of these same RCA Institutes Courses at no additional cost. No postage, no customs, no delay. Fill out coupon and send in envelope to: RCA Victor Ltd., 5581 Royalmount Ave., Montreal 9, Quebec.

tion in the order of 20 watts. Perhaps you have noticed the color change on the outsides of some epoxy molded coils in transistor systems. By comparison, the capacitor discharge system coil dissipation increases linearly with engine rpm but at most never exceeds 0.5 watt.

A detailed look at this construction immediately shows the reason for a low secondary resonance frequency of even the coil above. If you now consider a considerably more up-to-date coil such as the Mallory Flash Fire series (U-6 or U-12), you have a more conventional construction of excellent quality with the high-voltage winding

and terminal where it should be, on the outside. This coil's only disadvantage is that it can't dissipate high primary heat. Its secondary characteristics are excellent, with a resonant frequency much higher than the conventional coil, or about 5,000 cycles.

There are two additional ways an ignition coil can be made to have the extremely fast rise time of the capacitor discharge system. They both involve reducing secondary self-inductance. The first is to employ fewer total secondary turns and much lower turns ratio. The result is that obtained with the EI-4 system manufactured by Motion, Inc.,

an expensive unit using thyatron tubes because of the high primary discharge voltages (1 to 2 kv), but giving an extremely fast rise time.

The second method was implied previously when I mentioned a complete SCR capacitor discharge system using an ignition pulse transformer. Present-day ignition coils are very poor transformers because of their low magnetic-path efficiency. The effective permeability of the straight unclosed core is only about 4. This is to say that the coil inductance is only four times greater than that of an air core. The obvious answer is to provide a true closed-path magnetic core with an effective permeability of 1,000 or more. For the same value of primary inductance this then means fewer turns or a primary turns reduction of $\sqrt{4/1000}$.

While the secondary inductance also remains the same, the secondary self- or leakage-inductance is drastically reduced. That is what determines rise time, so an ignition pulse transformer using this technique can still use a nominal 100:1 ratio with fewer turns and much smaller physical size. A working model has been constructed in the volume of a 3-inch cube.

Now comes the question, why can't this construction be used with the transistor switching system? The reason is simple and mainly why even transistor systems must use the same old-fashioned coil of the early 1900's: dc saturates the core and dictates the use of the straight-rod core type coil. The capacitor discharge system, since the transformer is coupled through a capacitor, cannot send any dc through the primary, thus, no saturation.

For original manufacturers, then, the SCR capacitor discharge system with a very-low-cost multiple-wound ignition transformer and fired by either breaker points or an extremely low-cost, speed-insensitive transducer system is likely to be able to meet any future engine requirements.

H. W. LAWSON

Rochester, N. Y.

END

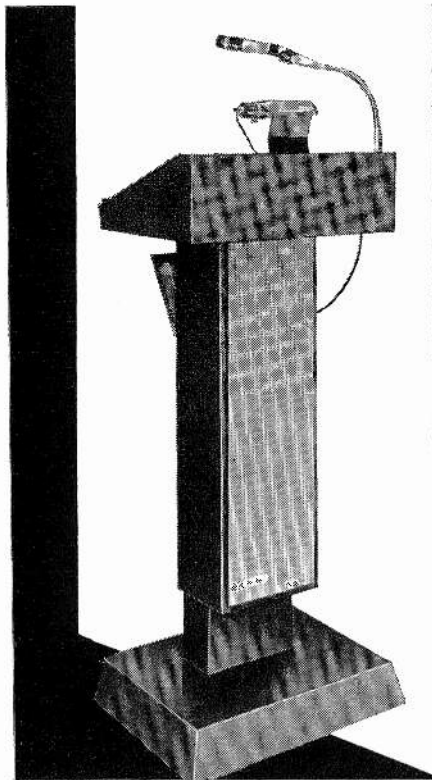

*why
compromise?
the AMPLI-VOX
sound
column
lectern
meets all
your needs!*

You don't have to weigh sound system features vs. lectern features vs. budget—and end up with a compromise.

Here's a deluxe lectern which includes a complete high volume sound system—available for only \$299! It's powerful enough for enormous auditoriums, versatile enough for every public address requirement, and it's battery operated, so *anyone* can use it *anywhere*. Check the features; compare them with any other equipment at any price; then write for complete data, source information, and/or a no-obligation demonstration.

Lectern Features

- Fingertip height adjustment over 10 inch range
- Instant set-up, immediate performance
- Sturdily constructed of heavy-duty wood covered with scuff-proof Texolite in rich looking black ostrich grain
- Retractable wheels let you *roll it* from place to place
- Weighs only 40 pounds
- Completely self-contained

Sound System Features

- 25 watt all-transistor amplifier (40 watt peak)
- Six built-in speakers in integrated sound column, for wide penetrating coverage
- Powered by flashlight batteries! No plug-in; no engineer or maintenance man required. AC adapter available
- High quality cardioid microphone
- 2 inputs, 2 outputs
- Adapts for audience participation

AMPLI-VOX AUDIO PRODUCTS

Manufactured in USA by

PERMA-POWER COMPANY

5740 NORTH TRIPP AVENUE
CHICAGO, ILLINOIS 60646
PHONE: 539-7171 (AREA CODE 312)



"You realize night calls cost more."

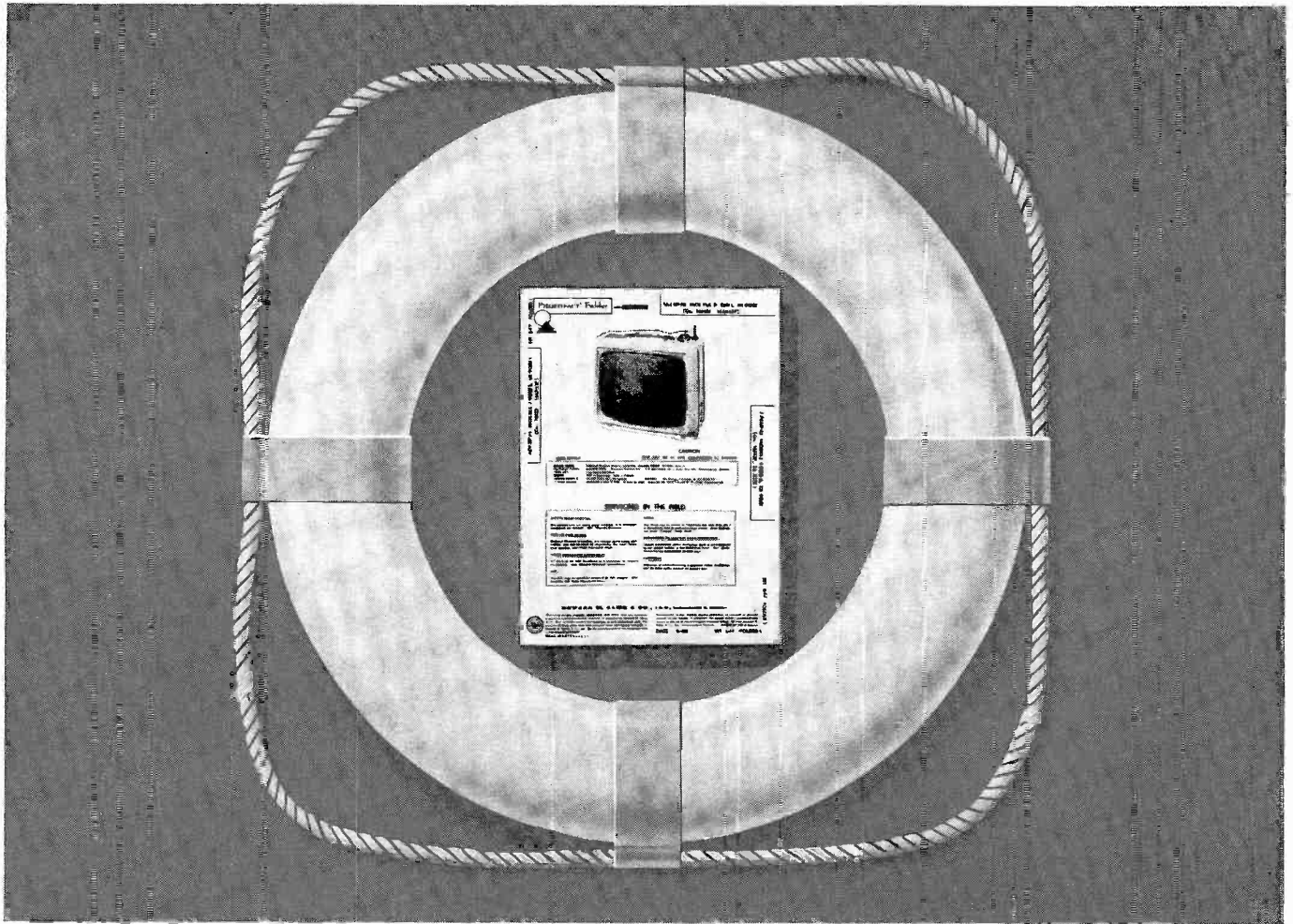

"It's a lifesaver."

We didn't say it. A lot of technicians have used these very words to describe PHOTOFACT. One particular letter (unsolicited) says it like this:

"I wouldn't think of being in business without PHOTOFACT. It's a lifesaver."

Others say they're sunk without PHOTOFACT. We don't really expect anyone to "drown" without it, but we do know it *saves* time and *saves* trouble and floundering around. We do

know it often means all the difference between making a profit and not.

There are over 40 "lifesaving" features in every PHOTOFACT Folder, time-saving features to show you the way to *fast* TV-radio troubleshooting. (Really keeps you on top of those tough-dog jobs.)

Users don't measure PHOTOFACT by its pennies-per-page cost. It's the time-saving, profit-making worth of

PHOTOFACT that counts.

Of course, you can get along without PHOTOFACT—a few do—and maybe they're making a living. But it's the hard way.

Doesn't it make good sense to see your Sams Distributor today for details on an Easy-Buy PHOTOFACT Library and Standing Order-Subscription?

Or use the coupon below.

A PHOTOFACT LIBRARY PAYS ITS OWN WAY—

Now, more than ever, it pays to own PHOTOFACT—the world's finest TV-radio service data. Now, you can start or complete your PHOTOFACT Library this Easy-Buy Way:

Only \$10 down • 30 months to pay • No interest or carrying charges • Prepaid transportation • Add-on privilege of a year's advance subscription to current PHOTOFACT on the same Easy-Buy contract • Save 30¢ per Set—special \$1.95 price applies on Easy-Buy (instead of the regular \$2.25 price).

4 Ways to Select Your PHOTOFACT Library: 1. Complete your present PHOTOFACT Library. 2. Order a PHOTOFACT "Start-er" Library—180 Sets (Sets 301 to 480—coverage from 1955 to 1960—only \$11.36 per month). 3. Order by brand name and year—see the handy selection chart at your Distributor. 4. Order a complete PHOTOFACT Library—get FREE file cabinets, *plus* a selection of invaluable books and Electronics Courses.

SEE YOUR SAMS DISTRIBUTOR FOR FULL DETAILS, OR MAIL COUPON ▲

Howard W. Sams & Co., Inc., Dept. REF-7
4300 W. 62nd St., Indianapolis 6, Indiana

- Send FREE Photofact Cumulative Index
- Send full information on Easy-Buy Plan
- Enter my Photofact Standing Order Subscription



My Distributor is _____

Shop Name _____

Attn. _____

Address _____

City _____ Zone _____ State _____

ELECTRONICS' FUTURE

The Great Things in Electronics are still to come...

Late last March, Prof. Seymour Melman of Columbia University made public certain important facts about the economic consequences of the contemplated long-term reduction in US armament.

His findings were so important that he presented them to Congress on March 24. They were part of a survey by the Seminar on Industrial Conversion of Columbia's Department of Industrial Engineering.

The gist of the report is that at the time of the announcement 67,-

000 professional engineers, technical and production workers as well as clerical personnel of 19 major defense and electronic concerns in 6 states had been laid off due to cut-backs and cost-cutting programs.

This is not surprising if we consider how much of today's military equipment is electronic and that more than 50% of the electronics industry's output is for defense.

Normally—if history had repeated itself—with the coming of peace at the end of World War II, the arms race should have terminated. But then came the Cold War, followed by the Korean war in 1950 to 1953. The Cold War—while it has abated—is still with us.

Washington, to be sure, long ago foresaw what was going to happen in the age of electronic decompression, in which we find ourselves now. When part of the second largest industry in the country, with annual sales of \$16 billion a year, is slowed down, the consequences at best must be disastrous to many of its workers as well as employers.

As long ago as Dec. 21, 1963, Gardner Ackley of the

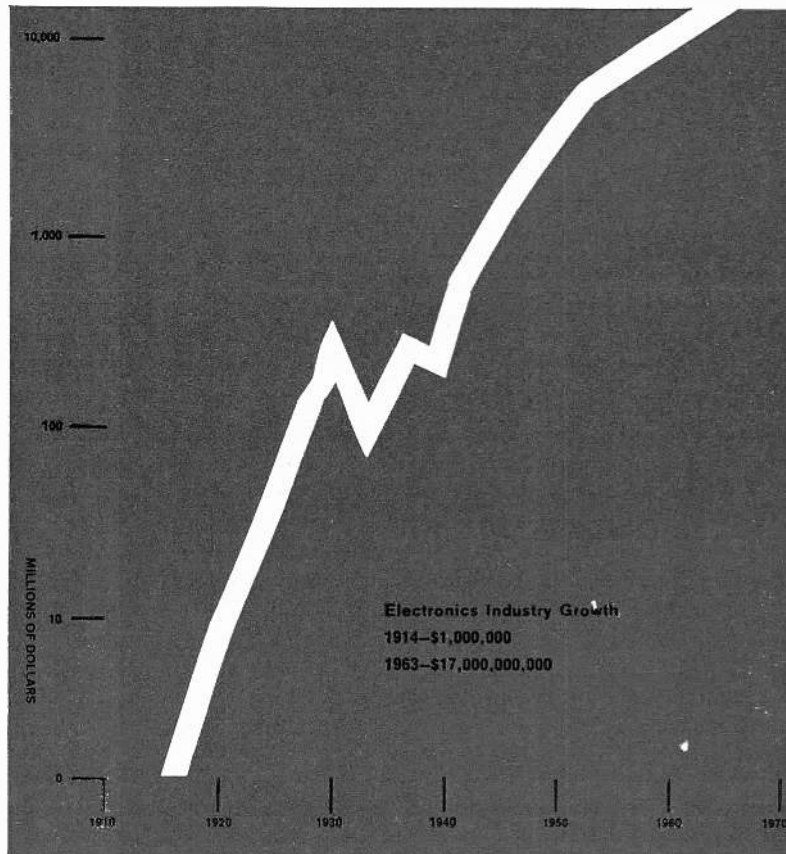

Council of Economic Advisers was named by President Johnson to head a 10-man Committee on the Economic Impact of Defense and Disarmament.

The path of electronics for the past 60 years has by no means been smooth. It has been marked by periodic ups and downs, soaring booms and depressions. This is true for most industries, whether they be motor cars, oil or electronics.

The young radio industry received its first setback in 1917. This

was before the US entered World War I. Then, by Presidential decree, it became unlawful to operate any radio station. Nor could radio supplies be sold during the duration of the war, from April 6, 1917 to Nov. 11, 1918.

This was followed by the electronic construction boom of 1919 to about 1925, the so-called "set builder's" parts boom, the heyday of the radio components expansion, when the whole country was building every imaginable type of radio set—the first broadcasting boom.

Then the builder's boom collapsed, bringing in its wake the factory-made receiver. Where heretofore components brought fancy prices and vacuum tubes sold for as high as \$12 apiece, many electronics manufacturers began to make parts themselves and the ensuing harsh competition lowered all component prices drastically.

Nevertheless, by 1929 the electronics industry had become much bigger than ever, in output as well as dollar value. Electronics had started to expand in all directions—communication, hundreds of different tubes, every imagin-

able type of radio receiver—industrial electronics.

In the meanwhile, in the late 1920's experimental television became a fact. It was first demonstrated by the present writer in August 1928 over his station WRNY in New York on a regulation broadcast wavelength of 362 meters (and shortwave of 30.91 meters). This was not television as we know it today—the resulting picture was postage-stamp size, and at first there was no sound. But the picture was clear and sharp.

Not until the late 1930's did the modern cathode-ray tube TV make its appearance. Before it could expand normally, World War II started for the US on Dec. 7, 1941. Few home TV (or radio) sets were made from then until the end of the war in 1945. After that, electronics grew at an unprecedented rate without letup until the early 1960's.

We felt it necessary to present this thumbnail sketch of electronic history to give the reader a better idea of the electronics economy and of its future.

In our opinion, the latter part of 1964 should see the end of the current devolution. This probably will be followed by the greatest electronic boom of all times.

What of the future?

End of Japanese Invasion

For a number of years, the Japanese have been inundating the US with low-priced, yet excellent electronic parts and sets with which we have been unable to compete. The value of Japanese imports amounts to \$176 million per year.

Within the next year or two much of this traffic should stop, for one simple reason: *microminiaturization*. The art and our know-how, plus certain patents, now make the most electronic components obsolete. In the long run we probably can do better than the Japanese, particularly if our manufacturers go all out in *automated microminiaturization*.

Supermagnification

We will not conquer virus diseases until we really have electronic magnification at an atomic level. The cancer virus, if cancer is a virus disease, is invisible unless enlarged to where atoms become visible. We believe electronic supermagnification is now on the horizon. Vastly more powerful electromagnets such as used in electron microscopes, if

energized by superconductors, could effect much higher magnification.

Miniature Television

Thanks to the Japanese, we now have small-scale portable TV sets. The smallest current Japanese model has a screen $3\frac{1}{2} \times 2\frac{3}{4}$ inches. This, however, is comparatively large.

For the Christmas 1945 issue of the writer's booklet entitled *Tame*, the inside cover showed the picture of a proposed television wristwatch, the *Teleview*. In the center was a watch, to the left the TV screen, to the right the loud-speaker. The miniature screen showed a "magnilens" for enlarged viewing of the picture.

This is about as small as TV's are likely to get, except for even smaller medical ones that surgeons or doctors will soon insert into patients' bodies for diagnostic purposes.

Such miniature TV's will probably be manufactured not later than 1970. There will be a good demand for them by that time. The key, of course, is microminiaturization. These sets will not have bulky cathode-ray tubes. They will be replaced by a special vacuum-fluorescent screen.

Space Exploration

It is in future space exploration that electronics will earn its laurels. Up to now we really have not explored the vacuum of space seriously. We merely have been theorizing and preparing ourselves for the coming electronic onslaught on space.

The great wonders of space will come after 1970. Entirely new means of space propulsion, not even seriously considered today, are yet to come. And they will be electronic in part. They will be better and faster than the slow ionic means.

The Administration is now committed irrevocably to the serious exploration of space—the neighboring moon and the more distant planets. Our future destiny depends on it, just as the Old World's destiny depended on Columbus and others for the exploration of the New World in the 16th century.

More important, immense treasures—dozens of billions—will be poured into the coming space research, far more than electronics has ever before received from the Government. It will probably make electronics the greatest industry in the US.

—H. G.

By **JOSEPH H. SUTTON**

A POWER DECADE BOX HAS INNUMERABLE uses around the shop or lab: checking power transformer output, amplifier output, temporary substitution in bleeder circuits or anywhere you want to find the right-value resistor without (ordinarily) worrying about possible resistor burnout in your box. (For applications where the current is near the box limit, it is always wise to connect a low-resistance ammeter in series with the box, or a high-resistance voltmeter across it.)

This decade box ranges from 1 to 100,000 ohms in 1-ohm steps. It will handle moderate current, 30 ma to 3 amps at up to 1,000 volts ac or dc (the switch breakdown rating). Each decade uses five resistors: one 10-watt and four 20-watt, so each step will dissipate 10 watts, and each decade 90 watts (Fig. 1). Wirewound power resistors are neither easily burned out nor permanently damaged by temporary overloads and, if inadvertently burned out, are inexpensive to replace.

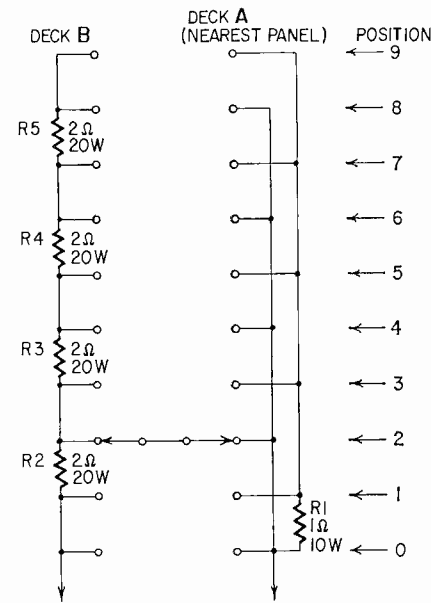
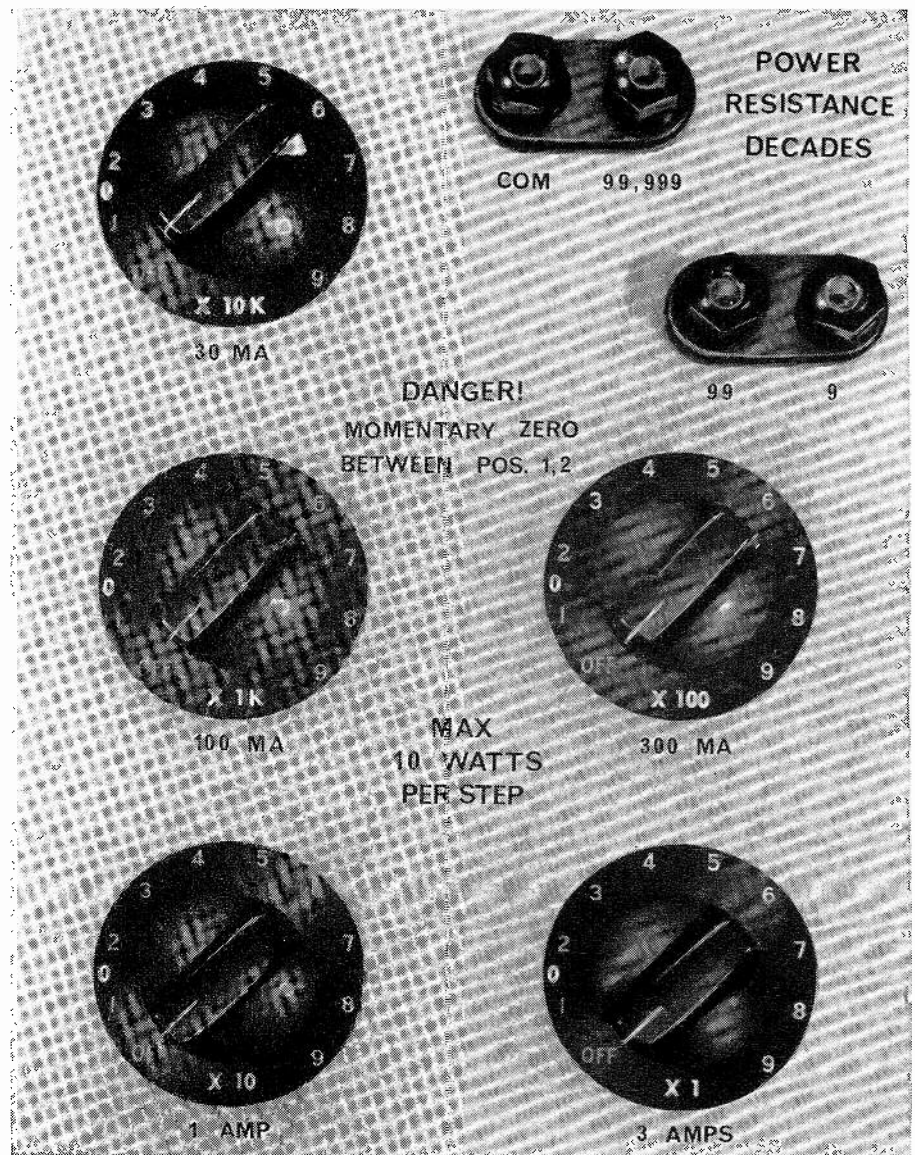

Fig. 1—Schematic of one resistance decade, with values shown for first (lowest) decade. For higher decades, multiply resistance values by 10, 100, etc.

By contrast, most commercially available decade boxes, even expensive ones, will handle only one-fourth to one-eighth as much current as this box, and correspondingly only from one-sixteenth to one-sixty-fourth as much power. The common kit-variety decade box uses four 1-watt resistors per decade, in 1, 2, 3, 6 combination, so from 1 ohm to 100,000 ohms, it will handle only 400 to 4 ma. For light loads, such a box is handy to have. But, in it, any carbon resistor may be ruined by temporary overload, and for expensive boxes, the wirewound replacements are costly. Hence the need for a moderate power box, even (or



Panel of decade box shows maximum current rating for each decade and carries other reminders.

DECADE BOX USES POWER RESISTORS

EASY-TO-BUILD, EASY-TO-USE SWITCHBOX HANDLES HIGHER CURRENTS THAN COMMERCIAL JOBS — AND COSTS LESS

especially) if you already have a low-power box.

Construction layout is not critical. Wire each decade completely before you mount it in the chassis. Either end of each decade is then soldered in the chassis to the outside terminal as shown in the schematic. Make all leads as short as convenient, and use No. 18 hookup wire.

Since the voltage rating of this box is 1,000 maximum, the two highest 20,000-ohm resistors can be rated less than 20 watts, say 10 watts for R4 and 5 watts for R5. I did not use these values because the construction symmetry would have been altered.

If this power box were intended for more than short-duty heavy-current

applications, ventilating holes could be punched in the chassis sides and bottom. Because such holes let dirt and dust into the switches, I decided just to remove the chassis bottom in the rare event of a long-duty heavy-current application.

In checking power transformer output, you may find it necessary to extend the 100-ma range with an externally connected 5,000-ohm 50-watt or 10,000-ohm 100-watt resistor.

Accuracy of this wirewound box can be high. Originally I aimed for 5%, the usual commercial rating for power resistors. With a bridge you can make finer adjustment: select the 1-ohm to 2,000-ohm units a trifle "long", then parallel with carbon resistors. The 10,000- and 20,000-ohm units can be

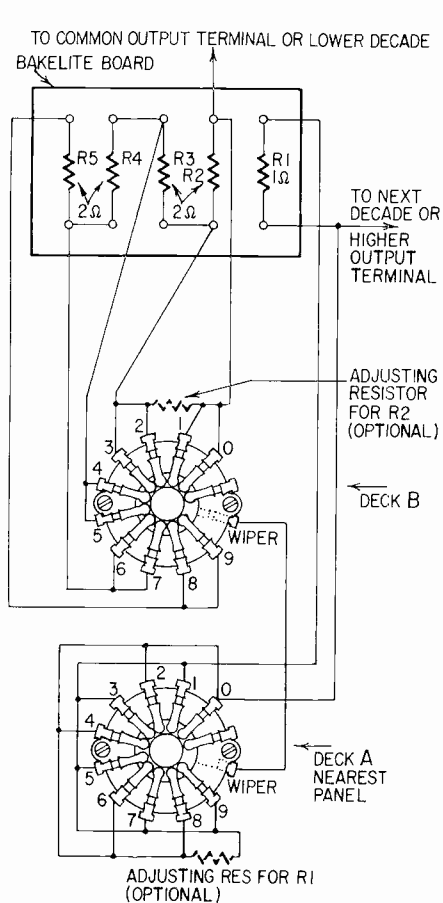
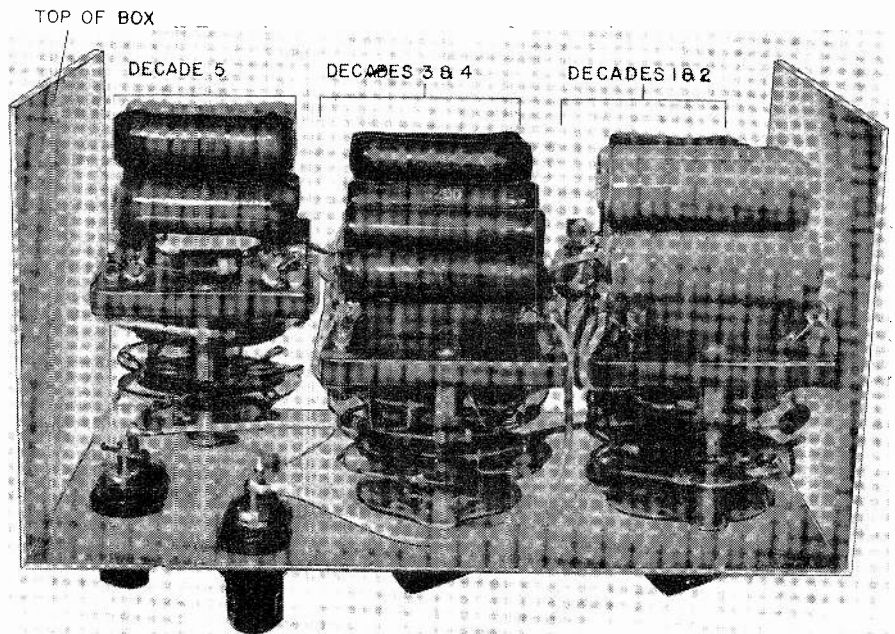

Fig. 2—Switch and Bakelite board wiring, rear view. Photographs show further details.

- 5 wirewound power resistors, 5% or better, 10 watts, one of each: 1, 10, 100, 1,000 and 10,000 ohms
- 5 wirewound power resistors, 5% or better, 20 watts, four of each: 2, 20, 200, 2,000 and 20,000 ohms
- 5 rotary switches, 2 gangs, 2 poles, 11 positions, shorting type (Mallory 1221L) with dial plates and knobs as desired
- 1 dual binding post
- 10 brass spacers, 3/8-inch CD., hole for No. 6 screw, unthreaded
- 10 machine screws, 5-40 x 1 1/2 inches, and nuts
- 50 spade mounting bolts
- Bakelite (see text)
- Hookup wire, chassis, miscellaneous hardware



Interior view of the completed box.

chosen "short", and resistance added in series. The trimming resistors must be wattage-rated to stand more than the maximum voltage rating across the wirewound resistor. By this adjustment, the box error at room temperature (could be brought down to 1% or less. Wirewounds will ordinarily gain 1/2% between room temperature and current-rated hot condition.

Switch wiring is in Fig. 2. Mallory switch 1221L seems to be the only catalog item adequate to carry the current. The switch *must* be a shorting (make-before-break) type to prevent opening and closing the circuit on high current. The four-resistor decade switch (Mallory 154L) will not do for this box because of the low current capacity of the 1, 2, 3, 6 combination.

There is a momentary short between positions 1 and 2 (Fig. 1). This is

noted on my box by a decal zero affixed between positions 1 and 2. Commercial boxes using this circuit (e.g. Leeds & Northrup 4775) normally fail to tell you that, with sometimes unpleasant consequences. But when you know the limitation, it is always easy to switch in additional resistance temporarily while crossing this zero.

The 2 1/2 x 2 3/8-inch mounting platform for the resistors was cut from 1/4-inch scrap electrical Bakelite. (Do not use cloth-filled Bakelite, which is electrically too leaky.) Spade lugs were mounted on the long side, and this platform affixed to the switch with 1 1/2-inch 5-40 bolts through 3/8-inch unthreaded brass spacers. These dimensions are precisely right for this switch; no cutting or filing has to be done. The wirewounds were then soldered to the lugs, the switch wired, and the adjusting resistors attached to the switch lugs as necessary. Actually, the box would have been quite good without these adjusting resistors: the maximum error was 2%.

I provided separate outlets for 9 and 99 ohms to circumvent the contact resistance of the three higher switches. Actually, this contact resistance proved to be very small, and I would now omit these outlets. The dual binding posts anchor easily and firmly to the chassis.

If the Mallory switch indexing mechanism appears too stiff, remove one of the indexing wheels and, only if necessary, bend the resulting free spring end so that it does not touch the index track. You can wait to make this adjustment until after the decades are installed in the chassis.

To apply decals, I use an eye loupe, small brush and toothpick. Let decals dry overnight, then lightly spray (don't brush) with lacquer thinner to make them adhere.

END

Decade switch detail.

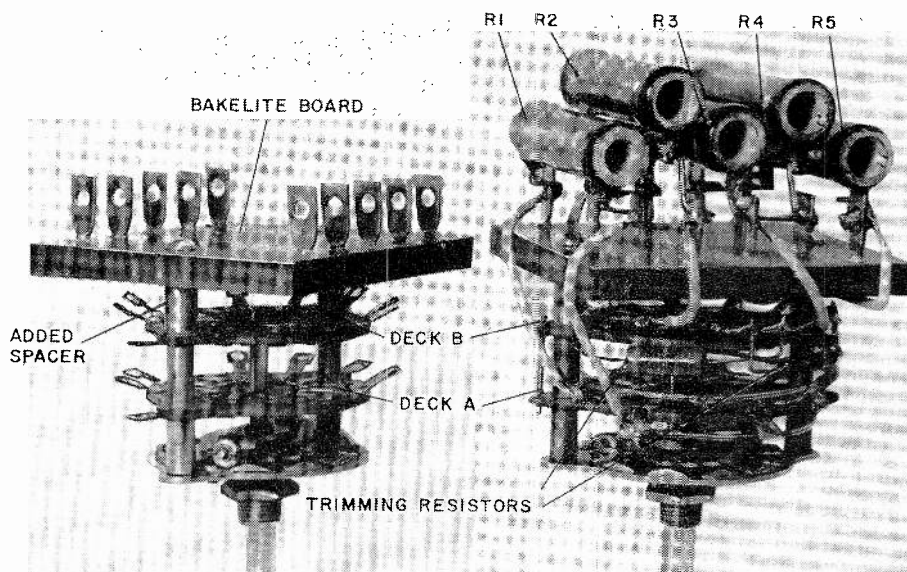

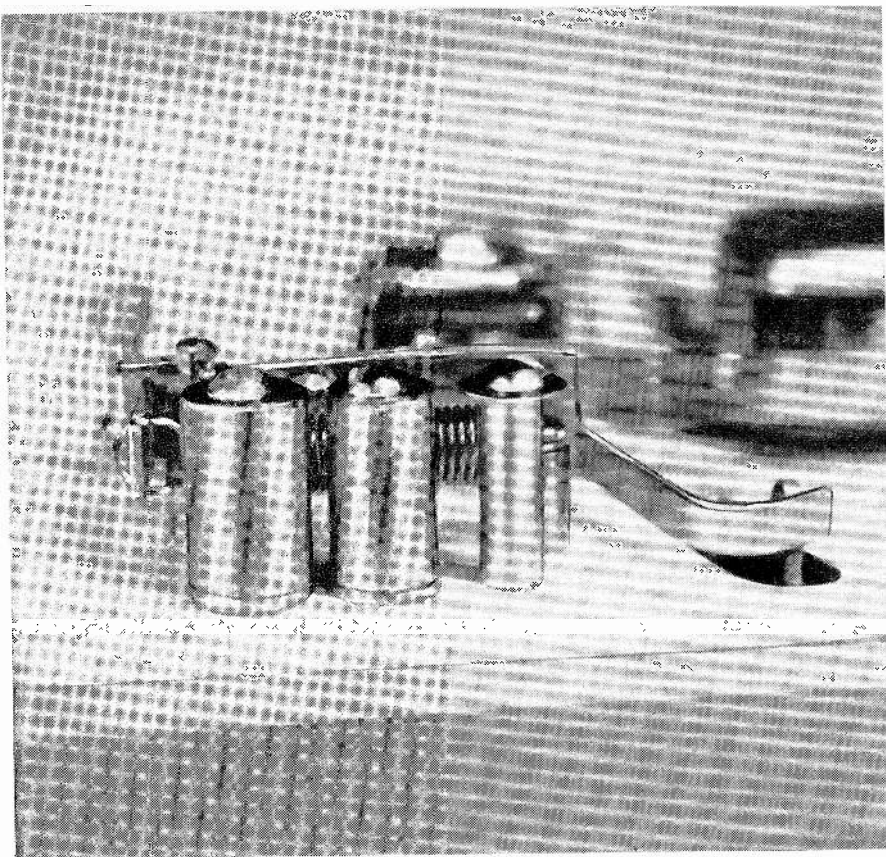

CAPSTAN SLEEVES AND SPEED CHANGES. Many imported machines are equipped for both 50- and 60-cycle operation. Most inexpensive models use capstan sleeves to adjust speed accordingly. Photograph shows three capstan sleeves used on Daiwa (Japanese). It is a two-speed machine, so it needs four capstan sizes: two speeds at 60 cycles, and two at 50. Fourth size is capstan diameter itself, not shown.

On a machine with mechanical shift, usually only one sleeve is needed to change frequency.

Should you want to figure speed of two- or four-pole motors, use $120 F/N$. If F is power frequency in cycles and N is the number of poles, the result is the speed in rpm.

A 50-cycle motor on 60-cycle current runs about 20% too fast. Easiest way to reduce speed is to reduce capstan diameter by 20%.

When you run a "switchable capstan" machine on 60 cycles, select *smallest* sleeve for 3¾ ips and *second largest* for 7½ ips. Smallest sleeve is usually capstan itself; when there are four sleeves, disregard capstan diameter.

On more expensive recorders frequency is changed by replacing motor pulley and changing motor capacitors, taps, etc.

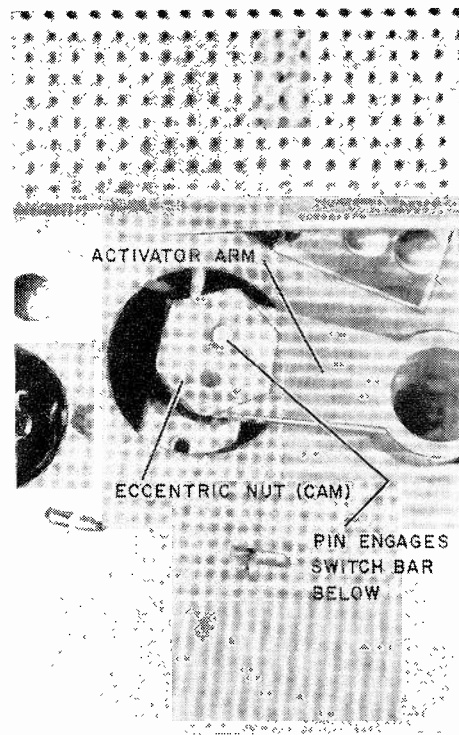

WOLLENSAK 1500 AND 1600. A Wollensak 1500 came in recently with a complaint of erratic playback. We confirmed it and found that record/play switch lever arm was not lined up with mechanical actuating mechanism.

We corrected this by adjusting the cam-pin (see photo). Put machine in "play" and adjust plastic nut until operation is normal. Check "record" position and seal nut with service cement. Wollensak 1600 uses same type of switch—trouble has come up in those, too.

These seven service tips grew out of actual experiences, and can save you lots of time

NOTES FROM A TAPE RECORDER SERVICE BOOK

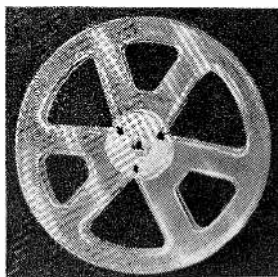

WATCH THAT REEL! Some recorders still use old-type reel with small center (see photo). Though this was popular and practical some years ago, many modern machines do not have automatic tape tensioning and are designed to provide constant tape speed with standard 2¼-inch-center EIA reel. When old-style reels are used on newer machines, speed may decrease near end of reel because of increased pulling force required. During rewind machine is subjected to far greater stress than it is designed to take, and so are tape and tape guide parts.

Pre-recorded tapes are usually supplied with large-center reels, because smaller angular variation of tape on supply reel means less variation in tape drag and less flutter.

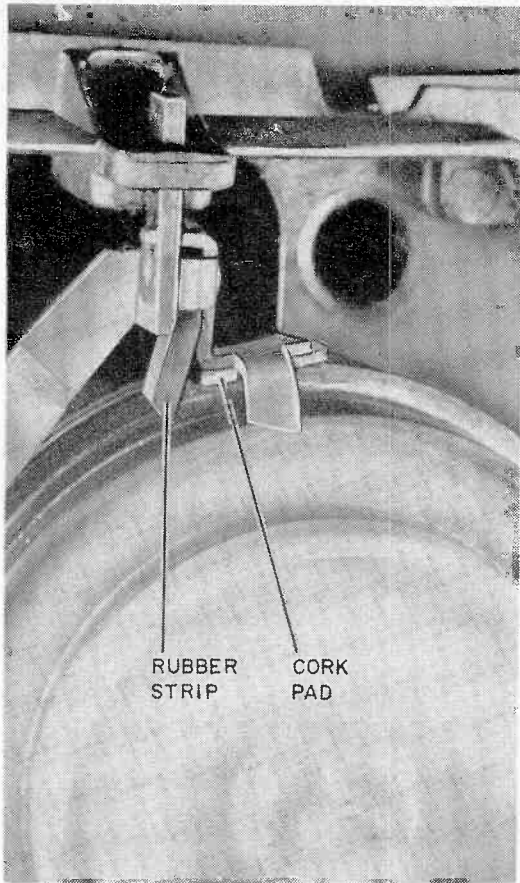

NORELCO/PHILIPS BRAKE. Photo shows brake arrangement on Norelco/Philips series 200. (Also, 300, 400.) When tape spindle runs counterclockwise, rubber strip acts only as slight drag and cork pad brakes. When direction is reversed, rubber strip brakes by catching drum at angle that throws strip back against brake assembly platform. Platform shown is takeup spindle; supply spindle has same arrangement.

Idea behind this is to insure that supply reel is stopped quickly with rubber strip and takeup reel slowed gently by cork pad, regardless of direction of tape travel. Smooth, tangle-free operation with minimum of brake parts.

Machine is shown here in playback position with brake off.

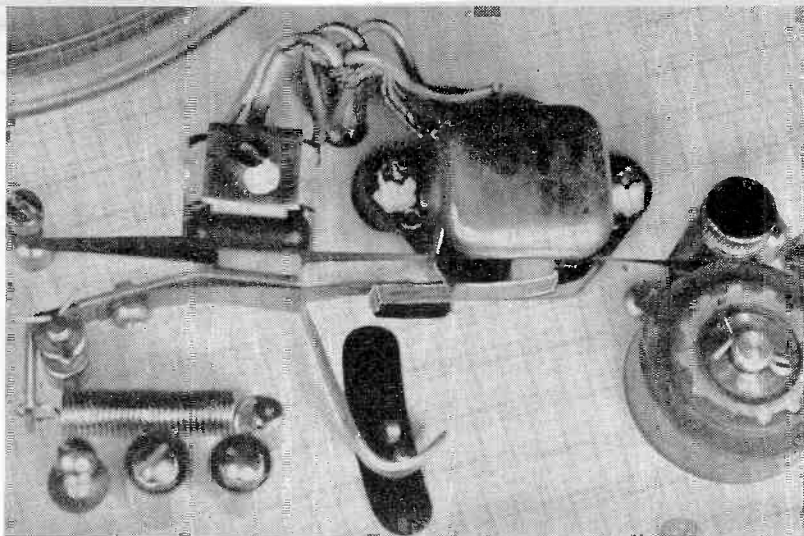

TAPE SQUEAL. Usual remedy here is to clean heads and pads. This usually works only for a while. This trouble is generally caused by mechanical oscillation of some part—like the spring-loaded pressure arm shown in the photo. A good cure is to cement small damping pad of foam rubber onto the arm so as not to interfere with normal operation.

Photo shows tiny square of foam rubber cemented to arm between heads. Use alligator clip to hold pad while cement dries.

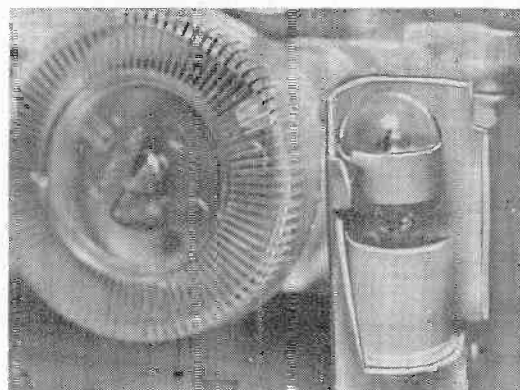

NEON LEVEL-INDICATOR POSITION. Many machines use NE-45 neon lamp as record-level indicator in circuit like that in schematic. During normal levels only one side of lamp lights. Above preset maximum level, bias is overcome and ac signal flashes both sides.

Recorder control panel is usually lettered with **NORMAL** and **DISTORT**, or such. When you replace this kind of lamp, be sure to line it up so the elements inside it correspond to the panel markings. Secure with drop of cement to prevent loosening and rotation.

Photo shows Wollensak 1500. Lamp is secured with piece of tape. **END**

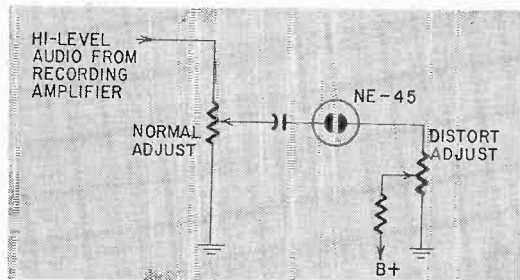

By **STEVE P. DOW**

KORTING 158S LIMIT SWITCH. Limit switch canceling bar on this machine prevents automatic stop from operating during loading or rewinding. Bar seldom causes trouble on its own, but any change in backswing of capstan roller arm directly affects it. May cause tape to spill.

To adjust bar, bend end nearest capstan roller arm slightly forward, advancing trip switch further into correct position.

Be sure machine operates normally for regular cutout operation. Do not adjust capstan roller arm—you'll have to tamper with several other critical adjustments.

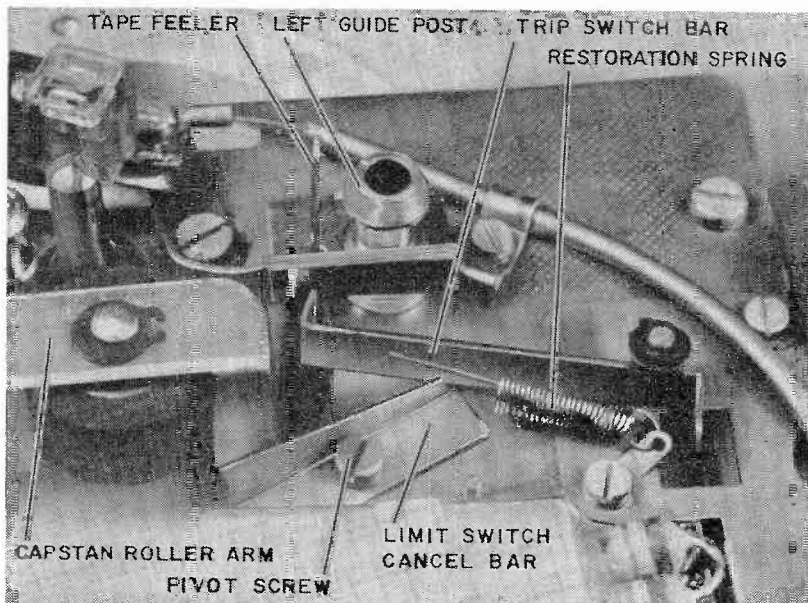

HAVE YOU EVER MADE A SERVICE CALL where a familiar-looking radio or TV set had a strange name or the name of a well-known mail-order-house or chain store? Your familiarity—or lack of it—with these “private-brand” sets depends on how long you have been in the radio-TV game.

What is a private brand? We are all familiar with the big brand names—Zenith, RCA, Westinghouse, etc. These companies put their own brand names on the sets they make. Private-brand sets are made by a manufacturer who sells his sets to a retail store company. Private-brand retailers include chains such as Sears, Roebuck; Montgomery Ward, Western Auto Supply and Gamble Stores. Outlets of one or all of these are found in cities of 5,000 or more throughout the United States and Canada. Although I could find no figures to prove it, I believe that these four companies account for the largest share of radios, TV's and stereo sets sold today.

Probably your next question is, “Who makes private-brand equipment?”

Private-brand radios, TV sets, uhf converters and other home entertainment equipment are made by several very large as well as many small companies. At present, the field is dominated by three large manufacturers. One, Warwick Manufacturing Co. in Chicago, is a captive plant of Sears, Roebuck & Co. The other two supply numerous retail organizations and are Wells-Gardner Electronics Corp., Chicago, Ill., and Trav-Ler Industries Inc., whose offices and laboratory are in Chicago and whose assembly plant is at Orleans, Ind.

Several companies make private-brand automobile radios for Ford, Chrysler and Rambler. The Delco Radio Div. of General Motors is a GM supplier and makes Studebaker radios too.

Another private-brand operation that was really big was the uhf converter business. One company (P. R. Mallory Co., Inc.) made several thousand converters a day for 20 or more of the best-known names in the industry. Some of the smaller private-brand manufacturers are listed in the chart with several of the name-brand companies that have built private-brand sets.

Many small auto parts chains, furniture stores, five-and-dime stores and drug stores have had their own brand names. You will also remember that only last year RCA was making color TV chassis for every company in the United States except two. The other set manufacturers bought the chassis from RCA, mounted them in their own cabinets and put their own brands on. This may have been the largest private-brand operation of all time.

The charts are intended to give you quick, concise information that will help

Private Brands—Who Makes 'em?

Think you've seen that same chassis before with a different name? You have!

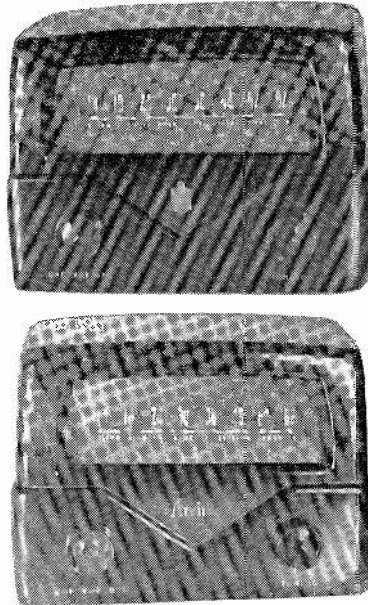

Both of these uhf converters were made by the P. R. Mallory Co. The one on the top carries the Mallory medallion, while the one on the bottom carries the name Arvin, trademark of Arvin Industries, Inc.

you identify strange sets by their brand names. Most of the sets in use since World War II are listed here. Some sold only in limited markets haven't been included because of lack of space. The columns, reading from left to right, list:

1. The trade name on the radio or TV set, with a notation of the retail company selling it.
2. The name of the company actually making the set.
3. The code letters in the model number that designate who made the

set. Not all manufacturers include this code.

4. The EIA identification number assigned by the Electronic Industries Association to member companies.
5. The address of the set manufacturer, not of the retail company.

Most electronic components are interchangeable from one model to another, but there comes a time in every serviceman's life when he needs a special part—a cabinet, a coil, a dial glass, a transformer, a speaker or some other part obtainable only from the factory. This is when the chart will come in handy. A letter to the company will usually bring information on how to get the needed part. Most set manufacturers are very cooperative when it comes to supplying parts to insure customer satisfaction. The repairman is often the only link between the manufacturer and the customer. Many people who retail private-brand sets have no repair facilities, and farm out their repair work to private service contractors.

Using the information in the accompanying tables and on the nameplates of the sets will make your repair work easier and more profitable.

[Merit Coil & Transformer Corp., Merit Plaza, Hollywood, Fla., publishes a catalog (*Form 810*) which carries on page 57 a list of manufacturers and trade names. No addresses are given, but the list includes some names not in the table published here. The Guide Section of the *Triad Replacement Handbook for Professional Servicemen* (Triad Distributor Div., 305 No. Bryant St., Huntington, Ind. contains similar information, with part numbers.—*Editor*]

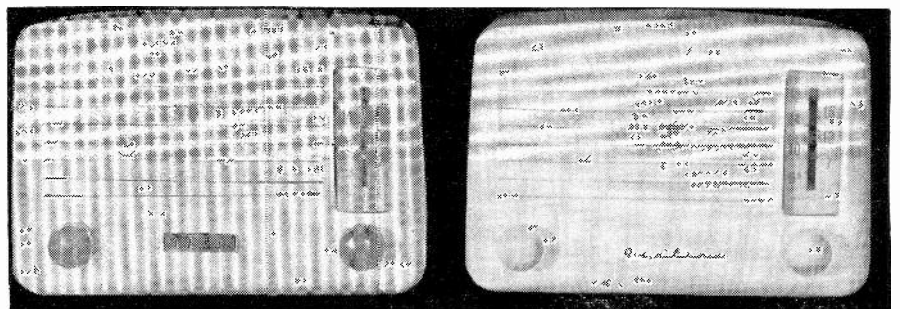

The small Airline radio on the right was made by the Kingston Products Corp. for Montgomery Ward. With different-colored knobs and a Kingston decal, we have another model.

WHO MAKES AND SELLS PRIVATE-BRAND SETS

TRADE NAME	RETAIL OUTLET OR AUTO MAKE	MFR. NAME	CODE LETTER	EIA CODE	ADDRESS OF MANUFACTURER
AMC	Many department stores	Arvin Ind., Inc.		248	1513 13th St., Columbus, Ind.
		Trav-Ler Ind., Inc.		320	571 W. Jackson Blvd., Chicago, Ill. Also Orleans, Ind.
		Wells-Gardner Electronics		334	2701 N. Kildare Ave., Chicago 39, Ill.
Airline	Montgomery Ward	Audio Industries	GAA		W. 4th St., Michigan City, Ind.
		Pentron	GPL		1214 N. Wells St., Chicago, Ill.
		Trav-Ler Ind., Inc.	GTC	320	Chicago, Ill. Also Orleans, Ind.
		Wells-Gardner Electronics	WG	334	2701 N. Kildare Ave., Chicago 39, Ill.
		Philco Corp.	GPS	260	C and Tioga Sts., Philadelphia, Pa.
		Westinghouse	GTM	337	Box 71, Metuchen, N. J.
		Esquire Radio Corp.	GEN	742	6201 15th Ave., Brooklyn 19, N. Y.
		Waters Conley Co., Inc.	JWR	382	645 N. Michigan Ave., Chicago 11, Ill. (Out of business)
		Belmont Radio Corp.	BR		(Out of business)
		Kingston Radio Corp.	KR		(Out of radio business)
Airline, Riverside	Montgomery Ward	Automatic Radio Sales, Inc.	FJB	120	122 Brookline Ave., Poston 15, Mass.
Allstate, Silvertone	Sears, Roebuck	Various			
Ambassador	Various	Trav-Ler Ind., Inc.		320	571 W. Jackson Blvd., Chicago, Ill. Also Orleans, Ind.
American Motors	American Motors	Bendix Radio Div.		125	Baltimore 4, Md.
		Motorola, Inc.		185	9401 W. Grand Ave., Franklin Park, Ill.
Bradford	W. T. Grant & Co.	Wells-Gardner Electronics	WGEC	334	2701 N. Kildare Ave., Chicago 39, Ill.
Buick, Cadillac Chevrolet	GMC	Delco Radio Div.		466	Kokomo, Ind.
Columbia	CBS Corp.	Trav-Ler Ind., Inc.		320	571 W. Jackson Blvd., Chicago, Ill. Also Orleans, Ind.
Coronado	Gamble Stores	Trav-Ler Ind., Inc.		320	571 W. Jackson Blvd., Chicago, Ill. Also Orleans, Ind.
		Elco			Michigan City, Ind.
		Hinners-Galanck			Not known
		Wells-Gardner Electronics	TV2	334	2701 N. Kildare Ave., Chicago 39, Ill.
Firestone	Firestone Tire & Rubber Co.	Trav-Ler Ind., Inc.		320	571 W. Jackson Blvd., Chicago, Ill. Also Orleans, Ind.
Ford Mercury	Ford Motor Co.	Bendix		125	Baltimore 4, Md.
		Motorola, Inc.		185	9401 W. Grand Ave., Franklin Park, Ill.
		Bendix		125	Baltimore 4, Md.
Mopar	Chrysler Corp.	Bendix		125	Baltimore 4, Md.
		Motorola, Inc.		185	9401 W. Grand Ave., Franklin Park, Ill.
Oldsmobile	GMC	Delco Radio Div.		466	Kokomo, Ind.
Penncrest	J. C. Penney Co.	Symphonic Electronic Corp.			
		Arvin Industries		248	1513 13th St., Columbus, Ind.
Pontiac	GMC	Delco Radio Div.		466	Kokomo, Ind.
Renault	Ford Motor Co.	Motorola, Inc.		185	9401 W. Grand Ave., Franklin Park, Ill.
Silvertone	Sears, Roebuck	Warwick Mfg. Co.		332	7300 N. Lehigh Ave., Chicago 48, Ill.
		Waters Conley Co.		382	645 N. Michigan Ave., Chicago 11, Ill.
		Arvin Ind., Inc.		248	1513 13th St., Columbus, Ind.
Studebaker	GMC	Delco Radio Div.		466	Kokomo, Ind.
Triumph	Ford Motor Co.	Bendix		125	Baltimore 4, Md.
Truetone	Western Auto Supply Co.	Trav-Ler Ind., Inc.		320	571 W. Jackson Blvd., Chicago, Ill. Also Orleans, Ind.
		Hinners-Galanck			Not known
		Wells-Gardner Electronics	2DC	334	2701 N. Kildare Ave., Chicago 39, Ill.
		Elco	4DC		Michigan City, Ind.
		Esquire Radio Corp.	DC	742	6201 15th Ave., Brooklyn 19, N. Y.
		Arvin Ind., Inc.		248	1513 13th St., Columbus, Ind.
Volkswagen	Ford Motor Co.	Bendix		125	Baltimore 4, Md.

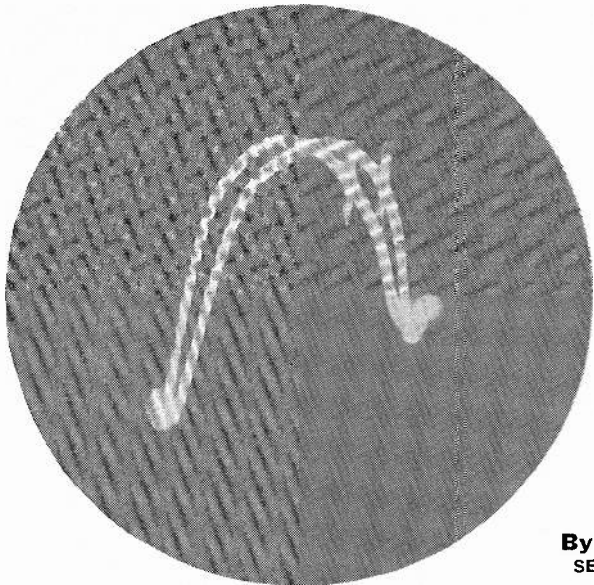

Fig. 2—Embryonic sweep curve: not enough width (sweep doesn't cover wide enough frequency range), phasing slightly off, and retrace blanking turned off.

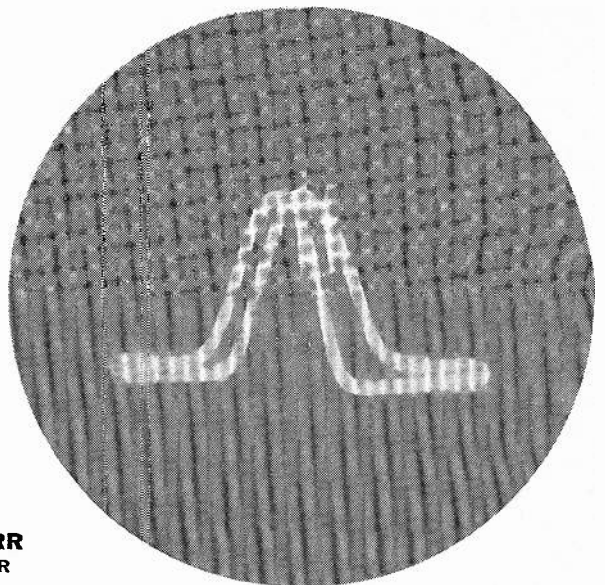

Fig. 3—Sweep width OK, curve well centered, but phasing still off. Curves should coincide exactly.

By JACK DARR
SERVICE EDITOR

SWEEP-ALIGNING TV IF'S

WHAT A SWEEP CURVE MEANS, HOW TO MAKE IT, HOW TO LOCATE IMPORTANT FREQUENCIES

LAST MONTH, WE COVERED SINGLE-FREQUENCY alignment of i.f. stages. Now let's see how to sweep-align the same circuits.

What is sweep alignment, anyhow? Why do we use it? Same reason we use any "dynamic" test in any circuit—it gives us a better picture of what the circuit does under actual operating conditions, which is what "dynamic" means. Instead of using a single-frequency rf signal, we use a signal from a special generator whose output sweeps from one end of the band to the other.

By displaying the result on a scope, we can see what the circuit response is to all frequencies simultaneously. (Or, at least, at intervals of 1/60 second, which is close enough for me.)

We must keep the swept signal from the generator exactly in step with the horizontal sweep of our scope to be able to lock the pattern. So we sweep *both* of them from the handiest source, the 60-cycle sine waves from the ac power line. About this time, someone asks the question, "But doesn't a sine-wave sweep give you distortion? Why don't we use a sawtooth sweep?" Yes, Elmer, it would cause distortion, *unless* we swept both from the same source! Since we do, it means that the scope sweep and the frequency sweep are in sync at all times. We could use a zig-zag sweep and they'd still be in step, as long as *both* are swept from the same source.

Another question—does a sweep generator have to be *absolutely* accurate? The answer is no. All this generator has to do is generate a reasonably *flat* rf output over the entire band of frequencies being swept; in this case, from about 40 to 47 mc (minimum). In other words, its output must have the same *amplitude* at all frequencies as it sweeps the band. If it has a peak at one end or the other, this could cause

distortion of the scope trace. (Not of the i.f. strip: just of the scope trace!) However, most commercial sweep generators are pretty flat, so you won't have to worry too much about it.

After we get a sweep curve from the generator set up on the scope, we find the location of each frequency by feeding in *markers*. Now, a *marker* generator *has* to be accurate. Should be within about 1%. If it isn't, our points on the curve will be way off.

Markers can be fed into a circuit in two ways: through a marker adder, which is by far the best way, since the markers are actually added to the signal *after* it has gone through the i.f. stages (see "Marker Adder for Your Sweep Generator," RADIO-ELECTRONICS, July 1963, page 62) or by feeding them into the i.f. input along with the sweep signal.

Markers are single rf frequencies. As the swept signal passes a marker, it quite naturally beats with it, producing the familiar zero-beat. In this case, we can't hear it, but we can *see* it. A marker beat on a curve looks like Fig. 1-a. This is pretty fuzzy. To get rid of the fuzz, we add a small bypass capacitor across the scope input terminals. (Something like a .001 μ f— not too critical.) This bypasses the higher frequencies and leaves us with a nice sharp "pip" (Fig. 1-b). The sharply defined pips give a better idea of where each significant frequency is on the curve.

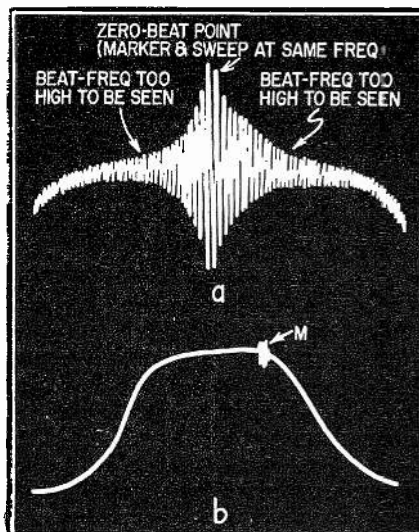

Fig. 1-a—Expanded view of unbypassed marker pip. It's too wide to be useful. In Fig. 1-b, the scope's vertical input terminals have been shunted with a small capacitor, which bypasses the higher beat frequencies (the ones farther from the center of the marker), leaving only the low ones near zero-beat point. Nice, sharp pip.

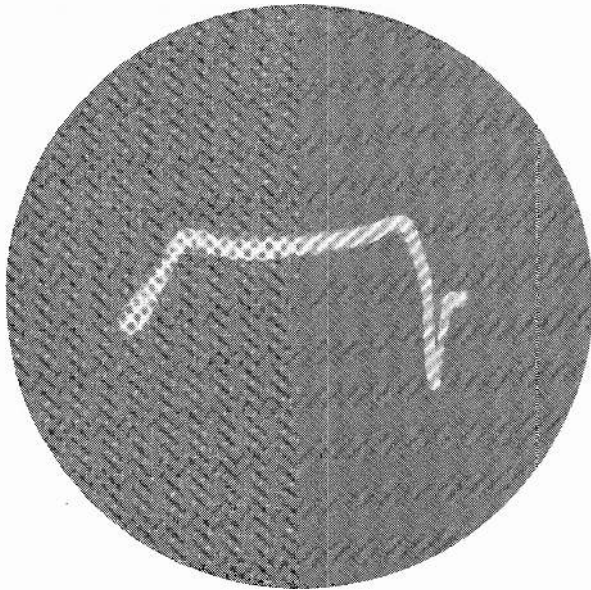

Fig. 4—Zero bias on i.f. stages makes them saturate with even small rf input voltages. Curve is flat even when alignment is way off.

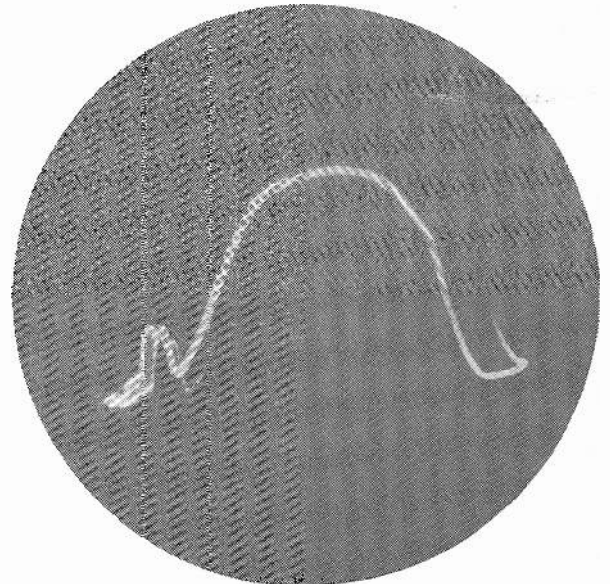

Fig. 5—Same conditions as in Fig. 4, but bias is more nearly correct. Curve is beginning to look right.

Instrument setup for a sweep job

Where most of us get into trouble is in the first setup of the test equipment, particularly in adjusting the sweep generator. In a normal sweep, you can get quite a few different curves, very few of which look anything like "what it shows in the book"! Now we'll show you how to get all of these *wrong* curves, and also how to identify the right ones.

First, set up the instruments as near to each other as possible. Ground all cases together. Turn 'em all on and let them warm up for a few minutes. Set up the TV chassis so that you can get at the alignment adjustments easily. In most cases, it makes things easier if you kill the horizontal sweep. It causes "hash" in the patterns, and we'll have enough trouble as it is.

If the tube heaters are in parallel, pull the horizontal output tube (*never* the oscillator!). If yours is a "series" chassis, best way is to open the cathode of the horizontal output tube. You can unsolder a wire or make up an adapter with the cathode open. It's *not* a good idea simply to lift the top cap off. You might damage the tube by drawing too much screen current.

If we kill horizontal sweep, we also kill *keyed* agc stages! So we *must* use a bias box on such sets to take the place of the missing agc voltage. Set this to whatever the alignment instructions call for.

Now we're about ready to go. First, connect the sweep generator output to the i.f. input. The alignment instructions usually tell where and how to do that: loose tube shield over the mixer tube, looker point on the tuner, etc. Connect the scope, with a direct probe, across

the video detector load resistor (instructions usually give you this, too). Set the scope sweep to EXT, and connect a lead between that binding post and the horizontal sweep output on the sweep generator. A lot of scopes have a built-in 60-cycle sweep, marked LINE on the sweep selector switch. If there is a phasing control with it, you can use either that or the one on the sweep generator.

Next, set up the sweep generator. The main dial is set to the center of the i.f. band, in this case about 44.0 mc. We've got to sweep a band of frequencies at least 4.5 mc wide, and we would like to see what's going on for a little way past, so set the sweep width control at about 10 mc. Now our signal will sweep from 39 to 49 mc—plenty of room to get outside of the bandpass and give us the full picture. Turn the output attenuator (rf output from the sweep gen) to maximum.

Now, with the TV set turned on, you ought to get something on the scope. Set the vertical gain high. You ought to see several vertical lines on the screen. These will be the *sides* of the response curves you want. Turn the vertical gain down until you can see the whole pattern. Keep the scope gain pretty high. In fact, it's best to turn down the rf output of the sweep generator, although either one will do it. If you see any signs of flattening on the top of the curve as the rf gain is increased, turn the generator rf output down, and bring the pattern height back up with the scope's vertical gain controls.

Funny pictures on the scope

Now the fun starts. Look at your pattern. Look like anything you've ever

seen? Probably not. You'll probably have some wild-looking thing like Fig. 2. You may have several curves, in fact. Let's find the right one.

First step, get the sweep in phase with the scope. Move the phasing control until you can see the patterns start to overlap. Move slowly: sometimes they're hard to recognize! You should be able to find some place where you can see definitely that you have a trace and retrace that are alike. Now, if you'll turn on the horizontal blanking control, one of them will disappear. Both of them can be seen in Fig. 2. Another common fault shows in Fig. 2: not enough sweep width. This was deliberately set up to illustrate this point. See how the curve has one leg in the air? This means that the generator isn't sweeping *far* enough to cover the i.f. band. Fig. 2 was made with 4-mc sweep, in fact.

Now let's correct the faults. Increase the sweep width to 10 mc. This brings both feet back to the ground. Moving the dial of the sweep generator slightly brought the curve to the center of the scope screen.

Now look at Fig. 3. The phasing isn't right yet, but I left it there to show you that each trace consists of *two* traces; by the position of the single marker, you can see that only a little bit of movement (phase adjustment) will make both overlap. Turning the blanking on will eliminate the retrace curve and make things less confusing.

If you can't get a curve at all, check every connection, especially the bias-box setting. Too much negative bias will cut off the i.f. amplifier tubes, and you'll get nothing but a straight line. Set the bias to make a good curve; don't

be afraid to experiment with it a little. See what too much bias and too little bias will do.

The curve of Fig. 4 was made with no bias at all (zero). Note the weird shape and the "flat-topping". Watch out for this! If your curves *ever* show a very distinct, sharp-cornered flat-top, you're more than likely overloading the input! You can't get any results at all that way. When you see a flat-top, reduce the rf input or increase the bias (more negative). Either will bring the curve back down to where it should be. Best way is to reduce the rf from the sweep generator.

Fig. 5 shows the curve of Fig. 4, with the proper bias. Now, this begins

far toward the edge of the band. In this instance, instead of the correct 44-mc setting, it was around 39 mc. So we're actually sweeping only about half of the band, and we get the peculiar marker action.

Cure: first, overlap your curves with the phasing control. Second, check sweep width and center-frequency setting. Finally, check the position of the curve by adding markers. When you get set right, the markers will behave better. By running a marker up, across and down the other side of the curve, you'll be able to tell when you've hit the right curve.

Keep your marker amplitude as low as possible, to avoid distorting the

curve. Fig. 7 shows the same curve, but with the marker generator turned wide open. See what happened? Even the *phasing* went off!

Best way to use markers: set up each frequency you need, as specified in the alignment instructions, and locate the marker on the scope trace. Mark its location on the plastic screen with a grease pencil. Unless you move the sweep generator dial, this position will remain on that frequency. Mark each of the frequencies you need: sound carrier, pix carrier, color, etc., and you can shape up the curve accordingly. After you find the marker locations, turn the marker generator completely off or disconnect it. This way, you'll know that

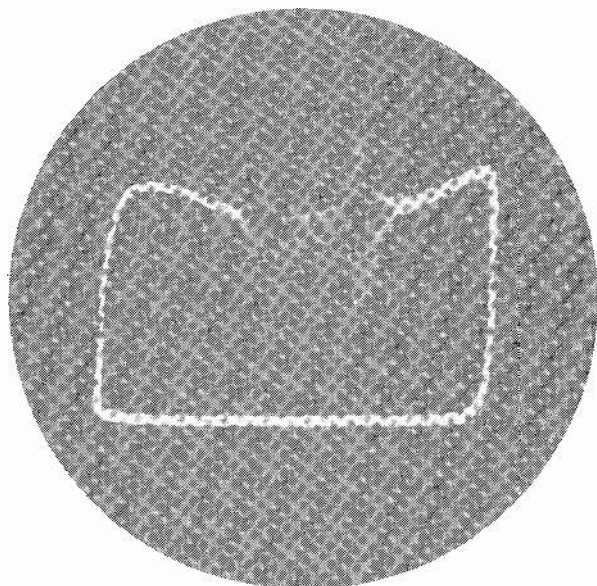

Fig. 6—How your curve will look when you do everything wrong!

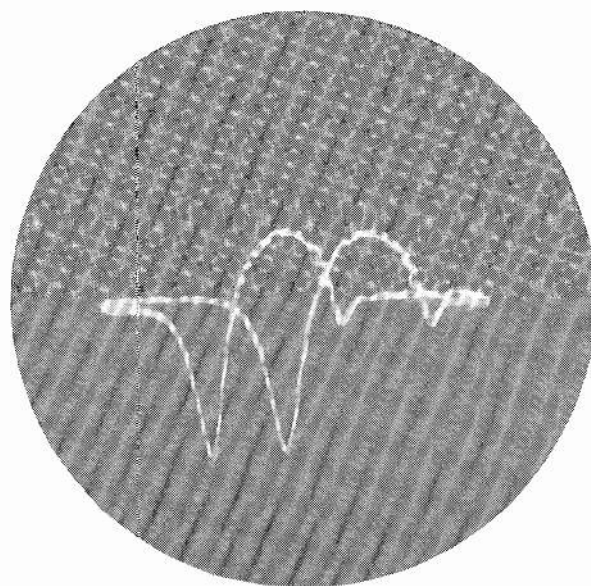

Fig. 7—Too-high marker signals mess up entire curve.

to look more like it. You can see a fairly symmetrical top on the curve, plus the characteristic "sound notch" on the left side. There are no markers on this curve.

How to misalign

I promised to show you how to do it wrong, and I will. Look at Fig. 6. This curve has *everything* wrong with it! One of the distinguishing characteristics is the peculiar action of the markers. Instead of sliding along the curve as they should, you'll get two markers. When the marker generator dial is moved, they'll promptly run together and disappear! Or run off the ends and disappear! Also, we've got a squarish-looking loop instead of a curve. This is caused by the horizontal phasing being as far off as possible: 180°! You can also get this pattern as a sort of "squared-up U" shape from the same cause.

The markers act the way they do because the sweep generator is set too

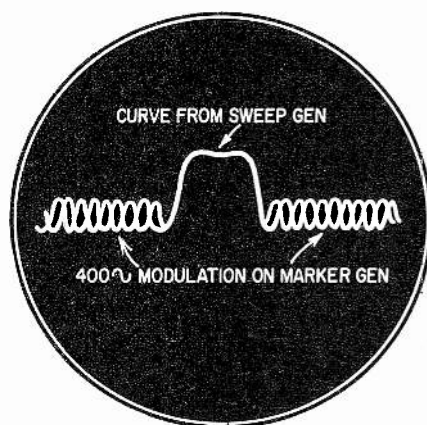

Fig. 8—Simple way to align traps is to use modulated marker signal at trap's frequency. When ripples along base line disappear, trap has removed marker.

it couldn't be the cause of any curve distortions.

Ordinarily, we use unmodulated markers to get cleaner pips. However, we can set traps a lot easier if we simply flip on the 400-cycle modulation and set the marker generator at the trap frequency. Now, our patterns will look something like Fig. 8. If the trap is off-frequency, you'll see the audio modulation in the form of "squiggles" along the base line, with the sweep still on. Just tune the trap for the *least* squiggles on the base line, and there you are; that frequency has been neatly removed from the circuit.

So there it is. We've not only shown you how to do it right, but how to do it wrong! By taking advantage of the errors shown here, you won't have to bother making them yourself. From no other technical magazine do you get this service! Aside from this, if you follow the alignment instructions in the service data, you've got it made! END

Knight-Kit C-555 CB Transceiver



Allied Radio

The C-555 in use.

A 100-MW CITIZENS-BAND TRANSCEIVER must have a receiver with good selectivity and sensitivity. The superhetrodyne receiver in the Knight-kit C-555 does not pick up adjacent-channel signals with the desired ones, as do many sets with superregenerative circuits.

The single transistor in the transmitter can be heard more than four times as far as with a superregen receiver under the same suburban QRM conditions. In open country away from other CB traffic, the improvement is not as apparent.

By carefully tuning and retuning both C-555's for maximum signals (as the distance between the two units is increased), it is possible to communicate between units nearly a mile apart.

The instructions tell you to tune the transmitter of the C-555 *before* the printed-circuit chassis is mounted in its case—before the whip antenna is connected.

A small lamp is supplied as a tuning indicator. With pigtail leads soldered on, it is soldered to the output coupling loop on the printed-circuit board of the tank coil (L4 in the schematic).

The slug inside the coil is adjusted for consistent oscillator operation—it should glow each time the TRANSMIT button is pressed.

When the adjustment has been made and the lamp unsoldered, the whip antenna connected and the printed-cir-

cuit board mounted in the plastic case, the tuning will change slightly. The change is not enough to be noticed unless you are striving for maximum distance.

The transmitter should be tuned for maximum output with a field-strength meter when you want to communicate over the longest possible distance. A slight slug adjustment will often show an increase over the original setting. If a field-strength meter is not available, or not sensitive enough, a receiver with an S-meter can be used when tuned to the frequency of the C-555.

The tank coil (L4) is not the only influence on the output—the whip antenna can also change the ERP (effective radiated power) since it (along with L6) is a tuned circuit too.

Antenna tuning affects directional characteristics. A $\lambda/2$ (half-wave) antenna has, for all practical purposes, a doughnut-shape radiation pattern—but only when it is tuned exactly to a half wavelength—an *electrical* $\lambda/2$, which differs from the measured length because currents travel at a different speed along a conductor than through what is commonly called "free space" (air).

Transceiver antennas should also be oriented with regard to one another—as near parallel as possible. When the whip antennas are at a skew angle to one another, the signal strength is reduced—just like turning a TV antenna away from the station antenna.—*Elmer C. Carlson.*

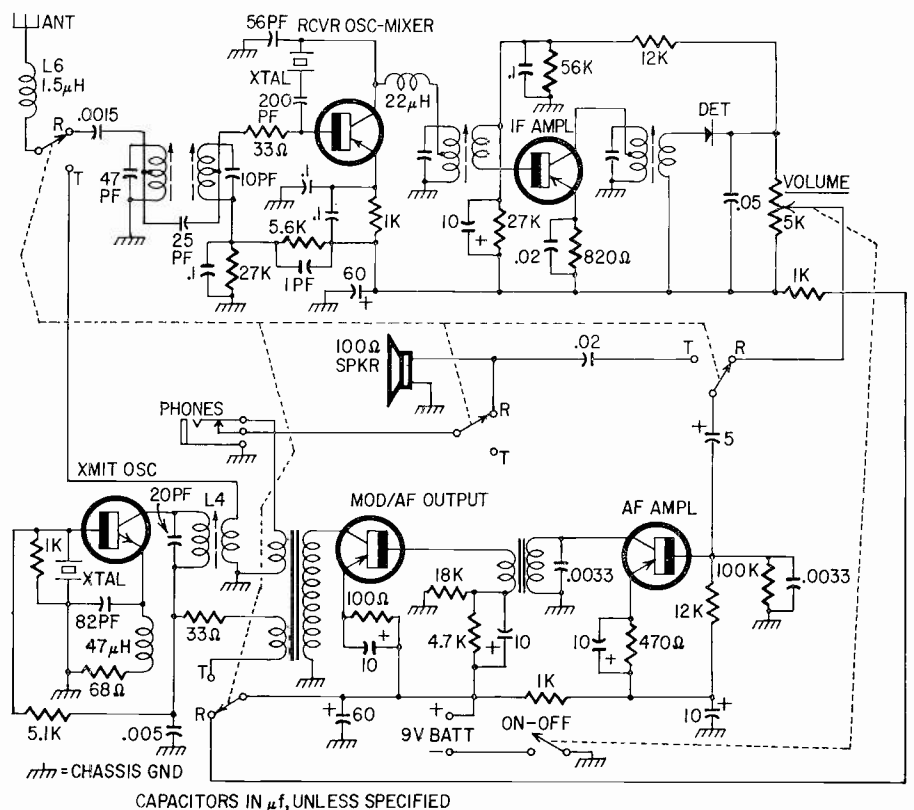

The C-555 uses crystal control in the receiver as well as the transmitter.

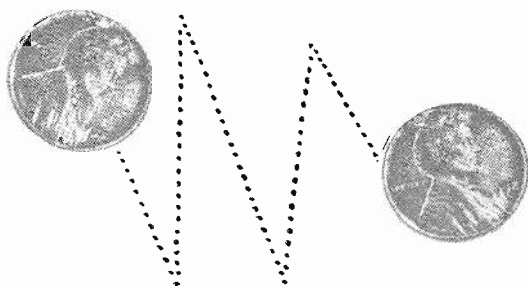

Two-transistor circuit counts money, sizes objects.

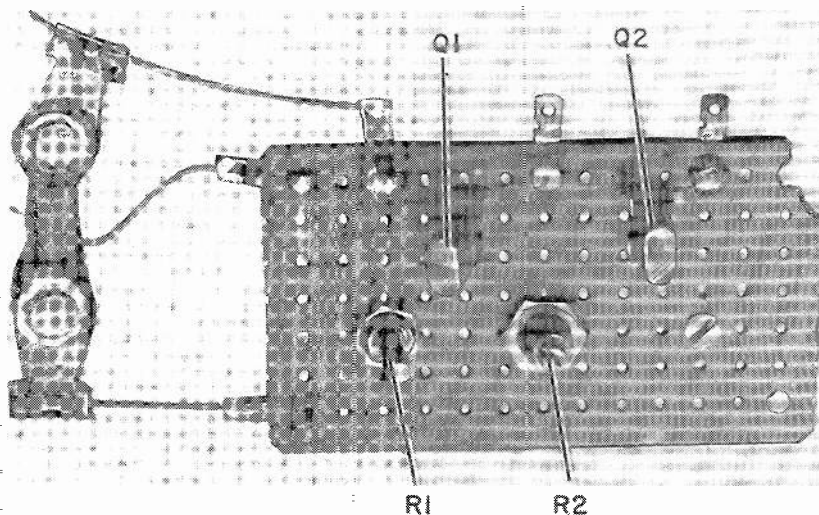

Front of perforated board—the entire chassis. At left, two photocells connected for testing. Power supply separate.

Try a Selective Photocircuit

By TOM JASKI

MOST PHOTOELECTRIC CONTROL CIRCUITS are designed for simple on-off operation, as in counting or safety devices. This circuit, however, is far more versatile. Besides the usual on-off counting operations, it can also selectively count objects of different sizes. It can count only objects which move in one direction; it can prevent an operation when a condition is not satisfied, and so on.

Fig. 1 shows the entire schematic diagram. Two photoconductive cells are shown in each circuit branch to the base of the first transistor. As many photocells as desired can be used in each branch, provided they all normally receive plenty of light. Let us call cells P1 and P2 the "action" cells, and P3 and P4 the "inhibit" cells. When light is blocked from the "action" cells, the effect is to decrease the negative bias on the base of Q1, which would tend to make the transistor conduct (this is an n-p-n transistor). Normally the cells have a low resistance when lighted and the high negative voltage applied to the base through the cells keeps Q1 cut off. Thus blocking the light on P1 or P2 has the effect of inserting a high resistance

in series with the bias source, and Q1 will conduct. Depending on the setting of R2, this will increase or decrease the current through Q2, and will either attract the relay armature or release it.

Normal operation should call for the relay to be energized when light is blocked off from the "action" cells.

Now if we also block the light to cell P3 or P4, Q1's base will again be

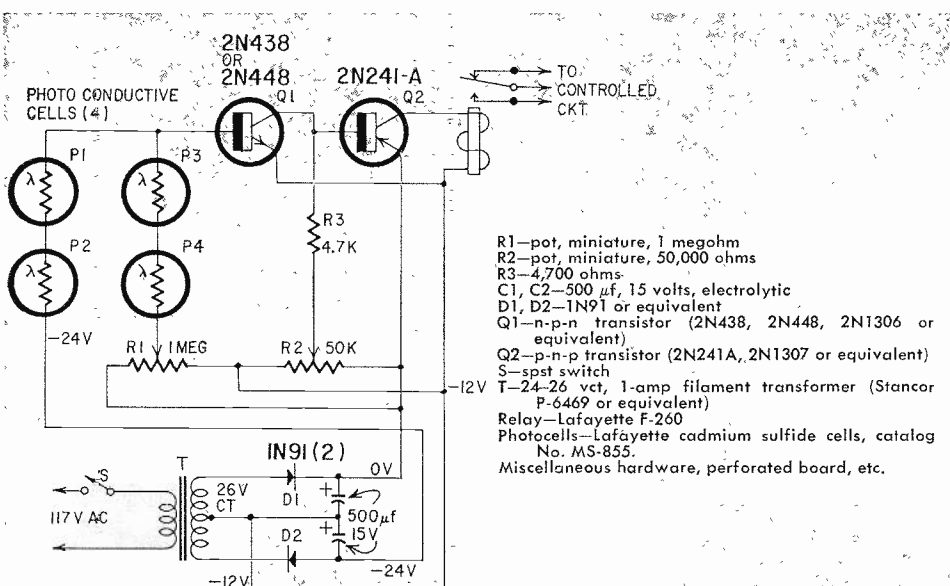

- R1—pot, miniature, 1 megohm
- R2—pot, miniature, 50,000 ohms
- R3—4,700 ohms
- C1, C2—500 μ f, 15 volts, electrolytic
- D1, D2—1N91 or equivalent
- Q1—n-p-n transistor (2N438, 2N448, 2N1306 or equivalent)
- Q2—p-n-p transistor (2N241A, 2N1307 or equivalent)
- S—5-spst switch
- T—24-26 vct, 1-amp filament transformer (Stancor P-6469 or equivalent)
- Relay—Lafayette F-260
- Photocells—Lafayette cadmium sulfide cells, catalog No. MS-855.
- Miscellaneous hardware, perforated board, etc.

Fig. 1—The circuit. Any number of photocells can be used in each leg.

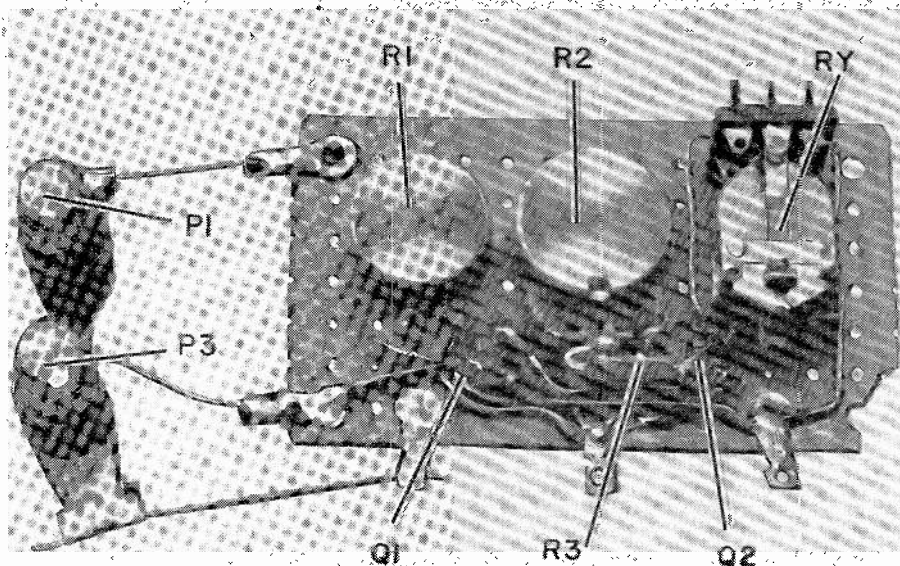

Other side. Tiny, but uncrowded.

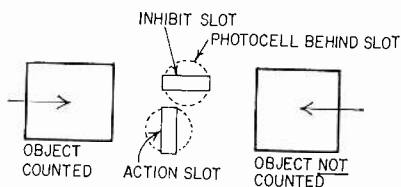

Fig. 2—Direction-sensing arrangement. Slots should be about $\frac{1}{4}$ by $\frac{1}{16}$ inch.

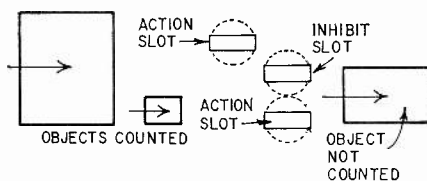

Fig. 3—Here, large and small objects are counted, medium-sized ones pass by without registering. Fineness of discrimination depends on slot placement.

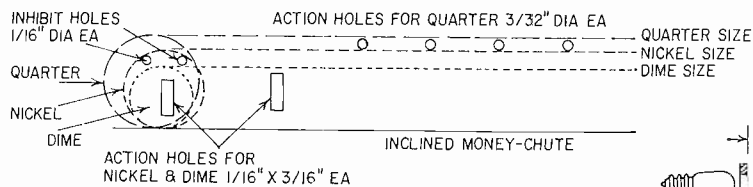

Fig. 4—Money counter. Slots are set up to count in terms of smallest value (nickel), not smallest size (dime). Nickel activates only second "action" hole; dime, first and second (two counts); quarter, second through sixth (five counts). Five more holes are needed to count half dollars. Rate depends on hole spacing and coin speed.

negatively biased, because of the high resistance inserted "in shunt" with the base circuit. The balance of the circuit has been changed, and Q1 will once more be cut off. If one cell in the P3-P4 circuit is blocked before the light is blocked from the "action" cells, these "inhibit" cells will prevent operation of the circuit.

So?

This opens up all kinds of possibilities for selective operation. For example, the simple arrangement in Fig. 2 provides unidirectional counting. Objects coming from the left will be counted, but objects coming from the right will not. An object coming from the right will obscure the inhibit cell opening before the "action" cell is blocked. But an object coming from the left will block the "action" cell before enough of the "inhibit" opening can be blocked.

Fig. 3 shows how the circuit can be used to discriminate between objects

of different sizes. The circuit will count large objects and small, but will ignore medium-size ones. This kind of arrangement could be used to reject over- and undersized objects, passing only the proper size. Some "reject" mechanism, rather than merely a counter, can then be operated by the relay. (Consider all the items in our economy that are sorted by size, from jelly beans to Florida oranges!) Different sets of "selective" circuits can grade such objects with great speed. The same idea is applied in Fig. 4 for counting coins. When a nickel passes by the slots, only one pulse will be recorded. When a dime passes by, even though it is smaller than the nickel, two pulses will register. When a quarter passes by the slots, five pulses will be counted. *Voilà*—a money counter, which can operate as fast as the relay or readout device will operate—conservatively, something like 10 coins per second.

The circuit has many other applications. It can be used as a secret lock on electrically operated doors. An object or animal taller than a human being could be blocked from entering. You can use it to solve the age-old question of whether the refrigerator light goes out when you close the door. Shut off the light from the action cell with the door, and, if the light inside the box goes out, it will prevent the relay from operating. The inhibit cell has operated.

With a low resistance (approximately 10,000 ohms) replacing the "inhibit" cells, the circuit is converted to a simple counter. The cells can be mounted any distance from the control circuit. The greater the amount of light that hits the cells, the more positive the operation when the light is blocked.

Adjustment

With lights on both sets of cells, adjust R2 until the relay just energizes. Then back off R2 until the relay just releases. Block light from the "action" cells and adjust R1 until the relay just energizes. Now the relay should de-energize when light is again admitted to these cells. The amount of light reduction required for inhibition depends on the setting of R1. With the particular hole configurations of Fig. 2 or 3, some readjustment of R1 may be necessary for satisfactory operation. Another way of adjusting operation of the circuit is to control the amount of light which reaches each type of cell (action or inhibition), leaving R1 set in its initial position. At some settings of R1, both sets of cells will become "action" cells. In that position the circuit acts as an "or" circuit: it will count objects passing by either cell set.

Q2 can be replaced with a power transistor. No other circuit changes need be made.

END

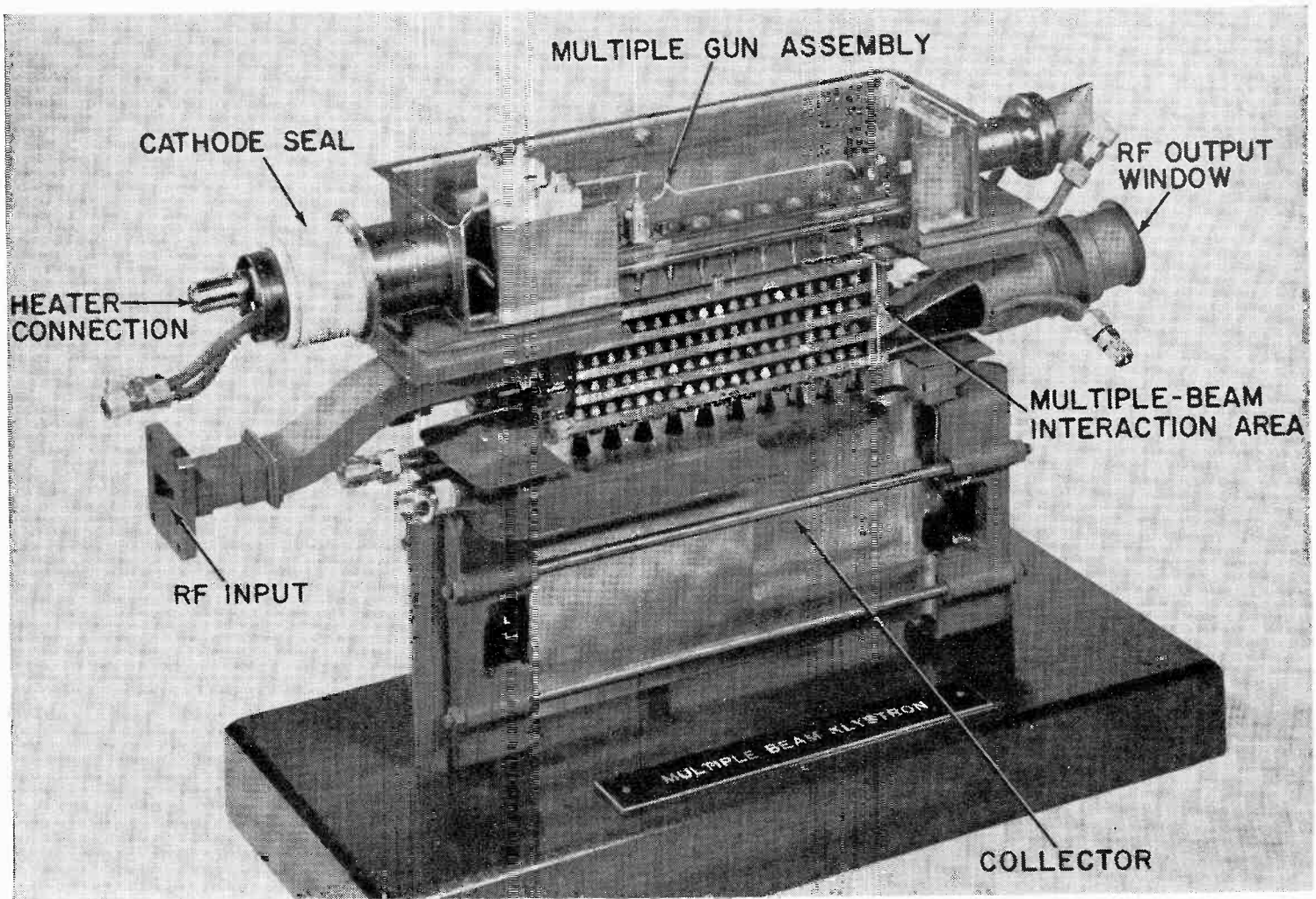

Multiple-Beam Klystron Pushes Back Microwave Frontiers

New breed of tube puts out more continuous power at higher frequencies than anyone thought possible

COVER STORY

By ERIC LESLIE

THE KLYSTRON—THE TUBE OF THE FUTURE—handles far higher frequency signals than the tubes we are used to. A very different kind of tube, it has a special approach to the job of generating or amplifying signals.

To find out how klystrons work, let's see what happens in the output circuit of an ordinary tube. For instance, take an audio signal generator, working at, say, 1,000 cycles—the type that would

supply a bridge or similar device. The output is produced across the secondary of the transformer in Fig. 1. But the current in the plate circuit of the tube, and therefore in the primary of the transformer, is not alternating current. It is a direct current of varying strength. We have little surges of electrons flowing 1,000 times a second through the primary winding. As each of these bunches of electrons flows through the primary, it creates a stronger-than-average field around the core. This field acts on the secondary and produces a true alternating current.

Thus there is not essentially such a tremendous difference between alternating and pulsating direct current. (A mathematician would call the pulsating

current in the primary a direct current with an alternating current superimposed on it.)

The klystron gets the same result in a different way—a way that works at extremely high frequencies, where ordinary tubes become too inefficient. Klystrons work from the uhf band to well up in the gigacycles. (A gigacycle is 1,000 mc.) One reason for its far better high-frequency performance is that instead of external coils and capacitors (which would be mere bits of wire above 1,000 mc), its tuning elements are *inside* the tube. They are *resonant cavities*.

You have probably read articles that derived the resonant cavity from a coil and capacitor. The description starts out by showing the capacitor as two

plates with a single half-turn of wire between them. Then more half-turns are placed in parallel with the first—reducing the inductance each time—until a solid wall has been built between the two plates. If you haven't run into this, Fig. 2 is the classical illustration, and you can get more detail in any textbook on klystrons. (Also, see "Klystron, Tube for Outer Space," RADIO-ELECTRONICS, February 1961.)

Here, let's just say that a resonant cavity tunes to a much higher frequency than any coil-capacitor combination could, unless it were fantastically smaller than the cavity.

This resonant cavity—or a number of them, in most klystrons—is used to

in the bottom cavity, they repel electrons in the metal around them as they approach it. These electrons circulate around the walls of the first cavity to the top, producing a negative charge at that end. (Because electrons are repelled from it, the bottom has a slightly positive charge.) The first electrons traveling on through the resonant cavity now approach the second tunnel, repelling the electrons from it back toward the bottom section of the first cavity. This makes it negative, while the top section tends to become positive.

As the bottom section becomes negative, it starts to retard electrons approaching it from the cathode, while giving those that have just passed it a

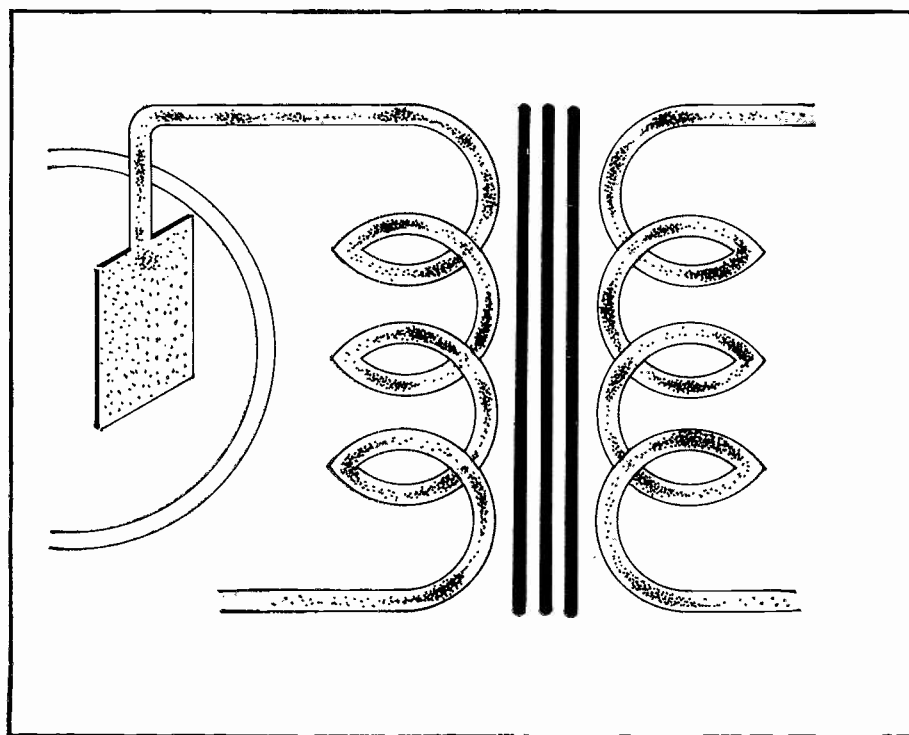

Fig. 1—Pulsating dc in transformer primary becomes ac in secondary.

bunch the electrons in the stream flowing through the tube to produce an alternating current like the one in Fig. 1. This is done by varying the velocity of the electron stream. For that reason, klystrons are called *velocity-modulated* tubes.

Electrons in bunches

Fig. 3 is a simplified sketch of a single-beam klystron. Electrons are emitted from a cathode at the bottom, and picked up by the collector at the top, which is maintained at a high voltage. We want to convert this high-voltage power, now being used to draw the electrons through the tube, into an ac power source that can supply ultra-high-frequency power to an external circuit.

Let's suppose that the cathode is hot and that the high voltage has just been turned on. Electrons start from the cathode toward the collector. As they approach the first section or tunnel

boost.

If the voltage (or rather the speed of the electron stream) and the dimensions of the cavity are correctly matched, the cavity will resonate at its natural frequency and build up high alternating charges at the top and bottom ends of the resonant cavities. An rf drive signal, injected into the first cavity, will help the process.

This process tends to *bunch* the electrons into groups by pushing those ahead of each negatively charged area while retarding those coming toward it or, on opposite alternations, holding back those above while attracting those below. As the electrons travel through the tunnels between cavities, the bunches are tightened as they catch up with slowed-down electrons ahead and are joined by speeded-up ones from the rear.

The electron stream goes through several other cavities, where the effect

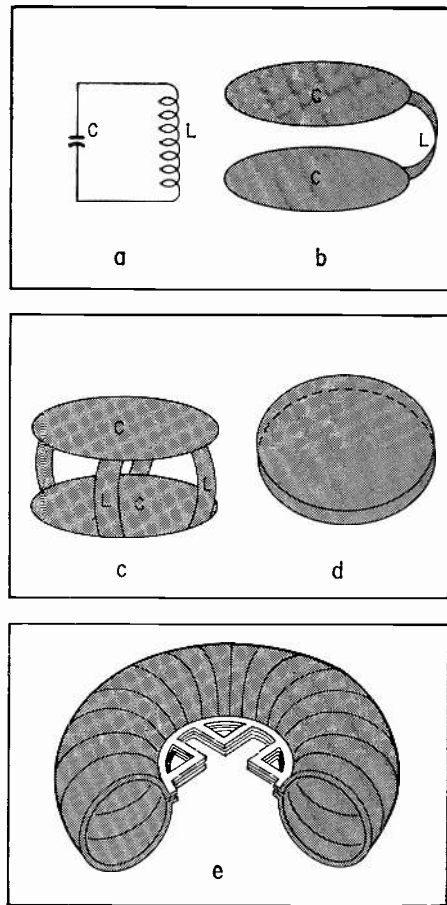

Fig. 2—Classic derivation of microwave resonant cavity from lumped-constant L-C circuit. In (a), schematic of ordinary coil-capacitor tank; b—highest possible frequency for discrete L-C components; c—"transition" step: paralleled "turns" to reduce inductance; d, cylindrical outcome of step c; e—klystron cavity.

is made greater as it passes through each one. By the time the last cavity is reached, we have a true pulsating electric current, the same as in our transformer primary. The resonant cavities have slowed down the first electrons in each bunch, and speeded up the last ones to where we have distinct "clumps" of electrons, traveling toward the collector.

As the electrons approach the last cavity, they are organized into very tight clusters or bunches—one such bunch for each rf cycle. These bunches of charge repel the like charges in the metal gap tips of the last cavity. This action establishes a very large voltage or electric field across these tips.

To move across the gap against this large electric field, the electrons must overcome the opposing electric force. In so doing they give up a large portion of their kinetic energy. This is transformed into microwave energy, which is piped through a section of waveguide located in the vacuum envelope, then through a vacuum-sealing

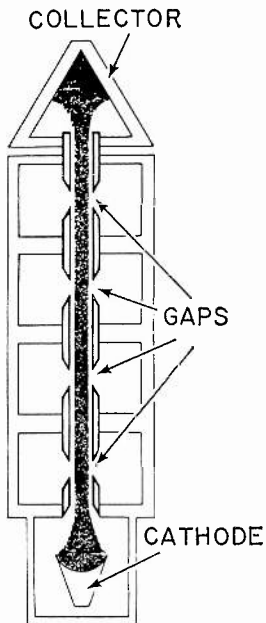

Fig. 3—Principle of single-beam, multiple-cavity klystron.

klystron fails, the whole group goes out of operation.

To avoid this, General Electric engineers developed the idea of building a new type of tube—one that would in effect be 10 klystrons with a common group of resonant cavities. Fig. 4 shows a portion of that tube. The broken section in the center is occupied by a similar set of cavities and 6 more electron beams. This makes it possible to get 10 times the power of a single klystron, while keeping many of the advantages of single klystron operation. Since the cavities are common to the 10 beams, they *must* remain in phase. If a single cathode breaks down, it simply means that one-tenth less power is produced. (By raising the voltage slightly, it may even be possible to compensate for that.) The General Electric 6601, shown on our cover, produces about 45 kilowatts output at about 8.4 gc, with a beam voltage of 12.4 kv and a cathode current of 11 amperes — a little over 1 ampere per gun.

In use, the tube is surrounded by a magnet coil, to focus the electron beams. Also important: The tube can be tuned over a range of 80 mc by varying the capacitance of the resonator. Cooling is needed to carry away the tremendous heat generated, so a water jacket circulates 30 gallons per minute around the tube.

Since the photograph on our cover was taken, a larger tube, the ZM6602, with a 17-kilowatt operating voltage and a cathode current of 17.5 amperes, has been introduced. It produces 100 kilowatts CW. Even larger tubes may be made in the future. END

window of special alumina ceramic material to the external waveguide.

Very large klystrons have been built. But voltage has to be increased to increase output, and more power was needed than can be obtained from a practical single klystron.

The natural step would be to couple two klystrons together. This has been done. In fact, as many as 8 have been coupled. But external coupling circuitry is complex. Slight misadjustments cut efficiency tremendously and, if a single

Fig. 4—New G-E multiple-beam klystron, in part.

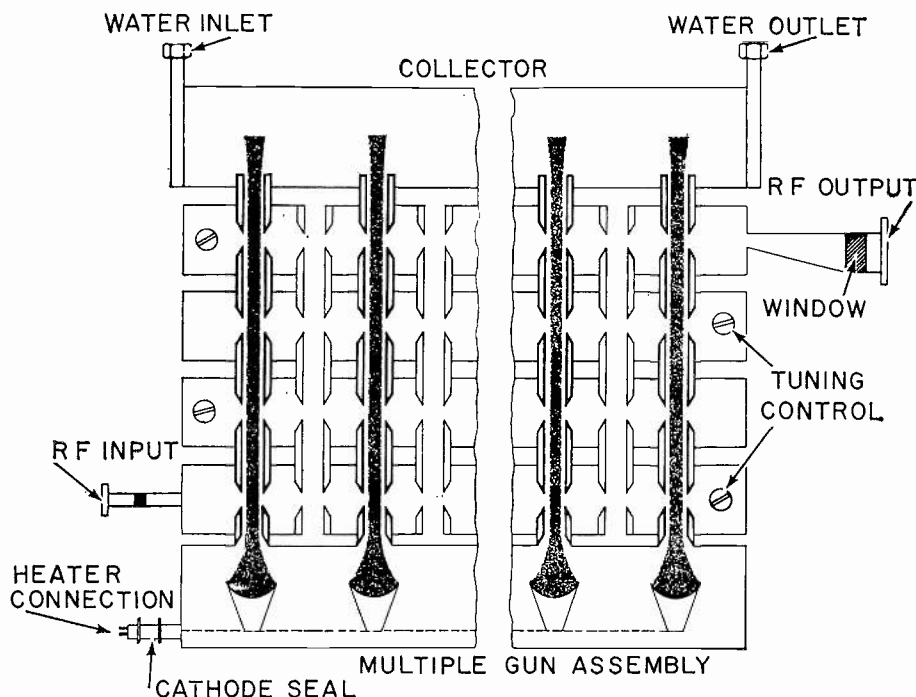

Align-and-Find Meter

Here's a handy piece of equipment that you can build in less than 2 hours and for about \$6. It takes the place of a vtvm when aligning the rf and i.f. stages of a receiver, and it will find the frequency of an unknown L/C circuit. Hence the name, Align-and-Find Meter. The unit (Fig. 1) is ultra-simple, accurate and reliable, and makes a worthwhile addition to your bench. There's no waiting for warmup, and the vtvm is left open for other jobs.

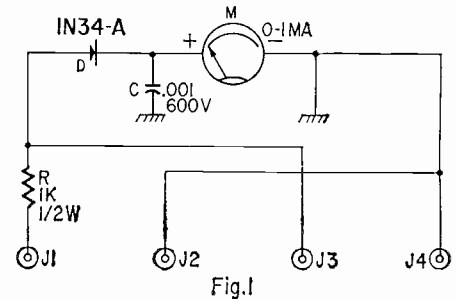

Lead dress isn't overly critical. See Fig. 2. I wired the circuit three ways, and very short leads failed to show much improvement.

Make your test leads from a piece of microphone cable instead of ordinary hookup wire. Use miniature clips on one end and pin or banana plugs on the other. The center conductor connects to J3, and the shield goes to J4, which is ground.

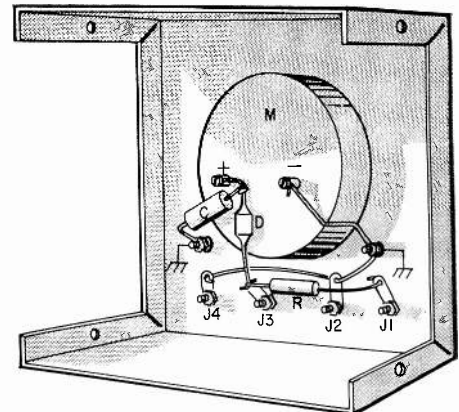
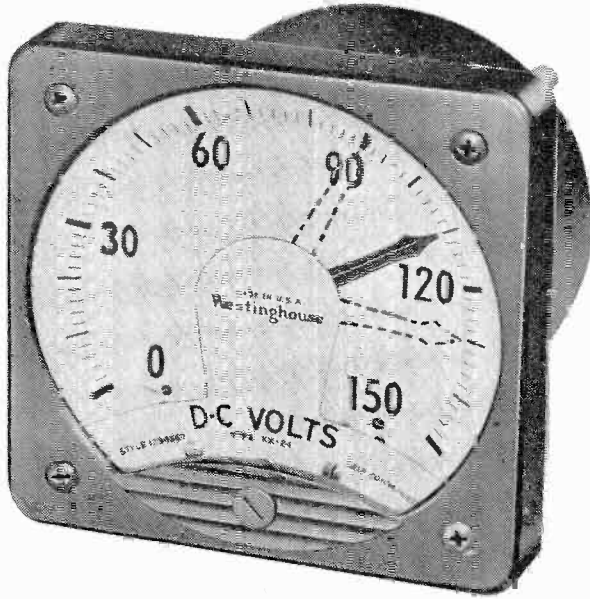

Fig. 2

To find the frequency of an unknown L/C circuit, clip the leads from J3 and J4 across the capacitor, then connect the hot lead from your rf generator to J1 and the ground lead to J2. Advance the rf output control until the meter climbs to about half scale. By rotating the signal generator's tuning dial you will find the point of resonance for your problem circuit and the needle will move upscale. At that point where the meter peaks, your previously unknown frequency can be read on the generator's dial.—Bill Hutchison

WHAT'S NEW

INSTRUMENTS THAT "REMEMBER" VOLTAGES hold any desired reading with an accuracy of $\frac{1}{2}\%$ of full scale. Moving coil of meter movement is held by cushioned spring that prevents all movement as long as actuating solenoid is de-energized. When new reading is desired, solenoid is actuated by pushbutton, releasing spring and allowing pointer to deflect. Pointer is "frozen" the instant that solenoid is energized, so operator can easily read simultaneous indications of many meters by actuating all solenoids with one pushbutton. Westinghouse has developed the new instrument.



LIGHTING BY THE YARD might be how you will specify illumination some time in the future. Sylvania's Tape-Lite comes in ribbons up to 150 feet long that can be coiled, bent, twisted or tied in knots. Sealed in plastic, it works by electroluminescence—phosphor excitation by alternating current. Tape is only $\frac{1}{32}$ inch thick, can be made in green, yellow, white and blue.



THERMOELECTRIC EPOXY CEMENT COOLER works without moving parts. Solid-state thermoelectric modules cool epoxy resin compounds to as much as 28°C below room temperature to keep them usable twice as long. Disposable aluminum container fits in aluminum-lined cavity set flush in foam insulation. Three-position (center-off) switch selects "high" or "low" cooling. Unit is made by Carter-Princeton, Princeton, N. J.

LATEST "GOLDEN EARS" let user locate sound remotely as though he were present at source. Replicas of human ears are fastened to two condenser microphones, which drive two-channel amplifier and semi-insertion condenser headphones. System bandwidth is 40 to 40,000 cycles. Researchers have found that outer ear is vital to sound localization. Device (which costs \$3,125) is being used for psychoacoustic research, training of newly blind persons, experiments in recording. Manufacturer is United Research, Inc., Cambridge, Mass.

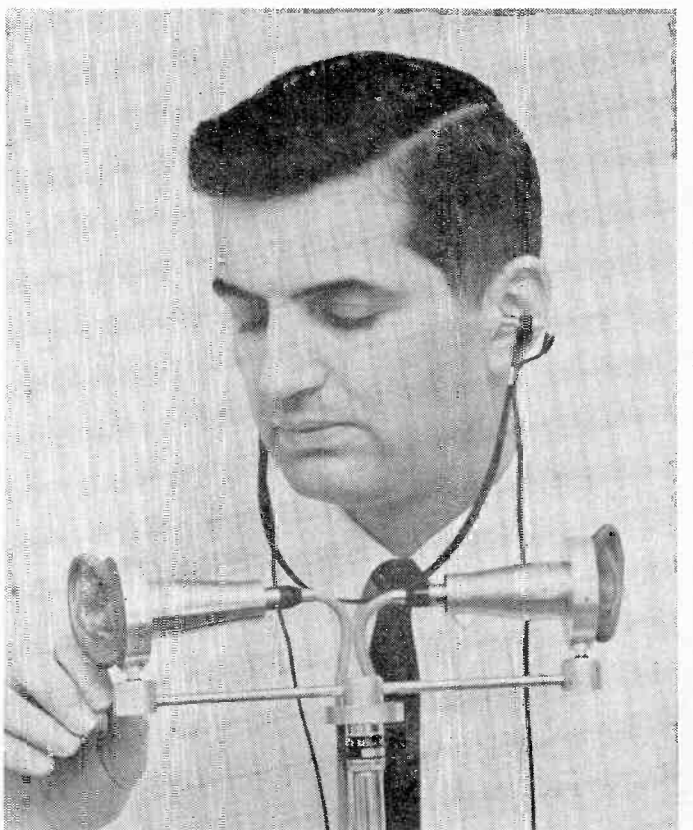

DECIBELS DEBUGGED

Gringe at the thought of figuring ratios to db and the other way 'round? It's easy!

By H. R. HOLTZ

CONVERTING A DECIBEL FIGURE TO A power or voltage gain (or loss) is a simple mathematical proposition. But it assumes that you have a slide rule or table of logarithms handy. That may not be true, particularly in the field. If you need only normal accuracy, as is usually the case, there is a simple method that gives pretty good accuracy, in most cases, and may be performed mentally or, at worst, with a hasty scrawl on any convenient surface.

To master the system you need to know only that any 2:1 power ratio is equal to 3 db or a 2:1 voltage ratio to 6 db, and that $10^0 = 1$, $10^1 = 10$, $10^2 = 100$, etc.

Ratio	Log ₁₀ (Number of 0's)	Db Power (10 log ₁₀)	Db Voltage (20 log ₁₀)
1	0	0	0
10	1	10	20
100	2	20	40
1,000	3	30	60
10,000	4	40	80
100,000	5	50	100

Suppose you have an amplifier that puts out a 100-watt output signal for a 1-watt input signal. You say that the output is "up 20 db." This means, simply, that the gain of the amplifier is 100:1. Let us first convert the power ratio, 100:1, to decibels:

$$\text{db} = 10 \log_{10} \frac{P_1}{P_2}$$

If P_1 represents the output and P_2 the input,

$$\text{db} = 10 \log_{10} \frac{100}{1}$$

"Log₁₀ 100" simply means the logarithm, to the base 10, of the number 100 or, to put it another way, the power of 10 that equals 100. This is 2, since 10^2 is equal to 100. Therefore

$$\text{db} = 10 \times 2 = 20 \text{ db}$$

Observe that 100 contains two 0's, 1,000 three 0's, etc. The number of 0's is the logarithm of 10. Multiply the number of 0's by 10 and you have the db figure! 1,000:1 is equivalent to 30 db, 10,000:1 to 40 db, 1,000,000:1 to 60 db. (See Table I.)

For voltage or current ratios, the formula is slightly different:

$$\text{db} = 20 \log_{10} \frac{E_1 \text{ (or } I_1)}{E_2 \text{ (or } I_2)}$$

Therefore, for voltage or current, multiply the number of 0's by 20. Then, 1,000:1 equals 60 db, 1,000,000:1 120 db, etc. *This holds only if the impedances across which E_1 and E_2 (or I_1 and I_2) are being measured are the same.*

To go from decibels to ratio, simply reverse the process: Given a power gain or loss of 30 db, divide by 10 and get 3. This means a 1 followed by *three* 0's, or 1,000. A voltage gain of 60 db is converted by dividing 60 by 20 and getting 3, again resulting in 1,000.

Until now, our db figures have been nice round numbers, easily divisible by 10 or 20. In practice, the numbers we have to work with are not always so cooperative. Suppose we must transpose a power gain of 27 db to a ratio. Dividing by 10 yields 2.7, which is $10^{2.7}$, or 10 followed by 2.7 zeros!

The number 10^2 represents 100; 10^3 represents 1,000. Therefore, $10^{2.7}$ represents a number between 100 and 1,000. We are dealing with an exponential quality, like the charging curve of a capacitor. Therefore, we cannot take seven-tenths of the difference. Instead, we shall resort to a trick used in grade-school arithmetic: we shall *borrow*.

Let us raise our 27-db figure to 30 db by borrowing 3 db. Now we have an easy figure to work with, since 30 can be divided evenly by 10. As shown in an earlier example, 30 db represents a power ratio of 1,000:1. Remember, we borrowed 3 db to make the conversion

easy. Now we must pay it back. It was pointed out that 3 db is equal to a power ratio of 2:1. Raising 27 db to 30 db is, therefore, *doubling* the ratio. If 30 db is 1,000:1, then it follows that 27 db must be 500:1.

Suppose the db figure given is 23 db. To convert this to a figure that is amenable to the method, let us *lend* 3 db. The resultant 20 db is half the ratio represented by 23 db. Since 20 db is 10^2 , or 100, and is one-half 23 db, 23 db must represent 200.

The object, then, is to use decibel figures evenly divisible by 10 for power ratios, or by 20 for voltage and current

Db Power	Ratio	Db Voltage
3	2	6
6	4	12
9	8	18
12	16	24

ratios. In lending or borrowing db to convert to such figures, use increments of 3 or 6 db (for power or voltage and current, respectively) because these represent simple multiplications or divisions by 2 in ratio.

To illustrate the method for voltage, let us convert a 52-db gain to voltage: 46 db is one-half 52 db, 40 db is one-half 46 db. Thus 40 db is one-fourth 52 db.

Forty db (voltage) is 10^2 (20 db is 10^1 , or just 10; 40 db—double the number of db—is 10^2 , or 100). Doubling twice or multiplying by 4 yields 400 (40 db = 100, 46 db = 200, 52 db = 400).

Suppose, now, that we run across a really recalcitrant number: 25 db power gain. Since this number does not lend itself readily to conversion, we have to *interpolate*. First, we determine that 23

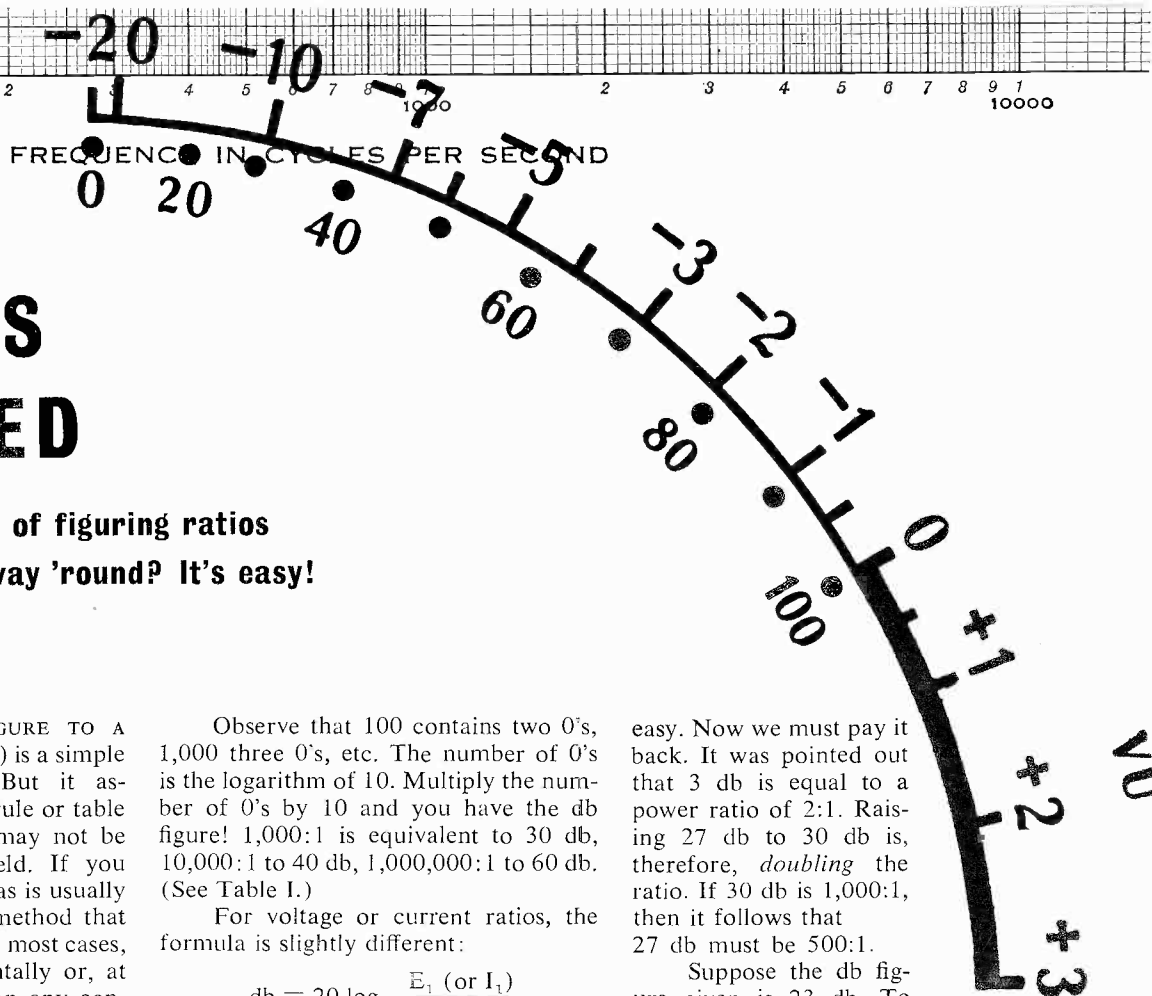

db represents the ratio 200. You may have observed by now that adding decibels is equivalent to multiplying the quantities they represent ($20 \text{ db} = 100$, $3 \text{ db} = 2$; $20 \text{ db} \text{ plus } 3 \text{ db} = 100 \times 2 = 200$). Although we are dealing with an exponential, not a linear function, for practical purposes we can treat a small

Ratio	Db Power	Db Voltage
5	7	14
10	10	20
20	13	26
50	17	34
100	20	40
200	23	46
500	27	54
1,000	30	60
2,000	33	66
5,000	37	74
10,000	40	80
20,000	43	86
50,000	47	94
100,000	50	100
200,000	53	106

remainder (2 db in this case) as though it were linear. That is, we shall say that the final ratio is $\frac{2}{3}$ the difference between 23 db (200) and 26 db (400). This gives us a final answer of about 332. The exact answer is slightly less than 317. Our accuracy is about 5%, more than adequate.

Reversing the process, consider the ratio 1,700. We split this into 1,000 and 700. The first, 1,000, we know to be 30 db, 2,000 would be 33 db. We know, then, that our figure is between 30 and

33 db. Interpolating the difference, again assuming linearity, we calculate seven-tenths of 3 db (3 db represents here the difference between 30 and 33 db, or 1,000 and 2,000): $0.7 \times 3 = 2.1 \text{ db}$. Rounding off and adding to our earlier figure of 30 db, we have a final answer of 32 db. Since the exact answer is 32.3 db, we have come very close, especially since the commonly accepted ratio of 2:1 for 3 db is approximate (it is exactly 1.995:1).

Expanding and combining Tables I, II and III and rounding off the numbers, we can easily evolve Table IV. Again, this table does not reflect the exact values of all the quantities shown, but it can be easily made up in a few minutes, if there are a number of conversions to be made under improvised conditions, and is accurate enough to be useful. Generating such a table is also good practice in understanding decibels. It was created entirely by combining the earlier figures and continuing the process of halving and dividing the ratios, subtracting and adding decibels in 3-db units. Every ratio shown is either half or twice the value of another entry.

To verify the accuracy of Table IV: $15 \text{ db} = 9 \text{ db} + 6 \text{ db} = 8 \times 4$ (from the table) = 32

Verify this by finding the exact ratio for 15 db.

If further proof is desired, find the ratios for 3 db and 12 db and verify that $12 \text{ db} + 3 \text{ db} = 15 \text{ db} = 16 \times 2 = 32$

Multiplying the ratios of any combination of decibels that adds up to 15 db will result in a ratio of 32, within the

accuracy of the table. This is of course true for any other figures. If you wished to find the ratio of 45 db, not given in the table,

Db Power	Ratio	Db Voltage	Db Power	Ratio	Db Voltage
1	1.25	2	21	125	42
2	1.56	4	22	156	44
3	2.0	6	24	250	48
4	2.5	8	25	312	50
5	3.125	10	27	500	54
6	4.0	12	28	625	56
7	5.0	14	30	1,000	60
8	6.25	16	31	1,250	62
9	8.0	18	33	2,000	66
10	10.0	20	34	2,500	68
11	12.5	22	35	3,125	70
12	16	24	36	4,000	72
13	20	26	37	5,000	74
14	25	28	38	6,250	76
15	32	30	39	8,000	78
16	40	32	40	10,000	80
17	50	34	41	12,500	82
18	63	36	44	25,000	88
19	80	38	47	50,000	94
20	100	40	50	100,000	100

$45 \text{ db} = 35 \text{ db} + 10 \text{ db} = 3,125 \times 10 = 31,250$.

The procedure may be reversed. Assume you wish to find a db figure for the ratio 40,000, not given in the table. Factoring 40,000 into convenient numbers, $40,000 = 10,000 \times 4 =$ (from the table) $40 \text{ db} + 6 \text{ db} = 46 \text{ db}$. END

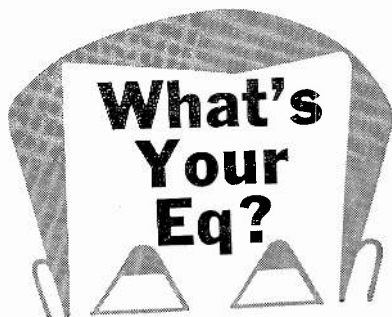

Conducted by
E. D. CLARK

Unsquare Waves

My audio generator was producing very bad square waves. It was new and I expected better from it, but the scope trace was rounded even at 1,000 cycles, worse at 5,000, and a misshapen sine wave at 10,000. My first impulse was to distrust the simple clipper-type shaping circuit. I recalled a similar circuit used in a Lafayette audio generator which gave very good square waves to 10 kc; the chief difference being small chokes used as peaking coils at two points.

I bought suitable chokes, wired them in—nothing. No improvement whatever. Still blaming the clipper, and knowing that my scope couldn't be as bad as all that, I even tried two Schmitt-trigger squaring circuits. When they failed to

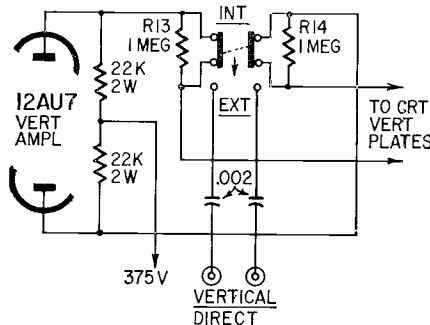

do any better, I began to wonder about my scope, and I decided to feed the signal direct to the CRT vertical-deflection plates, bypassing the amplifier. If the scope amplifier's response was really so bad, that test would show it.

Before I actually tried the direct feed, I found the trouble. It was the scope, but there wasn't really anything wrong with it! Can you figure out what

happened, with the help of the partial schematic.—Peter E. Sutheim

"Q"

Three capacitors, each charged initially as shown, are connected in series with a resistor and a switch. Determine the steady-state voltage on each capacitor after the switch is thrown.—Oscar D. Anderson

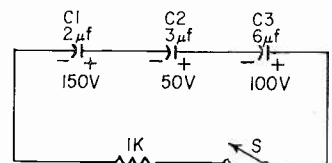

Two puzzlers for the students, theoretician and practical man. Simple? Double-check your answers before you say you've solved them. If you have an interesting or unusual puzzle (with an answer) send it to us. We will pay \$10 for each one accepted. We're especially interested in service stinkers or engineering stumbers on actual electronic equipment. We get so many letters we can't answer individual ones, but we'll print the more interesting solutions—ones the original authors never thought of.

Write EQ Editor, Radio-Electronics, 154 West 14th Street, New York, N.Y. 10011

Answers to this month's puzzles are on page 58.

Put those unmarked coils to work with this low-cost bridge. Covers 50 μ h to 100 h

Simple Inductance Bridge Checks Unknown Coils

By JOHN A. DEWAR

TEST EQUIPMENT FOR RESISTANCE AND capacitance measurements is common, but instruments to measure inductance are rare outside the laboratory. This checker contains few parts and is easy to build and operate.

It is used with a 1,000-cycle audio source capable of delivering 10 volts or more. This can be an audio generator or a one-tube oscillator built for the purpose. The actual frequency is not critical. In a spot check of six inductances ranging from 200 μ h to 15 h there was no variation in bridge reading from 400 to 2,500 cycles, though 1,000 cycles is the best for all ranges.

Due to losses in the bridge, a signal source variable up to 10 volts or better is necessary, particularly on the lower ranges.

The best null detector is also the cheapest: a little crystal earphone such as that used with portable transistor radios. A standard vtvm is not sensitive enough; an oscilloscope works, but not as well as the earphone. A tuning-eye tube requires a lot of amplification and was discarded in preliminary development.

With an oscilloscope, adjust for minimum trace height. The earphone does not give a silent null but a pitch change either side of the correct reading. Careful adjustment of balance control R6 gives a very sharp null. The residual tone is due to stray capacitance.

Ganged rotary switch S1 covers these ranges:

- A — 50 μ h to 1,000 μ h
- B — 1 mh to 20 mh
- C — 20 mh to 400 mh
- D — 0.4 h to 8 h
- E — 5 h to 100 h

S2, the HI-Q-LO-Q switch, converts the unit to either a Hay or Maxwell bridge. Both basic types are shown in Fig. 1. The Hay is best for high-Q coils while the Maxwell bridge gives best results with low-Q ones. The Q can be estimated

roughly by examining wire size, number of turns, dc resistance and core type. Most low-frequency iron-core chokes and transformers are low-Q. Small coils such as rf and i.f. transformers are high-Q and will give a null only in the Hay position. Note (from Fig. 1) that the bridge is little altered. In the Hay bridge

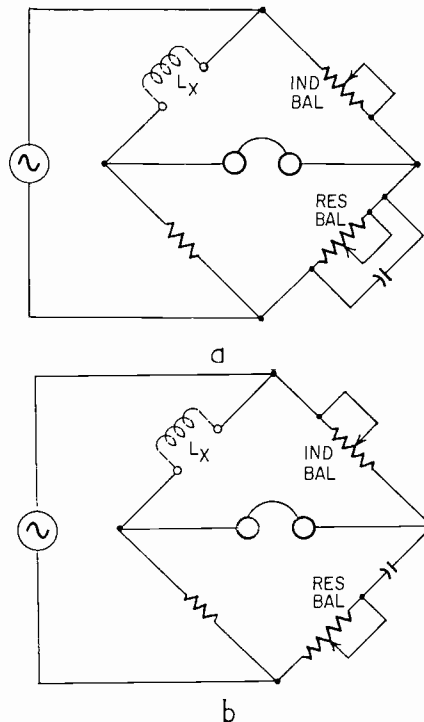
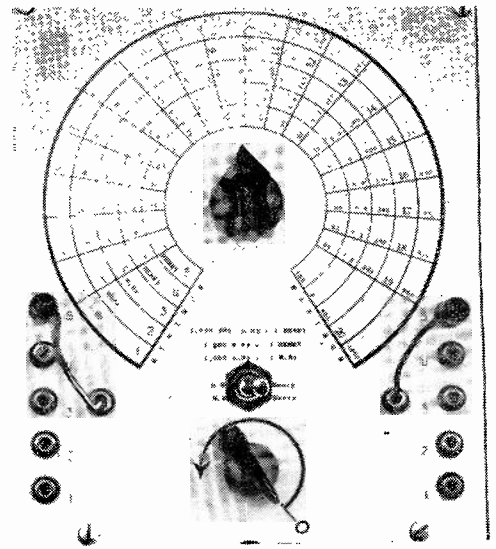

Fig. 1—Maxwell bridge (a) and Hay bridge (b) differ in connection of resistive balance pot. Hay bridge works best with high-Q coils, Maxwell with low.

the resistive balance potentiometer (connected as a rheostat) is in series with the range capacitors. In the Maxwell it is in parallel.

The complete circuit is shown in Fig. 2. Resistors R1 to R4 need not be high-precision but should be selected for accuracy with a good ohmmeter. Similarly, capacitors C1 to C4 should be checked on a capacitance bridge for cor-



Original version used banana jacks and patch-cords to change ranges. Rotary switch, as shown in Fig. 2, is more convenient.

- C1—2 μ f
- C2—0.1 μ f
- C3—0.01 μ f
- C4—0.001 μ f
- All capacitors 100 v, paper (see text)
- R1—25,000 ohms
- R2, R3—1,000 ohms
- R4—500 ohms
- R5—pot, 2,000 ohms, linear
- R6—pot, 2,000 ohms
- All fixed resistors 1/2 watt (see text)
- S1—rotary switch, 2 poles, 5 positions (Mallory 3129J or 3229J, or equivalent)
- S2—dpdt switch (rotary, toggle or slide)
- 6 binding posts, banana jacks, Fahnestock clips, etc.
- Crystal earphone
- Base, panel, miscellaneous hardware

rect value. Most stock capacitors tend to be lower in capacitance than marked.

The calibrated potentiometer (R5) must have a linear taper if used with the dial shown in Fig. 3. Other tapers, even if individually calibrated, will crowd portions of the scale. The dc resistance reading of R5 bears a direct linear relationship to the calibration. Taking range E as a reference, it will measure 100 ohms at 5 h, 200 ohms at 10 h and so on up to 2,000 ohms at 100 h. Taper of R6 doesn't matter.

Using the bridge

With the 1,000-cycle signal, the earphone and the unknown inductance connected, set the range switch to an estimated value and rotate the calibrated dial, looking for a null. If the inductance is larger than the maximum covered by the range, the tone will become loudest at the high-inductance end of the scale; if smaller, it will be loudest at the minimum end. Switch to the next range accordingly and repeat the procedure. If you cannot find a null, switch to the other bridge circuit.

The balance control compensates for the dc resistance of the coil. Once you have found a null, start at zero and advance the balance control a little, step by step. Swing the calibrated dial back and forth through the null until the sharpest null is obtained. Incorrect adjustment of R6 will give a false reading.

This is not a precision instrument. For instance, iron-core inductors, such as filter chokes, will have a lower in-cir-

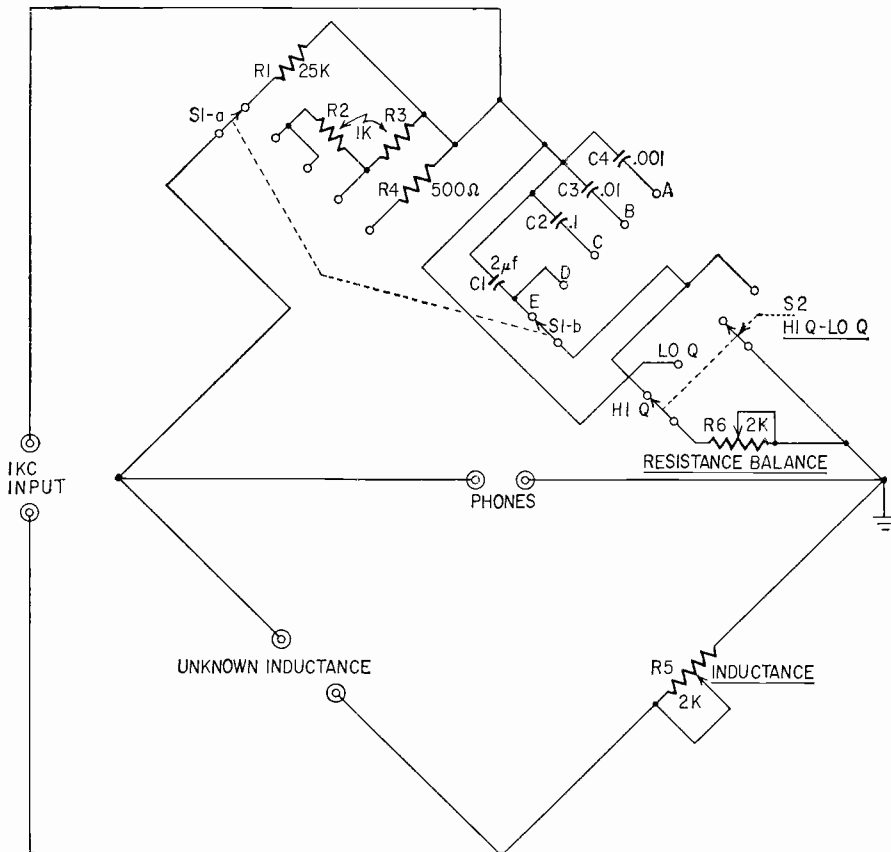

Fig. 2—Circuit of the twin bridge. You may already have most of the parts. Source frequency is not critical. Try what you have.

cuit inductance, when carrying large direct currents, than the value indicated on the bridge. But the bridge does eliminate a lot of guesswork when dealing with unknown values. And it is easy to build and cheap.

A wooden base and hardboard panel should suffice for chassis and panel.

Fahnestock clips, screwed to the base, make good connections.

Another use for the bridge is detecting shorted turns in flyback transformers. Compare the suspected transformer to the manufacturer's specifications or to a known-good flyback of the same type. **END**

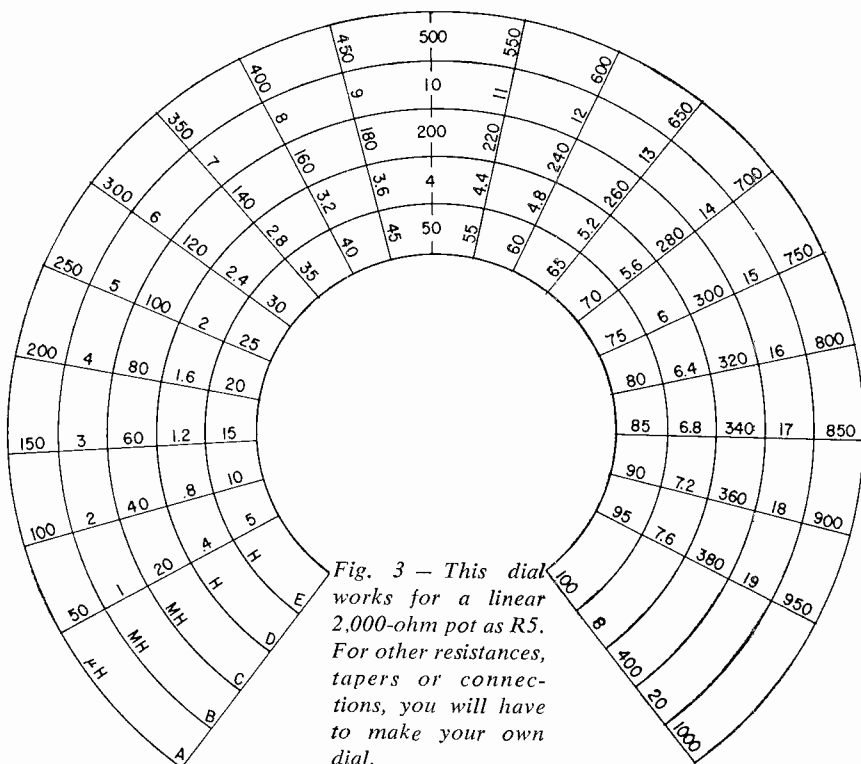
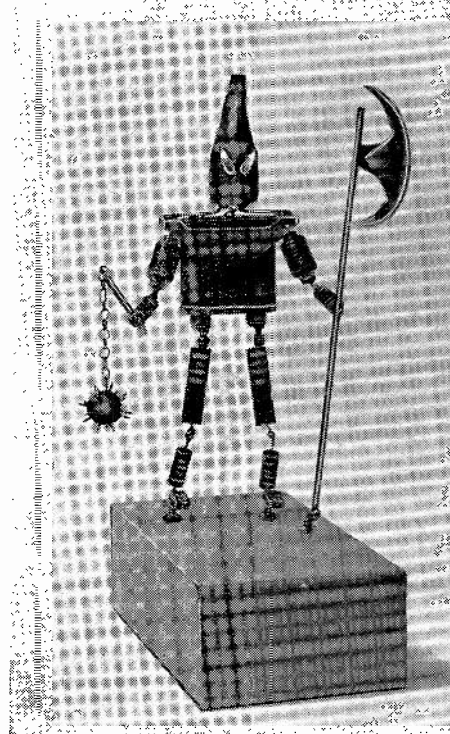

Fig. 3—This dial works for a linear 2,000-ohm pot as R5. For other resistances, tapers or connections, you will have to make your own dial.

Junk Parts Go to the Devil

CERTAINLY ONE OF THE MOST EVIL-EYED pieces of modern art around, this winking Satan was built by men of the Flag Administrative Unit of Fleet Air Hawaii.



The circuit is just a "push-pull" relaxation oscillator, and the two neon lamps, the eyes, wink alternately about once every second.

The 0.5- μ f capacitor forms the torso, while the resistive part of the time constant makes up the legs. The ax blade was made from an old meter face, its handle and that of the mace from No. 8 wire. (The ax handle serves as "ground return" to the battery.) Bits of hookup wire and a small wooden ball comprise the mace and chain. A red plastic alligator-clip insulator is the hood. The feet are small mica capacitors.

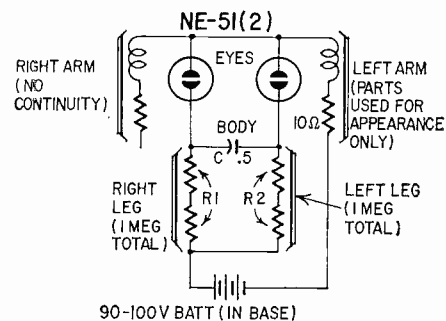

Three feedthrough insulators or capacitors on the base support the figure and pass current from the battery, located in the base.

While R1, R2 and C determine the wink rate, the other parts are there just for looks and to complete the circuit. Use components with low dc resistance. **END**

UNTIL A RELATIVELY FEW MONTHS AGO, a center or bass channel in stereo installations was restricted to a few component type systems. Now, center-channel bass speakers are featured in many stereo consoles and even in some inexpensive portables. Several unusual circuits have been developed to derive the center or bass channel. They are simple and easy to add to your stereo system or to the amplifier you are planning to build.

Fig. 1-a shows the output circuits of a typical ac-dc stereo amplifier with single-ended channels. Similar circuits are used by Motorola, Truetone, Philco and others. Note that there are three output transformers, one for each side channel and one for the bass content of the left and right channels. (Low notes do not have a pronounced directional characteristic so they don't have to be separated for stereo.)

The primary of the center-tapped bass output transformer has a much higher impedance than the primaries of the left and right output transformers. The middle and high-frequency notes from the left and right channels are developed across the respective right and left output transformers. They do not appear in the center channel because they are bypassed around the transformer by the 0.1- μ f capacitor. Only the lows from either channel are developed in the bass transformer. The output grids are fed 180° out of phase and the bass signals appear in push-pull across the center output transformer. Since the grids are 180° out of phase, the phase of one of the side speakers is reversed so the outputs are in phase.

Fig. 1-b is the output circuit used in some of the 1964 Philco radio-phonograph combinations. Note that the bass output transformer has a grounded center-tapped secondary and that the three secondaries are connected in series. Ad-

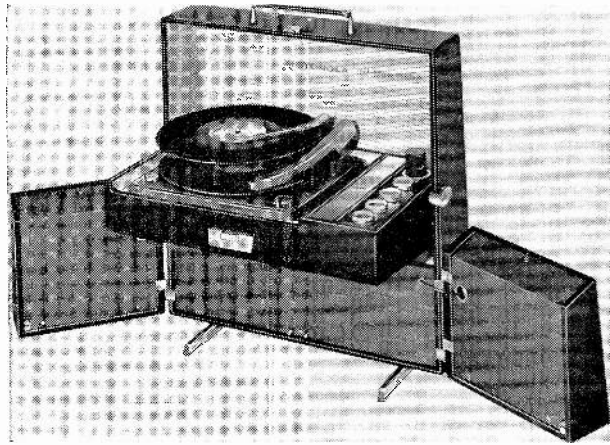

Motorola SP53 is typical of many stereo portables with center or bass channel output.

Center Bass Channel For Stereo

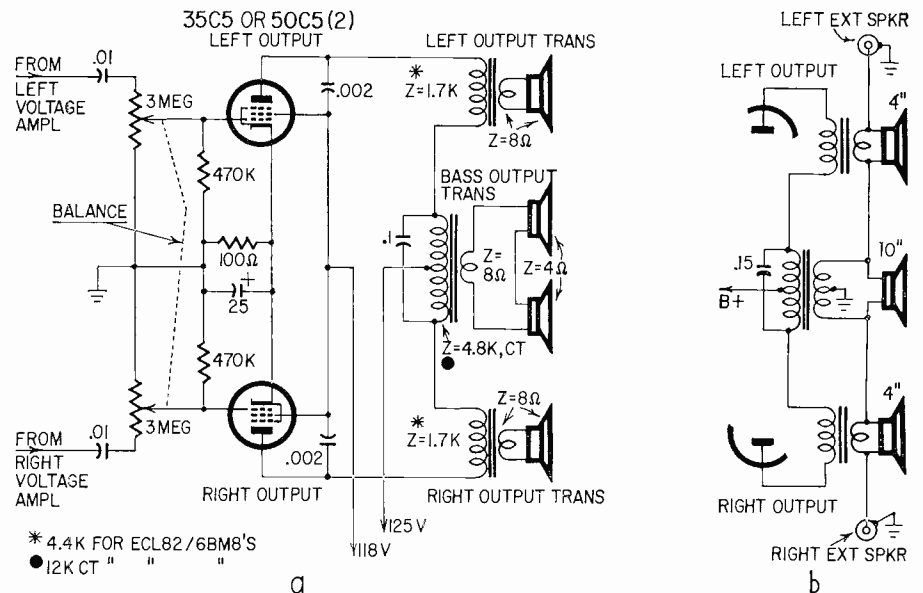
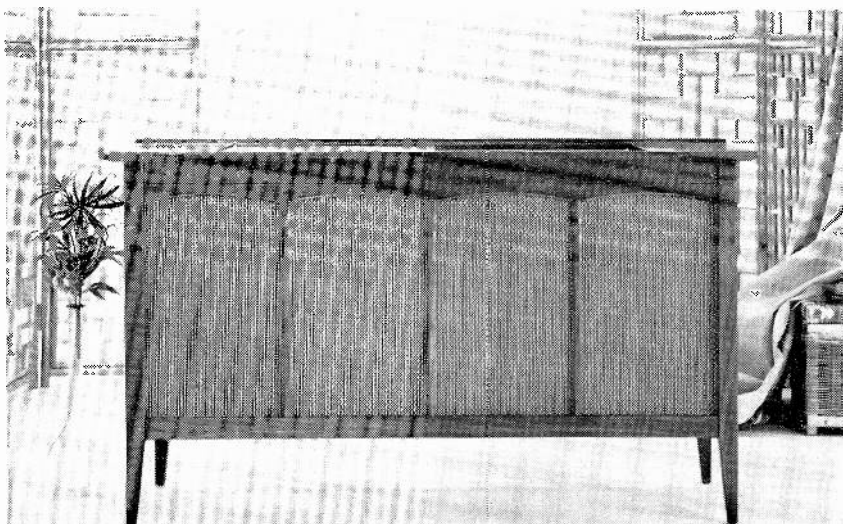

Fig. 1-a—Typical low-cost single-ended stereo output used in many small commercial phonos. A medium-sized universal output transformer can be used for the bass output transformer in a home-built version of the circuit. b—Series-connected secondaries in Philco phonos.



ditional jacks are provided for external speakers, which are fed the high and middle frequencies from the side speakers and the lows developed across half the bass secondary.

Fig. 2 shows the push-pull stereo output circuits in the Motorola HS-1130, a recent-vintage all-transistor stereo phonograph chassis. Two output transformers are used in the collector circuits of each push-pull channel. The bass output transformers (T3 and T6) are wound on large cores with a large number of turns so they present higher impedances at all frequencies than T2 and T5. The 10- μ f capacitors bypass the highs and

Westinghouse M-1350 transistor stereo console

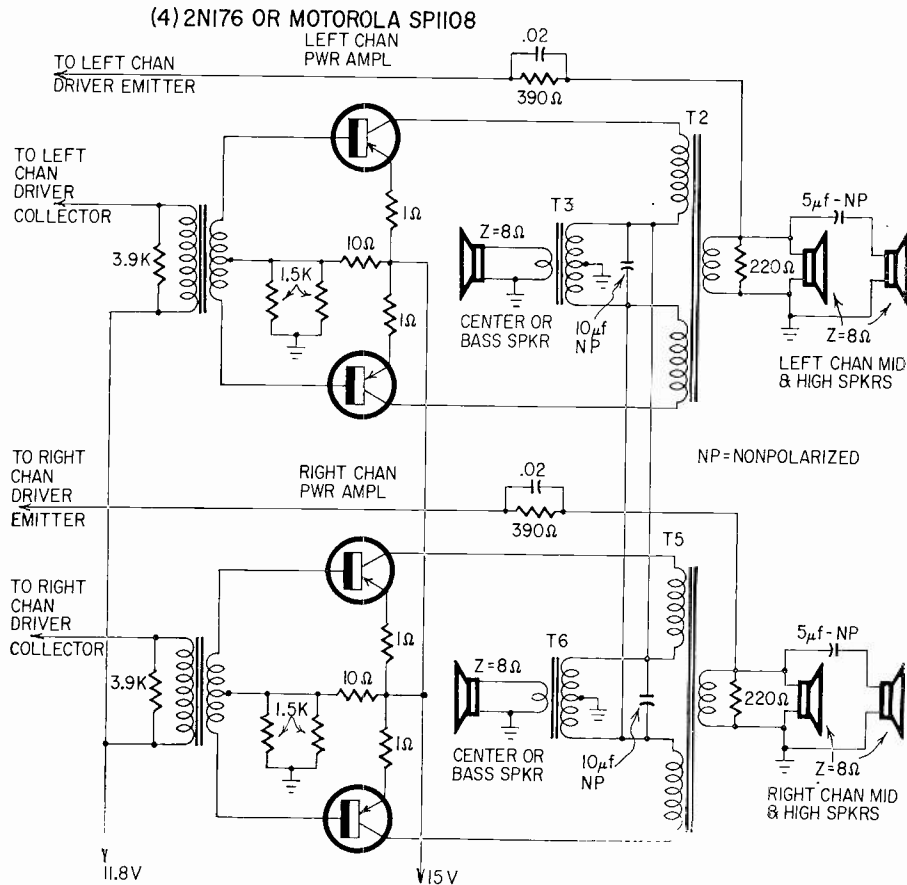

Fig. 2—Motorola transistor circuits use approach similar to that in Fig. 1-a.

only the lower notes are developed across the bass transformers. The highs are developed across the lower impedances of T2 and T5. The primaries of T3 and T6 are paralleled so the lows in either channel are fed to the bass speakers.

Westinghouse uses a simple L-C crossover network and carefully selected speakers to separate the ultra-highs, highs and middle frequencies in the side channels and to mix the lows in the bass channel. Fig. 3-a shows the output circuit of the V-2528-1 chassis used in the H-M1350 and H-M1450 series all-transistor AM-FM stereo phonograph combinations. Each channel has a push-pull OTL (Output-TransformerLess) power amplifier circuit. The 4-inch 45-ohm speakers have soft cones and the 4-inch 6.4-ohm units have hard ones. The three speakers in each side channel are carefully selected for smooth wide-range response through the middle and high frequencies. The woofer is fed from each channel through a 2.5-mh, low-resistance choke. Fig. 3-b is a similar arrangement used in a single-ended vacuum-tube amplifier. The 6-inch speakers carry the mid-range frequencies and the 3½-inchers handle the highs.

Service notes

Whenever the complaint is poor bass response, check the capacitor across the bass output transformer for a short. The capacitor is likely to be open if the complaint is poor separation or severe loss of highs.

intermittent or open speaker circuits. Some units have circuit-transfer jacks for external speakers (Fig. 3-a). Check the jacks for continuity, particularly if the external jacks are used for remote speakers.

Always check speaker phasing and cartridge connections when servicing a stereo system. Reversed cartridge connections cause poor bass response. Incorrect speaker phasing causes poor separation and some loss in the middle range.

To check speaker phasing, momentarily connect a 1.5-volt battery across the secondary of the left output transformer with the positive terminal on one of the marked or coded leads. Note which way the speaker cone moves when the circuit is made. Now, move the battery to the secondary of the right output transformer—making sure that battery polarity is the same as for the left channel. Speakers are in phase when their cones move in the same direction.

If possible, consult the manufacturer's service data. (Remember that in some systems, like the one in Fig. 1-a, speakers should be out of phase.) Transformer leads are generally color-coded, and speaker terminals are numbered or coded with a colored dot. The RCA WG-360A Phase Checker is handy when servicing stereo in the field, especially in cases where cone movement is not easy to see.

Always use exact replacements for defective speakers in high-quality systems. Speakers are generally matched to the enclosure and to each other for smooth response. Universal replacement speakers may result in a loss in overall response or in objectionable peaks. END

Many stereo units use plugs or clip-on connectors between the amplifier and the speaker leads. If you have trouble with a dead or intermittent channel, always check the speaker connections before the electronic circuitry. Several recent complaints have been traced to

Fig. 3-a—L-C crossover in Westinghouse transistor phonographs. b—Tube version, with output transformers.

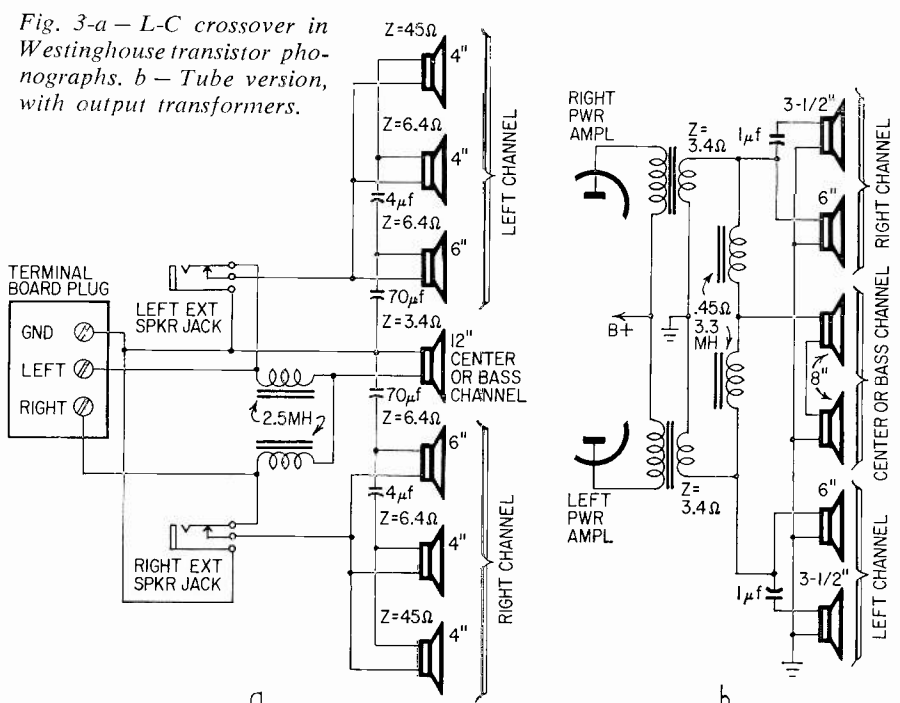

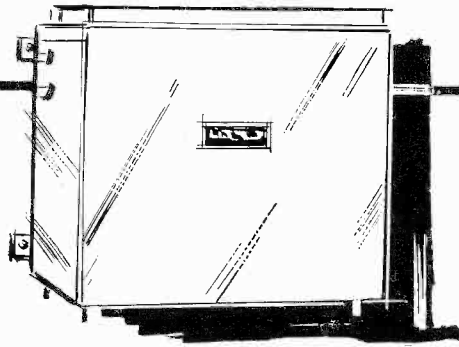

tachometers for *speed control*

By **MATTHEW MANDL**

Accurate speed control cuts costs and reduces delays along the production line

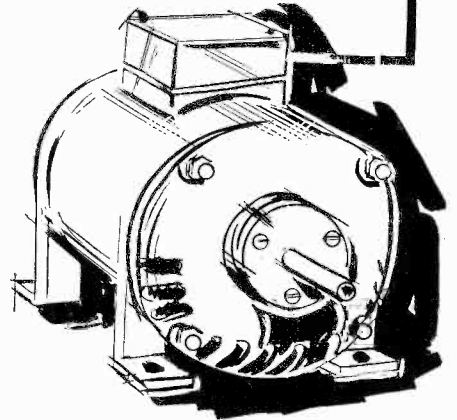
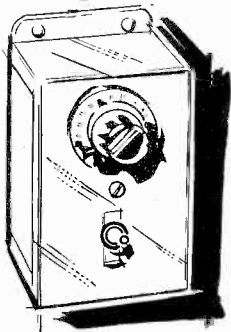

AN IMPORTANT DUTY OF INDUSTRIAL AUTOMATION is keeping conveyor belts, machinery, processing equipment, motors and other related gear at the right speed. This is necessary to keep the various processing operations synchronized. Steady operating speed also assures troublefree performance of the automatic processes and minimizes equipment damage.

As in many other phases of industrial automation, speed control requires a sensing device (transducer). It determines the speed of the object under test and indicates the exact number of revolutions per minute—or feet per second for moving belts and pulleys. When the speed or motion deviates from normal, it can be reset manually or automatically. For automatic operation, the transducer provides an output signal which is used to keep the speed within preset limits.

The tachometer is the sensing transducer that measures rotation. There are two basic types and both are used extensively in industry. One uses flashes of light and is based on the stroboscope principle used to measure the speed of phonograph turntables or time your car engine. The other is based on the dc generator principle—the output voltage is proportional to the rotation of the tachometer's shaft.



Generator type tachometer
Servo-Tek Products

Stroboscopic tachometer

The type 1531-A Strobotac made by General Radio is a portable unit containing a strobotron lamp in a parabolic reflector, an electronic pulse generator to control the flashing rate, and an ac power supply. The flashing light from the lamp is directed at the rotating object to be checked and the dial turned to change the repetition rate of the light flashes. When the speed of the light flashes match the speed of the object,

motion freezes—the object appears to stop. The exact speed is then read on the dial.

The Strobotac has a range of flash speeds from 110 to 25,000 flashes per minute and can read speeds up to: 250,000 rpm with flash rates that are submultiples of the speed to be measured. Light duration is between 1 and 6 microseconds with a peak light intensity up to 4,000,000 candlepower. Accuracy is within 1% of the dial reading after the unit's middle range is calibrated. An output trigger signal of 600 to 800 volts (negative pulse) is available for automatic control purposes.

The Strobotac can be used for observing latch operation of a hosiery-knitting machine, accurately measuring lathe speed, slow-motion observation of cutting action of tools, checking machines in underload and overload tests, and speed control and measurement of all sorts of rotating and reciprocating machine elements.

Generator type tachometer

By rotating the coil of a generator type tachometer in fields produced by



Strobotac Tachometer.

General Radio

permanent magnets, we get a dc output voltage whose amplitude is in direct proportion to the speed of rotation. To produce fairly ripplefree dc, however, a number of commutator segments must be used. This can be more easily understood by referring to the basic two-pole dc generator shown in Fig. 1.

The rotating armature has a number of slots containing coils. The individual wires of the coils are shown as small circles to represent the cross-sectional view. All the coils are wired in series, and a number of commutator segments contact the two carbon brushes. As the armature rotates, the individual coils cut the lines of force of the magnetic fields and generate electric power.

When a single coil is turned in a magnetic field, the energy builds up from zero, reaches a maximum peak and declines again, producing a single half-cycle. As the coil is continuously turned, pulsating dc appears at the output leads. When a number of coils are employed, the pulsating dc of each coil combines with the others to produce low-ripple dc, as in Fig. 2. Before the peak dc from one coil can decline, the next coil takes over, and the result is as shown.

A typical tachometer, with a speed-indicator dial, is the type SA-757 industrial tachometer of Servo-Tek Products Co. For long life, its commutator is almost pure silver, and the brushes are designed for continuous operation and carry a guarantee of a minimum 10-year life. Various indicators can be supplied for speeds ranging from 0 to 100 up to 12,000 rpm. A center-zero scale is also available. It indicates direction of rotation and speed. For increasing the scope of applications of this tachometer, a scale is also furnished which reads "0 to 100% of full speed" instead of actual revolutions per minute.

Speed-control systems

In a complete industrial speed-control system, the tachometer senses the actual speed, and control circuits keep it within a predetermined range. To do this, the speed indicated by the tachometer is compared to the desired speed of the moving belt, assembly line or other unit. Electronic circuits handle the comparison and correct for any deviation.

A block diagram of a basic system is shown in Fig. 3. The tachometer is so mounted that the moving belt or assembly line rotates its shaft and produces an output voltage proportional to the speed of belt movement. An indicator displays the speed visually at all times.

The voltage generated by the tachometer is applied to a dc amplifier. Output signals from the amplifier are sent to a phase-control unit that controls the firings of a gas-tube thyatron or a silicon-controlled rectifier. The rectifiers, under control of the phase unit, regulate the speed of the driving motor.

With the arrangement shown in Fig. 3, the tachometer can also be attached to the motor assembly instead of directly to the moving belt. With the tachometer shaft applied to the drive roller of the motor shaft, a direct reading and control of motor speed are also possible. With the tachometer applied to the motor shaft, the sensing is in motor rpm. Most tachometers, however, can be calibrated to read rpm in terms of feet per minute. A number of manufacturers of industrial control devices now furnish complete speed-control packages containing essentially the various items and circuits shown in Fig. 3.

A schematic of the Series 100 precision drive with tachometer feedback made by Servo-Tek Products is shown in Fig. 4. The ac line input is applied to the primary of the power transformer and converted to dc by the silicon rectifier and filter capacitor C. Filter resistors R1 and R2 are used instead of filter chokes, and together with the filter capacitor smooth out the ripple. A gas-tube voltage regulator is also included in the circuit.

The tachometer shaft is attached to the motor armature shaft and its positive-polarity output voltage is applied to the adjustable arm of R3. The negative output from the tachometer is sent to the dc control amplifier. The amplifier output is applied to the phase control circuit, where it causes the thy-

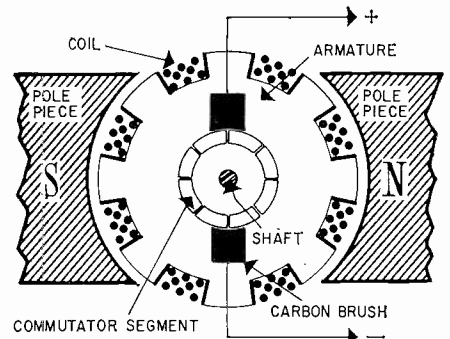

Fig. 1—Basic two-pole generator.

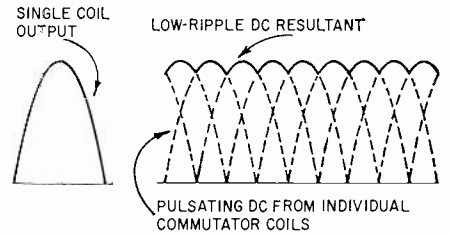

Fig. 2—Multi-pole tachometer produces low-ripple dc by combining the output from individual commutator coils.

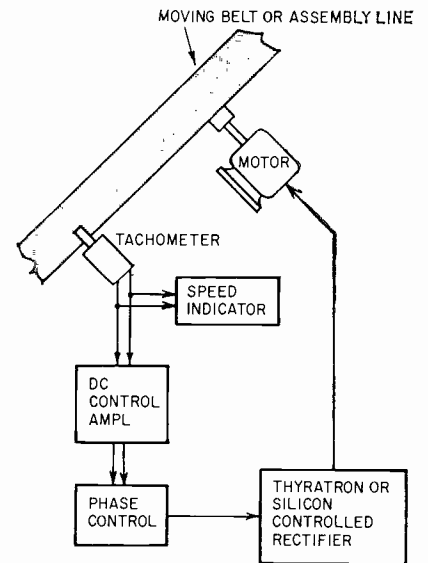
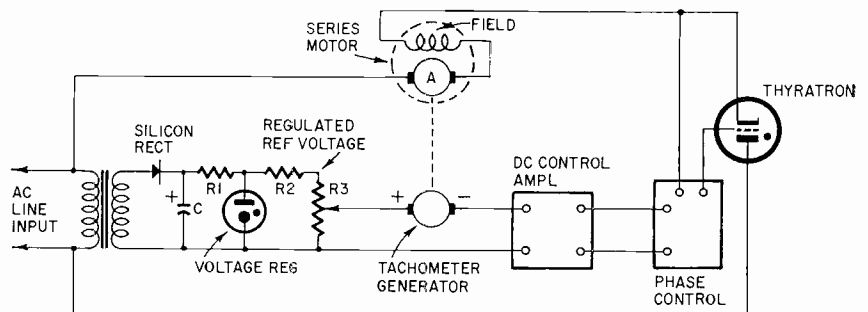
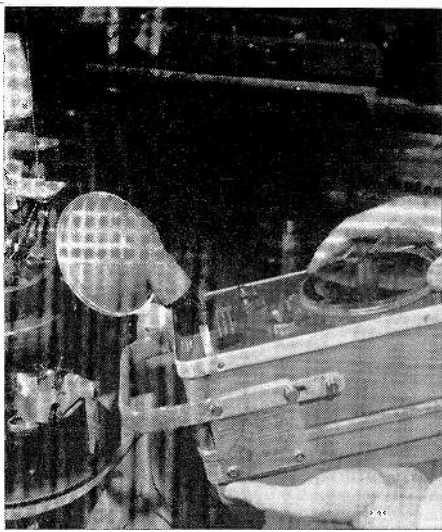

Fig. 3—Tachometer speed-control system.

Fig. 4—Circuit of the Series 100 precision-drive motor-control system made by Servo-Tek Products.





Strobotac used in hosiery knitting process to observe needle action.

General Radio

thyatron to fire by increasing grid voltage. The motor is in series with the cathode-plate of the thyatron, and ac line voltage is applied to it only when the thyatron is conducting.

The system shown, actually a servo device, is sometimes called a velocity servomechanism, because it is an automatic control assembly. With all such systems, the actual speed is first measured with an accurate tachometer mounted so it is part of the motor assembly. The voltage signal from the tachometer is compared with the reference voltage across potentiometer R3. It is adjusted to the proper level for the motor speed required. (The reference voltage is connected to oppose the polarity of the tachometer output voltage. Thus, any difference in the values of the reference voltage vs the tachometer voltage becomes an error voltage.) Because there is a complete closed circle of operation, the system is also known as a closed-loop velocity servo.

The error voltage produced when the motor speed varies above or below the preset value controls the firing time of the thyatron. Depending on the type of correction necessary, the error voltage either advances or retards the time of thyatron conduction. The resultant change in thyatron output causes a corresponding motor speed change, because the thyatron supplies current to the motor armature.

Many of the packaged speed-control systems available from various manufacturers contain patented circuits and assemblies. These, combined with matched units and circuits, make for highly efficient and accurate speed-control devices. With well designed systems, changes in line voltage have no appreciable effect on motor speed. Also, motor speed is held substantially constant even when the load changes. The speed is also virtually independent of the temperature of the motor and of component aging. Because a manual adjust is provided, the assembly-line motion or other speed can be set to meet varying conditions of automation and the servo system will maintain this precise speed until the manual control is reset.

END

Versatile Converters For The UHF

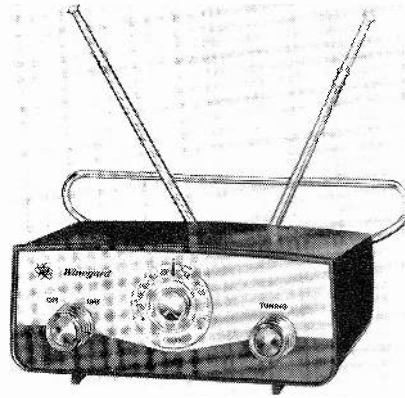

One antenna is for vhf, the other for uhf. The cabinet appearance is identical with the UC-100A, and, without the antennas, with the UC-410, -310 and -200.

TV RECEIVER MANUFACTURERS ARE MAKING a serious effort to meet the new challenge of uhf. TV auxiliary equipment and accessory manufacturers are no less active. New antennas, converters and boosters are being designed to cover the uhf spectrum. At least one piece of equipment—one of six converters put out by Winegard—combines all three in one unit. The UC-200A, a two-tube converter for medium ranges, has built-in uhf and vhf antennas, plus a nuvistor i.f. stage (operating at the frequency of a vhf channel). The added stage makes up for frequency conversion losses.

A companion converter, the UC-200, is identical except that it has no antennas. It is designed for use with an outdoor antenna instead.

For the fringe areas, a transistor rf stage is added to the circuitry of the 200, giving us the UC-310. In the far-fringe UC-410, the rf stage is a separate unit with its own power pack. It is placed at the top of the mast and supplied with 7 milliamps at 14 volts through the lead-in. The little power supply, which is inserted in the lead-in near the set, has its own power transformer, and is effectively isolated from the line.

(The rf unit and power supply is also available separately as the UHF-110 broad-band uhf antenna amplifier.)

The transistor type booster—which uses one 2N2966 in the circuit shown in the figure—is noticeably effective, even when the lead-in is not particularly long. Used with a Blonder-Tongue Golden Dart uhf antenna mounted indoors in a third-floor room, it made the difference between a recognizable-but-snowy picture and one with real entertainment value.

A pair of converters for listeners in strong-signal areas completes the half-dozen. Identical in appearance to those illustrated, they have one tube. The UC-100A has built-in uhf and vhf antennas; the UC-100 is intended for outside antenna use.

END

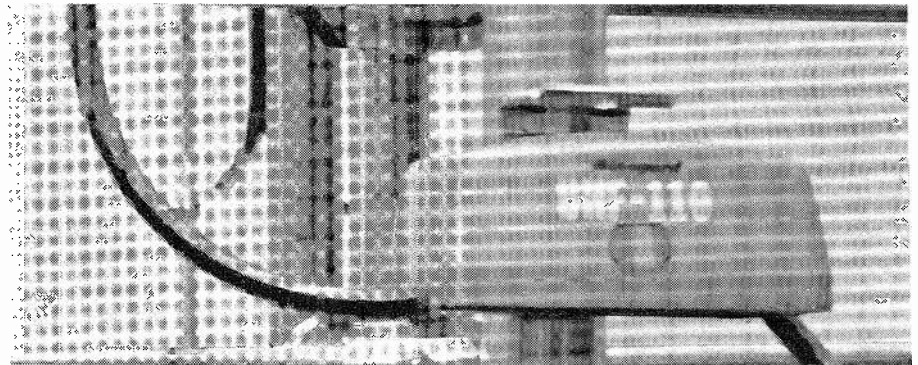

The UHF-110 transistor broad-band amplifier in position on a TV mast.

Schematic of the Winegard broad-band uhf amplifier.

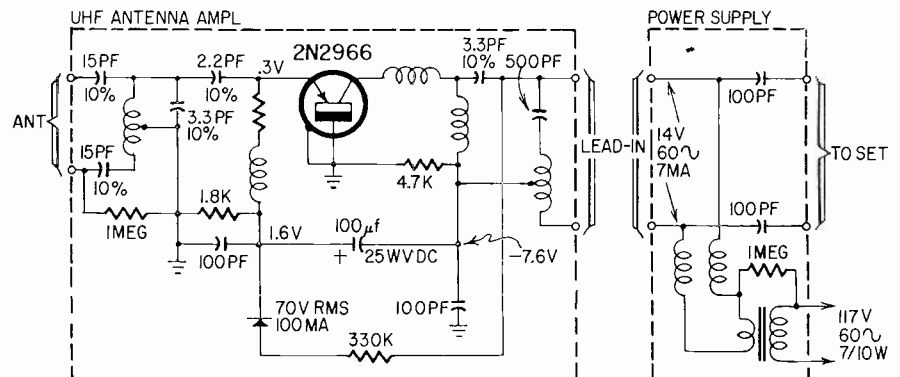

Transistors Keep A Roof On

AN ADVENTURE IN INDUSTRIAL ELECTRONICS

By J. K. BACH

RECENTLY THE LOCAL GAS AND ELECTRIC company had to reroute a gas main. The gas was cut off while the new pipe was being connected. Immediately after the gas was on again, one of the company's biggest customers complained, and a serviceman was dispatched. His report was confused and unlikely: he had lighted the first two heater pilots OK but, when he approached the third, he found the burner valve wide open and gas hissing out of the unlighted burner. He shut the whole system down immediately and called in.

Gas burners were the very first devices with a fail-safe feature built in. (The feature, in fact, antedated the term "fail-safe" by many years.) Originally, this comprised a heat-actuated mechanical element which operated the main burner valve directly. This has now given way to the thermocouple, because wires can easily be extended to a remote thermostat for automatic operation.

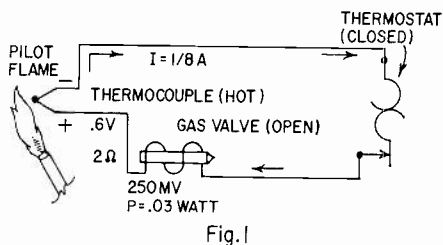

Fig. 1

Fig. 1 shows the usual arrangement. The pilot flame to light the main burner also heats a thermocouple (in practice, a number of such junctions, called a *thermopile*). This generates a potential—in this particular case, about 0.6 volt—sufficient to operate the gas valve to the main burner, when the contacts of the thermostat are closed.

When the room is warmer than the thermostat setting, its contacts are open. When the room cools, the contacts close, and voltage from the hot thermocouple opens the main valve to the burner, which is then lighted by the pilot flame. When the room warms up enough, the thermostat opens, the burner valve closes and the burner goes out. Only the pilot light remains lit.

If the pilot should go out—as happened in this case, because of the gas being shut off in the mains—the thermocouple cools and there is no voltage to open the burner valve. Until the pilot is lighted again, the valve should remain closed. How, then, could gas be coming

out of a cold burner? Though the burners are vented through the roof, gas is so dangerous one cannot afford to take any chances with it. Gas explosions are violent and destructive.

The company sent its ace troubleshooter to the scene. He found that the trouble was even worse and more dangerous than the serviceman had indicated. The location was a large garage: large enough to require 18 big space-heaters, suspended from a trussed ceiling in six rows of three. Each row had its own thermostat mounted on the far wall, and the wiring to them was encased in thin-wall conduit.

The trouble was not just in one burner—it was in all of them. There was no clearcut pattern. When two burners of any group were lighted, the third would gush out gas, but the lighting could be in any order: 1-2-3, 3-2-1, 2-3-1 and so forth. Sometimes even one burner of a group would operate the valve of another. There were "maybe" factors at work, too: whether the thermostat was "calling for heat" and how long the burner had been operating. It took a whole day of climbing ladders and tying up the garage space to work out most of the permutations, but the basic cause of trouble was obvious enough from the start. The burners were designed to be used singly, and each was intended to have its own thermostat. The man was all but certain that installing 12 more thermostats would solve the problem satisfactorily.

Except for the expense. The customer might stand still for the cost of the additional thermostats, but installing more conduit was another matter. Nor could the space be tied up for any extended time.

The consultant had a small laboratory in the main office building. Here, he assembled a mockup of the customer's layout, using three pilot units with their associated solenoid valves for the main burners. The burners themselves were not needed, and little wire "flags"

showed when the valves were operated. These valves work much like the water valves on an automatic washer—the solenoid opens a tiny needle valve which unbalances gas pressure on an operating diaphragm, which does the actual opening and closing. It is actually a servo type, since the power from the thermocouple is too small to work the valve directly.

A few minutes' testing confirmed what he already suspected: current from a hot thermocouple would flow backward through a paralleled cold one and operate the wrong valve. Fig. 2 shows this, and shows the thermostat open for simplicity. But if the wiring is extended far enough, the wire resistance plus the thermostat contact resistance may be high enough to permit the second valve to open even when the thermostat is closed. This is more likely when there are two hot thermocouples in the group, as in Fig. 3.

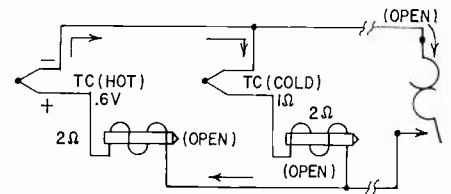

Fig. 2

He worked out the current-flow diagrams using Kirchhoff's law in case the Engineering Department had any questions, and with the lab mockup he was able to demonstrate the problem to the company Brass.

They were impressed, but clearly expected him to come up with some technical trick that would cost little or nothing. Also, time was important. The weather was mild, but in a mountain town it could change without notice.

There were several possible solutions, but not many practical ones. Resistances could be added to the circuit to reduce the operating margins so that no hot thermocouple would be able to operate any but its own solenoid valve. But this would make for cranky and unsatisfactory operation.

The solenoids could be polarized, but modifying the valves was out of the question, and the technician found it impossible to get enough residual magnetism in the cores.

This led to an idea that seemed to be a winner: simply put a rectifier in

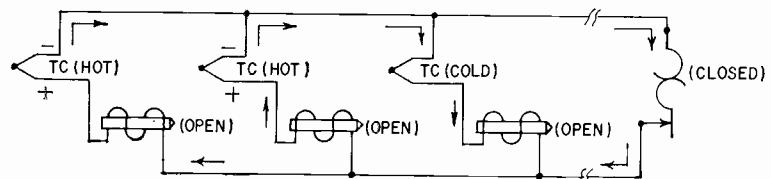

Fig. 3

series with each solenoid, and the problem should be solved. And at little expense, making the Brass happy, and maintaining ample operating margin. But the idea failed, and because of margin. There wasn't any, and there wasn't any operation either, with any rectifier the technician could lay his hands on.

The Brass helped. They secured a double handful of diodes from a large computer manufacturer, including mostly high-current and low-forward-resistance types, yet with the best of them the lab setup worked poorly when it worked at all.

They next consulted my company, and I suggested power transistors as rectifiers. They are cheap, widely distrib-

uted, and the germanium types have a low forward resistance. Happily, this notion worked like a charm (Fig. 4).

Not content with one transistor per solenoid, the power company man used two in parallel, with lowered forward-voltage drop, theory to the contrary not-

withstanding. This provided additional operating margin; though not equal to the original, there was ample for reliable operation.

Everyone concerned was happy, and at last report the customer's roof is still on. END

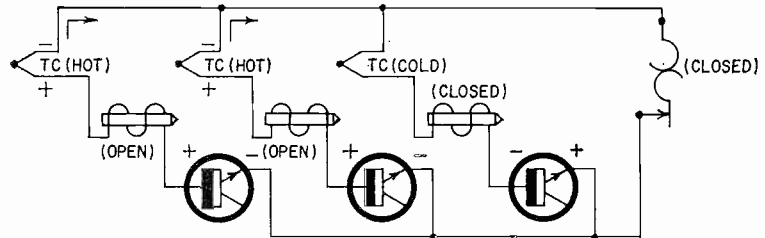

Fig. 4



This column is for your service problems—TV, radio, audio or general and industrial electronics. We answer all questions individually by mail, free of charge, and the more interesting ones will be printed here.

If you're really stuck, write us. We'll do our best to help you. Don't forget to enclose a stamped, self-addressed envelope. Write: Service Editor, Radio-Electronics, 154 West 14th Street, New York 10011.

RADIO-CONTROLLED GARAGE-DOOR OPENERS CAN BE SERVICED by the TV technician. They're pretty simple: they can have one-tube transmitters and one-tube receivers, although most have more than that. Transistor sets are also plentiful.

Mechanically, they're just as simple, as you can see in Fig. 1. The "traveler" is moved along the support rail by the motor (taking the door with it). The relay in the receiver starts the motor. As soon as the traveler moves, the limit switches take over. So, the relay doesn't have to be closed all the time the motor's running. When the traveler reaches the other end, the limit switch there stops the motor and cocks itself to start the motor in the other direction, the next time the relay is closed.

Most of the systems work on 27.255 mc, which is the radio-control channel (23) in the Citizen's band. Delco makes a system that radiates (as an "rf" signal!) between 5 and 10 kilocycles, to avoid interference in the radio band. This gets rid of some of the troubles, like the garage door opening every time Junior calls someone on his slightly off-frequency CB walkie-talkie!

Transmitter antennas range from small rods mounted on the case, in the 27-mc band, to cylindrical coil types, in the 5-10-kc sets. These can be moved and mounted elsewhere on the car, if the signal isn't strong enough.

Receiving antennas can be critical, too, especially if they have been installed pointing in the wrong direction or (as I've found a few) taped tightly to pipes, conduits or steel beams! This does nothing at all to aid rf pickup, believe me! For the best results, position the receiving antenna so that it is broadside to the position in which the car (transmitter) will be when the signal is sent out. In a very few cases, you may have to set this antenna outside the garage itself—if metal walls or large machinery interfere with the rf pickup.

Metering points are usually provided for tuning up, on the receiver. If not, you can always measure grid current with a milliammeter, or grid voltage with a vtvm. While a signal generator can be used, the set's own transmitter is the best source of signals. Always tune for maximum reading, with the car in the "normal" position—in the driveway as it would be when approaching the door.

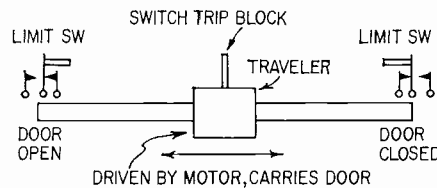

Basic mechanics of radio-controlled garage doors are quite simple. The traveler glides along the rail, driven by the motor via cable and pulleys or a rotating lead-screw. Limit switches at either end stop it and set it up to start again in the opposite direction the next time the transmitter is keyed.

Watch out for one peculiarity found in some systems: "pulsing" of the transmitter's rf signal. Many units have "timer" circuits: when the operating button on the dash is pressed, the transmitter is keyed, and holds "on" for about 2 seconds. Then it shuts itself off. This can be confusing if you're trying to realign the receiver! For tuning purposes, defeat the timer circuit. Block the relay closed, hook jumpers across the keying circuit, etc.

You'll find schematics on most of the popular units in Sams Photofacts, listed under their maker's names.

By the way, watch out for "tricky" tubes: not unusual types, but critical tubes in a few sets that use regenerative or even superregenerative receivers. It is entirely possible for a new tube to refuse to work in such circuits! If that happens, try another tube before pulling the receiver chassis for servicing.

THIS NEW HEATHKIT[®] FM STEREO GENERATOR



CAN PUT EXTRA PROFITS IN YOUR SHOP

- Produces all signals required for trouble-shooting and alignment of multiplex adapters, FM tuners and receivers
- Generates mono FM or composite stereo FM signals
- Crystal-controlled 19 kc (± 2 cps) pilot signal, level adjustable from 0 to 10% for check of tuner lock-in range
- Switch selection of 400 cps, 1000 cps, 5000 cps, 19 kc, 38 kc, 65 kc or 67 kc SCA test signals for complete alignment capability
- 100 mc sweep signal (adjustable ± 2 mc) for overall RF & IF alignment
- Built-in markers for 10.7, 90.95, 96.3, 101.65 & 107 mc
- No balance adjustment required for equal right and left channel modulation levels
- Phase test for accurate adjustment of subcarrier transformers

Here is an outstanding new instrument that will add extra profits to your service operations . . . the new Heathkit FM Stereo Generator! This completely self-contained instrument provides all the signals necessary for fast, easy alignment and trouble-shooting of FM stereo tuners, receivers and multiplex adapters in addition to standard mono FM.

Versatile Performance! Signals generated by the Heathkit IG-112 include an audio or composite stereo signal for multiplex adapter adjustments or an RF carrier modulated by these same signals to produce an "on-the-air" signal just like that transmitted by an FM station. A sweep function is also provided for over-all RF-IF alignment with marker frequencies at 90.95 mc, 96.30 mc, 101.65 mc and 107 mc for checks of dial tracking. Instant selection is made between either Right or Left channels, as well as a special "Phase Test" for accurate adjustment of stereo subcarrier transformers. No balancing is required for equal right and left channel modulation.

Advanced Design! Switch-selected audio fre-

quencies include 400 cps, 1000 cps, 5000 cps, 19 kc, 38 kc and special SCA frequencies for either direct or RF carrier modulation use. The SCA frequency is selected by a rear panel switch to be either 65 kc or 67 kc, providing a versatile system capable of aligning even the most deluxe tuners of advanced design. A crystal-controlled 19 kc (± 2 cps) pilot signal adjustable in level from 0 to 10% is provided to check the lock-in range of stereo receivers.

Easy To Use! RF signals supplied by the generator terminate at a 300 ohm balanced output, designed for direct connection to the antenna terminals of the tuner or receiver being tested . . . no complicated matching networks for impedance or balance required. A three-step (20 db per step) RF attenuator in addition to the variable output control, prevents overloading tuner input, and the carrier is adjustable ± 2 mc up or down to permit alignment on a clear portion of the FM band.

Easy To Build! Clean, open circuit layout provides easy access to all components for greatly simplified assembly. Complete with

test leads and detailed stereo alignment instructions. Order your Heathkit FM Stereo Generator now for faster, easier servicing . . . extra profits in this greatly expanding field of Stereo FM.

Kit IG-112, 10 lbs. \$99.00
Export model available for 115/230 V. AC, 50-60 cps; write for details.

IG-112 SPECIFICATIONS—RF Signal Output: Center frequency: 100 mc adjustable by approx. ± 2 mc. **Pilot modulating frequency:** 19 kc ± 2 cps. **FM modulation:** Left channel (stereo), right channel (stereo), Phase test (left plus right channel in phase). **Monophonic FM.** **Deviation:** Adjustable to 75 kc. **Sweep rate:** 60 cps. **Sweep width:** Adjustable to 750 kc. **RF attenuator range:** 60 db in 20 db steps. **Crystal-controlled markers:** 10.7, 90.95, 96.30, 101.65, & 107 mc. **Composite signal output:** Left channel (stereo). Right channel (stereo). Phase test (left plus right channels in phase). **Audio output:** 400, 1000, & 5000 cps; 19 kc (± 2 cps); 38 kc; & SCA (65 or 67 kc). **Maximum distortion:** (at 400, 1000 & 5000 cps) 5%. **Front panel controls:** 19 kc pilot level control, deviation-sweep width-composite, level-audio level control, function switch, frequency switch, & RF attenuator switches. **Rear panel adjustments:** Balance adjust, 38 kc sync, pilot level adjust, & SCA frequency switch. **Chassis adjustments:** Oscillator adjust, frequency adjust & modulation adjust. **Tube complement:** 12AT7—19 kc oscillator & 19 kc doubler; 6AU6—19 kc buffer & 38 kc amplifier; 6AN8—Reactance tube modulator & 100 mc oscillator; (3) 12AU7—Audio osc.; audio cathode follower & 19 kc pilot amplifier; composite/audio amplifier & 5.35 mc crystal osc. **Power requirements:** 105-125 volts AC, 50/60 cps, 35 watts. **Dimensions:** 10 1/4" H x 8" D x 13" W.



HEATHKIT-1964

FREE CATALOG
Fully illustrates over 250 exciting Heathkit products at savings of 50% or more! Choose from the world's largest selection of quality instruments in easy-to-build kit form. Send for your free copy today!



HEATH COMPANY, Dept. 20-7-1
Benton Harbor, Michigan 49023

Please send Free 1964 Heathkit Catalog.

Enclosed is \$ _____ plus postage. Send IG-112 FM Stereo Generator.

NAME _____
(Please Print)

ADDRESS _____

CITY _____ STATE _____ ZIP _____

Prices & specifications subject to change without notice. TE-129

Disc recorder cut too shallow

I'm restoring an old Philco 42-1008 disc-recorder-radio combination. I can't get a satisfactory cut: the stylus either cuts too deep or not deep enough. Where can I find the service data on this?—M. T., San Antonio, Tex.

Service data are in Rider's Vol. 13-9, *Perpetual Trouble Shooter's Manuals*. Nothing on the recorder unit here, though: you'll find that in Sams 1947 *Record-Changer and Recorder Manual* under G-1 (General Industries) RC-130L.

From experience, I'd say that your trouble is due to the "straddle-plate" of the recording arm being loose. There is a "staked" bushing at the pivot point, which used to work loose; this makes it impossible to get a good adjustment on the cutting depth.

Take this apart and see if you can restake it with a sharp punch and a light hammer. Be careful! In a few cases, you can carefully flow solder into this bushing and get it to hold.

Be sure that the knife edge of the follower arm, which rides on the lead screw under the turntable, is bearing just enough on the arm. It should hit the screw about 1/2 inch before the arm reaches the surface of the disc. With the cutter arm down, you shouldn't have any "slack" at all when you try to move the arm sidewise.

Watch the "chip" (the thread of plastic which curls up from the disc while you're cutting). If it is kinky and breaks up in short pieces, you're cutting too shallow. If it's long and curly, staying in one piece and wrapping around the spindle, you've got it just right.

Hi-fi won't turn off

I've a Motorola hi-fi console with an unusual condition. The owner hooked up a Collaro changer to it. He cut up the line cords and soldered them all together! When he turned it on, there was a "burst of light," he said. Now, the amplifier won't work with its own line cord, but it will when the cord to the changer is plugged in! You can't turn the amplifier off! Could this be a shorted capacitor, or what the heck?—T. B., East Paterson, N. J.

These things happen, don't they? I don't think this is a shorted capacitor. Line bypass capacitors are ordinarily connected in shunt between the ac line and chassis. They wouldn't be in a position to shunt the switches.

The most likely thing here is that he managed to get a short so that the switch contacts have welded themselves closed. (This is commonly caused by lightning, too.) The switch will still click, but that's all.

Remedy: take a pair of diagonals,

cut the whole mess out, and start all over again. If he wants to use the automatic shutoff switch in the changer to control the amplifier, this can be done—just hook the amplifier ac input on the motor side of this switch. While I don't recommend using too much load on these switches, they seem to be able to carry the amplifier current OK. (The one on mine has for some years now!)

Suggestion: get one of the small surface-mounted "table-tap" triple ac receptacles, and screw it to the back of the cabinet under the changer shelf. Then hook that up to a single line cord. Makes things a lot simpler.

Flashover and convergence

I've got troubles with two sets! In one, I can't get the blue lines the way I want them. All of the adjustments seem to work right, but I can't get the ends of the lines to converge properly.

In the other, with the same chassis, (RCA CTC 5) I've got a severe arcing at the end of one of the PC boards. It flashes with a noise like a rifle shot! There is a burned area on the board. Other technicians have told me to drill holes in the board, but I don't like to do this. What would you recommend?—J. B., Bradenton, Fla.

Let's take your convergence trouble first. Since all your adjustments seem to be working right, try a slightly different method of convergence. You see, you have all kinds of adjustments on your blue, while the other colors have only two major adjustments, both diagonal. So I'd run the purity, degaussing, etc. adjustments first, then turn the blue completely out (with the blue screen control, or shunt the blue gun, etc.) then run the red-green convergence until you get a good yellow line or lines. Now turn your blue back up and see if it isn't easier to get the blue to move over to converge with the yellow; I think you'll find it will be. You can move the blue laterally, horizontally and vertically, or alter the shape, by setting the blue adjustments: horizontal tilt, vertical tilt, blue lateral and blue static, etc. Most technicians use this method, and I think you'll find it easier.

As to the flashover trouble. There are several ways to cope with this, and drilling holes in unused sections of the board is one of them. This increases the gap the voltage has to jump.

A good general remedy is this: clean the bad section of the board very well, with a good solvent type service cleaner. Take a small burr and a hand-grinder, and carefully cut out the parts of the board that have been burned, like a dentist cleaning out a bad tooth. These parts are carbonized, and hence will carry current, so take 'em out entirely.

If any of the PC wiring goes with it, replace the conductors with very small insulated wire, "tacked" from point to point to complete the circuits (Fig. 1). In fact, it's a good idea in some cases to replace the PC wiring entirely, in the circuits causing the flashover. Run well insulated wire from the nearest terminal point on the PC board to the other terminal.

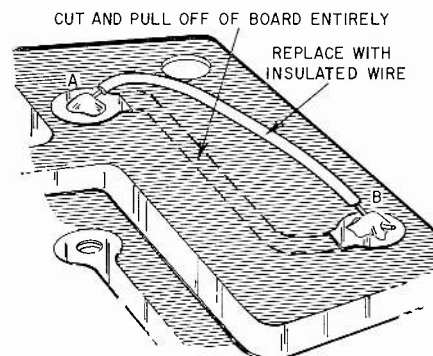

Fig. 1—Sometimes the wisest thing, in case of persistent flashovers, is to remove the offending strip of printed-circuit foil entirely and replace it with a piece of insulated hookup wire between the same points.

After you've made these repairs, spray the whole area with a good acrylic coating. The best way to do this is spray on a thin coat, allow to dry for 4-5 hours, then spray on another. Three coats won't hurt anything.

In some cases, you can kill an arc-over by painting the area with corona dope or a similar insulating compound. In other, you can lift the edge of the PC board and insert a piece of plastic tape to cover the damaged place.

RCA KCS-121 vertical troubles

The owner wants this RCA KCS-121 serviced in his home! It's got all kinds of vertical troubles: roll, not enough height, poor vertical linearity. You name it, we got it! New tubes didn't help too much, and it won't hold adjustments once made. I'll appreciate any help!—G. E. G., Baltimore, Md.

While I do not ordinarily recommend "shotgun replacement," I think that you'll save time here by doing it. Lift the vertical sweep board away from the chassis enough to let you get at it, and replace all the capacitors on it (about 8 or 9)! Check the schematic before you leave the shop, and pretest all of the replacement capacitors on something like a Sprague TO-5 or a capacitor tester which will detect even very small leakages. This circuit is critical, and prone to developing small dc leakages in the original capacitors. Replace all of them and you'll probably solve the problem. END

AUDIO EQUIPMENT REPORT

All-Transistor Stereo Amplifier KLH Model Sixteen

IF THERE ARE ANY AMPLIFIERS THAT CAN be counted on to clear away any remaining notions of the inferiority of transistors to tubes, the KLH Sixteen is certainly one of them.

I received what was apparently an early production model; the only literature with the amplifier was a 10-page "Instruction Sheet" that told how to connect the amplifier, phase the speakers, and use the controls.

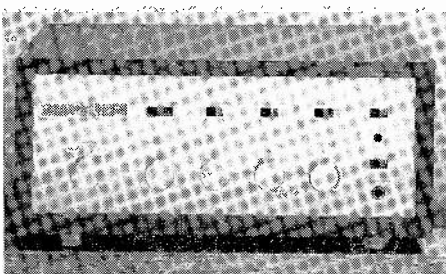

SPECIFICATIONS

(All specifications are the manufacturer's)

Power output: 70 watts rms, ± 0 , -1 db from 25 to 20,000 cycles, both channels driven simultaneously into 8-ohm loads. Decreased by 2 db with 16-ohm loads

Music Power IHF rating: over 100 watts

Harmonic distortion: Less than 2% from 25 to 20,000 cycles at 35 watts, both channels operating simultaneously into 8-ohm loads. Mid-band distortion at full power less than 0.5%

Response intentionally rolled off below 25 cycles to prevent high-power, low-frequency transients from damaging speakers

Semiconductor complement: 22 transistors, 8 diodes

Dimensions: 4½ in. high by 11¾ in. wide by 10½ in. deep including knobs

Price: \$219.95, fair traded. Oiled walnut case, \$19.95 extra

Hooking it up, I was rewarded with some uncommonly good sound. I don't like to lapse into audiophilic jargon, but the well worn expression "effortless" sound applies so well to what I heard!

Impressed and curious, I disconnected the amplifier after a while and made a few measurements. At that time I had no idea even of the power output to expect from it, so I began completely unprejudiced. I got 33 watts of purest sine wave from one channel at 1,000 cycles. When clipping did set in (35 watts) it was clean and symmetrical.

What was much more impressive was the fact that the amplifier was still putting out 30 watts per channel at 10,000 and at 30 cycles! Very few tube amplifiers can equal that performance, and no transistor amplifier I have yet seen can either. I decided to be brutal and leave the amplifier carrying 30 watts at 10,000 cycles, watching carefully for any creeping distortion (on the scope screen) or wisps of smoke, and feeling the output transistors every few seconds for signs of overheating.

From the time I began to the time I got bored with it, none of the output transistors got warmer than a casual handshake. Power stayed right where it was, and the scope trace did, too.

I was surprised not to see anywhere in the instructions the usual cautionary note about shorting speaker terminals. Whether this was an oversight, a piece of brash confidence or just candid honesty on the manufacturer's part, I decided it ought to be reported on.

So... with the amplifier going full tilt into an 8-ohm resistive load—I shorted the output terminals! (Very tentatively at first.) Naturally the scope trace flattened out into a straight horizontal line. But the *instant* I disengaged the screwdriver, the old sine wave bounced right back, and the meter again read 33 watts! I tried again, this time bridging the screws firmly with a big, fat screwdriver for 5 or 10 seconds. The model Sixteen couldn't have cared less.

I tried various capacitive loads, no load at all, square waves at all frequencies, but the amplifier would not misbehave. There was nothing to do but go back and listen to it.

Which I did, with renewed enthusiasm. I have been using it almost daily for several weeks, and I can't think of anything unfavorable to say about it. Oh—except that *hiss!* This one is not as bad as some, but the hiss is quite clearly audible in a quiet room during spots in a program. At least it is so soft and of such a "temperature" that it can be ignored.

One of the things I liked best about the model Sixteen is its solid construction and cool, low-key elegance. The panel is thick aluminum, with a brushed finish, the "grain" of which is horizontal above the knob axes and vertical below, giving the panel a two-tone effect but without paint. The knobs are solid aluminum with narrow grooves milled out as position indicators. Panel markings are black, simple and legible. The only color is the "vertical lines" background for the KLH emblem in the upper left corner: pale blue. A very handsome piece of design, carried even into the feel of the controls and switches, which handle as though they were all individually machined.

The tone controls have an unusually large amount of boost and cut. The Sixteen offers two loudness compensation positions (besides OFF—none at all). One is for very low levels or for highly damped or bass-deficient speakers, the other for moderate levels.

A STEREO-MONO mode switch makes it possible to feed the same signal to both channels from only one input

jack if desired, and to parallel the two channels for vertical-noise cancellation when you play mono records with a stereo cartridge. There is also a front-panel headphone jack and a speaker on-off switch. The amplifier has a high-cut filter and the very useful tape monitor switching facility.

There are only four inputs: phono, tuner and two auxiliary. The phono input can be switched to accommodate low-level or high-level cartridges, and the AUX 1 input to LO, MED or HI, depending on the source signal level.

Particularly appealing, too, are the Sixteen's weight and size: about 12 pounds and 11¾ inches across the panel. Pretty good for a 70-watt stereo amplifier with controls!—Peter E. Sutheim

All-Transistor AM-FM-Stereo Tuner Heathkit AJ-33

AM-FM STEREO TUNERS OF A FEW YEARS back fed AM to one channel and FM to the other, for the experimental stereo transmissions of the day. Those tuners had dual tuning: one knob for AM, one for FM. This tuner does not. It has only one tuning knob, with separate dial scales for AM and FM. It operates in three clearly indicated modes, selected by a switch.

In the AM and FM positions, both

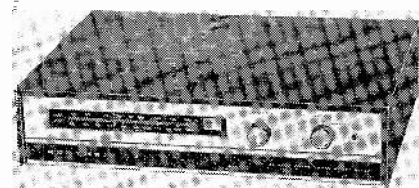

SPECIFICATIONS

(All specifications are the manufacturer's)

FM section

Sensitivity (for 30 db quieting): 3½ µv

Capture ratio: 7.5 db

Image rejection (30-µv input, mod 30%): 40 db

AM suppression: 22 db

Output impedance (emitter follower): variable to 3,000 ohms

Output voltage: 0.5

Audio-frequency response: 20 to 20,000 cycles ± 1 db

Harmonic distortion (25µv input at 98 mc, 100% mod): less than 1%

Hum and noise (25 µv, 100% mod): -48 db

Max channel separation: 30 db min at 1 kc; 25 db min at 10 kc

AM section

Usable sensitivity (20-db quieting at 1000 kc): 15 µv

Image rejection (1,000 kc): 40 db

Harmonic distortion (750 µv input, 95% mod): less than 1%

Output voltage (750 µv input, 30% mod): 0.45

Dimensions: 15¾ x 3¾ x 11½ in. in walnut cabinet supplied

Price: \$99.95 in kit form

Answers to

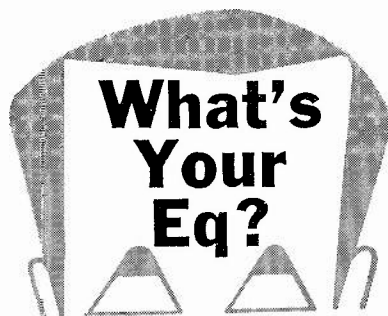

This month's puzzles are on page 33

monophonic, the output emitter followers feeding left and right channels deliver identical program. The FM STEREO position is for FM multiplex reception.

The circuit includes a stereo indicator light, which lights up when an FM multiplex signal is tuned in, regardless of which FM position of the mode switch is selected. In the FM (monophonic) position, the 38-kc locked oscillator is disabled, preventing noise from producing spurious stereo effects when receiving a monophonic signal.

The squelch circuit is very valuable for FM, because it kills the signal channel between stations, where little or no agc voltage is developed. The point at which this killing occurs is adjustable by a preset knob behind the trim flap.

Accurate tuning is facilitated by the clearly readable pointer type indicator. The only manual controls on the main panel are tuning, mode switch and on-off (pushbutton type); everything else is located behind the trim flap in the lower half of the front panel. There we find, reading from left to right: *SCA filter switch*, controlling a filter for rejection of the 67-kc SCA subchannel, when it is present; *squelch control*, to set the level at which the FM signal is squelched; *separation and balance controls* for the FM stereo mode; *left and right output level controls* (which serve as amplifier input level controls, if the tuner is used with an amplifier without them); *phase control* for stereo multiplex (this adjusts the phase at which the 38-kc oscillator is locked, on which accurate separation depends); *FM antenna switch*, marked distant-local (puts attenuation in local reception, where the signal might be strong enough to overload the rf section); *noise filter on-off* (this is simply increased high-frequency rolloff), and *AFC on-off*, which serves the usual function in FM reception.

As a tuner, this one handles very nicely in all three modes. Where two transmissions share the same frequency, it cannot separate them, of course. Means must be found to do this at the antenna, by using directivity. But for transmissions on adjacent channels the separation is unbelievably good. On AM, it seems to "cut" from one station to an adjacent one, rather than blending over with that horrible distortion some tuners have, often difficult to eradicate on either individual channel.

Compared with other tuners, the Heath AJ-33 gives the impression that it will get any station that can possibly be pulled in. Dead fringe areas prove to be not so dead as other tuners would have us believe! And noise, which previously seemed inevitable with distant reception, is astoundingly low. The quality is indistinguishable from high-quality record reproduction.—*Norman H. Crowhurst* END

Unsquare Waves

As I prepared to feed the square-wave signal to the vertical plates directly, I reached for the INT-EXT switch at the back of the scope. It had been in the EXT position for months!

Why hadn't I noticed? Because of R13 and R14, the deflection circuit was electrically continuous even though the switch was set to EXT. Because scope plates draw virtually no current, there was little voltage drop across R13 and R14. But the resistors, together with stray shunt wiring capacitance and the capacitance of the deflection plates themselves, formed a very effective low-pass filter that rounded off the square waves by progressively attenuating higher harmonics. On sine waves and most other waveforms, the discrimination wasn't noticeable.

I slid the switch back to INT, and found I had beautiful square waves—even from the original clipper circuit!

"Q"

The resistor has no effect on the steady-state values, so it can be disregarded. By using the reciprocal of the sum of the reciprocals (the capacitors-in-series formula), and the sum of the voltages, the effective capacitance of the three is found to be 1 μ f at 300 volts, and a charge Q of 300. ($Q = CE$)

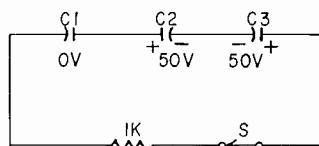

This is the total charge obtainable from the circuit after switch is thrown. The charge remaining on each capacitor in the steady state equals its original charge minus 300.

	Original Q	-300	Final Q	Volts $E = \left(\frac{Q}{C}\right)$
C1	300	-300	0	0
C2	150	-300	-150	-50
C3	600	-300	300	50

The polarity of C2 is reversed in the final or steady state.

Alternate Designs

We have received two similar alternate circuits for the April "Design Problem" puzzler in which the diagram sub-

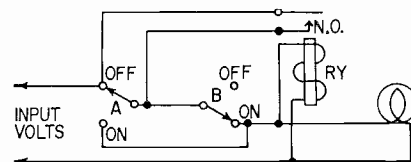

mitted by Frank Hanzsek is typical. In this circuit, only an spst relay is required, but there is no danger of the relay dropping out while switches are thrown.

Two Ways to Distort

There is another possible cause of distortion in Jack Darr's "A Distorted Puzzler," page 37 of the March issue. My solution was that the 6 volts on the control grid was caused by grid emission.

I check for grid emission by pulling the tube. If the voltage disappears I suspect the tube. If it remains, I suspect the coupling capacitor.

Miniature and subminiature power tubes are more susceptible to grid emission caused by excessive heat than are voltage amplifiers—a point Mr. Darr may have had in mind.—*James B. Edgerton*

That Two-Meter Puzzler

The solution to this April puzzler evoked some comment about the correctness of the dc ammeter reading. Reader Richard Mirdas came up with a solution using "ideal" components (zero meter resistance—diode with zero forward, infinite back resistance). When diode conducts, the current divides equally between diode and meter, allowing a meter peak-reverse current of $I_{max}/2$. With $I_{rms} = 1.15$ amp, and using the formula:

$$I_{ave} = I_{rms}/4 \times 0.637/0.707 = \text{dc amps, the dc ammeter reads } 0.2587 \text{ amp.}$$

Reader Jesse T. Hancock Jr. suggests (again using ideal components), that the original given solution could be gotten by inserting an additional diode in series with the meter, connected so that meter current is cut off while "black-box diode" conducts.

We ran bench tests with practical components (two different dc ammeters, two different-type diodes). Due to the diode's requiring a few-tenths-volt forward bias before it conducts, reverse current flows in the meter during part or all of the negative half-cycle. There would be no definite dc value indicated; it depends on the meter sensitivity and the diode characteristics. A sensitive meter would read zero, and an insensitive one (high voltage-drop for full-scale deflection) would approach the given reading of 0.515 amp.—*Editor* END

test equipment reports

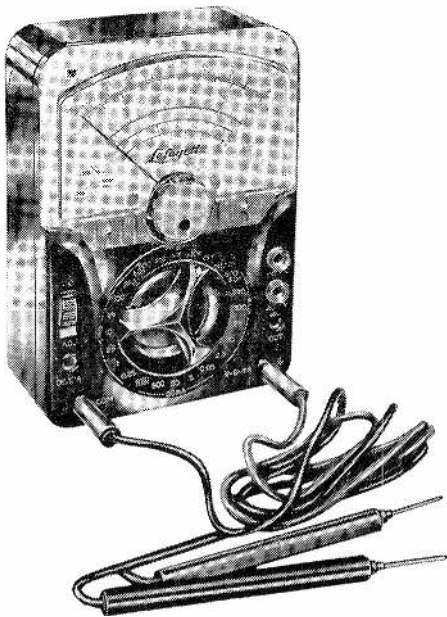

Lafayette TE-60
30,000 ohms/volt multimeter

HIGH SENSITIVITY (30,000 OHMS PER VOLT) is not common in an economy-priced meter. This compact ($3\frac{5}{16} \times 6\frac{1}{16} \times 2\frac{3}{4}$ inches) meter was designed for field servicing.

Lower-than-usual dc voltage ranges (0.25, 1, 2.5 and 10 volts) are made to order for transistor circuit testing. At 30,000 ohms per volt, the resistance of the meter circuit is 7,500 ohms on the 0.25-volt range—this will not seriously load a circuit resistance that is less than 750 ohms. (Voltage readings taken across a resistance of 750 ohms will be only 10% lower than normal.)

Many times an ohmmeter is used just to test circuit continuity. A small buzzer has been mounted in the case of the TE-60 to make continuity and short tests easier. You don't have to look at the meter—you can hear when the circuit has been completed. Wiremen and industrial technicians have used this method for years to speed up cable testing. This buzzer uses the same jacks that are used for most other measurements. You don't have to shift test leads around. Just switch to BUZZ.

The OFF position on the range switch is called "transit" by some manufacturers. It shorts the meter movement to damp pointer swing while the instrument is being moved.

The shorted coil becomes an electromagnet. Any movement of the coil generates (induces) a current in it. This current forms a magnetic field which opposes its movement in the magnetic

field of the permanent magnet of the meter assembly.

Just because this meter is sensitive doesn't mean it is limited to low-voltage testing or to transistor circuits. The dc and ac voltage ranges include 100-, 250-, 500- and 1,000-volt positions that are suitable for most vacuum-tube circuits. Special jacks are used for the 1,000-volt ranges—the selector switch is set to the 500-volt position.

Specifications

(All specifications are the manufacturer's)

Basic movement: 33 μ a, 4-inch, 2-color scale
Overall sensitivity: 30,000 ohms/volt dc; 15,000 ohms/volt ac
Dc ranges: 0-0.25, -1, -2.5, -10, -25, -100, -250, -500, -1,000 volts; 0-0.05, -5, -50, -500 ma, 0-12 amps.
Ac ranges: Vrms only, same as dc, from 2.5 volts up
Ohms: 0-60,000, -6 meg, -60 meg
Db: -20 to 56
 1% resistors in all multipliers
 $3\frac{1}{16} \times 6\frac{1}{16} \times 2\frac{3}{4}$ inches, 1 lb. 6 oz.

Another special jack is used for 12 amperes dc. The shunt for this range (.01 ohm) looks like a wire handle. It goes from the COMMON jack to the DC 12 A jack. The heavy current does not flow through the selector-switch contacts—they would be burned by a 12-ampere current. Also, the contact resistance of the range-selector switch could be as much as (or more than) the resistance of the shunt.

Center-scale readings of 400, 40,000 and 400,000 ohms make most common resistor values easy to read. A 15-volt battery is used for the high-resistance ($R \times 10K$) range. This is high enough to burn out some transistors and components—like electrolytic capacitors rated at less than 15 volts.

There are 24 basic ranges plus six output ranges (-20 to +56 db) and the buzzer. The scales are well spread out. Testing most hi-fi and TV circuits should give little trouble—as far as reading the meter scales is concerned.

The TE-60 is well built and rugged enough to be carried in the tube caddy—and so inexpensive (\$17.95) you can hardly afford to be without one for servicing trips.—Elmer C. Carlson

25-Inch Color Tube Coming

A total of 1,700,000 color tubes will be produced in 1964, of which 1,300,000 will be RCA tubes, says Douglas Smith, vice president, RCA Electronic Components & Devices. Nearly all will be 21-inch round, though some will be rectangular 25-inch 90° tubes. In spite of the large production, Mr. Smith believes demand for color tubes will exceed the supply throughout 1964.

FREE... New "Ready Reference Guide" to Customized Home Study

YOUR NEW **READY REFERENCE** GUIDE TO

PROGRAMS OF HOME STUDY INSTRUCTION

ELECTRONICS • MATH • AUTOMATION
BASIC • INTERMEDIATE • ADVANCED

Central Technical Institute
1644 WYANDOTTE ST.
KANSAS CITY, MISSOURI 64108

VOCATIONAL—ENGINEERING TECHNOLOGY

COURSES IN THE VOCATIONAL EDUCATION DIVISION
Basic Principles • TV Servicing • Appliances
Wiring • Math • Algebra • Data Processing
Computer Programming • Business Automation

COURSES IN THE ENGINEERING TECHNOLOGY DIVISION
Fundamentals • Service Technology • Communications
Nuclear Technology • Commercial Broadcast
Microwave Technology • Industrial Automation

HOME LABORATORY CODES AND EQUIPMENT LISTS

in
**ELECTRONICS
MATH
AUTOMATION**

- BASIC
- INTERMEDIATE
- ADVANCED

Central now offers a wide choice of Home Training Programs to prepare you for a well paying career or advancement in your present job assignment.

Now you can train at home in spare hours with EXACTLY the specialized instruction you need to reach your goal in Electronics, Communications, Broadcast, Service, Automation or Industrial Electronics! New "Ready Reference Guide" tells at a glance the kind of training you need... it can save you much wasted motion and money! Central's courses are practical... job oriented... offering efficient, personalized service. Get this new free Guide. Let it help you select your "customized" training program! Rush coupon today!

COURSES IN THE VOCATIONAL EDUCATION DIVISION

Basic Principles • TV Servicing • Appliances
Wiring • Math • Algebra • Data Processing
Computer Programming • Business Automation

COURSES IN THE ENGINEERING TECHNOLOGY DIVISION

Fundamentals • Service Technology • Communications
Nuclear Technology • Commercial Broadcast
Microwave Technology • Industrial Automation

HOME LABORATORY COURSE AND EQUIPMENT KITS

78 Experiments in Electronics available separately... or together with any of Central's Home Study Courses.

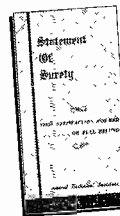

NEW! Statement of Surety!

Your satisfaction is assured when you enroll with Central... in writing! Your entire tuition is refunded if you are not 100% satisfied upon satisfactory completion of your course and compliance with the enrollment agreement. Only Central, established in 1931, offers you this Surety! Diplomas Awarded. Accredited by Nat'l Home Study Council.

Get Complete Information—No Obligation
Learn how Central has revolutionized the home study training in Electronics and allied fields for both the beginner and advanced student. Rush coupon today for your Ready Reference Guide.



Central Technical Institute
1644 Wyandotte St., Dept. 03074
Kansas City, Missouri 64108

FREE GUIDE-MAIL COUPON

Central Technical Institute, Dept. 03074
1644 Wyandotte St., Kansas City, Mo. 64108
Send "Ready Reference Guide". No obligation.

NAME _____
ADDRESS _____
CITY _____ STATE _____ ZIP _____

NEW PRICES from QUIETROLE



the oldest, most widely proved and sold radio and TV lubricant

2 oz. bottle with dropper	LIST \$1.49
4 oz. bottle	LIST 2.54
4 oz. bottle (brush-n-cap)	LIST 2.64
8 oz. bottle	LIST 5.07
6 oz. spray can — with extender	LIST 2.79
3 oz. spray can — with extender	LIST 1.79



Quietrole is your guarantee of the most effective, quick silencer of noisy radio and TV controls — the quality product that is a top value.

Get Quietrole at quality jobbers.

Some territories still available for experienced representation.



A SIMPLE SOLUTION

That Solves All Your TV Tuner Problems

One Price **8.95** All Makes

P & H replaces all defective parts, (tubes and major parts extra) and aligns tuner to exact original specifications.

Send us your defective tuner complete; include tubes, shield cover and any damaged parts with model number and complaint.

Try our service and prove to yourself you simply can't afford to handle your tuner problems any other way.

Your tuner will be overhauled and returned promptly, performance restored, aligned to original standards and warranted for 90 days.



TV TUNER SERVICE

118 Third Street West
TWIN FALLS, IDAHO

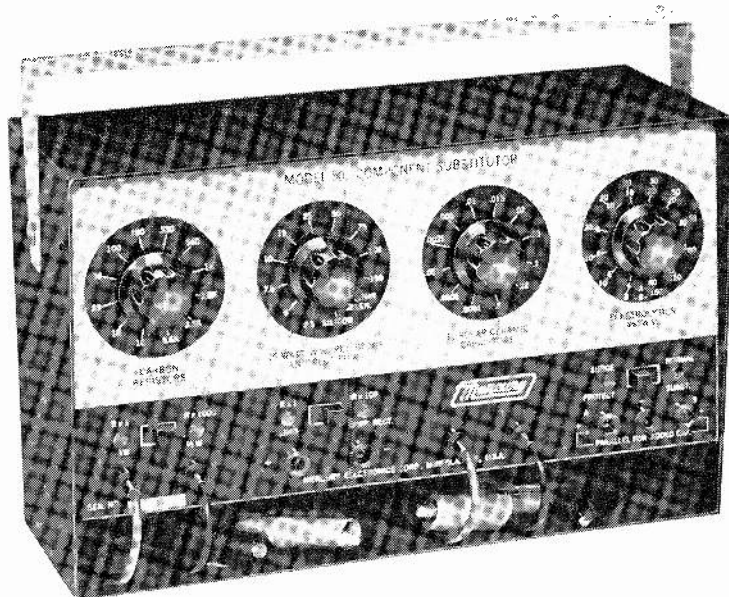

Mercury 501 Component Substitutor

THIS FOUR-IN-ONE INSTRUMENT CAN SUBSTITUTE for five components—at once—or be interconnected with itself to make a complete circuit!

Servicing by substitution has always been popular. Often it has been a dangerous method because of the usual haywire connections used to stick a known-good component temporarily into a circuit.

The resulting rat's nests of wires and components often shorted, burned out parts, and even technicians!

Neatly packaged substitution components will simplify and speed testing and make it much safer. Substitution no longer has to be a solder-in and unsolder, pick a different value, solder-in and unsolder time-consuming chore.

The Mercury 501 gives a choice of up to four different-type components ($\frac{1}{2}$ - or 1-watt resistors, 20-watt power resistors or diodes, coupling or bypass capacitors, dual electrolytics).

It is actually four substitution boxes in one. It contains twelve 1-watt resistors (ranging from 10 ohms to 5,600) and twelve $\frac{1}{2}$ -watt resistors (from 10,000 ohms to 5.6 megohms) on one selector switch. Either $\frac{1}{2}$ - or 1-watt resistors may be selected—but not at the same time.

A second selector has 20-watt resistors and 3 diode positions. Resistance values range from 2.5 to 15,000 ohms.

One diode position will substitute for the 1N34, 1N48, 1N60, 1N64, etc. and similar detector diodes.

The silicon and selenium power rectifier substitute is a 750-ma, top-hat silicon rectifier, used alone in one position and with a series resistor in another to simulate the characteristics of the selenium rectifier.

It is possible to interconnect the four selectors to make a substitute trans-

formerless half-wave power supply. The circuit is shown in the diagram. The tubular capacitors can be connected across the ac input to bypass line-voltage transients.

The tubular and ceramic capacitors include all the popular values from 100 pf to 0.5 μ f at 600 volts. A single ceramic plate contains the six lowest-capacitance units.

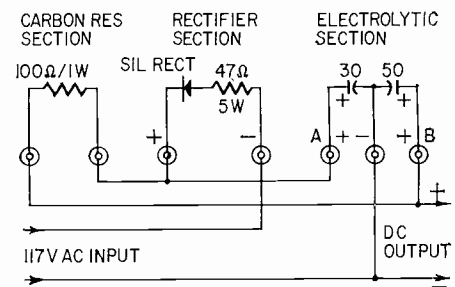

With the Mercury 501, you can even whip up a little ac-dc power supply in about 10 seconds. Puts out up to 150 volts at up to 100 ma.

Two four-section 450-volt electrolytic capacitors provide all the capacitance values from 4 to 150 μ f. The rotary switch selects most popular dual capacitors. For example, 30-50 μ f is used as the filter in many half-wave power supplies. Other combinations from 4-8 to 80-150 are available. Of course, the 80-150 sections can be connected in parallel to make 230 μ f.

Surge protection is also a part of the electrolytic substitution section. A resistor is connected in series with each capacitor initially to allow it to charge slowly to the working voltage—the resistor is then switched out. Permanently connected 330,000-ohm bleeders discharge the capacitors. Net price of the unit is \$37.50.—Elmer C. Carlson

New Semiconductors and Tubes

6HB7

Here is another vhf TV oscillator-mixer triode-pentode. The pentode section of this RCA tube has a relatively high transconductance (6,400 μ mhos) and a low plate-to-grid capacitance: .01 pf maximum, for low feedback between

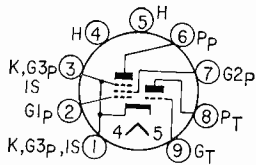
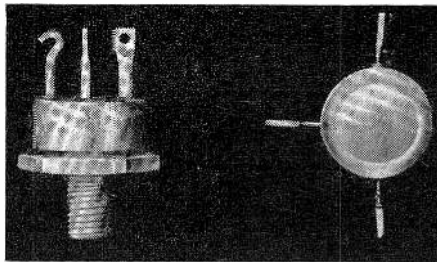

plate and grid. Two base pin connections to the pentode cathode minimize cathode lead inductance. Triode and pentode are separated by an interunit shield brought to pin 1 on the base.

The 6HB7 is a 9-pin miniature type with RCA "Dark Heater" and controlled warmup time for series heater strings.

High-power epitaxials

Four new high-power silicon epitaxial transistors with an f_T of 20 mc



and a continuous collector-current rating of 25 amperes maximum, have been announced by RCA. They are expected to be used in high-reliability aerospace and industrial applications where fast switching of high currents is necessary.

Typical proposed applications include switching control amplifiers, switching regulators, dc-ac inverters, and rf power oscillators and amplifiers.

Two of the devices, the 2N3263 and 2N3265, are electrically identical but are packaged differently. The 2N3263 is in a 3/4-inch diameter flat case with radial leads for physically "tight" locations (right in photo). The 2N3265 is in a 7/8-inch hexagonal double-ended stud package for maximum dissipation (left in photo). Collector-to-base voltage, 150; collector-emitter, 90.

The other two transistors, 2N3264 and 2N3266, are identical electrically, with lower maximum voltage ratings than the first pair. The 2N3264 is in the radial-lead package; the 2N3266 in the stud-mount housing. Collector-to-base voltage is 120; collector-to-emitter, 60.

DX247 klystron

This reflex klystron is claimed by Amperex, the manufacturer, to be the highest-frequency unit of its kind so far commercially available. It operates in the 2-mm wavelength region—mechanically tunable from 140 to 150 gc, and

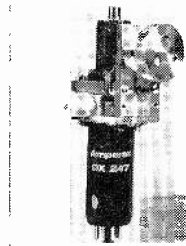

"features an exceptionally high power output of 20 mw over the band."

The DX247 is expected to aid research in areas like dielectric measurements, microwave spectrography, paramagnetic resonance and space communication.

Resonator voltage is 2,500. END

Correction

In the article "Don't Miss the Boats" in the May issue, the marine safety and calling frequency is erroneously listed as 158.6 mc (page 40, third column, 8th line). The correct frequency is 156.8 mc. Our thanks to Awrey's Radio Service of Hamilton and St. Catherine, Ont., for calling this error to our attention.

ALL NEW SENCORE component substitutor



MODEL RC121

All your favorite Sencore Substitution Time-Savers in One Compact Unit

A complete range of carbon resistors, wire wound power resistors, capacitors, electrolytics, and universal selenium and silicon rectifiers.

Imagine, all of these hard to locate parts at your finger tips for on the spot substitution. Say goodbye to messy, crumpled parts, unnecessary unsoldering and soldering of components for testing purposes only. Save valuable servicing time and be sure, by substituting.

NEW . . . each section operates independently with a value close enough for every substitution need. Components in each section are isolated from chassis and from the other sections. For example, a complete power supply can be constructed using the RC121 Components only.

NEW . . . dual electrolytics provided. A new circuit enables you to substitute up to 25 single electrolytic values or 9 duals. Exclusive surge protector provides protection on both singles and duals for both you and the circuit.

You save space and money. Equivalent Sencore substitution-pieces purchased individually (H36, PR111, RS106, ES102) cost you \$54.00

RC121 (all hand wired, all American made) only **39.95**
RC121K (Kit) 27.95

Now in stock at your Sencore Distributor. See him today!

SENCORE
ADDISON 2, ILLINOIS

booklets
New Literature
catalogs charts

CATALOG, Spring-Summer No. 643, 136 pp. Latest in electronic components. hi-fi stereo, tape recorders, CB equipment, transistor radios, ham gear, tools, test equipment, optical goods, auto accessories, intercoms, cameras, mikes, PA systems, musical instruments, tools.—**Lafayette Radio Electronics**, 111 Jericho Turnpike, Syosset, N. Y.

CATALOG, Spring-Summer Supplement No. 235, 144 pp., featuring among other items many transistorized products: walkie-talkies, AM portables, AM and short-wave portables, AM car radios, AM-FM portables, FM-AM-short-wave portables, 4½-in. TV set to operate from rechargeable batteries or 12-volt car battery or 110-volt 60-cycle ac outlet, hi-fi tuners and amplifiers (kits and factory-assembled), portable tape recorders, electronic tachometer, transistor ignition system, code-practice oscillator, intercoms, electronic lab kits, multi-function Ten-2 CB-band tester, all-in-one hi-fi receiver.—**Allied Radio**, 100 N. Western Ave., Chicago 80, Ill.

WIRE-CABLE GLOSSARY of common abbreviations for wire, cable and portable cord industry in pocket-sized 12-page booklet.—**Royal Electric Corp.**, Pawtucket, R.I.

BEAT-FREQUENCY OSCILLATORS described in 16-page technical brochure on models 1013, 1017 and 1022, with applications, curves and dimensional drawings. Photos and specs.—**B&K 153, B&K Instruments Inc.**, 3044 W. 106 St., Cleveland 11, Ohio

PRESSURE-FIT RECTIFIERS MANUAL, 90 pages, covers applications of 2 families of silicon

diodes: 18-amp family in 5 voltage ratings from 50 to 400; 25-amp family in 7 voltages from 50 to 600. Basic rectifying theory and standard circuits shown and explained, 27 special circuit applications, mounting methods.—**Tung-Sol Electric Inc.**, Technical Publications Dept., 1 Summer Ave., Newark 4, N.J. 75¢.

CB ANTENNAS CATALOG describes in 16 pages complete line of base-station and mobile antennas and accessories for Citizens-band market. Photos, specs, charts, drawings.—**Hy-Gain Antenna Products Corp.**, N.E. Highway 6, Lincoln, Neb.

DEALER'S CATALOG, *Radio & TV Catalog No. RT-64*, 84-page catalog lists radio, audio, TV, electrical supplies with illustrations of available display cards.—**Fedtro Inc., Federal Electronics Sales Div.**, Federal Electronics Bldg., Rockville Centre, N.Y.

TIN-LEAD RATIO CHART shows melting temperatures of different solder alloys. One loose-leaf page.—**Alpha Metals Inc.**, 56 Water St., Jersey City 4, N.J.

INVERTERS & CONVERTERS catalog 300, details more than 60 static dc-to-ac inverters and static frequency-converters rated at 6 to 15,000 va, variable-frequency and ultra-stable power sources. 4 pages, photos and specs.—**Communications Measurements Lab, Inc.; Tenney Engineering Inc.**, 350 Leland Ave., Plainfield, N.J.

TOOLS CATALOG. Universal arms, vises, circuit-board holders, board holders, chassis holders, chassis and harness board fixtures, clamps and table and arm assembly are described with dimensions and photos in 8-page catalog.—**Matrix Engineering Corp.**, 6160 Lemoona Ave., Van Nuys, Calif.

SEMICONDUCTORS CHART, Section 1/*Index and Replacement Guide*. 6-page folder in 2 colors charts and outlines in drawings company's line of transistors, diodes, rectifiers.—**Bendix Semiconductor Div.**, Holmdel, N.J.

TUBE WALL CHART of "Five Star" tube line gives base diagrams, classifications by function, average characteristics.—**General Electric, Distributor Sales, Electronic Components Div.**, Owensboro, Ky.

STATIONARY BATTERIES instruction book, revised edition of *Installation and Operation Instructions for Stationary Batteries*. 24-page booklet

with tear-out summary sheet for posting in battery room. Sections on receiving, unpacking and handling, installation and initial charging, hydrometer readings, and a table of battery types.—**C & D Batteries**, Conshohocken, Pa.

TRANSCEIVERS CATALOG. 16 page, 2-color brochure with photos of CB equipment and accessories.—**International Crystal Mfg. Co., Inc.**, 18 No. Lee, Oklahoma City, Okla.

STEREO TAPE TRANSPORT, model T-347, described in 4-page brochure. Photos, diagrams and specs.—**Bell Sound Div., Thompson Ramo Wooldridge Inc.**, 6325 Huntley Rd., Columbus 24, Ohio

HI-FI/STEREO EQUIPMENT. 6-page folder lists stereo amplifiers, tuners and tape transports. Photos, illustrations and spec.—**Bell Sound Div., Thompson Ramo Wooldridge Inc.**, 6325 Huntley Rd., Columbus 24, Ohio

Any or all of these catalogs, bulletins, or periodicals are available to you on request direct to the manufacturers, whose addresses are listed at the end of each item. Use your letterhead—do not use postcards. To facilitate identification, mention the issue and page of RADIO-ELECTRONICS on which the item appears.

UNLESS OTHERWISE STATED, ALL ITEMS ARE GRATIS. ALL LITERATURE OFFERS ARE VOID AFTER SIX MONTHS.

Re: Transistors Save Your Breaker Points

A number of readers have requested information on adapting the transistor ignition system ("Transistors Save Your Breaker Points", Gyorki, April 1964) for positive-ground operation and for installation in cars with 6-volt batteries.

Mr. Gyorki says that the system as shown in the April issue will not work on 6-volt electrical systems. He is testing a modification for 6-volt negative-ground operation and will give us full details if it is successful.

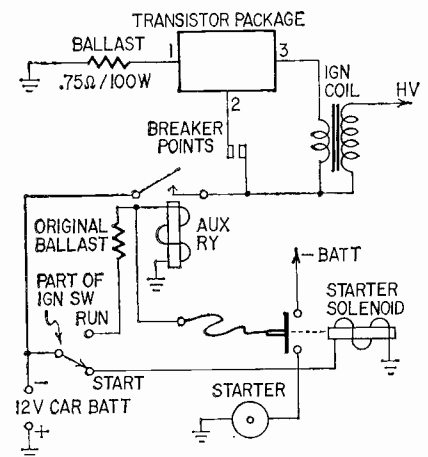

The diagram shows how the original system can be installed in a car with a 12-volt positive-ground electrical system. Note well that the points must be insulated from ground. We understand it is relatively easy to insulate the breaker points in most distributors. We have unconfirmed reports that insulating kits are available at some speed shops and auto accessory stores.

The heat sink is a Delco part No. 7281352, available from Delco distributors for \$1.00.—*Editor*

COMPUTER TECHNICIANS

Stateside & Overseas Openings

Must have a minimum of 2 years' experience in the maintenance of military or commercial computers or data processing systems.

Excellent benefits including stock savings plan.

Qualified candidates please send complete resume to Mr. Don Kirkland, Dept. 806.

PHILCO TECHREP DIV.

A Subsidiary of Ford Motor Company

P. O. Box 4730

Philadelphia, Pa. 19134

An Equal Opportunity Employer

TECHNOTES

Motorola 17T1

This one gave us three callbacks—speaker field burned out each time. Comparing its schematic with one of a similar but later model showed that an extra 150-ohm 15-watt

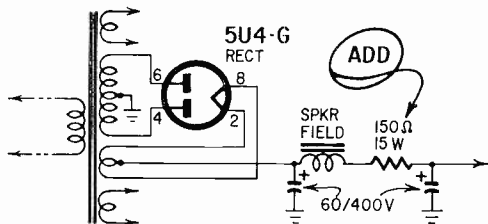

resistor had been added in series with the B-plus of the newer set. We added it to the 17T1, and had no more burned-out field coils.—*Carl Hennig*

Admiral 15C1 Chassis — Horizontal Trouble

If this set drifts off horizontal sync and requires readjusting the horizontal hold control again after playing awhile, try using two 500-pf N750-coefficient ceramics in parallel

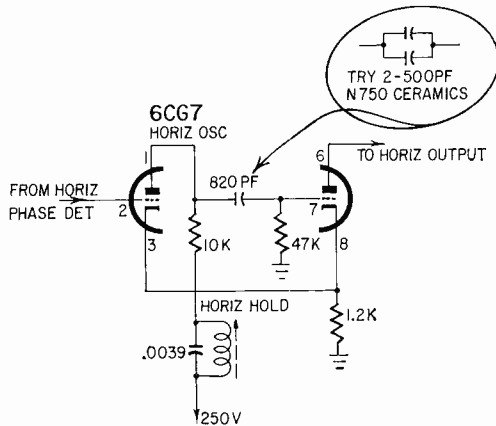

to replace the 820-pf coupling capacitor shown in the diagram.

Simple replacement of all critical parts had no effect on this chassis.—*Charles Andrews*

Line Voltage Loosens Tight Yokes

When you come across a frozen-on CRT yoke, disconnect the horizontal coil leads. Now connect them, in series with a 150-watt light bulb, to the set's ac line cord. Plug the line cord into an ac outlet and leave things for a few minutes. When the yoke gets warm, it will slide off the neck easily. Don't overdo it, though.—*A von Zook*

Steelman Transitate and Airline 7111-M Recorders

Trouble: tape speed steady but wrong.

The tape speed is controlled by the position of the small rubber drive wheel on the face of the large brass flywheel. The closer this wheel is to the rim of the flywheel, the slower the tape speed. The position of the wheel is controlled by the speed-selector switch which affects a V-shaped bracket. The two tabs on this bracket are bent to stop it in its two possible positions. When bending the bracket make certain that the idler does not hang up in the V, but can move freely

Everything you ever wanted in a CB transceiver!

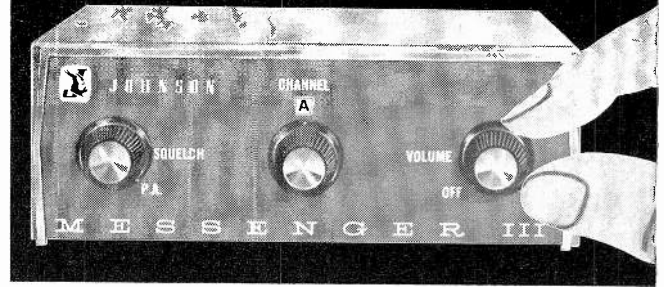

Newest! Most Versatile! Most Power Out!

The II channel "Messenger III" will change every idea you ever had about what a Citizens Band unit should offer! Tiny, all transistor, it's really quiet, really hot! Interchangeable for base or mobile—use it as a full 5-watt battery powered portable pack set or a 3-watt PA system. The "Messenger III", with an aerospace transistor developed for the "Relay" communications satellite, delivers more power output with maximum legal input! Double conversion receiver with high 1st I.F. provides excellent spurious and image rejection. Set-and-forget "Volume" and "Squelch" controls make it possible for the first time to work "close-in" or at extended range with initial settings. Furnished with dynamic microphone—full line of accessories available for selective calling, portable field pack, or public address use!

Cat. No. 242-150 \$189.95 Net

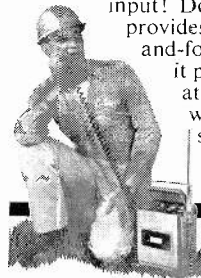

E. F. JOHNSON COMPANY

© 2510 Tenth Ave. S.W. • Waseca, Minnesota

Please send full details on the "Messenger" CB line.

WRITE TODAY for details on the "Messenger" CB line—or see your distributor!

NAME _____
 ADDRESS _____
 CITY _____ STATE _____



service faster with Fast-Fax

Raytheon Fast-Fax puts tube data for 600 types right at your fingertips. Stays up-to-date with "pop-in" supplements (including new types in '65 sets). Operates as an interchangeability guide and inventory control. See it at your Raytheon Distributor. You'll wonder how you ever got along without it. Fast-Fax. Only \$3.95.

RAYTHEON

BECOME A RADIO TECHNICIAN for only \$26.95

BUILD 20 RADIO

CIRCUITS AT HOME
with the New Progressive
RADIO "EDU-KIT"®
All Guaranteed to Work!

PRACTICAL only
HOME RADIO COURSE **\$26.95**

- NOW INCLUDES**
- ★ 12 RECEIVERS
 - ★ 3 TRANSMITTERS
 - ★ SQ. WAVE GENERATOR
 - ★ AMPLIFIER
 - ★ SIGNAL TRACER
 - ★ SIGNAL INJECTOR
 - ★ CODE OSCILLATOR



Reg. U.S. Pat. Off.

TRAINING ELECTRONICS TECHNICIANS SINCE 1946

- ★ No Knowledge of Radio Necessary
- ★ No Additional Parts or Tools Needed
- ★ Excellent Background for TV
- ★ School Inquiries Invited
- ★ Attractively Gift Packed

- FREE EXTRAS**
- SET OF TOOLS ● RADIO & ELECTRONICS TESTER ● ELECTRIC SOLDERING IRON ● TESTER INSTRUCTION MANUAL ● MEMBERSHIP IN RADIO-TV CLUB: CONSULTATION SERVICE ● HI-FI GUIDE ● QUIZZES ● TV BOOK ● FCC AMATEUR LICENSE TRAINING ● RADIO BOOK ● PRINTED CIRCUITRY ● PLIERS-CUTTERS ● ALIGNMENT TOOL ● WRENCH SET ● CERTIFICATE OF MERIT ● VALUABLE DISCOUNT CARD

WHAT THE "EDU-KIT" OFFERS YOU

The "Edu-Kit" offers you an outstanding PRACTICAL HOME RADIO COURSE at a rock-bottom price. Our kit is designed to train Radio & Electronics Technicians, making use of the most modern methods of home training. You will learn radio theory, construction, servicing, basic Hi-Fi and TV repairs, code, FCC amateur license requirements.

You will learn how to identify radio symbols, how to read and interpret schematics, how to mount and lay out radio parts, how to wire and solder, how to operate electronic equipment, how to build radios. Today it is no longer necessary to spend hundreds of dollars for a radio course. You will receive a basic education in radio, worth many times the small price you pay, only \$26.95 complete.

THE KIT FOR EVERYONE

The Progressive Radio "Edu-Kit" was specifically prepared for any person who has a desire to learn Radio. The "Edu-Kit" has been used successfully by young and old in all parts of the world, by many Radio Schools and Clubs in this country and abroad. It is used for training and rehabilitation of Armed Forces Personnel and Veterans throughout the world.

The Progressive Radio "Edu-Kit" requires no instructor. All instructions are included. Every step is carefully explained. You cannot make a mistake.

PROGRESSIVE TEACHING METHOD

The Progressive Radio "Edu-Kit" is the foremost educational radio kit in the world, and is universally accepted as the standard in the field of electronics training. The "Edu-Kit" uses the modern educational principle of "Learn by Doing." Therefore, you will construct radio circuits, perform jobs and conduct experiments to illustrate the principles which you learn.

You begin by examining the various radio parts included in the "Edu-Kit." You then learn the function, theory and wiring of these parts. Then you build a simple radio. With this first set, you will enjoy listening to regular broadcast stations, learn theory, practice testing and troubleshooting. When you build a more advanced radio, learn more advanced theory and techniques. Gradually, in a progressive manner, and at your own rate, you will find yourself constructing more advanced multi-tube radio circuits, doing work like a professional Radio Technician.

Included in the "Edu-Kit" course are 20 Receiver, Transmitter, Code Oscillator, Signal Tracer, Signal Injector, Square Wave Generator and Amplifier circuits. These are not unprofessional "bread board" experiments, but genuine radio circuits, constructed by means of professional wiring and soldering on metal chassis, plus the new method of construction known as "Printed Circuitry." These circuits operate on your regular AC or DC house current.

In order to provide a thorough, well-integrated and easily-learned radio course, the "Edu-Kit" includes practical work as well as theory; troubleshooting in addition to construction; training for all, whether your purpose in learning radio be for hobby, business or job; progressively-arranged material, ranging from simple circuits to wiring in Hi-Fi and TV. Your studies will be further aided by Quiz materials and our well-known FREE Consultation Service.

THE "EDU-KIT" IS COMPLETE

You will receive all parts and instructions necessary to build 20 different radio and electronics circuits, each guaranteed to operate. Our Kits contain tubes, tube sockets, variable, electrolytic, mica, ceramic and paper dielectric condensers, resistors, tie strips, coils, hardware, tubing, punched metal chassis, Instruction Manuals, hookup wires, selenium rectifiers, volume control potentiometers, etc.

In addition, you receive Printed Circuit materials, including Printed Circuit chassis, special tube sockets, hardware and instructions. You also receive a useful set of tools, a professional electric soldering iron, and a self-powered Dynamic Radio & Electronics Tester. The "Edu-Kit" also includes Code Instructions and the Progressive Code Oscillator, in addition to the F.C.C.-type Questions and Answers for Radio Amateur License training. You will also receive lessons for servicing with the Progressive Signal Tracer and the Progressive Signal Injector, and a High Fidelity Guide and Quiz Book. Everything is yours to keep.

J. Statais, of 25 Poplar Pl., Waterbury, Conn., writes: "I have repaired several sets for my friends, and made money. The "Edu-Kit" paid for itself. I was ready to spend \$240 for a Course, but I found your ad and sent for your Kit."

UNCONDITIONAL MONEY-BACK GUARANTEE

The Progressive Radio "Edu-Kit" has been sold to many thousands of individuals, schools and organizations, public and private, throughout the world. It is recognized internationally as the ideal radio course.

By popular demand Progressive Radio "Edu-Kit" is now available in Spanish as well as English.

It is understood and agreed that should the Progressive Radio "Edu-Kit" be returned to Progressive "Edu-Kits" Inc. for any reason whatever, the purchase price will be refunded in full, without quibble or question, and without delay.

The high recognition which Progressive "Edu-Kits" Inc. has earned through its many years of service to the public is due to its unconditional insistence upon the maintenance of perfect engineering, the highest instructional standards, and 100% adherence to its Unconditional Money-Back Guarantee. As a result, we do not have a single dissatisfied customer throughout the entire world.

ORDER FROM AD - RECEIVE FREE BONUS
RADIO & TV PARTS JACKPOT WORTH \$15

- Send "Edu-Kit" Postpaid. I enclose full payment of \$26.95.
- Send "Edu-Kit" C.O.D. I will pay \$26.95 plus postage.
- Send me FREE additional information describing "Edu-Kit."

Name
Address

Progressive "EDU-KITS" Inc. 1186 Broadway, Dept. 2236
Hewlett, N. Y.
(ATT: S. GOODMAN, M.S. in ED., PRES.)

from side to side.

If a correctly recorded tape is played through the machine, the tabs on the speed control bracket can be adjusted while the tape is playing, and a fairly accurate adjustment made using the ear as a guide.—Max Alth

Heath CT-1 "Capaci-tester"

If this instrument gets knocked around hard and often, the "eye" tube socket pins may touch the inside back of the

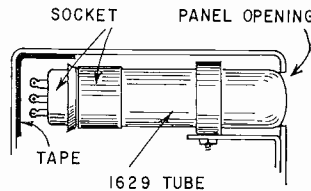

metal cabinet and short out. This can damage the device. Avoid the problem by sticking a 2-inch wide piece of adhesive tape on the inside of the case at the spot where the socket pins may touch. Plastic electrical tape (several strips laid side by side) will also do fine.—Allen Glaser

G-E 16T1, 16C103: No Raster

Symptom: No raster, sound OK.

Cause: Almost no accelerating anode voltage because of excessive blanking amplifier conduction (see diagram).

Cure: Replace shorted .01- μ f 1,000-volt coupling capac-

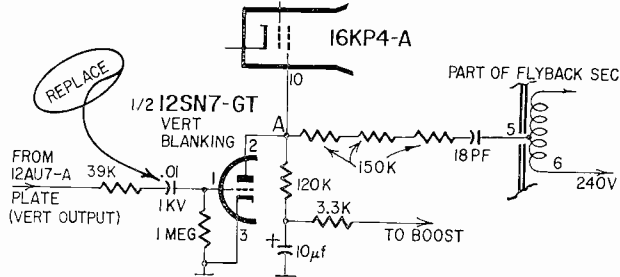

itor from vertical output plate. Note that there was no short from A to ground, yet still point A was near zero volts. Boost and B-plus checked OK.—Warren Dere

Erratic Drift on AM

This set, a Truetone clock-radio model 2086A, would shift frequency suddenly, and sometimes drift more gradually. I traced the trouble to the wire connecting the oscillator section of the tuning capacitor to the oscillator coil. It was about 4 inches long and ran near a vertical shield, but without any support. When the wire shifted (with stress on the cabinet, or thermal expansion), the oscillator frequency would change because of the change in stray capacitance.

I replaced the wire with low-capacitance shielded cable. I grounded the shield at the tuning capacitor frame and to the ground terminal of the coil. A touchup of the oscillator trimmer completed the job.

Another possible cure is to fasten the wire along the shield and chassis so it can't possibly move.—Victor H. Boisseau

Substitute for 6M3

The 6M3 damper tube designed especially for Philco color sets and sold only by Philco have been failing prematurely in their TV123 chassis. There was nothing wrong with the circuit. Since this tube has no manufactured substitute, lists at \$13.50 and can be obtained only from Philco, I set about devising a substitute—which has been giving better performance for more than a year.

I wired a pair of 6AU4-GT tubes in parallel to a plug-in

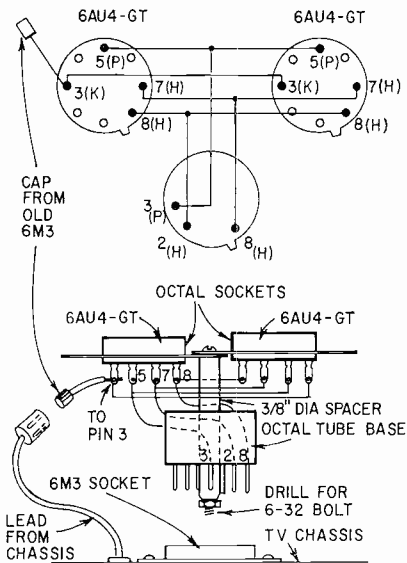

adapter. The drawings show how it was done. No changes are made in the circuit; the wire fuse in the heater circuit takes the extra 0.6-amp drain without strain.

The top cap of the old 6M3 is removed and soldered to a 6-inch lead which goes to pin 3 of the 6AU4's. The cap then plugs in to the existing cathode connector coming from the set.

This modification will end, once and for all, explanations about the short life of the tube, the wisdom of installing another one just like it, the \$13.50, and other embarrassing questions.—*John T. Hacker*

Complex Intermittent

We had a 24-inch RCA that would cut out and develop an intermittent vertical roll. The picture would get snowy and the sound volume would drop whenever the set was tapped. Didn't seem to matter *where* it was tapped.

Suspecting tuner trouble, I began checking around and came to a resistor I wanted to check. I unsoldered one end as usual, and the resistor just fell right out. Its other terminal, which passed through the hole in another solder lug, had never been soldered. But it had held out for 6 years, in the 6X8 oscillator-mixer circuit.

The unsoldered terminal was hidden away where it couldn't be seen until unsoldering the other end made the resistor drop out.—*Harry J. Miller*

Improve Small-Set Selectivity

Many low-cost short-wave receivers suffer from bad selectivity. This can usually be improved by inserting a low-value (50-500 pf) 200-volt capacitor in the antenna lead.

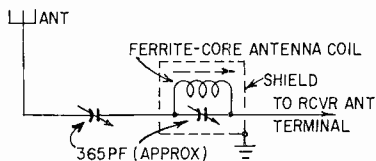

When trouble is severe, a wavetrap may be used, such as the one shown here. It really pepped up a Knight Space-Spanner. Circuit shown tunes out interfering AM broadcast stations. Other coil-capacitor combinations will be needed for other frequencies.—*Allan Glaser*

No Heater Voltage in Motorola TS-449, TS-578

Cold tubes in these sets can be caused by an open ground connection on the coax cable between tuner and chassis.

The CRT is the last tube in the string and is grounded via the tuner. This approach simplifies adding a uhf adapter (which puts a 2A4F in series with the CRT heater), but can cause an open heater string.—*Havens Electric Co., via TSA (Albany, N. Y.) Newsletter*

END

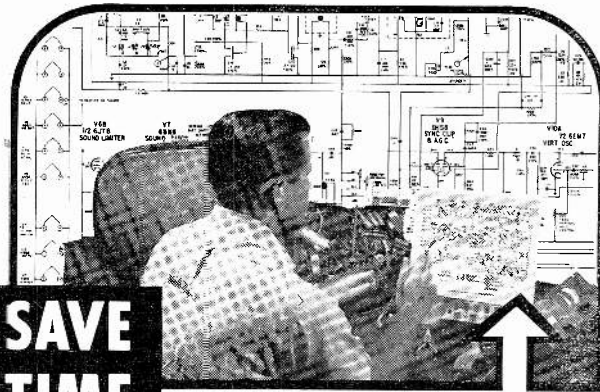

SAVE TIME WITH THE NEW SCHEMATIC LIBRARY

TV Service Men have wanted these Complete Schematic Charts to increase their production for years • Over 100 Schematic Drawings of all the latest popular models from Admiral to Zenith • Printed on big 10" x 12" easy to read cards. Schematic drawing on one side — Tube chart and board layout reverse side • Begin now to build your year to year Schematic Library • Quickly pays for itself.

only \$9.95 for complete set

order a set for each serviceman
WE PAY POSTAGE
MONEY BACK GUARANTEE IF NOT COMPLETELY SATISFIED

—Reference—
FIRST NATIONAL BANK OF ARIZONA, SCOTTSDALE, ARIZONA

—USE THIS COUPON TO ORDER NOW!—

SCHEMATIC LIBRARY

Post Office Box 1272 • • • Scottsdale, Arizona
SCOTTSDALE, THE HUB OF THE ELECTRONICS INDUSTRY

Please send me..... sets SCHEMATIC CHARTS at \$9.95 each
(ORDER A SET FOR EACH SERVICE MAN)

CHECK Sorry, No C.O.D. or Charges MONEY ORDER

NAME.....
ADDRESS.....
CITY.....ZONE.....STATE.....

EIGHT INSTRUMENTS IN ONE

- Out-of-Circuit Transistor Analyzer
- Dynamic In-Circuit Transistor & Radio Tester
- Signal Generator
- Signal Tracer • Voltmeter
- Milliammeter
- Battery Tester
- Diode Checker

Transistor Analyzer Model 212

Factory Wired & Tested — \$18.50
Easy-to-Assemble Kit — \$13.50

YOU DON'T NEED A BENCH FULL OF EQUIPMENT TO TEST TRANSISTOR RADIOS! All the facilities you need to check the transistors themselves — and the radios or other circuits in which they are used — have been ingeniously engineered into the compact, 6-inch high case of the Model 212. It's the transistor radio troubleshooter with all the features found only in more expensive units. Find defective transistors and circuit troubles speedily with a single, streamlined instrument instead of an elaborate hook-up.

Features:

Checks all transistor types — high or low power. Checks DC current gain (beta) to 200 in 3 ranges. Checks leakage. Universal test socket accepts different base configurations. Identifies unknown transistors as NPN or PNP.

Dynamic test for all transistors as signal amplifiers (oscillator check), in or out of circuit. Develops test signal for AF, IF, or RF circuits. Signal traces all circuits. Checks condition of diodes. Measures battery or other transistor-circuit power-supply voltages on 12-volt scale. No external power source needed. Measures circuit drain or other DC currents to 80 milliamperes. Supplied with three external leads for in-circuit testing and a pair of test leads for measuring voltage and current. Comes complete with instruction manual and transistor listing.

EMC, 625 Broadway, New York 12, N. Y.

Send me FREE catalog of the complete value-packed EMC line, and name of local distributor.

NAME..... RE-7

ADDRESS.....

CITY.....ZONE.....STATE.....

EMC

ELECTRONIC MEASUREMENTS CORP.
625 Broadway, New York 12, New York
Export: Pan-Mar Corp., 1270 B'way, N.Y. 1

new Products

SOUND SYSTEM LECTERN, Ampli-Vox Sound Column Lectern. 25-watt all-transistor push-pull amplifier handles 40-watt peaks. 6 built-in speakers in sound column; cardioid microphone; goose neck and lavalier cord. Powered

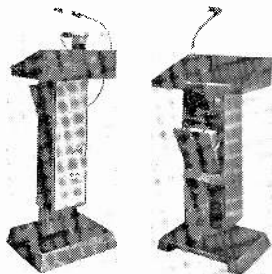

by 10 flashlight batteries, ac adapter available. Height adjustment from 36 to 46 in. Wood covered with Texolite, retractable wheels. 40 lb.—**Perma-Power Co.**, 5740 N. Tripp Ave., Chicago, Ill. 60646.

PROFESSIONAL MIKES. 2 low-impedance models, Nos. 802 and 803, and one high-impedance, models 801, 802: omnidirectional pickup



pattern. 803: cardioid type mike and recommended for use where external noise excessive.—**Ampex Corp.**, 401 Broadway, Redwood City, Calif.

FILTER CHOKE, No. C-4133, exact replacement for Admiral 74B24-2. Dumont, Emerson R102134, Magnavox M105195, RCA 102134, 112829, Traver, Truetime FC-23 and others. Electrical specs: 0.32 henry, 600 ma, 10 ohms. Shipping weight 1 lb. 4 oz.—**Merit Coil & Transformer Corp.**, Merit Plaza, Hollywood, Fla.

VARIABLE-FREQUENCY OSCILLATOR, model HE-89, for 6 and 2 meters. Operates with crystal oscillators in 8-9-mc region. Output 10-20 v rms. 117 volts 50/60 cycles. Tubes 6BA6, OB2

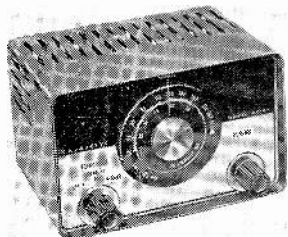

voltage regulator, silicon rectifier. 24-in. low-loss coaxial cable.—**Lafayette Radio Electronics Corp.**, 111 Jericho Turnpike, Syosset, N.Y.

MYLAR-PAPER BYPASS TUBULAR CAPACITORS, type DBE. Mylar, quality capacitor kraft tissue, and solid-setting thermo impregnant. Will not crack, soften or flow within temperature range of -55°C to +125°C. Standard capacitance tolerance of $\pm 10\%$ meets MIL-C-25 requirements. For 200, 400- and 600-volt ratings.—**Aerovox Corp., Distributor Div.**, New Bedford, Mass.

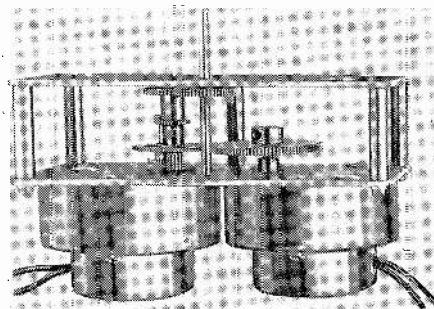

DUAL-SPEED MOTOR UNIT, model 42. For chart drives, control devices and timers where finite reset required. Choice of 3 output speeds by electrical switch control of 2 different-speed motors which can rotate in same direction or opposite at 180 rpm to 1 revolution per month or less. Standard output shaft $\frac{1}{8}$ -in. diameter by $\frac{3}{4}$ -in. length.—**Bristol Motors, Div. of Vocaline Co. of America**, Old Saybrook, Conn.

OMNIDIRECTIONAL FM ANTENNA, Rondo model 4407G, said to outperform turnstile and S types. With tri-dipole system, antenna up to 2.5 db better than turnstile on turnstile's strongest

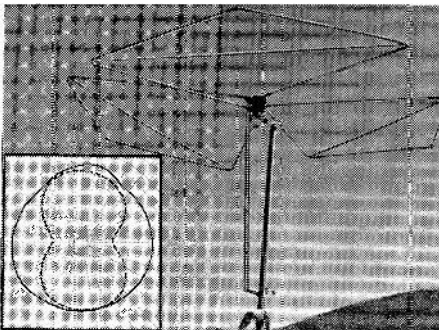

sides, to 7.4 db than turnstile on weak sides. In fringe areas, **Telstar FMX** booster can be added to make installation equal to 5-element Yagi on rotator. Gold-color finish.—**Channel Master Corp.**, Ellenville, N.Y.

HAM ANTENNA, Mark ABB-6, omnidirectional fixed-station antenna for 50-54 mc, 6-meter amateur radio band. $\frac{1}{2}$ -wave radiator, low angle of radiation gives gain over ground-plane antenna. Voltage-fed at bottom through $\frac{1}{4}$ -wave section of RG-8/U. Vswr less than 1.5:1 over 49-55-mc band. No radials, fiberglass-insulated aluminum. 10 ft.—**B & K/Mark Div. of Dynascan Corp.**, 1801 W. Belle Plaine Ave., Chicago, Ill. 60613

BOOSTER-COUPLER FOR TV AND FM, BC-208 drives 1 to 4 TV or FM sets; 8 db gain

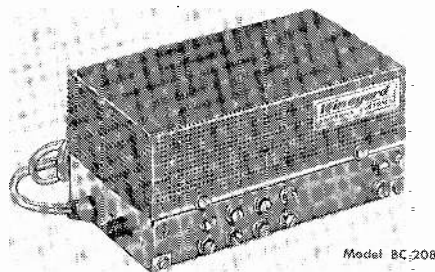

to each output. Takes up to 350,000 mv of signal input. No-strip terminals. Unused terminals need not be terminated. Isolates sets in system, preventing any interaction.—**Winegard Co.**, Burlington, Iowa



DETTENTED UHF TUNER. Afc prevents signal drift. Indexing lets TV viewer snap in 70 channels on uhf band, in contrast with continuous tuning as on radio dial.—**Oak Manufacturing Co.**, Crystal Lake, Ill.

WALL TAPS. Versa-Taps install in apartment and hotel MATV systems before rooms are painted. Standard ac wallplates cover flush-mounted tap-offs.—**Blonder-Tongue Labs, Inc.**, 9 Alling St., Newark 2, N.J.

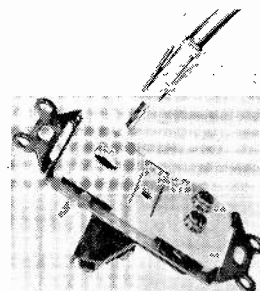

SELF-MOUNTING CLAMPS, Ty-Rap TC-116, TC-118, TC-120 reduce installation time of cables, wire bundles and harnesses by eliminating screws or other fasteners. For Ty-Rap cable ties,

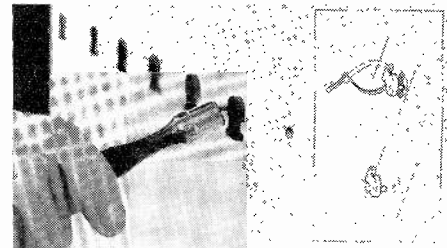

all-nylon clamp has expanding post, installs in mounting hole without special tools. 3 sizes fit Nos. 6, 8, 10 holes. Color-coded, pull-out strength from 25.5 to 35 lb.—**Thomas & Betts Co.**, 36 Butler St., Elizabeth, N.J.

CB TRANSCEIVER, model 777. Transmitter input 5 watts to final amplifier plate. frequency range 26.965-27.255 mc. 6 crystals selected by front panel switch. Oscillator circuit factory preset and sealed. AM plate modulation automatically limited to less than 100%. Variable pi network matches most popular antenna types. Dummy antenna load for off-the-air tuning. Ceramic microphone has push-to-talk switch. Double-conversion superhet receiver: rf stage, automatic noise limiter, adjustable squelch, spotting switch and S-meter.

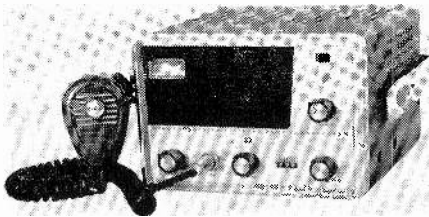

Continuous tuning with vernier drive, or crystal-controlled reception. 6 crystals selected by front-panel switch. Better than 1- μ v sensitivity for 10-db signal-to-noise ratio. Power supply for 6 and 12 vdc, 117 vac. 6 x 8½ x 10 in., 15 lb.—**Eico Electronic Instrument Co., Inc.**, 131-01 39th Ave., Flushing, N. Y. 11352.

ALL-TRANSISTOR TRUCK RADIO, ATR Truck Karadio.

5 transistors, 2 diodes. 5 x 3-in. elliptical speaker built in. 1-hole mounting in cab roof selected by front-panel switch. Better than 1- μ v sensitivity for 10-db signal-to-noise ratio. Power supply for 6 and 12 vdc, 117 vac. 6 x 8½ x 10 in., 15 lb.—**Eico Electronic Instrument Co., Inc.**, 131-01 39th Ave., Flushing, N. Y. 11352.



CB TRANSCEIVER, model HB-222, features tunable receiver with 23-channel crystal control. Dual conversion receiver uses 1650- and 262-kc i.f. system. Better than 1 μ v sensitivity. Audio output 3 watts to PM speaker. Illuminated meter calibrated in "S" units, relative power output and modulation percentage. Push-to-talk noise-

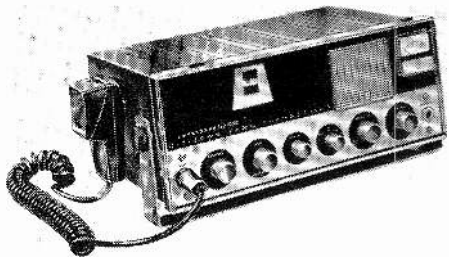

cancelling ceramic microphone; relay switching, illuminated channel selector dial. Pi-network output matches 30-100-ohm antennas. Front panel phone jack. Built-in 117-v ac and 12-v dc transistorized power supply. 10 tubes, 3 silicon diodes. 12 x 5 x 8½ in.—**Lafayette Radio Electronics Corp.**, 111 Jericho Turnpike, Syosset, N.Y.

2-WAY SPEAKER SYSTEM, Model SR1 Newport.

10-in. high-compliance woofer with single-roll suspension and long-throw voice coil, A 4-in. combination mid-range and tweeter speaker handles middle through super-high frequencies. Overall response: 53 cycles to 17,000 \pm 2½ db. Crossover at 1,800 cycles. Handles 45 watts of program material. Minimum drive 10 watts. Walnut veneer with cane grille, 24 x 13 x 9½ in.—**Sherwood Electronic Labs, Inc.**, 4300 N. California Ave., Chicago, Ill. 60618

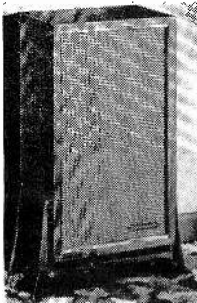

AM/SSB TRANSMITTER-RECEIVER, Comco model 606-SSB

operates on up to 6 selected channels in 1.6-16.0-mc range in either SSB mode (A3a emission) with carrier suppressed or in compatible-AM mode (A3h emission) with carrier transmitted. Upper sideband transmitted and lower sideband suppressed 50 db. Power output 100 watts p.e.p. for A3a emission or 30 watts carrier for A3h emission. Sensitivity better than 0.5 μ v for 10 db signal-noise ratio for SSB signals, 1.5 μ v for 10 db signal-noise ratio, 30% modulation when receiving AM signals. Frequency stability better than \pm 2 ppm. Age threshold 5 μ v. Audio bandwidth 350

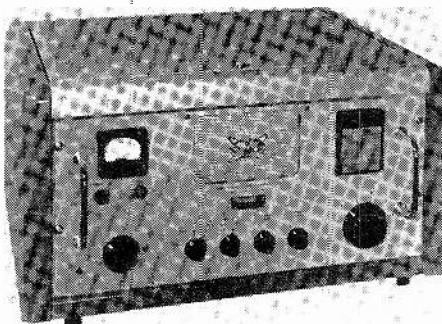

to 2450 cycles. Receiver audio output 1.5 watts. Takes up 8¾ in. rack space.—**Communications Co., Inc.**, 300 Greco Ave., Coral Gables, Fla. 33134

FOOT SWITCH, model 111, 5 x 2 x ¼ in. Easily taped or cemented to floor. Electrical rating 1 ampere at 117 volts ac (or 28 vdc) for loads

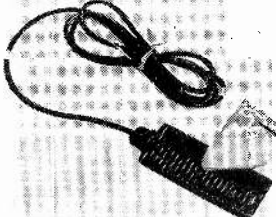

up to 100 watts. Ribbon switch element sealed in vinyl envelope.—**Tapeswitch Corp. of America,** 545 Meacham Ave., Elmont, N. Y. 11003

SOLID-STATE POWER CONTROLS, PD series Powerdials

use silicon controlled rectifiers. Half the size and 1/10 weight of conventional variable transformer controls. 120 volts ac input; outputs 0 to 120 volts ac and 0 to 85 volts dc, both at 0 to 5 amps. **2PD series;** 240 volts ac input, same output as **PD series.** 4½ x 4½ x 2½ in. aluminum housing. Slow blow fuses, 3-wire cords with receptacle, polarized outlets. For resistive and mildly inductive loads.—**International Resistance Co.,** 414 N. 13 St., Philadelphia, Pa. 19108



UNIVERSAL AM CAR RADIO, Autovox Bikini.

2 small units can be connected in various ways in autos with limited dashboard space. Power



output 2 watts. Illuminated dial. For 12- or 6-volt systems. Shortwave adapter or phono input.—**Autovox Corp. of America,** 250 W 57 St., New York, N. Y. 10019

TRANSISTOR IGNITION SYSTEMS.

4 basic kits: 1 each for 6 and 12 volts and positive and negative grounds. Installs in ½ hour with no engine or vehicle wiring modifications. Distributor points handle current of only ¼ to ½ ampere. Output voltage approximately 30 kv to the spark

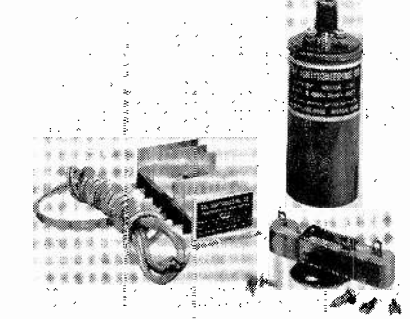

plugs; speeds up to 10,000 rpm. Special coil, transistor circuit with heat sink and ballast resistor. Adapters for voltage or polarity change when system transferred to another car.—**Ignitioneering Co.,** 84 Borglum Rd., Wilton, Conn.

POLYSTYRENE CAPACITOR KIT, CPK-150.

150 sealed polystyrene foil capacitors, rated at 500 volts, \pm 5% capacitance tolerance. 17 selected values from 22 pf to 0.1 μ f, with 5 to 20

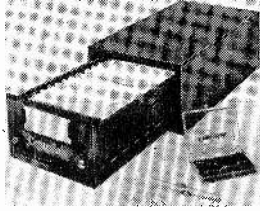

pieces per value. In 1-drawer blue-enamelled steel cabinet. Replacement capacitors for radio, TV, industrial, research and development applications.—**Centralab, Electronics Div. of Globe-Union Inc.,** Box 591, Milwaukee, Wis. 53201

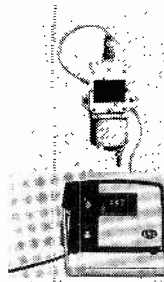

ELECTRONIC MANOMETER system to replace liquid manometers, for checkout of altimeters, pressure measuring devices and air-speed indicators. Accuracy of \pm 0.15%. Transducer has infinite resolution; repeatability .063%. Standard pressure ranges from 0-20 in. of water to 0-600 psi. Power requirements 115 volts, 60 or 400 cycles—**International Resistance Co.,** 401 Broad St., Philadelphia, Pa. 19108

PORTABLE LINE TESTER, model LT-1,

isolates common trunk and distribution line troubles with direct-reading portable meter. Tests for line termination, line splitting, open and shorted line. Self-contained power supply, pushbutton operation. 7 x 2½ x 27½ in.; 1 lb. 9 oz.—**Entron Inc.,** Silver Spring, Md.

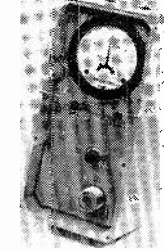

PORTABLE TAPECORDER, Sony model 801-A.

Battery-powered. 3¼ and 1½ ips, dual-track monophonic, 5-in. reel. Pushbutton operation, self-storing microphone with remote stop/start switch, built-in amplifier and speaker, VU

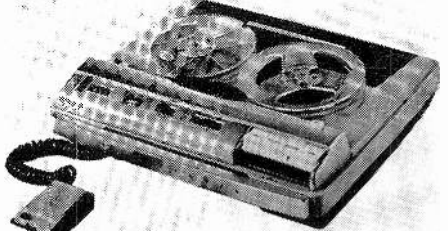

meter indicating record level or battery condition, and variable back-spacing lever for repetition of word, phrase or paragraph. 1.5 watts, 9 volts dc (6 size-D flashlight cells). Response: 90-9,500 cycles at 7½ ips. Inputs: external mike and aux line. Output, earphone monitor. 13 lb. 12½ x 10½ x 31½ in.—**Superscope,** 8150 Vineland Ave., Sun Valley, Calif.

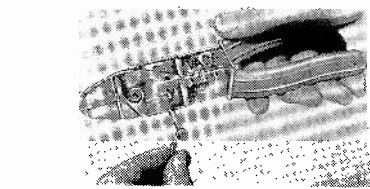

BOLT-SLICING CRIMPING TOOL slices through 6 sizes of bolts. Wire cutter at tip strips

Make This Your Luckiest Day!

Join the Gernsback Electronics Book Club today, and get this outstanding practical two-volume work

FREE!

... with your first selection. You agree to buy only three additional books during the next 12 months at low Club prices.

A \$9.90 Value ... Originally a \$25 Training Course!

How to Fix Transistor Radios and Printed Circuits! by Leonard C. Lane was originally prepared as a complete course in servicing transistor radios. This two volume version treats every aspect of transistors, much of it new, original, unavailable anywhere else in book form. Hundreds of illustrations aid understanding. Completely covers semiconductor fundamentals, how transistors work, transistor types, amplifiers, RF and IF stages, printed circuits, specific servicing methods and techniques, and many, many more subjects.

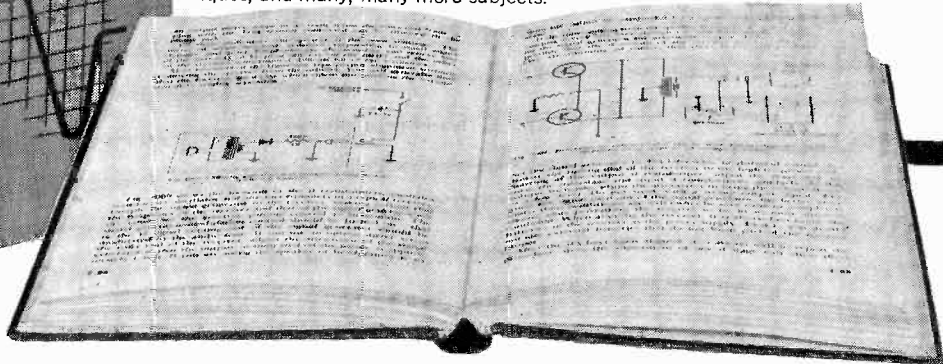
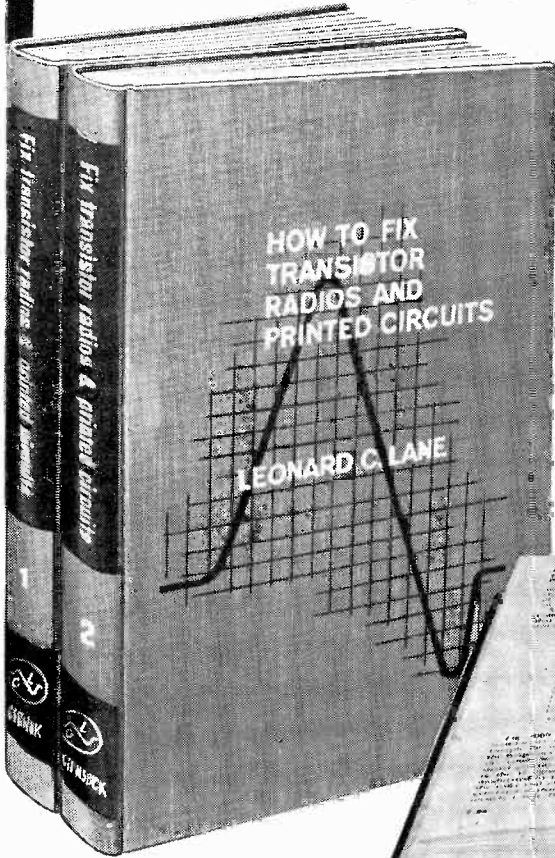

Here is a fabulous offer to introduce you to Gernsback Library's famous Electronics Book Club, specifically designed to help you increase your knowledge and earning power.

WHY YOU SHOULD JOIN

Whatever your interest in electronics - radio and TV servicing, audio and hi-fi, industrial or defense electronics, electronics as a hobby - you'll find that the Electronics Book Club will help you get the job you want, keep it, improve it, or make your leisure hours more enjoyable. By broadening your knowledge and skills, you'll build your earning power and electronics enjoyment as well.

WHAT KIND OF BOOKS ARE OFFERED?

From Gernsback Library and other leading publishers come the country's most respected books in the field of electronics. All are deluxe, hard-covered, attractive looking books of permanent value - books you'll want to own and keep in your personal, professional library.

HOW THE CLUB WORKS

Every two months, the Electronics Book Club will send you, ON APPROVAL, a significant new book on an important phase of elec-

tronics. Examine the book for up to 10 days. If you like it, keep it and send your check for the low club discount price - up to 27% off regular prices! If you are not completely satisfied, simply send it back and you owe nothing. You risk no money.

HOW TO JOIN

Simply fill out and mail the handy coupon today. You will be sent absolutely free your two-volume set of "How to Fix Transistor Radios and Printed Circuits", worth \$9.90, together with your first club selection from the outstanding volumes listed - at the special reduced club member's price (plus postage). If you are not satisfied with the books, send them back within 10 days and membership is cancelled. Remember, your only obligation is to buy three additional books from the many offered during the next 12 months. Take advantage of this fabulous introductory offer now!

INTRODUCTORY SELECTIONS AVAILABLE:

Television Simplified by Milton S. Kiver
Most complete book on TV written. Every stage and part of receiver carefully explained. 637 pages of updated data. Graphs, diagrams, giant charts.
Regularly \$9.95 **Club price \$7.95**

Basic Transistor Course by Paul R. Kenian
Teaches you transistor fundamentals clearly, simply. Discusses transistors all the way from elementary circuits to radio receivers.
Regularly \$5.75 **Club price \$4.50**

Horizontal Sweep Servicing Handbook by Jack Darr
Fast, simple methods of locating and repairing troubles in the sweep system. Lots of practical shortcuts, developed and proved on the bench.
Regularly \$5.75 **Club price \$4.50**

Basic Radio Course (revised and enlarged) by John T. Frye
The original sold out through eight printings! This lighthearted course in practical servicing techniques is now completely revised and updated.
Regularly \$5.75 **Club price \$4.85**

Basic TV Course by George Kravitz
Up-to-the-minute television—even covers transistorized portables! Presents technical detail in easy-to-follow writing style. A must book.
Regularly \$5.75 **Club price \$4.85**

Basic Industrial Electronics Course by Alfred Haas
A practical, simplified approach to industrial electronics - the branch where earnings are nearly limitless; opportunities always open to skilled technicians.
Regularly \$5.95 **Club price \$4.70**

Basic Electronic Test Procedures by Rufus P. Turner
Solves test and measurement problems in every phase of electronics—from radio to rockets. Practical course and reference for student, teacher, and technician.
Regularly \$8.50 **Club price \$5.95**

Practical Television Servicing by Richard Johnson
Explains everything necessary for rapid location and remedy of receiver troubles. Theory included only when it makes servicing easier, faster, more profitable.
Regularly \$7.95 **Club price \$6.75**

GERNSBACK LIBRARY, INC.

154 West 14th Street, New York, N. Y. 10011 74 B

Please send me the two-volume set HOW TO FIX TRANSISTOR RADIOS AND PRINTED CIRCUITS entirely without charge and enroll me as a member of the Electronics Book Club. My first selection at the special reduced member's price (plus a few cents postage) is noted below. I understand that I need accept only as few as three additional selections in the next 12 months, and I may cancel my membership any time after that. Send as my first selection _____

Name _____

Address _____

City _____ State _____ Zip _____
Code _____

We pay postage if you send your remittance with this coupon. You have the same return privilege. Remittance enclosed.

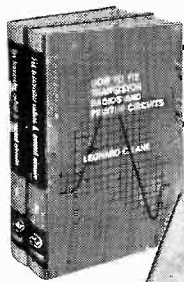

ADDITIONAL SELECTIONS FROM ELECTRONICS BOOK CLUB

Transistor Reference Book

Contains the most complete and up-to-date listing of semiconductor types available, with comprehensive specifications on each type.

Regularly \$6.00 Club price \$4.50

Semiconductor Devices

by Rufus P. Turner

Explains the theory of semiconductor devices in simple language and shows numerous applications. Profusely illustrated with hundreds of drawings and photographs.

Regularly \$6.00 Club price \$4.80

Electrical Appliance Service Manual

by William Gabbert

Expand your business! You can earn more with this complete guide for fast, easy repair of home electrical appliances. Fully illustrated, easy-to-follow charts.

Regularly \$6.75 Club price \$5.75

Radio Servicing Made Easy

(2 vols.) by Leonard C. Lane

Get the latest servicing information on new radio types. Full instructions on how to fix FM, M, AM-FM communications receivers, marine radios, transistors.

Regularly \$9.95 Club price \$7.75

The Oscilloscope

by George Zwick

A complete, practical, easy-to-understand guide to one of the most useful of all servicing instruments. Tells how to get more out of the scope in AM, FM and TV servicing—how to handle tough jobs faster!

Regularly \$5.20 Club price \$3.95

Elements of Electron Physics

by Norman H. Crowhurst

Explains in simple understandable language the how and why of electronics. Covers electron theory, semiconductors, tubes, circuits.

Regularly \$5.65 Club price \$4.45

How to Build Tiny Electronic Circuits

by Morris Moses

Explains "miniaturized" electronics for the hobbyist, experimenter and service technician.

Regularly \$5.85 Club price \$4.95

New Shortcuts to TV Servicing

(2 vols.) by Leonard C. Lane

A practical servicing speed-up course. No theory or math, but heavy on test and repair techniques that save time and make money.

Regularly \$9.90 Club price \$6.50

Basic Math Course for Electronics

by Henry Jacobowitz

Learn electronic mathematics and be miles ahead of your competitors. Use the math you learn in every electronics problem in and out of the shop.

Regularly \$6.45 Club price \$5.15

Industrial Electronics Made Easy

by Tom Jaski

Shows you opportunities in industrial electronics—and gives you the know-how to take advantage of them.

Regularly \$5.95 Club price \$4.35

MAIL COUPON TODAY!

insulation from 10 to 22-gauge wire, crimps insulated and noninsulated terminals. In plastic pouch with supply of insulated and noninsulated terminals.—Vaco Products Co., 317 E. Ontario St., Chicago, Ill. 60611

PHOTOCONDUCTOR KIT for electronic hobbyists. 3 photoconductors, a Sigma ac/dc relay, 22,000-ohm 1-watt resistor, mounting bracket, and

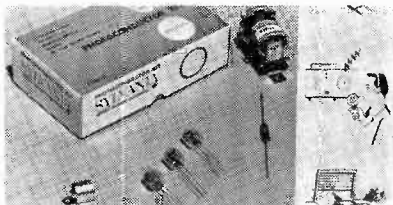

52-page circuits booklet describing variety of applications.—Electronic Tube Div., Sylvania Electric Products Inc., Emporium, Pa.



SOLID-STATE STEREO AMPLIFIER, Citation B. 40 watts per channel continuous power. Bandwidth at full power output 10-60,000 cycles. Frequency response flat from 1 to 100,000 cycles. Wiring harness couples all stages and silicon output transistors with casings fastened to heat sink, both channels mounted on epoxy boards. Output circuits safe even under direct shorts.—Harman-Kardon Inc., Ames Court, Plainview, N. Y.

HAM AND CB SPECTRUM MONITOR KIT, Ham-Scan panoramic adapter allows visual observation of band activity up to 50 kc above and

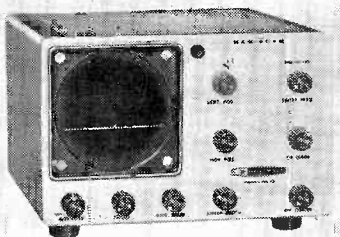

below frequency to which receiver is tuned. Identifies signals as to SSB, AM or CW types, spots band openings or clear portions of band, identifies splattering signals. As receiver is tuned, frequency you hear remains centered on screen.—Heath Co., Benton Harbor, Mich.

REPEATING TAPE PLAYER, Repeater accepts programs of from 20 sec. to 8 hr., recorded on 1/2-track recorder at 1 7/8, 3 3/4 or 7 1/2 ips. Program started with external momentary pulse of 1 to 12

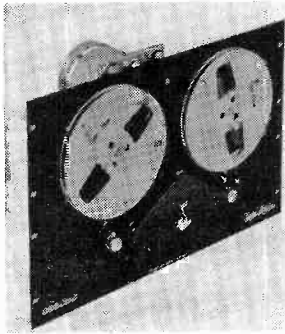

volts ac/dc to player via built-in connector. Program plays to end of recording, tape reverses and shuts off. Portable, rack mounting and console styles, mono or stereo.—Tape-Athon Corp., 523 S. Hindry, Inglewood, Calif.

All specifications from manufacturers' data.

COYNE
TRAINS YOU
IN SPARETIME
AT HOME

COYNE QUALITY TRAINING AT LOWEST COST

TELEVISION

COLOR TV-RADIO-ELECTRONICS

Coyne—and only Coyne—can give you this modern TV Home Training. Easy to follow 2150 photos and diagrams covering Radios-TV, Color, UHF, Transistors. We also show you how to start making money with the learning, right at home. Get your basic training at home, then make a flash finish with 2 weeks of actual shop work in Chicago under direction of same instructors who guide our resident students.

LOW COST—Easy to Pay
You don't pay for costly "put together" kits. Small monthly payments and low, low cost make it easy for everyone to train. Free employment service for graduates—or we show you how to start your own service business on a "shoestring." Send name today for complete facts and valuable book on Television. No salesman will call. Everything mailed free, postpaid.

Coyne Electrical School
Chartered as an Educational Institution Not for Profit
1501 W. Congress Parkway
Dept. B4-H5, Chicago 7, Ill.

FREE
of Extra Charge to Graduates
TWO WEEKS
Shop Training in Chicago

No increase in home training cost, but the day you graduate you will be entitled to two full weeks of personal instruction on actual projects in the great Shop-Labs of Coyne in Chicago—without one cent of extra tuition whatsoever.

FREE Just Send Name
No charge. No obligation. No salesman will bother you. Just send name for free copy of big 24 page book on quickest, lowest cost way to train for top pay job or business of your own... Mail coupon today.



B. W. Cooke, Pres. Home Training Division, Dept. B4-H5 1501 W. Congress Parkway, Chicago 7, Ill.

Please mail free book and offer of two weeks personal training in Chicago without extra tuition for home study graduates. Explain low monthly payments.

NAME.....AGE.....
ADDRESS.....
CITY & STATE.....

build your own bozak

URBAN OR EARLY AMERICAN
INFINITE-BAFFLE SPEAKER CABINETS

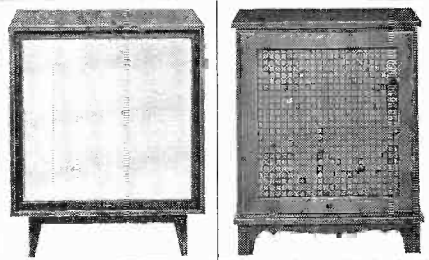

For the Bozak 2-way B-300 and 3-way B-302A Speaker Systems. Complete Kits for easy assembly and finishing.



See your Franchised Bozak Dealer DARIEN / CONNECTICUT

technicians' News

NATESA Clarifies Position On FTC Consent Order

The National Alliance of TV & Electronic Service Associations has detailed the circumstances under which it agreed to the Federal Trade Commission consent order dated Jan. 22, 1964. That order cited practices in restraint of trade on the part of NATESA and of TESA—Green Bay, Wis., concerning local parts wholesalers. (See "NATESA Bows to FTC Restraint Order," Technicians' News, RADIO-ELECTRONICS for April 1964.)

In an article in the April 1964 issue of the NATESA Scope, this explanation appeared: "... because we have not and positively will not knowingly violate laws it made better sense for NATESA to enter into a consent order with the FTC for settlement purposes only." Accordingly, the article continues, "The agreement between NATESA and the FTC provides in part that: 'This agreement

is for settlement purposes only and does not constitute an admission... that the law has been violated...'"

Since, even so, the order is legally binding on NATESA and on each of its member organizations, the article reminds all affiliates that they must be "extremely careful to avoid actions which might be interpreted as being in violation of the FTC consent order."

Pa. Licensing Bill Still Major Issue

Although the Pennsylvania Federation of Television & Radio Service Associations was unsuccessful in pushing through its licensing bill during the 1963 State Legislature session, strong efforts are being made to enact the bill during the next session.

According to Leon Helk, secretary of the FTRSA, the bill was all ready to come out of the committee. Strong opposition from certain distributors and manufacturers in the Philadelphia area apparently prevented passage. Meanwhile, local licensing is being encouraged as a stopgap measure.

Mr. Helk stated that there has also been substantial opposition from the Harrisburg (Pa.) chapter of the AFL/CIO, which has mailed out flyers opposing state licensing on the grounds that it would be unenforceable and ineffective. Mr. Helk was unable to say precisely what the union's motives are.

The bill that the FTRSA wants passed is much the same as others already in effect in other states. The federation

favors licensing as a means of halting the operation of "moonlighters", on the grounds that their work breeds complaints against the TV service trade as a whole. The proposed law would make it possible for the state to bar from doing business anyone not qualified according to certain regulations.

NARDA-NEA Merger Attempt Fails

Indianapolis—The possibility of a merger between the National Electronics Association and the National Appliance & Radio-TV Dealers Association has apparently ended.

At a meeting in Chicago in April, the executive committee of NARDA and officials of NEA failed to agree on plans for merging the groups. According to a spokesman, NEA, which originated the merger idea, will not press further.

The basic area of disagreement seemed to be that NARDA was unable to accept the group membership of NEA. NARDA wanted NEA members to join NARDA "as is" without NEA having a distinct voice on the NARDA board. That idea was unacceptable to NEA.

Local members expressed disappointment at the failure of the merger to come about.

Florida Group Launches Licensing Drive

The first official directors' meeting of the recently formed Florida Electronic Service Association early this year cul-

HOTTEST DEAL EVER OFFERED! **RCA** #CTC-11 COLOR TV CHASSIS \$86

We scooped the market—Wired complete (less Tubes & CRT) including full Set of Tubes (less CRT).....\$99

1 DOLLAR BUY FREE WITH EVERY 10 ORDERED — PLUS FREE GIFT

- \$17.50 WEBSTER DIAMOND CARTRIDGE #SC2-D Stereo .. \$1
- RONNETTE DUAL SAPPHIRE CARTRIDGE Ripover type \$2
- DIAM. NEEDLES Ronette BF40, Sonotone 2TS, Monarch, Vaco ea. \$1
- UNIVERSAL 5" PM SPEAKER Alnico 5 magnet, quality tone.. \$1
- UNIVERSAL 4" PM SPEAKER Alnico 5 magnet, quality tone.. \$1
- 3 — \$2.50 SAPPHIRE NEEDLES guaranteed 5000 playings .. \$1
- 2 — UNIVERSAL 2 1/4" PM SPEAKERS for Radios, Intercom, as multiple Speakers, etc. \$1
- 3—SAPPHIRE STYLUS NEEDLES for all type pickups .. \$1
- 3 — AUDIO OUTPUT TRANSFORMERS 50L6 type .. \$1
- 3 — AUDIO OUTPUT TRANSFORMERS 3V4, 3Q4, 3S4 .. \$1
- 15 — RADIO OSCILLATOR COILS standard 456kc .. \$1
- 4 — I.F. COIL TRANSFORMERS 456kc, most popular type \$1
- 3 — I.F. COIL TRANSFORMERS 262kc, for auto radios .. \$1
- 3 — I.F. COIL TRANSFORMERS 10.7mc for FM .. \$1
- 3—1/2 MEG VOLUME CONTROLS with switch, 3/8" shaft \$1
- 5 — ASST. 4 WATT WIREWOUND CONTROLS .. \$1
- 10 — ASSORTED VOLUME CONTROLS less switch .. \$1
- 5—ASSORTED VOLUME CONTROLS with switch .. \$1

- 50—G.E. FLASHLIGHT BULBS #PR-9, 2.7 volts .. \$1
- 3—ELECTRIC MOTORS 1 1/2 Volt wonderful experimenters item... \$1
- 5—ASST. SIZES RADIO CHASSIS PANS drilled & plated .. \$1
- 5—VARIABLE CONDENSERS asst. popular super-het types .. \$1
- 50—ASSORTED PRINTED CIRCUIT SOCKETS best types .. \$1
- 100—ASST. RADIO KNOBS all selected popular types .. \$1
- 20 — INSTRUMENT POINTER KNOBS selected popular types .. \$1
- 1000—ASST. HARDWARE KIT screws, nuts, washers, rivets, etc. \$1
- 100' — FINEST NYLON DIAL CORD best size, .028 gauge .. \$1
- 20—ASST. PILOT LIGHTS #44, 46, 47, 51, etc. \$1
- 20 — PILOT LIGHT SOCKETS bayonet type, wired .. \$1
- 3 — ELECTROLYTIC CONDENSERS 50/30-150v .. \$1
- 3 — ELECTROLYTIC CONDENSERS 40/40mfd-400 volts. .. \$1
- 10 — ASST. RADIO ELECTROLYTIC CONDENSERS .. \$1
- 5 — ASST. TV ELECTROLYTIC CONDENSERS .. \$1
- 5—CD ELECTRO CONDENSERS 10/10/10-450 volts .. \$1
- 6 — ASST. SELENIUM RECTIFIERS 65ma, 100ma, 300ma, etc. \$1
- CRYSTAL LAPEL MICROPHONE High impedance, 200-6000 cps \$1

- 5—IBM COMPUTER SECTIONS loaded with valuable parts ... \$1
- 100 — ASSORTED 1/2 WATT RESISTORS some in 5% .. \$1
- 100 — ASST 1/4 WATT RESISTORS choice ohmages, some 5% \$1
- 70 — ASSORTED 1 WATT RESISTORS some in 5% .. \$1
- 35 — ASSORTED 2 WATT RESISTORS some in 5% .. \$1
- 50—PRECISION RESISTORS asst. list price \$50 less 98% \$1
- 20 — ASS'TED WIREWOUND RESISTORS, 5, 10, 20 watt .. \$1
- 50 — ASST. DISC. CERAMIC CONDENSERS popular numbers \$1
- 50 — ASST. MICA CONDENSERS some in 5% .. \$1
- 10—DIODE CRYSTALS 1N34 .. \$1
- 10—ASST. DIODE CRYSTALS 5-1N60 and 5-1N64 .. \$1
- 2—SILICON RECTIFIERS 750ma, 400 PIV .. \$1
- 5—PNP TRANSISTORS general purpose, TO-5 case .. \$1
- 20 — PLUG & JACK SETS with wired leads, 101 uses .. \$1
- 5—NPN TRANSISTORS general purpose, TO-5 case .. \$1
- 50 — ASST. TUBULAR CONDENSERS. .001 to .47 to 600v \$1
- 20—GOODALL TUBULAR CONDENSERS .047-600v .. \$1
- CHAPT ZU DI MITZIA "JACK-POT" double your money back if not completely satisfied ... \$1
- \$12 TALKING DOLL 25" TALL sophisticated — blonde, brunette or redhead, 11 cuts recitations \$5

MARKET SCOOP COLUMN

- STEREO PHONO AMPLIFIER wired—each channel 3 watt .. \$2
- 2—25BK5 TUBES & 2-OUTPUT TRANS completes above Amp .. \$2
- STARLITE 8-TRANSISTOR RA-6 D10 complete needs slight adjust \$6
- \$200 SONOTONE HEARING AID less Earpiece & Batteries .. \$5
- \$27 MERCURY RECTIFIER TESTER #600 in sealed cartons \$8
- BATTERY CHARGER 9-VOLT incl trans chargeable battery .. \$1
- STANDARD TV TUNER 47mc Comp. with Tubes & Schematic \$5
- STANDARD TV TUNER 21mc Comp. with Tubes & Schematic \$5
- 50—RCA LUCITE RADIO KNOBS popular type w. indicator pointer \$1
- 40—ASSORTED TV KNOBS all standard types, \$40 value .. \$1
- 10—ITT SELENIUM RECTIFIERS 65ma-14v brand new fact. stock \$1
- 8—ITT SELENIUM RECTIFIERS 100ma-14v brand new fact. stock \$1
- 2—ITT SELENIUM RECTIFIERS 500ma, nothing finer made ... \$1
- 5—ASSORTED TRANSFORMERS Radio, TV and Industrial .. \$1
- \$1900 IBM RATIO COUNTING SCALE in perfect condition.... \$250

BROOKS RADIO & TV CORP., 84 Vesey St., Dept. A, New York 7, N.Y. TELEPHONE CORtland 7-2359

minated in a unanimous decision to press for statewide licensing of TV and electronic servicers.

In an editorial in *FESA News*, formerly the *TESA-MIAMI News*, A. Edward Stevens, president of FESA, wrote: "Licensing was enacted there [in other states] not as a means of 'cornering' the service market for the politically favored few, but as a safeguard to the public. Existing laws do not cover fully the situation at hand . . . When pushcarts ruled the streets, traffic signals were few.

"With licensing comes the dignity of a recognized profession. As tinkers and hobbyists we remained a mild sort of 'freak', . . . treated with no more respect than . . . the court jester."

NARDA Tackles Industry Problems

The National Appliance & Radio-TV Dealers Association has "launched a major offensive" against two of the biggest problems facing appliance and radio-TV retailers: direct sales from manufacturers, and the decreasing share America's "disposable income" coming the way of appliance dealers.

Because the industry could not agree on a one-price policy to builders and dealers, the Government has been asked to step in as arbitrator. Specifically, the Executive Committee of NARDA has asked the Federal Trade Commission to set up a Trade Practices Conference to resolve the issues and factions. END

NARDA Hopes to Boost Appliance Sales

Taking steps to combat what seems to be a decline in appliance sales, or at least a decreasing share of America's "disposable income" going for appliances, National Appliance & Radio-TV Dealers Association president Earl T. Holst has called on members of the trade to launch a drive to improve the consumer's image of the appliance-radio-TV industry.

One of the most delightful of Mr. Holst's ad campaign ideas was to stress that too many people turn summer vacations into nightmares "by loading families into hot stuffy cars, caught in holiday traffic jams, for a few days of supposed rest." In contrast, he feels that "the family who vacations at home in an air-conditioned apartment in front of a color television set obviously gets much more enjoyment."

Possibly those diehards who stubbornly insist on traveling could pack along a few of the family's home appliances and plug them in from time to time along the way.

ANTARCTIC ANYONE?

Engineers interested in joining the team from the Boulder Laboratories of the National Bureau of Standards to the Antarctic (summer and autumn training in Boulder—the Antarctic in Decem-

ber as summer starts south of the Equator) may write to the Personnel Office, National Bureau of Standards, Boulder, Colo. These projects constitute an exciting study of electromagnetic phenomena, characteristics and behavior of the ionosphere, and the effects of solar activities on radio transmissions.

50 Years Ago

In Gernsback Publications

HUGO GERNSBACK, Founder	
Modern Electrics	1908
Wireless Association of America	1908
Electrical Experimenter	1913
Radio News	1919
Science & Invention	1920
Practical Electrics	1921
Television	1927
Radio-Craft	1929
Short-Wave Craft	1930
Television News	1931

Some larger libraries still have copies of Modern Electrics and the Electrical Experimenter on file.

In July, 1914, Electrical Experimenter

The Speaking Arc Light, by H. Winfield Secor.

Experimental Electricity Course, by S. Gernsback and H. Winfield Secor. Progress in Radiotelegraphy.

Radio-Transmission and Weather, by A. H. Taylor.

A Vacation Radio Pocket Set, by Harry V. Johnson.

A Laboratory Switchboard, by Godfrey S. Bloch.

A Novel Detector Switch, by Albert St. Cyr.

A Looped Aerial Switching Scheme, by Thos. N. Benson.

IMMEDIATE DELIVERY... SCIENTIFIC LIGHT PACKING for safe delivery at minimum cost. **HANDY WAY TO ORDER**—Pencil mark items & enclose with check or money order, add extra for shipping, excess refunded with advantage to customer. Tearsheet will be returned with order, as your packing slip.

- | | | | |
|---|---|--|----------------------------|
| <input type="checkbox"/> 1-LB SPOOL ROSIN-CORE SOLDER 40/60 top quality .. \$1 | <input type="checkbox"/> WESTERN ELECTRIC Piece of \$1 Equipment with valuable parts .. \$1 | <input type="checkbox"/> \$15.00 RADIO PARTS "JACK-POT" handy assortment \$1 | MARKET SCOOP COLUMN |
| <input type="checkbox"/> 250-ASST. WOOD SCREWS finest popular selection .. \$1 | <input type="checkbox"/> WESTINGHOUSE TV TUNER 4 inc, brand new (less tubes) .. \$1 | <input type="checkbox"/> 30-BALL POINT PENS retractable, assorted colors ... \$1 | |
| <input type="checkbox"/> 250-ASST. SELF TAPPING SCREWS #6, #8, etc. \$1 | <input type="checkbox"/> MAGNAVOX PIECE OF EQUIPMENT loaded with deluxe parts \$1 | <input type="checkbox"/> 25-2 TERMINAL PIN JACKS asst types for various uses ... \$1 | |
| <input type="checkbox"/> 150-ASST. 6/32 SCREWS and 150 6/32 HEX NUTS \$1 | <input type="checkbox"/> MAGNAVOX SET OF TUBES 12AU7 and 2-12AX7, for above \$1 | <input type="checkbox"/> ELECTROSTATIC 3" TWEETER SPEAKER for FM, III-FI, etc. ... \$1 | |
| <input type="checkbox"/> 150-ASST. 8/32 SCREWS and 150-8/32 HEX NUTS .. \$1 | <input type="checkbox"/> 4-TRANSISTOR EARPHONES 15 ohm standard for Radios, etc \$1 | <input type="checkbox"/> 20-STANDARD FUSE HOLDERS for 3AG fuses, easy mount \$1 | |
| <input type="checkbox"/> 150-6/32 HEX NUTS and 150-8/32 HEX NUTS .. \$1 | <input type="checkbox"/> \$15.00 TELEVISION PARTS "JACKPOT" best buy ever .. \$1 | <input type="checkbox"/> 5-I.F. COIL TRANSFORMERS sub-min for Transistor Radios .. \$1 | |
| <input type="checkbox"/> 500-ASSORTED WASHERS most useful selected sizes \$1 | <input type="checkbox"/> 4-TV ALIGNMENT TOOLS most useful assortment .. \$1 | <input type="checkbox"/> 5-AUDIO OUTPUT TRANSFORM sub-min for Trans Radios \$1 | |
| <input type="checkbox"/> 500-ASSORTED RIVETS most useful selected sizes \$1 | <input type="checkbox"/> 50-ASSORTED TV PEAKING COILS all popular types .. \$1 | <input type="checkbox"/> 20-BENDIX BUFFER CONDENSERS .007-2000v \$15 value .. \$1 | |
| <input type="checkbox"/> 4-TOGGLE SWITCHES SPST, SPDT, DPST, DPDT \$1 | <input type="checkbox"/> REGO INDOOR TV ANTENNA hi-gain, 4 section, tiltproof .. \$1 | <input type="checkbox"/> 25-SYLVANIA HEAT SINKS for Transistors, etc. \$1 | |
| <input type="checkbox"/> 15-ASST. ROTARY SWITCHES all popular types \$20 value .. \$1 | <input type="checkbox"/> 10 SETS - DELUXE PLUGS & JACKS asst. for many purposes \$1 | <input type="checkbox"/> 50-RCA PHONO PLUGS Standard for phonos, male \$1 | |
| <input type="checkbox"/> 100-ASST RUBBER & FELT FEET FOR CABINETS best sizes \$1 | <input type="checkbox"/> 20-ASSORTED TV COILS I.F. video, sound, ratio, etc. .. \$1 | <input type="checkbox"/> 10-TOGGLE SWITCHES SPST deluxe U.L. approved, 161 uses \$1 | |
| <input type="checkbox"/> 50-ASSORTED #3AG FUSES Popular assorted ampere ratings \$1 | <input type="checkbox"/> 20-ASSORTED GRID CAPS for 1B3, 1X2, 6BG6, 6BQ6, etc. \$1 | <input type="checkbox"/> 1-SQ. YARD GRILLE CLOTH most popular brown & gold design \$1 | |
| <input type="checkbox"/> 250-ASST. SOLDERING LUGS best types and sizes .. \$1 | <input type="checkbox"/> 100'-TWIN TV LEAD-IN WIRE 300 ohm, heavy duty .. \$1 | <input type="checkbox"/> 100-MIXED DEAL "JACKPOT" Condensers, Resistors, Surprises \$1 | |
| <input type="checkbox"/> 50-STRIPS ASSORTED SPAGHETTI handy sizes .. \$1 | <input type="checkbox"/> 5-TV CHEATER CORDS with both plugs .. \$1 | <input type="checkbox"/> BONANZA "JACKPOT" not gold, not oil, but a wealth of Electronic Items—Money-Back-Guarantee .. \$5 | |
| <input type="checkbox"/> 100-ASSORTED RUBBER GROMMETS best sizes .. \$1 | <input type="checkbox"/> 10-6' ELECTRIC LINE CORDS with plug standard brands .. \$1 | <input type="checkbox"/> 2-EMERGENCY AUTO LAMPS Red dome blinker, incl Battery saves lives on highway stops .. \$1 | |
| <input type="checkbox"/> 10-SURE-GRIP ALLIGATOR CLIPS 2" plated .. \$1 | <input type="checkbox"/> 4-50' SPOOLS HOOK-UP WIRE 4 different colors .. \$1 | <input type="checkbox"/> 100-CERAMIC CONDENSERS Erie 50mmf-500v, 5% .. \$1 | |
| <input type="checkbox"/> 10-SETS PHONO PLUGS & PIN JACKS RCA type .. \$1 | <input type="checkbox"/> 100'-MINIATURE ZIP CORD 2 conductor, serves 101 uses.. \$1 | <input type="checkbox"/> 30-GOOD-ALL CONDENSERS .19-60Cv (tests .25-1000v) .. \$1 | |

BROOKS RADIO & TV CORP., 84 Vesey St., Dept. A, New York 7, N. Y. TELEPHONE ORlondt 7-2359

CASTLE

NEW EASTERN LOCATION

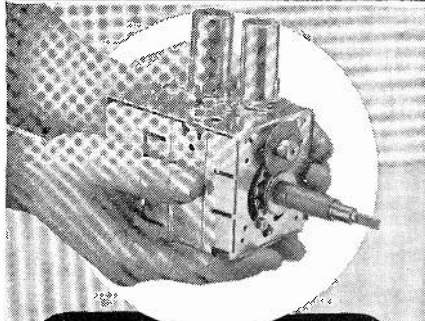

ALL MAKES ALL LABOR AND PARTS (EXCEPT TUBES)* ONE PRICE

9.95

ONE LOW PRICE INCLUDES ALL UHF VHF AND UV COMBINATION* TUNERS

Fast Service . . . Simply send us your defective tuner complete; include tubes, shield cover and any damaged parts with model number and complaint.

90 Day Warranty

Exact Replacements are available for tuners unfit for overhaul. As low as \$12.95 exchange. (Replacements are new or rebuilt.)

CASTLE TV TUNER SERVICE, INC.

5715 N. Western Avenue, Chicago 45, Ill.

New Eastern Location

41-96 Vernon Blvd., Long Island City 1, N.Y.

In Canada: 136 Main St., Toronto 13, Ont.

*Major Parts are additional in Canada

NEW! LAFAYETTE 1-WATT 2-CHANNEL SUPER CB "WALKIE TALKIE"

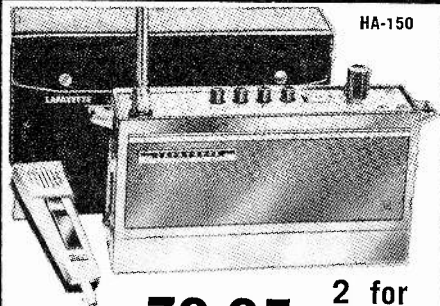

79.95 2 for 154.95

- Lightweight, compact . . . Self-contained with Leather Case and Shoulder Strap
- External Push-to-Talk Dynamic Microphone
- Powerful 13-Transistor 5-Diode Circuit
- Modulation/Battery Strength Meter
- Push-Button Operation
- Powered by Flashlight Batteries or External 12 VDC Supply
- Complete with 2-Pair Transmit/Receiver Crystals Imported

Free! Lafayette's 1964 Catalog No. 640

422 Giant-Size Pages Everything in Electronics, Hi-Fi, C.B., Test Equipment, Amateur Gear, TV and Radio Parts, and much more.



LAFAYETTE Radio ELECTRONICS
Dept. JG-4 P.O. Box 10,
Syosset, L.I., N.Y. 11791

Rush me FREE Giant 422 Page 1964 Cat. 640

HA-150L Walkie-Talkie \$ Enclosed Shipping Charges Collect

NAME _____
ADDRESS _____
CITY _____ STATE _____ ZIP _____

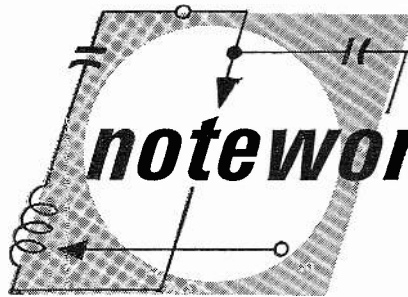

noteworthy Circuits

Two-Tube Superhet

I built this 2-tube superhet for bedside use. Being interested only in local reception, I decided that a 6BE6 converter and a 6AU6 grid-leak detector would be adequate. Oscillator pulling was a problem in the original version—even after the detector was converted to

from the secondary winding until it tunes to 900 kc. Align both windings on a 450-kc signal. The secondary will peak at 900 kc.

The converter runs wide open and there is no need for a volume control on my set. If the converter overloads on a

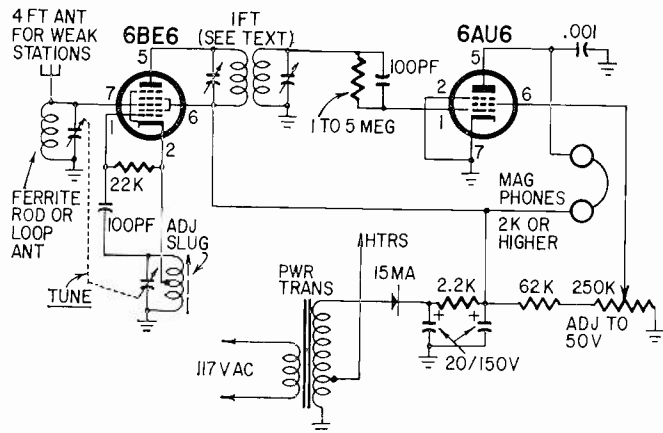

a regenerative type.

I solved the problem by using a 900-kc i.f. (There are no stations on 900 kc in this area so i.f. interference is not a problem.) The i.f. transformer must be modified. Using a grid-dip meter as a resonance indicator, remove turns

strong signal, apply fixed or variable negative bias to the signal grid. The power transformer came from an old TV booster. Any small half-wave power transformer will work. Select the tuning capacitor to match the antenna and oscillator coils.—Robert E. Flanagan

Simple Noise Clipper

This simple noise clipper and volume limiter can be added to most receivers without drastic circuit modifications. It is inserted between the voltage amplifier and the output stage or between the receiver and the headphones. It prevents signals from exceeding a pre-set level.

The author, G3OGR, says in *Short Wave Magazine* (London, England): "Set the clip control for maximum volt-

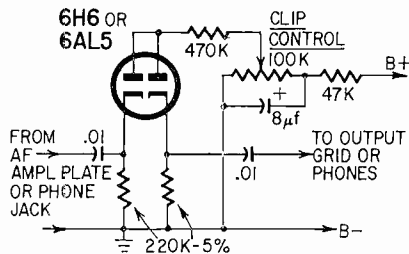

age on the diode plates and adjust the receiver's volume control to the level that you don't want to exceed. Now, adjust the clip control until the volume just begins to drop. The volume will not exceed this level."

Improving the Cascode Circuit

The reliability of the series-connected cascode circuit can be considerably improved by the simple addition of one resistor. The circuit commonly employed is shown in Fig. 1. Here the input and agc voltages are applied to the grid of the first tube, while the grid of the

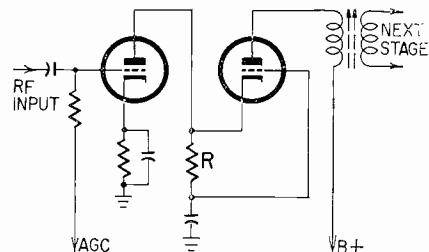

second tube receives grid-leak bias through R. When a strong signal is being received, the agc increases the negative bias on the first tube, and reduces the plate current. However, the bias on the second tube does not change. For the given plate current, then, the voltage across the first tube becomes much greater than the voltage across the sec-

ond. Since the heaters are near ground potential, the heater-cathode voltage of the second tube is greatly increased. Although the tubes normally used for cascode service are rated to withstand this increased voltage, reliability is obviously better served if it can be avoided.

This can be done by adding a resistor equal in value to R, and connecting the two resistors as in Fig. 2. Here the grid voltage on the second tube is held fixed at one-half the B-plus voltage.

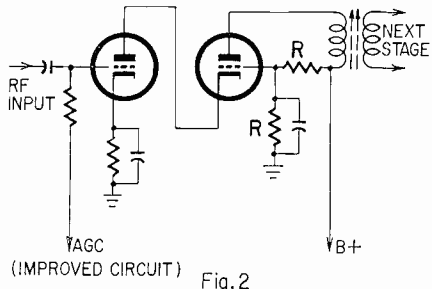

Fig. 2

Now, when the agc voltage on the first tube increases, and its plate voltage rises, the negative bias on the second tube will increase, and the voltage drops across the two tubes will be equalized. The increase in the heater-cathode voltage of the second tube will thus be almost completely eliminated.—Charles Erwin Cohn

Rf Output Indicator

This device indicates when your ham rig is on the air. No direct coupling is needed. The components are few.

The silicon controlled rectifier (SCR), a G-E type X-5, is energized by 6.3 volts ac. It conducts and lights the pilot when sufficient rf is picked up at the gate element. The potentiometer which controls the firing point (without

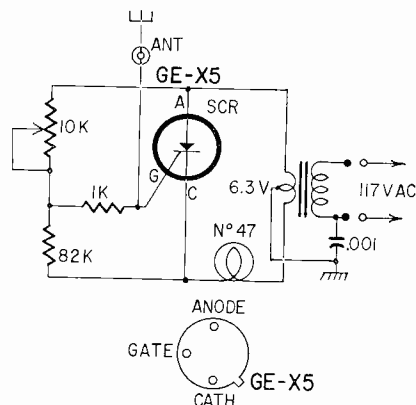

rf pickup) is set just under the firing point. Then the rf fires it. To increase sensitivity, tie a metal plate or can cover (about 2 inches in diameter) to the junction of the pot and the two resistors.

I use this arrangement in connection with a 40-watt transmitter using pi-network coupling to a single-wire antenna. The indicator is about 4 feet from the antenna terminal, and operates well on all bands from 15 to 80. Not only does it remind me to throw the antenna switch, it can be used to check keying, and to some extent can be used to tune the antenna. Brightness of the lamp varies somewhat with rf output.—I. Queen, W2OUX

END

All you need to know about SERVICING COLOR TV

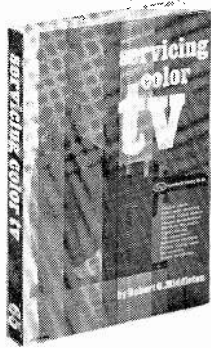

By Robert G. Middleton. A practical book that tells how to service color TV sets and make money doing it. Packed with information. Illustrated with hundreds of photos, drawings and troubleshooting charts. 224 pages.

G/L No. 65 \$2.90

and then some...



RAPID TV REPAIR
By G. Warren Heath. Lists over 500 TV troubles alphabetically. Helps you fix the toughest troubles fast. Cross-referenced. 224 pages.
G/L No. 60 \$2.90



NEW SHORTCUTS TO TV SERVICING
By Leonard C. Lane (2 vols.) A practical servicing speed-up course. No theory or math, but heavy on test and repair techniques that save time and help you get those sets off your bench. 320 pages.
G/L 95 set/\$5.90



BASIC TV COURSE
By George Kravtitz. A book on TV as it is today. Technical details presented in easy-to-follow writing style.
G/L No. 105 \$4.10

BOOKS PURCHASED FOR PROFESSIONAL PURPOSES ARE TAX DEDUCTIBLE. Buy these books from your electronic parts distributor or send in the coupon below.

GERNSBACK LIBRARY/154 West 14th Street, New York, N.Y. 10011



74

ENCLOSED is \$.....
Please send me the books indicated.

Name.....

Write book number:

Street.....

City.....State.....Zip Code.....

ZIP stands for the Post Office Department's new Zoning Improvement Plan. When renewing your RADIO-ELECTRONICS subscription, or sending us a change of address, please let us know what your ZIP Code is. We'll add it to your address mailing plate... and you'll get speedier delivery service from the Post Office. By the way, when writing to us, address: RADIO-ELECTRONICS, 154 West 14th St., New York, N. Y. 10011.

ELECTRONICS



Engineering-Technicians

Bachelor of Science Degree, 30 Months
Save Two Years' Time

- Radio-Television Plus Color Technician (12 Months)
- Electronics Engineering Technology (15 Months)
- Electronics Engineering (B.S. Degree)
 - Electrical Engineering (B.S. Degree)
 - Mechanical Engineering (B.S. Degree)
 - Civil Engineering (B.S. Degree)
 - Architecture (B.S. Degree) (36 Months)

The Nation's increased demand for Engineers,

Electronic Technicians, Radio TV Technicians is at an all time high. Heald Graduates are in demand for Preferred High Paying Salaries. Train now for a lucrative satisfying lifetime career.

Approved for Veterans
DAY AND EVENING CLASSES

Write for Catalog and Registration Application.
New Term Starting Soon.

HEALD'S

ENGINEERING COLLEGE

Est. 1863—101 Years
Van Ness at Post, RE
San Francisco, Calif.

Your Name

Address

City

State

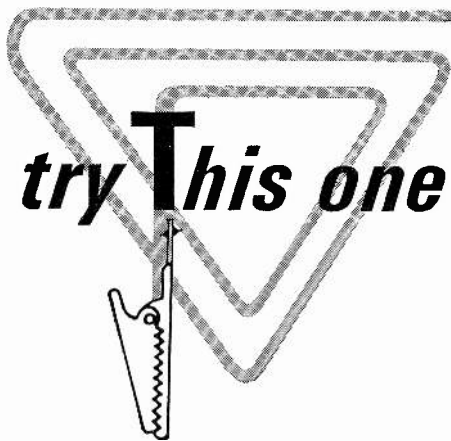

Handy Radio Tool

Slip a Mueller No. 60 alligator clip over the tapered tip of an artist's brush to make a handy home-made radio

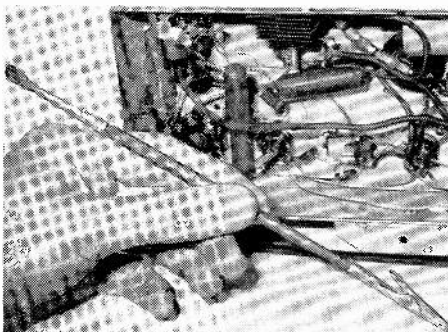

tool. Use the clip end to hold parts or wires while soldering them in and out of circuits. Use the same end for stringing dial cords and starting nuts and screws. Solvent and lubricant application is easy with the brush end.—*Allen C. Johnson*

Ring of "Plastic Metal" Prevents Cord Pull-Out

To prevent a cord from pulling out of a phone plug, a ring of Duro "Plas-



tic Aluminum" or steel daubed around the cord as shown makes a good stop. This idea is also applicable to many other types of electrical connectors.—*John A. Comstock*

Anchoring and Shielding Subminiature Tubes

When you breadboard circuits with subminiature tubes, hold them in place and shield them as well with strips of copper tape as shown in the drawing below.

Lay a strip of the tape down on the breadboard where you want to put the

tube. Position the tube over it and tape the tube down with another strip. If you let an edge of the lower strip stick out, you can bond the two electrically with an overlapping blob of solder, and attach a ground wire.

If you can't get adhesive copper tape, strips of copper foil coated with rubber cement will work as well.—*Tom Jaski*

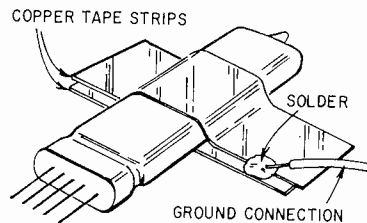

Soldering Phone Tips

To save time and do an extra-neat job when you have a number of phone

tips to solder, adapt an old soldering iron point by drilling a hole through it. This hole should slip over the solder cup easily. Insert the end of the wire, drop the iron down over the holder, and lift

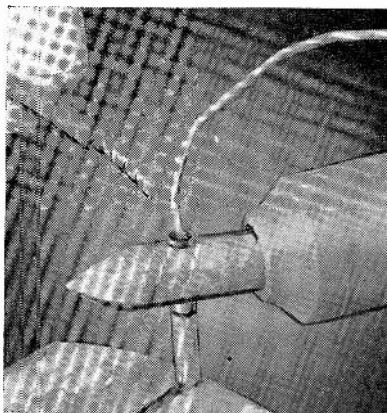

Fig. 1

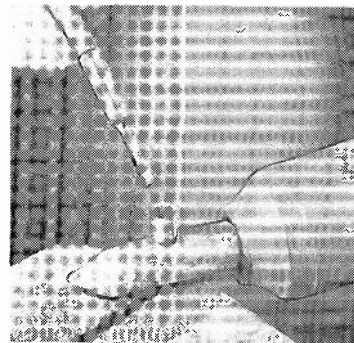

Fig. 2

tips to solder, adapt an old soldering iron point by drilling a hole through it. This hole should slip over the solder cup easily.

Fasten an extra phone tip firmly in a

the wire away as soon as the solder has cooled sufficiently (Fig. 2.) The result is a clean job without the usual little globs of solder on the outside.—*Hugh Lineback*

Make an Allen-Wrench Kit

This tool will get your Allen wrenches into tight spots and also store them all together inside itself!

Get an old socket wrench (nut driver) whose business end can take a 1/4-inch spacing nut. Bore out its handle to as large a diameter as possible and

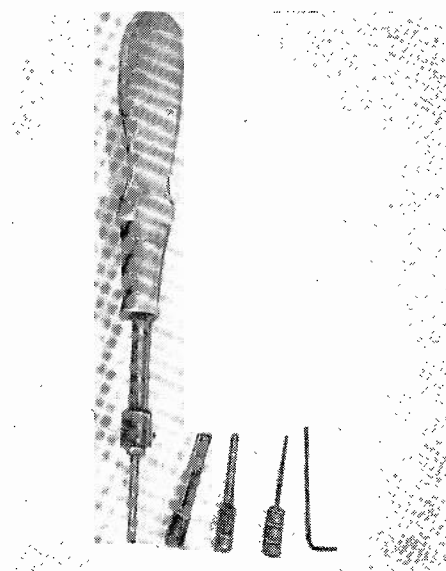
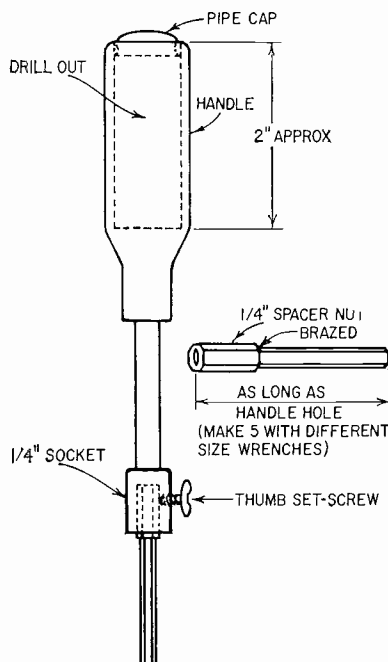

about 2 inches deep. Anneal the socket end (if necessary) and drill and tap an 8-32 hole for a setscrew or thumbscrew.

Fit the ends of your Allen wrenches into 1/4-inch spacing nuts and braze or silver-solder them in. To use them, slip them into the socket of the nut driver and tighten the setscrew. When you're through, slip all the wrenches into the drilled-out handle and close the end with a pipe cap.—*Peter Legon*

Tube and Bottle Caps Make Control Knobs

Toothpaste tubes, medicine bottles, hair tonic bottles and many other sources will provide you with an unlimited variety of colorful and modern

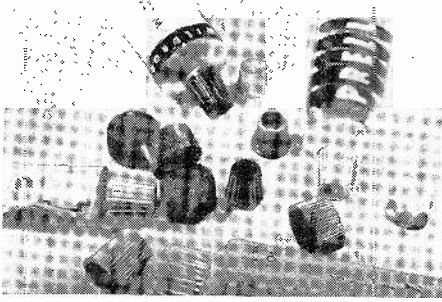

control knobs for your electronic equipment.

The first photograph shows a few of the products that come in tube form and the different styles of caps available

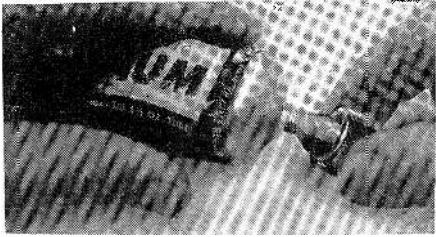

from them. The second photograph shows how the hollow part of the cap is filled with a quick-setting metallic plastic and is then pressed onto the shaft of the control. When the plastic has set, a

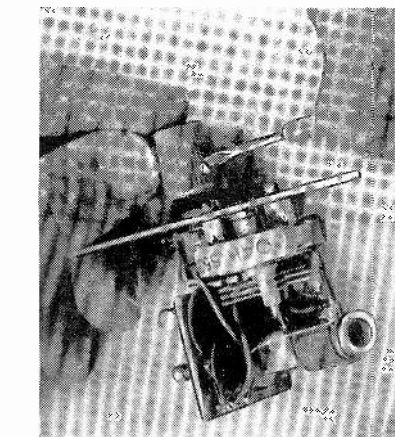

hole is drilled through and tapped so that a control knob setscrew can be inserted.

The last photograph shows a completed knob mounted on the gain control of a transistorized receiver.—*Capt. René E. Pittet, Jr.*

Nail Clippers Trim Leads

A pair of fingernail clippers will snip wires in tight chassis corners and do an exceptionally neat job of nipping off the ends of leads on printed circuit boards.

Smaller than "dykes," they make a cleaner cut and a much closer one. They

BRAND NEW UNITED'S FIRST QUALITY TUBES DISCOUNTS up to 80% OFF GUARANTEED ONE FULL YEAR! NOT USED! NO PULLS! WHY PAY MORE?

Tube	Price	Tube	Price	Tube	Price	Tube	Price	Tube	Price	Tube	Price	Tube	Price	Tube	Price
0A2	.80	3D74	.79	6A05	.57	6C78	.90	6GX6	.92	7HG8	1.67	12D4	.67	17H3	.95
0A3	.99	3GR8	.77	6A06	.59	6C79	.88	6GX8	.92	7J7	1.50	12D5	1.05	17JZ	1.98
0A4G	1.35	3HS8	1.29	6A07	1.55	6C80	1.10	6GY5	.92	7K7	1.45	12D6	.91	17L6	1.25
0B2	.80	3Q4	.79	6A08	1.20	6C81	.87	6GZ5	.94	7L7	1.45	12D7	1.02	18E8	1.54
0B3	1.20	3S4	.73	6A09	.84	6C82	.86	6H5	2.99	7N7	1.25	12D8	1.02	18FX6	.51
0C3	.75	3V4	.71	6A09	.95	6C83	1.05	6H6	1.51	7P7	1.50	12D9	1.33	18FX6	.48
0D3	.80	4AU6	.94	6A09	2.19	6C84	1.75	6H8	1.65	7R7	1.15	12D9	.82	18Y6	.48
0G3	2.75	4AV6	1.15	6A11	1.64	6C84	1.75	6H8	1.65	7S7	1.60	12DT5	.74	19A4	.85
0V4	1.20	4B6	.85	6A11	1.64	6C85	1.10	6H8	1.65	7U7	1.45	12DT7	.77	19B6	1.35
0Z4	.77	4BC5	.95	6A12	1.00	6C86	1.52	6H8	1.65	7V7	1.45	12DT8	.76	19E8	1.79
1A3	.70	4B8	1.69	6A12	2.75	6C87	.89	6J4	2.95	7X6	.95	12DW7	1.20	19HV8	1.44
1A5	.90	4B8	1.90	6A13	1.20	6C88	1.20	6J4	2.95	7Y7	1.25	12DY8	1.75	19JN8	1.20
1A6	.70	4B8	1.35	6A14	1.00	6C89	1.20	6J4	2.95	7Z7	.95	12E6	.87	20E8	1.47
1A7	1.05	4B8	.99	6A15	.47	6C90	1.40	6J6	3.65	7Z7	.95	12E6	.60	21E6	1.37
1A7A	1.35	4B8	.95	6A16	.84	6C91	1.75	6J8	3.65	8A8	.93	12E6	.99	21E6	1.92
1AG4	1.73	4B8	1.29	6A17	.84	6C92	2.50	6J8	3.65	8A8	.93	12E6	.60	25A4	.68
1AX2	.60	4B8	.95	6A18	1.75	6D0	1.56	6J8	3.65	8A8	.93	12E6	.60	25A4	.68
1B4	1.20	4C6	.95	6A19	.50	6D1	1.96	6J8	3.65	8A8	.93	12E6	.60	25A4	.68
1C5	.70	4C6	.95	6A20	.50	6D2	1.96	6J8	3.65	8A8	.93	12E6	.60	25A4	.68
1DN5	.53	4C6	.95	6A21	.85	6D3	1.96	6J8	3.65	8A8	.93	12E6	.60	25A4	.68
1G6	.69	4D6	1.25	6A22	1.75	6D4	1.96	6J8	3.65	8A8	.93	12E6	.60	25A4	.68
1H5	1.00	4D6	.57	6A23	1.49	6D5	1.96	6J8	3.65	8A8	.93	12E6	.60	25A4	.68
1H6	.70	4E6	.94	6A24	.88	6D6	1.96	6J8	3.65	8A8	.93	12E6	.60	25A4	.68
1J5	.95	4E6	1.19	6A25	.73	6D7	1.96	6J8	3.65	8A8	.93	12E6	.60	25A4	.68
1J6	.95	4E6	.59	6A26	1.30	6D8	1.96	6J8	3.65	8A8	.93	12E6	.60	25A4	.68
1K3	.64	4G6	1.29	6A27	.99	6D9	1.96	6J8	3.65	8A8	.93	12E6	.60	25A4	.68
1LA4	1.30	4H6	.92	6A28	3.80	6D0	1.35	6J8	3.65	8A8	.93	12E6	.60	25A4	.68
1LA5	2.50	4H6	1.10	6A29	1.34	6D1	1.35	6J8	3.65	8A8	.93	12E6	.60	25A4	.68
1LB6	1.45	4H6	.92	6A30	1.34	6D2	1.35	6J8	3.65	8A8	.93	12E6	.60	25A4	.68
1LB8	1.80	4H6	.77	6A31	.48	6D3	1.35	6J8	3.65	8A8	.93	12E6	.60	25A4	.68
1L6	1.25	4H6	.88	6A32	.92	6D4	1.35	6J8	3.65	8A8	.93	12E6	.60	25A4	.68
1LD5	1.95	4H6	1.90	6A33	2.00	6D5	1.35	6J8	3.65	8A8	.93	12E6	.60	25A4	.68
1LE4	2.95	4H6	.81	6A34	.59	6D6	1.35	6J8	3.65	8A8	.93	12E6	.60	25A4	.68
1LG5	1.95	4H6	.84	6A35	1.00	6D7	1.35	6J8	3.65	8A8	.93	12E6	.60	25A4	.68
1LM4	1.25	4H6	.99	6A36	.95	6D8	1.35	6J8	3.65	8A8	.93	12E6	.60	25A4	.68
1LN4	1.25	4H6	1.29	6A37	1.15	6D9	1.35	6J8	3.65	8A8	.93	12E6	.60	25A4	.68
1NS	.95	4H6	.79	6A38	.42	6E0	1.35	6J8	3.65	8A8	.93	12E6	.60	25A4	.68
1R5	.75	4H6	.82	6A39	.82	6E1	1.35	6J8	3.65	8A8	.93	12E6	.60	25A4	.68
1S4	1.15	4H6	.84	6A40	1.60	6E2	1.35	6J8	3.65	8A8	.93	12E6	.60	25A4	.68
1S5	.75	4H6	.75	6A41	1.60	6E3	1.35	6J8	3.65	8A8	.93	12E6	.60	25A4	.68
1T4	.70	4H6	.75	6A42	.63	6E4	1.35	6J8	3.65	8A8	.93	12E6	.60	25A4	.68
1U5	.63	4H6	.99	6A43	1.45	6E5	1.35	6J8	3.65	8A8	.93	12E6	.60	25A4	.68
1V	1.05	4H6	1.49	6A44	1.50	6E6	1.35	6J8	3.65	8A8	.93	12E6	.60	25A4	.68
1X2B	.80	4H6	.84	6A45	1.50	6E7	1.35	6J8	3.65	8A8	.93	12E6	.60	25A4	.68
2A3	1.15	4H6	.82	6A46	1.05	6E8	1.35	6J8	3.65	8A8	.93	12E6	.60	25A4	.68
2A5	1.10	4H6	.82	6A47	1.49	6E9	1.35	6J8	3.65	8A8	.93	12E6	.60	25A4	.68
2A6	1.10	4H6	1.07	6A48	1.07	6E0	1.35	6J8	3.65	8A8	.93	12E6	.60	25A4	.68
2A7	1.50	4H6	1.45	6A49	1.03	6E1	1.35	6J8	3.65	8A8	.93	12E6	.60	25A4	.68
2AH2	1.23	4H6	.95	6A50	1.03	6E2	1.35	6J8	3.65	8A8	.93	12E6	.60	25A4	.68
2AS2	1.25	4H6	.90	6A51	.95	6E3	1.35	6J8	3.65	8A8	.93	12E6	.60	25A4	.68
2B3	.95	4H6	.80	6A52	1.05	6E4	1.35	6J8	3.65	8A8	.93	12E6	.60	25A4	.68
2B7	.70	4H6	.84	6A53	1.25	6E5	1.35	6J8	3.65	8A8	.93	12E6	.60	25A4	.68
2BN4	.95	4H6	1.10	6A54	1.40	6E6	1.35	6J8	3.65	8A8	.93	12E6	.60	25A4	.68
2C5	.95	4H6	1.40	6A55	.68	6E7	1.35	6J8	3.65	8A8	.93	12E6	.60	25A4	.68
2D21	.70	4H6	1.00	6A56	1.20	6E8	1.35	6J8	3.65	8A8	.93	12E6	.60	25A4	.68
2X2	.60	4H6	1.25	6A57	1.25	6E9	1.35	6J8	3.65	8A8	.93	12E6	.60	25A4	.68
2ZA	1.20	4H6	.80	6A58	1.25	6F0	1.35	6J8	3.65	8A8	.93	12E6	.60	25A4	.68
3A3	.74	4H6	2.25	6A59	1.05	6F1	1.35	6J8	3.65	8A8	.93	12E6	.60	25A4	.68
3A4	.74	4H6	1.45	6A60	1.05	6F2	1.35	6J8	3.65	8A8	.93	12E6	.60	25A4	.68
3A5	1.10	4H6	1.95	6A61	1.07	6F3	1.35	6J8	3.65	8A8	.93	12E6	.60	25A4	.68
3AF4	1.50	4H6	1.95	6A62	.99	6F4	1.35	6J8	3.65	8A8	.93	12E6	.60	25A4	.68
3AL5	1.44	4H6	1.00	6A63	1.25	6F5	1.35	6J8	3.65	8A8	.93	12E6	.60	25A4	.68
3AT2	1.25	4H6	1.95	6A64	1.43	6F6	1.35	6J8	3.65	8A8	.93	12E6	.60	25A4	.68
3AU6	.52	4H6	2.50	6A65	1.40	6F7	1.35	6J8	3.65	8A8	.93	12E6	.60	25A4	.68
3AV6	.40	4H6	2.00	6A66	2.00	6F8	1.35	6J8	3.65	8A8	.93	12E6	.60	25A4	.68
3B2	.45	4H6	1.45	6A67	1.92	6F9	1.35	6J8	3.65	8A8	.93	12E6	.60	25A4	.68
3B7	1.35	4H6	.99	6A68	1.45	6F0	1.35	6J8	3.65	8A8	.93	12E6	.60	25A4	.68
3BA6	.88	4H6	.99	6A69	.79	6F1	1.35	6J8	3.65	8A8	.93	12E6	.60	25A4	.68
3BC5	.61	4H6	.99	6A70	1.92	6F2	1.35	6J8	3.65	8A8	.93	12E6	.60	25A4	.68
3BE6	.90	4H6	.68	6A71	.95	6F3	1.35	6J8	3.65	8A8	.93	12E6	.60	25A4	.68
3BN4	.99	4H6	.95	6A72	.95	6F4	1.35	6J8	3.65	8A8	.93	12E6	.60	25A4	.68
3B6	.79	4H6	1.05	6A73	.95	6F5	1.35	6J8	3.65	8A8	.93	12E6	.60	25A4	.68
3BU8	.76	4H6	1.05	6A74	.95	6F6	1.35	6J8	3.65	8A8	.93	12E6	.60	25A4	.68
3BV6	.56	4H6	1.95	6A75	.95	6F7	1.35	6J8	3.65	8A8	.93	12E6	.60	25A4	.68
3BZ6	.54	4H6	1.95	6A76	.95	6F8	1.35	6J8	3.65	8A8	.93	12E6	.60	25A4	.68
3CB6	.89	4H6	1.95	6A77	.95	6F9	1.35	6J8	3.65	8A8	.93	12E6	.60	25A4	.68
3CE5	.54	4H6	.79	6A78	.95	6G0	1.35	6J8	3.65	8A8	.93	12E6	.60	25A4	.68
3CF6	1.00	4H6	1.45	6A79	.95	6G1	1.35	6J8	3.65	8A8	.93	12E6	.60	25A4	.68
3CG5	.56	4H6	.76	6A80	.95	6G2	1.35	6J8	3.65	8A8	.93	12E6	.60	25A4	.68
3CD6	1.45	4H6	3.18	6A81	1.80	6G3	1.35	6J8	3.65	8A8	.93	12E6	.60	25A4	.68
3DE6	.83	4H6	2.45	6A82	1.60	6G4	1.35	6J8	3.65	8A8	.93	12E6	.60	25A4	.68
3DK6	.58	4H6	1.50	6A83	1.60	6G5	1.35	6J8	3.65	8A8	.93	12E6	.60	25A4	.68
3DT6	.52	4H6	1.50	6A84	1.60	6G6	1.35	6J8	3.65	8A8	.93	12E6	.60	25A4	.68

SEND FOR COMPLETE PARTS CATALOG WITHOUT COST

TERMS: Minimum order \$5.00 exclusive of postage. Remit full price plus postage NO C.O.D. The above list does not reflect our entire stock as we have one of the largest selections of SPECIAL PURPOSE, BROADCAST & TV TUBES in the U.S. Write for quotation.

SAMS Best Sellers

LATEST EDITIONS OF TWO FAMOUS HOWARD W. SAMS HANDBOOKS!



Tube Substitution Handbook

still the Leading Reference—lists 10,000 Tube Substitutions Absolutely indispensable! 7 Sections cover: Cross-reference of American Receiving Tubes; Cross-reference of Subminiature Tubes; Industrial Substitutes for Receiving Tubes; Communications and Special-Purpose Tubes; Foreign Substitutes for American Types; American Substitutes for Foreign Types; Picture Tube Substitutions. 128 pages; 5½ x 8½". \$150
Order TUB-7, still only.....



Transistor Substitution Handbook

Computer-Selected Substitutes for Over 5,000 Transistors—Updated! Lists over 40,000 direct substitutions, including all popular types used in transistor radios and similar equipment. Shows basing diagrams, polarity identification and manufacturers for over 5,000 types. Special section lists more than 15,000 American replacements for foreign transistors—plus a semiconductor and diode guide containing 800 substitutions. 128 pages, 5½ x 8½". Order SSH-5, still only \$150

Transistor Ignition Systems Handbook

by Brice Ward. Transistor ignition systems are revolutionizing the auto industry. This new book clearly explains the principles of these highly efficient systems—how they work, how to install them, how to tune them up. Describes typical systems now in use; provides complete data on installation. 128 pages; 5½ x 8½". Order IGS-1, only..... \$250

Color TV Servicing Made Easy

by Wayne Lemons. Written in "make easy" style. Takes the mystery out of color TV servicing. Introduces you to color principles and setup adjustments; thoroughly covers color circuitry, adjustments, and servicing of all color TV sets produced to date. This book will help to put you into this fast-growing, profitable service work. 128 pages, 5½ x 8½". \$295
Order CSL-1, only.....

PHOTOFACT Guide to TV Troubles

by Herrington & Oliphant. Contains over 240 photos of actual TV picture troubles, keyed to defective components in typical circuits. Shows exactly what happens to picture tube display when any component becomes defective. By making the quick checks recommended in special charts, troubleshooting is reduced to minutes. 160 pages, 5½ x 8½". \$295
Order PFG-1, only.....

Troubleshooting with the Oscilloscope

by Bob Middleton. Explains how you can best use the scope to actually view and analyze electronic circuit actions, and apply what you see to more effective TV and radio troubleshooting. Practical chapters on scope operation, use of probes, signal-tracing, visual alignment, signal testing, circuit analysis, and troubleshooting TV, Radio, and Hi-Fi. 128 pages; 5½ x 8½". Order TOS-1, only \$250

Troubleshooting with the VOM-VTVM

by Bob Middleton. Shows how to use these instruments for troubleshooting TV circuits. Tells how to check and interpret voltages; gives step-by-step procedures for analyzing every type of TV circuit. Also describes measurement and analysis of both AC and DC voltages, resistance, capacitance, and RF signals. 160 pages; 5½ x 8½". \$250
Order TWV-1, only.....

Phonograph Cartridge & Needle Replacement Guide

by the Howard W. Sams Technical Staff. Most comprehensive guide available to replacement cartridges and needles. Listed by original parts numbers and by equipment manufacturers' model and part numbers. Fully cross-referenced. 96 pages, 5½ x 8½". Order RCN-1, only..... \$195

HOWARD W. SAMS & CO., INC.

Order from your Sams Distributor today, or mail to Howard W. Sams & Co., Inc., Dept. RE-7 4300 W. 62nd Street, Indianapolis 6, Ind.

Send me the following books:

- TUB-7 IGS-1 PFG-1 TWV-1
 SSH-5 CSL-1 TOS-1 RCN-1

\$ _____ enclosed. Send FREE Booklist

Name _____

Address _____

City _____ Zone _____ State _____

My Distributor is _____

IN CANADA: A. C. Simmonds & Sons, Ltd., Toronto 7

new Patents

Stereo Television

PATENT No. 2,955,156

Morton L. Heilig, New York, N. Y.

Many feel that the best audio stereo effect is obtainable from phones rather than speakers. Likewise, 3-D pictures look more natural through a direct viewer than through a projector.

through optical systems. The case also holds two earphones connected via separate audio channels.

Various controls are included for focusing and adjusting the picture and sound.

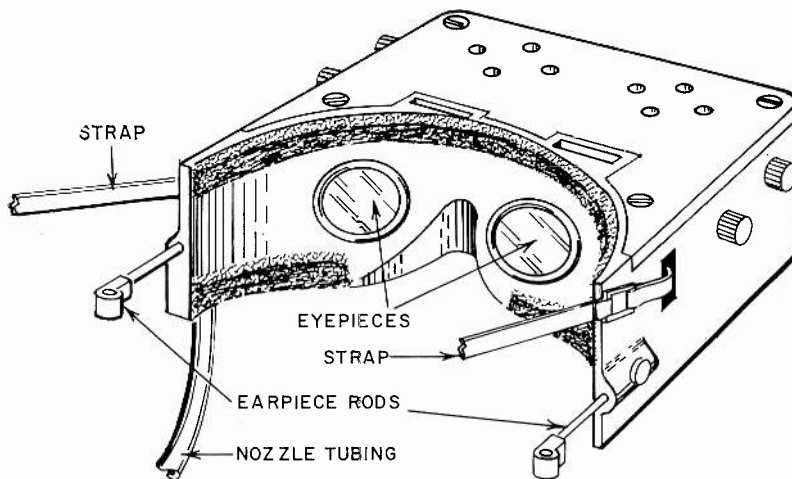

These principles are applied here to TV. Two small kinescopes within a small case are strapped to the head of the viewer. The tubes are energized by separate video channels, and the pictures focused

For added realism, small nozzles, connected via external tubing, send air streams to the viewer's nostrils. They may bring scents, breezes, or temperature changes as desired.

Wireless Microphone

PATENT No. 3,105,938

Peter K. Onnigian, Sacramento, Calif., and Keith Kirstein, Sacramento, Calif.

This radio transmitter is designed especially for TV studios. In the diagram, Q1 and Q2 are audio amplifiers, and the output is fed through an

modulated rf is further amplified by Q4, then radiated from a ferrite loop antenna.

The FM signals override static and manmade

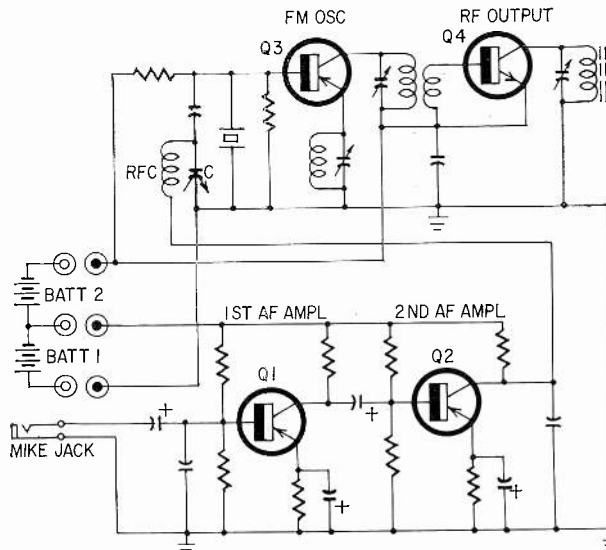

rf choke to C, a voltage-controlled capacitor. As its capacitance changes (at the audio rate), it frequency-modulates crystal oscillator Q3. The

noise. The entire circuit may be constructed as a self-contained, sealed module, with batteries accessible for replacement.

SCHOOL DIRECTORY

B. S. Degree in 36 months

Small professionally-oriented college. Four-quarter year permits completion of B.S. Degree in three years. Summer attendance optional. **Engineering:** Electrical (electronics or power option), Mechanical, Civil, Chemical, Aeronautical. **Business Administration:** General Business, Accounting, Motor Transportation Administration. One-year Drafting-Design Certificate program. Outstanding placement of graduates. Founded 1884. Rich heritage. Excellent faculty. Small classes, 200-acre campus. Well equipped labs. New library. Residence halls. *Modest costs.* Enter Sept., Jan., March, June. *For Catalog and View Book, write J. G. McCarthy, Director of Admissions.*



TRI-STATE COLLEGE

2474 College Avenue • Angola, Indiana

ENGINEERING EDUCATION for the Space Age

NORTHROP INSTITUTE of Technology is a privately endowed, nonprofit college of engineering offering a complete Bachelor of Science Degree Program and TWO-YEAR accredited technical institute curricula. Students from 50 states, many foreign countries. Outstandingly successful graduates employed in aeronautics, electronics, and space technology. Write today for catalog—no obligation.

NORTHROP INSTITUTE OF TECHNOLOGY
1181 West Arbor Vitae Street, Inglewood 1, California

WHEN YOU ORDER MERCHANDISE BY MAIL . . .

- Be sure to include your name and address. Use your zip code number if you know it.
- Type or print if you can—if not, write clearly.
- Don't send cash! Remit by check or money order.
- Include allowances for postage charges if you know the weight of what you're ordering.
- Mention you saw it in **RADIO-ELECTRONICS**.

Antilog Circuit

PATENT No. 3,089,968

Dale W. Dunn, Van Nuys, Calif. (Assigned to General Precision, Inc.)

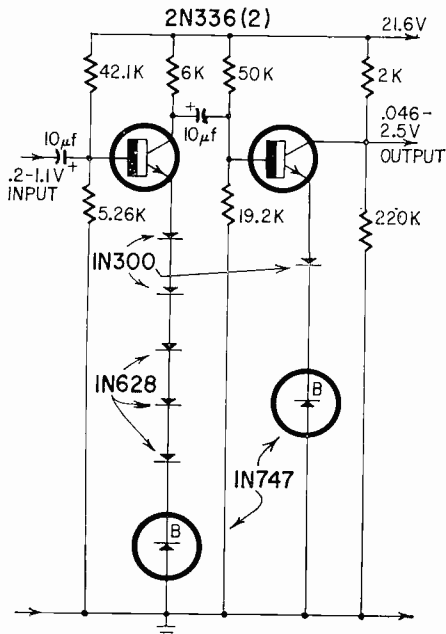

GET INTO ELECTRONICS

V.T.I. training leads to success as technicians, field engineers, specialists in communications, guided missiles, computers, radar and automation. Basic & advanced courses in theory & laboratory. Electronic Engineering Technology and Electronic Technology curricula both available. Assoc. degree in 29 mos. B.S. also obtainable. G.I. approved. Graduates in all branches of electronics with major companies. Start Sept., Feb. Dorms, campus. High school graduate or equivalent. Catalog.

VALPARAISO TECHNICAL INSTITUTE
Department C, Valparaiso, Indiana



EARN Engineering DEGREE

You can earn an A.S.E.E. degree at home. College level HOME STUDY courses taught so you can understand them. Continue your education, earn more in the highly paid electronics industry. Missiles, computers, transistors, automation, complete electronics. Over 27,000 graduates now employed. Resident school available at our Chicago campus—Founded 1934. Send for free catalog.

American Institute of Engineering & Technology
1139 West Fullerton Parkway, Chicago 14, Ill.



Engineering Technician
A.S. Degree—2 Years
Electronics Engineer
B.S. Degree
Evening Courses Available

ELECTRONIC TECHNICAL INSTITUTE
970 W. Manchester Ave., Inglewood, Calif.
4863 El Cajon Blvd., San Diego, Calif.



MICROWAVE TECHNIQUES—TV
INDUSTRIAL ELECTRONICS
COMPUTERS—RADIO TRANS-
MITTERS—RADAR—TRANSISTORS

PHILADELPHIA WIRELESS TECHNICAL INSTITUTE

1333 Pine Street Philadelphia 2, Pa.
Founded in 1908 • A Non-Profit Corp.

Write For Free Catalog RE
WEEKLY TUITION

With very low inputs, the resistance of a crystal diode varies logarithmically with respect to voltage. The resistance drops sharply with rising voltage. When a diode is connected in the emitter return of a transistor, the voltage gain of the stage becomes proportional to the antilog of the signal. With larger signals, the gain rises sharply.

This circuit provides true antilog outputs over the voltage ranges indicated. Diodes are connected in series to extend the logarithmic range. Zeners prevent current flow until a critical voltage is exceeded.

This circuit converts any log to its original number or antilog. It is useful in computers where numbers are multiplied by adding their logs.

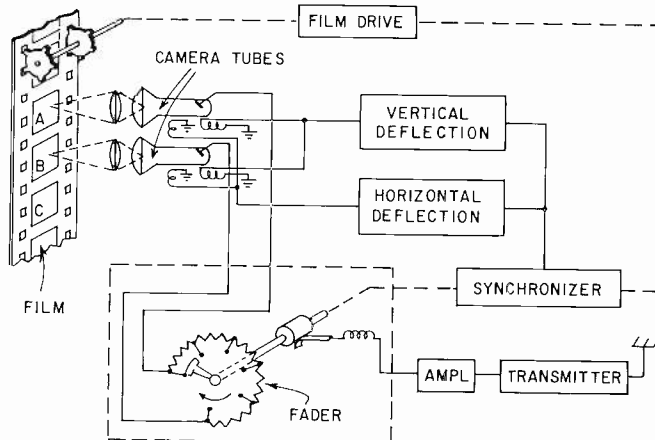

Narrow-Band TV

PATENT No. 3,108,155

Jacob Rabinow, Takoma Park, Md. (Assigned to Rabinow Engineering Co., Inc., Takoma Park, Md.)

This patent suggests transmitting only 6 frames per second to save bandwidth. The receiver repeats frames to make a total of 30 per second as usual. To avoid jumpiness (resulting from so few different frames), two successive frames, say A and B, are stored at the receiver, while A is faded out and B faded in.

One possible method (see drawing) utilizes image orthicon tubes to scan identical portions of A and B. Outputs appear across the tapped potentiometer. A rotating wiper arm stays on each tap for the duration of a frame. Thus on the first tap, the output will be that of A alone. On the second tap, the output will be 80% of A and 20% of B, and so on. When the wiper reaches the last tap, the system is blanked out and the film moved one frame. When it reaches the first tap again, the output will be that of B alone, and then an increasing amount of C will be added.

The film is moved at the relatively slow speed of 6 frames per second.

when it's time to think of college you should read this **FREE CAREER BOOKLET** about electronics at

MISOE

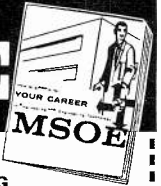

MILWAUKEE SCHOOL OF ENGINEERING

Dept. RE-764, 1025 N. Milwaukee Street

Milwaukee, Wisconsin 53201

Tell me about an engineering career through residential study in:

Electrical fields Mechanical fields

Name.....Age.....

Address.....

City, State.....



\$3 TO \$5 AN HOUR REPAIRING ELECTRIC APPLIANCES

FREE BOOK tells about profitable business. 400 MILLION Appliances now in use. People need them fixed. YOU make good money doing it—right at home! Easy course trains you for top earnings. At no extra charge you get Appliance Tester. Get FREE Book, FREE Sample Lesson!

NATIONAL RADIO INSTITUTE, Appliance Division
Dept. 503-74, Washington 16, D. C.

Send Free Book, Free Appliance Repair Course Lesson.

Name

Address

City

Zone

State

new Books

BASIC JUNCTION DEVICES AND CIRCUITS, by Roy H. Mattson. John Wiley & Sons, 605 3rd Ave., New York 16, N.Y. 5 3/4 x 9 in., 460 pp. Cloth, \$9.75.

Engineering text with many examples to illustrate circuit design.

ABC's of TELEVISION SERVICING, by Howard W. Sams Engineering Staff. Howard W. Sams & Co., Inc., 4300 W. 62 St., Indianapolis 6, Ind., 5 1/2 x 8 1/2 in., 96 pp. Paper, \$1.95.

Prepared for radio technicians. Includes some theory, troubleshooting charts, color codes and pilot-lamp data.

G-E SCR MANUAL, third edition. Rectifier Components Dept., General Electric Co., Auburn, N.Y. 5 1/2 x 8 1/2 in., 409 pp. \$2.00, spiral-bound.

New schematics and new applications, plus design notes, protective methods, cooling data, and detailed characteristics. The newly developed gate turn-off switch and light-activated SCR are included.

ELEMENTS OF TRANSISTOR TECHNOLOGY, by Robert G. Middleton. Howard W. Sams & Co., Inc., 4300 W. 62 St., Indianapolis 6, Ind. 5 1/2 x 8 1/2 in., 288 pp. Cloth, \$6.95.

Principles of transistors and circuits,

written for technicians. Discusses theory, bias, feedback, ratings and practical circuits. Questions and answers.

FARADAY, MAXWELL, AND KELVIN by D. K. C. MacDonald. Anchor Books, Doubleday & Co., Inc., Garden City, N.Y. 4 x 7 in., 143 pp. Paper, \$1.25.

Serious and well written biographies of these three pioneers of electronics. With excellent illustrations.

INTRODUCTORY TOPICS IN THEORETICAL PHYSICS, by Roald K. Wangsness. John Wiley & Sons, Inc., 605 Third Ave., New York 16, N.Y. 5 3/4 x 9 in., Cloth, \$8.50.

An advanced text on relativity, thermodynamics, kinematics and statistical mechanics.

TRANSISTORS — A Self-instructional Programed Manual, Prentice-Hall, Inc., Englewood Cliffs, N.J. 6 1/2 x 9 in., 430 pp. Cloth, \$12.

As the reader slides a card down each page, he finds first a question and then (just below it) its answer. Thus he learns at his own pace, from elementary theory to amplifier, modulator, switching and logic circuits.

HALL-EFFECT INSTRUMENTATION, by Barron Kemp. Howard W. Sams & Co., Inc., 4300 W. 62 St., Indianapolis 6, Ind. 5 1/4 x 8 1/2 in., 128 pp. Cloth, \$4.95.

Complete, non-math description of Hall devices for measuring fields and currents, generating FM, PM and SSB. Many practical circuits.

ELECTRIC COMPONENT TESTS AND MEASUREMENTS, by Robert G. Middleton. Howard W. Sams

& Co., Inc., 4300 W. 62 St., Indianapolis 6, Ind., 5 1/2 x 8 1/2 in., 159 pp. Paper, \$2.95.

Shows how to make quick, accurate tests on capacitors, diodes, transformers, transmission lines, etc.

THE RESEARCH AND DEVELOPMENT ENGINEER AS MANAGER, by Thomas Moranian. Holt, Rinehart & Winston, Inc., 383 Madison Ave., New York 17, N.Y. 5 1/2 x 8 1/2 in., 152 pp. Cloth, \$3.00.

Problems in correlating research, production and management, written from the standpoint of the project leader and his engineers.

INSIDE ELECTRONICS by Monroe Upton. Devin-Adair Co., 23 E. 26 St., New York, N.Y. 10010. 6 x 8 1/2 in., 262 pp. Cloth, \$5.95.

The how and why of electronics, from the discovery of the peculiar properties of amber to hi-fi stereo, explained in the language of the layman.

TV SERVICING METHODS GUIDEBOOK, by Robert G. Middleton. Howard W. Sams & Co., Inc., 4300 W. 62 St., Indianapolis 6, Ind. 5 1/2 x 8 1/2 in., 159 pp. Paper, \$2.95.

This new method uses one section of a receiver to check another. Diagrams and photos explain.

ELECTRONIC ENGINEERS AND TECHNICIANS REFERENCE HANDBOOK, by Electronic Teaching Laboratories. Howard W. Sams & Co., Inc., 4300 W. 62 St., Indianapolis 6, Ind. 5 1/2 x 8 1/2 in., 224 pp. Cloth, \$4.95.

Provides a basic understanding of oscillators, multivibrators, resonant circuits, semiconductors, etc. Covers theory and numerical examples. Math limited to simple algebra.

BASIC PULSE CIRCUITS, by Richard Blitzer. McGraw-Hill Book Co., 330 W. 42 St., New York, N.Y. 10036. 6 x 9 1/2 in., 436 pp. Cloth, \$11.75.

This interesting work explains the mathematics it uses as it goes along. Thus it becomes a simple and useful, though limited, mathematics course, since all the mathematical instruction is in connection with practical problems.

TRANSISTOR SUBSTITUTION HANDBOOK (Fifth Edition). Howard W. Sams & Co., Inc., 4300 W. 62 St., Indianapolis 6, Ind. 5 1/2 x 8 1/2 in., 128 pp. Paper, \$1.50.

Accurate and complete guide to domestic and foreign transistors and diodes. END

TRANSISTOR NETWORK CALCULATIONS, by Dr. Harry E. Stockman. Sine-Ser Co., PO Box 3, Arlington, Mass. 02174. 8 1/2 x 11 in., 125 pp. Paper, spiral bound, \$2.75.

Rigorous classroom text covers network problems on college level, using transistors as active elements. All problems solved. Symbolic and LaPlace-transform solutions, floating matrix techniques, other transformations. Appendices contain two-port theory and matrix tables.

TELEVISION SYSTEMS MAINTENANCE (Vol. 4 of Broadcast Engineering Notebooks), by Harold E. Ennes. Howard W. Sams & Co., Inc., 4300 W. 62 St., Indianapolis 6, Ind. 5 1/2 x 8 1/2 in., 288 pp. Paper, \$5.95.

A reference and study text for broadcast engineers and technicians. Describes systems theory and techniques for testing and troubleshooting especially with oscilloscope. END

Now save hours of design time with GERNSBACK LIBRARY'S new

ELECTRONIC DESIGN CHARTS

By Norman H. Crowhurst

A comprehensive collection of nomographs in one convenient book.

Simplifies design procedures. Saves hours of time and effort on computations. Helps solve virtually every electronic design problem quickly. Eliminates uncertainty and mistakes. Large, accurate, clear charts on 8 1/2 x 11 page size. Lies flat or stands up.

Permanently cloth-bound **\$5.95**

Money-back guarantee within 10 days if not completely satisfied with book

GERNSBACK LIBRARY, Inc.
154 West 14th Street, New York, N. Y. 10011 74E

Enclosed is \$_____. Please send _____ copy(ies) of **Electronic Design Charts** @ \$5.95.

Name _____

Street _____

City _____ State _____ Zip Code _____

- 59 CHARTS
- 128 PAGES
- FULL EXPLANATION
- EASY-TO-READ TEXT

An invaluable, convenient working tool for engineers and technicians with useful charts like these: Frequency and Wavelength • Reactance and Frequency • Time Constants • Input Chokes • Vector Addition of Complex Quantities • Parallel Resistors and Series Capacitors • AND 53 OTHER CHARTS.

BOOKS PURCHASED FOR PROFESSIONAL PURPOSES ARE TAX DEDUCTIBLE

Radio-Electronics Market center

SILICON RECTIFIER SALE

IMMEDIATE DELIVERY
FULLY GTD AMERICAN MADE  NEWEST TYPE FULLY TESTED

750 MA-SILICON "TOPHAT" DIODES
LOW LEAKAGE FULL LEAD LENGTH

PIV/RMS 50/35 .05 ea.	PIV/RMS 100/70 .09 ea.	PIV/RMS 200/140 .12 ea.	PIV/RMS 300/210 .16 ea.
PIV/RMS 400/280 .20 ea.	PIV/RMS 500/350 .24 ea.	PIV/RMS 600/420 .32 ea.	PIV/RMS 700/490 .40 ea.
PIV/RMS 800/560 .48 ea.	PIV/RMS 900/630 .55 ea.	PIV/RMS 1000/700 .70 ea.	PIV/RMS 1100/770 .75 ea.

ALL TESTS AC & DC & FWD & LOAD

SILICON POWER DIODE STUDS

D.C. AMPS	50 PIV 35 RMS	100 PIV 70 RMS	150 PIV 105 RMS	200 PIV 140 RMS
.3	.15 ea.	.20 ea.	.25 ea.	.35 ea.
.5	.45	.65	.75	.90
.75	1.05	1.30	1.50	1.70
1.0	1.60	2.10	2.40	3.00
1.5	1.80	2.30	2.75	3.25

D.C. AMPS	300 PIV 210 RMS	400 PIV 280 RMS	500 PIV 350 RMS	600 PIV 450 RMS
.3	.43 ea.	.52 ea.	.62 ea.	.68 ea.
.5	1.10	1.35	1.50	1.70
.75	2.40	2.55	3.00	3.50
1.0	3.50	4.20	5.25	7.00
1.5	3.80	4.65	5.65	8.00

"SCR" SILICON CONTROLLED RECTIFIERS "SCR"

PRV	7 AMP	16 AMP	25 AMP	PRV	7 AMP	16 AMP	25 AMP
.75	.55	.90	1.25	2.50	2.55	2.80	3.30
1.0	1.40	1.95	2.25	4.00	3.50	3.75	4.30
1.50	1.75	2.25	2.75	5.00	4.30	4.60	5.00
2.00	2.00	2.65	3.05	6.00	5.00	5.35	5.80

Money Back guarantee. \$2.00 min. order. Orders F.O.B. NYC. Include check or money order. Shpg. charges plus. C.O.D. orders 25% down.

Warren Electronic Components

87 Chambers St. NYC 7, NY Wo 2-5727

SEMI-CONDUCTORS***NEW

2N705, 2N711: Tungsol, VHF, 325 MC min., PNP 1.25
 2N696 VHF Planar Silicon 1.25
 PNP and NPN transistors; Audio, IF, HF, HFT, Osc. etc. 3/\$1.00
 1N537, Tophat; Silicon, Raytheon, etc. .30
 Zener Diodes—12 volt; 1 amp. 1.00
 Zener Diodes—1½ volt; Transistron SV3372 .30
 NE 2A-Neon Bubs 8/\$1.00
 DPDT slide switch: Stackpole .15
 DPST Slide Switch—Stackpole 8/\$1.00
 C.B. Transformer: Pri. 5000 ohms, output to speaker, phones, and modulation at 4 watts 1.50
 2K, 5K & 10K volume control with switch—P.C. (CTS) Miniature Your Choice 3/\$1.00
 Parts for 2 Watt Audio Power amplifier, consisting of 3 transistors, including 1 power transistor, resistors, electrolytics, together with schematic. Miniature .30
 Above amplifier completely assembled in module, with instructions .50
 Preamp to match above with schematic .15
 Code Oscillator Module; completely assembled, schematic .10
TRANSISTOR IGNITION SYSTEM; 6 to 12 volt negative ground, factory packed with instructions, simple installation .21.95
 455 KC I.F. transformer, 455 KC oscillator coil; sub-min 3/\$1.00
 Parts for 12 volt, 1 amp. REGULATED power supply, with schematic and instructions .87.75
 S. C. R. stud rectifiers, silicon controlled 10 amp -50 volt \$2.00
 S. C. R. Stud—3 amp—100 volt \$1.00
 Electrolytics; all values, miniature 8/\$1.00
 1N 91 Germanium Diode (GE) .30
 Battery Clip for 9 volt transistor batteries with red & white wire leads 10/\$1.00
 ST415—Silicon VHF (Transistron) 1.50
 Mesa Transistor, 100 mc, NPN 1.00

WRITE FOR FREE ADDITIONAL CATALOG.

Minimum order \$3 Prepaid Postage free in U.S.A.
TRANSISTORS UNLIMITED COMPANY

Post Office Box #442, Great Neck, L. I., N.Y.
 516 - PI 7-7221

"TAB", SILICON 750MA* DIODES

Factory Tested!
 *NEWEST TYPE! LOW LEAKAGE G.I.D.

PIV/RMS 50/35 .05	PIV/RMS 100/70 .09	PIV/RMS 200/140 .12	PIV/RMS 300/210 .16
PIV/RMS 400/280 .20	PIV/RMS 500/350 .24	PIV/RMS 600/420 .32	PIV/RMS 700/490 .40
PIV/RMS 800/560 .48	PIV/RMS 900/630 .55	PIV/RMS 1000/700 .70	PIV/RMS 1100/770 .75

ALL TESTS AC & DC & FWD & LOAD!

D.C. Power Supply: OULPAC 330&165VDC @ 150 Ma. Inpt 115V/60 to 80 yrs. Cased! Special \$5

Silicon Power Diodes Studs & P.F.*

D.C. AMPS	50PIV 35RMS	100PIV 70RMS	150PIV 105RMS	200PIV 140RMS
.3	.12	.18	.22	.30
.5	.25	.45	.60	.85
.75	1.00	1.25	1.50	1.80
1.00	1.75	2.25	2.65	3.20
1.50	6.50	7.70	8.90	10.40

D.C. AMPS	300PIV 210RMS	400PIV 280RMS	500PIV 350RMS	600PIV 420RMS
.3	.40	.50	.60	.66
.5	1.10	1.30	1.50	1.70
.75	1.00	1.30	Query	Query
1.00	2.35	2.55	3.00	3.50
1.50	3.75	4.60	5.00	8.00
2.40	19.50	27.50	32.00	36.00

Sil. Pressfit 18A up to 100 Piv .4 for \$1
 Micro or MuSwitch CSD 35 Amp/AC-DC .3 for \$1

"TAB" * SCR'S * TRANSISTORS * DIODES!!!

Full Leads Factory Tested & G.I.D. U.S.A. Mfg.

2N441, 442, 277, 278, DP501 up to 50 volts VCB0 \$1.25 @ .5 for \$5
 2N278, 443, 174 up to 80V Pkg \$2 for \$5
 PNP 10Watt/3A-2N155, 156, 235, 242, 252, 255, 256, 257, 301, 351, 351, 351 @ 4 for \$1
 PNP Signal up to 350MHz TO-18, c25 @ 6 for \$1
 NPN/Signal I.F. RF. OSC. TO-18, c25 @ 6 for \$1
 PNP 2N670/300Wm c35 @ 4 for \$1
 Silicon PNP TO5 & TO18 Pkg c25 @ 5 for \$1
 TO36, TO3, Pkg Mica Mtg Kit 5 for \$1
 Power Heat Sink Finned 80 Sq \$1.25 @ 5 for \$5
 3 Amp/TO3/Pwr Transistors Untested 10 for \$1
 Pwr Transistors TO3/3A Untested 10 for \$1
 Stabilizer Diodes up to one watt 5 for \$1
 Silicon Diodes 35 Amp Studs Untested 3 for \$1
 Silicon Diodes epoxy/750Ma Untested 25 for \$1

2N1038 4/\$1, 1039 3/\$1, 1040 2/\$1, 1041 \$1
 2N538, 539, 540/3 Amp \$1
 Zener 30/60V Auto Ignition \$1
 100K Auto Ignition Transistors Untested \$3
 Kit Zeners 400 Mw to 10W Ass'd 3 for \$1

"SCR" SILICON CONTROLLED RECTIFIERS!

PRV	7A	16A	25A	PRV	7A	16A	25A
.75	.55	.90	1.25	2.50	2.55	2.80	3.30
1.0	1.40	1.95	2.25	4.00	3.50	3.75	4.30
1.50	1.75	2.25	2.75	5.00	4.30	4.60	5.00
2.00	1.85	2.50	3.00	6.00	5.00	5.15	5.65

Silicon Diodes 3&6 Amp Studs Untested 12 for \$1
 Glass Diodes 1N34/48/60/64 Untested 20 for \$1

"TAB" TERMS: Money Back Guarantee!
 Our 18th year. \$2 Min. order
 F.O.B. N.Y.C. Add shpg charges
 or for C.O.D. 25% Dep. Prices
 shown subject to change.
 111-GU, Liberty St., N. Y. 6, N.Y.
 Send 25¢ Phone: REctor 2-6245 for Catalog

GIGANTIC SALE

FACTORY TESTED NEW

SILICONS	750 M.A. 600 PIV	AUTO-RADIO	SAVE THAT
10—\$2.50	D.S.501 3—\$2.50	METER	METER SAVER
100—\$22.00	2N155 3—\$1.00	\$1.98	

QUANTITY PRICES — DIODES, ZENERS, SCR'S

A. B. ENG. 2043 E. 52nd St.
 BROOKLYN 34, N.Y.

LOW-COST BUSINESS AIDS FOR RADIO-TV SERVICE

Order books, invoice forms, job ticket books, service call books, cash books and statement books for use with your rubber stamp. Customer file systems, book-keeping systems, many others. Write for **FREE 32 PAGE CATALOG** now.

OELRICH PUBLICATIONS
 6556 Higgins Rd., Chicago, Ill. 60656

FREE CATALOG!

148 PAGES • NEARLY 4,000 BARGAINS
 OPTICS • SCIENCE • MATH

completely new, enlarged edition, new items, categories, illustrations. 148 new, easy-to-read pages packed with nearly 4,000 items. Dozens of electrical and electromagnetic parts, accessories. Enormous selection of Astronomical Telescopes, Microscopes, Binoculars, Magnifiers, Magnets, Lenses, Prisms. Many war surplus items: for hobbyists, experimenters, workshop, factory. Write for catalog "EH"

CLIP AND MAIL COUPON TODAY

EDMUND SCIENTIFIC CO., Barrington, N. J.
 PLEASE SEND ME FREE CATALOG "EH"
 Name _____
 Address _____
 City _____ State _____ Zip _____

Solve Electronics Problems Fast With Special New Slide Rule

Professional, high quality instrument . . . specifically designed for electronic engineers and technicians . . . made to our rigid specs by Pickett & Eckel. Has special scales for solving reactance and resonance frequency problems. Accurately and quickly locates decimal points. Carries widely used formulas and conversion factors not found on any other slide rule. Comes complete with top-grain leather carrying case, illustrated instruction manual, 90 day consultation service — all for just \$14.95. Carries lifetime guarantee against defects in material and workmanship.

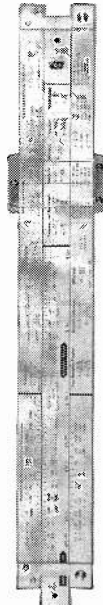

SEND COUPON TODAY

TO: CLEVELAND INSTITUTE OF ELECTRONICS

1776 E. 17th St., Dept. RE-101, Cleveland, Ohio 44114
 Please send me your electronics slide rule. I am enclosing \$14.95. (If not fully satisfied after 10 day trial, CIE will refund payment.)
 Please send additional descriptive literature.

Name _____ (Please Print)
 Address _____
 City _____ State _____ Zip _____

FREE Catalog OF THE WORLD'S FINEST ELECTRONIC GOVT SURPLUS BARGAINS



HUNDREDS OF TOP QUALITY ITEMS — Receivers, Transmitters, Microphones, Inverters, Power Supplies, Meters, Phones, Antennas, Indicators, Filters, Transformers, Amplifiers, Headsets, Converters, Control Boxes, Dynamometers, Test Equipment, Motors, Blowers, Cable, Keyers, Chokes, Handsets, Switches, etc., etc. Send for Free Catalog—Dept. RE.

FAIR RADIO SALES
 2133 ELIDA RD. • Box 1105 • LIMA, OHIO

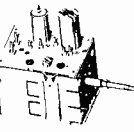

TV TUNERS REBUILT and Exchanged \$9.50 plus shp. chgs. ONLY*
 All Makes-Models
 • Includes All Parts Except Tubes
 • Aligned to Factory Specifications
 • 90 Day Full Warranty
 • Practical repairs

Ship tuner complete with tubes, broken parts, tuner cover. Give model # and state complaint.
VALLEY TV TUNER SERVICE • PO 9-4730
 5641-A Cahuenga Blvd., North Hollywood, Calif.

WANTED RADIO NEWS, Vol. 10-July '28-Apr. '29

Needed a complete volume of the above magazine. We are willing to pay a reasonable sum for it. It can be either the loose copies, if in good condition, or a bound volume. State best price to:
RADIO-ELECTRONICS
 Room 301, 154 W. 14 Street, New York, N.Y. 10011

RENT STEREO TAPES

FREE BROCHURE  Postpaid 2 to 5 day delivery (48 States)
stereo-parti
 1616-D TERRACE WAY, SANTA ROSA, CALIF.

CLASSIFIED ADVERTISING ORDER FORM

Please refer to heading on top of classified section for complete data concerning terms, frequency discounts, closing dates, etc.

1	2	3	4	5
6	7	8	9	10
11	12	13	14	15
16	17	18	19	20
21	22	23	24	25
26	27	28	29	30
31	32	33	34	35

No. of Words { @ .30 Non-Commercial Rate } = \$ _____
 { @ .55 Commercial Rate }

Total Enclosed \$ _____

Insert _____ time(s)

Starting with _____ issue

Payment must accompany order unless placed through accredited advertising agency.

NAME _____

ADDRESS _____

CITY _____ STATE _____ ZIP _____

SIGNATURE _____

SEE HEADING OF CLASSIFIED SECTION FOR WORD COUNT.

GIANT \$ DOLLAR SALE

FREE \$25.00 Check Here **WORTH OF** TRANSISTORS DIODES
 RECTIFIERS COILS
 RESISTORS KNOBS
 CONDENSERS ETC.
 Add 25¢ for handling

FREE \$1.00 Check Here **PLUS** **CHOOSE ANY \$1.00 ITEM LISTED BELOW FREE**

BOTH BONUS #1 AND #2 FREE WITH ANY \$10.00 ORDER

SALE! SALE! SALE!
25 25 TRANSISTORS: audio switching, 115 VAC SPST
 25 TOP HAT RECTIFIERS 750 mil
 25 EPOXY RECTIFIERS axial lead, 750 mil
 25 GERMANIUM DIODES 1N34, 1N48
\$1 per pak



EPITAXIAL NPN PLANAR SILICON 2N1613 \$1.49
 • 3 WATT 125 mc WORTH \$10.00
 • TO5 case

WORLD'S MOST POPULAR \$1 PARTS PAKS

- 2 SENSITIVE RELAYS, 6500 OHM, 2-mil, SPST ..\$1
- 3 MERCURY SWITCHES, 115 VAC SPST ..\$1
- 25 SPRAGUE YELLOW MYLAR COND., to 1mf. ..\$1
- 3 UTC SUBOUNCER TRANSISTOR TRANSFORMERS \$1
- 10 ELECTROLYTICS, FP & tubulars, to 500 mf ..\$1
- 40 "TEXAS" PRECISION RESISTORS to 2W, 1%, 1/10W \$1
- 60 CERAMIC CONDENSERS, discs, npo's to .05mf \$1
- 40 WORLD'S SMALLEST RESIST., 5% too, 1/10W \$1
- 40 SUBMINIATURE COND., to .05mf, ceramal too ..\$1
- 3 'TINY' V. CONTROLS, w/sw. 2K, .5meg, 1meg \$1
- 10 TRANSISTOR TRANSFORMERS, asst, worth \$25. \$1
- 1 INFRARED PHOTO DETECTOR TRANSDUCER \$1
- 1 INFRARED PARABOLIC REFLECTOR & FILTER \$1
- 50 ONE WATTERS, resistors, asst values, 5% too \$1
- 60 TUBULAR CONDENSERS, to .5mf to 1KV ..\$1

10 WATT ZENERS \$1.49 ea.

<input type="checkbox"/> 5V	<input type="checkbox"/> 14V	<input type="checkbox"/> 42V	<input type="checkbox"/> 70V	<input type="checkbox"/> 100V
<input type="checkbox"/> 6V	<input type="checkbox"/> 20V	<input type="checkbox"/> 45V	<input type="checkbox"/> 80V	<input type="checkbox"/> 110V
<input type="checkbox"/> 12V	<input type="checkbox"/> 24V	<input type="checkbox"/> 60V	<input type="checkbox"/> 90V	<input type="checkbox"/> 124V

SILICON POWER DIODE STUDS

Amps	Volts	Sale	Amps	Volts	Sale	Amps	Volts	Sale
10	50	1.50	100	1.25	50	100	2.95	
10	100	2.95	200	1.50	100	25	1.50	
10	200	3.75	300	1.75	100	25	1.50	
10	400	5.95	400	1.95	100	50	1.50	
10	800	8.95	600	2.50	100	100	2.95	
10	1000	9.95	35	50	1.05	100	150	2.75
10	50	49.50	150	1.50	240	25	4.95	
10	100	69.50	200	1.75	240	100	6.95	
10	200	88.50	250	1.95	240	150	8.75	
10	300	1.19	35	2.00	240	200	8.25	
10	400	1.37	50	2.5	100	240	12.50	
10	50	.99	50	1.95	240	400	19.95	

POLY PAKS
 TERMS: send check, money order, include postage—avg. wt. per pak 1 lb. Rated, net 30 days. CODs 25%
 P.O. BOX 942R
 SO. LYNNFIELD, MASS.
 "PAK-KING" OF THE WORLD

FACTORY TESTED SEMI-KON-DUCTORS

- 2-2N341 NPN SILICON TRANSISTORS, 1 watt \$1
- 3 CB5 20-WATT TRANSISTORS, pnp, stud, 2N1320 ..\$1
- 1 3N35 TETRODE 150mc transistor, silicon ..\$1
- 5 SUN BATTERIES TO 1 1/2" sizes, lite sensitive ..\$1
- 3 2N255 PWR TRANSISTORS, or equal, TO3 case \$1
- 25 SEMI-KON-DUCTORS: transistors, diodes, rect. \$1
- 2 40-WATT TRANSISTORS, 6V, gold, axial ..\$1
- 3 ONE WATT ZENERS, 5V, gold, axial ..\$1
- 4 GENERAL ELECTRIC 2N107 PNP transistors ..\$1
- 5 GENERAL ELECTRIC 2N170 RF NPN transistors \$1
- 4 GENERAL ELECTRIC SILICON SUN CELL, 3/4x1" \$1
- 15 UPRIGHT SILICON DIODES, worth \$40 ..\$1
- 2 'MESA' 4-WATT TRANSISTORS, TO22 case ..\$1
- 4 2N35 NPN TRANSISTORS, TO22 case ..\$1
- 6 TRANSISTOR RADIO SET, osc-ifs-driver, p-p ..\$1
- 2-25-AMP SILICON STUD RECTIFIERS ..\$1
- 1-2N705 MESA 300 mc, 300 mw, pnp, TO18 ..\$1
- 20 WATT NPN SILICON MESA 2N1648 transistors \$1
- 2-500 MC PNP MESA TRANSISTORS, TO18 case \$1
- 6 TOP HAT RECTIFIERS, 750 mil, 400 volts ..\$1
- 1-SILICON NPN 'PLANAR' 2N718, TO18 case. \$1

TRANSISTRON SCRS TESTED SILICON CONTROLLED RECTIFIERS

BRAND	PRV	7 Amp	15 Amp	25 Amp
NEW	50	1.00	1.25	1.50
LOWEST	100	1.50	1.95	2.25
PRICES	200	2.25	2.75	2.95
	300	2.69	3.19	3.50
	350	2.95	3.50	4.25
	400	3.25	3.95	4.50

- 15 NPN TRANSISTORS, asst types and cases ..\$1
- 15 PNP TRANSISTORS, asst types and cases ..\$1
- 10 FAMOUS CK722 TRANSISTORS, pnp ..\$1
- 2 CBS 35W PWR TRANSISTORS, 2N1434, pnp, stud ..\$1
- 10 NPN SWITCHING transistors, 2N440 equals ..\$1
- 4 SUBMINIATURE 2N131 TRANSISTORS, rf-if, pnp ..\$1
- 4 CK721 TRANSISTORS in new aluminum case, pnp ..\$1
- SILICON PLANARS: 2N497, 2N498, each ..\$1
- 2 TRANSISTRON 1N429 ZENER REFERENCES ..\$1
- 10 2-AMP SILICON POWER RECTIFIERS, stud ..\$1
- 1 85W SILICON PWR TRANSISTOR, pnp, like 2N1212 ..\$1
- 3 2N243 750 MW NPN SILICON transistors, TO22 ..\$1
- 6 ZENER DIODES, upright styles, assorted ..\$1
- 4 2N43 OUTPUT TRANSISTOR EQUALS, pnp, TO5 ..\$1
- 6 "TEXAS" 750 MA 400V EPOXY DIODES ..\$1
- 6-2N408 RCA OUTPUT TRANSISTORS, pnp, TO1 ..\$1
- 2-2N1264 UHF TRANSISTORS, 300 mc ..\$1
- 3 TEXAS 20W. TRANSISTORS, 2N1038, pnp ..\$1
- 1-2N424 85 WATT TRANSISTOR, pnp, silicon ..\$1
- 1-2N705 300 MC, 400 MW NPN PLANAR ..\$1
- 10 TEXAS PNP-NPN TRANSISTORS ..\$1
- 3 TRANSISTRON ZENER REF. 1V, axial leads ..\$1

10¢ FOR OUR "SUMMER" BARGAIN CATALOG ON:
 Semiconductors Poly Paks Parts

ADVERTISING INDEX

Radio-Electronics does not assume responsibility for any errors which may appear in the index below.

Amperex Electronic Corp.....Second Cover
 Bozak 69
 Brooks Radio & TV Corp.....70-71
 Capitol Radio Engineering Institute, The..... 13
 Castle TV Tuner Service, Inc..... 72
 Central Technical Institute..... 59
 Centralab (Electronics Div. of Globe Union, Inc.) 21
CLASSIFIED 81
 Cleveland Institute of Electronics.....11, 79
 Coyne Electronics Institute..... 69
 DeVry Technical Institute..... 7
 EICO Electronic Instrument Co., Inc..... 16
 Electronic Measurements Corp. (EMC)..... 65
 Gernsback Library, Inc.....68-69, 73, 78
 Grantham School of Electronics..... 9
 Heald's Engineering College..... 73
 Heath Co. 55
 International Crystal Manufacturing Co., Inc. 15
 Johnson Co., E. F. 63
 Lafayette Radio Electronics Corp..... 72
 Mallory & Co., Inc., P. R.....Third Cover
MARKET CENTER 79
 National Radio Institute..... 3, 77
 National Technical Schools 5
 P&H TV Tuner Service..... 60
 Perma-Power Co. 24
 Philco-Teclrep Division (Subsidiary of Ford Motor Co.)..... 62
 Polypaks 80
 Progressive "Edu-Kits", Inc. 10
 Quam-Nichols Co. 64
 Quietrol Co. 60
 Rad-Tel Tube Co..... 62
 Raytheon 83
 RCA Electronic Components & DevicesFourth Cover
 RCA Institutes 23
 Sams & Co., Inc., Howard W.....25, 76
 Sarks Tarzian, Inc. (Tuner Service Div.)..... 8
 Schematic Library 65
SCHOOL DIRECTORY 77
 Scott, Inc., H. H. 22
 Sencore 61
 Sonotone Corp. 14
 Sylvania (Subsidiary of General Telephone & Electronics) 12
 Tarzian, Inc., Sarks (Tuner Service Div.).... 8
 United Radio Co. 17
 Weller Electric Corp.....18-19
 Winegard Co. 79
MARKET CENTER 79
 A. B. Engineering
 Cleveland Institute of Electronics
 Edmund Scientific Co.
 Fair Radio Sales
 Oelrich Publications
 Stereo-Parti
 Tab
 Transistors Unlimited Co.
 Valley TV Tuner Service
 Warren Electronic Components
SCHOOL DIRECTORY 77
 American Institute of Engineering & Technology
 Electronic Technical Institute
 Milwaukee School of Engineering
 Northrop Institute of Technology
 Philadelphia Wireless Technical Institute
 Tri-State College
 Valparaiso Technical Institute

Classified Ads

COMMERCIAL RATE (for firms or individuals offering commercial products or services): 55¢ per word... minimum 10 words.

NON-COMMERCIAL RATE (for individuals who want to buy or sell personal items): 30¢ per word... no minimum.

Payment must accompany all ads except those placed by accredited advertising agencies. 10% discount on 12 consecutive insertions, if paid in advance. Misleading or objectionable ads not accepted. Copy for September issue must reach us before July 14th.

WORD COUNT: Include name and address. Name of city (Des Moines) or of state (New York) counts as one word each. Zone or Zip Code numbers not counted. (We reserve the right to omit Zip Code if space does not permit.) Count each abbreviation, initial, single figure or group of figures or letters as a word. Symbols or groups such as 8x10, COD, AC, etc., count as one word. Hyphenated words count as two words. Minor over-wordage will be edited to match advance payment.

Audio—Hi-fi

HI-FI COMPONENTS, Tape Recorders, at guaranteed "WE will not be undersold" prices. 15-day moneyback guarantee. Two-year warranty. NO Catalog. Quotations Free. **HI FIDELITY CENTER**, 1797 (R) 1st Ave., New York, N. Y. 10028.

SAVE 30-60% Stereo music on tape. Free bargain, catalog / blank tape / recorders / Norelco speakers. **SAXITONE**, 1776 Columbia Road, Washington, D. C.

SALE ITEMS — tapes — recorders — component quotes. **BAYLA**, Box 131-RE, Wantagh, N. Y.

WRITE for highest discounts on components, recorders, tapes, from franchised distributors. Send for FREE monthly specials. **CARSTON**, 125-R East 88, N.Y.C. 10028.

RENT STEREO TAPES—over 2,500 different—all major labels—free brochure. **STEREO-PARTI**, 811-RE, Centralia Ave., Inglewood 3, Calif.

HI FI, Ham Equipment, Discount Catalog, MENDOTA CAMERA SHOP, Mendota, Minn.

TAPE recorders, Hi-Fi components, Sleep-learning equipment, Tapes, Unusual values. Free catalog. **DRESSNER**, 1523 Jericho Turnpike, New Hyde Park 5, N.Y.

EDUCATION/INSTRUCTION

FCC LICENSE in 6 weeks. First Class Radio Telephone. Results Guaranteed. **ELKINS RADIO SCHOOL**, 2603E Inwood, Dallas, Tex.

SLEEP LEARNING. Hypnotism! Tapes, records, books, equipment. Details, strange catalog FREE. **RESEARCH ASSOCIATION**, Box 24-RD, Olympia, Wash.

HOW COMPUTERS WORK. Send \$2.00 for this easy to understand bulletin. **ELECTRONICS RESEARCH LABORATORY**, Box 154, Colonial Park Station, New York, N.Y. 10039

HIGHLY—effective home study review for FCC commercial phone exams. Free literature! **COOK'S SCHOOL OF ELECTRONICS**, Craigmont, Idaho 83523.

TECHNICAL WRITING. Personal instruction by professional writers. Free lesson without obligation. **CENTURY CORRESPONDENCE SCHOOLS**, 1186A Fay, Largo, Florida.

BUSINESS AIDS

1,000 Business Cards, "Raised Letters" \$3.75 postpaid. Samples. **ROUTH**, RE7, 2633 Randleman, Greensboro, N.C. 27406.

JUST STARTING IN TV SERVICE? Write for FREE 32 PAGE CATALOG of Service Order books, invoices, job tickets, phone message books, statements and file systems. **OELRICH PUBLICATIONS**, 6556 W. Higgins, Chicago, Ill. 60656.

Electronics

PROFESSIONAL ELECTRONICS PROJECTS—Organs, Timers, Computers, etc.—\$1 up. Catalog free. **PARKS**, Box 1665, Seattle, Wash. 98125.

C-B'ERS—Ground Plane Antennas. List \$9.95 and up. Dealers wanted. Write circular. **KOMET ELECTRONICS**, P.O. 222RE, Tilton, N. H. 03276.

RADIO & TV TUBES 33¢. Free List. **CORNELL**, 4217-E University, San Diego, Calif. 92105.

BEFORE You Buy Receiving Tubes, Test Equipment, Hi-Fi Components, Kits, Parts, etc.... send for your Giant Free Zalytron Current Catalog, featuring all STANDARD BRAND TUBES all Brand New Premium Individually Boxed, One Year Guarantee—all at BIGGEST DISCOUNTS in America! We serve professional servicemen, hobbyists, experimenters, engineers, technicians. **WHY PAY MORE? ZALYTRON TUBE CORP.**, 469R Jericho Turnpike, Mineola, N. Y.

JIFFY-MAST No holes, clamps, brackets; just slip into chimney. Ideal for light weight T.V., F.M. antenna. Adjustable, fits openings to prox 11 x 11". Send \$1.95 plus .25 postage USA. **VAN ALLAN CO.**, P.O. Box 8246, Cleveland, Ohio 44133.

PRINTED CIRCUIT BOARDS. Hams, Experimenters. Catalog 10¢. **P/M ELECTRONICS**, Box 6288, Seattle, Wash. 98188.

TRANSISTOR TELEVISION TRANSLATORS. Rebroadcast 25 miles, meets F.C.C. specifications, Battery powered. **KEITH ANDERSON COMPANY**, Piedmont, So. Dak.

TRANSISTORIZED Treasure Detectors Find buried gold, silver, coins. \$19.95 up. Kits available. Free catalog. **RELCO-A25**, Box 10563, Houston 18, Texas.

7" TV TEST TUBE—\$6.99. Tubes 6146—\$2.95; 6211 (12AU7 equiv.) 39¢, 3 for \$1. Germanium diodes, tested, equiv. 1N34, 1N60 etc., 30 for \$1. Tophat silicon rectifiers, 750MA—1000 PIV 75¢. Transistors, tubes, resistors, condensers, etc., bargain priced. Free catalog. **ARCTURUS ELECTRONICS**, Dept. RE, 502-22nd St., Union City, N. J. 07087.

DIAGRAMS FOR REPAIRING RADIOS \$1.00. Television \$2.50. Give make, model. **DIAGRAM SERVICE**, Box 1151 RE, Manchester, Conn.

FREE ELECTRONICS CATALOG. Tremendous Bargains. **ELECTROLABS**, Dept. C-224-G, Hewlett, N. Y. 11557.

GOVERNMENT SURPLUS, jeeps—\$62.50, Voltmeters \$1.05, Transmitters \$6.18, Oscilloscopes, Multimeters, Speakers, Parts, Typical surplus prices. Exciting details, FREE. Write: **ENTERPRISES**, Box 402-F18, Jamaica 30, N. Y.

IGNITION! Transistor, Coil, Ballast \$7.50. Free Parts List. **TRANSFIRE**, Carlisle 20, Mass.

WHOLESALE prices on TV cameras, transmitters, converters, etc. direct from factory. Catalog 10¢. **VANGUARD**, 190-48 99th Ave., Hollis, N. Y. 11423

TRANS-NITION Electronic Ignition parts kit, Negative ground \$20. Coil, Manual **SPECIAL \$8.50 Manual \$2. ANDERSON ENGINEERING**, Wrentham, Mass.

TRANSISTOR IGNITION COILS—lowest prices, guaranteed. Information free. **ELECTROSPECIALTIES**, Box 548, Trion, Georgia 30753.

FREE CRYSTAL with 12 sensitive crystal set circuits 50¢ KTB-1, 3524 Farm Hill Blvd., Redwood City, Calif.

DIAGRAMS for 1923 to 1952 radios \$1.00, condensed television diagrams \$1.00. Give model. **DIAGRAMS**, Box 55, Williamsport, Pa.

"COIL WINDING METHODS" Handbook—50¢. Experimenter's catalog 250 exclusive items—25¢, refundable. **LABORATORIES**, 1131-B Valoia, Redwood City, Calif.

TRAN-UNIT TRANSISTORIZED IGNITION, Zener protected, coil, mounting hardware, 12 V negative ground. Free information. \$21.95 Guaranteed. **TRANS-UNIT**, 3700 Lincoln, El Paso, Texas 79930.

CONVERT any television to sensitive, big-screen oscilloscope. Only minor changes required. No electronic experience necessary. Illustrated plans \$2. **RELCO**, Box 10563, Houston 18, Tex.

TRANSISTORS, SCR's, diodes, nickel-cadmium batteries, meters, crystals, components. Quality guaranteed. Send 10¢ for catalog. **ELECTRONIC COMPONENTS CO.** P.O. Box 2902B, Baton Rouge, La. 70821.

ANSA FONE schematic, your money back on first service call. \$1.00, **JERRY REEVES**, 1815 4th Street, Seabrook, New Jersey 08303.

TRANSISTOR circuitboard semikits CB, 2M, 6M, Police/Fire converters \$1.00 each. Sweep generator 100 kc to 100mc \$2.00. Many other projects. Free catalog. **PAULIN SALES**, Box 122B, Upland, Calif. 91786.

TRANSISTORIZE your television! Free details. Write to: P.O. Box 2498, Gardena, Calif. 90247

General

TV SERVICE ORDER BOOKS for use with your rubber stamp. Duplicate or triplicate. Low cost. Write for FREE 32 PAGE CATALOG and Special Rubber Stamp Offer. **OELRICH PUBLICATIONS**, 6556 W. Higgins, Chicago, Ill. 60656.

Canadians

GIANT SURPLUS BARGAIN PACKED CATALOGS. Electronics, Hi-Fi, Shortwave, Amateur, Citizens Radio, Rush \$1.00 (Refunded), **ETCO**, Box 741, Dept. R, Montreal 1, Can.

CANADIANS Have you seen ELECTRON, Canada's own Service and Hobby magazine? Subscription \$3.50. **ELECTRON**, Box 796, Montreal, Canada.

WANTED

G-R, H-P, L&N, etc. Special tubes, manuals, military electronics. **ENGINEERING ASSOCIATES**, 434 Patterson Road, Dayton 19, Ohio.

QUICK CASH... for Electronic EQUIPMENT, COMPONENTS, unused TUBES. Send list now! **BARRY**, 512 Broadway, New York, N. Y. 10012, 212 WALKER 5-7000.

PHOTOGRAPHS and COLOR SLIDES Wanted. To \$500 each. Free information write **PICTURE**, Box 74607, Hollywood 90004.

NEW DISTRIBUTOR now buying CRT's from reliable manufacturers. Send complete details. **BEDNARCHUK SALES**, 517 Sand Creek, Coon Rapids, Minn.. 55433

SERVICES

METERS—MULTIMETERS REPAIRED and calibrated. **BIGELOW ELECTRONICS**, Box 71-B, Bluffton, Ohio.

TRANSISTORIZED products dealers catalog, \$1. **INTERMARKET**, CPO 1717, Tokyo, Japan.

SPEAKER RECONING. Satisfaction Guaranteed. **C & M REONE CO.**, 18 E. Trenton Ave., Morrisville, Pa.

ALL MAKES OF ELECTRICAL INSTRUMENTS AND TESTING equipment repaired. **HAZELTON INSTRUMENT CO.**, 128 Liberty St., New York, N.Y.

INVENTORS. We will develop, help sell your idea or invention, patented or unpatented. Our national manufacturer clients are urgently seeking new items for outright cash sale or royalties. Financial assistance available. 10 years proven performance. For free information, write Dept. 53, **WALL STREET INVENTION BROKER-AGE**, 79 Wall Street, New York, N. Y. 10005.

HELP WANTED

TELEVISION TECHNICIAN for new communication center on campus of dynamic, expanding midwestern college of 9,000+ enrollment. Complete benefit program. Experience in closed-circuit and broadcast engineering, FM and IO TV. First class FCC license required. Salary from \$6,000. Maximum age 55. Contact William R. Freed, Personnel Officer, Room 8, Administration Building, **BALL STATE TEACHERS COLLEGE**, Muncie, Indiana.

RAD-TEL'S
AMAZING OFFER...
YOUR CHOICE

IB3-IG3-IK3-IJ3

FREE!

HURRY OFFER EXPIRES
AUGUST 31, 1964

**RAD-TEL'S QUALITY
BRAND NEW TUBES**

ONE YEAR GUARANTEE

Rad-Tel will replace any tube that does not give efficient performance for 1 year from date of purchase.

ONE TUBE FREE

IB3-IG3-IK3-IJ3

with the purchase of every 10 Rad-Tel Quality
BRAND NEW TUBES

up to **75% OFF***

Manufacturers Suggested List Price

500 TYPES IN STOCK



EACH TUBE INDIVIDUALLY & ATTRACTIVELY
BOXED & BRANDED RAD-TEL

RAD-TEL TUBE CO. NOT AFFILIATED WITH ANY
OTHER MAIL ORDER TUBE COMPANY

Qty.	Type	Price	Qty.	Type	Price	Qty.	Type	Price	Qty.	Type	Price
—	0Z4	.79	—	5AQ5	.54	—	6AX5	.74	—	6DA4	.68
—	1AX2	.62	—	5AT8	.83	—	6BA6	.50	—	6DE6	.61
—	1B3	.79	—	5BK7	.86	—	6BC5	.61	—	6DG6	.62
—	1DN5	.55	—	5BQ7	1.01	—	6BC8	1.04	—	6DJ8	1.21
—	1G3	.79	—	5BR8	.83	—	6BE6	.55	—	6DK6	.59
—	1J3	.79	—	5CG8	.81	—	6BF5	.90	—	6DN6	1.55
—	1K3	.79	—	5CL8	.76	—	6BF6	.44	—	6DQ6	1.10
—	1R5	.77	—	5CQ8	.84	—	6BG6	1.70	—	6DT5	.81
—	1S5	.75	—	5EA8	.80	—	6BH8	.98	—	6DT6	.53
—	1T4	.72	—	5EU8	.80	—	6BJ6	.65	—	6DT8	.94
—	1U5	.65	—	5J6	.72	—	6BJ7	.79	—	6EA8	.79
—	1X2B	.82	—	5T8	.86	—	6BK7	.85	—	6EB5	.73
—	2AF4	.96	—	5U4	.60	—	6BL7	1.09	—	6EB8	.94
—	3AL5	.46	—	5U8	.84	—	6BN6	.74	—	6EM5	.77
—	3AU6	.54	—	5V6	.56	—	6BQ6	1.12	—	6EM7	.82
—	3AV6	.42	—	5X8	.82	—	6BQ7	1.00	—	6EU8	.79
—	3BC5	.63	—	5Y3	.46	—	6BU8	.70	—	6EV5	.75
—	3BN6	.75	—	6AB4	.46	—	6BX7	1.11	—	6EW6	.57
—	3BU8	.78	—	6AC7	.96	—	6BZ6	.55	—	6EY6	.75
—	3BY6	.58	—	6AF4	1.01	—	6BZ7	1.03	—	6F7	.69
—	3BZ6	.56	—	6AG5	.70	—	6C4	.45	—	6FV8	.79
—	3CB6	.56	—	6AH4	.81	—	6CB6	.55	—	6GH8	.80
—	3CS6	.58	—	6AH6	1.10	—	6CD6	1.51	—	6GK5	.61
—	3DG4	.85	—	6AK5	.95	—	6CG7	.61	—	6GK6	.79
—	3DK6	.60	—	6AL5	.47	—	6CG8	.80	—	6GN8	.94
—	3DT6	.54	—	6AM8	.78	—	6CL8	.79	—	6H6	.58
—	3GK5	.99	—	6AQ5	.53	—	6CM7	.69	—	6J5GT	.51
—	3Q4	.63	—	6AS5	.60	—	6CN7	.70	—	6J6	.71
—	3S4	.75	—	6AT6	.45	—	6CQ8	.92	—	6K6	.63
—	3V4	.63	—	6AT8	.86	—	6CR6	.60	—	6S4	.52
—	4BQ7	1.01	—	6AU4	.85	—	6CS6	.57	—	6SA7GT	.99
—	4CS6	.61	—	6AU6	.52	—	6CS7	.69	—	6SH7	1.02
—	4DT6	.55	—	6AU8	.87	—	6CU5	.58	—	6SJ7	.88
—	4GM6	.60	—	6AV6	.41	—	6CU6	1.08	—	6SK7GT	.95
—	5AM8	.79	—	6AW8	.90	—	6CY5	.70	—	6SL7GT	.84
—	5AN8	.90	—	6AX4	.66	—	6CY7	.71	—	6SN7	.65

Qty.	Type	Price	Qty.	Type	Price	Qty.	Type	Price	Qty.	Type	Price
—	6S4	.52	—	65Q7GT	.94	—	12AL8	.95	—	12DT5	.76
—	6S7	.88	—	6T4	.99	—	12AQ5	.60	—	12DT7	.79
—	6S8	.94	—	6T8	.85	—	12AT6	.50	—	12DT8	.78
—	6T4	.99	—	6U8	.83	—	12AT7	.76	—	12DW8	.89
—	6T8	.85	—	6V6GT	.54	—	12AU6	.51	—	12DZ6	.62
—	6U8	.83	—	6W4	.61	—	12AU7	.61	—	12ED5	.62
—	6V6GT	.54	—	6W6	.71	—	12AV6	.41	—	12EG6	.62
—	6W4	.61	—	6X4	.41	—	12AV7	.82	—	12EK6	.62
—	6W6	.71	—	6X8	.80	—	12AX4	.67	—	12EL6	.50
—	6X4	.41	—	7A8	.68	—	12AX7	.63	—	12EZ6	.57
—	6X8	.80	—	7AU7	.65	—	12AY7	1.44	—	12F8	.66
—	7A8	.68	—	7EY6	.75	—	12A27	.86	—	12FA6	.79
—	7AU7	.65	—	7Y4	.69	—	12B4	.68	—	12FM6	.50
—	7EY6	.75	—	8AU8	.90	—	12BD6	.50	—	12FR8	.97
—	7Y4	.69	—	8AW8	.93	—	12BE6	.53	—	12FX8	.90
—	8AU8	.90	—	8BQ5	.60	—	12BF6	.60	—	12GC6	1.06
—	8AW8	.93	—	8CG7	.63	—	12BH7	.77	—	12J8	.84
—	8BQ5	.60	—	8CM7	.70	—	12BK5	1.00	—	12K5	.75
—	8CG7	.63	—	8CN7	.97	—	12BL6	.56	—	12L6	.73
—	8CM7	.70	—	8CS7	.74	—	12BQ6	1.16	—	12SF7	.69
—	8CN7	.97	—	8EB8	.94	—	12BR7	.74	—	12SQ7GT	.95
—	8CS7	.74	—	8FQ7	.56	—	12B7	.76	—	12SL7	.80
—	8EB8	.94	—	9CL8	.79	—	12BY7	.77	—	12SN7	.67
—	8FQ7	.56	—	11CY7	.75	—	12BZ7	.86	—	12SU7GT	.91
—	9CL8	.79	—	12A4	.60	—	12C5	.58	—	12T6	.63
—	11CY7	.75	—	12AB5	.60	—	12CU5	.58	—	12W6	.71
—	12A4	.60	—	12AC6	.55	—	12CV6	1.06	—	12X4	.47
—	12AB5	.60	—	12AD6	.57	—	12CX6	.54	—	17AX4	.67
—	12AC6	.55	—	12AE6	.50	—	12D4	.69	—	17DQ6	1.06
—	12AD6	.57	—	12AF3	.94	—	12D8	.83	—	18FW6	.49
—	12AE6	.50	—	12AF6	.67	—	12DL8	.88	—	18FX6	.53
—	12AF3	.94	—	12AJ6	.62	—	12DQ6	1.04	—	18FY6	.50
—	12AF6	.67	—	12AL5	.47	—	12DS7	.84	—		

**OUR
16th
YEAR**

ORDER TYPES NOT LISTED

FREE! Send For New Tube & Parts Catalog
Send For Trouble Shooting Guide

Fast, Dependable service — Selling direct by mail for over 16 years

RAD-TEL Tube Co.
Dept. RE

55 Chambers Street
Newark, New Jersey 07105

ENCLOSED IS \$ _____ Please rush order.

SEND: _____ TUBE SUBSTITUTION BOOK, No. 193 @ 1.25 EACH
_____ Cheater Cord 29c ea. Lots of 3 - 25c ea. #154

Orders under \$5.00 - Add \$1.00 handling charge - plus postage.

FREE! Send FREE Tube and Parts Catalog
 Send FREE Trouble Shooting Guide

NAME _____
ADDRESS _____
CITY _____ ZONE _____ STATE _____



CHEATER CORD
Easy to work on set while panel is off.
6 ft., No. 154..... **29¢ ea.** Lots of 3 — 25¢ ea.



TUBE SUBSTITUTION BOOK

- Over 11,000 direct tube substitutes
- Only all-inclusive directory of electron tube equivalents:
 - For USA electron tubes
 - Substitutes for foreign tubes
 - Picture tubes, newer models
 - Picture tubes, older models
 - transistor replacements
 - Army-Navy, V.T. substitutes

\$1.25
No. 193

RAD-TEL TUBE CO. TV, RADIO AND HI-FI
DEPT. RE 55 CHAMBERS STREET, NEWARK, NEW JERSEY 07105

TERMS: 25% deposit must accompany all orders, balance C.O.D. Orders under \$5 add \$1 handling charge plus postage. Orders over \$5 plus postage. Approx 8 tubes per 1 lb. Subject to prior sale. No C.O.D.'s outside continental U.S.A.



Tips for Technicians

Mallory Distributor Products Company
 A division of P. R. Mallory & Co. Inc.
 Indianapolis, Indiana 46206

New Kind of Zener Diode

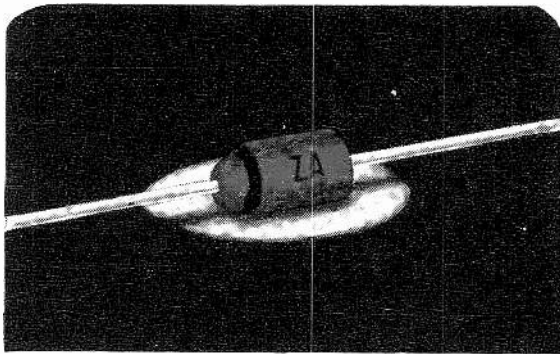

A zener diode, as you're probably aware, is a special kind of semiconductor which has excellent voltage regulating characteristics. It's the solid-state successor to the gas discharge tube. It acts like a rectifier diode, blocking current in the reverse direction, until the "zener voltage" is reached—then it starts to conduct with a capital C. The zener diode can carry appreciable current continuously. So this makes it a fine regulating device. You can use it in power supplies where you need highly accurate output. Or you can use it in clipper or clamper circuits, by biasing the diode negative.

The big news in zener diodes is that you can now get them from Mallory at a price which makes them practical for service work, experimentation, or commercial circuitry. The news-maker is the new Mallory Type ZA molded-case diode. Its electrical properties and reliability record are comparable to those of military grade units. In fact, we use the same silicon cell in the ZA as in the zener diodes we make for military requirements. But the price is only about *half* that of hermetically sealed diodes.

The ZA is rated 1 watt at 25°C. If you install it in a hot spot, you can use it at ambients up to 100°C, derating linearly to 0.5 watt. Voltage ratings go from 6.8 to 200 volts, in small increments so that you can get exactly the regulating voltage you need. Standard tolerances are 20%, 10% and 5%.

You'll like the cold-case design of the ZA. No need for insulating sleeves when you squeeze it into tight layouts. It's so small—only $\frac{3}{8}$ " long by 0.220" in diameter—that it fits practically anywhere.

Your Mallory distributor has the Type ZA in a range of ratings. He also stocks Mallory silicon rectifiers... including handy packaged doubler, bridge and center-tap circuits. See him soon!

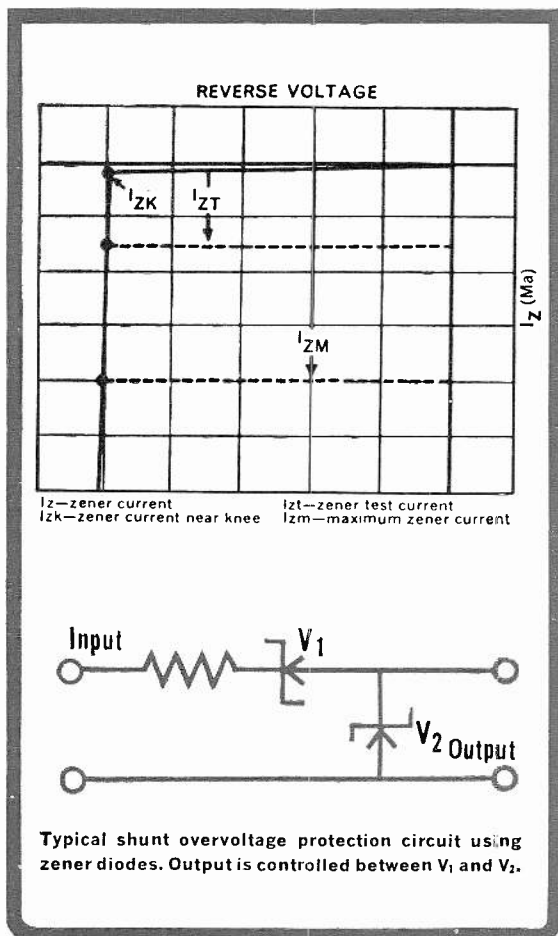



Tubes That Perform Reliably Here...



Work Well Here

At top, you're looking into the RCA Receiving Tube Reliability Laboratory—a most important factor behind the exceptional reliability of RCA receiving tubes, and one more plus-value that you have in RCA tubes.

Here in two-hundred TV sets of all sizes—black-and-white and color—samples of each week's production of RCA receiving tubes are subjected to extensive tests under actual field conditions. The operating conditions for the TV sets vary from low-line to high-

line voltages. And the sets are regularly cycled on and off to check the effects of heating and cooling on the tubes.

The Tube Reliability Laboratory reveals—and allows us to eliminate—problems that do not show up under normal production life testing. It also permits us to conduct pre-production tests of new tube designs to make certain that the RCA standards of quality will be fulfilled before the new tubes are marketed.

Testing in the Tube Reliability Lab-

oratory enables us to verify the consistent high quality of RCA receiving tubes—to maintain uniformity of characteristics from tube to tube and throughout life. It is another example of the care we take to assure that RCA receiving tubes give RELIABLE PERFORMANCE where it really counts—in your customers' sets.

SEE YOUR AUTHORIZED RCA DISTRIBUTOR FOR TOP-QUALITY RCA RECEIVING TUBES

RCA ELECTRONIC COMPONENTS AND DEVICES, HARRISON, N. J.



The Most Trusted Name in Electronics