

Radio-Electronics

NOVEMBER

TELEVISION • SERVICING • HIGH FIDELITY

MUGO GERNSBACK, Editor

**How to Fix Radios
Faster and Better**

**Hi-Way FM
The Easy Way**

**Simple Sweep Gen
Uses Varicap**

**Build a
COMPUTER for
SPORTS CAR
RALLIES - See Page 46**

50c

STEVEN WELSH 12-60
6240 TRIPP AVE
CH 6 TIL

...THERE'S NO QUESTION!

HERE'S YOUR

"BEST BUY"

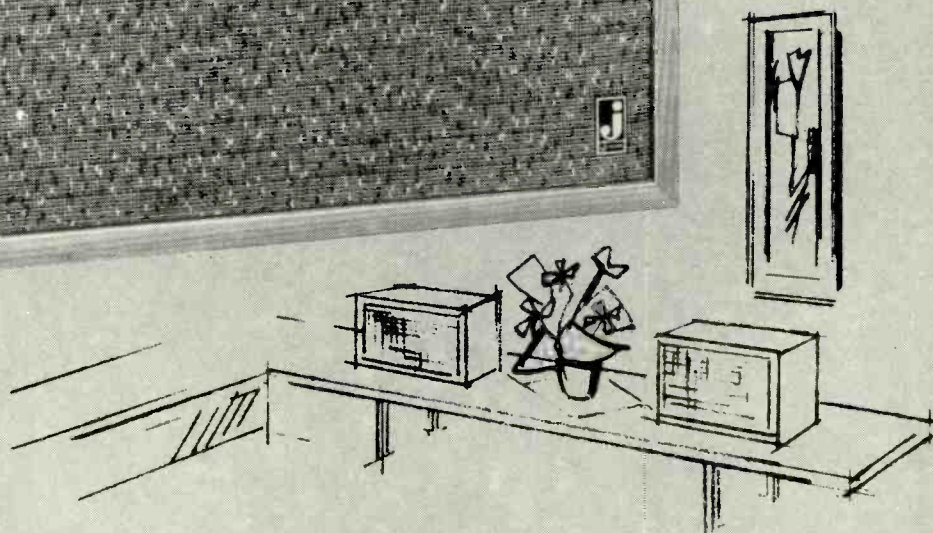
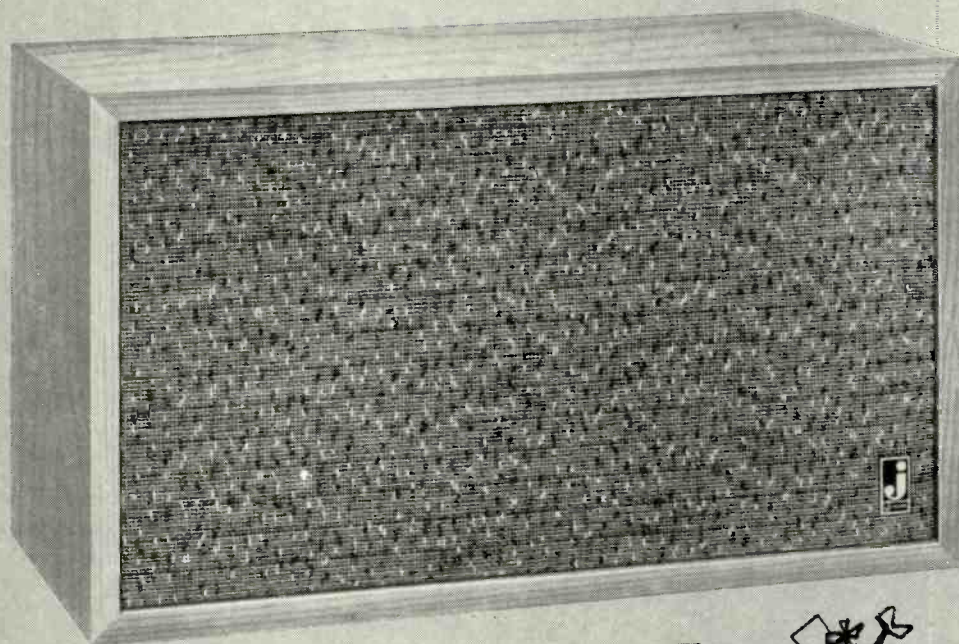

The Thrifty 4-Speaker TF-3 from **jensen**



In the "budget" price range, there is no finer speaker system on the market. In fact, careful comparison proves that Jensen's beautifully balanced TF-3 is unquestionably the finest . . . not only the "best buy" . . . but point for point, the best system—and you pay much less. **Compare . . . components:** The TF-3 uses a 10" FLEXAIR* woofer, effective from 25 cycles, two special midrange units, and the new Jensen Sono-Dome* Ultra Tweeter. . . so brilliant a speaker, it does not even begin to operate until 10,000 cycles! **power ratings:** The TF-3 drives to full room volume with a good quality 10 watt amplifier. It does not require a 20 watt amplifier for clean performance. **enclosures:** In the Jensen TF-3 you get top quality construction ¾" gum hardwood, rigidly built. It stains beautifully—or paint or build-in as you choose. Dimensions: 13½"H., 23¾"W., 11¾"D. **Compare . . . price:** There is no real comparison. \$79.50

You are invited to make these comparisons—and any others you wish—between the Jensen TF-3 and any other "rated" speaker system on the market regardless of price. Comparison with the thrilling *sound* of the TF-3 will still further prove that . . .

*T.M.

there is always something better from

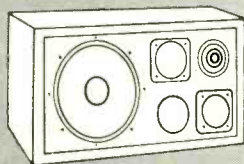

Write for Free Illustrated Brochure "KU".

jensen

Division of The Muter Co.

MANUFACTURING COMPANY
6601 S. Laramie Ave., Chicago 38, Illinois
In Canada: Renfrew Electric Co., Ltd., Toronto
In Mexico: Universal De Mexico, S. A., Mexico D.F.

If you have some knowledge of Radio or Television or Electronics now and want to BECOME A PROFESSIONAL SERVICE TECHNICIAN



Over 40 years ago, J. E. Smith, founder of the National Radio Institute, pioneered in teaching Radio by the home study method. Today, this magnificent building is completely devoted to NRI's Radio-TV Electronics training. Here up-to-date laboratory and research facilities are constantly testing new developments and improved methods of training men for Radio-TV Electronics careers.

All-Practice Method



NRI's Professional TV Servicing Training is practical, complete. You make tests and experiments to help thoroughly understand TV problems. You get equipment to build a 5" Oscilloscope, a 17" picture tube and all components for building a TV receiver. Comprehensive Color TV manuals also included. You learn how experts diagnose TV defects, get knowledge of professional techniques. Mail the coupon for free catalog now. NATIONAL RADIO INSTITUTE, Washington 16, D. C.

you will want to investigate the special **ALL-PRACTICE TRAINING PLAN** developed for men like you by the **OLDEST AND LARGEST** home study **Radio-Television school**

MAIL THIS TO NRI NOW

National Radio Institute, Dept. OMFT, Washington 16, D.C.

Accredited Member National Home Study Council

Please send me a FREE copy of your catalog "How to Reach the Top in TV Servicing." I understand no salesman will call.

Name..... Age.....

Address.....

City..... Zone..... State.....

(Note: This training is NOT for beginners)

Radio-Electronics

NOVEMBER, 1960

Formerly RADIO-CRAFT — Incorporating SHORT WAVE CRAFT — TELEVISION NEWS — RADIO & TELEVISION*

OVER FIFTY YEARS OF ELECTRONIC PUBLISHING

Hugo Gernsback
Editor and Publisher

M. Harvey Gernsback
Editorial Director

Fred Shunaman
Managing Editor

Robert F. Scott
W2PVG, Technical Editor

Larry Steckler
Associate Editor

I. Queen
Editorial Associate

Elizabeth Stalcup
Production Manager

Fernando Martinez
Art Director

Wm. Lyon McLaughlin
Tech. Illustration Director

Fred Neinast
Art Associate

Lee Robinson
Director, Advertising Sales

John J. Lamson
Eastern Sales Manager

G. Aliquo
Circulation Manager

Adam J. Smith
Director, Newsstand Sales

Robert Fallath
Promotion Manager

Average Paid Circulation
Over 163,000



ON THE COVER

(Story on page 46)

Behind the wheel and ready to begin a sports car rally, the driver sets up his home-made electronic computer. The device will help him to be in the right place at the right time—vital if he is to be a winner.

Color original by
Jack Allison.

editorial

- 33 Future Space Traffic—*Hugo Gernsback*

radio

- 38 FM Finally Makes It—*David Lachenbruch*
43 How to Fix Radios Faster (and Make More Money)—*Jack Darr*
56 Convert to Economical Hi-way FM—*John J. Borzner*
80 Simple FM Converter for TV Uses Minimum Parts
—*Jonathan Vanderwall*

electronics

- 34 Electromyography—*Dr. Bernard S. Post*
46 Build the Rally-Pal Computer (Cover Feature)—*Jack Allison*
55 New for Radar
62 Microwave Transistors
98 6E5 for Transistor Circuits—*Rufus P. Turner*

what's new

- 63 Pictorial Reports of New Developments

audio-high fidelity

- 40 6DZ7 Amplifier Is Neat Job to Make—*Robert M. Voss*
52 New Stereo Pickups, Part III—*Julian D. Hirsch*
71 Improving PA Systems—*Leo G. Sands*

industrial electronics

- 49 Subcarrier Techniques for Telemetry—*Ed Bukstein*
79 The Transient Capacitor, What's It For?—*Dellroye D. Darling*

test instruments

- 42 Construct a Tunnel-Diode Noise Generator—*I. Queen*
58 Simple-to-Build Sweep Generator Uses Varicap—*Morris Barron*
91 PNP-NPN Transistor Oscillator Easily Built—*F. T. Merkler*

television

- 60 Servicing TV Distribution Systems, Part I—*Jack Beever*
64 TV Service Clinic—*Conducted by Jack Darr*
84 Legal Pitfalls—*Leo T. Parker*
90 Sawtooth Sticklers—*Robert P. Balin*

the departments

- | | | |
|-------------------------|----------------------------------|-------------------------|
| 121 Business and People | 99 New Patents | 119 Noteworthy Circuits |
| 118 Corrections | 102 New Products | 112 Technicians' News |
| 26 Correspondence | 115 New Tubes and Semiconductors | 110 Technotes |
| 130 New Books | 6 News Briefs | 124 Try This One |
| 127 New Literature | | 120 50 Years Ago |

Radio-Electronics November, 1960, Vol. XXXI, No. 11. Published monthly at Mt. Morris, Ill., by Gernsback Publications, Inc. Second-class postage paid at Mt. Morris, Ill. Copyright 1960 by Gernsback Publications, Inc. All rights reserved under Universal, International and Pan-American Copyright Conventions.

Subscription Rates: U.S., U.S. possessions and Canada, \$5.00 for one year; \$9.00 for two years; \$12.00 for three years. Pan-American countries \$6.00 for one year; \$11.00 for two years; \$15.00 for three years. All other countries \$6.50 a year; \$12.00 for two years; \$16.50 for three years.

Subscriptions: Address correspondence to Radio-Electronics, Subscription Dept., 154 West 14th St., New York 11, N.Y. When requesting a change of address, please furnish an address label from a recent issue. Allow one month for change of address.

Gernsback Publications, Inc. Executive, Editorial and Advertising Offices, 154 West 14th St., New York 11, N.Y. Telephone ALkonquin 5-7755. Hugo Gernsback, Chairman of the Board; M. Harvey Gernsback, President; G. Aliquo, Secretary.

Advertising Representatives: Los Angeles: Harker-Husted-Coughlin, 400 South Alvarado St., Tel. DUmkirk 7-2328. San Francisco: Harker-Husted-Coughlin, 444 Market St., Tel. GARfield 1-0151. Chicago: 8631 East Prairie Road, Skokie, Ill. Tel. ORchard 5-3740.

Foreign Agents: Great Britain: Atlas Publishing and Distributing Co., Ltd., 15 Bride Lane, London E.C. 4.

Postmaster: If undeliverable, send Form 3579 to: RADIO-ELECTRONICS, 154 West 14th St., New York 11, N.Y. *Trademark registered U. S. Pat. Office.

RADIO-ELECTRONICS

BREAK THROUGH TO HIGHER PAY

in ELECTRONICS

TV-RADIO

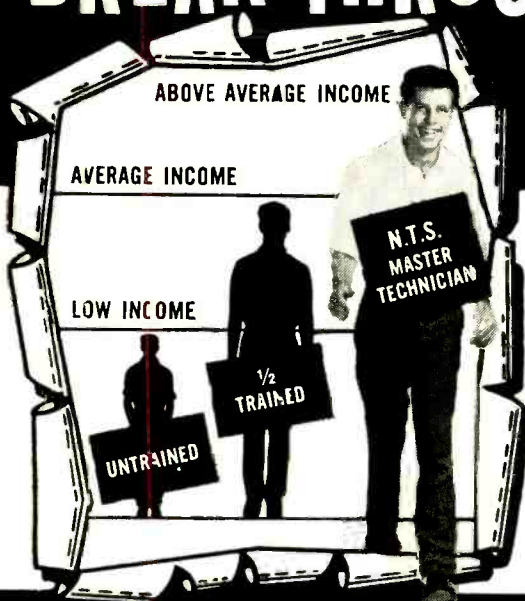

START NOW! Break through the Earning Barrier that stops half-trained men. N.T.S. "All-Phase" training prepares you — at home in spare time — for a high-paying CAREER in Electronics — TV — Radio as a MASTER TECHNICIAN. One Master Course at One Low Tuition trains you for unlimited opportunities in All Phases: Servicing, Communications, Preparation F.C.C. License, Broadcasting, Manufacturing, Automation, Radar and Micro-Waves, Missile and Rocket Projects.

A more rewarding job... a secure future... a richer, fuller life can be yours! As an **N.T.S. MASTER TECHNICIAN** you can go straight to the top in industry... or in your own profitable business.

You work on actual job projects

SUCCEED IN MANY HIGH-PAYING JOBS LIKE THESE...

- TV-Radio Sales, Service and Repair
- Profitable Business of Your Own
- Communications Technician — F.C.C. License
- Hi-Fi, Stereo & Sound Recording Specialist
- TV-Radio Broadcasting Operator
- Technician in Computers & Missiles
- Electronics Field Engineer
- Specialist in Microwaves & Servomechanisms
- Expert Trouble Shooter
- All-Phase Master Technician

19 BIG KITS YOURS TO KEEP

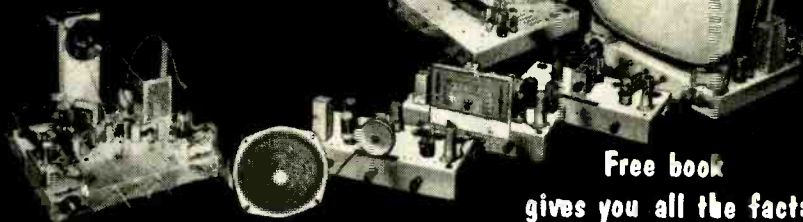

Free book gives you all the facts

NATIONAL TECHNICAL SCHOOLS

WORLD-WIDE TRAINING SINCE 1905
4000 SO. FIGUEROA ST., LOS ANGELES 37, CALIF., U. S. A.
Write Dept. RG-110



RESIDENT TRAINING AT LOS ANGELES

If you wish to take your training in our Resident School at Los Angeles, start NOW in our big, modern Shops and Labs. Work with the latest Auto and Diesel engines — all types — fuel injection, automatic transmissions, all power equipment — most complete facilities offered by any school. Expert, friendly instructors. Graduate Employment Service. Help in finding home near school — and part time job while you learn.

WRITE FOR SPECIAL RESIDENT SCHOOL CATALOG AND INFORMATION



ACCREDITED MEMBER... the only nationally recognized accrediting agency for private home study schools.

N.T.S. Shop-Tested HOME TRAINING is **Better, More Complete, Lower Cost**... and it is your key to the most fascinating, opportunity-filled industry today!

YOU LEARN QUICKLY AND EASILY THE N.T.S. SHOP-TESTED WAY

You get lessons, manuals, job projects, unlimited consultation, graduate advisory service. You build a Short Wave-Long Wave Superhet Receiver, plus a large-screen TV set from the ground up, with parts we send you at no addi-

tional cost. You also get a Professional Multimeter for your practical job projects.

EARN AS YOU LEARN... WE SHOW YOU HOW!

Many students pay for entire tuition — and earn much more — with spare time work they perform while training. You can do the same... we show you how.

SEND FOR INFORMATION NOW... TODAY! IT COSTS YOU NOTHING TO INVESTIGATE.

N.T.S. HOME TRAINING is

- Classroom Developed
- Lab-Studio Planned
- Shop-Tested
- Industry-Approved
- Specifically Designed for Home Study



MAIL COUPON NOW for FREE BOOK and ACTUAL LESSON

NO OBLIGATION! NO SALESMAN WILL CALL

NATIONAL TECHNICAL SCHOOLS

WORLD-WIDE TRAINING SINCE 1905

Mail Now To
National Technical Schools, Dept. RG-110
4000 S. Figueroa St., Los Angeles 37, Ca. f.

Please rush FREE Electronics-TV-Radio "Opportunity" Book and Actual Lesson. No Salesman will call.

Name _____ Age _____
Address _____
City _____ Zone _____ State _____

Check here: if interested ONLY in Resident Training at Los Angeles.
VETERANS: Give date of discharge.

News Briefs

Power Converter on Market

Thermionic power converters, producing electricity direct from heat, are now being turned out commercially by General Electric at the company's power-tube plant at Schenectady. The devices, somewhat similar in action to a two-element vacuum



tube producing "contact-potential" current, are about the size of a silver dollar. They will produce at least 1 watt apiece, according to K. E. Wilson, who is in charge of marketing the new converters. They operate at a cathode temperature of 1100°C. Efficiency is 2.5%. Since electricity is required to heat the cathode, the chief applications of the new converters will be for special and experimental uses.

Short-wavers Cooperate

Plans to reduce interference in the short-wave broadcast bands have been put into effect by the International Frequency Registration Board (IFRB) pursuant to decisions made at the Geneva Conference last year. Administrations concerned with short-wave broadcasting are to submit their schedules to the IFRB four times a year. The IFRB compares schedules and, where stations would interfere, proposes improvements to the parties concerned. At the end of each period, the IFRB will publish a "High Frequency Broadcasting Schedule" which includes the schedules of the various broadcasters, to which the notified changes have been applied, and indicates those changes that the administrations did not consider satisfactory. It is hoped that this system will substantially reduce short-wave interference.

Electronic Medicine Meet

Electric and electronic techniques in biology and medicine will be dis-

cussed in more than 50 papers to be presented at the 13th Annual Conference on Electrical Techniques in Medicine and Biology. The conference is being held in Washington, D. C., on Oct. 31, Nov. 1 and 2.

Authorities from both the medical and electronic fields, including the US Department of Agriculture, the National Institutes of Health and a large number of American universities and medical, scientific and electronic concerns, will take part in the eight sessions of the conference. Main subjects are grouped under analytical methods and instrumentation, electroanalytical methods, instruments, digital computers, telemetry of physiological data, analogues and system analysis and general discussion.

California Amateur Honored

Raymond E. Meyers, W6MLZ, of San Gabriel, Calif., was awarded the Edison Radio Amateur Award for 1960. The plaque is given each year by General Electric to an outstanding amateur.

Meyers' award was given, in the words of the citation: "For promot-



W6MLZ, Raymond E. Meyers (left), receives Edison Award from B. S. Angwin of G-E.

ing international good will through his skillful planning, organizing, establishing and operation of extensive world-wide radio communications during the Ninth Plenary Assembly of the Consultative Committee on International Radio (CCIR) held in Los Angeles in April, 1959. The special radio station, K6USA, handled more than ten thousand important communications during the conference."

W6MLZ was assisted in setting up the radio service extended by

K6USA by Herbert Hoover, Jr., W6ZH, son of the former President who, as Secretary of Commerce, contributed greatly toward the recognition of the American amateur radioist and to his present status.

Voice of Africa?

The Voice of America has contracted for construction of a powerful station to be built near Monrovia, Liberia. It will consist of six 250-kw and two 50-kw transmitters. It will give the Voice of America coverage of Africa, parts of central Europe and the middle East.

The Voice will operate under international rules and will not interfere with other African broadcasts. Completion is expected in 1962. The engineering design of the new station is being handled by Page Communications. Contracts for the actual construction of the transmitters has not been let at the time of writing.

Jap Radios Self-Limited?

In an attempt to maintain the prestige of Japanese transistor radios, the Ministry of International Trade and Industry has been clamping on restrictions and obtaining information looking toward an export quota. First step of the MITI was to ban export of all radios containing less than three transistors. This was softened slightly to permit export of such radios only if plainly labeled as toys. The ministry explained that the little radios have been hurting the market for six-transistor or bigger sets.

American manufacturers pointed out that the move would have little effect on Japanese competition, as no American manufacturers make two-transistor radios.

Humans Telemetered

A new manned vehicle monitor that can tell at a glance the immediate condition of a pilot and the craft he is flying has been designed for the Air Force Flight Test Center, International Telephone & Telegraph Laboratories announced.

The new device, to be manned by ground personnel, will give for the first time direct readout or "real-time" safety reports on the physiological and environmental conditions of the pilot, in addition to telemetered "how goes it" information on the vehicle itself.

According to Paul Sehnert, proj-
(Continued on page 10)

Prepare Today... to Succeed Tomorrow...

ELECTRONICS

ONE OF THE GREATEST JOB OPPORTUNITY FIELDS OF OUR TIME

Train in Spare Time at Home

Just think! DeVry Tech can now train you at home as an Electronics technician for a wider range of jobs in one of today's most profitable opportunity fields. DeVry's new Space and Missile Electronics training helps you get ready—in your spare time—for a future career in the vast new Space Program. But here's more good news! Other DeVry programs prepare you for a start in the multi-billion dollar field that includes Radio-TV, Communications, Radar, Automation and many other branches. Yes, in Electronics a trained technician finds **REAL OPPORTUNITY . . . EXCELLENT JOBS . . . GOOD PAY . . . A PROMISING FUTURE . . .** almost everywhere. Check the fields that interest you on the coupon below . . . then mail it to us for **FACTS** on how YOU may prepare to become a skilled Electronics technician, ready for a part in this thrilling field.



New... All New!

Shown at right is the versatile . . . usable combination oscilloscope and voltmeter which DeVry Tech men build during the new Space and Missile Electronics program. New movies, new subjects, new texts, new experimental projects, all prepare you thoroughly, in this latest and greatest DeVry Tech training program. No advanced education, no previous technical experience is needed.

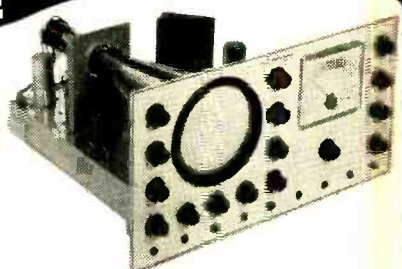

DeVRY TECH PRESIDENT VISITS MISSILE FACILITIES

Mr. T. J. Lafeber, President of DeVry Technical Institute, recently visited missile facilities and was impressed with the important part played by Electronics Technicians.

EXPLORER VII SATELLITE

Picture of the famous satellite. Remember, assembling and checking Electronic devices in satellites and missiles is only one of the exciting new jobs now open to trained technicians.



2 FREE BOOKLETS . . .

MAIL COUPON TODAY!



DeVry Technical Institute
Chicago 41, Illinois

Accredited Member of National Home Study Council
"One of North America's Foremost Electronics Training Centers"

Effective Employment Service

When your training is completed, our Employment Service helps you get started in Electronics—either in a good job or a profitable business of your own. What a valuable aid to your progress!

Draft Age?

If you are subject to military service, mark the coupon. We have valuable information for you.

SEND FOR FULL FACTS NOW!

DeVry Technical Institute, Dept. RE-110
4341 Belmont Avenue, Chicago 41, Ill.

Please give me your two free booklets, "Pocket Guide to Real Earnings" and "Electronics in Space Travel"; also include details on how to prepare for a career in Electronics, I am interested in the following opportunities: (check one or more):

- Space & Missile Electronics Television and Radio Microwaves
 Radar Automation Electronics Communications Computers
 Broadcasting Industrial Electronics Special "Short Course"

Name _____ Age _____

Address _____ Please Print _____ Apt. _____

City _____ Zone _____ State _____

Check here if you face military service, Canadian residents: Write DeVry Tech of Canada, Ltd., 970 Lawrence Avenue West, Toronto 19, Ontario.

207

Now you can charge Westinghouse parts and tubes with the first and only Courtesy Credit Card for TV Service Technicians!



The credit goes to you. Just say, "Charge it" with your new Westinghouse Credit Card, and order the parts you need without tying up your cash or waiting for credit clearance. You can order by mail, phone or over the counter with 30 days open credit in an amount to be determined by your needs.

Westinghouse is happy to extend credit to you, the independent service technician, in the hope that it will help you give better service to Westinghouse customers at a profit. It goes without saying that your reputation as a good businessman makes it possible for Westinghouse to do this.

You can get your Westinghouse Credit Card through an eligible service association, or from

your local Westinghouse District Service Manager. All applications are subject to approval by the local Westinghouse Credit Manager.

The credit goes to you... and Westinghouse is glad to acknowledge it. You can be sure, if it's Westinghouse.

For information concerning Westinghouse Tech-Lit... a factory direct mailing service on all product service information, write to Service Dept., Westinghouse Electric Corp., Metuchen, N. J., or your Westinghouse Distributor.

Westinghouse

Westinghouse Electric Corp., TV-Radio Division, Metuchen, N. J.

how to get an FCC COMMERCIAL LICENSE

YOUR FCC LICENSE OR YOUR MONEY BACK

Completion of the Master Course (both Sections) will prepare you for a First Class Commercial Radio Telephone License with a Radar Endorsement. Should you fail to pass the FCC examination for this license after successfully completing the Master Course, you will receive a full refund of all tuition payments. This guarantee is valid for the entire period of your enrollment agreement.

Successful
Electronics
Training

here is one example of the good
jobs C.I.E. trainees get . . .

James Glen:



When Jim enrolled, he was a temporary employee of the City of Tacoma, Washington. In the space of 14 months, he completed the Master Course and received his first class license. He is now installing and maintaining mobile and micro-wave equipment.

*James S. Glen, Jr.
2920 Knob Hill Road
Tacoma, Washington*

Accredited by The National Home Study Council

Cleveland Institute of Electronics

Deck RE-47B, 4900 Euclid Ave., Cleveland 3, Ohio



THESE BOOKLETS

FREE

find out how . . .

1. You can handle the new electronic devices.
2. You can solve the problems that stump your fellow technicians.
3. Training is Job Insurance when employment is tough to find . . . and more money for you when times are good.

**Mail This Coupon Today . . .
Receive These Booklets
FREE**

Cleveland Institute of Electronics,

Desk RE-47B, 4900 Euclid Ave., Cleveland 3, Ohio



Please send FREE Career Information Material prepared to help me get ahead in Electronics. I have had training or experience in Electronics as indicated below:

- | | |
|---|---|
| <input type="checkbox"/> Military | <input type="checkbox"/> Broadcasting |
| <input type="checkbox"/> Radio-TV Servicing | <input type="checkbox"/> Home Experimenting |
| <input type="checkbox"/> Manufacturing | <input type="checkbox"/> Telephone Company |
| <input type="checkbox"/> Amateur Radio | <input type="checkbox"/> Other |

In what kind of work are you
now engaged?

In what branch of Electronics
are you interested?

Name Age

Address

City Zone State

Desk RE-47B

A perfect fit every time



with **Centralab**
Twist-Tab Controls

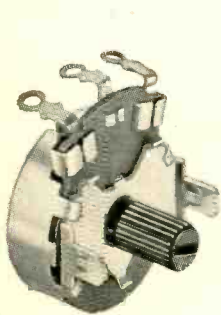

These CENTRALAB tab-mounted Radiohm® Controls are sure to suit you—because they're tailored to the minimum shaft length needed for TV set hidden controls. When you need a longer shaft, you simply use the 2" polyethylene extension packed with each unit. Nothing to saw—a snip of the scissors gives you an insulated shaft of the length you need, and the adjustment slot is still there, and still easy to get at.

CENTRALAB Twist-Tabs are available in 25 values from 200 ohms to 7.5 megohms . . . rated at 1/2 watt, 15/16" diameter, 7/16" deep. Ask your distributor for full details about the new fashion in controls—Model TT Radiohms.

Centralab
B-6032

THE ELECTRONICS DIVISION OF GLOBE-UNION INC.
9221 EAST KEEFE AVENUE • MILWAUKEE 1, WISCONSIN
CENTRALAB CANADA LIMITED—AJAX, ONTARIO

**ELECTRONIC SWITCHES • VARIABLE RESISTORS • CERAMIC CAPACITORS
PACKAGED ELECTRONIC CIRCUITS • ENGINEERED CERAMICS**

(Continued from page 6)

ect initiator of Edwards Air Force Base, and Carlos Miller, executive engineer of ITTL, the "real-time" console will keep abreast of man's conditions within fractions of a second and can indicate immediately when he is undergoing or entering an unsafe condition. No computation of data, graph or gauge analysis is necessary.

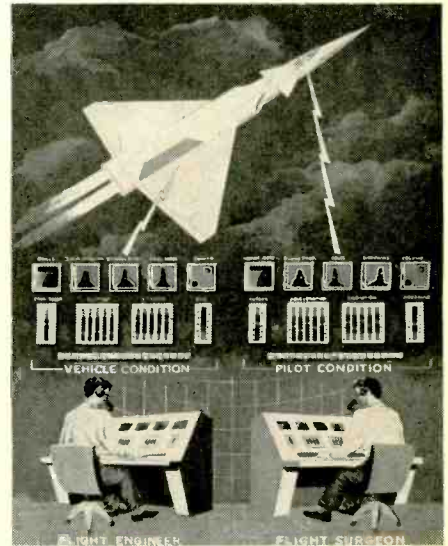

The information displayed on the vehicular panel includes various stability and aerodynamic parameters, structural strains, flutter, power-plant behavior, and other data such as skin temperature, fuel, fire warning and electrical equipment.

The information shown on the physiological panel includes the man's heart rate, blood pressure, temperature, breathing rate and volume, the parameters concerning his environment, oxygen supply, acceleration, radiation count, etc.

The cathode-ray displays will present a green color indication of the OK condition. It changes to a harsh orange when either the actual value or the rate-of-change becomes unsafe. For the plot displays of inter-related parameters, the green spots of light are located inside "safety-envelope" areas which have been previously determined for the particular parameters for both the man and the vehicle. The spots of light change their color to orange when the parameters move outside these areas.

Bell Begins Paging System

The New York Telephone Co. announced the opening of their bell-boy radio signaling service covering Binghamton, Endicott, Johnson and an area surrounding these cities. The system has also been put into use in areas around Columbus, Ohio, and Allentown-Bethlehem, Pa., the company reported.

A person subscribing to the service carries a small (7½-ounce) transistor receiver which buzzes when he is wanted on the phone. On hearing the buzz, he can then call his home,

ALLIED value-packed 1961

444-PAGE ELECTRONICS CATALOG

including products available only from Allied

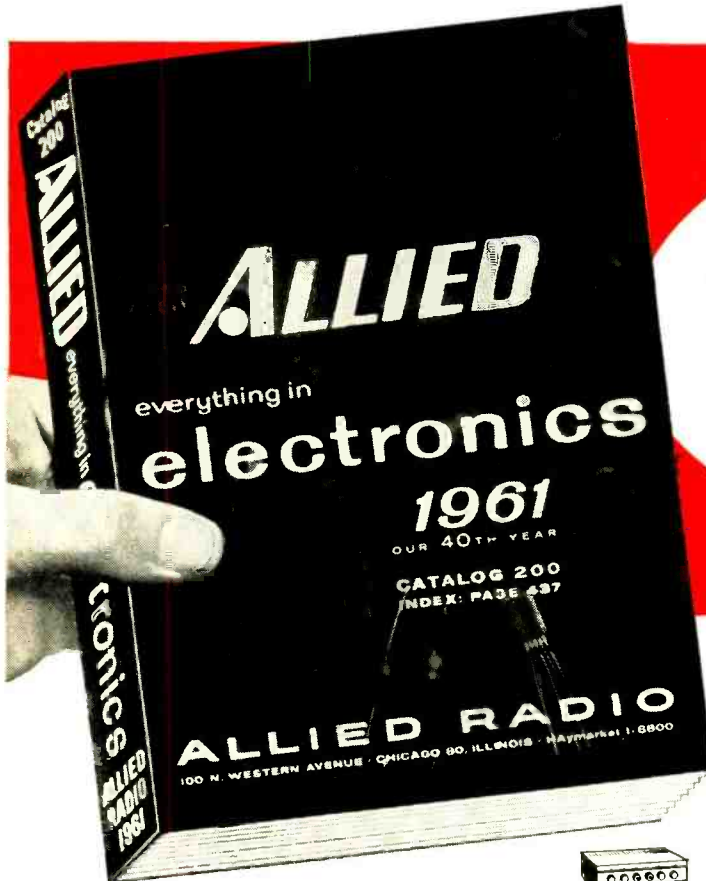

complete
up-to-date

free

send for it today!

SAVE MOST ON EVERYTHING IN ELECTRONICS

- Newest Stereo Hi-Fi Systems— Everything in Hi-Fi Components
- Money-Saving, Build-Your-Own KNIGHT-KITS® for Every Need
- Best Buys in Recorders & Supplies
- Newest Public Address Systems, Paging and Intercom Equipment
- Amateur Receivers, Transmitters, and Station Gear
- Citizen's Band 2-Way Radio
- Test and Laboratory Instruments
- TV Tubes, Antennas, Accessories
- Huge Listings of Parts, Tubes, Transistors, Tools, Books

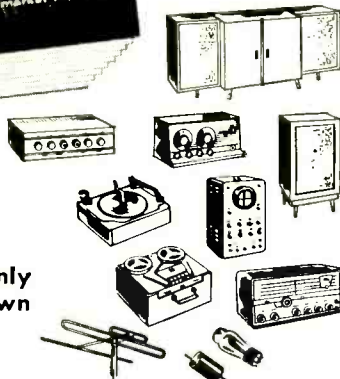

**BUY ON EASIEST TERMS
ONLY \$2 DOWN**

Yes, only \$2 down on orders up to \$50; only \$5 down on orders up to \$200; only \$10 down over \$200. Up to 24 months to pay.

ALLIED Exclusives:

MONEY-SAVING KNIGHT-KITS®—truly the very best in build-your-own electronic equipment—designed to save you money, easiest to assemble—the only kits offered with Free Inspection Privilege. See the complete selection of Stereo hi-fi kits, Hobbyist kits, Test Instrument and Amateur kits. KNIGHT-KITS are an exclusive ALLIED product.

KNIGHT® STEREO HI-FI—comparable to the best in quality and performance, yet priced far lower in cost. Select super-value KNIGHT components or complete systems and save most. Also see the largest selection of famous-name hi-fi components and money-saving ALLIED-recommended hi-fi systems.

ALLIED RADIO

our 40th year

**SATISFACTION GUARANTEED
OR YOUR MONEY BACK**

World's Largest Electronic Supply House

Get every buying advantage at ALLIED: lowest money-saving prices, fastest shipment, expert personal help, easiest-pay terms, satisfaction guaranteed or your money back.

free the most complete
electronics catalog!



ALLIED RADIO, Dept. 2-L
100 N. Western Ave., Chicago 80, Ill.

Send FREE 1961 ALLIED Catalog.

Name _____

Address _____

City _____ Zone _____ State _____

STEREO QUALITY SOARS TO NEW HEIGHTS...

Presenting the
finest ceramic stereo cartridge
ever perfected by Sonotone

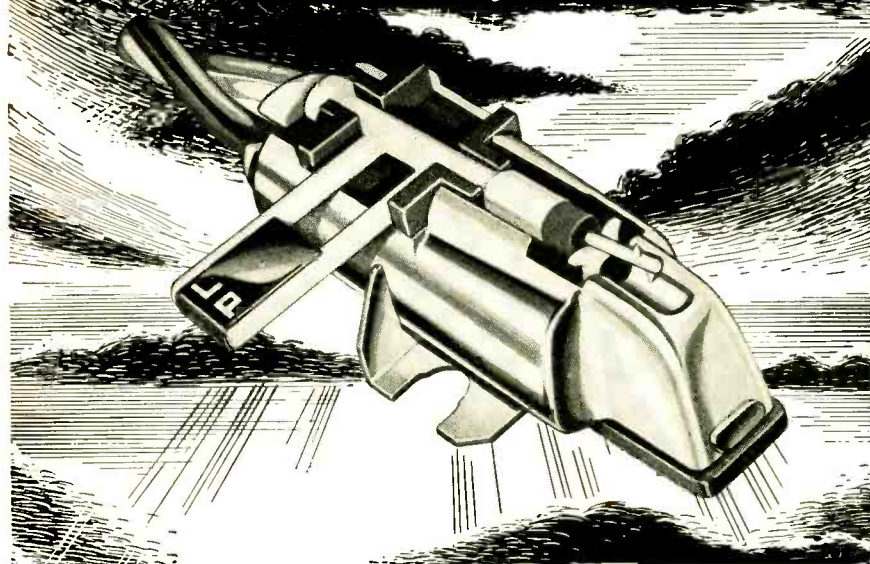

THE "PROFESSIONAL QUALITY" 9T!

Now, the ceramic cartridge proved in independent A-B listening tests to perform as well as the highest-priced "professional" types. It's Sonotone's revolutionary new 9T. So superior, you can expect faithful reproduction from the most robust musical passages to the most subtle overtones. Sonotone's new 9T series stereo cartridge:

GUARANTEES performance equal to cartridges costing up to 3 times as much—as proven in A-B listening tests.

GUARANTEES highest compliance—allows major reduction of tracking force.

GUARANTEES more than adequate channel separation.

GUARANTEES crisp definition.

GUARANTEES superior, more compact mechanical design—including revolu-

tionary new needle design with instant "snap-in, snap-out" replacement needle feature and built-in jewel tip protector.

ELIMINATES distortion—incredibly flat response of ± 1 db from 20 to 17,000 cps—cuts listening fatigue.

ELIMINATES dust pile-up—at recent trade show the 9T ran 4 straight hours, collected no dust.

ELIMINATES most record groove noise or hiss—no "needle talk".

Imagine, the 9T boasts all these "professional" features...yet sells for less than half the price of the least expensive "professional" cartridge. Simplify your inventory...cut call-backs—increase sales and profits—with Sonotone's great new 9T cartridge...unsurpassed for performance—and for value.

LIST PRICE:	9T-S... \$16.50 (0.7-mil and 3-mil sapphires)	9T-S77... \$16.50 (Two 0.7-mil sapphires)	9T-SD... \$19.50 (Sapphire-Diamond)
-------------	--	--	--

Sonotone[®]

ELECTRONIC APPLICATIONS DIVISION, ELMSFORD, N. Y. DEPT. C2-110

IN CANADA, CONTACT ATLAS RADIO CORP., LTD., TORONTO

LEADING MAKERS OF

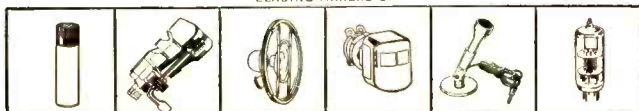

BATTERIES · CARTRIDGES · SPEAKERS · TAPE HEADS · MIKES · ELECTRONIC TUBES

office or other contact from the nearest telephone.

The telephone company said the cost of installing the Bellboy equipment was more than \$100,000. It can handle a maximum of about 3,000 receivers. Customers are charged \$15 a month if one receiver is used. A second receiver costs \$12.50 a month. The rate is for a maximum of 80 signals a month.

De Forest Award to N.M. Student

Dwight Jaeger, 17, a Los Alamos, N.M. high school student, was awarded a \$1,000 de Forest Scholarship awarded annually by the Western Electronic Show and Convention (WESCON). Jaeger's experiment, which was displayed at the Future Engineers Show (a feature of WESCON), was called



"Gravitational Pit" and simulated the gravitational pull of satellites as they orbit around the earth.

Dr. de Forest, at the time inviolated at his Hollywood home, sent a message to be given to the recipient of this year's and future awards.

Second place in the awards, a \$600 scholarship, was given to Donald Shapero, a student at Cubberly High, Palo Alto, for his work on "Precession Magnetometry." Third place, a \$400 scholarship, went to Melvin Rosowski of Clayton Valley High School, Concord, Calif., for an experiment called "Cloud Chamber Research."

Fourth place, a \$300 scholarship, was awarded to Edward Longe of Santa Barbara High for "Gaseous Discharge Phenomenon," and fifth place, a \$200 scholarship, went to Steve Walther of Punahou School, Honolulu, for a display titled "Seeing with Sound."

Booster Operators Cooperate

Results of a series of meetings in the United States Northwest to explain the new FCC booster rules to booster operators have been excellent, according to engineer McIvor Parker of the FCC. The long-banned boosters are permitted to go into legal operation, provided their stations meet FCC requirements. The chief requirement is that they create no harmful interference to other services, including other TV stations.

Booster operators queried the FCC representatives on a number of subjects, the most commonly asked questions being on the FCC stipulation

What Does F. C. C. Mean To You?

What is the F. C. C.?

F. C. C. stands for Federal Communications Commission. This is an agency of the Federal Government, created by Congress to regulate all wire and radio communication and radio and television broadcasting in the United States.

What is an F. C. C. Operator License?

The F. C. C. requires that only qualified persons be allowed to install, maintain, and operate electronic communications equipment, including radio and television broadcast transmitters. To determine who is qualified to take on such responsibility, the F. C. C. gives technical examinations. Operator licenses are awarded to those who pass these examinations. There are different types and classes of operator licenses, based on the type and difficulty of the examination passed.

What are the Different Types of Operator Licenses?

The F. C. C. grants three different types (or groups) of operator licenses—commercial radiotelePHONE, commercial radioteleGRAPH, and amateur.

COMMERCIAL RADIOTELEPHONE operator licenses are those required of technicians and engineers responsible for the proper operation of electronic equipment involved in the transmission of voice, music, or pictures. For example, a person who installs or maintains two-way mobile radio systems or radio and television broadcast equipment must hold a radiotelePHONE license. (A knowledge of Morse code is NOT required to obtain such a license.)

COMMERCIAL RADIOTELEGRAPH operator licenses are those required of the operators and maintenance men working with communications equipment which involves the use of Morse code. For example, a radio operator on board a merchant ship must hold a radioteleGRAPH license. (The ability to send and receive Morse is required to obtain such a license.)

AMATEUR operator licenses are those required of radio "hams"—people who are radio hobbyists and experimenters. (A knowledge of Morse code is necessary to be a "ham.")

What are the Different Classes of RadiotelePHONE Licenses?

Each type (or group) of license is divided into different classes. There are three classes of radiotelePHONE licenses, as follows:

(1) **Third Class RadiotelePHONE License.** No previous license or on-the-job experience is required to qualify for the examination for this license. The examination consists of F. C. C. Elements I and II covering radio laws, F. C. C. regulations, and basic operating practices.

(2) **Second Class RadiotelePHONE License.** No on-the-job experience is required for this examination. However, the applicant must have already passed examination Elements I and II. The *second class* radiotelePHONE examination consists of F. C. C. Element III. It is mostly technical and covers basic radiotelePHONE theory (including electrical calculations), vacuum tubes, transistors, amplifiers, oscillators, power supplies, amplitude modulation, frequency modulation, measuring instruments, transmitters, receivers, antennas and transmission lines, etc.

(3) **First Class RadiotelePHONE License.** No on-the-job experience is required to qualify for this examination. However, the applicant must have already passed examination Elements I, II, and III. (If the applicant wishes, he may take all four elements at the same sitting, but this is

not the general practice.) The *first class* radiotelePHONE examination consists of F. C. C. Element IV. It is mostly technical covering advanced radiotelePHONE theory and basic television theory. This examination covers generally the same subject matter as the second class examination, but the questions are more difficult and involve more mathematics.

Which License Qualifies for Which Jobs?

The **THIRD CLASS** radiotelePHONE license is of value primarily in that it qualifies you to take the second class examination. The scope of authority covered by a third class license is extremely limited.

The **SECOND CLASS** radiotelePHONE license qualifies you to install, maintain, and operate most all radiotelePHONE equipment except commercial broadcast station equipment.

The **FIRST CLASS** radiotelePHONE license qualifies you to install, maintain, and operate every type of radiotelePHONE equipment (except amateur, of course) including all radio and television stations in the United States, and in its Territories and Possessions. This is the highest class of radiotelePHONE license available.

How Long Does it Take to Prepare for F. C. C. Exams?

The time required to prepare for FCC examinations naturally varies with the individual, depending on his background and aptitude. Grantham training prepares the student to pass FCC exams in a minimum of time.

In the Grantham *correspondence course*, the average beginner should prepare for his *second class* radiotelePHONE license after from 200 to 250 hours of study. This same student should then prepare for his *first class* license in approximately 75 additional hours of study.

In the Grantham *resident course*, the time normally required to complete the course and get your license is as follows:

In the **DAY course** (5 days a week) you should get your *second class* license at the end of the first 9 weeks of classes, and your *first class* license at the end of 3 additional weeks of classes. This makes a total of 12 weeks (just a little less than 3 months) required to cover the whole course, from "scratch" through *first class*.

In the **EVENING course** (3 nights a week) you should get your *second class* license at the end of the 15th week of classes and your *first class* license at the end of 5 additional weeks of classes. This makes a total of less than 5 months required to cover the whole course, from "scratch" through *first class*, in the evening course.

HERE'S PROOF that Grantham Students prepare for F. C. C. examinations in a minimum of time. Here is a list of a few of our recent graduates, the class of license they got, and how long it took them:

Name	License	Weeks
Neil W. Michel, 402 E. Jefferson, Owensville, Mo.	1st	12
L. Gordon Combs, RR#3, Box 279A, Hemet, Calif.	1st	11
Daniel A. Ruch, Station KVOZ, Box 1498, Laredo, Texas	1st	12
George H. Sanderson, 128½ W. 4th Street, Marysville, Ohio	1st	8
Donald F. Teneych, 58 Brighton Road, Worcester, N. Y.	1st	12
Richard Scherzer, Apt. 5, 1175 S. Franklin Ave., Los Angeles, Calif.	1st	13
Jerry Miller, P. O. Box 1253, Charleston, West Virginia	1st	11
David M. Tarter, 1174 Hilltop Road, Kansas City 4, Kansas	1st	12
Vern S. Melton, Jr., 1014 Canyon Road, Santa Fe, New Mexico	1st	8
Gerald T. Bullock, 613 Keefer Place, NW, Washington, D. C.	1st	12

Resident Classes Offered at Four Locations

To better serve our many students throughout the nation, Grantham School of Electronics maintains four separate schools—located in Hollywood, Seattle, Kansas City, and Washington, D. C.—all offering the same resident courses in F. C. C. license preparation. (Correspondence courses are conducted from Hollywood.)

The Grantham course is designed specifically to prepare you to pass FCC examinations. All the instruction is presented with the FCC examinations in mind. In every lesson test and pre-examination you are given constant practice in answering FCC-type questions, presented in the same manner as the questions you will have to answer on your FCC examinations.

Why Choose Grantham Training?

The Grantham Communications Electronics Course is planned primarily to lead to an F. C. C. license, but it does this by **TEACHING** electronics. This course can prepare you *quickly* to pass F. C. C. examinations because it presents the necessary principles of electronics in a simple "easy to grasp" manner. Each new idea is tied in with familiar ideas. Each new principle is presented first in simple, everyday language. Then after you understand the "what and why" of a certain principle, you are taught the technical language associated with that principle. You learn more electronics in less time, because we make the subject easy and interesting.

Is the Grantham Course a "Memory Course"?

No doubt you've heard rumors about "memory courses" or "cram courses" offering "all the exact FCC questions". Ask anyone who has an FCC license if the necessary material can be memorized. Even if you had the exact exam questions and answers, it would be much more difficult to memorize this "meaningless" material than to learn to understand the subject. Choose the school that teaches you to thoroughly understand—choose Grantham School of Electronics.

Is the Grantham Course Merely a "Coaching Service"?

Some schools and individuals offer a "coaching service" in FCC license preparation. The weakness of the "coaching service" method is that it presumes the student already has a knowledge of technical radio and approaches the subject on a "question and answer" basis. On the other hand, the Grantham course "begins at the beginning" and progresses in logical order from one point to another. Every subject is covered simply and in detail. The emphasis is on making the subject easy to understand. With each lesson, you receive an FCC-type test so you can discover daily just which points you do not understand and clear them up as you go along.

For further details concerning F. C. C. licenses and our training, send for our **FREE** booklet, "Careers in Electronics". Clip the coupon below and mail it to the School nearest you.

Get your First Class Commercial F. C. C. License Quickly by training at



GRANTHAM SCHOOL OF ELECTRONICS

1505 N. Western Ave.
Hollywood 27, Calif.
(Phone: HO 7-7727)

408 Marion Street
Seattle 4, Wash.
(Phone: MA 2-7227)

3123 Gillham Road
Kansas City 9, Mo.
(Phone: JE 1-6320)

821 - 19th Street, N.W.
Washington 6, D. C.
(Phone: ST 3-3614)

MAIL COUPON NOW—NO SALESMAN WILL CALL →

MAIL COUPON TO SCHOOL NEAREST YOU

(Mail in envelope or paste on postal card)

To: **GRANTHAM SCHOOL OF ELECTRONICS**

1505 N. Western • 408 Marion • 3123 Gillham Rd. • 821-19th, NW
Hollywood • Seattle • Kansas City • Washington

Please send me your free booklet telling how I can get my commercial F. C. C. license quickly. I understand there is no obligation and no salesman will call.

Name _____ Age _____

Address _____

City _____ State _____

I am interested in: Home Study, Seattle classes

Hollywood classes, Kansas City classes, Washington classes

045

RCA KITS

FOR VALUE, QUALITY AND PERFORMANCE!

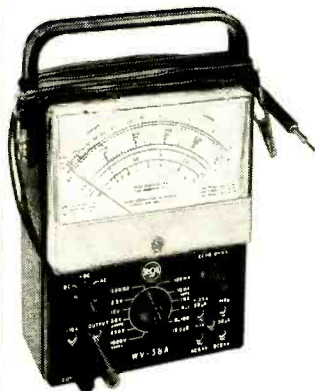

RCA WV-38A (K) VOLT-OHM-MILLIAMMETER

only **\$29.95*** (includes batteries, probe and cable with slip-on alligator clip, ground lead and clip, assembly and operating instructions) (available factory-wired and calibrated—only \$43.95*)

Exclusive features make this RCA VOM kit the buy of a lifetime! Extra 1-volt and 0.25 volt (250 mv) ranges for wider usage in transistor servicing—new handle clip accommodates probes and test leads for extra carrying convenience. Assemblies in a breeze!

FEATURING: ohms-divider network fuse-protected • easier-to-read scales • extra-large 5/4 inch meter • polarity reversal switch • excellent frequency response • full-wave bridge rectifier • low circuit loading • standard dbm ranges.

SPECIFICATIONS: Input Resistance—20,000 ohms per volt on DC; 5,000 ohms per volt on AC • Accuracy—± 3% DC, ± 5% AC (full scale) • Regular Scales—2.5, 10, 50, 250, 1000, 5000 volts, AC and DC; 50 μ a 1, 10, 100, 500 ma, 10 amps (DC) • Extra Scales—250 mv. and 1 volt (dc) • Frequency Response—AC-flat from 10 cycles to 50 Kc (usable response at 500 Kc) • Ohms—3 ranges: Rx1—(0-2,000 ohms); Rx100 (0-200,000 ohms); Rx10,000 (0-20,000,000 ohms) • Dimensions—W. 5 1/4", H. 6 7/8", D. 3 1/8"

RCA WO-33A (K) 3-INCH OSCILLOSCOPE

only **\$79.95*** (complete with Low-Cap, Direct Input Probe and Cable) (also available factory-wired and calibrated—only \$129.95*)

The first "scope kit with "get-up-and-go!" Use it for practically everything—video servicing, audio and ultrasonic equipment, low level audio servicing of pickups, mikes, pre-amps, radios and amplifiers, troubleshooting ham radio, hi-fi equipment, etc.—and you can take it with you, on the job, anywhere!

FEATURING: voltage-calibrated frequency-compensated, 3 to 1 step attenuator • scaled graph screen and calibrating voltage source for direct reading of peak-to-peak voltages • "plus-minus" internal sync... holds sync up to 4.5 Mc • shielded input cable with low capacitance probe included • weighs only 14 pounds • includes built in bracket to hold power cord and cables.

SPECIFICATIONS: Vertical Amplifier (Narrow Band Position)—Sensitivity, 3 rms mv/inch; Bandwidth, within -3 db, 20 cps to 150 Kc • Vertical Amplifier (Wide Band Position)—Sensitivity, 100 rms mv/inch; Bandwidth, within -3db, 5.5 cps to 5.5 Mc • Vertical Input Impedance—At Low-Cap cable input... 10 megohms, 10 μ f (approx.); At Direct-cable input... 1 megohm, 90 μ f (approx.) • Sweep Circuit—Sawtooth Range, 15 cps to 75 Kc; Sync, external, \pm internal; Line Sweep, 160° adjustable phase.

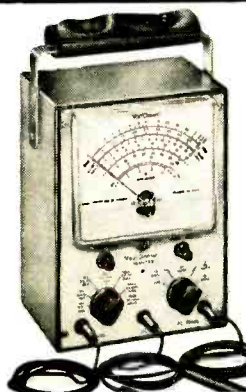
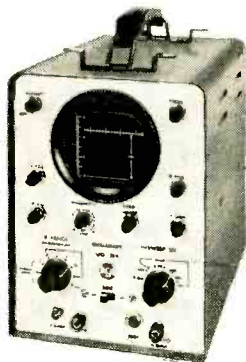

RCA WV-77E (K) VOLTOHMYST®

only **\$29.95*** (also available factory-wired and calibrated only \$43.95*)

Think of it—an RCA VoltOhmyst Kit at this low, low price! You get famous RCA accuracy and dependability, plus the easiest to assemble kit you've ever seen!

FEATURING: ohms-divider network protected by fuse • ultra-slim probes and flexible leads • sleeve attachment on handle stores probes, leads, power cord • separate 1 1/2 volts rms and 4 volts peak-to-peak scales for accuracy on low ac measurements • front-panel lettering acid-etched.

SPECIFICATIONS: Measures: DC Volts—0.02 volt to 1500 volts in 7 overlapping ranges; AC Volts (RMS)—0.1 volt to 1500 volts in 7 overlapping ranges; AC Volts (peak-to-peak)—0.2 volt to 4000 volts in 7 overlapping ranges; Resistance—from 0.2 ohm to 1000 megohms in 7 overlapping ranges. Zero-center indication for discriminator alignment • Accuracy—± 3% of full scale on dc ranges; ± 5% of full scale on ac ranges • Frequency Response—flat within ± 5%, from 40 cycles to 5 Mc on the 1.5, 5, and 15-volt rms ranges and the 4, 14, and 40-volt peak-to-peak ranges • DC Input Resistance—standard 11 megohms (1 megohm resistor in probe).

*User Price (Optional)

See them all at your local RCA Test Equipment Distributor!



RADIO CORPORATION OF AMERICA
ELECTRON TUBE DIVISION HARRISON, N. J.

that the TV station's permission to rebroadcast its signals must be obtained. The provision that boosters must be so designed that they can be turned off immediately—from a remote point if unattended—also came up for discussion.

It is likely that many boosters will require additional equipment before they meet with FCC standards as to quality of signal, according to engineer Parker. Some of the pictures, he pointed out, were of such quality that one might get a headache watching them.

Stereo Standards Coming Soon

A strong feeling that FM multiplex stereo standards will be set by the FCC before the end of 1960 pervaded the New York High-Fidelity Show held early in September. The results of the field tests conducted from Pittsburgh were to be filed with the FCC Oct. 28. According to *Television Digest*, five of the systems tested gave results that observers considered "good stereo."

Knee Noise Signals Arthritis

Sound patterns from the knee joints indicate rheumatoid conditions, states Dr. Herbert Fisher of Ohio State University. Speaking before the International Congress of Physical Medicine at Washington recently, Dr. Fisher reported on records made of 75 subjects, of whom 25 were patients with rheumatoid involvements and 25 had been diagnosed as suffering from degenerative arthritis.

"Normal knees produce a relatively regular pattern," he said. "In rheumatoid arthritis, the entire pattern is distorted, while in degenerative joint disease, there are high amplitude spikes superimposed on a normal pattern."

Japanese TV's Coming

Television receivers from Japan, now being seen in a few American stores, are expected in quantity for the Christmas trade, according to *Television Digest*. Those reaching the counters first were 8-inch units, some portable and some ac-operated. Contrary to previous experience with small-screen sets, sales have been good, according to the few dealers who have handled them. Sets were selling at \$100. A 19-inch receiver was expected by the beginning of this month, to sell for something less than \$200, and a 23-inch set early in 1961.

Elevator + TV = Safety

A closed-circuit television system has been installed at the Ansonia residential hotel in New York City solely for the purpose of observing a self-service elevator. Users of operatorless elevators are particularly vulnerable to robbery and attack. To protect them, a remote-controlled, 10-lb vidicon camera is mounted on top of the elevator, with a special

(Continued on page 20)

Here's The Offer No Other Radio-TV School DARES MAKE!

LEARN AT HOME in Spare Time!

YOU DO MANY PRACTICAL JOBS with the kits we send you. That's right, you PRACTICE what we TEACH! You build a Signal Generator, AC-DC Power Pack, and AC-DC Superheterodyne Radio Receiver and top quality 21 inch TV Set. EARN AS YOU LEARN with the famous RTS 30 Day Income Plan. Full instructions provided. NO HIGH SCHOOL DIPLOMA NECESSARY. This is a COMPLETE course which starts with basic subjects and gradually advances to Radio-TV. . . . ALL FOR A PRICE YOU CAN AFFORD!

*THE ONLY VERTICAL MULTI-CHASSIS 21" TV KIT OFFERED BY ANY RADIO-TV SCHOOL

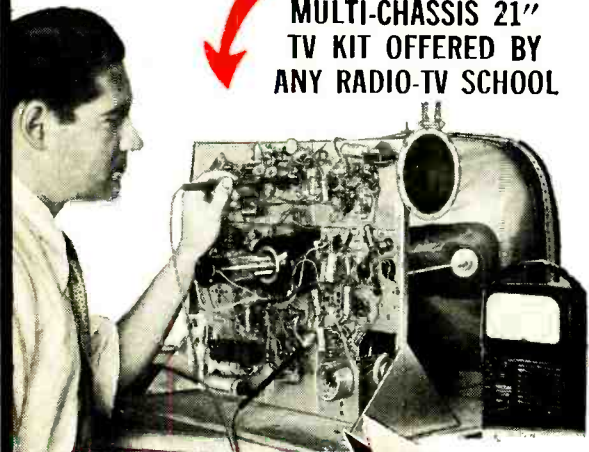

YOU BUILD THESE AND OTHER UNITS!

COMPLETE COLOR TV INSTRUCTION INCLUDED!



Each student is entitled to unlimited consultation service. All questions are answered promptly and completely by highly specialized instructors.

*Tubes Excluded

RTS' Membership in The Association of Home Study Schools is your assurance of Reliability, Integrity and Quality of Training.



RADIO-TELEVISION TRAINING SCHOOL

815 E ROSECRANS AVENUE
LOS ANGELES 59, CALIFORNIA

L 101D

Est. 1922



Rush Coupon for FREE FACTS!

RTS Will Train You at a Price You Can Afford and When You Are a Qualified Graduate Will Help You Open a Service Shop of Your Own and Supply You With Every Bit of Equipment You Need to Get Started - Plus an Inventory of Parts and Necessary Supplies.

ALL FINANCED WITHOUT INTEREST OR CARRYING CHARGES!!

You Also Receive . . . Advertising Help and Material, Shop Plans, Business Systems, Letterheads, Calling Cards and Much More!

Here's What Two of Many Business Plan Shop Owners Have to Say!

This business takes in between \$1500 and \$2000 a month. I've had to hire help to keep up with it.

CULLEN W. IRBY
Corpus Christi, Texas

The school lives up to its promises 100%. RTS does not lose interest in its students once they graduate.

HAROLD R. STANLAKE
Perry, Michigan

DON'T LOSE OUT — FIND OUT!

RADIO TELEVISION TRAINING SCHOOL, Dept. RE-110
815 E. Rosecrans Ave. Los Angeles 59, Calif.
Rush me full information by return mail. (Please Print)

NAME _____ AGE _____
STREET _____
CITY _____ ZONE _____ STATE _____

NO SALESMAN WILL CALL ON YOU!

Why are more Service-Dealers Switching to **JFD** EXACT REPLACEMENT TV ANTENNAS?

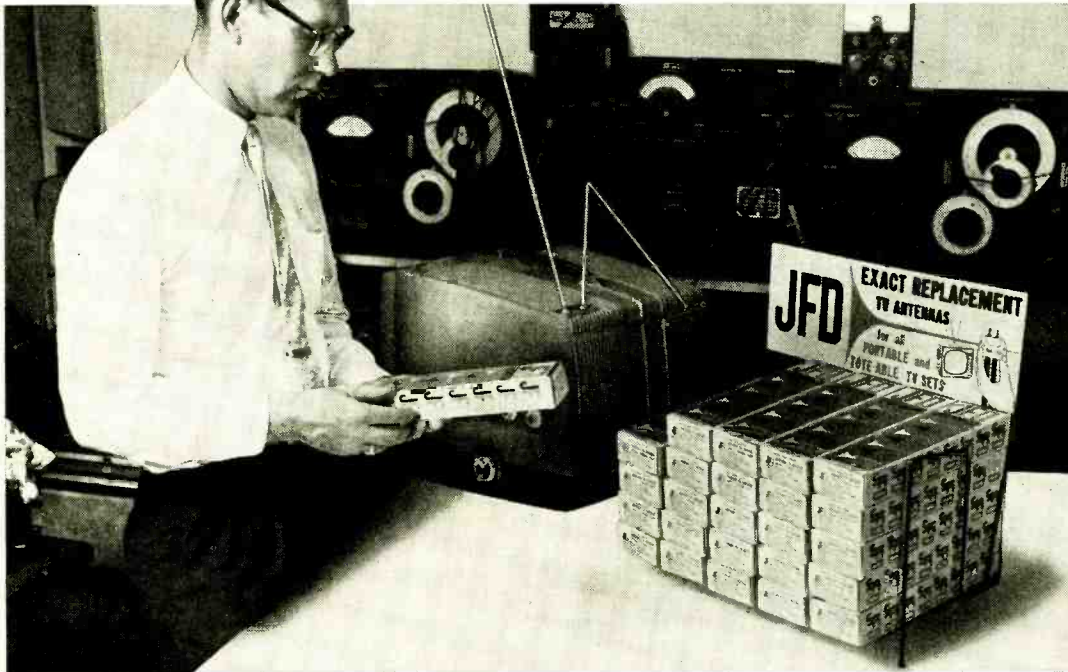

because

50 per cent of all TV sets made in the last 4 years are portables—sending *more* antenna replacement business to service-dealers every day.

because

with the JFD PA500 and PA515 Exact Replacement Kits, dealers are ready and able to service *90%* of antenna replacements for portables and tote-ables.

because

as JFD Exact Replacement Specialists, service-dealers can get out of the unprofitable “rabbit-ear” business—earn a *profit* on the antenna sale (at full mark-up) *and* on the *installation*.

because

with JFD guides, streamers, and sales helps, service-dealers get the merchandising *know-how* that nets them a bigger slice of the *3,500,000* dollar portable antenna replacement market.

***NOW IS THE TIME TO WRITE JFD OR ASK YOUR JFD DISTRIBUTOR
FOR YOUR EXACT REPLACEMENT PROFIT PLAN PORTFOLIO!***



Only JFD keeps you up-dated with the 1960 Portable TV Antenna Guide covering every portable TV set made since 1956 (compiled and edited by Howard W. Sams & Co., Inc.)

Check **SAMS PHOTOFACT FOLDERS** for JFD Exact Replacement Antenna Information.



THE BRAND THAT PUTS YOU

JFD

JFD ELECTRONICS CORPORATION BROOKLYN 4, NEW YORK
JFD International, 15 Moore Street, New York, New York • JFD Canada, Ltd., 51 McCormack Street, Toronto, Ont., Canada IN COMMAND OF THE MARKET

Why are more Service-Dealers Switching to **JFD HI-FI TV ANTENNAS?**



The Businessman in the Sergeantman suit knows five million TV antennas are in need of replacement. For his installations he relies on the superior performance and quality of JFD Hi-Fi Colortennas to guarantee complete customer satisfaction—guard his reputation.

JFD

HI-FI HELIX HI-FI BANSHEE HI-FI FIREBALL



because

they know 5 million antennas need replacement—that JFD HI-FI TV antennas assure them a bigger share of this profitable market.

because

JFD all-out advertising sells for them in powerful national mass media—such as Look, TV Guide, Successful Farming, Farm Journal, Progressive Farmer.

HOW MUCH INSTALLATION BUSINESS ARE YOU LOSING BY NOT SWITCHING TO JFD? THE TV ANTENNA LINE AMERICA KNOWS BEST!

because

JFD is the total antenna line with the right model, at the right price for every location—does the most for them in mile-shrinking performance and customer confidence.

because

JFD sales stimulators such as cloth patches, decals, mobiles, banners, displays and direct mail give them the complete package to sell new customers.

HI-FI HELIX
Silver or Gold Anodized



HI-FI BANSHEE
Silver or Gold Anodized

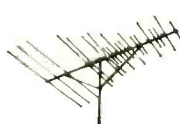

HI-FI FIREBALL
Silver or Gold Anodized



THE BRAND THAT PUTS YOU

JFD

IN COMMAND OF THE MARKET

JFD ELECTRONICS CORPORATION, Brooklyn 4, New York
JFD International, 15 Moore Street, New York, New York • JFD Canada, Ltd., 51 McCormack Street, Toronto, Ont., Canada

see the exciting **1961**

knight-kits[®]

A PRODUCT OF ALLIED RADIO

in this value-packed **ALLIED** catalog

free

**444 pages
most complete**

send for it!

use coupon
on next page

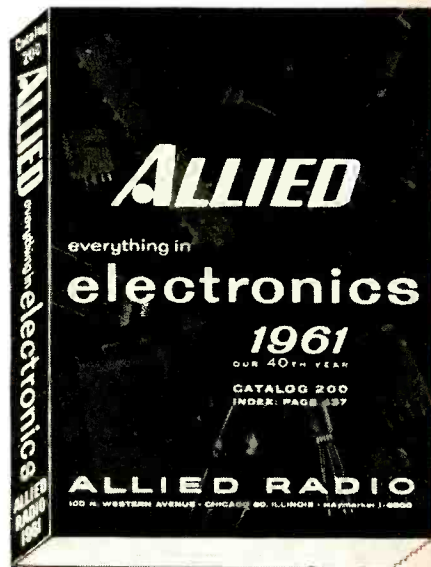

knight-kits—Best by Design

FUN TO BUILD Building it yourself is always satisfying fun—it's fun at its best when you build Knight-Kits—they're so beautifully engineered, so much easier, more pleasurable to work with...

YOU SAVE You save substantially because you buy direct from Allied at our money-saving big-volume-production prices—and because you do the easy building yourself...

YOU OWN THE BEST You'll be glad you built a Knight-Kit, because you'll own and enjoy with pride a true custom-built product, professionally engineered and styled—designed for superior performance...

EASIEST TO BUY **only \$2 down** on orders up to \$50; \$5 down up to \$200; \$10 down over \$200—up to twenty-four months to pay...

exclusive knight-kit

MONEY BACK GUARANTEE

Every Knight-Kit is unconditionally guaranteed to meet our published specifications for performance or your purchase price is refunded in full.

**Buy Any Knight-Kit!
...Build and Use It!
It Must Perform
Exactly as Claimed!**

Your Satisfaction is Guaranteed

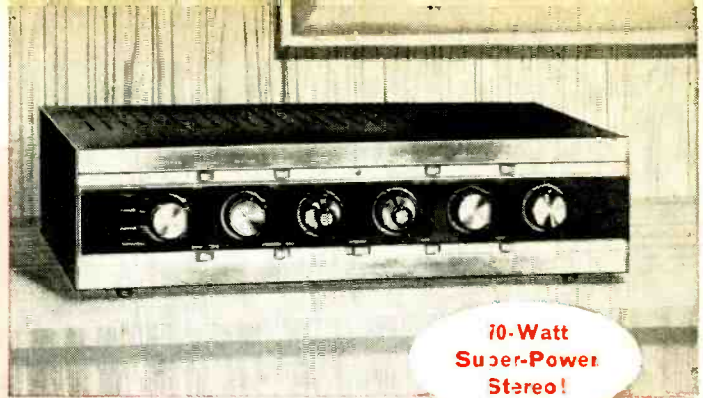

**70-Watt
Super-Power
Stereo!**

DELUXE 70-WATT STEREO AMPLIFIER

Super-power to drive any of today's speakers; the ultimate in control flexibility and functions. 83 YU 934 **\$119.95** **only \$5 down**

see many more great **HI-FI KITS**

Stereo Preamp	18-Watt Amplifier
60-Watt Stereo Amplifier	12-Watt Amplifier
Stereo Control	FM Tuner
25-Watt Amplifier	Speaker Systems



ALL-BAND SUPERHET RECEIVER

Covers 540 kc to 36 mc, plus 6 meters; general coverage tuning and calibrated Amateur bandspread tuning. 83 YU 935 **\$67.50** **only \$5 down**

see many other **HOBBYIST KITS**

"Space Spanner" [®] Receiver	Transistor Radios
"Ocean Hopper" Radio	Intercom Systems
Radio-Intercom	Electronic Lab Kits
Clock-Radio	Photoelectronic System



◀ BEST VTVM VALUE

High sensitivity general-purpose VTVM; 11 meg input resistance; balanced-bridge circuit; 4 1/2" meter. 83 Y 125 **\$25.75**

only \$2 down



only \$2 down

From original concept to final design, each Knight-Kit is produced by and comes directly to you from **ALLIED**

sold exclusively by

ALLIED

knight-kits: best in build-your-own electronic equipment



STEREO TAPE RECORD/PLAY PREAMP

Professional quality; permits tape monitoring, sound-on-sound and echo effect; use with any tape transport. 83 YX 929 (less case) \$79.95

only **\$5** down

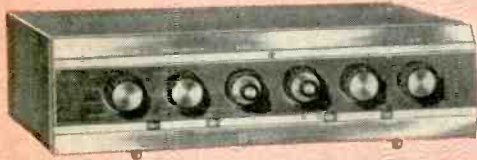

DELUXE 40-WATT STEREO AMPLIFIER

Full frequency center channel. Finest amplifier available anywhere in this price range. 83 YU 774 \$76.95

only **\$5** down

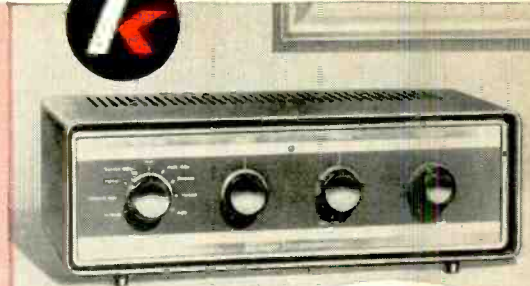

Only **\$39.95**
For Full 20 Watts
Stereo!

SUPER-VALUE STEREO HI-FI AMPLIFIER

20-Watt Stereo Hi-Fi Amplifier, with special clutch-type dual-concentric level control; biggest bargain in Stereo hi-fi. 83 YX 927. \$39.95

only **\$2** down

DELUXE FM-AM STEREO HI-FI TUNER

Dynamic Sideband Regulation, variable AFC, "Magic Eye" slide-tuning, multiplex add-in. 83 YU 731. \$87.50

only **\$5** down



SUPERHET CITIZENS BAND TRANSCEIVER

Dual-conversion receiver for highest sensitivity and selectivity; 2-channel crystal-controlled 5-watt transmitter. 83 YX 712-2. \$79.95

only **\$5** down



only **\$2** down

\$39.95 For
This Citizen's Band
Transceiver

TOP VALUE CITIZENS BAND TRANSCEIVER

Lowest-priced complete Citizens Band Transceiver. Tunable 22-channel super-regenerative receiver; 5-watt transmitter. 83 Y 713-2. \$39.95



FM-AM HI-FI TUNER BUY

Outstanding FM-AM Hi-Fi Tuner; with AFC and tuned RF stage on FM; includes multiplex jack. 83 YX 928. \$49.95

only **\$2** down

SENSATIONAL 4-BAND "SPANMASTER" RECEIVER

For thrilling world-wide reception; exciting Shortwave and Broadcast; band-switching, 540 KC to 80 MC. With cabinet. 83 YX 258. \$25.95



only **\$2** down



32-WATT STEREO AMPLIFIER VALUE

Money-saving 32-Watt Stereo Hi-Fi Amplifier; high power at low cost; full frequency center channel. 83 YU 933. \$59.95

only **\$5** down



only **\$2** down

"600" TUBE CHECKER

Checks over 700 types; illuminated roll-chart; obsolescence-proof design. 83 YX 143. \$32.95

RF SIGNAL GENERATOR

Output to 112 mc on fundamentals; 400-cycle modulation. 83 Y 145. \$19.75

full selection of INSTRUMENT KITS

- 5" Oscilloscopes
- AC VTVM
- Tube Checkers
- Signal Tracer
- Audio Generator
- Sweep Generator
- Battery Eliminator
- Capacity Checker
- Transistor Checker
- R/C Tester,
- plus many others

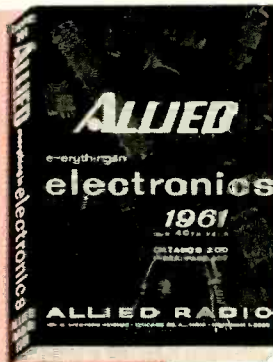

free

SEND FOR THE 444-PAGE 1961 ALLIED CATALOG

Write today for the world's biggest electronics catalog, featuring the complete KNIGHT-KIT line. See the big news in quality electronic kits—save on everything in Electronics. Send for your FREE copy.

send for it today!

ALLIED RADIO, Dept. 162-L
100 N. Western Ave., Chicago 80, Ill.

Send FREE 1961 ALLIED Catalog

Name _____

Address _____

City _____ Zone _____ State _____

RADIO

Pioneer in electronic
kit development

Biggest Soldering Gun Value on the market!

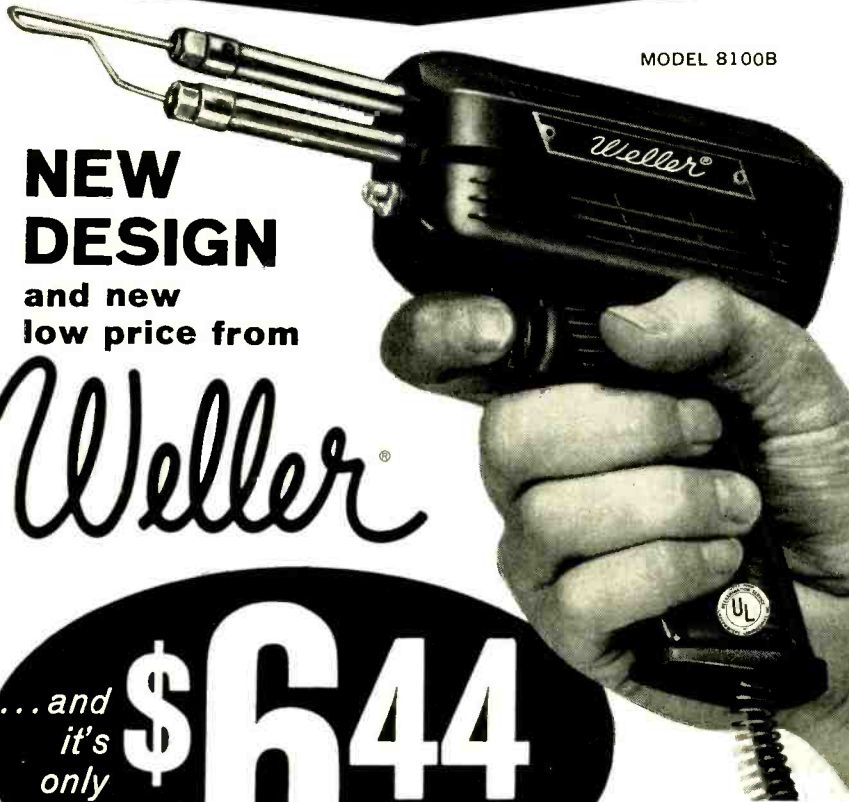

MODEL 8100B

**NEW
DESIGN**
and new
low price from

Weller

...and
it's
only **\$644**
LIST PRICE

Check these advanced features:

- ✓ **New Long-Life Wellertip**— Utilizes copper for superior heat transfer, plus iron-plating for rigidity and long life. Copper conducts heat 5 times faster than steel, permits operation at lower temperature, prevents damage to components. Long reach for easier use in difficult places.
- ✓ **100 watts**—single heat
- ✓ **Tip heats instantly** when trigger is pulled—no waiting
- ✓ **Prefocused spotlight illuminates work**, eliminates shadows
- ✓ **New compact, streamlined design** with rugged housing
- ✓ **Perfect balance** for greatest soldering accuracy
- ✓ **Guaranteed for 1 year**—UL approved



On sale now at your Electronic Parts Distributor

Send for Weller Gun Bulletin

WELLER ELECTRIC CORP. 601 Stone's Crossing Rd.
Easton, Pa.

(Continued from page 14)

wide-angle lens looking through an opening in the top of the cab. A 24-inch monitor is set so that it can be viewed from any part of the lobby. Two 17-inch monitors are placed at opposite ends of the 16-foot main desk so that they will be in direct view of the desk clerk at all times.

CALENDAR OF EVENTS

Conference on Electronic Techniques in Medicine and Biology, Oct. 31–Nov. 2, Sheraton Park Hotel, Washington, D.C.

IRE-EIA Radio Fall Meeting, Oct. 31–Nov. 2, Syracuse Hotel, Syracuse, N.Y.

Conference on Magnetism & Magnetic Materials, Nov. 14–17, New Yorker Hotel, New York, N.Y.

Mid-America Electronics Conference (MAECON), Nov. 15–16, Muehlebach Hotel, Kansas City, Mo.

Northeast Research & Engineering Meeting (NEREM), Nov. 15–17, Commonwealth Armory and Sheraton Plaza Hotel, Boston, Mass.

Northwest Hi-Fi Show, Nov. 25–27, Leamington Hotel, Minneapolis, Minn.

EIA Winter Conference, Nov. 29–Dec. 1, Fairmont Hotel, San Francisco, Calif.

Third Annual Futronics Exposition, Nov. 30–Dec. 2, Roosevelt Raceway Exhibit Hall, Westbury, N.Y.

Vehicular Communications Meeting, Dec. 1–2, Sheraton Hotel, Philadelphia, Pa.

URSI-IRE Fall Meeting, Dec. 12–14, NBS Boulder Laboratories, Boulder, Colo.

Eastern Joint Computer Conference, Dec. 13–15, New Yorker Hotel and Manhattan Center, N.Y.

Radio Signals from Saturn

The Navy reports receiving "the first conclusive signals" from the planet Saturn. They were picked up by scientists at the University of Michigan, using that university's 85-foot radio telescope. This may make possible a study of the temperature and density of Saturn's rings, and of the distribution of gases in its atmosphere.

Signals were also picked up from a nebula so distant that the radio waves took 3,000 years to reach the receiving antenna.

World TV's up to 94 Million

The number of TV receivers in the world took a more than 10% jump during the 12 months preceding Aug. 1, 1960, to reach nearly 94,000,000, reports *Television Digest*. TV stations are now operating in 66 countries, with a total of 1,383 stations on the air in foreign countries, (plus 570 in the United States). First of the foreign countries in TV set ownership is Britain, with 10,900,000 sets, followed by Japan with 5,000,000, then by West Germany and Russia, with over 4,000,000 each.

Electrons Weld Metals

An electron gun is being used to weld molybdenum alloys and pure tungsten, according to Republic Aviation Corp. The metals are considered very useful for space-vehicle work because of their resistance to high temperatures.

A narrow beam of electrons from the gun raises the metal's temperature to the 6,000°F needed for welding. The gun operates in a cylindrical vacuum chamber that allows contamination-free welds. **END**

Mercury offers you **MORE** for your TEST EQUIPMENT DOLLAR!

NEW



**Model 700
TRANSISTOR TESTER**
Dealer Net **\$2425**

NEW



**Model 500
COMPONENT SUBSTITUTOR**
Dealer Net **\$2995**

**Model 400
VOM-CAPACITY TESTER**
Dealer Net **\$3995**



**Model 600 IN-CIRCUIT
RECTIFIER TESTER**
Dealer Net **\$2750**



NEW



Model 700—Tests all transistors and diodes quickly and accurately • Checks all transistors (RF, IF, Audio, Power Output, Industrial) for leakage and gain • Checks all diodes for forward-reverse current ratio • *No time consuming reference to data charts necessary* • *Positively cannot become obsolete* as the Model 700 will accommodate new transistors as they are introduced • Sturdy hammertone finish steel case • Size, 5 7/8 x 7 3/4 x 3 1/2".

Model 500 — Actually substitutes for 44 different values of resistors, condensers, electrolytics, power rectifiers, crystal diodes, power resistors and bias voltages. Substitutes: 20 values of resistors from 33 ohms to 10 megohms • 10 values of condensers .001 mfd. to .5 mfd. • 10 values of electrolytics from 4 mfd. to 330 mfd. • Power rectifiers up to 500 ma. • Crystal diodes • Power resistance, continuously variable up to 5000 ohms • Voltages, continuously variable up to 15 volts either polarity • Sturdy hammertone finish steel case • Size, 5 7/8 x 7 3/4 x 3 1/2".

Model 400—A 20,000 ohms per volt VOM and an accurate capacity meter. DC VOLTAGE RANGES: 0 to 15/75/150/300/750/1500/7500 V. • AC VOLTAGE RANGES: 0 to 15/75/150/300/750/1500 V. • RESISTANCE RANGES: 0 to 1,000/100,000 ohms/0 to 10 meg-ohms • RANGES: 0 to 75 microamps/7.5 ma./75 ma./15 amps • CAPACITY RANGE: .001 mfd. to 80 mfd. • Sturdy hammertone finish steel case • Size, 5 7/8 x 7 3/4 x 3 1/2".

Model 600—Checks all power rectifiers *in-circuit* (whether SELENIUM, GERMANIUM, SILICON, COPPER OXIDE, etc.) rated from 10 ma. to 500 ma. • Checks with 100% effectiveness for quality, fading, shorts, opens, arcing, life expectancy • Simple to use: just clip test lead, across rectifier under test *without disconnecting rectifier from circuit*. Press test switch and get an instant indication on the 3-color metal scales • Checks all power rectifiers out-of-circuit with equal effectiveness • Sturdy hammertone finish steel case • Size, 5 7/8 x 7 3/4 x 3 1/2".

New Mercury design projects meter forward . . . metal handle swings back to serve as rest so that instrument can be used in tilted position

Model 300 COMBINATION TESTER

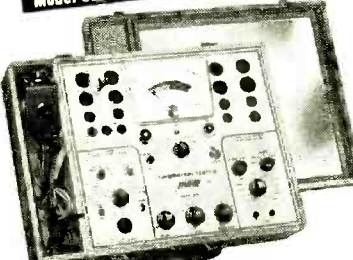

NOW also available in KIT form!

Model 101 TUBE TESTER

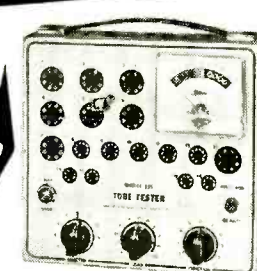

Model 800 CRT TESTER-REACTIVATOR



✓ A multiple-socket tube tester ✓ A CRT tester-reactivator ✓ A 20,000 ohms per volt VOM and capacity tester **ALL COMBINED IN ONE COMPACT UNIT!**
 • AS A TUBE TESTER . . . will check emission, interelement leakage and gas content of over 700 tube types • AS A CRT TESTER-REACTIVATOR . . . will test, repair and reactivate all black and white and all color picture tubes • AS A VOM AND CAPACITY TESTER . . . sensitivity is 20,000 ohms per volt/DC and 5000 ohms per volt/AC . . . Capacity ranges: .001 mfd. to 80 mfd. • Unbreakable mirror for TV adjustments inside detachable cover • Handsome wood carrying case • Size, 17 1/2 x 13 1/2 x 4 1/2".
 Dealer Net **\$9975**

A versatile economy priced tube tester
 • Checks quality (emission, shorts and gas) of over 700 tube types, including the newest series-string TV tubes, OZ4s, gas regulators, hi-fi and foreign tubes • Checks each section of multi-purpose tubes • Easy-to-read 3 color meter scales • 17 long lasting phosphor bronze tube sockets • Positively cannot become obsolete. New tube listing furnished periodically to all registered owners • Sturdy-gray hammertone steel case • Size: 9 x 8 1/2 x 2 3/4".
KIT — \$3195 **WIRED — \$3995**
 Dealer Net Dealer Net

✓ TESTS ✓ REPAIRS ✓ REACTIVATES all **BLACK AND WHITE** and all **COLOR** picture tubes
 • TESTS . . . emission, inter-element leakage and life expectancy • REPAIRS . . . shorts and open elements • REACTIVATES . . . weak tubes with a controlled high voltage pulse (reactivation is seen and controlled on the meter as it takes place)
 • Tests the red, green and blue sections of color tubes separately • Also provides the newer 2.35 and 8.4 filament voltages • Unbreakable mirror for TV adjustments inside detachable cover • Handsome wood carrying case • Size 11 x 9 1/2 x 4 1/2".
 Dealer Net **\$4995**

Model 102-P TUBE TESTER

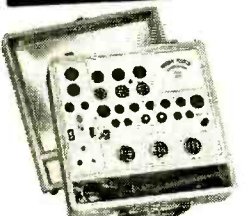

Same specifications as the Model 101 • Also tests picture tubes, all diodes, rectifiers, fuses, pilot lamps • Unbreakable steel mirror for TV adjustments inside detachable cover • Handsome wood carrying case.
 Dealer Net **\$5950**

Model 102-C CADDY TUBE TESTER

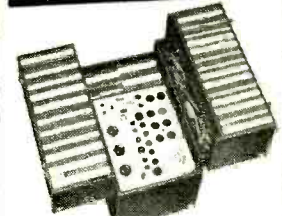

Tube tester has same specifications as Model 102-P • Tester is removable • Extra storage compartment under tester • Drawer for tools and test leads • Unbreakable mirror mounted under tester case for TV adjustments.
 Dealer Net **\$7450**

SELF-SERVICE TUBE TESTERS

Cannot become obsolete as new tube types are introduced!

Model 201-F (floor model)
 Dealer Net **\$15850**

Model 201-C (counter model)
 Dealer Net **\$10950**



SOLD ONLY THROUGH PARTS DISTRIBUTORS

FREE The instruction manual for any instrument shown is available upon request . . . use coupon below.

MERCURY ELECTRONICS CORP.
 77 Searing Avenue, Mineola, N. Y. E-11

Please send me instruction manuals of the test instruments I have checked.

<input type="checkbox"/> Model 700	<input type="checkbox"/> Model 101
<input type="checkbox"/> Model 500	<input type="checkbox"/> Model 800
<input type="checkbox"/> Model 400	<input type="checkbox"/> Model 102-P
<input type="checkbox"/> Model 600	<input type="checkbox"/> Model 102-C
<input type="checkbox"/> Model 300	<input type="checkbox"/> Model 301

Name _____
 Address _____
 City _____ State _____

MERCURY ELECTRONICS CORP. 77 SEARING AVENUE, MINEOLA, NEW YORK
 West Coast Office: 4306 W. Victory Blvd., Burbank, Calif.

Here's the SPECIALIZED

Let these 2 Ghirardi manuals teach you to
**REPAIR ANY TELEVISION
OR RADIO RECEIVER ever made!**



A. A. GHIRARDI

SAVE \$2.00!

Make your service library complete! Get both these famous Ghirardi books at a saving of \$2.00 under the regular price. See **MONEY - SAVING COMBINATION OFFER** in coupon.

①

RADIO & TV CIRCUITRY and OPERATION

Learn about circuits . . . and watch service headaches disappear

You can repair ANY radio, TV or other electronic equipment lots easier, faster and better when you're fully familiar with its circuits and know just why and how each one works . . . and that's exactly the kind of specialized training you get in Ghirardi's 669-page Radio & TV CIRCUITRY AND OPERATION training guide. First it gives a complete understanding of

basic modern circuits and their variations. Finally it shows what troubles to look for and how to eliminate useless service testing and guesswork. Throughout, it gives you the above-average training that takes the "headaches" out of trouble-shooting—the kind that fits you for the best-paid servicing jobs. Contains 417 clear illustrations.

Sold separately for \$9.00—or see **MONEY-SAVING COMBINATION OFFER.**

②

RADIO & TV TROUBLESHOOTING and REPAIR

Complete training in modern service methods

Radio & TV TROUBLESHOOTING and REPAIR is a complete 822-page guide to professional service methods . . . the kind that help you handle jobs faster, more profitably. For beginners, this giant book with its 417 clear illustrations is an easily understood course in locating troubles fast and fixing them *right*. For experienced servicemen, it is an ideal way to develop better

methods and shortcuts; or to find fast answers to problems. You learn troubleshooting of all types from "static" tests to dynamic signal tracing methods. Step-by-step charts demonstrate exactly what to look for and how to look. A big television section is a down-to-earth guide to all types of TV service procedures. Read it 10 days at our risk!

Sold separately for \$10.00 or save \$2.00 on **MONEY-SAVING COMBINATION OFFER.**

Cut Radio-TV Test Time IN HALF!

In modern electronic work it's what you know about using instruments that really counts!



This new 316-page BASIC ELECTRONIC TEST PROCEDURES manual with its more than 190 illustrations, pattern photos and procedure diagrams teaches you to test any circuit, equipment or component in a fraction of the usual time.

In brief, it is a complete course in professional instrument testing techniques! Covers different ways of doing jobs. For instance, you learn to check for distortion by the scope, rejection filter, harmonic distortion meter, wave analyzer or oscillator methods. You learn to measure resistance with a current meter, a volt-ammeter, voltmeter, ohmmeter, or via the bridge method—and so on through all types of testing.

Includes Current checks; measuring Power, Capacitance, Resistance, AF, RF, Phase, Distortion & Modulation; testing Tubes and Semiconductors; testing Amplifiers; checking Sensitivity, RF Gain, Fidelity, AVC Voltage, etc. Even includes industrial electronic test procedures. Everything is *really* complete—and written so you can understand it! Price \$8.00.

Order **BASIC ELECTRONIC TEST PROCEDURES** in coupon.

Now! FIX ANY ELECTRIC MOTOR

Handle ANY job from minor repairs to complete rewinding

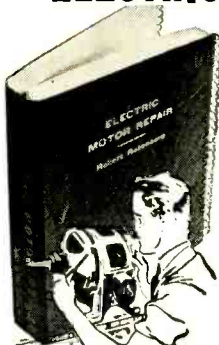

560 pages—Over 900 how-to-do-it pictures

It pays to train for something different! **ELECTRIC MOTOR REPAIR** is a complete guide that helps you cash in on this vast, rapidly growing field. Shows step by step how to handle all repair jobs (including complete rewinding) on practically ANY AC or DC motor or generator in common use—from fractional horsepower to giant industrial motors. Special duo-spiral binding brings text and related how-to-do-it diagrams side by side explained so clearly you can hardly fail to understand it. Over 125,000 copies in use in motor repair shops, schools, and for home study. Fully approved by repair specialists, unions and instructors.

It's the ideal book whether you want to train for a good-pay motor repair job or simply want to fix motors as a sideline or hobby!

Order **ELECTRIC MOTOR REPAIR** in coupon. Price only \$9.25.

TRAIN FOR BETTER PAY IN A FIELD THAT ISN'T CROWDED!

DON'T THROW OLD RADIOS AWAY!



Here's the data you need to fix old sets in a jiffy!

Just look up the how-to-do-it data on that old radio you want to fix.

Four times out of 5, this giant, 3½-pound, 744-page Ghirardi **RADIO TROUBLESHOOTER'S HANDBOOK** tells what is likely to be causing the trouble . . . shows how to fix it. No useless testing. No wasted time. Using it, even beginners can easily fix old sets which might otherwise be thrown away because service information is lacking. With a few simple repairs, most of these old sets can be made to operate perfectly for years to come.

THE ONLY GUIDE OF ITS KIND!

Cuts service time in half!

Included are common trouble symptoms and their remedies for over 4,800 models of old home, auto radios and record changers. Airline, Apex, Arvin, Atwater Kent, Belmont, Bosch, Brunswick, Clarion, Crosley, Emerson, Fada, G-E, Kolster, Majestic, Motorola, Philco, Philo, RCA, Silvertone, Spartan, Stromberg and dozens more. Includes hundreds of pages of invaluable tube and component data, service short cuts.

Specify **RADIO TROUBLESHOOTER'S HANDBOOK** in coupon. Price only \$10.00. 10-day trial.

USE COUPON FOR **10-day Free Trial!**

TRAINING YOU NEED

in its most complete
economical and
easily understood form

TRAIN AT HOME FOR TV-RADIO-ELECTRONICS . . . at rock-bottom cost!

Now! Get your basic training from these two easily understood, low cost books!

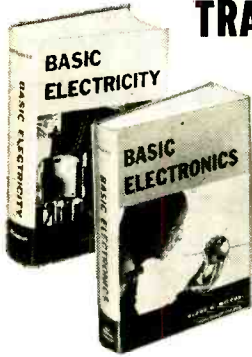

Here is complete basic electrical-electronic training specifically written for beginners—priced at a fraction of what you might expect. 785 pages and almost 700 pictures, diagrams and charts in these two big books bring you top notch training that can pave your way to a fascinating electronic career. Every detail is fully and clearly explained. Nothing is omitted—nothing is condensed. In every respect, the material in these books compares more than favorably with "courses" costing many times as much!

BASIC ELECTRICITY—Fundamental electrical principles are the basis of all Electronics—and this 396-page manual gives you a complete working knowledge of them all! Covers everything from electromagnetism to 'phone principles, circuits, wiring, illumination, reactance, impedance, power factor, instruments, controls, measurements, and all types of components and equipment. Includes set-up diagrams, practical examples and problem solutions. Price \$6.25 separately. See Money-Saving Offer!

ONLY \$11.00 FOR THIS COMPLETE HOME TRAINING!

BASIC ELECTRONICS—This new 389-page guide takes up where Basic Electricity leaves off. Shows how electrical principles are applied in Electronics and gives you a sound grasp of electronic theory, methods, circuits and equipment. Over 375 illustrations explain details clearly. The ideal basic training to help you build a profitable future in TV, radio, communications, hi-fi, industrial electronics and related fields! Price \$6.25 separately.

Save \$1.50! See special Money-Saving Offer in Coupon!

Here's everything you need to know about

OSCILLOSCOPES!

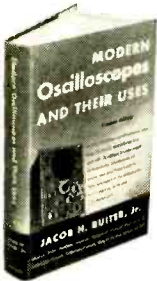

Complete data on using the handiest instrument of all!

Men who know how to use oscilloscopes on all types of jobs don't guess about troubleshooting and tough re-alignment problems! They locate troubles in a jiffy, adjust them quickly and accurately—and this famous 346-page manual teaches you the methods they use.

MODERN OSCILLOSCOPES AND THEIR USES gets right down to earth in telling you all about these versatile instruments and exactly how to use them.

Particular attention is paid to AM, FM, and TV realignment procedures. Every detail of testing with 'scopes is explained from connecting the 'scope and setting its controls to adjusting components in the chassis being tested. Illustrated instructions teach you to analyze patterns. Even includes data on quantitative measurements (as used in color TV servicing) and use of 'scopes in lab, industrial electronics and atomic work. 370 illustrations. Price \$8.00.

Specify **MODERN OSCILLOSCOPES AND THEIR USES** in coupon to order.



SHORT CUT TO TV REPAIR!

Just turn the dial of the pocket-size **PIX-O-FIX TROUBLE-FINDER GUIDE!** When the picture in the PIX-O-FIX window matches the image on the TV screen—presto!—you've got your clue. PIX-O-FIX shows the likely causes of the trouble—indicates

the receiver section involved—then gives clear repair instructions. Two PIX-O-FIX units Nos. 1 and 2 cover 48 different TV troubles. Together, they're a comprehensive guide to quick "picture analysis" servicing of any TV. Price only \$3.00 for the two.

Get your COMMERCIAL OPERATORS LICENSE!

Train for radio's most fascinating, best paid jobs!



This famous book makes it easy to train for your FCC commercial license as an operator aboard ship, in aviation, broadcasting, telecasting, etc. **LICENSE MANUAL FOR RADIO OPERATORS** is a quick, easily understood guide that covers ALL

EIGHT FCC examination elements—not just some of them. Reviews almost 2200 exam questions. Covers everything you'll need to know to pass your examination for 1st or 2nd class radio-phone license holder with flying colors! Price \$6.75.

REPAIR ANY ELECTRICAL APPLIANCE!

Save on repair bills! . . . Earn in your Spare Time!

This 370-page **ELECTRICAL APPLIANCE SERVICE MANUAL** helps you service practically any home electrical appliance. Includes standard and automatic washers, ironers, toasters, ranges, cleaners, mixers, razors, clocks, motors, and many more.

Troubleshooting charts quickly help you locate troubles. Easy instructions guide you in making repairs. Tells how to make your own low-cost test tools. Includes appliance refinishing methods. An ideal guide for fixing your own appliances or for building a profitable appliance repair business! \$6.25.



ORDER NOW

TRY ANY BOOK 10 DAYS FREE!

Dept. RE-110, Technical Division, Holt, Rinehart & Winston, Inc., 383 Madison Ave., New York 17, N. Y.

Send books checked for 10 day FREE examination at prices indicated plus postage. **SAVE!** Send cash with order and we pay postage. Same 10 day return privilege with money refunded.

- Check here for **MONEY-SAVING SERVICE COMBINATION** on Ghirardi's Radio & TV CIRCUITRY & OPERATION and Radio & TV TROUBLESHOOTING & REPAIR. Price only \$17.00 for both (plus postage). Regular price \$19.00—save \$2.00!
- Check here for **MONEY-SAVING Basic Training, COMBINATION ON BASIC ELECTRICITY AND BASIC ELECTRONICS**. Price only \$11.00 plus postage for both big books. Regular price \$12.50—save \$1.50!

- Check here to order**
- | | | | |
|--|---------|---|---------|
| <input type="checkbox"/> Radio & TV CIRCUITRY & OPERATION | \$ 9.00 | <input type="checkbox"/> Basic Electronics | \$ 6.25 |
| <input type="checkbox"/> Radio & TV Receiver TROUBLESHOOTING and REPAIR. | 10.00 | <input type="checkbox"/> Modern Oscilloscopes & Their Uses | 8.00 |
| <input type="checkbox"/> Basic Electronic Test Procedures | 8.00 | <input type="checkbox"/> PIX-O-FIX TV Trouble Finder Guides, Nos. 1 and 2 | 3.00 |
| <input type="checkbox"/> Electric Motor Repair | 9.25 | <input type="checkbox"/> License Manual for Radio Operators | 6.75 |
| <input type="checkbox"/> Radio Troubleshooter's Handbook | 10.00 | <input type="checkbox"/> Electrical Appliance Service Manual | 6.25 |
| <input type="checkbox"/> Basic Electricity | 6.25 | <input type="checkbox"/> Handbook of TV Troubles | 7.50 |

OUTSIDE U. S. A. Add 50¢ to price of each book. Cash with order, but money refunded if books are returned in 10 days.

Name _____
Address _____
City, Zone, State _____

New! Master Guide to TIME-SAVING TV SERVICE



Almost regardless of set make or model this remarkable new 302-page **HANDBOOK OF TV TROUBLES** helps you track down TV troubles from the symptoms they produce in the set itself: screen intermittently dark; "blooming"; abnormal contrast; "snow"; poor detail; sync troubles; sound troubles—and all the many other symptoms that indicate something is wrong. Just turn to the "Quick Trouble-Finder Guide" inside the cover. Look up the symptoms exhibited by the set you're working on. The **HANDBOOK** then tells you just

LOOK! LISTEN! what to do and how to do it. Outlines time-saving shortcuts. Eliminates guesswork. More than 150 test patterns, wave form and circuit illustrations explain test results, details and procedures. Printed in large type and bound in sturdy varnished covers for use at the bench. All methods presented have been bench-tested by the author through actual shopwork! Price \$7.50.

Order **HANDBOOK OF TV TROUBLES** in coupon.



clear
as
a
"bell"...

CDE rotors get

the biggest customer reception!

CD Rotors have the power to end your service problems . . . because they are designed with a direct line of power that out performs them all. Even in the stormiest, snowiest areas, you can just install them and forget them. CD Rotors give clear-as-a-"bell" reception that's trouble-free, longer lasting, require no call-backs. So order your CD Rotors today . . . you'll shout their praises from the roof-tops! Write for Catalog #1630 to Cornell-Dubilier, South Plainfield, New Jersey.

**CORNELL-DUBILIER
ELECTRONICS DIVISION**
Federal Pacific Electric Company





Let's
clear the
air...

WITH VOCALINE 4-CHANNEL COMMAIRE ED-27M CITIZENS BAND RADIO

Ranked first for
dependability
distance • clarity



Citizens band radio can be no more effective than the equipment you use! In fact, no judgment on the subject can be valid until one has heard the type of performance possible when properly engineered; truly superior equipment is utilized. Example: the Vocaline Commaire ED-27M, the finest citizens band radio available anywhere today! The difference between Vocaline Commaire ED-27M and ordinary Citizens band radios can be as substantial as the difference between the two photos above. For distance, reliability, flexibility and uniform clarity on the entire 22 channel citizens band . . . you have only to hear the Commaire to convince yourself that this is the

one unit that is unmatched by any other in its class. Specifications and features: Finished to pass U.S. Navy 500 hour salt spray test! "Silent-Aire" squelch with exclusive noise suppression. Double conversion superheterodyne single crystal receiver—accepted as the finest. Transistorized power supply. 5 watts input — 3 watts output. 6 and 12 VDC — 115 VAC. Only 5 1/4" x 9 1/4" x 8 1/4".

Also available in single channel model — Commaire ED-27M proven as the world's finest-performing class D Citizens Band Radio! Only \$179.50 each, list.

\$189.50
each, list.

VOCALINE
COMPANY OF AMERICA
123 Coulter Street
Old Saybrook, Conn.



Send complete literature to:
Name _____
Address _____
City _____ Zone _____ State _____

Correspondence



REPORT FROM A USER

Dear Editor:

I was very interested in "How to Obtain Faster Break-in" which appeared on page 137 of the March, 1960, issue. It showed how to remedy the problem of slow recovery in radio receivers when the amateur throws his T-R switch from *Transmit* to *Receive*.

I was having a terrific amount of

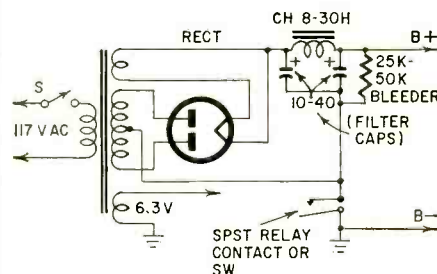

trouble with this problem and I thought I would give this idea a try. I was amazed at how perfectly the change in circuitry solved my problem. No matter how fast I flick my T-R switch, I don't get any of that annoying leftover signal from the transmitter.

Since I have made this change, a number of other hams in this area have made this modification too and all report equally perfect results.

J. DANTE AMOROSE—K4IIW
Richmond, Va.

[Thanks for the note of appreciation. And for those readers who missed this item we are reprinting the switching circuit here.—Editor]

FOR TV TECHNICIANS

Dear Editor:

The "Philadelphia Plan" announced in the August Technicians' News column seems worthy of comment.

How large a portion of the wholesaler's business is involved with the over-the-counter cash sale? It can't be much or the wholesaler would not be willing to relinquish it and take on the added burden of accounting and making the "kickbacks" to the various service shops. Now, then, when this very small portion of the total volume of business is divided between the individual service shops, how much have you really gained?

Then the cost. The cost of the wholesaler has already been mentioned, but now that you are demanding the retail profit you must bear the retail load, that of maintaining a retail stock over and above your bench stock items. This takes space and capital. It can't be circumvented by telling the customer

to come back later while you obtain the desired items. And what is the consumer's reaction to all this? He will certainly become incensed at you, the neighborhood service shop, especially when he learns of the "kickback gimmick" on top of the drastic increase in cost.

The TV service industry in general has never done much toward enhancing its customer relations in the past and this latest maneuver is not going to improve the situation. Why did the man take to trying to fix his own TV in the first place if he felt that he was being treated fairly by his local service man?

Consider the auto repair business. It has lived with this problem a long time. It succeeds by rendering service and not through selling parts. The car owner can still buy his own parts and do his own work if he so chooses. But he can usually get the work done better and quicker at the local garage. He goes there.

The "Philadelphia Plan" certainly typifies the type of thinking that has made the TV service industry "sick" in the first place.

MAJOR WILLIAM M. PRICE
Little Rock AFB, Ark.

[Technicians! How do you feel about this?—Editor]

DANGEROUS TEFLON

Dear Editor:

Referring to the article "Solder Removal Made Easy" on page 68 of the June issue. The use of Teflon tubing to pick up molten solder can be very dangerous since the decomposition products are highly toxic.

Above 200°C, Teflon gives off fumes which, if inhaled, has caused polymer fume fever. Deaths have occurred when granular or dispersion polymers were heated above 300°C.

Particles of Teflon must not be allowed to contaminate cigarettes and they must not be carried where contamination is possible.

If someone were to apply this method of solder removal with the use of a torch, it is possible that death could result.

LEE E. VANDERVEER
Ludington, Mich.

AUTHOR'S REPLY

Dear Editor:

Mr. VanderVeer's comments concerning toxic products of decomposition of Teflon are well known and do apply for steady-state thermal conditions such as those obtained from heating a solder joint with a torch. However, under transient thermal conditions such as the application described in my article, appreciably higher temperatures can be tolerated without the danger of Teflon decomposition. The system described in the article was developed for use in the removal of solder from terminal connections in complex miniature electronic assemblies, not in plumbing work. A torch of any kind is never used for this kind of work; only low-wattage soldering irons.

There are other reasons why this

Build This Superb Schober Organ From Simple Kits and SAVE OVER 50%!

The Beautiful
Schober
CONSOLETTÉ

— the only small organ with two full 61-note keyboards and 22 stops. Requires only 2' x 3'2" floor space! Commercial value approximately \$1600 or more — yet you save over 50% when you build this thrilling instrument!

LET US
SEND YOU
FREE
DETAILS
HOW TO ASSEMBLE A
Schober
ELECTRONIC ORGAN
IN SPARE TIME!



Give Your Family A Lifetime of Musical Joy
With A Magnificent Schober ELECTRONIC Organ!

Now you can build the brilliant, full-range Schober CONSOLETTÉ or the larger CONCERT MODEL with simple hand tools. No skills are necessary to construct an instrument with one of the finest reputations among electronic organs. No woodworking necessary — consoles come completely assembled and finished. All you do is assemble clearly marked electronic parts guided by clear illustrations and detailed step-by-step instructions. Even teenagers can assemble the Schober! You build from kits, as fast or as slowly as you please... at home, in spare time — with a small table serving as your entire work shop!

Send For Complete Details On Schober Organs and For Hi-Fi Demonstration Record

The coupon will bring you a handsome 16-page booklet in full color describing Schober organs in detail, plus articles on how easy and rewarding it is to build your own organ and how pleasant and quick it is to learn to play the organ. In addition, we have prepared an exciting 10" hi-fi LP record demonstrating the full range of tones and voices available on the Schober, which you may have for only \$2.00 (refunded when you order a kit). Literature on the Schober is FREE! There is no obligation; no salesman will call.

THE GREAT
CONCERT MODEL
meets specifications of
American Guild
of Organists

Pay As You Build Your Organ;
Start With As Little As \$18.94!

You may start building your Schober at once with an investment of as little as \$18.94. The musical instrument you assemble is as fine, and technically perfect, as a commercial organ built in a factory — yet you save over 50% on top-quality electronic parts, on high-priced labor, on usual retail store markup! In your own home, with your own hands you build an organ with *genuine pipe organ tones* in an infinite variety of tone colors to bring into your home the full grandeur of the Emperor of Instruments. You may build the CONSOLETTÉ for your home, or you may want to build the great CONCERT MODEL for home, church, school or theatre. You save 50% and more in either case.



Mail This Coupon
For FREE Literature
and Hi-Fi Record
Today!

The Schober Organ Corp., Dept. RE-8,
43 West 61st St., New York 23, N. Y.

Please send me FREE full-color booklet and other literature on the Schober organs.
 Please send me the 10" hi-fi Schober demonstration record. I enclose \$2.00 (refundable on receipt of my first kit order).

Name.....

Address.....

City..... Zone... State.....



the
advantage
of using a
PRECISION
LOUDSPEAKER

in your high fidelity installation

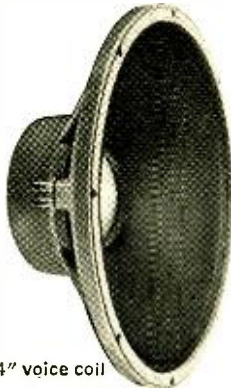

JBL D130
15" full-range
speaker with 4" voice coil



JBL D123
12" full-range
speaker with 3" voice coil



JBL D208
8" full-range
speaker with 2" voice coil

HIGH EFFICIENCY SPEAKERS

are characterized by excellent transient response, strong impressions of immediacy and presence. Power requirements are low. For precision bass reproduction they require a bass reflex or exponential horn acoustical enclosure. Voice coil: o.d. ratio of the highly efficient units shown above is 1:4, an exclusive JBL feature.

Write for complete catalog of JBL precision loudspeakers, precision high frequency units, and acoustical enclosures...Bulletin SC508.

Products of James B. Lansing Sound, Inc., are marketed by

JBL INTERNATIONAL, LOS ANGELES 39, CALIFORNIA

Intricate audio wave forms can be reproduced accurately only by transducers of the highest precision. Anything less introduces sonic impurities which in minutes become vaguely annoying and ultimately intolerable. The great advantage of precision in loudspeaker construction is *lasting* listening pleasure. You will find that you feel *satisfied* when you live with a precision instrument, and this can represent a decided economic advantage. Precision also contributes to efficiency. High efficiency not only lowers your power requirements, but, more important, gives you superior reproduction of transients, a more realistic dynamic range; and cleaner, smoother sound over the entire frequency spectrum. If you are installing a system for someone else, your reputation as an expert depends on how the system sounds to the client six months, and even six years from now. Play it safe; install JBL, choice of the conscientious technician.



JBL LEB
8" linear-efficiency
full-range speaker
with 2" voice coil

LINEAR-EFFICIENCY SPEAKERS

provide long linear cone excursion so that clean, full bass can be generated in a relatively small space. They can be mounted directly in a wall or partition, but are usually mounted in an "infinite baffle" type enclosure of minimum dimensions. Power requirements for JBL Linear-Efficiency units are moderate because they are built to the highest standards of precision.

application of Teflon tubing isn't dangerous:

The end of the tube is not brought close to the solder joint until it is fluid and the soldering iron removed.

A high-volume vacuum pump guarantees adequate air flow to pick up the solder and insure quick chilling of the molten solder. If there is some decomposition of the end of the tube, the toxic products are immediately picked up by the intruding air and carried into the vacuum pump where they are trapped out.

This technique has been used successfully in many applications throughout the electronics industry for more than 3 years without any reported difficulty.

WILLIAM J. MCGUINNESS

Rochelle Park, N. J.

DON'T TRY THIS!

Dear Editor:

The legitimate TV service dealers in our area operate under a hardship today. They're getting a black eye from the malpractices of a few jackleg and back-alley shops and from customers who move here and then complain that their TV goes out more frequently than it did at "home."

"Here" is Sarasota, Fla., a coastal town, and the heat, humidity and salt air are all adverse factors. Even with a new set, a Sarasotan can expect more TV breakdowns than he did in the North.

For this reason, our service operation embraces two factors. We won't accept for repair any set that is 8 to 10 years old, because to do a good job on such a dog would involve the customer in exorbitant costs and bring cries of "gyp."

Also, since customers are madly adverse to "labor charges," we often submit an invoice which, instead of listing \$1.50 for parts and \$7.50 for labor, lists \$7.50 for parts and \$1.50 for labor. That keeps the customers far happier than a small amount for parts and a high labor charge.

NAME WITHHELD

Sarasota, Fla.

[Your billing technique sounds nice, but can get you into trouble. What happens when the Better Business Bureau or a local newspaper comes around, traps you with a gimmicked set; and discovers that you are charging for parts you didn't replace? That's the kind of billing that can put you out of business.—Editor]

CORRECTION PLEASE

Dear Editor:

In my article "Radio Waves and Life" (September issue), the third paragraph on page 45 states that the field reduced the stimulation of secretion of digestive juices when atropine had been injected.

This is incorrect as was pointed out by Dr. Jarrett of Phoenix, Ariz. The correct version is:

The field reduced the inhibition of digestive juices when these were inhibited by the drug atropine.

TOM JASKI

San Mateo, Calif.

END



DESIGNED

AS YOU WOULD DESIGN IF YOU WERE AN ELECTRONICS ENGINEER...

Praised by the experts as Best Buys... **EICO**

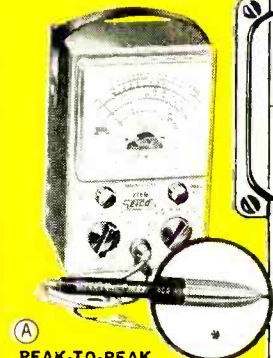
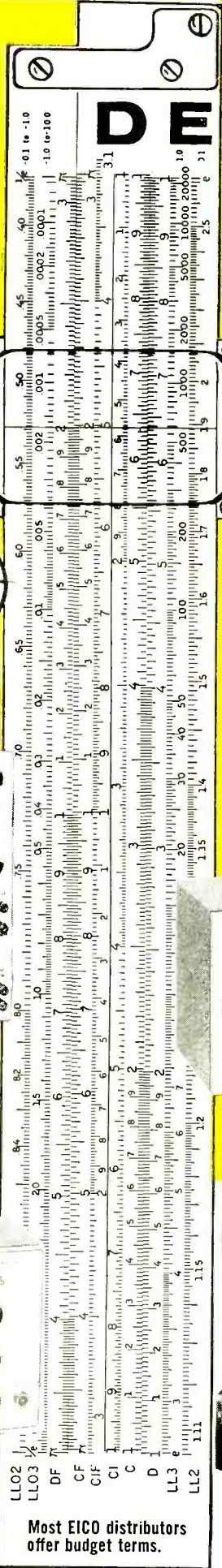

A PEAK-TO-PEAK VTVM #232 & UNI-PROBE KIT \$29.95 WIRED \$49.95



B COLOR & MONOCHROME DC TO 5 MC LAB & TV OSCILLOSCOPE #460 KIT \$79.95 WIRED \$129.50

Also available:
5" Push-Pull Oscilloscope #425
Kit \$44.95 Wired \$79.95

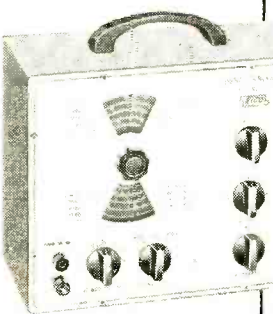

C RF SIGNAL GENERATOR #324 KIT \$26.95 WIRED \$39.95
Turn Page For More EICO Values

Most EICO distributors offer budget terms.

A By far the best professional VTVM value in electronics; nobody but EICO brings you such outstanding instrument performance for so low a price! Calibration without removing from cabinet. Measure directly p-p voltage of complex & sine waves: 0-4, 14, 42, 140, 420, 1400, 4200. DC/RMS sine volts: 0-1.5, 5, 15, 50, 150, 500, 1500 (up to 30,000 volts with HVP probe, & 250 mc with PRF probe). Ohms: 0.2 ohms to 1000 meg. 4 1/2" meter, can't-burn-out circuit. 7 non-skip ranges on every function. Zero center. Features EICO's exclusive UNI-PROBE: your terrific time-saver, performs all functions: a half turn of probe-tip selects DC or AC-Ohms!

B An engineering achievement unmatched in the industry! EICO-designed for laboratory precision and EICO-priced for lowest cost. Features DC amplifiers. Flat from DC to 4.5 mc, usable to 10 mc. Vert. Sens: 25 mv/in.; input Z 3 meg; direct-coupled & push-pull throughout. 4-step frequency-compensated attenuator up to 1000:1. Sweep: perfectly linear 10 cps - 100 kc (ext. cap. for range to 1 cps). Pre-set TV V & H positions. Auto sync limiter & amplifier Direct or C coupling; balanced or unbalanced inputs; edge-lit engraved lucite screen with dimmer control.

C More features and versatility, more range and accuracy than its generators costing three to four times as much. 150 kc to 435 mc with ONE generator in 6 fundamental bands and 1 harmonic band! ±1.5% frequency accuracy. Colpitts RF oscillator directly plate-modulated. Variable

depth of internal modulation 0-50% by 400 cps Colpitts oscillator. Variable gain external modulation amplifier: only 3 volts needed for 30% mod. Turret-mounted, slug-tuned coils for max. accuracy. Fine & Coarse (3-step) RF attenuators. RF output 100,000 uv, AF output to 10 v.

D Provides more ranges, greater ease and accuracy, and better performance than any competitive unit. Entirely electronic sweep circuit with accurately-biased inductor for excellent linearity. Extremely flat RF output. Exceptional tuning accuracy. Hum & leakage eliminated. 5 fundamental sweep ranges: 3-216 mc. Variable marker range: 2-75 mc in 3 fund. bands, 60-225 mc on harmonic band. 4.5 mc crystal marker osc., crystal supplied. Ext. marker provision. Attenuators: Marker Size, RF Fine, RF Coarse (4-step decade). Narrow range phasing control for accurate alignment.

E Speedy, simple operation, unexcelled sensitivity and accuracy; superb electrical and mechanical design. Tests all receiving tubes (picture tubes with adapter), n-p-n and p-n-p transistors. Composite indication of Gm, Gp & peak emission. Simultaneous selection of any one of 4 combinations of 3 plate voltages, 3 screen voltages, 3 ranges of continuously variable grid voltage (with 5% accurate pot.). Sensitive 200 ua meter. 10 six-position lever switches: freepoint connection of each tube pin. 10 push-buttons: rapid insert of any tube element in leakage test circuit. Direct reading of inter-element leakage in ohms. New gear-driven rollchart. CRA Adapter \$3.50.



D TV-FM SWEEP GENERATOR & MARKER #368 KIT \$69.95 WIRED \$119.95

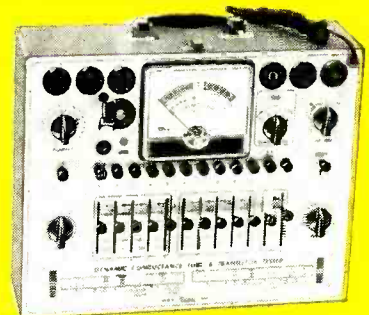

E DYNAMIC CONDUCTANCE TUBE & TRANSISTOR TESTER #666 KIT \$69.95 WIRED \$109.95
Complete with steel cover and handle



All Transistor Portable RA-6
Kit \$29.95
Wired \$49.95
less battery



Power & Bias Supply for Transistorized Eqt. #1020
Kit \$19.95
Wired \$27.95

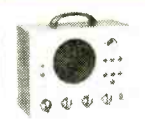

DeLuxe Multi-Signal Tracer #147
Kit \$24.95
Wired \$39.95



Tube Tester #625
Kit \$34.95
Wired \$49.95
Pix Tube Test Adapter \$4.50



6 & 12V Battery Eliminator & Charger #1050
Kit \$29.95
Wired \$38.95
#1060 Kit \$38.95
Wired \$47.95



V-O-M #565
Kit \$24.95
Wired \$29.95
V-O-M #536
Kit \$12.90
Wired \$14.90

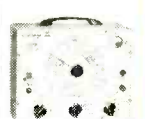

R-C Bridge & R-C-L Comparator #950B
Kit \$19.95
Wired \$29.95

EICO 33-00 Northern Blvd., L. I. C. 1, N. Y. C-11

Show me HOW TO SAVE 50% on Test Instruments
 Hi-Fi Ham Gear. Send free Stereo Hi-Fi Guide. Send me FREE Catalog, name of neighborhood dealer. Send free Short Course for Novice License.

Name.....
Address.....
City..... Zone..... State.....

© 1960 EICO 33-00 N Blvd. L. I. C. 1, N. Y. Add 5% in the West

EICO KITS

IF YOU LOVE TO CREATE... BUILD

In **STEREO** and

**Mono Hi-Fi...
the experts say
your Best Buy
is EICO**

Over 2 MILLION EICO instruments in use throughout the world. Add 5% in the West.



Stereo Amplifier-Preamplifier HF81†



Stereo Preamplifier HF85††



FM Tuner HFT90††
AM Tuner HFT94††
FM/AM Tuner HFT92††

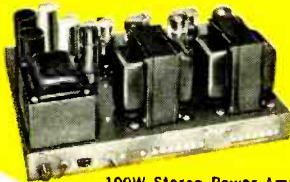

100W Stereo Power Amplifier HF89
70W Stereo Power Amplifier HF87
28W Stereo Power Amplifier HF86



Stereo Integrated Amplifier AF4††



3-Way Speaker System HFS3
2-Way Bookshelf Speaker Systems
HFS5 and HFS1



Stereo Automatic Changer/
Player 1007

NEW!



- Exclusive advanced systematized engineering
 - Latest and finest quality parts
 - Exclusive "Beginner-Tested" easy step-by-step instructions
 - Exclusive TRIPLE quality control
 - Exclusive LIFETIME guarantee at nominal cost
- IN STOCK** — Compare, then take home any EICO equipment — right "off the shelf" — from 1500 neighborhood EICO dealers throughout the U. S. & Canada, most of whom offer budget terms.

HF81 Stereo Amplifier-Preamplifier selects, amplifies, controls any stereo source & feeds it thru self-contained dual 14W amplifiers to a pair of speakers. Provides 28W monophonically. Ganged level controls, separate balance control, independent bass and treble controls for each channel. Identical Williamson-type, push-pull EL84 power amplifiers. "Excellent" — SATURDAY REVIEW. "Outstanding... extremely versatile." — ELECTRONICS WORLD. Kit \$69.95. Wired \$109.95. Incl. cover.

HF85 Stereo Preamplifier: Complete master stereo preamplifier-control unit, self-powered. Distortion borders on unmeasurable. Level, bass, & treble controls independent for each channel or ganged for both channels. Inputs for phono, tape head, mike, AM, FM, & FM-multiplex. One each auxiliary A & B input in each channel. "Extreme flexibility... a bargain." — HI-FI REVIEW. Kit \$39.95. Wired \$64.95. Incl. cover.

New HF89 100-Watt Stereo Power Amplifier: Dual 50W highest quality power amplifiers. 200W peak power output. Uses superlative grain-oriented steel output transformers for undistorted response across the entire audio range at full power, assuring utmost clarity on full orchestra & organ. 60 db channel separation. IM distortion 0.5% at 100W; harmonic distortion less than 1% from 20-20,000 cps within 1 db of 100W. Kit \$99.50. Wired \$139.50.

HF87 70-Watt Stereo Power Amplifier. Dual 35W power amplifiers identical circuit-wise to the superb HF89, differing only in rating of the output transformers. IM distortion 1% at 70W; harmonic distortion less than 1% from 20-20,000 cps within 1 db of 70W. Kit \$74.95. Wired \$114.95.

HF86 28-Watt Stereo Power Amp. Flawless reproduction at modest price. Kit \$43.95. Wired \$74.95.

FM Tuner HFT90: Prewired, prealigned, temperature-compensated "front end" is drift-free. Prewired exclusive precision eye-tronic® traveling tuning indicator. Sensitivity: 1.5 uv for 20 db quieting; 2.5 uv for 30 db quieting, full limiting from 25 uv. IF bandwidth 260 kc at 6 db points. Both cathode follower & FM-multiplex stereo outputs, prevent obsolescence. Very low distortion. "One of the best buys in high fidelity kits." — AUDIOCRAFT. Kit \$39.95. Wired \$65.95. Cover \$3.95. *Less cover, F.E.T. incl.

AM Tuner HFT94: Matches HFT 90. Selects "hi-fi" wide (20-9000 cps @ -3 db) or weak-station narrow (20-5000 cps @ -3 db) bandpass. Tuned RF stage for high selectivity & sensitivity. Precision eye-tronic® tuning. "One of the best available." — HI-FI SYSTEMS. Kit \$39.95. Wired \$65.95. Incl. cover & F.E.T.

FM/AM Tuner HFT92 combines renowned EICO HFT90 FM Tuner with excellent AM tuning facilities. Kit \$59.95. Wired \$94.95. Incl. cover & F.E.T.

AF4 Economy Stereo Integrated Amplifier provides clean 4W per channel or 8W total output. Kit \$38.95. Wired \$64.95. Incl. cover & F.E.T.

HF12 Mono Integrated Amplifier (not illus.): Complete "front end" facilities & true hi-fi performance. 12W continuous, 25W peak. Kit \$34.95. Wired \$57.95. Incl. cover.

HFS3 3-Way Speaker System Semi-Kit complete with factory-built 3/4" veneered plywood (4 sides) cabinet. Bellows-suspension, full-inch excursion 12" woofer (22 cps res.) 8" mid-range speaker with high internal damping cone for smooth response, 3 1/2" cone tweeter. 2 1/4 cu. ft. ducted-port enclosure. System Q of 1/2 for smoothest frequency & best transient response. 32-14,000 cps clean, useful response. 16 ohms impedance. HWD: 26 3/8" x 13 7/8" x 14 5/8". Unfinished birch. Kit \$72.50. Wired \$84.50. Walnut or mahogany. Kit \$87.50. Wired \$99.50.

HFS5 2-Way Speaker System Semi-Kit complete with factory-built 3/4" veneered plywood (4 sides) cabinet. Bellows-suspension, 3/8" excursion, 8" woofer (45 cps. res.), & 3 1/2" cone tweeter. 1 1/4" cu. ft. ducted-port enclosure. System Q of 1/2 for smoothest freq. & best transient resp. 45-14,000 cps clean, useful resp. 16 ohms.

HWD: 24" x 12 1/2" x 10 1/2". Unfinished birch. Kit \$47.50. Wired \$56.50. Walnut or mahogany. Kit \$59.50. Wired \$69.50.

HFS1 Bookshelf Speaker System complete with factory-built cabinet, Jensen 8" woofer, matching Jensen compression-driver exponential horn tweeter. Smooth clean bass; crisp extended highs. 70-12,000 cps range. 8 ohms. HWD: 23" x 11" x 9". Kit \$39.95. Wired \$47.95

HFS2 Omni-Directional Speaker System (not illus.) HWD: 36" x 15 1/4" x 11 1/2". "Fine for stereo" — MODERN HI-FI. Completely factory-built. Mahogany or walnut \$139.95. Blond \$144.95.

New Stereo/Mono Automatic Changer/Player: Jam-proof 4-speed, all record sizes, automatic changer and auto/manual player. New extremely smooth, low distortion moisture-proof crystal cartridge designed integrally with tonearm to eliminate mid-range resonances. Constant 4 1/2 grams stylus force is optimum to prevent groove flutter distortion. No hum, turntable attractions, acoustic feedback, center-hole enlargement. Only 10 3/4" x 13". 1007S: 0.7 mil, 3 mil sapphire, \$49.75. Incl. F.E.T. and "Magnadaptor."

†Shown in optional Furniture Wood Cabinet WE71: Unfinished Birch, \$9.95; Walnut or Mahogany, \$13.95.

††Shown in optional Furniture Wood Cabinet WE70: Unfinished Birch, \$8.95; Walnut or Mahogany, \$12.50.

EICO, 33-00 N. Blvd., L.I.C. 1, N. Y. C-11

Show me how to SAVE 50% on easy-to-build top-quality Hi-Fi. Send FREE catalog, Stereo Hi-Fi Guide plus name of neighborhood EICO dealer.

Name.....

Address.....

City..... Zone..... State.....

Listen to the EICO Hour, WABC-FM, N. Y. 95.5 MC, Mon.-Fri., 7:15-8 PM.

© 1960 by EICO, 33-00 N. Blvd., L. I. C. 1, N. Y.

FUTURE SPACE TRAFFIC

... Tens of Thousands of Spacecraft will Soon be Aloft ...

AS this is written (at the end of August), 34 space vehicles are in orbit. The United States accounts for 26, the Soviet Union 8. Still transmitting data to earth are 10—US 9, Soviet Union 1. The rest—i.e., 24 space vehicles—either through mechanical malfunction or for electronic reasons, are still gravitating in space, voiceless and signal-less, silent.

This is the short and epic 3-year record of man's first excursion into space, above the earth's atmosphere, since the advent of Sputnik I—the true start of the Space Age, on Oct. 4, 1957. What of the future, immediate and distant?

Columbus and the intelligentsia of 1492 certainly never dreamt what the opening of the New World could mean to mankind—riches beyond imagination, steamships that transport 3,000 people across the Atlantic in a little over 4 days (it took Columbus 70), speaking under and above the ocean, flying over it in 6 hours and less, seeing across the ocean by television (Baird on Feb. 8, 1928). Certainly no one alive in 1492 would have had the temerity to predict such "arrant nonsense"!

Likewise, we of 1960 are often prone to look at the conquest of space now in the making as an enigma, wrapped in doubt and disbelief, that appears of little consequence to humanity at large.

Let us then push aside the thick veils of the future and examine some of the possible scientific predictions of the Space Age. Remember always that space is a new and completely alien and harsh world, never visited by living man before.

Extreme heat and cold, dozens of harmful radiations—many deadly, weightlessness, a variety of gravitational effects, meteorites and other matter flying at the rate of over 10 miles *a second*, a total vacuum—these are only a few conditions in this new world never experienced by man.

Let us stay for a few moments with only one branch of space vehicles, the satellite type that circles the earth in orbit from 250 to thousands of miles above. We mentioned that at this moment there are 34. In time there will be many thousands of every imaginable type. By the end of this century there will certainly be more than 10,000 earth, lunar and other planetary satellites of every description of dozens of nations. Many will be for research, many for communication purposes. They will be of all sizes, from a few feet to thousands of feet in diameter. Most will be automatic, highly sophisticated unmanned ones; others will be manned.

Hovering observatories will be "stationed" 22,238 miles above the equator. Seen from the earth, they will appear stationary as they travel at about 6,882 miles per hour, which compares to the surface speed of 1,000 miles an hour at which the earth revolves.* Equipped with *light amplifiers*, three such observatories, spaced equidistant over the equator, can directly view and photograph any part of any country (except the polar regions) and spot any activity such as troop movements, intercontinental missiles when launched,

weather conditions such as cloud formation and cyclones, ice patrolling and hundreds of other activities.

All space observatories will also be equipped with the most modern and sensitive infrared receiving equipment. Even with present-day equipment, it would be possible to detect a multitude of heat effects at a distance of 22,238 miles overhead, *even through overcasts*. In the future the stationary space observatories will do vastly more refined observing and detecting of many activities on the earth—particularly for military purposes.

Also connected by cable to every floating observatory will be a huge aluminized plastic ball or sphere from 750 to 1,000 feet in diameter. The three observatories, stationed equidistant around the earth 22,238 miles over the equator, will reflect from their spheres ALL electronic long-distance, national and international communication traffic, be it radio, TV, telegraph or telephone, or other signaling. Signals can be directly bounced from earth against the reflecting balls, then returned to earth. Others, to reach the antipodes, will be relayed between the observatories, then transmitted to their destination.

By the time the observatories are in space by the end of this century, it is almost certain that all spacecraft will be propelled by atomic power. This will be true of satellites as well as interplanetary spaceships.

Won't there be many collisions in space between these tens of thousands of spaceships, satellites, observatories and dozens of other types of spacecraft? Not at all—certainly many fewer than between the thousands of propeller and jet airplanes now crowding the air lanes. All present air traffic moves in a thin space less than 50,000 feet thick. Future space traffic will be dispersed into millions of miles. There could be tens of millions of spacecraft maneuvering in space without fear of collision. The only possible danger will come when thousands of space vehicles descend *en masse* toward the earth to land.

Inasmuch as all landing craft must have permission to alight, exactly as aircraft today, collisions will be a rarity. This will even be more true than now, because future spacecraft will not require long landing strips. All space vehicles of the future will descend *vertically* into rather small numbered spaces, many flights terminating on top of city skyscrapers, just as helicopters do now.

Will not our communications spectrum be severely overloaded with all this tremendous traffic between earth and tens of thousands of satellites, observatories, spaceships to and from the planets?

Fortunately not. There is sufficient room in the radio-frequency spectrum to accommodate 300,000 simultaneous separate communications at a minimum.

Incidentally, once thousands of interlunar and interplanetary spaceships are in transit, they probably will not communicate directly with the earth at all. There will be an interplanetary communication center on the airless moon, its sole purpose being to clear all distant message traffic, which then will be relayed to earth on special frequencies. Even communications between the various spaceships will be via the moon center, unless the spacecraft are near each other, which probably won't be too often.

—H.G.

*At an altitude of 22,238 miles, the observatories must travel nearly 7 times as fast as the earth's speed at the equator.

ELECTRO

By DR. BERNARD S. POST*

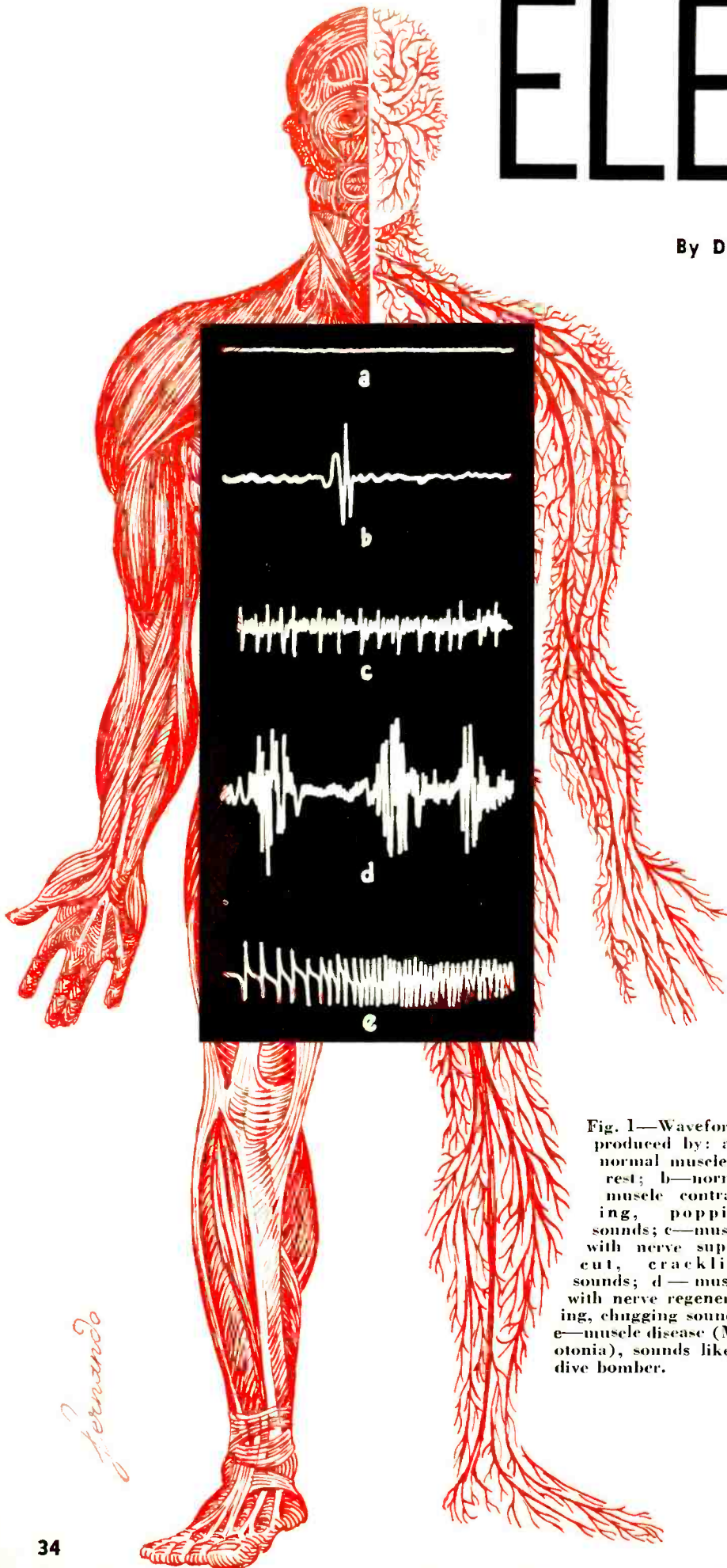

Fig. 1—Waveforms produced by: a—normal muscle at rest; b—normal muscle contracting, popping sounds; c—muscle with nerve supply cut, crackling sounds; d—muscle with nerve regenerating, chugging sounds; e—muscle disease (Myotonia), sounds like a dive bomber.

ELECTROMYOGRAPHY is an electronic method of measuring and recording the electrical activity of muscles. It is a valuable diagnostic tool in the hands of a competent operator. Most often used in physical medicine, neurology, orthopedics and neurosurgery, it has many applications in other fields, including research. The high incidence of muscular and nervous-system injuries during World War II, and more recently during the Korean conflict, served to speed up the development of electromyographic techniques.

A normal muscle at rest emits no detectable electric signal but in action or in certain abnormal states of the muscle (or of the nerve connected to it) waveforms are produced. The shape of these waves varies with the condition that causes them. For instance, a normal muscle contraction will produce a tracing like that of Fig. 1-b. The amplitude of the waveforms varies between approximately 100 and 1,500 μv , with a frequency of 5 to 30 per second or higher, depending on the intensity of the muscular contraction being measured. The average duration of the spike is about 5 to 10 milliseconds. The waveform is bi- or triphasic in character. Other characteristic waveshapes are also shown in Fig. 1. Most are abnormal and are found in disease states or injuries.

Electrodes

The action potentials are picked up with a needle electrode which is pushed through the skin into the muscle being examined. Three types of needles are in use (Fig. 2). The first, a monopolar type, consists of a plain sewing needle passed through a cork and insulated completely except at its very tip. Such an electrode must be used with a reference electrode on the skin to complete the circuit. This reference electrode sets up numerous problems due to skin current and the distance between electrodes. The second and third types are hypodermic needles fitted with either one or two wires through the needle bore and insulated from the needle shaft (and in the two-wire case, from each other). If one wire is used, it is called a single coaxial electrode. If two

*BS, MD, PGME of IRE. In charge of Electromyography Laboratory, St. Johns Episcopal Hospital, Brooklyn, N.Y. Research Fellow in Physical Medicine, Downstate Medical Center, University State of New York.

MYOGRAPHY

Waveforms produced by contracting muscles are helpful in diagnosing muscle and nerve disorders

are used, it is referred to as a double coaxial electrode. Again the shaft of the needle is insulated except at its tip.

The advantage of the coaxial electrode is that it makes it possible to contact individual muscle fibers, since the tip of the needle electrode is a complete circuit unit only a fraction of a millimeter in size. This is approximately equal to the size of the individual muscle fiber or collection of fibers (known as a motor unit), which are controlled by only one nerve fiber. When a double coaxial needle is used, the shaft of the needle is connected to ground, since the second wire inside the bore acts as the reference electrode. Ground electrodes are used to minimize the effect of stray pickup and interference.

The signals from the needle electrode are fed to the input grids of a pre-amplifier having a very high noise-rejection ratio, flat low-frequency response and high-frequency-cutoff circuitry. The preamplifier output is fed into a multistage differential amplifier with gain enough to produce an increase in signal strength of at least 100,000. This amplifier is designed to produce the absolute minimum of waveform distortion. The output stage of this amplifier is coupled to the vertical amplifier of an oscilloscope and a tape recorder (for restudy when convenient). Pictures of the waveform may be taken later during the tape playback by arranging a triggering mechanism in the oscilloscope sweep circuit. This synchronizes the opening of the camera shutter with the sweep. Note in the block diagram (Fig. 3) that a calibration circuit is also built into the system. Also shown is a separate audio power amplifier (Fig. 4) of standard hi-fi quality which allows the low-frequency impulses to be heard through a loudspeaker. This is possible because all the muscle impulses fall within the lower end of the audio spectrum.

The different sounds produced by the various waveforms are very useful to the examiner because each is characteristic of a particular condition. After some experience with the electromyograph, an individual can recognize an abnormal condition by sound alone. Some muscle impulses produce sounds like static noise in a radio, others like a diving airplane, still others like machine-gun fire or a diesel locomotive or the chugging of an old model-T Ford.

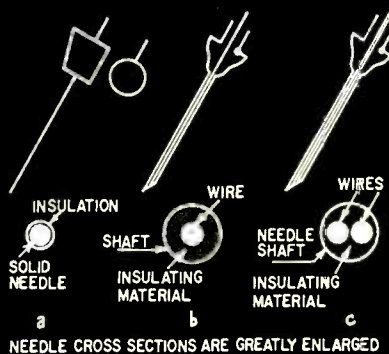

Fig. 2—Various needle electrodes and their cross-sections: a—monopolar (single wire) with reference electrode; b—single-wire coaxial (most commonly used); and c—two-wire coaxial.

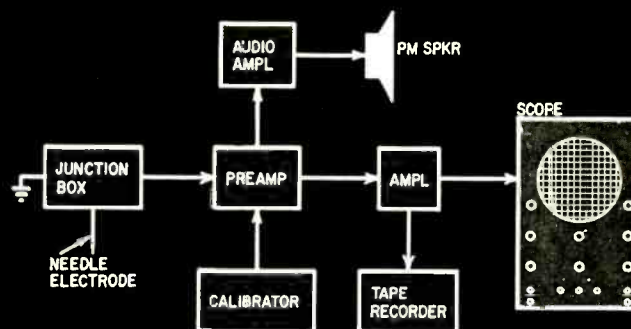

Fig. 3—Block diagram of an electromyograph.

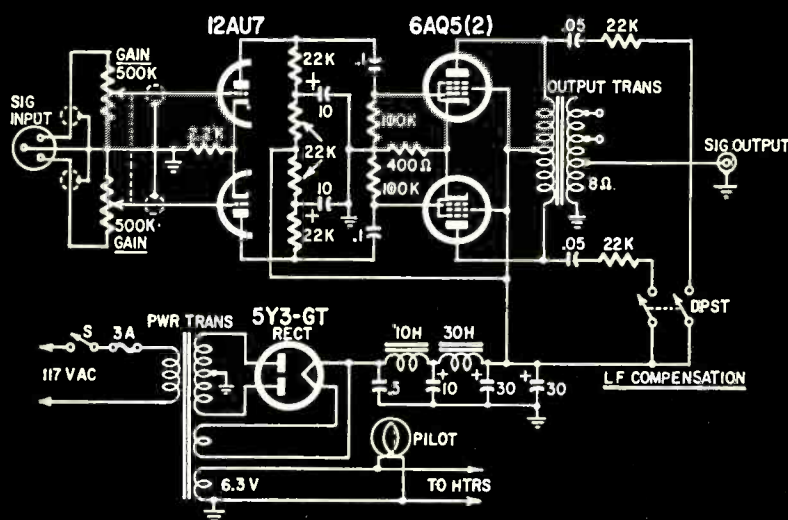

Fig. 4—Audio amplifier used to reproduce the sound of muscle contractions.

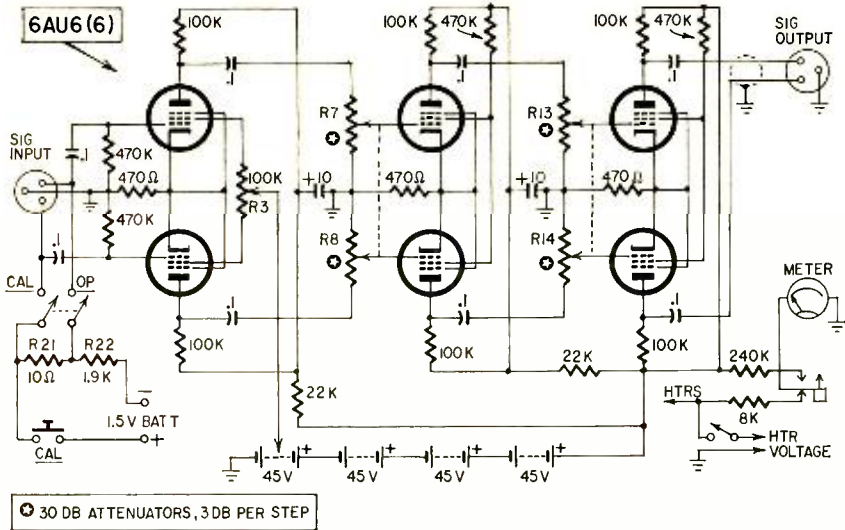

Fig. 5—Schematic of combination preamplifier, amplifier and calibrator.

Fig. 6—Schematic of oscilloscope and muscle stimulator.

This is not the whole list; there are many others.

Circuitry

The basic circuitry of the electromyograph is shown in Fig. 5. (Since manufacturers tend to object to having the diagrams of their particular instruments published, this is a generalized schematic.) It consists, first, of a high-gain, low-noise, balanced push-pull preamplifier with a built-in calibrator. There are three stages of push-pull R-C coupled voltage amplification. Because of the tandem balance attenuators R7, 8, 13 and R14, linear amplification of all input voltages can be obtained. Each attenuator has a loss of 3 db per step. The frequency response is flat ± 1.5 db from 10 to 4,000 cycles.

Extraneous electrical interference is reduced without shielding by the screen-grid balancing potentiometer R3. Since most of such interference appears as a grid-to-ground signal, R3 can be varied to make the unwanted signals equal in amplitude. Since they are already 180° out of phase, they cancel each other out. Tubes are shock-mounted to prevent vibration. Precision wire-wound resistors in the first stage plus careful shielding reduce inherent noise still further.

The calibrator circuit consists of a 1.5-volt battery, R21, 22 and a push-button. When the OP-CAL switch is turned to CAL, depressing the CAL button introduces an 0.8-mv square-wave pulse. The vertical gain on the oscilloscope can then be adjusted to the desired deflection height. A well filtered power supply may be used in place of the batteries.

The preamplifier output is fed into the vertical amplifier of the scope (Fig. 6). This consists of two 6AN5's which, because of their high transconductance and high plate current, deliver a high voltage across a low plate-load impedance. This produces linear deflection because the beam leaves the face of the scope before the tubes are driven past the linear portion of their characteristic curve. The sweep generator

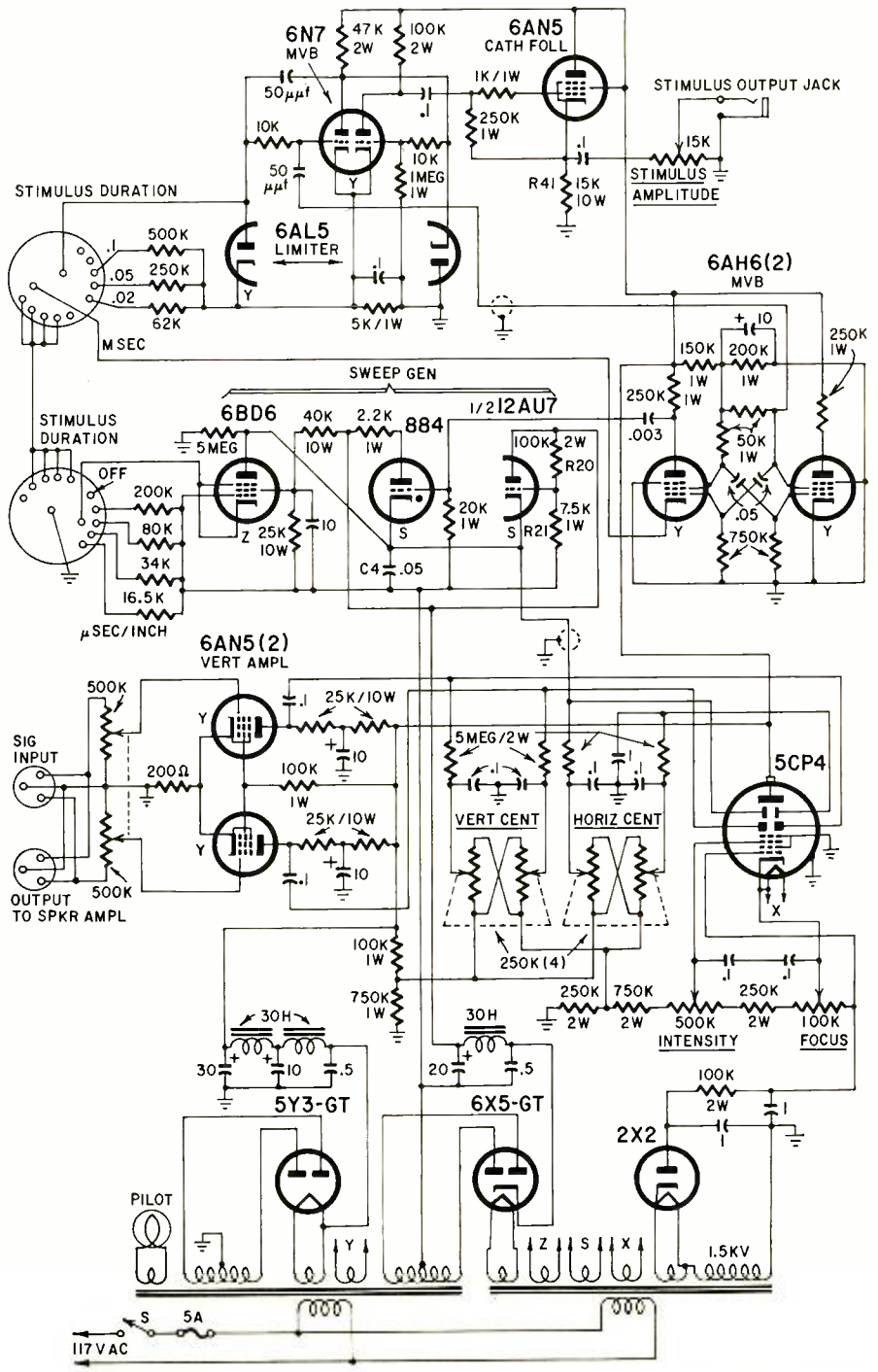

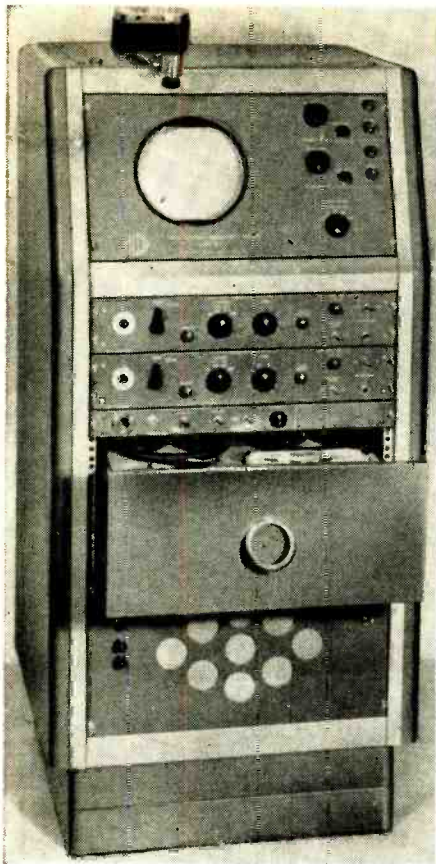

TECA Corp. two-channel electromyograph model TE-2-7.

employs an 884 thyratron, a 6BD6 constant-current pentode and half of a 12AU7 limiter. Normally the 884 thyratron is biased to cutoff and is prevented from flashing or conducting by the 12AU7 limiter connected in parallel with it. However, a positive pulse from the multivibrator raises the grid bias of the thyratron, causing it to conduct and thereby charging C4. This capacitor is then discharged at a linear rate through the 6BD6 constant-current pentode. When the potential across C4 drops to a low value, the grid of the 12AU7 limiter is driven positive with respect to the cathode (since the cathode is made more negative than the bias on the grid by R20 and 21). As a result, the 12AU7 conducts heavily, preventing further conduction by the thyratron until the next positive trigger pulse arrives from the multivibrator.

The multivibrator itself consists of two 6AH6 pentodes in which the screen grids are used as plates for the switching action. The circuit provides positive pulses for triggering the sweep generator and negative pulses to trigger the muscle-and-nerve stimulator circuit. The frequency is set at 7.5 cycles. The square-wave pulse from the appropriate plate of the multivibrator is passed through a differentiating network to produce the sharp, positive trigger pulse for the sweep generator. The negative trigger pulse is obtained from the grid of the nonconducting tube of the multivibrator as it suddenly swings negative. The output of the stimulator

circuit is a negative square-wave pulse with a frequency of 7.5 cycles. The duration of each impulse may be set at 1, 0.5 and 0.2 millisecond. The amplitude can be varied from 0 to 90 volts. The stimulator employs a 6N7 one-shot multivibrator triggered by the negative pulse just described. The output, a negative square wave, is passed through the 6AN5 cathode follower. This arrangement minimizes distortion of the square-wave stimulus. Plate current of 6AN5, which is normally conducting heavily, is reduced by the negative square-wave input from the 6N7. The current decrease through R41 results in a negative square-wave output. Stimulus duration is kept constant by the 6AL5 duration limiter which stabilizes the grid-voltage excursions of the two triode sections of the 6N7.

The power amplifier (Fig. 4) is a two-stage resistance-capacitance-coupled circuit, with frequency compensation in the plate circuit of the first stage. The output is flat from 10 to 10,000 cycles, but the lows may be accentuated and the highs attenuated by switching in the low-frequency booster. The output is 6 watts undistorted. Careful attention to power-supply design is responsible for the very low hum level.

Commercial equipment

It is worth mentioning at this point that a number of commercial pieces of equipment are available for electromyography. One of these is seen in the photo. This is a two-channel unit with a twin-gun scope and a two-channel tape recorder (using both halves of a standard ¼-inch tape). This machine also incorporates a muscle-stimulator circuit for use during the examination. The two channels give the advantage of being able to compare one side of the patient with the other. The second channel may also be used

for simultaneous display of any other related physical parameters such as force, pressure or rotation by means of suitable transducers. The dual-beam 7-inch cathode-ray tube used has a P7 screen (a short-persistence blue spot followed by a long-persistence yellow-green afterglow).

The tape recorder will record any pattern which can be displayed on the cathode-ray-tube screen. It has a bias-and-erase oscillator and a recording amplifier for each channel. The electromyographic amplifiers are used for tape playback to obtain good low-frequency response and a low noise level. Relays in each amplifier switch the amplifier input to the tape playback heads and also insert correction networks within the amplifiers to compensate for the nonlinear frequency response of the tape. Information stored on tape during electromyography may be played back through the loudspeaker and the cathode-ray display system for study or photorecording as well. The tape-recorder mechanism uses three motors and electrodynamic tensioning in its design, eliminating slip clutches and mechanical complexities (and a need for critical adjustment).

The technique of electromyography is still in its infancy and there will no doubt be many changes in instrumentation in the near future (since most of the larger institutions are now beginning to use this important diagnostic tool). Extremely important information is being obtained with this technique in the research on such diseases as polio, muscular dystrophy, myasthenia gravis and many others. It is hoped that some of the answers being sought lie in electrical abnormalities in muscle and nerve tissue. This is what makes medical electronics so important (beyond pure instrumentation). Other phases of its application will be discussed in future articles. **END**

Nobody gets fooled in RADIO-ELECTRONICS!

Fast operating tube salesmen are not permitted to try their shell game in the advertising pages of Radio-Electronics. Since January 1956 we have insisted that mail order tube advertisers tell you directly if the tubes they were selling were either new and unused, or imperfect if that was the case. It's cost us money in advertising but saved our readers more than just embarrassment.



FINALLY MAKES IT

Radio's "dead dog" now begins
to look like the
wave of the future

By DAVID LACHENBRUCH

JUST 4 years ago, FM radio was officially "dead" as a broadcasting medium. Its phenomenal rise immediately after World War II was nipped in the bud in the late 1940's by the coming of television. Now there was nothing left to do but call in the undertaker and fight over the will. It seemed that the only legacy FM would leave was the valuable spectrum space between 88 and 108 mc, and the heirs (various nonbroadcast services) were already fighting over it.

But the corpse refused to lie down for the funeral oration. Artificial respiration by about 500 FM broadcasters, a handful of radio manufacturers, several thousand hi-fi enthusiasts and the Federal Communications Commission kept it breathing.

If FM died in 1950—as many people believed at the time—today it's a very lively zombie. And now, for the first time since 1948, its future seems virtually unlimited.

To get an idea of the kind of comeback FM radio has made, look at the charts showing FM stations on the air and factory sales of FM receiving devices (Figs. 1 and 2). In both leagues, you will see that FM is setting an all-time record in 1960.

Immediately after World War II, FM was hailed as "radio's second chance" and the first FM boom was on. By 1946, the FCC had authorized more than 1,000 FM stations—many of them to recently discharged veterans who wanted to get a foothold in this new and superior type of radio broadcasting.

In 1948, when nearly 700 FM stations were on the air, radio factories sold 1,600,000 FM radios and tuners. But things were far from rosy.

A new type of broadcasting suddenly was creating public excitement—broadcasting you could see! Television was here, and as picture tubes got larger, speakers got smaller. Radio became an appliance for the kitchen, the bed-

room, the car. Music was just a thrumming noise to beat eggs to or to keep you awake on those new turnpikes.

By 1954, FM radio production had dropped to an annual rate of less than 200,000 sets. There were still about 550 FM stations on the air to provide some programming for the listeners who were stuck with FM sets, but the vast majority merely broadcast the programs carried on their sister AM stations (at just about the same fidelity).

From this low point, let's look at what is happening in 1960. By mid-year, there were already 741 FM broadcast stations on the air—ahead of the record 730 in late 1959. There would be more, except that there weren't enough channels to go around—and applicants were competing with each other to prove their qualifications to operate FM stations in such cities as Los Angeles, New York, Chicago, Philadelphia and Washington.

This year, too, will see FM receiver production and sales exceed 1948's record by perhaps as much as 30%. Our estimate is that factory production of sets designed for sale in the US will total close to 2,000,000 units this year, possibly even more.

At the mid-point of 1960, the FCC had authorized another 169 applicants to broadcast on the FM band—in addition to the 741 already on the air. Of the stations on the air, a large proportion were broadcasting special programs on FM only—even those stations who also owned AM outlets.

And there seemed to be no end to the applications flowing into the FCC for new FM stations. An FM expert at the commission estimates that by the end of 1961 there will be more applications than there are available FM channels in most cities with a million or more population.

The Los Angeles area already has 28 FM stations compared with 21 on AM. In New York City and environs there are 23 FM stations and 24 AM;

San Francisco and its suburbs have 19 FM stations to 21 AM outlets.

And people are listening! No reliable set count has been made, but it's estimated that at least 10,000,000 FM sets are now in regular use. That's one out of every four households in the country, even though many rural and small-town areas aren't yet adequately served by FM stations.

Why the big boom now? The common and most obvious answer is that people have become more conscious of good music and high-fidelity sound reproduction. But there's more to it than that.

There couldn't be an FM boom if there were no stations. The 500-odd (and some of them were quite odd) FM stations which hung on during the lean years did it mainly from force of habit. It didn't cost much to keep the FM transmitter operating, repeating AM programs. And there was still a hard core of rabid hi-fi FM fans, who would raise a ruckus if the stations went off the air.

Some broadcasters did deliberately knock their FM outlets off the air for a week or so just to see if there would be adverse reaction. There was. So they knew somebody was listening.

But there was still no way to make money out of FM broadcasting. A few stations tried simplex operation (broadcasting to restaurants and businesses) with special equipment to eliminate commercials in these establishments.

Simplexing was outlawed when FCC established multiplexing rules. Today, 208 FM stations are authorized by the FCC to multiplex (transmit a special program in addition to the normal one, and unheard by the regular listeners) for various purposes, most of them for special storecasting and functional music services. This is providing needed revenue for stations with the courage to program their FM outlets separately from AM—for very few FM stations are yet showing a profit on broadcast

Fig. 1—Estimated factory sales of receiving devices (including foreign units sold in U.S.). Included are TV sets with continuous tuners that receive the FM band, of which 420,000 were produced in 1949 alone.

operations. Madison Avenue ad agencies, by and large, still don't realize how many people are listening.

Hobbyists and sound enthusiasts never abandoned FM. In areas where stations were broadcasting good hi-fi music, there was a small but loyal audience of hi-fi bugs with component rigs.

But the radio makers who went into television production forgot all about FM—with one exception. Zenith kept turning out FM table radios and, because it was virtually the sole manufacturer, did a fairly brisk business in them.

When the LP phonograph record began to arouse real consumer interest with its excellent reproduction, FM's second boom began to germinate.

Among the first high-quality phonographs introduced in this country for realizing the full sound potential of LP records were German-made units.

In Europe, where the post-war AM band was hopelessly overcrowded, FM broadcasting has become standard—strictly from necessity. German phonographs with radios included naturally contained FM tuners. The American purchasers listened, and pricked up their ears.

Then came the "cheap" FM set, pioneered by Granco products, who sold scads of FM-only table models at \$29.95. Other manufacturers followed.

When American radio manufacturers began to offer hi-fi consoles in a single package, they took another look at FM—largely because the German units had them. A few dropped in FM tuners as extras or even as standard equipment on some models.

Then along came stereo. Experimental AM-FM stereo broadcasts aroused the interest of set manufacturers. Today, most makers of so-called "packaged" hi-fi offer "drop-in" simulcast AM-FM tuners as an option. Some manufacturers estimate that more than 70% of their stereo consoles now are sold with AM-FM tuners. Industry-wide, it's a good guess that the proportion is more than 50%.

In the field of hi-fi components, manufacturers say sales of FM tuners are increasing, too. The concept of the combination tuner, preamp and amplifier has resulted in added FM sales.

Our estimate of close to 2,000,000 new FM receivers this year includes all types of devices to receive FM broadcasts. It breaks down this way: Table-model FM and FM-AM radios, 750,000 to 820,000 units (up from 540,500 made in 1959); "packaged" phonograph systems with FM tuners, 700,000 to 1,000,000 (from 623,000 last year); component FM tuners, 150,000 to 200,000 (from an esti-

Fig. 2—FM stations actually on the air, by years. Low-water mark came in 1956 after many stations had given up and gone off the air. Some of those silent stations have now been reactivated.

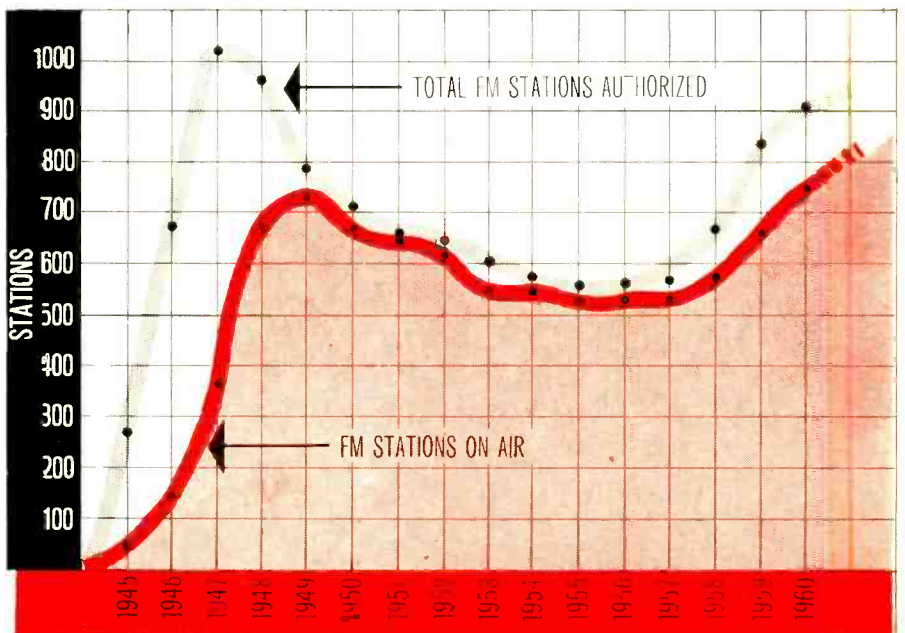
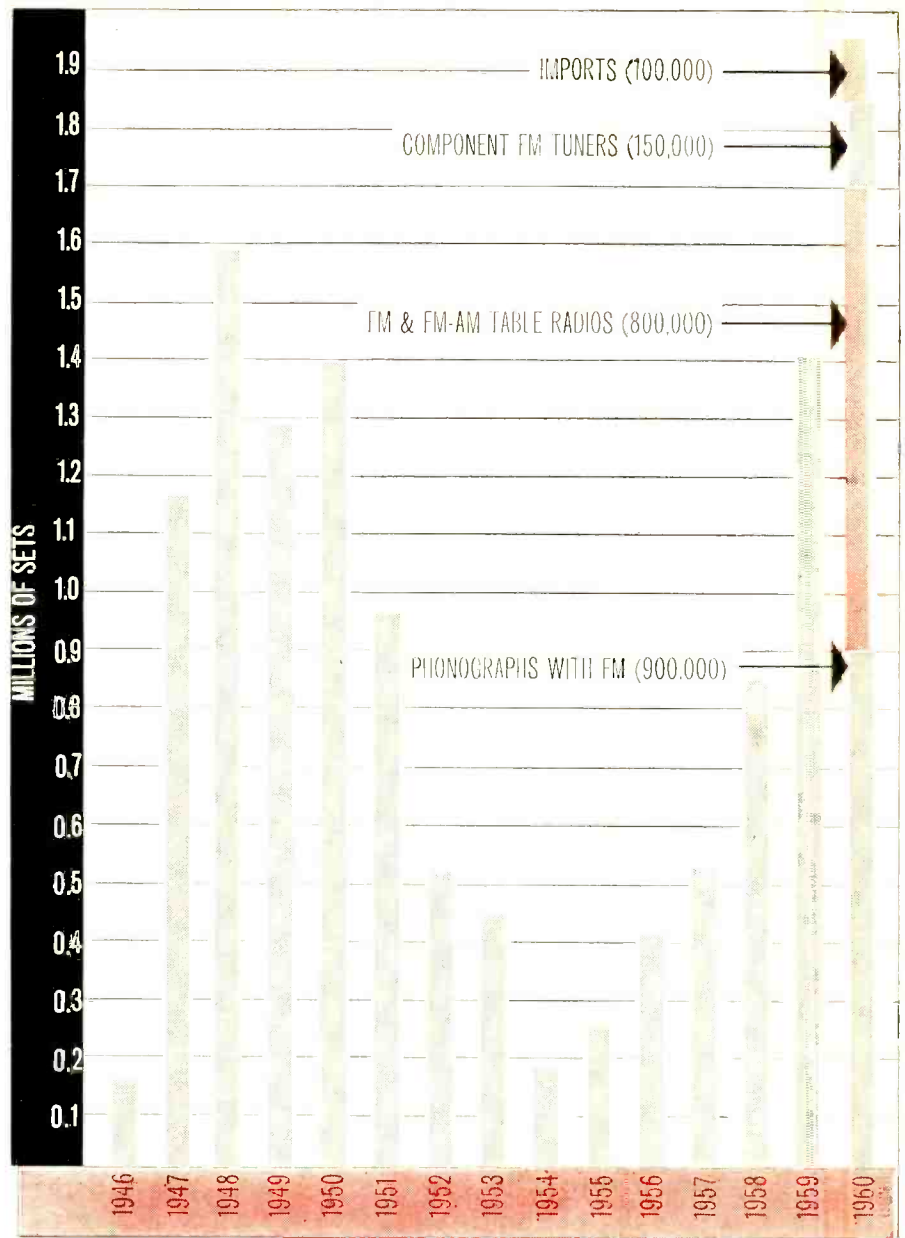

mated 150,000); imported FM receiving devices of all kinds, 80,000 to 120,000 (from about 100,000).

We have given a high and low figure in each case, because estimates within the industry vary widely. Adding up the "lows" would give a 1960 minimum of 1,680,000 sets (compared with 1,413,500 last year); the "highs" total 2,140,000. The best guess is that the final 1960 figure will be closer to the high estimate than the low one.

What of the future? Write this down and paste it inside your hatband: You're going to see more and more FM sets in the coming years, and FM radios will some day rival AM in popularity. Here are some of the reasons FM radio can't go any place from here but up:

FM achieved its sales record this year despite the fact that it isn't yet a nation-wide medium. Many areas have few FM stations—or none at all. This situation is rapidly changing, and FM broadcasting will be transformed in the next few years from a basically big-city service to a type of radio which reaches into every nook and cranny of America.

New types of FM receiving devices are just beginning to come on the market. The one with the biggest immediate potential is the FM auto radio. German manufacturers (including Blaupunkt and Becker) have been offering FM car radios here for several years. Smaller US manufacturers (Gonset, Automatic, and others) have also had FM tuners and converters for cars. But the big-business FM car radio push is just beginning.

It actually started with Motorola's introduction this year of an FM-only car radio at \$125, which reportedly has been accepted well by the customers despite its relatively high price.

The race was really on with the debut Granco converter (marketed by Emerson Radio) at \$49.95. Granco, which specializes in low-priced FM sets, hopes its converter will do for the auto market what its \$29.95 FM table model did for the home market. Its president, Henry Fogel, sees a "reliable market for 100,000 auto FM sets a year" beginning in 1961.

You'll see other FM car radios in the coming months. Sears, Roebuck even has one now in its fall catalog.

The portable FM transistor radio is just in its infancy, too. Zenith is now competing with Japanese manufactur-

ers with a battery-operated set. You can expect many more models—from Japan, Europe and the US—next spring. FM clock radios, too, will be coming into their own soon. Other FM receiving devices are on the way also, including the return of the combination TV and FM set (Magnavox introduced a new one this year).

But FM's biggest push will come from the source that gave hi-fi its largest lift—stereo.

Nobody knows when the FCC will finally establish standards for FM stereo multiplexing. Engineering work and field testing of all proposed FM stereo systems have been completed by the National Stereophonic Radio Committee, an industry-wide group established by the Electronic Industries Association.

The opening gun for FM stereo broadcasting *could* come very soon. Or it could be delayed for months by legal action and bureaucratic red-tape. But it's coming—and every radio manufacturer is poised to be off and running with the "first FM stereo radio."

The FCC, too, is eager to get FM stereocasting started almost immediately. But delays could result if its decision on a specific multiplexing system is challenged either through the FCC's own rule-making machinery or the federal courts. Because so much depends on the FCC's decision, this is a distinct possibility.

The establishment of FM stereo multiplex standards by the FCC will mean—almost immediately—that FM tuners will be a *must* in all new stereo phonographs; stereo tuners will be added to existing ones; a whole new field of stereo FM table radios will open up; all hi-fi rigs must be equipped with multiplex converters.

Every radio manufacturer now has engineers designing multiplex receiver circuits—even before the FCC itself knows which system will be adopted. Radio makers expect the FM stereo decision to touch off the biggest consumer-electronics boom since TV, and to vastly increase stereo phonograph sales as well.

Will FM ever realize its proponents' long-time dream of replacing AM? We don't think so. But it is being increasingly accepted for what it really is—a far superior form of radio. It's building up real momentum now, and with the introduction of stereo multiplexing there'll be no stopping it. END

6DZ7 6DZ7 6DZ7 6DZ7

By ROBERT M. VOSS

THE 6DZ7, recently put on the market, should solve a few space and circuit problems of audio-amplifier designers. It consists of *two* beam-power pentodes in an envelope the size of a 6L6-GB. The sections have a common cathode and internally connected screen grids. With 400 volts on the plates and 250 on the screens, the tube will deliver 20 clean watts into a 14,000-ohm load.

Naturally, the internally tied screens limits the possible uses of the tube. It obviously cannot be used for Ultra-Linear or triode operation, unless two or more are used in a push-pull-parallel circuit. When powered by a supply that delivers 250 volts at 90 ma, the 6DZ7 will put out 10 watts into a 9,000-ohm load.

Besides using the 6DZ7, the amplifier described here has one other unusual though not unique feature—it uses silicon diodes in the power supply. Having had no experience with silicon rectifiers, I tried to use only two Sarkes Tarzian K-200's in a standard full-wave hookup. Both shorted after about 15 seconds. The moral—the *voltage ratings of silicon rectifiers must be derated considerably when feeding a capacitive load* (see page 40, June, 1960, RADIO-ELECTRONICS). (Even with the 150-ohm resistor the load is essentially capacitive.) Therefore, it is necessary to use four in series—two in each leg of T1's high-voltage winding.

Inspection of the rest of the circuit will reveal nothing unusual. A pentode voltage amplifier is direct-coupled to a phase splitter. The balance control is adjusted for equal ac voltages at the output tube plates. Feedback is, in the conventional manner, returned from the output transformer secondary to the input cathode. The heaters are biased at 10 volts to reduce hum.

A stereo amplifier may easily be built using the same amplifier circuit. It is necessary to change only the power transformer and choke; the rectifiers will easily handle the added current.



AMPLIFIER

Neat little
10-watt amplifier
has a 1-tube
push-pull output
stage... uses a
new dual-pentode

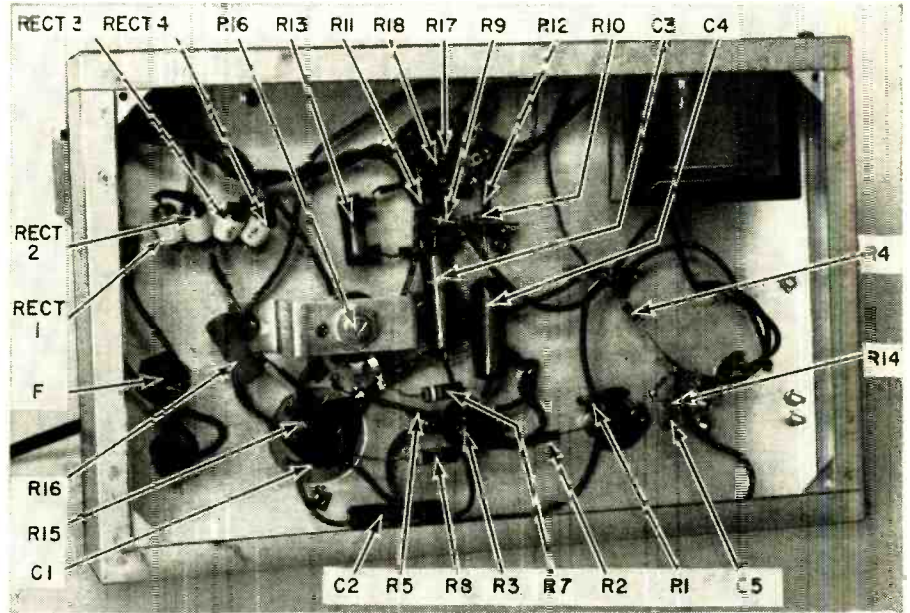

A look under classis. Potentiometer R6 is mounted on U-shaped bracket.

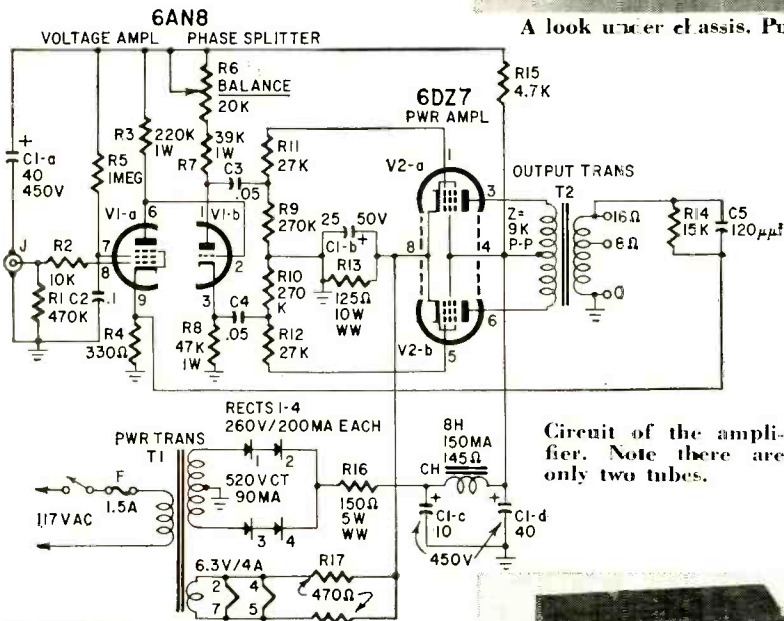

Circuit of the amplifier. Note there are only two tubes.

- 10 watts
- Sensitivity: 350 mv input for full output
- 20-20,000 cycles within 1 db
- distortion below 1.5%
- 17-db feedback at 1 kc
- hum and noise 55 db below 10 watts

Unit was tested for frequency response, power output, distortion, hum and noise, and sensitivity. All results verified the author's statements and are summarized above. Conclusions drawn from the tests are: "The Vess amplifier will give satisfactory service as a hi-fi amplifier in low- or medium-cost systems."



- R2—10,000 ohms
- R3—220,000 ohms
- R4—330 ohms
- R5—1 megohm
- R6—pot, 20,000 ohms, linear
- R7—39,000 ohms, 1 watt
- R8—47,000 ohms, 1 watt
- R9, 10—270,000 ohms
- R11, 12—27,000 ohms
- R13—125 ohms, 10 watts, wirewound
- R14—15,000 ohms
- R15—4,700 ohms
- R16—150 ohms, 5 watts, wirewound
- R17, 18—470 ohms
- All resistors 1/2-watt 10%, unless noted
- C1—40-40-25-10 μ f, 450-450-50-450 volts, can type electrolytic (Cornell-Dubilier D0-65 or equivalent)
- C2—0.1 μ f, 600 volts, molded tubular
- C3, 4—05 μ f, 600 volts, molded tubular
- C5—120 μ f disc ceramic
- CH—choke, 8 henries, 150 ma, 145 ohms (Thordarson 20C54 or equivalent)
- F—1.5 amps
- J—phono jack
- RECT 1, 2, 3, 4—360 volts, 200 ma (Sarkes-Tartan K-200 or equivalent)
- T1—power transformer: primary, 117 volts; secondary, 520 volts ct, 90 ma; 6.3 volts, 4 amps (Stancor PC-8420 or equivalent)
- T2—output transformer: primary, 9,000 ohms plate-to-plate; secondary, 8 and 16 ohms (Stancor A-8054 or equivalent)
- V1—6AN8
- V2—6DZ7 (G-E or equivalent)
- Chassis to suit
- Miscellaneous hardware

END

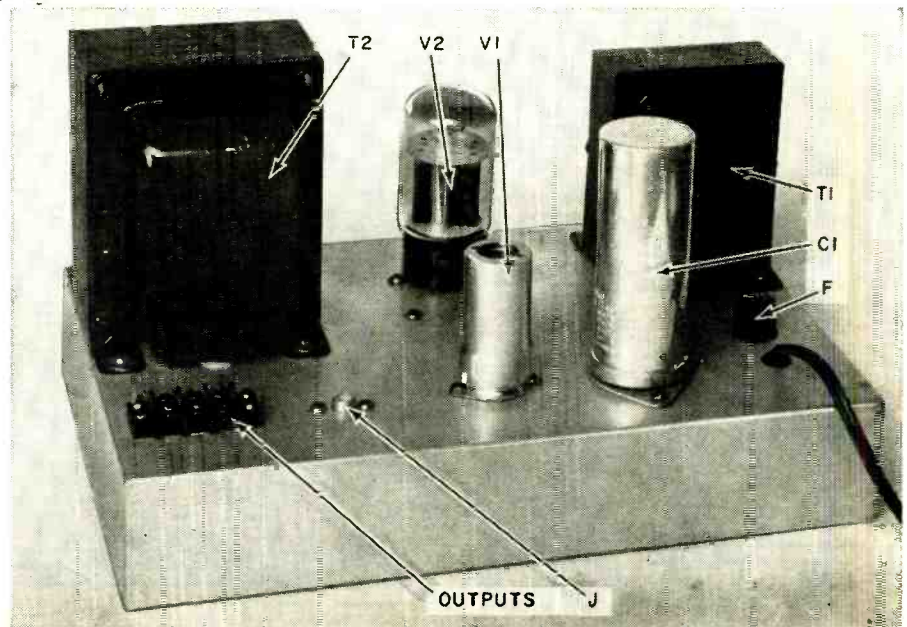

This is how the completed amplifier looks.

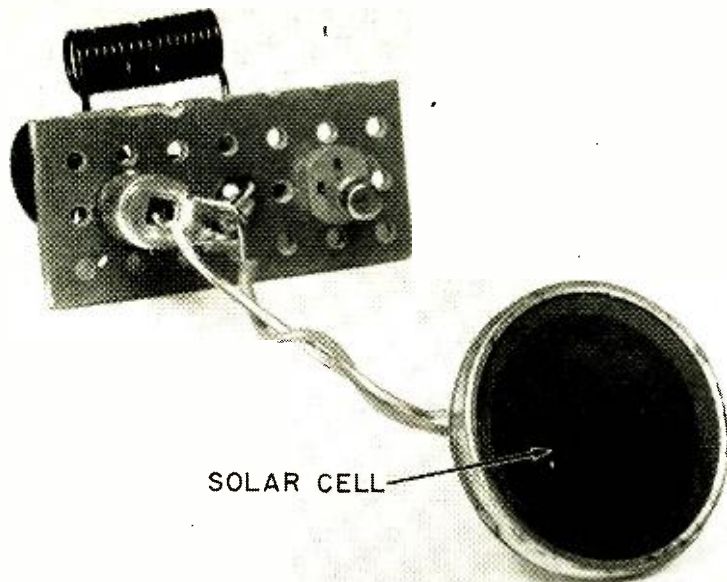

Generator and solar cell power supply.

A TUNNEL DIODE NOISE GENERATOR

Three components and a power source
make a useful test instrument

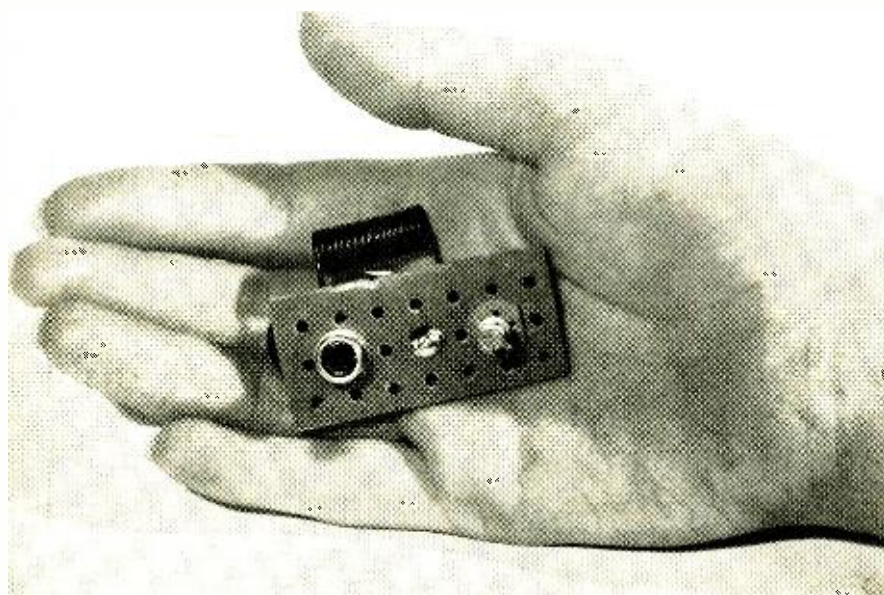

Nothing bulky about this instrument!

By I. QUEEN
EDITORIAL ASSOCIATE

THE newest thing in radio is the tunnel diode. This amazing diode has built-in negative resistance and operates on a few hundred mv of bias. It can oscillate, amplify and switch.

A novel application for the tunnel diode is shown in the schematic. This is an oscillator tuned to about 11 meters by L and C. The diode is a Texas Instruments unit 1N653, now available on the market. It is energized by a Hoffman S-1A solar cell, placed 4 to 5 inches from a 40-watt lamp powered by the 60-cycle line. The 1N653 has three leads, one for the cathode and the other two for its anode.

The rf is modulated by a 120-cycle buzz, from the ac output from the cell when illuminated by an ac lamp. The ac generates many strong sidebands above and below the carrier, resulting in a very broad signal. Measurement shows nearly constant output over a mc or more! For example, with typical coupling to a receiver, an S7 signal was noted throughout the band, and practically zero outside.

There is a slight variation in frequency with the amount of light falling on the solar cell. Here are some results obtained:

Bandwidth (mc)	Cell output (mv)
25.5-27	180
27.0-28.2	200
29.0-29.8	240

The voltage was measured directly across the solar cell. Varying the distance between lamp and cell changed the mv output. Over the bandwidth noted, a loud hum was heard in a nearby receiver.

The output from this simple generator is low; there is little danger of creating interference. A superregenerator will receive the hum signal up to about 10 feet from the oscillator. This signal can serve to check the performance of a receiver or for alignment and adjust-

D—1N653
Socket for above
C—.001 μ f, disc
L—16 turns No. 18 enameled, 1/4-inch diameter close-wound
SC—Hoffman S-1A photocell

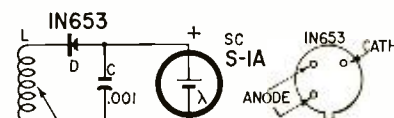

16 T. N° 18 WIRE, 1/4" DIA

Noise generator is inherently simple.

ment. For example, if the oscillator is adjusted for the Citizens band, you will have a strong signal inside the band, practically nothing outside.

The oscillator requires a low-resistance power source such as the solar cell mentioned above. Other types may not be suitable for this purpose.

Note that the diode must be biased in the conduction direction.

This circuit is a good start if you want to experiment with the tunnel diode. The solar cell output is so low that it cannot damage the diode. END

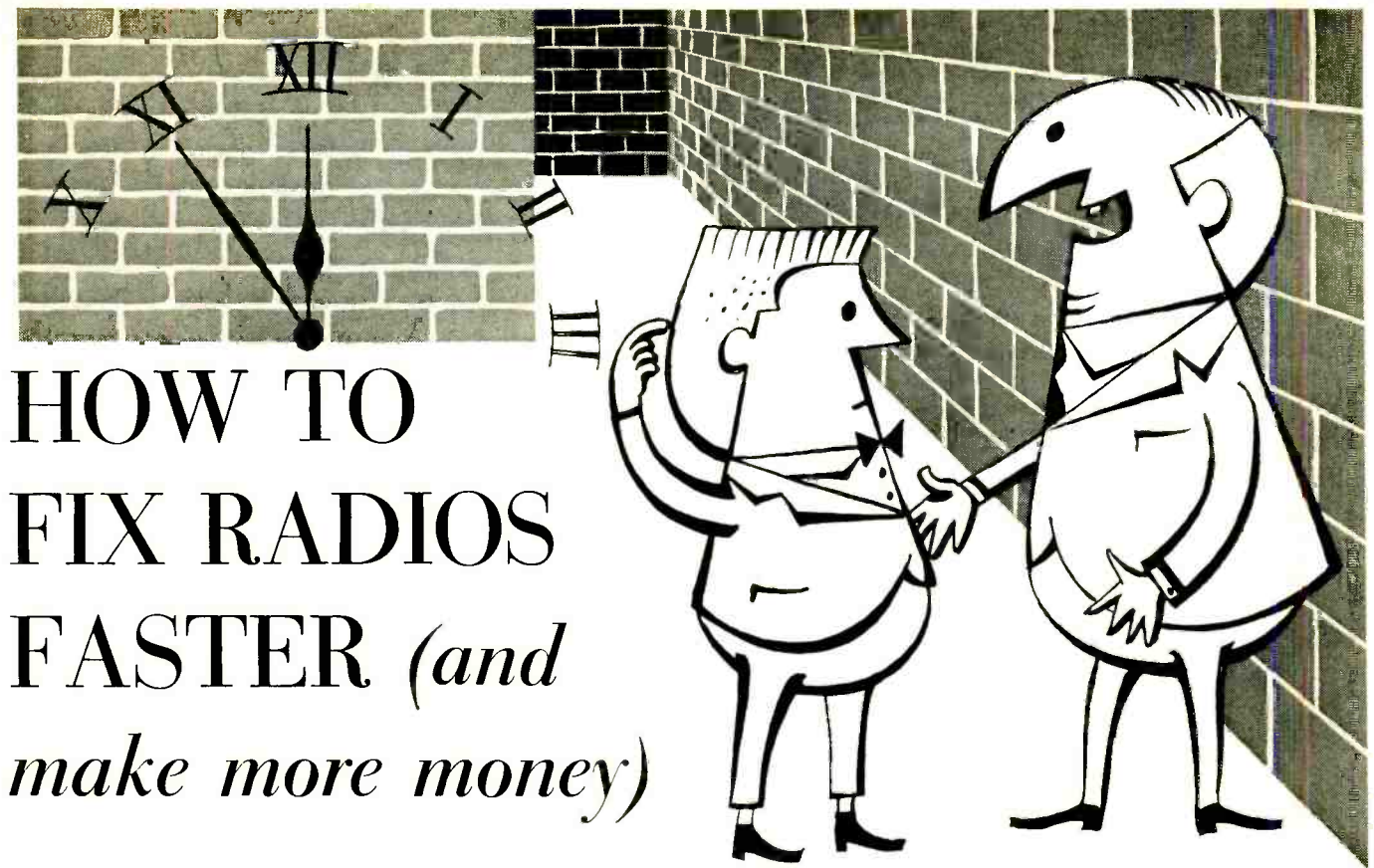

HOW TO FIX RADIOS FASTER *(and make more money)*

By JACK DARR

THE two figures, one tall lanky and balding, the other shorter and crew-cut, came out the back door of the drugstore and went down the alley. From the amount of arm waving and jaw flapping, it was apparent some kind of discussion was going on! As they drew nearer, the Old-Timer could be heard to insist, "Five minutes, I said!"

"FIVE MINUTES!" howled the Young Ham. "Why you can't even get a radio warmed up in that time!"

They came in the back door of the shop and down the long hall. "Five minutes," repeated the Old-Timer firmly. "If you can't get a firm diagnosis on *any* radio in 5 minutes, you sure need your procedures re-examined! Theoretically this is a money-makin' business, right? Right. Well, now, radios are an important part of it! Look there. A flock, seven or eight of 'em, came in this morning! All right, if we can fix 'em fast enough, we can make money. If it takes us all day, we lose money. Why? 'Cause radios don't cost too much nowadays. They're either new low-priced sets or older ones that have depreciated. We just can't git a \$19.95 service charge on a \$12.95 radio and that's all there is to it!

"Your *diagnosis* is th' most important part. Fixin' th' set'll take maybe 20 minutes or so. That's O.K. We can let 'em off for a couple or three dollars service charge. But, if you spend 2 or 3 hours tryin' to find out what's wrong with it and another hour fixin' it, we're in th' hole!"

"Yes, but—," yes-butted the Young

Ham. "But *only five minutes!*"

"All right, I'll have to show you," said the Old-Timer wearily, settling himself creakily on the stool at the radio end of the bench. "Gimme one of them sets."

The Young Ham handed him a small radio from the unfinished work bench. "You watch th' time. Holler when th' hand gits to 60."

The Young Ham watched the shop clock, then called, "Go!"

The Old-Timer plugged the set into the bench wattmeter, watching the needle—it didn't move. Removing the back, he pulled the tubes and plugged them one at a time into a small battery-powered continuity tester. One failed to light the indicator lamp. Hopping up, he grabbed a tube from the shelf and inserted it in the socket. The wattmeter needle now showed about 30 watts and the set began to hum softly, then play. Turning the volume control wide open, the Old-Timer ran up and down the dial, listening to the different stations. He turned the volume control several times, then took the chassis out of the cabinet. Turning it upside down, he squirted fluid from a spray can into the control. Flipping it over again, he sprayed the tuning capacitor. Then, tuning in a station near the high end of the dial, he adjusted the trimmers on the gang for maximum volume.

Picking up a rag, he wiped the inside of the dial glass, and the dial scale itself. Slipping it back into the cabinet, and replacing the screws and knobs, he ran the dial over its full scale. Turning it off, he whirled around on the stool.

"There she is," he cried. "How much time did that take, now?"

"Four minutes, 45 seconds," said the Young Ham. "But, hey! That ain't fair! There wasn't anything wrong with it! Just had a dead tube!"

Just a dead tube?

"Whoa-up!" demurred the Old-Timer. "For your information, young feller, this set had a dead tube, a noisy volume control, a noisy tuning capacitor, the dial was off calibration and I cleaned it up too. Now she's back in good shape again, and I'm gonna charge the customer a bit extra for takin' care of all those little things. Result: she gits a better-playin' radio so she's happy, we make more money so I'm happy! However, that ain't th' point I was tryin' to make. *That was easy, yeah.* But, if you'll check back in your memory, you'll remember that near 90% of th' radios we service ain't got anything but a dead tube wrong with 'em, plus little stuff like this. So, if you can git th' easy ones playin' quick, you'll have a little more time to spend on th' harder ones."

"Th' darn trouble is, most of 'em are either real easy or real hard!" complained the Young Ham.

"They ain't any of 'em real hard if you use th' proper procedure on 'em," returned the Old-Timer. "You might not have noticed, but I used quite a few shortcuts there while I was checkin' that set. F'rinstance, by the way it played and the volume I had, and th' number of stations it got, I knew that the power supply and th' rest of th'

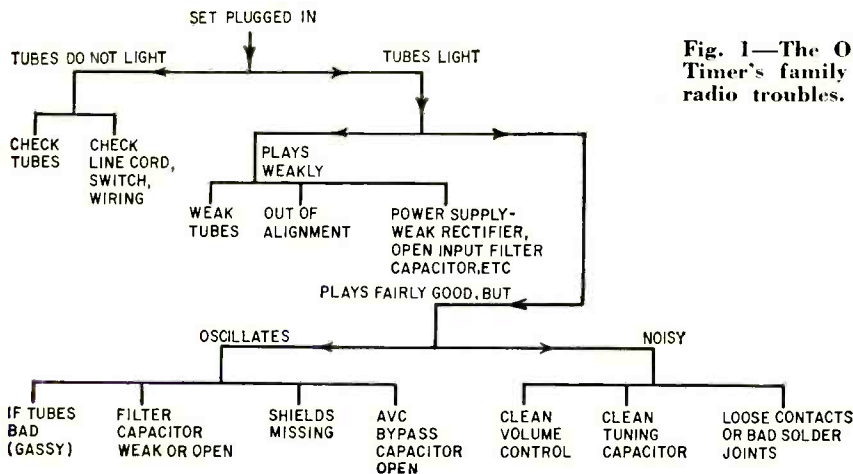

Fig. 1—The Old Timer's family tree of radio troubles.

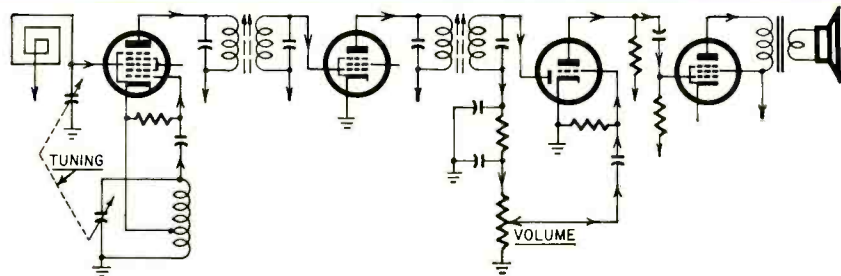

Fig. 2—Signal path through any vacuum-tube radio.

tubes were OK. Why? Because it played as good as the average set of that size oughta—got as many stations, played as loud, an' so on. If it'd been weak, I'd have checked voltages and tubes while I had it out of th' cabinet. See?"

"Yes, I do," said the Young Ham. "But it sure takes a lot of experience to recognize all of those things!"

"Son, experience is what you're gettin', right here." The Old-Timer grinned.

"That's for sure, Pappy," laughed the Young Ham. "I sure ain't gettin' rich on the salary you pay me! Why didn't I get a paper route like the other kids?"

"Cause you couldn't git up that early in th' mornin'," said the Old-Timer, with a straight face. "Now, looky here. Lemme show you once more, an' see if you can't remember it, this time. Here's what you might call a 'Family Tree' of radio troubles." He sketched rapidly on a piece of paper (Fig. 1). "Now, if you'll follow this outline for quick-checking every set, you'll be surprised how much you can cut down your diagnosing time!"

The Young Ham studied the drawing. "Yeah," he admitted, "I can see how it would."

"It will, it will," affirmed the Old-Timer. "Just remember that chart, an'

learn it by heart. Hmm, poetry already! No kiddin', if you've got that up here," rubbing the Young Ham's burr head, "it'll always help you out! Say, didn't I give you something like this quite a while ago, in a different form? What happened to that notebook you used to keep that stuff in?"

"It's here somewhere," answered the Young Ham, scrabbling in the litter at the back of the bench. "Here it is," and he pulled out a medium-sized notebook, blowing the dust off it.

"That's about what I thought," laughed the Old-Timer. "There's quite an accumulation of dust on that material, meanin' it ain't been used for some time, huh?"

"Awww," said the Young Ham, "I ain't needed it much till now."

"Junior," said the Old-Timer seriously, "you always need that stuff, preferably up here between th' ears, but if not then somewhere where you can git at it. Gimme." He took the notebook, and leafed through it. "Yeah, here it is. Now, here's something you want to remember. This signal-path schematic here (Fig. 2). This is nothin' but the parts of th' set that actually handle the signal! It'll fit all radios, I don't give a dern what kind they are! Don't you remember how I used to hammer

this into your head when you first started out? It can be thought of as a series circuit—th' signal starts at the antenna and keeps on goin' on a single path until it gits to the speaker! Anything that causes a break in the path stops th' signal! To find it, all you gotta do is feed th' right kind of signal into each stage and see where it stops!"

"Yeah, but it ain't always as easy as that," demurred the Young Ham.

"Yes, 'tis," argued the Old-Timer, "If you know what a normal response is, you can always find a stage that ain't got it, if you know what I mean."

"Well, it's a little mixed up, but I think I'm beginnin' to get it."

"Well, I hope so," said the Old-Timer. "Now here is the more detailed check list that I worked out for you a while ago (page 45). You follow this all the way through, an' I'll guarantee you'll find your troubles right quick-like!"

"Well, sir, I jist bet you're right," said the Young Ham, in an exaggerated imitation of the Old-Timer's drawl. "I'll bet you what I know you'll like better."

"What?" said the Old-Timer, in mock innocence.

"A cuppa cawfee!" said the Young Ham, making a dash for the door. "Right!" agreed the Old-Timer, following him out. END

THE OLD TIMER'S CHECK LIST

1. **Tubes, check.** For continuity.
2. **Voltages, check.** Since the majority of radios now are ac-dc, the voltages are given for them. Others can be checked from service data.

a. Audio output	90-100 v
b. Audio output screen	90-100 v
c. 1st audio plate†	40-50 v*
d. if amplifier plate	90-95 v
e. if amplifier screen	90-95 v
f. mixer-oscillator plate	90-95 v
g. mixer-oscillator screen	90-95 v

h. avc voltage. Measured at diode plate, and on if or mixer grid. On strong local station, should be 8-10 volts, negative.†

i. Oscillator grid. Measured on oscillator grid. Should read 10-12 volts negative, varying as dial is tuned from high to low end. Highest voltage at high-frequency end of dial.†

* Watch this one: If it's too much, the tube may be very weak! Should never be over about 50 volts. Too-high voltage indicates tube not drawing enough plate current.

†Measured with vtvm.
3. **Signal path.** As voltage measurements are made, listen for 'pop' when probe touches plates and grids. Pop should get louder as you go toward the antenna.
4. **Signal injection.** Use signal generator. Put audio signal on audio output grid, then 1st audio grid. If signal on if amplifier grid, then on mixer grid. Rf signal on mixer grid, then on antenna. Signal should get louder as you go toward the antenna.
(Shortcut: touch center connection (slider) of volume control with finger or screwdriver—volume full up. A good loud buzz should result. This means audio stages and power supply OK. No buzz, trouble in audio stages.)
5. **Alignment.** Feed signal at specified if into if grid, tune last transformer. Move signal generator to mixer grid, tune first transformer. Tune signal generator and set dial to about 1400 kc. Feed signal into antenna by laying output cable on bench nearby or clipping it to edge of loop. Tune antenna trimmer for maximum.

Output indicators: What you need is something to read the amount of signal coming out of the set. Connect ac voltmeter across voice coil to read demodulated signal. A vtvm can be connected anywhere in the if network, except the grids themselves, and the avc voltage used for alignment indication. Avc voltage will increase (go more negative) as set is tuned up. Always keep signal generator output low, to prevent blocking. Should use meter reading of 1 to 2 volts.

Audio distortion: Hum: leaky or open filter capacitors. Symptom: hum will not be reduced as volume control is turned down. Heater-cathode leakage in audio output tube. Open loop antenna; this hum will decrease as volume control turned down.

Distorted tone: Speaker-cone dragging. (Turn set off, move cone with fingers very carefully, listening for rubbing.) Leaky coupling capacitor on grid of power amplifier tube. Measure grid voltage. Should be zero, or slightly negative. If 2 to 3 volts positive, replace capacitor. Also check output tube for grid emission.

Hum while station tuned in: Leaky or gassy mixer-oscillator or if amplifier tube. Check by substitution.

Oscillation: Weak or open filter capacitors. Open avc bypass capacitor. Open screen bypass capacitor.



Don't Miss these Highlights

NEXT MONTH

Three Ignition-Operated Tachometers

No sports car fan would be without a tachometer. They're very useful too for checking engine speed on cars, outboard motors, racing models or other engine driven equipment. Here are three dependable transistor-operated units that are easy to build.

Electronic Timer Integrates Light

A unique all-transistor device that is controlled by the amount of light it receives instead of remaining "on" a given number of seconds. Invaluable for electronic photoflash operation and other applications where ordinary timers just won't do.

Ultra-Sensitive 3-Transistor Regenerative Radio

For those who want more sensitivity than usually found in 3-transistor radios (and good selectivity too). A special input circuit controlled regeneration, larger-than-usual antenna loop and careful choice of components do the trick. An ideal project for the hobbyist.

Electronic Strain Gauge and its Uses

This versatile instrument is used to check the design of all kinds of equipment and structures from airplanes to bridges. It plays a vital role in engineering progress in many fields. This illuminating article tells how strain gauges are made and how they're used in industry.

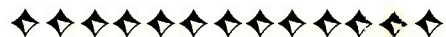

COVER STORY



build
the

RALLY-PAL COMPUTER

The counter tells you how
far you should have
gone at any given instant

By JACK ALLISON

IF you are one of those unrepressed souls who still think driving is fun, then rallying is the sport for you.

In spite of what some people think, rallying is *not* racing. Far from it. A rally, or "rallye" as some purists would have it, is an individual competition in which drivers try to find their way over an unfamiliar route. At the same time they attempt to maintain a prescribed speed (always less than the posted speed limit). Check points are set up along the route at locations unknown to the driver. When he comes to one, he pulls in and his time of arrival is recorded. This makes "being at the right place at the right time" a continuous challenge. Hundreds of motor-sports clubs all over the country run rallies

as regular features of their programs.

The complexities of rallying make a navigator a must. He (or she) does the mathematical gymnastics necessary to see that the car is properly located on the route (and everything else the driver can't do while driving). This often means husband and wife teams. This point alone makes rallying popular.

Navigating is done on one simple premise. At an even speed you can cover a certain distance in a precise time. For example, if you travel 30 minutes at 30 mph (most rally speeds are to the nearest tenth of a mile per hour), you will cover exactly 15 miles. However, little annoyances such as other cars, stop lights and turns make it impossible to keep the even speed called for.

The rallyist turns our equation around. He knows that if his clock shows 30 minutes have elapsed and his odometer (mileage indicator) turns up just 15 miles he has done this "leg" of his route at a precise 30 mph. Rallying can be done several ways. Some competitors use a book of rally tables to help them figure out their time-distance ratio. These are usually accurate to the nearest minute. You can successfully compete in a rally with nothing more than a stop watch and one of these books, provided not too many other cars are fitted with more elaborate gear. More advanced rallyists use a stop watch for reference only. They prefer to have a short-wave receiver in the car picking up WWV or

ly 10 minutes, so dividing the counter reading by 10 gives you the number of counts per minute. This may be marked directly on the dial or later entered on a sheet of cross-section (graph) paper.

Repeat the process with a new dial setting, five points lower than before. Continue until the entire range is covered. Move the switch to position 4 and calibrate that range. Do the same for the remaining ranges.

If you are going to use graph paper rather than marking the figures on the dial, number the bottom of a sheet (holding it horizontally) from 0 to 100. Number the side of the paper according to your count-per-minute determination. Now, plot your findings on the paper (make one graph for each range). You should have a neat arc traced by 20 points (Fig. 2). Join these (using a French curve). The vertical scale of the graph may be calibrated in miles per hour to save time in the rally.

The number of counts per minute is equivalent to the number of 100ths of a mile you will travel per minute. For example, if you are moving at 12 miles per hour (average), at the end of one minute, you should have traveled 0.20 mile. If your counter is clicking away at 20 counts per minute, at the end of that minute it will also read 00.20 (the last two digits on the counter read 100ths of a mile).

Transistor version

For those of you who want a unit of greatly increased accuracy, the transistor version in Fig. 3 should be suitable. This unit is used by my friend Joe White, of Toronto, Canada. The separate 9-volt (dry-cell) source for the multivibrator improves stability. The cost of this version will be higher than that of the thyatron unit. No range switch is needed as the one control will vary the count-per-second rate from about 0.6 to 3.3 (10 to 60 miles per hour). The low-voltage counter required is somewhat higher priced.

Calibrating the transistor computer is similar to calibrating the 2D21 version except that only one graph must be plotted.

Using the computer

When you receive your rally instructions, the navigator looks up the speed on a table and converts it to counts per minute (or skips that part if the graphs have already been calibrated in mph). He or she finds the desired count rate (or speed) on the side scale of the graph. He then draws a horizontal line across the paper to intersect the arc. From the intersection, a vertical line is drawn to the logging scale at the bottom of the page. This is the computer setting.

R1—pot, 100,000 ohms, linear taper
 R2—8,200 ohms, 10%, 1/2 watt
 R3—510 ohms, 5%, 1/2 watt
 C—40 μ f, 10 volts, tantalum
 V1—2N256
 V2—2N170
 V3—2N489
 RY—spst, 6- or 12-volt coil
 S1—spst pushbutton switch
 S2—dpst toggle switch
 Counter—4-digit, resettable with 6-volt (or 12, depending on auto voltage) coil
 Miscellaneous hardware, case, sockets, etc.

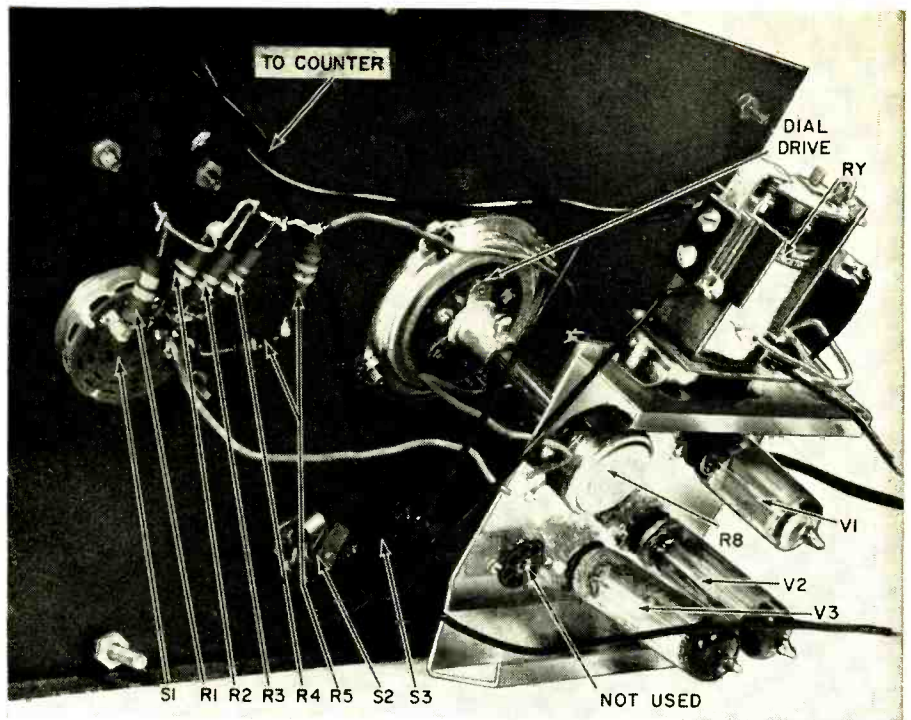

Rear view of computer. R5 is actually two resistors in series.

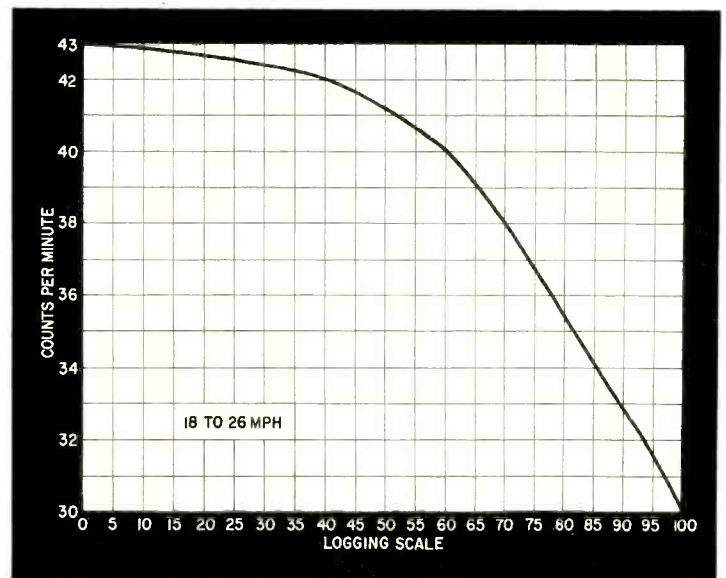

Fig. 2—Sample graph produced when calibrating computer. Find counts-per-minute (or speed desired) at left, go across to intersect arc and then drop line to logging scale at bottom. This gives setting for computer.

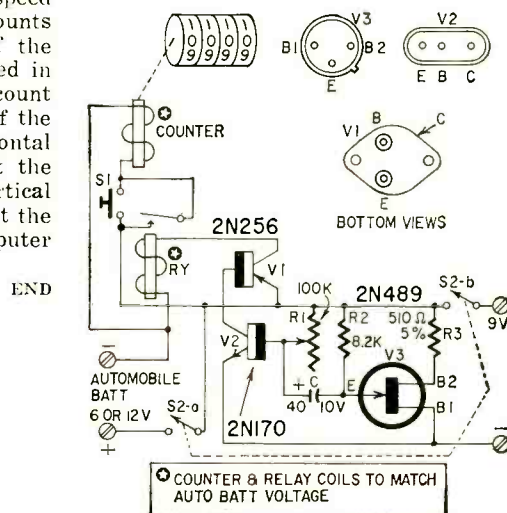

Fig. 3—Transistor version of computer uses Unijunction transistor.

Subcarrier Techniques for

TELEMETRY

By ED BUKSTEIN *

Systems can be designed to measure almost any quantity and transmit the figures any desired distance

BY definition, *telemetry* means measuring at a distance. Remote measurement is used when the quantities to be measured are inaccessible or when it is not practical to have an operator "take the readings." Telemetry apparatus is used extensively in missile and satellite equipment to *radio back* information on temperature, pressure, acceleration, fuel-flow rate, vibration, and other variables. Each of these variables is converted to an electrical signal and used to modulate a transmitter. A system of subcarrier oscillators is used, so that all of the telemetered information can be transmitted within a single radio channel.

Transmitting systems

The block diagram of a typical telemetry system is shown in Figs. 1 and 2. Only three subcarrier oscillators are shown, but many more may be used. Each of these oscillators operates at a different center frequency. The frequency of each oscillator varies in accordance with changes in the quantity to be telemetered. The first subcarrier oscillator in Fig. 1 (SCO 1) is used to telemeter temperature information. A thermistor (negative-temperature coefficient resistor) is used as a

* Northwestern TV & Electronics Institute, Minneapolis, Minn.

temperature-sensing component. Since the resistance of the thermistor varies with temperature, and since the thermistor is connected in series with a voltage source and a fixed resistor (R1) the voltage drop across R1 varies with temperature changes. If the temperature should increase, for example, the resistance of the thermistor would decrease and a higher voltage appears across R1. This voltage controls the frequency of SCO 1. The frequency of the oscillator at any given instant may therefore be 400 cycles, or above or below this value, depending upon the temperature (assuming SCO 1 is a band-1 oscillator. See table.). The thermistor in Fig. 1 is connected as part of a voltage divider, but frequently it is used as an arm of a bridge circuit.

SCO 2 responds to changes of humidity. The humidity-sensing element is a coating of lithium chloride on a glass or plastic base. The coating absorbs moisture from the surrounding air and its resistance changes accordingly. The voltage drop across fixed resistor R2 therefore depends upon the humidity and controls the frequency of SCO 2.

Information regarding air pressure is also telemetered. An increase of external pressure (or decrease of internal pressure) compresses the bellows. A decrease of external pressure (or increase of internal pressure) allows the bellows to expand. The arm or slider of a vari-

able resistor is mechanically coupled to the bellows so that the voltage across resistor R3 is a function of air pressure. This voltage controls the frequency.

The subcarrier frequencies are so selected that the maximum allowable deviation (7.5%) will not result in overlapping adjacent subcarriers. Table I shows the standard subcarrier bands, allowable deviation and upper and lower limits. These standards are variously referred to as RDB, IRTG or IRTWG standards. The initials designate the organizations which contributed to the establishment of the standards (Research and Development Board, Inter-Range Instrumentation Group and Inter-Range Telemetry Working Group). As shown in the table, five optional bands (A through E) permit deviations of $\pm 15\%$ if adjacent bands are not used.

The frequency-modulated outputs of

Subcarrier Bands and Limits				
Band	Center Frequency (cps)	Maximum Deviation (percent)	Band Limits	
			Upper	Lower
1	400	± 7.5	430	370
2	560	"	602	518
3	730	"	785	675
4	960	"	1,032	868
5	1,300	"	1,398	1,202
6	1,700	"	1,828	1,572
7	2,300	"	2,473	2,127
8	3,000	"	3,225	2,775
9	3,900	"	4,193	3,607
10	5,400	"	5,805	4,995
11	7,350	"	7,901	6,799
12	10,500	"	11,286	9,714
13	14,500	"	15,588	13,412
14	22,000	"	23,650	20,350
15	30,000	"	32,250	27,750
16	40,000	"	43,000	37,000
17	52,500	"	56,440	48,560
18	70,000	"	75,250	64,750
A	22,000	± 15	25,300	18,700
B	30,000	"	34,500	25,500
C	40,000	"	46,000	34,000
D	52,500	"	60,380	44,610
E	70,000	"	80,500	59,500

Bands A through E are optional and may be used in place of numbered bands by omitting adjacent bands as follows:

Band Used	Omit Bands
A	15 and B
B	14, 16 A C
C	15, 17, B D
D	16, 18 C E
E	17 and D

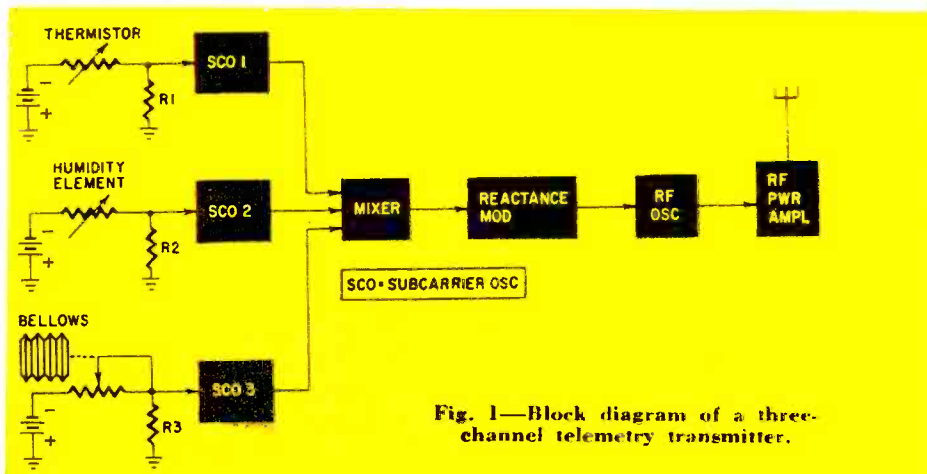

Fig. 1—Block diagram of a three-channel telemetry transmitter.



Geotechnical Corp.

Channel 5 voltage-controlled oscillator.

the subcarrier oscillators are mixed and applied to a reactance modulator stage. The main carrier is therefore frequency-modulated by the frequency-modulated subcarriers. For this reason, the technique is sometimes referred to as FM/FM telemetry. Transmission is generally in the 216- to 235-mc band and power output of 3 to 50 watts.

The receiving (ground-station) equipment (Fig. 2) includes an FM receiver. The output of the second detector (discriminator) consists of the varying subcarrier frequencies. Bandpass filters are used to separate the individual subcarriers which are then amplified and applied to the subcarrier discriminators.

Since a discriminator is a frequency-to-voltage converter, each subcarrier discriminator produces a dc output that varies with changes of the telemetered quantity. The dc output of discriminator 1, for example, will vary with changes of temperature; the output of discriminator 2 with humidity; etc.

The discriminator outputs control recording pens. These resemble ordinary meter movements except that the pointers have been replaced by small lightweight pens. Writing on a motor-driven paper chart, they indicate variations of temperature, humidity, etc.

Transducers

As a first step in the telemetering process, the quantities to be telemetered must be converted to some type of electrical signal. The components used for this purpose are referred to as transducers, data pickups, pickoffs, end instruments or sensing elements.

In Fig. 1, for example, the thermistor functions as a temperature-to-resistance transducer, the bellows-controlled rheostat serves as a pressure-to-resistance transducer, and the humidity element provides humidity-to-resistance conversion. Several other techniques are illustrated in Fig. 3.

As shown, a bellows responding to pressure changes can be used to control the spacing between two metal plates, one fixed and the other movable. The

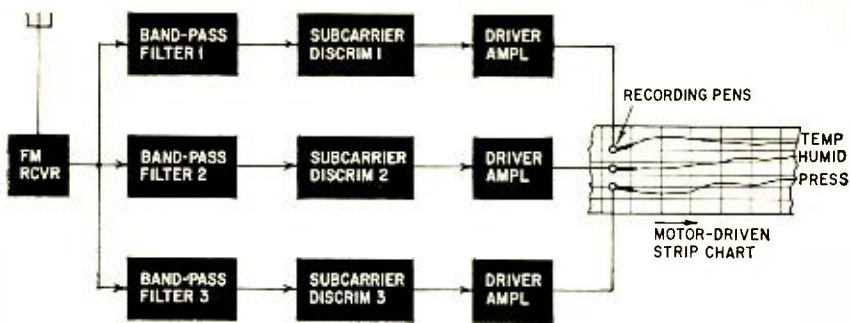

Fig. 2—Block diagram of a three-channel telemetry receiver. The output from each channel is recorded on a paper tape.

capacitance of this two-plate capacitor will therefore vary with pressure changes. If this capacitor is used in the tank circuit of an oscillator, pressure changes will be converted to frequency changes.

Alternatively, the bellows can be used to control the position of a core with respect to a coil. Pressure variations produce inductance changes. Again, the inductance can be part of an oscillator tank circuit. A Bourdon tube is frequently used in place of the bellows. As shown in Fig. 3-c, this consists of a bent, hollow tube closed at one end. An increase of pressure (in the tube) tends to straighten it and the resulting mechanical motion can be used to vary the value of a capacitor, inductor or resistor.

The accelerometer consists of a spring-supported weight known as a seismic mass. In some models, the accelerometer case is filled with oil to prevent excessive vibration of the mass. The position of the mass with respect to the case depends upon the rate of acceleration. If the accelerometer is mounted in a missile, for example, the mass will move backward when the missile accelerates (for the same reason the driver of an automobile is pushed against the back of the seat when the car is speeding up). When the missile decelerates, the mass moves forward in its case (just as a driver is thrown forward when the brakes are suddenly applied). The mass of the accelerometer may be mechanically coupled to a variable resistor, capacitor or inductor.

As shown in Fig. 3-e, the differential transformer contains a movable core and two secondary windings connected in series. The secondaries are 180° out of phase so that normally their voltages cancel and there is no output. But if the position of the core is changed, the coupling to one secondary is increased and to the other secondary decreased.

Under these conditions, the voltages induced in the two secondaries are no longer equal. The net output voltage will therefore have an amplitude and phase determined by the amount and direction of core movement. The position of the core can be controlled by a bellows, Bourdon tube, accelerometer or any other component providing mechanical motion.

The strain gauge consists of a piece of resistance wire cemented to a paper backing. Strain (dimension change) in the structure to which the gauge is

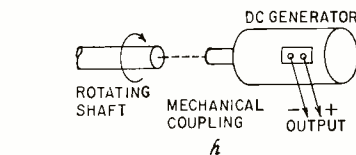
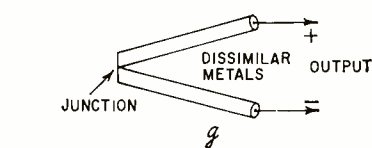
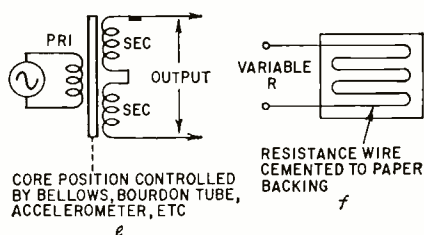
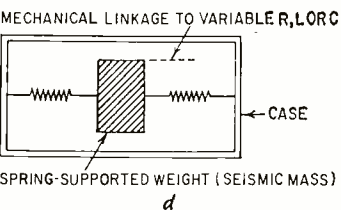
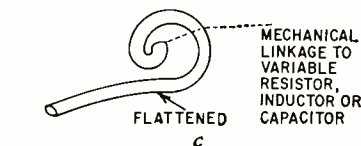
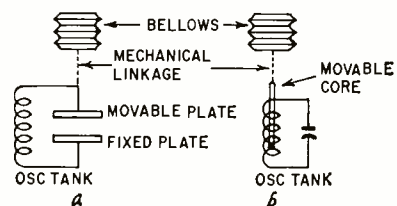
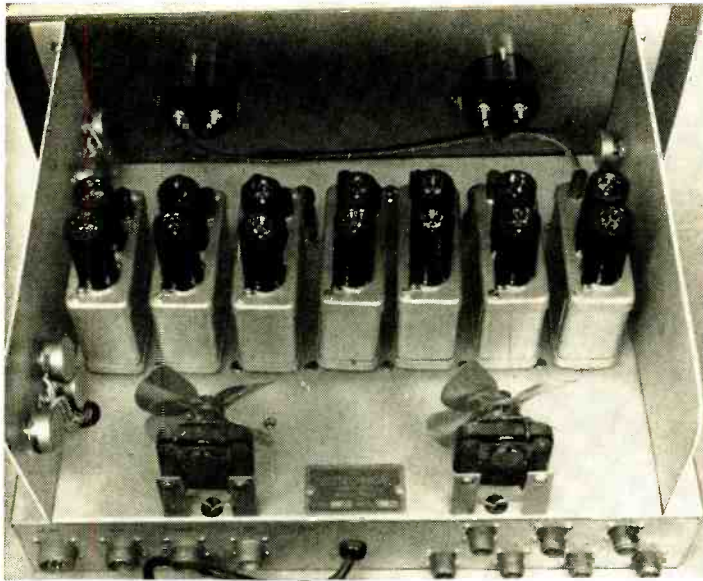

Fig. 3 — Transducers: a — bellows-controlled capacitor; b — bellows-controlled inductor; c — Bourdon tube; d — accelerometer; e — differential transformer; f — strain gauge; g — thermocouple; h — tachometer-generator.



Geotechnical Corp.

Multiplexer containing seven plug-in subcarrier oscillators.

attached causes the wire to stretch. As the wire becomes longer and thinner, its resistance increases. The strain gauge is connected as part of a bridge circuit so that the degree of unbalance of the bridge is a measure of the mechanical strain in the structure being tested. Strain gauges are often mounted on the skin and structural members of a missile.

The thermocouple is a temperature-to-voltage transducer. Consisting of two dissimilar metals, it produces a voltage whose amplitude is determined by the junction temperature. This voltage is relatively small so the thermocouple must be followed by several stages of amplification. As compared to the thermistor, the thermocouple has the advantage of responding faster to temperature changes.

The tachometer generator is a small dc generator used for measuring the rate of shaft rotation. The generator is mechanically coupled to the shaft whose speed is to be telemetered, and the output voltage of the generator is therefore a function of the rpm of the shaft. An ac generator may be used if rpm-to-frequency conversion is desired.

Subcarrier oscillators

Subcarrier oscillators are classified according to the method used to control the frequency—voltage-controlled, resistance-controlled, inductance-controlled or capacitance-controlled.

The resistance-controlled subcarrier oscillator generally employs an R-C tuned circuit such as the Wien bridge or phase-shift oscillators. The oscillation frequency is determined by the time constant of a resistance-capacitance feedback network. A variable-resistance transducer (thermistor, bellows-actuated rheostat, etc.) can therefore be used as a frequency-determining element of the circuit.

Inductance- and capacitance-controlled subcarriers are usually generated by a Hartley oscillator circuit. The transducer controls either the inductance or capacitance of the tank circuit and varies the output frequency.

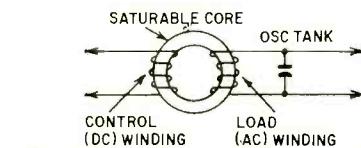

Fig. 4—Saturable reactor used as a variable inductor.

ance or capacitance of the tank circuit and varies the output frequency.

A variation of the inductance-controlled oscillator uses a small saturable reactor as the tank coil. The saturable reactor, as shown in Fig. 4, has two windings: the control or dc winding and the load or ac winding. Passing dc through the control winding will saturate the core to an extent determined by the magnitude of the current flow. Since the degree of core saturation determines the inductance of the ac winding, the saturable reactor can be used as a variable inductor. When the ac winding is connected in the tank circuit of a subcarrier oscillator, the oscillation frequency depends upon the current flow through the control winding.

The voltage-controlled oscillator, as the name implies, oscillates at a fre-

quency determined by the voltage applied to its input terminal. As shown in Fig. 5, this type of subcarrier oscillator employs a multivibrator circuit. The grid resistors of the multivibrator are connected to the plate of the control tube rather than being grounded as in the conventional multivibrator. The plate voltage of the control tube therefore varies the bias of the multivibrator and consequently controls the frequency of oscillation. The control tube is in effect a dc amplifier for coupling the transducer to the multivibrator. A small change of input voltage (from the transducer circuit) can therefore produce a relatively large variation of multivibrator frequency. Trimmer capacitors are sometimes shunted across the coupling capacitors of the multivibrator to serve as center-frequency adjustments. As an alternative, controls (R1 and R2) such as those shown in Fig. 5 may be used. The two potentiometers are interacting in effect and are used to set the center-frequency as well as the deviation limits of the oscillator.

Characteristically, the multivibrator produces a square-wave output. The harmonic components of the square wave contribute nothing to the telemetered information and may interfere with higher subcarrier channels. A low-pass filter is therefore used to attenuate the harmonics while allowing the fundamental sine-wave frequency to pass through. The filter is followed by an amplifier stage, sometimes connected as a cathode follower (shown) to provide a low-impedance output.

A commercial model of a voltage-controlled subcarrier oscillator is shown in one photo. An input of ± 2.5 volts to this unit will produce a frequency shift of $\pm 7.5\%$. The control knobs shown are used to adjust the center-frequency and the deviation limits. A multiplexer containing seven of these subcarrier oscillators is shown in the other photo.

A transistor version of the voltage-controlled oscillator is shown in Fig. 6. The transducer circuit is coupled to the multivibrator through an emitter follower. By controlling the bias of the multivibrator, the emitter-follower stage determines the frequency of oscillation. END

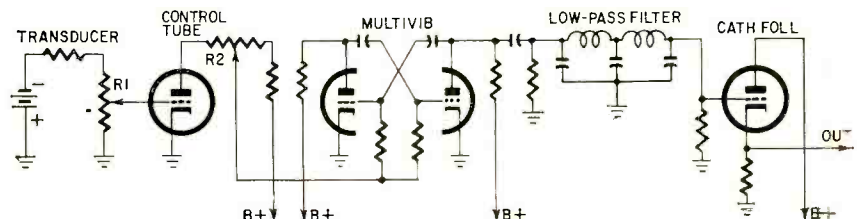

Fig. 5—Voltage-controlled oscillator. Control tube varies bias and therefore frequency of multivibrator.

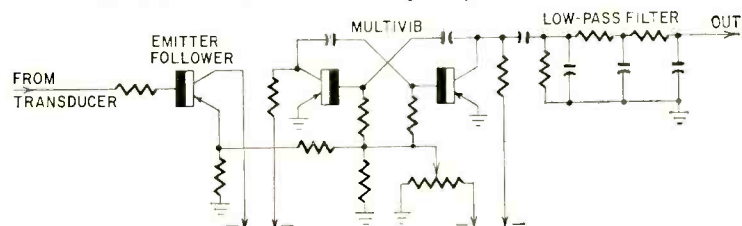
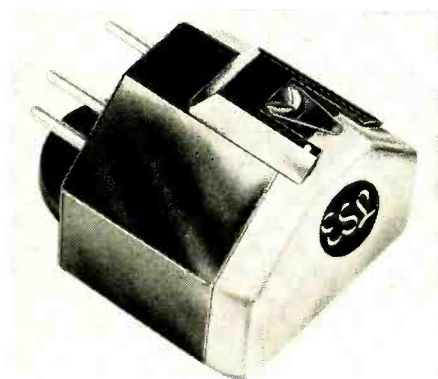

Fig. 6—Transistorized voltage-controlled multivibrator schematic.

NEW stereo PICKUPS

Part III—The ESL C99 Micro/Flex, Empire 88, Pickering 380, Shure M212/M216, Stereotwin 210/D and Fairchild SM-1

By JULIAN D. HIRSCH



ESL C99 Micro/Flex Cartridge.

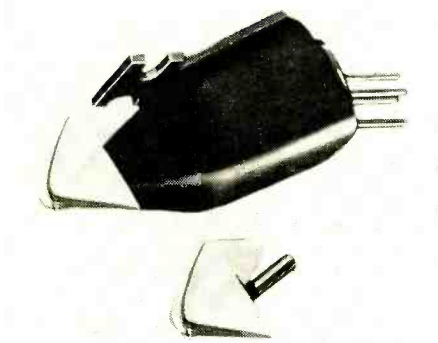

Pickering 380 and its slip-in stylus assembly.

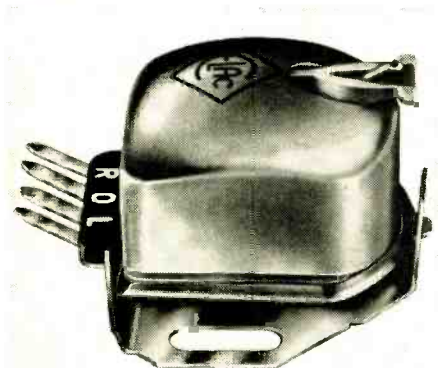

Stereotwin 210/D. Stylus assembly is designed for simple replacement.

TWO moving-coil stereo cartridges were described in last month's installment of this series. Since that article was prepared, information has been released on another new moving-coil cartridge, the ESL C99 Micro/Flex.

In many ways this unit resembles the ESL C100 Gyro Jewel (October 1958, page 48). It incorporates the D'Arsonval type of moving coil which has characterized all ESL cartridges. The C100 employed an ingenious gimbal structure which allows each coil to rotate independent of the other. The delicacy of this design is reflected in its relatively high price (\$69.50).

In the C99, the basic operating features of the C100 have been retained, with a simpler mechanical design which permits a lower selling price.

One of the photos shows the ESL C99 stereo cartridge. The cantilever stylus shoe is made of a black plastic material. The curved portions visible at the base of the stylus shoe are part of the Micro/Flex coupling system.

Fig. 1 shows how the Micro/Flex separating system couples the stylus to the two coils, each wound with 20 turns of very fine precious-metal alloy wire (only a fourth the diameter of a human hair). The long, narrow coils are positioned between a pair of magnetic pole pieces located in front of and behind each coil. Each end of each coil form (armature) is supported by a latex holding block, which also serves as a damping element.

The Micro/Flex separating system is a molded plastic piece which is split down the middle. At the bottom, the two sections are joined by a thin flexible plastic lever to which the base of the stylus shoe is attached.

Modulation of the inner wall of the record groove moves the stylus up and to the right. The flexible lever bends so

that no motion is imparted to coil B, which is held at both ends by the latex support blocks. The left side of the Micro/Flex system rotates with the stylus, causing coil A to rotate in the magnetic field passing through it. This generates a voltage in coil A proportional to the stylus velocity. Similarly, modulation of the outer groove wall generates a voltage only in coil B.

Although this coupling system functions very much like that of the C100 Gyro/Jewel, it is more rugged and simpler to manufacture. The improved ruggedness makes the C99 suitable for use in good record changers.

The compliance of the moving system of the C99 is 5×10^{-6} cm/dyne in both vertical and lateral planes. Its dynamic mass is 2.5 mg. The recommended tracking force is as low as 2 grams in a well designed arm, though somewhat higher forces may be required in some arms.

The output of the ESL C99 is very low (0.6 mv at 10 cm/sec stylus velocity) and a stepup transformer is re-

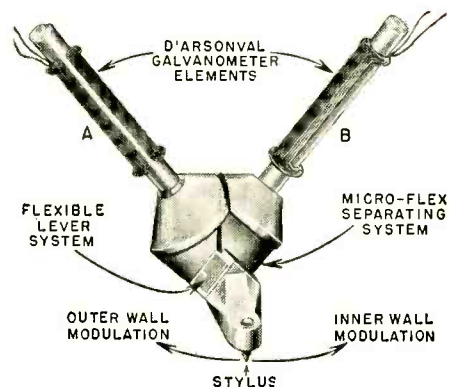

Fig. 1—The Micro/Flex separating system used in the ESL C99.

quired for practically all installations. A pair of the ESL TM-100 transformers is recommended. The frequency response is 18-20,000 cycles, ± 2 db, and the channel separation is 20-25 db over most of the audio range. The price of the ESL C99 is \$49.50.

A moving magnet is the generating element in the cartridges described below. Most moving-magnet cartridges have relatively high output voltages, and rugged moving systems which usually allow the stylus to be replaced by the user. All except the Fairchild SM-1 use a rectangular bar magnet made of a ferrite material which has low mass and good magnetic properties. Although the various cartridges differ in details of coil and pole-piece design, as well as specific materials and stylus support structures, they are similar to the first unit to be described, so its assembly drawing will suffice to explain their operating principles.

Empire 88

This cartridge has a bar type moving magnet, with mass concentrated close to the pivot axis, giving a low moving mass when referred to the stylus tip. Fig. 2 is an assembly drawing of the Empire 88. The rectangular bar magnet is mounted in an elastomer damping material which positions it between the four pole pieces. Its entire length is fastened to the light aluminum stylus shoe, which is angled for stiffness. A fine support wire runs to the front of the stylus assembly to hold the shoe and magnet in a definite position, and to provide the compliance for the moving system.

When the stylus is moved by modulation of one or the other of the groove walls, the magnet rocks about a pivot point located approximately halfway between the front and rear coils. This varies the flux through the corresponding pair of coils generating a voltage in them. In Fig. 2, modulation in the inner groove wall produces an output in the coils nearest the stylus; the outer



The Shure M212 arm and pickup.



The Empire 88. Remove screw to replace stylus.

groove wall controls the output of the rear pair of coils.

A pair of coils is used for each channel. The coils are so interconnected that the effects of external hum fields are cancelled. In addition, a mu-metal shield encloses the front of the cartridge, where the coils are located.

An interesting feature of the Empire 88 cartridge design is that the replaceable stylus assembly contains the quadrature pole-piece structure shown in Fig. 2. The four cylindrical pole pieces which pass through the coils protrude slightly from the cartridge body and contact the flat pole pieces when the stylus assembly is mounted to the cartridge body. This design insures that all critical portions of the cartridge are fully protected and are replaced as a unit when the stylus is replaced. The stylus assembly is held in place by a single screw, visible in the photo.

Compliance of the Empire 88 is 5×10^{-9} cm/dyne, in both vertical and lateral planes. The moving (dynamic) mass is claimed to be only 0.7 mg. Its output is 5 mv per channel at average recording levels. Channel separation is greater than 20 db. Frequency response is 20-20,000 cycles ± 2 db. The recommended tracking force is 2 to 5 grams. The price of the Empire 88 is \$24.50.

Pickering 380

Unlike previous Stanton Fluxvalve cartridges (made by Pickering), which were variable-reluctance types, the new 380 Collectors Series use moving magnets. Although the principles of operation of the Pickering 380 are identical to those of other moving-magnet cartridges, several unique design features which are not immediately obvious are incorporated.

The photos include a Pickering 380 cartridge and one of the plug-in stylus assemblies. The stylus assembly consists of a brass tube containing a rectangular bar magnet, surrounded by a

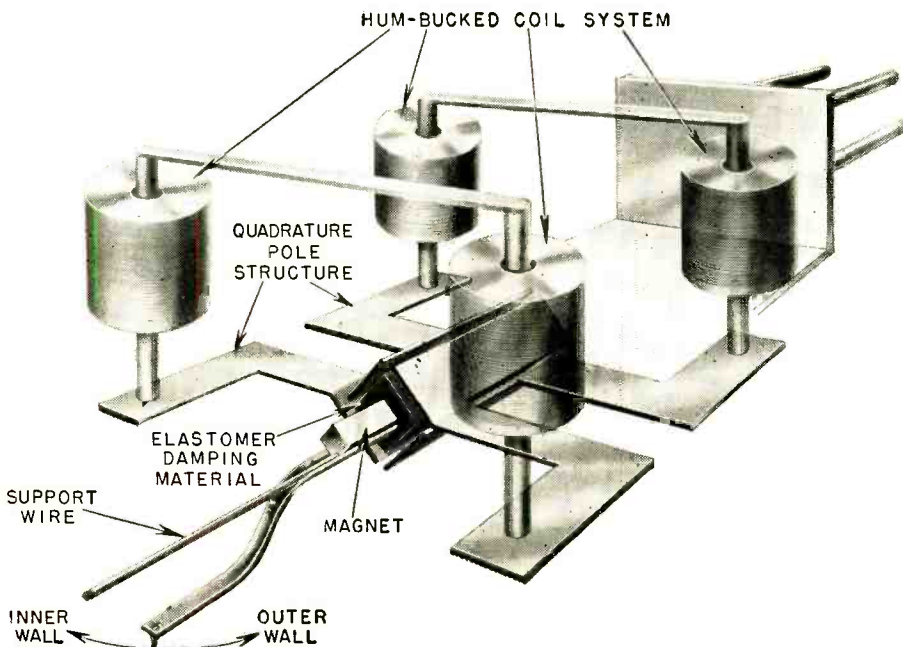

Fig. 2—Assembly drawing of the Empire 88.

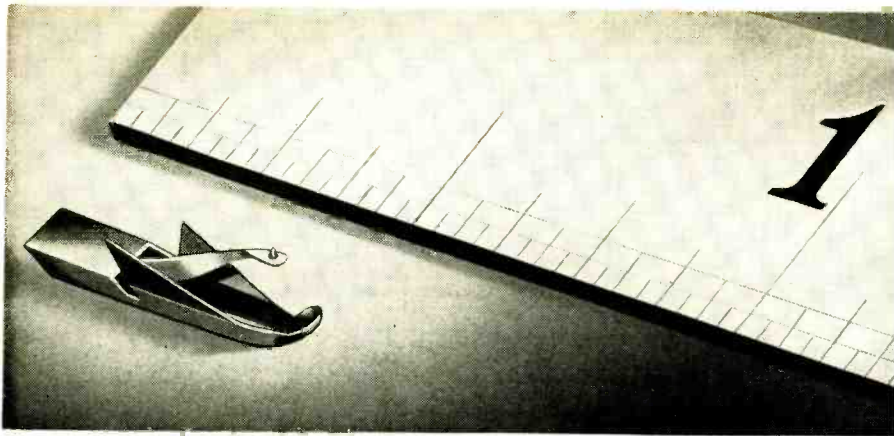

Fig. 3—Replaceable stylus assembly of Shure M212 cartridge.

damping material. A short, stiff aluminum tube extends from one end of the magnet, and carries the 0.7-mil diamond stylus at its far end. The plastic V-Guard cone serves as a handle for inserting or withdrawing the stylus, and protects it if the arm is dropped onto the record surface.

The coils and pole pieces are firmly encapsulated within the body of the cartridge, which is shaped like a completely symmetrical pyramid. At its tip is a small hole into which the brass tube of the stylus assembly fits. Extending along the length of this hole inside the cartridge are the four pole pieces. They are curved to fit the shape of the brass tube, and to obtain maximum magnetic coupling to the magnet within the tube.

The body of the Pickering 380 cartridge is fully enclosed with a one-piece drawn mu-metal shield, and the rear is capped with a piece of mu-metal through which the terminals protrude. The result is virtually perfect shielding against external hum fields, both electromagnetic and electrostatic.

Output is exceptionally high, 20 mv at 10 cm/sec stylus velocity. Frequency response is within 2 db from 20 to 20,000 cycles. Channel separation is 25 db or better through most of the audio range.

The 380 is available with a choice of two styli, for transcription arms or for record changers. The 380-A, designed for transcription arms, tracks at 2 to 5 grams. The 380-C stylus has less compliance and tracks at 3 to 7 grams. Pickering does not publish compliance figures, but experience with the 380-A shows that it will track very well at 2 grams, indicating a very high compliance. The Pickering 380-A sells for \$34.50, and the 380-C sells for \$29.85.

Shure M212/M216

The Shure M212 is the stereo counterpart of the well known Studio Dynamic pickup, model M12. The M216 is identical to the M212 except for the length of the arm, which will accommodate 16-inch records.

Shure introduced monophonic moving-magnet cartridges to the American hi-fi scene a few years ago, and have continued the same approach to the design of stereo cartridges. The Shure M3D (November 1958, page 83) is widely

recognized as one of the finest stereo cartridges, and the M7D (March 1959, page 84) is a lower-priced version of this cartridge.

The integrated pickup, M212, uses the same internal structure as the M3D and M7D, packaged in a very compact form and designed to operate only in a special snakelike arm. It is straight, with the necessary offset angle built into the cartridge (the stylus is mounted at an angle to the axis of the arm). The arm is free to move laterally, but is constrained vertically. Only the extreme forward portion, containing the cartridge, can move vertically. It is raised from the record surface by pressing

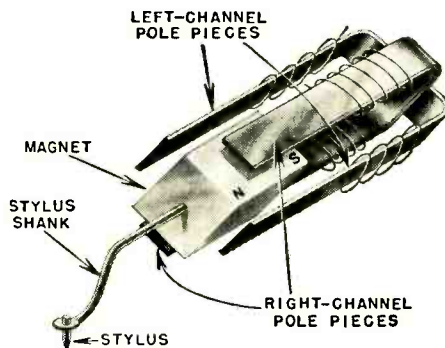

Fig. 4—Moving-magnet assembly used in the Shure cartridge.

down on the plastic button protruding from the top of the arm.

Fig. 3 shows the replaceable stylus assembly of the M212. The thin aluminum member holding the stylus is fastened at its other end to the rectangular cross-section bar magnet. The magnet is surrounded by an elastomer damping material. A fine wire (not visible in Fig. 3) extends from the end of the stylus shoe to the body of the stylus housing, to provide stiffness for the moving system.

The internal structure of the Shure cartridge is shown in Fig. 4. It is very similar to most of the moving-magnet cartridges we have described. The pole pieces are within the body of the cartridge, while the stylus shank and magnet are in the removable stylus assembly.

The frequency response of the Shure M212 pickup is rated at 20–20,000 cycles ± 2.5 db, with more than 20-db channel

separation at 1,000 cycles. Its output is fairly high, about 9 mv at 10-cm/sec stylus velocity.

Stylus compliance is very high, 9×10^{-6} cm/dyne in both lateral and vertical planes. The needle-tip mass is 1.3 mg. Tracking force is adjustable between 1.5 and 2.5 grams. The price of the complete Shure M212 Stereo Studio Dynamic pickup is \$89.50.

Stereotwin 210/D

The Stereotwin 210/D is an improved version of the Stereotwin 200 (November 1958, page 88). The original Stereotwin 200 had three solder lugs for its output terminals. The new 210/D has four terminals which accept clip-on connectors as do most other cartridges. The stylus structure has been refined and made more rugged.

The Stereotwin 210/D is fully encased in mu-metal and has extremely low hum pickup. Its output is also very high, about 13 mv per channel.

The cartridge assembly features a simplified mounting system. The cartridge is removed from its mounting clip, which can then be mounted in an arm without difficulty. The cartridge then snaps into the clip.

The stylus assembly, visible in the photo, includes the moving-bar magnet and damping material common to most moving magnet cartridges. It can be slipped in or out of the cartridge without tools.

The design of the mounting clip allows the cartridge to be positioned for correct stylus position in both changers and transcription arms. Slots in the clip permit sliding it forward or backward to obtain the correct stylus overhang for minimum tracking error. Not visible in the photo are two slots in the end of the clip, which permit adjusting the angle the stylus makes with the record surface.

The Stereotwin 210/D will track at 3 to 4 grams in a good arm, or 5 to 6 grams in a record changer. The price

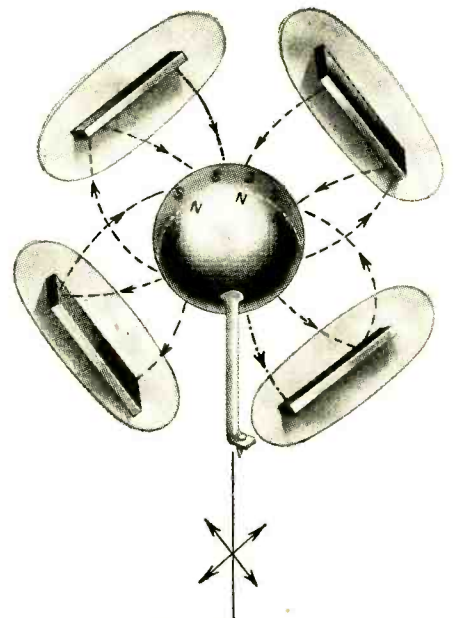

Fig. 5—How the spherical magnet in the Fairchild SM-1 works.

NEW for RADAR

TWO accessories that increase the value of radar have recently been announced. One, made by Intercontinental Electronics, Mineola, N. Y., is a new type of indicator system that removes stationary and slow-moving objects from the trace. It uses two storage tubes in cascade as comparison memory gates to eliminate any fixed or slow-moving targets. The difference can be clearly seen in the photos. Photo 1 is a normal radar trace. Photo 2 is a radar picture of the same area, but with the nonmoving targets eliminated. Note how clearly the moving targets appear now.

The second radar aid was announced by Lockheed Electronics, Plainfield, N. J. It is similar to a unit described in the November, 1959, issue of RADIO-ELECTRONICS, page 6. Both are designed to eliminate spurious signals known as "fruit" from radar displays. It is especially useful with radar designed for IFF (*Identification Friend or Foe*) and ATC (*Air Traffic Control*). The unit assists in locating and identifying aircraft by preventing a display of spurious signals caused by overinterrogation, clutter, weather or other phenomena. In military applications it will separate targets from interference, intentional or otherwise. END

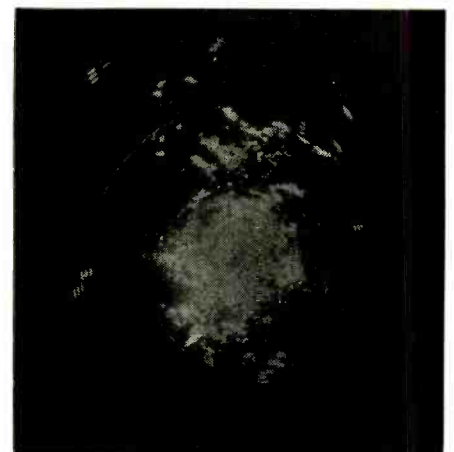

PHOTO 1

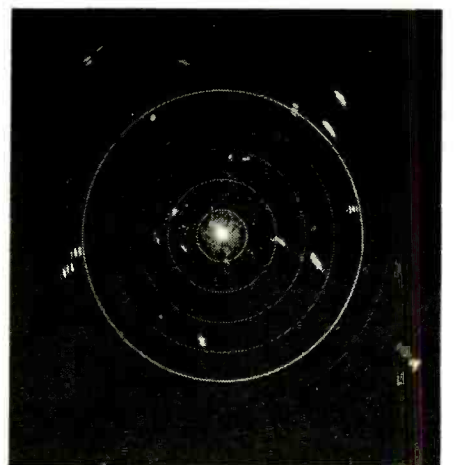

PHOTO 2

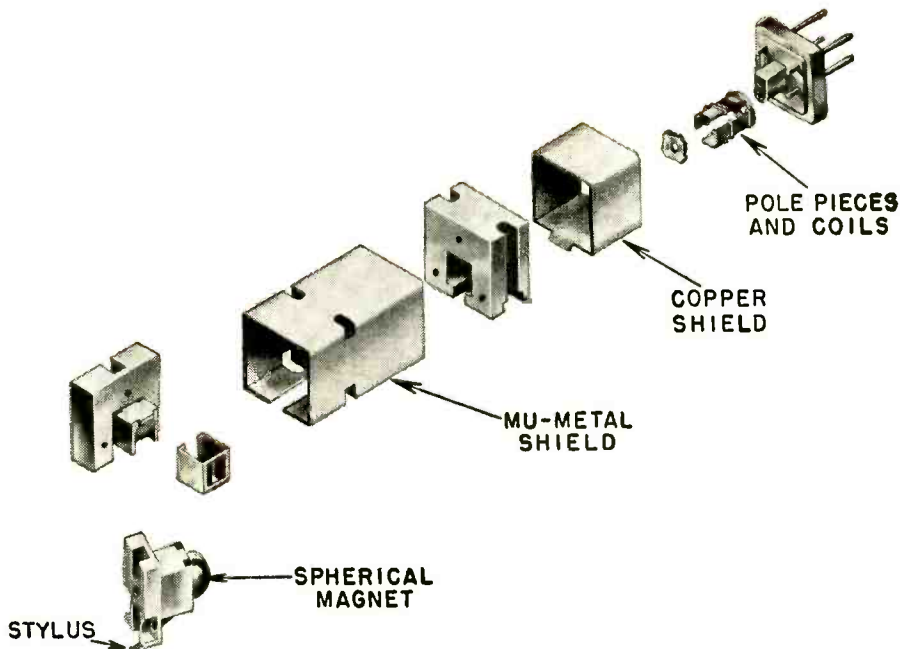

Fig. 6—Exploded view of the Fairchild SM-1.

of the 210/D has been reduced substantially compared to its predecessor. It sells for \$34.50.

Fairchild SM-1

The Fairchild SM-1 is a moving-magnet cartridge of radically different design, compared to the ones previously described.

A sphere of Indox V (a magnetic ceramic material) is the magnet in the SM-1. The sphere is magnetized along an axis parallel to the length of the cartridge. Fig. 5 shows the orientation of the magnetic sphere between the four pole pieces, and the distribution of the flux lines. In the neutral position of the stylus, the flux lines pass through the tips of the pole pieces on their way from the front N of the magnet to the rear S. Since the "equator" of the sphere is symmetrical with respect to the four pole pieces, there is no tendency for flux to pass down the pole pieces and link the coils.

If the stylus is displaced from its neutral position, the ball rotates and the

balance of flux lines is disturbed. In Fig. 5, the stylus has been displaced vertically, moving the "equator" of the magnet into the position shown by the dashed line. Some of the flux lines, shown as light dashed lines, still bridge across the pole pieces and do not link the coils. Others, shown as dash-dot lines, enter one pole piece and pass down through the coils to return via the opposite pole piece.

The exploded view of the SM-1 cartridge (Fig. 6) shows how the pole pieces pass through the coils and extend forward to the "equator" of the spherical magnet. As the ball rotates slightly due to the stylus following a stereo groove, there is a net change of flux linkage through the four coils and a corresponding generation of stereo output signals.

The ball magnet is mounted in a damping ring which damps vertical motion, and is supported at the sides by damping blocks to control lateral resonances. The damping ring and blocks are shown in Fig. 7.

The stylus bar of the Fairchild SM-1 is of tubular construction, for maximum torsional rigidity. Since the ball magnet pivots about an imaginary point at its center, the moving mass referred to the stylus tip is very low. Lateral compliance of the SM-1 is approximately 6×10^{-6} cm/dyne, and its vertical compliance is approximately 4×10^{-6} cm/dyne.

To reduce the effects of external hum fields, a shorted turn of copper surrounds the coils, and the entire cartridge is surrounded by a mu-metal shield. The output voltage of the SM-1 is high, 22 mv for 10-cm/sec stylus velocity. It is designed to track at 3 to 4 grams force. The price of the Fairchild SM-1 cartridge is \$34.95.

This sums up our current survey of stereo phono cartridges. As additional units appear, they too will be described. Look for them in future issues. END

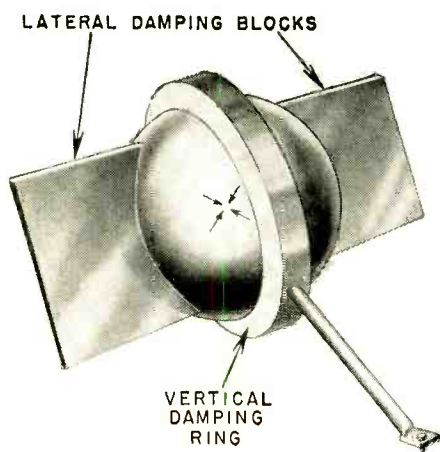
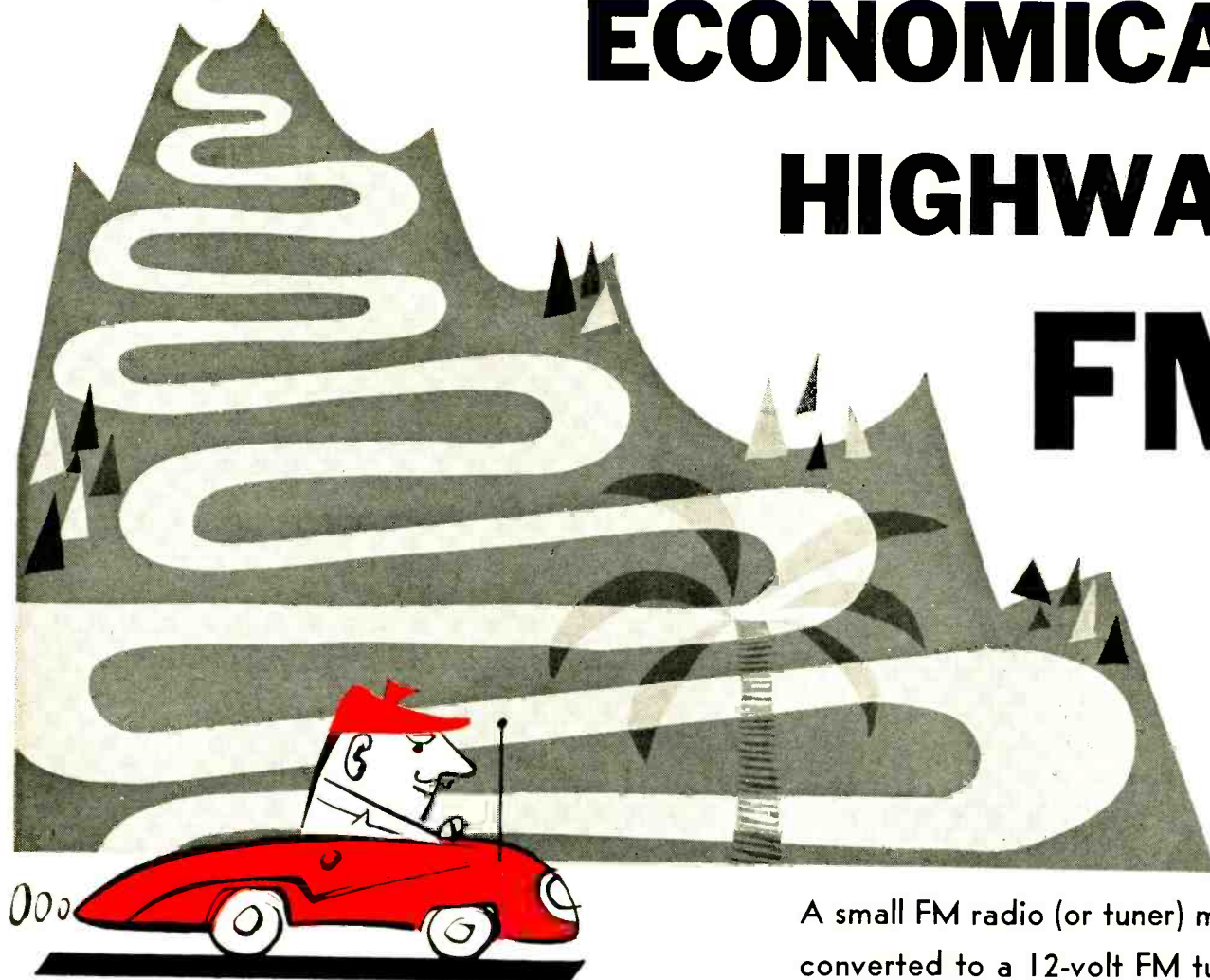

Fig. 7—Damping ring and blocks used with the spherical magnet.

ECONOMICAL HIGHWAY FM



A small FM radio (or tuner) may be converted to a 12-volt FM tuner

By JOHN J. BORZNER

MOST automobiles have built-in AM radio. For the individual who wants to listen to an FM station while driving, there has been just one "choice" (assuming his car does not already have an FM radio): buy a commercial FM receiver. Most commercial sets cost a good deal more than the average man wants to pay. Now, for \$40 (much less if you already have a small FM radio), you can add FM to your car.

What are the advantages of FM? Distortion is less, signals are much cleaner, there is much more good music on FM than AM; there are fewer commercials and the audio-frequency range of most FM stations is better than that of AM stations.

I have taken two FM receivers and converted them to 12-volt-powered tuners. One is the Granco 601 FM table radio; the other is the Heathkit FM-3A tuner.

The power supplies of both units were removed and replaced with a transistor-oscillator B-plus supply. Since one is a tuner, few other changes are necessary. The audio output stage and speaker were removed from the radio. The audio signal is fed to the car's AM radio audio system.

Both sets are quite free from drift,

especially the Granco. The Heath has age, which is helpful when driving through areas where signal strength varies—cities with many tall steel-frame buildings.

Both sets are powered by a small, dependable transistorized power supply. It puts out about 125 volts dc for the Granco and 250 volts for the Heath. Granco uses three 12-volt tubes (which present no problem and one 19-volt tube which performs satisfactorily on 12-volts. Later models have a 14-volt tube in place of the 19-volt one). The Heath set uses six 6-volt tubes which can be readily hooked up as three 12-volt strings.

Before building the power supply, decide which radio you are going to use. The supply can be built into either cabinet very neatly. The space used by the rectifier tube and transformer in the Heath is more than adequate for the transistor power supply. In the Granco (which uses a selenium rectifier), the loudspeaker, output transformer and audio output tube are removed to make room for the mobile power setup (see photos).

Granco conversion

The Granco radio is ready to play when received. I suggest that you let

it run a few days before the conversion. When you are convinced that it is operating satisfactorily, start the conversion. Remove the loudspeaker, output transformer and the audio output tube (50C5). Snip the two colored leads to the output transformer close to their source. Ground the black lead which runs from the volume control to the output side of the transformer.

In the space previously occupied by the speaker and output tube, mount the transistor power-supply transformer, a Triad TY-68S. Then, in any convenient spot, mount the two transistors. They will not require a heat sink, even under sustained use. The collector in the 2N256 is tied internally to the case so you must insulate the transistors from each other and from the mounting plate. Wire the power supply according to Fig. 1. RECT 3 and 4 are not used for the Granco.

Ground the center connector of the power-supply rectifier to the chassis. The B-plus lead is simply soldered to the output side of the selenium rectifier (Fig. 2). The power supply output is filtered by the power-supply filter in the receiver.

Now rewire the heaters for 12-volt operation (Fig. 3). There is no need to remove any components. (Watch bat-

R1—68 ohms, 1 watt
 R2—270 ohms, 1 watt
 All resistors 10%,
 V1, 2—2N256 or equivalent
 T—transistor oscillator power transformer,
 12 volts to 250 volts, 65 ma, center-tapped
 (Triad TY-68S or equivalent)
 RECT 1, 2, 3, 4—500 ma, 130 volts silicon rectifiers
 (Sarkes Tarzian M500 or equivalent)
 F—SFE 32-volt, 9-ampere fuse and in-line fuse holder

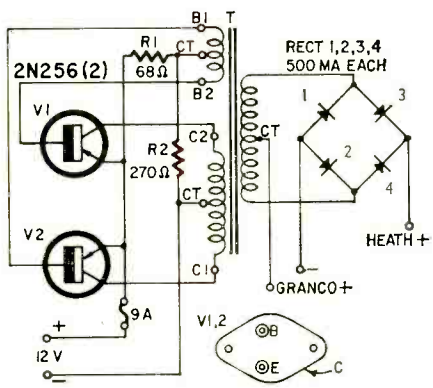
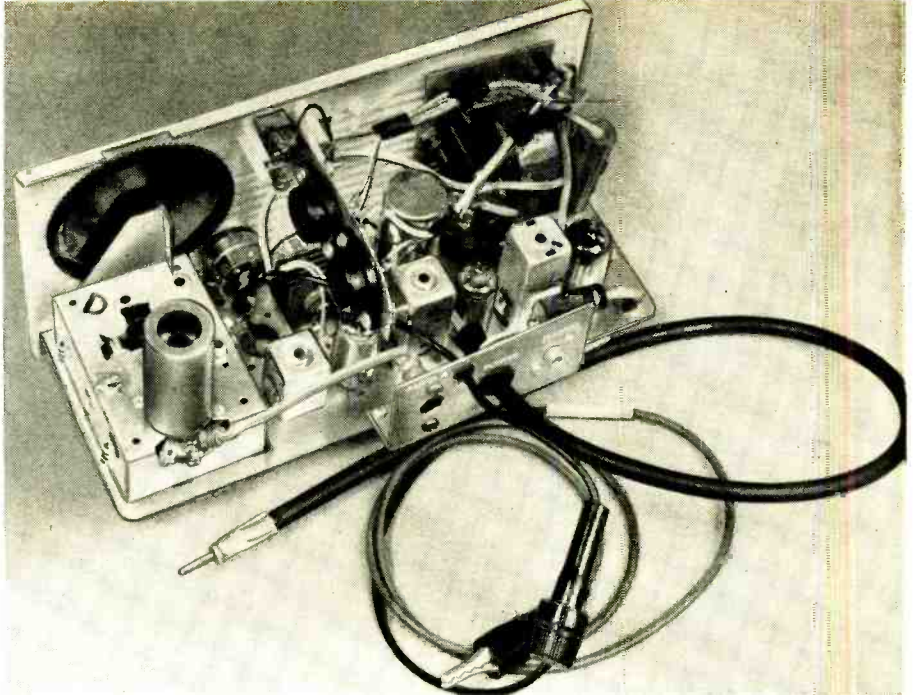

Fig. 1—Power supply schematic. RECT 3 and RECT 4 are not used with the Granco and the secondary center tap is not used with the Heath.



Rear view of converted Granco.

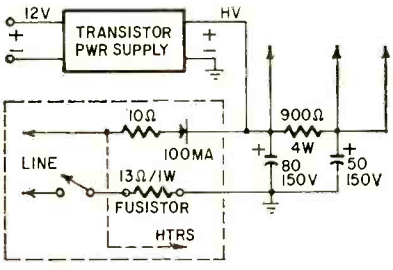

Fig. 2—Method of hooking the power supply to the Granco. Except for the on-off switch, parts in the dashed box are not used.

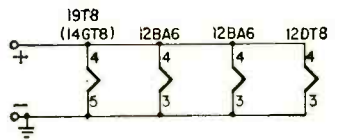

Fig. 3—The Granco heaters are wired in parallel. On late model sets, a 14GT8 replaces the 19T8.

tery polarity. Fig. 3 shows connections for a negative ground. If your car has a positive ground, connect the positive battery lead to the grounded side of the heater line.) When you are sure the wiring is correct, attach a lead to the car battery and ground the chassis. Note whether the heaters light properly.

Electrically, all that is left to the conversion is to pick the audio signal off the output tube socket. Run a length of shielded lead from pin 2 through a 0.5- μ f capacitor to a phono jack.

Mount a piece of sheet aluminum (bent to a right angle) on the rear of the set. On this plate, mount the phono jack for audio takeoff, the fused power line input, auto antenna input and output.

The 12-volt power line goes through a fuse holder to the switch on the back of the volume control. A standard auto-antenna jack is mounted on the plate and connected to pin 8 on the 12DT8

rf oscillator tube through the existing capacitor. A length of shielded lead, auto-antenna type with bayonet connector (to fit the antenna input jack on the AM radio) is connected to an spst slide or toggle switch on the front panel (Fig. 4). The other side of this switch goes to pin 8 of the 12DT8. The switch allows us to change over from FM to AM without changing the antenna connections. The .05- μ f capacitor from pin 2 on the 50C5 tube socket goes to the phono jack on the plate.

Cut a hole in the cabinet back to accommodate the aluminum plate. Replace the cabinet, secure the bottom screw and the conversion is complete.

Now the AM radio must be converted to receive the audio signal from the tuner. This is usually a very simple matter. In my car, a Motorola model 84MS is used. The audio signal was applied to the base of the driver transistor. A diagram of your particular set should indicate a suitable point. These diagrams are available in many municipal libraries if you do not have one. A shielded lead terminating in a plug to fit the tuner's phono jack completes the conversion.

To operate the set, attach the power lead to any convenient 12-volt source. Make sure that the 12-volt source is

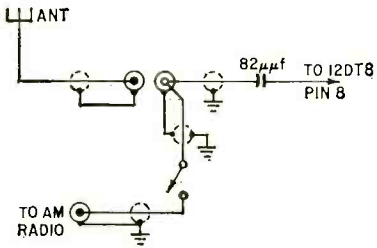

Fig. 4—A spst switch allows the AM radio to be connected directly to the antenna.

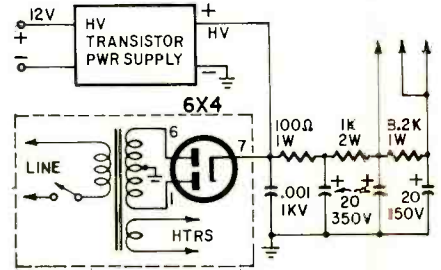

Fig. 5—The B-plus lead from the power supply is connected to pin seven on the 6X4 socket. The boxed parts (except for the switch) are not used.

turned off when the ignition is turned off. If this is not done, there is a chance of leaving the converter on overnight, discharging the battery.

Insert the auto antenna plug (which will also serve as the set's ground), connect the audio plug and turn both sets on. Set the auto radio to a neutral spot on the dial. Control the volume with the volume control of the AM set.

Heathkit conversion

The Heathkit FM tuner must be assembled before the conversion can be attempted. It is advisable to build the set according to the instructions included, using the supplied 117-volt power-supply and heater-string setup. After the set is finished and plays to the builder's satisfaction (scope alignment is recommended), the conversion to a fine mobile car radio can be started.

Begin the changeover by removing the power transformer and rectifier tube (6X4). This will provide adequate room for the transistor power supply. Wire the supply according to the schematic (Fig. 1). The B-plus lead is attached to pin 7 on the 6X4 socket (Fig. 5).

Rewire the heaters according to Fig. 6. Then apply 12 volts to the pins side

of the heaters and ground the chassis to see whether the tubes light (see previous warning on heater grounds.)

You will not need the aluminum plate described above for mounting the sockets and jacks on the back of the cabinet. Since this set was originally designed as a tuner, the phono output jack is already installed. The antenna coupler can easily be changed to the automotive type jack. Be careful to note polarity.

The antenna changeover switch can be located on the front panel.

With the Heath set, volume is controlled by *both* the AM and FM units, so make sure that both are turned up when testing.

General

Both sets are hooked up to the car in the same manner. The auto antenna lead will serve as a ground (by means of the cable shield). Power is taken from the cigar lighter or ignition switch. Attach the audio output cable to the car radio's input jack and turn on both sets. The power supply in the converted set may appear to race or take off until the heaters warm up; however it will stabilize once operating temperature is reached (usually 1 minute).

If your set showed a tendency to drift while warming up in the preconversion test, you will have to allow some time for the set to settle down. This is usually not over 15 minutes even in the

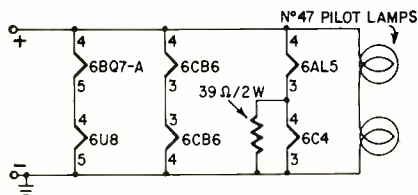

Fig. 6—The Heath heaters are in series-parallel. A resistor is required across the 6C4 heater.

poorest sets. This completes the conversions. These are reasonably simple changes and sets that do not function properly can be usually traced to troubles in the receiver itself.

Noise

There should be no interference from the AM radio because the auto antenna is connected to the FM set. When the car radio is not connected to an external antenna, its sensitivity is reduced to near zero. However, it doesn't hurt to set the AM radio to a quiet spot on the dial. If a crackle or ignition noise is heard, better shielding of the FM set or antenna may be required. While FM radios are usually noise free, they are susceptible to motor noise. Proper shielding is the answer to almost all these problems. Your car will pose its own problem which careful custom installation can solve.

By using reasonable care in building and converting, the experimenter will be rewarded with many enjoyable hours of pleasing highway FM. END

SIMPLE SWEEP GENERATOR USES VARICAP

By MORRIS BARRON

A UNIQUE component from the semiconductor family promises to provide a new and better technique for voltage-controlled tuning and for frequency modulation in particular. The Varicap,* a voltage-variable capacitor, should prove useful and effective in building or designing new equipment or modifying older equipments. It is actually a diode whose capacitance changes in accordance with the applied bias voltage. Among its other good attributes, the Varicap voltage-variable capacitor is inexpensive, costing no more than an ordinary receiving tube.

There is a real need for a good but simple and inexpensive FM alignment tool in the service technician's or experimenter's shop. An rf signal generator was modified with the help of this handy component, and demonstrated its aptness and simplicity of use. The 20- μ f voltage-variable capacitor† was used to modify an ordinary signal generator to provide a sweep-signal source for 10.7-

mc if and discriminator FM receiver alignment. The photograph shows how the necessary circuit components can fit into an instrument, and how little space they require, making this modification easy. Fig. 1 is the schematic of the sweep frequency-modulation circuit.

In working out the design of this circuit, the details were considered in the following order: first, the sweep voltage frequency of 60 cycles was established. It is the standard used for many other instruments and test procedures used for this purpose. Next, the chart of Fig. 2 was consulted to determine the required modulation voltage. The chart shows the voltage-capacitance relationship for all Varicap diodes regardless of their initial capacitance. It was found that the generator's 6.3-volt filament supply was not only convenient but could provide ample voltage, 17.6 volts peak to peak.

That voltage is more than enough for the required frequency deviation. However, the exact amount of frequency swing of an oscillator is determined by the L-C ratio of the coil-capacitor combination which produces the 10.7-mc frequency. Thus, for a tuning condition

* Trademark for Pacific Semiconductors Inc. voltage-variable capacitor.

† Type V-20, capacitance at -4 volts, 20 μ f.

A simple circuit that will make an AM signal generator into a sweep gen, with a deviation that can be as great as 600 kc.

The unit worked exactly as specified by the author. Sweep patterns as observed on scope screen were sharp with rapidly rising front edges and rapidly falling rear edges.

BENCH

TESTED

Make a narrow-sweep generator for FM if alignment out of your own AM sig gen

where the tuning capacitor of the signal generator is at a minimum, the voltage-variable capacitance produces a relatively large frequency change, up to 600 kc. If the 10.7-mc point occurs at the low-frequency end of the band (tuning capacitor fully meshed), the voltage-variable capacitor produces a relatively small amount of frequency change, no more than 60 kc.

If you wish to use your signal generator without changing its calibration, the circuit of Fig. 1 can be switched in or out very simply. For recalibration of the 10.7-mc point, within the band, using the voltage-variable capacitor, a shorted turn was used to overcome the excess static capacitance of the circuit, even though the calibration trimmer was removed from the tuning band.

Many methods can be used to recalibrate the signal-generator band, and find a good 10.7-mc point. There are also various procedures for FM alignment. These will not be discussed here. The information is available in standard texts, and experienced service technicians, advanced experimenters and technicians will have no difficulty with these problems.

Another very good feature of using a voltage-variable capacitor is that a 60-cycle phase shifter, normally needed for the oscilloscope horizontal sweep, is not necessary. Since the circuit in the signal generator is electronic, with no mechanical device to produce phase lag, it was possible to use the 6.3-volt 60-cycle test voltage, right at the front of the oscilloscope, for the horizontal sweep required for viewing the band-pass response curve of the equipment under test. In this case, only a few degrees phase shift of the sweep pattern on the oscilloscope was noted.

Very good results were obtained without lengthy experimenting or "playing around." Approximately half the ac voltage provided well over 300-kc swing, with the 10.7-mc point at the top of the band. A 7.5-volt C-battery, with taps every 1.5 volts, is ideal for providing bias voltage for any required amount of frequency swing. This circuit will work equally well at 4.5 mc, TV sound channel, or even the broadcast band, where a relatively small (10-kc) frequency shift is needed. Other values of voltage-variable capacitors are available to provide practically any frequency sweep, provided the circuit Q is not brought down so low as to stop oscillation.

(The Varicap must be reverse-biased for correct operation. Forward bias may damage it, so check the manufacturer's instruction sheet carefully for the markings corresponding to the positive and negative ends. Also, the sum of the bias and peak signal voltages should not exceed the maximum operating voltage. Set the bias high enough so the signal cannot swing the diode into the conducting region.—Editor) END

- R1—150,000 ohms, 1/2 watt
- R2—100 ohms, potentiometer
- C1—.005 μ f, paper
- C2—.002 μ f, ceramic
- V-20—Varicap V-20
- S1—switch, spst, optional
- S2—switch, spst, toggle
- BATT—6-volt, tapped

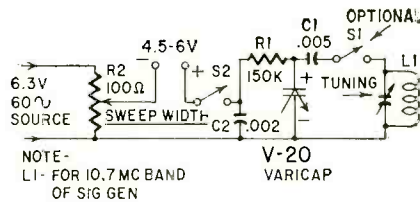

Fig. 1—Schematic of the circuit that modifies a signal generator.

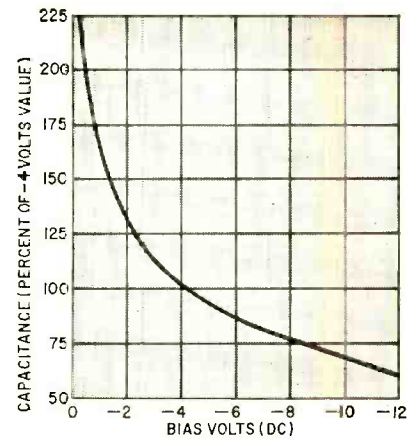
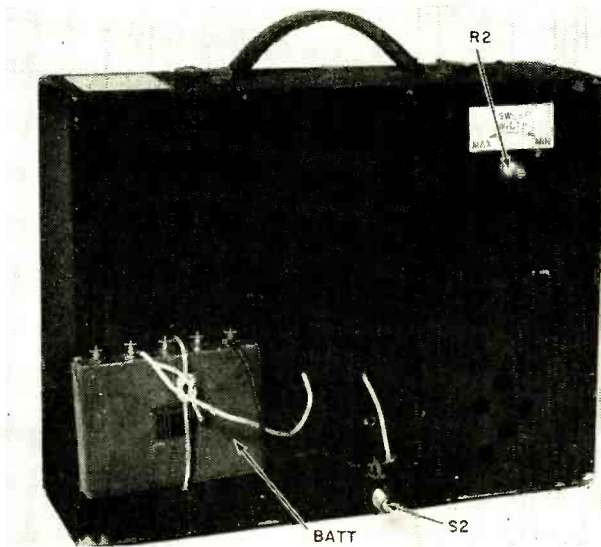
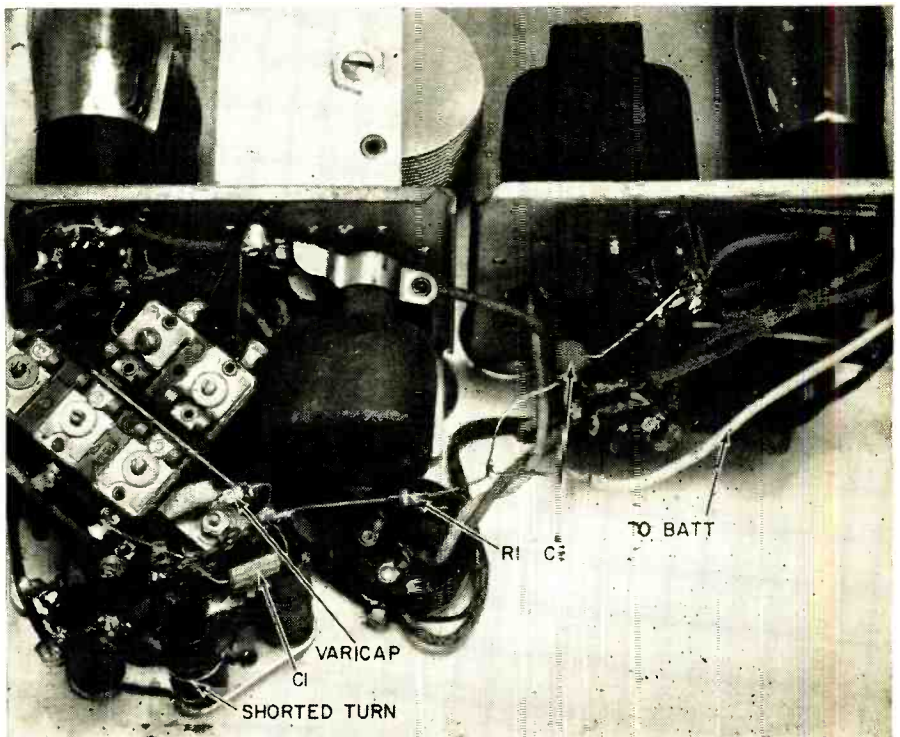

Fig. 2—How a Varicap's capacitance varies with voltage.



View of the sweep generator, showing added components.



Rear of generator (an old Philco).

servicing TV

DISTRIBUTION SYSTEMS

Part I—TV distribution systems are becoming more common in motels, hotels and apartment houses.

By JACK BEEVER *

TELEVISION distribution systems cannot be successfully serviced unless their workings are understood. The "why" and "how" are essential before difficulties can be intelligently treated. For this reason, it is best to examine first the general requirements of TV distribution systems.

In terms of the job to be done, we must feed a number of television receivers (from 5 to perhaps 2,000) with signals from a single receiving site or perhaps a single antenna. The signals at each set, to quote the usual specifications, must be "equal or superior to those found on a single set fed from a single antenna in the same location."

The systems are similar to PA systems, but are immensely different in detail and in design technique. This is because of the great difference in the frequencies handled. The highest audio frequencies in public-address work rarely exceed 15,000 cycles, but the TV distribution systems handle from 54 to 216 megacycles (216,000 kc). Fig. 1 is a block diagram of a basic system drawn with typical symbols used in the trade.

Components

The components are: an antenna (it may be a group of cut-to-channel Yagis); an amplifier; line splitters; tap-offs to connect television sets to the system; terminating resistors to terminate the lines in their characteristic impedance, and connecting cables. In any system worthy of the name, coaxial cable is used for interconnecting the various components. The cables are standardized to types having characteristic impedances of 75 ohms. The more commonly used types are RG-59/U and RG-11/U (or their polyfoam-dielectric equivalents).

First, we have an antenna delivering signals to an amplifier. The amplifier raises these signals to a higher level,

usually by a factor between 20 and 1,000 times depending on the ratio between the antenna signals and those required to drive the system properly. This calls for amplifiers of between 26- and 60-db gain.

From the amplifier on, we have a branched cable system to cover the various points where TV sets will be located. At these points, tapoffs are inserted into the line to allow the set to be connected to the line *without causing undue disturbance in the line or to other sets on the line*. The splitters are devices designed to divide the energy in the input cable between two (or more) output cables and to maintain the impedance match in all directions.

The ends of the lines are terminated in resistors of the same value as the characteristic impedance of the cable, 75 ohms. These are usually mounted in special fittings to provide the smallest possible reactive component.

Basically then, we have a system which consists of a signal source (the antenna, an amplifier or amplifiers) and a distribution system whose most important characteristic is the very

large losses "seen" in it. Unlike power or speaker wiring, we cannot ignore these losses. Indeed, the amplifier's major function is to overcome these losses. In the commonly used RG-59/U type coax, the losses at channel 13 will be around 6 db per 100 feet (see table); in other words, the voltage will be down to one half at the end of a 100-foot run. The next 100 feet will reduce it to one-fourth, the next to one-eighth and so on.

Decibels

System calculations are always carried out in terms of voltage (since the system impedance is fixed) and db for convenience.

The db is not as puzzling as it would first appear. It is an expression of *ratio* rather than a multiplying factor. In other words, an increase in *voltage* of six db means the voltage has doubled.

Now this boils down to the fact that when we say 6 db, we mean that we are talking about something which is twice as great as 0 db, since 0 db is 1 times and 6 db is two times. The question always comes, "What's 0 db?" The answer is 0 db is anything you choose to make it! In TV systems you can specify whatever you like as 0 db. It can be the antenna signal, or you can choose (as we at Jerrold do) 1,000 μ v read across an impedance of 75 ohms. The great advantage of using db is that you can add and subtract numbers in db when computing a system, and the numbers stay small. Otherwise you'd

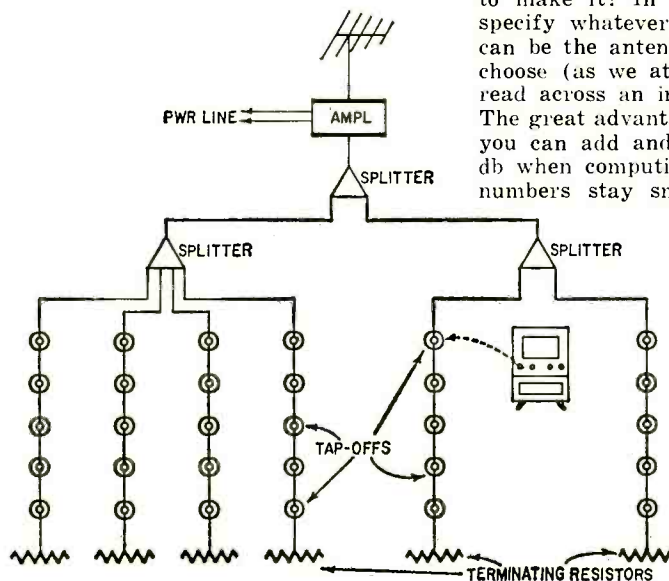

Fig. 1—Block diagram of a typical building system.

* Applications engineer, Jerrold Electronics Corp.

have to divide or multiply at each step, and your computations would involve large, complex numbers.

Here are some examples (in terms of voltage):

- 6 db = 2 ×
- 10 db = 3.14 ×
- 12 db = 4 ×
- 18 db = 8 ×
- 20 db = 10 ×
- 30 db = 31.4 ×
- 40 db = 100 ×
- 60 db = 1,000 ×

Let's take a more practical example. A particular antenna delivers a 1,000-microvolt signal on channel 7. The channel 4 signal is 6 db higher or 2,000 microvolts (approximately). The signal on channel 2 is 4,000 microvolts, 12 db higher than the channel 7 signal and 6 db higher than the channel 4 signal.

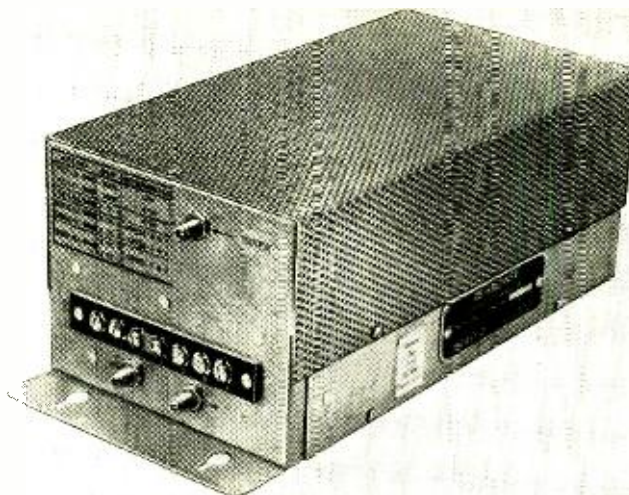

Broad-band preamplifier (Jerrold ABD-1).

System types

Distribution systems are generally either of two types requiring slightly

CABLE ATTENUATION DATA/CHANNEL*

CHANNEL CABLE	2	3	4	5	6	7	8	9	10	11	12	13
	CABLE ATTENUATION db/per 100' at pix carrier freq.											
RG-59 U	2.8	3.0	3.2	3.4	3.6	5.3	5.4	5.5	5.6	5.7	5.8	5.9
RG-6 U	2.1	2.2	2.3	2.4	2.6	4.0	4.05	4.10	4.15	4.20	4.25	4.3
RG-11 U	1.6	1.7	1.8	1.9	2.0	2.7	2.75	2.80	2.85	2.90	2.95	3.0
RG-35 U	0.52	0.55	0.58	0.62	0.65	1.10	1.15	1.20	1.25	1.30	1.35	1.4

*Maximum attenuation.

different service techniques—the broad-band and the strip-amplifier type. The broad-band uses a single amplifier which is capable of accepting and amplifying all (or any) TV channels. Such amplifiers are usually a dual amplifier with a common power supply on a single chassis. One amplifier handles the low-band channels (2 to 6) and the



Broad-band amplifier (Jerrold 2300).

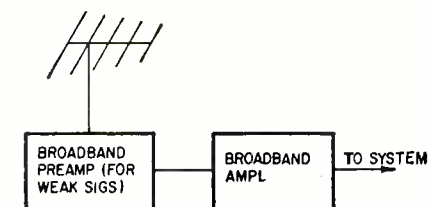

Fig. 2—Head end of broad-band system.

other the high-band channels (7-13). The strip-amplifier type uses a single narrow-band amplifier for each channel.

In general, strip type amplifiers are used to avoid the necessity of reamplifying the signals when high levels are required and broad-bands are used where output requirements are less severe.

Components

The most complex component of a system is the amplifier portion, usually referred to as the head end. A typical broad-band head end is block-diagrammed in Fig. 2.

A strip-amplifier head end is more complex, but provides higher output levels and greater ease of control. Fig. 3 is a block diagram of a four-channel

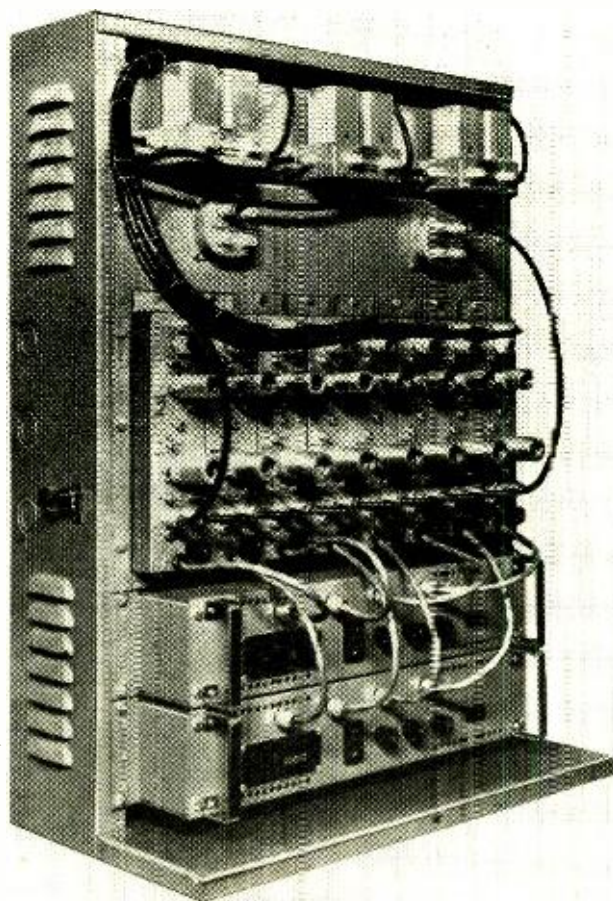

Strip type head end for 7 channels of TV and 1 FM.

Jerrold

head end of this type. Strip amplifiers are available with automatic gain control. Preamplifiers, especially designed for a low noise figure, are used in conjunction with such amplifiers where signal levels are too low to drive the strips to the rated output.

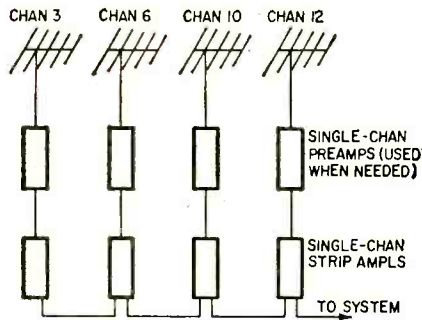
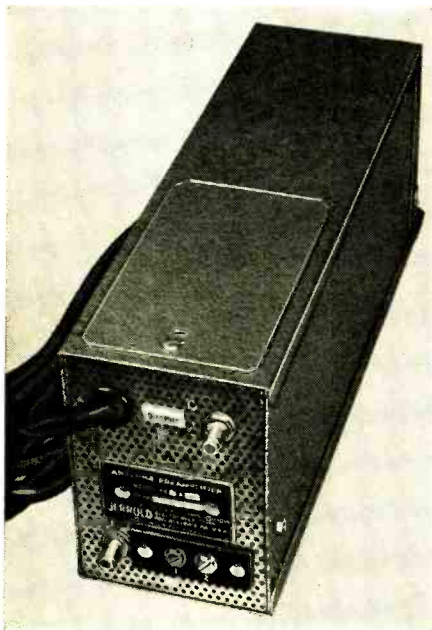

Fig. 3—Head end of strip type system.

Coaxial line splitters are made in two general types—reactive and resistive. Reactive splitters are transformerlike devices and have the lowest splitting losses—2-way splitters showing a little over 3-db loss per leg (not really loss, the input power is divided in two halves) and four-way reactive splitters show 6 to 7-db loss per leg. Special types having nonsymmetrical splits are made but they are not commonly used in building systems. Resistive splitters show higher losses: 6 db per leg for two-way splitters and 12 db per leg for four-way splitters, but they have the advantage of improving system impedance matching.

Tapoffs are used to extract a small amount of rf energy from the coax and feed it to a television receiver. They must therefore have a resistance or impedance in the tap line. The energy taken from the line must be kept small so that the tap (and the set connected to it) will not disturb the line impedance to an extent that will cause reflections and ghosts. Two types are in common use—the resistive (Fig. 4-b)



Single-channel preamplifier (Jerrold 406-A).

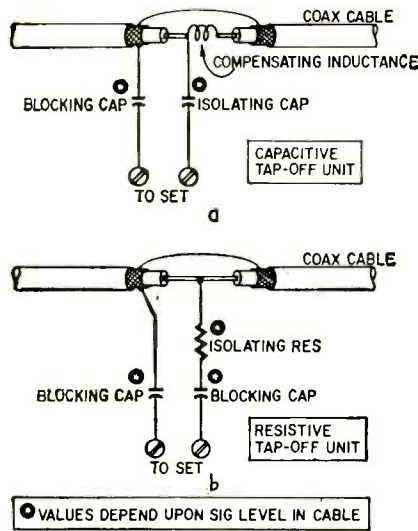
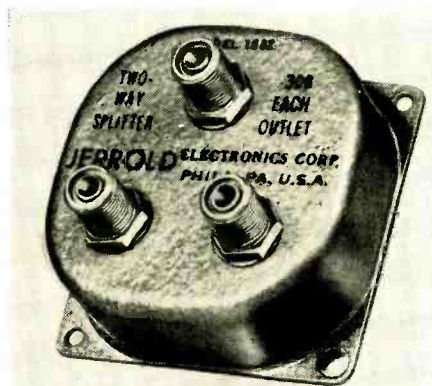

Fig. 4—Tapoffs, capacitive (a) and resistive (b).



Jerrold

Two-way coaxial line splitter.

and the capacitive tap (Fig. 4-a). These taps have two important characteristics: a loss from the line to the receiver, called isolation loss, and a loss in the line itself, called feedthrough or insertion loss. The general rule is that the less isolation loss in the tap, the more feedthrough loss.

The two types have different characteristics, resistive taps showing the same isolation loss at all frequencies, but causing more line disturbance than capacitive taps. Capacitive taps show greater isolation at the low channels (2 to 6) and less at the high channels (7 to 13). This tends to offset the loss characteristic of coaxial cables, less loss at the low channels and more loss at the high channels.

Terminating resistors will be found at the end of all coaxial lines. These are usually designed into the modified body of a coaxial-cable connector with the resistor mounted coaxially. It is difficult to connect a resistor to the end of a coaxial cable in such a manner that it will not show inductive or capacitive behavior at vhf, so this is no place to look for economies.

Part II of this series will discuss some of the symptoms (and their causes) that appear in a distribution system when something throws it out of kilter.

TO BE CONTINUED

MICROWAVE TRANSISTORS

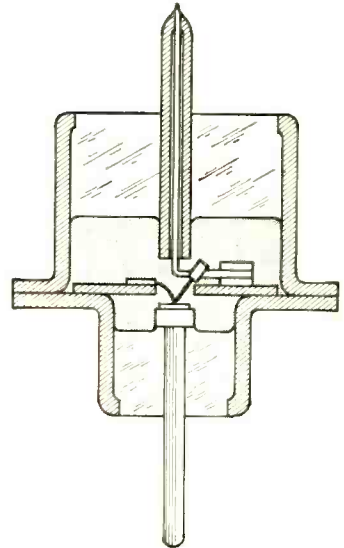

TWO ways to use transistors at microwave frequencies have been announced. One mode was discovered a few months ago by V. W. Vodicka of Lenkurt Electric Co., San Carlos, Calif. He found that a Philco 2N502 with a 700-mc maximum frequency operated up to 2,500 mc. Further tests showed that other available transistors that have heavily doped bases produce similar results.

The cause of the greater-than-expected frequency range is not completely understood, but Vodicka says it appears to have characteristics that combine tunneling and avalanche effects.

Under the right circuit conditions, transistor bandwidth is radically increased while noise is reduced greatly. Already noise figures approach those of parametric amplifiers.

Another approach toward microwave transistors is used at Bell Labs. They start off with a mesa transistor whose total active area is smaller than the cross section of a human hair. It is a p-n-p unit that has a diffused base and an alloyed emitter. It is designed for use as an oscillator at frequencies up to 3 kmc or as an amplifier up to 1 kmc. The mesa section is only 1.8 mils long and 1.5 mils wide. Three metal stripes, each 0.3 mil wide and 1.5 mils long, are evaporated onto the surface and alloyed into the three parts of the device. Gold wire, 0.2 mil in diameter, is used for the connections. The transistor's diffused base is only 1/50 mil thick.

The unit is built into a coaxial shell (see diagram) that prevents parasitic capacitance and inductance. The shell itself has an impedance equal to that of a 50-ohm line and is connected to the transistor's emitter.

END

WHAT'S NEW

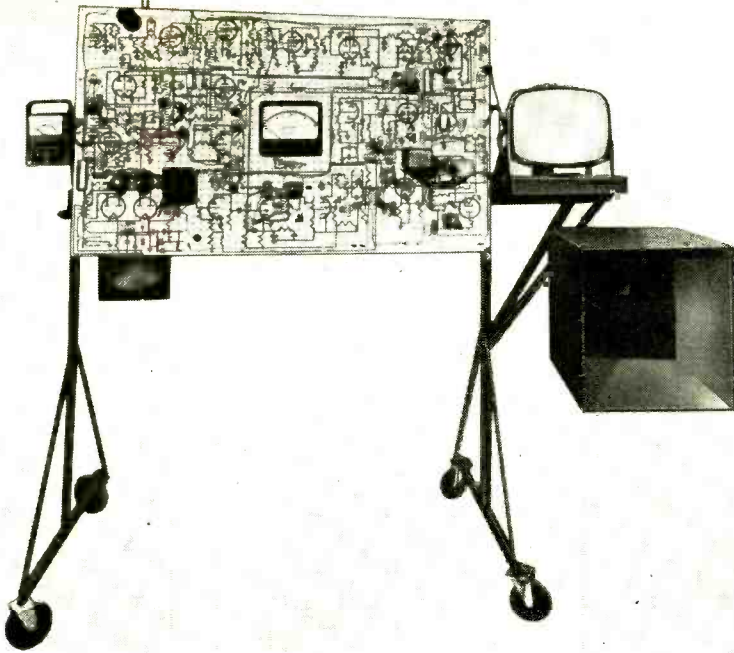

TV DEMONSTRATOR is designed to teach basic principles of electronics from fundamental electronic circuits through television. It consists of a 3 x 5-foot breadboard, 17-inch picture tube, speaker, and test instruments. The unit is assembled and studied circuit by circuit in the class. Completely assembled, it becomes an operating TV receiver superimposed on a large circuit diagram. The unit is made by Transvision.

PARAMETRIC TRANSISTOR has been developed for use in a Vodka circuit for ultrahigh and microwave frequencies. A Hughes transistor has been modified to favor this mode of operation. The transistor is a 3-terminal package in which input and output are easily separated. Also, the unit oscillates and delivers its own pump power. The pointer indicates the transistor mounted in a developmental circuit.

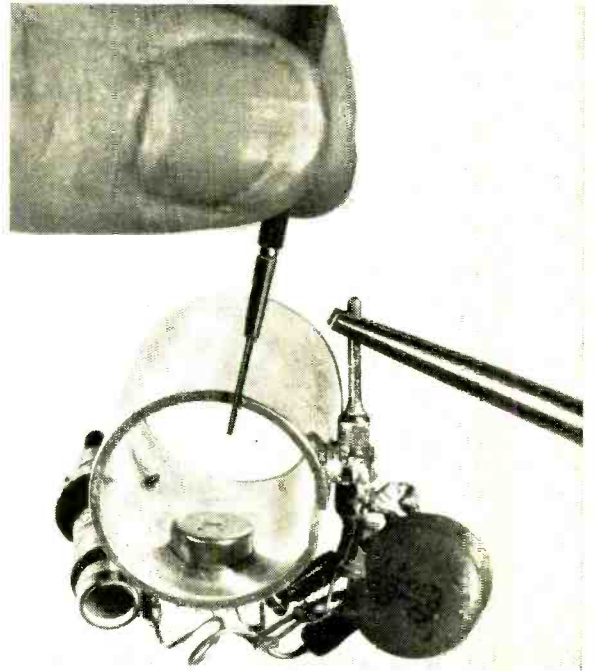

INDUCTORS FOR PRINTED CIRCUITS announced by Corning Electronic Components have wire leads for printed-circuit board mounting. The new units, 26 models, are claimed to have superior stability under physical shock, vibration and temperature changes.

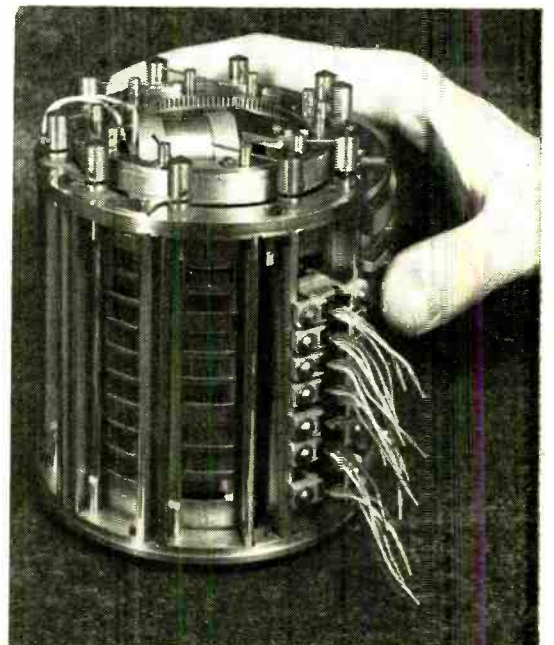
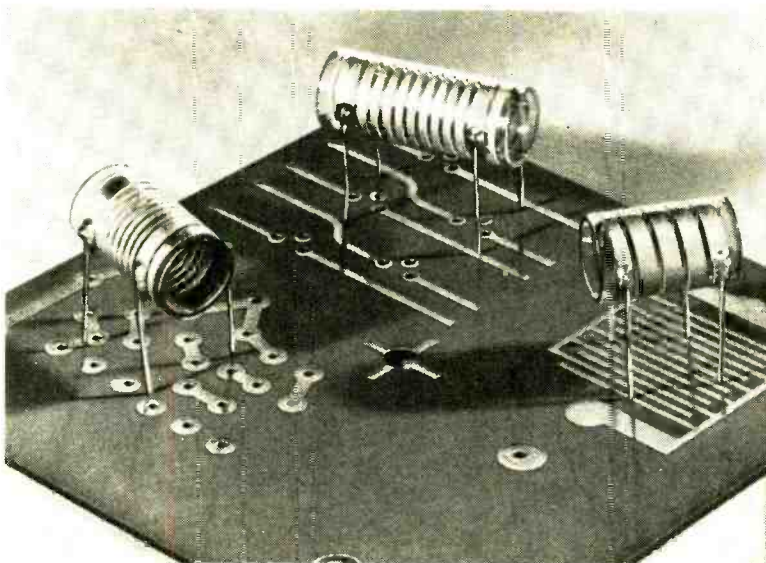

MINIATURE MEMORY DRUM weighs only 6 ounces yet can store 100,000 bits of information. Data are recorded on the magnetic surface of the stainless steel drum (not shown). Measuring 3 inches long and 3 inches in diameter, the IBM unit is designed for airborne computers.

TV Service CLINIC

conducted by
JACK DARR

THERE are many more uses for the oscilloscope than hunting distortion in complex waveforms, measuring peak-to-peak voltages, and the other "regular" jobs. When used right, it can be a very useful timesaver in locating the source of TV troubles.

For instance; no high voltage, screen dark, horizontal output tube *not* running red. Where's the trouble? Grab the scope and very carefully place the probe close to but *not touching* the horizontal output tube's plate. See any pulses? (Should look something like Fig. 1).

If they're *not* there, you can begin looking in the horizontal oscillator stage. There doesn't seem to be any drive at all and the output tube is probably so weak it won't draw enough current for the plate to overheat!

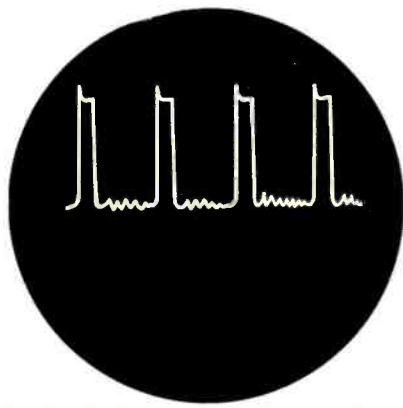

Fig. 1—Pulses are found near plate of horizontal output tube. Bring scope probe near but not touching plate.

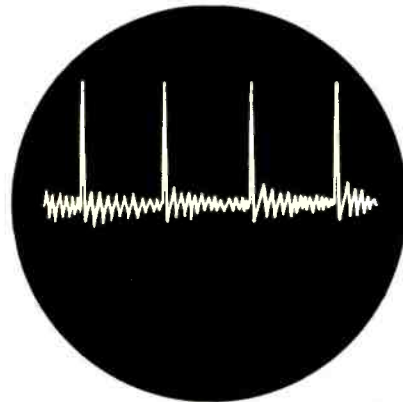

Fig. 2—Scope probe near high-voltage lead to CRT should produce pips somewhat like these.

If the pulses are there but pretty small (you'll have to experiment a little to get an idea of about how high they should be with the scope gain set at a certain place, etc.), the horizontal output tube's probably weak, again.

Waveforms at the horizontal-output tube plate, but only a very small pip when you hold the probe close to the high-voltage lead indicates a weak or defective high-voltage rectifier tube. Ought to get pretty good sized pips anywhere close to this lead (Fig. 2).

Damper trouble? Hold the scope probe close to the damper tube from the top of the chassis. If you've got high voltage on it, it ought to show up. You should have a pattern something like Fig. 3.

Be sure to keep the probe tip far enough away from exposed points like the 1B3 plate, the horizontal output tube plate and so on. If you'll practice with this a little, you'll find that you can tell pretty quickly just about what's wrong in or around the flyback circuits by just holding the probe close to them in the right places. It will give you an idea of what's going on and, most important, it'll tell you whether the horizontal oscillator is working or not.

Signal circuits can be checked the same way. Got a weak picture with no contrast? Might be a bad picture tube, age trouble, bad video amplifier tube, video if trouble or tuner trouble. Pull the socket slightly loose on the base of the picture tube and check at the grid (or cathode, whichever the signal is fed to). If you get a nice fat signal at this

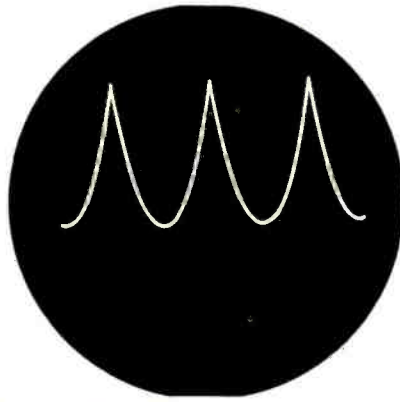

Fig. 3—Near the damper tube these pulses should be found.

point (at least 50 volts peak to peak), you can suspect the picture tube.

You can also go through the video amplifier circuits (with a bit more trouble), if you have one of those adapters that brings the tube elements out at the sides for testing. Check the signal at the video amplifier grid and plate to see if you've enough gain. Same thing with sync tubes: this is most useful on some of the vertical chassis sets which are a bit difficult to get out of the cabinet.

Incidentally, for all these jobs, use a calibrated low-capacitance probe of the type used for signal-tracing in video circuits. The probe must be matched to the scope's input impedance and compensated for best results. With the right probe, you can get nice sharp sync pulses (Fig. 4) and clean video. The wrong probe can throw you quite a curve, unless you know its limitations.

So, there you are. You can get some kind of indication in any ac-carrying circuit by just holding the probe close to it (higher-voltage circuits) or by direct contact (lower-voltage circuits).

Inadvisable conversion

I have an RCA KCS-82D TV chassis which I would like to convert to use the 110° 23CP4A picture tube. Would you kindly advise me as to what changes I would have to make to do this?—J. A., Sacramento, Calif.

I'm afraid that your KCS-82 chassis would require a rather extensive working over to use the 23CP4. Although this tube is listed as a nominal 110° type, the actual deflection angle is nearer to 114°, thus requiring a tremendous amount of sweep power.

You see, to alter the sweep circuits of a TV set, you must provide not only more deflection but the large amount of *extra power* needed in the deflection circuits. You have a 70° yoke and deflection system in your present set. If you changed the yoke to a 90°, for example, you would get a full 90° scan only if you increased the *power input* to the yoke. Changing only the yoke would result in scanning the tube only partly; you'd find about an inch or so not covered at top, bottom and sides. On a 70° to 90° conversion, this can sometimes be overcome by adjusting height and vertical linearity, width and

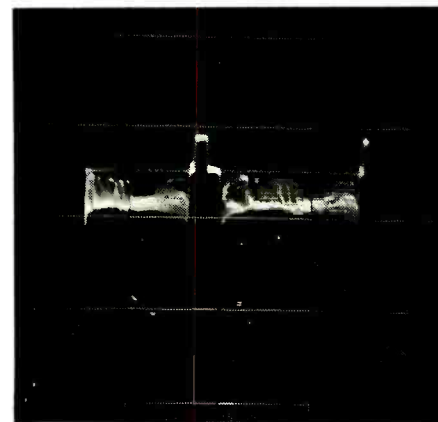

Fig. 4—Sharp sync pulses obtained by using a calibrated low-capacitance probe.

horizontal linearity, increasing horizontal drive and substituting "hotter" tube types—for example, a 6DQ6 for 6BQ6 replacing 5U4's with special silicon rectifiers. This would demand new filter capacitors, of course, as the increase in voltage might exceed the safe ratings of the originals.

You might check up on such tube types as the 24AEP4, which is a 90° tube with a much lower high-voltage requirement. There are several tubes in that group which could be used with the changes listed.

Out-of-tune traps

We have a Freed-Eisemann set with the traps out of tune. I cannot find any information on this particular model anywhere. The only diagram I can find has one less tube than this one. This is a model 1916 and has one more 6AU6 than the one in the diagram. Can you

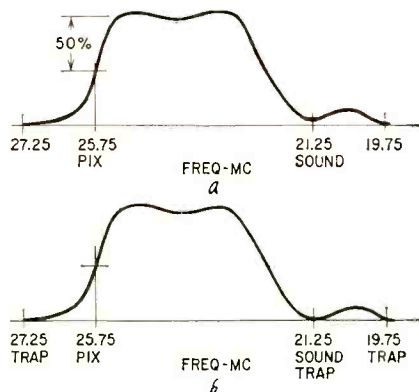

Fig. 5—Video if response curves; a—some sound signal getting through; b—sound trap adjusted for minimum sound signal.

give me this information?—W. H., Astoria, N. Y.

I'm sorry, but I couldn't find any service data on this exact model either. However, there are some generalizations on trap tuning that should help you.

In the first place, I'm going to assume that this is a split-sound circuit, from the age of the set. These sets often had more traps than the others: adjacent-channel picture, adjacent-channel sound and sound if are standard. However, these can be tuned up if you have sweep-alignment equipment.

Set up the equipment and TV set to display the video if response curve on the scope. I am assuming that the set uses a 21-mc if from its age. It might be a good idea to "strap" the traps *all* out at this time to avoid troubles due to their misalignment. Simply tack a short piece of wire across each one. This takes it out of the circuit. Set the picture and sound carriers as shown on the curve of Fig. 5-a.

With this done, find the first trap. This should be the sound trap and will probably be located in the tuner, in or near the converter output transformer. This is tuned for a *minimum* amplitude on the curve at the sound frequency (Fig. 5-b).

The next trap will be in the plate circuit of the first video if and will be the adjacent-channel sound; this is set

at 27.25 mc. Remember, all these traps are tuned for *minimum* response. You may have to crank up the signal generator gain to see the results, but always tune for the lowest possible amplitude at the trap frequency.

The next trap will be in the second video if plate and should be tuned to 19.75 mc. You may find cathode traps in this set; they were used in several models. If you have a fourth video if, look for a trap in its cathode circuit. This is tuned to the sound frequency, 21.25 mc.

You may find that the video if adjustments are on the chassis between the tubes. Be sure to check the circuit connections carefully. Your traps will always be "coupled" while the if coils themselves will always be in series with the plate circuits!

Here are the most likely alignment frequencies for the video if's: Converter (in tuner) 21.8 mc; first video if plate, 25.3 mc; second if plate, 22.3 mc; third if plate 25.2 mc, and fourth if plate, 22.4 mc.

As to the exact procedure: With the equipment set up to produce the video if curve, remove the short from one trap at a time and move the adjustment slug. See which section of the curve is most affected (by means of the markers.) For instance, if the left (picture) side of the curve is most affected, the trap is probably the 27.25-mc trap. If the right side of the curve is most affected, this trap is likely to be the 21.25 mc sound or adjacent-channel pix trap, and so on.

Build-it-yourself Yagi

I would like to obtain the plans for a 10- or 16-element Yagi antenna, with the shortest boom, to work on channel 4. If I want to operate it on another channel, would only the length of the elements need to be changed?—D. F., Kingston 11, Jamaica, B. W. I.

To be a true Yagi configuration, not

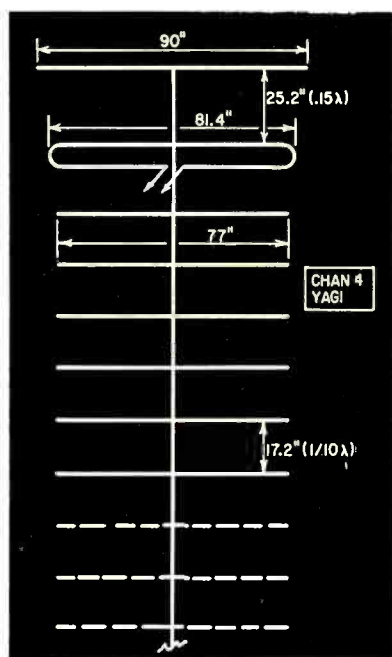

Fig. 6. Sketch of Yagi antenna with elements cut for Channel 4.

only the length of the elements but their spacing from each other determine the wavelength for which the antenna is built. For instance, the sketch (Fig. 6) shows a channel-4 Yagi with eight elements. The most popular spacing for this type seems to be that shown: 0.1-wavelength spacing for directors, and 0.15-wavelength for the reflector.

To make this antenna work on another channel, you should cut the elements for that channel and also change their spacing.

I do not believe you will gain anything by trying to use more than a total of eight elements: reflector, dipole and six directors. At this point in Yagi design, you have the maximum gain. Addition of more directors will serve to narrow the frontal lobe slightly, but will give you only an imperceptible amount of additional gain. Besides this, the antenna will get so long that it will be most unwieldy to handle!

Hum in Crosley

A Crosley 11-459MU has a severe hum. How can we get rid of it?—W. M., Westville, N. J.

This set has a full-wave rectifier and power transformer. If the hum is 120-cycle (two bars on screen) it's a weak or open filter capacitor in the power supply. If the hum is 60-cycle (one bar on screen), it's heater-cathode leakage in some tube in the signal channel.

Remote uncontrol

We had a Zenith 16C21Q, with Space Command automatic tuner playing on the bench the other day after repairs to the if strip. Suddenly, the set turned itself off. Later on, the tuner started running and the volume went up and down although the control box was not being used. We have checked the control unit in the set several times. Apparently not a thing is wrong with it of a nature which could cause this intermittent false triggering. Do you have any ideas as to the cause of this?—J. D. Q., Big Cedar, Okla.

I sure do! The same thing happened to me not too long ago! Evidently, there were other sets in operation on the same bench, and probably close to the microphone of the Space-Command receiver. If another TV set is operating close by and the horizontal oscillator is turned off frequency (not necessarily enough to cause the flyback to "sing" audibly) enough to generate a harmonic in the range of the Space-Command receiver, the control unit will "fire!" The operating signals of the control unit are in the supersonic range, around 30-40 kc. What is happening here is this: The horizontal oscillator of the other TV set is generating harmonics and causing the flyback or some other part to radiate an actual audio signal. Somewhere in this mess of frequencies, there is a harmonic that is exactly on frequency to operate the tuner or volume control. This is more apt to happen if the other horizontal oscillator is quite a way off frequency. You can even make
(Continued on page 70)

HEATHKIT®... for finer

PORTABLE 4-TRACK STEREO TAPE RECORDER KIT

What better gift than this? ... a compact portable tape recorder just waiting to record the caroling, frolicking family joys of the holiday season! You'll thrill to the natural stereophonic sound of this new unit that also serves as a hi-fi, power center for your tuner and record player. Tape deck and cabinet are preassembled.

Model AD-40... \$18.00 dn., \$16.00 mo. **\$179.95**

STEREO/MONO PORTABLE STEREO PHONO KIT

Thrill to your favorite Christmas recordings in life-like stereo! This GD-10 offers you complete stereo and mono operation *plus* portable convenience. Handsome aqua and white two-tone vinyl clad cabinet and four-speed automatic changer come preassembled—you build only the amplifier in just a few enjoyable hours. Changer has turnover diamond and sapphire stereo cartridge. Complete tone controls. Measures 15½" W x 18" D x 8¾" H. 28 lbs.

Model GD-10... \$7.00 dn., \$7.00 mo. **\$69.95**

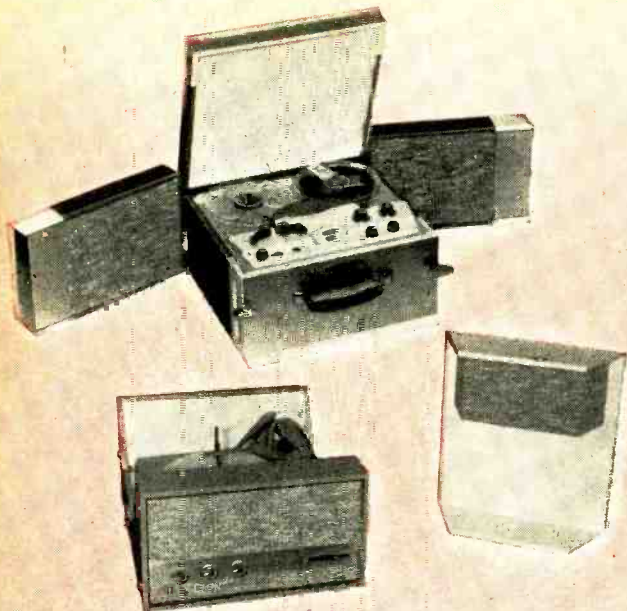

HIGH FIDELITY AM TUNER KIT

Here is the AM counterpart of the best selling Heathkit FM-4 tuner bringing you high fidelity AM reception plus many extras. Switch selection of broad or narrow band width, flywheel tuning, edge-lighted slide rule dial built-in antenna self-powered. Styled to match Heathkit FM-4.

Model AJ-20... **\$29.95**



AUTOMATIC RECORD CHANGER KIT

Anti-dust mechanism... quick-change cartridge holder... "moting" switch... and "size selector" for interpreting 10" and 12" records of the same speed. Holds up to 10 records for hours of delightful stereo or mono listening enjoyment.

Model AD-50... **\$49.95 to \$54.95** depending on cartridge.

Other models from **\$22.95**. Send for **FREE** Heathkit catalog today!

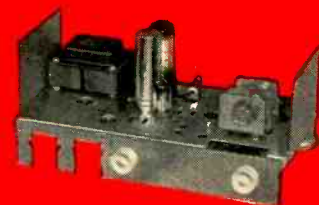

EDUCATIONAL KIT

Perfect gift of all ages... a basic course in radio that teaches radio theory in a way you can understand. Actual experiments are performed with radio parts supplied leading in successive steps from the construction of a simple crystal radio to a genuine regenerative radio receiver. Designed as a continuation of the popular EK-1 Educational Kit—but equally valuable as a starting point in radio electronics.

Model EK-24... 3 lbs. **\$19.95**



HAND-HELD CITIZENS BAND TRANSCEIVER

The perfect HEATHGIFT for everyone on your shopping list! No license required... anyone can use this 2-way radio! Operates up to a mile between units... more with regular Citizens Band stations. It's ideal for hunting, fishing, boating... most anywhere you need 2-way communications. Features 4-transistor circuit: fixed-tuned, super-regenerative receiver and crystal-controlled transmitter. 3 lbs.

Model GW-30 (kit) ... **\$32.95** (64.95 a pair)
Model GWW-30 (wired) ... **\$50.95** (99.95 a pair)

DELUXE 2-WAY CITIZENS BAND TRANSCEIVER

This Christmas, give the best that money can buy in a Citizens Band Transceiver. The efficient superheterodyne receiver has an automatic "noise limiter" and adjustable "squelch" control, single channel "crystal" or continuous tuning. The transmitter has press-to-talk microphone and can be switched to any of the three crystal-controlled channels. Choose the "under-dash" DC mobile model or "fixed" station AC unit. 11 lbs.

Model GW-10 (kit) ... \$6.30 dn., \$6.00 mo. **\$62.95**
Model GWW-10 (wired) ... \$10.00 dn., \$9.00 mo. **\$99.95**

(specify 117 v AC or 6 or 12 v DC model)

gifts of lasting value!

"SPACE-SAVER" 3" DC OSCILLOSCOPE KIT

Almost, but not quite tiny enough for a Christmas stocking, this compact scope saves valuable work-bench space while providing versatile features to fill a multitude of applications in medical, industrial and general service fields. Ideal as a "read-out" for computers; for wave-form observations; and for voltage, frequency and phase shift measurements. Identical vertical and horizontal DC coupled amplifier, transformer operated power supply—and many more outstanding features.

Model IO-10... 14 lbs.... \$8.00 dn., \$8.00 mo. **\$79.95**

LABORATORY 5" OSCILLOSCOPE KIT

A real time-saver in audio and TV service work, where the same sweep frequencies are used over and over; the IO-30 offers two extra, switch-selected, pre-set sweep frequencies. Kit is supplied with capacitors appropriate for TV service giving preset frequencies of 30 cycles and 7875 cycles; by changing capacitor values, any two desired preset frequencies within the sweep frequency range can be made available.

Model IO-30... 22 lbs.... \$7.70 dn., \$7.00 mo. **\$76.95**

2 new scopes...

just in time for Christmas!



Model IO-10

Model IO-30



PHONE AND CW TRANSMITTER KIT

Brand-new in every respect, the DX-60 combines smart styling, top-flight performance and low Heathkit cost to offer the "Amateur rig" value of the season. Ideal for General class Amateurs, the Transmitter may also be run at reduced power for novice operation. Covers 80 through 10 meters. Power input: 90 watts peak, carrier controlled phone or CW.

Model DX-60... 55.30 dn. **\$82.95**



2, 6 & 10 METER TRANSCEIVER KITS

Make a hit with the "Hams" on your gift list by giving one of these outstanding transceivers. All are identically styled to the popular Heathkit CB-1 Citizens Band Transceiver; feature variable-tuned superregenerative receivers, 5-watt input crystal-controlled transmitters. All are supplied with mike, power cables and AC power supply.

Model HW-30... (2 meter) **\$49.95**

Model HW-29... (6 meter) or

HW-19 (40 meter) **\$39.95 ea.**



DELUXE VACUUM TUBE VOLTMETER KIT

Hobbyist and professional alike will prize this useful gift. This brand-new Heathkit features big, easy-to-read 9" meter with multi-color scales; high-visibility switches; greater accuracy; longer meter scales; special low voltage AC scales; broader frequency response; thumb-wheel controls and easy-access adjustments.

Model IM-10... 7 lbs. **\$32.95**



SEND FOR
YOUR FREE
HEATHKIT®
CATALOG

You'll find the perfect gift for family or friends among the over 200 Heathkit items for hi-fi fans, amateur radio operators, students, technicians, marine enthusiasts, sports car owners and hobbyists. And many Heathkit products are now available in both wired and kit form!



ORDER DIRECT BY MAIL OR SEE YOUR HEATHKIT DEALER



ORDERING INSTRUCTIONS

Fill out the order blank below. Include charges for parcel post according to weights shown. Express orders shipped delivery charges collect. All prices F.O.B. Benton Harbor, Mich. A 20% deposit is required on all C.O.D. orders. Prices subject to change without notice.

HEATH COMPANY,
Benton Harbor 20, Michigan

Please send the following HEATHKITS:

ITEM	MODEL NO.	PRICE

Ship via () Parcel Post () Express () COD () Best Way

() SEND MY FREE COPY OF YOUR COMPLETE CATALOG

Name _____

Address _____

City _____ Zone _____ State _____

Dealer and export prices slightly higher.

ATR PRODUCTS FOR MODERN LIVING



ATR PLUG-IN TYPE PORTABLE INVERTERS*

A.C. HOUSEHOLD ELECTRICITY Anywhere... in your own car!

- Operates Standard A.C.
 - Record Players
 - Dictating Machines
 - Small Radios
 - Electric Shavers
 - Heating Pads, etc.
- In your own car or boat!

MODELS
 6-RMF (6 volts) 60 to 80 watts. Shipping weight 12 lbs. DEALER NET PRICE \$33.00
 12T-RME (12 volts) 90 to 125 watts. Shipping weight 12 lbs. DEALER NET PRICE \$33.00
 *Additional Models Available

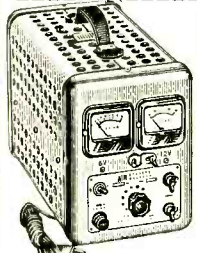

ATR "A" BATTERY ELIMINATOR

For Demonstrating and Testing Auto Radios—TRANSISTOR or VIBRATOR OPERATED!

Designed for testing D.C. Electrical Apparatus on Regular A.C. Lines—Equipped with Full-Wave Dry Disc-Type Rectifier, assuring noiseless, interference-free operation and extreme long life and reliability.

MAY ALSO BE USED AS A BATTERY CHARGER
MODEL 610C-ELIF... 6 volts at 10 amps. or 12 volts at 6 amps. Shipping weight 22 lbs. DEALER NET PRICE \$49.95
MODEL 620C-ELIT... 6 volts at 20 amps. or 12 volts at 10 amps. Shipping weight 33 lbs. DEALER NET PRICE \$66.95

ATR AUTO-RADIO VIBRATORS

By every test ATR Auto-Radio Vibrators are best!... and feature Ceramic Stack Spacers, Instant Starting, Large Oversized Tungsten Contacts, Perforated Reed, plus Highest Precision Construction and Workmanship and Quiet Operation!

There is an ATR VIBRATOR for every make of car!

Ask your distributor for ATR's Low Priced type 1400, 6 volt 4-prong Vibrator; and 1843, 12 volt 3-prong; or 1840, 12 volt 4-prong Vibrator. THE WORLD'S FINEST!

There is a trim plate kit for YOUR CAR!

ATR CUSTOMIZED KARADIO

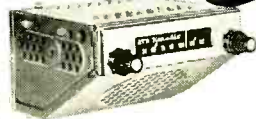

Vibrator-Operated with Tone Control

ATR KARADIO... is ideal for small import cars or compact American cars! Unit is completely self-contained—extremely compact! Powerful 8-tube performance provides remarkable freedom from engine, static and road noises. The ATR Customized Karadio comes complete with speaker and ready to install. Can be mounted in-dash or under-dash—wherever space permits! No polarity problem. Neutral Gray-Tan, baked enamel finish. Overall size, 7" deep, 4" high, and 6 1/2" wide. Shipping weight, radio set, 7 lbs. Model K-1279—12 for 12V Dealer Net Price \$33.57 Model K-1279—6 for 6V Dealer Net Price \$33.57

Airplane Style Overhead Mounting under Cab Roof

NO PRINTED CIRCUITRY

ATR TRUCK KARADIO

Excellent Tone, Volume, and Sensitivity!

Compact, yet powerful. Fits all trucks, station wagons, most cars and boats. Just drill a 3/8 inch hole in roof and suspend the one-piece unit (aerial, chassis and speaker) in minutes. Watertight mounting assembly holds antenna upright. Yoke-type bracket lets you tilt radio to any angle.

Extra-sensitive radio has 6 tubes (2 double-purpose), over-size Alnico 5 PM speaker for full, rich tone. Big, easy-to-read illuminated dial. Fingertip tuning control. Volume and tone controls. 33-in. stainless steel antenna. Neutral gray-tan enameled metal cabinet, 7 x 6 1/2 x 4 in. high over-all. Shipping weight 10 1/2 lbs. Model TR-1279—12A for 12V Dealer Net Price \$41.96 Model TR-1279—6A for 6V Dealer Net Price \$41.96

SEE YOUR ELECTRONIC PARTS DISTRIBUTOR WRITE FACTORY FOR FREE LITERATURE...

ATR AMERICAN TELEVISION & RADIO CO.
 Quality Products Since 1931
 SAINT PAUL 1, MINNESOTA—U.S.A.

(Continued from page 65)

the controller do this by turning the Zenith's own horizontal oscillator quite a way off the correct operating frequency. Under normal circumstances, in the home, it never happens. We checked for this!

Pulling

A Raytheon model C-2111A, has me puzzled. When the contrast is fully advanced, the top of only the picture pulls to the left, not the raster.

A scope on the plate of the 6AH6 shows (at low contrast levels) that the sync pulses are there. As the contrast control is advanced, a straight horizontal line comes up and "chokes" out the pulses. There is also a loud hum in the sound.—E. J. S., St. Louis, Mo.

Your observation is correct: the horizontal line you saw in the scope pattern is the basic cause of the trouble. This could be the sync tips and you are obviously getting a severe overload somewhere in the video circuits.

Carefully check all components in the video plate circuit, with special attention to the series-peaking and shunt-peaking coils (Fig. 7). This type of choke, with a resistor in parallel, can

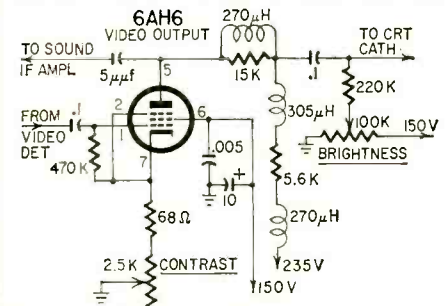

Fig. 7—Video amplifier of Raytheon C-2111A.

cause trouble if it opens, leaving the resistor to provide the plate loading.

If everything checks out (including the 6AH6), go back to the 6BE6 sync-clipper stage and check the operating voltages very carefully. Your pulling is obviously sync trouble as it doesn't affect the raster. It could be caused by an unbalance somewhere in the sync clipper or its circuitry. Check the setting on the age switch (marked AREA SELECTOR). If you're in a strong-signal location and it's set for fringe operation, you'll get normal overloading from excessive age.

Drifting sync

What can be wrong with a Trav-Ler portable, chassis 729-17A that goes for a few minutes perfectly and then falls out of sync. If it is turned off and allowed to "rest" for a few minutes, it goes OK, then falls out again. Tubes have been changed with no results. Using the horizontal hold to straighten the picture is no use because turning it left or right won't correct defect.—A. D. C., West Orange, N. J.

This trouble seems to be in the horizontal phase-comparer diodes from the description. Shunt horizontal oscillator input grid to ground, then run a complete realignment on the horizontal

oscillator transformer. If you can get a floating picture (floating from side to side, but obviously a complete picture horizontally), then the trouble must lie in the phase-comparer circuit.

Replace these with a Federal K-1616. This is the unit with both diodes "looking the same way." Be sure to install it so that the polarity is the same as in the original. It would also be wise to make resistance checks of all resistors in the phase-comparer output circuit and a scope check for the presence of the comparison pulse from the flyback (also of a horizontal sync pulse).

"Ringing?"

A Sylvania I-523 TV chassis in the shop has bright vertical lines (ringing). I've checked the components in the yoke and horizontal circuit, changed the yoke, changed component values, replaced the 6CD6 with a 6DN6 and ion trap, installed a grid-drive variable capacitor and tried several other substitutions to no avail. All voltages are normal: yoke and flyback are the original.—W. N. S., Sarnia, Ontario.

From the lack of response to your cures for yoke ringing, I think your trouble lies elsewhere. You know, sometimes a negative result to a test is as valuable as a positive one! There are some other possibilities such as a distorted waveform being fed to the grid of the horizontal output tube, although judging by the thoroughness of your testing, it is very likely you have already covered that possibility. Any tiny traces of ringing here would, of course, be amplified by the output stage.

The most likely cause, it seems to me, would be video pickup of radiated energy from the horizontal circuits. Check the appearance of the raster without signal. If the scanning lines curve where the lines are showing up, then it is yoke ringing (Fig. 8). If they are straight but vary in intensity, then the trouble is due to horizontal pickup in rf, video if, detector, etc. stages. This is usually due to radiation from the yoke connecting leads. Wrap them in metal foil and ground both ends of the foil by wrapping a bare wire around the foil and grounding it under a nearby screw. Dress the lead-in cable, from antenna terminals to tuner, along the side of the chassis or as far away from the yoke leads as possible. END

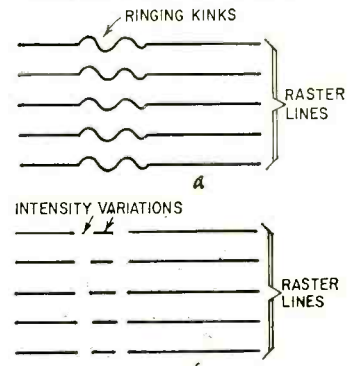

Fig. 8—(a) In true yoke ringing, raster lines bend. (b) When video stage picks up horizontal radiation, they vary in intensity.



improving PA systems

University Loudspeakers, Inc.

Outdoor PA speaker. Different power drivers are available as well as different-size horns.

A simple series capacitor can improve the intelligibility of a PA system

By LEO G. SANDS

A PUBLIC-ADDRESS system can be made to sound better by simply connecting a capacitor in series with each loudspeaker (or the speaker feed line). Power requirements are cut and power-handling capacity can be doubled.

In voice reinforcement systems, there is no need for overheating speaker voice coils with unheard audio power. For maximum speech intelligibility, low-frequency response can be cut off anywhere between 200 and 600 cycles.

Horn type speakers which cut off at, say, 300 cycles will continue to consume power at frequencies below 300 cycles but for no good purpose. In fact, most of the available amplifier power is wasted on unwanted (and unheard) low-frequency signals.

By connecting an 8- μ f capacitor in series with the voice coil of a 16-ohm speaker, the power-handling capacity of the speaker is doubled. Low-frequency response is cut off at approximately 400 cycles. Since an 8- μ f paper or oil-filled capacitor is expensive, the two sections of a dual 16- μ f electrolytic capacitor (or two independent 16- μ f electrolytic capacitors) can be connected in series opposing as shown in Fig. 1-a.

At 400 cycles, current flow through the voice coil is cut 4 to 1 (12 db); at 1,250 cycles, voice-coil current is halved (6 db); at 3,000 cycles, the attenuation is barely noticeable to the ear (3 db) and at 5,000 cycles, attenuation is only 2 db. At 10,000 cycles, the loss imposed by the capacitor is less than 1 db.

For an 8-ohm speaker, a 16- μ f capacitor is used (two 32- μ f electrolytics in series) and when a 500-ohm speaker

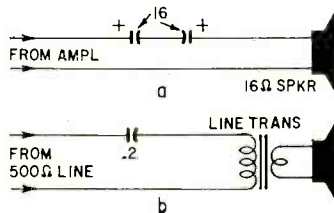

Fig. 1-a—An 8- μ f (two 16- μ f electrolytics in series) capacitor in series with a loudspeaker keeps unwanted low frequencies out of voice coil; b—a capacitor may be used in similar fashion in a speaker feed line.

IMP. (Ω)	LINE	MULTIPLY BY
4	B	100
8	G	100
16	H	100
32	K	10
45	J	10
100	C	10
125	F	10
165	H	10
250	E	—
500	D	—
1000	C	—
2000	A	—
5000	D	—

feed line is used, a 0.2- μ f paper capacitor may be connected in series with the line (Fig. 1-b).

Fig. 2 shows capacitor values for various low-frequency cutoff points for different impedances. Find the correct level line by referring to the first and second columns of the table. Next, select a horn cutoff frequency from the scale at the left of the chart and find where it intersects with the level line. From this point, go downwards to the bottom scale. This will give you the capacitor value (in μ f) when multiplied by the proper factor which is found in the third column of the table.

Loudspeakers

The speaker is the most critical part of a PA system. For indoor use, cone type speakers are often used because there is no need for a weatherproof speaker. However, most cone speakers are extremely inefficient (1% to 5%)

(Continued on page 74)

Fig. 2—Chart gives series-capacitor values for different impedances and frequencies.

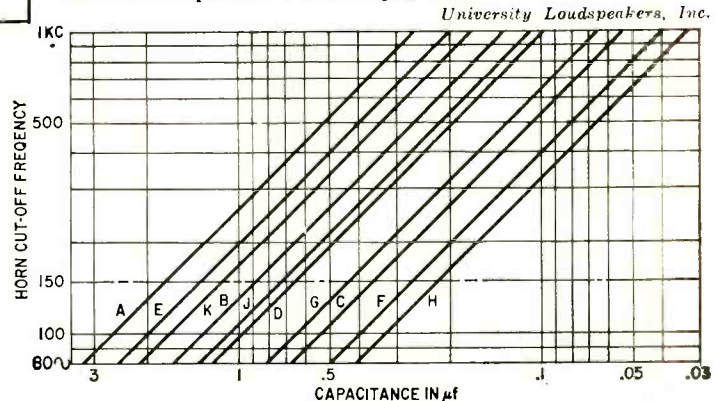

SENCORE

Most Popular Time Savers for Servicemen, Technicians, Engineers, Maintenance Men, Hobbyists!



"MIGHTY MITE" TUBE CHECKER

Smaller than a portable typewriter . . . yet will outperform testers costing hundreds of dollars.



\$5950

A new dynamic approach to tube testing. Check over 1,300 tubes for cathode emission, grid emission, leakage, shorts and gas. A "mite" to carry but a whale of a performer that outperforms testers costing much more. New unique "stethoscope" approach tests for grid emission and leakage as high as 100 megohms yet checks cathode current at operating levels. Special short test checks for shorts between all elements. The Mighty Mite will test every radio and TV tube that you encounter (over 1,300!) plus picture tubes. Set up controls as easy as "ABC" from easy to follow tube chart. New features: • Meter glows in dark for easy reading behind TV set. • Stainless steel mirror in cover for TV adjustments. • Rugged, all steel carrying case and easy grip handle. • Smallest complete tester made. Measures only 9" x 8" x 2 1/2" and weighs just seven pounds.

It's a real money-maker

LC3 LEAKAGE CHECKER

Provides grid emission and leakage checks with the same sensitivity as the famous Mighty Mite but checks critical tubes only; 172 types

\$2895

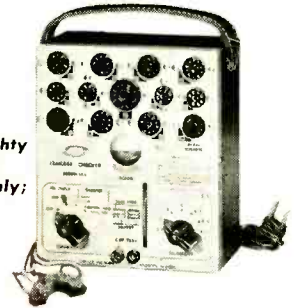

Ask any serviceman who owns one . . . or try one for just one day of servicing. You'll see for yourself how much time the LC3 can save you. Checks for leakage between all elements, whether caused by gas, grid emission or foreign particles. Also checks leakage on all capacitors with voltage applied — including electrolytics. Provides instant filament checks in "Fil-Check" position—no need for a second filament checker. One spare pre-heating socket and new roll chart prevent obsolescence. New charts provided free. For 110-120 volts, 60 cycle AC.

SENCORE SS105 SWEEP CIRCUIT TROUBLE SHOOTER

The Missing Link in TV Service . . .

IT'S A . . . UNIVERSAL HORIZONTAL OSCILLATOR. For direct substitution. No wires to disconnect in most cases. Traces trouble right down to the defective component. Variable output from 0-200 volts, peak-to-peak. Oscillator will sync to TV sync signal giving check on sync circuits.

HORIZONTAL OUTPUT CATHODE CURRENT CHECKER. A proven method that quickly checks the condition of the horizontal output tube and associated components. Adaptor socket prevents breaking wires. Easily replaceable Roll Chart gives all necessary pin, current and voltage data. New Roll Charts are Free.

UNIVERSAL DEFLECTION YOKE. A new, simple way to determine yoke failure accurately—without removing yoke from picture tube. Merely disconnect one yoke lead and substitute. If high voltage (also bright vertical line) is restored, TV yoke is defective.

DYNAMIC FLYBACK TRANSFORMER CHECKER. Merely flip switch to "Flyback Check" and meter will indicate condition of flyback transformer, in degrees of horizontal deflection. Extremely sensitive and accurate; even shows up one shorted turn on flyback.

VOLTMETER. For testing bootstrap, screen and other voltages. Direct-reading voltmeter, 0-1000 volts.



\$4295



HORIZ. OSC.	VERT. OSC.
HORIZ. O.P. STAGE	VERT. C.P. STAGE
HORIZ. FLYBACK XFORMER	VERT. O.P. XFORMER
HORIZ. DEFLEC. YOKE	VERT. DEFLEC. YOKE

UNIVERSAL VERTICAL OSCILLATOR. Checks oscillator, output transformer and yoke. Merely touch lead to component and check picture on screen. **SS105 is completely self-contained, nothing else is needed.** New, improved Circuit.

FC4 FILAMENT CHECKER

The ideal tool for servicing string filaments.

\$275

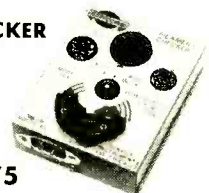

Purposely works off your cheater cord to give you a positive check on line voltage. Prevents checking all tubes to find that your trouble was no line voltage. Only checker that checks all tubes automatically and has no batteries to replace. Cost half that of battery operated testers. Patented.

FC4 with test leads for checking continuity or AC or DC Voltage . . . \$295

VB2 "VIBRA-DAPTOR"

Checks 3 and 4 prong Vibrators Faster and Easier . . .

Plugs into any tube checker; ideal for use with LC3 or the Mighty Mite. To check 6v. vibrators, set for 6AX4 or 6SN7; for 12 v. vibrators, set for 12AX4 or 12SN7. Two No. 51 lamps indicate whether vibrator needs replacing. Instructions on front panel. Steel case.

\$275



"FUSE-SAFE" CIRCUIT TESTER FS3

Instantly tells you whether or not it is safe to replace fuse resistors, fuses, or circuit breakers. Separate red and green scale for each commercially available fuse resistor used in radio and TV. Eliminates guesswork, wasted time. Also handy for wattage checks up to 1100 watts at 115v.

\$895



Time Savers for America's

ALL PARTS



Radio, TV and Electronic Mini-Men

MADE IN AMERICA

See your Parts Distributor Now or Mail Coupon on Opposite Page

SENCORE

You can own all these popular Time Savers for less than some Mutual Conductance Tube Testers!



For TRANSISTOR RADIO SERVICING

Everything you need for less than \$50.00

SENCORE TRC4
TRANSISTOR-RECTIFIER CHECKER

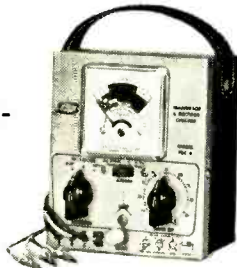

\$1995

Now lists Japanese equivalents

Checks Transistors, Diodes, Rectifiers . . .
A transistor tester that is used by over 50,000 servicemen, engineers and experimenters from Coast to Coast. Recommended by TV and Radio manufacturers; used by such leading companies as Sears Roebuck, Bell Telephone and Commonwealth Edison. Tests indicate that the TRC4 will outperform testers costing many times more. The TRC4 tests all transistors for gain, leakage, and open or shorts. Simple to operate without set-up chart for service work and with set-up chart for more accurate checks. With batteries.

SENCORE PS103
BATTERY ELIMINATOR & TROUBLE SHOOTER

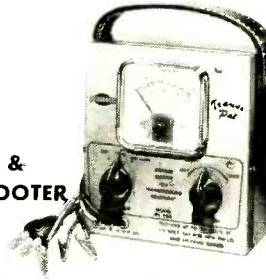

\$1995

Replaces Batteries During Repair . . .
Replaces batteries during repair time of transistor radios and helps trouble shoot, too. For transistor radio servicing, experimenting and to charge nickel cadmium batteries. Dial output voltage from 0 to 24 volts DC and read on meter. Low ripple insures no hum or feedback problem. Meter reads from 0 to 100 MA. Shorted stage will cause current to read high as indicated on PF schematics; open stage will cause current to read low. To align transistor radio, tune in station signal and adjust IF slugs for maximum current. The PS103 is the only supply that will operate radios with tapped battery supplies: such as Philco, Sylvania, Motorola, etc.

SENCORE HG104



HARMONIC GENERATOR

\$995

Finds Defective Stage in a Minute . . .
Believe it or not. Just touch the output leads of the HG104 to inputs and outputs of transistors and a clear 1000 cycle note from speakers will tell you whether or not the stage is defective. Here is an unexcelled time saver, not a "pencil" gimmick. It actually works every time from speaker to antenna. Two leads and calibrated output (not found on pencils) are a must for speaker connection, grounding to prevent RF spray and front end checks. Also saves time when servicing Hi-Fi, TV and radios. With life-time batteries.

Get all 3

COMPLETE TRANSISTOR RADIO SERVICE LAB
All 3 Time Savers shown above in handsome display carton carrying case

MODEL TL107
\$4985



For SUBSTITUTION SERVICING

Goodbye to messy parts . . . the mess of soldering and unsoldering in testing.

SENCORE H36

"HANDY 36"

\$1275



Substitute for Capacitors, Resistors . . .
Provides the 36 most often needed resistors and capacitors for experimenting, substituting or testing. Eliminates searching for replacement components, unnecessary soldering and unsoldering and the mess it creates. Says goodbye to crumpled parts. Flick of a switch instantly selects any of: 24 Resistors from 10 ohms to 5.6 meg-ohms, 10 Capacitors from 100 mfd to .5 mfd, 2 Electrolytics, 10 mfd and 40 mfd at 450 Volts. All components are standard American brand.

SENCORE ES102

ELECTRO-SUB

\$1595

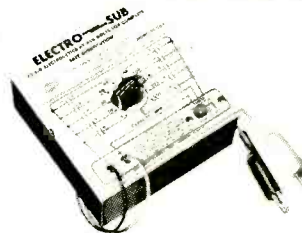

Substitute for Electrolytic Capacitors . . .
Complete, safe substitution . . . from the smallest electrolytics used in transistor radios to the largest used in costly Hi-Fi amplifiers. Contains 10 electrolytics from 4 to 350 mfd. Select correct value with the flick of a switch. Features automatic discharge, surge protector circuit. Prevents accidental "healing" of capacitor being bridged. Completely safe—no arc or spark when connecting or disconnecting. Usable from 2 to 450 volts, DC.

SENCORE RS106

RECTIFIER TROUBLE-SHOOTER

\$1275



Locate faulty Rectifiers, Diodes . . .
This unique substitution unit simplifies trouble shooting rectifiers and diodes, gives you a positive check every time. Substitute for suspected rectifier or diode, watch picture or listen to sound and you'll know in seconds whether or not the rectifier or diode should be replaced. No guess work, soldering mess or time lost. The RS106 costs less than having loose rectifiers and diodes in the shop for testing and is worth many times more. A must for servicing voltage doubler circuits. Protected by a 1/2 amp. Slow Blow Fuse.

All 3 Time Savers shown above in handsome display carton carrying case

MODEL SL108
\$4145

See your Distributor . . . if he cannot help you, Pat will . . .

SENCORE BE3 "ALIGN-O-PAK"

Eliminates messy batteries in TV service work. Handy for alignment, ACC troubleshooting or checking gated sync circuits. Dial the voltage you need, 0-18 volts, positive or negative. Completely isolated DC supply, less than 0.1% ripple. Covers all voltages recommended by TV set manufacturers and in Photo Fact schematics. For 110-120V, 60 cycle AC.



\$785



SENCORE, ADDISON 3, ILLINOIS

Dear Pat: Will you please . . .

Send me _____ Time Savers

(Model Numbers)

Check or M.O. enclosed (PP Prepaid.) Send C.O.D.

PAT RUDE,
Customer Service

Distributor's Name (if any) _____

Your Name _____

Street _____

City _____ Zone _____ State _____

ALL UNITS FULLY GUARANTEED OR MONEY BACK WITHIN 10 DAYS

how much?

\$24~~50~~

Consider the new 15" Wolverine full-range speaker—not just bigger—better, too!

The larger radiating area of the Wolverine LS15 gives it a performance edge in the bass region. The greater air load of the larger cone lowers the speaker's resonant frequency, allows the LS15 to radiate more sound power at those hard-to-get bass frequencies.

You can see the superior strength and rigidity of the cone of the LS15 that maintains truer rigid-piston motion at bass frequencies, and provides better control of the more complex modes of operation that come into play at higher frequencies.

Compare the Wolverine loudspeaker series with any other make. Whether you're interested in the LS8 (8"), LS12 (12") or the LS15 (15"), you'll find more quality per feature, and more features per dollar, in the remarkable Wolverine components . . . by Electro-Voice.

You get all these specific quality features. Heavy duty, diecast frames permanently maintain the alignment of the voice coil in the high-precision magnetic gap . . . glass coil forms maintain voice coil shape for life . . . edgewise-wound voice coil increases efficiency 18% over conventional coils . . . two specialized cones give efficient reproduction of both bass and treble frequencies . . . compact design makes them easy to install in today's sound-conditioned homes.

When your budget allows, you can get even wider range and better overall listening quality with Wolverine midrange and high-frequency step-up kits, easily added to any of the three basic Wolverine full-range speakers. Add the HF1 first, to bring out the subtle brilliance of modern stereo records, tape, and FM radio. Then, add the MF1, for greater midrange clarity, spread more evenly throughout the room by the famous E-V diffraction principle.

If you're shopping for quality and economy, your finest choice is an Electro-Voice Wolverine speaker.

Model LS15 — Specifications — Frequency response 35 to 13,000 cps; EIA sensitivity rating 46 db. Free-space cone resonance 35-45 cps. Power-handling capacity 20 watts program, 40 watts peak. Impedance 8 ohms. Mechanical cross-over 4500 cps. 15½ inch diameter, 6½ inch depth, 13¼ inch baffle opening; mounts with four holes ½ inches equally spaced on 14⅞ inch circle. Net weight 11 pounds. Shipping weight 12 pounds. Net each \$24.50.

Electro-Voice®

Dept. 110E, Consumer Products Division

ELECTRO-VOICE, INC., BUCHANAN, MICHIGAN

WOLVERINE LS 15 FULL RANGE 15-INCH LOUDSPEAKER

SPEAKING OF LINES ...

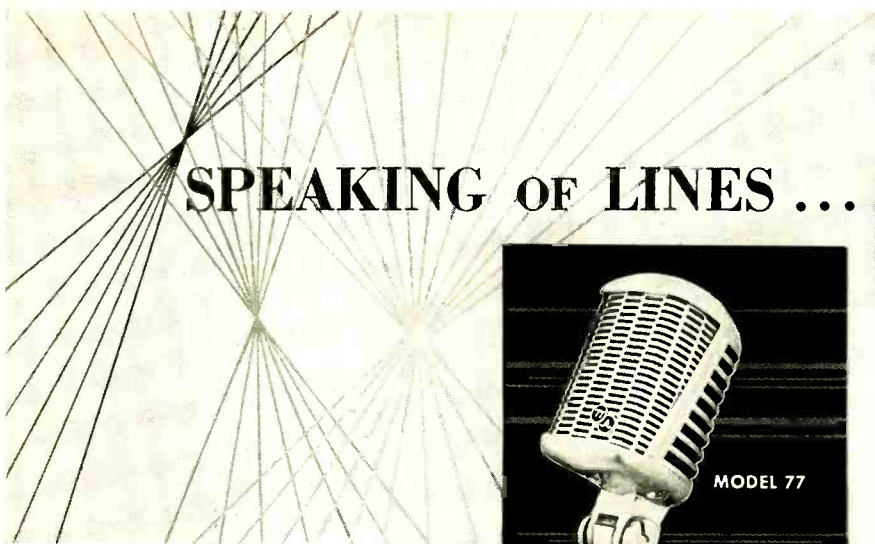

... The complete line of Astatic microphones includes types and styles to meet all communication and amplification needs. Astatic offers a full range of models ... every one superbly engineered with many advanced features found in no other line. There is an Astatic microphone to meet all demands for finest fidelity ... to resist wear and tear of the most abusive service, extremes of temperature and the elements ... to fill the bill whatever is required. This is why Astatic microphones are preferred by sound engineers and installers the world over. Astatic has been manufacturing quality microphones for more than a quarter century ... and none which carries the Astatic label is ever unworthy of the name. Illustrated are a few popular Astatic models.

Model 77—highest fidelity with most positive anti-feedback characteristics of any cardioid.

Vogue 988—utmost professional instrument quality.

Three-Thirty Series — small, compact, classically simple in design with professional performance.

Model DN-50—famous for performance with famous traditional microphone design.

WORLD'S MOST FAMOUS NAME IN PHONO CARTRIDGES AND NEEDLES, MICROPHONES

THE **Astatic** CORPORATION,
ASTATIC CONNEAUT, OHIO

In Canada: Canadian Astatic Limited, Toronto, Ont.
Export Sales: Roburn Agencies, Inc.,
431 Greenwich St., N. Y. 13, N. Y., U.S.A.

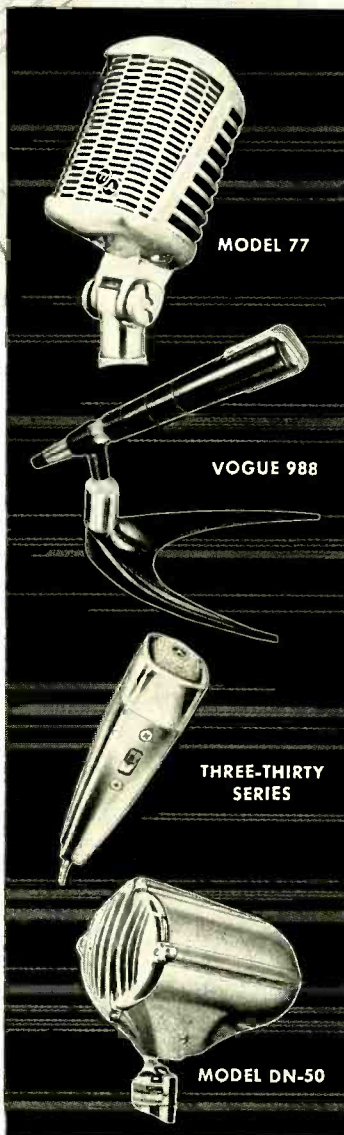

for the power level desired. In 25- and 141-volt systems, required primary impedance equals

$$\frac{(\text{Output voltage})^2}{\text{Desired power to speaker}}$$

The other type of stepdown transformer has its primary connected to the 70-volt line. The speaker is connected to the common terminal and the terminal that will give the desired power level. The taps are marked in terms of volts. Wattage ratings are for 16-ohm speakers. Ohm's law will give the output power available at each tap (Fig. 4-b).

When the amplifier has good output voltage regulation characteristics, we can connect (and disconnect) speakers from the line without significantly affecting the level of other speakers on the same line. This is particularly advantageous from the servicing angle.

Overall efficiency

A 10-watt amplifier can be made as effective as a 100-watter by using more efficient methods. A 10-watt amplifier feeding 33 1/3% efficient horn speakers will deliver more than three times as much sound as a 100-watt amplifier feeding a like number of 1% efficient cone speakers.

Power waste can be reduced by using more efficient line-matching transformers. If we feed 10 speakers through 10 line transformers of 80% efficiency in a 100-watt system, we will be wasting 20 watts in the transformers. If 95% efficiency transformers are used, only 5 watts will be wasted.

By selecting the right speaker (or speaker combinations) for a specific application, we can use less power for a given sound level and put the sound where we want it. When directional loudspeakers are used, the correct illusion (sound appears to be coming from microphone location) can be preserved and acoustic feedback problems can be minimized.

But, the biggest jump in efficiency, speaker life and speech reproduction quality can be made by keeping unwanted low frequencies out of speakers by adding a series capacitor. END

[The capacitance tolerance of an electrolytic capacitor may vary from -20% to +250%, depending on the type and voltage rating. The actual cutoff frequency of the speaker will then vary inversely as the capacitance in the circuit. For example, the chart shows that a 4-ohm speaker will cut off at 150 cycles with a 90-μf capacitor in the circuit. If this unit has a +100% tolerance, its actual value is 180 μf and the actual cutoff frequency is 75 cycles. If the capacitance is 20% low, the cutoff rises to around 190 cycles.

If the size of the capacitor makes it necessary to select an electrolytic, you can select the unit on a capacitance bridge or hand-pick the unit with the help of using an audio signal generator and an output meter. Try capacitors of approximately the correct value until you find one that drops the output 6 db at the desired cutoff frequency.—Ed-itor]

Over 1000 Sold The 1st Month! Not One Returned To Date!

JUMBO PAKS!

RADIO-TV PARTS BY THE POUND 500-1000 pcs. per pound

16 TONS of mfr's Over-runs pre-packed to save you money

COMPLETE SATISFACTION—MONEY BACK GUARANTEE

- ONE POUND Precision ResistorsWorth \$100, NOW
- ONE POUND Disc CondensersWorth \$50, NOW
- ONE POUND Ceramic CondensersWorth \$85, NOW
- ONE POUND Discs & CeramicsWorth \$75, NOW
- ONE POUND Discs, Ceramics, Precisions.....Worth \$70, NOW

\$3⁰⁰ per pound

BUY 4 PAKS for \$11.00

Clip out & mail

FREE GIANT BARGAIN CATALOG WRITE FOR YOURS!

HOW TO ORDER: Include check or M.O. with sufficient postage; excess returned. C.O.D. orders, 25% down; rated, net 30 days. INCLUDE POSTAL ZONE in address.

LEKTRON

131 Everett Ave. CHELSEA 50, MASS.

THE TRANSIENT CAPACITOR

By DELLROYE D. DARLING *

ANY good technician knows the secret of troubleshooting is the ability to analyze a circuit and puzzle out how it works. However, most types of electronic equipment have some component parts that always seem to be there, yet don't seem essential to the operation of the circuit. A good example is the "fusible resistor" found in most television receivers. The circuit will probably work if it were shorted out, and only a TV technician knows how serious it would be to eliminate it.

The TV-trained man called to service industrial equipment for the first time may be able to figure out how the circuit works, yet the purpose of some items may puzzle him.

For example the "transient capacitor," a ceramic or mica of about .01 μf usually found across the grid-cathode socket lugs on thyratron timer tubes, and often on thyratrons used in other applications, such as power control.

The need for this capacitor stems from the fact that the grids of gas-filled tubes have a very different control action than those of vacuum tubes. Most TV technicians know that a thyratron can be held blocked as long as its grid is sufficiently negative. It will suddenly come to full conduction when the negative bias drops below a certain level.

But few realize how sharp this "threshold" is. When a thyratron is about to conduct, a change in grid bias of a very small fraction of a volt can push it over the edge into full conduction. If this small push comes from an external source such as a transient voltage, the tube may fire sooner than it should.

In timer circuits, this transient firing can cause serious trouble. It may shorten a timed interval and upset the accuracy of the whole timer.

Most thyratron timers operate on 60-cycle ac taken from the plant supply lines. Theoretically, these lines should always be at their rated voltage, 230, 460, etc. However, large motors, welding machines and many other types of

What's It For?

TRANSIENT CAPACITORS

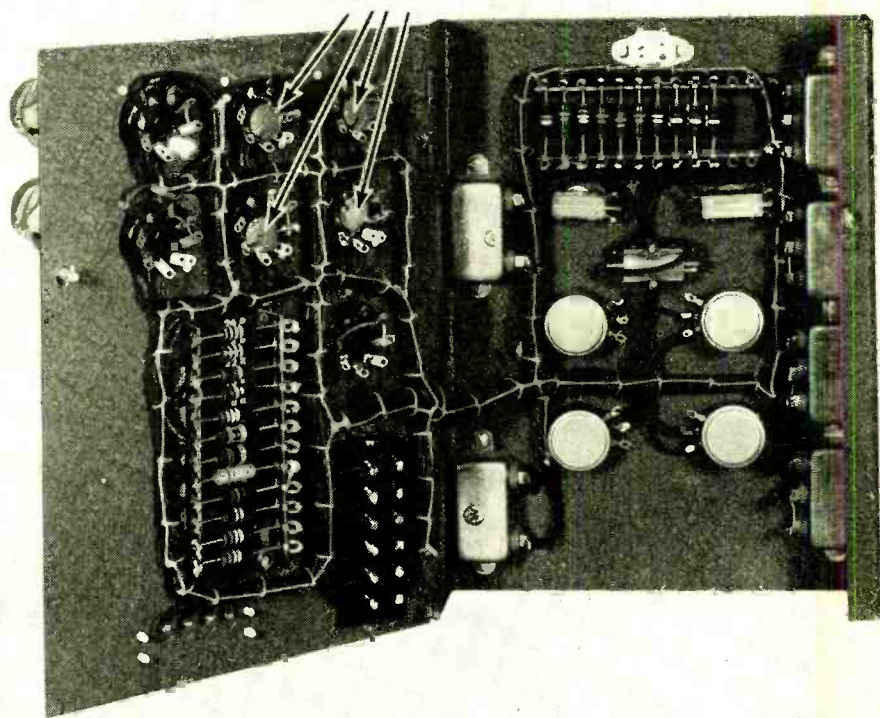

Underchassis of weld-timer, "brain panel," showing transient capacitors.

Robotron Corp., Detroit, Mich.

heavy equipment are often connected to the same lines. When these inductive loads are switched on and off, they cause large pulses of transient voltage across the line. These transients can be as high as thousands of volts, and may travel hundreds of feet along the supply lines to upset the operation of thyratron tubes. Although an isolation transformer is usually used in the timer, the transient may be coupled almost as well as the supply voltage, and will appear across the cathode-anode of the tube (Fig. 1).

Even though the interelectrode capacitances of the tube are small, at the high frequency of the transient they may have enough reactance to form a capacitive voltage divider, and—since the cathode-grid and anode-grid capacitances are approximately equal—a transient that is positive to the anode of the tube can cause the grid to go positive by half or more of the transient voltage. If this occurs near the start of a positive half-cycle on the anode, the tube will fire for the remainder of that half-cycle, energizing the load.

When the transient capacitor is added between grid and cathode, it upsets this

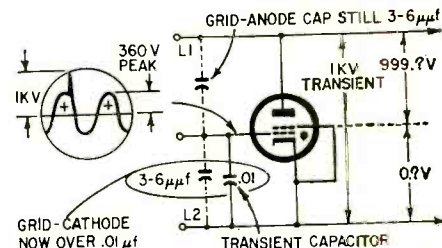

Fig. 2—Transient capacitor upsets voltage-divider effect—hardly any of transient appears on grid-cathode circuit.

voltage divider as shown in Fig. 2. It causes practically all of the transient to appear between the grid and anode, where it does no harm, since it only makes the grid more negative for an instant.

These capacitors don't fail often. Still, it does happen. If the transient capacitor shorts, the grid will be tied to the cathode, and the trouble will be obvious. If it opens, the circuit may appear to work normally, but transients on the line will cause an annoying "intermittent" of the sort that occasionally drives good technicians to drink. END

*Director, Industrial Electronics, Radio Electronic Television Schools, Detroit, Mich.

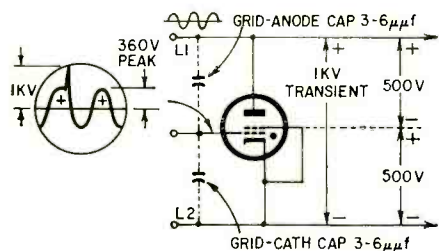
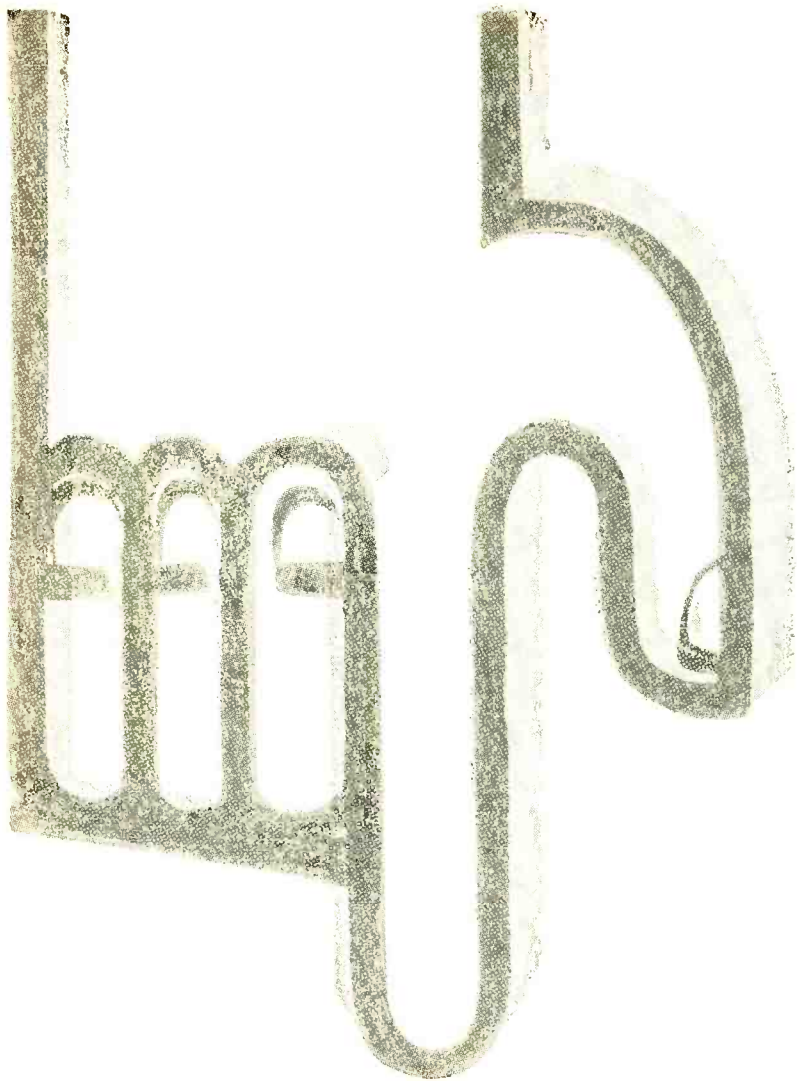

Fig. 1—Internal capacitances of tube form voltage divider (in dashed lines) that may drive grid 500 volts positive.



exact replacement **STANCOR TRANSFORMERS**
 that do the job...and do it better
 FLYBACKS • YOKES • POWER TRANSFORMERS

Your distributor has them in stock—along with many other types and the complete line of Stancor Coils. Complete replacement listings in PHOTOFACTS and COUNTERFACTS.

CHICAGO STANDARD TRANSFORMER CORPORATION
 3501 WEST ADDISON STREET • CHICAGO 18, ILLINOIS

ANOTHER
MERCURY
SERVICE AID

The versatile **MULTI-PROBE** Patent Pending
DOES THE WORK OF 4 PROBES!

DC Probe AC/Ohms Probe RF Probe Lo-Cap Probe

Model MP-1 \$975
 MULTI-PROBE Net

Now for the first time — exclusive with MERCURY — a MULTI-PROBE that does all the work of 4 different probes. Functions: DC position . . . matches VTVM input impedance • AC/Ohms position . . . for all low frequency, low impedance, voltages and wave forms • RF position . . . a demodulator for checking RF voltages, wave forms and signals and TV/radio RF and IF stages • Lo-Capacity position . . . a must for high impedance, TV sync and radio circuits where regular probes overload the circuit.

Can be used with your VTVM, SCOPE or SIGNAL TRACER

Save the cost of 4 separate probes!

A quarter turn of the head selects either DC, AC/Ohms, Lo-Cap, or RF probe positions

See your electronics parts distributor

MERCURY ELECTRONICS CORP., 77 SEARING AVENUE, MINEOLA, NEW YORK
 West Coast Office: 4306 W. Victory Blvd., Burbank, Calif.

SIMPLE FM CONVERTER FOR TV

By **JONATHAN VANDERWALL**

ONE day recently, I wished to listen to a local FM station. Unfortunately, the only FM set in the house was not working—the ratio-detector coil was defective. Since it was Sunday, no coil could be obtained and I faced the prospect of missing a good program. However, with a grid-dip oscillator, an intercarrier TV receiver and an old copy of **RADIO-ELECTRONICS**, a simple but effective converter was devised.

Before going further, let me mention that the principle involved here has been "borrowed" from the description of the Regency RC-103 FM Televerter given on page 33 of the April, 1958, issue of **RADIO-ELECTRONICS**.

It is common knowledge that an intercarrier TV set requires not only the sound signal but also an additional signal (usually the picture carrier) displaced 4.5 mc from it. When these two signals reach the video detector, they produce a 4.5-mc beat signal which is fed to the sound if amplifier and then the ratio detector or quadrature detector or what have you. Note that the additional signal need contain *no modulation* and, further, that it may be either 4.5 mc above or below the sound signal.

The trick is to use the fundamental and a harmonic from a single oscillator to do two jobs. The fundamental combines with the given FM signal to produce a difference frequency lying somewhere in the lower TV band. The second harmonic of the oscillator must lie 4.5 mc away from our difference frequency. We choose the frequency of our local oscillator by using the formula: $f_o = \frac{FM + 4.5}{3}$ where FM is the frequency of the FM station that you wish to receive and f_o is the oscillator frequency. Both are in megacycles.

For example, let's say we have an FM signal at 92.1 mc. The oscillator frequency is: $\frac{92.1 + 4.5}{3}$ or 32.2 mc.

This is then beat against the 92.1-mc signal to produce a signal at 59.9 mc which is in reach of the set's fine tuning on channel 3. The second

harmonic of the oscillator signal is 64.4 mc, just 4.5 mc from our sound-carrying signal. These two signals are fed to the TV set, which does the rest.

The simple circuit (see diagram) may be used with a grid-dip oscillator or conventional signal generator. The local oscillator (grid-dip or generator) is coupled by a two-turn link to the tuned circuit. The tuned circuit shown is not critical; I simply set it to resonate at 95 mc. As it is loaded heavily, its Q is low.

C—3 to 30 μf , variable
 D—IN82
 L1—4-turn $\frac{5}{8}$ -inch-diameter air-wound coil tapped at 1 turn, No. 20 wire wound 16 turns per inch (Air-Dux 516T or equivalent)
 L2—2-turn link

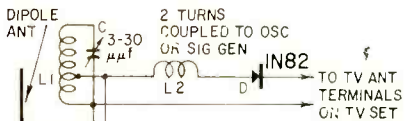

Detail of circuit connected to TV; grid-dip oscillator couples to L2, antenna is cut to FM band.

Therefore, changing the tuning does not make much difference.

There are two tips about using this unit which I would like to pass along. First, use channel 3 for stations between 88 and 100 mc and channel 4 for stations between 100 and 108 mc. Second, juggle the TV's fine-tuning control and the frequency of your local oscillator for best sound. Other possible uses for this circuit are monitoring local airport, fire department, police department or taxi frequencies. END

BRITISH DEAF WANT VISIBLE SOUND

The Associated Press reports from London, England, that an organization called "The Campaign for Television for the Deaf and Dumb" has sent a resolution to British Prime Minister Harold Macmillan recommending:

Translating the most important news bulletin each day into sign language.

Transmitting one play a month with an interpreter giving the lines to the deaf.

Presenting at least one sports event a month accompanied by a sign-language description.

One televised church service each month with the pastor's sermon translated into sign language.

The request is understandable since British viewers, whether they can hear or not, pay a license fee of three pounds (\$8.40) per year.

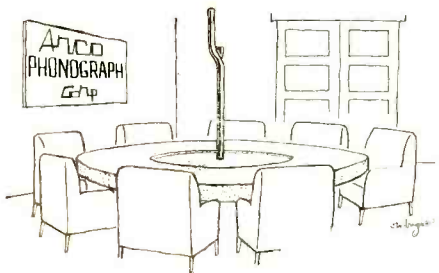

NOVEMBER, 1960

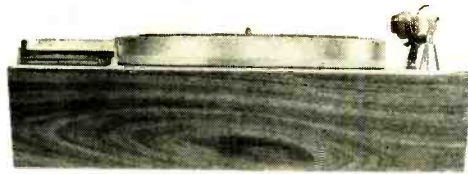

"REK-O-KUT"—the safest word you can say to your dealer

For sixteen years, Rek-O-Kut has been synonymous with highest quality in turntables. As other brands have risen, fallen and even completely disappeared, Rek-O-Kut has won consistent acclaim as the overwhelming choice in its field. In performance ratings as well as engineering contributions to turntable design, Rek-O-Kut has compiled a record unchallenged by any other turntable producer. Now, this tradition is again emphasized by the introduction of the N-34H STEREO TABLE... a professional quality, two speed (33 $\frac{1}{3}$ and 45 rpm) turntable. Quiet power is furnished by a Rek-O-Kut hysteresis synchronous motor and an efficient new belt-drive system. Speeds can be changed even while the table is rotating, merely by pressing a lever.

The N-34H is a symphony of crisp, clean lines accentuated by the unusual deck design. Mated with the new tapered base, the N-34H becomes one of the proudest and most beautiful components ever to grace a home music system. See it at your dealer's.

N-34H STEREO TABLE only—\$79.95 net. Shown with new Rek-O-Kut Micropoise Stereo Tonearm, Model S220, \$29.95 net. Tapered base in hand-rubbed, oiled walnut, \$14.95.

A NEW DIMENSION IN TURNTABLES—12 $\frac{5}{8}$ " x 19"— DESIGNED TO FIT NARROW CABINETS AND BOOKSHELVES!



SPECIFICATIONS: Noise Level:—53db below average recording level; Wow and Flutter: 0.15%
 Drive: Nylon, neoprene-impregnated endless belt. 2 Speeds, 33 $\frac{1}{3}$ and 45 rpm.

NOTE: COMING SOON... ANOTHER GREAT DEVELOPMENT... Rek-O-Kut AUTO-POISE—makes any Rek-O-Kut tonearm you buy now—fully automatic



REK-O-KUT STEREO TABLES

Export: Morhan Exporting Corp., 458 Bway, N.Y. 13
 Canada: Atlas Radio, 50 Wingold Ave., Toronto 19

Rek-O-Kut Company, Inc., Dept RE-11
 38-19 108th Street, Corona 68, N.Y.
 Please send me complete details on the
 new N-34H STEREO TABLE:

Name _____
 Address _____
 City _____ Zone _____ State _____



Progress is our most important product

GENERAL ELECTRIC

311-404



GIVE YOUR STORE THE

WORTH NEW TV



LEGAL PITFALLS

What can you do when
you finish a service job
and the owner tells
you to charge it?

The answer to this and other questions appears below.

By LEO T. PARKER *

SERVICE technicians engaged regularly in servicing TV sets and other electrical appliances are confronted daily with legal problems that could add up annually to a substantial sum of money.

For example, recently I received an interesting letter from Mr. W. C. White, who owns and operates a TV service shop. He says in part: "Yesterday I went on a call to a private home to service a TV set. I had had no previous business with this home owner. After I had made proper repairs on the set, including putting in two new tubes, I made out a bill for \$18.50 and handed it to the home owner. He told me to 'charge it.' I told him that I operate strictly on the cash basis and have no charge accounts. He said I should have told him that before I started to work on his set, and that if I had told him

that I operated on a cash basis he would have told me that he would not pay the bill until 90 days. I did not know what to do, so I told him to pay me in 90 days. Maybe he will pay me and maybe he won't, as I have no credit approval on him. What do you suggest that I do in cases of this kind?"

The answer is: The higher courts very consistently hold that unless the testimony shows conclusively that before a serviceman rendered services, or a seller delivered merchandise to a purchaser, an agreement was made whereby the serviceman or seller agreed to extend credit, cash payment is implied.

For illustration, in *Zeff v. Harvey Company*, 315 Pac. (2d) 371, it was shown that a service technician took a customer's note for certain equipment, when the latter told the service technician that he could not pay cash.

In subsequent litigation, the higher court held that a note is not cash payment.

This higher court also held that there can be no substitute for cash, and, if a contract or agreement for service fails to clearly state that credit is extended, cash is always implied. In other words, unless the service technician clearly and distinctly agrees to credit or time payment, cash must be paid by the customer.

Furthermore, the service technician is not obligated to inform his customer before he does the work that cash must be paid.

Therefore, where a home owner refused to pay cash after a service technician has repaired his TV set, the technician can do one of two things: First, he may at once sue the home owner for the amount due and positively recover a court judgment against

* Attorney at law, Cincinnati, Ohio

DOUBLES YOUR EFFECTIVE MANPOWER

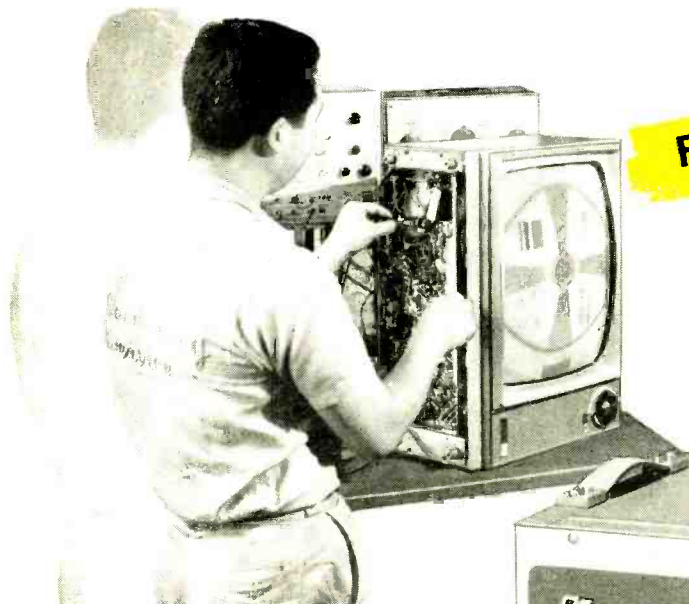

Fix "Tough Dogs" Fast!

Save Half Your Time!

Step Up Your Profit!

B&K NEW
MODEL 1076

TELEVISION ANALYST

for Black & White and Color



Check all circuits—Pinpoint any TV trouble...in minutes

**By Easy Point-to-Point Signal Injection,
You See the Trouble on the TV Screen and
Correct it—Twice as Fast and Easy!**

There's no longer any need to "lose your shirt" (and customers)—and worry about the lost hours you never recover—on "tough dogs" or even intermittents. The remarkable *B&K Analyst* enables you to inject your own TV signal at any point and watch the resulting test pattern on the picture tube itself. *Makes it quick and easy to isolate, pinpoint, and correct TV trouble in any stage throughout the video, audio, r.f., i.f., sync, and sweep sections of black & white and color television sets—including intermittents.* Makes external scope or wave-form interpretation unnecessary. Most useful instrument in TV servicing! Its basic technique has been proved by thousands of successful servicemen the world over.

The Analyst enables any serviceman to cut servicing time in half, service more TV sets in less time, really satisfy more customers, and make more money.

Model 1076. Net, \$29995

Available on Budget Terms. As low as \$30.00 down.

Combines all the features of both
the Model 1075 and Model A107

- | | |
|--|--------------------------------------|
| COMPLETE R.F. and I.F. | HI-VOLT INDICATOR |
| VIDEO TEST PATTERN | YOKE and HI-VOLTAGE TRANSFORMER TEST |
| COMPOSITE SYNC | |
| FM MODULATED AUDIO | Also Now Provides: |
| COLOR PATTERNS | SWITCH-TYPE TUNER |
| HORIZONTAL and VERTICAL PLATE and GRID DRIVE | NEGATIVE BIAS SUPPLY |
| B+ BOOST INDICATOR | AGC KEYING PULSE |
| | PICTURE TUBE MODULATION |



B&K MANUFACTURING CO.
1801 W. BELLE PLAINE AVE • CHICAGO 13, ILL.
Canada: Atlas Radio Corp., 50 Wingold, Toronto 19, Ont.
Export: Empire Exporters, 277 Broadway, New York 7, U.S.A.

See Your B&K Distributor or Write for Bulletin AP16-E

the home owner for this amount. Second, he may at once remove from the repaired TV set all the new tubes and like appliances that he installed and then later sue the home owner and recover a court judgment for the labor and service call.

In *Havas v. Ray Lundy, 276 Pac (2d) 727*, the testimony showed that an appliance was taken to a service shop for necessary repairs. The appliance was not fully paid for. On completion of the repairs, the service technician retained possession of the appliance because his bill remained unpaid.

The higher court held that the service technician could remove the newly installed parts from the appliance before the holder of the conditional contract could repossess it. The court held that the conditional vendor was not entitled to the parts which had been installed in the appliance by the repairman.

For comparison, see *Clarke v. Johnson, 187 P. 510*. Here a service technician installed parts and repairs in a mortgaged appliance. The court held that the conditional seller who later repossessed the appliance must pay the repairman for the new parts and labor.

Reasonable bill is collectable

Another important point of law was brought up to the writer recently by the owner and operator of a TV service establishment. He explained that in many instances the owner of a TV set will order repairs without inquiring the cost. Then, when the bill is presented, the home owner refuses payment on the grounds that the charges are too high and that he did not agree to pay such a high bill.

Modern higher courts consistently hold that if a home owner or appliance owner wants to limit his expenditures for a repair job, he is obligated to have the service technician make a price or bid before the work is started. If the owner of the TV set or other appliance does not strictly follow this established rule of law and allows the service technician to do the repair work, the owner becomes automatically obligated to pay the "reasonable" cost of the repairs. What is meant by the term "reasonable" is that price which other technicians of "like" experience, reputation, and dependability would have charged to do the same job.

For instance, in a late case a litigant named Crawford owns an appliance store in a high-class location. He rendered a bill to a customer for \$280.50

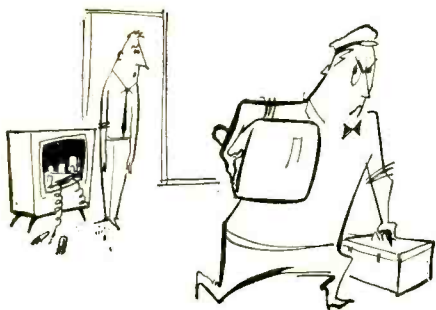

"He may at once remove. . ."



"... the reasonable cost . . ."

for a repair job. The customer refused to pay the bill. Crawford sued the customer who had, as a witness, a man who owned a repair shop located in a disreputable and cheap neighborhood. This witness testified that he would have done the same repair job for \$125.

The higher court held that the home owner must pay Crawford's \$280.50 bill because the testimony showed that other proprietors of repair shops in better-class, respectable neighborhoods considered Crawford's \$280.50 bill reasonable.

This higher court explained that men located in cheap neighborhoods naturally will do service and repair work for less money than those in better or high-class neighborhoods where rent is higher and probably service technicians are paid higher wages.

Jury will decide

Here is another interesting legal question: "Recently a service technician went into a home and after inspecting a TV set told the home owner that he could put it in good condition for \$87.50. The TV owner told him to go ahead with the job. When the technician finished the job, the owner of the set refused to pay \$87.50, saying that he understood the service technician to say that he would do the job for \$27.50. The question is what can the service technician do to collect this \$87.50?"

The answer is: He should file suit against this home owner and let the jury decide the case. The jury will listen to all testimony and decide whose testimony is truthful and render its verdict accordingly.

Bad check is no payment

Some time ago I talked personally with a man named Wilson who is the owner and operator of a TV repair shop that employs about 26 service technicians. He told me that a few days ago a customer gave a bank check in payment for a repair job, demanding a receipt stating that the account was "paid in full." Later the check was returned from the bank marked "insufficient funds." Wilson said the bill remains unpaid because the customer states that he cannot be compelled to pay because he has in his possession the receipt showing that the bill was paid in full.

Quite obviously, Wilson can easily

win a favorable court judgment against this customer. All he need do is file a suit and at the trial show the unpaid bank check to the court, which will immediately hold the "paid in full" receipt void and with no legal value. At the same time, the court will render a judgment against the customer in favor of Wilson for the full amount of the repair bill plus court costs.

At this same meeting Wilson asked me whether he can sue a customer and recover a court judgment for a TV repair bill on which he issued a "paid in full" receipt, but part of which the customer paid with a counterfeit bill.

The answer to this question is: Yes, under ordinary circumstances, Wilson can sue and the court will issue a judgment against the customer who paid the repair bill with counterfeit money. This is so because—generally speaking—payment with counterfeit money is not a valid payment. However, this is not so in all instances, as the following anecdote will show:

A man named White is said to have registered in a hotel, and to have deposited in the hotel safe for safekeeping a United States bill for \$100. That

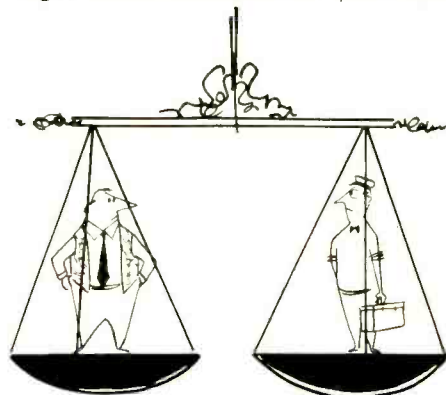

"The jury will decide."

day the hotel proprietor used the \$100 bill to pay a long overdue debt to a real estate broker, who in turn used the bill to pay off an overdue debt owed to a TV service technician. The latter was pleased with the settlement and, thereupon, used the \$100 bill to pay the balance he owed a funeral director. The latter gave the bill to one Ellis who had furnished services to the funeral director. Then Ellis, in response to urgent requests for payment of past due debts he owed to the hotel, gave the hotel proprietor the \$100 bill. The hotel proprietor immediately placed it in the safe.

A few days later White requested delivery of his previously deposited \$100 bill. The hotel proprietor produced the bill from the safe and gave it to White who thereupon lighted a match to it, saying that it was counterfeit.

The important point is that the counterfeit bill was satisfactorily used to pay off valid debts, and everybody connected with the transactions was satisfied and happy.

How good a witness?

Another rather unique legal problem was presented very recently by an



“... and refused to give it . . .”

acquaintance. He said that when he goes into a home on a service call he is alone, whereas the home owner has members of his family who may be used as witnesses in future litigation and legal controversies. He wants to know what chance he has to win a suit for \$68.50 he now has on his hands against a TV set owner. The owner says he has witnesses to prove that the service technician told him that he would do the job for \$39.50 because of past favors the set owner had rendered the technician.

Obviously, such a case is farfetched and hardly worth this space for consideration. Nevertheless, it borders on an unusual case where a TV repairman was making change in the home of a customer. He laid a \$20 bill on the TV. Later the home owner picked up the \$20 and refused to give it to the technician, saying that he, the home owner, had put it on top of the TV set.

All these unusual and unsatisfactory occurrences breed personal combat. However, it is advisable in such cases to present the facts to a jury, who will listen to all testimony and render a verdict in favor of the litigant whose testimony it believes to be true. The jury may make its own decision, irrespective of faked testimony intended to favor the owner of the TV set. In other words, the jury may believe or disbelieve a part or all the testimony given by the TV set's owner and his witnesses, who contest a repair bill. The courts give little or no weight or consideration to testimony of relatives or close friends of a litigant. This holds whether the suit involves payment for service, merchandise or in suits for damages by injured persons. Generally speaking, if a customer fails to introduce witnesses before the court to prove that the service technician promised to do a job for less than the amount for which he sued, the jury will decide the verdict in favor of the service technician.

For example, in *Reeves v. Child*, 194 Pac. (2d) 919, a workman sued a home owner to recover a bill amounting to \$372.41. The property owner testified that the man had orally promised to do the job for considerably less than the \$372.41. On the other hand, the workman testified that his oral agreement was to complete the job for about \$375.

Since the jury believed the workman's testimony, the court held him entitled to full recovery of this amount.

Quite obviously, all service technicians can avoid legal controversies over the price for repair work by having any stranger sign a printed agreement to pay a named price for work to be

done on his television set or other appliance.

Law of minors

It is certain that a minor is not obligated on any ordinary contract or promise he makes. Hence, service or repair work for a minor is a financial loss unless the minor voluntarily pays the bill.

For illustration, in the late and leading case of *Doenges v. Gillen*, 328 Pac. (2d) 1077, the higher court said:

“An infant lacks capacity to make a firm and binding contract; in all such contracts lies the inherent weakness and condition that the infant may disaffirm the contract during his minority or within a reasonable time after reaching his majority. The right to disaffirm is not lost by reason of the fact that the infant has induced the making of the contract by deliberate misrepresentation of his age.”

Law of mechanic's lien

A great deal of discussion has arisen from time to time over the legal ques-



“... a minor is not obligated . . .”

tion: “If a conditional contract of sale of a TV set contains a clause to the effect that the conditional buyer will not encumber the set, does this render a service technician's lien void?”

The answer is no.

For example, in *Champa v Consolidated Finance Corporation*, 98 N. E. (2d) 925, the testimony showed that a man named Barnett purchased an appliance, paying part cash. He signed a conditional sales contract which provided that Barnett would not attempt to sell or “encumber the appliance during the life of the contract.”

Sometime later, Barnett ordered the equipment repaired at a service shop but he did not notify the finance company that it was being repaired. After the repairs were completed Barnett decided that the costs were more than he could pay, and he so notified the finance company.

In later litigation the higher court held that the technician could keep possession of the equipment to solve payment of his bill. The court said:

“The vendor, by entrusting the vendee (Barnett) with possession . . . impliedly clothed him with authority to contract for necessary repairs, so that such repairs were as though made by vendor's request or direction.”

On the other hand, some higher courts have held that where a chattel mortgage or conditional sale contract

on a TV set is properly recorded, a service technician has only a secondary lien to secure payment for his work. [See *Allied v. Shaney*, 74 N.W. (2d) 723; and *Lincoln v. Netter*, 253 S.W. (2d) 260.]

An important point of law is that once a service technician has given up possession of a set on which money is due for repair work, his mechanic's lien is forfeited. In other words, the instant the owner takes his set out of possession of the service technician, the lien automatically becomes void.

Law of service guarantees

Modern higher courts consistently hold that after the purchaser of a TV set puts it in operation, the seller is bound by any and all reasonable provisions and guarantees relating to the service he has agreed to give. However, the courts will not permit any purchaser to impose on a seller, unless such imposition is clearly expressed in the contract.

For illustration, in one case a contract of sale contained a clause in which the seller “guarantees that the purchaser shall be satisfied.”

Although the TV was reasonably good and worth the purchase price, the purchaser continually and at unreasonable frequency requested the seller to supply an unnecessary amount of service in adjusting, repairing and otherwise performing work on the set.

At last the seller refused to supply more service. Then the purchaser notified the seller that he was not satisfied, and since the seller had guaranteed “satisfaction” the purchaser demanded that the seller take back the set and refund the amount paid. He notified the seller that he would not make other monthly payments when they became due.

The seller filed suit and proved that the set had given reasonably good service, notwithstanding the complaints registered by the purchaser. In view of this testimony, the higher court ordered the purchaser to pay the balance due on the set. END

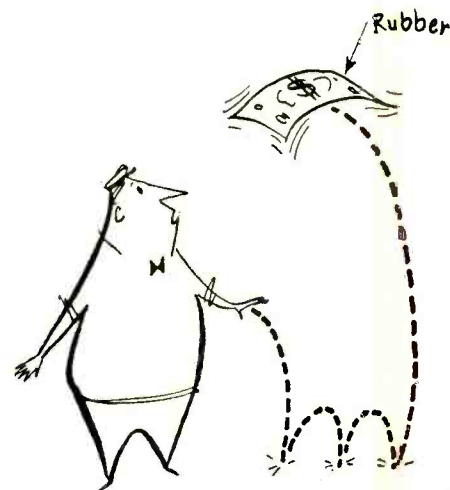

“... counterfeit money is not valid . . .”

REVIEWS LIKE THESE...

The PR-500 Turntable . . .

" . . . a single speed (33 1/3-rpm) turntable with an integrally mounted arm . . . employs a somewhat unconventional drive system which results in a totally inaudible rumble level, and low wow and flutter. The arm is simple yet effective, with a mounting system which makes the unit relatively insensitive to shock and vibration."

"The arm tracks well at the lowest stylus forces recommended by the cartridge manufacturer."

"The hum field surrounding the PR-500 is very low, and no difficulty should be experienced from this source even with poorly shielded cartridges."

" . . . the Stromberg-Carlson PR-500 performs in a manner comparable to that of the most expensive turntables and arms, yet sells for much less."

"The PR-500 is an excellent value at **\$69.95.**"

Hirsh-Houck Laboratory —
High Fidelity Magazine, May '60

...hint at the performance of new

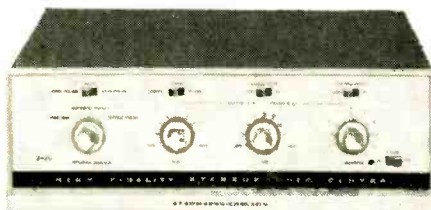
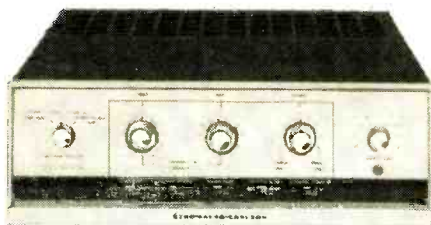

New Amplifiers . . .

ASR 660—an extremely clean, beautifully designed stereo amplifier • **Continuous power:** 36 watts (18 watts per channel) • **Music power:** (IHFM standard): 44 watts (22 watts per channel) • **Total harmonic distortion:** 0.6% at 18 watts per channel • **Intermodulation distortion:** 1% at rated output (4:1 ratio, 60 and 7,000 cps) • **Frequency response:** ± 0.5 db, 20-20,000 cps • **Separate channel, clutch-type bass and treble controls** • **Scratch filter** (18 db/oct); **Rumble filter** "Twin T" filter, null at 20 cps • **Loudness contour switch;** **Balance control;** **Channel reverse switch;** **Program selector;** **Master gain control** • **DC on pre-amp heaters** for low noise; **A plus B center speaker terminals.**

Suggested Audiophile net: **\$159.95**

ASR 220C—an unusually versatile medium power stereo amplifier • **Continuous power:** 24 watts (12 watts per channel) • **Music power:** (IHFM standard) 28 watts (14 watts per channel) • **Total harmonic distortion:** 0.7% at 12 watts per channel • **Intermodulation distortion:** 2% at rated output (4:1 ratio, 60 and 7,000 cps) • **Frequency response:** ± 0.5 db, 20-20,000 cps • **Separate channel clutch-type bass and treble controls** • **Scratch filter** (18 db/oct); **Rumble filter** "Twin T" filter, null at 20 cps • **Magnetic phono pre-amp** with new, low noise tubes • **A plus B center-speaker terminals.**

Suggested Audiophile net: **\$119.95**

New Speaker Systems

Three new, wide range speaker systems. A new elliptical tweeter with a heavily silver-plated voice coil prevents harshness caused by cone breakup in conventional circular speakers. Woofers of extra-heavy cone stock are capable of long, linear excursions for outstanding low frequency power handling without distortion. Tweeter level switches included on all models. Enclosures are carefully matched to the woofer.

Suggested Audiophile net:
RS511 59.95 to 84.95
RS514 74.95 to 99.95
 (prices vary with finish) **RS516 105.00 to 135.00**

For the sheer joy of listening . . . "There is nothing finer than a Stromberg-Carlson"

The FM-443 Tuner . . .

"The Stromberg-Carlson FM-443, one of the least expensive FM tuners on the market, approaches the performance of more expensive equipment. It is therefore an especially good value for anyone who wants to obtain the highest level of performance in a moderate-priced system."

"The distortion at 100% modulation is about 1% for signals stronger than 10 microvolts."

"The sensitivity measurement of the FM-443, according to IHFM standards, is amazing. Its usable sensitivity is 3 microvolts, a figure not usually found in tuners in this price range. This high sensitivity has not been obtained at the expense of IF bandwidth."

"The tuner sells for \$79.95."

Hirsh-Houck Laboratory —
High Fidelity Magazine, Jun. '60

The ASR-880 Amplifier . . .

"... a compact integrated stereo amplifier rated at 32 watts per channel. Noteworthy . . . it exceeds its rated power substantially over most of the audio range, has excellent power-handling capabilities at both ends of the spectrum."

"Each channel delivered 50 watts at 2% harmonic distortion, or 48 watts at 1% distortion. This is unusual in an amplifier rated at 32 watts . . ."

"The distortion of the ASR-880 is very low at usual listening levels when correctly operated . . . it has a rare combination of very high gain and very low hum. The amplifier has a number of special features, such as center channel output and a very effective channel-balancing system, as well as the usual stereo control functions found in all good amplifiers."

"Only 0.6 or 0.7 millivolts at the phono inputs will drive the amplifier to 10 watts output per channel. At normal gain settings . . . the hum level is better than 70 db below 10 watts even on phono input. This is completely inaudible."

"With a listening quality matching its laboratory response, the Stromberg-Carlson ASR-880 must be considered a very good value at its \$199.95 price."

Hirsh-Houck Laboratory —
High Fidelity Magazine, Sept. '60



Stromberg-Carlson components like these:

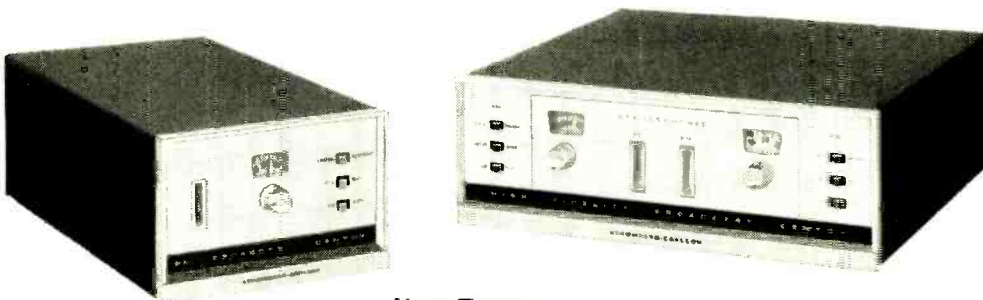

New Tuners

FM-443A—an improved version of the highly rated FM-443 • New, high-accuracy, precision dial • Precision components in de-emphasis network, giving improved frequency response: 20-20,000 cps \pm 1 db • Sensitivity: 3.5 microvolts for 20 db quieting • Improved local-distance control in RF stage for lowest distortion and best signal-to-noise ratio on both local and distant stations • Total harmonic distortion; less than 1% full deviation.

Suggested Audiophile net: \$79.95

SR-445A—a combination of the FM-443A and an entirely new, wide-band AM section. FM specifications: identical to FM-443A • AM frequency response: Broad: 25 to 9,000 \pm 1½ db • Sharp: 25 to 2,500 cps \pm 1½ db • AM noise level: 60 db below 1 volt output • AM harmonic distortion: less than 1% at 100% modulation • Separate tuning indicators for AM and FM.

Suggested Audiophile net: \$139.95

All the new Stromberg-Carlson components have so many impressive features, you'll find a visit to your Stromberg-Carlson dealer most rewarding. He will be glad to demonstrate either an individual component or a complete Stromberg-Carlson Component Ensemble. See him or write: Stromberg-Carlson, 1476 — 011 North Goodman Street, Rochester 3, New York.

STROMBERG-CARLSON
A DIVISION OF **GENERAL DYNAMICS**

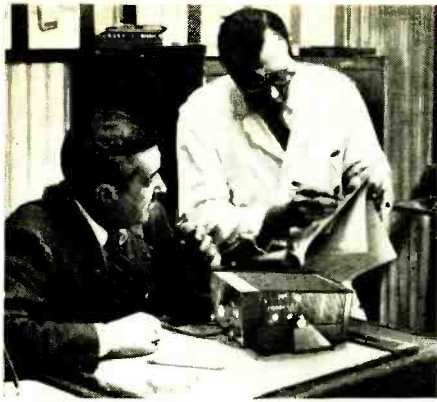

GONSET LOW-COST 2-WAY RADIO

Built for rugged "industrial-type" service where dependability is essential!

Two models available: G-12 four-channel unit, and lower cost G-11 single-channel unit. Ideal for making up 2-way industrial communications systems for buildings... yards... warehouses... aviation... branch businesses... contractors. Also for fishing, boating, hunting—special events. 11-meter Citizens Band radio offers virtually unlimited business or personal usage in vehicle, office, boat or plane. Simple licensing—no exam or special skills... merely fill out simple FCC form.

G-12 CITIZENS COMMUNICATOR

Every feature for dependable operation under heavy business and commercial use! Trans/rec channels are crystal-controlled for highest stability, ease of tuning. Features press-to-talk operation, front panel channel selector, ANL, adjustable squelch, transmitter tuning indicator, built-in speaker. *FCC type accepted.*

Compact! fits into tight Quarters—only 4½" H, 7" W, by 10" D, weighs only 11 pounds. Built-in power supply is universal 12VDC/117VAC (optionally available with 6VDC/117VAC) operates from power mains or vehicular battery.

G-11 CITIZENS COMMUNICATOR

Similar to G-12 except for single-channel operation, and mounting arrangement (3 models: 6VDC, 12VDC or 117VAC).

G-12..... **149.95** per unit
G-11..... **124.50** per unit

SUGGESTED PRICE INCLUDES P-T-T MICROPHONE AND TRANS/REC CRYSTAL FOR ONE CHANNEL.

Write for details and **FREE**

Citizens Band radio booklet!

GONSET DIVISION Dept. RE
Young Spring & Wire Corp.
801 South Main Street, Burbank, Calif.

Gentlemen: Rush complete details on your Citizens' Band radio, and free booklet

NAME _____

ADDRESS _____

CITY _____

ZONE _____

STATE _____

GONSET

Division of Young Spring & Wire Corporation

801 SOUTH MAIN ST., BURBANK, CALIFORNIA

Sawtooth Sticklers

This quiz will show how good you are at associating waveform distortion with the distortion of a circle on a TV screen

By **ROBERT P. BALIN**

SAWTOOTH vertical and horizontal deflection waveforms in your television receiver control the picture's appearance. A sawtooth with a straight slope beginning and ending with the correct amplitude produces a linear sweep. This, in turn, will reproduce a circle, for example, that not only looks perfectly round but is also centered correctly. If the sawtooth is distorted because of defective components, the circle becomes distorted and displaced.

Fortunately, every waveform distortion produces a predictable change in the shape of the circle. A good troubleshooter can tell what one will look like by looking at the other.

Can you match the distorted waveforms shown by solid lines with the

resulting circles they will produce on the TV screen? It is to be assumed that a linear sawtooth (such as that shown by the dotted lines) will produce a normal centered circle on the screen. When the distortion pictured is in the vertical waveform, the horizontal waveform is assumed to be normal. The reverse is also true. In either case, however, video reception (required to produce the circle) is not affected in any way. The deflection waveforms shown can represent either *vertical or horizontal* waveforms.

The problem: find the distorted waveform that will produce a circle having the appearance shown. For each circle, there is a corresponding waveform.

If you got stuck answers are on page 134. **END**

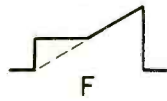
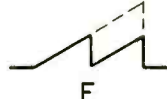
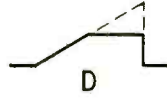
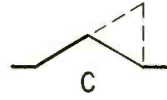
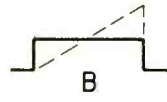
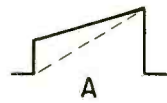

1

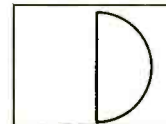

2

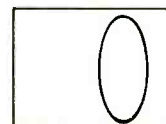

3

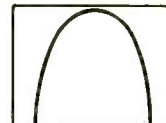

4

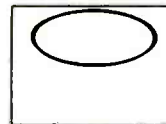

5

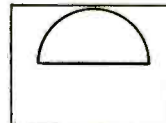

6

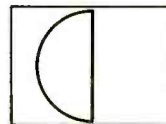

7

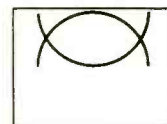

8

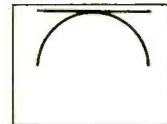

9

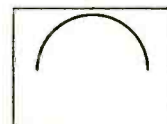

10

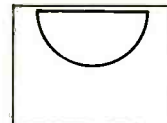

11

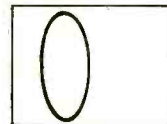

12

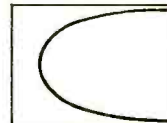

13

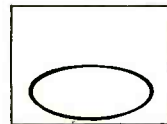

14

PNP-NPN TRANSISTOR OSCILLATOR

Need a 100-kc signal source?

This oscillator uses no tuned circuits and almost any complementary pair of transistors may be used

THIS simple oscillator is a construction must for service technicians, experimenters or anyone else who needs a precision signal source at a reasonable cost. It can also be used to power an rf bridge, drive flip-flops, logic circuits or a square-wave generator.

Complementary transistors make for a stable, easy-starting crystal oscillator designed to use a minimum of parts. The crystal forms the feedback path from emitter to emitter, making the circuit the dual of the vacuum-tube cathode-coupled crystal oscillator. Direct coupling between the p-n-p and n-p-n transistors insures stability over the temperature range of -5° to $+55^{\circ}$ C. The p-n-p transistor, V1, is connected in the common-base fashion. The n-p-n transistor, V2, is connected common-collector. (Fig. 1). This method of coupling makes V1's collector current stabilize V2, eliminating the possibility of thermal runaway.

The high stability allows large transistor-parameter variations ("Predictable Design of Transistor Amplifiers," R. B. Hurley, *Tele-Tech & Electronic Industries*, August, 1955).

Almost any combination of p-n-p and n-p-n transistors in this circuit will result in close to sine-wave output. Audio types, drift transistors, converter or if amplifier types will all work. Just be sure that one is a p-n-p and one is an n-p-n. The ones shown in the schematic were used in the original oscillator. If you have none in your parts box, buy these types.

The size and shape of the original oscillator was based on the size of the crystal used (Bliley AR 23-W) and the small wooden box that was available. The AR 23-W is a surplus crystal no longer manufactured, but the KV-3 by the same company is quite suitable. This unit mounts in a standard octal socket. James Knights Co. also makes a 100-kc crystal, type H-9. This unit is

By F. T. MERKLER

2 inches high by $1\frac{1}{8}$ inches in diameter. The crystal you use will determine the size of your oscillator.

Construction

Any reasonable parts layout will do. There are no critical leads or circuit dress to worry about. Barring an actual wrong connection, the unit will perform as designed.

Five $\frac{1}{2}$ -watt 10% tolerance carbon

resistors and one paper capacitor are mounted on a small phenolic board (photo). In the model, the parts were run point to point, with leads through small holes in the board. The transistor sockets were glued to the top edge of the board with service cement. Carefully solder all connections. Follow the schematic (Fig. 1).

CAUTION! Remember one of the transistors is p-n-p, the other n-p-n;

Interior view shows parts layout. Crystal just visible behind chassis.

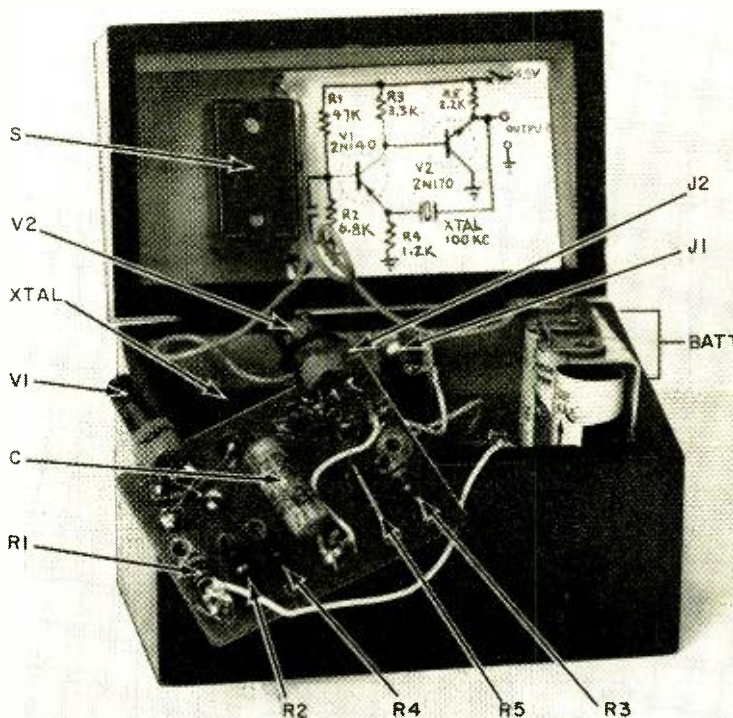

BENCH



TESTED

Unit is small and compact. When tested by a member of the staff of RADIO-ELECTRONICS, it produced the 100-kc waveform specified by the author. When the oscillator is brought close to a radio receiver, oscillation is heard at 100-kc intervals. Almost any transistors can be used as long as they make a p-n-p n-p-n pair. Several combinations were tried and all worked well, with only slight variations in the waveform.

There is no fine-frequency trimmer in this unit, so it may not be exactly on frequency. For any exact calibration work, the

oscillator would have to be calibrated first. Don't forget, any error is additive. 1 kc off at 100 kc becomes 10 kc off at 1 mc.

- Two-transistor crystal oscillator.
- Uses almost any pair of complementary transistors.
- Useful range—100 kc to well into the megacycles (on harmonics).
- May be used without crystal as sawtooth generator or code oscillator. Compact and inexpensive.

A new standard of broadcast performance from UNIVERSITY NO OTHER PROFESSIONAL MICROPHONE AT ANY PRICE CAN DO WHAT THIS ONE CAN!



Never before has there been a microphone like this . . . and it's just one of *six* professional models that herald the entrance of University into the field of microphones. Each sets a new standard of wide-range, distortion-free performance . . . with frequency response available as low as 30 cps, as high as 20,000 cps. Each offers the years-ahead-of-its-time concept of modular flexibility. Each is styled with clean, uncluttered lines totally adaptable to every environment.

To accomplish all this, University drew upon its more than two decades of leadership in sound, and applied all this vast experience to the challenge of producing a better microphone than had ever been known before. University — the leading manufacturer of speakers — now sets the pace in microphones.

MODULAR FLEXIBILITY . . . a major breakthrough in microphone design . . . gives you total interchangeability between all microphones and all accessories at all times. Need a microphone with a switch and another without . . . or for slide-on and screw-on stands . . . or for cables with and without cannon plugs? Buy just one University microphone plus only the adapters you need, and you've got them all! You don't pay for features you don't need . . . you don't compromise to meet a price. That's *true* modular flexibility, and you get it only from University.

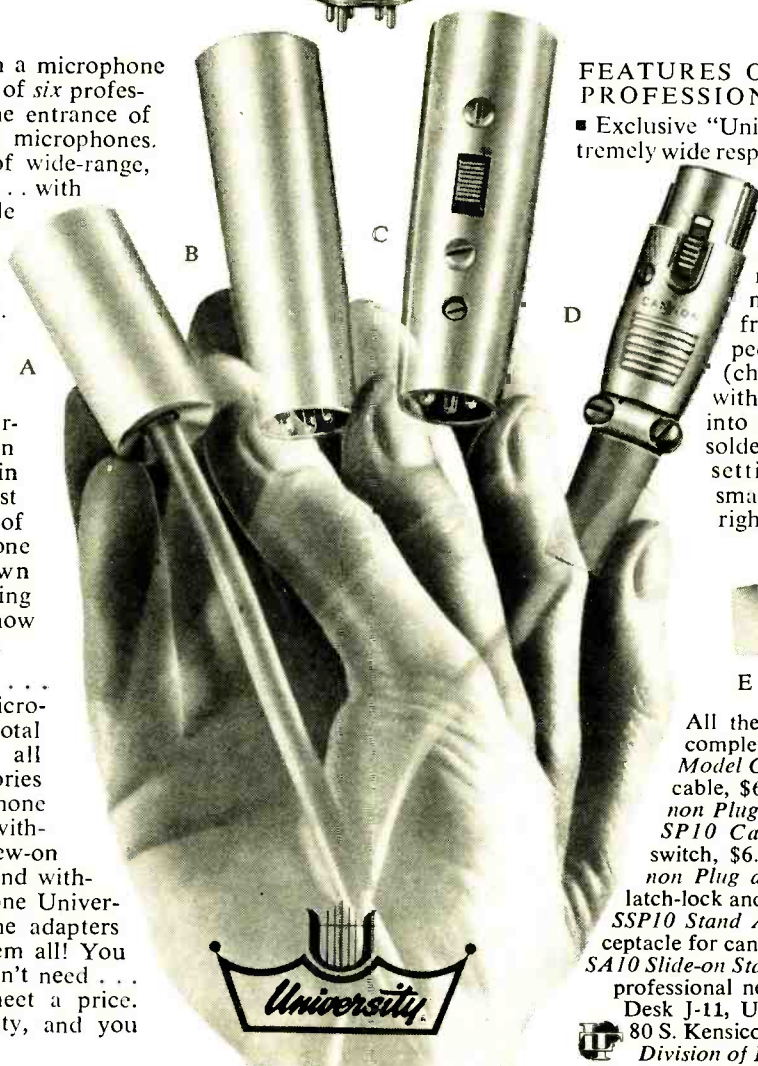

FEATURES OF THE UNIVERSITY PROFESSIONAL MICROPHONES

- Exclusive "Unilar" diaphragm assures extremely wide response . . . from as low as 30 cps to as high as 20,000 cps. ■ Rugged generating element is indestructible in normal use. Internal elements of shock-mounted models float in vibration-free foam insulations. ■ Impedance matching simplicity (choice of two low, one high) with press-on connectors built into every accessory. No tools, soldering, or rewiring. ■ Trend-setting exterior design with smart modern finishes . . . just right for every application.

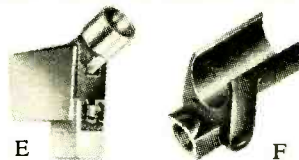

All these accessories available for complete modular flexibility: [A] *Model CC10 Cable Adapter* with 18' cable, \$6.00. [B] *Model PA10 Cannon Plug Adapter*, \$6.30. [C] *Model SP10 Cannon Plug Adapter* with switch, \$6.90. [D] *Model CA10 Cannon Plug and Cable* with push/action latch-lock and 18' cable, \$6.00. [E] *Model SSP10 Stand Adapter* with switch and receptacle for cannon plug, \$11.10. [F] *Model SA10 Slide-on Stand Adapter* \$4.20. All prices professional net. For further details, write Desk J-11, University Loudspeakers, Inc. 80 S. Kensico Ave., White Plains, N. Y. A Division of Ling-Temco Electronics, Inc.

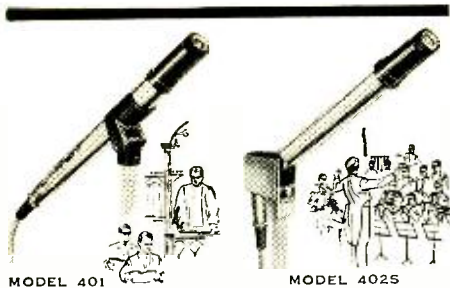

MODEL 401 OMNI-DIRECTIONAL DYNAMIC
Professional broadcast microphone for diversified broadcast applications. Also ideally suited for every quality sound system: night club, church, school, commercial and industrial p.a. Exclusive "Unilar" diaphragm. Response: 40-20,000 cps. \$43.50 professional net.*

MODEL 402S OMNI-DIRECTIONAL DYNAMIC (SHOCK MOUNTED) Deluxe version of Model 401, shock-mounted to prevent mechanical feedback and pickup of spurious noise. Response: 35-20,000 cps. Otherwise identical in performance to Model 401. Exclusive "Unilar" diaphragm. \$47.70 professional net.*

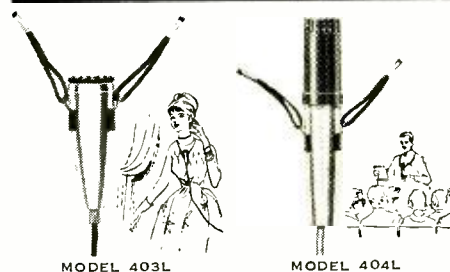

MODEL 403L TELEVISION LAVALIER
Extremely rugged professional lavalier only 3 1/2" long... for telecasting, broadcasting and recording where uncompromised quality reproduction, minimum weight and unobtrusiveness are required. Performance factors exceed previous lavalier microphone standards. Exclusive "Unilar" diaphragm. Over-all response: 60-20,000 cps. \$52.50 professional net.

MODEL 404L BROADCAST LAVALIER
Designed for exacting broadcast applications requiring specifications of the large omni-directional microphones. For the first time, a lavalier microphone that exceeds performance of full-size units, yet is only 4 1/4" long, 1-3/32" in diameter. Exclusive "Unilar" diaphragm. Over-all response: 50-20,000 cps. \$57.00 professional net.

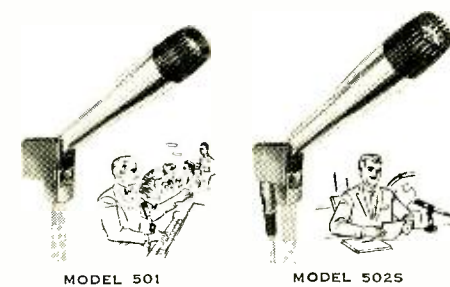

MODEL 501 PROFESSIONAL DYNAMIC CARDIOID Finest quality full-range reproduction under diverse acoustic conditions. Cardioid pattern rejects unwanted background noises and room reverberations, allowing non-critical placement of microphone. Exclusive "Unilar" diaphragm. Response: 35-15,000 cps. \$75.00 professional net.*

MODEL 502S PROFESSIONAL DYNAMIC CARDIOID (SHOCK MOUNTED) A deluxe shock-mounted microphone designed to prevent mechanical feedback and pick-up of spurious noise. Response: 30-16,000 cps. Otherwise identical in performance to Model 501. Exclusive "Unilar" diaphragm. \$87.00 professional net.*

*microphone only.



double-check your polarity at the transistor sockets. The p-n-p transistor (V1) collector pin connects to load resistor R3, and R3 connects to the negative voltage source. The n-p-n transistor (V2) collector pin goes direct to ground (which is positive). Reverse

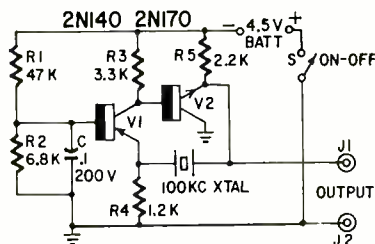

- R1—47,000 ohms
- R2—6,800 ohms
- R3—3,300 ohms
- R4—1,200 ohms
- R5—2,200 ohms
- All resistors: 1/2 watt, 10%
- C—0.1 µf, 200 volts
- XTAL—100 kc
- V1—p-n-p transistor (2N140)
- V2—n-p-n transistor (2N170)
- J1, J2—phone-tip jacks
- BATT—4.5 volts (3 penlight cells in series)
- S—spst toggle
- Transistor sockets (2)
- Box or case to contain oscillator
- Battery holders
- Phenolic board (chassis)
- Miscellaneous hardware

Fig. 1—Schematic. Green and orange paint is used to color code the transistor sockets.

these connections and the circuit will not oscillate. In the model the sockets were color-coded; V1's socket was given a dot of orange paint, V2's a dot of green.

Oscillator output is taken from the emitter of V2 and ground. A pair of tip jacks serve as the output terminals in the model. Since these terminals are connected to the battery through R5, shorting the output terminals will draw 2 ma from the battery. The oscillator operates at a low power level, 6 mw. This provides a long life expectancy for all components. No adjustments are needed to put unit into operation. Carefully check all wiring, connect a scope across the output terminals and turn on the power with switch S. The approximate waveshape is shown in Fig. 2. If a scope is not available, turn on the oscillator and place it close to a broadcast receiver. Beats and whistles will be heard as the receiver is tuned across the low end of the band. The frequency of the output will be very close to 100 kc. If a crystal which is

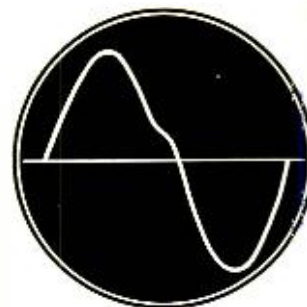

Fig. 2—Output waveform with 100-ke crystal and 2N140 and 2N170 transistors used in the oscillator.



Front view of unit. Power switch is located on top of wooden box.

ground to be used in a series-resonant circuit is purchased, the ultimate frequency accuracy will depend on the crystal's frequency tolerance and the temperature at which it is operated. For high-order precision, some form of oven with automatic temperature control is needed. Such a system is beyond the scope of this article.

The original oscillator with the 2N140 and 2N170 transistors will work with crystals in the range of 70 kc to 400 kc. If a sawtooth output is required, substitute a paper capacitor for the crystal.

A standard headphone in series with a 0.1-µf capacitor and connected in place of the crystal, makes the unit a handy code oscillator (key the unit at one of the battery leads). Use the unit as a high-gain low-level amplifier by connecting an input coupling capacitor to the emitter of V1 and leaving out the crystal. Take output from J1 and J2. END

A NEW COMPLAINT

We at Howard's Television (1070 A St., Hayward, Calif.) thought we had heard everything in the nature of complaints from ingenious customers, but this was a new one to be added to a long list.

My husband gave a Mr. S. an estimate of \$10 to repair his set. Mr. S. went away happy. He asked for the bill after he had picked up his set. He glanced down at it. Then his face and body bristled. "What's the idea of this bill for \$10?" he challenged me.

I was puzzled and reminded him, "I

was right here and heard my husband give you an estimate of \$10. You knew that the bill would be \$10 before you left your set."

He set his face in harder lines. "Yeah, I know. That was just an estimate. It would never happen in a million years that the bill would come out exactly at the estimate. Might be \$9.99, or \$10.35 maybe, but \$10, never!"

Angry color flooded his face as he grudgingly paid the bill and went away muttering, "\$10! Never in a million years!"—Myrtle Spracklen

**CREI's Extension Division offers Engineering Technicians and Engineers a combination of courses in advanced electronic engineering technology.*

**The program is designed to meet your present and future employment requirements and to increase your professional status and earning power.*

-this CREI College-level Home Study Program in Electronics is Comparable in Technological Content to Advanced Residence Courses!!!!

The CREI home study program is the culmination of 33 years of working closely with leading companies and Government agencies in the critical field of electronics. This accredited program is designed for men already employed in a technical capacity in the electronics industry.

This CREI college-level program is comparable in technological content to advanced residence courses. You may complete the program in 2 to 4 years, depending on the amount of free time you can devote to study, and the courses you choose.

For several years the electronics industry has suffered a serious shortage of technical personnel with

modern advanced education, and there is every indication that this shortage will increase in the years ahead. New jobs are being created daily through the application of electronic developments in missiles, space exploration, automation, instrumentation, computers, telemetering and many other fields. These positions must be filled by men with modern advanced education, which fact is evidenced by the experience of the CREI Placement Bureau, where the demand for graduates and advanced students far exceeds the supply. It is of interest to note that Help Wanted ads frequently specify "CREI education or equivalent."

CREI is recognized by industry and government

Another reason why CREI men are respected and eagerly sought by industry and Government agencies alike is the accreditation and enthusiastic approval accorded the CREI home study program in advanced electronics. We co-founded the National Council of Technical Schools, and we were among the first three technical institutes whose curricula were accredited by the Engineers' Council for Professional Development. Further, the U.S. Office of Education lists CREI as "an institution of higher education."

Of equal importance, we believe, is the appreciation expressed by industry and government for the CREI programs. Dozens of major electronics organizations, ranging from industrial giants to the Government's Voice of America, have agreements with CREI for enrollment of students under company sponsorship. U.S. Navy electronic personnel in the number of 5,240 are enrolled in CREI extension programs. The British Royal Air Force, Army and Navy have approved CREI courses under their tuition assistance plan. The following companies comprise only a partial list of the organizations which not only recommend CREI study but actually, in many cases, pay all or part of the tuition for employees taking CREI courses:

National Broadcasting Company
Jerrold Electronics Corporation
Pan American Airways
Radio Corporation of America
Canadian Aviation and Electronics
Federal Electric Corporation
The Martin Company
Voice of America
Canadian Broadcasting Corporation
Northwest Telephone Company
Commercial Cable, Incorporated
Canadair Limited
Columbia Broadcasting System
All America Cable and Radio
Canadian Marconi
Mackay Radio
United Air Lines
Gates Radio Company
Mohawk Airlines
Florida Power and Light Company

RESIDENCE SCHOOL

... in Washington, D.C., for those who can attend classes. Day and evening classes start at regular intervals. Graduates earn AAS degree in 27 months. Electronics experience is not required for admission.

QUALIFICATIONS FOR CREI ENROLLMENT FACTS ABOUT TUITION, REGISTRATION

If you have a high school diploma or equivalent, basic electronic training and practical experience in electronics, you meet the minimum requirements for enrollment. Tuition is reasonable and may be paid monthly, if you wish. Veterans qualify for this program under the GI bill.

Over 20,500 CREI students find home study convenient and profitable

You can pursue the CREI program while you continue your regular full-time job. You study at home during hours chosen by you. You are not rushed and you have plenty of time to do your best.

The courses are prepared in easy-to-understand format, and the CREI staff of experienced instructors guides your progress all along the way. These instructors stand ready to assist you whenever you need help. You will find our personal assistance and guidance efficient and helpful, because 33 years of experience in home study teaching enables us to anticipate questions in our lesson material.

Many CREI students have learned that they do not have to wait until they have completed the program to realize significant improvement in their status and income. The very fact that you are ambitious enough to pursue this college-level program enhances your opportunities for rapid promotion. Project leaders and supervisors recognize the value of CREI education.

How you benefit from CREI program of home study

CREI students are electronic engineers and technicians engaged in every phase of electronics. They are in research laboratories and manufacturing plants. They work on the design, development and production of the latest computers; on the latest military and civilian aircraft; on the electronic equipment associated with the Nation's missiles and space exploration efforts; on communications equipment of all kinds; they maintain electronic equipment for the air lines, the Government and private corporations. You will find CREI students in all 50 States and in most foreign countries of the free world.

To the serious-minded and ambitious CREI student our home study program offers a series of important benefits:

1. You gain a solid college-level education in advanced electronic engineering technology; you keep abreast of continuous new developments in the field.
2. You can gain higher status and enjoy the increased respect of your associates.
3. You facilitate more rapid professional advancement with corresponding significant increases in pay.
4. You gain the personal satisfaction that comes from working and communicating intelligently with your technical colleagues and superiors.

WRITE FOR DETAILED 44-PAGE BOOK of curricula and other information about CREI, entitled "Insurance for Your Future in the New World of Electronics." USE POSTAGE-PAID CARD ATTACHED, or write to Dept. 1411-G.

The Capitol Radio Engineering Institute

ECPD Accredited Technical
Institute Curricula
FOUNDED 1927

3224 16th Street, N.W.
Washington 10, D.C.

Dept. 1411-G



FREE!

Olson Radio Catalogs FOR ONE YEAR

- ★ 8 Different Issues
- ★ All Bargain Packed



FREE One Year Subscription to OLSON RADIO'S Fantastic Bargain Packed Catalog—Unheard of LOW, LOW WHOLESALe PRICES on Brand Name Speakers, Changers, Tubes, Tools, Hi-Fi's, Stereo Amps, Tuners and other Bargains.

Another OLSON Bargain!

NEW! TUBE TESTER



★ Made in U.S.A.

FACTORY WIRED
No. TE-148 \$18.83

KIT FORM
\$14.83
No. KB-92

Olson Radio brings you the smallest lowest priced domestic tube tester on the market. Only 6 3/4" w x 2 1/2" d x 5 1/4" h. Not just a filament checker, but a real tube tester that checks each section of multi-purpose tubes for quality of emission and inter-element shorts. Tests for opens and intermittents also. Checks all miniature 7 and 9 pin tubes plus 8 pin octals and 8 pin locals. Quality of emission is indicated on easy to read 2" meter with 2 color dial. 10 switches select individually each element so that short tests can be made easily and quickly. Neon lamp indicates shorts. This tube tester will also test ballast tubes and voltage regulator tubes. Operates on 117 volts AC. Completely flexible and obsolescent proof. Comes with instructions and tube charts.

Picture Tube Test Adaptor.....No. TE-149.....Ea. \$3.83

MAIL COUPON TODAY

Fill in coupon below for your FREE one year subscription to Olson's Bargain Packed Catalog. To order Tube Tester, simply check wired or kit model (also Adaptor if desired) and send remittance along with coupon. (Include enough for postage or parcel post shipment. Send \$2.00 deposit for C.O.D. orders.)

- FREE Olson Catalogs for One Year
- Tube Tester Kit No. KB-92.....\$14.83
- Tube Tester Wired No. TE-148 \$18.83
- Picture Tube Test Adaptor
No. TE-149.....\$ 3.83

NAME _____
ADDRESS _____
CITY _____ ZONE _____ STATE _____

OLSON RADIO CORPORATION

713 S. Forge St., Akron 8, Ohio

6E5 for TRANSISTOR CIRCUITS

Simple dc-to-dc converter lets you add an indicator tube to your all-transistor devices

By RUFUS P. TURNER

YOU don't have to do without an electron-ray indicator in low-voltage, battery-operated equipment such as transistor receivers, amplifiers and test instruments. The indicator can be operated by an all-transistor converter circuit.

The diagram shows a circuit for operating a 6E5 indicator tube from a 6-volt battery tapped at 3 volts. The tube's heater receives the full 6 volts, while 3 volts drives the converter circuit which supplies the high dc voltage for the plate and target.

The voltage stepup is provided by a 6.3-volt filament transformer, T. Two 2N255 transistors (V1, V2) and two 10-ohm 1-watt resistors (R1 and R2) form an oscillator circuit with the transformer's center-tapped 6.3-volt winding.

The high ac voltage delivered by the transformer's 117-volt winding is rectified and doubled by two miniature

selenium rectifiers (RECT 1 and RECT 2) and two 50- μ f 150-volt electrolytic capacitors (C1 and C2). The full-load dc output voltage of this circuit is approximately 100.

The battery can be four 1.5-volt dry cells in series. If a storage battery is used, the tap can be at 4 volts (two cells) instead of the specified 3 volts. For short-term use, as in bridge balancing, signal tracing, etc. where the device is in operation only a few minutes at a time, four size-D flashlight cells will do. END

- R1, 2—10 ohms, 1 watt
- R3, 4—1 megohm, 1/2 watt
- C1, 2—50 μ f, 150 volts, electrolytics
- RECT 1, 2—selenium, 130 volts, 20 ma. miniature (Federal 1159 or equivalent)
- S1—dpst toggle
- T—filament transformer: primary, 117 volts; secondary, 6.3 volts ct, 1 amp (Merit P-2944 or equivalent)
- V1, 2—2N255
- V3—6E5
- Sockets, 9-pin miniature, for 2N255's (2)
- Socket, 6 pin, for 6E5
- Chassis, to suit
- Miscellaneous hardware

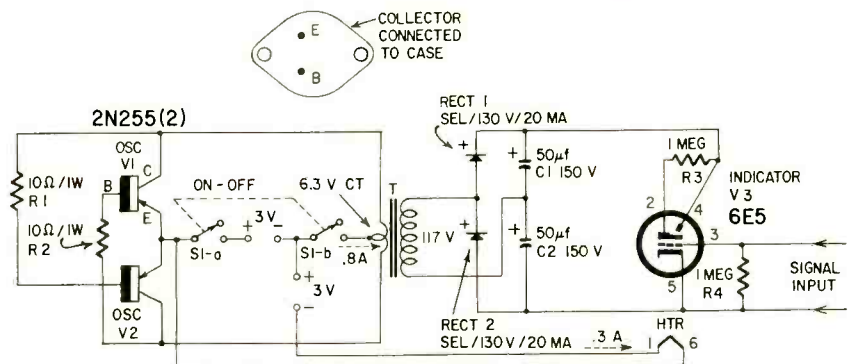

Indicator circuit for all-transistor instruments.

AMPLIFIER TEST-LOAD BOX

If your shop handles an appreciable amount of audio amplifier servicing, you may find this idea helpful. To save time often wasted looking for the correct resistor with a power rating sufficient to be used as an amplifier output load, I constructed a variable output-load box. I mounted a 25-ohm 100-watt potentiometer (Ohmite K0148) in a small plastic parts box, added a bar knob and calibrated the pot with an ohmmeter for all the common output impedances encountered in audio work. A pair of short leads with alligator clips were soldered to the pot

in conventional rheostat fashion. Holes for the leads were made in the plastic box with the tip of a hot soldering iron and the edges smoothed off with a file.

When an amplifier is to be instrument tested, the load box is simply clipped across the output terminals and adjusted for the correct load. Although a noninductive resistance should be used, I have found that the load box is satisfactory for most tests because frequency response is usually not affected until the frequencies of the signal being tested approach 100 kc.—Warren J. Smith

new PATENTS

ADDER

Patent No. 2,937,286

T. H. Bonn and J. P. Eckert, Jr., Philadelphia, Pa. (Assigned to Sperry Rand Corp.)

This adder provides output only when one of its two inputs is energized. Such a device is useful in binary counting. For example, adding 1 plus 1, or 0 plus 0, should (disregarding the carry) give zero. Adding 1 plus 0 should give 1. This adder requires no operating power. It is comprised of a transformer and diodes.

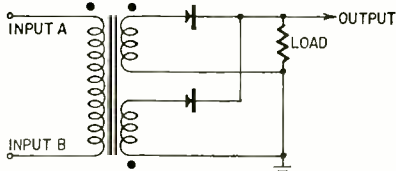

Assume that a pulse exists at input A only. Current flows through the primary using input B as the return path. The secondaries are oppositely wound (note dots) so one will pass current, depending upon which diode permits it. On the other hand, no output exists when signals are present at both A and B due to cancellation.

V-R TUBE CIRCUIT

Patent No. 2,944,206

Charles B. Brahm, Windsor Locks, Conn. (Assigned to United Aircraft Corp., E. Hartford, Conn.)

The firing voltage of a VR tube is higher than its regulating voltage. For example, the OA3 fires at 105 volts and regulates at 75 volts. In a conventional circuit (Fig. 1), we want R to be

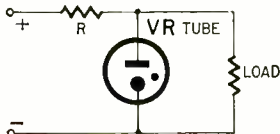

Fig. 1

small to permit firing, but it should be large to limit current to that required by load and tube.

In the new circuit (Fig. 2), R1-R2 form a divider that delivers slightly more than regulated voltage across the load. R2 is chosen for minimum VR current through the tube (5 ma).

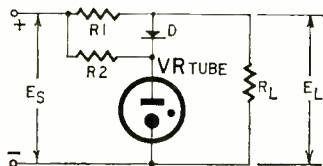

Fig. 2

When the circuit is switched on, EL drops to approximately the regulated voltage, while full Es is available to fire the voltage regulator through R2. This is possible because diode D remains blocked. After firing, D allows a small current flow through the VR tube. Thus lower supply voltages may be used.

MISSILE MEASUREMENTS

Patent No. 2,944,250

John R. Outt, Malvern, Pa. (Assigned to General Electric Co.)

This invention uses solar cells to study conditions in space. Solar battery BATT 1 is

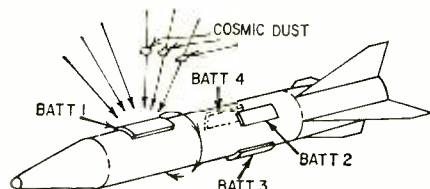

NOVEMBER, 1960

American Motel MAGAZINE

SURVEY on TELEVISION in MOTELS reports...



JERROLD

FACT: More TV Master Antenna Systems Have Been Installed Than The Next 4 Makes Combined!

While the survey shows a tremendous acceptance of Master Antenna Systems—56% of the Motel operators report having one—there is still an overwhelming segment of the market yet to be sold! And construction of new Motels—new markets—is progressing at a faster-than-ever pace!

Look to Jerrold—the leader in Master TV Antenna Systems—to help you get your share of this profitable business. The top portion of this advertisement is now appearing in AMERICAN MOTEL MAGAZINE... doing a strong "pre-selling" job on your Motel prospects!

And remember—your trained Jerrold distributor is always ready to show you how to plan and install Master Antenna Systems quickly, easily, profitably.

Yes, look to Jerrold—the world's largest manufacturer of TV distribution systems and equipment. It's the profitable thing to do!

FREE! Valuable Installation Handbook...

A complete "How-to-do-it" manual—normally selling for \$1—that covers almost every conceivable type of installation. Included are 150 typical system layouts in detail.



Jerrold Electronics Corporation
Distributor Sales Division
Dept. Ids-92, Philadelphia 32, Pa.

Gentlemen:
Please send me the "TV Distribution Handbook." I am enclosing 25c to cover handling costs and postage.

Name _____
Firm _____
Address _____
City _____ Zone _____ State _____

JERROLD

ELECTRONICS CORPORATION, Phila. 32, Pa.

Jerrold Electronics (Canada) Ltd., Toronto
Export Representative: CBS International, New York 22, N.Y.

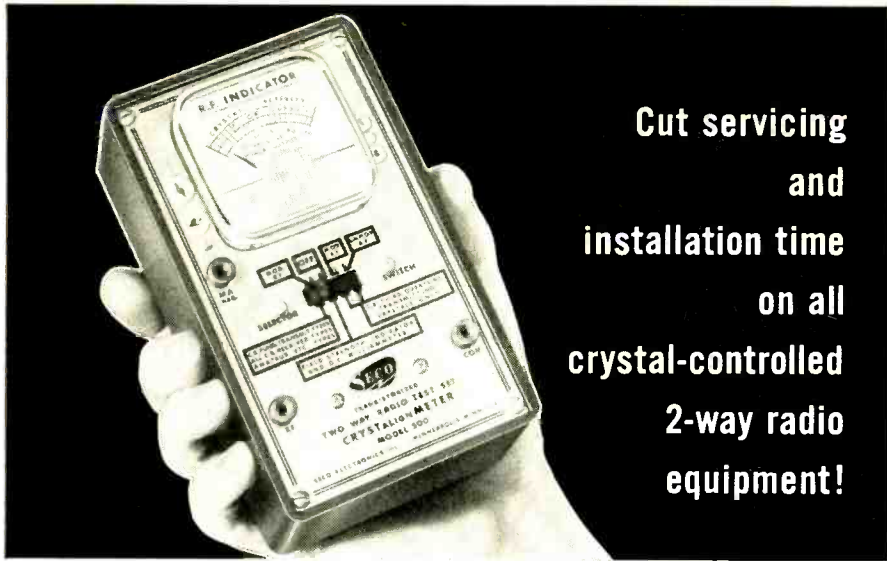

Cut servicing
and
installation time
on all
crystal-controlled
2-way radio
equipment!

SECO 2-WAY RADIO TEST SET

Compact, portable, use it anywhere. Designed to assist you in the following applications:

- CHECKS WIDE RANGE OF CRYSTAL TYPES! Checks fundamental types at fundamental frequency—5th and 7th overtone types at fundamental frequency—3rd overtone types in 25-30 mc range in special overtone circuit.
- RF POWER INDICATOR FOR DIRECT OR REMOTE METERING! Simply place next to antenna or use 15 ft. remote metering cable furnished with unit.
- MODULATED RF CRYSTAL-CONTROLLED SIGNAL GENERATOR!
- MODULATION CHECKER! • BEAT FREQUENCY DEMODULATOR!
- PLATE MILLIAMMETER FOR RF TUNING! • AUDIO FREQUENCY SIGNAL GENERATOR!

MODEL 500—Fully transistorized—the perfect "assist" instrument even for the fully equipped shop. **\$29.95 NET**



GCT-9W

GCT-9S

ONLY GRID CIRCUIT TUBE TESTER WITH FULL TV TUBE COVERAGE!

Complete coverage all TV tube types—including voltage amplifiers, power output and heater-type diodes, hundreds of Foreign and Industrial types, types with Grid, Plate or Cathode caps. Test for Grid Emission, Leakage, Shorts and Gas in one operation—indicates results instantly. Offers two exclusive new tests: 1. Cathode Continuity Check; and 2. Complete Inter-Element Short Test, with shorts identified to pin numbers. Wired and factory tested in sturdy metal case (GCT-9S) or portable carrying case (GCT-9W)—with easy to read tube set-up data and "Piggy-Back" caddy adapter.

MODEL **\$32.95 NET** MODEL **\$34.95 NET**
GCT-9S GCT-9W

WRITE TODAY!

NEW LITERATURE AND SPECIFICATIONS AVAILABLE ON ALL SECO TEST EQUIPMENT.



SECO ELECTRONICS, INC.
5015 Penn Ave. So. • Minneapolis 19, Minn.

EAST CANADA: Daveco Agencies, Ltd., Montreal, Quebec WEST CANADA: Ron Merrill Co., Vancouver 1, B. C.

situated near the nose cone of a high-speed missile. The missile rolls during flight, so the sun's rays reach the cell periodically. Therefore ac is generated, its frequency being equal to the roll rate of the missile.

BATTERIES 2, 3 and 4 are connected in series, so the sun always shines on at least one. Their output will be nearly constant. However, it gradually decays due to the sandblasting effect of tiny meteors.

Since cell output is high, no amplifiers are needed. The voltage information may be transmitted by radio as usual, to indicate roll rate and meteor activity.

RADIATION DETECTOR

Patent No. 2,942,110

Kurt Lehavec, S. Williamstown, Mass. (Assigned to Sprague Electric Co., N. Adams, Mass.)

No batteries are used here. The radiation sensor is a barrier-layer cell, sensitive to beta

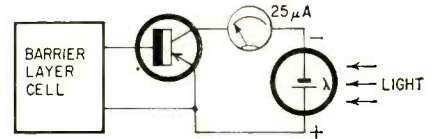

rays. Output is about 1 microamp, which is amplified by the transistor. A solar cell powers the transistor. The meter should have a maximum deflection of 25 ma.

DIRECT-COUPLED AMPLIFIER

Patent No. 2,936,345

John F. Kinkel, Altona, Calif. (Assigned to Bell & Howell Co., Chicago)

This amplifier handles high power for motors, servos, etc. V1, has a high amplification factor and is coupled to V2, a low-plate-resistance tube. They form one channel. A second channel, made up of V3 and V4, is identical with the first. However, V2 and V4's currents flow in opposite directions through the load.

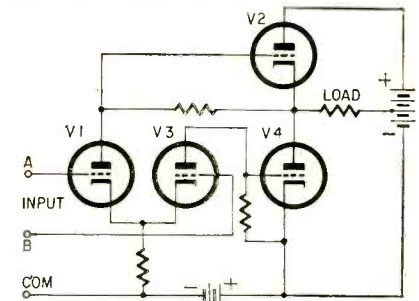

Normally V1 and V3 are blocked and V2 and V4 are conducting, but load currents cancel. A positive signal at A causes V1 to conduct, lowering the output from V2, and power is fed to the load. Likewise, a positive signal at B reduces V4 conduction and results in power at the load, this time of opposite polarity.

The input signal determines whether V2, V4 or both will conduct and how much. END



QUIETROLE LUBRI-CLEANER

The first of its kind and still best for silencing noisy controls and switches in TV, Radio & all Electronic Equipment.

Spray it or Drop it

Just Press and whoosh . . . aerosol QUIETROLE quickly and easily cleans as it lubricates.

• Or, if you prefer, use this handy eye-dropper and just a drop or two of quality QUIETROLE does the job perfectly.

Either way, make sure it's QUIETROLE

QUIETROLE Company, Inc.

Spartanburg, South Carolina



In Canada: CROSS CANADA ELECTRONICS
67 Ontario St., S., Kitchener, Ont.

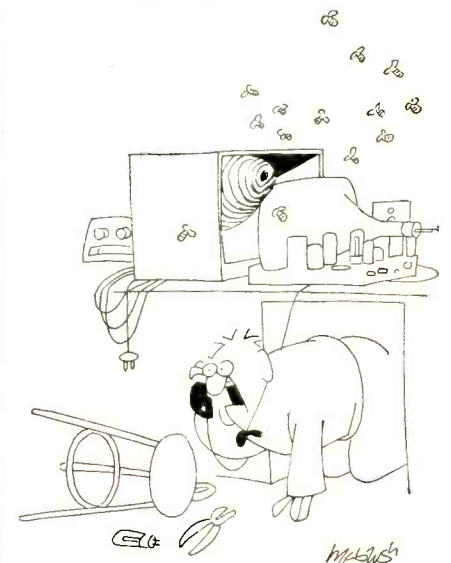

"I was wrong. It is *not* sync buzz!"



PUZZLED

...no need to be

look to this sign of assurance!

The Distributor displaying this sign will solve your tuner problems at a profit to you.

He has available the New Standard Tuner Replacement Guide, including replacement parts listings. This is the only Guide of its kind in the world. Covers all Standard tuners produced through 1959. Includes replacements for many tuners not produced by Standard. He handles our 48-hour Factory Guaranteed Repair Service and Trade-In Allowance on unrepairable Standard tuners.

See This Authorized Distributor Today



standard kollman

INDUSTRIES INC. Formerly Standard Coil Products Co., Inc.
2085 N. HAWTHORNE AVENUE, MELROSE PARK, ILLINOIS

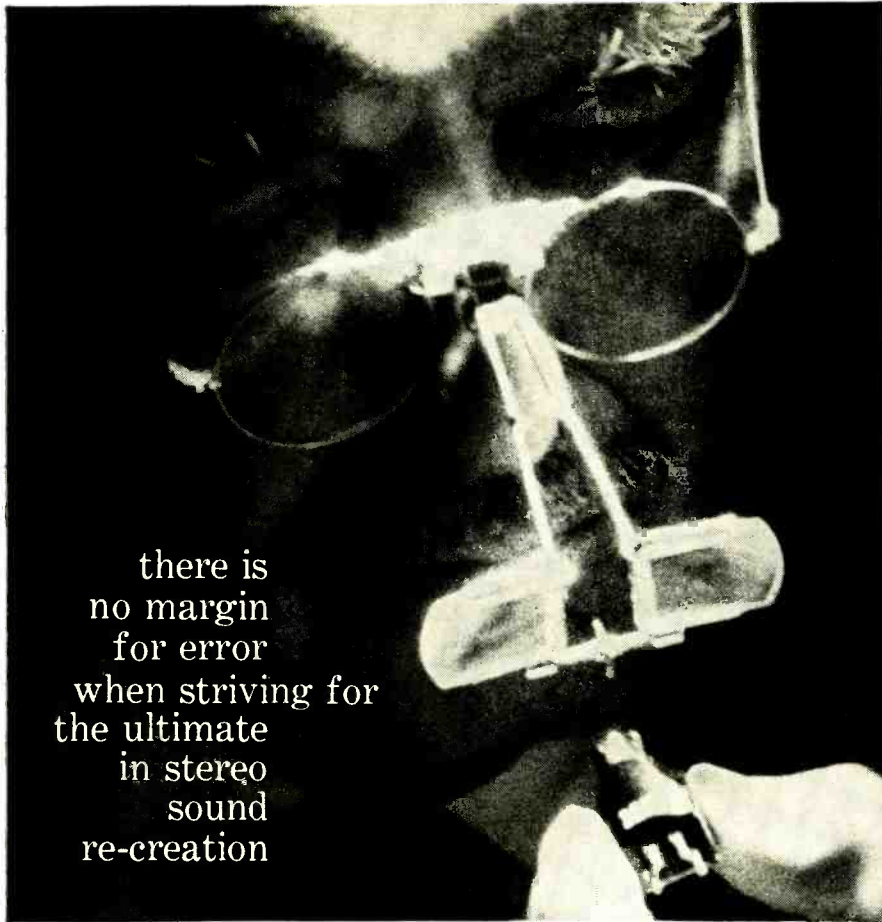

there is
no margin
for error
when striving for
the ultimate
in stereo
sound
re-creation

SHURE

Stereo Dynamic

HI-FI PHONO CARTRIDGES

Tiny though it is, the cartridge can make or break a stereo system. For this breath-takingly precise miniaturized electric generator (that's really what it is) carries the full burden of translating the miles-long undulating stereo record groove into usable

electrical impulses... without adding or subtracting a whit from what the recording engineer created. Knowing this keeps Shure quality standards inflexible. Shure Brothers, Inc., 222 Hartrey Avenue, Evanston, Illinois.

CARTRIDGES

- Standard M8D. A superb blend of quality and economy. . . . \$16.50
- Custom M7D. Widely acclaimed; moderately priced. . . . \$24.00
- Professional M3D. Overwhelming choice of the critics. . . . \$45.00
- Laboratory Standard Model M3LS. Individually calibrated, limited quantity \$75.00



TONE ARMS

- Studio Dynamic. Integrated arm and cartridge. Cannot scratch records. \$89.50
- Professional Independent Tone Arm. For any quality cartridge . . . stereo or mono. \$29.95

new PRODUCTS



FM TUNER KIT, LT-10. Wide-band. Silver-plated. Preamsembled, prealigned front end. Tube sockets, terminal strips and transformers premounted. Carrying case with handle opens to make work table. Full-color instruction book with



part charts for mounting in order of use. Color-coded, precut, prestripped and pretinned wires. Built-in-kit meter aligns tuner.—H. H. Scott, Inc., Dept. P, 111 Powdermill Rd., Maynard, Mass.

STEREO PREAMP M65. Extra voltage and equalization for operation of magnetic cartridge with amplifier de-

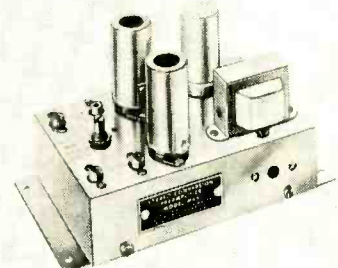

signed for ceramic. Single rotary switch for function selection. Operates from 117-volt 60-cycle outlet. Dual input and output jacks accepting standard phono plugs.—Shure Bros., Inc., 222 Hartrey Ave., Evanston, Ill.

BASS-REFLEX ENCLOSURE KIT Model 7. Adjustable port. Mounting cut-outs for 15-, 12-, 8½-, 8-inch speakers

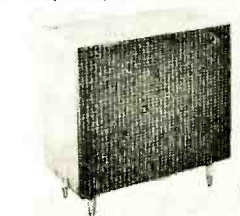

and most tweeters. ¾-inch birch veneer. Installed acoustic damping material. Fullface grille cloth. 29 x 28 x 16 inches.—Homewood Industries, 26 Court St., Brooklyn, N. Y.

SPEAKER SYSTEMS. TR-30 Triette, complete 3-way system: 12-inch Flexair woofer for response to 25 cycles; frequency range 20 cycles to be-

RADIO-ELECTRONICS

Glidelite
ILLUMINATED MAGNIFIER . . .

An Ideal Tool for EVERY Inspection Requirement!

Provides

- Distortion-Free Magnification
- Uniform Glare-Free Lighting

•45 MAG with bracket as shown **\$37.50**

22 watt G.E. Circline Tube **3.50**

Available in Grey & Green

GLIDELITE FEATURES INCLUDE:

- LARGE LENS—5" diameter ground and polished lens.
- REFLECTOR SWIVELS—can be rotated in a complete circle, tilted up and down.
- PROPERLY TENSIONED SPRINGS—provide exact balance. Magnifier stays put . . . both your hands are free!
- ARMS ROTATE in full circle around base.
- DOUBLE CLAMP— for clamping securely.

GLIDELITE

11 Moonachie Road, Hackensack, New Jersey

Please send me the name of my nearest GLIDELITE distributor and FREE illustrated literature.

NAME.....

ADDRESS.....

CITY..... STATE.....



yond audibility with crossover points at 900 and 6,000 cycles; power rating 30 watts (60 peak); impedance 8 ohms. **GALAXY III** (shown), complete stereo speaker system: bass-center unit and 2 satellites; 12-inch Flexair woofer reproduces bass up to 350 cycles from both channels; 2 satellites, each containing special elliptical speaker for 350-4,000-cycle range and compression tweeter for 4,000 cycles to beyond audibility, spaced from 8 to 20 feet. **TF-3**, 4-speaker 3-way system: 10-inch long-travel Flexair woofer for bass response to 25 cycles; 2 mid-range units take over from 2,000 to 10,000 cycles; spherical sector super-tweeter extends response to beyond audibility.—**Jensen Mfg. Co.**, 6601 S. Laramie Ave., Chicago 38, Ill.

SPEAKER SYSTEM, Medallion XXI. 3-way. 12-inch high-compliance woofer. 8-inch mid-range speaker for 500 to 3,-



000 cycles. Super tweeter with 40,000-cycle range. Linear flat 28 to 22,000-cycles. 24 x 17 x 12½ inches. 4 finishes or unfinished. Snap-on frames for enclosure to give Swedish Modern, Modern, Colonial and Italian and French Provincial stylings.—**University Loudspeakers, Inc.**, 80 S. Kensico Ave., White Plains, N. Y.

SPEAKER SYSTEM model SK-181. Specially designed speaker in rear-loaded reflex type enclosure. Response

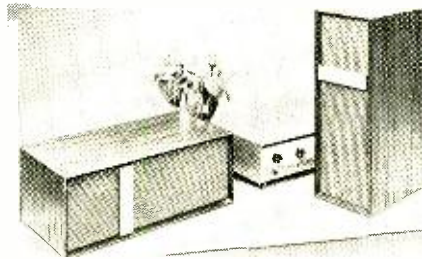

100 to 12,000 cycles. Impedance 8 ohms, rated at 10 watts. Finished in walnut on four sides. 15¼ x 5¾ x 8¼ inches. 6-foot cable and phone plug.—**Lafayette Radio Corp.**, 165-08 Liberty Ave., Jamaica 33, N. Y.

SPEAKER model S-394 Thin-Line



series. Mounts flush on wall or ceiling. 60-13,000-cycle response. 8-ohm voice coil. Speaker 6 inches. Overall depth 3 inches. Dull gold.—**Olson Radio Corp.**, 260 S. Forge St., Akron, Ohio.

HI-FI KITS. Citation III, professional FM tuner (shown): completely factory-assembled FM cartridge embodies most of critical tuner elements; Nu-vistor tube in front end; 2-stage audio circuit; charcoal brown and gold; walnut enclosure. **Citation IV**, stereophonic preamp; separate bass and treble tone controls for each channel; dc on all heaters; low noise resistors in critical places; 0 to infinity balance control; military type terminal boards; charcoal brown and brushed gold; walnut enclosure. **Citation V**, 80-watt stereophonic power amplifier: 40 rms per channel with 95-watt peaks; two 7581's per channel output stage; bias meter for

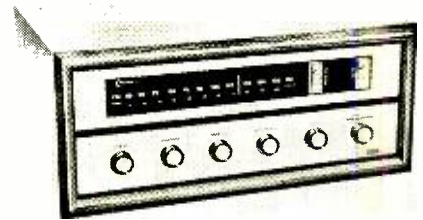

output tube adjustment; 4 hermetically sealed silicon diodes and heavy-duty electrolytic power supply; charcoal brown and brushed gold; metal enclosure.—**Harman Kardon**, 520 Main St., Westbury, N. Y.

RECORD PLAYER. Lesa Model SM5/DU2. 4 speeds. Manual. Stereomonaaural U-type stereo cartridge. Quick-flip switching. Built-in 45-rpm (Continued on page 106)

Just Out

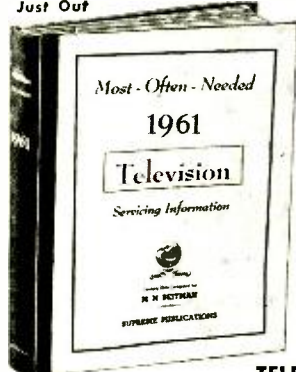

New SUPREME 1961 TV Manual

AMAZING BARGAIN

The new 1961 TV manual is the bargain of the year. Covers all important sets of every make in one giant volume. Your price for this mammoth manual is only \$3. This super-value defies all competition. Other annual volumes at only \$3 each. Factory service material simplifies repairs. Includes all data required for quicker TV servicing. Practically tells you how to find each fault and make needed repair. More pages, more diagrams, more service data per dollar of cost.

TELEVISION SERVICING COURSE

Let this new course help you in TV servicing. Amazing bargain, complete, only \$3, full price for all lessons. Giant in size, mammoth in scope, topics just like a \$200.00 correspondence course. Lessons on picture faults, circuits, adjustments, short-cuts, UHF, alignment facts, hints, antenna problems, trouble-shooting, test equipment, picture analysis. Special, only..... **\$3**

SIMPLIFIED RADIO SERVICING (Introduction to TV)

Explains how to use comparison method to find most radio faults in minutes. Many practical tests without any equipment. Also several sections on use of instruments. Introduction to TV. Schematics, charts, service hints. Job sheets cover all sets. New edition. Only..... **\$1.50**

RADIO VOLUMES

RADIO DIAGRAMS

SUPREME is your best source for all needed **RADIO** diagrams and service data. Covers everything from the most recent 1960 radios to pre-war old-timers; home radios, stereo, combinations, transistor portables, FM, and auto sets. Sensational values. Only \$2 for many volumes. Every manual has extra large schematics, all needed alignment facts, printed boards, voltage values, trimmers, dial stringing, and helpful hints. Volumes are large in size, 8½x11 inches, about 190 pages. See coupon at right for a complete list of these popular radio service manuals. →

COVERS ALL POPULAR SETS

Here is your service data for faster, easier TV repairs. Lowest priced. Best by comparison. **Supreme TV** manuals have all needed service material on every popular TV set. Helpful, practical, factory-prepared data that will really make TV servicing easy for you. Benefit and save with these amazing values in service manuals. Only \$3 per large, yearly volume.

SIMPLIFIES TV REPAIRS

These giant TV manuals have complete circuits, needed alignment facts, printed boards, servicing hints, production changes, voltage charts, waveforms, and double-page schematics. Here are your authentic service instructions to help you do expert work quicker; and priced at only \$3 per large annual manual. Repair any TV model ever made by having in your shop all 15 volumes as listed in coupon. Your special price for all, only \$40. Or try the new 1961 TV manual to see what an amazing bargain you get for \$3. Send no-risk trial coupon today.



The repair of any television set is really simple with **Supreme TV** service manuals. Every set is covered in a practical manner that will simplify trouble-shooting and repair. This is the help you need to find toughest faults in a jiffy. Most \$3 TV volumes cover a whole year of service material. Now **Television Servicing Course** will aid you in learning TV. Be wise, buy **Supreme Manuals** only once each year instead of spending dollars every week.

NO-RISK TRIAL ORDER COUPON

SUPREME PUBLICATIONS, 1760 Balsam Rd., Highland Park, ILL

- 1960
- 1959
- 1958
- 1957
- 1956
- 1955 Radio Manual, only \$2
- 1954
- 1953
- 1952
- 1951
- 1950
- 1949
- 1948
- 1947
- 1946
- 1942
- 1941
- 1940
- 1926-1938 Manual, \$2.50
- Simplified Servicing, \$1.50

Popular **RADIO** Diagram Manuals at only \$2.50 each..... **\$2.50**
These annual **RADIO** volumes specially priced at only \$2.50 each..... **\$2.50**

THIS GROUP ONLY
\$2 EACH

Rush today TV manuals checked below and Radio manuals at left. Satisfaction guaranteed.

- New 1961 TV Manual, \$3.
- Additional 1959 TV, \$3.
- 1958 TV Manual, \$3.
- Early 1957 TV, \$3.
- Additional 1955 TV, \$3.
- 1954 TV, \$3.
- 1951 TV, \$3.
- New Television Servicing Course, complete... \$3.
- 1960 TV, \$3.
- Early 1959 TV, \$3.
- Additional 1957 TV, \$3.
- 1956 TV Manual, \$3.
- Early 1955 TV, \$3.
- 1952 TV, \$3.
- 1957-58 RCA TV Manual, \$1.50

I am enclosing \$..... Send postpaid.
 Send C.O.D. I am enclosing \$..... deposit.

Name:
Address:



Supreme Publications
Sold by All Leading Parts Jobbers

NOVEMBER, 1960

TUBE TESTER

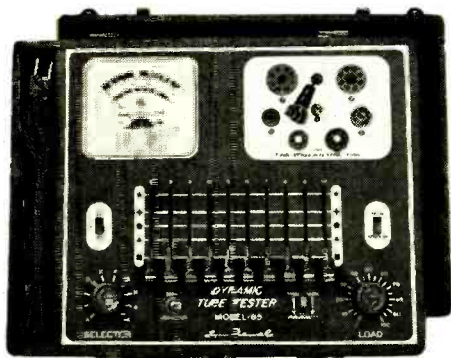

Model 85—Trans-Conductance Tube Tester. Total Price—\$52.50. Terms: \$12.50 after 10 day trial, then \$8.00 monthly for 5 months if satisfactory. Otherwise return, no explanation necessary.

• Employs latest improved TRANS-CONDUCTANCE circuit. Tests tubes under "dynamic" (simulated) operating conditions. An in-phase signal is impressed on the input section of a tube and the resultant plate current change is measured as a function of tube quality. This provides the most suitable method of simulating the manner in which tubes actually operate in radio, TV receivers, amplifiers and other circuits. Amplification factor, plate resistance and cathode emission are all correlated in one meter reading.

• **SYMBOL REFERENCES:** For the first time ever in a trans-conductance tube tester, Model 85 employs time-saving symbols (★, +, ●, ▲, ■) in place of difficult-to-remember letters previously used. Repeated time studies proved to us that use of these scientifically selected symbols speeded up the element switching step. As the tube manufacturers increase the release of new tube types, this time-saving feature becomes more necessary and advantageous.

• **THE "FREE-POINT" LEVER TYPE ELEMENT SWITCH ASSEMBLY** marked according to RETMA basing, permits application of test voltages to any of the elements of a tube. The addition of an extra switch position permits the application of the necessary grid voltage needed for dynamic testing and insures against possible obsolescence due to changes in basing design.

• **NEW IMPROVED TYPE METER** with sealed air-damping chamber provides accurate, vibrationless readings.

• **FREE FIVE (5) YEAR CHART DATA SERVICE.** The chart provided with Model 85 includes easy-to-read listings for over 1,000 modern tube types. Revised up-to-date subsequent charts will be mailed to all Model 85 purchasers at no charge for a period of five years after date of purchase.

• **SPRING RETURN SAFETY SWITCH** guards Model 85 against burn-out if tube under test is "shorted."

• **7 AND 9 PIN TUBE STRAIGHTENERS** have been included on the front panel to eliminate possibility of damaging tubes with bent or out-of-line pins.

• **AN ULTRA-SENSITIVE CIRCUIT** is used to test for shorts and leakages up to 5 megohms between all tube elements.

Model 85 comes complete, housed in a handsome portable cabinet with slip-on cover. Only.....

\$52.50

SUPERIOR'S NEW MODEL 77

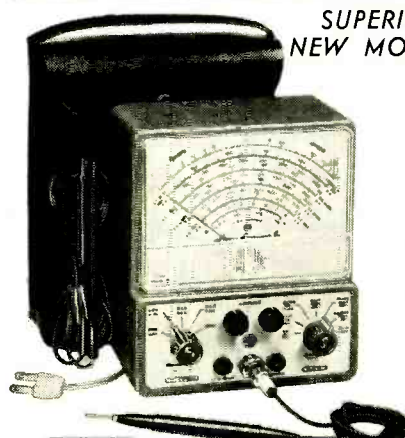

Model 77—VACUUM TUBE VOLTMETER. Total Price \$42.50—Terms: \$12.50 after 10 day trial, then \$6.00 monthly for 5 months if satisfactory. Otherwise return, no explanation necessary!

VACUUM TUBE VOLTMETER

WITH NEW 6" FULL-VIEW METER

Compare it to any peak-to-peak V.T.V.M. made by any other manufacturer at any price

✓ Model 77 completely wired and calibrated with accessories (including probe, test leads and portable carrying case) sells for only \$42.50.

✓ Model 77 employs a sensitive six inch meter. Extra large meter scale enables us to print all calibrations in large easy-to-read type.

✓ Model 77 uses new improved SICO printed circuitry.

✓ Model 77 employs a 12AU7 as D.C. amplifier and two 9006's as peak-to-peak voltage rectifiers to assure maximum stability.

AS A DC VOLTMETER: The Model 77 is indispensable in Hi-Fi Amplifier servicing and a must for Black and White and color TV Receiver servicing where circuit loading cannot be tolerated.

AS AN AC VOLTMETER: Measures RMS values if sine wave, and peak-to-peak value if complex wave. Pedestal voltages that determine the "black" level in TV receivers are easily read.

AS AN ELECTRONIC OHMMETER: Because of its wide range of measurement leaky capacitors show up glaringly. Because of its sensitivity and low loading, intermittents are easily found, isolated and repaired.

Model 77 comes complete with operating instructions, probe and test leads. Use it on the bench—use it on calls. A streamlined carrying case, included at no extra charge, accommodates the tester, instruction book, probe and leads. Operates on 110-120 volt 60 cycle. Only.....

✓ Model 77 uses a selenium-rectified power supply resulting in less heat and thus reducing possibility of damage or value changes of delicate components.

✓ Model 77 meter is virtually burn-out proof. The sensitive 400 microampere meter is isolated from the measuring circuit by a balanced push-pull amplifier.

✓ Model 77 uses selected 1% zero temperature coefficient resistors as multipliers. This assures unchanging accurate readings on all ranges.

SPECIFICATIONS

• DC VOLTS—0 to 3/15/75/150/300/750/1,500 volts at 11 megohms input resistance. • AC VOLTS (RMS)—0 to 3/15/75/150/300/750/1,500 volts. • AC VOLTS (Peak to Peak)—0 to 8/40/200/400/800/2,000 volts. • ELECTRONIC OHMMETER—0 to 1,000 ohms/10,000 ohms/100,000 ohms/1 megohm/10 megohms/100 megohms/1,000 megohms. • DECIBELS—10 db on 0 db = .006 watts (6 mw) into a 500 ohm line (1.73v).

• ZERO CENTER METER—For discriminator alignment with full scale range of 0 to 1.5/7.5/37.5/75/150/375/750 volts at 11 megohms input resistance.

\$42.50 NET

GENOMETER

7 Signal Generators in One!

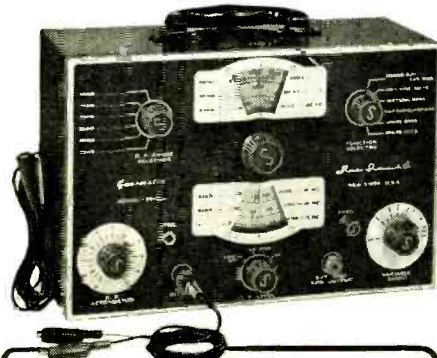

Model TV-50A—Genometer. Total price—\$47.50—Terms: \$11.50 after 10 day trial, then \$6.00 monthly for 6 months if satisfactory. Otherwise return, no explanation necessary!

- ✓ R.F. Signal Generator for A.M.
- ✓ R.F. Signal Generator for F.M.
- ✓ Audio Frequency Generator
- ✓ Bar Generator
- ✓ Cross Hatch Generator
- ✓ Color Dot Pattern Generator
- ✓ Marker Generator

A versatile all-inclusive GENERATOR which provides ALL the outputs for servicing:

A.M. Radio • F.M. Radio • Amplifiers • Black and White TV • Color TV

R.F. SIGNAL GENERATOR: The Model TV-50A Genometer provides complete coverage for A.M. and F.M. alignment. Generates Radio Frequencies from 100 Kilocycles to 60 Megacycles on fundamentals and from 60 Megacycles to 180 Megacycles on powerful harmonics.

VARIABLE AUDIO FREQUENCY GENERATOR: In addition to a fixed 400 cycle sine-wave audio, the Model TV-50A Genometer provides a variable 300 cycle to 20,000 cycle peak wave audio signal.

BAR GENERATOR: The Model TV-50A projects an actual Bar Pattern on any TV Receiver Screen. Pattern will consist of 4 to 16 horizontal bars or 7 to 20 vertical bars.

CROSS HATCH GENERATOR: The Model TV-50A Genometer will project a cross-hatch pattern on any TV picture tube. The pattern will consist of non-shifting, horizontal and vertical lines interlaced to provide a stable cross-hatch effect.

DOT PATTERN GENERATOR (FOR COLOR TV) Although you will be able to use most of your regular standard equipment for servicing Color TV, the one addition which is a "must" is a Dot Pattern Generator. The Dot Pattern projected on any color TV Receiver tube by the Model TV-50A will enable you to adjust for proper color convergence.

MARKER GENERATOR: The Model TV-50A includes all the most frequently needed marker points. The following markers are provided: 189 Kc., 262.5 Kc., 456 Kc., 600 Kc., 1000 Kc., 1400 Kc., 1600 Kc., 2000 Kc., 2500 Kc., 3579 Kc., 4.5 Mc., 5 Mc., 10.7 Mc. (3579 Kc. is the color burst frequency).

THE MODEL TV-50A comes absolutely complete with shielded leads and operating instructions.

\$47.50 NET

➔ **EXAMINE BEFORE YOU BUY!** ➔
USE APPROVAL FORM ON NEXT PAGE

The Model 88.... A New Combination TRANSISTOR RADIO TESTER and DYNAMIC TRANSISTOR TESTER

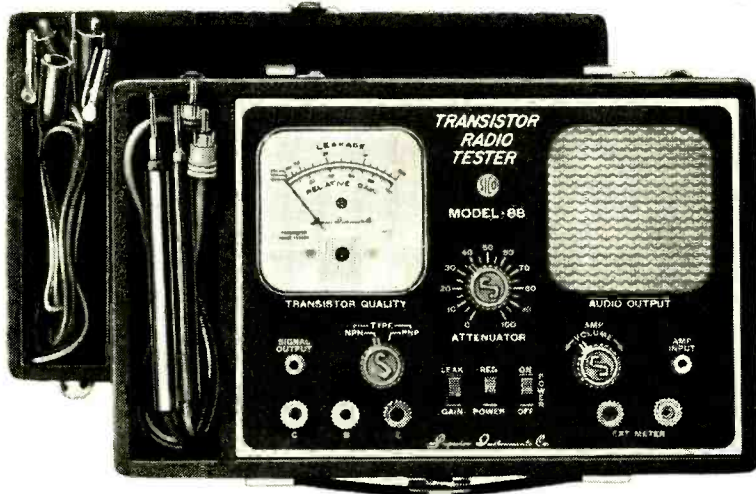

The Model 88 is perhaps as important a development as was the invention of the transistor itself, for during the past 5 years, millions of transistor radios and other transistor operated devices have been imported and produced in this country with no adequate provision for servicing this ever increasing output.

The Model 88 was designed specifically to test all transistors, transistor radios, transistor recorders, and other transistor devices under dynamic conditions.

AS A TRANSISTOR RADIO TESTER

We feel sure all servicemen will agree that the instruments and methods previously employed for servicing conventional tube radios and TV have proven to be impractical and time consuming when used for transistor radio servicing. The Model 88 provides a new simplified rapid procedure — a technique developed specifically for transistor radios and other transistor devices.

An R.F. signal source, modulated by an audio tone is injected into the transistor receiver from the antenna through the R.F. stage, past the mixer into the I.F. Amplifier and detector stages and on to the audio amplifier. This injected signal is then followed and traced through

the receiver by means of a built-in High Gain Transistorized Signal Tracer until the cause of trouble whether it be a transistor, some other component or even a break in the printed circuit is located and pinpointed. The injected signal is heard on the front panel speaker as it is followed through the various stages. Provision has also been made on the front panel for plugging in a V.O.M. for quantitative measurement of signal strength.

The Signal Tracing section may also be used less the signal injector for listening to the "quality" of the broadcast signal in the various stages.

AS A TRANSISTOR TESTER

The Model 88 will test all transistors including NPN and PNP, silicon, germanium and the new gallium arsenide types, without referring to characteristic data sheets. The time-saving advantage of this technique

is self-evident. A further benefit of this service is that it will enable you to test new transistors as they are released!

SPECIFICATIONS:

- ✓ Model 88 operates on a self-contained 4½ volt battery and is always ready for instant use on the bench or in the field.
- ✓ **Signal Injector:**
The signal injector used in the Model 88 is a new departure in signal source design. Previously, signal sources were provided by signal generators operating on a single frequency and requiring retuning. The Signal Injector of the Model 88 employs a transistor in a grounded emitter self-modulating blocking oscillator generating a low R.F. frequency providing stable harmonics to 30 megacycles. A power output of over 2.5 volts peak to peak is provided. An attenuator prevents overload of the receiver or the amplifier under test.
- ✓ **Signal Tracer:**
Two high-gain grounded emitter transistors are utilized in a high gain amplifier with sufficient output to operate the built-in 4½" Alnico V Speaker. A diode is used as a "clamp" to prevent overloading of the output stage. A volume control permits attenuation of strong signals. Provision is also made on the front panel for the addition of a meter or an oscilloscope for quantitative evaluation of the signal strength.

- ✓ **Transistor Tester:**
The transistor tester used in the Model 88 measures the two most important transistor characteristics needed for transistor servicing; leakage and gain (beta).
The leakage test measures the collector-emitter current with the base connection open circuited. A range from 50 ohms to 100,000 ohms covers all the leakage values usually found in both high and low power transistor types.
The gain test (beta) translates the change in collector current divided by the base current. Inasmuch as the base current is held to a fixed value of 50 microamperes, the collector current calibrated in relative gain (beta), is read directly on the meter scale.
The Model 88 will test all transistor types, including NPN or PNP, germanium, silicon, gallium arsenide and the newer diffused junction and mesa types.
Model 88 comes housed in a handsome portable case. Complete with a set of Clip-On Cables for Transistor Testing; an R.F. Diode Probe for R.F. and I.F. Tracing; an Audio Probe for Amplifier Tracing and a Signal Injector Cable. Complete—nothing else to buy!

\$38⁵⁰

SHIPPED ON APPROVAL NO MONEY WITH ORDER — NO C.O.D.

Try any of the instruments on this or the facing page for 10 days before you buy. If completely satisfied then send down payment and pay balance as indicated on coupon. **No Interest or Finance Charges Added!** If not completely satisfied return unit to us, no explanation necessary.

MOSS ELECTRONIC, INC.

Dept. D-820 3849 Tenth Ave., New York 34, N.Y.

Please send me the units checked on approval. If completely satisfied I will pay on the terms specified with no interest or finance charges added. Otherwise, I will return after a 10 day trial positively cancelling all further obligations.

- | | |
|---|---|
| <input type="checkbox"/> Model 85..... Total Price \$52.50
\$12.50 within 10 days. Balance \$8.00
monthly for 5 months. | <input type="checkbox"/> Model 77..... Total Price \$42.50
\$12.50 within 10 days. Balance \$6.00
monthly for 5 months. |
| <input type="checkbox"/> Model TV-50A..... Total Price \$47.50
\$11.50 within 10 days. Balance \$6.00
monthly for 6 months. | <input type="checkbox"/> Model 88..... Total Price \$38.50
\$8.50 within 10 days. Balance \$6.00
monthly for 5 months. |

Name.....

Address.....

City..... Zone..... State.....

All Prices net, F.O.B., N. Y. C.

Export Division: Rocke International Corp., 13 East 40th St., New York 16, N.Y.

BIG, BIG SAVINGS on PARTS from Tee Vee Supply

(Continued from page 103)



spindle. 2-tone colors.—Electrophone & Parts Corp., 530 Canal St., New York 13, N. Y.

TURNTABLE Empire 208. Hysteresis synchronous motor. Belt coupling. Variable 3-speed adjustment. Pushbutton power control. 6-lb. table with double-rim flywheel design. Cushioned



vertical thrust support. Acoustically isolated motor suspension. Satin chrome or gold Swiss finish.—Dyna-Empire, Inc., 1075 Stewart Ave., Garden City, N. Y.

DISC RECORDER, Imperial II. Cuts 6- to 13 1/4-inch master records at 33 1/2 and 78 rpm. Idler and adapter for 45 rpm. Recording-head response 30 to



13,000 cycles. Recording and playback amplifier 20-watt output and 20-20,000-cycle response.—Rek-O-Kut Company, Inc., 38-19 108 St., Corona 68, N. Y.

TAPE RECORDER, RCA MI-35120. 7 1/2, 3 3/4 and 1 7/8 ips. Operates from 117 volts, 60 cycles. 7-inch reel holds 1,200

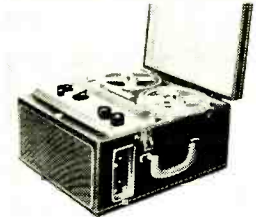

feet standard 1/4-inch tape recording on half tape's width. 2 built-in speakers with output jack for external speaker. 8 1/2 x 14 1/2 x 16 inches. Charcoal gray grained fabric.—RCA, 30 Rockefeller Plaza, New York 20, N. Y.

TONE ARM complete with crystal stereo cartridge *T1 Series*. Plastic with plated finger lift. Compression-type or solid rear mounting post. Wired from cartridge plug through arm with approximately 13 inches additional wire

RADIO-ELECTRONICS

TINY CAPACITOR KIT \$1.89
NEEDED NOW!



50 assorted tiny capacitors in a variety of mfd's and voltages ideal for small electronic assemblies such as transistor sets or other applications. Consists of 35 tiny insulated paper capacitors and 15 ceramic capacitors. All mfd's clearly printed on each. Wt.: 3 oz.

SPRING KIT \$1.49



200 piece spring assortment consists of 8 different types of springs including compression and expansion types commonly used in TV, radio and phonographs. Shipped in a really useful heavy duty plastic box with hinged lid. Wt.: 8 oz.

TRIMMER CONDENSER KIT \$1.69



25 postage stamp mica compression trimmers many with brackets. The 25 different condensers in this kit represent a wide range of capacities from 3 to 280 MMFD. Packaged in a clear plastic bag. Wt.: 8 oz.

CROSSOVER CONDENSER KIT 5 CROSSOVER COND. \$1.89



5 non-polarized capacitors ideal for coupling the tweeter to the woofer speakers... anyone of which can do the job, ranging from .5 mfd to 10 mfd and priced so low, that one capacitor only would cost more than the kit. You will be pleased. Order now Wt.: 12 oz.

21 MC. TV I.F. KIT 99c
10-21 MC. TV I.F.S.



Here's an amazing value!! 10 standard type 21 to 26 megacycle I.F.s... include a liberal variety of shielded and unshielded types... All are replaced by popular Stancor-Merli numbers. Use just one and it pays for the entire kit. Order now at great savings... Wt.: 4 oz.

TV COIL KIT \$1.69

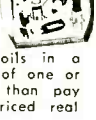

25 assorted TV coils for the repair shop or lab. Contains peaking coils. IF's, width and ratio detector coils in a plastic bag. The use of one or two coils will more than pay for the entire kit. Priced real low! Wt.: 8 oz.

TAB MOUNT CONTROLS \$1.99



10 tab mount volume controls. Hard to get items, not normally available in distributor stocks!! Kit includes a wide range of ohmages used in radio phono, and TV work. All controls are designed for direct mount to the chassis. These are the most commonly used controls in modern design automation and printed circuit work.

DUAL CONCENTRIC CONTROLS \$3.29



10 assorted dual concentric controls used in TV and auto radio. Kit includes 5 each controls with and without switch. All were made for very large TV and auto radio mfgs... Wt.: 1 lb. Order now at great savings!

VERTICAL MOUNT CAPACITORS



All Popular Values
20 Vertical Capacitors \$1.69

Here is an assortment of plastic cased vertical mount tubulars for all printed circuit chassis today. A wide variety of mfd's to meet most demands, ranging from .00 to .1 Twenty all packed in clear plastic bags. This is a must for all servicemen and experimenters today. Order now at our low price! Wt.: 6 oz.

20 METAL CLAD RESISTORS \$1.89



Top quality metal clad resistors sometimes called canohms. A wide range of resistance values and lengths from 2 1/2" to 9". Dissipate heat rapidly when mounted to metal chassis Wt.: 2 lbs

100 ASS'T INSULATED RESISTORS \$2.89



100 always popular value 1/2, 1 and 2 watt insulated carbon resistors. Every resistor standard RMA color coded and made by standard manufacturer. Kit includes 70-1/2, 20-1, and 10-2 watt resistors. Ideal for labs, TV and radio servicemen. Packed in a clear plastic bag. Wt.: 6 oz.

HUGE HARDWARE ASS'T \$1.49



King size 2 lb. assortment includes hard to get nuts, screws, bolts, bushings, etc., in a strong plastic jar... All shops want this...

Send 25% deposit with order, balance C.O.D. plus postage. Freight prepaid on orders of \$50.00 or more. SEND FOR COMPLETE CATALOGS OF KITS.
TEE-VEE SUPPLY CO. 3211 Washington St., Jamaica Plain 30, Mass.

Please mention
RADIO-ELECTRONICS
when answering advertisements

FREE Catalog Of The WORLD'S FINEST GOV'T SURPLUS ELECTRONIC BARGAINS



UNIVERSITY 25 WATT DRIVER UNIT —
Delivers 25 Watt high volume low distortion output. Excellent reproduction for music and speech. Frequency range 90 to 9000 cycles, 15 ohm impedance matches all amplifiers. Standard 24 thread x 1 1/2" mounting nipple fits all trumpets and projectors. Size: 5 x 4 1/2". Wt.: 4 lbs. University No. SA-30B—Gov't #MX-1054/U. Our Low Price—only **\$5.95**
Address Dept. RE • All Prices F.O.B., Lima, Ohio
• 25% Deposit Required on C.O.D. Orders

FAIR RADIO SALES
2133 ELIDA RD. • P.O. Box 1105 • LIMA, OHIO

ADD ARTHUR GODFREY TO YOUR SALES STAFF

WITHOUT ADDING HIM TO YOUR PAYROLL!



Tie in locally with the national Sylvania Silver Screen 85 TV Tube promotion featuring you, the independent service dealer

Arthur Godfrey, America's Number One Salesman, is selling — the Sylvania Silver Screen 85 TV picture tube—and Sylvania quality small tubes—in a dynamic national advertising campaign. Just look where you're being promoted . . . twice each week on 200 CBS Radio Network stations across the country . . . *The Saturday Evening Post* . . . and lots more!



To make the most of this sales-getting promotion, be sure you use all the local tie-in aids Sylvania now offers:

GIANT WINDOW DISPLAY—colorful, 3-dimensional . . . features you and Arthur Godfrey. (Order #1139)

3-PIECE DECAL KIT—Sparkling glassine signs with Arthur Godfrey saying, "Stop Here For Quality TV Service." (Order #1138)

GIANT WINDOW POSTER—Big 20" x 26" poster promotes your service. (Order #2095)

Each and every promotion piece is designed to help you sell Sylvania Silver Screen 85 TV tubes plus Sylvania quality small tubes. For your supply—and helpful hints on how to make the best use of these selling aids—contact your Sylvania distributor. Do it today!

Electronic Tubes Division, Sylvania Electric Products Inc., 1740 Broadway, New York 19, New York

SYLVANIA

Subsidiary of **GENERAL TELEPHONE & ELECTRONICS** 

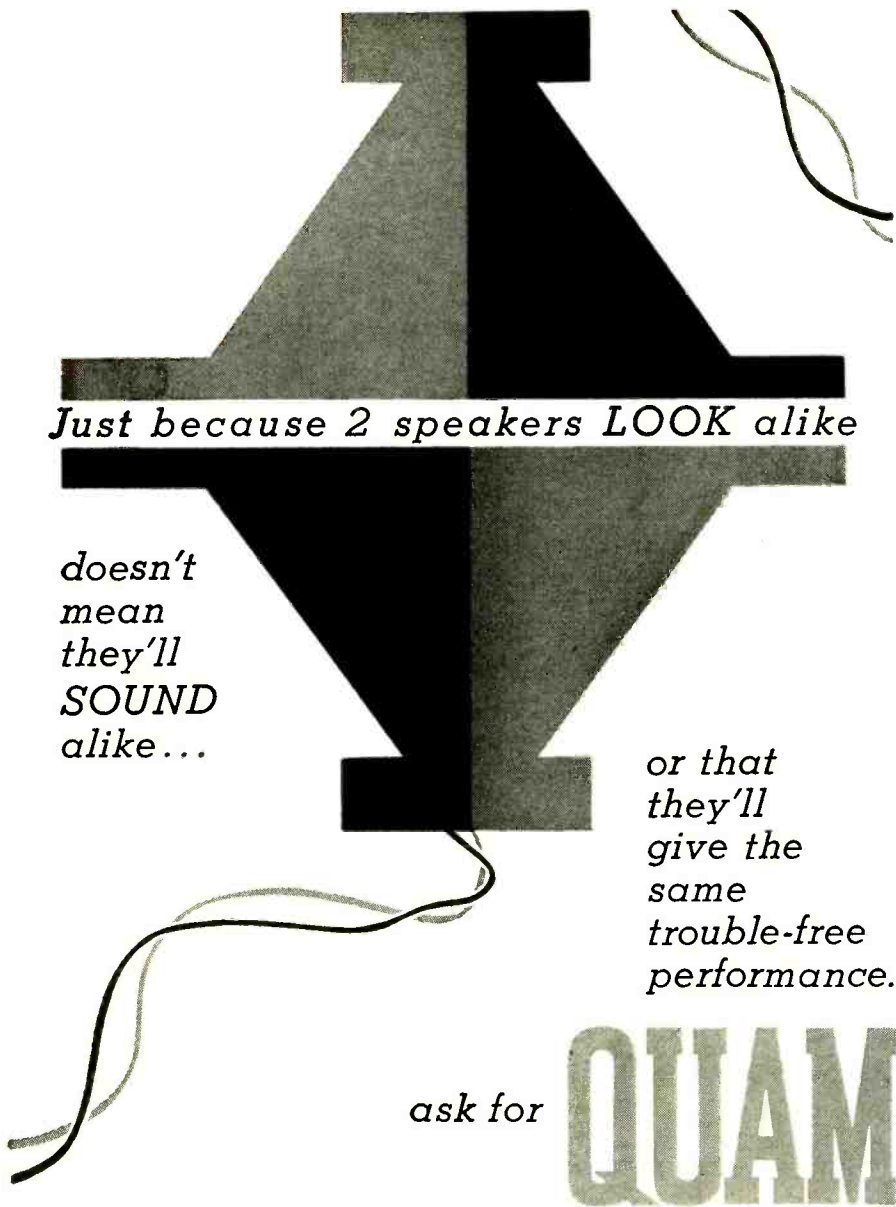

Just because 2 speakers LOOK alike

doesn't
mean
they'll
SOUND
alike...

or that
they'll
give the
same
trouble-free
performance.

ask for

QUAM

The NO CALL-BACK speaker with the exclusive Adjust-a-Cone Suspension
Completely manufactured in the United States of America

QUAM-NICHOLS COMPANY

238 East Marquette Road • Chicago 37, Illinois

ANOTHER
Mercury
SERVICE AID

CONVERT YOUR TUBE TESTER INTO A HIGHLY
EFFICIENT PICTURE TUBE TESTER...



The MULTI-HEAD incorporates:

- 12-pin socket—for all standard base black and white tubes
- 8-pin socket—for all 110 degree narrow-neck RCA type tubes
- 7-pin socket—for all 110 degree narrow-neck Philco and Sylvania type tubes
- 14-pin socket—for all color TV tubes in use today
- Color gun switch—for checking the red, green and blue color guns separately

See your electronics parts distributor

No other CRT Adapter does
as much as the MULTI-HEAD!

✓ TEST **ALL**
BLACK AND
WHITE PICTURE
TUBES

✓ TEST **ALL**
COLOR
PICTURE TUBES

Model MH-1
MULTI-HEAD **\$12.45**
Net

MERCURY ELECTRONICS CORP., 77 SEARING AVENUE, MINEOLA, NEW YORK
West Coast Office: 4306 W. Victory Blvd., Burbank, Calif.

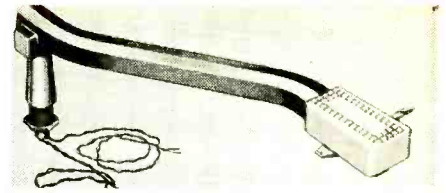

from end of mounting post. High- or low-output voltage cartridges. Turnover lever snaps out for replacement. Brown or gray.—Sonotone Corp., Elmsford, N. Y.

FM ANTENNA, Lark. S-type all-direction design. Available as individual antenna or complete kit. Golden anodized.—Technical Appliance Corp. (TACO), Sherburne, N. Y.

UHF ANTENNAS, TR604, 4-bay for primary uhf translator locations; **TR-606,** 6-bay for near-fringe uhf; **TR612** (shown), 12-bay for fringe and far-fringe. For improved broad-band response on channels 70-83. Highly rigid, heavy-gauge, galvanized, welded wire

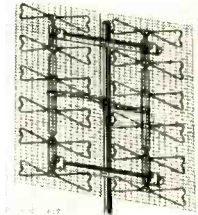

rod construction. Oversized precision-formed cardioid dipoles of corrosion-proof solid aluminum rod. Half-wave horizontal and vertical spacing of bays. Solid busbar multistage phasing transformers for constant 300-ohm impedance over uhf translator spectrum.—JFD Electronics Corp., 6101 16th Ave., Brooklyn 4, N. Y.

BOOSTERS, TV and FM, DSA-202 preamp (shown): remote power supply; mast-mounted; 2 tubes; 5½ lbs, 8½ x 6¼ x 4 inches; iridite-finished alumi-

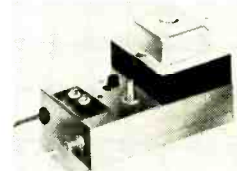

num case. **HSA-43:** 3-set coupler; single tube; special circuitry; 4½ x 4½ x 3 inches; die-cast case; brown and beige finish.—Jeerold Electronics Corp., 15th and Lehigh Aves., Philadelphia 32, Pa.

TRANSCIEVER TRC-27 for Citizens band. Meets FCC requirements. Completely wired, ready to operate. 117 vac and 12 vdc transistorized power supplies, positive or negative ground. 10 tubes, 5 with dual stages. Electronic



switching. Crystal-controlled transmitter and receiver each with 22 possible channels. 4½-inch PM speaker. Push-to-talk dynamic microphone. Light gray enamel finish, 5 x 13 x 7 inches.—Radio Shack Corp., 730 Commonwealth Ave., Boston 17, Mass.

CONTACT CLEANER, Formula BC-

RADIO-ELECTRONICS



44. Lubricates and conditions. 6-oz push-button spray can with 5-inch plastic extender.—Electronic Chemical Corp., 813 Communipaw Ave., Jersey City 4, N. J.

ILLUMINATED MAGNIFIER. 5-inch-diameter 4-power magnification ground and polished lens surrounded by

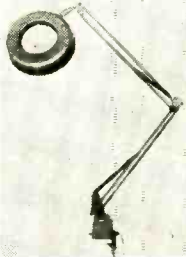

22-watt circular fluorescent tube. Reflector swivels for rotating in complete circle or up and down tilting.—Glidelite, 11 Moonachie Rd., Hackensack, N. J.

CONNECTORS. Molded cable assemblies. Y-type junction *ST-90* for headphones, binaural and stereophonic headsets. *ST-26*, 4-contact type for electron-

ic and portable equipment. *ST-25* (not shown), single-contact type for microphones, amplifiers, transmitters, tape

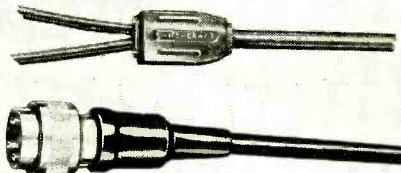

recorders, headphones.—Switchcraft, Inc., 5555 N. Elston Ave., Chicago 30, Ill.

DUAL PURPOSE TEST INSTRUMENT model 400. 20,000-ohms-per-volt vom and capacitance meter. Slope front

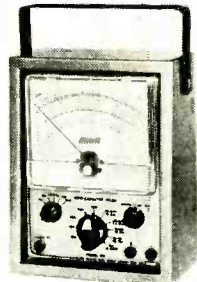

projects 4½-inch meter forward. 3 knobs and 3 jacks. Wide range of operation.—Mercury Electronics Corp., 77 Searing Ave., Mineola, N. Y.

OSCILLOSCOPE KIT for general-purpose, medical, industrial use. Model

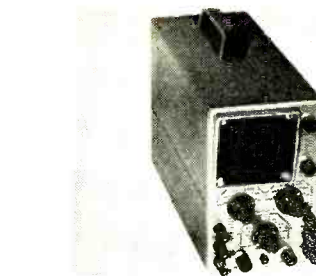

IO-10 has identical dc vertical, horizontal amplifiers. 3-inch CRT. Bandwidth dc to 200,000 cycles (2-db point). Sensitivity 0.1 volt (peak to peak) per ¼ inch. 3-position attenuator, continuously variable gain control. Multivibrator type sweep generator cover 5 to 50,000 cycles in 4 ranges. Low relative phase shift between channels.—Heath Co., Benton Harbor Mich.

CAPACITORS *MLE* (shown) subminiature electrolytics. Temperature range -40°C to +85°C for critical circuits. *CQM*, electrolytic in hermetically sealed aluminum container to operate at



-20°C to +65°C; *TAK-H*, wet electrolyte tantalum meeting specifications MIL-C-3965; *TAD*, solid tantalum in varied sizes and values hermetically sealed for -40°C to +85°C. 125°C range.—Pyramid Electric Co., 1445 Hudson Blvd., N. Bergen, N. J. **END**

All specifications on these pages are from manufacturer's data.



Replace improper equipment with the only microphone designed specifically **THE TURNER 350C** for citizen's band

This reasonably priced, mobile-type ceramic microphone is the perfect replacement for the many improper, tape recorder-type microphones now being used on CB equipment. Has DPST switch wired for relay operation with easily reversible terminals to allow modifications (if necessary); wiring diagram enclosed with each microphone; hanger button and standard dash bracket for mobile rig mounting; and an 11" retracted (five foot extended), plastic-jacketed, coiled cord. Response: 80-7,000 cps. Output: -54 db. List price: \$16.80 complete. See your Turner Distributor, listed below, he has the 350C in stock.

THE TURNER MICROPHONE COMPANY
933 17th St. N.E.
Cedar Rapids, Iowa

ARKANSAS
Little Rock: Southern Radio Supply
Texarkana: Lavender Radio & T.V. Sup.
CALIFORNIA
Downey: Net Electronics
Hemet: Gil Sevens
Hollywood: Pacific Radio Exchange
Los Angeles: Radio Product Sales
The Sound Foyer
Oakland: Elmar Electronics
Sacramento: Selectronics
San Francisco: Market Radio Sound Dept.
San Pedro: Marine Radio Service
DISTRICT OF COLUMBIA
Washington: Electronic Wholesalers
FLORIDA
Miami: East Coast Radio & TV
Tampa: Kinkade Radio Supply
GEORGIA
Atlanta: Specialty Distributing
ILLINOIS
Chicago: Nationwide Radio
La Salle: La Salle Electronics
INDIANA
Anderson: Seybert's Radio Sup.

Bloomington: Stansifer Radio Co.
Evansville: Hutch and Son, Inc.
Ohio Valley Sound
Fort Wayne: Pembleton Laboratories
Indianapolis: Brown Distributing Co.
Graham Electronic Sup.
Van Sickle Radio Supply
Kokomo: George's Electronic Sup.
Michigan City: Tri-State Electrical Sup.
Portland: Buck's Hi-Fi
Richmond: Fox Electronics Company
Terre Haute: Midwest Supply Company
IOWA
Cedar Rapids: Iowa Radio Supply
Des Moines: Radio Trade Supply Co.
KANSAS
Topeka: Acme Radio Supply
KENTUCKY
Lexington: Radio Equipment Co.
Louisville: Arby Electronics
P. I. Burks Company
LOUISIANA
Baton Rouge: Davis Electronics Sup.
New Iberia: Brooks Electronics

MASSACHUSETTS
Boston: A. W. Mayer Company
Radio Shack Corp.
Lawrence: Alco Electronics
MICHIGAN
Ann Arbor: Purchase Radio Supply
Detroit: High Fidelity Workshop
Lansing: Offenbauer Company
MINNESOTA
Minneapolis: Schaack Electronics
MISSOURI
St. Louis: Radonics
NEW JERSEY
Berlin: Midstate Radio Supply
Jersey City: Nidisco-Jersey City
Mountainside: Federated Purchaser
NEW YORK
Buffalo: Radio Equipment Corp.
Farmingdale, L.I.: Gem Electronics
Forest Hills: Beam Electronics
Mt. Vernon: Davis Electronics
New York: Harvey Radio Company
Acme Electronics
OHIO
Cleveland: Pioneer Electronic Sup.

Columbus: Whitehead Radio Company
Mansfield: Wholesaling, Inc.
Toledo: Lifetime Electronics
OKLAHOMA
Oklahoma City: Johnson Wholesale
OREGON
Portland: United Radio Supply
PENNSYLVANIA
Lancaster: George D. Barbey Co.
Lebanon: George D. Barbey Co.
Philadelphia: Radio Electric Service Co.
Pottstown: George D. Barbey Co.
Reading: George D. Barbey Co.
Wilkes-Barre: General Radio & Electronic
York: Radio Electric Service Co.
TEXAS
Houston: Sound Equipment Inc.
VIRGINIA
Arlington: Rucker Electronic Products
Falls Church: The Television Workshop
WISCONSIN
Chippewa Falls: Bushland Radio Spec.
Eau Claire: Bushland Radio Spec.

BECOME A RADIO TECHNICIAN
for only \$26.95

BUILD 20 RADIO

CIRCUITS AT HOME
with the New Progressive
RADIO "EDU-KIT"®

All Guaranteed to Work!

PRACTICAL only
HOME RADIO COURSE **\$26.95**

NOW INCLUDES

- ★ 12 RECEIVERS
- ★ 3 TRANSMITTERS
- ★ SQ. WAVE GENERATOR
- ★ AMPLIFIER
- ★ SIGNAL TRACER
- ★ SIGNAL INJECTOR
- ★ CODE OSCILLATOR



Reg. U.S. Pat. Off.

TRAINING ELECTRONICS TECHNICIANS SINCE 1916

- ★ No Knowledge of Radio Necessary
- ★ No Additional Parts or Tools needed
- ★ Excellent Background for TV
- ★ School Inquiries Invited
- ★ Attractively Gift Packed

FREE EXTRAS

- SET OF TOOLS • RADIO & ELECTRONICS TESTER • ELECTRIC SOLDERING IRON • TESTER INSTRUCTION MANUAL • MEMBERSHIP IN RADIO-TV CLUB: CONSULTATION SERVICE • HI-FI GUIDE
- QUIZZES • TV BOOK • FCC AMATEUR LICENSE TRAINING
- RADIO BOOK • PRINTED CIRCUITRY • PLIERS-CUTTERS
- ALIGNMENT TOOL • WRENCH SET • CERTIFICATE OF MERIT
- VALUABLE DISCOUNT CARD

WHAT THE "EDU-KIT" OFFERS YOU

The "Edu-Kit" offers you an outstanding **PRACTICAL HOME RADIO COURSE** at a rock-bottom price. Our kit is designed to train Radio & Electronics Technicians, making use of the most modern methods of home training. You will learn radio theory, construction, servicing, basic Hi-Fi and TV repairs, code, FCC amateur license requirements.

You will learn how to identify radio symbols, how to read and interpret schematics, how to mount and lay out radio parts, how to wire and solder, how to operate electronic equipment, how to build radios. Today it is no longer necessary to spend hundreds of dollars for a radio course. You will receive a basic education in radio, worth many times the small price you pay, only \$26.95 complete.

THE KIT FOR EVERYONE

The Progressive Radio "Edu-Kit" was specifically prepared for any person who has a desire to learn Radio. The "Edu-Kit" has been used successfully by young and old in all parts of the world, by many Radio Schools and Clubs in this country and abroad. It is used for training and rehabilitation of Armed Forces Personnel and Veterans throughout the world.

The Progressive Radio "Edu-Kit" requires no instructor. All instructions are included. Every step is carefully explained. You cannot make a mistake.

PROGRESSIVE TEACHING METHOD

The Progressive Radio "Edu-Kit" is the foremost educational radio kit in the world, and is universally accepted as the standard in the field of electronics training. The "Edu-Kit" uses the modern educational principle of "Learn by Doing." Therefore, you will construct radio circuits, perform jobs and conduct experiments to illustrate the principles of radio.

You begin by examining the various radio parts included in the "Edu-Kit." You then learn the function, theory and wiring of these parts. Then you build a simple radio. With this first set, you will enjoy listening to regular broadcast stations, learn theory, practice testing and troubleshooting. Then you build a more advanced radio, learn more advanced theory and techniques. Gradually, in a progressive manner, and at your own rate, you will find yourself constructing more advanced multi-tube radio circuits, and doing work like a professional Radio Technician.

Included in the "Edu-Kit" course are twenty Receiver, Transmitter, Code Oscillator, Signal Tracer, Signal Injector, Square Wave Generator and Amplifier circuits. These are not unprofessional "breadboard" experiments, but genuine radio circuits, constructed by means of professional wiring and soldering on metal chassis, plus the new method of radio construction known as "Printed Circuitry." These circuits operate on your regular AC or DC house current.

In order to provide a thorough, well-integrated and easily-learned radio course, the "Edu-Kit" includes practical work as well as theory, troubleshooting in addition to construction; training for all, whether your purpose in learning radio be for hobby, business or job; progressively-arranged material, ranging from simple circuits to well-advanced topics in Hi-Fi and TV. Your studies will be further aided by Quiz materials and our well-known FREE Consultation Service.

THE "EDU-KIT" IS COMPLETE

You will receive all parts and instructions necessary to build 20 different radio and electronics circuits, each guaranteed to operate. Our Kits contain tubes, tube sockets, variable electrolytic, mica, ceramic and paper dielectric condensers, resistors, tie strips, coils, hardware, tubing, punched metal chassis, Instruction Manuals, hookup wire, solder, selenium rectifiers, volume controls, switches, knobs, etc. In addition, you receive Printed Circuit materials, including Printed Circuit chassis, special tube sockets, hardware and instructions. You also receive a useful set of tools, a professional electric soldering iron, and a self-powered Dynamic Radio & Electronics Tester. The "Edu-Kit" also includes Code Instructions, and the Progressive Code Oscillator, in addition to the F.C.C.-type Questions and Answers for Radio Amateur License training. You will also receive lessons for servicing with the Progressive Signal Tracer and the Progressive Signal Injector, and a High Fidelity Guide and Quiz Book. Everything is yours to keep.

J. Statistis, of 25 Poplar Pl., Waterbury, Conn., writes: "I have repaired several sets for my friend, but I found your ad and sent for your Kit."

UNCONDITIONAL MONEY-BACK GUARANTEE

The Progressive Radio "Edu-Kit" has been sold to many thousands of individuals, schools and organizations, public and private, throughout the world. It is recognized internationally as the ideal radio course.

By popular demand the Progressive Radio "Edu-Kit" is now available in Spanish as well as English.

It is understood and agreed that should the Progressive Radio "Edu-Kit" be returned to Progressive "Edu-Kits" Inc., for any reason whatever, the purchase price will be refunded in full, without quibble or question, and without delay.

The high recognition which Progressive "Edu-Kits" Inc. has earned through its many years of service to the public is due to its unconditional insistence upon the maintenance of perfect engineering, the highest instructional standards, and 100% adherence to its Unconditional Money-Back Guarantee. As a result, we do not have a single dissatisfied customer throughout the entire world.

ORDER FROM AD—RECEIVE FREE BONUS RESISTOR AND CONDENSER KITS WORTH \$7.00

Send "Edu-Kit" Postpaid. I enclose full payment of \$26.95.
 Send "Edu-Kit" C.O.D. I will pay \$26.95 plus postage.
 Send me FREE additional information describing "Edu-Kit."

Name _____
 Address _____

Progressive "EDU-KITS" Inc. 1186 Broadway, Dept. 170G
 Hewlett, N. Y.

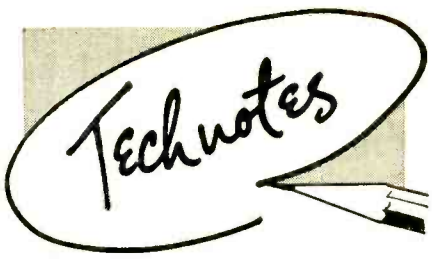

PRINTED CIRCUIT GROUNDS

The ground circuit of a printed-circuit board should connect to the main chassis securely, adequately and permanently at all ground points. Some circuits will perform with only one such ground, but many printed boards carry high-frequency signals and the loss of a ground may cause instability and other undesired effects.

When renewing a board, or replacing the ground screws after service, put a small star washer under each screw. Tighten securely enough so the teeth of the washer bite into the plating, but not enough to tear or break it. A solder lug with shakeproof teeth does the job too and provides a handy place to clip a vtvm ground lead in the future.—*Lawrence Shaw*

USING SINE WAVES

A sine wave, viewed on a scope, will reveal certain types of distortion. (The diagram shows the appearance of a sine wave, before and after harmonic distortion.) The sine wave at the output of an amplifier should look just like the sine wave applied to the input. A sine-wave check will also show overall amplifier gain or stage gain or loss.

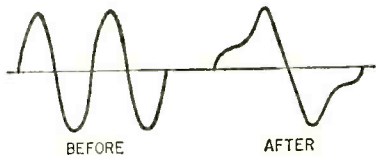

A sine-wave test will not show up frequency distortion (loss of highs or lows) since only one frequency is amplified at a time (use square waves if you are looking for loss of high or low frequencies). IM distortion also will not show up since it is produced by the heterodyning of two or more frequencies and cannot be detected by using a single-tone sine wave.—*W. C. Warren*

SNIVET INTERFERENCE

Occasionally, dark irregular lines may be seen on the right side of the television picture in weak and moderate signal areas. This trouble (snivets) originates in the horizontal output tube and is caused by a very rapid change of plate and screen current when the tube operates near the knee of its plate characteristic. The sudden change of plate and screen current may cause rf radiation which often appears on low- or high-band vhf or uhf channels.

To reduce this kind of interference, try dressing the antenna line away from the deflection circuit. If this doesn't work, try making small adjustments of width, linearity and horizontal drive. These adjustments may change the operating condition causing the snivets. The third thing to do is replace the horizontal output tube. You may have to try more than one replacement before finding one that will eliminate the trouble. The "bad" tube can be used in stronger signal areas or sometimes in another TV receiver without causing any trouble.—*M. L. Leonard*

SYLVANIA CHASSIS 1-544-1

The complaint was vertical compression, but of a rather unusual type. The compression was only in white areas. Directly below this area, the scanning lines were spread. A check of Sylvania service data in our files revealed that

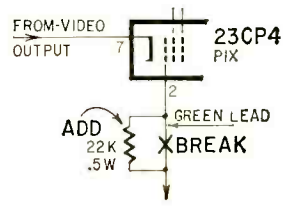

this trouble is often caused by grid current in the picture tube (the video signal drives the picture tube's cathode negative with respect to the grid). This grid current disrupts the waveshaping accomplished in the vertical retrace plate and causes a notch in the waveshape at the grid of the vertical oscillator. A quick field repair called for inserting a 22,000-ohm resistor between the picture tube grid and the lead now connected to the picture tube. The resistor isolates the picture tube grid.—*Warren Roy*

NO SOUND

If a transistor auto radio is dead (no sound) and the power transistor is cold, check the transistor very carefully. Beware of hasty diagnosis. Before ordering another transistor, make a careful ohmmeter test of the output trans-

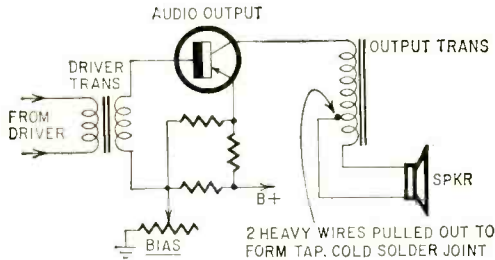

former, especially if it is an autotransformer type. The transformer tap may be open because of an imperfect solder joint, causing the same symptoms as a defective transistor! This defect can usually be repaired. Carefully slit the paper covering the transformer to expose the leads. Then clean and resolder, coat with insulating compound and retape.—*Jack Darr*

MAGNAVOX 105 SERIES

The complaint was that, about once a week, the picture would fall into some peculiar behavior sounding to us like a piecrust or multiple-triggering condition. We replaced the horizontal sweep tubes and after a short air test told the customer to let us know if there was any further trouble.

We were back again 4 days later and this time were lucky enough to have the set act up while we were there. Sure enough, it looked like multiple triggering since each scanning line was displaced from its sidekicks. We also discovered that, each time the trouble cleared up, we could make it recur by turning the brightness control way down.

From this we deduced that the offending component must be directly associated with the high voltage since varying the brightness does affect the current flow through the second-anode supply source. A new 1B3 did not help and neither did a high-voltage capacitor and limiting resistor.

We pulled the set and installed a new flyback transformer. Although we had never seen a flyback behave in this manner before, it seemed like a logical hunch—and it paid off. The old transformer was evidently setting up its own parasitic oscillations, giving all the symptoms of a defective afe circuit.—*Frank A. Salerno*

MOTOROLA CAR RADIO 78MF

The trouble was a loud squeal no matter how the volume control was set. A check of this receiver revealed an open

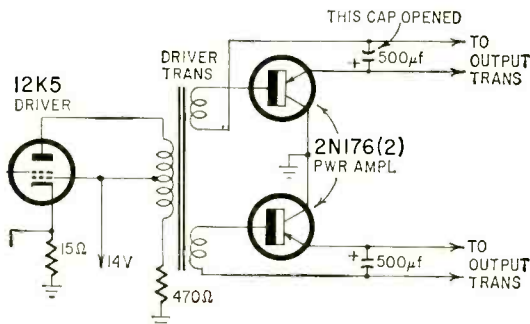

500-µf electrolytic in the transistor power output stage. The solution was to replace the open electrolytic with a new one.—*M. L. Leonard*

END

BUY PYRAMID! GET MORE!



Only Pyramid offers you so much! Only Pyramid gives you highest quality capacitors plus so many "all new" extras.

THE VU-PAK

An entirely new way to package capacitors . . . clear plastic tubes, plainly labeled and packed with the highest quality electrolytic twist-mount capacitors. Each re-usable Vu-Pak comes with a blank label, ideal for storing small parts and tools on your bench or in your tool kit.

EXTRA OFFER!

Save 50 Vu-Pak labels and get the fabulous new Pyramid storage rack the Capac-o-mat, at tremendous savings from your authorized Pyramid distributor. The Capac-o-mat fits right on your shelf, is dust-free and holds 54 Vu-Paks.

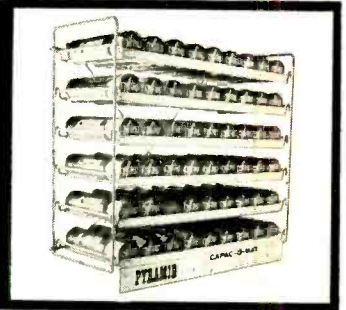

JEWEL BOX

Handsome tan plastic, high impact cabinet with 9 drawers, contains 45 assorted Mylar* paper Gold Dip capacitors, type 151. Practical . . . convenient . . . for storage in your shop, or home. Actual value of the Jewel Box with 45 Gold Dip capacitors—\$19.50, dealer net only \$9.25.



Gold Dip capacitors are also available in Clear-Vu paks . . . 5 to a package. Find them on Pyramid's new Whirl-o-mat on your favorite parts distributor counter.

"GOLD STANDARD" 111 KIT

Clear lucite hinged box containing 75 Pyramid's popular assorted Gold Standard Mylar* capacitors. You'll find so many uses for the Gold Standard 111 Kit. Actual value is \$26.00, dealer net only \$13.00.

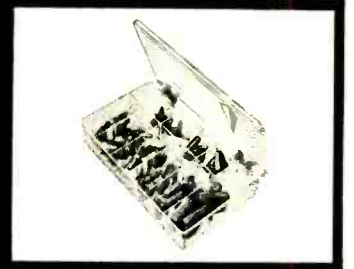

515 LYTIK-KIT

Hinged cover, clear lucite box with 15 assorted miniature low voltage electrolytic capacitors for transistorized circuit replacements, type MLV. This Kit is a constant companion to any busy serviceman. Actual value, \$20.60, dealer net only \$10.30.



PYRAMID ELECTRIC COMPANY

DISTRIBUTOR DIVISION: UNION CITY, NEW JERSEY

Factories: Gastonia, North Carolina • Darlington, South Carolina
In Canada: Wm. Cohen, Limited, 8900 Tanguay Street, Montreal
Export: Morhan Exporting Co., 485 Broadway, New York 13, N. Y.

"My Photofact Library is the most important tool in my daily servicing. With my Photofacts I am able to complete a job in just half the time it would take without them . . . Membership in the PEET program is the best thing that could happen to any Electronic Technician. I believe I speak from experience as this is my 19th year of full-time servicing."

—A. Kish, Jr.
Al's Radio & Television
Carteret, N. J.



Service Technicians! YOU EARN MORE... YOU RATE with the public when you own the PHOTOFACT® service data library!

You enjoy maximum earnings as the owner of a complete PHOTOFACT Service Data Library! It's inevitable, because no matter how expert you are, you can always *save more time on any job, get more jobs done daily*—EARN MORE, DAY IN AND DAY OUT...

What's more—as the owner of a complete PHOTOFACT Library, you know your customers' sets *best*. You can actually show each customer you have the PHOTOFACT Folder covering his very own set. Result: You command public respect and acceptance which paves the way to more business and earnings for you.

HOW TO STAY AHEAD...

Yes, the truly successful Service Technicians are those who own the complete PHOTOFACT Library, who can meet and solve any repair problem—faster and more profitably. And these men *keep ahead* because they're on a Standing Order Subscription with their Distributors to receive all new PHOTOFACTS as they are released monthly. (They're eligible for the benefits of membership in PEET, too—see below!)

ONLY \$10 DOWN puts the complete PHOTOFACT Library in your shop—and you have up to 30 months to pay. See your Sams Distributor today, or write to Howard W. Sams

TECHNICIANS'

NEWS



NATESA ANNUAL CONVENTION

The National Alliance of Television & Electronic Service Associations met in Chicago, Aug. 19–21. Those attending represented 98 affiliated cities and total attendance showed a 30% increase over last year.

Following a closed council meeting the day before, the convention officially opened the morning of Aug. 19. Morris Finneburgh, vice president in charge of public relations at the Finney Antenna Co., was keynote speaker during the convention and delivered, according to *TESA News*, "a most inspirational talk . . . the kind where you can hear a pin drop in the room."

An important part of the convention was the election of officers. Alphonse A. Benoit from New Orleans became the new NATESA president. He succeeds Mac Metoyer.

Other officers elected were: Wally Hirschberg, St. Louis, secretary general; Nelson Burns, Memphis, re-elected treasurer; Irving Toner, Eastern vice president; T. R. Nabors, East Central vice president; John Graham, East Central secretary; Harry Eales, West Central vice president; Ralph Woertendyke, West Central secretary; Winston Haines, Western vice president, and Jim Humphrey, Western secretary.

QUERY SERVICE RATES

In an attempt to aid its members in charging proper, reasonable rates for service work, the Tri-State Council of Television Service Associations will circulate questionnaires among its members in New Jersey, Delaware and Pennsylvania asking for information on business problems. The association stresses that there will be no price fixing.

The results of the survey will be used only to assist members who are not charging enough or who are charging too much.

SERVICE CALL

TSA Service News states that many technicians have been asking for a definition of a service call. They use the following definition adopted by NATESA:

"Service Call: Consisting of travel time to the home, the inspection and/or testing of circuit tubes, and minor adjustments, with a 30-minute time limit and no chassis pull. Beyond the 30-minute time limit, regular hourly rates apply."

TUBE WARRANTIES

R. M. Andrews, assistant district sales manager for Tung-Sol, recommended discontinuing receiving tube

NOW IS THE TIME TO JOIN

"PEET"

THE POWERFUL NEW PROGRAM FOR QUALIFIED TECHNICIANS

If you now own a PHOTOFACT Library or plan to own one, you can apply for membership in "PEET." It's the first industry program really designed to build powerful public acceptance for the Service Technician who qualifies. Builds enviable prestige and business for its members. Benefits cost you absolutely nothing if you qualify. Ask your Sams Distributor for the "PEET" details, or mail coupon today.

HOWARD W. SAMS & CO., INC.

1726 E. 38th St., Indianapolis 6, Ind.

- Send me full details on the new "PEET" Program.
- Send full information on the Easy-Buy Plan and Free File Cabinet deal.
- I'm interested in a Standing Order Subscription.
 - I'm a Service Technician full-time; part-time

My distributor is _____

Shop Name _____

Attn: _____

Address _____

City _____ Zone _____ State _____

warranties and reducing the retail price of the tubes some 30% at the NATESA convention in Chicago. He backed his recommendation by stating that with the quality now put into tubes, the industry could actually dispense with all warranties and make a policy of adjustment when and where necessary. In this way, the industry could save hundreds of thousands of dollars in handling, and also do away with one of its big by-products, namely the "dishonest tube jockey who is often the plague of the service technician."

ESFETA ON LICENSING

At a recent meeting in Buffalo, N. Y., Daniel Hurley, chairman of the Empire State Federation of Electronic Technicians Associations license committee, presented a final draft of the ESFETA-sponsored state license bill. A delegate from Long Island introduced a motion that the license bill include a provision for licensing the shop owner as well as technicians. After debate, the motion was defeated. Then the bill was presented to the delegates for final ratification.

The vote to accept the final draft of the bill was unanimous.

NEWS FROM G-E ST. LOUIS

Independent service dealers in St. Louis were notified by General Electric that the company was discontinuing "out of warranty" service. The news marks the culmination of TEAM efforts to get G-E to change its policy according to *TEAM News*.

Under the new policy, there will be franchised G-E service dealers with approved telephone book listings, store identification, technical assistance, parts and service information.

THIS IS JUSTICE?

From CSEA member Lee Hoy comes this true tale.

In early March of this year, a man brought in a 14-inch portable for an estimate. After checking it completely, Lee found two bad tubes and a shorted picture tube and called the man, who told him not to repair it, and that he would pick it up in a few days. When he came in, Lee asked for \$3.50 for the estimate fee and the gentleman (?) hit the ceiling and said that he would refer the matter to his attorney.

Subsequently, Lee received a letter from the attorney demanding the return of the set or legal action would be taken. Turning this letter over to his own attorney, Lee heard nothing more until March 24, when he received an order to appear in Small Claims Court on a claim of \$115.00, plus cost of the rental of a television set while the set was being held.

On April 24 Hoy appeared in court, before Judge Sims and was ordered to release the set at no charge and pay the man \$30 for the rental of a TV while his was held. The reason—"Lee had not told the man that there would be a charge, even though he did have a sign posted, stating that a charge would be made for estimating repairs."

The moral: Have a *large* sign posted

and point it out to each customer in a case such as this. Better yet, deliver to the customer a claim check on which you have stated that there will be a fee and how much.—(CSEA)

CALIFORNIA WAGES INCREASED

RTA-SCVSC directors at a recent regular meeting made the following changes in their pay scales:

Apprentice pay begins at 50% of journeyman's pay for the first 6 months, increasing 5% each month, with boosts of 10% each 6 months during the final year. Thus, the beginning apprentice pay is raised from \$1.32½ an hour to \$1.50. The current journeyman wage is \$3 an hour.

The increase is part of a program designed to make TV and radio servicing more competitive with surrounding industry which has lured many technicians into manufacturing and research and development because of fringe benefits.

WINS "MAC" AWARD

The motion picture industry has the "Oscar," television has the "Emmy" and TSE (Television Service Engineers, Inc.) has the "MAC." Just as the Oscar and the Emmy are the highest awards in their respective fields, the MAC award is the highest honor which TSE can bestow upon a member or an individual.

This year the award went to Bob Hester. It is inscribed, as always, "In recognition of outstanding effort on behalf of the industry and the Television Service Engineers of Greater Kansas City."

SERVICE CHARGES

This story comes from the New York State *TSA News*.

We are finding it hard to raise our service charge to \$5.95. If you find it hard also, just tell people this incident that happened in our shop.

A useless, idle loafer (bum) walked into our shop asking for a handout. He became furiously affronted upon receiving a dime from a sympathetic bystander. This "bum" said he had never been so insulted in all his life. He vowed he would never, as much as he needed it, take a little old dime from any fellow being.

So, as you can see, even their prices are going up.

ARTSNY STUDIES CITIZENS BAND

The Associated Radio Television Servicemen of New York together with RCA distributor Bruno-New York ran a technical demonstration and lecture on Citizens-band radio that was open to the public. Held at the Central Plaza Annex in New York City, it was conducted by Chet Gaven, Bruno's district sales manager. Each person who came to the lecture received an application for a Citizens-band station license.

BBB TO SET STANDARDS, ARBITRATE DISPUTES

Uniform standards of repair, ethical advertising and charges will be set by a proposed Television Service Dealers Div. of the Better Business Bureau of

IMPORTANT NEW SAMS BOOKS

Electronic Organ Handbook

by H. Emerson Anderson

ONLY BOOK OF ITS KIND ON THIS IMPORTANT SUBJECT



Here's all the information you need to get into this brand-new servicing market! Over 1,000,000 electronic organs are now in use. With your radio-TV servicing experience, plus the wealth of schematics, detailed operating data and troubleshooting information in this book, you'll be ready for profitable service work in this big new field. Twelve comprehensive chapters cover these popular organs: Baldwin, Conn, Gulbransen, Hammond, Kinsman, Lowrey, Thomas and Wurlitzer. First chapter explains general operation of the electronic organ. Also includes data on the Leslie organ speaker, the Conn Strobotuner and Peterson Chromatic Tuner. The book you've been waiting for! Over 140 illustrations. 272 pages; 5½ x 8½". Only..... \$495

Video Speed Servicing

NEW VOLUME 5

Latest volume in Sam Marshall's very useful series. Consists of 456 more practical troubleshooting hints for solving hard-to-find faults in major makes of 1959-60 TV receivers. All models are indexed by brand name, model and chassis number for quick reference. Each hint is accompanied by an explanatory diagram or schematic. An invaluable, time-saving shop reference. 160 pages; 8½ x 11". Only \$295



TV Tube Location Guide

NEW VOLUME 10

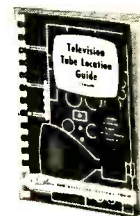

Latest in this invaluable series. Gives tube location data for TV sets produced in 1959-1960. Shows position and function of tubes in hundreds of models—just find the trouble and replace defective tubes without removing chassis! Shows major component placement; signal path; pin orientation on socket; series string filaments; fuse location. Includes tube failure check charts. 96 pages; 5½ x 8½"; spiral bound. Only..... \$125

HOWARD W. SAMS REPLACEMENT GUIDE FOR TV & AUTO RADIO CONTROLS

Vol. 3. Greatly expanded—covers 27,000 TV and over 1,000 auto radio models. Lists recommended replacement controls of Centralab, Clarostat, IRC and Mallory. \$100 8½ x 11". Only.....



HOWARD W. SAMS & CO., INC.

Order from your Sams Distributor today, or mail to Howard W. Sams & Co., Inc., Dept. L-20 1720 E. 38th St., Indianapolis 6, Ind.

Send me the following books:

- "Electronic Organ Handbook" (EOA-1)
 "Video Speed Servicing" Vol. 5 (VSM-5)
 "Television Tube Location Guide" Vol. 10 (ITGL-10)
 "Replacement Control Guide" (RCG-3)

\$..... enclosed. Send Free Book List

Name.....

Address.....

City..... Zone..... State.....

(Outside U.S.A. priced slightly higher)

2 for the money

circuit by

**SARGENT-
RAYMENT**

tubes by

Amperex®

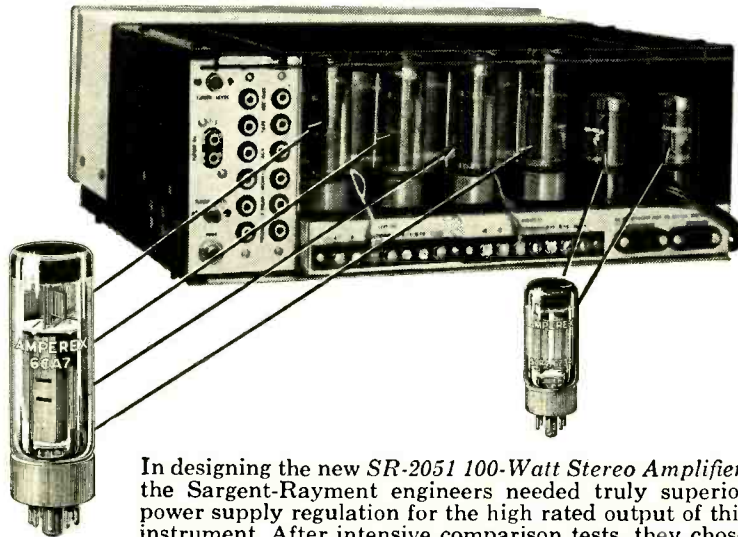

In designing the new SR-2051 100-Watt Stereo Amplifier, the Sargent-Rayment engineers needed truly superior power supply regulation for the high rated output of this instrument. After intensive comparison tests, they chose two Amperex 5AR4/GZ34 Rectifier tubes.

For Power Output, they wanted a tube with high efficiency and high sensitivity, produced to standards of absolute uniformity, in order to assure maximum power output, plus inaudible distortion. Their goal was achieved with four Amperex 6CA7/EL34's

These and many other Amperex 'preferred' tube types have proven their reliability and unique design advantages in the world's finest audio components.

Applications, engineering assistance and detailed data are always available to equipment manufacturers. Write: Amperex Electronic Corp., Special Purpose Tube Division, 230 Duffy Avenue, Hicksville, L. I., New York.



about hi-fi tubes
for hi-fi circuitry

OTHER AMPEREX TUBES FOR QUALITY HIGH-FIDELITY AUDIO APPLICATIONS

POWER AMPLIFIERS

6CA7/EL34: 60 w. distributed load
7189: 20 w., push-pull
6BQ5/EL84: 17 w., push-pull
6CW5/EL86: 25 w., high current, low voltage
6BM8/ECL82: Triode-pentode, 8 w., push-pull

VOLTAGE AMPLIFIERS

6267/EF86: Pentode for pre-amps
12AT7/ECC81: Twin triodes, low hum, noise and microphonics
12AX7/ECC82: }
12AX7/ECC83: } microphonics
6BL8/ECF80: High gain, triode-pentode, low hum, noise and microphonics

RF AMPLIFIERS

6ES8: Frame grid twin triode
6ER5: Frame grid shielded triode
6EH7/EF183: Frame grid pentode for IF, remote cut-off
6E17/EF184: Frame grid pentode for IF, sharp cut-off
6AQ8/ECC85: Dual triode for FM tuners
6DC8/EBF89: Duo-diode pentode

RECTIFIERS

6V4/EZ80: Indirectly heated, 90 mA
6CA4/EZ81: Indirectly heated, 150 mA
5AR4/GZ34: Indirectly heated, 250 mA

INDICATORS

6FG6/EM84: Bar pattern
IM3/DM70: Subminiature "exclamation" pattern

SEMICONDUCTORS

2N1517: RF transistor, 70 mc
2N1516: RF transistor, 70 mc
2N1515: RF transistor, 70 mc

IN542:

Matched pair discriminator diodes

IN87A:

AM detector diode, subminiature

What articles would you like to see published in RADIO-ELECTRONICS? Maybe you're the man to write them. Ask for an author's guide. RADIO-ELECTRONICS 154 West 14th St. New York 11, N. Y.

ENGINEERING DEGREE IN SCIENCE 27 or 36 MOS. MATH

Accelerated year-round program prepares for early employment in fields of Science and Engineering. Regular 4-year program for B.S. Degree completed in 36 months, special engineering degree program in 27. Classes start quarterly—January, March, June, July, September. Quality education. Graduates employed from coast to coast. Government approved for veteran training. Students from 50 states, 40 countries, 20 buildings; dorms, gym, Campus. Save time and money. Earn board while studying. Write for catalog and complete information. 1711 E. Washington Boulevard, Fort Wayne 2, Indiana

INDIANA TECHNICAL COLLEGE

TAPE RECORDERS



HI-FI COMPONENTS SLEEP LEARN KITS

MERITAPE Low cost, high quality recording tape, in boxes or cans. **UNUSUAL VALUES FREE** 1961 CATALOG **DRESSNER, 69-02RE 174 St., Flushing 65, N.Y.**

SERVICEMEN

T.V. and RADIO TUBES ALL TOP NAME BRANDS

60-10-50¢ New—first quality—regular boxed—No Jobs. closets or pull-outs. SEND for catalog.

(Representatives wanted for all states. High commission.)

RADIO TUBE SPECIALISTS

397-7th Ave., Brooklyn 15, N.Y.

Memphis (Tennessee).

"We have been handling about 1,000 public inquiries and complaints about TV service each year," George V. Morse Jr., BBB manager, said. "It is quite apparent that the industry is suffering from a lack of public confidence and understanding. We all know that most of Memphis' 200 licensed shops are honest and fair, but there is a fringe group who give the industry a bad name."

The most frequent complaints were: replacing parts unnecessarily, charging new prices for used parts, low estimates and high prices, inadequately trained men and bait advertising.

The BBB's new division will set up a code of ethics to which members would subscribe, undertake an advertising and public-relations program to regain public confidence (cost of program to be borne by qualified service dealers), set up a grievance committee to investigate complaints, set up an arbitration panel and a committee to work with city officials to get ordinances passed that will eliminate undesirable operators.

The BBB set up a similar group to handle complaints and disputes in the laundry and dry-cleaning industry. Their arbitration panel consists of two laundry-cleaner industry men, two housewives, a BBB official and two retailers. The panel does not know the names of the principals in any dispute. They are referred to as "Customer A" and "Dealer B."

Members of the program will be identified by decals in their shop windows.

At the first organizational meeting, 26 firms signed applications to join the program.

NEW APPRENTICE PLAN

A program has been planned to reduce the number of steps between starting apprentice and journeyman technician by the International Brotherhood of Electrical Workers Local 46, Seattle, Wash.

According to Don Macpherson, the business representative of the union, the apprentice would work in the shop 2 days a week in his first year with the other 3 days in school. The second year would have him in the shop 3 days a week with 2 days spent in school. The third year would be spent in the shop full time.

The apprentice would start at half the journeyman's pay as he does in the present program, but he would advance to full pay in two steps instead of the previous three.

Mr. Macpherson said this would aid the small shop that cannot afford to hire a full-time man or that cannot afford to have a full-time journeyman instructing the apprentice at all times.

TESA-SHEBOYGAN ELECTS

The Television and Electronic Service Association—Sheboygan County (Wis.) elected Fred Leonard, president; Elroy Van Shuy, vice president; Paul Miller, secretary; John Bruder, treasurer; and Roger Curtiss, NATESA director. END

NEW TUBES and SEMI-CONDUCTORS

I_c (ma)	300	300	300
P_{total} (mw)	150	150	150
h_{FE} ($I_c=200$ ma, $V_{CE}=0.35$)	(10)	10	15
(minimum)	(10)	10	15
			(20)

2N1564, 1565, 1566
A group of general-purpose n-p-n

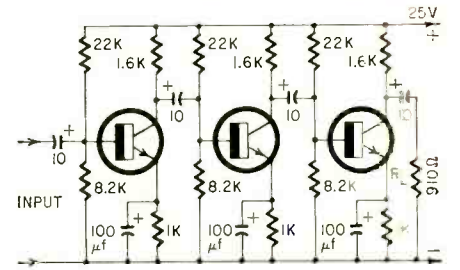

double-diffused silicon mesa transistors that cover an ac beta range from 20 to 200. In free air, all three types have a maximum dissipation of 600 mw. The diagram shows the 2N1566 in a cas-

A NEW semi-conductor device stands out this month. It is a tetrode device called a Binistor. All other releases, with the exception of a TV damper tube, are also in the semiconductor category.

2N1302, -1303: 2N1304, -1305: 2N1306, -1307
Three sets of complementary alloy-junction germanium transistors for

computer and switching applications. The diagram shows a circuit for using these transistors as a non-saturating switch cascade that operates at a 3-mc rate.

Maximum ratings of these Texas Instruments complementary pairs are:
2N1302, 3 -1304, 5 -1306, 7
 V_{CS}^* (25) 30 (25) 30 (25) 30
 V_{EB} 25 25 25
*Values in parentheses apply to n-p-n devices only.

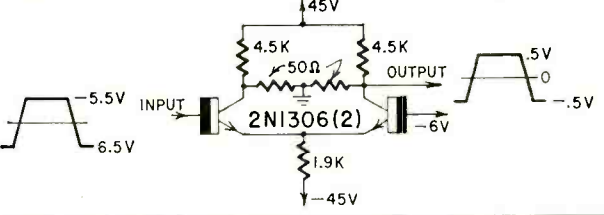
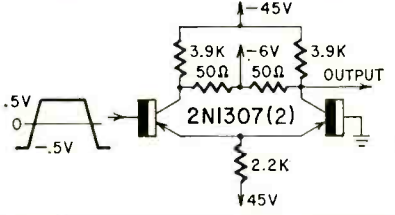
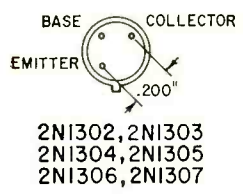

TV-RADIO Servicemen or Beginners...

Send for *Coyne's* 7-Volume Job-Training Set on 7-Day **FREE TRIAL!**



The First Practical TV-RADIO-ELECTRONICS Shop Library!

Answers ALL Servicing Problems QUICKLY... Makes You Worth More On The Job!

Put money-making, time-saving TV-RADIO-ELECTRONICS know-how at your fingertips—examine Coyne's all-new 7-Volume TV-RADIO-ELECTRONICS Reference Set for 7 days at our expense! Shows you the way to easier TV-Radio repair—time saving, practical working knowledge that helps you get the BIG money! How to install, service and align ALL radio and TV sets, even color-TV, UHF, FM and transistorized equipment. New photo-instruction shows you what makes equipment "tick". No complicated math or theory—just practical facts you can put to use immediately right in the shop, or for ready reference at home. Over 3000 pages; 1200 diagrams; 10,000 facts!

SEND NO MONEY! Just mail coupon for 7-Volume TV-Radio Set on 7-Day FREE TRIAL! We'll include the FREE BOOK below. If you keep the set, pay only \$4 in 7 days and \$4 per month until \$27.25 plus postage is paid. Cash price only \$24.95. Or return set at our expense in 7 days and owe nothing. Either way, the FREE BOOK is yours to keep. Offer limited, so act NOW!

"LEARNED MORE FROM THEM THAN FROM 5 YEARS WORK!"
"Learned more from your first two volumes than from 5 years work."
—Guy Bliss, New York
"Well set for either the serviceman or the beginner. Every service bench should have one."
—Melvin Masbruch, Iowa.

FREE DIAGRAM BOOK!

We'll send you this big book, "150 Radio-Television Picture Patterns and Diagrams Explained" ABSOLUTELY FREE just for examining Coyne's 7-Volume Shop Library on 7-Day FREE TRIAL! Shows how to cut servicing time by reading picture-patterns, plus schematic diagrams for many TV and radio sets. Yours FREE whether you keep the 7-Volume Set or not! Mail coupon TODAY!



Like Having An Electronics Expert Right At Your Side!

- VOL. 1—EVERYTHING ON TV-RADIO PRINCIPLES!** 300 pages of practical explanations; hundreds of illustrations.
- VOL. 2—EVERYTHING ON TV-RADIO-FM RECEIVERS;** 403 pages; fully illustrated.
- VOL. 3—EVERYTHING ON TV-RADIO CIRCUITS!** 336 pages; hundreds of illustrations, circuit diagrams.
- VOL. 4—EVERYTHING ON SERVICING INSTRUMENTS!** How they work, how to use them. 368 pages; illustrated.
- VOL. 5—EVERYTHING ON TV TROUBLESHOOTING!** Covers all types of sets. 437 pages; illustrations, diagrams.
- VOL. 6—TV CYCLOPEDIA!** Quick and concise answers to TV problems in alphabetical order, including UHF, Color TV and Transistors; 868 pages.
- VOL. 7—TRANSISTOR CIRCUIT HANDBOOK!** Practical Reference covering Transistor Applications; over 200 Circuit Diagrams; 410 pages.

ALL 7 BOOKS HAVE BRIGHT, MODERN, VINYL CLOTH WASHABLE COVERS

FREE BOOK—FREE TRIAL COUPON!

Educational Book Publishing Division
COYNE ELECTRICAL SCHOOL
1455 W. Congress Parkway, Dept. BO-T1, Chicago 7, Illinois

Yes! Send me COYNE'S 7-Volume Applied Practical TV-RADIO-ELECTRONICS Set for 7-Days FREE TRIAL per your offer. Include "Patterns & Diagrams" book FREE!

Name _____ Age _____

Address _____

City _____ Zone _____ State _____

Check here if you want Set sent C.O.D. Coyne pays shipping charges. 7-Day Money-Back Guarantee.

Coyne ELECTRICAL SCHOOL 1455 W. Congress Parkway Dept. BO-T1, Chicago 7, Illinois

spend one hour a day with either of these courses and prepare yourself for a rewarding future

BASIC ELECTRICITY



BASIC ELECTRONICS

two fabulous illustrated training courses now used by the U. S. Navy and the nation's leading industrial firms

These are the same famous courses sponsored by the U. S. Navy to turn out trained technicians in record time! More than 100,000 trainees have already learned the basics of electricity and electronics with this "learn-by-pictures" training course. What's more, the nation's leading firms rely on these courses to teach their personnel electricity and electronics. And, now you can learn these important subjects in the same easy-to-understand way!

Here's why these courses are the easiest, fastest way to learn the basics of electricity and electronics. Each idea is made completely understandable with specially created illustrations. These illustrations are so clear, so dramatic that you immediately grasp the idea. There's at least one of these illustrations to a page, each supported by text that is clear, concise and technically accurate. The illustrations and the text are the perfect combination to make the subject completely understandable. (These courses are not available from the U. S. Govt. Printing Office).

BASIC ELECTRICITY

by Van Valkenburgh, Nooger & Neville, Inc.

Regardless of your previous education, you can learn the basics of electricity with this "pictured-text" course. You will understand the fundamentals of electricity and the role it plays in our daily living. These fundamentals are applicable to the many electrical devices you own and use — machinery and other equipment. More than 900 carefully selected illustrations supported by crystal clear text makes these subjects completely understandable: DC components and their circuits; AC components and their circuits; AC and DC motors and machinery.

A knowledge of electricity is the key to a rewarding future in repair or maintenance work. It's a step up the ladder to an even more rewarding field — electronics — where technical men are participating in the highest paid jobs in America. And, if you just want to know about electricity for your own information, you'll understand enough to save many dollars in electrical repairs in your home or be able to participate in exciting hobbies such as kit building, amateur radio, experimentation and hi-fi. #169, 5 vols. soft covers, \$10.00 per set; #169-H, 5 vols. in one cloth binding, \$11.50.

BASIC ELECTRONICS

by Van Valkenburgh, Nooger & Neville, Inc.

Only a knowledge of the basics of electricity is necessary for you to easily master the basics of electronics. More than 800 carefully selected drawings make the function and operation of vacuum tube diodes and power supplies, oscillators, amplifiers, receivers and transmitters crystal clear. This course will prepare you for a bright future in electronics. What's more, it opens up many new, exciting hobbies — amateur radio, kit building, high fidelity. And even in business, it will speed your advance by helping you understand situations that require a basic knowledge of electronics.

BASIC ELECTRONICS famous 5-volume course available as heretofore. #170, Vols. 1 to V in soft covers, \$10.00; #170-H, all 5 vols. in one cloth binding \$11.50.

BASIC ELECTRONICS Vol. 6 only — for the great many thousands who have completed the 5 volume course, can be purchased separately. #170-6 soft cover \$2.90; cloth, \$3.60.

These and many other Rider titles are available at bookstores, electronic parts distributors, dept. stores or direct. Send for new catalog. Dept. RE-11
Buy these books today — No matter where you buy these books, we guarantee satisfaction, or your money back within 30 days of purchase.

JOHN F. RIDER PUBLISHER, INC. 116 West 14th Street, New York 11, N. Y.

Canada: Chas. W. Pointon, Ltd., 66 Racine Rd., Rexdale, Ont.

India: Asia Publishing House, Bombay and other cities

caded audio amplifier. This circuit gives a typical current gain of 92 at 25°C.

Characteristics of these Texas Instruments devices are:

BV_{CEO} (breakdown voltage)			
($I_C=10$ ma, $I_E=0$) (max)			60
I_{CBO} (reverse current)			
($V_{CB}=40$, $I_E=0$) (max) (μ a)			1
	2N1564	-1565	-1566
h_{fe} ($V_{CE}=5$, $I_E=5$ ma, $f=1$ kc)	20	40	80

3N56, 3N57

Called Binistors, these silicon n-p-n tetrodes are designed for switching and storage circuits. Typical applications include ring counters, binary counters, shift registers and general-purpose switching circuits.

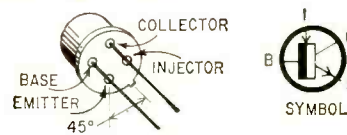

3N56, 3N57

INJECTOR IDENTIFIED BY YELLOW DOT ON CAP

Maximum ratings of these Transistron units are:

V_{CE}	15
V_{CJ} (collector to injector)	20
V_{CB}	18
V_{EB}	3
I_C (25°C) (ma)	30
I_J (injector current) (25°C) (ma)	30
Forward base current (I_b on) (25°C) (ma)	30
(I_b off) (25°C) (ma)	5
P_{total} (mw)	150

The 3N56 has a wider temperature range than the 3N57 (-65°C to 150°C vs -55°C to 100°C). This characteristic makes the 3N56 suitable for military applications.

6CQ4

An octal-based indirectly heated half-wave rectifier designed for TV damper diode service in horizontal deflection circuits. The design incorporates a glass-button suspension that is said

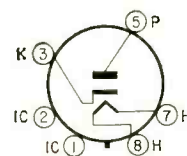

6CQ4

virtually to eliminate plate-cathode mica arcing and permits a peak inverse plate voltage which is conservative for 110° autotransformer deflection systems.

Maximum ratings of the Westinghouse 6CQ4 when used in damper service are:

PIV	5,500
I_P (peak) (ma)	1,200
I_P (ma)	190
P_P (watts)	6.5

Heater-cathode voltages

Heater neg with respect to:	
cathode	900
total dc and peak	5,500
Heater pos with respect to:	
cathode	100
total dc and peak	300

2N1671, -A, -B

A series of silicon Unijunction tran-

CARTOONS RADIO-ELECTRONICS pays \$3.00 for good cartoon ideas and \$15 and up for finished work

RADIO-ELECTRONICS

154 West 14th St.

New York 11, N. Y.

RENT stereo tapes

- OVER 1500 DIFFERENT ALBUMS
- POSTPAID TO AND FROM YOUR HOME

SEND FOR FREE BROCHURE | stereo-parti 811-BA Centinela Avenue, Inglewood 3, California

A NOTE TO THE HI-FI BUYER
AIR MAIL us your requirements for an IMMEDIATE LOWEST PRICE QUOTATION Components, Tapes and Recorders SHIPPED PROMPTLY AT LOWEST PRICES
WRITE TODAY FOR FREE CATALOG
AUDIO UNLIMITED 714-R Lexington Ave. New York 22, N. Y.

LOOK
no further . . . if you're searching for hi-fi savings. Write us your requirements now.
Key Electronics Company
120-A Liberty St., N.Y. 6, N.Y.
Cloverdale 8-4288

FREE! CATALOG OF HI-FI, RADIO, TV PARTS & ACCESSORIES — yours for the asking!
Vidaire ELECTRONICS MFG. CORP.
365 BABYLON TPKE. — ROOSEVELT, N. Y.

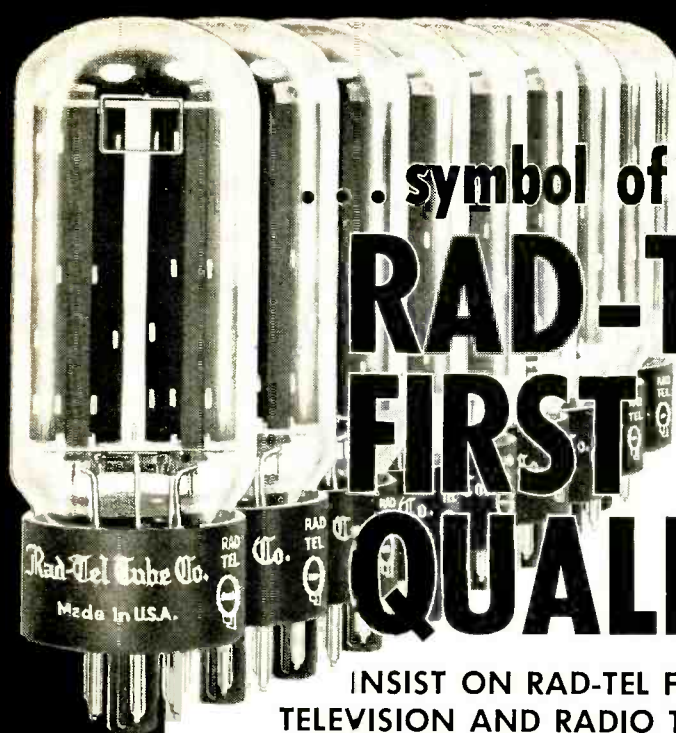



... symbol of
RAD-TEL
FIRST
QUALITY

INSIST ON RAD-TEL FOR EVERY TELEVISION AND RADIO TUBE NEED

TRANSISTORS

at fabulous discounts

 **RF** MIXER and IF **49¢** ea.

 **AF** DRIVER and OUTPUT **39¢** ea.

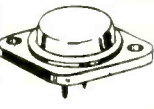
 **AUTO TYPE** **80¢** ea.

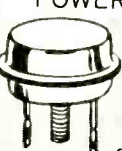
 **HIGH POWER** **15 AMP** **\$1.40** ea.
Collector Current

Up to 75% OFF on BRAND NEW TUBES

GUARANTEED ONE FULL YEAR! You Can Rely On Rad-Tel's Speedy One Day Service!

Not Used — Not Pulled Out Of Old Sets • Each Tube Individually and Attractively Boxed!

Qty.	Type	Price	Qty.	Type	Price	Qty.	Type	Price	Qty.	Type	Price	Qty.	Type	Price	Qty.	Type	Price	Qty.	Type	Price						
—	024M	.79	—	30T6	.50	—	6AB4	.46	—	6B16	.62	—	6E08	.79	—	12A4	.60	—	12B06	.50	—	12EG6	.54	—	198G	1.39
—	1AX2	.62	—	30S5	.80	—	6AC7	.96	—	6BK7	.85	—	6EA8	.79	—	12AB5	.55	—	12B06	.53	—	12EZ6	.53	—	1918	.80
—	1B33T	.79	—	3S4	.61	—	6AF3	.73	—	6BL7	1.00	—	6H6GT	.58	—	12AC6	.49	—	12BF6	.44	—	12F5	.66	—	21EX	1.49
—	1DN5	.55	—	3V4	.58	—	6AF1	.97	—	6BN4	.57	—	6J5GT	.51	—	12A06	.57	—	12BH7	.73	—	12F8	.66	—	25B0	1.11
—	1G3	.73	—	4BC5	.35	—	6AG5	.65	—	6BN6	.74	—	6J6	.67	—	12AE6	.43	—	12BL6	.56	—	12FM6	.45	—	25C5	.53
—	1J3	.73	—	4EC8	.36	—	6AH6	.99	—	6BQ5	.65	—	6K6	.53	—	12AF3	.73	—	12B06	1.06	—	12K5	.65	—	25CA5	.59
—	1K3	.73	—	4EN6	.75	—	6AK5	.95	—	6BQ6GT	1.05	—	6SA	.48	—	12AF6	.49	—	12B7	.74	—	12SA7M	.86	—	25C0	1.44
—	1L6	1.05	—	4EQ7	.95	—	6AL5	.47	—	6BQ7	.95	—	6SA7GT	.76	—	12A16	.46	—	12B7	.75	—	12SK7GT	.74	—	25C0	1.11
—	1LN5	.59	—	4ES8	.93	—	6AM8	.78	—	6BR8	.78	—	6SK7	.74	—	12A15	.45	—	12C5	.56	—	12SN7	.67	—	25D0	1.42
—	1R5	.62	—	4EU8	.71	—	6AN4	.95	—	6BU8	.70	—	6SL7	.80	—	12A18	.95	—	12CA5	.59	—	12SQ7M	.73	—	25EH5	.55
—	1S5	.51	—	4EZ6	.58	—	6AN6	.85	—	6BY6	.54	—	6SN7	.55	—	12A25	.52	—	12CN5	.56	—	12U7	.62	—	25L6	.57
—	1T4	.58	—	4BZ7	.96	—	6AQ5	.50	—	6BZ6	.54	—	6SQ7	.73	—	12AT6	.43	—	12CR6	.54	—	12V6GT	.53	—	25W4	.68
—	1U4	.57	—	4CS6	.61	—	6AR5	.55	—	6BZ7	.97	—	6T4	.39	—	12AT7	.76	—	12CU5	.58	—	12W6	.69	—	25Z6	.66
—	1U5	.50	—	4DE6	.62	—	6AS5	.60	—	6C4	.43	—	6U8	.78	—	12AU6	.50	—	12CU6	1.06	—	12X4	.38	—	35C5	.51
—	1X2B	.82	—	40K6	.60	—	6AT5	.43	—	6CB6	.54	—	6V6GT	.54	—	12AU7	.60	—	12CX6	.54	—	17AX4	.67	—	35L6	.57
—	2AF4	.96	—	40T6	.55	—	6AT3	.79	—	6CD6	1.42	—	6W4	.57	—	12AV5	.97	—	12DB5	.69	—	17BQ6	1.09	—	35W4	.52
—	3AL5	.42	—	5AM8	.79	—	6AU4	.82	—	6CF6	.64	—	6W6	.59	—	12AV6	.41	—	12DB8	.75	—	17C5	.58	—	35Z5CT	.60
—	3AU5	.51	—	5AQ5	.86	—	6AU6	.50	—	6CG7	.60	—	6X4	.39	—	12AV7	.75	—	12DE8	.85	—	17CA5	.62	—	50B5	.60
—	3AV6	.41	—	5AT8	.52	—	6AU7	.61	—	6CG8	.77	—	6X5GT	.53	—	12AX4	.67	—	12DL8	.85	—	17D4	.69	—	50C5	.53
—	3BA6	.51	—	5B7A	.80	—	6AU8	.87	—	6CM7	.66	—	6X8	.77	—	12AX7	.63	—	12DM7	.67	—	17DQ6	1.06	—	50D0	.37
—	3BC5	.54	—	5BQ7	.97	—	6AV5	.40	—	6CN7	.65	—	7AU7	.61	—	12AX7	.86	—	12DQ6	1.04	—	17L6	.58	—	50EH5	.55
—	3BE6	.52	—	5BR8	.79	—	6AV8	.89	—	6CR6	.51	—	7A8	.68	—	12B4	.63	—	12D7	.79	—	17W6	.70	—	50L6	.61
—	3BN6	.76	—	5C8	.76	—	6AX4	.65	—	6CS6	.57	—	7B6	.69	—	12BA6	.50	—	12Z6	.56	—	19A4	.83	—	117Z	.61
—	3BU8	.78	—	5CL8	.76	—	6AX7	.64	—	6CU5	.58	—	7Y4	.69	—			—								
—	3BY6	.55	—	5EA8	.80	—	6B8A	.49	—	6CU6	1.08	—	8AU8	.83	—			—								
—	3BZ6	.55	—	5E08	.80	—	6BC5	.54	—	6CY5	.70	—	8AW8	.93	—			—								
—	3CB6	.54	—	5E08	.80	—	6BC7	.94	—	6CY7	.71	—	8BQ5	.60	—			—								
—	3CF6	.60	—	5J6	.68	—	6BC8	.97	—	6DA4	.68	—	8CG7	.62	—			—								
—	3CS6	.52	—	5T8	.81	—	6BD6	.58	—	6DB5	.69	—	8CM7	.68	—			—								
—	3CY5	.71	—	5U4	.60	—	6BE3	.55	—	6DE6	.58	—	8CN7	.97	—			—								
—	3DK6	.60	—	5U8	.81	—	6BF3	.44	—	6DE6	.59	—	8CX8	.93	—			—								
			—	5V6	.56	—	6BG5	1.66	—	6DQ6	1.10	—	8EB8	.94	—			—								
			—	5X8	.78	—	6BH5	.65	—	6DT5	.66	—	10DA7	.71	—			—								
			—	5Y3	.46	—	6BH8	.87	—	6DT6	.53	—	11CY7	.75	—			—								

SEND FOR FREE TROUBLE SHOOTER GUIDE AND NEW TUBE & PARTS CATALOG.

Not a Kit, but Completely Wired
STEREO AMPLIFIER
CHASSIS \$4.95

Single, \$5.95 ea.
 Set of tubes: 2-35C5; 1-12AX7; 1-35W4 \$1.15

Set of 3 grey 1/2" knobs 30c

Lots of 3 ea.



RAD-TEL TUBE CO.

55 Chambers St
 Newark 5, N. J.

TERMS: 25% deposit must accompany all orders — balance C. O. D.
 \$1 HANDLING CHARGE FOR ORDERS UNDER \$5. Subject to prior sale.
 Please add postage. No C. O. D.'s outside continental U. S. A.

RE-116C

new "LEADER" test instrument

LAG-55 AUDIO GENERATOR SINE SQUARE

A multi-purpose generator for measurements on audio equipment—amplifiers, speakers, networks. Three waveforms: sine, square and complex for all types of measurements including response, distortion, transient and I-M distortion checks. Full range is from 20 to 200,000 cps, output 5 volts with minimum amplitude variation throughout whole range.



The LEADER test instruments are being used in the more than 36 countries, attesting their excellence in design, performance and usefulness.

OHMATSU ELECTRIC CO. LTD.

850 TSUASHIMA-CHO KOHOKU-KU YOKOHAMA, JAPAN

SERVICEMEN

FREE TO OUR TUBE CUSTOMERS

A MINK STOLE FOR YOUR BEST GIRL

Top name brands—First quality—Brand New—Full replacements—60% off—plus FREE tube bonus.

WRITE FOR DETAILS

RADIO TUBE SPECIALISTS

397-7th Ave., Brooklyn 15, N.Y.

HI-FI & STEREO COMPONENTS

Send us your list for a **SPECIAL PACKAGE DEAL QUOTE**. No sale too small. Trades accepted. **BONAFIDE** offers biggest discounts on all standard brands. Expert advice and full guarantee are assured at

BONAFIDE ELECTRONICS

Dept. RE-11, 89 1/2 Cortland St., N.Y. 7, N.Y.
WE WILL NOT BE UNDERSOLD

all new edition

up-to-date
component prices

PLUS

the quick easy way
to figure service charges

EQUALS



Dave Rice's

OFFICIAL PRICING DIGEST

VOL. 4, NO. 1



Flat rate and hourly service charges, based on and showing regional and national averages, plus up-to-date list or resale prices on over 63,000 components, arranged alphabetically by manufacturers and products, numerically by part number. Compact, convenient size fits in tube caddy, toolbox or pocket. \$2.50 per copy from your distributor.

ELECTRONIC PUBLISHING COMPANY, INC.
180 N. WACKER DRIVE, CHICAGO 6, ILL.

Television RADIO-ELECTRONICS Electricity ELECTRONICS IN NEW SHOP-LABS OF COYNE

TRAIN QUICKLY! OLDEST, BEST EQUIPPED SCHOOL of ITS KIND in U.S.

Get practical training in New Shop-Labs of Coyne. Prepare for a better job and a successful future in a top opportunity field. Advanced education or previous experience not needed. Employment service to graduates.

Enroll NOW—Pay Later

Finance Plan and Easy Payment Plan. Also Part Time Employment help for students.

FREE BOOK Clip coupon or write to address below for Free Illustrated Book: "Guide to Careers"—Describes all training offered; No obligation and No Salesman Will Call. Act NOW.

B. W. Cooke, Jr., President

COYNE
ELECTRICAL SCHOOL
1501 W. Congress Pkwy.
Chicago, Dept. 6D

Use this coupon to get our free book
"GUIDE TO CAREERS"

COYNE ELECTRICAL SCHOOL training at Coyne
1501 W. Congress Pkwy. training at home
Chicago 7, Ill. Dept. of Electronics 6D

NAME _____
ADDRESS _____
CITY _____ STATE _____
Unlike most other schools, we do not employ salesmen.

sistors useful in oscillators, timing circuits and pulse generators where they can serve the purpose of two conventional silicon or germanium transistors.

The 2N1671 is intended for general-purpose industrial applications. The 2N1671-A is intended for industrial use in firing circuits for silicon controlled rectifiers (see diagram) and other ap-

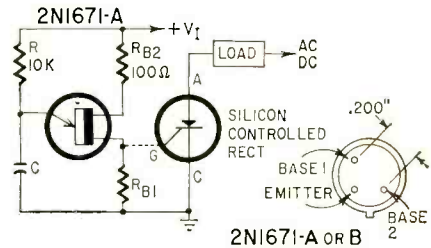

plications where a guaranteed minimum pulse amplitude is required. The 2N1671-B is intended for applications where a low emitter leakage current and a low peak point emitter current (trigger current) are required.

Maximum ratings of the General Electric 2N1671 series are:

P_{total} (mw)	450
I_E (ma)	50
I_E (peak) (amps)	2
V_E (reverse)	30

HT-1 through HT-10

A series of silicon tunnel diodes designed for use in digital pulse circuits, gating, memory matrices, negative resistance amplifiers and microwave oscillators.

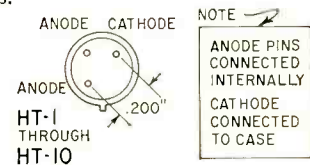

All will handle a maximum of 200-ma forward current and 200-ma reverse current.

Electrical characteristics of these Hoffman tunnel diodes are:

Type	Peak Current (ma)	Voltage at I_p (mv)	Voltage at I_v (mv)	Typical Neg Resistance (ohms)
HT-1	1.0	65	420	220
HT-2	1.2	65	420	180
HT-3	1.5	65	420	150
HT-4	1.8	65	420	120
HT-5	2.2	65	420	100
HT-6	2.7	65	420	83
HT-7	3.3	65	420	68
HT-8	3.9	65	420	56
HT-9	4.7	65	420	47
HT-10	5.6	65	420	39

Note: I_p is current at peak of characteristic curve. I_v is valley current (current at lowest point on negative-resistance slope). END

CORRECTION

There is an error in the value of the capacitor bank used to develop the 5,000,000-ampere arc described on page 45 of the September issue. The value (390,000) is in μf , not $\mu\mu f$. This is apparent from the words immediately following the wrong value, which state that the bank is made up of 2,000 capacitors of almost 200 μf each.

Our thanks to Mr. H. Q. Duguid, of Darien, Conn., for bringing this to our attention.

NOTEWORTHY CIRCUITS

SIMPLE STEREO AMPLIFIER

This circuit was described in the March, 1959, issue of the French magazine *Le Haut-Parleur*. It is a simple stereo amplifier used in portable stereo

cartridge connected to its input, the amplifier is quite versatile. It has a rather elaborate group of controls: a MODE control for selecting the type of

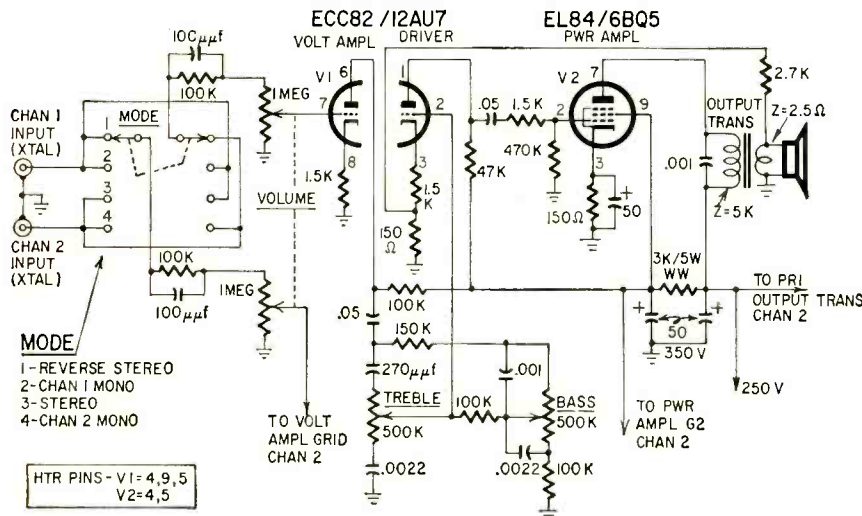

record players. Only one channel is shown. The actual unit uses two ECC82's, two EL84's and a common power supply. Despite its being uncomplicated and requiring a crystal

operation, a dual VOLUME control and separate BASS and TREBLE controls. Feedback over two stages is used—from the secondary of the output transformer to the driver tube's cathode.

TRANSISTOR PULSE INTEGRATOR

Integrating the pulses from a high-impedance low-current source is difficult. In this specific problem, I wanted to integrate the pulses from a standard Geiger tube to provide a meter indication with a minimum of circuitry. The same circuit and method will prove useful in many similar applications.

The diagram includes a high-voltage power supply. Complete information on this part of the circuit may be found in *RADIO-ELECTRONICS*, February 1957, page 58. Resistor R should have the largest value that will let 10 µa be drawn through the voltage-regulator

tube. This minimizes current drain from the high-voltage battery.

In the pulse integrator part of the circuit, the high-voltage low-current pulses are stepped down through a transformer to low-voltage high-current pulses. Almost any interstage transformer can be used here. I used a Chicago UM-112 to keep size down. Connect transformer secondary leads for maximum current. One way provides four times as much as the other.

The pulses are rectified and integrated by germanium diode D and capacitor C. The average dc is then

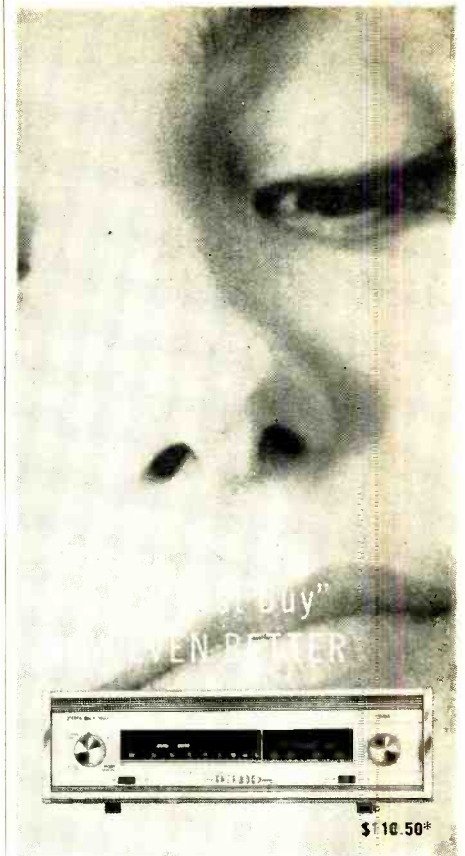
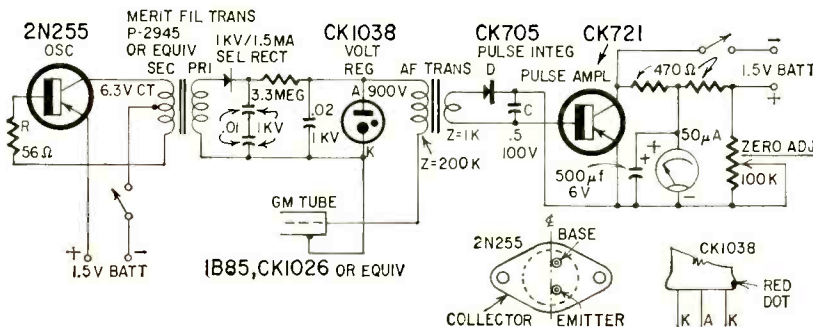

only for those who want the ultimate

SHERWOOD S-3000 III

FM/MX STEREO TUNER

The FM tuner that has everything . . . 0.95µv sensitivity, Interchannel Hush noise muting system, "Acro-Beam" tuning eye, cascode balanced input, automatic frequency control, "local-distant" switch . . . now brings you the only

FM TUNER with "CORRECTIVE" INVERSE FEEDBACK

Every high fidelity amplifier today incorporates "corrective" inverse feedback for lower distortion and improved response. Now, Sherwood brings the same performance benefits to the S-3000 III FM Tuner; these include reduction of distortion due to overmodulation by the FM station and better quality long-distance reception.

READY FOR FM STEREO

Stereo via FM multiplex broadcasting is just around the corner. The S-3000 III contains chassis space and all control facilities to plug in a stereo multiplex adapter. Other features include flywheel tuning, plus 7" expanded slide rule tuning scale, cathode-follower output, and front panel output level control. Sherwood Electronic Laboratories, Inc., 4300 N. California Ave., Chicago 18, Ill.

(*) Other fine Sherwood Tuners:
S-2000 II AM-FM Tuner \$145.50
S-2200 AM-FM MX Stereo Tuner \$179.50

For Complete Technical Details Write Dept. RE-11

BUSINESS and PEOPLE

Sencore, Addison, Ill., is building a new addition to its present plant which will nearly double capacity. Herb Bowden, Sencore president, is surrounded by plant personnel and well wishers as he breaks ground for the



new addition. Sencore recently released the third in its series of slide films on how to use Sencore testers in servicing. The latest in the series, "Old Tubes Sel-

dom Die, They Just Fade Away," features the Mighty Mite tube checker. Sylvania Electronic Tubes Div.'s re-



ceiving tube operations won the president's Safety Citation for 15 months of operating without a single disabling injury. Matthew D. Burns (left), president of the division, presents the award to Walter A. Weiss (right), vice president in charge of receiving tube operations.

Pyramid Electric Co., Darlington, S. C., is merchandising its electrolytic



twist-mount capacitors in new clear plastic tubular Vu-Paks which are reusable for storing small parts and tools.

George C. Connor (left) was elected a senior vice president of Sylvania Electric Products, New York, with responsibility for the company's marketing activities. He had been regional sales vice president-East. William O. Spink was



appointed vice president-sales of Sylvania Electronic Tubes Div., New York. He had been equipment sales manager for the division. He succeeds Donald W. Gunn, who is now regional vice president of Sylvania, covering marketing activities in the 12 Western states and Hawaii.

"ONE DOLLAR" buys

As much as \$15 worth - Everything Brand New and sold to you with a money back guarantee. Pick - ANY 1 DOLLAR BUY FREE with every 10 you buy. FREE GIFT - with every Order of \$5.00 or over.

HANDY WAY TO () - Simply tear out advertisement and pencil mark items wanted, enclose with money order or check. (Dot in square is sufficient). You will receive a new copy of this ad for re-orders. ON SMALL ORDERS - Include stamps for postage, excess will be refunded. Larger orders shipped express collect.

- | | | |
|---|---|--|
| <ul style="list-style-type: none"> <input type="checkbox"/> 10 - TOP NAME #1U4 TUBES also serves as 1T4 \$1 <input type="checkbox"/> 4 - KENRAD TUBES #6SH7 \$1 <input type="checkbox"/> 2 - TOP NAME #6S07 TUBES \$1 <input type="checkbox"/> 2 - GENERAL ELECTRIC TUBES #35W4 \$1 TOP NAME TUBES OZ4, 1B3, 1X2B, 5U4, 6AC7, 6AX4, 6CB6, 6J6, 6K6, 6U8, 6V6, 6SN7, 6X8, 12AU7, 12AX7, 50L6 \$1 <input type="checkbox"/> ELECTRIC PHONO MOTOR 78 rpm \$1 <input type="checkbox"/> 12 - RADIO OSCILLATOR COILS 4.56 kc \$1 <input type="checkbox"/> 1 - LB. SPOOL ROSIN CORE SOLDER \$1 <input type="checkbox"/> 4 - 50' SPOOLS HOOK-UP WIRE 4 colors \$1 <input type="checkbox"/> 10 - 6' ELECTRIC LINE CORDS with plugs \$1 <input type="checkbox"/> 5 - TV CHEATER CORDS with both plugs \$1 <input type="checkbox"/> 5 - TV CRT. SOCKETS with 18" leads \$1 <input type="checkbox"/> 5 - HI-VOLT. ANODE LEADS with 18" leads \$1 <input type="checkbox"/> 100' - TWIN LEAD-IN WIRE 300# heavy duty \$1 <input type="checkbox"/> 50' - FLAT 4-CONDUCT. WIRE many purposes \$1 <input type="checkbox"/> 25' - INSULATED SHIELDED WIRE \$1 <input type="checkbox"/> 32' - TEST PROD WIRE (red or black) \$1 <input type="checkbox"/> 1 - S7 INDOOR TV ANTENNA 1/2 grain 3 section \$1 20 - ASST. TV KNOBS, ESCUTCHEONS, Etc. \$1 1 - RCA 70° FLYBACK TRANS. #75240 \$1 1 - FLYBACK TRANS. 90° w/ schematic \$1 1 - TV VERT. OUTPUT TRANS. 10 to 1 ratio \$1 15 - ASST. TV COILS screw, peaking, width, etc. \$1 15 - ASST. STANDARD TUNER VHF STRIPS \$1 6 - ASST. STANDARD TUNER UHF STRIPS \$1 2 - SILICON RECTIFIERS 500ma \$1 1 - SILICON RECTIFIER 750ma \$1 25 - ASST. PEAKING COILS popular types \$1 10 - TV CARTWHEEL CONDENSERS 10kv \$1 3 - TV CARTWHEEL CONDENSERS 20kv \$1 2 - TV CARTWHEEL CONDENSERS 30kv \$1 1 - TV RATIO DETECTOR COIL 4.5mc \$1 1 - TV RATIO DETECTOR COIL 10.7mc \$1 1 - TV SOUND I.F. COIL 4.5mc \$1 1 - TV VERT. BLOCKING TRANS. standard \$1 1 - TV FOCUS COIL 270, 330 or 470 ohms \$1 3 - HV RECTIFIER SOCKETS 1B3 mnt'd \$1 3 - HV RECTIFIER SOCKETS 1X2 mnt'd \$1 1 - TV SYNCHROGUIDE COIL #205R1 \$1 \$15 - "JACKPOT" TELEVISION PARTS \$1 3 - TV ALIGNMENT TOOLS assortment #1 \$1 3 - TV ALIGNMENT TOOLS assortment #2 \$1 3 - TV ALIGNMENT TOOLS assortment #3 \$1 3 - TV ALIGNMENT TOOLS assortment #4 \$1 3 - TV ALIGNMENT TOOLS assortment #5 \$1 | <ul style="list-style-type: none"> <input type="checkbox"/> 1 - 5" PM SPEAKER alnico #5 magnet \$1 <input type="checkbox"/> 1 - 4" PM SPEAKER alnico #5 magnet \$1 <input type="checkbox"/> 1 - 3" PM SPEAKER alnico #5 magnet \$1 <input type="checkbox"/> 1 - 3 1/2" TWEETER SPEAKER for HI-FI \$1 <input type="checkbox"/> 4 - AUDIO OUTPUT TRANS. 50L6 type \$1 <input type="checkbox"/> 3 - AUDIO OUTPUT TRANS. 6K6 or 6V6 type \$1 <input type="checkbox"/> 3 - I.F. COIL TRANSFORMERS 450 kc \$1 <input type="checkbox"/> 3 - I.F. COIL TRANSFORMERS 10.7 mc. FM \$1 <input type="checkbox"/> 3 - I.F. COIL TRANSFORMERS 262 kc (auto) \$1 40 - ASST. PRECISION RESISTORS best sizes \$1 5 - SELENIUM RECTIFIERS 65ma 1st \$1.50 ea \$1 4 - SELENIUM RECTIFIERS 75ma \$1 3 - SELENIUM RECTIFIERS 250ma \$1 2 - SELENIUM RECTIFIERS 300ma \$1 2 - SELENIUM RECTIFIERS 1-350ma 1-75ma \$1 3 - ASST. SIZES RADIO CHASSIS PANS \$1 3 - VARIABLE CONDENSERS super 420/162mfd \$1 50 - STRIPS ASST. SPAGHETTI best sizes \$1 100 - ASST. RUBBER GROMMETS best sizes \$1 4 - OVAL LOOP ANTENNAS ass't hi-grain type \$1 3 - LOOPSTICK ANT. new ferrite adjustable \$1 3 - 1/2 MEG VOLUME CONTROLS with switch \$1 5 - 50K VOLUME CONTROLS less switch \$1 5 - ASST. 4 WATT WIREWOUND CONTROLS \$1 5 - 1/2 MEG VOLUME CONTROLS less switch \$1 5 - 1 or 2 MEG VOLUME CONTROLS 1/switch \$1 100 - VOLUME CONTROL HEX NUTS \$1 10 - SURE GRIP ALLIGATOR CLIPS \$1 1 - GOLD GRILLE CLOTH 1 1/2" x 1 1/2" or 1 1/2" x 1 1/8" \$1 5 - SETS SPEAKER PLUGS wired \$1 10 - SETS PHONO PLUGS and PIN JACKS \$1 2 - \$2.50 SAPPHIRE NEEDLES 1000 playings \$1 4 - ELECTROLYTIC CONDS. 80-400v \$1 35 - MICA COND. 20-50 mmf & 15-68 mmf \$1 35 - MICA COND. 20-100 mmf & 15-270 mmf \$1 35 - MICA COND. 20-470 mmf & 15-680 mmf \$1 35 - MICA COND. 20-820 mmf & 15-1000 mmf \$1 35 - MICA COND. 20-2200 mmf & 15-2400 mmf \$1 35 - MICA COND. 20-6800 mmf & 15-10000 mmf \$1 35 - CERAMIC COND. 20-5 mmf & 15-10 mmf \$1 35 - CERAMIC COND. 20-25 mmf & 15-47 mmf \$1 35 - CERAMIC COND. 20-56 mmf & 15-82 mmf \$1 35 - CERAMIC COND. 20-100 mmf & 15-150 mmf \$1 35 - CERAMIC COND. 20-270 mmf & 15-470 mmf \$1 35 - CERAMIC COND. 20-1000 mmf & 15-1500 mmf \$1 35 - CERAMIC COND. 20-200 mmf & 15-5000 mmf \$1 | <ul style="list-style-type: none"> <input type="checkbox"/> 100 - ASST. 1/2 WATT RESISTORS some 50% \$1 <input type="checkbox"/> 70 - ASSORTED 1 WATT RESISTORS \$1 <input type="checkbox"/> 35 - ASSORTED 2 WATT RESISTORS \$1 <input type="checkbox"/> 50 - ASST. TUBULAR CONDENSERS \$1 <input type="checkbox"/> 50 - ASSORTED FUSES popular sizes \$1 <input type="checkbox"/> 50 - 1000 1/2 WATT RESISTORS 10% \$1 <input type="checkbox"/> 75 - 470K 1/2 WATT RESISTORS 10% \$1 5 - DIODE CRYSTALS 1N34A \$1 5 - DIODE CRYSTALS 1N60 \$1 5 - DIODE CRYSTALS 1N64 \$1 5 - DIODE CRYSTALS 1N69 \$1 100 - ASST. CERAMIC CONDENSERS \$1 10 - ASST. WIREWOUND RES. 5, 10, 20 watt \$1 10 - HV TUBULAR CONDENSERS .006-600v \$1 10 - HV TUBULAR CONDENSERS .005-500v \$1 35 - ASST. DISC CERAMICS best numbers \$1 50 - ASST. MICA CONDENSERS some in 50% \$1 6 - ASST. SLIDE SWITCHES spst, dpdt, etc. \$1 4 - BAKELITE KNIFE SWITCHES dpdt \$1 3 - ASST. TOGGLE SWITCHES spst, dpdt, etc. \$1 15 - ASST. ROTARY SWITCHES \$15 worth \$1 100' - FINEST NYLON DIAL CORD best size \$1 200 - SELF TAPPING SCREWS #8 x 1 1/2" \$1 35 - ASST. RADIO KNOBS screw and push-on \$1 100 - ASSORTED KNOB SET-SCREWS \$1 25 - ASSORTED CLOCK RADIO KNOBS \$1 600 - ASST. H'DWARE screws, nuts, rivets, etc. \$1 35 - ASST. SOCKETS octal, noval and miniature \$1 25 - ASST. PRINTED CIRCUIT SOCKETS \$1 10 - ASST. VOLUME CONTROLS less switch \$1 5 - ASST. VOLUME CONTROLS with switch \$1 20 - ASST. PILOT LIGHTS popular types \$1 10 - PILOT LIGHT SKTS. bayonet type, wired \$1 50 - ASST. TERMINAL STRIPS 1, 2, 3, 4 lug \$1 10 - ASST. RADIO ELECTRO. CONDENSERS \$1 5 - ASST. TV ELECTROLYTIC CONDENSERS \$1 25 - ASST. MICA TRIMMER CONDENSERS \$1 15 - TUBULAR CONDENSERS 1-600v \$1 15 - TUBULAR CONDENSERS .017-600v \$1 10 - TUBULAR CONDS. .47-800v \$1 10 - ELECTROLYTIC COND. 100/25.5v \$1 2 - ELECTROLYTIC COND. 10-40-150v \$1 3 - ELECTROLYTIC COND. 50-30-150v \$1 3 - ELECTROLYTIC COND. 80-450v \$1 35 - DISC. CERAMIC CONDENSERS 5000ohm \$1 25 - ASST. RADIO DIAL POINTERS \$1 8 - ASST. LUCITE CASES handy for parts \$1 |
|---|---|--|

BROOKS RADIO & TV CORP., 84 Vesey St., Dept. A, New York 7, N.Y.

TELEPHONE
CORtland T-2359

Now...INCREASE YOUR RADIO SALES with the SEG RADIO DEMONSTRATION SYSTEM

- Radios sell immediately on demonstration
- Completely hidden
- No direct connection
- Simple to install
- FM & Shortwave outlet

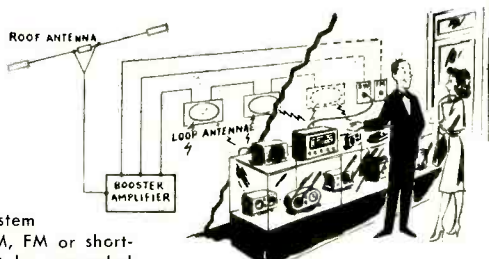

Demonstrate with Pride—No Excuses

The new Master Radio Demonstration system is a "must" for every retailer who sells AM, FM or short-wave radios. Powerful signals are sent out by concealed loop antennae to give all the radios on your display shelves strong and clear input signals... permitting them to function at the peak of their capacity, despite interference from fluorescents, elevator starting motors, or any other steel construction in the building that might introduce noise or weaken the signal.



MODEL SPA

SUPER POWERED SINGLE CHANNEL AMPLIFIER OVER 20V—5 WATTS OUTPUT

DELIVERS TREMENDOUS SIGNALS OVER LONG DISTANCES

- Channels 2-13
- Over 26db gain
- 6-8 mcs band width
- Response flat \pm 2db
- Input 1 Volt max.
- 75 OHM Termination
- Linear Class—A operation
- C. C. S. Service

Write for details today

U. S. Govt. Install. Panama Canal Zone, Iwo Jima.

SEG ELECTRONICS

1778 FLATBUSH AVE.

BROOKLYN 10, NEW YORK



CBS Electronics, Danvers, Mass., is offering distributors a colorful new Tools and Service aids floor - easel merchandiser.

W. Walter Watts (left), recently elected chairman of the board and president of RCA Sales Corp., in addition to his post as RCA group vice president, was elected a director of Radio Corp. of America. He succeeds Dr. Charles B. Jolliffe, vice president and technical director of RCA. Dr. Jolliffe retired last



year but continues to serve the corporation on special assignments. RCA also announced the consolidation of institutional and staff advertising and sales promotion activities under R. H. Coffin (right) as staff vice president, advertising and sales promotion. He had been director, advertising and sales promotion, and a vice president.



had been general sales manager.



Robert E. Svoboda, manager of the Amphenol Distributor Div. of Amphenol - Borg, Broadview, Ill., was made president of the division.

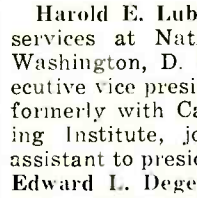

James W. Noland is now general manager of the Gosset Div., Young Spring & Wire Corp., Burbank, Calif. He was formerly manager of manufacturing services at National Radio Institute, Washington, D. C., was appointed executive vice president. Everett A. Corey, formerly with Capitol Radio Engineering Institute, joined NRI as special assistant to president J. Morrison Smith. Edward L. Degener, general manager, and an NRI employee for 42 years, retired.

Sam Poncher of Newark Electronics, Chicago, was elected president of the Electronic Industry Show Corp. for 1 year. Other new officers are: Robert D.

SAVE on everything in
stereo hi-fi
and
electronics

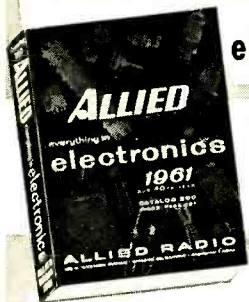

send for the 1961

ALLIED CATALOG

free

444-PAGES • VALUE PACKED. Write today for the leading Electronics Catalog. World's largest selection, including products and values available only from ALLIED. SAVE ON:

- Everything in Hi-Fi Music Systems & Components
- Biggest Selection of Hi-Fi Cabinetry
- Exclusive Knight® Super-value Stereo
- Knight-Kits®—Best in Build-Your-Own Hi-Fi
- Tape Recorders and Phono Equipment
- Everything in Electronic Parts, Tubes, Transistors, Test Equipment, Amateur Gear, P.A. Systems, TV Accessories, Tools, Books.

Save most at ALLIED. Write for FREE 1961 Catalog today!

only \$2 down on orders up to \$50

ALLIED RADIO

free catalog

ALLIED RADIO, Dept. 103-L
100 N. Western Ave., Chicago 80, Ill.

Send FREE 1961 ALLIED Catalog.

Name _____

Address _____

City _____

Zone _____

State _____

voices from outer space!

SPECIAL OFFER, 25¢

Dramatic Events Recorded First Time From Short Wave Radio!

President's voice from outer space... police capture of a gunman... radio contact with record altitude flight! Many other fascinating, historic events—ships, planes, foreign stations—all transcribed on a limited-edition recording, "The Amazing World of Short Wave Listening," narrated by world-famous newscaster Alex Dreier. If you're alert, adventuresome, send for this remarkable recording today!

As heard on Hallicrafters precision receivers, \$59.95 to \$395.00.



Department 23, Chicago 11, Ill.

Enclosed is 25¢. Please rush "The Amazing World of Short Wave Listening."

NAME _____

ADDRESS _____

CITY _____ STATE _____

Ferree, International Resistance Co., vice president; Norman Triplett, Triplett Electrical Instrument Co., secretary, and Robert E. Svoboda, Amphenol-Borg Electronics, treasurer.

Obituaries

Bond P. Geddes, radio industry pioneer and for many years executive vice president and secretary of the Radio Manufacturers Association (now the EIA), in Washington, D. C., at the age of 78.

William A. Nicely, vice president and general manager of CTS Corp. (formerly Chicago Telephone Supply Corp.), in Elkhart, Ind., after a sudden illness.

William H. Miller, sales manager Jerrold Electronics Corp., Philadelphia, of a heart attack at the age of 48.

David H. Ormont, president of Hudson Radio & Television Corp., New York, in an automobile accident in Las Vegas.

Wesley M. Angle, president of Stromberg-Carlson Co. from 1934 to 1945, suddenly at his summer home in Kennebunk, Me., at the age of 77. **END**

TECHNICIANS' CALENDAR

We hear, with increasing frequency, that the inequities of our calendar are the source of much business woe. Many plans have been submitted and a special UN committee of international experts is discussing a 13-month calendar.

Not to be outdone, and as another special service, the following calendar is being submitted for the benefit of hard-pressed service business:

Sun.	Sat.	Fri.	Thurs.	Wed.	Tue.
8	7	6	5	4	3
17	16	14	13	12	11
24	23	22	21	20	19
31	30	29	28	27	26

Here are the reasons why you will like it:

1. Each month starts with a Sunday, a day of rest. After all, who can rest properly if he's too tired from working all week.
2. With this calendar you can speed up your work. For example, you can start a job on the 7th and get it back on the 6th to the customer who knew his set was broken down a month ago but wants the job done yesterday, once he makes up his mind to call you.
3. Saturday is usually a busy day so this calendar has two of them and they are early in the week so you can do a lot of work before getting tired.
4. You'll note the calendar has no 1st, 10th or 15th so you won't have to pay those pesky bills, taxes, etc., that are due on those days.
5. You will note, too, that the 13th is always on a Friday and, since Friday the 13th is unlucky, you just stay in bed all that day and stay out of trouble.

We are sure that anyone with a good imagination will discover many other great advantages to this calendar and that it will soon be adopted.

From the NATESA Scope

TV TUNERS OVERHAULED

ALL MAKES AND MODELS **\$9.95** NET — VHF OR UHF

UHF/VHF COMBINATION—\$19.90

90 DAYS WARRANTY

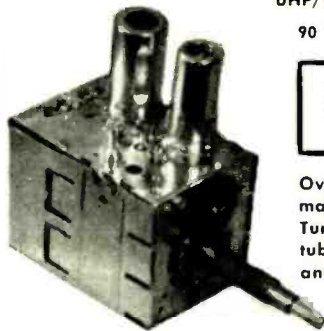

SAME DAY SERVICE

ON POPULAR TYPES—48 HOURS MOST OTHERS

Overhaul charge includes labor and minor parts; tubes and major parts are extra at net prices. Tuner to be overhauled should be shipped complete; include tubes, shield cover and any damaged parts. Quote model and state complaint. Pack well and insure.

WE WILL SHIP C.O.D.—F.O.B. CHICAGO OR TORONTO

Castle TV Tuner Service, Inc.

5710 N. WESTERN CHICAGO 45, ILL.

U.S.A.

136 MAIN ST. TORONTO 13

CANADA

Suppliers of rebuilt TV Tuners to manufacturers, technicians & service dealers, coast to coast.

Original and Only Complete TV Tuner Service covering the North American Continent.

STAMP OF APPROVAL



A mail-order tube advertisement in RADIO-ELECTRONICS is its own stamp of approval—your assurance that you will get what you pay for when you order. Since January, 1956, RADIO-ELECTRONICS has insisted that mail-order tube advertisers tell you that their tubes are new and unused, or if they're not—that they are seconds, rejects or otherwise imperfect. Over the years this has cost us thousands of dollars in advertising—but it has protected you.

Ask By Name For

GENUINE

your assurance of brand name quality

"NO NOISE" PRODUCTS



NO-NOISE VOLUME CONTROL and CONTACT RESTORER

- Cleans • Lubricates
- Protects Not a Carbon Tet Solution

2 oz. Bottle \$1.00
6 oz. Spray Can \$2.25
Net to Servicemen

NO-NOISE TUNER-TONIC with PERMA-FILM

- Cleans, lubricates, restores all tuners, including water type.
- Non-toxic, non-inflammable.
- For TV, radio and FM use.
- Eco-nomical—a little does a lot.

6 oz. Aerosol Can \$3.25
Net to Servicemen



FREE At your Jobbers

5" PLASTIC EXTENDER

- Push Button Assembly For Pin-Point Applications
- Does Not Cause Shorts

ELECTRONIC CHEMICAL CORP.

813 Communipaw Avenue Jersey City 4, N. J.

P.S. Be Sure To Ask For

NO-NOISE RUBBER COAT

6 oz. Spray Can \$3.25

Purchasing A HI-FI SYSTEM?

Send Us Your List Of Components For A Package Quotation

PARTIAL LIST OF BRANDS IN STOCK

- Jim Lansing*
- Altec Lansing
- Electrovoice
- Jensen
- Hartley • Viking
- University
- Acoustic Research
- Janszen
- Wharfedale
- USL Citizen Band
- Gonset • Harlicrafter
- Texas Crystals
- Concertone
- Bell • G.E.
- Weathers
- Harman-Wardon
- Eico • Pilot
- Acrosound
- Quad Ampl & Spkrs*
- Dual Changer
- Bogen • Leak
- Dynakit • Fisher
- H. H. Scott
- Thorens* Sherwood*
- Pentron • Roberts
- Ampeg • DeWald
- Sony • Tandberg*
- Challenger
- Wollensak
- Garrard
- Miracord
- Glaser-Steers
- Rek-O-Kat
- Components
- Norelco
- Fairchild
- Pickering • Gray
- Audio Tape
- Magnecord*
- Artizan Cabinets
- Rockford Cabinets

WE WON'T BE UNDERSOLD!

All merchandise is brand new, factory fresh & guaranteed.

Free Hi-Fi Catalog

AIREX RADIO CORPORATION

64-RE Cortlandt St., N.Y. 7, CO 7-2137

Get the best in Electronics

- For today's enjoyment
- For Christmas giving
- For year 'round pleasure

Send for Radio Shack's

FREE

Electronics CATALOGS

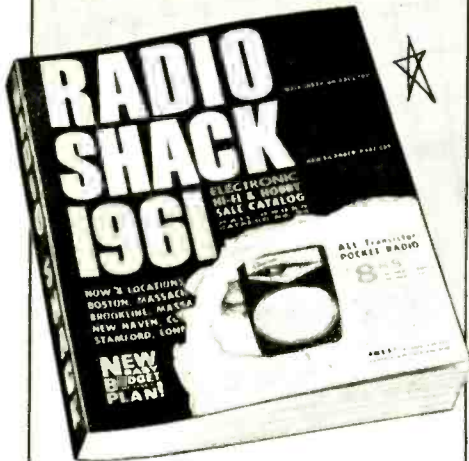



Mail coupon for latest free 192-page Radio Shack catalog plus every new issue for full year.

See world's largest line of electronics items: Hi-Fi, Ham Radio, Stereo, like values shown below.

Buy on Easy Budget terms, up to 2 years to pay. Money-back guarantee on every item always.

TYPICAL VALUES IN RADIO SHACK CATALOGS

 All Transistor Pocket Radio\$8.88	 T-5 FM-AM Stereo Tuner\$59.50
 3.98 & 4.98 Stereo RecordsEach \$1.00	 Duo Remote Control Speaker\$3.98

RADIO SHACK CORPORATION
730 Commonwealth Ave., Boston 17, Mass.

MAIL COUPON NOW

Radio Shack Corp. Dept. 60L10
730 Commonwealth Ave., Boston 17, Mass.
Send latest Electronics Catalog plus every new issue for one year, FREE.

Name _____
Address _____
Postoffice or City _____ Zone _____ State _____



BATTERY REMINDER

Because of the small current required, the average multimeter will continue to work even after the internal battery may have started to leak and corrode nearby components.

After losing one expensive meter this way, I formed the habit of taping a note on the face of the instrument every time I replace the batteries. Mine say: "Replace Battery Dec. 25," or whatever date is a safe 6 months from installation.—William E. Bentley

CORKSCREW FOR TIGHT CAP

Many plastic insulating tool-dip containers have plastic plug type caps that are very difficult to remove. If you use



a screwdriver or similar tool to pry the cap off, you are likely to damage the cap. A guy-wire ring screwed into the cap as shown makes a dandy corkscrew to help you pull the cap off easily even though it might be stuck.—John A. Comstock

HANDY HOLDER

A small corrugated cardboard box with a double rim at the top will be found to be extremely useful in making TV repairs or adjustments. The tubes



can be removed from the radio or TV and their prongs easily speared into the "sockets" of the double thickness of the corrugated cardboard. They may be placed in the same relative position as they are in the TV and, of course, need not be marked. The interior of the

Now—24-Hour Tuner Service

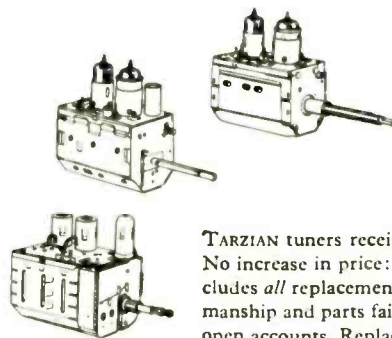

Tarzian Offers 24-hour Direct Factory Service on TUNER REPAIRS ... \$8.50

TARZIAN tuners received one day will be repaired and shipped out the next. No increase in price: \$8.50 per unit and \$15 for UV combinations. That includes all replacement parts, and a 6-month warranty against defective workmanship and parts failure due to normal usage. Tuners repaired on approved, open accounts. Replacements available at low cost on tuners beyond practical repair.

Tarzian-made tuners easily identified by this stamping. When inquiring about service on other than Tarzian-made tuners, always give tube complement . . . shaft length . . . filament voltage . . . series or shunt heater . . . IF frequency . . . chassis identification. And, allow a little more time for service on these tuners. Use this address for fast, factory repair service;

SERVICE MANAGER • TUNER DIVISION Dept. C



SARKES TARZIAN INC

east hillside drive
bloomington, indiana
edison 2-7251

Mfgs. of Tuners, Semiconductors, Air Trimmers, FM Radios, Audio Tape, and Broadcast Equipment

box is useful for small parts, extra tubes, etc. By cutting down the height of the box you can make the necessary double thickness rim for it from the material you trim off.—*Glen F. Stillwell*

TOOL HOLDERS

Empty metal wire spools can be used as tool holders. The spool shown is a 4-inch type with 6½-inch diameter flanges.

By removing the top flange, an ordi-



nary two-cell flashlight will fit into the spool. The remaining flange can be attached to the shop wall with the flash lamp extending outward.—*H.*

CUSTOM TIPS

Low-wattage pencil type soldering irons are handy, but every so often their relatively short tips may not penetrate far enough into crowded chassis corners. Since most of these irons have screw-in tips, it is easy to make your own special tips at low cost.

Buy several lengths of small-diameter copper rod and an inexpensive die to cut the thread used in the tip end of the heating element of your iron. Clip off a length of rod to suit the job, run a thread ¼ inch long on one end and file the other to the tip shape best suited to the joint being soldered.

An added bonus arises from the fact that the longer tip also radiates more heat to the air, and thus provides a slightly gentler tip for delicate printed-circuit boards.—*Benjamin Yeltin*

SERVICE BENCH AID

In the course of servicing electronic equipment, line power is often connected and disconnected many times. Most service technicians do this by withdrawing and inserting the line-cord plug. This soon becomes a nuisance as the plug usually falls to the floor when it is withdrawn. Using the power switch on the unit being serviced sometimes opens only one side of the line which doesn't completely isolate the unit from the power line.

I solved this problem by making an ac outlet control board and mounting it next to the ac outlet on my service bench. This control board includes a dpdt switch, pilot light and circuit breaker. With a flick of a finger, I can

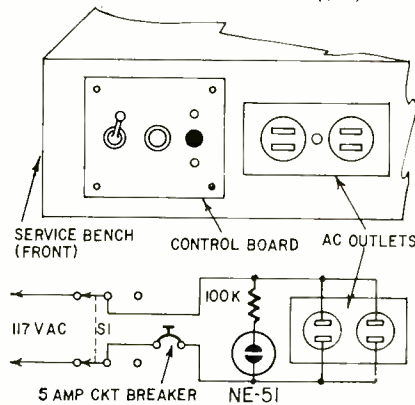

PLASTIC PTT-PWE CASED PTT-PWE 'LYTICS PTT-PWE BY AEROVOX

Small in Size!

Big in Performance!

Designed especially for wide applications transistorized circuitry and cramped electron assemblies, here is a truly miniature electrolytic tubular that will handle full sized loads.

Aerovox Type PTT-PWE units feature "Polycap" plastic cases that are the next best thing to metal cans for maximum protection against humidity. Advanced construction techniques assure long capacitor life.

Available in voltage ratings of 3, 6, 10, 12, 15, 25 and 50 VDCW in a wide range of capacitance values from 1 to 500 mfd. Units are rated for operation at temperatures from -30°C to +65°C.

Available for "off-the-shelf" delivery from your local Authorized Aerovox Distributor. See your distributor today for all your Aerovox capacitor requirements.

AEROVOX CORPORATION

DISTRIBUTOR DIVISION

NEW BEDFORD MASSACHUSETTS

For 1960 It's...

"COMPACT"

tools by

VACO®

for the
Electronics Service Trade

• "Compact" in Size:
they fit the pocket

• "Compact" in Price:
they fit your
pocketbook too

Ask Your Parts Jobber or
Your Jobber Salesman

HK-17 Hex Key Set
\$1.00 net

DE-810 Double Nut Driver
\$.79 net

AN-2 Tester
\$.79 net

PK-8 Nut Driver
\$.48 net

ND-141 Combination
Screw & Nut Driver
\$.79 net

SP-19 Probe
\$.96 net

A-86 Pencil Type Driver
\$.60 net

VACO PRODUCTS COMPANY, 317 E. Ontario St., Chicago 11, Illinois

In Canada: Atlas Radio Corp., Toronto 19, Ontario

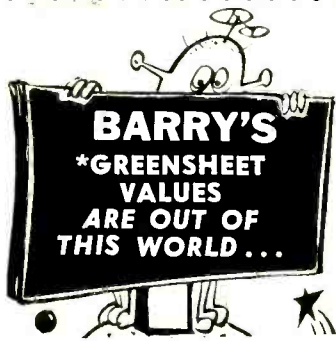

- ★ A complete catalog of specialized industrial Electronic TUBES and COMPONENTS . . . featuring Barry Electronics savings to Industry, Servicemen and Experimenters.
- We have thousands of tube types in stock. First Quality at Sensible Prices. Buy with confidence.
- Prove these values to yourself! Complete and mail the coupon below for your copy of the *Greensheet.
- We'll also purchase your equipment and unused tubes. Send details: BARRY ELECTRONICS CORP. 512 Broadway, New York 12, N.Y. Dept. RE11.
- Please send me a copy of the *Greensheet and add my name to your mailing list.

(RE11)
 Name..... Title
 Company.....
 Address.....
 City..... State

PACKAGE HI FI or SINGLE COMPONENTS
You'll find our prices low and service fast.
 Write for our quotation
CENTER INDUSTRIAL ELECTRONICS, Inc.
 74-R Cortlandt Street, New York 7, N.Y.

RADIO HANDBOOK

- the comprehensive reference source
- a problem solver for designers and builders of radio equipment

Gives simplified theory on practically every phase of radio. Tells how to design, build, and operate the latest standard types of radio transmitting and receiving equipment. More "How-To-Build" articles than any book in the field.

All information is original, up-to-date, and complete. 800 pages of data, clearly indexed, between hard covers—the largest RADIO HANDBOOK ever published.



\$7.50 —at your distributor
EDITORS and ENGINEERS, Ltd.
 Summerland 5, California

completely disconnect the unit being serviced from the power line. The pilot light indicates when the power is on, and the circuit breaker will prevent blowing the main fuses should there be a short in the unit being serviced.

The circuit and details of the control board are shown in the diagram. I found it practical to construct the control board on a 4-inch square of aluminum. Needless to say, this unit has made servicing much faster and safer.—
Albert J. Krukowski

TIGHTEN SELF-TAPPING SCREWS

When a self-tapping metal screw continues to turn as you attempt to tighten it, flow some solder into the

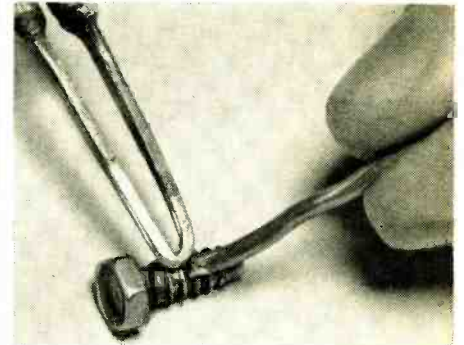

screw's threads. When you put the screw back in, the heavier solder-tinned threads will make the screw anchor firmly again.—*Alan C. Johnson*

ATTRACTIVE PANELS

Professional-looking panels for home-built equipment are easy to make from white Formica, often used on table and counter tops. Available in small pieces at hardware and lumber stores, this material is dirtproof, scratch-resistant and easily worked with ordinary hand tools. The smooth white surface gives the equipment a modern look and takes black decal lettering for easy control identification.

If shielding is a problem, mount the Formica panel directly over a regular metal panel or simply back the plastic panel with aluminum foil.—*William E. Bentley*

PLASTIC RUBBER CLEANS FILE

The electronic hobbyist will find that Duro plastic rubber does a good job of removing filings of solder, brass and aluminum from a fine-cut file. The



plastic rubber (available at hardware stores) is applied to the file and allowed to dry. Then it is peeled off. The filings adhere to the sticky rubber and are removed from the file teeth.—*Charles A. Cunningham*
 END

WANT RESULTS?
 —you'll get them with classified advertising in RADIO-ELECTRONICS
Opportunity Adlets
 Only 50c a word. See details P. 134.

ELECTRONICS

Engineering-Technicians



Missile headed for outer space. Courtesy of Space Technology Laboratories, Inc.

U.S. Air Force Photo

Bachelor of Science Degree, 30 Months
 Save Two Years' Time

- Radio-Television Plus Color Technician (12 Months)
- Electronics Technician (12 Months)
- Industrial Electronics Technician (12 Months)
- Electronics Engineering (B.S. Degree)
- Electrical Engineering (B.S. Degree)
- Mechanical Engineering (B.S. Degree)
- Civil Engineering (B.S. Degree)
- Architecture (B.S. Degree)

Heald College ranks FIRST West of the Mississippi in "Who's Who in America"

Approved for Veterans
DAY AND EVENING CLASSES

Write for Catalog and Registration Application.
 New Term Starting Soon.

HEALD'S
ENGINEERING COLLEGE
 Established 1863
 Van Ness at Post, RE
 San Francisco, Calif.

Your Name

Address

City

State

new LITERATURE

Any or all of these catalogs, bulletins, or periodicals are available to you on request direct to the manufacturers, whose addresses are listed at the end of each item. Use your letter-head—do not use postcards. To facilitate identification, mention the issue and page of RADIO-ELECTRONICS on which the item appears. UNLESS OTHERWISE STATED, ALL ITEMS ARE GRATIS. ALL LITERATURE OFFERS ARE VOID AFTER SIX MONTHS.

ELECTRONICS CATALOG. 414 pages list over 40,000 items. 240 pages of rotogravure.—Allied Radio Corp., 100 N. Western Ave., Chicago 80, Ill.

SEMICONDUCTOR PRODUCT GUIDE contains transistor classification charts for audio- and radio-frequency and computer and switching service for germanium alloy-junction types, power-switching and amplifier applications for silicon diffused-junction types, and silicon rectifiers.—RCA Semiconductor Products-Distributor Sales, Harrison, N. J.

"JENSENEEDLOG" lists in its 12 pages 800 types of special-shank phonograph needles and their matching cartridges by a cartridge-number to needle-number reference section. Supplements Jensen's large needle wall chart.—Jensen Industries, Inc., 7333 Harrison St., Forest Park, Ill.

MOLDED-CABLE ASSEMBLIES for the industrial electronics industry appear in the 4 pages of *Catalog M-701*. A guide for engineers, it lists engineering considerations for standard assemblies and illustrates those most commonly used.—Switchcraft, 5555 N. Elston Ave., Chicago 30, Ill.

FUSES of the small-dimension nonindicating and indicating type for aircraft, electronics, instruments, appliances, industrial and automotive use are outlined in a new 12-page catalog.—Sightmaster Corp., 50 Aleppo St., Providence, R.I.

TV AND FM TUNER *Catalog T60* presents their uses, features, specifications, mounting dimensions, terminal connections and installation instructions for the company's line of tuners.—Sarkes-Tarzian Inc., Tuner Div., Bloomington, Ind.

STEREO is defined and explored in *Stereo and High Fidelity* with emphasis on live broadcasting, discs and tapes, stereo systems using various combinations of component setups, design principles of such components and conver-

FREE

GIANT 1961 204 PAGE CATALOG



SAVE UP TO 50% ON 8-A SELECTED KITS

TOP VALUES IN POWER AND HAND TOOLS

HI-FI AND STEREO SYSTEMS & COMPONENTS

30 PAGES OF BARGAINS NOT IN ANY OTHER CATALOG

100'S OF NEW ITEMS LISTED HERE FOR 1ST TIME



A Complete Buying Guide for Everything in
RADIO TV ELECTRONICS

for: DEAN'S ELECTRONIC SCHOOL, MANUFACTURERS, CHICAGO, ILLINOIS, WESTINGHOUSE, PITTSBURGH, PENNSYLVANIA, SAMSUNG ELECTRONIC CO., SUWON, KOREA, SONY ELECTRONIC CO., JAPAN, TOSHIBA ELECTRONIC CO., JAPAN, YAMAHA ELECTRONIC CO., JAPAN.

BURSTEIN-APPLEBEE CO. Dept. RE 1012-14 McGee St., Kansas City 6, Mo.

RUSH COUPON TODAY!

Send Free 1961 B-A Catalog No. 611

NAME _____

ADDRESS _____

CITY _____ STATE _____

Unbelievable LOW PRICES! NOT KITS . . . But Factory Wired and Guaranteed HIGH QUALITY INSTRUMENTS



New! Model B-45 Radio & TV SIGNAL GENERATOR

Provides highly stable signal. Generates R. F. frequencies from 150 Kilocycles to 50 Megacycles. (150 Kc. to 12.5 Mc. on Fundamentals and from 11 Mc. to 50 Mc. on Harmonics). R.F. is obtainable separately or modulated by the Audio Frequency.

Measures 7 3/4" x 7 3/4" x 5". Weight 8 Lbs. Complete—only \$14.95

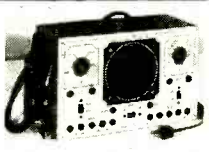

New! TC-75 Univ. Combination TEST SPEAKER & SIGNAL TRACER

Plus resistor tester. Plus condenser tester. Plus output indicator. Plus speaker substitution. Plus resistor substitutor. Plus substitute 100 V D.C. power supply. Plus field substitutor. Plus condenser substitutor. Plus voice coil substitutor. Plus signal tracer. Plus universal output transformer. Plus experimental one stage audio amplifier.

Measures 7" x 11" x 5". Weight, 8 Lbs. Complete—only \$19.95

Order directly from METROPOLITAN ELECTRONICS • 106 Fifth Ave., New York 11, N.Y.

Win with **EMC**



By far the **BEST VALUE** obtainable in either wired or kit form... compare and you'll agree **"THE BEST BUY IS EMC."**

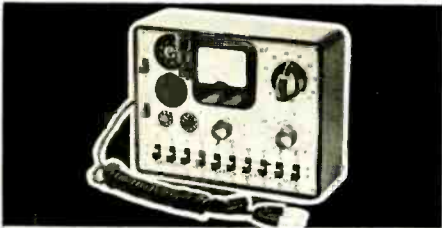

EMC Model — 211 Tube Tester — The smallest, lowest priced, domestic made tube tester on the market. It is completely flexible and obsolescent proof. It checks each section of multi-purpose tubes separately, checks all octal, loctal, 9 prong and miniature tubes for shorts, leakages, opens, intermittents as well as for quality. Quality is indicated directly on a two color meter dial using the standard emission test. Comes complete with instructions and tube charts in ring bound manual. Size 6 3/4" x 5 1/4" x 2 1/4" deep. Shipping weight: 3 lbs. Wired \$22.90 Kit \$14.90 CRT Picture Tube Adapter \$ 4.50

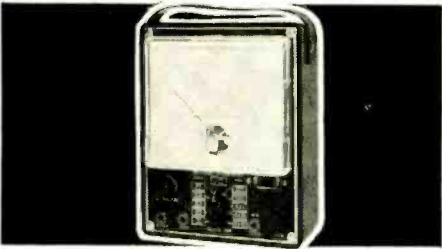

EMC Model 109 — Voltmeter — Features 20,000 OHMS volts DC sensitivity and 10,000 OHMS per volt AC sensitivity. Uses a 4 1/2, 40 microampere meter, with 3 AC current ranges, and 3 resistance ranges to 20 megohms. 5 DC and AC voltage ranges to 3000 volts and 3 DC current ranges; also 5 DB range.
Model 109 — With carrying strap, Weight 2 lbs. 5 ozs.; Size: 5 1/4" x 6 3/4" x 2 7/8" \$26.95
Model 109K — Kit Form 19.25
Model HVT — 30,000 Volt Probe for Model 109 7.95



EMC Model 107A — Peak to Peak Vacuum Tube Volt-Ohm Capacity Meter — 6" meter cannot burn out — entirely electronic. Measures peak to peak AC voltages to 2800 volts in 6 ranges. Measures capacity in 6 ranges from 50 mmfd to 5000 mfd. Measures resistance in 6 ranges from .2 ohm to 1000 megohms. Measures DC volts to 1000 volts in 6 ranges. Input resistance to 16.5 megohms. Wired \$51.40 Kit \$36.50

Yes, tell me more, send me **FREE** a detailed catalog of the Complete EMC Line. Dept. RE-116

NAME
STREET
CITY STATE

EMC Electronic Measurements Corp.
525 B'way, New York 12, N. Y.
Ex. Dept., Pan-Mar Corp., 1270 B'way, New York 1, N. Y.

sion of monaural equipment to stereo operation. 4-page booklet includes easy-to-read diagrams for each setup and phono cartridge section.—Electronic Instrument Co. Inc., (EICO) 33-00 Northern Blvd., Long Island City 1, N.Y.

HOME STUDY, its advantages, the proper choice of a school, state regulations and restrictions, contracts and additional sources of guidance are considered in *Facts You Should Know About Home Study Schools*.—Better Business Bureau of Metropolitan Boston, 52 Chauncey St., Boston 11, Mass., 15¢

CAR RADIO troubleshooting is taught in *Guide to Noise-Free Car Radio Installation*. How to find and cure the source of motor noise is described and illustrated with photographs and diagrams. Booklet closes with suppression and installation accessories.—Motorola Consumer Products, Inc., 4545 W. Augusta Blvd., Chicago 51, Ill. 50¢.

RECORD SELECTION is just one of the subjects in the *Art of Selecting, Playing and Preserving Records*. The 20-page booklet also offers the layman guidance in musical etiquette, preserving recording fidelity, the role of the cartridge and stylus and the practical and decorative aspect of hi-fi and stereo systems in the home.—Shure Brothers Inc., 222 Hartrey Ave., Evanston, Ill., 25¢.

FALL AND WINTER CATALOG, 1960-61. Heathkit hi-fi components, from pickup or tape recorder to loudspeaker. Marine, test and wired equipment. Amateur radio gear. Science kits. 83 pages. Illustrated.—Heath Co., Benton Harbor, Mich.

MASTER RADIO AND TV SET INDEX to service manuals, from the old Atwater Kent and Majestic through newest 1960 radio and TV sets.—Supreme Publications, 1760 Balsam Rd., Highland Pk., Ill. 25¢.

TRANSISTOR HOME-STUDY COURSE revised for 1960 transistor devices and applications. 10 lessons cover simplified basic semiconductor theory with practical experiments and service techniques for amplifiers, oscillators, rectifiers and deflection circuits.—CBS Electronics, 100 Endicott St., Danvers, Mass.

CATALOG No. 96. 192 pages carry over 30,000 electronic, hi-fi and hobby items. Profusely illustrated. 3-page index.—Radio Shack, 730 Commonwealth Ave., Boston 17, Mass.

HOME HI-FI, both stereophonic and monophonic, is considered in *Stereomaster High Fidelity Components* for 1960 and its companion booklet, *How to Use Stereo High Fidelity Components in Your Decorating Plans*.—H. H. Scott, 111 Powdermill Rd., Maynard, Mass.

RECORD CHANGERS SERVICING GUIDE in 2 parts (I for the manufacturer's VM changer and II for his BSR changer) describes the equipment, its step-by-step assembly and the handling of possible repair problems, with the help of detailed drawings and exploded views throughout.—Motorola Consumer Products Inc., 4545 W. Augusta Blvd., Chicago 51, Ill. 50¢ each. END

SCHOOL DIRECTORY

SCIENCE ENGINEERING

BACHELOR'S DEGREE IN 27 OR 36 MONTHS
Accelerated year-round program: Agro., Chem., Civil, Elec., Mech., Metal., Math., Chem., Physics. Modest rate. Earn board. New classes start Jan., Mar., June, July, Sept. Catalog: 15110 E. Washington Blvd., Fort Wayne 2, Ind.

INDIANA TECHNICAL COLLEGE

GET INTO ELECTRONICS

V.T.I. training leads to success as technicians, field engineers, specialists in communications, guided missiles, computers, radar and automation. Basic and advanced courses in theory and laboratory. Assoc. degree in electronics in 28 mos. B.S. in electronic engineering obtainable. ECPD accredited, U.I. approved. Graduates in all branches of electronics with major companies. Start February, September, Marine campus. High School graduate or equivalent. Catalog.

VALPARAISO TECHNICAL INSTITUTE

Dept. C Valparaiso, Indiana



ENGINEERING HOME STUDY COURSES

Courses written by world authorities in all branches of engineering and science and proved successful by thousands of our graduates. One hour each day in your spare time will start you off to higher pay, security and prestige. Personalized instruction methods ensure rapid progress. Fill in the coupon and indicate the course of interest. We will send you a complete outline of the course and a booklet describing the Institute and our advanced teaching methods.

RADIO
ELECTRONICS
TELEVISION
CIRCUIT
MATHEMATICS
ELECTRICAL ENG.
TELEPHONY
CIVIL ENG.
SURVEYING
ARCHITECTURE
FORESTRY
MINING
STRUCTURAL
MECHANICAL ENG.
INDUSTRIAL ENG.
& MANAGEMENT
REFRIGERATION
DRAFTING
PLASTICS
AERONAUTICAL
ENG.
HIGH SCHOOL
CHEMICAL
MATHEMATICS
JOURNALISM
ACCOUNTING

MAIL THIS COUPON TODAY

CANADIAN INSTITUTE OF SCIENCE & TECHNOLOGY LIMITED
758 Century Bldg., 412, 5th St. N.W., Wash., D.C.

NAME.....

ADDRESS.....

CITY..... STATE

COURSE OF INTEREST.....

Canadians: Send to C.I.S.T., 758 Garden Bldg., 263 Adelaide St. West, Toronto, Ontario.



C. I. S. T.

RADIO-ELECTRONICS

SCHOOL DIRECTORY

LEARN

LEARN
RADAR MICROWAVES
COMPUTERS—TRANSMITTERS
CODE • TV • RADIO

Phila. Wireless Technical Inst.
1533 Pine St., Philadelphia 2, Pa.
A Non-Profit Corp.
Founded in 1908
Write for free Catalog to Dept. RE-11
Classes now forming

ELECTRONICS

PREPARE FOR A GOOD JOB!
BROADCAST ENGINEER
RADIO SERVICING AUTOMATION

TELEVISION SERVICING
BLACK & WHITE—COLOR

APPROVED FOR VETERANS AND SURVIVORS
OF VETERANS
BUILDING AIR CONDITIONED
SEND FOR FREE LITERATURE

BALTIMORE TECHNICAL INSTITUTE
1425 EUTAW PLACE, BALTIMORE 17, MD.

TRANSISTORS

explained in 32 pages of terse copy and modern illustration. Invaluable to Service and Installation Technicians and Students. Available at \$1.25 a copy, 10 copies or more \$1.00 each. Special rates to schools and business firms.



saedi unlimited
626 SOUTH FEDERAL STREET
CHICAGO 5, ILLINOIS

ENGINEERING COURSES

E.E.
Option Electronics or Power
Mechanical, Civil & Physics
Also in Liberal Arts
presented through

HOME STUDY
Resident Classes Also
Available if Desired

PACIFIC INTERNATIONAL
COLLEGE OF ARTS
& SCIENCES

Primarily a correspondence school

5719-N Santa Monica Blvd. Hollywood 38, Calif.

Learn Transistor Electronics At Home!

■ Prepare now for a profitable career in this growing field. Learn theory, construction and applications of all types of transistors with this proven home-study course from the Philco Technological Center.

FOR FREE INFORMATION
PLEASE WRITE TO:

PHILCO
TECHNOLOGICAL CENTER
"C" and Ontario Sts., Philadelphia 34, Pa.

ENGINEERING EDUCATION
for the Space Age

NORTHROP INSTITUTE of Technology is a privately endowed, nonprofit college of engineering offering TWO-YEAR accredited technical institute curricula and complete Bachelor of Science degree programs. Students from 50 states, many foreign countries. Outstandingly successful graduates employed in aeronautics, electronics, and space technology. Write today for catalog—no obligation.

NORTHROP INSTITUTE OF TECHNOLOGY
1181 West Arbor Vitae Street, Inglewood 1, California

engineering degree in 27 months

Grasp your chance for a better life. Rapid advancement. Better income. **BACHELOR OF SCIENCE DEGREE IN 27 MONTHS** in Elect. (Electronics or Power major), Mech., Civil, Aero, Chem., Engineering. **IN 36 MONTHS** in Business Administration (General Business, Acctg., Motor Transport Mgt. majors). Small classes. More professional class hours. Well-equipped labs. Campus Dorms. Modest costs. Year-round operation. Founded 1884. Enter Jan., Mar., July, Sept. Write J. G. McCarthy, Director of Admissions, for Catalog and "Your Career in Engineering and Commerce" Book

TRI-STATE COLLEGE 24110 College Ave. Angola, Indiana

AT LAST! A home study course covering all phases of electric and electronic organ servicing.

A NEW COURSE An extensive course covering every make of organ—repair, regulating, and troubleshooting.

Electronic ORGAN SERVICING

Your Opportunity To Get Into A New, Rapidly Expanding Field At The Start. Don't Miss It!!

WRITE NOW FOR FREE BOOKLET

NILES BRYANT SCHOOL
Dept. E., 3731 Stockton Blvd.
Sacramento 20, California

NHSC Approved * The Pioneer School
Established 1898

FREE! ELECTRONICS CAREER KIT

If you're interested in breaking into a good-paying job in Radio-TV-Electronics, I.C.S. will send you absolutely free a famous Career Kit with 3 famous booklets that have helped thousands of others—just like yourself—on the road to real success. Includes:

- 1 "HOW TO SUCCEED" Career Guide—36-page gold mine of career tips and information.
- 2 "JOB CATALOG" of opportunities in your field of interest.
- 3 "SAMPLE LESSON" (math) to demonstrate the famous I.C.S. method.

Send today for your free I.C.S. Career Kit with these 3 famous booklets. There's no obligation. This may be the big break you've been waiting for. Mark and mail the coupon today.

INTERNATIONAL CORRESPONDENCE SCHOOLS
Dept. 37683K, Scranton 15, Penna.

Please send free Career Kit with 3 famous booklets

General Electronics Radio-TV Serv'g Practical Electrician
 Industrial Electronics Sound Equip't. Serv'g Profess'l Eng. (Elec.)
 Radio-TV Eng'r'g Electrical Eng'r'g Electrical Drafting
 Electronic Servicing Electrical Tech. Other

Name _____ Age _____
Address _____
City _____ State _____

prepare for your career in

ELECTRICAL ENGINEERING ELECTRONICS COMPUTERS RADIO-TV

At MSOE, you can equip yourself for a career in many exciting, growing fields: **MISSILES**
RADAR • AUTOMATION
RESEARCH • DEVELOPMENT
ELECTRICAL POWER
AVIONICS • ROCKETRY

When you graduate from the Milwaukee School of Engineering, you are prepared for a dynamic career as an Electrical Engineer or Engineering Technician. Under a faculty of specialists, you gain a sound technical education in modern, completely equipped laboratories and classrooms. As a result, MSOE graduates are in great demand and highly accepted by industries nationally.

At MSOE you will meet men from all walks of life and all parts of the country—some fresh out of high school or prep school, others in their twenties—veterans and non-veterans.

You can start school in any one of four quarters and begin specializing immediately. Engineering technicians graduate in 2 years with an Associate in Applied Science degree. For a Bachelor of Science degree in Engineering, you attend 4 years. A 3-month preparatory course also is available.



FREE CAREER BOOKLET!
If you're interested in any phase of electronics, radio or television, be sure to look into the programs of study offered by the Milwaukee School of Engineering. Just mail the coupon.

MILWAUKEE SCHOOL OF ENGINEERING

Dept. RE-1160, 1025 N. Milwaukee St., Milwaukee, Wisconsin

Please send FREE Career Booklet. I'm interested in Electrical Engineering;

Electronics Computers
 Electrical Power Radio-TV
 Mechanical Engineering.

PLEASE PRINT

Name _____ Age _____
Address _____
City _____ Zone _____ State _____
 I'm eligible for veterans education benefits. MS-123



"TAB" Tubes Tested, Inspected, Boxed
Six Months Guarantee!! No Rejects!
NEW & Used Gov't & Mfgs. Surplus!

Orders \$10 or more, Receiving Types only ppd. 48 states

0A2	.80	6B16	.69	12AT6	.59	18S1	1.00
0B2	.65	6BK7	.99	12AU6	.81	11Z76	1.10
0C3	.69	6BL7	1.25	12AV6	.69	4-65A	16.00
0D3	.35	6BN6	.98	12B7	.59	20Z1	2.75
0Z4	.59	6BQ6	1.19	12AX7	.79	3D23	3.85
1A7	.89	6BZ7	1.25	12BA6	.65	717A	5.81
1B3	.74	6C5	.43	12CA7	.43	1-125	29.00
1R5	.78	6C5	.69	12DB6	.59	4-250	35.00
1S4	.78	6CB6	.80	12BE6	.59	4E27	7.00
1T4	.78	6C06	1.49	12BF6	.59	4PR60	29.50

Send for Catalog!

1U4	3/81	6H6	3/81	12BH7	.99	4X150G	\$15
1U5	.74	6J5	.52	12BY7	.98	4X250	35.00
12A2	.68	6J6	.18	12DZ7	.59	4X500	38.00
304	.88	6K6	.59	12CU6	1.45	5BP1	4.98
3G5	.88	6K7	.74	12SA7	.64	5BP4	4.98
3B4	.68	6L5	1.19	12SQ7	.89	5ST	4.00
3V4	.83	6S4	.59	12SH7	.59	100T	7.00
5R4	.98	6S8	.89	12SJ7	.75	316A	5.81
5U4	.63	6S7	.89	12SK7	.49	388A	4.98
5V4	.80	6SB7	1.19	12SQ7	.81	416B	16.00

Wanted Surplus Electronics from schools & U

5Y3	.59	6SC7	.89	198G6	2.15	450T	42.00
6AR4	.59	6CT7	.79	12B7	1.10	100Z1	1.00
6AC7	.70	6SH7	.69	25B06	1.39	809	3.00
6AG7	.88	6S7	.69	25L6	.69	811	4.40
6AH6	.99	6K7	.79	25Z6	.69	812	3.00
6AK5	.69	6SL7	.89	25Z6	.69	813	9.00
6ALS	2/81	6SN7	2/81	25Z6	.75	814	3.15
6AS7	3/00	6SR7	.75	EL37	2.49	826	2.75
6AT6	.49	6T8	.98	35L6	.69	829B	8.00

Wanted 50¢ TL Tubes Top \$3 Paid

6AU4	1.10	6UB	.70	35Y4	.69	832A	7.00
6AU5	1.19	6V6GT	.70	35Y4	.69	866A	2.75
6AU6	.69	6W4	.79	35Z5	.63	1625	5.81
6A4	.89	6W6	.89	50A4	.69	250	3.90
6BA6	.59	6X4	2/81	50B5	.69	5879	.98
6BA7	1.00	6X5	.49	50C5	.69	5881	2.70
6BD6	.69	6Y6	.49	50L6	.69	6550	3.90
6BE6	.59	6Y7	.49	50L6	.69	6550	3.90
6BG6	1.50	12AL5	.59	75	.89	5894	12.00
6BH6	.72	12AQ5	.75	80	.59	7193	10.81

TUBES WANTED! WE BUY! SELL & TRADE!

NEW POWER CONVERTER
12VDC to 500VDC up to 200MA 100 Watts; Top 250VDC Type C1250E
\$35. Hi efficiency, low ripple, low all current — Silicon rectifiers! Toxic-free! Hi-Pot! Magnetical tape wound transformer. fuses & short circuit proof, small in size! Quiet! Light weight! C1250E! built ready to go. Consistent quality. Rated. Delco Transistors Heavy Copper-Heat Sink. 12VDC to 250VDC up to 150MA Type C1255A \$30.



TRANSISTORS & ACCESSORIES

2N441	\$3.	2N142	\$4.50	2N277	\$4.	2N278	\$5.
2N175	\$1.39	2N176	\$1.80	2N177	\$1.	2N178	\$1.75
2N179	\$2.47	2N180	\$2.20	2N181	\$1.20	2N182	\$1.50
2N274	\$1.25	2N108	\$1.80	2N114	\$1.20	2N378	\$1.80
2N180	\$2.20	2N378	\$1.25	2N582	\$2.10	2N174	\$8.50
2N174	\$8.50	2N176	\$6.				

DIAMOND BASE MICA MOUNTING KIT \$.30
DELCO ROUND BASE MICA MOUNTING KIT \$.30
DELCO POWER HEAT SINK WITH FINS \$.75

"TAB" KITS! "TAB" THE BEST KITS! "TAB"

- All Kits Contain Most Popular Values & Sizes
- | | |
|----------------------------|----------------------------|
| Kit 2 Eng. Parallel Rules | Kit 5 Sub-Min Tubes |
| Kit 35 Precision Resistors | Kit 40 Standoff Insulators |
| Kit 10 Switches | Kit 25 Power Resistors |
| Kit 75 Resistors 1/2 1/2W | Kit 75 Mica Condensers |
| Kit 150 Carbon Resistors | Kit 5 Crystal Diodes |
| Kit 25 Panel Lamps | Kit 100 Fuses, Assorted |
| Kit 12 Electrolytic Cond's | Kit 100 Ceramic Cond's |
| Kit 56 Tube Sockets | Kit 10 Germanium Diodes |
| Kit 65 Tubular Cond's | Kit 5 ET243 Xtal Holders |
| Kit 500 Lugs & Spacers | Kit 10 Silicon Diodes |
| Kit 10 Bathing Oil Cond's | Kit 5 Microswitches |
| Kit 5 lbs. Surprise Pkgs. | Kit 4 Asst Rectifiers |
| Kit 10 Xmttr Mica Cond's | Kit 2 PNP Transistors |
| Kit 3 Phone/Patch Xfms | Kit 4x50 FT Hookup Wire |
| Kit 3 Searchlights | Kit 2 Veeder Counters |
| Kit Circular Slide Rule | Kit 2 Circular Slide Rds |
| Kit 12 Algrt Clip Asst'd. | Kit High Gain XTAL Mike |

BUY 10 KITS—GET ONE FREE! EACH KIT 99¢

"SUNTAR" @ BATTERY-SELENIUM PHOTOCCELL

5AP—Round 1 1/8" Dia.	\$1.00
10AP—ROUND 1 1/2" Dia.	\$1.75
15AP—ROUND 2" Dia.	\$3.00
2BP—RECT. 3/8 x 7 1/16	70c
5BP—RECT. 1-7 1/16 x 7/8	200 ua 1.35
10BP—RECT. 1-11 1/16 x 7/8	360 ua 1.80

ORDER QTY'S. TEN OR MORE DEDUCT 20%
This Item Shipped Postpaid Orders \$5 Up

NEW Selenium Radio & TV Rectifiers! GTD.

65MA 45c.	@ 6 for \$2.	100MA 45c	@ 12 \$5.
250MA 65c.	@ 10 \$6.	300MA 88c.	@ 10 \$8.
500MA \$1.	@ 10 \$8.	25 \$18.	

Orders this item \$10 or more. Postpaid 48 States!
SNOOPERSCOPE TUBE 3" \$5 @ 2 for \$9
AN-AR2 RVC (400) (OX) less tubes \$1.59
HVY DTY 115V 60CY SELSYNS TWO for \$9

★ NEW "TEKSEL" SELENIUM RECTIFIERS
FULL WAVE BRIDGE RECTIFIERS. ONE YEAR GTD!
AMP. 18VAC 36VAC 72VAC 144VAC
CONT. 14VDC 28VDC 56VDC 118VDC

1AMP	\$ 1.30	\$ 2.00	\$ 4.90	\$ 6.50
2AMP	2.15	3.00	6.25	12.30
3AMP	2.90	4.00	8.65	16.75
6AMP	4.15	8.00	18.75	36.15
10AMP	6.10	12.15	26.30	48.90

Write for Complete Rectifier Catalog

NEW SILICON 750MA * DIODES TOP

GENERAL PURPOSE	400 PIV at 250 MA
SPECIAL 39c	25 FOR \$8

rms/piv	rms/piv	rms/piv	rms/piv
35/100	70/100	140/100	210/300
19c	29c	34c	43c
rms/piv	rms/piv	rms/piv	rms/piv
280/400	350/500	420/600	490/700
50c	89c	89c	95c
rms/piv	rms/piv	rms/piv	rms/piv
560/800	630/900	700/1000	770/1100
\$1.05	\$1.25	\$1.40	\$2

* CAPACITOR INPUT DERATE 20%:
(\$5 or more we pay postags 48 states)

"TAB" TERMS: Money Back Guarantee! Our 6th year. \$2 min. order F.O.B. N.Y.C. Add shpg charges or for C.O.D. 25% Dep. Prices shown subject to change.

111-GP LIBERTY ST., N. Y. 6, N. Y.
Send 25¢ PHONE: RECTOR 2-6245 For Catalog

new BOOKS

INTERNATIONAL ELECTRONIC AND TRANSISTOR HANDBOOK (6th Edition).
Muiderkring N.V., Netherlands. Available from Diamond Television Ltd., 8636 Birman St., Montreal 15, Canada. 5 x 9 in. 384 pp. \$4.

An extremely useful handbook for those who deal with foreign tube types, the directory has an introduction in 10 languages and from there on uses only the international language of electronics. It's divided into seven color-coded sections according to tube classification and contains basic data on a large number of European and American types, showing each one in a basic circuit diagram. An eighth section covers transistors.

SO YOU WANT TO BE A HAM (2nd edition), by Robert Hertzberg, W2DJJ. Howard W. Sams & Co., Inc., Indianapolis, Ind. 5 1/2 x 8 1/2 in. 188 pp. \$2.95.

You will want to refer to this book before and after you get your ticket. It tells where to apply, how to learn the code and what the requirements are. In an interesting manner it tells you what hamming is and how to operate your station. It does not cover the theory portion of a license exam, so radio theory must be studied from

other books. Much of the book is devoted to a description of receivers, transmitters and test equipment to help make an intelligent choice. Prices and specifications are listed.—IQ

GLOSSARY OF TERMS IN COMPUTERS AND DATA PROCESSING, by Edmund C. Berkeley and Linda L. Lovett. Berkeley Enterprises, Inc., 815 Washington St., Newtonville 60, Mass. 5 1/4 x 8 in. 90 pp. \$3.95.

Over 870 terms and ideas in the fields of computers, logic, programming, etc., are listed and defined. Meanings are made clear so that beginners can understand them.

THE MOBILE MANUAL FOR RADIO AMATEURS (2nd edition). American Radio Relay League, W. Hartford, Conn. 6 1/2 x 9 1/2 in. 282 pp. \$2.50.

The mobile ham will find here the information he needs to make and use the latest and best in receivers, transmitters, converters, etc. Practical tube and transistor circuits are represented. They range from the simplest to the most complex, all described in detail with photos, diagrams and construction data.

(Continued on page 134)

SAVE 20% BUY DIRECT

You can now buy this **VOXBOX** at BIG SAVINGS



A voice-controlled relay device for voice-operated "break-in" with any voice modulated rig either fixed or mobile. Gives you tremendous advantage in contest operating, traffic handling, telephone type conversation and "two hands on the wheel" mobiling.

\$35.70 Buy Direct **\$28.56** For Only

Send check or money order to
TRANSCON DIVISION
NORTHEAST TELECOMMUNICATIONS, INC.
Danbury, Conn.

Send for **NEW Catalog**
Available from franchised distributors at slightly higher cost.

KILLER AT LARGE
Muscular dystrophy dooms children to early death. Help scientists track down this killer by giving generously to the **MARCH FOR MUSCULAR DYSTROPHY**

*** RECORDING TAPE**

*Oxide guaranteed not to rub off or squeak — or money back. Compare ours with other " bargain" tape. You'll find it's more than just "price" when you deal with us. We are original pioneers in the tape recorder business and our reputation means everything to us.

600' acetate (plastic), 5"	.75
900' MYLAR (Polyester), 5"	.95
1200' MYLAR, 1/2 mil, 5" reel	1.28
1200' Acetate (plastic), 7"	1.29
1200' MYLAR, 1 1/2 mil (strong)	1.99
1800' Acetate (plastic), 7"	1.79
1800' MYLAR 1 mil thick, 7"	2.29
2100' MYLAR, untensitized, 7"	2.69
2100' MYLAR, tensitized, 7"	3.49

SEND FOR FREE CATALOG

NORELCO SPEAKERS

Famous 0710M, twin-cone 8" speaker, original list 39.95, usual NET 23.97. NOW, while they last 1/2 off net — 11.98 plus postage. (discontinued model). Frequency 40-20,000 c/s. Other SENSATIONAL speaker reductions on a first come, first served basis. SEND FOR SPEAKER SPECIFICATION SHEET.

COMMISSIONED ELECTRONICS CO.
1776 Columbia Road Washington, D. C.

OUT OF SPACE?

You bet we'd be... if we were to tell you all about AUDION's "Out of this World Hi Fi Values."

Write for free Catalog
audion
25-E Oxford Road
Massapequa, New York

FREE!

LAFAYETTE'S 1961 CATALOG 324 GIANT SIZED PAGES

The Complete Catalog Featuring
"The Best Buys In The Business"

- Stereophonic Hi-Fi Equipment
- Public Address Systems
- Tape Recorders
- Radio and TV Tubes and Parts
- Citizen Band Equipment
- Amateur Equipment
- Industrial Supplies

Send for Lafayette's FREE Catalog—the most complete, up-to-the-minute electronic supply catalog crammed full of everything in electronics at our customary down-to-earth money-saving prices.

CONTAINS HUNDREDS OF EXCLUSIVE LAFAYETTE ITEMS NOT AVAILABLE IN ANY OTHER CATALOG OR FROM ANY OTHER SOURCE — SEND FOR YOUR COPY NOW!

A "must" for the economy-minded hi-fi enthusiast, experimenter, hobbyist, engineer, technician, student, serviceman and dealer.



Our 40th Year

EASY PAY PLAN—the simplest, and quickest way to get what you want when you want it. As little as \$2 down . . . up to 24 months to pay.

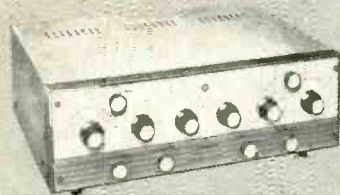

Stereo Control Center
KT-600, Kit LA-600, Wired
79.50 134.50



KT-650 FM Tuner Kit
54.50



TE-15 Tube Checker
19.95



RW-60 20,000 Ohms Per
Volt Multitester
13.50



RK-400 2-Speed
Portable Tape Recorder
49.50



Communications Receiver
KT-200, Kit HE-10, Wired
64.50 79.95

LAFAYETTE RADIO

Mail the coupon today for your
FREE copy of Lafayette Radio's
1961 catalog.



Lafayette Radio Electronics Corp.

Dept. JK-6, P.O. Box 100
Jamaica 31, N. Y.

Send me the FREE Lafayette 324 page
1961 catalog 610

Name.....

Address.....

City..... Zone..... State.....

**Emergency
Industry
Farming
Pleasure**

NEW! LAFAYETTE HE-15A 2-WAY SUPERHET CITIZENS BAND TRANSCEIVER!



**Completely
Wired-
NOT A KIT!**

Made in U.S.A.

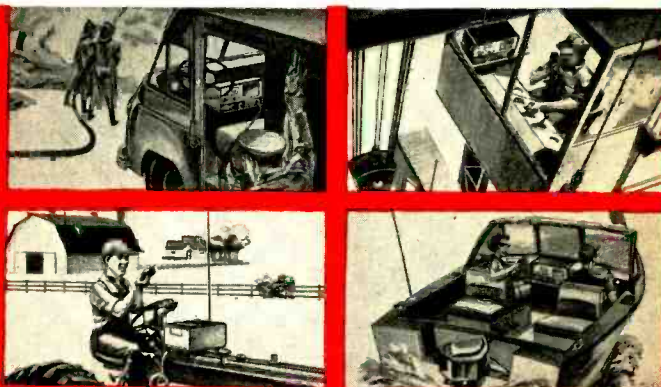

Not Superregenerative but SUPERHET!

COMPLETE 2-WAY COMMUNICATIONS FOR
BUSINESS, HOME, FARM, BOAT, AND SPORTS

NOW WITH ADDED FEATURES

Effective Full-Wave Variable Noise Limiter • Five Prong Microphone Jack For Easy Relay Addition • RF Jack on Front Panel

AND

• 5 Transmitting Positions • Tuneable Receiver Over Full 23 Channels • Planetary Vernier Tuning • Complete with Transmitting Crystal for Channel 9

CITIZENS BAND — The New Two-Way Personal Communications Method for Everyone — Fill out the FCC form enclosed with each Lafayette Transceiver. No examination or technical knowledge required — Any citizen 18 years or older is eligible for a license.

THE GREATEST VALUE in the CITIZENS BAND FIELD

Just think . . . now you can have economical, efficient 2-way radio communication from your home, office, store, auto, truck or boat . . . literally hundreds of uses. The Lafayette HE-15A Superheterodyne Transceiver is both a compact precision transmitter and receiver designed to operate on the new class D "Citizens Band." Two or more of these units furnish your own communications system covering up to a 20 mile or more radius depending on antenna height and terrain. The Lafayette HE-15A meets all FCC requirements and operates in much the same manner as police and other short-wave communications systems. The Transceiver features 5 crystal controlled transmitting channels operating at a maximum legal power input of 5 watts fully modulated, RF stage in both transmitter and receiver. The 5 position crystal selector on the front panel selects any one of 5 transmitting frequencies. These 5 crystals are readily accessible by means of a removable front plate. The superheterodyne receiver is tuneable over the full 23 channel band with 3 watts audio output, AVC, and an amazingly effective Full-Wave Variable Noise Limiter. The noise limiter is continuously variable from the front panel for diminishing ignition and other unwanted noise pickup. A new 5 prong microphone jack makes

57⁵⁰
**ONLY
5.00 Down**

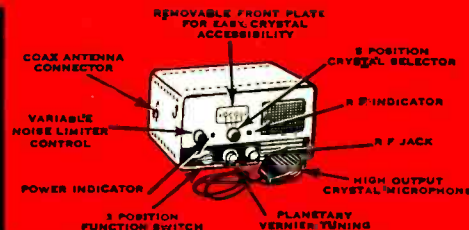

conversion to a push-to-talk relay a cinch. RF jack on the front panel may be used to monitor the current in the final tube using external meter.

Controls include a 3 position function switch (transmit, receive, and transmit with spring return), planetary vernier tuning plus variable noise limiter. Output impedance matches 52 and 72 ohm antenna with Amphenol type coax connector. Has large 4" PM speaker; input jack for crystal or ceramic microphone; power receptacle in rear for AC line and 6 or 12 volt external power supply. Supplied with single transmitting crystal for channel 9, high output crystal microphone, and brackets for easy mounting of units in auto, boat, etc. Operates on 115 volts AC. Addition of 6 or 12 volt power supply (separately supplied) adapts transceiver, for mobile operation. Size: 10 1/4" x 5 1/2" x 6 3/8" D. Tube complement: 2-6U8A/6EA8, 1-6AL5, 16V6, 1-12AX7, 1-6AW8. Shpg. wt., 11 lbs.

HE-15A 5.00 Down Net 57.50

POWER SUPPLY: Adapts HE-15A for mobile operation. Complete with cable, 6 or 12 volt vibrator and mounting flanges. Completely enclosed. Size 4 1/4" x 6" x 4" H. Shpg. wt., 4 lbs.

HE-16 For 12 Volts Net 10.95

HE-18 For 6 Volts Net 10.95

TRANSMITTING CRYSTALS: For any of the 23 channels. Specify channel or frequency.

HE-830 Net 1.95

6.95

SENSATIONAL LAFAYETTE CITIZEN BAND MOBILE ANTENNA

THE SCOOP BUY FOR CITIZENS BAND MOBILES

- CHROME SWIVEL BASE
- PLUS STAINLESS STEEL SPRING
- PLUS 102 1/2" STAINLESS STEEL WHIP FOR OPTIMUM 11 METER PERFORMANCE

Chrome swivel ball mount base designed to be mounted on any surface. Stainless steel spring holds rod in properly adjusted position and prevents rod damage from shocks and blows. Stainless steel whip for maximum resiliency and strength. Shpg. wt., 4 lbs.

HE-800WX Net 6.95

NEW! LAFAYETTE TELESCOPIC CITIZEN BAND WHIP ANTENNA

- Chrome Plated
- Telescopes From 16 1/2 to 40"
- Mounts Vertically or Right Angle

3.95

An outstanding antenna value. This high quality three section telescoping antenna is designed for attachment directly to your citizens band transceiver. Ideal for point to point service over short distances. Molded base loading coil has a threaded stud with a PL-259 plug—connector for vertical or right angle mounting. Shpg. wt.; 1 lb.

HE-19 Net 3.95

NEW! 10,000 OHMS PER VOLT MULTITESTER

Outperforms Instruments Many Times Its Size

9.95

- Extra Large 3 1/2" Meter Face
- Completely Wired and Tested
- All Accessories Included

A convenient, pocket-sized instrument with an unusually sensitive 14,000 ohms-per-volt AC-DC meter, 1% resistors, single range selector switch. First capacity range requires 120V AC; second range requires 6V AC. Durable Bakelite case and panel; probes and flexible leads are plastic coated and color coded. Complete with battery. 4 1/2" x 3 1/2" x 1 1/8". Shpg. wt., 1 1/2 lbs.

TE-10 Net 9.95

TE-14 Pigskin Carrying Case, shpg. wt., 8 oz. Net 1.95

NEW! LAFAYETTE RADIO FIELD INDICATOR

- Provides a Continuous Indication of Transmitter Output
- Rugged 200 ua Meter Movement • Completely Portable
- Requires no Electricity, Batteries or Transmitter Connection.

With this rugged, new radio field indicator you can check performance of your marine, mobile or fixed transmitter . . . actually measures the RF field generated by any transmitter between 100KC and 250MC regardless of power. Features a 200 ua meter movement with a variable sensitivity control. Phone jack at rear of indicator accepts earphones thus providing an aural check of transmitter output. Antenna extends from 3/4 to 10 3/4". Powerful magnet on bottom plate allows easy mounting on car dashboard or metal surfaces. Use anywhere . . . requires no electricity or batteries. Dimensions: (less antenna) 3 1/8" x 2 1/4" x 2" D.

YM-14 Net 7.95

PLEASE INCLUDE SHIPPING CHARGES WITH ORDER

**LAFAYETTE
RADIO**
165-08 LIBERTY AVENUE JAMAICA 33, NEW YORK

NEW YORK, N. Y.

100 6th Avenue

NEWARK, N. J.

24 Central Avenue

BRONX, N. Y.

542 E. Fordham Rd.

PARAMUS, N. J.

182 Route 17
(1 Mi. North Garden State Plaza)

BOSTON, MASS.

110 Federal Street

PLAINFIELD, N. J.

139 W. 2nd Street

LAFAYETTE
HI-FI KITS

Build A Path to A New World of Entertainment

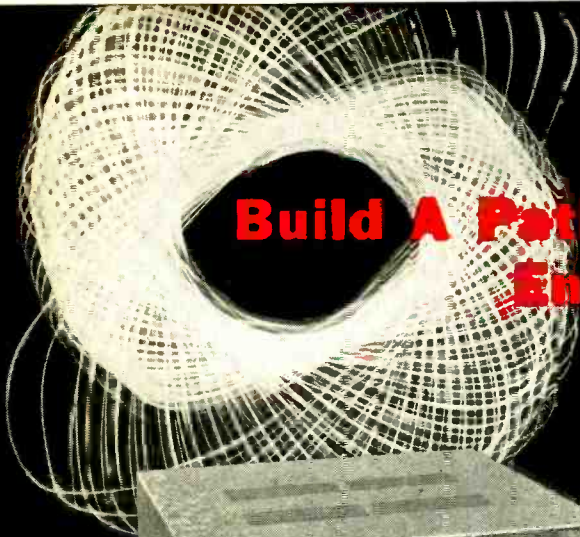

KT-250A
50-WATT STEREO AMPLIFIER ... 74.50



KT-500A
FM-AM STEREO TUNER ... 74.50



KT-600A
STEREO PREAMPLIFIER ... 79.50

ENGINEERING:

Crafted with the non-technical builder in mind. There's much more fun in assembling your own kit... and it's so easy.

DESIGN:

Each kit has the fine professional-looking touch. Styled to blend with every decor.

VALUE:

You can't get better units at these money saving prices.

QUALITY:

Top performance due to high quality parts and engineering.



KT-600 FM TUNER ... 74.50



KT-236A
36-WATT STEREO AMPLIFIER ... 59.50



KT-350 100-WATT
BASIC STEREO AMPLIFIER ... 134.50

MONEY-BACK GUARANTEE

Lafayette Kits are exclusive products of Lafayette Electronics. Each Lafayette kit must meet or exceed its published specifications, or your money is refunded in full.

All Lafayette Kits are Available on the Easy Pay Plan.



Lafayette Radio Dept. JK-6
P.O. Box 190 Jamaica 31, N.Y.

Send me the **FREE** 324-Page
1961 Catalog No. 610

CUT OUT
AND PASTE
ON POST
CARD

Name _____
Address _____
City _____ Zone _____ State _____

ATLAS "Job Rated" P. A. SPEAKERS

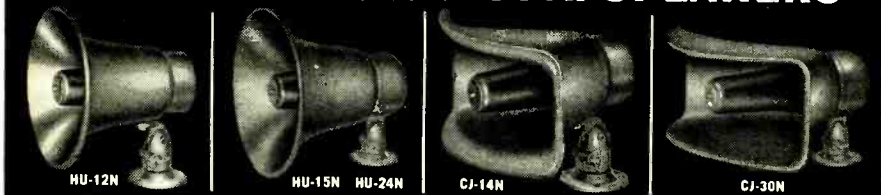

There is an Atlas Speaker Ideally Suited for Every Job

All Atlas P. A. speakers are highly efficient, especially in the voice frequency range, providing the extra "punch" needed to override high level background noise. Most are 100% weatherproof; aluminum and diecast parts are treated with corrosion inhibitors, then finished in "stone hard" baked enamel. The CJ Cobra-Jector horns are constructed of nonresonant, indestructible fiberglass, and HU and TP speaker horns of aluminum, finished in gun-metal grey. The HU and TP speakers are particularly designed for efficient talkback operations. The peaked characteristics within the voice frequencies increase the sensitivity of these speakers as pickup devices.

All HU and CJ speakers are equipped with versatile "Versalock" . . . This rugged, reliable mounting bracket, completely adjustable both horizontally and vertically, provides positive locking in any position.

The DU-12 and DC-5, Atlas' renowned DeCor projectors, are styled to harmonize with any decor, modern or traditional.

Send for free catalog to Dept. RE11

Model	HU-12N	HU-15N	HU-24N	CJ-14N	CJ-30N	CJ-44	TP-15N	TP-24N	DU-12	DC-5
POWER*	7.5 w	25 w	25 w	7.5 w	25 w	60 w	25 w	25 w	7.5 w	6 w
IMPEDANCE**	8 ohm	8 ohm	8 ohm	8 ohm	8 ohm	16 ohms	8 ohm	8 ohm	8 ohm	8 ohm
FREQUENCY	350-	250-	200-	400-	250-	150-	250-	200-	400-	120-
C.P.S.	10,000	10,000	10,000	10,000	10,000	9000	10,000	10,000	10,000	7000
LENGTH OVERALL	7 1/4 in.	8 3/4 in.	12 in.	8 in.	1 1/4 in.	23" x 13"	16 1/2 in.	23 in.	14 in.	14 in.
BELL DIAMETER	7 1/2 in.	9 3/4 in.	11 1/4 in.	9 1/2" x 5 1/2"	14" x 6"	19 in.	9 3/4 in.	11 1/4 in.	7 in.	7 in.
NET PRICE	\$16.20	\$20.10	\$22.35	\$18.00	\$24.60	\$43.50	\$31.20	\$34.50	\$19.80	\$13.20

*Input range limited to frequencies above horn cutoff **All models available in 45 ohms at slightly higher prices

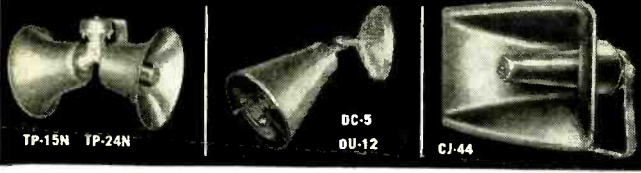

ATLAS SOUND CORP.
1449 39th Street
Brooklyn 18, N. Y.
In Canada:
Atlas Radio Corp., Ltd.,
Toronto, Ontario

OPPORTUNITY ADLETS

Rates—50¢ per word (including name, address and initials). Minimum ad 10 words. Cash must accompany all ads except those placed by accredited agencies. Discount, 10% for 12 consecutive issues. Missleading or objectionable ads not accepted. Copy for Jan. issue must reach us before November 10, 1960.

RADIO-ELECTRONICS,
154 West 14 St., New York 11, N. Y.

QUALITY PRINTING. Economically priced. Speedy service. Free samples on request. JOHN H. TAYLOR, R. D. 2, Box 215, West Middlesex, Pa.

NEW CONCEPT OF LEARNING SELF-HYPNOSIS! Now on tape or record! Free literature. MCKINLEY-SMITH CO., Dept. T5, Box 3088, San Bernardino, Calif.

CASH PAID! Sell your surplus electronic tubes. Want unused, clean radio and TV receiving, transmitting, special-purpose, Magnetrons, Klystrons, broadcast types, etc. Want military & commercial lab/test and communications equipment such as G.R., H.P., AN/U.P.M. prefix. Also want commercial receivers and transmitters. For a fair deal write BARRY, 512 Broadway, New York 12, N. Y. Walker 5-7000.

RADIO & TELEVISION RECEIVING TUBES, brand new, first line name brands only. No rejects, no pulls. Discounts up to 66% off list. EDISON TUBE CO., Menlo Park, N.J.

DIGNIFIED-EMBOSSED BUSINESS CARDS — \$3.95 per 1000. EDWARD PRINTING SERVICE, 7430 Setwick Drive, Parma 20, Ohio.

BEFORE YOU BUY RECEIVING TUBES OR ELECTRONIC COMPONENTS, send NOW for your Giant Free ZALYTRON Catalog No. 163—featuring nationally known Zaltron First Quality TV Radio Tubes, plus all types of Components, Kits, Amplifiers, Transmitters, etc. All priced to Save you Plenty—Why Pay More? ZALYTRON TUBE CORP., 229 W. 12nd St., N. Y. C.

LEARN WHILE ASLEEP. Hypnotize with your recorder, phonograph or amazing new Electronic Emitter and endless tape recorder. Catalog, details free. SLEEP-LEARNING ASSOCIATION, Box 24-RD, Olympia, Wash.

RADIO & TV TUBES at Manufacturers' Prices! 100% Guaranteed! Brand New! No re-brands or pulls! UNITED RADIO, Box 1000-R, Newark, N.J.

SERVICEMEN: TV and Radio Tubes, all top name brands, 60-10-5% New—First quality—regular boxed—No Jobbies, close-outs or pull-outs. SEND for catalog. (Representatives wanted for all states. High commission.) **RADIO TUBE SPECIALISTS,** 397-7th Avenue, Brooklyn 15, N. Y.

PROFESSIONAL ELECTRONIC PROJECTS — Organs, Timers, Computers, etc.—\$1 each. List Free. PARKS, Box 1665, Lake City Station, Seattle 55, Wash.

LEARN CODE. Quality for Amateur or Commercial License. Free Book. CANDLER SYSTEM, Dept. RE-11, Box 9226, Denver 20, Colo.

DISCOUNTS UP TO 50% on Hi-Fi amplifiers, tuners, speakers, tape recorders, individual quotations only. no catalog. CLASSIFIED HI-FI EXCHANGE, 2375 East 66th Street, Brooklyn 34, N.Y.

COMPONENTS, Recorders, Tapes. FREE Wholesale Catalogue. CARSTON, 215-T East 88th St., New York 28, N.Y.

LEARN THE MORSE CODE IN MINUTES BY A PROVEN METHOD. Copyright 1960, send \$2.00 to: EASY METHOD MORSE SYSTEM, Box 86, Perrysburg, Ohio.

DON'T BUY HI-FI COMPONENTS, Kits, Tape, Tape Recorders until you get our low, low return mail quotes. "We Guarantee Not To Be Undersold." Wholesale Catalog Free. HI-FIDELITY CENTER, 1797C First Avenue, New York 28, N.Y.

AMPEX, Concertone, Crown, Magnecord, Presto, Norelco, Rogen, Tandberg, Sherwood, Rek-O-Kut, Scott, Shure, Dynakit, others . . . Trades. BOYNTON STUDIO, Dept. RE, 10 Pennsylvania Ave., Tuckahoe, N.Y.

ALL MAKES OF ELECTRICAL INSTRUMENTS AND TESTING equipment repaired. HAZELTON INSTRUMENT CO., 128 Liberty Street, New York, N.Y.

HI-FI DOCTOR will solve your hi-fi problems on the spot. Acoustic, Audio, Radio Engineer, Stereo Designing. Professional visits, day evening, New York area. WILLIAM BOHN, Plaza 7-8569, weekdays.

NEW, TRANSISTORIZED SIGNAL GENERATOR, 150 KC. to 120 MC. on fundamentals. Battery operated. Internal 100 cycle, any external audio modulation. Socket for Citizens Band Crystals. Send for free information. PELL ELECTRONICS, Box 555, Ridgewood, N. Y.

KNOWS FOR ALL TV SETS, HARD TO GET RADIO & TV COMPONENTS COMPLETE HI-FI & STEREO EQUIPMENT. Receiving Tubes at discounts. Special Coils, Special Resistors, Transformers, Controls, Condensers, Diodes, etc. Free Technical Hints and Tips for repair and maintenance of TV Sets. Send for free catalogue. STEVENS ELECTRONICS, INC., 459A Broadway, Hicksville, L.I., N.Y.

HIGHLY EFFECTIVE HOME-STUDY REVIEW FOR FCC Commercial Phone Exams. Free literature. WALLACE COOK (RELI), Box 19634, Jackson 9, Miss.

DIAGRAMS FOR REPAIRING RADIOS \$1. Television \$2. Give make, Model, DIAGRAM SERVICE, Box 672 RE, Hartford 1, Conn.

(Continued from page 130)

Among other topics are antennas, noise, power supplies and test equipment. This new edition also covers emergency and portable operation.

USING AND UNDERSTANDING PROBES, by Rudolf F. Graf, Howard W. Sams & Co. Inc., 1720 E. 38 St., Indianapolis 6, Ind. 5 1/2 x 8 1/2 in. 192 pp. \$3.95.

Where and how to use probes to test all types of electronic equipment accurately is the subject of this text. Written for the service technician and engineer, the book describes the many probes used in radio and TV servicing plus special-purpose probes used in industry, agriculture and medicine. —LS

ELECTROMAGNETIC FIELDS, ENERGY, and FORCES, by Robert M. Fano, Lan Jen Chu, Richard B. Adler. John Wiley & Sons, Inc., 440 Park Ave. South, New York 16, N. Y. 6 x 9 in. 520 pp. \$12.00.

Most of this book is suitable for junior and senior college students, the last 2 chapters being at graduate level. Readers should know physics, math and circuit theory. Vectors are introduced in the second chapter. Beginning with Maxwell's equations in integral form, the authors discuss circuit and field theory. All chapters close with problems and references.

TV SERVICING SHORT CUTS, by Milton S. Kiver, Howard W. Sams & Co. Inc., 1720 E. 38 St., Indianapolis 6, Ind. 5 1/2 x 8 1/2 in. 104 pp. \$1.50.

History repeats itself. In TV repair work, certain defects are more likely to recur than others. A group of 69 case histories are described here in detail. The symptoms, trouble location and repair are given, together with some theory so the reader will be in position to know what happened. Thus he is able to cope with similar troubles in the future. Schematics illustrate the procedures.—IQ

TOPICS IN ELECTROMAGNETIC THEORY, by Dean A. Watkins. John Wiley & Sons, Inc., 440 Park Ave. S., New York 16, N. Y. 6 x 9 1/4 in. 118 pp. \$6.50.

This is based on a lecture course organized for graduate students. The topics are related to microwave engineering. They include periodic transmission systems, the helix, coupled-mode theory and anisotropic media. Much of this material has never before appeared in book form. END

Answers to "Sawtooth Sticklers," page 90
ANSWERS: 1—F, 2—F, 3—A, 4—J, 5—H, 6—D, 7—D, 8—E, 9—I, 10—C, 11—G, 12—H, 13—J, 14—A.



Learn TRANSISTOR, COMPUTER OR RADAR TECHNOLOGY at home

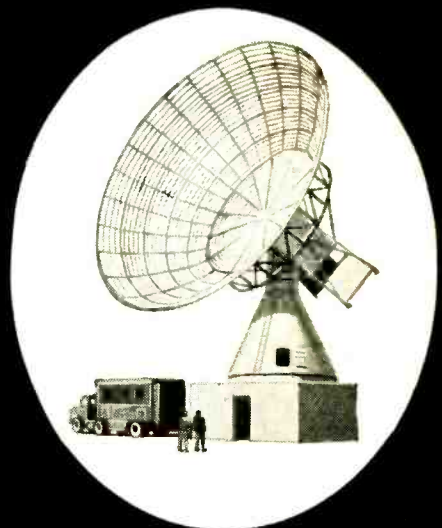
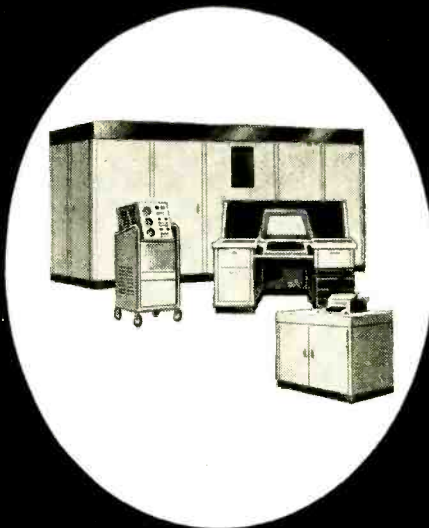

Prepare now for advancement... and for a secure and profitable career in one of these growing fields of electronics

CHOOSE FROM 7 PROVEN COURSES

1. **SEMICONDUCTORS**—Transistor Principles and Practices. Learn Theory, construction, application of all types of transistors.
2. **PRINCIPLES OF RADAR CIRCUITS AND EQUIPMENT**—Introduction to, and detailed study of radar fundamentals.
3. **RADAR SYSTEMS PRINCIPLES AND PRACTICES (Advanced Level)**—Applications of radar components, systems, design... performance measurement.
4. **INTRODUCTION TO ANALOG COMPUTERS**—Covers theories and fundamentals of all makes of analog computers.
5. **ANALOG COMPUTER SYSTEMS (Advanced Level)**—Covers the analog system concepts and methods.
6. **AUTOMATIC DIGITAL COMPUTERS**—Digital computer theory, maintenance, installation, basic programming.
7. **PROGRAMMING FOR DIGITAL COMPUTERS**—Covers encoding, set-up and operation.

MAIL COUPON TODAY FOR FREE INFORMATION

PHILCO TECHNOLOGICAL CENTER TCR-8
 "C" and Ontario Streets, P.O., Box 4730, Phila. 34, Pa.
 Please send full information on subjects checked below. (No obligation)

<input type="checkbox"/> 1. Semiconductors	<input type="checkbox"/> 4. Intro. to Analog Comp.
<input type="checkbox"/> 2. Principles of Radar	<input type="checkbox"/> 5. Analog Comp. Systems
<input type="checkbox"/> 3. Radar Systems	<input type="checkbox"/> 6. Automatic Digital Comp.
<input type="checkbox"/> 7. Programming for Digital Computers	

NAME _____
 HOME ADDRESS _____
 CITY _____ STATE _____
 COMPANY _____ POSITION _____

Expand your knowledge in one of these rapidly advancing fields of electronics and you'll be set for a secure and profitable future. Transistor technology is becoming one of the biggest fields in electronics. The use of automatic computers in automated factories, business offices and military systems is outpacing the technical manpower needed to build and maintain them. New developments in radar have given new life to this dynamic field. Electronics men are in demand, but it takes specialists to land the big jobs. Now's the time to prepare... advance and prosper in this new era.

Learn with proven home study courses from the Philco Technological Center. Get a practical, working knowledge with proven courses developed by specialists in electronics and training... men who know the kind of knowledge you need. Philco Technological Center is a department of Philco TechRep Division, one of the world's leading field engineering organizations.

NOW READY—A special computer programming course that covers all important techniques of encoding and operation... ideal for maintenance men, or those who wish to become Programmers. Send for full details. No salesman will call.



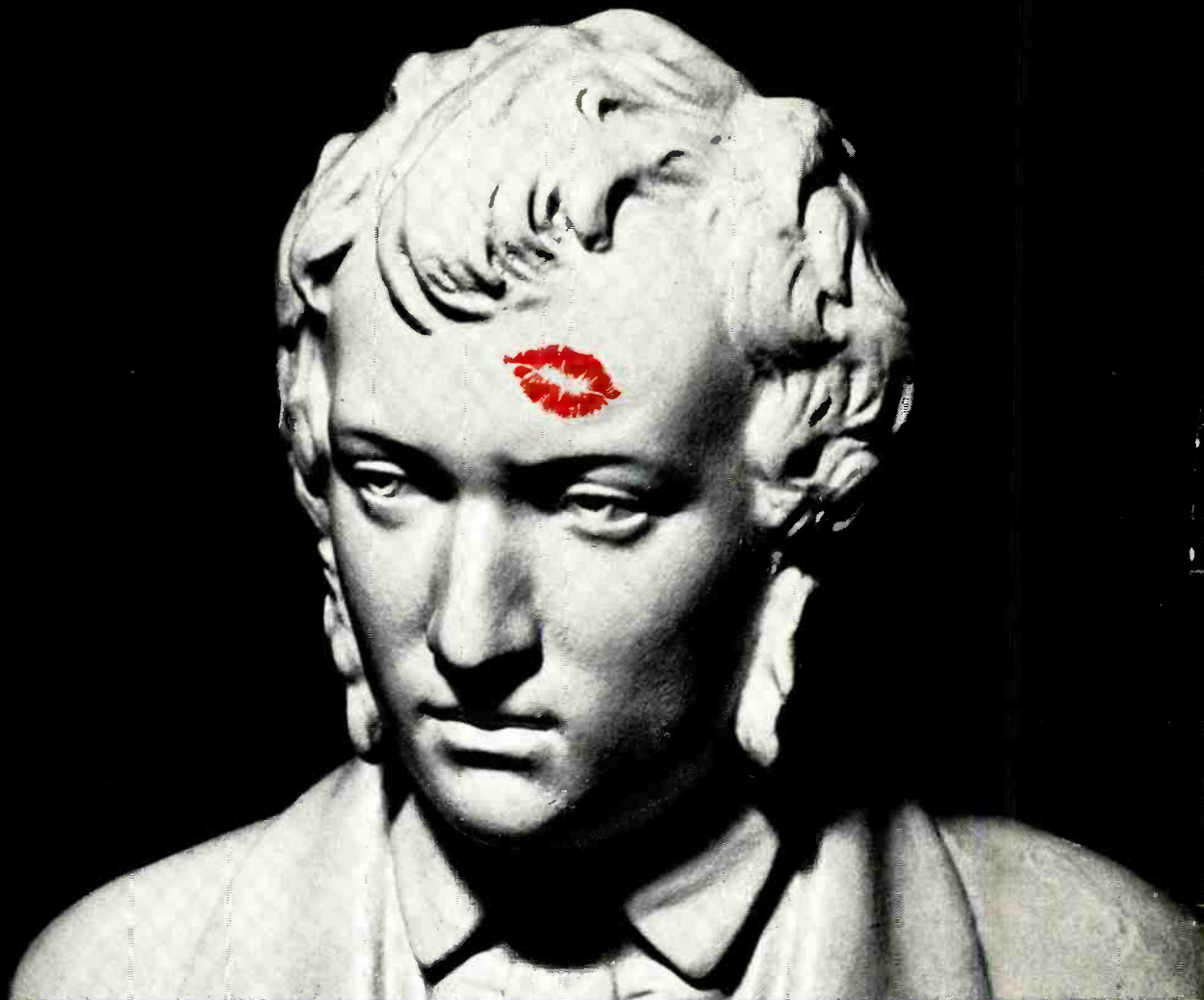

CLASSICS THAT MADE THE HIT PARADE

DETAILS OF THE PROGRAM

"Classics that Made the Hit Parade" includes these popular symphonic themes:

Borodin	Polovtsian Dances from Prince Igor (Stranger in Paradise)
Tchaikovsky	Symphony No. 5 in E (Moon Love)
Waldteufel	Espana Waltz (Hot Diggity)
Chopin	Polonaise No. 6, in Ab Major (Till the End of Time)
Tchaikovsky	Symphony No. 6 in B (The Story of a Starry Night)
Rachmaninoff	Piano Concerto No. 2 in C Minor (Full Moon and Empty Arms)
Chopin	Fantasia Impromptu in C# Minor (I'm Always Chasing Rainbows)
Tchaikovsky	Romeo and Juliet Overture (Our Love)

DETAILS OF THE OFFER

This exciting recording is available in a special bonus package at all Audiotape dealers. The package contains one 7-inch reel of Audiotape (on 1½-mil acetate base) and the valuable "Classics that Made the Hit Parade" program (professionally recorded on Audiotape). For both items, you pay only the price of two reels of Audiotape, plus \$1. And you have your choice of the half-hour two-track stereo program or the 55-minute monaural or four-track stereo versions.

See your Audiotape dealer now.

— a new bonus reel from Audiotape

Some of our greatest popular songs — hits like "Full Moon and Empty Arms," "Till the End of Time," "Stranger in Paradise" — took their melodies from the classics. Eight of these lovely themes—in their original classical setting—are the basis for "Classics that Made the Hit Parade," a program with strength, variety, and, of course, rich melodic beauty.

This unusual program, professionally recorded in sparkling full fidelity on Audiotape, is available RIGHT NOW from Audiotape dealers everywhere. (And only from Audiotape dealers.) Ask to hear a portion of the program, if you like. Then, take your choice of a half-hour of two-track stereo, or 55 minutes of four-track stereo or dual-track monaural sound — all at 7½ ips. Don't pass up this unique opportunity.

"Classics that Made the Hit Parade" makes an ideal addition to Audio's first two bonus reels, "Blood-and-Thunder Classics" and "High Spirits," still available at Audiotape dealers.

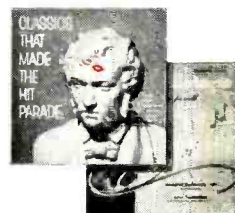

audiotape
TRADE MARK

"it speaks for itself"

AUDIO DEVICES, INC., 444 Madison Ave., N. Y. 22, N. Y.
In Hollywood: 840 N. Fairfax Ave. • In Chicago: 5428 N. Milwaukee Ave.

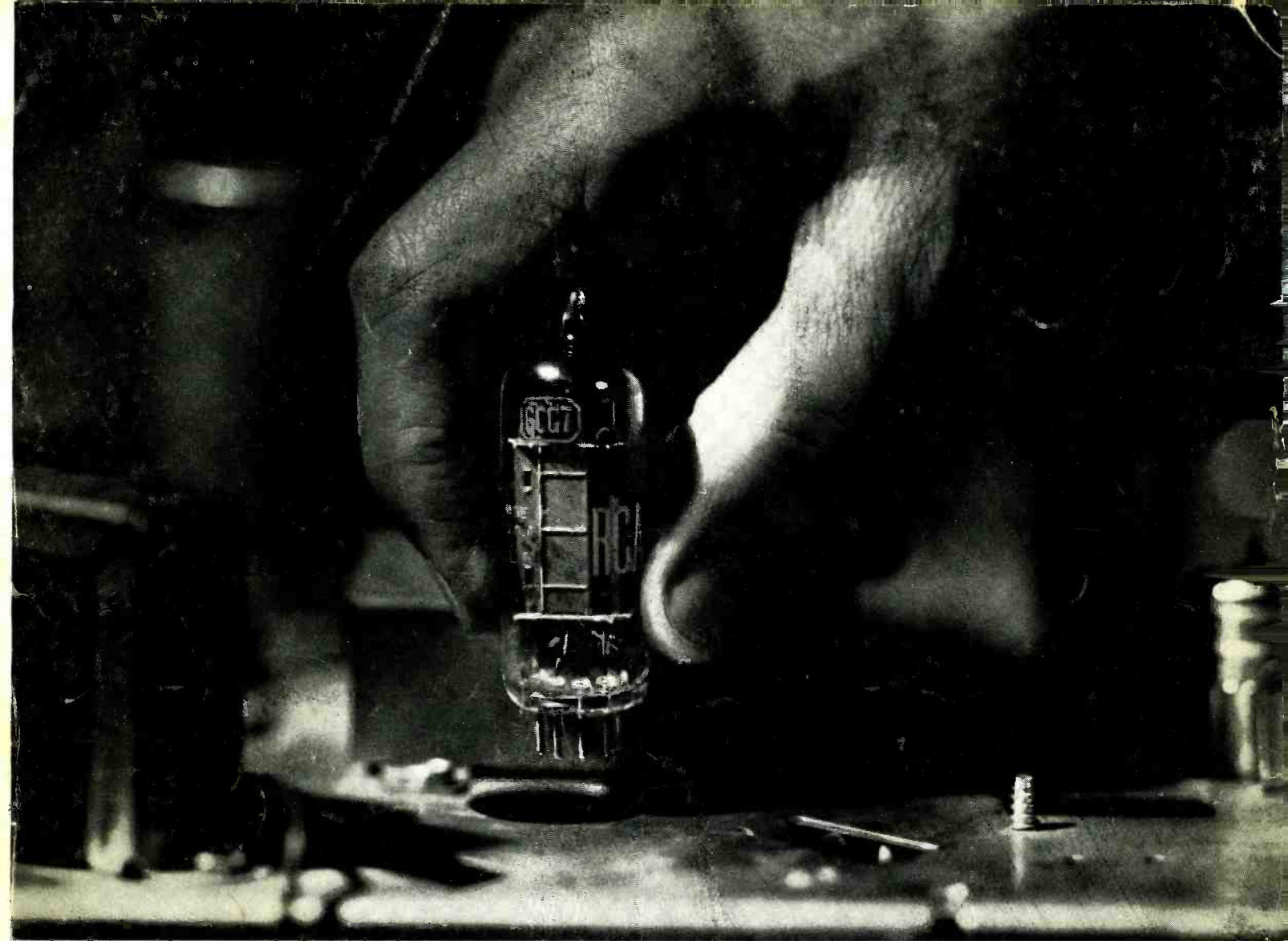

WHEN YOU REPLACE A TUBE . . .

You have a lot at stake each time you replace a receiving tube in a customer's set. Your professional reputation, your customer's confidence, your day's profits—even future business—all depend on the quality of that replacement tube.

It is RCA's constant aim to provide receiving tubes you can install with confidence. To this end, RCA carefully controls every step of the tube making process from initial design to final test.

QUALITY BY DESIGN—Some of the foremost tube experts in the industry collaborate on each new RCA tube design. Engineers, chemists, physicists, metallurgists, production specialists, field representatives, all contribute their own skills and knowledge before a new RCA tube design ever leaves the drafting board.

IMPROVED QUALITY FROM NEW AND IMPROVED MATERIALS—All parts and materials in RCA tubes are either *produced or processed* by RCA under strictest quality control. Moreover, RCA scientists search constantly for new and better materials which will still further improve performance of RCA tubes. Many tube types you install today benefit from new cathode and plate materials developed in RCA labs.

QUALITY IN MANUFACTURING—Because tube construction is just as important as design and materials, RCA maintains a system of supervisory microscopic inspection at key points on every production line to detect any flaw in assembly. And to minimize the chance of human error, RCA has automated certain critical steps in tube production.

QUALITY BY TESTING AND CONTROL—Before shipment, *every single RCA receiving tube* is factory-tested for every significant characteristic. *A tube that fails one single test is rejected and destroyed. So there is no such thing as a "second" when you buy RCA.* In addition, thorough aging of tubes and rating-lab tests assure strict adherence to performance specifications.

This is why **YOU CAN REPLACE WITH CONFIDENCE** with RCA tubes . . . and why RCA tubes give you an extra advantage on every service job. Electron Tube Division, Harrison, N. J.



The Most Trusted Name in Electronics
RADIO CORPORATION OF AMERICA