

60-WATT HI-FI AMPLIFIER WITH NEW KT88's

AUGUST 1957

# Radio-Electronics

TELEVISION • SERVICING • HIGH FIDELITY

HUGO GERNSBACK, Editor

**Servicing the  
Gated-Beam Detector**

•

**Build a 10-Watt  
Transistor Amplifier**

•

**Add a Remote  
TV Speaker**

•

**Inexpensive  
Service Instruments**

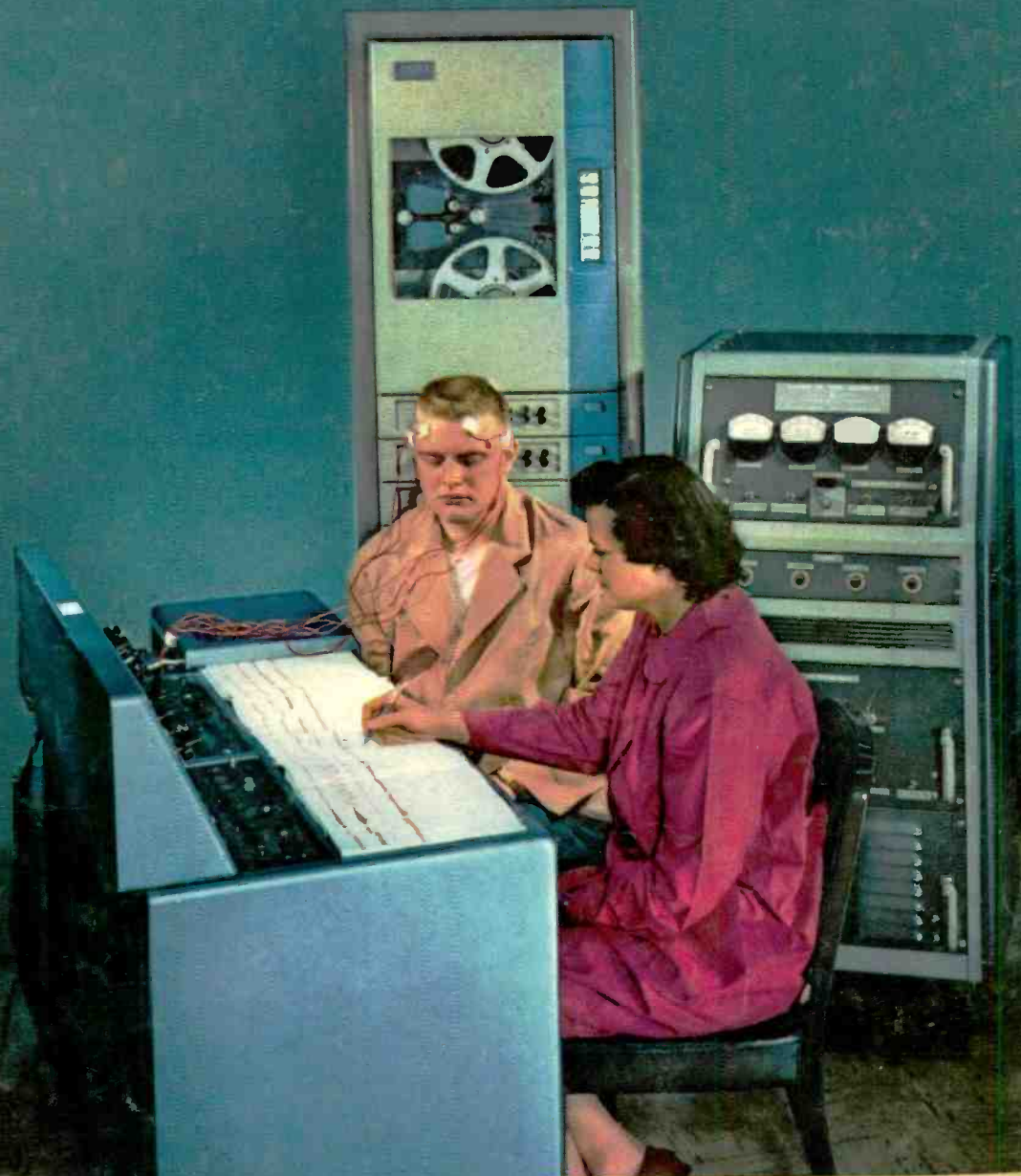
•

**Electronic  
Computer  
Analyzes  
Human Brain ▶**

(See page 55)

35c

U.S. and Canada



R BYFLOT 12-57  
4 MC NULTY DRIVE  
FLORISSANT 21 MISSOURI

# to do more

...today and tomorrow!



The first  
low priced  
tube tester  
to provide  
**DUAL SENSITIVITY  
SHORT TEST**  
Triplet Model  
**3413-B Tube Tester**  
**\$79.50**

BURTON BROWNE ADVERTISING

And here are just 2 answers that tell you why.  
**Question:**

Why Will Triplet Model 3413-B "do more" tomorrow?

**Answer:**  
Because it will test *any new tube*. Unlike testers with preset panels of test sockets which become obsolete with the release of a new tube, Triplet flexibility of switching allows a set-up to test any new tube.

**Question:**  
Why Will Triplet Model 3413-B "do more" today?

**Answer:**  
Because it combines provision for conventional short test (0.25 megohms) with high sensitivity leakage test (2.0 megohms) — will test series string tubes without adapter. At only \$79.50 today's and tomorrow's biggest value.



And for the ultimate in laboratory quality testing examine MODEL 3423 MUTUAL CONDUCTANCE TUBE TESTER \$199.50. Proportional Mutual Conductance testing of *all* radio and TV tubes plus selenium rectifiers, crystal diodes, pilot lamps, thyratrons, transistors, etc., by a new patented circuit.

At leading Parts Distributors everywhere, see the finest and most complete line of test equipment by

Triplet Electrical  
Instrument Company  
Bluffton, Ohio

53 years of experience.

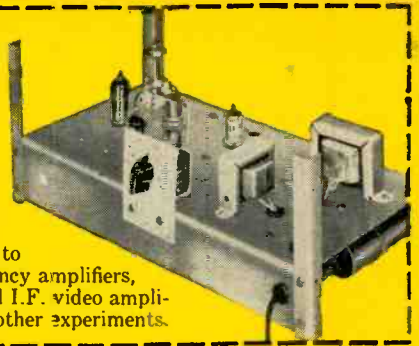


### YOU BUILD Broadcasting Transmitter

As part of N.R.I. Communications Course you build this low power Transmitter; use it to learn methods required of commercial broadcasting operators, train for FCC license.

### YOU BUILD Signal Generator

N.R.I. sends kits of parts to build this Signal Generator. You get practical experience, conduct tests to compensate Radio frequency amplifiers, practice aligning a typical I.F. video amplifier in TV circuit, many other experiments.



### YOU BUILD Vacuum Tube Voltmeter

Use it to get practical experience, earn extra cash fixing neighbors' sets in spare time, gain knowledge to help you work in Radio, Television, Color TV. With N.R.I. training you work on circuits common to both Radio and TV. Equipment you build "brings to life" things you learn in N.R.I.'s easy-to-understand lessons. 64 page Catalog FREE, shows all equipment you get.



### YOU BUILD AC-DC Superhet Receiver

N.R.I. servicing training supplies all parts, everything is yours to keep. Nothing takes the place of practical experience. You get actual servicing experience by practicing with this modern receiver; you learn-by-doing.



# Learn RADIO TELEVISION by Practicing at Home

## WHAT GRADUATES DO AND SAY

### Chief Engineer

"I am Chief Engineer of Station KGCU in Mandan, N. D. I also have my own spare time business servicing high frequency two-way communications systems." R. BARNETT, Bismarek, North Dakota.



### Paid for Instruments

"I am doing very well in spare time TV and Radio. Sometimes have three TV jobs waiting and also fix car Radios for garages. I paid for instruments out of earnings." G. F. SEAMAN, New York, N. Y.



### Has Own TV Business

"We have an appliance store with our Radio and TV servicing, and get TV repairs. During my Army service, NRI training helped get me a top rated job." W. M. WEIDNER, Fairfax, South Dakota.



## NEED FOR TECHNICIANS INCREASING Fast Growing Field Offers Good Pay, Bright Future

Today's OPPORTUNITY field is Radio-Television. Over 125 million home Radios plus 30 million sets in cars and 40,000,000 Television sets mean big money for trained Radio-TV Technicians. More than 4,000 Radio and TV Broadcasting stations offer interesting and important positions for technicians, operators. Color television, portable TV sets, Hi-Fi, other developments assure future growth.

It's the trained man who gets ahead. The fellow who uses his spare time to develop knowledge and skill gets the better job, drives a better car, lives in a better home, is respected for what he knows

and can do. So plan now to get into Radio-TV.

Keep your job while training with N.R.I. You learn at home in your spare time. N.R.I. is oldest and largest home study Radio-TV School. Our methods have proved successful for more than 40 years, provide practical experience.

Soon after enrolling, many N.R.I. students start to earn \$10, \$15 a week extra in spare time fixing sets. Many open their own full time Radio-TV shops after getting N.R.I. Diploma. Find out more. Mail Coupon. Cost is low, terms easy; includes all equipment. Address: **National Radio Institute, Dept. 7HF, Washington 16, D.C.**

Send for  
**LESSON  
and CATALOG  
FREE**

**VETERANS**  
Available under  
G.I. Bills



## MAIL COUPON NOW

**NATIONAL RADIO INSTITUTE**  
Dept. 7HF, Washington 16, D. C.

Mail me Sample Lesson and 64-Page Catalog, FREE. (No Salesman will call. Please write plainly.)

Name \_\_\_\_\_ Age \_\_\_\_\_

Address \_\_\_\_\_

City \_\_\_\_\_ Zone \_\_\_\_\_ State \_\_\_\_\_

ACCREDITED MEMBER, NATIONAL HOME STUDY COUNCIL

# Radio-Electronics

Formerly RADIO CRAFT ■ Incorporating SHORT WAVE CRAFT ■ TELEVISION NEWS ■ RADIO & TELEVISION\*

## EDITORIAL

- 29 Electronmechanics—Hugo Gernsback

## TELEVISION

- ✓ 30 Defective Interlace—A. R. Clawson
- 33 TV and Sunspots—M. E. West
- 34 TV Stations of Latin America—Muriel Schiller
- 35 TV Service Clinic—Conducted by Jerry Kass
- 37 Servicing Gated-Beam Discriminators—James A. McRoberts
- 38 A Shocking Sink—B. W. Welz
- 39 Remote the TV Speaker—Joseph F. Sodaro

## AUDIO—HIGH FIDELITY

- 40 How to Lose Money with a PA System—John Howard
- ✓ 43 60-Watt Amplifier Uses New KT88's—Larry Steckler
- 45 Simplest Electronic Organ, Part II—Harold C. Hubbard
- 47 6-Transistor Amplifier—Modulator Delivers 10 Watts—Bill Hamlin
- 49 Choosing the Phase Inverter—Norman H. Crowhurst
- 108 New Records—Monitor

## TECHNICAL REPORTS

- 52 The European Approach to Electronics—A. V. J. Martin
- 54 What's New

## ELECTRONICS

- 55 Computer Checks Human Brain (Cover Feature)—Carl J. Zaander
- ✓ 57 Radio Telescopes—Dr. H. C. Ko

## RADIO

- 60 Broadcast-Set Front End Traps If Interference—Ronald L. Ives
- 76 Wafer-Switch Repair—J. A. McRoberts
- 78 Things Ain't Always What They Seem—Jack Darr
- 84 Transistor Shortwave Receiver—Joseph Braunbeck
- 85 Vtvm Measures Ac Amps—Paul S. Lederer

## TEST INSTRUMENTS

- 88 Inexpensive TV—Radio Service Aids—Robert F. Scott
  - 91 Peak-to-Peak High-Frequency Probe—Robert G. Middleton
  - 92 A-I-R Generator—I. Queen
  - 96 Frequency Marker Inserter—Richard Graham
- |                                  |                               |
|----------------------------------|-------------------------------|
| 130 Books                        | 126 Patents                   |
| 117 Business and People          | 114 Question Box              |
| 106 Corrections                  | 120 Radio-Electronic Circuits |
| 16 Correspondence                | 128 Technical Literature      |
| 98 New Devices                   | 110 Technicians' News         |
| 6 News Briefs                    | 122 Technotes                 |
| 104 New Tubes and Semiconductors | 124 Try This One              |
|                                  | 106 35 Years Ago              |

## ON THE COVER

(story on page 55)

Subject's brain waves are measured, analyzed and recorded by an electronic device called an electroencephalogram analyzer.

- Hugo Gernsback  
.....Editor and Publisher
- M. Harvey Gernsback  
.....Editorial Director
- Fred Shunaman  
.....Managing Editor
- Robert F. Scott  
.....W2PWG, Technical Editor
- Larry Steckler  
.....Assistant Editor
- I. Queen  
.....Editorial Associate
- Robert G. Middleton  
.....Television Consultant
- Elizabeth Stalcup  
.....Production Manager
- Cathy Coccozza  
.....Advertising Production
- Wm. Lyon McLaughlin  
.....Tech. Illustration Director
- Sol Ehrlich  
.....Art Director
- Fred Neinast  
.....Staff Artist
- Lee Robinson  
.....General Manager
- John J. Lamson  
.....Sales Manager
- G. Aliquo  
.....Circulation Manager
- Adam J. Smith  
.....Director, Newsstand Sales
- Robert Fallath  
.....Promotion Manager



NEXT MONTH: HOW TO ORGANIZE AN EFFICIENT TV SERVICE BUSINESS • PRACTICAL COLOR TV INSTALLATION

Associate Member Institute of High Fidelity Mfrs., Inc.

RADIO-ELECTRONICS, August, 1957, Vol. XXVIII, No. 8. Published monthly at Mt. Morris, Ill., by Gernsback Publications, Inc. Second-class mail privileges authorized at Mt. Morris, Ill. Copyright 1957 by Gernsback Publications, Inc. All rights reserved under Universal, International and Pan-American Copyright Conventions.  
 SUBSCRIPTION RATES: U. S., U. S. possessions and Canada, \$4.00 for one year; \$7.00 for two years; \$9.00 for three years; single copies 35c, Pan-American countries \$4.50 for one year; \$8.00 for two years; \$10.50 for three years. All other countries \$5.00 a year; \$9.00 for two years; \$12.00 for three years.  
 SUBSCRIPTIONS: Address correspondence to Radio-Electronics, Subscription Dept., 404 N. Wesley Ave., Mt. Morris, Ill., or 154 West 14th St., New York 11, N. Y. When requesting a change of address, please furnish an address label from a recent issue. Allow one month for change of address.  
 GERNSBACK PUBLICATIONS, INC. Executive Editorial and Advertising Offices, 154 West 14th St., New York 11, N. Y. Telephone Algonquin 5-7755. Hugo Gernsback, Chairman of the Board; M. Harvey Gernsback, President; G. Aliquo, Secretary.  
 BRANCH ADVERTISING OFFICES and FOREIGN AGENTS listed on page 135.  
 POSTMASTER: If undeliverable, send Form 3578 to: RADIO-ELECTRONICS, 154 West 14th St., New York 11, N. Y.

\*Trademark registered U. S. Pat. Office.

RADIO-ELECTRONICS

**GREATEST  
ADVANCE IN  
SHOP-METHOD  
HOME TRAINING**

**EARN MORE MONEY... GET INTO**

# TELEVISION

**ELECTRONICS - RADIO**

**Learn ALL 8 PHASES in ONE MODERN HOME-STUDY COURSE**  
At Home - In Spare Time

## YOU GET ALL THIS NEWEST PRACTICAL EQUIPMENT

- Parts to build a modern TV set, including all tubes plus a large screen Picture Tube
- Parts to build a powerful Superhet Receiver, standard broadcast and short wave
- Parts to conduct many experiments and build Continuity Checker, RF Oscillator, TV Circuits, Audio Oscillator, TRF Receiver, Signal Generator
- A Valuable Professional Multitester



**19 BIG KITS  
YOURS TO KEEP**

## YOUR NATIONAL SCHOOLS TELERAMA COURSE COVERS ALL 8 PHASES

- |                                    |                                |
|------------------------------------|--------------------------------|
| 1. TELEVISION, INCLUDING COLOR TV  | 5. PREPARATION FOR FCC LICENSE |
| 2. RADIO, FM AND AM                | 6. AUTOMATION                  |
| 3. INDUSTRIAL ELECTRONICS          | 7. RADAR AND MICRO WAVES       |
| 4. SOUND RECORDING AND HI FIDELITY | 8. COMMUNICATIONS              |

## YOU ARE NEEDED IN THE TELEVISION-ELECTRONICS-RADIO INDUSTRY!

You can build a secure future for yourself if you get into Electronics NOW! Today's shortage of trained technicians creates tremendous opportunities. National Schools Shop-Method trained technicians are in constant and growing demand for high-pay jobs in Broadcasting and Communications, Electronic Research, Servicing and Repair, and many other branches.

Let National Schools, a Resident Technical School for over 50 years train you for today's unlimited opportunities in electronics! Our Shop Method trains you to be a MASTER-TECHNICIAN. Completely up to date, developed by experienced instructors and engineers, your Telerama Course will teach you all phases of the industry quickly, clearly and correctly. You can master the most modern projects, such as Color TV, printed circuits - even prepare for FCC License without taking a special

course. You can handle sales, servicing, manufacturing, or make good money in your own business. SEND FOR FACTS TODAY!

**EARN AS YOU LEARN.** Many of our students earn their entire tuition and more in Spare Time jobs we show them how to do while learning.

**YOU GET EVERYTHING YOU NEED** - Clear, profusely illustrated lessons, shop-tested manuals, modern circuit diagrams, practical job projects - all the valuable equipment shown above

- many other materials and services  
- consultation privilege with our qualified staff, and Graduate Employment Service. EVERYTHING YOU NEED for outstanding success in Electronics.

## RESIDENT TRAINING AT LOS ANGELES

If you wish to take your training in our Resident School at Los Angeles, the world's TV capital, start NOW in our big, modern Shops, Labs and Radio-TV Studios. Here you work with latest Electronic equipment—professionally installed—finest, most complete facilities offered by any school. Expert, friendly instructors. Personal attention. Graduate Employment Service Help in finding home near school—and part time job while you learn. Check box in coupon for full information.



**FREE!** Fully illustrated "Career" Book in TV-Radio-Electronics. PLUS actual sample lesson—yours at no cost, no obligation. CLIP COUPON NOW... MAIL IT TODAY!

APPROVED FOR G. I. TRAINING

# NATIONAL SCHOOLS

4000 S. FIGUEROA ST., LOS ANGELES 37, CALIF.

## NATIONAL SCHOOLS

TECHNICAL TRADE TRAINING SINCE 1905  
LOS ANGELES 37, CALIFORNIA

**GET FAST SERVICE—MAIL NOW TO**

NATIONAL SCHOOLS, DEPT. RG-87  
4000 S. FIGUEROA ST.  
LOS ANGELES 37, CALIF.

Rush free TV-Radio "Opportunity" Book and sample lesson. No salesman will call.

NAME \_\_\_\_\_ AGE \_\_\_\_\_  
ADDRESS \_\_\_\_\_  
CITY \_\_\_\_\_ ZONE \_\_\_\_\_ STATE \_\_\_\_\_

Check if interested ONLY in Resident School training at Los Angeles. VETERANS. Give date of Discharge.

# News Briefs



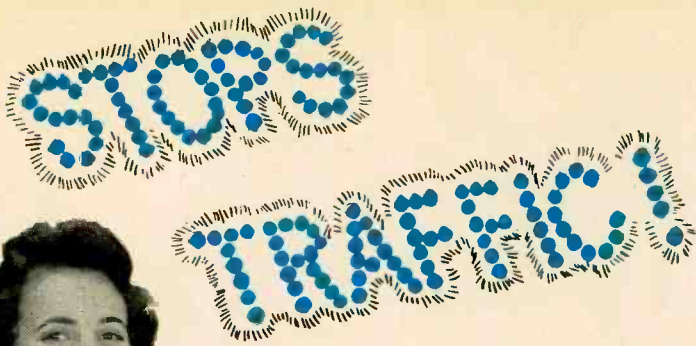
**RADIATION SCARE**, due to a statement by New York State Commerce Department research consultant Dr. James B. Kelley, was still having repercussions at the time this issue went to press. Dr. Kelley told the Radiological Safety Conference held recently at Buffalo, N. Y., that boosters used on aging picture tubes might convert them into sources of mild X-rays. A standard black-and-white receiver, Dr. Kelley said, uses about 15,000 volts, but a booster uses 30,000 to 40,000. Medical X-rays start at 50,000 volts.

It was pointed out to Dr. Kelley that the common picture-tube brightener (booster) increases the heater voltage only and that by just a few volts. Newspapers reported that he had backed down on his earlier statement, explaining that he was not entirely familiar with the operating principles of the standard TV tube booster. But, two days later, Dr. Kelley insisted that he had not retracted his original statement, and emphasized that he had personally seen TV sets "which had their anode voltages raised from the usual 15,000 to as high as 30,000 or 35,000 volts." Since the average picture tube would not handle much more than 20,000 volts without breaking down, and since deflection voltages would not be sufficient to produce a picture over more than a small portion of the screen if the anode voltage were greatly increased, it is not clear how these sets could have operated. In any event, none of RADIO-ELECTRONICS' technical staff has ever seen or heard of a boosted receiver such as Dr. Kelly describes. Meanwhile many set owners have been alarmed needlessly. The one good angle in the whole unfortunate mess: some TV owners will have new picture tubes installed!

**REFLECTING RADIO SIGNALS** off meteor trails has led to a novel experimental medium-range communications link, between Stanford Research Institute, Menlo Park, Calif., and Montana State College, Bozeman, Mont. (800 miles). Tests with voice and teletype communications have been successful.

These applications of forward scattering from meteor trails were carried out by the institute in a research program sponsored by the Air Force Cambridge Research Center.

Operating in the 30-100-mc range, the two stations reflect radio signals off meteor trails that occur 60 miles above the earth's surface. These trails



Thousands of dealers have increased their sales of two set couplers with this beautiful AMPHENOL Telecoupler display. They are reaping *plus profits* from the growing second set market in TV, black & white and color.

Don't let plus profits escape you!  
See your AMPHENOL Distributor!



TELECOUPLER  
by AMPHENOL



AMPHENOL ELECTRONICS CORPORATION

# Wanted: Men of Vision

Men 17-55

Prepare Now for a Profitable  
Career in the Opportunity-  
Packed Fields of

## ELECTRONICS

as used in

## GUIDED MISSILES

ETC.

**NO ADVANCED EDUCATION OR PREVIOUS  
TECHNICAL EXPERIENCE NEEDED!**

Men who are planning a solid future and are anxious for a brighter tomorrow will find real opportunities in the big, fast-growing field of Electronics. Imagine being able to prepare for the advantages offered in Electronics without having advanced education—or previous technical experience! And what's so important, you can get this preparation in your spare time at home without interfering with your present job . . . following the same basic method used in our Chicago and Toronto training laboratories. Send coupon for FREE booklet NOW!

**An INDEX  
To A Better Job,  
A Brighter Future**

Industrial Electronics  
Automation Electronics  
Guided Missiles  
Micro-Waves      Communications  
Radio              Radar  
Computers  
Remote Control Systems  
Broadcasting  
Electronics      Television  
Your Own Service Shop



### Live-Wire Employment Service

Puts you in touch with job opportunities  
—or helps you toward a better  
position in the plant where  
you are now employed.

"One of North America's Foremost Electronics Training Centers"



**DeVRY TECHNICAL INSTITUTE**  
CHICAGO 41, ILLINOIS  
FORMERLY  
**DeFOREST'S TRAINING, INC.**

### MAIL TODAY FOR FREE FACTS

DeVry Technical Institute  
4141 Belmont Ave., Chicago 41, Ill., Dept. RE-8N  
Please give me your FREE booklet, "Electronics and YOU," and tell me how I may prepare to enter one or more branches of Electronics as listed above.

Name \_\_\_\_\_ Age \_\_\_\_\_  
Street \_\_\_\_\_ Please Print \_\_\_\_\_ Apt. \_\_\_\_\_  
City \_\_\_\_\_ Zone \_\_\_\_\_ State \_\_\_\_\_

Check here if subject to Military Training.  
DeVry Tech's Canadian Training Center is located at  
2023 626 Roselawn Avenue, Toronto 12, Ontario

### Draft Age?

We have valuable information for every man of draft age; so if you are subject to military service, be sure to check the coupon.



**FREE  
BOOKLET**

We'll give you a free copy of an interesting booklet, "Electronics and YOU." See for yourself how you may take advantage of the opportunities in this fast-growing field.

FOR  
A **brighter**  
TV picture



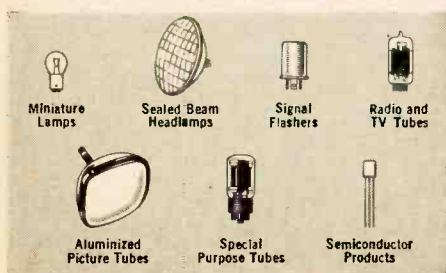
FOR  
A **brighter**  
profit.  
picture



Keep your customers sold on you! Use the exact same tubes leading independent set makers specify. Tell your supplier you'd rather have Tung-Sol Tubes.

Tung-Sol Electric Inc., Newark 4, N. J.

**TUNG-SOL**  
MAGIC MIRROR ALUMINIZED  
PICTURE TUBES  
RECEIVING TUBES



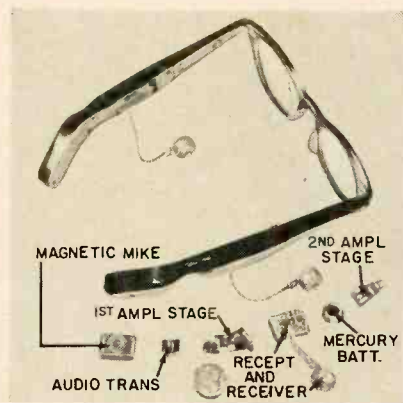
NEWS BRIEFS

of ionized air act like reflecting wire arrays. A 1,500 mile range is possible. The radio link employs equipment similar to that used by military and civilian agencies for short-range communications. With reflected signals and equipment adapted for intermittent transmission, the SRI-Bozeman system enables long-range transmission of messages with transmitters of substantially lower power than needed for continuous transmission on ionospheric forward-scattered circuits.

Stanford University scientists have held another experiment in long-range communications to support a new concept of the ionosphere's thickness, suggesting that charged particles can be found 20,000 miles out in space. Calculations showed that, if a signal was transmitted by the Navy's transmitter at Annapolis, it would pass through the ionosphere and return to earth near Cape Horn, at the tip of South America.

A pulse, repeated every 2 seconds, was sent from Annapolis. It was received at a Cape Horn listening post over two routes. One was that taken by signals bouncing off the bottom of the ionosphere. The other was through the ionosphere and space and took 0.75 second for the trip, 0.7 second longer than the ionosphere-reflected signal. The fact that the delayed signal was received provides evidence that particles of matter do exist above what is now considered to be the upper limit of the ionosphere.

**BINAURAL HEARING** is now made possible for great number of hard-of-hearing people, with the help of a dual hearing aid installed in slightly enlarged temples of eyeglasses. Twin amplifying circuits and a microphone for each ear allow users to locate sounds in terms



of direction and comparative distance, tremendously increasing the naturalness of sound reception. An exploded view of the components in one amplifying channel is shown in the photograph. The system was developed by Dictograph Products' Acousticon Division.

Another feature is the use of tuned earpieces (receivers) to match the more common patterns of hearing deficiency. one hundred combinations of 10 receivers, each with a different frequency pattern, compensate for various types of hearing loss. As they parallel cor-

rective lenses for vision, these receivers are called Hearing Lenses.

**RADIO SIGNALS FROM JUPITER** have been studied for almost two years by astrophysicist Roger Gallet, a scientist at the Boulder, Colo., laboratories of the National Bureau of Standards. Five sources of these signals on the planet have been located. The sources seem to be permanently fixed and do not emit on all radio frequencies at once.

So far there is no indication that the signals may be the work of intelligent beings.

Calendar of Events

- Annual Electronics Clinic and Fair, Aug. 2-4, Texas Hotel, Fort Worth, Tex.
- German Radio, Television and Phonograph Exhibition, Aug. 2-11, Frankfurt am Main, West Germany.
- NATESA Convention, Aug. 16-18, Chicago Sheraton Hotel, Chicago, Ill.
- West Coast Electronic Show and Convention (WESCON), Aug. 20-23, Cow Palace, San Francisco, Calif.
- 12th General Assembly of International Scientific Radio Union, Aug. 22-Sept. 5, National Bureau of Standards, Boulder, Colo.
- American Institute of Electrical Engineers Pacific General Meeting, Aug. 28-30, Pasco, Wash.
- National Radio & Television Exhibition, Aug. 28-Sept. 7, Earls Court, London, England.
- ARRL National Convention, Aug. 30-Sept. 1, Palmer House, Chicago.
- Conference and Exhibit on Magnetic Amplifiers, Sept. 4-6, Hotel Penn Sheraton, Pittsburgh, Pa.
- Cincinnati High Fidelity Music Show, Sept. 6-8, Sheraton-Gibson Hotel, Cincinnati, Ohio.
- Instrument-Automation Conference and Exhibit, Sept. 9-13, Cleveland Public Auditorium, Cleveland, Ohio.
- International Sight and Sound Exposition, Sept. 13-15, Palmer House, Chicago, Ill.
- Heart of America Chapter of The Representatives, Distributor Conference, Sept. 15-19, Excelsior Springs, Mo.
- Institute of High Fidelity Manufacturers Show, Sept. 17-21, Morrison Hotel, Chicago, Ill.
- RETMA Symposium On Numerical Control Systems for Machine Tools, Sept. 17-18, Ambassador Hotel, Los Angeles, Calif.
- Industrial Electronics Symposium, Sept. 24-25, Morrison Hotel, Chicago.

**FOUR NEW TV STATIONS** have begun telecasting since our last survey:

- WPSD, Paducah, Ky..... 6
- KBTX, Bryan, Tex..... 3
- WBLN, Bloomington, Ill.....15
- WRLP, Greenfield, Mass.....32

WBLN is not a beginner, but is resuming operation on an interim basis. WRLP is a satellite of WWLP, Springfield, Mass., channel 32. It will, however, originate a few local shows.

- Two stations have left the air:
- KCCC-TV, Sacramento, Calif.....40
- WTOB-TV, Winston-Salem, N.C.....26

There were several changes in call letters:

- WTPA, Harrisburg, Pa.....27  
(formerly WCMB-TV)
- WCMB-TV, Harrisburg, Pa.....71  
(Formerly WTPA)
- WJCT, Jacksonville, Fla..... 7  
(formerly WET.J)
- WTVM, Columbus, Ga.....28  
(formerly WDAK-TV)

As a result of these changes, our present total of operating U. S. stations is 501 (409 vhf and 92 uhf). Of these 25 are noncommercial (6 uhf).

(Continued on page 12)



# ALLIED'S sensational purchase of manufacturer's closeout BRINGS YOU THE YEAR'S GREATEST BUY IN HI-FI!



**SAVE \$33<sup>25</sup>**  
on this famous

**Bell**

**20-WATT HI-FI  
MUSIC AMPLIFIER**

**IT'S THE QUALITY BELL 2300 MODEL...**

**SOLD REGULARLY AT \$107<sup>75</sup>...NOW YOURS FROM ALLIED FOR ONLY**

**\$74<sup>50</sup>**

- Big 31% Savings!
- Complete with Handsome Case
- Full Equalization
- Includes Seven Inputs
- Rumble and Scratch Filters
- Loudness Control
- A-B Speaker Selector Switch

ALLIED has the buy of the year for you in this famous Bell Hi-Fi amplifier. Advanced features include: Variable equalization for ceramic as well as magnetic cartridges; switch to select one of two speakers, or both; distortion less than 0.3% at 20 watts; response  $\pm 0.5$  db, 20-20,000 cps; inputs—2 for low magnetic or tape, ceramic or crystal, high magnetic, radio, TV or auxiliary; Controls—Off-on, Rumble Filter, Scratch Filter, Speaker, Bass, Treble, Loudness, Volume, Radio Input Level, Equalizer (Tape, 78, RIAA, LP, Eur), input selector. Dual 4, 8, 16 ohm taps. Complete in beautiful "space-saver" case. 4 x 15  $\frac{5}{8}$  x 11  $\frac{3}{8}$ ". 20 lbs.  
98 SZ 959. Net, F.O.B. Chicago, Only ..... **\$74<sup>50</sup>**

Easy Terms Available:  
Only \$7.45 Down  
**QUANTITIES LIMITED  
ORDER NOW**

**ANOTHER GREAT  
ALLIED  
HI-FI VALUE!**

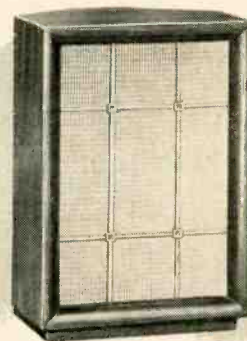
**SAVE \$80<sup>00</sup> on this Complete "Space-Saver"  
Phono System Featuring the Bell 2300 Amplifier**



COMPONENTS SOLD  
REGULARLY FOR  
**\$306.55**



Easy Terms Available  
Only \$21.97 Down



ALLIED RECOMMENDED

SPECIAL  
ONLY  
**\$219<sup>75</sup>**

Unprecedented Hi-Fi phono music system value. You save \$86.80 over cost of individual components. Beautiful "space-saver" design—no cabinets required. Includes: (1) the famous Bell 2300 Amplifier (described above); (2) Garrard RC 121-4 Changer and base (specify Mahogany or Blonde finish for base), with (3) genuine G.E. RPX 052-A Triple-Play Cartridge (diamond-sapphire styli); (4) Electro-Voice "Aristocrat" Speaker Enclosure, with (5) Electro-Voice 12TRXB Speaker installed (specify Mahogany or Blonde enclosure finish; FREE plastic record changer cover. Ready for easy installation. Shpg. wt., 97 lbs.  
94 PA 285. Net, F.O.B. Chicago, only ..... **\$219<sup>75</sup>**

**SAVE EVEN MORE—assemble your own speaker enclosure!** System as above, but with E-V enclosure in unfinished kit form (KD-6 Kit). You save an additional \$29.40 by doing the easy assembly yourself! Includes amplifier, changer and speaker as listed above. Shpg. wt., 90 lbs.  
94 PA 286. Net, F.O.B. Chicago, only ..... **\$190<sup>35</sup>**

Easy Terms Available: Only \$19.00 Down.

**ORDER FROM  
ALLIED RADIO**

ALLIED RADIO CORP., Dept. 2-H7  
100 N. Western Ave., Chicago 80, Ill.

Ship the following:

- 98 SZ 959 Bell 2300 Amplifier
  - 94 PA 285 Complete Phono System
  - 94 PA 286 Phono System with Enclosure Kit
- \$..... enclosed (all prices Net F.O.B. Chicago)

Name.....

Address.....

City..... Zone..... State.....

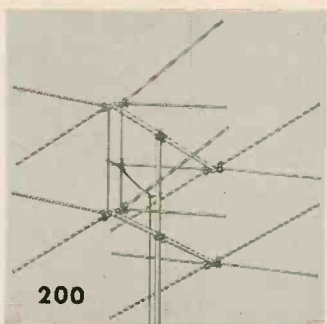
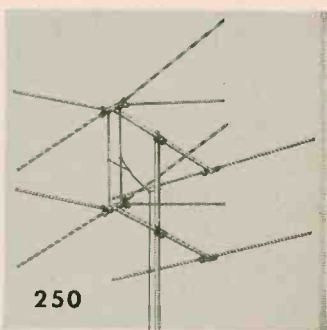
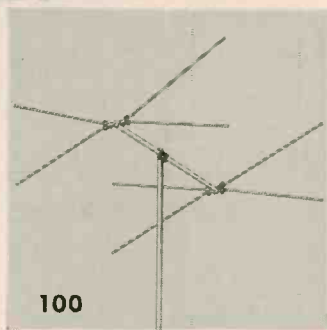
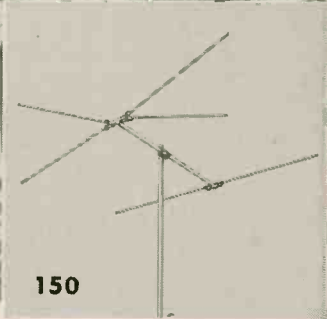
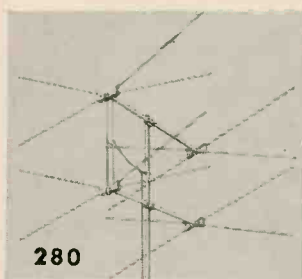
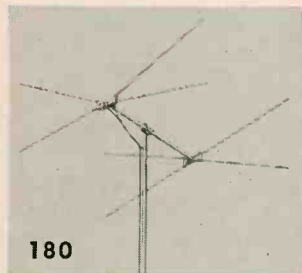
**MODEL 280SW** (shown right)

- Double stacked array PLUS high frequency elements.
- All Aluminum Construction.
- Mounts on any mast up to 1 3/4".
- QUICK-RIG design for speedy one man installation.
- Complete with stacking bars.

**MODEL 180SW** . . . . same as 280SW only not double stacked.

**MODEL 180** . . . . QUICK-RIG 8 element "Lazy-X" Conical.

**MODEL 280** . . . . QUICK-RIG double stacked "Lazy-X" Conical.



# 12 NEW RADIART TV ANTENNAS

Proven Unquestionably . . .  
 the best performing at  
 the lowest possible price!

RADIART . . . the name you can depend upon for QUALITY and VALUE . . . offers a COMPLETE . . . and NEWLY ENGINEERED line of superbly performing TV antennas at an economy price. Carefully tested under all conditions . . . each of these new models is guaranteed to be the best performing at the lowest possible price.

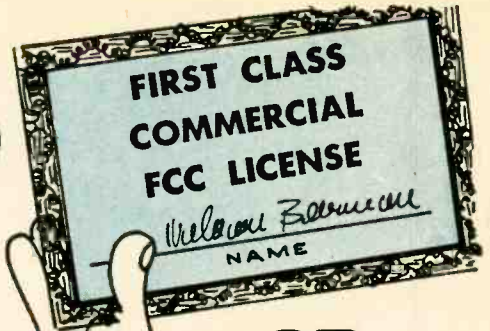
- LZX 100 single array
- LZX 101 single array, unassembled
- LZX 200 8 element conical completely assembled, stacked array
- LZX 201 8 element conical unassembled, stacked array
- LZX 150 single array
- LZX 151 single array, unassembled
- LZX 250 6 element conical assembled, stacked array
- LZX 251 6 element conical unassembled, stacked array.

SUBSIDIARY OF



THE RADIART CORPORATION / CLEVELAND 13, OHIO

6 months  
from today



WHICH WILL YOU HOLD...

OR



add technical training to your practical experience. GET YOUR FCC LICENSE QUICKLY!

then use our effective

Job Finding Service!

We Guarantee

Your FCC License

If you fail to pass your Commercial License exam after completing our course, we guarantee to continue your training without additional cost of any kind until you successfully obtain your Commercial License.

Here's proof FCC Licenses can be secured in a few hours of study with our training at home in spare time.

Name and address	License	Time
John J. Johnson, Boise City, Okla.	1st Class	20 weeks
Prentice Harrison, Lewes, Delaware	1st Class	27 weeks
W. E. Evey, Ottawa, Kansas	2nd Class	24 weeks
Raymond L. Gersig, Pittsburgh, Pa.	2nd Class	24 weeks
Francis W. Bartley, Danbury, Conn.	2nd Class	15 weeks

Employers Make Offers Like These

to Our Graduates Every Month

Broadcast Station in Illinois: "We are in need of an engineer with a first class phone license, preferably a student of Cleveland Institute of Radio Electronics; 40 hour week plus 8 hours overtime."

West Coast Manufacturer: "We are currently in need of men with electronics training or experience in radar maintenance. We would appreciate your referral of interested persons to us."

Our Trainees Get Jobs Like These Every Month



CHIEF ENGINEER

"Since enrolling with Cleveland Institute I have received my 1st class license, served as a transmitter engineer and am now Chief Engineer of Station WAIN. I also have a Motorola 2-Way Service Station. Thanks to the Institute for making this possible."

Lewis M. Owens, Columbia, Ky.

TEST ENGINEER

"I am pleased to inform you that I recently secured a position as Test Engineer with Melpar, Inc. (Subsidiary of Westinghouse) A substantial salary increase was involved. My Cleveland Institute training played a major role in qualifying me for this position."

Boyd Daugherty, Falls Church, Va.



Names of Trainees in Your Area  
Provided on Request

Carl E. Smith, E.E., President

CLEVELAND INSTITUTE OF RADIO ELECTRONICS  
Dept. RE-8, 4900 Euclid Bldg., Cleveland 3, Ohio

Get these valuable Booklets

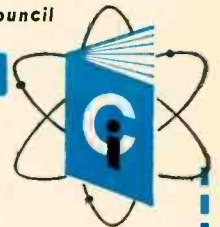
FREE!



Accredited by National Home Study Council

Cleveland Institute of Radio Electronics

Dept. RE-8, 4900 Euclid Bldg., Cleveland, Ohio



Please send Free Booklets prepared to help me get ahead in Electronics. I have had training or experience in Electronics as indicated below:

- |   |   |
|---|---|
| <input type="checkbox"/> Military           | <input type="checkbox"/> Broadcasting       |
| <input type="checkbox"/> Radio-TV Servicing | <input type="checkbox"/> Home Experimenting |
| <input type="checkbox"/> Manufacturing      | <input type="checkbox"/> Telephone Company  |
| <input type="checkbox"/> Amateur Radio      | <input type="checkbox"/> Other _____        |

In what kind of work are you now engaged? \_\_\_\_\_ In what branch of Electronics are you interested? \_\_\_\_\_

Name..... Age.....

Address.....

City..... Zone..... State.....

Special Tuition Rates to Members of Armed Forces

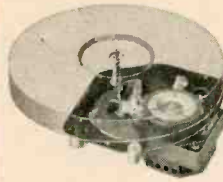
*For Every Application!*

# RELY on GI

## PHONOMOTORS

"A Complete Line  
from a Single Source"

Leading O.E.M.'s everywhere specify G.I. phonomotors — and have for the last half century. Their preference — based on G.I.'s unmatched record of performance — is your best assurance of quality, economy and dependability. For anything from kiddie phonographs to the last word in hi-fi, remember that you can be sure if you RELY on G.I.



MODEL DSS  
3-speed, 4-pole  
motor



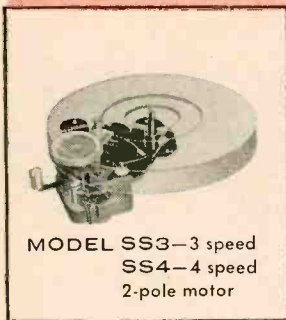
MODEL DR  
2-speed  
4-pole motor



MODEL AX  
Single speed  
2-pole motor



MODEL RM 4  
Single speed  
4-pole motor



MODEL SS3—3 speed  
SS4—4 speed  
2-pole motor

Other General Industries AC induction type motors for applications ranging from 1/40 HP to 1/1100 HP.



MODEL D-10, 4-pole,  
shaded pole A.C. in-  
duction type for tape,  
wire, or disc recorders



MODEL BX  
Battery powered,  
3-speed motor  
(45, 33 1/4, 16 1/2 R.P.M.)



THE GENERAL INDUSTRIES CO.

DEPT. GR • ELYRIA, OHIO

**LOOK** ... what **RADIO-ELECTRONICS**  
has in store for you  
in the months ahead ...

- All-Transistor Tape Playback Preamplifier
- How to Use Tube Data
- Testing Audio Amplifiers
- Transistor TV Bar Generator Is Hand-Size
- Tricky Circuits in TV
- Power Transistor Tester
- Practical Color TV Installation
- Practical Slant on Color TV Servicing
- Good Loudspeaker Bass Reproduction
- Transistor Headphone Radio

The SEPTEMBER issue of RADIO-ELECTRONICS goes on sale August 27 at all better parts distributors and newsstands

**SUBSCRIPTION RATES**

One year \$4.00      Two years \$7.00      Three years \$9.00  
RADIO-ELECTRONICS      154 West 14th Street, New York 11, N.Y.

NEWS BRIEFS

(Continued)

Canada now has 42 stations with its inauguration of:

CJOX-TV, Argentinia, Nfld.....10

CJOX-TV is a satellite of CJON-TV, St. John's, channel 6.

**COL. SOSTHENES BEHN**, retired chairman of International Telephone & Telegraph Corp., died June 6 at the age of 75. Known throughout the world as the builder of a great public utility and industrial empire, he saw his creation grow from a modest telephone and telegraph company to a worldwide electronics manufacturing and telecommunications system. On May 23, 1956, his business career of almost 60 years came to a close when he retired from IT&T chairmanship. Since then he was honorary chairman of the corporation.

Colonel Behn was born on St. Thomas in the Virgin Islands in 1882 and was fond of pointing out that he twice became an American citizen—once by naturalization and again when the United States bought the Virgin Islands from Denmark.



**ELECTROCHEMICAL UNITS** may replace vacuum tubes and transistors in electronic applications where high sensitivity and low power consumption are important. The new subminiature electrochemical control device (developed by the United States Naval Ordnance Laboratory, White Oak, Silver Spring, Md.) is a double-chambered unit in which current is generated by the movement of ions between electrodes through an iodine solution, which floats between diaphragms sealing the ends of the unit. The current flow is started with a low-voltage dry cell in series with the unit. It is then sustained and varied by stimulation of temperature, pressure, light, sound or acceleration applied to the diaphragms.

Lyman C. Fisher, chief of the Underwater Mechanical Engineering Department, predicts that one use of these new units may be in "rate" circuits, to give maximum speed and accuracy in operation of heat controls, burglar and fire alarms, furnace regulators and pressure indicators.

Another application of this technology is as a navigational aid. The system uses an integrator unit consisting of a small cylinder divided into two sections by a porous ceramic filter. Two electrodes are immersed in a solution of potassium iodide to which a

# NOW—A Faster Way to Reach the Top in TV SERVICING



**NRI SENDS YOU** 17" Picture Tube, components for a TV Receiver, 5" Oscilloscope and Signal Generator. Pay on Convenient Monthly Terms.

## N. R. I. All-Practice Method Trains You at Home in Spare Time to Fix TV Sets, Quickly, with Confidence

The man who knows the answers—the Professional TV Technician enjoys the prestige, gets the better jobs, the higher pay. Here is the learn-by-practice training to be a Professional TV Technician. It shows you the way to be the boss, to earn top pay. Television Servicing needs more than well trained men. If you have a basic knowledge of radio and electronics you can make some Television repairs simply by trial and error. But sooner or later you will face TV Service problems you can not solve. And you can't get the training you need while customers wait.

### N. R. I. Is Oldest and Largest Home Study Radio-TV School

Over forty years experience and the record and reputation of NRI back up this learn-by-doing Professional TV Servicing Course. Instead of just reading about TV problems, you build and conduct experiments on circuits in a TV receiver. You learn methods, "Tricks of the trade" proved by top TV Servicemen. You learn to fix any set, any model with confidence.

### You Get COLOR TV Textbooks Early

The day you enroll, N.R.I. sends you special Color-TV books to speed your knowledge and understanding of this vast, growing phase of Television.

Many full color pictures and diagrams help you recognize defects and help you learn how to correct them quickly and properly. To cash in on the coming Color TV boom, you'll need the kind of knowledge and experience this NRI training gives.

This is 100% learn-by-doing, practical training. Here is a course for men who know basic theory, either from Radio or TV Servicing experience or planned training but realize the need for more knowledge to forge ahead. Here is what one graduate, G. G. Stethem of Belpre, Ohio, says, "I can not praise N.R.I.'s Professional TV Course highly enough. I have my own spare time

shop and all the Radio-TV work I can handle."

Another graduate, Edward Ravitsky of Northumberland, Pa., says, "I have taken your course in Professional TV Servicing. It takes the kind of experience you offer to really learn." If you want to go places faster in TV Servicing, make your future more secure as the industry develops, we invite you to find out what you get, what you practice, what you learn from NRI's Course in Professional TV Servicing. Mail the coupon now. There is no obligation. NATIONAL RADIO INSTITUTE, Dept. 7HFT, Washington 16, D. C.



Send for  
**FREE BOOK**

### NATIONAL RADIO INSTITUTE

Dept. 7HFT, Washington 16, D. C.

Please send FREE copy of "How to Reach the Top in TV Servicing." I understand no salesman will call.

Name..... Age.....

Address.....

City..... Zone..... State.....

ACCREDITED MEMBER NATIONAL HOME STUDY COUNCIL

**MORE USES—MORE INCOME**  
 With New Adapter, the famous B&K CRT Now Also  
 Tests and Repairs Color and 110° Picture Tubes



**CRT 400 PROVES REAL MONEY-MAKER**

Thousands of servicemen today make money and keep customer good-will by checking and correcting b&w picture tube troubles with the famous B&K CRT 400, right in the home without removing tube from set. Restores emission and brightness. Repairs inter-element shorts and open circuits. Checks leakage. Indicates picture quality customer can expect. Life Test checks gas content and predicts remaining useful life of picture tube. Makes new picture tube replacement sales easier!

Model 400 (without adapter) . . . Net, **\$54<sup>95</sup>**

**NEW MODEL C40 ADAPTER DOUBLES VALUE OF B&K CRT**

Designed for use with all B&K Models 400 and 350 CRT's. Makes it easy to test and rejuvenate TV color picture tubes and 110° picture tubes. Isolates and detects difficult color troubles. Tests and rejuvenates each gun of the color picture tube separately the same way as a black & white tube.

Model C40 Adapter . . . Net, **\$9<sup>95</sup>**

See your B&K distributor, or write for Bulletin 400-C40-E

Makers of CRT, DYNA-QUIK, DYNA-SCAN and CALIBRATOR

**B & K MANUFACTURING CO.**

3726 N. Southport Ave. • Chicago 13, Illinois



**WANT BACK ISSUES?**  
**BACK NUMBERS OF MOST ISSUES OF**  
**RADIO-ELECTRONICS ARE AVAILABLE UPON REQUEST**

THIS YEAR'S ISSUES 35c  
 LAST YEAR'S ISSUES 40c  
 PREVIOUS YEAR 45c, etc.  
 ALL JANUARY TV ISSUES 50c

**RADIO-ELECTRONICS**

154 WEST 14th STREET

NEW YORK 11, N. Y.

NEWS BRIEFS

(Continued)

small amount of iodine is added. Movement of the plane results in chemical changes inside the integrator that produce electric current. Any change in the direction of movement causes a measurable change in current output. Thus a change in the original course will produce an electric current that can be read on recorders, showing the amount of change and its direction.

**GERNSBACK SCHOLARSHIP** for the academic year 1957-58 has been awarded to Gerard Alphonse. The scholarship was established by Hugo Gernsback for presentation to an outstanding student, through the Department of Electrical Engineering of New York University.



Gerard Alphonse was born Dec. 22, 1935, in Port-au-Prince, Haiti. Upon graduating high school, he attended the Polytechnic School of Haiti for 1 year. Since that institution did not then offer a program in electrical engineering, Gerard came to the United States and entered NYU in September, 1954.

**WALL-TYPE TV SETS** should be perfected within 5 years, according to a prediction by Dr. Lee deForest, who has applied for a patent on such a set.

"The entire receiver will be 4 inches thick and capable of hanging on a wall," he said.

"Chassis and controls will be located on each side and the bottom of the screen."

**SPEEDED-UP FACSIMILE**, in which a picture can be taken, transmitted and reproduced at a distant point within 5 minutes, was demonstrated by the Signal Corps at a press conference in New York City. The speedup is made possible by using Polaroid Land cameras at the transmitting and receiving ends. The photograph made with a Land camera can be developed and inserted in the scanner within 1 minute. Polaroid film is also used in the receiver and, after a 3-minute scanning process, is developed in 1 minute.

Another feature of the equipment is a revolving polygonal mirror scanner which permits scanning the photo without wrapping it around a drum. Transmission can be by wire or radio and the complete unit, made by Times Facsimile Corp., can be placed easily in the back of a car or jeep. Besides military uses, the equipment may well have important commercial applications and could be used in radio cars now operated by large newspapers. **END**

# how long would it take you to solve this service problem?

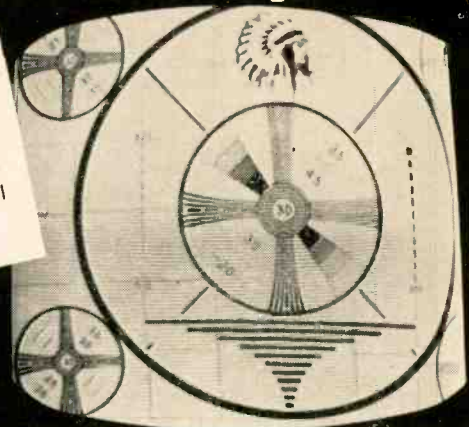
## PHOTOFACT

helps you lick problems  
like this in just minutes

for only \* **2½¢** per model!

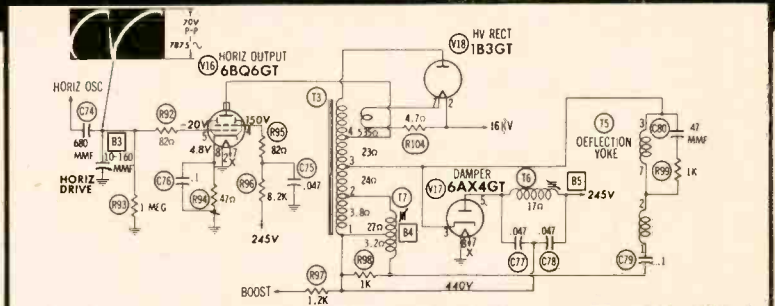
### SYMPTOM:

Horizontal Foldover affecting the right side of the screen, accompanied by an overall reduction in width



Let's look at this problem: When the foldover occurs at the right side of the picture, the trouble usually originates in the horizontal discharge or output circuits. Look for the following possible causes:

1. Defective tube in the flyback circuit
2. Leaky coupling capacitor (C74)
3. Misadjusted or defective drive control
4. Open or leaky capacitor (C76) in the cathode of the output stage
5. Incorrect value of the grid resistor (R93) in the horizontal output stage
6. Open or leaky screen bypass capacitor (C75) in the output stage
7. Incorrect value of the cathode resistor (R94) in horizontal output stage
8. Incorrect value of the screen resistor (R96) in horizontal output stage
9. Defective yoke or flyback transformer



(Based on an actual case history taken from the Howard W. Sams book "TV Servicing Guide")

the quickest procedure you can use to localize the trouble. Check the waveform at the junction of the two capacitors, B3 and C74. The correct waveform and peak-to-peak voltages are shown right on the PHOTOFACT Standard Notation Schematic. Waveform incorrect?—Then, using the easy-to-read resistance chart and the correct voltages shown on the schematic, check for proper resistance and voltage values to determine which part is defective. The exclusive PHOTOFACT chassis photos with "call-outs" keyed to the schematic help you locate the faulty part quickly. Important! Horizontal Foldover may result from improperly matched components in this circuit. It is *imperative* that all parts replaced duplicate the originals. You'll find the proper replacement parts for all components listed in the complete PHOTOFACT parts list.

Remember, whatever the trouble may be, you'll locate it faster and solve it easier and more profitably with a PHOTOFACT Folder by your side.

With the applicable PHOTOFACT Folder at your fingertips, you'll trouble-shoot and solve this problem in just seconds. Here's-how:

Using the Tube Placement Chart (you'll find it in every PHOTOFACT TV Folder) you'll quickly locate and check the tubes in the Flyback Circuit. Tubes okay?—then: A waveform analysis of the signal in the sweep section is perhaps

Use the servicing method you prefer—checking of waveform, voltage or resistance—you'll find all the information you need at your finger-tips in PHOTOFACT.

For only \*2½¢ per model, PHOTOFACT helps you solve your service problems in just minutes—helps you service more sets and earn more daily!

\*Based on the average number of models covered in a single set of PHOTOFACT Folders.



**MONEY BACK  
GUARANTEE!**

Got a tough repair? Try this—at Howard W. Sams' own risk: see your Parts Distributor and buy the proper PHOTOFACT Folder Set covering the receiver. Then use it on the actual repair. If PHOTOFACT doesn't save you time, doesn't make the job easier and more profitable for you, Howard W. Sams wants you to return the complete Folder Set direct to him and he'll refund your purchase price promptly. **GET THE PROOF FOR YOURSELF—TRY PHOTOFACT NOW!**

**FREE**



**FOR SERVICE  
TECHNICIANS ONLY**

Fill out and mail coupon today for Free subscription to the Sams Photofact Index—your up-to-date guide to virtually any receiver model ever to come into your shop. Send coupon now.

## HOWARD W. SAMS & CO., INC.

Howard W. Sams & Co., Inc.  
2205 E. 46th St., Indianapolis 5, Ind.

Put me on your mailing list to receive the Sams Photofact Index and Supplements. My (letterhead) (business card) is attached.

I'm a Service Technician:  full time;  part time

My Distributor is: \_\_\_\_\_

Shop Name \_\_\_\_\_

Attn: \_\_\_\_\_

Address: \_\_\_\_\_

City \_\_\_\_\_ Zone \_\_\_\_\_ State \_\_\_\_\_

# BUILD THE BEST—

BUILD ALLIED'S OWN

# knight-kits®

LOWEST COST because our giant buying power passes biggest savings on to you... you do the easy assembly, get professional results and SAVE!

\*  
**knight-kits**

EASIEST TO BUILD because KNIGHT-KIT "Step-and-Check" instruction manuals are marvels of clarity—it's just like having a good instructor at your side.

\*  
**knight-kits**

MONEY-BACK GUARANTEE: When properly assembled, KNIGHT-KITS fully meet published specifications, or we refund your money.

EASY TERMS AVAILABLE

**NEW knight-kit HI-FI VALUE  
 30-WATT DELUXE AMPLIFIER KIT**



- New Printed Circuit Switches!
  - Three Printed Circuit Boards!
  - 8 Inputs • Full Equalization!
  - Full 30 Watts • Custom Case!
- Model Y-762 **\$74<sup>95</sup>**

A Hi-Fi triumph at low cost! Linear-deluxe Williamson-type power amplifier circuit (flawless response  $\pm 1/2$  db, 15-100,000 cps at full 30-watt level!); equalization for all records, within  $1/2$  db of recommended accuracy; 2 exclusive new printed-circuit switches; 3 printed-circuit boards for quickest, easiest, error-free construction; separate continuously variable Level and Loudness controls; 8 inputs for every signal source; DC on all filaments of preamp tubes; exclusive 3-way speaker selector switch (use speakers of mixed impedance without mismatch!); Power Amplifier Distortion—Harmonic, 0.55% at 30 watts—IM, 0.74% at 20 watts; rumble filter switch; variable damping. With beautiful "space-saver" case—ready for easy, money-saving assembly. Shpg. wt., 32 lbs.

Model Y-762. Net F.O.B. Chicago . . . **\$74<sup>95</sup>**

See our Supplement No. 165 for additional knight-kit Hi-Fi values

**free SUPPLEMENT**

featuring **knight-kits**  
 Send for our FREE Supplement No. 165 featuring 45 great Knight-Kits, including Test Instruments, Hi-Fi, Hobbyist and Amateur kits. Write for your copy today.



ORDER FROM

## ALLIED RADIO

Dept. 02-H7, 100 N. Western Ave., Chicago 80, Ill.

## Correspondence



### DR. FIPS REPLIES

Dear Editor:

The color TV reception via my Lumistron (page 20, July) is not surprising. Indeed, I said so in my article, and I quote: "It (the Lumistron) will for instance revolutionize television."

One of my most recent experiments was with Lollobrigida. I trained a Lumistron on her, which naturally reversed its action and converted her image back into radio waves. I had connected the Lumistron with my oscilloscope and you should have seen the resulting gorgeous curves she threw! Lollobrigida's shortwaves are the McCoy, better than any pinup girl!

This fall we will market a tiny TV Lumistron (2 x 1 inch) for the small fry to take to bed with them. The Lumistron programs will be all-cartoon, but no commercials. Instead we give spelling and arithmetic lessons between cartoons. You'd be surprised how fast that puts 'em to sleep!

MOHAMMED ULYSSES FIPS

New York, N. Y.

### LETTER FROM THAILAND

Dear Editor:

I have read your magazine for many years and through it have taken home-study courses in Radio, electronics and television. But up to now I have been unable to get into the business due to lack of financial backing.

My aim in writing is to point out that in this country people are very keen about TV and FM and there is a large opening for the right type of person or persons interested and willing to invest in this country.

There is already one TV station here in Bangkok and I have heard talk of starting another to transmit in color. All that is needed is for someone to start a chain of relay stations so that the programs can be received nationwide.

Through your publication I am hoping to be able to contact people who are ready and willing to invest in developing and expanding the radio-TV business here. I will be happy to be of assistance in getting business started.

THOS. B. SNOW

Rayong, Thailand

### MORE ENCLOSURE KITS

Dear Editor:

May we call your attention to the fact that River Edge manufactures a line of kits while you have only listed one in your tabulation in the May issue. Other kits we make are:

(Continued on page 20)

## SPOT INTERMITTENTS FAST!




**\$89<sup>95</sup>**  
 NET

NEW

## Wintronix INTERMITTENT CONDITION ANALYZER

Makes any TV or Radio Super-Sensitive to Intermittents & Noisy Components . . .

NO WAITING 

NO "COOKING" 

NO "FREEZING" 

Save valuable time and bench space when troubleshooting intermittents. Just connect output of Model 828 to Radio or TV receiver antenna terminals, and use exclusive "Electro-Wand" (for tubes) or "Electro-Probe" (for components) to quickly pinpoint intermittent or noisy tubes, capacitors, resistors, coils, transformers, defective connections, etc. No direct circuit connection needed.

Special Wintronix circuit immediately makes any receiver super-sensitive to intermittents. Lets you hear intermittents through built-in speaker. Reduces callbacks by detecting borderline components before they fail.

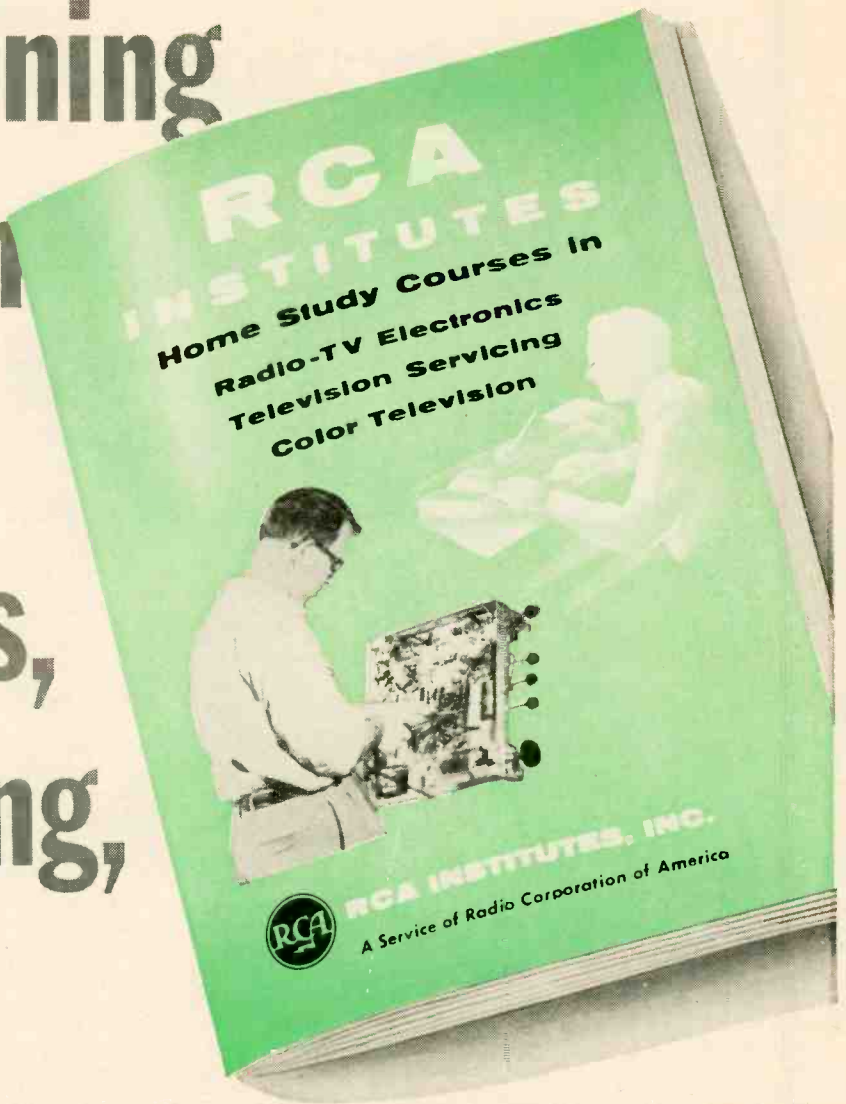
See the Wintronix Model 828 at your local parts distributor or write for free literature.

**WINSTON  
 ELECTRONICS INC.**

4312 Main St., Phila., 27, Pa.



**RCA** offers you the  
 finest training  
 at home in  
 Radio-TV  
 electronics,  
 TV servicing,  
 Color TV



**SEND FOR THIS FREE BOOK NOW!**

**Pay-as-you-learn. You need pay for only one study group at a time. Practical work with very first lesson. All text material and equipment is yours to keep. Courses for the beginner and advanced student.**



**RCA INSTITUTES, INC.**  
 A SERVICE OF RADIO CORPORATION OF AMERICA  
 350 WEST FOURTH STREET, NEW YORK 14, N.Y.

In Canada—RCA Victor Company, Ltd.,  
 5001 Cote de Liesse Rd., Montreal 9, Que.

RCA Institutes, Inc., Home Study Dept. RE-87  
 350 West Fourth Street, New York 14, N. Y.  
 Without obligation, send me FREE 52 page CATALOG on Home Study Courses in Radio, Television and Color TV. No Salesman will call.

Name ..... Please Print

Address .....

City ..... Zone .... State .....

KOREAN VETS! Enter discharge date \_\_\_\_\_  
 To save time, paste coupon on postcard

# Sylvania

---

# TV Tuner

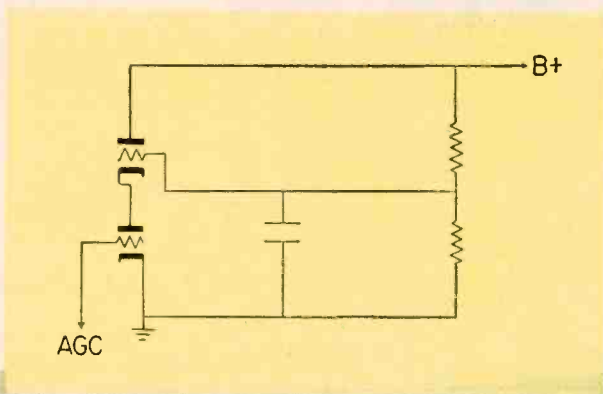
---

# Tubes

---



“R-X metered” at



Simplified schematic is a typical cascode circuit in which double-triode amplifiers are tested for transconductance and plate current under actual operating conditions. In this way, Sylvania offers you maximum assurance of proper circuit performance when you repair TV tuners. Regardless of make or model TV, Sylvania tuner tubes mean dependability backed by industry's most exhaustive dynamic testing program.

Type by type, Sylvania's own JEMC (Joint Engineering and Manufacturing Committee) establishes test conditions which represent the most realistic measure of a tube's ability to stand up in the sets you service. Their working knowledge of the needs of TV tuner manufacturers eventually means greater service profits through less callbacks for you.





## 200 mc for controlled, dependable performance

Measuring input resistance and capacitance of all TV tuner tubes at 200 mc, places important controls over gain and tuning characteristics. This and many other tuner tube tests have been developed by Sylvania to provide you with maximum assurance of dependable performance regardless of make, model, or age of the TV sets you service.

All tuner tubes are fixed-bias tested under conditions which simulate actual

applications in TV sets. Cascode types are subjected to series Gm and series Ib tests in typical circuits. In addition, all types are checked both before and during life tests for serviceability at high and low line voltages.

Protect yourself against costly and unnecessary callbacks. Specify Sylvania TV Tuner Tubes in the new yellow and black carton.



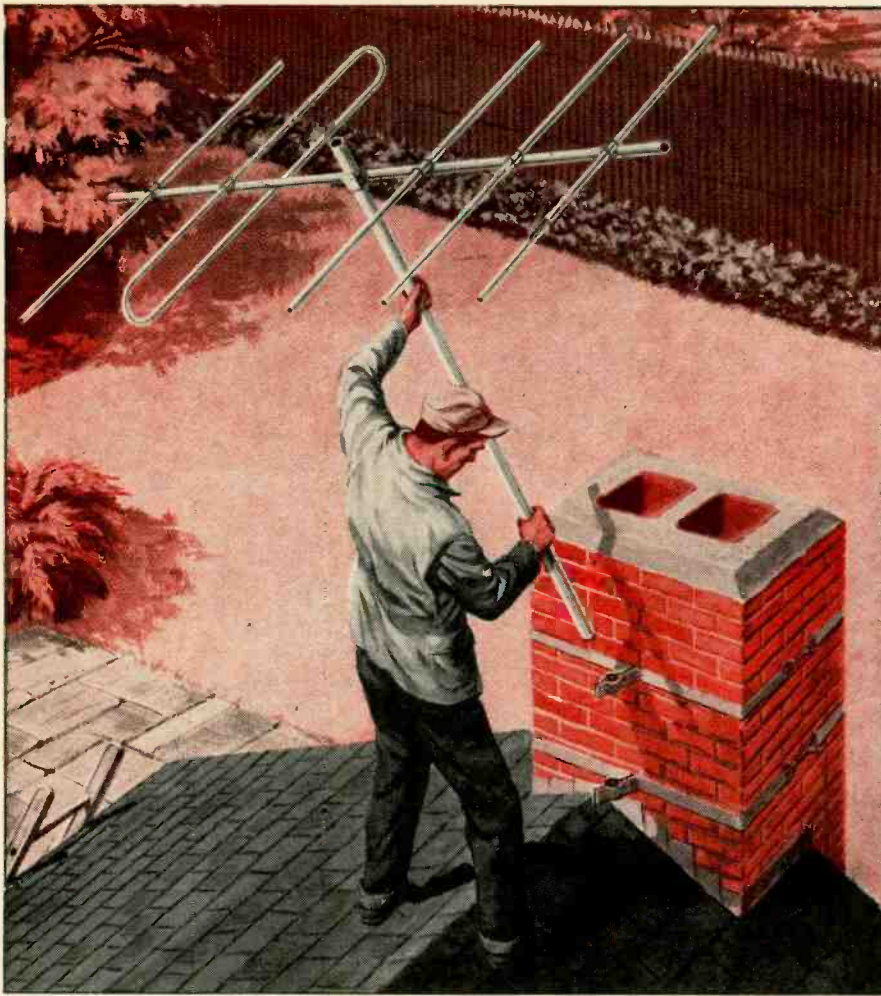
# SYLVANIA

SYLVANIA ELECTRIC PRODUCTS INC.  
1740 Broadway, New York 19, N. Y.  
In Canada: Sylvania Electric (Canada) Ltd.  
University Tower Bldg., Montreal

LIGHTING • RADIO • ELECTRONICS • TELEVISION • ATOMIC ENERGY

AUGUST, 1957

19



## sturdy, steel **PERMA-TUBE** lasts three times longer than galvanized TV masting

Resistance to bending in Perma-Tube TV masts is greater than in galvanized masting. Perma-Tube's extra resistance to bending and damage by wind-force protects your reputation and improves TV reception.

Machine-fitted joints speed field assembly, insure close tolerance. *Perma-Tube joints are stronger than the tubing itself.*

Perma-Tube is corrosion-proof. It is treated with vinsynite—then coated with a metallic vinyl resin base both *inside and outside*. It successfully passes ASTM's 500-hour

minimum salt spray test—which guarantees longer life under corrosive conditions.

Five diameters of fitted joint Perma-Tube are available, ranging from 2½" OD to 1¼" OD. Telescoping masts can also be erected up to 50 feet high, using 10 foot lengths of high strength J&L 16-gage Perma-Tube.

For complete details on easy-to-sell Perma-Tube TV masting, write to the Jones & Laughlin Steel Corporation, Dept. 496, 3 Gateway Center, Pittsburgh 30, Pennsylvania.



**Jones & Laughlin**  
**STEEL . . . a great name in steel**

### CORRESPONDENCE

(Continued from page 16)

No. 912 Bass Reflex for 12-inch speaker.....\$18  
No. 915 Bass Reflex for 15-inch speaker.....\$18  
No. 962 Bass Reflex for 12-inch speaker.....\$24  
No. 965 Bass Reflex for 15-inch speaker.....\$24  
No. 900 Horn Loaded 12- or 15-inch  
speaker .....\$23.94

JAY H. QUINN

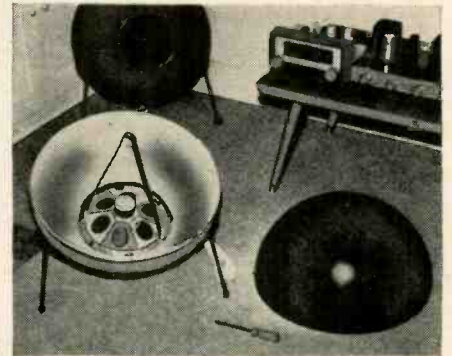
River Edge Sales Corp.  
Port Washington, N.Y.

### WE'VE GOT ONE LIKE IT

Dear Editor:

Upon perusal of our April copy of RADIO-ELECTRONICS, we took particular note of your What's New section.

The German-made "Treble Ball" caught my eye, especially. The enclosed photo will probably shout louder in expression of our interest than any letter could.



Our Satellite comes in three sizes, for 8, 12 and 15-inch speakers. Built of Fiberglas, it opens and closes with one screw. It is portable and may be used indoors or out.

Your attention and interest are highly appreciated.

HOWARD L. WILBER

Wilber Enterprises  
4465 University Ave.  
San Diego 4, Calif.

### OLD TIMER'S HINT

Dear Editor:

I have been repairing radio sets since June, 1924, and operate my own shop. Two months ago a man about 60 years old came into my store with a five-tube Hallcrafters radio. He said, "This thing needs fixing, the knob turns but the dial doesn't move. *I won't need any new tubes because they are all new ones.* I'm in a hurry, be back in a couple of days."

Before he left I said, "Let's take a look at these tubes." I took the back off and wrote the following, copying from the tubes:

1—12SN7 Hallicrafters	2-35
1—12SQ7 Ken Rad	2-26
1—50L6 Hytron	51-22
1—35Z5 RCA	0-43
1—12SA7 G-E	5-52

35Z5 code 0-43 meant, 1950, 43rd week

I let the owner take a look at each tube, and explained the code date. I had him sign a statement that read: "As the owner of this radio, I agree it had the following tubes in it on this date."

I wouldn't mind getting blamed for a job I did wrong, but I am not taking chances on something like this.

RICHARD J. GREGG

Realto, Calif.



**Train for a secure career  
—not just another job!  
Success ahead for trained men  
only in**



# Radio-TV-Electronics

**Stop Dreaming! Start Planning!**

**START YOUR CREI CAREER TRAINING  
AT HOME TO INSURE MORE INCOME!**

What would a \$10 or \$20 a week raise mean to you? Only one \$10-a-week raise will repay your investment in CREI training, and leave you a profit of \$200 or more the very first year! Your increases in pay thereafter are all pure profit, and you'll be prepared for many more promotions and pay raises in the future years of your life!

**WHAT YOU DO NOW**—today, tomorrow, next week—will decide your success in the electronics field. Every day counts because the trained technicians are the ones who get the "plums" when promotions are handed out. How can you be sure to step ahead of competition, to earn more money, to get the position that carries more responsibility—and the pay that goes with it? The answer is contained in a CREI booklet called "Your Future in the New World of Electronics."

## ERA OF COMMUNICATION

This is the era of Communication: aeronautical, marine, police and fire, industrial, land transportation. This is the era of defense orders and a manufacturing industry which last year alone sold billions of dollars worth of electronic equipment, which will top ten billion dollars (without military) this year. This is the era of electronic development, research, design, production, testing, inspection, manufacture, broadcasting, telecasting and servicing. This is the era of electronic careers—well-paid, interesting, and secure.

## PRACTICAL COURSES

Your work is under the supervision of a regular staff instructor who knows and teaches what industry needs. Training is accomplished on your own time, during hours chosen by you.

**KEY TO SUCCESS** — As a graduate you'll find your CREI diploma the key to success in the entire field of electronics. At your service is the Placement Bureau which finds positions for advanced students and graduates. No short cuts are promised; no jobs are guaranteed—but requests for CREI-trained personnel far exceed current supply.



**COLLEGE DEGREE NOT ESSENTIAL**—You don't have to be a college graduate to benefit from CREI's famed courses. You do have to be willing to study at home. You can do it while holding down a full time job. Thousands have. No matter what your level of electronics experience, CREI has a course for you.

CREI's professional guidance is recognized all over the world. Since 1927 CREI has trained technicians; you find them in radio and television stations; you find them in electronics planning and manufacture; you find them everywhere and, generally, near the top. During World War II CREI trained men for the Armed Services. Leading firms choose CREI courses for group training in electronics (among them are United Air Lines, Canadian Broadcasting Corp., Douglas Aircraft Co., Glenn L. Martin Co., and All-America Cable & Radio, Inc.).



## THIS CAN BE YOUR BIG YEAR!

Write today for this **FREE BOOKLET**. Tuition is reasonable, terms are easy, information is free. Fill out the coupon and mail it at once.

**AVAILABLE TO VETERANS UNDER GI BILL!**

## FILL OUT AND MAIL TODAY—BEFORE YOU FORGET IT!

### CAPITOL RADIO ENGINEERING INSTITUTE

Accredited Technical Institute Curricula, Founded 1927  
Dept. 148-D, 3224 16th St., N.W., Washington 10, D. C.

Please send me your course outline and **FREE** Illustrated Booklet "Your Future in the New World of Electronics" . . . describing opportunities and CREI home study courses in Practical Electronic Engineering Technology.

- CHECK** }  Electronic Engineering Technology  
**FIELD OF** }  Broadcast (AM, FM, TV) Engineering  
                  } Technology  
**GREATEST** }  Television Engineering Technology  
**INTEREST** }  Aeronautical Electronic Engineering Technology

**E**

Name ..... Age .....  
Street .....  
City ..... Zone ..... State .....  
CHECK:  Home Study  Residence School  Korean Veteran

To help us answer your request intelligently, please give the following information:

EMPLOYED BY.....  
TYPE OF PRESENT WORK.....  
SCHOOL BACKGROUND.....  
ELECTRONICS EXPERIENCE.....  
IN WHAT BRANCH OF ELECTRONICS ARE YOU MOST INTERESTED?  
.....  
.....

# BUILD THE BEST— BUILD ALLIED'S OWN knight- kits

Here is a typical Knight-Kit value—available only from ALLIED—one of 45 great Knight-Kits you'll find in our special Supplement No. 165. Write for your FREE copy today.

## knight-kit HOBBYIST VALUE 2-TRANSISTOR POCKET RADIO



Model  
Y-262  
\$14<sup>65</sup>

It's fun to build this efficient pocket-size broadcast band radio. Entirely self-contained, complete with built-in antenna (no external antenna required), battery and earphone. Features reflex-type 2-transistor circuit. Printed circuit panel simplifies assembly. Has high-gain ferrite-core antenna; super-sensitive miniature dynamic earphone for excellent tone quality; variable capacitor for accurate tuning; months of dependable operation from single long-life alkaline cell battery supplied. Two simple controls—On-Off-Volume and Tuning. Handsomely styled leatherette carrying case. Fits coat pocket or may be worn from belt; only 4 x 3 3/4 x 1 3/4". Complete, with step-by-step instructions. Shpg. wt., 1 1/2 lbs. \$14<sup>65</sup>

Model Y-262. Net, F.O.B. Chicago.

## OTHER knight-kit HOBBYIST VALUES



"10-IN-1" LAB KIT  
Y-265 \$12<sup>65</sup>



"6-IN-1" LAB KIT  
Y-770 \$7<sup>95</sup>



3-WAY PORTABLE  
RADIO KIT  
Y-730 \$19<sup>95</sup>



"OCEAN HOPPER"  
SW RECEIVER KIT  
Y-740 \$11<sup>75</sup>

See our Supplement No. 165 for 12 other knight-kit hobbyist values

## free SUPPLEMENT featuring knight-kits



Send for our FREE Supplement No. 165 featuring 45 great Knight-Kits, including Test Instruments, Hi-Fi, Hobbyist and Amateur Kits. Write for your copy today.

## ORDER FROM ALLIED RADIO

Dpt. O2-H-7, 100 N. Western Ave., Chicago 80, Ill.

## CORRESPONDENCE

### MORE FACTS OF ACOUSTICAL LIFE

Dear Editor:

The "facts of (acoustical) life" given by Paul Klipsch in RADIO-ELECTRONICS, May, 1957, illustrate some of the problems which beset the audiophile who wants to hear 20-40-cycle sound. However, he states that "the undistorted output of a small cone at low frequency would be too small to hear, regardless of the response curve. If the "low" frequency chosen is such that this statement is true, then using a large 15-inch woofer is not going to be much help, for the woofer has only about four times the area of radiating surface of a "little" 8-inch speaker and can thus radiate only about four times the amount of sound with the same cone excursion.<sup>1</sup> An inspection of the Fletcher-Munson curves<sup>2</sup> will reveal another disheartening "fact of life" based on the response of our ears. It takes about 25 times the sound intensity or power to hear a 30-cycle tone as it does for a 40-cycle one and over 10,000 times the intensity to hear the fundamental of the elusive 20-cycle tone. The reproducer of the future for the serious audiophile may have to be a vibrating wall.

However, speaker enclosures which increase the coupling between the cone and the air to be moved increase the acoustical output from the .06-inch cone excursion. Mr. Klipsch listed a number of variables (box shape, suspension compliance, etc.) which do not affect his figures. He omitted type of enclosure from this list, as well he might, since horn type enclosures give a larger acoustical power output with the same diaphragm or cone movement.<sup>3</sup> Mr. Klipsch knows this well; his enclosures have been of that type.

Incidentally, in this day of 50-watt amplifiers, it is well to realize that our ears are quite sensitive. The sound intensity of normal conversation is only about 10-40 microwatts of acoustical power. In a livingroom, a critical listener could just hear the .00045 watt of 30-cps sound<sup>4</sup> which comes from a .06-inch excursion of the 10-inch piston, as described by Klipsch.

High fidelity for the auditorium, out of door or our next-door neighbor's "enjoyment" is one thing, and for the enjoyment of sound in the home is something quite different in terms of power and speaker requirements. Little (8-inch) speakers of high quality mounted in efficient enclosures are not outmoded yet.

CARL F. ROTHE

Savannah, Georgia

### I'D LIKE TO SEE

Dear Editor:

I like John Comstock's suggestion.

<sup>1</sup> to <sup>4</sup>. As found or derived from data and references in Langford-Smith, *Radiotron Designer's Handbook*; 4th edition, 1952; pp. 834, 620, 851 and 864, respectively.

(Continued from p. 20)

I'd like to see a 27.255-mc, remote-control garage-door opener with a transistorized receiver that would operate off 117 volts. It should respond to a modulated signal of approximately 1,000 cycles. Low power consumption would make it attractive. I now have a receiver using standard tubes, for this purpose, and it draws 15-20 watts.

J. M. HIRSCHINGER

Quincy, Ill.

Dear Editor:

I would like to see electronic components with built-in indicators that would show when they were not functioning properly. Open resistors, shorted capacitors or other bad components would immediately identify themselves and thus be of aid to the technician. Some house fuses have such an indicator, why not other electronic components?

JOHN A. COMSTOCK

Wellsboro, Pa.

Dear Editor:

TV sets now tune by various sounds. Garage doors are opened by auto horn sounds. Ultrasonic whistles are heard a mile by dogs. So why not a super-power pocket whistle or sounder for saving people in lifeboats, lost hunters, etc.

Find the tone range or pitch that is heard the furthest and develop a simple transistor receiver for detecting and pinpointing these sounds. At a 10-mile range?

AUBRA DUNHAM

Pasadena, Calif.

Dear Editor:

I have looked everywhere for circuit diagrams of electric tachometers for outboard motors and auto engines. I am primarily interested in a tach for a 2-cycle 2-cylinder outboard motor.

DONALD H. HOLMES

Holmes Television  
West Boylston, Mass.

### TRANSISTORS ON 10 METERS

Dear Editor:

During the months I have made tests with my transistor transmitter, with all out-of-Arizona contacts on 29.450 mc, I have been successful with 132 hams. Phone modulation has been successful with 13 stations covering 7 states. One maritime-mobile, W3JBW . . . was worked when he was 105 miles east of Jacksonville, Fla.—1,835 miles from Tucson. My signal was identified in New Zealand and heard in Japan. Worked Canton Island, 4,500 miles from Tucson, and 6 stations in Hawaii.

RICHARD S. GRIFFITH, W7MPQ

Tucson, Ariz.

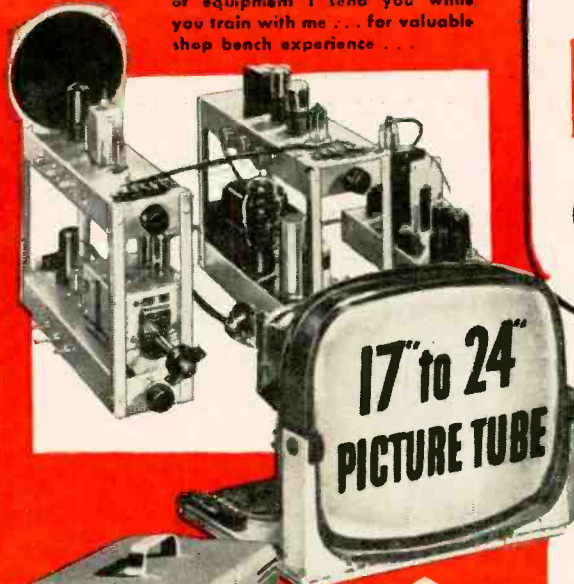
(W7MPQ is the author of the article "Transistorized Rig Works 10-Meter DX" in the May issue of this magazine.—Editor)

END

Prepare for a Good Paying Job — Or Your Own Business

Learn PRACTICAL RADIO-TV  
with **25 BIG KITS**

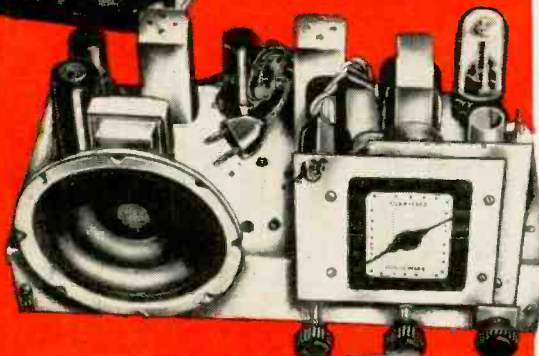
of equipment I send you while  
you train with me . . . for valuable  
shop bench experience . . .



This is the new Sprayberry Training Television Receiver, built and tested in sections for greatest instructional value.

I now offer this fine modern oscilloscope to help you learn practical Television servicing.

You will build this powerful short wave and broadcast superb radio receiver for valuable shop instruction practice.



You build the new Sprayberry Tester . . . 15-range Volt-Ohm-Milliammeter readings plus output meter and condenser and resistor substitution selector.

In addition to modern lesson training, I also give you plenty of home practice on actual Radio-Television equipment . . . you will build and use the units shown here plus many more. All this equipment is yours to keep . . . keep everything you need to set up your shop.

# "I Will Train You at Home in RADIO-TELEVISION

## On Liberal No Obligation Plan!"

New Equipment! New Lessons! Enlarged Course! The true facts are yours in my big new catalog . . . **YOURS FREE . . .**

**JUST MAIL COUPON!**

I can train and prepare you in as little as 10 months to step into the big opportunity Radio-Television service field. Train *without* signing a binding contract . . . without obligating yourself to pay any regular monthly amounts. You train entirely at home in spare hours . . . you train as fast or as slowly as you wish. You'll have your choice of **THREE SPRAYBERRY TRAINING PLANS . . .** planned for both beginners as well as the more experienced man. Get the true facts about the finest most modern Radio-Training available today . . . just mail the coupon for my big new 56 page fact-filled catalog plus sample lesson—both **FREE.**



Frank L. Sprayberry  
President, Sprayberry  
Academy of Radio

### Train the Practical Way—with Actual Radio-Television Equipment

My students do better because I train both the mind and the hands. Sprayberry Training is offered in 25 individual training units, each includes a practice giving kit of parts and equipment . . . all yours to keep. You will gain priceless practical experience building the specially engineered Sprayberry Television Training Receiver, Two-Band Radio Set, Signal Generator, Audio Tester and the new Sprayberry 18 range Multi-Tester, plus other test units. You will have a complete set of Radio-TV test equipment to start your own shop. My lessons are regularly revised and every important new development is covered. My students are completely trained Radio-Television Service Technicians.

### NEWEST DEVELOPMENTS

Your training covers UHF, Color Television, FM, Oscilloscope Servicing, High Fidelity Sound and Transistors.

**See for Yourself . . . Make Your Own Decision . . . Mail Coupon Today!**

The coupon below brings you my big new catalog plus an actual sample Sprayberry Lesson. I invite you to read the facts . . . to see that I actually illustrate every item I include in my training. With the facts in your hands, you will be able to decide. *No salesman will call on you.* The coupon places you under no obligation. Mail it now, today, and get ready for your place in Radio-Television.

## SPRAYBERRY ACADEMY OF RADIO

1512 Jarvis Ave., Dept. 20-P, Chicago 26, Illinois

**Mail This Coupon For Free Facts and Sample Lesson**



SPRAYBERRY ACADEMY OF RADIO  
1512 Jarvis Ave., Dept. 20-P, Chicago 26, Illinois

Please rush all information on your ALL-NEW Radio-Television Training Plan. I understand this does not obligate me and that no salesman will call upon me. Include New Catalog and Sample Lesson **FREE.**

Name \_\_\_\_\_ Age \_\_\_\_\_

Address \_\_\_\_\_

City \_\_\_\_\_ Zone \_\_\_\_\_ State \_\_\_\_\_



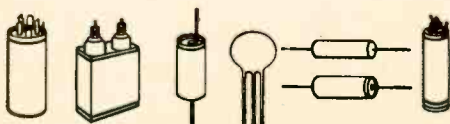
# 20,000 megawatts

**What's this "big feller" doing in a service ad?  
The story behind it is important to you.**

The "big feller" is known as a "low-inductance energy-storage capacitor." It's made by Tobe, and used in nuclear research. And get this . . . it has a rating of 100,000 volts. What's more, it is capable of delivering a peak power of 20,000 megawatts.

This is just one example of the many types of capacitors Tobe has been building for 35 years. This fact is important to you because the new quality line of Tobe service capacitors is built to the same high standards. The line includes all the popular types required to meet 90% of all replacement needs.

You'll be pleased when you switch to Tobe. So will your customers. See your Tobe jobber today for full details, or write Tobe Deutschmann Corp., Service Div., 2900 Columbia Ave., Indianapolis, Ind.



**Specify**



**Capacitors • Pioneers Since 1922**



# "Sensational I call it"

A **2** SPEED  
3/8" POWER DRILL

by **WEN**



Lets you change from 1,000 to 3,000 RPM and back again as desired, to get just the right speed for different jobs. Speed change is easy, quick, positive. Auxiliary grip handle can be inserted in either end for proper grip at either speed. Ingenious motor delivers maximum torque under load. 3/8" geared chuck. Handy, husky, streamlined design. Fully guaranteed.

MODEL #808



only  
**\$29.95**  
LIST



## A TRUE ALL PURPOSE DRILL

Here in 1 tool is everything needed in an electric drill. The 3/8" size is just right for most work — and the 2-Speed feature gives you just the right speed. Hi Speed (3000 RPM) for drilling through Steel to 5/32" — Wood to 3/8" — Aluminum, Brass, Copper to 1/4". Best also for Rotary Sanding, Sawing, Grinding, Buffing. The Lo Speed (1000 RPM) is best for heavier materials and Masonry, Concrete to 1/2". Also for Polishing, Waxing, Screw Driving, Paint Mixing, etc. Naturally, there's big demand for such a multi-useful tool. Deliveries are already a problem.

Orders pouring in. Don't delay.

## Rounds Out the **WEN** Line

of high grade, low cost, electric power tools ideal for home and shop.



**3** "Quick-Hot" Electronic Soldering Guns and Kits—\$7.95 to \$12.95 List.



**3** Electric Sanders, Polishers and Kits, with assorted abrasives and polishers — \$13.95 to \$19.95 list.



**8** Power Saws in 1. Cuts practically anything, any shape. Complete with 3 blades — \$29.95 List.

AND SAW TABLE \$12.95

# WEN PRODUCTS, INC.

5808 NORTHWEST HIGHWAY • CHICAGO 31, ILL.

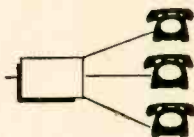
(Export sales, Scheel International, Inc., Chicago)

# Pacemakers in the technology of our electronic age

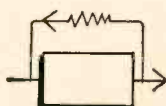
Certain discoveries, inventions and developments of Bell Telephone Laboratories have been truly epochal in their effect upon the technology of our time. Each has come out of a single quest—a search for ways to make telephony ever better. But many have opened the way to exciting advances in TV, movies, radio, horology, astronomy. Here are ten of Bell Laboratories' contributions to the modern world.



**Electronic amplifier.** First high-vacuum electronic amplifier. Made possible long distance telephony and then opened the way to radio broadcasting.



**Wave filter.** Precisely separates bands of frequencies. Provided major key to economical sharing of the same wires by many voices or radio programs. Indispensable control tool in radio, television and radar.



**Negative feedback amplifier.** Provides distortionless and stable amplification. Made possible the enormous, precisely controlled amplification needed in long distance telephone calls. The principle is now basic in high-quality amplifiers for radio, TV and high-fidelity reproduction.



**Quartz crystal.** Standard super-accurate quartz crystal oscillator developed for frequency controls in radio telephony. Has also become the standard control for clocks in world's astronomical laboratories.



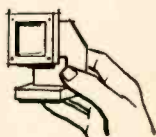
**Coaxial cable system.** Hollow tube with a central conductor was developed to transmit hundreds of voices simultaneously. Now also provides long distance carrier for TV in partnership with microwave beams.



**Transistor.** Tiny solid-state device uses extremely small amounts of power to amplify signals. Makes possible electronic telephone switching and much smaller hearing aids, radios, TV sets and electronic computers.



**Dial system "brain and memory."** Takes over your call and sees that you are connected in the best and quickest way. Newest example: Direct Distance Dialing from home telephones to any part of the nation.



**Waveguide.** Hollow conductor transmits high-frequency waves. From this came the "pipe" circuits that are essential to radar and very short-wave radio communications.



**Microwaves.** Bell Laboratories developed long distance microwave transmission. It operates by focusing radio beams from station to station, carries cross-country telephony and TV.



**Radio astronomy.** This great new science began in the study of radio interference at Bell Laboratories . . . with the tremendous discovery that radio waves emanate from the stars.

**BELL TELEPHONE LABORATORIES**  
WORLD CENTER OF COMMUNICATIONS RESEARCH AND DEVELOPMENT



**NEW! 12-WATT Williamson-type HIGH FIDELITY INTEGRATED AMPLIFIER HF12**



with Pre-amplifier, Equalizer & Control Section  
KIT \$34<sup>95</sup> WIRED \$57<sup>95</sup>

Compact, beautifully packaged & styled. Provides complete "front-end" facilities and true high fidelity performance. Direct tape head & magnetic phono inputs with NARTB (tape) & RIAA (phono) feedback equalizations. 6-tube circuit, dual triode for variable turnover bass & treble feedback-type tone controls. Output Power: 12 w cont., 25 w pk. IM Dist. (60 & 6000 cps @ 4:1): 1.5% @ 12 w; 0.55% @ 6 w; 0.3% @ 4 w. Freq. Resp.: 1 w: ±0.5 db 12 cps - 50 kc; 12 w: ±0.5 db 25 cps - 20 kc. Harmonic Dist: 20 cps; 2% @ 4.2 w; 1/2% @ 2.5 w; 30 cps; 2% @ 11 w; 1/2% @ 6.3 w; 40 cps; 1% @ 12 w; 1/2% @ 9.3 w; 2000 cps; 1/2% @ 12 w; 10 kc; 1% @ 10 w; 1/2% @ 6 w. Transient Resp: excellent square wave reproduction (4 usec rise-time); negligible ringing; rapid settling on 10 kc square wave. Inverse Feedback: 20 db. Stability Margin: 12 db. Damping Factor: above 8, 20 cps - 15 kc. Speaker Connections: 4, 8, 16 ohms. Tone Control Range: @ 10 kc. ±13 db; @ 50 cps. ±16 db. Tubes: 2-ECC83/12AX7, 1-ECC82/12AU7, 2-EL84, 1-EZ81. Size: HWD: 3 3/8" x 12" x 8 1/4". 13 lbs.

**NEW! 50-WATT Ultra-Linear HIGH FIDELITY POWER AMPLIFIER**



HF50 KIT \$57<sup>95</sup> WIRED \$87<sup>95</sup>

Like the HF60 shown below, the HF50 features virtually absolute stability, flawless transient response under either resistive or reactive (speaker) load, & no bounce or flutter under pulsed conditions. Extremely high quality output transformer with extensively interleaved windings, 4, 8, & 16 ohm speaker connections, grain-oriented steel, & fully potted in seamless steel case. Otherwise identical to HF60. Output Power: 50 w cont., 100 w pk. IM Distortion (60 & 6000 cps @ 4:1): below 1% at 50 w; 0.5% @ 45 w. Harmonic Dist.: below 0.5% between 20 cps & 20 kc within 1 db of rated power. Freq. Resp. at 1 w: ±0.5 db 6 cps - 60 kc; ±0.1 db 15 cps - 30 kc at any level from 1 mw to rated power; no peaking or raggedness outside audio range. All other specs identical to HF60 below. Matching cover Model E-2, \$4.50.



**NEW! 50-WATT Ultra-Linear HIGH-FIDELITY**

**INTEGRATED POWER AMPLIFIER HF52** with Pre-amplifier, Equalizer & Control Section  
KIT \$69<sup>95</sup> WIRED \$109<sup>95</sup>

Combines a power amplifier section essentially identical to the HF50 power amplifier with a preamp-equalizer control section similar to HF20 below. Provision for use with electronic crossover network & additional amplifier(s). See HF50 for response & distortion specs; HF60 for square wave response, rise-time, inverse feedback, stability margin, damping factor, speaker connections; HF20 for preamplifier, equalizer & control section description. Hum & noise 60 db below rated output on magnetic phono input (8 mv input for rated output), & 75 db below rated output on high level inputs (0.6 v input for rated output). Matching cover Model E-1, \$4.50.

**The specs are the proof... 7 NEW BEST BUYS by**



**HIGH FIDELITY PREAMPLIFIER**

#HF61A KIT \$24<sup>95</sup>, WIRED \$37<sup>95</sup>

With Power Supply: #HF61 KIT \$29<sup>95</sup>, WIRED \$44<sup>95</sup>

Will not add distortion or detract from the wide-band or transient response of the finest power amplifiers at any control settings. High quality feedback circuitry throughout plus the most complete control & switching facilities. Heavy-gauge solid brushed brass panel, concentric controls, one-piece brown enamel steel cabinet for lasting attractive appearance. Feedback-type, sharp cut-off (12 db/octave) scratch & rumble filters. Low-distortion feedback equalization: 5 most common recording curves for LPs & 78s including RIAA. Low-distortion feedback tone controls: provide large boost or cut in bass or treble with mid-freqs & volume unaffected. Centralab printed-circuit Senior "Compentrol" loudness control with concentric level control. 4 hi-level switched inputs (tuner, tv, tape, aux.) & 3 low-level inputs (separate front panel low-level input selector permits concurrent use of changer & turntable). Proper pick-up loading & attenuation provided for all quality cartridges. Hum bal. control. DC superimposed on filament supply. 4 convenience outlets. Extremely flat wideband freq. resp.: ±1 db 8-100,000 cps; ±0.3 db 12-50,000 cps. Extremely sensitive. Negligible hum, noise, harmonic or IM distortion. Size: 4-7/8" x 12-5/16" x 4-7/8". 8 lbs.



**60-WATT Ultra-Linear**

**HIGH FIDELITY POWER AMPLIFIER #HF60** with ACRO TO-330 OUTPUT TRANSFORMER  
KIT \$72<sup>95</sup> WIRED \$99<sup>95</sup>

Superlative performance, obtained through finest components & circuitry. EF86 low-noise voltage amplifier direct-coupled to 6SN7GTB cathode coupled phase inverter driving a pair of Ultra-Linear connected push-pull EL34 output tubes operated with fixed bias. Rated power output: 60 w (130 w peak). IM Distortion (60 & 6000 cps @ 4:1): less than 1% at 60 w; less than 0.5% at 50 w. Harmonic Distortion: less than 0.5% at any freq. between 20 cps & 20 kc within 1 db of 60 w. Sinusoidal Freq. Resp.: at 1 w: 35 kc at any level from 1 mw to rated power; no peaking or raggedness outside audio range. Square Wave Resp.: excellent from 20 cps to 25 kc, 3 usec rise-time. Sensitivity: 0.55 v for 60 w. Damping Factor: 17. Inverse Feedback: 21 db. Stability Margin: 16 db. Hum: 90 db below rated output. ACRO TO-330 Output Transformer (fully potted). Speaker Taps: 4, 8, 16 ohms. CZ34 extra-rugged rectifier (indirectly-heated cathode eliminates high starting voltage on electrolytics & delays B+ until amplifier tubes warm up). Input level control. Panel mount fuse holder. Both bias and DC — balance adjustments. Std octal socket provided for pre-amplifier power take-off. Size: 7" x 14" x 8". 30 lbs. Matching cover Model E-2 \$4.50.



**COMPLETE with Pre-amplifier, Equalizer & Control Section**  
**20-WATT Ultra-Linear Williamson-Type HIGH FIDELITY AMPLIFIER #HF-20**

KIT \$49<sup>95</sup> WIRED \$79<sup>95</sup>

A low-cost, complete-facility amplifier of the highest quality that sets a new standard of performance at the price, kit or wired. Rated Power Output: 20 w (34 w peak). IM Distortion (60 & 6000 cps @ 4:1) at rated power: 1.3%. Max. Harmonic Distortion between 20 & 20,000 cps at 1 db under rated power: approx. 1%. Mid-band Harmonic Distortion at rated power: 0.3%. Power Response (20 w): ±0.5 db 20-20,000 cps; ±1.5 db 10-40,000 cps. Freq. Resp. (1/4 w): ±0.5 db 13-35,000 cps; ±1.5 db 7-50,000 cps. 5 feedback equalizations for LPs & 78s. Low-distortion feedback tone controls: large boosts or cuts in bass or treble with mid-freqs. & volume unaffected. Loudness control & separate level set control on front panel. Low Z output to tape recorder. 4 hi-level switched inputs: tuner, tv, tape, aux; 2 low-level inputs for proper loading with all cartridges. Hum bal. control. DC superimposed on filament supply. Extremely fine output transformer: interleaved windings, tight coupling, careful balancing, grain-oriented steel. 8 1/2" x 15" x 10". 24 lbs. Matching cover Model E-1, \$4.50.

**NEW COMPLETE with FACTORY-BUILT CABINET — 2-WAY HI-FI SPEAKER SYSTEM #HF51 \$39<sup>95</sup>**

See the "BEST BUYS" NOW IN STOCK at your nearest distributor. Fill out coupon on other side for FREE CATALOG.

Prices 5% higher on West Coast.



Genuine 2-way book-shelf size speaker system. Jensen heavy duty 8" woofer (6.8 oz. magnet) & matching Jensen compression-driver exponential horn tweeter with level control. Smooth clean bass & crisp extended highs free of coloration or artificial brilliance. Factory-built tuned bass reflex birch hardwood cabinet (not a kit) conformed to high quality standards. Neutral acoustical grille cloth framed by a smooth-sanded solid birch molding. Freq. Resp. measured 2 ft. away on principal axis in anechoic chamber with 1 watt input — Woofer: ±4 db 80-1800 cps; Tweeter: ±2 db 2800-10,000 cps; Crossover Region: 1800-2800 cps, shift in level over this region depends on tweeter level control setting. Power-handling capacity: 25 watts. Size: 23"x11"x9". 25 lbs. Wiring Time: 15 min.



33-00 Northern Blvd., L.I.C. 1, N.Y.

Turn page for other EICO ad.

the specs prove it . .  
your BEST BUY is

**EICO**®

for COLOR & Monochrome TV servicing

**FREE CATALOG**

shows you HOW TO SAVE 50%  
on 50 models of top quality  
professional test equipment.  
**MAIL COUPON NOW!**



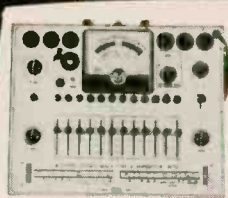
**NEW!**  
**TV-FM SWEEP  
GENERATOR &  
MARKER #368**  
KIT \$69<sup>95</sup> WIRED \$119<sup>95</sup>

Entirely electronic sweep circuit (no mechanical devices) with accurately-biased inductor for excellent linearity. Extremely flat RF output: new AGC circuit automatically adjusts osc. for max. output on each band with min. ampl. variations. Exceptional tuning accuracy: edge-lit hairlines eliminate parallax. Sweep Osc. Range 3-216 mc in 5 fund. bands. Variable Marker Range 2-75 mc in 3 fund. bands; 60-225 mc on harmonic band. 4.5 mc Xtal Marker Osc., xtal supplied. Ext. Marker provision. Sweep Width 0-3 mc lowest max. deviation to 0-30 mc highest max. dev. 2-way blanking. Narrow range phasing. Attenuators: Marker Size, RF Fine, RF Coarse (4-step decade). Cables: output, scope horiz., scope vertical. Deep-etched satin aluminum panel; rugged grey wrinkle steel cabinet.

**NEW! RF  
SIGNAL GENERATOR  
#324**  
KIT \$26<sup>95</sup> WIRED \$39<sup>95</sup>



150 ke to 435 mc with ONE generator! Better value than generators selling at 2 or 3 times its cost! Ideal for IF-RF alignment, signal tracing & trouble-shooting of TV, FM, AM sets; marker gen.; 400 cps audio testing; lab. work. 6 fund. ranges: 150-400 ke, 400-1200 ke, 1.2-3.5 me, 3.5-11 me, 11-37 me, 37-145 me; 1 harmonic band 111-435 me. Freq. accurate to ±1.5%; 6:1 vernier tuning & excellent spread at most important alignment freqs. Etched tuning dial, plexiglass windows, edge-lit hairlines. Colpitts RF osc. directly plate-modulated by K-follower for improved mod. Variable depth of int. mod. 0-50% by 400 cps Colpitts osc. Variable gain ext. amplifier: only 3.0 v needed for 30% mod. Turret-mounted coils slug-tuned for max. accuracy. Fine & Coarse (3-step) RF attenuators. RF output 100,000 uv; AF sine wave output to 10 v. 50-ohm output Z. 5-way jack-top binding posts for AF in/out; coaxial connector & shielded cable for RF out. 12AU7, 12AV7, selenium rectifier; xmfr-operated. Deep-etched satin aluminum panel; rugged grey wrinkle steel cabinet.



**NEW! DYNAMIC  
CONDUCTANCE  
TUBE & TRANSISTOR  
TESTER #666**  
KIT \$69<sup>95</sup> WIRED \$109<sup>95</sup>

**COMPLETE with steel cover and handle.**  
**SPEED, ease, unexcelled accuracy & thoroughness.** Tests all receiving tubes (and picture tubes with adapter). Composite indication of Gm, Gp & peak emission. Simultaneous set of any 1 of 4 combinations of 3 plate voltages, 3 screen voltages, 3 ranges of continuously variable grid voltage, 3 ranges of continuously variable grid voltage (with 5% accurate pot). New series-string voltages: for 600, 450, 300 ma types. Sensitive 200 ua meter. 5 ranges meter sensitivity (1% shunts & 5% pot). 10 SIX-position lever switches: freepoint connection of each tube pin. 10 pushbuttons: rapid insert of any tube element in leakage test circuit & speedy sel. of individual sections of multi-section tubes in merit tests. Direct-reading of inter-element leakage in ohms. New gear-driven rollechart. Checks n-p-n & p-n-p transistors: separate meter readings of collector leakage current & Beta using internal dc power supply. Deep-etched satin aluminum panel; rugged grey wrinkle steel cabinet. CRA Adapter \$4.50



**NEW!**  
**COLOR  
and Monochrome  
DC to 5 MC LAB & TV  
5" OSCILLOSCOPE  
#460**  
KIT \$79<sup>95</sup> WIRED \$129<sup>95</sup>

• **Features DC Amplifiers!**  
Flat from DC-4.5 mc, usable to 10 mc. VERT. AMPL.: sens. 25 rms mv/in; input Z 3 megs; direct-coupled & push-pull thruout; K-follower coupling bet. stages; 4-step freq-compensated attenuator up to 1000:1. SWEEP: perfectly linear 10 cps-100 kc (ext. cap. for range to 1 cps); preset TV V&H positions; auto. sync. ampl. & lin. inputs; edge-lit engraved lucite graph screen; dimmer; filter; bezel fits std photo equip. High intensity trace CRT. 0.06 usec rise time. Push-pull hor. ampl., flat to 400 kc, sens. 0.6 rms mv/in. Built-in volt. calib. Z-axis mod. Sawtooth & 60 cps outputs. Astig. control. Retrace blanking. Phasing control.



**NEW! PEAK-to-PEAK  
VTVM #232 & UNI-  
PROBE (pat. pend.)**  
KIT \$29<sup>95</sup> WIRED \$49<sup>95</sup>

Half-turn of probe tip selects DC or AC-Ohms. Uni-Probe - exclusive with EICO - only 1 probe performs all functions!  
Latest circuitry, high sensitivity & precision, wide ranges & versatility. Calibration without removing from cabinet. New balanced bridge circuit. High Z input for negligible loading. 4 1/2" meter, can't burn-out circuit. 7 non-skip ranges on every function. 4 functions: +DC Volts, -DC Volts, AC Volts, Ohms. Uniform 3 to 1 scale ratio for extreme wide-range accuracy. Zero center. One zero-adj. for all functions & ranges. 1% precision ceramic multiplier resistors. Measure directly peak-to-peak value of complex & sine waves: 0-4, 14, 42, 140, 420, 1400, 4200. DC/RMS sine volts: 0-1.5, 5, 15, 50, 150, 500, 1500 (up to 30,000 v with HVP probe & 250 mc with PRF probe). Ohms: 0.2 ohms to 1000 megs. 12AU7, 6AL5, selenium rectifier; xmfr-operated. Deep-etched satin aluminum panel, rugged grey wrinkle steel cabinet.



**5" PUSH-PULL  
OSCILLOSCOPE  
#425**  
KIT \$44.95  
Wired \$79.95



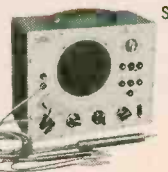
**7" PUSH-PULL  
OSCILLOSCOPE  
#470**  
KIT \$79.95  
Wired \$129.50

Pix Tube Test Adapter ..... \$4.50



Sep. volt-meter & ammeter  
KIT \$29.95  
Wired \$38.95

6V & 12V BATTERY ELIMINATOR & CHARGER #1050



Sep. hi-gain RF & lo-gain audio inputs. Special noise locator. Calibrated wattmeter.  
KIT \$24.95  
Wired \$39.95



20,000 Ohms/Volt MULTIMETER #565  
KIT \$24.95  
Wired \$29.95



1000 Ohms/Volt MULTIMETER #536  
KIT \$12.90  
Wired \$14.90



Reads 0.5 ohms -500 megs, 10 mmfd-5000 mfd, power factor.

KIT \$19.95  
Wired \$29.95

R-C BRIDGE & R-C-L COMPARATOR #950B

VTVM PROBES	KIT	Wired
Peak-to-Peak	\$4.95	\$6.95
RF	\$3.75	\$4.95
High Voltage Probe-1		\$6.95
High Voltage Probe-2		\$4.95
SCOPE PROBES		
Demodulator	\$3.75	\$5.75
Direct	\$2.75	\$3.95
Low Capacity	\$3.75	\$5.75

TURN PAGE FOR MORE EICO VALUES

**EICO**®

Send for FREE CATALOG now

Prices 5% higher on West Coast.

L.I.C. 1, N.Y.

EICO, 33-00 Northern Blvd., Long Island City 1, N. Y. C-8  
Show me HOW TO SAVE 50% on Test Equipment and Hi-Fi. Send me FREE Catalog and name of neighborhood distributor.

Name.....  
Address.....  
City..... Zone..... State.....

## ELECTRONMECHANICS

... *Recent Electronic Inventions Are Epoch-making* ...

IT WAS probably Sir William Crookes who in the early 1880's first demonstrated kinetic-mechanical effects caused *directly* by free electrons in an evacuated vessel. He made the first electrical radiometer by mounting four light metal vanes on a thin metal rod with needlepoints. These points were set in glass bearings. The whole assembly was placed in an evacuated glass bulb. Two electrodes, which carried high-tension currents from the outside to the inside of the glass vessel, were eccentrically placed inside the radiometer. When the current was turned on, the windmill-like vanes rotated rapidly. *Thus a pure electron stream impinging on the vanes was made to furnish mechanical energy.*

In everyday electronics we have so far used few *pure* mechanical effects. Thus most of our radios drive their loudspeakers via electromagnetism. In recent years we have begun using electrostatic speakers—a *pure* electronic-mechanical device. Here electrons move the opposite surfaces of the speaker *directly* without the interposition of magnets and coils.

In television the picture tube uses cathode rays—a stream of electrons—to trace the resulting image. However, here the electrons are used to excite the phosphors on the screen, making them luminous. This results in the picture on the face of the tube.

While the two examples cited—the electrostatic speaker and the TV picture—give more or less direct electron-mechanical effects, the mechanical output is of a relatively low order.

If we turn our attention now to another example, the Radarange, the situation is quite different. Here radio waves of radar frequencies impinge *directly* on a large steak of 5-10 pounds, for example, and cook it efficiently in a few minutes—from the inside out—solely by the direct action of electrons. Here we have a powerful thermal-electronic effect through free space, without mechanical motion.

Since the late 'Thirties other novel electronic means have been devised which give what we may term pure electronic thermomechanical effects. Many devices of this type are now in use in various industries. The first ones of this type were designed to produce extremely fine-holed mechanical filters, unknown before. Electron beams generated by an intense electron source are focused on metal foils. The resulting electron spot pierces extremely fine holes in the metal foil, so fine as to be hardly visible. The holes are actually burned, but they are of uniform size, about 0.5 millimeter or less.

By using multiple beams and deplating the foil quickly at a constant rate, 5,000 holes and more can be pierced simultaneously in a fraction of a second. Filters and ultra-filters made by such means are of importance in atomics, chemis-

try—particularly the art of colloidal chemistry—and medicine in many plants throughout the world.

For example, such ultra-filters are used successfully for the separation of bacteria and viruses of various sizes or for different ultra-visible blood particles, for fractional filtration and other uses. Filters of this type can be produced at reasonable prices.

These devices were first invented by H. Ruska and Bodo von Borries (Patent 2,267,752; Dec. 30, 1941) and by von Ardenne (Patent 2,345,080; Mar. 28, 1944).

Yet a far more spectacular and far-reaching invention in this category has just been patented. The United States patent calls it *Drilling by Electrons*. It does just that. Like the two patents mentioned above, it also uses an electron beam but a much more intense one of high current density. The electron beam formed at the emitter has a substantially constant current density over its entire area.

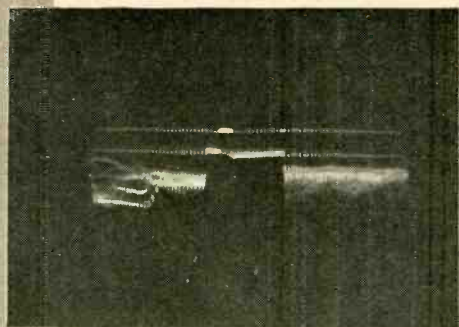
It uses the kinetic energy of a concentrated electron beam to drill fine holes of the unprecedented order of 0.1 millimeter. *Yet these microscopic holes can be drilled in the hardest materials, such as steel, stone, glass, tungsten (and its carbides), molybdenum, and even diamonds!*

Using the same means, unbelievably fine holes with a diameter of only .001 millimeter can be drilled in these same substances in times measured in seconds. Nor are the holes drilled through thin foils. *They have a depth of several millimeters.* Also, the holes can be drilled conically, if desired.

While the term "drilling" is constantly used in the description of the invention, it should be noted that the drilling is actually done by heat. Nevertheless, it must be called a thermomechanical means. The inventor, R. H. Steigerwald, patented the device on May 21, 1957 (Patent 2,793,281).<sup>4</sup>

He obtained another patent—No. 2,793,282—on the same date for an associated invention which he terms *Forming Spherical Bodies by Electrons*. Using means similar to those for drilling holes, he has shown that he can form extremely small perfect spheres (balls) by melting certain refractory crystalline substances of irregular shapes into exact spheres within seconds. They measure from 1 millimeter down to tenths of a millimeter.

If we plot these and other devices of this class into the future, we can see that the art of electronmechanics is bound to turn up astonishing and—so far—undreamt-of inventions and improvements. Here are but a few—television masks of all kinds, electronengraving of every description: halftones, engraved plated ware, printing stencils; insignia mass production; master precision phonograph records; tape records; microrecords; "printed" circuits—the list is endless, with the most far-reaching inventions still to come. —H.G.

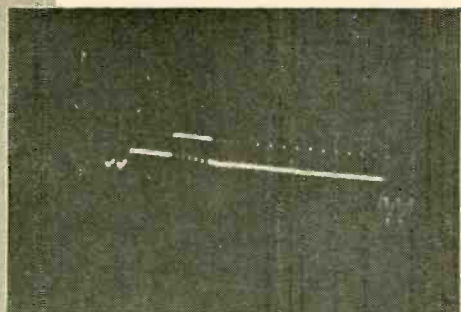


Normal waveform at point "X" in Fig. 4.

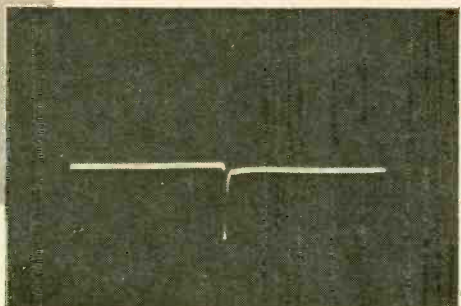
# defective interlace

By A. R. CLAWSON

*Symptoms, causes and cures for this aggravating TV trouble*



Expanded view of waveform at point "X".



Normal waveform at point "Y" in integrator network.

**D**EFFECTIVE interlacing of successive TV fields may pass nearly unnoticed or produce very annoying symptoms in addition to mere detail loss. The trouble may be easy or very hard to service, depending on the cause.

Fig. 1 shows exaggerated sketches of the visual effect produced by interlace defects. Proper interlace (1-a) has uniform spaces between successive lines—even and odd. Consecutive fields

trigger the vertical oscillator into retrace exactly half a horizontal line apart. Note that the first line starts at top dead center of the raster and the second at the upper left corner.

With impaired interlace, the first line may start to the left or right of center. Or the second line may start away from the left corner. Usually both even and odd lines wander somewhat. Change from the half-line spacing (1-b) characterizes a partial loss

of interlace or touching lines. On sets without retrace blanking, this touching is easily observed on the retrace lines by turning up the brightness. A magnifier reveals a similar touching of the normally visible lines.

Fig. 1-c depicts complete loss of interlace. Alternate lines are paired, twinned or superimposed. A magnifying glass can be used to reveal this loss and black stripes in place of the missing lines. Vertical detail deteriorates rapidly, becoming about 250 lines at twinning, contrasted to about 490 for perfect interlacing.

The increased black darkens the picture and quickly degrades the contrast. From the touching lines on to complete pairing, contrast is destroyed rapidly for another reason. As Fig. 2 illustrates, if both paired lines are black, the eye sees black. White is white, too, if both are white. But black with white yields a light gray. Visually 50% black with 50% white results in an 18% gray appearance or close to white. For intermediate shades of gray mixed with white or black, the visual effect is far different from the transmitted information. Contrast is destroyed more rapidly for this reason than any other.

Flicker becomes pronounced below 40 changes of brightness per second. With complete loss of interlace, the flicker is high since only 30 changes per second are apparent.

Still another effect can be seen. The nearly horizontal lines are severely distorted, particularly the horizontal wedges of a test pattern. If there is some fluctuation in the starting point of the separate fields (commonly the case), the lines will weave in or out, producing a wormy sort of cross-hatched pattern known as a moiré effect.

## Visual check

In addition to the foregoing symptoms, there is a rapid visual check (see Fig. 3). Position the raster lower than normal, turn up the brightness and observe the lines in the vertical blanking area immediately above the picture. With correct interlace one line will start at almost exactly the center of the mask and remain in that position. The next line will start at the left corner (may be obscured by the mask) immediately below the unlit portion of the screen. With interlace impairment the lines will wander and start at different places.

Interlace impairment may be intermittent or continuous. Random impairment means intermittent interference is upsetting the vertical system, particularly the vertical oscillator. A permanent symptom means a continuous interference or other trouble and constant upsetting of the sync.

The integrator of a TV set (Fig. 4 and photos) builds up a vertical trigger (sync) pulse like that seen in Fig. 5-a from the vertical pulse group of the standard TV signal. A normal pulse

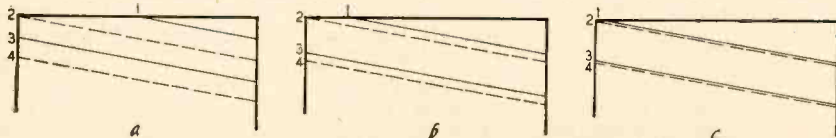


Fig. 1-a—Normal interlacing; b—slight impairment with lines touching; c—complete loss of interlace, alternate lines are superimposed or almost so.

triggers the vertical oscillator. If its amplitude is low (see Fig. 5-b), triggering may be random with random interlace. The trigger pulse should fire the oscillator at about the fourth notch (caused by the vertical serrations).

**Troubleshooting**

Customer education takes care of the frequent case of improper VERTICAL HOLD control setting. Tube substitution eliminates vertical oscillator and vertical output tube trouble, often a result of gas not particularly troublesome in other tube locations. The sync clipper should next be checked by replacement. Progressively try the video amplifier, detector and if tubes (for sync compression cases).

Two important check points are X and Y in Fig. 4. A scope reveals the proper waveform and amplitude of the sync pulse at Y with the vertical oscillator tube removed.<sup>1</sup> Fig. 5-a shows this pulse. All vertical oscillators in common use rely on a trigger pulse to drive them to conduction at about the fourth notch in the vertical pulse.<sup>2</sup> Check particularly for enough amplitude since a low vertical pulse (Fig. 5-b) may trigger the oscillator erratically. Manufacturers' schematics usually show the shape and the amplitude of this pulse. It may be measured by a peak-to-peak voltmeter if a scope is not available.

A low or deformed pulse at Y requires checking at X next. If normal, then the integrator is bad. If not satisfactory, trace the waveform through the sync clipper and amplifiers, noise immunity tubes (if any), video amplifier and video if until the reason is found. Without a scope, change tubes, take voltage measurements and make resistance tests.

Excessive gain in stages preceding the integrator may result in an abnormally high signal amplitude with an increase in the vertical pulse. This, too, will cause impaired interlace, but will seldom cause complete loss. Sync would be very stable. Search for the reason for the excess gain and remedy it. Waveform voltage measurements are probably the easiest way to localize the trouble to a stage for both too much and too little sync pulse amplitude.

**Bad integrator**

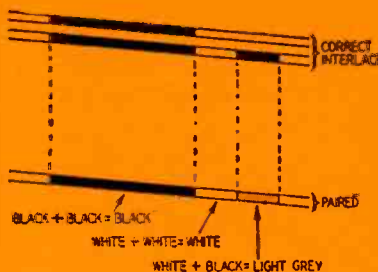
Proper waveform at X but not Y means a bad integrator.<sup>3</sup> However, test for a short or other defects in the vertical oscillator prior to condemning the integrator.

Increased value of a series resistor reduces the generated pulse amplitude. Capacitance loss reduces amplitude too. Just as important is loss of bypassing

<sup>1</sup> The oscillator generates a pulse itself which is easily mistaken for the sync pulse.

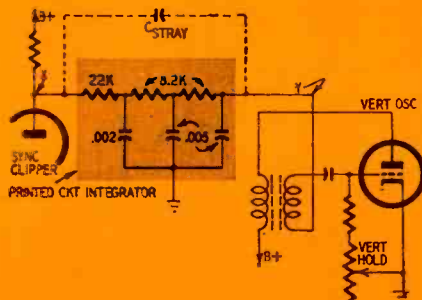
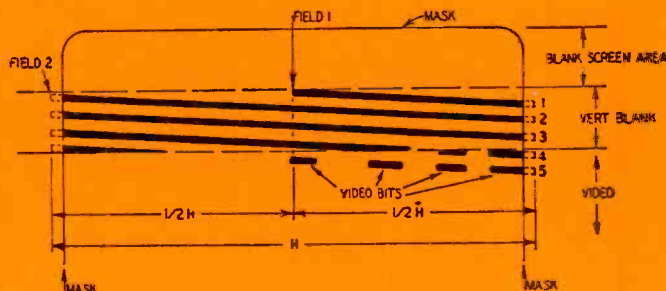
<sup>2</sup> Notches are due to serrations in the vertical pulse group.

<sup>3</sup> Some cases of an improper pulse at X are due a bad integrator or to some trouble in one of the leads to the horizontal afc which may be taken off at this point. The wave at the grid of the tube feeding X will be normal, thereby localizing the trouble.



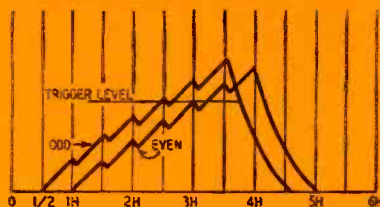
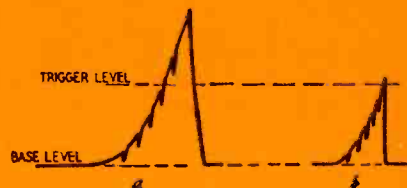
**Fig. 2—Effect on brightness. Combination of black and white yields only 18% gray.**

**Fig. 3—Shift the raster to determine definitely trouble due to defective interlace. H is time from start of one line to start of next line.**

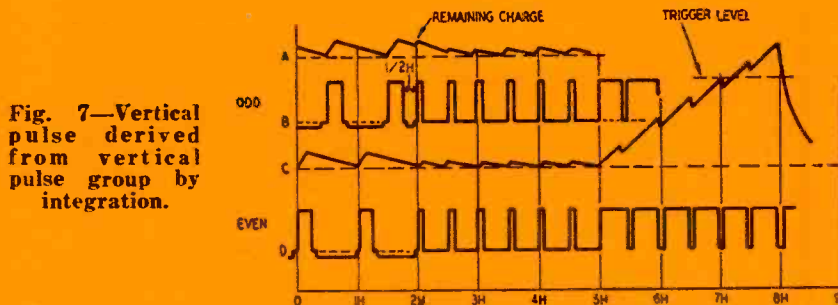


**Fig. 4—Typical integrator circuit supplies vertical pulse to oscillator.**

**Fig. 5-a—Normal vertical pulse from integrator; b—weak pulse due to bad integrator or weak input.**



**Fig. 6 — Successive vertical pulses for alternate fields. Pulses shown spaced at 1/2 line are actually 262.5 lines apart.**



**Fig. 7—Vertical pulse derived from vertical pulse group by integration.**

## TELEVISION

action for horizontal and equalizing pulses.

Figs. 6 and 7 illustrate this action. In Fig. 6 both pulse groups result in exactly the same vertical pulses. The first starts at 0.5 and the second at 263 (horizontal lines). Except for the time displacement both pulses are identical.

Disturbance of the charge on the last integrator capacitor (see Fig. 7-a) is caused by close spacing of the preceding horizontal pulse (Fig. 7-b).<sup>4</sup> The short time constant and bypass action leak this off by the time the vertical pulses begin. If some charge should remain, the start of the vertical pulse would not be from zero charge on the last capacitor and interlace would be bad.

This capacitor also bypasses noise and video information not previously eliminated. If not eliminated at the last integrator capacitor, the resulting charge will cause wobbly and random interlace.

Random loss of interlace from incompletely stripped video will be revealed by observation at point X of Fig. 4. The reason may be found by scope observation back through the sync stages. Proper electrode voltages and good tubes clear up most troubles. Video feedthrough to the sync clippers along B-plus lines can be halted by a decoupling filter in the clipper B plus. Use a series resistor of about 1,000 ohms and a bypass capacitor of .05  $\mu\text{f}$  or so. If a heater feedthrough, bypass the hot leg with .01 to 0.1  $\mu\text{f}$  as required. Defects in time constants and signal-generated bias of the clipper (stripper) stages may be found by resistance measurement and capacitor shunting or substitution. Sometimes these may have to be altered to clip properly (observe wave on scope while making such alterations).

Video information reaching point Y upsets interlace even if not fed there via the sync clippers and integrator. Feedthrough along the B plus and heaters by radiation from wiring and the video output tube are common causes. Capacitors on the video output heater and the vertical oscillator cure heater feeds while a decoupling filter on the B plus does the same as for the sync clippers mentioned above. Shielding and redressing leads of either video or vertical oscillator tubes and wiring may be required.

### Constant trouble

The interlace may be bad constantly. The indication is horizontal information getting to the grid of the vertical oscillator. It may come through the integrator or may be directly coupled through radiation or along the B-plus and heater lines to the vertical oscillator.

Fig. 8 shows the effect on the vertical pulse seen with a scope. The vertical

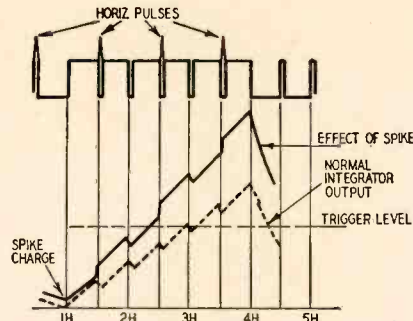


Fig. 8—Effect of horizontal pulses getting to vertical oscillator grid.

oscillator must start its retrace on a half line compared to the former field as previously noted. Now, if horizontal pulses arrive in the vertical pulse group, they can cause a distortion of the generated vertical pulse as illustrated. Instead of a notch in the pulse at each serration there may be a spike. The spike will occur at alternate half-line times when caused by horizontal pulses getting through. The effect of these horizontal pulses is premature triggering, resulting in loss of interlace.

Filters cure B-plus feedthrough. Bypasses cut down heater-carried interference. Smaller feed capacitors from the sync to the horizontal afc will reduce horizontal pulse feedback to the sync clipper. From there the feedback pulses go to the vertical oscillator traveling through the integrator and stray capacitance between points X and Y in Fig. 4. Even a very few  $\mu\text{f}$  will cause trouble. The same is true of very little capacitance from point Y to the horizontal output plate, the high-voltage rectifier plate and filament, etc.

Shielding of the vertical oscillator tube will help in many instances as well as a shield over the horizontal oscillator (source of the interfering pulses) and the sync which may pick them up. Care in horizontal circuit lead dress is likewise important. The high-voltage cage may not be grounded properly—check with a file.

Some economy sets can be helped by adding another integrator section. At times even a full integrator may not do too good a job of horizontal pulse filtering. Add about 2,200 ohms resistance in series with the integrator output and shunt with a .005- $\mu\text{f}$  ceramic capacitor to ground as in Fig. 9.

In addition to the foregoing general causes and cures, you may find the following very useful in some sets.

If the vertical oscillator or vertical output is supplied by B boost, filter it with about a 4,700-ohm resistor in series and a .05- $\mu\text{f}$  capacitor on the vertical side. Shunt the capacitor to ground as in other decoupling networks.

Filter the retrace blanking network with a decoupling filter. Use about 100,000 ohms in series and a 680- $\mu\text{f}$  or so shunt bypass capacitor.

Increase the capacitance across the primary of the vertical output transformer. Double this value may be necessary.

Reduce the value of the peaking resistor in the vertical oscillator or vertical discharge circuit. One-quarter the nominal resistance has been used. Check for proper operation in other respects, like height, vertical linearity, etc.

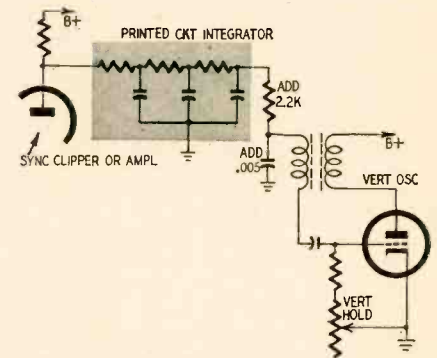


Fig. 9—Adding extra section to integrator provides better horizontal pulse filtration and noise immunity.

The cathode resistor in the multivibrator may require doctoring. Usually it is decreased in value but one instance required an increase.

An effect similar to interlace impairment results from degeneration in the horizontal output tube's cathode circuit. Alternate lines are staggered due to a form of jitter. Reroute the screen capacitor from connection to cathode to the chassis or to B minus as appropriate. Make a change in capacitor and cathode resistor values, if required, to maintain the normal picture.

Now it's up to you. Follow the suggestions and you'll find very little difficulty in solving annoying interlace problems. END

**COMING**  
next  
month...

**HOW TO ORGANIZE AN EFFICIENT  
TV SERVICE BUSINESS**

*Servicing in the home is one key  
to profitable operation*

**PRACTICAL COLOR TV INSTALLATION**

*Bob Middleton uses a new technique to get the story of a  
not-too-easy operation across in a simple way*

<sup>4</sup> Fields have been shifted a half line by contrast with Fig. 6, which is the correct positioning, to illustrate this effect clearly.



# TV and Sunspots

What to tell the set owner about TV dx interference

By M. E. WEST, W4SMN

SUNSPOT cycle 19 is well under way. The Swiss Federal Solar Observatory has announced that it will reach a maximum during 1957. That maximum will probably be greater than any ever recorded. (The first sunspot cycle was recorded in 1750.)

If the cycle does reach the maximum predicted between September, 1957, and May, 1958, shortwave radio propagation will probably be better than at any other time in history.

This extra-long-range radio communication will be fine for the amateur radio operators and dx television fans, but what about the average TV owner? He probably does not care about receiving Havana, Cuba, or some other distant TV station over his favorite local channel, which could happen if he is located in a fringe area and dx conditions are right. The TV service technician will undoubtedly receive many unnecessary complaints from set owners in coming months. He will have to be prepared to instruct the owner about what will be happening, thereby preventing many needless service calls.

The present-day concept considers sunspots as giant cyclones or whirlpools caused by violent explosions on the surface of the sun, similar to but millions of times more powerful than hydrogen-bomb explosions. During the peak of the sunspot cycle, the number and size of the spots increase. With increased sunspot activity, the earth receives more ultra-violet radiation, which in turn ionizes the earth's upper air.

When a radio wave reaches the ionosphere, it either penetrates it or is refracted to earth. Refraction is a bending process but, for all practical

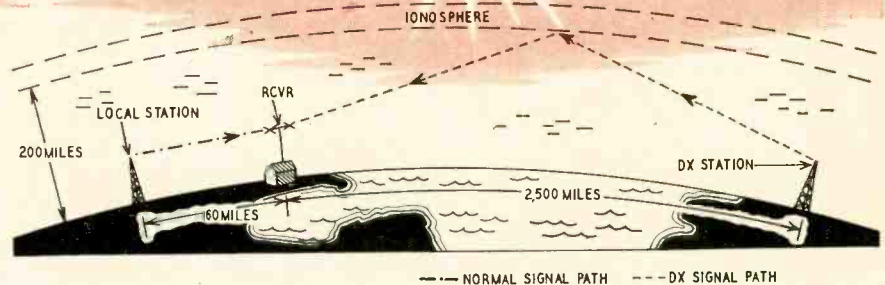


Fig. 2—How TV dx interferes with local programs.

purposes, it can be thought of as a reflection of radio waves.

### Frequencies reflected

Long-distance radio communication is possible only because of the existence of the ionosphere, which acts like a mirror, reflecting high-frequency radio signals over great distances. Reflection is easiest over the range of frequencies between 3 and 30 mc, but at times frequencies considerably lower and higher are reflected.

Generally, dx television interference will be confined to the low-band stations—channels 2 through 6. Fig. 1 shows the frequency limits in the low- and high-band vhf television channels. Some interference troubles can be expected to come from adjacent television channels.

There are no television transmissions immediately below channels 2, 5 and 7. When your set is tuned to them, there will be no adjacent-channel sound interference. There are no TV transmissions immediately above channels 4, 6 and 13, and on these stations there will be no adjacent-channel video interference.

Channels 2 and 3 will have the most trouble because they lie on the lower end of the frequency spectrum, which is most easily reflected by the ionosphere. During peak sunspot activity this interference will be caused almost entirely by dx stations operating on the same frequency as the local station.

To most television set owners and service technicians, sunspot cycle 19 will be a new experience. Television was in its infancy during the last cycle, which reached a maximum in 1947 and 1948,

and relatively few sets were in use. This year and the coming two years will present to the television public distant interference in its full power. True, we have had some dx interference in the past, but for the next few years this type of trouble will be more prevalent.

One reason the problem is troublesome to a technician is the fact that all sets in the community may not be affected at the same time. This is due to several reasons.

First, there will probably be a wide variety of antennas in one particular area. The single-channel Yagi will bring in the least interference, as it is a narrow-band directional antenna set to a particular channel. Sets connected to a conical or broad-band Yagi will pick up the most interference.

The second cause for confusion is that a number of channels can be received in certain locations. Many sets will be tuned to the higher channels, which will be relatively unaffected.

### What to do

When a technician receives a call from a customer with an interference complaint, knowing the type of antenna being used will help him diagnose the trouble. He should also get the customer to describe the condition of the picture as closely as possible. If there is a properly operating set on the bench, he can watch the screen for any signs of dx interference before making the service call. (Meanwhile tell the owner to try other channels.) The slightest sign of interference on the bench set would indicate that the cus-

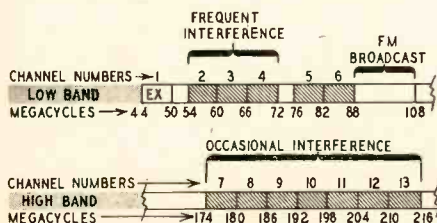


Fig. 1—Frequency limits of low- and high-band vhf television channels.

# TELEVISION

tomer may have the right combination of antenna, set and location to bring in distant stations interference.

If the trouble has been diagnosed as dx interference, the next step is to explain to the owner what is happening and that the condition will probably pass in a short while. Ask him to call the next day if the trouble is still there. This can save many unnecessary calls. The customer is also saved needless expense.

Should the trouble continue and the customer insist that his set be checked, the technician can tell if it really is dx interference by seeing the set in operation. If interference is the trouble, try reorienting the antenna. If that fails to help, set the age control to a less sensitive position, reducing the gain of the rf and if stages. Finally, check the tubes or use new substitutes in those stages. After making the above rough checks, if interference is still severe, the set will have to be taken to the shop for possible realignment and

further testing. It is possible the set is in good condition and it will be up to the technician to explain, in simple terms, what is happening.

## Inform the customer

A good way to educate a customer is to draw a simple sketch of the earth and ionosphere as in Fig. 2.

Point out to the customer the layer of gases known as the ionosphere and tell him that the sun goes through a sunspot cycle about every 11 years. This cycle causes a bombardment of the ionosphere with increased ultra-violet radiation and strong magnetic fields. The bombardment of the upper air, which lies about 200 miles above the earth, can cause these rarified gases to reflect radio waves more readily. Normally, vhf television signals pass through the ionosphere and are lost in space but, during periods of peak sunspot activity, the ionosphere changes into a good reflector of these signals.

Often the distant station interfering with a favorite channel is thousands of miles away but, due to unusual atmospheric conditions, its signal is being reflected to the earth near his location. It is arriving strong enough to show up on his screen as waving lines, loss of vertical and horizontal sync and buzzing in the sound. Sometimes the distant signal will override the local fringe-area signal and produce a picture.

Since we are due, during the next two years, for possibly the greatest sunspot activity that has ever been recorded, the technician should tell his customers that their sets will have occasional interference trouble. Not much can be done about it, except to wait until the peak reflection periods pass. When the owner understands what is happening to his set at these times, he will be less likely to call a service technician and thereby leave the technician more time to devote to true television troubles. END

# TV STATIONS OF LATIN AMERICA

(U.S. and Canadian listings appeared in the January, 1957, issue and monthly supplements.)

By MURIEL SCHILLER

LOCATION	CALLS	CHANNEL	POWER	NETWORK	LOCATION	CALLS	CHANNEL	POWER	NETWORK
<b>ARGENTINA</b>									
Buenos Aires	LR3-TV	7	5 kw. ERP 40 kw	Radio Belgrano TV	San Luis	Satellite of CMAB-TV	7	5 kw. ERP 32 kw	Telemundo, S.A.
					San Miguel de los Canasi	Satellite of CMAB-TV	11	5 kw. ERP 32 kw	Telemundo, S.A.
					Santa Clara	Satellite of CMAB-TV	8	5 kw. ERP 32 kw	Telemundo, S.A.
					Santa Clara	CMH-TV (Satellite of CMA-TV)	3	5 kw. ERP 28 kw	Radio Television Nacional, S.A.
					Santa Clara	CMHQ-TV (Satellite of CMQ-TV)	5	5 kw. ERP 25.6 kw	Circuito CMQ, S.A.
					Santiago de Cuba	Independent	10	5 kw	Cadena Oriental de Radio, S.A.
<b>BRAZIL</b>									
Belo Horizonte	PRH6-TV	4	5 kw. ERP 25 kw	Radio Guarani (Emissoras Associadas)					
Rio de Janeiro	PRG3-TV	6	5 kw. ERP 21.2 kw	Radio Televisao Tupi (Emissoras Associadas)					
Rio de Janeiro		13		Radio Record TV (J. B. Amoral)					
Sao Paulo	PRF3-TV	3 (to shift to 4)	5 kw. ERP 18.4 kw	Radio Difusora de Sao Paulo (Emissoras Associadas)					
Sao Paulo		5	5 kw. ERP 19.4 kw	Radio Televisao Paulista (Helio Marmo)					
Sao Paulo	PRB9-TV	7	10 kw. ERP 32.7 kw	Radio Record TV (J. B. Amoral)					
<b>COLOMBIA</b>									
Bogota	HJRN-TV	8	1 kw. ERP 45 kw	Televisora Nacional (Govt.)					
Cali	Satellite	7	ERP 50 kw, directional	Televisora Nacional (Govt.)					
Cerro Gauji	Satellite	11	ERP 50 kw, directional	Televisora Nacional (Govt.)					
Cerro Majui	Satellite	7	ERP 500 kw, directional	Televisora Nacional (Govt.)					
Manizales	Satellite	9	ERP 100 kw, directional	Televisora Nacional (Govt.)					
Medellin	Satellite	6	ERP 300 kw, directional	Televisora Nacional (Govt.)					
<b>CUBA</b>									
Camaguey	Satellite of CMAB-TV	9	5 kw. ERP 32 kw	Telemundo, S.A.					
Camaguey	CMJL-TV (Satellite of CMQ-TV)	6	10 kw. ERP 57.5 kw	Circuito CMQ, S.A.					
Camaguey	Satellite of CMA-TV	4	5 kw. ERP 25 kw	Radio Television Nacional, S.A.					
Ciego de Avila	Satellite of CMA-TV	2	0.5 kw	Radio Television Nacional, S.A.					
Havana City	CM-TV (Independent)	10	5 kw	Televisora CM-TV, S.A.					
Havana City	CMA-TV	4	5 kw	Radio Television Nacional, S.A.					
Havana City	CMAB-TV	2	5 kw. ERP 110 kw	Telemundo, S.A.					
Havana City	CMBF-TV (Independent)	7	10 kw	Radio Universal, S.A.					
Havana City	CMQ-TV	6	10 kw. ERP 100 kw	Circuito CMQ, S.A.					
Holguin	Satellite of CMAB-TV	13	5 kw. ERP 32 kw	Telemundo, S.A.					
Holguin	Satellite of CMQ-TV	3	5 kw	Circuito CMQ, S.A.					
Holguin	Satellite of CMA-TV	8	5 kw	Radio Television Nacional, S.A.					
Jatibonico	Satellite of CMAB-TV	12	5 kw. ERP 32 kw	Telemundo, S.A.					
La Cumbre	CMGQ-TV (Satellite of CMQ-TV)	9	5 kw. ERP 14.4 KW	Circuito CMQ, S.A.					
La Cumbre	Satellite of CMA-TV	13	5 kw	Radio Television Nacional, S.A.					
Puerto Boniato	CMKU-TV (Satellite of CMQ-TV)	2	5 kw. ERP 13.7 kw	Circuito CMQ, S.A.					
Puerto Boniato	Satellite of CMA-TV	5	5 kw	Radio Television Nacional, S.A.					
Reparto La Coronela Marianao	Independent	12	5 kw	Gaspar Pumarejo Suhr					
<b>DOMINICAN REPUBLIC</b>									
					Ciudad Trujillo	HIT-TV	4	5 kw. ERP 16 kw	La Voz Dominicana
					Santiago de los Caballeros	Booster Transmitter	4		La Voz Dominicana
<b>EL SALVADOR</b>									
					San Salvador	YSEB-TV	6	500 watts	Television Salvadorena
<b>GUATEMALA</b>									
					Guatemala City	TG-BOL	3	10 kw. ERP 15.5 kw	Radio-TV Guatemala (Mario Bolanas)
					Guatemala City	TGW-TV	8	100 watts, ERP 200 watts	Television Nacional de Guatemala
<b>MEXICO</b>									
					Juarez	XEJ-TV	5	ERP 3.65 kw	Television de la Frontera
					Mexico City	XEW-TV	2	5 kw, 3-gain antenna	Cadena Radiodifusora Mexicana
					Mexico City	XHGC-TV	5	5 kw, 3-gain antenna	Television Gonzalez Camarena
					Mexico City	XHTV	4	5 kw, 3-gain antenna	Television de Mexico
					Monterrey	XHNL-TV	10		Televisora del Norte
					Paso de Cortes	XEQ-TV	9	5 kw, 6-gain antenna	Cadena Radiodifusora Mexicana
					Paso de Cortes (Ahtzomoni) Queretaro	XEX-TV	7	7.5 kw, 3-gain antenna	Cadena Radiodifusora Mexicana
					Tijuana	XEZ-TV	3	10 kw	Cadena Radiodifusora Mexicana
					Chihuahua	XETV	6 11		Radio Television Chihuahua (Affiliated with Telesistema Mexicana)
<b>PERU</b>									
					Lima		5		Radio Nacional (Govt.)
<b>URUGUAY</b>									
					Montevideo		10	350 watts	Sociedad Anonima Emissoras de Television y Anexos
<b>VENEZUELA</b>									
					Caracas	YVKA-TV	5	10 kw, ERP 37.2	Televisora Nacional
					Caracas	YVLV-TV	4	5 kw, ERP 15 kw	Televisa Venezolana
					Caracas	YVKS-TV	2	10 kw, ERP 62.6 kw	Radio Caracas TV
					Coro	Satellite	10	10 kw, ERP 33 kw	Radio Caracas TV
					La Guaira	Satellite	7	100 kw, ERP 250 kw	Televisa Venezolana
					Maracaibo	Satellite	13	2 kw, ERP 12 kw	Ondas de Lago TV
					Maracaibo	Satellite	2	6 kw, ERP 500 kw	Radio Caracas TV
					Maracaibo	Satellite	9	2 kw, ERP 13 kw	Televisa Venezolana Radio-Caracas TV

**L**AST month we discussed printed-circuit board construction and how to repair wiring breaks. Of equal importance is parts replacement on printed-circuit boards. Other than tubes, the most common replacement is that of a resistor or capacitor.

Because of the compactness of these boards, it is important to replace a component with another of the same or as close to the same physical size as possible. To prevent disturbing the relatively delicate etched or plated wiring, always try to remove a component by clipping leads as close to the body of the part as space permits. The remaining leads then serve as lugs or anchors and the new part is soldered to them.

If it appears that the leads will be slightly too short for this procedure, some additional length can be obtained by cutting the component in half with a pair of diagonals and then crushing or cutting away the body of each half to expose the length of pigtail lead that extends into it. Avoid excessive heat when soldering to these short lengths as they can easily fall out of the board.

On occasion a component will be mounted so as to defy replacement by either method. When this occurs, the entire defective component must be removed. To do this, heat its connections on the wiring side of the board and clear away the molten solder with a stiff wire brush. Then use a knife blade or similar tool to straighten out the pigtail lead from the component that goes through the board; the lead should be perpendicular to the board to avoid any strain on the wiring. The connection can then be reheated and the lead removed. In many cases the job is simplified and the strain relieved by first cutting the component in half since each connection can then be handled separately.

One further technique is to remove heat from the connection just before the lead clears the wiring. This will usually leave a clear hole in the wiring for easy replacement. When inserting a new part, leave about  $\frac{1}{8}$  to  $\frac{1}{4}$  inch of lead extending through the board, bend these ends against the copper foil and solder. Be sure to cover important contact areas such as tube socket holes (masking tape is useful here) when recoating a joint with an insulating spray.

#### Tube sockets

Replacing tube sockets on printed-circuit boards is not simple and should be done as a last resort only. In case of intermittent pin contacts, try bending the contacts for a firmer grip on the tube pins. If this fails or if some other trouble necessitates socket removal, study the socket connections carefully. Some sockets are mounted on the wiring side of the board and others on the components side. In either case, a number of terminals will have to be removed from connecting strips.



In a simple socket connection, such as used by RCA, it is necessary only to apply heat to each of the socket terminals, brushing off the excess solder. Then use a knife blade under the socket contacts to pry them up from the connecting strips. Next, unsolder and pry up the center-pin ground connection.

When replacing a socket, insert it in the position indicated by the key. Then solder the pins and center-pin ground connection to the connecting strips. On some boards the contacts have to be bent back for soldering on the tube side of the board. Very often socket removal is simplified by cutting a tube socket into several parts and removing one piece at a time. If a tube shield grounding strap is used, leave it on.

On many Admiral receivers the ground terminal connections to the tube socket are made beneath the sockets with copper wiring foil. When removing the tube socket, be sure none of the foil has peeled off between the socket lugs and the center ground connection. When this occurs, an indentation or dull section can be seen on the board. This often happens when a socket is removed and, if not repaired, frequently leads to intermittent conditions difficult to locate.

When installing a new socket where the socket lugs pass through holes in the board, difficulty may be encountered due to the close tolerance of the holes. In such a case, rather than forcing the socket terminals and possibly breaking the board, enlarge the holes slightly with a small reamer or pocket knife.

#### We are happy to announce:

Beginning next month, TV Service Clinic will be conducted by Robert G. Middleton, well known to readers through his articles in this and most other TV and electronic magazines and for his books on TV servicing and other subjects, as well as personally because of his field trips and lecture tours. Bob, formerly chief field engineer of Simpson Electric Co., is now director of Technical Information Division, Radio Electronic Television Schools, with headquarters at Detroit, Mich. Besides handling the Clinic, he will also be Television Consultant to RADIO-ELECTRONICS.

Replacing other components on the printed-circuit board follows generally the same pattern. In some cases, such as replacing certain filter capacitors, it is difficult to push aside the terminals. In this case the solder should be melted away from the terminals and the terminals then cut as short as possible. Finally, apply heat to the terminals and pry each side away from the board.

Terminal lugs of coils are not generally bent over against the foil, therefore brushing solder away is unnecessary. Simply heat until the solder melts and break the connection. Be sure to insert the replacement coil in the same position. In many cases coil terminals need not be lifted, but merely pushed sideways from the connecting strips. Before replacing, it is a good procedure to clean the area with thinner, and after replacement to cover the area with lacquer.

#### Soldering pot

With the growth of printed-circuit servicing, the usefulness of a soldering pot is becoming more evident. A low-wattage iron has the disadvantage that it takes a long time to melt solder and there is always the possibility that during this time the wiring will lift from the board and crack. A higher-wattage iron, 100 watts or more, when properly handled is preferable for a skilled technician since it can do the job quickly. However, the tip must be well shaped and tinned or heat damage from it can be ruinous.

Thus, the ideal approach to removing components in printed circuits is with a temperature-controlled soldering pot. This combines the advantages of being able to heat many terminals simultaneously and operating at a temperature that will not damage the board or wiring. After a component has been removed with a soldering pot, the holes on the board can be cleaned with a conventional soldering iron. The pot is most appreciated on difficult jobs such as removing tube sockets or multiple-connection coils.

A soldering pot can be kept filled with 60/40 bar solder and some flux should be added from time to time for better solder flow. To reach a maximum

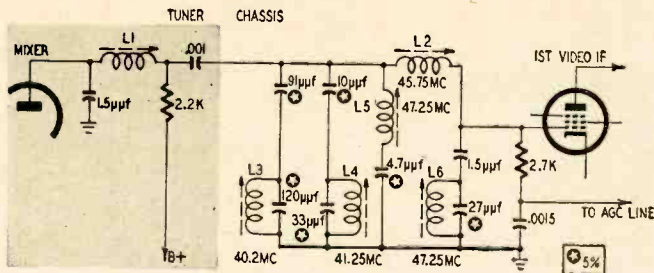


Fig. 1—Bandpass network in Du Mont RA-370/371.

number of contacts, the pot should be kept filled to the top. Oxidation scum often forms on the surface of the molten solder and should be skimmed off. Pots come in conventional form and in specially shaped cups made to fit on the barrel of conventional soldering irons.

It can be seen that the technician must prepare for more critical circuit analysis and testing, as parts-substitution checking is tedious and time-consuming in printed circuitry.

Picture smear

I have a Du Mont receiver with an RA-370/371 chassis. The set performed very well in a strong signal area but when moved to a fringe area there was considerable adjacent-channel interference. I tried installing traps but the effects varied from reduced gain to a smear, especially noticeable on moving objects. The adjacent-channel interference is very bad and I would appreciate some advice on how to get rid of it. I have good test equipment but everything in this set seems to be very critical.—K. S., Elmira, N. Y.

Your unit is a particularly fine receiver and has adequate traps and tuning adjustments to reduce adjacent-channel interference. The primary bandpass determinants lie in the tuner output link and bandpass network shown in Fig. 1. Since you have alignment equipment, your first step is to carefully align each circuit precisely to the frequency shown. Coils L1 and L2 are important for overall bandpass tuning, while L3 and L4 permit obtaining good sound gain and better quieting in fringe areas. As seen in the alignment curve (Fig. 2), L3 aids in keeping the slope of the bandpass steep on the adjacent-channel video (39.75-mc) side of the curve. When adjusted properly, this will give sharp rejection to adjacent-channel video. Coils L5 and L6 are adjacent-channel sound traps.

With these adjustments it takes very little trimming to narrow the overall if bandpass and thus reject adjacent-channel interference. Fig. 2 shows an alignment curve that can be easily obtained by careful adjustments. Of particular importance is the location of the video if carrier which is brought high up on the response curve. By placing the video carrier within 10% or so of the maximum if amplitude instead of in the conventional 50% area, attenuation from the video carrier to the adjacent-channel sound

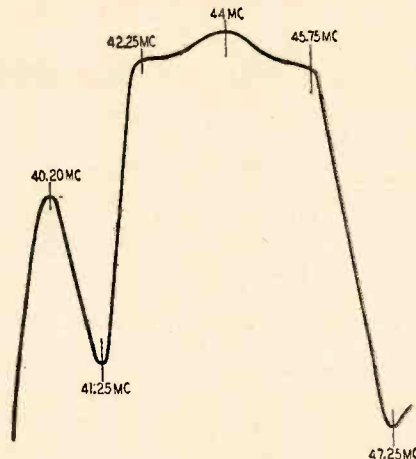


Fig. 2—Bandpass alignment curve for Du Mont RA-370/371.

is tremendous and there will be virtually no danger of interference. Be sure to use a good marker generator in making these adjustments.

Horizontal oscillator hunt

I have what appears to be a most unusual trouble on an Emerson 120245DN chassis. At the top of the picture there appears to be a damped sine wave that dies away near the center. In every other respect the picture is fine. Contrast is very good and sync stability, both horizontal and vertical, is satisfactory.

At first I couldn't be sure whether the trouble was in the horizontal or the vertical circuits. However, a careful analysis of the vertical stage indicates that everything is operating perfectly. Checking the horizontal circuits shows almost every voltage slightly off and I can't seem to find the point of trouble. Short of replacing every component in the horizontal stages, which I have found in the past to be

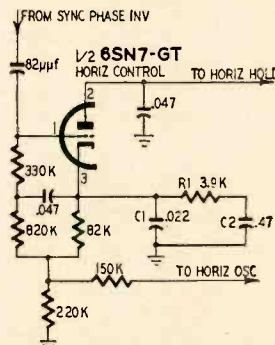


Fig. 3—Horizontal oscillator anti-hunt network, used in Emerson 120245DN chassis.

unwise, I have reached an impasse as to what to check next.—F. B., Indianapolis, Ind.

Your description of the trouble appears to be a rather unusual, but not rare, form of horizontal oscillator hunt. Almost invariably the trouble will be found in the anti-hunt network of R1 and C2 (Fig. 3). It takes only a very slight change in the characteristics of these parts to bring on a hunting condition.

R1 and C2 introduce a delay in the voltage change across C1. This delay prevents overcontrol which causes the horizontal oscillator frequency to vary or hunt around the correct frequency before finally stabilizing. The effect of overcontrol is a ringing at the top of the picture, as you describe.

6BQ6-6CU6-6DQ6

There has been a lot of confusion over the use of the 6BQ6, 6CU6 and 6DQ6 in the horizontal output stage of television receivers. They appear to be almost exactly the same, and this is further shown since many of these are double-branded. Since the 6DQ6 is the most recent model or type number, why can't it be used to replace the first two? In practice I have found that this cannot always be done.—F. P., Medford, Mass.

The trouble is that they are interchangeable only unilaterally. That is, a 6CU6 can be used in place of a 6BQ6 and a 6DQ6 can be used in place of a 6CU6, and not vice versa. (See the sweep tube chart on page 51 of the April, 1957, issue.)

In a great many instances, trying to use a 6DQ6 as a replacement for the other two types results in excessive width which could not be sufficiently reduced. As a practical matter, replace with the tube the set has been designed for. If you want improvement, try using the sequence indicated above. In time the 6DQ6, which has closer tolerances than the 6CU6, will supersede the other two, but it should not be used indiscriminately.

Printed-circuit boards

I have found that many cases of interaction between circuits can be cleared up by cleaning off flux from printed-circuit boards. Usually a simple scraping is sufficient, but I have been experimenting with different cleaners to do a more complete job. I would like to know what might be considered a good one.—T. L., San Francisco, Calif.

The problem of interaction between circuits on these boards is common and is due to leakage paths produced by excess flux. Not only is interaction possible, but occasionally below-normal operation that is extremely difficult to locate. Whenever this trouble is suspected the board should be cleaned with a good solvent such as denatured alcohol. Use a stiff brush over the troublesome area; a toothbrush usually works very well in this application. The alcohol will wash away excess flux and eliminate flux leakage paths. END

Servicing

Gated-

## Beam Discriminators

Quadrature detectors have  
their own peculiar troubles

By JAMES A. McROBERTS

**M**ANY TV models have been engineered down to two tubes in the audio section, an output and a gated-beam discriminator-limiter-amplifier. Even the original 6BN6 type has been simplified by the later 6DT6 breed with less critical circuitry. The 6BN6 never oscillates normally while the 6DT6 employs oscillation on low sound inputs to maintain a large output of audio to the audio output stage. Essentially the circuits and alignment are similar for both types and may be considered together.

Aside from the special formed beam type tube, the circuits feature a quadrature coil connected to what would be the suppressor grid of a pentode. In the 6BN6 arrangement (Fig. 1) there is almost invariably a potentiometer in the cathode circuit for adjustment of residual buzz. In many sets this is called the BUZZ CONTROL. Instead of returning directly to ground as in 6BN6 circuitry, the quadrature coil returns through a time-constant bias network in the 6DT6 arrangement. (See Figs. 2 and 3.)

As in most places, a bad tube is the commonest troublemaker and can be eliminated by substitution. Next in order of frequency is alignment creep due to aging, etc. This alignment is simple and may be carried out with a station signal. There are also mis-

cellaneous troubles which will be treated after alignment.

Field alignment requires a very strong signal and a very weak one. The weak signal is obtained by disconnecting the set's antenna leads. Then:

1. Tune a station for best picture. Attenuate the signal to as weak as possible. Retune for best picture. Set BUZZ (quieting, etc.) CONTROL at its mid-range position.

2. Adjust all sound takeoff and sound coupling transformers for maximum sound. Recheck. It is important that tuning prior to the gated-beam discriminator be on the button. If two peaks develop, use the peak that is highest in frequency—slug farthest out of the coil or transformer.

3. Apply a strong signal and do not retune the fine-tuning control. Adjust the quadrature coil slug for maximum sound output. Again select the higher frequency in case of two peaks.

4. Weaken signal again and set the BUZZ CONTROL for minimum buzz and noise. Retouch all adjustments *except the quadrature coil*. Readjust the BUZZ CONTROL. Retouch adjustments for maximum sound with least buzz.

5. Retune the quadrature coil with a strong signal. Repeat steps 4 and 5 until no further improvement is noted.

Most faults other than tubes also show up in alignment of the 6DT6 circuit:

1. Adjust the quadrature coil slug on a strong signal. A high-impedance voltmeter or vtvm can be connected to the test point between the quadrature coil and its series bias network (see Figs. 2 and 3). Output is roughly  $-5$  volts or a trifle less.

2. With a very weak signal (see 6BN6 alignment), adjust the slugs on

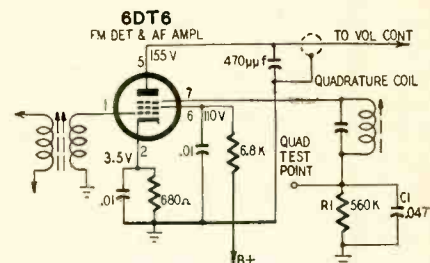


Fig. 3—Gated beam using a 6DT6 as in Magnavox V/U73-01AA.

all 4.5-mc sound takeoff coils and interstage coils or transformers. If two peaks develop, use the higher one in all cases. In tuning the sound takeoff and following interstage coil, the volume and noise will weaken on one side of the peak while on the other side the noise alone will drop immediately. Be careful to get the coil on the peak by listening for noise rather than volume.

3. Repeat steps 1 and 2 alternately until no further improvement is found.

### High hiss level

If the plate capacitor opens, the symptom will be a high hiss level. Check by shunting it. A similar condition may occur with a drop in the capacitance of the screen and cathode bypass capacitors. Check by shunting with units of roughly the same size. In the 6BN6 circuit, this high noise can arise from improper setting of the BUZZ CONTROL or from instability.

Parasitic oscillation of the 6BN6

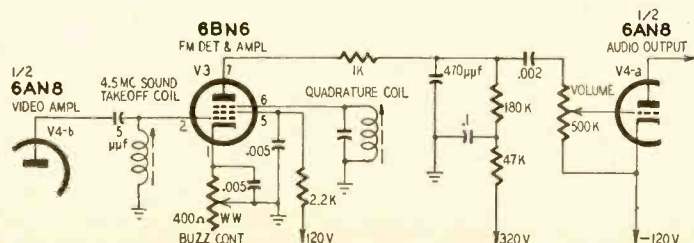


Fig. 1—The 6BN6 gated-beam discriminator in Olympic chassis.

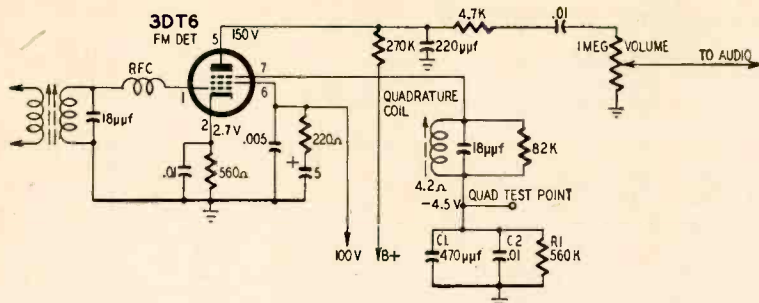


Fig. 3—The 3DT6, series-string version of the 6DT6, in Motorola TS-537.

type circuit may be quenched by a resistor in the control grid lead or plate lead or both. Value in the plate lead ranges from 820 to 1,500 ohms; in the grid lead from 47 to 220 ohms. (Note the 1,000-ohm resistor in the plate lead of Fig. 1. A 100-ohm resistor is used in series with pin 2 of the 6BN6 by other manufacturers.) One stubborn case needed a 100-ohm resistor in series with the screen lead as well. Some manufacturers shunt the secondary of the last if transformer with a resistor of about 47,000 ohms for a similar purpose. Check them in case of high hiss level not accounted for by other causes. In some cases these values will have to be increased or resistors inserted in series with other electrodes.

**Excessive buzz**

A high buzz level can result from improper alignment of all 4.5-mc adjustments except the quadrature coil. To repeat, these adjustments must be exact on a weak signal. Recheck after, and with, adjustment of the BUZZ CONTROL in 6BN6 types.

Selection of the low-frequency peak may be the cause of the buzz. If there's too much capacitance, the high-frequency peak may not be reached—a defective if transformer, shunt capacitor, tube, etc., is the cause. The alignment procedure will localize it to a particular interstage location.

Excessive buzz in a 6DT6 circuit not due to misalignment may be the result of an improper value of the cathode resistor. With aging of other components, the nominal value (even if it agrees with the schematic) may not be satisfactory. A potentiometer may be substituted for the fixed resistor and left in place as a "factory" adjustment. Use about double the value of the fixed cathode resistor; 1,000 ohms is almost always satisfactory. The fixed resistor can be doctored with another resistor in series or in shunt. Although the value for a 6DT6 is far less critical than for a 6BN6, the bias set by the cathode resistor must be such that the no signal (quiescent) operation of the tube is midway between saturation and cutoff. This insures proper limiting action, removing amplitude variations—buzz, noise, etc.

Video amplifier overload also causes an abnormally high buzz level, or an overload due to overdriving can occur in the pix detector or the video if.

Should the signal cause cutoff in these stages, the sound has holes punched in it which cannot be removed by any limiter. Co-channel interference is another cause of a high buzz level that no work on the audio proper will cure.

**Weak sound**

As usual, a defective tube is the most common cause of weak or no sound. Next in order are low electrode voltages which can be readily detected with vtvm measurements.

Misalignment of the quadrature coil will result in weak sound, or no sound in extreme cases. Suspect a defect—shorted turns, changed shunt capacitor, etc.—if the quadrature coil is far from proper alignment.

Wrong peak on the quadrature coil results in low sound level. Recheck alignment. If the higher-frequency peak cannot be reached, the capacitor or coil is defective. When replacing, check for the presence of two peaks and select the higher frequency.

Abnormal detuning of the sound trap or interstage coils will result in weak sound. These will be caught by attempted alignment.

In a 6BN6 arrangement, weak video results in weak sound. With a 6DT6 the gain is due to oscillatory amplification. This is about 3 or 4 to 1 so that good sound is obtained even with an unusable picture. For the 6DT6 to have this advantage it must break into self-oscillation on weak stations. If it cannot oscillate, the gain is lost. Check capacitors by shunting, giving particular attention to the plate and cathode bypasses. Abnormal capacitance drop of the screen bypass can stop oscillation. The damping resistor across the quadrature coil may be too small. In Fig. 3 this is 82,000 ohms. Try raising it 25% to 100,000 ohms. Do not raise its value too much as the tube is not supposed to self-oscillate on strong signals.

Improper bias applied to the quadrature grid (pin 7 of the 6DT6) due to some defect in the resistors or capacitors of the bias network will cause weak sound. Check these by capacitor shunting and ohmmeter measurement (C1 and R1 of Fig. 2; C1, C2 and R1 of Fig. 3). The bias will drop a little from that obtained during alignment to about 3 volts or so. On weak signals self-oscillation maintains this bias.

Improper electrode voltages give rise to both weak and buzzy sound, furnishing a clue to this condition and may be checked with a vtvm or vom. END

**A SHOCKING SINK**

By B. W. WELZ

ONE day a lady called me and said she was getting a shock from her sink "when I touch the hot water faucet while I have one hand in the sink. And the TV set has something to do with it, because I get a shock only when it is on."

"Psychological," I told myself as I went to her place. "Purely psychological. She thinks she's going to get a shock and she gets one. Who ever heard of anyone getting a shock off a sink? It's all in her mind."

"I never get a shock in the afternoon," she told me when I arrived. "Only in the evenings when the TV is on."

She turned on the TV set and put water in the sink to prove it. I touched the hot water faucet and put one hand in the sink, just to prove to her that nothing would happen, and I got bit! "I got a shock!" I exclaimed, probably in the same tone of voice I would have used if I had suddenly discovered I had grown another arm.

When she turned off the TV set, the faucet was harmless.

I went into the front room and wasted 5 minutes looking at the TV set and scratching my head. Then I noticed the antenna wire running up over the kitchen roof. "My husband just put up a new antenna," she told me, "on the roof, right over the kitchen."

"Investigate, Sherlock," I said and went out a bedroom window onto the roof. The TV antenna was strapped-mounted to the kitchen sewer vent.

What was happening was this: The TV chassis, although it had a power transformer, had a small voltage with respect to ground. There was no ground wire on the set. The chassis ground—through the antenna system in the tuner—appeared on the antenna lead-in. The TV antenna was grounded to the mast in the center of the elements, so this chassis ground appeared on the mast. The mast was attached to the sink, but not to earth, because the vent pipe ran into a terra-cotta sewer pipe. When the woman touched the sink and the water pipe, which ran to earth, she conducted that small voltage from the TV chassis to ground!

Solution: a ground wire on the TV chassis—and behold! no more shocking sink! END



"Now those spots before my eyes are out of convergence."

*Keep the volume down by bringing  
the speaker nearer to the listener*

# remote the TV speaker



By JOSEPH F. SODARO

**L**ARGE-screen TV sets are viewed at a distance of many feet. As a result TV sound must travel a long distance to reach the viewer. In many cases the audio distance is greater than the viewing distance and the sound reaches the viewer by reflections which increase the transmission distance. To compensate, the volume is often raised to a level uncomfortable for those in adjacent rooms. This discomfort can be minimized by moving the TV speaker nearer to the viewing area.

This should be an interesting project for the home experimenter and a lucrative side line for TV service shops. The experimenter can use his ingenuity in the way the speaker is concealed. The best location depends upon the furniture arrangement in each case. Any concealing object which protects the speaker adequately, is large enough to hold it and does not restrict the emission of sound can be used.

A service technician can work up a standard kit around one item such as a sofa pillow. This can be supplied in various colors to complement the customer's furniture. The idea can be suggested at the completion of a service call and the speaker demonstrated.

Circuit changes may be as simple as inserting a two-wire line between the output transformer and speaker. This arrangement is satisfactory in most cases and should be tried. First remove the speaker from the cabinet. Remove the output transformer usually mounted on the speaker and remount it in the cabinet. Input connections remain unchanged. Output connections are made to the remote cable. The circuit is shown in Fig. 1.

Source and load impedances should be matched for maximum power transfer. To do this would require a cable impedance of a few ohms. Ordinary lamp cord was tried and volume was not noticeably reduced when 33 feet of wire was used.

The remote cable path depends upon the arrangement of the room and type of carpeting. Wall-to-wall carpeting may make it necessary to run the cable along the floor and around doorways to reach the viewing area.

Be sure that the mounting is mechanically firm to avoid vibrational sounds. The enclosure must protect the speaker cone.

The photos show how a foam-rubber pillow pad was cut out to house the



Above—Cutting the speaker hole in a foam-rubber pillow. Left—The completed speaker mounting.

author's speaker. The speaker was placed cone downward on the pad and its outline traced. A razor blade was used to start the opening. Scissors were used to open the cavity. This opening is about half the depth of the pillow.

A small hole in the back of the foam-rubber pad accommodates the cord. The speaker cone is protected by a covering of wire mesh. After the wire mesh was fastened to the speaker with four small machine screws, the cable was soldered to the voice coil terminals and its free end was passed through the pillow pad. The speaker was pressed into the cavity. A sheet of wire mesh slightly larger than the cone area helps to make a snug fit and holds the speaker in place.

The problem of cutting and sewing up the pillow case was avoided by purchasing a removable case with a zipper on one side. The photo shows the pad with speaker being inserted into the pillow case. Afterward the zipper was pulled up except for a small opening for the speaker cord. When the pillow is placed on the back of the sofa, the cord is invisible.

With the speaker on the back of the sofa at the listener's ear, the volume can be set at an adequate level for those

seated on the sofa and at the same time hardly detectable several feet away. What a comfort to allow the children to watch TV without having the roar of hoofbeats and gunshots pounding your ears! On the other hand it's a pleasure to watch TV late at night without disturbing those in the family who are asleep. **END**

(You may not want to remove the speaker from your TV set or may want to use it together with the remote one. In that case it may be preferable to wire a second speaker to the present output circuit of your set. This is much the same as installing a rear-seat speaker in your car. See Fig. 2. Be sure that the remote speaker has the same impedance as the one in the set. —Editor)

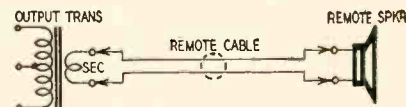


Fig. 1—Wiring the remote speaker.

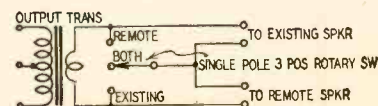
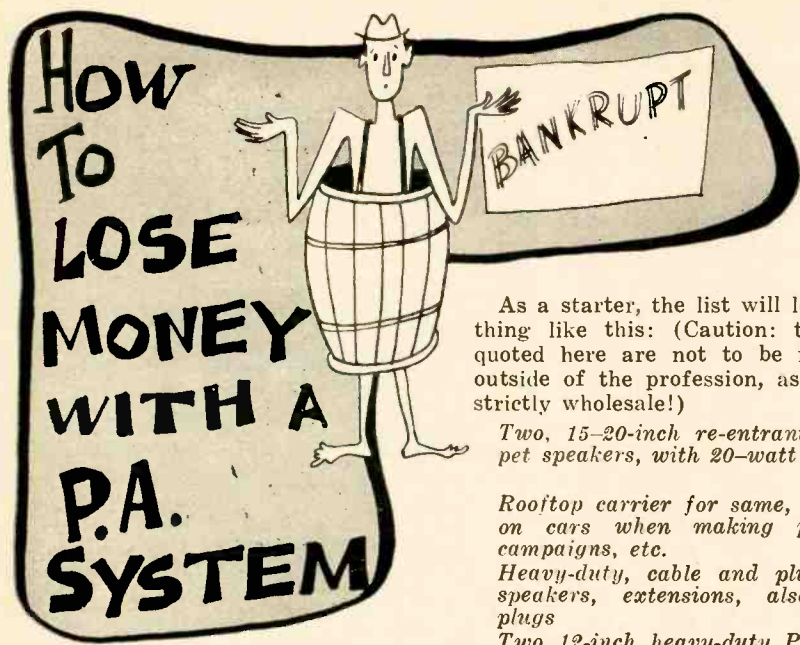


Fig. 2—Adding second speaker. Mount switch in any convenient place.

*If you want to try the PA business, don't follow this system*



By **JOHN HOWARD**

**A** GREAT many articles have been written about "How to Make Money in the — Business," "How to Retire in Five Years By —." In fact, most of the articles you read in some magazines deal exclusively with that subject—how to make money in various enterprises, all of them connected with electronics in one form or another. Public address and sound work in general has had its share—sometimes a little more than its share. The reader will, for a change, welcome a discussion of some of the actual methods used in the field by practicing technicians who are trying to *lose* money. To judge from our own experiences, no easier way can be found to dispense with some of the extra collateral which inevitably accumulates around the well-run electronics repair shop.

The procedures outlined are *not* simple; unless they are followed to the letter, you may actually find yourself making a small profit on your work. Therefore, make careful notes of these methods and procedures—they are the direct result of years of experience! If followed faithfully, they will certainly give the desired results.

In the beginning, all that is required is the desire to make a name for yourself in the PA and sound field. It's really much easier if the community is one of our smaller towns, say from 5,000 to 10,000 people. To start, you should select and purchase your equipment. This can be done easily merely by mentioning the fact to your distributor's salesman when he makes his next call. Whipping out his order pad, he will sell you, as rapidly as possible, a complete set of all the components needed to establish yourself as the leading PA and sound man in your community.

As a starter, the list will look something like this: (Caution: the prices quoted here are not to be mentioned outside of the profession, as they are strictly wholesale!)

*Two, 15–20-inch re-entrant trumpet speakers, with 20-watt drivers* \$80

*Rooftop carrier for same, for use on cars when making political campaigns, etc.* \$15

*Heavy-duty, cable and plugs for speakers, extensions, also with plugs* \$20

*Two 12-inch heavy-duty PM cone type speakers in wooden baffles, for indoor jobs* \$60

*Extension cables and plugs for these (use POSJ for this)* \$10

This takes care of the speakers. For something to drive them with, you'll need an amplifier. In the better establishments two are used, one a straight ac powered job with about 25–30 watts output, for indoor work, banquets, football games, etc. So here you have:

*Amplifier for indoor work* \$150

For mobile work, you'll need a 6- or 12-volt amplifier, or a dual-powered job with about 30 watts output.

*Amplifier for mobile work* \$150

Now, we come to the most interesting section of all, the microphones. The catalogues are full of the most fascinating pictures of these gadgets. A far cry from the simple grilled case hung in a ring of springs of Dad's day, mikes today are as varied in shape and size as women's hats. Well, perhaps not that bad, but close anyhow. The beginning sound entrepreneur will need at least two, one of the "Slim-Jim" type used by TV announcers who wave them about to make them as conspicuous as possible while ostensibly trying to conceal them, and another more conventional studio type cardioid.

*Pair of microphones* \$75

To hold these dingbats, you'll need a pair of stands, to say nothing of a "third-hand" for football games. One floor stand for dances, speeches, etc., and a short banquet stand for a table or rostrum. Add

*Mike stands* \$20

To take care of special requirements, such as the time when the elocution teacher decides that she wants to hold May Day ceremonies in the center of the football field, while your amplifier is installed in the press box, you'll need a large assortment of microphone cables: a 100-footer, a 50-footer and a

couple of 25-foot jobs. These must all be equipped with the special type plugs which can be screwed down to make either male or female plugs at will; this is so that you can string up to 200 feet of mike line for the elocution teacher, by simply joining them together. At 10c per foot and 65c per plug, for

*Cables and plugs*

\$25

Almost set to go

Now, you're almost ready to start. First though, you'll have to check the speaker plugs on the amplifiers. Due to wide variations among manufacturers of this equipment, you'll find one using the old faithful seven-prong plug, another with octals, some with Jones, some with Cannon and some with a terminal strip on the back of the amplifier. Best thing to do is change all plugs, on amplifiers and speakers, so they are all alike, with the same connections; thus, the speakers may be interchanged from one amplifier to another. Microphone plugs, too, should be the same. The screw-on or Amphenol plug has become almost standard, except among makers of electric guitar amplifiers, so that won't be too much trouble. Be sure to check these plugs to see that you can use them as either male or female plugs; remember the elocution teacher!

Now, you're ready to take the initial plunge into the sound business. You rack all your gleaming new equipment on a shelf in the shop and settle back to await the golden flood which will most assuredly come pouring in. Sure enough, it is no time at all until you get your first nibble. A cheerful soul comes bounding in the door and announces, "The Tiger's Club is having its annual minstrel show next week, and we want to advertise it all over town. Being as you're a member in good standing, I'm sure you wouldn't mind lending us your sound system, to put on a car and use on the streets!"

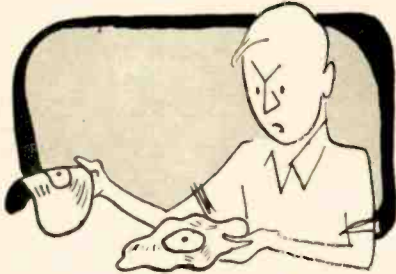
Well, figuring that this is bound to create publicity and a lot of goodwill for your budding enterprise, you agree. After all, the Tigers are made up of the best merchants in the whole town, aren't they? You load the mobile system on to this happy extrovert's car, show him how to operate it, and he goes bellowing happily off up the street. (Of course, he is suffering from the common delusion that the closer you get to a mike, and the louder you talk, the more intelligible your message is!) The growling and roaring are broken at intervals by snatches of music, from the records you have loaned him, punctuated at regular intervals by a loud rasping screech, when he turns a corner too fast, sliding the pickup across the record. Oh yes, we forgot to mention that this is in the middle of the summer with the thermometer hovering around 100°.

Three days later, the system is returned. He drives up in front of the shop and honks his horn until you come



out to take the equipment off the car and carry it into the shop. With the surly remark, "There's something wrong with the phonograph, and the whole thing doesn't have enough volume! You can't hear it across the street!" he leaves.

Carrying the equipment into the shop you hook it up for testing and discover



The records . . . resemble . . . Lily cups, with ruffles.

that there is, indeed, "something wrong with the phonograph." In the first place, the records you gave him now resemble nothing so much as a group of Lily cups, with ruffles. The phonograph needle is bent almost sidewise; evidently it has been dropped upon some hard surface. Examination of the amplifier shows a deep groove under the arm, where the pickup has been sliding back and forth out of its clamp. Checking the cartridge discloses no output at all!

With a sinking feeling, you touch the microphone input of the amplifier. A loud honk shows that it at least is working. Checking the crystal cartridge of the mike discloses that along with the phonograph cartridge it has gone the way of all good piezoelectric devices using Rochelle salt crystals that have been locked in a tightly closed automobile for several hours in the hot sun, allowing the ambient temperature to rise somewhere in the neighborhood of 160°! Replacing the phono and mike cartridges, allowing for a two-week delay while your distributor gets the special cartridge from the factory, brings the total outlay for this little jaunt, including a new needle, up to:

\$17.50

Oh, well, it's a beginning! People know you've got a sound system and you should get a lot of advertising from the minstrel show. When the show is put on, you find at the bottom of the program in very small type this line: "The Tigers Club wishes to thank all of those who have contributed to the success of this fine program."

#### Fire Department's next

They know you've got a sound system, all right! About the middle of the next week in comes another character, this time from the Fire Department, volunteer of course. He wants the sound system for the same purpose and for the same price. When you boggle slightly, he says in an aggrieved voice, "You let the Tigers Club use it last week!" Well, what can you do? He marches out with the equipment, slam-

ming it into a battered pickup truck.

Several days later it is returned. Having just begun to catch on to things, you replaced the phono cartridge with a ceramic, immune to heat—but, unfortunately, not to broken needles. Oh, well, it was only a \$1.50 needle. Hardly enough to count. He lugs the amplifier in, coated with a inch layer of yellow dust, and says cheerfully, "It worked fine!" You take a deep breath and think happily of all the kudos you've earned with the Jolly Smoke-Eaters. About now, he comes in again carrying the speakers. One of them resembles something that Mr. John of Hollywood might whip up on an off day rather than the perfectly round, gleaming gray unit you sent out. He remarks, "We had a little hard luck with this. One of the boys ran under a low limb on the way to a fire and knocked it off. You can straighten it out easy, it's soft!" and leaves, whistling loudly.

After replacing the needle, you disassemble the damaged horn, thankful that the bell *was* made of spun aluminum, and take it to a body shop. The happy mechanic charges you only \$7.50 to roll it out and repaint it. But, you are quite philosophic about it. This time you got off for only:

\$9

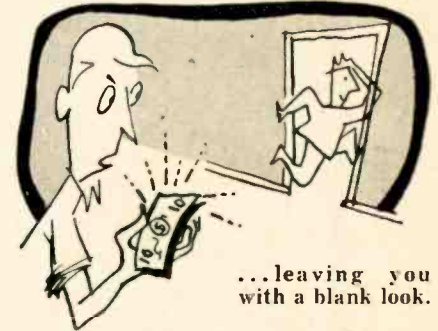
By this time, you feel that perhaps everything that *could* happen has already happened and that you'll be bound to come up with something in the way of earnings pretty soon. Sure enough, here comes another potential customer, a sharp-looking cookie who inquires, "Do you have a sound system for rent that I can use on a car?" After you come out of the initial shock, you tell him that indeed you have and that it is of the finest, etc. and immediately available. It seems that he is introducing a brand-new kind of insurance and wants to attract attention to the general excellence of his policies. You mention that the system rents for \$10 a day. To your utter astonishment this seems to come as no shock to him and he says he'll use it for about two or three days.

Still in something of a daze, you mount the equipment on his shiny car and check him out on the operation. It works beautifully, and he is very pleased with it. During the next two days you hear him running up and down the street, peddling his wares. For a wonder, he has at least a smattering of an idea of how to use a microphone and there are times when you can almost tell what he is saying! The days go on, and you're happily counting up the profits; five days, then six, then a week, while your eyes get bigger and bigger. Who knows, maybe you'll make enough out of this one job to make up for some of the other fiascos!

Eleven days after he picked up the system, he brings it back. You unload it from the car and both go into the shop to settle up. You begin by saying, "Well, you've had it 11 days. Now let's see, that would be—" you hesitate for

effect only; you know exactly what 11 days would be! \$110! You've counted it up in your head too many times!

At this point he interrupts. "Yes, I know. I had it about a week but, you see, I only actually used it for *two days!* I've been out of town the rest of the time! So, I owe you for two days."



...leaving you with a blank look.

Before you can think of enough arguments, he has handed you two \$10 bills and departed, leaving you with a blank look.

#### Profit? At last

After you get your mouth closed, you wander into the shop with the two tens clutched tightly in your hot little hand. At last! You have actually rented the sound system and made some money from it! Maybe life's not so bad after all! As we often do in life, you have had quite a come down, from \$110 to \$20, but what the heck. At least the darned thing has made you some money!

Admiring the two ten-spots, you lay them on the bench so you can see them, and start to put up the equipment. You get the amplifier about halfway back on the shelf, when something peculiar about the battery cables catches your eye. That old sinking feeling comes back and you examine them closely. Sure enough, there are two distinct arc marks on them! A few strands of copper wire are caught in the perforations on one clip. You hook the amplifier up to the shop battery and try to operate it. And silence prevails; no buzz, no light, no nothing.

With your heart back in your mouth, you pull the cover from the amplifier and test one of the 6L6's. Dead. You test the other, also dead. A complete check of the seven tubes shows every one blown out. Along about now, you begin to realize what has happened; some jerk has applied 110 volts to the *battery clips!* Another horrible thought enters your mind: the heavy-duty horizontal vibrator with which this hunk of electronic apparatus is equipped! Checking, you're very relieved to find out that it is still all right; the designer *was* thoughtful enough to include a fuse in that circuit, which has obligingly committed hari-kari but protected the very expensive vibrator.

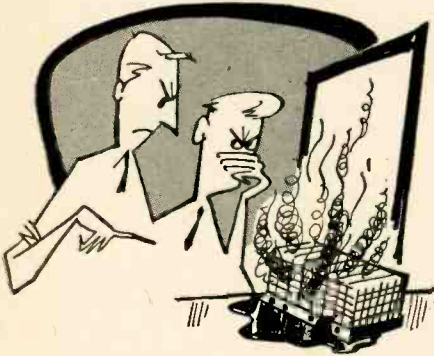
Later that day you manage to corner the insurance salesman and finally wring the admission from him that he had left the equipment at the house while he was out of town and his little brother might have been fooling with it! After this understatement, he

## AUDIO—HIGH FIDELITY

promises to pay you in full for the damage and you part friends. (Note: He left town the next day and hasn't been seen since!) As a totally irrelevant thought you wonder how in thunder this juvenile delinquent had managed to get the 6-volt battery clips into a 110-volt socket! This mystery is still unsolved, but the inescapable fact remains that he *did* do it!

Total income from job \$20  
7 tubes, two pilot lights, fuses,  
net \$17.50

You replace the blown tubes and check the equipment out. For a wonder, it still works and you congratulate yourself on owning a very durable piece of equipment. With the amplifier back in shape, you wonder what's going to happen next. You're not left in doubt for long. Into the shop gallop a pair of presumably male teen-agers, com-



... obviously gone!

plete with ducktails, etc. They address you in an unknown tongue. After some small confusion, you finally extract from the maze of "Cool, man!" and "Daddy-O" the fact that they are giving a dance for the Junior Class at the High School and *they* want to use your precious sound system to ballyhoo up and down the street!

You open and close your mouth a couple of times and they, with the lightning reaction speed of youth, take this for assent. Flinging your hundred dollar's worth of bugles atop a peculiar-looking piece of automotive equipment resting near the curb, they roar off down the street with a screech of burning rubber. You can't look; you just shudder and walk limply back into the shop where you try to take your mind off of the probable horrid fate of your PA system by working on a couple of intermittents.

The next day, bright and early, you get the surprise of your life. The same two characters come dashing in, carrying the system and ask, "Where do you stack it, Pops?" You gesture feebly at the shelf, and they stow it away, with all the cables neatly tied in bundles.

At the end of another session of bop talk, you finally get the totally unbelievable message that they are trying to *pay you* for the use of it! This is so unnerving that you hear a strange voice croaking, "That's all right, boys. Glad to help the Junior Class out!" and it turns out to be yours!

With a cheerful "You're the most,

Daddy-O!" they are off again in another cloud of burnt oil. With the gravest of misgivings you pull the set down and check it out only to find it in absolutely perfect shape. Not the slightest damage! This throws you into a state of mild shock and you totter off to the coffee shop, to restore your shattered nerves.

### What next

A few days later, you get a call from the manager of the Chamber of Commerce. He wants to discuss your sound system. The old familiar chills start down the back but you manage to ask him just what he wants. It seems that the local merchants are having a series of Appreciation Days, which turns out to be a giveaway affair with coupons good for certain amounts of merchandise given away. This goes on every Wednesday afternoon. Further questioning elicits the fact that it will take you about 30 minutes, in his opinion, and you are expected to act as master of ceremonies at the giveaway drawing and to ballyhoo the main streets of the town for 30 minutes beforehand, to draw the expected crowds to the site of the drawing. Much to your surprise, he actually expects to pay you for your participation in this affair! You finally find out that the \$10 you ask for will be paid, not in coin of the realm, but in the merchandise certificates. Oh, well, your wife can always use them on that ungodly big grocery bill, so you accept.

Comes the day of the first drawing. You've set up your ac system in a store behind the platform in the street where the barrel and tickets are located. With the mobile system, you make several runs up and down the business district before the appointed hour. Running with the car windows closed, to avoid feedback from the speakers, in 90° heat, you're just a mite soggy when you arrive at the platform but you make it up on the platform all right. Wringing out your shirt as much as possible, you begin to make the necessary announcements in your best Andre Baruch manner. Just as you reach the climatic moment and are about to read the number from the winning ticket which the ubiquitous small boy has just drawn from the barrel, there ensues a ghastly silence. You tap the mike, nothing. With the amplifier inside the store, and only a long mike cord out to the platform, you are faced with the problem of getting through the 127,963 people jammed between you and the store, and then back again.

Figuring that the ac amplifier has blown a fuse, you reach into the car for the mobile system's mike, after coaxing a helpful bystander to turn it on. The initial result of this is a deafening yawp! from the speakers as you forgot to turn the gain down and the speakers are as usual located about 2 feet behind the mike. After some screaming and scrambling, complicated somewhat by the fact that you're ineffectively trying to muffle the mike

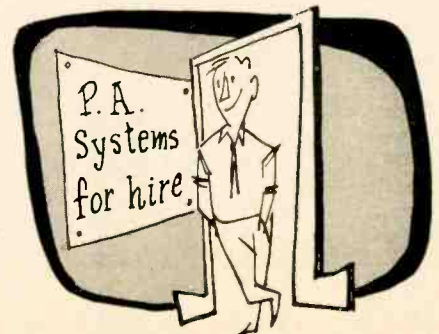
with your hand, you manage to get the gain down to a usable level and proceed with the drawing. The winning ticket meanwhile has been dropped and is finally discovered lodged in your pants cuff. Among numerous dirty looks from nearby spectators, you read the number. Not there.

This goes on for quite some little time; the holder of the ticket you draw is not there. After about 30 minutes, you finally succeed in giving away all the coupons and you scramble thankfully down from the platform, mopping your streaming brow, to shut off the PA system. As soon as the crowd has drifted away sufficiently to open a path to the store, you make your way into the front to pick up the dead amplifier. As you open the door, you are greeted simultaneously by the manager's dreadful scowl and a sickeningly familiar odor! (The odor in his store is what causes the scowl.) You rush to the amplifier too late and find it sitting there in a small puddle of liquid tar. Tiny whorls of smoke are still drifting lazily up through the vents on top of the case. There is no need to go into more gruesome details; the power transformer has obviously gone.

Picking up the pitiful corpse in your arms and assuring the store manager that you will be glad to pay for the window carpeting ruined by the tar, you take the amplifier out to the car. Taking down the speakers and rolling up the mike cables, noting that someone has apparently shut a sharp-edged door on one in the middle, you prepare to depart. I say, prepare to depart, for the car's battery, suffering under the heavy load imposed by the mobile sound system's 30 amperes for over an hour, has quietly expired. It will not even blow the horn!

At this point, we will quietly draw the curtain over the rest of the day's activities, for there are limits to the amount of human suffering that one can witness unmoved. For readers with a mathematical bent, we suggest adding up the sums italicized on these pages. This will give you some idea of what a howling success a sound business can be, literally and financially, and cause you to wonder if you have after all made a Sound Investment!

(Note: We're only kiddin! I have made lots of money out of sound, even though not one of the events narrated above is fictitious! It's been strenuous, but it's been fun!) END



# 60-watt Amplifier uses new KT88's

*Ultra-Linear circuit makes good use of a new British power pentode*

By LARRY STECKLER

**A** FEW weeks ago, while running through the April issue of our British contemporary, *Wireless World*, we came across an article on a 50-watt (British watts, that is) hi-fi amplifier on page 158. This amplifier was designed by W. Jan Heath of the British General Electric Co. and G. R. Woodville of the M-O Valve Co. It uses Genalex KT88's (see *New Tubes*, page 126, *RADIO-ELECTRONICS*, March, 1957) for its push-pull output and appeared so interesting that we decided to present it to our readers.

Among the more interesting features is the fact that this amplifier is practically push-pull throughout. Symmetrical input to the output stage is provided by the two triodes of a 12AU7, thus preventing unbalanced operation. The phase-splitter, a 12AX7, uses a see-saw circuit, the output of which is also essentially push-pull.

## Stabilizing circuits

The unusual appearance of the circuitry between the 12AX7 and the 12AU7 is due to inclusion of special stabilizing circuits. Instability in feedback amplifiers occurs mainly at the high and low ends of the audio spectrum, with low-end instability the most troublesome. By arranging phase shifts to occur at different frequencies, low-frequency peaking which might introduce such instability is reduced. For one thing, coupling capacitors are made large enough so phase shifts due to them are at a lower frequency than that due to the output transformer.

Another special circuit reduces the gain of the amplifier at the very low frequencies where feedback usually results in motorboating or ringing. This is the purpose of the networks composed of R13, C7 and R17 and R16, C-10 and R19.

A small capacitor (.005  $\mu$ f in this case) shunted by a high-value resistor is connected in series with the second-stage grid resistors R17, R19, forming a voltage divider across the first stage output. Since the second stage receives part of its signal through the capacitor and part through the resistor, the signal is greatly attenuated at the lower frequencies. Since the circuit then becomes essentially resistive, phase shift is also greatly reduced. The resistance shunting the capacitor is 10

times that of the grid resistor, resulting in a 10-1 gain reduction on the lowest frequencies.

High-frequency peaks which may cause instability are usually due to resonances in the output transformer. Such peaking has been taken care of in this amplifier by stabilizing circuits consisting of resistors and capacitors in series (C8-R14 and C9-R15) shunted across the 12AX7 plate load resistors R10 and R11. The values of the components in these circuits will depend somewhat on the frequency of the lowest important peak in the high-frequency response.

Before describing this unusual new amplifier, our first step was to make sure you could get all the parts for the unit. Everything appeared to be fairly standard except for the output transformer. We had a lot of specifications but couldn't find an American output transformer to fit.

The nearest was the Acro TO-340. As it was not an exact duplicate we called Herbert I. Keroes at Arco and told him of our problem. He offered to build a prototype amplifier for us, using the Acro TO-340 and following the British circuit as closely as possible.

About two weeks later a large cardboard box, marked fragile, was delivered to us, containing the amplifier. Mr. Keroes had delivered. Accompanying

the package was a letter describing his results.

## Circuit specifications

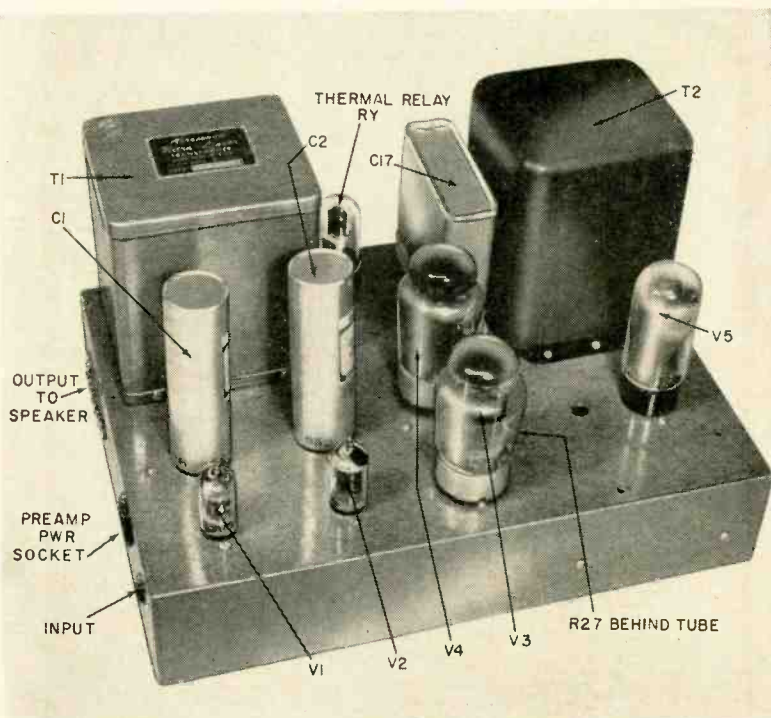
The Ultra-Linear circuit delivers 60 watts with a 0.5-volt input. It uses the new KT88's, power pentodes with maximum anode-plus-screen dissipation ratings of 40 watts.

The first thing to strike our eyes is that rating of 60 watts—10 more than *Wireless World* had stated. Intermodulation distortion measures 1% at 61 watts and 0.65% at 49.6 watts.

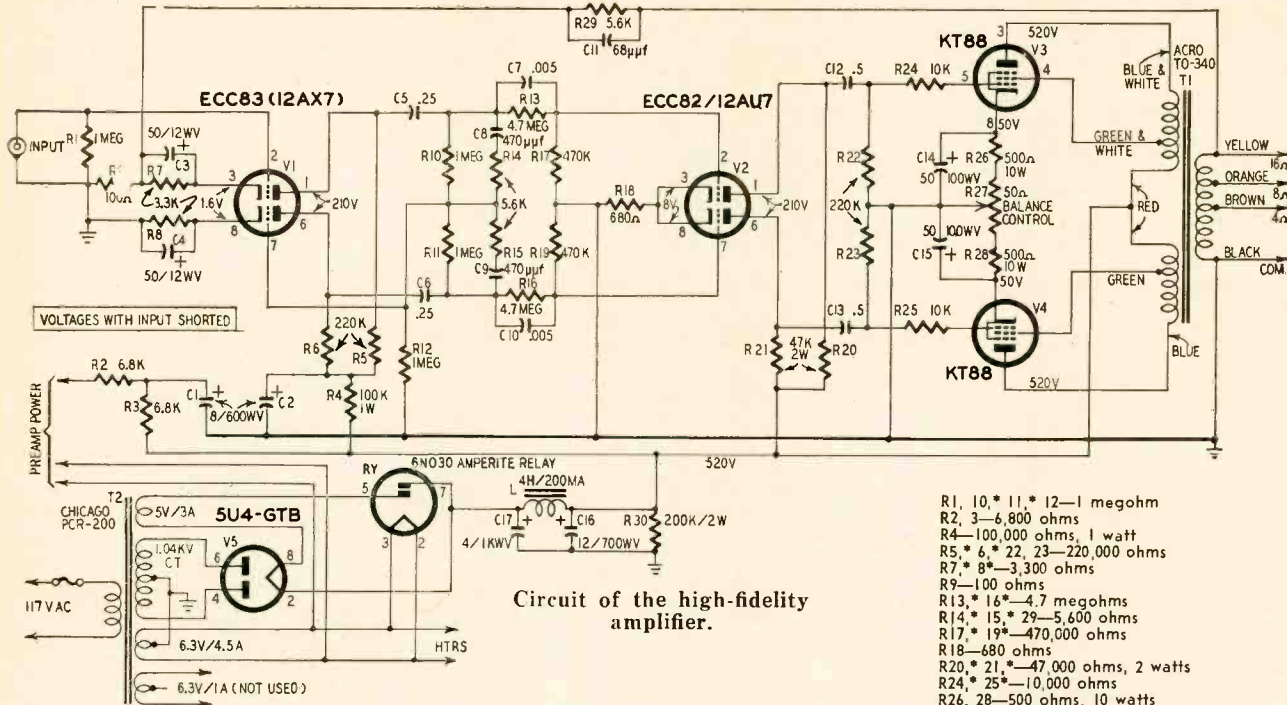
"It was found advantageous," Mr. Keroes wrote, "to increase the high-frequency stability margin of the amplifier by lowering R14, R15, the original 10,000-ohm resistors in the grid circuit of the second stage, to 5,600 ohms with a consequent improvement in square-wave response."

"Although the authors of the original article did not advocate it, a 68- $\mu$ f capacitor was installed across the 5,600-ohm feedback resistor. This eliminates almost all ringing on inductive or capacitive loads, which they warn against in the original article."

"Regarding our measured results on the amplifier," he continued, "we obtain at 1-watt output a frequency response curve similar to the original at the low-frequency end [flat from below 20 cycles]."

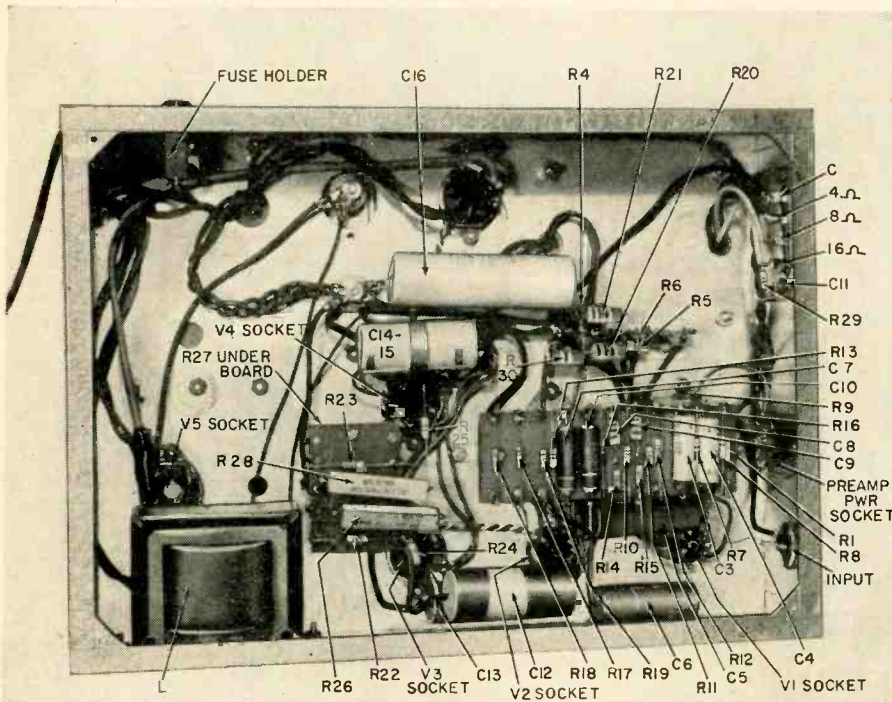


The completed KT88 amplifier.



Circuit of the high-fidelity amplifier.

- R1, 10,\* 11,\* 12—1 megohm
  - R2, 3—6,800 ohms
  - R4—100,000 ohms, 1 watt
  - R5,\* 6\* 22, 23—220,000 ohms
  - R7,\* 8\*—3,300 ohms
  - R9—100 ohms
  - R13,\* 16\*—4.7 megohms
  - R14,\* 15,\* 29—5,600 ohms
  - R17,\* 19\*—470,000 ohms
  - R18—680 ohms
  - R20,\* 21\*—47,000 ohms, 2 watts
  - R24,\* 25\*—10,000 ohms
  - R26, 28—500 ohms, 10 watts
  - R27—pot, 50 ohms
  - R30—200,000 ohms, 2 watts
- All resistors 1/2 watt unless noted  
 C1, 2—8µf, 600 volts, electrolytics  
 C3, 4—50 µf, 12 volts electrolytics  
 C5,\* 6\*—0.25 µf, 600 volts  
 C7,\* 10\*—0.05 µf, 600 volts  
 C8,\* 9\*—470 µµf, tubular ceramic  
 C11—60 µµf, disk ceramic  
 C12,\* 13\*—0.5 µf  
 C14,\* 15\*—50 µf, 100 volt, electrolytics  
 C16—12 µf, 700 volt, electrolytic  
 C17—4 µf, 1,000 volt, electrolytic  
 L—choke, 4 h, 200 ma  
 RY—Relay, thermal delay (Amperite 6N030)  
 T1—Acro TO-340  
 T2—Power transformer (Chicago PCR-200)  
 V1—ECC83/12AX7 (Amperex)  
 V2—ECC82/12AU7 (Amperex)  
 V3, 4—KT88  
 V5—5U4-GTB  
 Miscellaneous hardware  
 \*Matched components where possible



Underchassis view shows parts layout. Terminal boards aid in simple construction.

"With the modified high-frequency compensation, there is no peaking in the 100-to-200-kc region, as found in the original, and we obtain a response curve with a smooth rolloff that measures 1 db down at 40 kc, 2 db down at 80 kc and 3 db down at 105 kc.

"Full power output in the mid-band is exactly 60 watts at sine-wave clipping. At 20 and 20,000 cycles, power response is 1 db down, or 48 watts."

Some modifications in the original circuit were found desirable with the American components. Among these was the use of a Chicago Standard PCR-200 power transformer. The high-voltage winding is 20 volts higher than

specified but seems to cause no difficulty. It has an extra 6.3-volt 1-amp winding which is not used.

A thermistor was used in the British version to delay application of B voltage until the heaters had warmed up. An equivalent was not available and an Amperite 6N030 thermal delay relay is substituted. As this relay has a 6.3-volt heater you may prefer connecting it to the unused transformer winding.

Feedback resistor R29 is corrected to give 22-db feedback with the Acro TO-340. Screen resistors were not found necessary and were eliminated since they waste output power. Para-

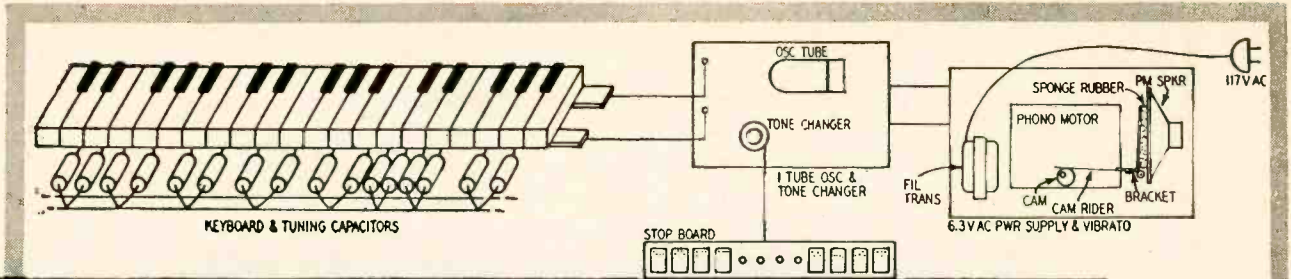
sitic suppressors in the grid circuit of the driver stage were also found unnecessary and caused square-wave overshoot. These, too, have been left out.

### Amplifier construction

The unit is built on a 14 x 9 x 3-inch chassis. Heater wiring should be completed first, with twisted twin leads laid along the bend of the chassis. Tube sockets are positioned to avoid having heater wiring crossing grid wiring.

The signal input leads should be kept as short as possible. A single ground point is selected and all ground connections are made at that terminal. Terminal boards are used for mounting resistors and capacitors. They are helpful but not absolutely necessary. Point-to-point wiring with short, direct leads would be just as good, and would probably have been used had a second model been constructed.

Construction is straightforward and should not present any problems. Reasonably careful construction should result in a satisfactory amplifier. END



# Simplest Electronic Organ

By HAROLD C. HUBBARD

Part II — Construction details guide builder of this unusual musical instrument

If you built the basic oscillator and tone-changer circuits as recommended last month, you will no doubt be waiting patiently for construction details so you can finish the job. We showed how a simple vibrato can be made by fastening a small Alnico magnet to a piece of flexible steel strip and letting it vibrate in the field of the oscillator transformer.

A vibrato based on this principle produces the most pleasing effect. In practice, the magnet is moved to and fro in the transformer field by a motor-driven cam as in Fig. 6. I used a 350-rpm synchronous timing or clock motor (Flexo-Action model SG15; Soundtronics Labs, 630 Arch St., Philadelphia, Pa.). You have a certain latitude in selecting the speed and type of motor because vibrato speed, like music itself, is a matter of personal taste. The motor specified has a small concentrated field but must be shielded from the oscillator transformers. One disadvantage of this method is that the vibrato will have to be on constantly because the instrument sounds sharp without it. When the Alnico magnet approaches the transformer from a point of rest, it always flats the note being produced. So, if the circuit is tuned with the vibrato at rest, the note will flat at vibrato speed and the ear will interpret the average between the two as the true frequency, thus all tuning will be with the vibrato on.

The second type of vibrato and the easiest to build is shown along with the heater supply in Fig. 7. Any slight varying voltage injected into the oscillator causes phase and amplitude modulation. One of the simplest ways to inject such a voltage is to insert the voice coil of a small PM speaker into the cathode lead. The addition of the slight inductance and resistance of the voice coil will not affect the oscillator,

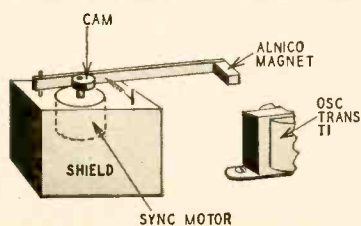


Fig. 6—Construction of one type of vibrato that can be used.

but it is enough to generate an ac vibrato voltage when the speaker cone is moved in and out mechanically. In this unit this is done by a cam mounted on the idler wheel of a 78-rpm phono motor. Each revolution of the cam causes a pivoted L-shaped sheet-metal bracket to press a wad of sponge rubber against the speaker's cone. Study the construction in Fig. 7. Note well that a heavy sponge-rubber shim (cut from a kneeling pad) is used between the motor and its mounting strap. The motor is the type of replacement unit that has been featured in mail-order catalogs and costs around a dollar. This motor and a 3- or 4-inch PM speaker make an inexpensive vibrato. A speaker with a heavy magnet is recommended here.

This type of motor produces a vibrato that is a little slower than usual but very nice for solo work. It also gets away from any tendency for the vibrato to sound like wow or sour on rapid runs as is true of some musical instruments. Also, it can be turned off without affecting the tuning.

## Keyboard

Perhaps you will wish to purchase double-contact keys from an organization selling organ kits. If not, the actual

construction of keys is not too difficult. You can use the spring-leaf contacts used for relays with keys from new toy pianos. These toys have hollow plastic keys, both white and black, and will stand rough treatment. Most of these pianos have at least two octaves of keys and sell for under \$5. At \$2.50 an octave, keys can be considered inexpensive.

A small drilling fixture can be made to insure that the keys line up on the 3/16-inch diameter shaft as shown in Fig. 8. This also shows the type of toy and keys used.

Double keying contacts must be used, one making contact slightly before the other. The one making contact first selects the frequency desired, the other starts the oscillator. If you desire the most in economy, spring wire can be used to form the contacts as shown in Fig. 9.

The spring wire can be easily bent and shaped as shown at *a* and inserted into the hollow key. A plastic insert or block is pressed into the key on top of the wire and speaker cement holds all the parts in place. After it is dry, nip section A-A out of the hairpin loop in Fig. 9-c. This leaves two connections to key contacts. When the key is installed, one contact loop extends out

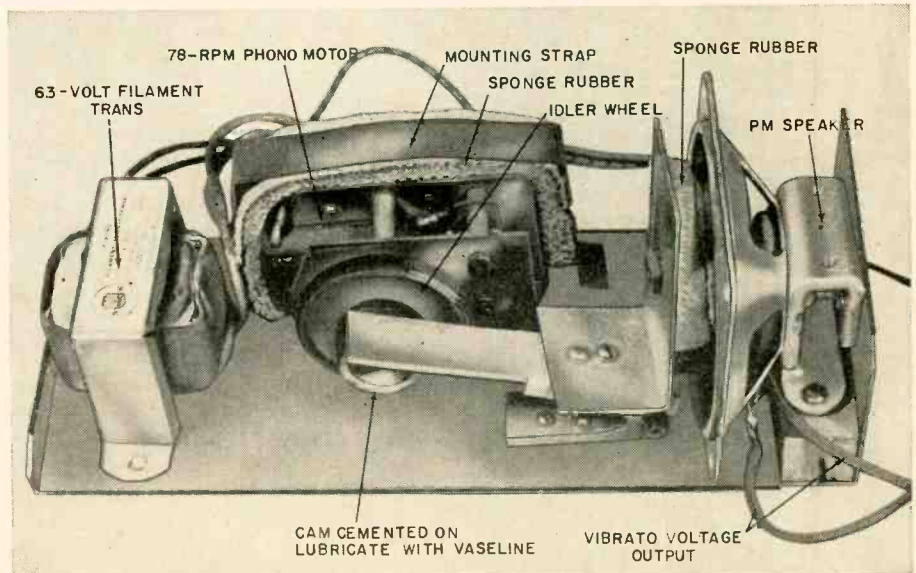
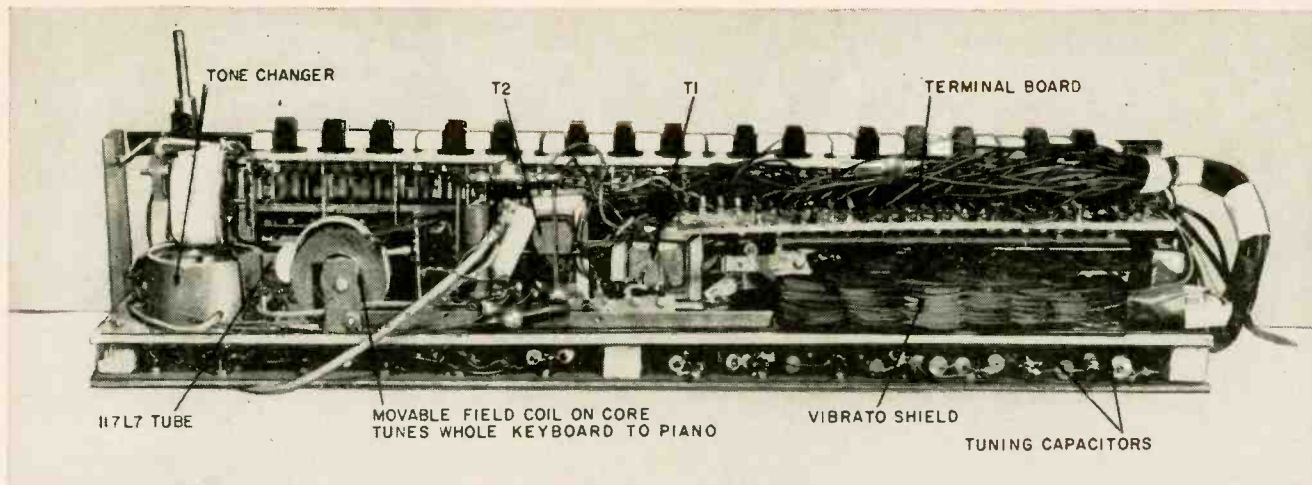
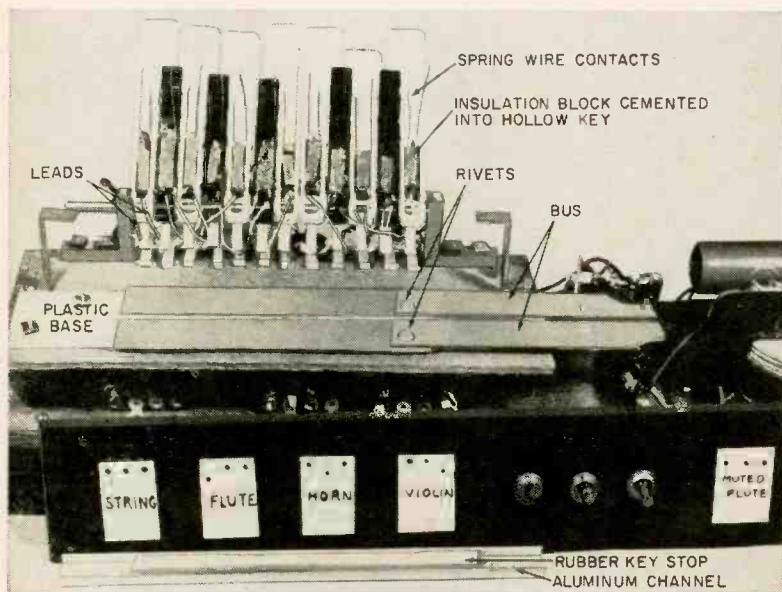


Fig. 7—The simplest vibrato for satisfactory performance.



Rear view of 3-octave organ using vibrato of Fig. 6. Alnico slug (not visible) moves in field of transformer T1.



Instrument with keys raised to show construction and keying buses.

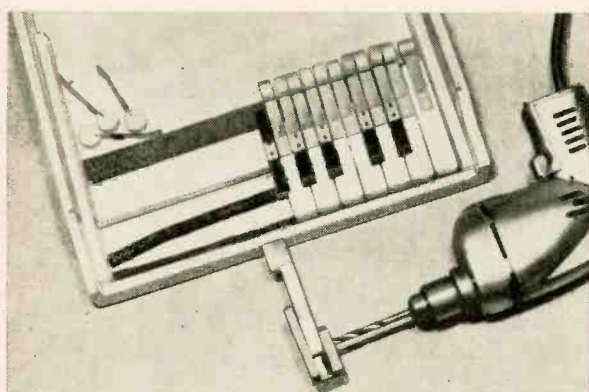


Fig. 8—Keys are from toy piano. A drilling jig insures pivot holes in perfect alignment.

from the other so each can touch a separate bus (b).

**Keying circuits**

The cathode-grid resistor bus should be well insulated. High leakage here can cause trouble. The bus is mounted on plastic sheeting in the instruments shown. The tuning capacitors (C1 to C36, Fig. 3, Part I) are mounted under the keys as in the photos and in Figs.

1 and 2 (Part I). They are in series and only the lower note of any two or more keys pressed simultaneously will sound. The approximate values are given in Fig. 2. They will run very close to the values you will use, except perhaps in the highest octaves.

A piano may be used when tuning the organ. C1 is adjusted so C of the first octave is in tune with the piano. C2 through C36 are selected and padded

one at a time to tune successively higher notes. A substitution box of small values will be handy in this operation. A capacitor of around 100  $\mu\text{f}$  can change a note from "barely acceptable" to "on the nose."

If you use transformers other than those recommended in the parts list, you may have to add a variable inductor (L1) so tuning capacitors—particularly those for the lower notes—will tune to or close to the correct frequency. L1 may consist of a Waldom 1,000-ohm replacement type speaker field coil fitted with an adjustable iron core or slug.

No volume control has been shown, but one should be used for expression. A foot-pedal type or a knee arm can be added as in standard practice. The ideal would be for the knee or foot action to move the signal coil away

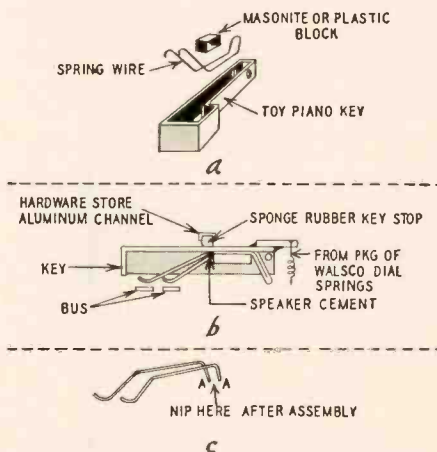
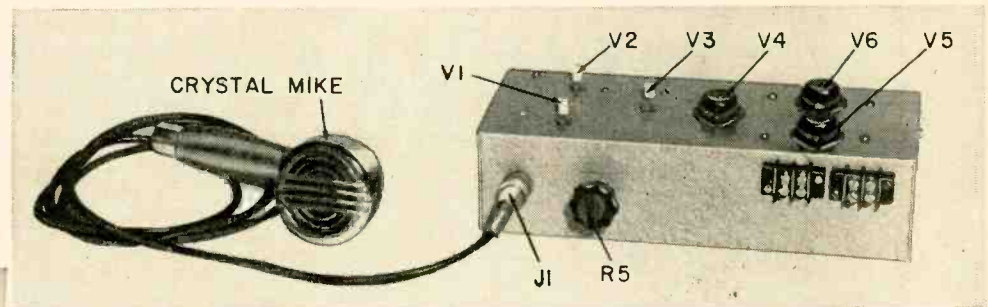


Fig. 9—Key construction. Hairpin wire loop and block (a) are cemented in key (b) loop is snipped (c) and key is ready for installation in keyboard.

from or close to the pickup coil. A control of this type is used in the 3-octave in the photograph in last month's installment. This type of control would not be likely to wear out nor become noisy or defective. This would limit service on parts to the one tube which lasts a long time in the absence of any high voltage. In the present instrument the tube is nearly 3 years old and has never affected the tuning. END

*This amplifier for the mobile ham will also interest audio enthusiasts.*



Completed unit with crystal mike attached.

## 6-transistor amplifier-modulator delivers 10 watts

By BILL HAMLIN, W1MCA \*

**T**HE new 12-volt automobile electrical systems and inexpensive transistors make a transistorized modulator practical. With a suitable output transformer, this might make a good amplifier for a mobile PA system or wandering audio fan.

It would be nice to have a completely transistorized mobile rig, but unfortunately transistors are not yet suitable for high-power rf applications. So the best we can do is use transistors in the audio section of our mobile phone. High-power transistors operate very nicely from the 12-volt system and this power-packed amplifier will deliver up to 12 watts of audio, enough to modulate fully a 20-watt rf amplifier.

A transistor modulator not only increases the overall efficiency of operation but also saves valuable space. Besides the advantages of an all transistor modulator, it is fun to build and use.

The cost of the unit is not high. Transistors designed for use in automobile radio receivers are available at a low price. The total transistor cost is only \$21.50. All parts are standard and readily available. The power transistors are CBS 2N255's and CBS 2N256's. Of course there are other available transistors that will do the same job.

Power obtained from the modulator depends a great deal upon proper matching to the rf section and on the modulation transformer design. A special transistor modulation transformer is available. An ordinary universal power output transformer for tube to speaker could also be used. The speaker winding would be connected to the transistors and the tube-plate winding to the modulated rf stage.

Using the transformers specified, a perfect match is obtained with a 3,000-ohm load. With such a close match, over 12 watts of audio output is available for modulation.

The usual load, when modulating a 2E26 or 6V6, is about 3,750 ohms. The

slight mismatch to the transistors decreases the power to about 10 watts. It is somewhat self-regulating as heavier loads increase modulation power available.

### Construction hints

The modulator is built into a 10 x 4 x 2½-inch channel box. If a smaller chassis is desired, 2 inches can be cut off the length and ¾ inch off the depth and still leave enough room. Most of the unit's weight and bulk are in the transformers.

Looking at the under side of the unit (see photos) from left to right: The input stage is at the top; the second transistor stage at the bottom; the third amplifier stage is centered to the right of these; next the driver transistor followed by the driver transformer; the push-pull power output transistors between the two transformers and finally the modulation transformer at the extreme right.

The voltage-amplifier transistors are plugged into standard three- or five-pin transistor sockets. The power output transistors are bolted to the chassis through an insulator. The collectors of these transistors are connected directly to their copper flanges, therefore the flange must be insulated from the chassis. Anodized aluminum insulators of the type found in the new hybrid automobile radios were used. If these special insulators are hard to get, use heat radiators in the form of plates, miniature open-end chassis, or Miniboxes, which must be insulated from the chassis. The optimum size for each plate would be a 6 x 6 x ¼-inch aluminum sheet or equivalent area of Minibox. The radiators could be mounted vertically with the transistors bolted to them to save chassis space.

Sockets for the power transistors present no problem. A nine-pin miniature-tube socket has the right spacing between opposite terminals to fit the transistor pins properly. The ends of these sockets were sawed off to fit into

a smaller space. Of course, sockets used in the automobile transistor receivers would be fine. They are available as replacement parts for these radios.

All other items in the modulator are standard components. Electrolytic capacitors are miniature type units. Coupling capacitors of 1 μf are used, but larger values will provide better low-frequency response. Some motor-boating was experienced with larger sizes—such as 5 μf—between each stage, when using a dry cell or electronic A supply. This does not occur with a wet-cell battery.

An on-off switch may be installed in the positive battery lead if desired. It was not included because an external relay controlling the dynamotor for the rf section also turns on the modulator.

### Modulator circuitry

The circuit has two variations. First, as shown in the photographs, three voltage amplifier stages are used ahead of the driver transistor. They are necessary when either a dynamic or crystal microphone is employed (see Fig. 1). If a carbon microphone is used, eliminate the first two stages. This leaves one voltage-amplifier stage, one driver stage and a push-pull output stage. The alternate circuit is shown in Fig. 2.

When using a carbon mike, a microphone transformer or other suitable transformer with a high impedance ratio should be employed to match the base of the 2N180 transistor. An impedance ratio of 200 to 10,000 ohms matches the mike to the transistor base fairly well.

Other transistors can be used in the various stages of this unit. Not all of them give the same voltage gain or power output. Substitutes for the 2N180 are the 2N107, GT222 and CK722. The 2N180 is preferred because of its high amplification. The 2N255 and 2N256 power transistors are inexpensive types especially designed for experimenters. In place of these, the automobile type 2N155 or 2N176 may be used. The de-

\* Supervisor of Technical Information Service, CBS-Hytron

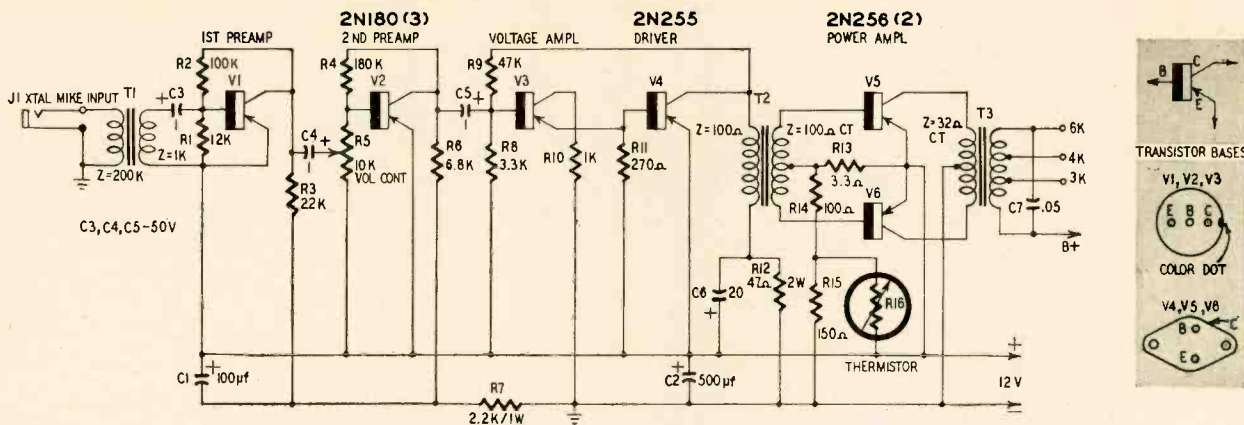


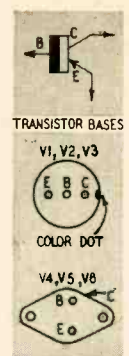
Fig. 1—Circuit of the 10-watt amplifier-modulator.

- R1—12,000 ohms
- R2—100,000 ohms
- R3—22,000 ohms
- R4—180,000 ohms
- R5—pot, 10,000 ohms
- R6—6,800 ohms
- R7—2,200 ohms, 1 watt
- R8—3,300 ohms
- R9—47,000 ohms
- R10—1,000 ohms
- R11—270 ohms
- R12—47 ohms, 2 watts

- R13—3.3 ohms
  - R14—100 ohms
  - R15—150 ohms
  - R16—Thermistor, 100 ohms, ±10% at 25°C, temp coefficient 3.7% per °C (Veco 21W1 or equivalent); with mounting kit, Veco A 815 or A 818
  - R17—220 ohms
- All resistors 1/2 watt unless noted
- C1—100 µf, 25 volts
  - C2—500 µf, 25 volts
  - C3, 4, 5—1 µf, 50 volts
  - C4—20 µf, 25 volts
  - C7—.05 µf, 600 volts

- All capacitors except C7 miniature electrolytics
- J1—Microphone jack
  - T1—Microphone transformer; primary, 200,000 ohms; secondary, 1,000 ohms (Argonne AR100 or equivalent)
  - T2—Interstage transformer; primary, 100 ohms; secondary, 100 ohms ct; 50 mw (Triad TY-61X or equivalent)
  - T3—Modulation transformer; primary, 32 ohms ct, 575 ma; secondary 6,000—4,000—3,000 ohms; 10 watts. (Triad T-65Z or equivalent). Or Audio output transformer; primary, 32 ohms

- ct, 575 ma; secondary, 16—8—4 ohms; 10 watts (Triad TY-64X or equivalent)
  - T4—Microphone transformer; primary, 10,000 ohms; secondary, 200 ohms (Triad TZ-25 or equivalent)
  - V1, 2, 3—2N180
  - V4—2N255
  - V5, 6—2N256
- Chassis, 10 x 4 x 2 1/2 inches, channel box
- Sockets, 3- or 5-pin transistor (3)
  - Sockets, 9-pin miniature (3)
  - Crystal or carbon mike
  - Terminal strips, barrier type (2)
  - Miscellaneous hardware



sign shown is optimized for the 2N255, 2N256, or 2N155 transistors.

The first and second amplifier stages in Fig. 1 have very high gain and must be treated accordingly to avoid instability and oscillation. As automobiles with a 12-volt electrical system have a negative ground, the negative terminal is connected by a single wire to ground from the microphone input and bypass capacitor C2.

An input transformer is required for crystal microphones to prevent instability. Bypassing with a very large capacitance (5,000 µf or more) will stabilize the circuit, but a transformer is less bulky.

Notice the thermistor in the power output stage bias circuit. It stabilizes the collector cutoff current and prevents the output transistors from running away under high temperature conditions. A thermistor insures against de-

struction when operating at full output, especially when there is possibility of excessive temperatures (over 151°C on the surface of the case). A Veco 21W1 themistor has the correct resistance (100 ohms) and temperature coefficient (-3.7% per degree C).

The output impedance of one power transistor is approximately 6 ohms and the collector-to-collector impedance is approximately 24 ohms. To match these impedances to the rf load a Triad TY-65Z modulation transformer or multitap speaker transformer may be used. We used a speaker transformer that has a 16-ohm center-tapped winding. It has common, 4-ohm, 8-ohm and 16-ohm speaker connections. The 4-ohm tap is the center between the common and 16-ohm because the impedance varies as the square of the turns ratio. The common lead is connected to the collector of V5 and the 16-ohm lead to

V6's collector. The 4-ohm tap goes to B minus.

The other transformer winding has a common lead and a 2,000-ohm lead in addition to some other taps. To match a final amplifier with a load impedance

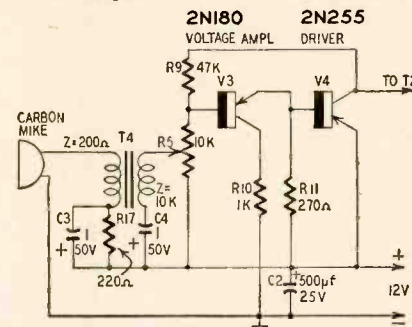
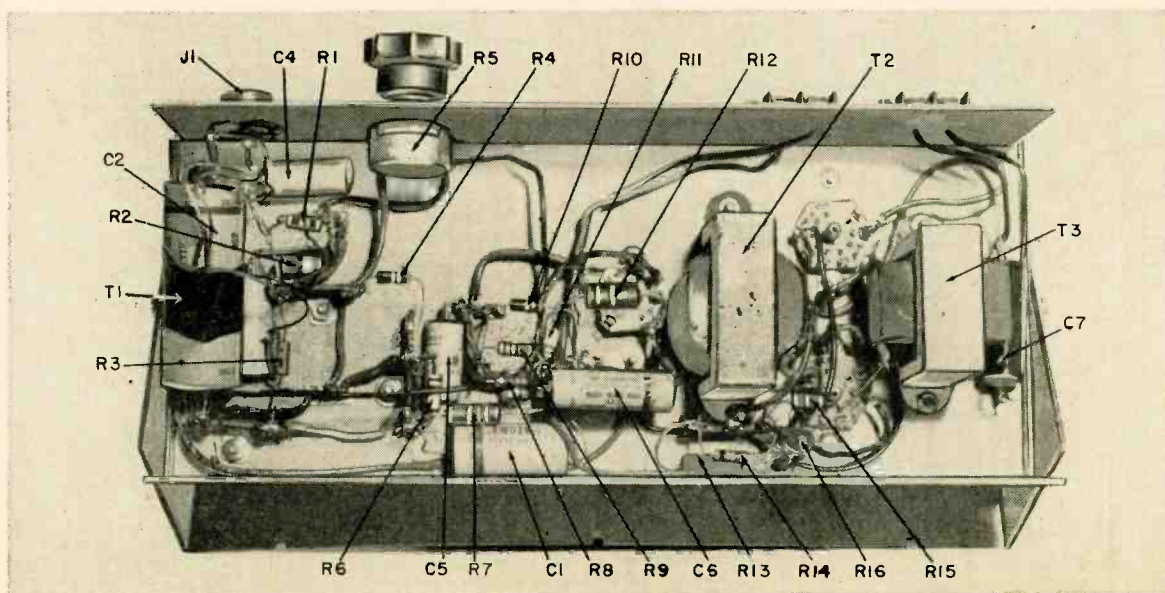


Fig. 2—Input circuit for carbon mike.

Bottom view shows parts layout.





of 3,500 to 4,000 ohms, use the 2,000-ohm tap and the common lead as the secondary or output winding. Then the ratio would be 4,000 to 32 ohms rather than the 2,000 to 16 ohms marked on the transformer. As the load is increased, the impedance decreases and more closely matches the transistors, allowing a little greater output.

With either transformer, speaker or modulation, it is possible to 100% modulate an rf amplifier with 20 watts input.

No difficulty should be experienced with the interstage coupling transformer. This transformer is readily available, being especially made for use with transistors.

### Precautions

There is no special trick to constructing transistor equipment, but there are a few precautions to observe. First, be sure that the polarity of all electrolytic capacitors is right. Second, be especially sure that the supply voltage is applied with the correct polarity.

Another precaution is to insure against high-voltage pulses such as those caused by plugging and unplugging transistors while the equipment is on, or making other adjustments and changes with voltage applied.

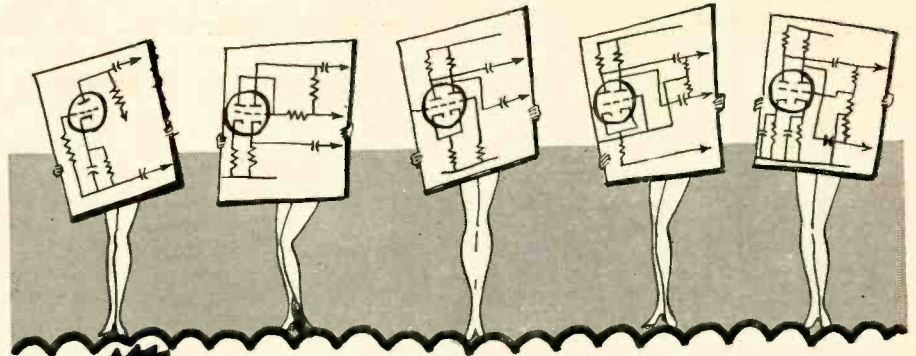
Do not unplug the driver transistor or disconnect the load from the output transistors with power applied. To test the modulator without the rf stage attached, use a 10-watt 3,750-ohm resistor across the output terminals. Do not drop the microphone on the floor or bang in such a way as to cause extremely high noise pulses. It is very easy to damage a transistor with a sudden voltage surge.

After making a thorough continuity check of the equipment, apply power carefully and check bias voltages of each stage and collector current of the output stage. At zero signal the collector current of both 2N256's should total about 100 ma. If adjustment is necessary, vary the value of R14. Increase its resistance to decrease the current.

As an overall check, the total current of the entire unit should be about 314 ma. At full-signal sine-wave input it rises to 1,214 ma.

The transistor modulator provided a crisp, clear, low-distortion audio output when used with several rigs, both fixed and mobile. Many enjoyable QSO's were had with the modulator powered from a dry-cell battery and modulating a 6V6 final amplifier at the fixed station. It was also used as a modulator for a 2E26 mobile transmitter on 2 meters.

One of the most pleasing parts about using a transistor modulator for mobile use is the complete lack of dynamotor hash sometimes heard in vacuum-tube amplifiers. If ignition noise or other interference does leak into the modulator, it may be eliminated with an additional filter network in the supply leads. END



## CHOOSING THE PHASE INVERTER

Part 1—Presenting a few facts (and attempting to crush a few fallacies) about that old standby, the split-load inverter

By

NORMAN H. CROWHURST

THE other day a caller on the telephone asked me: "Which is the best kind of phase inverter?" without offering any qualification as to the kind of amplifier circuit he had in mind. "Does that matter?" he asked. This is too typical of a current attitude in approach to audio design and circuitry—the idea that one circuit for a particular position in the audio setup must be the best without qualification. I have shown in previous articles that, in other parts of an audio system, a number of somewhat conflicting requirements have to be met. That is no less true of a phase inverter.

On this subject so many "authorities" have made conflicting claims for different circuits that considerable confusion exists. This article discusses the relative merits and demerits of the more popular circuits in meeting the six main requirements of a phase-inverter circuit. At the same time I will endeavor to discuss some prevalent ideas about phase inverters that may be somewhat short of truth or completeness.

In discussing the choice of a phase inverter, we have to consider:

1. Will it deliver the required grid swing for the output tubes?
2. Will it contribute adequate gain to the overall performance of the amplifier?
3. How much distortion does it contribute to the total amount in the amplifier?
4. How much does the balance of the push-pull drive depend upon the tube parameters being accurate?
5. Does the circuit maintain its balance to the extreme ends of the frequency response, very low and very high frequencies?

6. How well is the circuit suited for use in the overall amplifier from the viewpoint of contributing stability to the various feedback arrangements?

It should at once be obvious that no one kind of circuit is going to provide the best answer to all these questions, with all possible kinds of amplifier circuits. If you are using a push-pull output arrangement that requires only a small voltage swing on the grids to achieve full output, the question of available swing from the phase inverter will not be very important. If, on the other hand, your output stage uses some degeneration by taking partial coupling from the cathode (such as a unity-coupled or cross-coupled Ultra-Linear or some such output), then the amount of swing delivered by the phase inverter becomes probably the most important feature to consider.

We could continue down the list to show how each of these factors may become of dominant importance in different circumstances. But to get on with the story, let's take each of the popular types of phase inverter and examine its characteristics in each of these features.

### The split-load inverter

The first type is variously called the split-load, concertina, kangaroo or cathodyne inverter. It is made by simply dividing the plate coupling resistor of the stage equally between the plate and cathode circuit of the tube (Fig. 1).

The question of available swing can be very quickly answered. If the total resistance, adding the plate and cathode portions together, is about the same as that normally used as a plate-coupling resistor with the same tube, then the total swing delivered at the

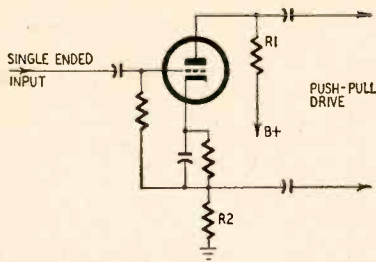


Fig. 1—Essential parts of split-load phase inverter. R1 and R2 must be equal for correct inversion.

cathode and plate will be about that obtained from the tube operating as a straightforward voltage amplifier. So the swing delivered at each output, from the plate and cathode, for use on the output tube grids, will be exactly half the normal swing obtainable from the tube as a voltage amplifier.

This is probably the most serious limitation of this circuit. Because of this it is not suitable directly for the kind of output circuits that need a large grid swing. For output circuits using a smaller grid swing it proves to be ideal.

The split-load inverter does not contribute any gain to the amplifier—in fact, it contributes a slight loss, considered from input to each output. Assume that the tube, with the total plate coupling resistor chosen, has a gain of 14. This will be a gain of 7, considering the input as from grid to cathode and the output from plate to ground or from cathode to ground. As the grid-cathode voltage is in the same phase as the cathode-ground voltage, the voltage at the cathode, or grid return, will rise until it nearly equals the signal on the grid. Thus an input of a little more than 7 volts (from grid to cathode) is required for 7 volts output, due to this 100% feedback. An input from grid to ground will need to be in the ratio of 8/7 times each output voltage. Otherwise stated, the "gain" of the stage will be 7/8 or 0.875, on each half, or 1.75 using the total output.

This means that the preceding stage must be capable of supplying a little more than the swing required for each output tube grid. However, if half of a twin triode is used for the preceding stage and the other half for the split-load inverter, there should be ample margin because the total swing provided by the inverter with both its loads is that for both the output tube grids.

The split-load inverter itself contributes very little distortion because half the total output voltage—that from cathode to ground—is used as voltage feedback. So the principal contribution that the two stages make toward the overall distortion will most likely come from the stage driving the split-load inverter because it does not have the advantage of such negative feedback cancellation.

This type of inverter is excellent from the viewpoint of maintaining stability of balance with tube para-

meter variations. In the first place, the variation in gain of the inverter tube will be very small. Suppose, for example that the working gain of the tube, with the plate load used, drops from 14 to 12. This means the gain, using grid to cathode as an input, to each of the output terminals will change from 7 to 6. This is a drop of 14%. However, measuring the change in gain as the tube operates in the amplifier, this means that the stepdown in this stage will change from 8/7 to 7/6, which is a change of only 2%.

The more important figure, from the viewpoint of a feedback amplifier, is the stability of balance between the two outputs. If the plate and cathode coupling resistors are equal in value and coupling capacitors and following-stage grid resistors are equal, then the phase-inverter tube will have identical impedances in its plate and cathode circuits. If the capacitance from each output tube grid to ground—including strays due to associated wiring—is equal, this identity in the two halves of the load impedance for the phase-inverter tube is preserved right up to the highest frequencies, for which reason the voltages appearing at the cathode and plate of the phase inverter will always be exactly equal and in 180° phase relation.

The commonest fallacy

That sounds reasonable enough, doesn't it? But somewhere you may have read that the split-load inverter produces unbalance, particularly at the high frequencies, because of the difference in source resistance at the plate and cathode of this kind of circuit.

It is true of course that the source resistance at the plate is much higher than the source resistance at the cathode. The plate circuit is operating with current feedback due to the large resistor in the cathode, for which reason the effective source resistance will be very

little lower than the actual coupling resistor used. The cathode circuit, on the other hand, is operating halfway to being a cathode follower and thus will have a source impedance approximately double that of the tube operating fully as a cathode follower. This means the relative source resistances at plate and cathode are in the ratio of at least 10 to 1—possibly higher.

How can it be, then, that the same input capacitance of the following tube, say 30 μf, does not produce a greater rolloff applied to the plate circuit than it does applied to the cathode circuit? Looking at the matter this way, it would at first seem as if we must reverse our conclusion—there must be a difference! This argument is illustrated in Fig. 2.

Let's pursue this approach in a little more detail by examining the whole effect of shunt capacitance at each point. This is illustrated in Fig. 3. Assuming R<sub>a</sub> (the tube's plate resistance) is 8,000 ohms: R<sub>a</sub>(1 + A) is 64,000 ohms and the source resistance at the plate is about 16,000 ohms. A is the stage gain for each side, or 7. So the rolloff point occurs where 30 μf has a reactance of 16,000, about 330 kc. But at the same time there will be a slight boost in the cathode output, due to the working gain going up from 7 to an ultimate approaching 14, as we will see below. So the gain at the cathode will step up from 0.875 to about 0.93, beginning in the region of 330 kc also.

Now the effect of the capacitance at the cathode only: It will be shunting an effective source resistance, deduced from Fig. 3, of 950 ohms. This will not cause rolloff until about 5.8 mc. But it will affect the output at the plate circuit before this. When the cathode impedance degenerates 3 db, by the reactance of the shunt capacitance being 22,000 ohms, the current swing for a given grid input will be almost 3 db greater so the output at the plate will

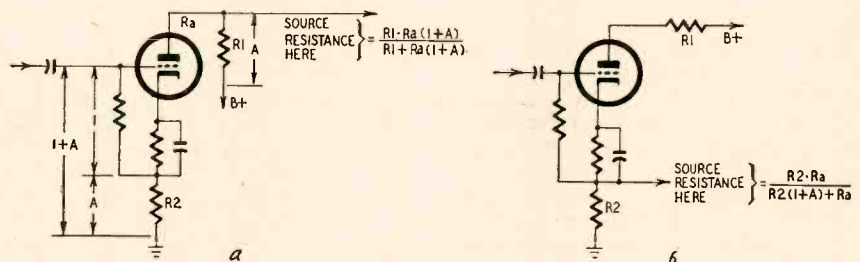


Fig. 2-a—Derivation of source impedance at plate of split-load inverter; 2-b—source impedance at cathode. R1 and R2 are equal.

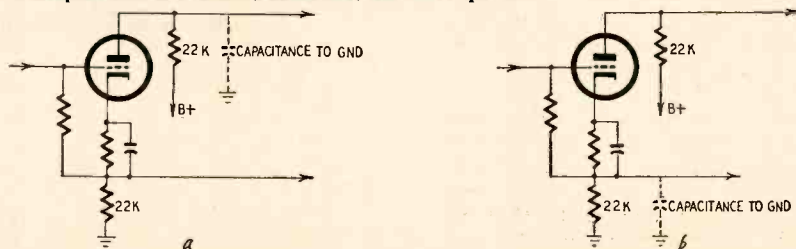


Fig. 3—Differences in effect of capacitance loading at plate (a) and at cathode (b).

show almost 3-db boost at about 240 kc and go on rising until the gain approaches 14 at that point.

So, whether the capacitor is connected at plate or cathode, its effect on response is much greater at the plate than at the cathode. One boosts, and the other causes a drop.

But, when equal capacitances are connected both places, *both plate and cathode will show equal rolloff*. Considering the input as from grid to *cathode* the source resistance of the stage is 8,000 ohms in parallel with 44,000, about 6,500. Across this, the two 30- $\mu$ f capacitances appear in series, as 15  $\mu$ f, giving a rolloff at about 1.6 mc. But the cathode degeneration will extend this by a factor of 8 to 1, to about 13 mc.

The curves for a slightly different circuit appear in Fig. 4. Curves 1 and 2 show response at plate and cathode, respectively, when capacitance is connected at the plate only. Curves 3 and 4 show response at plate and cathode when capacitance is connected in the cathode circuit only. Curve 5 is the response when equal capacitance is connected at both plate and cathode. Roll-off is the same for both plate and cathode, and one curve suffices for both.

Of course the value of 30  $\mu$ f used to illustrate is rather low. But it is obvious that the circuit should give a very good response.

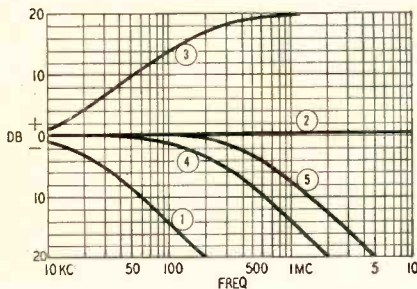


Fig. 4—Effects of shunt capacitance. Curves are explained in the text.

Unbalance between the capacitance "loading" will chiefly modify the response at the grid of the output tube connected to the plate. If that circuit capacitance is the larger, there will be a drop; if the cathode circuit has the larger capacitance, the plate circuit will rise at the high end.

But someone will inject here, "I have actually *measured* the difference in frequency response at the plate and cathode of a split-load phase inverter under operating conditions."

True, almost any measuring instrument you care to use for this purpose will show a difference at the high-frequency end because the measuring instrument itself introduces some extra capacitance *over and above that provided by the output tube*, onto the side you are measuring at the instant. Thus you are really making measurements under a condition similar to that by which the operation is usually explained—of applying a high-frequency load to *either the plate or the cathode*,

one at a time, and measuring the output response at the point to which you applied the high-frequency loading. As soon as you remove your measuring instrument, however, the balance of the circuit is restored.

For output stages in which the output tubes operate as pentodes, we have shown elsewhere that it is desirable to employ short-loop feedback as well as long-loop feedback. This is a disadvantage of the split-load phase inverter: it is not convenient to utilize this circuit for short-loop feedback from the output stage plates. This means that using a split-load phase inverter to drive a couple of output pentodes—for which it seems otherwise admirably suited—leaves us with only the option of using overall feedback. From the viewpoint of feedback design this is not the *best* approach to the problem, but sometimes it can prove to be "satisfactory."

The fact that the split-load phase inverter does not provide any gain also complicates matters for the design of a feedback amplifier. There is an offsetting feature here, if the preceding stage is direct-coupled to the split-load inverter, as shown in Fig. 5. The preceding stage will, of course, achieve at least the maximum gain this tube normally attains as a voltage amplifier (it will in fact have slightly more gain due to the avoidance of a grid resistor for the following stage).

Direct connection is made practical by the fact that the grid of the phase inverter requires to be at a considerable dc potential above ground to correspond with the potential of its cathode above ground.

However, the precise operating point of the grid is critical, otherwise the available swing in the phase inverter will become asymmetrical, due to the operating plate current being either too high or too low. This means that the dc potential at the plate of the preceding

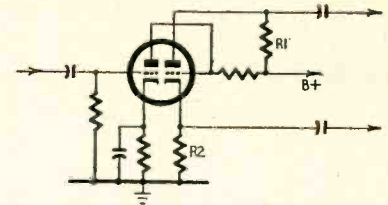


Fig. 5—Some objections are overcome by adding a direct-coupled stage to the split-load inverter.

stage must be carefully controlled. This is usually achieved by using plate-coupling and cathode resistors of rather higher than normal value for the tube type used. The cathode bias resistor can of course be bypassed with a suitable capacitor to avoid unnecessary degeneration in gain.

This combined phase-inverter circuit is really a very good one. The preceding stage operates at comparatively low distortion for the type of tube used and the phase shift involved in the use of a coupling capacitor is avoided by direct coupling. Much of the phase shift at the high-frequency end is also avoided because the grid-cathode input capacitance of the inverter stage is divided by the feedback factor between grid and cathode. With careful circuit layout this is the major component of capacitance at this point, particularly as the direct coupling consists merely of a strap between two pins on the tube holder. Thus the effective plate-ground capacitance on the preceding stage can be made extremely small so as to contribute a very small proportion of phase shift at the high-frequency end.

The split-load inverter is the one about which most of the misconceptions have arisen. After straightening these out, it should be possible to go over the remaining popular circuits rather quickly. This will be done in one or more future articles. TO BE CONTINUED



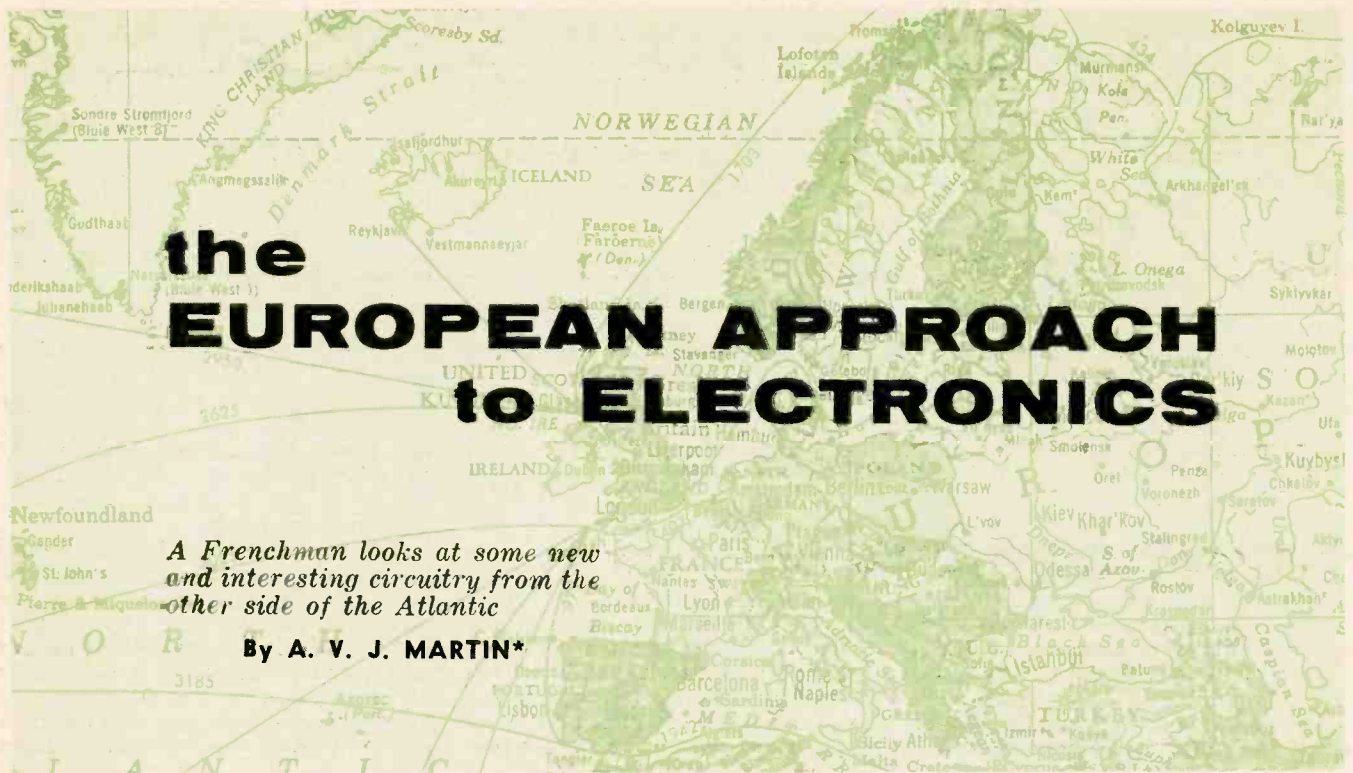
# Pig in a Poke?

When you buy tubes through mail order advertising, do you know what you are getting, or are you buying a pig in a poke?

RADIO-ELECTRONICS believes the buyer has a right to know exactly what kind of tubes he's getting when he answers a mail order ad. Since January 1956, we have insisted that mail order tube advertisers state that tubes advertised are:

- New and unused
- Not mechanical or electrical rejects
- Not washed or rebranded

If the tubes offered for sale do not measure up to these qualifications, the advertiser must say so. Advertising which does not comply with these standards is refused. RADIO-ELECTRONICS established this strict policy to protect you.



# the EUROPEAN APPROACH to ELECTRONICS

*A Frenchman looks at some new and interesting circuitry from the other side of the Atlantic*

By A. V. J. MARTIN\*

## Bilingual television

The European interconnected television system or Eurovision has shown over several years of use that transformation of standards causes no difficulty with the picture. The net includes 405-, 625- and 819-line transmissions. It is the sound that offers problems, due to the difference in language. The usual technique has been a completely separate sound distribution, each language having its own commentator speaking over his country's network. This is only a partial

\*Professor, Carnegie Institute of Technology, Pittsburgh. Formerly editor of *Television* (Paris, France).

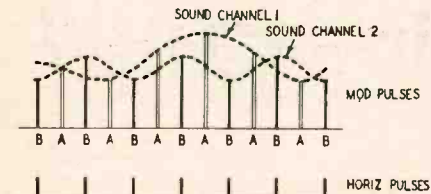


Fig. 1—How two sound signals are transmitted via one channel.

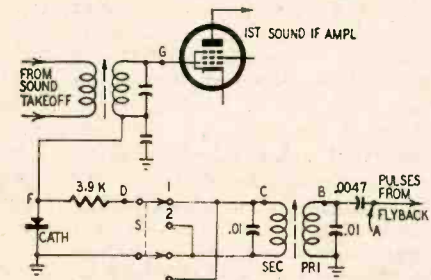


Fig. 2—This decoder allows listeners to choose the language desired.

solution to the problem of multilingual countries like Belgium or Switzerland, to say nothing of stations near a border and which can be received in a country with a different language.

A similar case arose with the television transmitters now under construction in North Africa, since both Arabic and French should be used simultaneously for the audio channel. This had to be done at the least possible expense. A pulse amplitude-modulation system was adopted. The sound channel carries two distinct series of pulses, regularly spaced (Fig. 1). Each series is amplitude-modulated with the sound of either the French or Arabic transmission. These pulses are locked to the horizontal scanning frequency, which is

20,475 cycles in the 819-line system. The receiver's decoder is very simple (Fig. 2). It uses a transformer tuned to the horizontal scanning frequency and a crystal diode. A sinusoidal voltage (Fig. 3) 90° out of phase with the primary voltage appears at the transformer's secondary so that its positive peak coincides with the horizontal sync pulse. By transposing the connection to the secondary with switch S, the phase can be reversed, the positive peaks of the secondary voltage now falling between the line pulses.

The crystal diode clips the signal and allows only the positive peaks to remain. It also creates a negative voltage large enough to maintain the first if sound amplifier beyond cutoff except during the positive peaks of the secondary voltage. Thus the sound channel is active only when a positive peak appears across the diode. Switch S allows the user to choose between the peaks coinciding with line pulses or the peaks halfway between pulses and hence to tune the sound amplifier for the desired sound channel, in this case Arabic or French.

Notice that the clipped sinusoidal provides pulses much wider than the sound pulses to provide a margin of safety. The line pulses are taken off the horizontal output transformer or the horizontal output stage. The sound pulses are 10 microseconds long and the sound frequencies are limited to 9,000 cycles. The cross-modulation between sound channels is negligible.

Extensions of this system are obvious—for example, in binaural sound or with several series of pulses in multilingual programs.

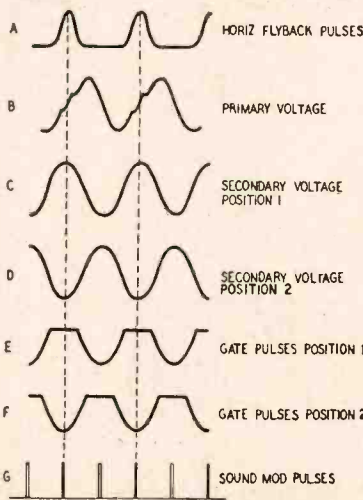
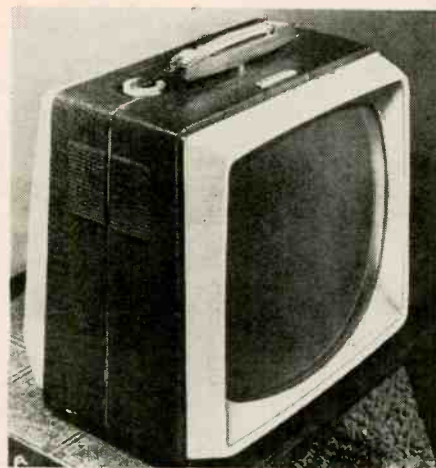


Fig. 3—Waveforms in decoder circuit.

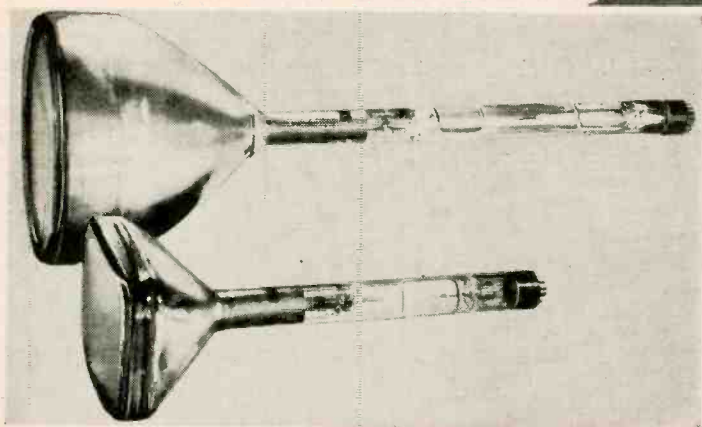


what's

new ?



**SLENDER SEVENTEENER**, a portable TV set whose width is greater than its depth, is featured in Philco's 1958 line. Its 17-inch lightweight picture tube provides 155 square inches of viewing area. A dipole antenna with collapsible 39-inch arms is concealed in the rotatable handle.



A **NEW WAMOSCOPE**, a radically different type of cathode-ray tube for radar, television and other electronic display applications has been announced by Sylvania. The Wamoscope (wave-modulated oscilloscope), the earlier model of which was described in our New Tubes section of November, 1956, has a rectangular screen and combines most of the essential functions of a microwave receiving set in a single tube envelope. Still in the developmental stage, it operates over a microwave frequency band of 2,000 to 4,000 mc.

The size of the picture-tube bulb was reduced from the 30 inches of the old tube (at rear in photo) to 17 inches by using a 90° deflection system instead of the previous 52° system, standard in radar sets.



**RADAR PRESERVES FOOD** in a process which combines the features of the vacuum freeze-drying technique with that of high-frequency heating. As explained by Dr. David A. Copson, manager of Raytheon's food laboratory, the process depends on the fact that liquids will evaporate at a lower temperature as air pressure is reduced. Vegetables, meats, fruits, etc., are therefore often dehydrated in vacuum. However, some heat is required (even in deep freeze the temperature is far above absolute zero) and, as the material dries, the outer layers become very efficient heat insulators. This slows the process. To speed drying, Raytheon uses an apparatus similar to the Radarange, which agitates (heats) the molecules containing water while having no effect on dry nonconducting outer layers. The microwave energy thus bypasses the already dried portions and follows the receding ice volume to the center of the food. The preserved food can be stored at room temperature for indefinite periods and, because its weight is reduced from 70% to 90%, can be shipped very economically.

Food is restored to its original fresh condition simply by soaking in water. Flavor and nutrient values are better preserved this way than by earlier dehydration methods, according to food experts.



**HELMET RADIO** developed by the Army Signal Engineering Laboratories, Fort Monmouth, N. J., gets its power from sunlight. Solar cells placed on either side of the helmet's crown provide power for the radio during normal daylight operation. They also charge four small nickel-cadmium storage batteries to supply peak current in daytime and operate the transceiver at night. The set can be operated for an indefinite time. Life of the dry cells now used in the helmet radio is less than a day when operated continuously. The solar cells produce about 4.5 volts, which is stepped up to 50 volts by a completely transistorized converter. It fits into the housing now used for the radio's dry batteries. With the solar batteries, power converter and storage cells the unit weighs slightly less than a pound.

# Computer Checks Human Brain

*Automatic interpretation of brain waves,  
a new step in the growing electronics field*

By **CARL J. ZAANDER**

**T**HE brain waves of jet pilots and crew members are now being studied with a unique electronic wave analyzer and computer to measure objectively the pilot's alertness and reactions under stresses such as fatigue and oxygen deficiency. The extraordinary demands made on the airmen's reflexes have made it essential to have a precise way of gauging their responses. The new computer is called an electroencephalogram analyzer.

This instrument provides a faster, more accurate interpretation of the information provided by another instrument widely used in the medical profession — the electroencephalograph. The latter is a sensitive electronic instrument which detects, amplifies and records human brain waves as a continuous irregular curve. This record is usually diagnosed visually or with wave analyzers to find repeating wave patterns characteristic of types of brain damage, certain mental disorders,

\*Physicist, Mechanics Research Department of American Machine & Foundry Co., Chicago, Ill.

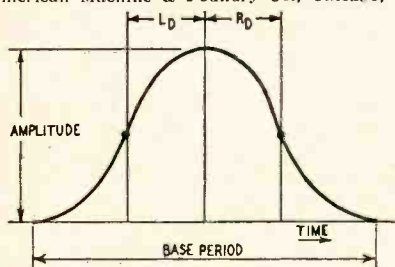


Fig. 1—A single pulse curve, showing deviation coefficients

and degrees of wakefulness, concentration and reactions to stress.

The electroencephalogram (EEG) analyzer was developed by the Mechanics Research Department of American Machine & Foundry Co., of Chicago in association with the Aero Medical Laboratory of the Air Research and Development Command's Wright Air Development Center. The EEG analyzer is a significant departure from conventional methods and instruments. Instead of plotting a single curve of the signals picked up by detectors strapped on the subject's head, the instrument analyzes each individual pulse of energy originating in the brain's nerve cells and breaks them down into three separate curves, presenting their significant features in three parallel plots of triangular spikes.

The need for more exact correlation between a subject's physical state and the appearance of his encephalogram has given rise to a new theory of wave generation. The theory holds that the pulses from a group of nerve cells are relatively independent of each other and occur in a statistically normal distribution.

## What is measured

The important factors are the shape and time of the positive EEG signal. The amplitude of a pulse is not clinically significant because increased brain activity shows up as more frequent bursts. Because the waveforms of each set of pulses are symmetrical about the zero axis, it is simpler to

consider only the positive half of the wave.

The shape of a single pulse curve completely described by three quantities (Fig. 1): the left and right deviation coefficients ( $L_D$  and  $R_D$ ), which are the times elapsing between the point where the wave slope changes from concave to convex on the left and the wave peak, and the time between the peak and the slope change on the right; the base period, which is the time between the two wave crossings of the zero axis.

The length of the base period gives the duration of each pulse and can be related to the degree of alertness of a subject. When a person is asleep, he puts out long, slow waves (Fig. 2). During periods of alertness these waves are characterized by fast high-frequency signals, primarily from the visually stimulated areas of the brain. The deviation coefficients are also experimentally important because they show the skewness (relative shape of the two sides of the curve) of individual bursts.

Rather than plotting these three time measurements along the graph's moving axis, the EEG analyzer plots them as vertical spikes. Direct comparison of the length of three corresponding spikes gives the analyst a ready indication of each waveshape. Also, changes in each set of spikes clearly reveal changes and trends.

The EEG analyzer consists of two principal parts, a zero-crossing detector and a computer unit. Basically, the

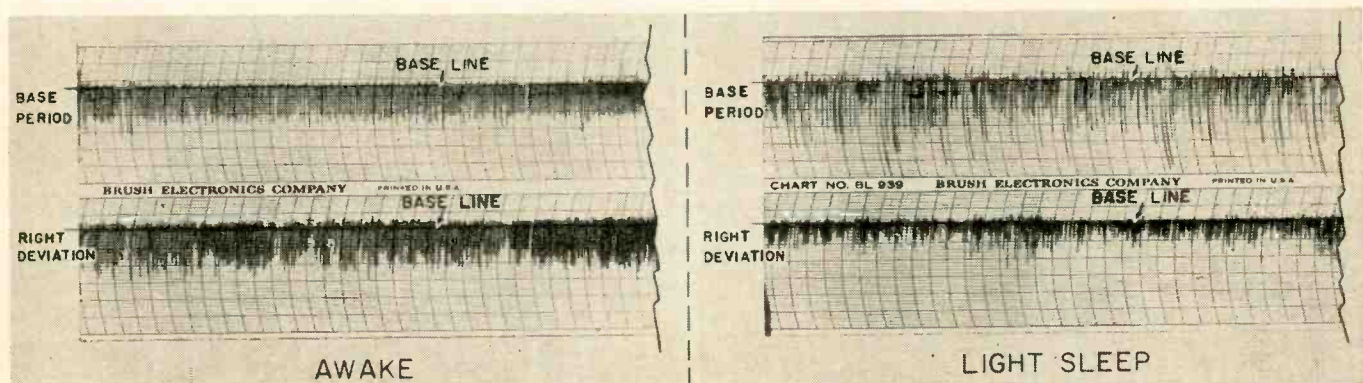


Fig. 2—Electroencephalograph shows base period and right deviation pulses for a subject resting and in light sleep.

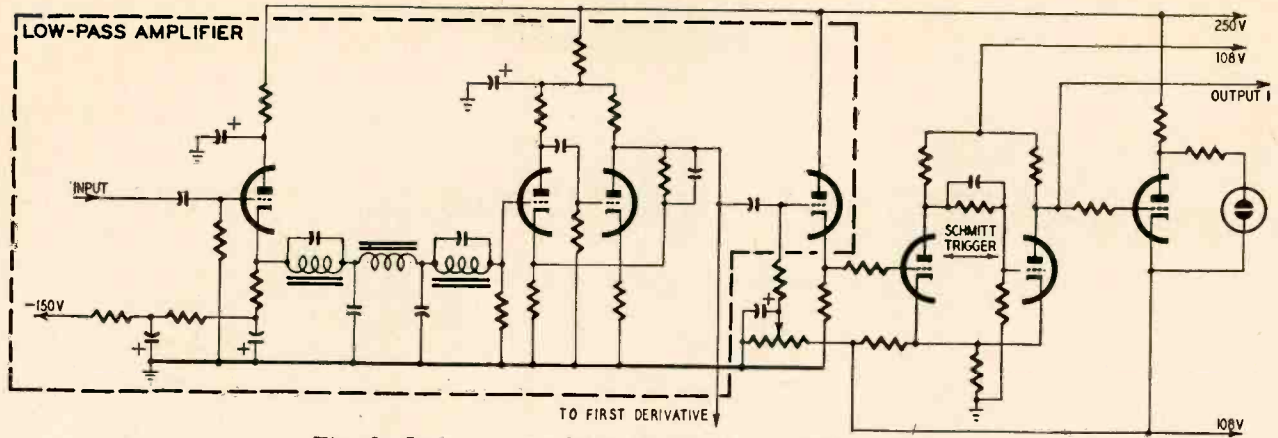


Fig. 3—Low-pass amplifier circuit of the EEG analyzer.

zero crossing detector locates the zero-axis (base-line) crossings of each primary curve and the zeroes of the first and second derivatives. Following the zero-crossing detector, the computer produces an analog voltage proportional to the time between corresponding zero crossings (the base period). The computer then generate voltages proportional to the left and right deviation coefficients based on the first and second derivatives of the primary curve.

**Zero detection**

The points where the curve crosses the base line are determined by the zero-detecting circuits to start and stop the circuits generating the base period and deviation coefficient signals. First the EEG signal is amplified and band-limited by the circuit shown in Fig. 3 before being delivered to the Schmitt trigger circuits which are the decision elements of the circuits.

In the zero detector the outputs of the three Schmitt amplitude discriminator circuits are fed to the computer. In addition, they are directly coupled to three amplifiers which operate neon lamps. Each amplifier is cut off when one half of its trigger circuit tube is cut off. When the EEG signal goes

negative, the plate potential on one half of the Schmitt trigger increases and lights the indicator light. When the trigger is not conducting, the amplifier has zero bias and, consequently, low plate voltage and the light does not glow. The indicator lights are very useful in setting the Schmitt sensitivity controls to the proper operating points.

The output of the first Schmitt circuit (OUTPUT 1) determines the points where the wave crosses the zero axis. The time between these crossings is the wave's base period (Fig. 4-a).

The primary signal is differentiated to locate the peak of the curve. This first derivative signal is fed to the second Schmitt circuit (OUTPUT 2), stops the left deviation and starts the right deviation pulses (Fig. 4-b).

The second differentiation locates the inflection points of the primary signal (the points at which the curve changes from concave to convex, or the reverse) and as OUTPUT 3 from the third Schmitt starts the left deviation and stops the right deviation pulse (Fig. 4-c). The three outputs from the zero-detection circuits are fed to the electronic computer circuits.

**Computer circuits**

The electronic computer derives the deviation coefficients from the first and second derivatives of the primary pulses. It then forms electrical pulses whose heights are proportional to the duration of the deviation coefficients.

The left deviation coefficient is proportional to the time between a negative-going second derivative zero and the following negative-going first derivative zero as shown in Fig. 4.

Fig. 5 shows the functional relationship between the major units that generate the left deviation pulse. The flip-flops are monostable multivibrators that generate constant-length output pulses when they receive the differentiated negatives signals generated in the zero detector as negative spikes.

When V13 receives a negative pulse from OUTPUT 3, it produces a pulse activating the scaler, V11. The scaler delivers a constant amplitude pulse until a negative pulse from OUTPUT 2 stops the scaler. The output of V11 is a pulse whose duration is equal to the

time between points A and B in Fig. 4. The scaler output pulse is fed into a parallel R-C pulse former through the gate tube. Deviation pulses are produced only during positive excursions of the primary signal. The cathode follower permits the use of ground as the signal reference level and provides a relatively low output impedance.

Right deviation coefficient pulses are generated in an identical circuit controlled by pulses from outputs 2 and 3 except that OUTPUT 3 is of the wrong polarity. Therefore the termination pulse is obtained from the OUTPUT 3 indicator light amplifier.

The base period pulse is obtained by feeding the output-1 pulse directly into a pulse former and then to an output cathode follower.

The multivibrators have input sensitivities of 1.5 volts and produce an output pulse of approximately 200 microseconds duration. The scaler stages are of the bi-stable flip-flops with an input sensitivity of approximately 15 volts and produce a rectangular output pulse of approximately 30 volts. The gate tubes are two cathode followers with a common cathode connection so that the cathode follows the most positive grid. The common cathode produces an output only when the primary EEG signal is positive.

END

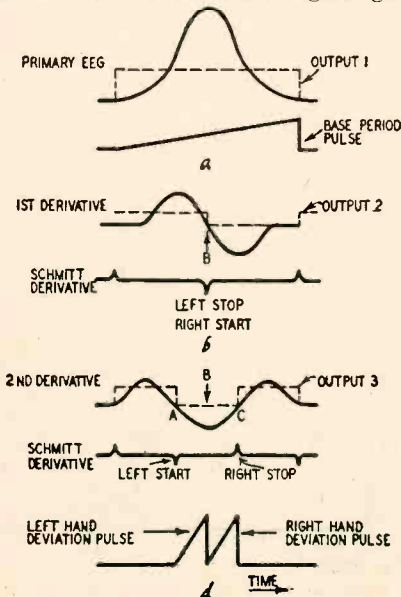


Fig. 4—Waveforms of outposts and deviation pulses.

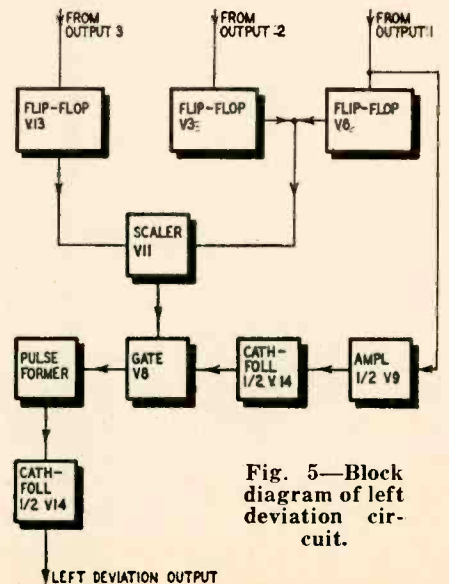


Fig. 5—Block diagram of left deviation circuit.



# Radio Telescopes

*Some practical information on simple equipment the experimenter can build*

By DR. H. C. KO\*



Fig. 2—The Ohio State 96-helix radio telescope.

FOR the first time scientists are scanning the heavens with the aid of radio equipment. Instead of observing light waves through optical telescopes, we now listen to radio waves from the depths of outer space. The radio equipment consists of high-gain antenna system and very sensitive receiver system. The antenna system collects and focuses incoming radio waves and the receiving system detects and records the signals. By analogy to the function of an optical telescope, the entire system is called a "radio telescope."

The first discovery of radio waves from outer space was made by Karl G. Jansky of Bell Telephone Laboratories, in 1931, while studying the direction of arrival of static at 20.5 mc. Jansky

\* Radio Observatory, Department of Electrical Engineering, Ohio State University, Columbus 10, Ohio.

found that small residuals of static persistently appeared on his automatic intensity recorder when all other radio disturbances were absent. Tracing down these residuals, he discovered that his rotating directive antenna picked up the greatest amount of static when pointed at the constellation of Sagittarius, the brightest part of the Milky Way.

During the past decade radio astronomers have made many discoveries concerning the nature of these cosmic radio waves. In addition to widely distributed background noise coming from the Milky Way, there are radio waves coming from definite points in the sky as though individual stars were sending to us. These are often called "radio stars." The character of radio waves received from the Milky Way and radio stars is similar to that of radio receiver set noise, causing a hiss in the phones.

The intensity of these signals varies with frequency.

As a general rule, the higher the frequency the weaker the signal. Cosmic radio signals are randomly polarized, permitting horizontally and vertically polarized antennas to receive them.

Several hundred radio stars are now known. The Sun is a very strong radio source. During periods of high sunspot activity, radio amateurs can detect radio signals from the Sun. Television is also often affected. Recently the planets Jupiter and Venus have been also found to be radio sources.

## Design factors

An important factor in designing a radio telescope is to make certain that it has sufficient resolution to pinpoint the direction of radio-signal arrival. Resolving power is a telescope's ability to distinguish separate objects that are close together. The resolution of a radio telescope is determined by the antenna and is expressed in terms of beam width or gain of the antenna. The higher the gain, the sharper the beam and the better the resolution of the radio telescope. The resolution of any telescope is proportional to its aperture in wavelengths. Thus, a larger antenna system results in better resolution for a radio telescope. For a radio telescope to equal the resolution of the human eye, operating at 60 mc you would need an antenna nearly 20 miles wide. Fig. 1 shows several radio-telescope antennas, their resolving power (in terms of half-power beam widths) and gain.

Another important factor is the sensitivity of the receiver. Since power collected by the antenna is usually very

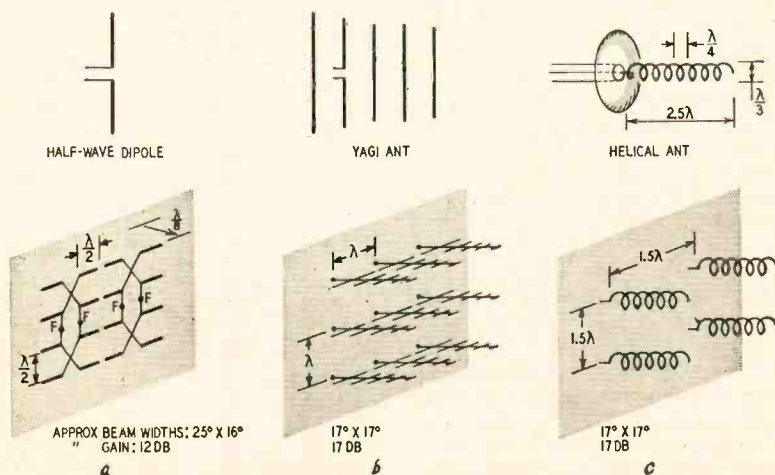


Fig. 1—Types of radio-telescope antennas; a—half-wave dipole; b—Yagi; c—helical. Each helical unit has 10 turns.

## ELECTRONICS

weak, not more than about  $10^{-10}$  watts per 1-mc bandwidth, a very stable high-gain receiver with low internal noise is required. A low-noise rf pre-amplifier followed by a superheterodyne receiver is generally employed at frequencies below 1,000 mc. The receiver requires an overall gain in the order of 130 db. Receiver output is used to actuate an automatic recorder with a pen registering the intensity of the signals on a paper chart.

As the antenna beam sweeps across the sky (either by rotating the antenna or by the Earth's rotation with a fixed antenna), the recorder pen will register the intensity of radio signals coming from the region of the sky toward which the antenna is directed. The pen draws a straight line when there is no change in the radio signals. If a radio star is encountered by the antenna beam, the pen will move up in proportion to the intensity of the radio star. Therefore, the presence of a radio star is seen as a rise in intensity on the recorder. If the star is a point source, the pattern on the record is a direct indication of the antenna beam pattern.

### Radio-telescope antennas

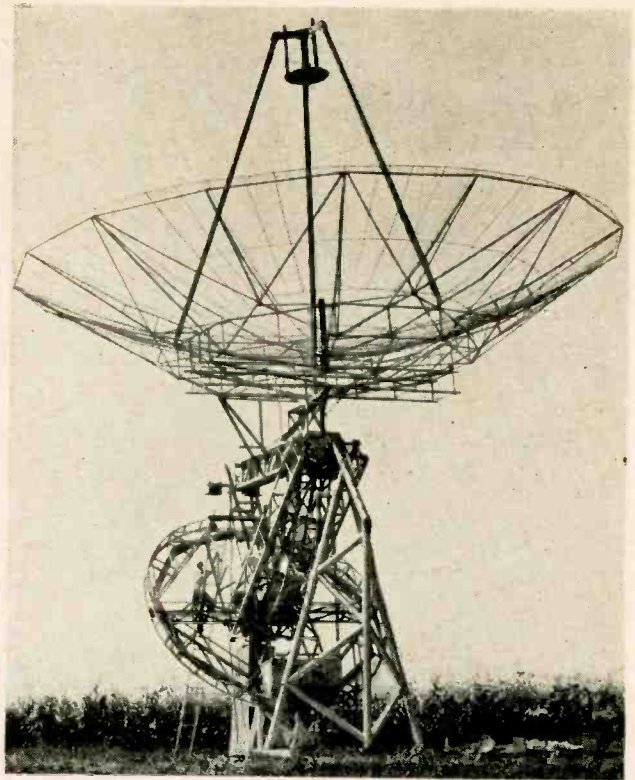
Today a wide variety of radio telescopes are operating at a number of observatories all over the world. Many types of antennas have been used for these radio telescopes; broadside arrays of half-wave dipoles, yagis, helical-beam antennas, rhombics, parabolic reflectors, electromagnetic horn antennas, etc. A detailed description of them has recently been given by Dr. John D. Kraus (*Scientific American*, March, 1955). Fig. 2 is a photograph of the 96-helix radio telescope of Ohio State University. It consists of 96 helical beam antennas mounted on a ground screen 160 feet by 22 feet. The entire array is pivoted on a horizontal east-west axis. The telescope has beam widths of about  $1^\circ$  in the east-west direction and  $8^\circ$  in the north-south direction between half-power points at 250 mc. Over 200 radio stars were detected and a detailed radio map of the sky was made using this telescope.

The large dish shown in Fig. 3 is a 40-foot parabolic-reflector antenna operating at Ohio State University. This parabolic dish, made of wire screen, reflects incoming radio waves to a focal point where a small dipole is placed to pick up the energy and transmit it by a cable to the receiver. The dish is steerable so that it can track a radio star across the sky. A new super radio telescope is under construction at the Ohio State-Ohio Wesleyan Radio Observatory near Delaware, Ohio (see Fig. 4.)

### Build your own?

There are a number of interesting observations in radio astronomy which do not require the use of large and expensive instruments. A relatively simple and inexpensive radio telescope

Fig. 3—The Ohio State 40-foot parabolic reflector radio telescope.



may be constructed to pick up radio signals from the Milky Way; strong radio stars such as Cassiopeia A, Cygnus A, Sagittarius A and Taurus A; the Sun and the planets Jupiter and Venus. This presents an opportunity for individuals with experience in radio and television techniques to participate in radio astronomy.

For radio-telescope observations, the best frequencies are between 30 and 200 mc. The arrangement of a simple radio telescope is sketched in Fig. 5. Gain of the antenna should be about 10 db at 30 mc. As the frequency increases, the antenna gain must be increased. At about 200 mc an antenna gain of about 20 db may be desirable. High-gain directive antennas can be constructed without too much difficulty. An antenna can be made by arranging a number of dipoles, yagis or helices in an array like Fig. 1. To reduce interference, the antenna should be away from population centers, busy highways and other sources of radio noise. It is preferable to mount an antenna on a polar axis so it can conveniently track a region of the sky. However, this involves (particularly at lower frequencies) difficult mechanical mounting problems. A more practical method is to construct an array of antennas whose elements are pivoted in a horizontal east-west line. Thus, the antenna beam can be tilted to point toward different declinations of the sky while it is fixed in the meridian plane (north-south line). As with a transit type telescope, a part of the sky drifts through the antenna beam as the Earth rotates.

The receiver uses one or two stages of low-noise rf preamplification. The low-noise preamplifier may consist of

a conventional grounded-grid triode circuit or a cascode circuit. A noise figure of 2 to 4 db can be obtained with such an arrangement at frequencies between 30 and 200 mc. The preamplifier is followed by a superheterodyne unit. The output from the second detector of the superheterodyne unit is stepped up by a dc amplifier which actuates the recorder. An automatic pen recorder such as an Esterline-Angus, Brown or Brush can be used. The sensitivity of the receiver is limited by the smallest change that can be recognized on the output recorder reading. Therefore, the ultimate sensitivity of a receiver is set by fluctuations in its output indicator. Contributions to the output fluctuations arise from noise generated by the receiver, instability of receiver gain due to variation of high-voltage and heater supplies and man-made radio interference such as radio and television signals.

It can be shown in theory that fluctuations due to receiver noise can be reduced by using a wide bandwidth or a long time constant in the receiver. However, owing to man-made radio interference and other considerations, a bandwidth of 1 to 2 mc is recommended. At higher frequencies it is not difficult to find a silent band of this width free from man-made radio interference. At lower frequencies where communications are crowded, narrower bandwidths may be required to avoid radio interference. To increase the time constant of the receiver, an R-C network with a long time constant should be inserted between the output of the detector and the input of the dc amplifier. A time constant up to 1 minute can be used. In order to suppress output fluctu-

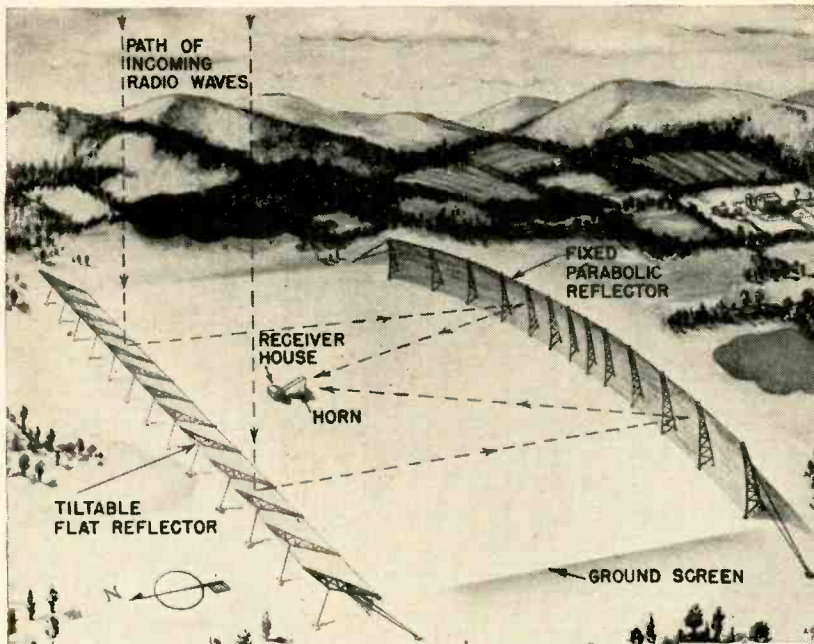


Fig. 4—Radio telescope under construction at Ohio State-Ohio Wesleyan Radio Observatory.

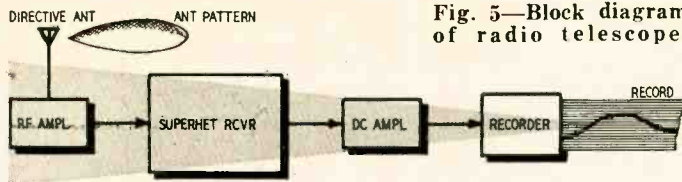


Fig. 5—Block diagram of radio telescope.

tuations due to gain instability of the receiver, it is very important that both high-voltage and heater supplies be very well regulated.

For a simple radio-telescope receiver, you can use radar, television or communication receivers modified to meet the requirements of low noise, high gain, good stability and proper bandwidth. A low-noise rf preamplifier can be added to make a satisfactory radio-telescope receiver at higher frequencies. The preamplifier may consist of a grounded-grid triode circuit or a cascode circuit. A noise figure of about 2 to 4 db can be obtained with such an arrangement at frequencies between 30 mc and 200 mc. The output of the receiver is stepped up by a dc amplifier which actuates an automatic pen recorder.

With this arrangement radio signals from the Milky Way can be detected and a simple radio map of the sky can be made. Violent solar disturbances can also be detected. These noise storms and outbursts of the Sun are known to have strong effects on the ionosphere and radio communications.

Star charts are familiar to most of us, but radio maps of the sky are relatively new. A radio map shows how the sky would appear if our eyes were sensitive to radio waves of a certain wavelength instead of light. The map shows the location of radio stars and the distribution of cosmic radio background noise intensities over the sky as observed with a radio telescope. The background noise distribution is often

shown by contour lines of equal radio-noise intensities on the map.

**Radio interferometer**

Since signals from radio stars are much weaker than those from the Milky Way, the radio telescope described above is incapable of detecting an individual radio star. To distinguish signals of radio stars against background noise from the Milky Way, a radio interferometer is effective. It consists of two identical antennas spaced many wavelengths apart directed toward the radio star and connected to the same receiver. (See Fig. 6.) This arrange-

ment produces a pattern with interference lobes.

Fig. 6 is a sketch of a simple radio telescope of this type. The two identical antennas, each having a narrow beam pattern in an east-west and broad in a north-south direction, are separated by 10 to 15 wavelengths on a horizontal east-west line. The resulting antenna pattern consists of many narrow lobes in the east-west direction while these lobes are very wide in the north-south direction. The wide north-south pattern is useful for covering a large region of the sky without changing the orientation of the antenna elements. The receiver is the same as that shown in Fig. 5. When a radio star moves across the interferometer pattern, its signal varies in a periodic manner. This simple radio telescope is capable of detecting several strong radio stars and the Sun.

At low frequencies the signals from radio stars often show peculiar fluctuations caused by refraction in irregularities of the Earth's ionosphere. This effect is very similar to the scintillation, or twinkling, of ordinary stars. To detect weaker radio stars both antenna gain and receiver sensitivity must be increased.

The young science of radio astronomy is coming of age. Using radio antennas and receivers it has opened a new window on the universe. Radio astronomy is now at about the point where astronomy was when Galileo invented the first optical telescope. There are many questions about our Sun, galaxy and the universe that can be answered with the aid of radio telescopes in the years to come. END

**Bibliography**

The story of radio astronomy is excellently described in a popular-level book *The Changing Universe* by John Pfeiffer (Random House, N.Y., 1956).

For more technical information on radio telescopes and radio astronomy the books *Radio Astronomy* by Pawsey and Bracewell (Oxford Press, 1955) and *Radio Astronomy* by Lovell and Clegg (Chapman Hall Ltd., London, 1952) are especially informative and valuable. For information on actual construction of directive antennas and low-noise receivers, refer to *Radio Handbook* and *Radio Amateur's Handbook*.

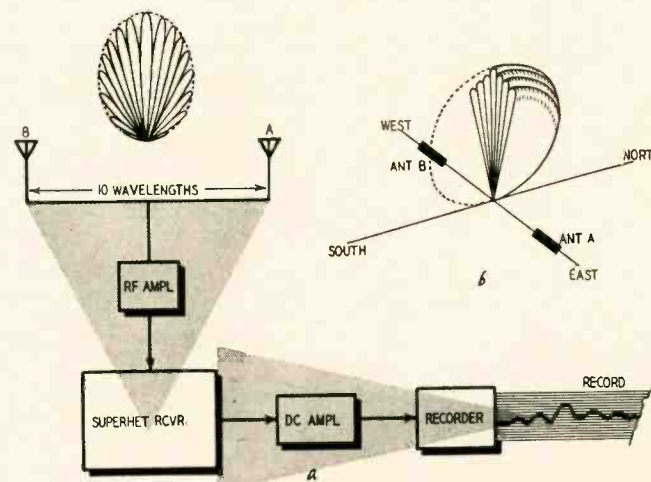


Fig. 6—a—Block diagram of a radio interferometer; b—antenna pattern of interferometer.

# Broadcast-set front end traps IF interference

*This simple circuit improves AM reception remarkably in crowded areas; may be modified to give some boost for weak signals*

By RONALD L. IVES

**L**ISTENING on the AM broadcast band is hardly an unmixed pleasure, particularly in heavily populated urban areas where most of the listeners seem to have "railroad receivers" which whistle at each station.

We can do nothing electronically about bad programs, soap operas or "high-fidelity" programs that are anything but. The problem of several stations on exactly the same frequency can be solved in some places with a directional antenna, although that won't work in all areas.

One of the most common difficulties has a definite cause, one that can be reduced very greatly by simple means. This is the melange of broadcast programs in the background at all dial settings, with added volume at about 910 and 1365 kc. (Another phase of this same trouble is a series of banshee-like wails about 455 kc above and below each strong local station.) The trouble is due in large part to oscillating if systems in receivers without adequate

reradiation suppression. It is so severe in some areas that its strength can be measured in millivolts at the receiver input.

This particular nuisance cannot be removed with the usual crystal filters, Q-5-second conversions or Q-multipliers. The damage is already done by the time the mixer is reached. In most receivers, the desired signal is cross-modulated in the first tube by the 455-kc reradiation. A simple series trap, tuned to about 455 kc, connected in the input, is not too effective because of low attainable Q. Other simple traps were found equally ineffective. More complex expedients, such as three tuned circuits at signal frequency, a Q-multiplier from antenna to ground and a series of shunt crystals across the input, were quite successful but costly and complicated.

Best overall performance was attained with a series-resonant circuit, tuned to 455 kc, across the input and isolated from the receiver by a vacuum

tube. When no additional gain is desired (usual condition), a simple cathode follower (Fig. 1-a) performs well. Where additional gain is desired (unusual condition), a cathode follower driving the cathode of a grounded-grid triode (Fig. 1-b) works excellently. Construction of either type of front end is simple and straightforward, requiring no special tools or instruments and entailing only one adjustment after completion.

Since no high frequencies are involved, the format of this front end is not at all critical. The device is self-powered. This permits better hum reduction than is possible if the front end is parasitic on the receiver power supply. A SeeZak 4 x 5 x 2-inch expandable aluminum chassis is large enough to hold the front end and power supply without any "packing-factor" problems.

## Circuitry and construction

The complete circuit of front end and power supply, with constants, is given in Fig. 2 and the general appearance of the front end from the top front is shown in Fig. 3. The chassis is modified by drilling out the corner bosses and replacing them with 6-32 binding-head machine screws threaded into hex nuts on the inside. Top and bottom plates are attached with 4-40 binding-head machine screws tapped into the side rails of the chassis.

Components may be mounted in any desired manner. The arrangement shown is convenient if rear power connections (Fig. 4) are desired. The two-section filter capacitor is mounted in a Cinch socket, which facilitates replacement and supplies a number of good tie points. All chassis holes are protected by rubber grommets and rf connections are made with Eby dual insulated binding posts. The neon static drain, which connects between antenna

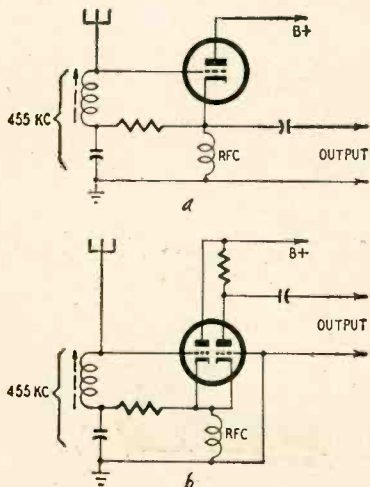


Fig. 1-a—The trap circuit used where amplification is not needed; 1-b—circuit giving appreciable amplification.

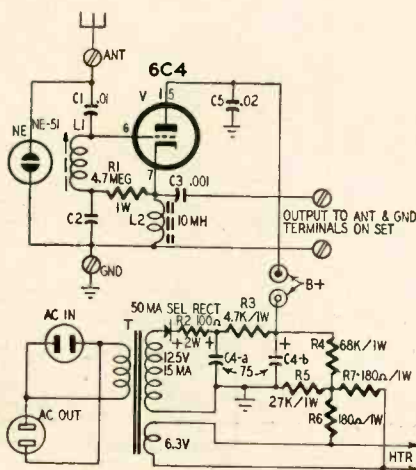


Fig. 2—Front end and power supply.

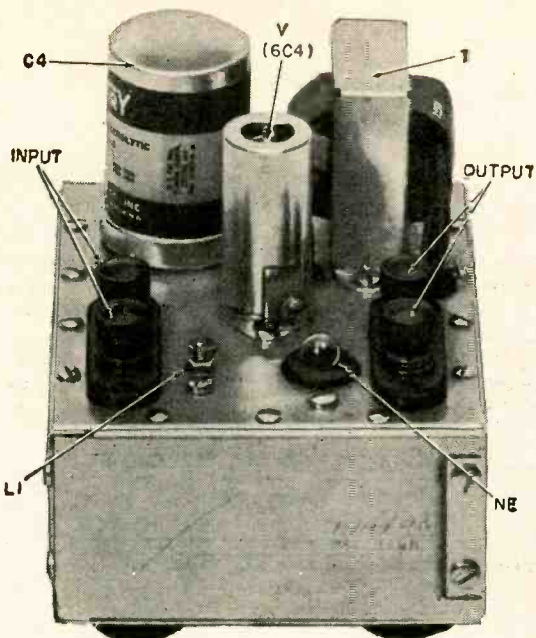


Fig. 3—Top view of broadcast front end.

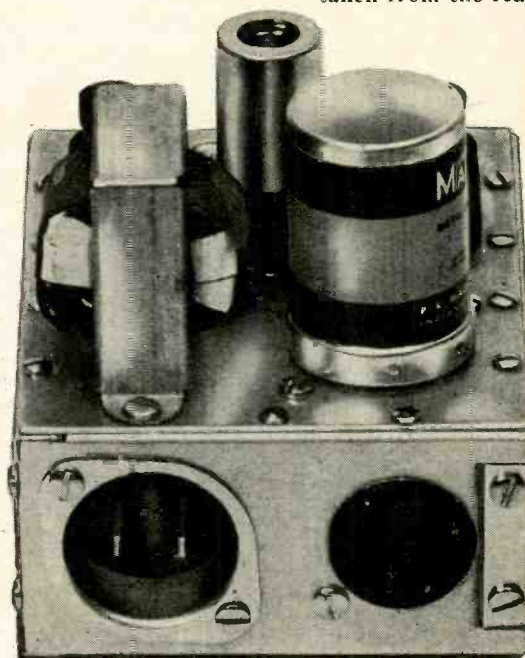


Fig. 4—Top view taken from the rear.

and ground, passes through a grommet-protected hole in the top plate and is mounted in a bracket type socket which, after bending to shape, is held to the top plate by a screw and spacer.

Because only one receiver-controlled ac outlet was available and this was already occupied by a Q-multiplier, an additional ac outlet, connected in parallel to the infeed, was mounted on the back of the front end case (Fig. 4). The ac infeed was connected to the ac outlet on the receiver, and the Q-multiplier to the outlet on the rear.

Internal construction, shown in Fig. 5, is entirely straightforward with no special features or special problems. Note that the selenium rectifier is mounted with the cooling vanes vertical. This permits better convective cooling and extends rectifier life.

The heater center-tap connection (Fig. 2) is of the type most commonly used on audio-frequency preamplifiers and is used here to permit use of a wide variety of unselected triodes, with no hum modulation. When premium or selected 6C4 tubes are used, the circuit functions very well with one side or the center of the heater grounded. With unselected 6C4 tubes or a wide variety of other triodes or triode-connected pentodes, there may be some difficulty with hum modulation if the heater is at approximately ground potential. This is because the cathode is positive with respect to the heater, producing diode action. By making the heater considerably more positive than the cathode, diode action is impossible and the circuit will not hum with any operable tube.

The tube shield here functions only as a good dependable mechanical hold-down and is not electrically necessary. The chassis bottom plate is equipped with four rubber feet, bolted on, to prevent slippage and scarring of the

(Continued on page 76)

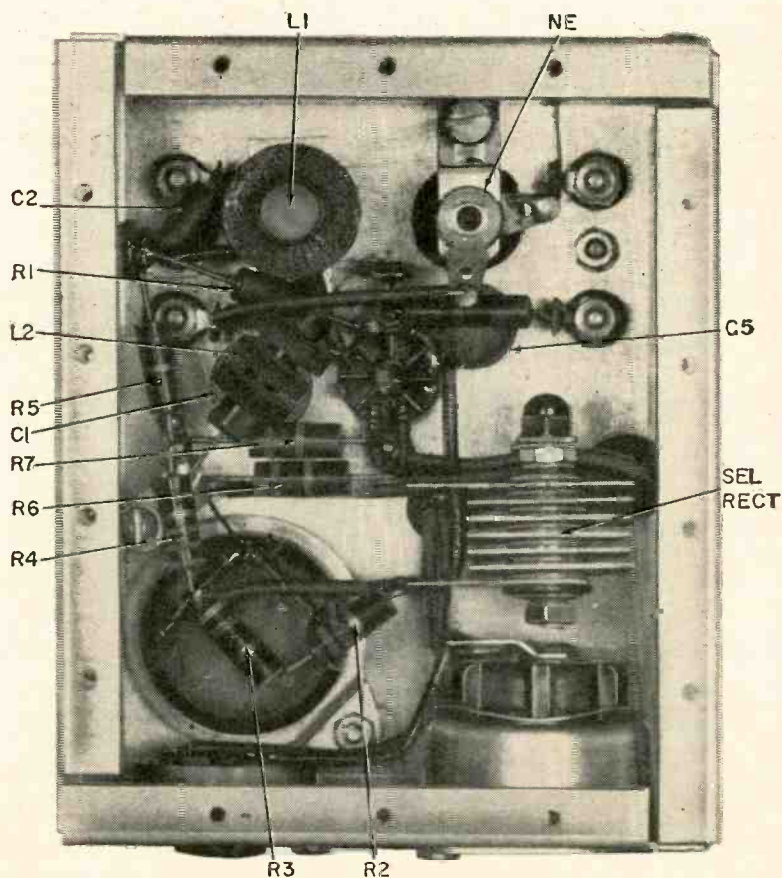


Fig. 5—Interior appearance of front end.

New



MODEL O-11

Shpg. Wt.  
21 Lbs.

\$69<sup>50</sup>

- \* An improved model of what was already an outstanding instrument.
- \* Performance is unmatched in this price range.
- \* Incorporates the extra features required for color TV servicing.

*Extra!*

**A FULL YEAR TO PAY**

SEND FOR DETAILS OF HEATH  
TIME-PAYMENT PLAN.

**5  
BIG  
REASONS  
WHY**



**HEATH  
COMPANY**

A SUBSIDIARY OF DAYSTROM, INC.

**BENTON HARBOR 20, MICH.**

**HEATHKIT ETCHED CIRCUIT, PUSH-PULL**

## 5" Oscilloscope Kit COLOR TV

The previous Heathkit oscilloscope (Model O-10) which was already a most remarkable instrument, has been improved even further with the release of the Heathkit Model O-11. It incorporates all the outstanding features of the preceding model, *plus* improved vertical linearity, better sync stability, especially at low frequencies, and much-improved over-all stability of operation, including less vertical bounce with changes in level. These improvements in the Model O-11 circuit make it even more ideally suited for color TV servicing, and for critical observations in the electronic laboratory. Vertical response extends from 2 CPS to 5 MC without extra switching. Response only down 2.2' DB at 3.58 MC. The 11-tube circuit features a 5UP1 cathode-ray tube. Sync circuit functions effectively from 20 CPS to better than 500 kc in five steps. Modern etched circuit boards employed in the oscilloscope circuit cut assembly time almost in half, permit a level of circuit stability never before achieved in an oscilloscope of this type, and insure against errors in assembly. Both vertical and horizontal output amplifiers are push-pull. Built-in peak-to-peak calibrating source — step-attenuated input — plastic molded capacitors and top-quality parts throughout — pre-formed and cabled wiring harness — and numerous other "extra" features. A professional instrument for the servicershop or laboratory. Compare its specifications with those of scopes selling in much higher price brackets. You can't beat it!

**1 FEWER DOLLARS BRING MORE REAL QUALITY.**

- Factory-to-you sales eliminate extra profit margin.
- "Build-it-yourself" eliminates labor charge.
- Heath purchasing power cuts component costs.

**2 PERSONAL SERVICE ASSURES CUSTOMER SATISFACTION.**

- You deal directly with the manufacturer.
- We are interested in you before and after sale.

# Heathkits®

**ARE YOUR BEST BUY...**

**3 PROVEN DESIGNS MEAN RELIABLE PERFORMANCE.**

- Research and development efforts concentrated on kits only.
- All kits guaranteed to meet advertised specifications.

**4 EVERY KIT BACKED BY WORLD-WIDE REPUTATION.**

- The world's largest manufacturer of electronic equipment in kit form.
- Producer of more than a million electronic kits for the home workshop and industry.

**5 EASY TIME-PAYMENT PLAN TO FIT YOUR BUDGET.**

# New HEATHKIT ETCHED CIRCUIT

## 5" Oscilloscope Kit

**GREATEST SELECTION . . .**  
 Whether your particular special interest is in servicing, ham-radio, high-fidelity, or just experimenting—there are Heathkits to fill your needs. You can equip an entire service shop or lab, buy a complete ham station or high-fidelity system, or set up a really deluxe home workshop, by choosing from the more than 70 different "do-it-yourself" electronic kits by Heath. Just glance through the kits displayed in this ad, and you will get some idea of the tremendous array of low-priced, high-quality electronic equipment available.

- \* Brand new model with improved performance specifications.
- \* Full 5" scope for service work at a remarkably low price.
- \* Attractively styled front panel in charcoal gray with sharp white lettering.
- \* Easy to build from step-by-step instructions and large pictorials. Not necessary to read schematic.

This new and improved oscilloscope retains all the outstanding features of the preceding model, but provides wider vertical frequency response, extended sweep-generator coverage, and increased stability. A new tube complement and improvements in the circuit make these new features possible. Vertical frequency response is essentially flat to over 1 mc, and down only 1½ DB at 500 kc. The sweep generator multivibrator functions reliably from 30 to 200,000 CPS, almost twice the coverage provided by the previous model. Deflection amplifiers are push-pull, and modern etched circuits are employed in critical parts of the design. A 5BP1 cathode-ray tube is used. The scope features external or internal sweep and sync, one volt peak-to-peak reference voltage, 3-position step-attenuated input, adjustable spot-shape control, and many other "extras" not expected at this price level. A calibrated grid screen is also provided for the face of the CRT, allowing more precise observation of wave shapes displayed. The new Model OM-2 is designed for general application wherever a reliable instrument with good response characteristics may be required. Complete step-by-step instructions and large pictorial diagrams assure easy assembly.



MODEL OM-2  
**\$42.50**

Shpg. Wt.  
 21 lbs.

### HEATHKIT LOW CAPACITY PROBE KIT

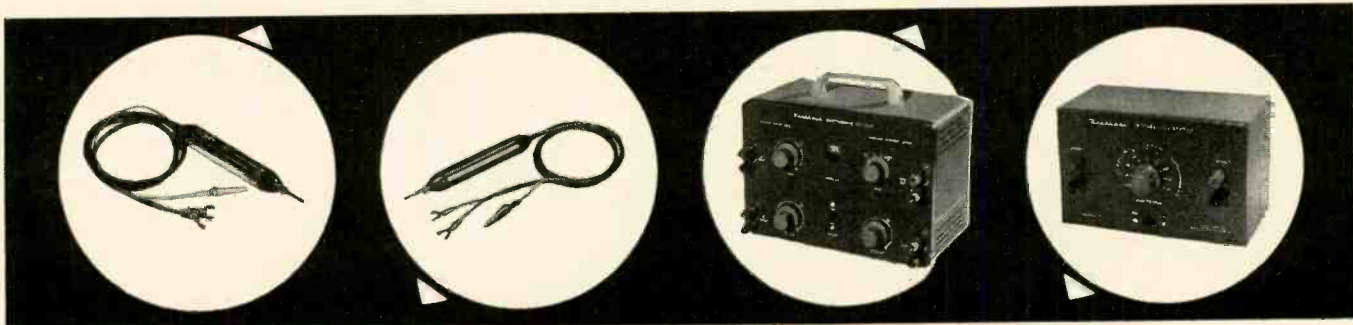
Oscilloscope investigation of high frequency, high impedance, or broad bandwidth circuits encountered in television requires the use of a low-capacity probe to prevent loss of gain, circuit loading, or waveform distortion. The Heathkit low-capacity probe may be used with your oscilloscope to eliminate these effects. It features a variable capacitor, to provide correct instrument impedance match. Also, the ratio of attenuation can be varied.

No. 342  
**\$3.50**  
 Shpg. Wt. 1 Lb.

### HEATHKIT ELECTRONIC SWITCH KIT

This handy device allows simultaneous oscilloscope observation of two signals by producing both signals, alternately, at its output. It features an all-electronic switching circuit, with no moving parts. Four switching rates are selected by a panel switch. Provides actual gain for input signals, and has a frequency response of ± 1 DB from 0 to 100 kc. Sync output provided to control and stabilize scope sweep. Will function at signal levels as low as 0.1 volt. This modern device finds many applications in the laboratory and service shop. It employs an entirely new circuit, and yet is priced lower than its predecessor.

MODEL S-3  
**\$21.95**  
 Shpg. Wt. 8 Lbs.



### HEATHKIT SCOPE DEMODULATOR PROBE KIT

Extend the usefulness of your oscilloscope by employing this probe. Makes it possible to observe modulation of RF or IF carriers found in TV and radio receivers. Functions much like an AM detector to pass only modulation of signal, and not the signal itself. Among other uses, it will be helpful in alignment work, as a signal tracer, and for determining relative gain. Applied voltage limits are 30 volts (RMS) and 500 volts DC. It uses an etched circuit board to simplify assembly.

NO. 337-C  
**\$3.50**  
 Shpg. Wt. 1 Lb.

### HEATHKIT VOLTAGE CALIBRATOR KIT

This entirely new voltage calibrator produces near-perfect square wave signals of known amplitude. Precision 1% attenuator resistors assure accurate output amplitude, and multivibrator circuit guarantees good, sharp square waves, as distinguished from clipped sine waves. Output frequency is approximately 1000 CPS. Fixed outputs selected by panel switch are: .03, 0.1, 0.3, 1.0, 3.0, 10, 30, and 100 volts peak-to-peak. Allows measurement of unknown signal amplitudes by comparing to known peak-to-peak output of VC-3 on an oscilloscope. Will also double as a square wave generator at 1000 cycles for determining gain, frequency response, or phase-shift characteristics of audio amplifiers. Equally valuable in the laboratory or in radio and TV service shops.

MODEL VC-3  
**\$12.50**  
 Shpg. Wt. 4 Lbs.

## HEATHKIT ETCHED CIRCUIT VACUUM TUBE



MODEL  
V-7A

**\$24<sup>50</sup>**

Shpg. Wt.  
7 Lbs.

- \* Easy to build — a pleasure to use.
- \* 1% precision resistors employed for high accuracy.
- \* Etched circuit board cuts assembly time in half.

# Voltmeter Kit

The fact that this instrument is the world's largest-selling VTVM says a great deal about its accuracy, reliability, and overall quality. The V-7A is equally popular in the laboratory or service shop, and represents an unbelievable test equipment bargain, without a corresponding sacrifice in quality. Its appearance reflects the performance of which it is capable. A large 4½" panel meter is used for indication, with clear, sharp calibrations for all ranges. Front panel controls consist of a rotary function switch and a rotary range selector switch, zero-adjust, and ohms-adjust controls. Precision 1% resistors are used in the voltage divider circuits and etched circuits are employed for most of the circuitry. This makes the kit much easier to build, eliminates the possibility of wiring errors, and assures duplication of laboratory instrument performance. This multi-function VTVM will measure AC voltage (rms), AC voltage (peak-to-peak), DC voltage, and resistance. There are 7 AC (rms) and DC voltage ranges of 0-1.5, 5, 15, 50, 150, 500, and 1500. In addition, there are 7 peak-to-peak AC ranges of 0-4, 14, 40, 140, 400, 1400, and 4000. 7 ohmmeter ranges provide multiplying factors of X1, X10, X100, X1000, X10K, X100K, and X1 megohm. Center-scale resistance readings are 10, 100, 1000, 10K, 100K ohms, 1 megohm, and 10 megohms. A DB scale is also provided. The precision and quality of the components used in this VTVM cannot be duplicated at this price through any other source. Model V-7A is the kind of instrument you will be proud to own and use.

### HEATHKIT Etched Circuit RF PROBE KIT

This RF probe extends the frequency response of any 11-megohm VTVM so that it will measure RF up to 250 megacycles within ± 10%. Employs printed circuits for increased stability and ease of assembly. Ideal for extending service and laboratory applications of your Heathkit VTVM. Shpg. Wt. 1 Lb.

No. 309-C  
**\$3<sup>50</sup>**

### HEATHKIT 20,000 OHMS/VOLT VOM KIT

Sensitivity of this instrument is 20,000 ohms-per-volt DC and 5,000 ohms-per-volt AC. Measuring ranges are 0-1.5, 5, 50, 150, 500, 1500, and 5000 volts for both AC and DC. Also measures current in the ranges of 0-150 microamperes, 15 ma, 150 ma, 500 ma, and 15 a. Resistance ranges provide multipliers of X1, X100, and X10,000, resulting in center scale readings of 15, 15,000, and 150,000 ohms. DB ranges cover from -10 db to +65 db. Housed in attractive black bakelite case with plastic carrying handle, this fine instrument provides a total of 25 meter ranges on its two-color scale. It employs a sensitive 50 microampere, 4½" meter and features all 1% precision multiplier resistors. Requires no external power, and is, therefore, valuable in portable applications where no AC power is available.

MODEL MM-1  
**\$29<sup>50</sup>**

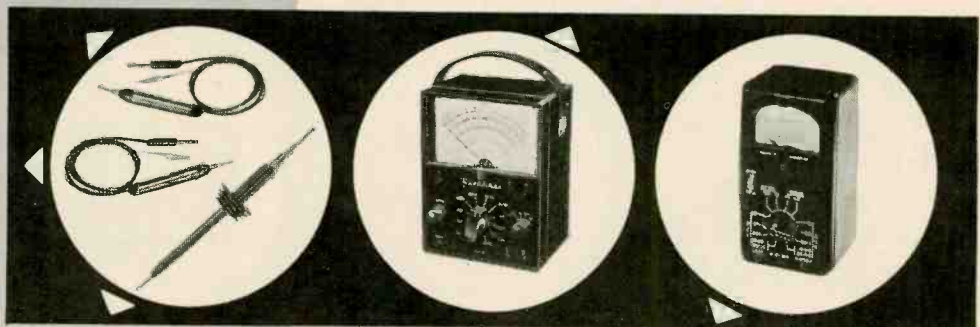
Shpg. Wt. 6 Lbs.

### ETCHED CIRCUIT PEAK-TO-PEAK PROBE KIT

Use this peak-to-peak probe with your 11-megohm VTVM to measure peak-to-peak voltages directly on the DC scales of the instrument. Will measure p-to-p voltages in the frequency range of 5 kc to 5 mc. Employs etched circuit boards for increased circuit stability and simplified construction. Extend the usefulness of your VTVM. NOTE: Not required for the Heathkit V-7A VTVM.

No. 338-C

**\$5<sup>50</sup>** Shpg. Wt. 2 Lbs.



### HEATHKIT 30,000 VOLT DC HIGH VOLTAGE PROBE KIT

This probe provides a multiplication factor of 100 on the DC ranges of the Heathkit 11-megohm VTVM. Precision multiplier resistor mounted inside the two-color plastic probe body. Plenty of insulation for completely safe operation, even at highest TV potentials. Designed especially for TV service work.

No. 336

**\$4<sup>50</sup>**

Shpg. Wt. 2 Lbs.

### HEATHKIT HANDITESTER KIT

The Model M-1 measures AC or DC voltage at 0-10, 30, 300, 1000, and 5000 volts. Direct current ranges are 0-10 ma, and 0-100 ma. Ohmmeter ranges are 0-3000 (30 ohm center scale) and 0-300,000 ohms (3,000 ohms center scale). Uses a 400 microampere meter for sensitivity of 1000 ohms-per-volt. A very popular test device for the home experimenter, electricians, and appliance repairmen, and for use as an "extra" instrument in the service shop. Its small size and rugged construction make it perfect for any portable application. Easily slips into your tool box, glove compartment, coat pocket, or desk drawer. Top quality, precision components employed throughout.

MODEL M-1

**\$14<sup>50</sup>**

Shpg. Wt. 3 Lbs.



**HEATH COMPANY**  
A Subsidiary of Daystrom, Inc.  
BENTON HARBOR 20, MICH.



**CONTROLLED QUALITY . . .**  
 Incoming parts inspection, and inspection of material coming off of our own production line assures you of the finest "build-it-yourself" kit that money can buy. Each kit contains all the components you need for assembly—and you can have confidence in the quality of the parts themselves. In addition to this inspection procedure, an extensive proof-building program for each new kit guarantees easy-to-follow instructions and reliable performance.

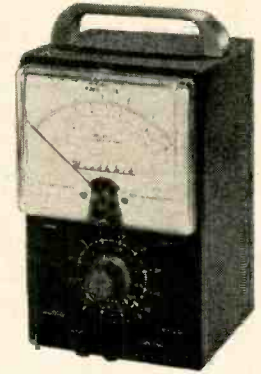
**HEATHKIT NEW AUDIO VACUUM TUBE**

**Voltmeter Kit**

- \* Brand new circuit for extended frequency response and added stability.
- \* Ten accurate ranges from 0-.01 to 0-300 volts.
- \* Modern, functional panel styling. "On-off" switch at both extreme ends of range switch.

This brand new AC vacuum tube voltmeter emphasizes stability, broad frequency response, and sensitivity. It is designed especially for audio measurements, and low-level AC measurements in power supply filters, etc. Employs a cascode amplifier circuit with cathode-follower isolation between the input and the amplifier, and between the output stage and the preceding stages. An extremely stable circuit with high input impedance (1 megohm at 1000 CPS). Response of the AV-3 is essentially flat from 10 CPS to 200 kc, and is usable for tests even beyond these frequency limits. Increased damping in the meter circuit stabilizes the meter for low frequency tests. Nylon insulating bushings at the input terminals reduce leakage, and permit the use of the 5-way Heath binding post.

The extremely wide voltage range covered by the AV-3 makes it especially valuable not only in high-fidelity and service work, but also in experimental laboratories. AC (RMS) voltage ranges are 0-.01, .03, .1, .3, 1, 3, 10, 30, 100, and 300 V. Decibel ranges cover -52 DB to +52 DB. An entirely new circuit as compared to the previous model. Employs 1% precision multiplier resistors for maximum accuracy. Handles AC measurements from a low value of one millivolt to a maximum of 300 volts.



**MODEL AV-3**  
**\$29<sup>95</sup>**

Shpg. Wt.  
 5 lbs.

**HEATHKIT AUDIO WATTMETER KIT**

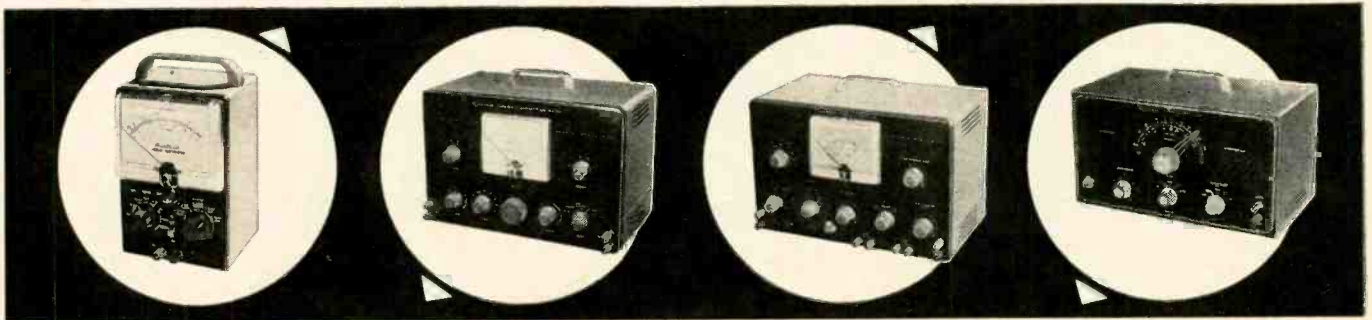
This instrument measures audio power directly at 4, 8, 16, or 600 ohms. Load resistors are built in. Covers 0-5 MW, 50 MW, 500 MW, 5 W, and 50 W full scale. Provides 5 switch-selected DB ranges covering from -10 DB to +30 DB. Large 4½" 200 microampere meter and precision multiplier resistors insure accuracy. Frequency response is ± 1 DB from 10 CPS to 250 kc. Functions from AC power line. Use in the audio laboratory or in home workshop.

**MODEL AW-1**  
**\$29<sup>50</sup>**  
 Shpg. Wt. 6 lbs.

**HEATHKIT AUDIO ANALYZER KIT**

This multi-function instrument combines an AC VTVM, an audio wattmeter, and an intermodulation analyzer into one case, with combined input and output terminals and built-in high and low frequency oscillators. The VTVM ranges are .01, .03, .1, .3, 1, 3, 10, 30, 100, and 300 volts (RMS). Wattmeter ranges are .15 MW, 1.5 MW, 15 MW, 150 MW, 1.5 W, 15 W, 150 W. IM scales are 1%, 3%, 10%, 30%, and 100%. Provides internal load resistors of 4, 8, 16, or 600 ohms. A valuable instrument for the engineer or serious audiophile.

**MODEL AA-1**  
**\$49<sup>95</sup>**  
 Shpg. Wt. 13 lbs.



**HEATHKIT HARMONIC DISTORTION METER KIT**

The HD-1 is equally valuable for the audio engineer or the serious audiophile. Used with a low-distortion audio signal generator, this instrument will measure the harmonic content of various amplifiers under a variety of conditions. Functions between 20 and 20,000 CPS, and reads distortion directly on the panel meter in ranges of 0-1, 3, 10, 30, and 100 percent full scale. Built-in VTVM for initial reference settings and final distortion readings has voltage ranges of 0-1, 3, 10, and 30 volts. 1% precision resistors employed for maximum accuracy. Features voltage regulation and other "extras". Meter calibrated in volts (RMS), percent distortion, and DB.

**MODEL HD-1**  
**\$49<sup>50</sup>**  
 Shpg. Wt. 13 lbs.

**HEATHKIT AUDIO OSCILLATOR KIT**

Producing both sine waves and square waves, the Model AO-1 covers a frequency range of 20 to 20,000 CPS in three ranges. An extra feature is thermistor regulation of output for flat response through the entire frequency range. AF output is provided at low impedance, and with low distortion. Produces good sine waves, and good, clean square waves with a rise time of only two micro-seconds for checking square wave response of audio amplifiers, etc. Designed especially for the serviceman and high-fidelity enthusiast. A real dollar value in test equipment.

**MODEL AO-1**  
**\$24<sup>50</sup>**  
 Shpg. Wt. 10 lbs.

## HEATHKIT



MODEL  
AG-9

**\$34<sup>50</sup>**

Shpg. Wt.  
8 Lbs.

- \* Less than 0.1% distortion — ideal for hi fi work.
- \* Large 4½" meter indicates output.
- \* Step-type tuning for maximum convenience.

# Audio Generator Kit

This particular audio generator is "made to order" for high fidelity applications. It provides quick and accurate selection of low-distortion signals throughout the audio range. Three rotary selector switches on the front panel allow selection of two significant figures and a multiplier for determining audio frequency. In addition, it incorporates a step-type output attenuator and a continuously variable attenuator. Output is indicated on a large 4½" panel meter calibrated in volts and in db. Attenuator system operates in steps of 10 db, corresponding with the meter calibration. Output ranges are 0-.003, .01, .03, .1, .3, 1, 3, and 10 volts rms. A "load" switch provides for the use of a built-in 600 ohm load or an external load of higher impedance when required. Output and frequency indicators accurate to within ± 5%. Distortion is less than .1 of 1% between 20 cps and 20,000 cps. Total range is 10 cps to 100 kc. New engineering details combine to provide the user with an unusually high degree of operating efficiency. Oscillator frequency selected entirely by the switch method means that accurate resetability is provided. Comparable to units costing many dollars more, and ideal for use in critical high fidelity applications. Shop and compare, and you will appreciate the genuine value of this professional instrument.

### HEATHKIT RESISTANCE SUBSTITUTION BOX KIT

The RS-1 contains 36 10% 1-watt resistors ranging from 15 ohms to 10 megohms in standard RETMA values. All values are switch-selected for use in determining desirable resistance values in experimental circuits. Many applications in radio and TV service work.

MODEL RS-1

**\$5<sup>50</sup>**

Shpg. Wt. 2 Lbs.

### HEATHKIT CONDENSER SUBSTITUTION BOX KIT

This kit contains 18 RETMA standard condenser values that can be selected by a rotary switch. Values range from 0.00001 mfd to 0.22 mfd. All capacitors rated at 400 volts or higher. Capacitors are either silver-mica, or plastic molded.

MODEL CS-1

**\$5<sup>50</sup>**

Shpg. Wt. 2 Lbs.

### HEATHKIT AUDIO GENERATOR KIT

The Model AG-8 is a low cost, high performance unit for use in service shop, or home workshop. It covers the frequency range of 20 cps to 1 mc in five ranges. Output is 600 ohms, and overall distortion will be less than .4 of 1% from 100 cps through the audible range. Output is available up to 10 volts, under no load conditions, and output remains constant within ±1 db from 20 cps to 400 kc. A five-step attenuator provides control of the output. Precision resistors are employed in the frequency determining network.

MODEL AG-8

**\$29<sup>50</sup>**

Shpg. Wt. 11 Lbs.

### HEATHKIT DECADE CONDENSER KIT

Precision, 1% silver-mica capacitors are employed in the Model DC-1 in such a way that a selection of precision capacitor values is provided ranging from 100 mmf (.0001 mfd) to 0.11 mfd (110,000 mmf) in 100 mmf steps. Extremely valuable in all types of design and development work. Switches are ceramic wafer types.

MODEL DC-1

**\$16<sup>50</sup>**

Shpg. Wt. 3 Lbs.



### HEATHKIT DECADE RESISTANCE KIT

The Model DR-1 incorporates twenty 1% precision resistors arranged around five rugged switches so that various combinations of switch positions will provide a total range of 1 ohm to 99,999 ohms in 1-ohm steps. Switches are labeled "units," "tens," "hundreds," "thousands," and "ten thousands." Use it for ohm-meter calibration in bridge circuits as test values in multiplier circuits, etc.

MODEL DR-1

**\$19<sup>50</sup>**

Shpg. Wt. 4 Lbs.

### HEATHKIT VARIABLE VOLTAGE REGULATED POWER SUPPLY KIT

This power supply is regulated for stability, and the amount of DC output available from the power supply can be controlled manually from zero to 500 volts. Will provide regulated output at 450 volts up to 10 ma, or up to 130 ma at 200 volts output. In addition to furnishing B-plus, the power supply provides 6 volts AC at 4 amperes for filaments. Both the B-plus output and the filament output are isolated from ground. Ideal power supply for use in experimental work in the laboratory, the home workshop, or the ham shack. Large 4½" panel meter indicates output voltage or current.

MODEL PS-3

**\$35<sup>50</sup>**

Shpg. Wt. 17 Lbs.



**HEATH COMPANY**  
A Subsidiary of Daystrom, Inc.  
BENTON HARBOR 20, MICH.

**BONUS PERFORMANCE . . .**  
 If a single word had to be selected to describe Heath Company advertising policy, it would be "conservative." By this we mean that the performance specifications and features are not exaggerated, and that the descriptions are accurate. We specify performance on the conservative side so you can be sure of equaling or exceeding our specifications. In almost every instance our kits will do more than we claim. Extra care in construction, and calibration against an accurate standard can extend performance well beyond advertised levels.

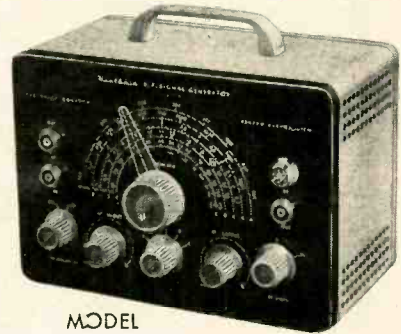
**HEATHKIT**

**Signal Generator Kit**

- \* No calibration required with pre-aligned coils.
- \* Modulated or unmodulated RF output.
- \* 110 mc to 220 mc frequency coverage.

Here is an RF signal generator for alignment applications in the service shop or the home workshop. Thousands of these units are in use in service shops all over the country. Produces RF signals from 160 kc to 110 mc on fundamentals on five bands. Also covers from 110 mc to 220 mc on calibrated harmonics. RF output is in excess of 100,000 microvolts at low impedance. Output is controllable with a step-type and a continuously variable attenuator. Front panel controls provide selection of either unmodulated RF output or RF modulated at 400 cps. In addition, two to three volts of audio at approximately 400 cps are available at the output terminals for testing AF circuits. Employs a 12AU7 and a 6C4 tube. Built-in power supply uses a selenium rectifier.

One of the most outstanding features about the Model SG-8 is the fact that it can be built in just a few hours, even by one not thoroughly experienced in electronics work. Complete step-by-step instructions combined with large pictorial diagrams assure successful assembly. Pre-aligned coils make calibration from an external source unnecessary.



MODEL SG-8

**\$19<sup>50</sup>** Shpg. Wt. 8 Lbs.

**HEATHKIT LABORATORY GENERATOR KIT**

This laboratory RF signal generator covers from 100 kc to 30 mc on fundamentals in five bands. The output signal may be pure RF, or may be modulated at 400 cycles from 0 to 50%. Provision for external modulation has been made. RF output available up to 100,000 microvolts. Output controlled by a fixed step and a variable attenuator. Output impedance is 50 ohms. Panel meter reads RF output or percentage of modulation. Incorporates voltage regulated B+ supply, double shielding of oscillator circuits, copper plated chassis, and other "extras."

MODEL LG-1

**\$48<sup>95</sup>**

Shpg. Wt. 16 Lbs.

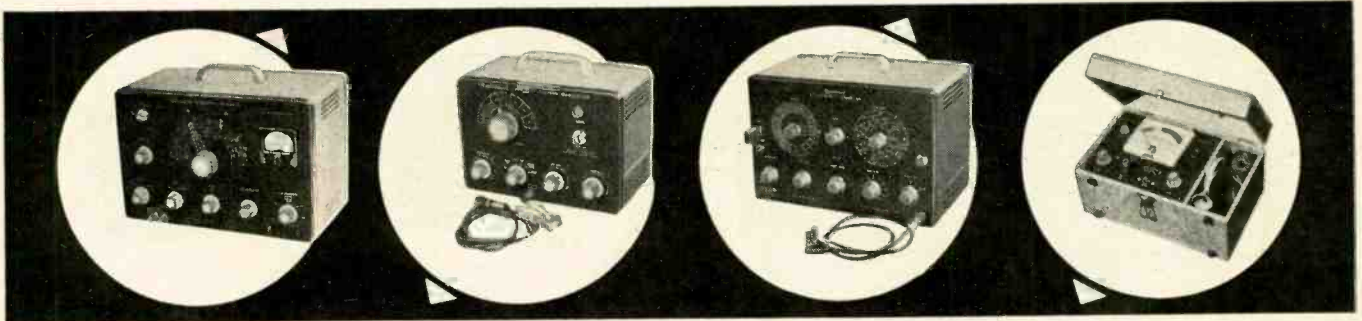
**HEATHKIT TV ALIGNMENT GENERATOR KIT**

This improved sweep generator model provides essential stability and flexibility for work on FM, monochrome TV, or color TV sets. Covers 3.6 mc to 220 mc in four bands. Provides usable output even on harmonics. Sweep deviation from 0-42 mc, depending on base frequency. All-electronic sweep circuit eliminates unwieldy mechanical arrangements. Includes built-in crystal marker generator providing output at 4.5 mc and multiples thereof, and variable marker covering 19 to 60 mc on fundamentals and from 57 to 180 mc on harmonics. Effective two-way blanking.

MODEL TS-4A

**\$49<sup>50</sup>**

Shpg. Wt. 16 Lbs.



**HEATHKIT LINEARITY PATTERN GENERATOR KIT**

This instrument supplies information for white dots, cross-hatch pattern, horizontal bar pattern, or vertical bar pattern. It feeds video and sync signals to the set under test, with completely controlled gain, and unusual stability. Covering channels 2 to 13, the LP-2 will produce 5 to 6 vertical bars and 4 to 5 horizontal bars. The dot pattern presentation is a *must* for the setting of color convergence controls in the color TV set. Panel provision made for external sync if desired. Use for adjustment of vertical and horizontal linearity, picture size, aspect ratio, and focus. Power supply is regulated for added stability. Essential in the up-to-date TV service shop.

MODEL LP-2

**\$22<sup>50</sup>**

Shpg. Wt. 7 Lbs.

**HEATHKIT CATHODE RAY TUBE CHECKER KIT**

This instrument checks cathode emission, beam current, shorted elements, and leakage between elements in electro-magnetic picture tube types. It eliminates all doubt for the TV serviceman, and even more important, for the customer. Features its own self-contained power supply, transformer operated to furnish normal test voltages for the CRT. Employs spring-loaded switches for maximum operator protection. Large 4 1/2" meter indicates CRT condition on "good-bad" scale. Luggage-type portable case ideal for home service calls. Special "shadowgraph" test permits projection of light spot on screen. Also gives relative check of picture tube screen coating.

MODEL CC-1

**\$22<sup>50</sup>**

Shpg. Wt. 10 Lbs.

HEATHKIT



MODEL  
TC-2

**\$29<sup>50</sup>**

Shpg. Wt.  
12 Lbs.

- \* Attractive counter-style cabinet.
- \* Wiring-harness simplifies assembly.
- \* Large 4½" meter with two-color "good-bad" scale.
- \* Separate tube element switches prevent obsolescence.

## Tube Checker Kit

This fine piece of test gear checks tubes for quality, emission, shorted elements, open elements, and filament continuity. Will test all tube types normally encountered in radio and TV service work. Sockets provided for 4, 5, 6, and 7-pin large, rectangular, and miniature types, octal and loctal types, the Hytron 9-pin miniatures, and pilot lamps. Condition of tubes indicated on a large 4½" meter with multi-color "good-bad" scale. An illuminated roll chart is built right in, providing test data for various tube types. This tester provides switch selection of 14 different filament voltage values from 0.75 volts to 117 volts. Individual switches control each tube element. Close tolerance resistors employed in critical test circuits for maximum accuracy. A professional instrument both in appearance and performance.

The Model TC-2 is very simple to build, even for a beginner. It employs a color-coded cable harness for neat, professional under-chassis wiring. Comes with attractive counter style cabinet, and portable cabinet is available separately. At this price, even the part-time serviceman can afford his own tube checker for maximum efficiency in service work.

### HEATHKIT TV PICTURE TUBE TEST ADAPTER

Designed especially for use with the Model TC-2 tube checker. Use it to test TV picture tubes for emission, shorts, etc. Consists of 12-pin TV tube socket, 4 ft. cable, octal connector, and necessary technical data. Not a kit.



MODEL 355

**\$4<sup>50</sup>**

Shpg. Wt.  
1 Lb.

### HEATHKIT PORTABLE TUBE CHECKER KIT

This portable tube checker is identical, electrically, with the Model TC-2. However, it is housed in an attractive and practical carrying case, finished in proxylin impregnated material. The cover is detachable, and the hardware is brass plated. This rugged unit is ideal for home service calls or any portable application.



MODEL  
TC-2P

**\$34<sup>50</sup>** Shpg. Wt.  
15 Lbs.

### HEATHKIT VISUAL-AURAL SIGNAL TRACER KIT

Although designed primarily for radio receiver work, this valuable instrument finds extensive application in FM and TV servicing as well. Features a high-gain channel with demodulator probe, and a low-gain channel with audio probe. Will trace signals in all sections of a radio receiver and in many sections of a FM set or TV receiver. Uses built-in speaker and electron beam eye tube for indication. Also features built-in wattmeter and a noise locator circuit. Provision for patching speaker and/or output transformer into external set.

MODEL T-3

**\$23<sup>50</sup>**

Shpg. Wt. 9 Lbs.

### HEATHKIT DIRECT READING CAPACITY METER KIT

Operation of this instrument is simplicity itself. One has only to connect a capacitor to the terminals, select the proper range, and read the capacity value directly on the large 4½" meter calibrated in mmf and mfd.

Ranges are 0 to 100 mmf, 1,000 mmf, 0.01 mfd, and 0.1 mfd full scale. Precision calibrating capacitors supplied. Not susceptible to hand capacity effects. Residual capacity less than .1 mmf. Especially valuable in production line checking, or in quality control.



MODEL CM-1

**\$29<sup>50</sup>**

Shpg. Wt.  
7 Lbs.



### HEATHKIT CONDENSER CHECKER KIT

The Model C-3 consists of an AC powered bridge for both capacitive and resistive measurements. Bridge balance is indicated on electron beam eye tube, and capacity or resistance value is indicated on front panel calibrations. Measures capacity in four ranges from .00001 mfd to .005 mfd, .001 mfd to .5 mfd, .1 mfd to 50 mfd, and 20 mfd to 1000 mfd. Measures resistance in two ranges, from 100 ohms to 50,000 ohms, and from 10,000 ohms to 5 megohms. Selection of five different polarizing voltages for checking capacitors, from 25 volts DC to 450 volts DC. Checks paper, mica, ceramic, and electrolytic capacitors. Indicates power factor of electrolytic condensers.

MODEL C-3

**\$19<sup>50</sup>**

Shpg. Wt. 7 Lbs.



**HEATH COMPANY**  
A Subsidiary of Daystrom, Inc.  
BENTON HARBOR 20, MICH.

### PIONEER DESIGN . . .

New and unique approaches to instrument and equipment designs are a Heath Company tradition. We concentrate all our development efforts on kit projects, since this is our prime activity—and not just a sideline. This logically results in more efficient, more reliable circuit designs—and you benefit from this constant engineering progress. Buying from the undisputed leader in the electronic kit field assures you of completely modern equipment, with outstanding advanced design features.

## HEATHKIT

# Impedance Bridge Kit

- \*  $\frac{1}{2}\%$  precision resistors and silver-mica capacitors.
- \* Battery-type tubes, no warm-up required.
- \* Built-in phase shift generator and amplifier.

The Model IB-2 is a completely self-contained unit. It has a built-in power supply, a built-in 1000 cycle generator, and a built-in vacuum tube detector. Provision has been made on the panel for connection to an external detector, an external signal generator, or an external power supply. A 100-0-100 micro-ampere meter on the front panel provides for null indications. Measures resistance from 0.1 ohm to 10 megohms, capacitance from 10 mmf to 100 mfd, inductance from 10 mh to 100 h, dissipation factor (D) from 0.002 to 1, and storage factor (Q) from 0.1 to 1000.  $\frac{1}{2}$  of 1% decade resistors employed for maximum accuracy. Typical accuracy figures are: resistance,  $\pm 3\%$ ; capacitance  $\pm 3\%$ ; inductance,  $\pm 10\%$ ; dissipation factor,  $\pm 20\%$ ; storage factor,  $\pm 20\%$ . Employs a Wheatstone bridge, a Capacity Comparison bridge, a Maxwell bridge, and a Hay bridge. Special two-section CRL dial provides maximum convenience in operation. Use the Model IB-2 for determining values of unmarked components, checking production or design samples, etc. A real professional instrument.



MODEL  
IB-2

**\$59<sup>50</sup>** Shpg. Wt.  
12 lbs.

### HEATHKIT "Q" METER KIT

The Q Meter permits measurement of inductance from 1 microhenry to 10 millihenries, "Q" on a scale calibrated up to 250 full scale, with multiplying factors of 1 or 2, and capacitance from 40 mmf to 450 mmf,  $\pm 3$  mmf. Built-in variable oscillator permits testing components from 150 kc to 18 mc. Large  $4\frac{1}{2}$ " panel-mounted meter is featured. Very handy for checking peaking coils, chokes, etc. Use to determine values of unknown condensers, both variable and fixed. Compile data for coil winding purposes, or measure RF resistance. Distributed capacity, and Q of coils.

MODEL QM-1

**\$44<sup>50</sup>**

Shpg. Wt. 14 lbs.

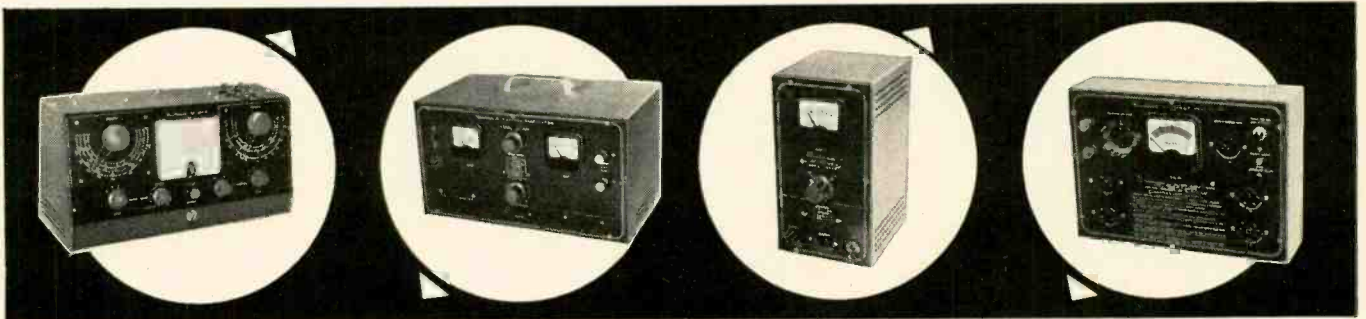
### HEATHKIT ISOLATION TRANSFORMER KIT

This device isolates equipment under test from the power line. It is rated at 100 volt-amperes continuously, or 200 volt-amperes intermittently. AC-DC sets may be plugged directly into the IT-1 without the chassis becoming "hot." Additionally, since the IT-1 is fused, it is ideal for use as a buffer between the power line and a questionable receiver, or a new piece of equipment. Protects main fuses. Features voltage control, allowing control of the output from 90 volts to 130 volts. Panel meter monitors output voltage. A very handy device at an extremely low price.

MODEL IT-1

**\$16<sup>50</sup>**

Shpg. Wt. 9 lbs.



### HEATHKIT 6-12 VOLT BATTERY ELIMINATOR KIT

This completely modern battery eliminator will supply DC output in two ranges for both 6-volt and 12-volt automobile radios. The output is variable for each range, so that operating voltage can be raised or lowered to determine how the receiver functions under adverse conditions. Range is 0-8 volts DC or 0-16 volts DC. Will supply up to 15 amperes on the 6-volt range, or up to 7 amperes on the 12-volt range. Two 10,000 microfarad output filter capacitors insure smooth DC output. Two separate panel meters indicate output voltage or output current. Makes it possible to test automobile radios inside at the workbench. Will also double as a battery charger.

MODEL BE-4

**\$31<sup>50</sup>**

Shpg. Wt. 17 lbs.

### HEATHKIT 6-VOLT VIBRATOR TESTER KIT

This instrument functions very much like a tube checker, to test auto radio vibrators. Vibrator condition is indicated on a simple "good-bad" scale. Tests for proper starting and overall quality of operation, of both interrupter and self-rectifier types of 6-volt vibrators. The model VT-1 is designed to operate from any battery eliminator capable of delivering continuously variable output from 4 to 6 volts DC at 4 amperes or more. It is an ideal companion unit for the Heathkit Model BE-4 battery eliminator. The construction book for the VT-1 contains vibrator test chart for popular 6-volt vibrator types. A real time saver!

MODEL VT-1

**\$14<sup>50</sup>**

Shpg. Wt. 6 lbs.

## HEATHKIT DX-100 PHONE AND CW



**MODEL  
DX-100**  
Shpg. Wt.  
107 Lbs.

**\$189<sup>50</sup>**

Shipped motor freight unless otherwise specified.  
\$50.00 deposit required on c.o.d. orders.

- \* Phone or CW on 160, 80, 40, 20, 15, 11 and 10 meters.
- \* Built-in VFO, modulator, and power supplies.
- \* High quality components used throughout for reliable performance.
- \* Features 5-point TVI suppression.

# Transmitter Kit

The Heathkit DX-100 transmitter is in a class by itself in that it offers features far beyond those normally received at this price level. It takes very little listening on the bands to discover how many of these transmitters are in operation today. A truly amazing piece of amateur gear. The DX-100 features a built-in VFO and a built-in modulator. It is TVI suppressed, and uses pi network interstage coupling and output coupling. Will match antenna impedances from approximately 50 to 600 ohms. Extensive shielding is employed, and all incoming and outgoing circuits are filtered. The cabinet features interlocking seams for simplified assembly and minimum RF radiation outside of the cabinet. Provides a clean strong signal on either phone or CW, with RF output in excess of 100 watts on phone, and 120 watts on CW. Completely bandswitching from 160 through 10 meters. A pair of 1625 tubes are used in push-pull for the modulator, and the final consists of a pair of 6146 tubes in parallel. The VFO dial and meter face are illuminated, and all front panel controls are located for maximum convenience. Panel meter reads driver plate I, final grid I, final plate I, final plate voltage, and modulator current. The chassis is constructed of heavy #16 gauge copper-plated steel. Other high-quality components include potted transformers, ceramic switch and variable capacitor insulation, silver-plated or solid-silver switch terminals, etc. All coils are pre-wound, and the main wiring cable is pre-harnessed. The kit can be built by a beginner from the comprehensive step-by-step instructions supplied. It is a proven, trouble-free rig, that will insure many hours of "on-the-air" enjoyment in your ham shack.

### HEATHKIT COMMUNICATIONS TYPE ALL BAND RECEIVER KIT

This receiver covers 550 kc to 30 mc in four bands, and is ideal for the short-wave listener or beginning amateur. It provides good sensitivity and selectivity, combined with good image rejection. Amateur bands clearly marked on illuminated dial scale. Employs transformer type power supply—electrical bandspread—antenna trimmer—separate RF and AF gain controls—noise limiter—headphone jack—and automatic gain control. Has built-in BFO for CW reception.

**CABINET:** Fabric covered cabinet with aluminum panel as shown. Part 91-15A. Shipping weight 5 Lbs. \$4.95

MODEL AR-3

**\$29<sup>95</sup>**

INCLUDING NEW  
EXCISE TAX  
(Less Cabinet)  
Shpg. Wt. 12 Lbs.

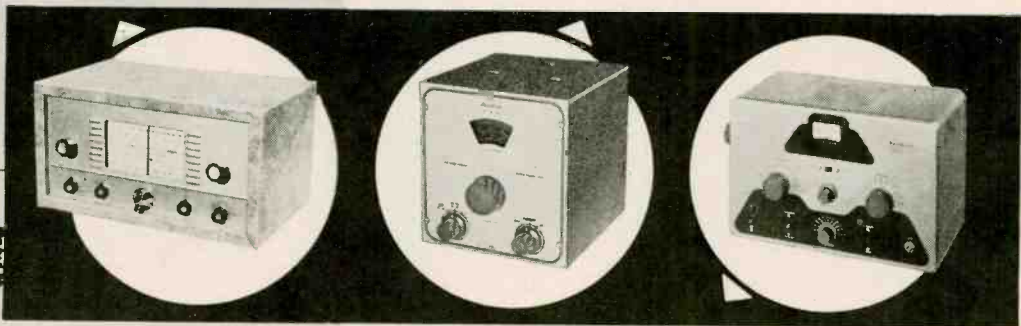
### HEATHKIT VFO KIT

You can go VFO for less than you might expect. Here is a variable frequency oscillator that covers 160, 80, 40, 20, 15, 11, and 10 meters with three basic oscillator frequencies, that sells for less than \$20. Provides better than 10 volt average RF output on fundamentals. Plenty of drive for most modern transmitters. Requires a power source of only 250 VDC at 15 to 20 ma. and 6.3 VAC at 0.45A. Incorporates a regulator tube for stability. Illuminated frequency dial reads frequency directly on the band being employed. Temperature-compensated capacitors offset coil heating.

MODEL VF-1

**\$19<sup>50</sup>**

Shpg. Wt. 7 Lbs.



### EASY ON THE BUDGET!

You can buy Heathkits on an easy time-payment plan that provides a full year to pay. Write for complete details and special order blank.



**HEATH COMPANY**

A Subsidiary of Daystrom, Inc.

BENTON HARBOR 20, MICH.

### NEW HEATHKIT CW TRANSMITTER KIT

The brand new Heathkit Model DX-20 Transmitter is one of the most efficient little rigs available today. Featuring an entirely new circuit, it is ideal for the novice, and even for the advanced-class CW operator. A 6DQ6A final amplifier provides plate power input of 50 watts. A 6CL6 oscillator is employed, and a 5U4GB rectifier. The transmitter features one-knob bandswitching to cover 80, 40, 20, 15, 11 and 10 meters. It is designed for crystal excitation, but may be excited by an external VFO. A pi network output circuit matches antenna impedances between 50 and 1000 ohms. Front panel controls are functionally located for your convenience. If you appreciate a good signal on the CW bands, this is the transmitter for you!

MODEL DX-20

**\$35<sup>95</sup>**

Shpg. Wt. 18 Lbs.

**DOLLAR-SAVING ECONOMY . . .**  
 There would be no particular achievement in selling inexpensive merchandise at a low price—although it is being done every day. However, there is something to crow about when, through tremendous purchasing power and factory-to-you distribution, Heath Company can offer top-quality equipment, using name-brand components, at such low prices. This is real economy, as opposed to the so-called "bargains". Needless to say, there is a big difference.

## HEATHKIT PHONE AND CW Transmitter Kit

- \* 6146 final amplifier for full 65-watt plate power input.
- \* Phone and CW operation on 80, 40, 20, 15, 11, and 10 meters. Pi network output coupling.
- \* Switch selection of three crystals — provision for external VFO excitation.

The DX-35 features a 6146 final amplifier to provide 65 watts plate power input on CW, with controlled carrier modulation peaks up to 50 watts on phone. In addition, it is a most attractive transmitter. Modulator and power supplies are built-in, and the rig covers 80, 40, 20, 15, 11, and 10 meters with a single band-change switch. Pi network output coupling provided for matching various antenna impedances. A 12BY7 buffer stage provided ahead of the final amplifier for plenty of drive on all bands. 12BY7 oscillator and 12AU7 modulator. Provision for switch selection of three different crystals. Crystals reached through access door at rear. Front panel controls marked "off—CW—stand-by—phone", "final tuning", "antenna coupling", "drive level control", and "band change switch". Panel meter indicates final grid current or final plate current. A perfect low-power transmitter both for the novice, and for the more experienced operator. A remarkable power package for the price. Incidentally, the price includes tubes, and all other components necessary for assembly. As with all Heathkits, comprehensive instruction manual assures successful assembly.



MODEL DX-35  
**\$56<sup>95</sup>** Shpg. Wt. 24 Lbs.

### HEATHKIT ANTENNA IMPEDANCE METER KIT

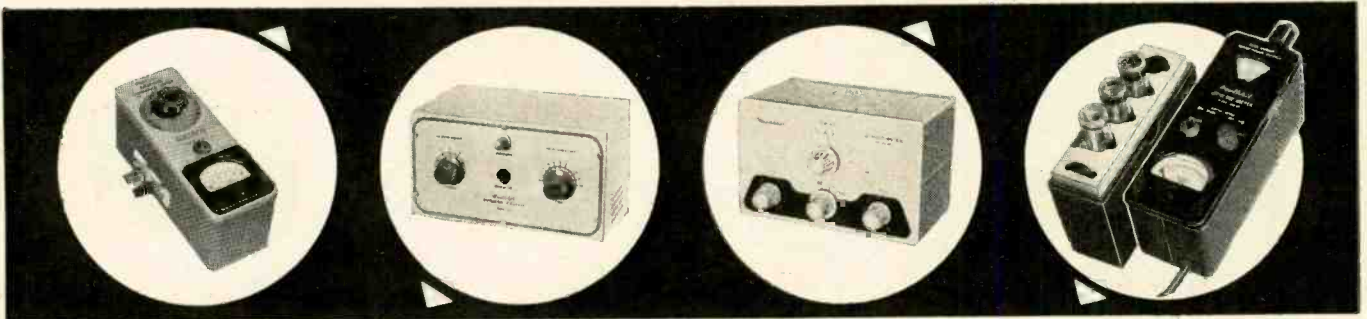
This instrument employs a 100 microampere panel meter and covers the impedance range of 0-600 ohms for RF tests. Functions up to 150 mc. Used in conjunction with signal source, such as the Heathkit Model GD-1B grid dip meter, the Model AM-1 will determine antenna resistance and resonance, match transmission lines for minimum standing wave ratio, determine receiver input impedance, etc. Will also double as a phone monitor. A very valuable device for many uses in the ham shack.

MODEL AM-1  
**\$14<sup>50</sup>**  
 Shpg. Wt. 2 Lbs.

### HEATHKIT "Q" MULTIPLIER KIT

The QF-1 functions with any receiver with an IF frequency between 450 and 460 kc that is not AC-DC type. Operates from the receiver power supply, requiring only 6.3 VAC at 300 ma. and 150 to 250 VDC at 2 ma. Simple to connect with cable and plugs supplied. Provides additional selectivity for separating two signals, or will reject one signal and eliminate heterodyne. A big help on crowded bands. Provides an effective Q of approximately 4,000 for sharp "peak" or "null". Tunes to any signal within the IF bandpass of the receiver, without changing main receiver tuning dial.

MODEL QF-1  
**\$9<sup>95</sup>**  
 Shpg. Wt. 3 Lbs.



### HEATHKIT ANTENNA COUPLER KIT

This device is designed to match the Model AT-1 transmitter to a long-wire antenna. In addition to impedance matching, this unit incorporates an L-type filter which attenuates signals above 36 megacycles, thereby reducing TVI. Designed for 52 ohm coaxial input. Handles power up to 75 watts, 10 through 80 meters. Uses a tapped inductor and variable capacitor. Neon RF indicator on front panel. Copper-plated chassis—high quality components throughout—simple to build. Eliminates waste of valuable communications power due to improper matching. A "natural" for all AT-1 transmitter owners.

MODEL AC-1  
**\$14<sup>50</sup>**  
 Shpg. Wt. 4 Lbs.

### HEATHKIT GRID DIP METER KIT

The grid dip meter was originally designed for the ham shack. However, its use has been extended into the service shop and laboratory. Continuous frequency coverage from 2 mc to 250 mc with pre-wound coils. 500 microampere panel meter employed for indication. Use for locating parasitics, neutralizing, determining RF circuit resonant frequencies, etc. Coils are included with kit, as is a coil rack. Front panel controls include sensitivity control for meter, and phone jack for listening to zero-beat. Will also double as an absorption-type wavemeter.

MODEL GD-1B  
**\$19<sup>95</sup>**  
 Shpg. Wt. 4 Lbs.

## HEATHKIT BROADCAST BAND



**MODEL BR-2**  
(Less Cabinet)  
Shpg. Wt. 10 Lbs.

**\$18<sup>95</sup>**

INCLUDING NEW  
EXCISE TAX\*

### ATTENTION BEGINNERS . . .

This kit is an ideal "first project" if you have never built a Heathkit before. A good chance to "learn by doing."

- \* Miniature tubes and high-gain IF transformer.
- \* 5½-inch PM speaker.
- \* Rod-type built-in antenna.
- \* Provision for phono jack.
- \* Good sensitivity and selectivity.
- \* Transformer-operated power supply.

## Receiver Kit

You need no previous experience in electronics to build this table-model radio. The Model BR-2 receiver covers 550 kc to 1620 kc and features good sensitivity and selectivity over the entire band. A 5½" PM speaker is employed, along with high gain miniature tubes and a new rod-type built-in antenna. Provision has been made in the design of this receiver for its use as a phonograph amplifier. The phono jack is located on the back chassis apron. A transformer operated power supply is featured for safety of operation, as opposed to the usual AC-DC supply commonly found in "economy radio kits." Don't let the low Heathkit price deceive you. This is the kind of set you will want to show off to your family and friends after you have finished building it.

Construction of this radio kit is very simple. Giant size pictorial diagrams and detailed step-by-step instructions assure your success. The construction manual also includes an explanation of basic receiver circuit theory so you can "learn by doing" as the receiver is built. The manual even provides information on resistor and capacitor color codes, soldering techniques, use of tools, etc. If you have ever had the urge to build your own radio receiver, the outstanding features of this popular Heathkit deserve your attention.

**CABINET:** Proxylin impregnated fabric covered plywood cabinet available for the BR-2 receiver as shown. Complete with aluminum panel, reinforced speaker grill, and protective rubber feet. Shipping weight 5 lbs., part No. 91-9A. . . . . \$4.95\*

### HEATHKIT PROFESSIONAL RADIATION COUNTER KIT

This sensitive and reliable instrument has already found extensive application in prospecting, and also in medical and industrial laboratories. It offers outstanding performance at a reasonable price. Front-panel meter indicates radiation level, and oral indication produced by panel-mounted speaker. Meter ranges are 0-100, 600, 6,000 and 60,000 counts per minute, and 0-.02, .1, 1 and 10 milliroentgens per hour. The probe, with expansion cord, employs type 6306 bismuth counter tube, sensitive to both beta and gamma radiation. It is simple to build, even for a beginner.

**MODEL RC-1**  
**\$79<sup>95</sup>**

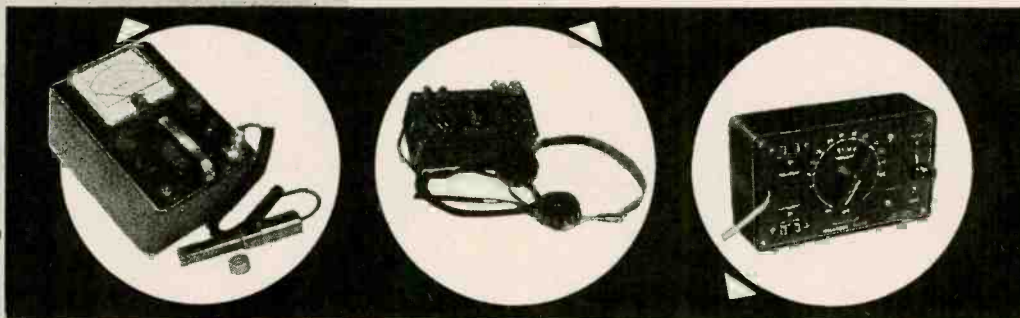
Shpg. Wt. 8 Lbs.

### HEATHKIT CRYSTAL RECEIVER KIT

The crystal radio of Dad's day is back again, but with big improvements! The Model CR-1 employs a sealed germanium diode, eliminating the critical "cat's whisker" adjustment. It is housed in a compact plastic box, and features two Hi-Q tank circuits, employing ferrite core coils and variable air tuning capacitors. The CR-1 covers the standard broadcast band from 540 kc to 1600 kc, and no external power is required for operation. Could prove valuable for emergency signal reception. This easy-to-build kit is a real "learn by doing" experience for the beginner, and makes an interesting project for all ages.

**MODEL CR-1**  
**\$7<sup>95</sup>**

INCLUDING NEW  
EXCISE TAX\*  
Shpg. Wt. 3 Lbs.



\* Amazing new circuit for high efficiency.

- \* Compact, portable and rugged.
- \* Stable circuit requires only one 67½ volt "B" battery and two 1½ volt "A" batteries.

### HEATHKIT ENLARGER TIMER KIT

The Model ET-1 is an easy-to-build device for use by amateur or professional photographers in controlling the timing cycle of an enlarger. It covers the range of 0 to 1 minute with a continuously variable, clearly calibrated scale. The timing period is pre-set, and the timing cycle is initiated by depressing the spring-return switch to the "print" position. Front panel provision is made for plugging in the enlarger and a safelight. The safelight is automatically turned "on" when the enlarger is "off". Handles up to 350 watts. The timing cycle is controlled electronically for maximum accuracy and reliability. Very simple to build in only one evening, even by a beginner.

**MODEL ET-1**  
**\$11<sup>50</sup>**

Shpg. Wt. 3 Lbs.



**HEATH COMPANY**  
A Subsidiary of Daystrom, Inc.  
BENTON HARBOR 20, MICH.



HEATHKIT HIGH FIDELITY

# Preamplifier Kit

## COMPREHENSIVE INSTRUCTIONS . . .

The step-by-step assembly instructions provided with each Heathkit are the finest available anywhere. Each manual begins at the beginning, and assumes no previous training or experience on the part of the kit builder. This means that our kits can be built successfully by anyone who can follow instructions. As a matter of fact, new manuals are tested by having the kit built by someone in our office who has had no previous experience in electronics. This is your guarantee of complete and thorough instruction material.

- \* 5 switch-selected inputs, each with its own level control.
- \* Equalization for LP, RIAA, AES, and Early 78's.
- \* Separate bass and treble tone controls, and special hum control.
- \* Clean, modern lines and satin-gold enamel finish.

Literally thousands of these preamplifiers are in use today, because the kit meets or exceeds specifications for the most rigorous high-fidelity applications, and will do justice to the finest available program sources. Provides a total of 5 inputs, each with individual level controls (three high-level and two low-level). Frequency response is within 1 DB from 25 CPS to 30,000 CPS, or within 1 1/2 DB from 15 CPS to 35,000 CPS. Hum and noise are extremely low, with special balance control for absolute minimum hum level. Tone control provides 18 DB boost and 12 DB cut at 50 CPS, and 15 DB boost and 20 DB cut at 15,000 CPS. Cabinet measures only 12-9/16" W. x 3 3/8" H. x 4 7/8" D, and it is finished in beautiful satin-gold enamel. 4-position turnover and 4 position roll-off controls provide "LP," "RIAA," "AES," and "early 78" equalization, and 8, 12, 16, and 1 flat position for roll-off. Derives operating power from the main amplifier, requiring only 6.3 VAC at 1 ampere and 300 VDC at 10 MA. Easy to construct from step-by-step instructions and pictorial diagrams provided.



MODEL WA-P2 (With Cabinet)  
Shpg. Wt. 7 Lbs.

**\$19<sup>75</sup>**

## HEATHKIT HIGH FIDELITY FM TUNER KIT

- \* Illuminated slide-rule dial covers 88 to 108 MC.
- \* Modern circuit emphasizes sensitivity and stability.
- \* Housed in attractive satin-gold cabinet to match WA-P2 and BC-1.

This amazing new FM tuner can provide you with real high-fidelity performance at an unbelievably low price level. Covering 88 to 108 MC, the modern circuit features a stabilized, temperature-compensated, oscillator, A.G.C., broadbanded

IF circuits, and better than 10 UV sensitivity for 20 DB of quieting. A high gain, cascaded, RF amplifier is used ahead of the mixer to increase overall gain and reduce oscillator leakage. It employs a ratio detector for high efficiency without sacrifice in high-fidelity performance. IF and ratio transformers are pre-aligned, as is the front end tuning unit. This means the kit can be constructed by a beginner, without elaborate test and alignment equipment. The FM-3A is designed to match the WA-P2 preamplifier and the BC-1 AM tuner. An illuminated slide-rule dial is employed for frequency indication. Step-by-step instructions and large pictorial diagrams assure success.

MODEL FM-3A  
**\$25<sup>95</sup>**  
INCLUDING NEW EXCISE TAX  
(With Cabinet)  
Shpg. Wt. 7 Lbs.



## HEATHKIT BROADBAND AM TUNER KIT

This AM tuner has been designed especially for high-fidelity applications. It incorporates a low-distortion detector, a broadband IF, and other features essential to usefulness in high-fidelity. Special voltage-doubler detector employs crystal diodes for low distortion. Sensitivity and selectivity are excellent. Audio response is  $\pm 1$  DB from 20 CPS to 2 kc, with 5 DB of pre-emphasis at 10 kc to compensate for station roll-off. Covers the standard broadcast band from 550 to 1600 kc. Incorporates a 10 kc whistle-filter and provides a 6 DB signal-to-noise ratio at 2.5 UV. RF and IF coils are pre-aligned, and power supply is built-in. Incorporates AVC, two outputs, and two antenna inputs.

MODEL BC-1  
**\$25<sup>95</sup>**  
INCLUDING NEW EXCISE TAX  
(With Cabinet)  
Shpg. Wt. 8 Lbs.

## HEATHKIT ELECTRONIC CROSS-OVER KIT

This unusual device functions to separate low frequencies and high frequencies so that they may be fed to separate amplifiers and to separate speakers. This eliminates the need for conventional cross-over circuits, since the Model XO-1 does the complete job electronically. Cross-over frequencies of 100, 200, 400, 700, 1,200, 2,000 and 3,500 CPS are selectable with front panel controls on the XO-1, and a separate level control is provided for each channel. Minimizes inter-modulation distortion problems. Handles unlimited power, since frequency division is accomplished ahead of the power stage. Attenuation is 12 DB per octave, with sharp "knee" at cut-off frequency.

MODEL XO-1  
**\$18<sup>95</sup>**  
Shpg. Wt. 6 Lbs.

## HEATHKIT ADVANCED-DESIGN



**MODEL W-5M**  
Shpg. Wt. 31 Lbs.  
Express Only

**\$59.75**

### MODEL W-5

Consists of Model W-5M plus Model WA-P2 pre-amplifier.

Shpg. Wt. 38 Lbs.  
Express only... \$79.50

- \* Full 25 watt output with KT-66 output tubes.
- \* All connectors brought out to front chassis apron.
- \* Protective cover over all above-chassis components.

### HEATHKIT DUAL-CHASSIS—WILLIAMSON TYPE HIGH FIDELITY AMPLIFIER KIT

This 20-watt high-fidelity amplifier employs the famous Acrosound Model TO-300 "ultra-linear" output transformer and uses 5881 output tubes. The power supply is built on a separate chassis, and the two chassis are inter-connected with a power cable. This provides additional flexibility in mounting. Frequency response is  $\pm 1$  DB from 6 CPS to 150 kc at 1 watt. Harmonic distortion is only 1% at 21 watts, and IM distortion is only 1.3% at 20 watts. (60 and 3,000 CPS). Output impedance is 4, 8, or 16 ohms. Hum and noise are 88 DB below 20 watts. A very popular high-fidelity unit employing top-quality components throughout.

MODEL W-3M: Shpg. Wt. 29 Lbs. Express only... \$49.75

MODEL W-3: Consists of Model W-3M plus Model WA-P2 pre-amplifier. Shpg. Wt. 37 Lbs. Express only... \$69.50

### HEATHKIT 7-WATT AMPLIFIER KIT

This amplifier is more limited in power than other Heathkit models, but it still qualifies as a high-fidelity unit, and its performance definitely exceeds that of many so-called "high-fidelity" phonograph amplifiers. Using a tapped-screen output transformer of new design, the Model A-7D provides a frequency response of  $\pm 1\frac{1}{2}$  DB from 20 to 20,000 CPS. Total distortion is held to a surprisingly low level. Output stage is push pull, and separate bass and treble tone controls are provided. Shpg. Wt. 10 Lbs.

MODEL A-7E: Similar to the A-7D, except that a 12SL7 tube has been added for pre-amplification. Two inputs, RIAA compensation, and extra gain.

MODEL A-7D  
**\$17.95**

INCLUDING NEW  
EXCISE TAX

**\$19.95†**



## HIGH FIDELITY

# Amplifier Kit

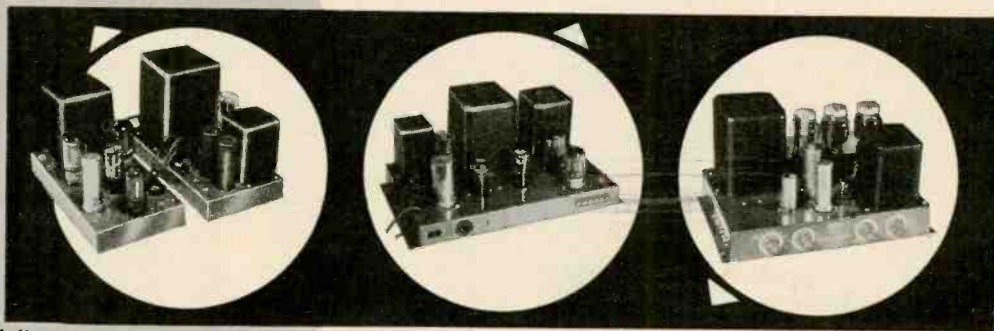
This 25 watt unit is our finest high-fidelity amplifier. Using a special design peerless output transformer, and KT-66 output tubes by Genalex, the Model W-5M provides performance characteristics unsurpassed at this price level. Frequency response is  $\pm 1$  DB from 5 to 160,000 CPS at 1 watt. Harmonic distortion is less than 1% at 25 watts and IM distortion is less than 1% at 20 watts (60 and 3,000 CPS, 4 to 1). Hum and noise are 99 DB below 25 watts. Damping factor is 40 to 1. Input voltage for 5 watts output is 1 volt. Tubes employed are a pair of 12AU7's, a pair of KT-66's and a 5R4GY rectifier. Measures 13-3/32" W. x 8 1/2" D. x 8 1/4" H. Output impedance is 4, 8, or 16 ohms. Featured, also, is the "tweeter saver" which suppresses high frequency oscillation, and a new type balancing circuit requiring only a voltmeter for indication. This balance is easier to adjust, and results in a closer "dynamic" balance between output tubes. The Model W-5M provides improved phase shift characteristics, reduced IM and harmonic distortion, and improved frequency response. Conservatively rated high-quality components are used throughout to insure years of trouble-free operation. No technical background or training is required for assembly. Step-by-step instructions are provided for every stage of construction, and large pictorial diagrams illustrate exactly where each wire and component is to be placed. An amplifier for music lovers who can appreciate subtle differences in performance. Just ask the audiophile who owns one!

### HEATHKIT SINGLE CHASSIS—WILLIAMSON TYPE HIGH FIDELITY AMPLIFIER KIT

The 20-watt Model W-4AM Williamson type amplifier is a tremendous high-fidelity bargain. Combining the power supply and main amplifier on one chassis, and using a special-design output transformer by Chicago Standard brings you savings without a sacrifice in quality. Employing 5881 output tubes, the frequency response of the W-4AM is  $\pm 1$  DB from 10 CPS to 100 kc at 1 watt. Harmonic distortion is only 1.5% at 20 watts. Output impedance is 4, 8, or 16 ohms. Hum and noise are 95 DB below 20 watts.

MODEL W-4AM: Shpg. Wt. 28 Lbs. Express only... \$39.75

MODEL W-4A: Consists of Model W-4AM plus Model WA-P2 pre-amplifier. Shpg. Wt. 35 Lbs. Express only... \$59.50



### HEATHKIT 20-WATT HIGH FIDELITY AMPLIFIER KIT

This high-fidelity amplifier features full 20-watt output using push pull 6L6 tubes. Built-in preamplifier provides 4 separate inputs, selected by a panel-mounted switch. It has separate bass and treble tone controls, each offering 15 DB boost and cut. Output transformer is tapped at 4, 8, 16, and 500 ohms. Designed primarily for home installations, but also used extensively for public address applications. True high-fidelity performance with frequency response of  $\pm 1$  DB from 20 CPS to 20,000 CPS. Total harmonic distortion only 1% (at 3 DB below rated output).

MODEL A-9B  
**\$35.50**

Shpg. Wt. 23 Lbs.

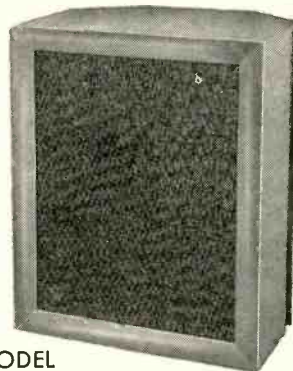


**HEATH COMPANY**  
A Subsidiary of Daystrom, Inc.  
**BENTON HARBOR 20, MICH.**

HEATHKIT HIGH FIDELITY

# Range Extending SPEAKER SYSTEM KIT

- \* High quality speakers of special design — 15" woofer and compression-type super-tweeter.
- \* Easy-to-assemble cabinet of furniture-grade plywood.
- \* Attractively styled to fit into any living room. Matches Model SS-1.



MODEL  
SS-1B

**\$99<sup>95</sup>**

Shpg. Wt. 80 Lbs.

All prices marked with a ‡ include a new federal excise tax that now applies to receivers, tuners and some amplifiers, even though they may be in kit form. Since the tax is in effect as of July 5, 1956, we have no choice but to reflect it in our kit prices. This note is just to let you know we are not increasing our prices on some kits, but merely including this new tax in them.

Thank you,  
HEATH COMPANY

This range extending unit is designed especially for use with the Model SS-1 speaker system. It consists of a 15" woofer, providing output between 35 and 600 CPS, and a compression-type super-tweeter that provides output between 4,000 and 16,000 CPS. Cross-over frequencies are 600, 1,600, and 4,000 CPS. The SS-1 provides the mid-range, and the SS-1B extends the coverage at both ends of the spectrum. Together, the two speaker systems provide output from 35 to 16,000 CPS within  $\pm 5$  DB. This easy-to-assemble speaker enclosure kit is made of top-quality furniture-grade plywood. All parts are pre-cut and pre-drilled, ready for assembly and the finish of your choice. Complete step-by-step instructions are provided for quick assembly by one not necessarily experienced in woodworking. Coils and capacitors for proper cross-over network are included, as is a balance control for super-tweeter output level. The SS-1 and SS-1B can provide you with unbelievably rich audio reproduction, and yet these units are priced reasonably. The SS-1B measures 29" H. x 23" W. x 17½" D. The speakers are both special-design Jensens, and the power rating is 35 watts. Impedance is 16 ohms.

## HEATHKIT HIGH FIDELITY SPEAKER SYSTEM KIT



MODEL  
SS-1

**\$39<sup>95</sup>**

Shpg. Wt. 30 Lbs.

- \* Special design ducted-port, bass-reflex enclosure.
- \* Two separate speakers for high and low frequencies.
- \* Kit includes all parts and complete instructions for assembly.

This speaker system is a fine reproducer in its own right, covering 50 to 12,000 CPS within  $\pm 5$  DB. However, the story does not end there. Should you desire to expand the system later, the SS-1 is designed to work with the SS-1B range extending unit — providing additional frequency coverage at both ends of the spectrum. It can fulfill your present needs, and still provide for the future. The SS-1 uses two Jensen speakers; an 8" midrange-woofer, and a compression-type tweeter. Cross-over frequency is 1,600 CPS, and the system is rated at 25 watts. Nominal impedance is 16 ohms. The cabinet is a ducted-port bass-reflex type. Attractively styled, the Model SS-1 features a broad "picture-frame" molding that will blend with any room decorating scheme. Pre-cut and pre-drilled wood parts are of furniture grade plywood. The kit is easy-to-build, and all component parts are included, along with complete step-by-step instructions for assembly. Can be built in just one evening, and will provide you with many years of listening enjoyment thereafter.

### HEATH COMPANY A Subsidiary of Daystrom, Inc. BENTON HARBOR 20, MICH.

## ORDER BLANK

NOTE: All prices subject to change without notice.

Enclosed find ( ) check ( ) money order for  
Please ship C.O.D. ( ) postage enclosed for \_\_\_\_\_ pounds.

On Express orders do not include transportation charges — they will be collected by the express agency at time of delivery.

ON PARCEL POST ORDERS include postage for weight shown. ORDERS FROM CANADA and APO'S must include full remittance.

Name \_\_\_\_\_

Address \_\_\_\_\_

City & Zone \_\_\_\_\_ State \_\_\_\_\_

(PLEASE PRINT)

SHIP VIA

- Parcel Post
- Express
- Freight
- Best Way

QUANTITY	ITEM	MODEL NO.	PRICE

(Continued from page 61)

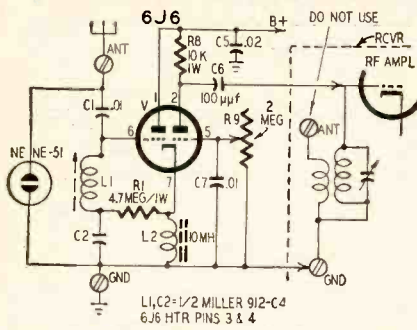


Fig. 6—The high-gain version for isolated areas, including T-R function.

surface on which the instrument rests.

Adjustment of the front end is simple and straightforward. Connect antenna and ground to the input terminals as in Fig. 2; connect the output terminals to the antenna and ground posts of the receiver. Making sure that the power is on, tune to any point between stations. Couple a signal generator rather closely to the front end input; tune it to about 455 kc and increase the generator output until a signal is heard in the receiver. Adjust the core of the coil in the front end until this signal is at a minimum, then clamp the adjustment with the lock nut (Fig. 3).

Performance of this front end is quite satisfactory according to tests in Buffalo, N. Y.; Albuquerque, N. M., and in Los Angeles and Palo Alto, Calif. By its use, many of the banshees on the standard broadcast band are "sent back to Ireland"; the nontunable background melange of "The Boozing Organist," "Ma's Other Husband" and Israfil Cooler's Jeremiads is reduced to a minimum at all times and eliminated most of the time in most areas. There is no insertion loss and, if the antenna trimmer is adjusted carefully, there is a gain of from one-half to one S number when the front end is used. Also, tuning is slightly sharper, due to removal of the antenna load from the first tuned stage and substitution

of a fixed light load for it. It should be noted that this type of front end, not only prevents reception of 455-kc radiations from external sources, but also keeps any such radiation from your receiver from your antenna.

**A booster version**

A relatively simple modification of the original circuit makes possible a definite voltage gain in the front end and also biases off the input in the presence of very strong signals. This circuit (Fig. 6) is useful in isolated areas where more sensitivity is needed and in the immediate vicinity of very powerful transmitters which cannot easily be tuned out with ordinary front ends. This circuit is quite similar to the "S-9er" developed by Sam Canter, W6TSSQ<sup>1</sup>; in combination with the Barker and Williamson Model 380 T-R Switch. The R-C circuit in the second triode grid furnishes some T-R action.

**Parts list for Figs. 2 and 6**

- C1—0.01 μf, disc ceramic
- C3—0.001 μf, tubular ceramic (Fig. 2 only)
- C4—75-75 μf, 150 volts, electrolytic (Mallory FP214.5 or equivalent)
- C5—0.02 μf, disc ceramic
- C6—100 μf, disc ceramic (Fig. 6 only)
- C7—0.01 μf, disc ceramic (Fig. 6 only)
- L1, C2—one winding and capacitor from J. W. Miller 912-C4 455-kc half-wave if transformer
- L2—10-mh rf choke (National R-50-1)
- R1—4.7 megohms, 1 watt
- R2—100 ohms, 2 watts
- R3—4,700 ohms, 1 watt
- R4—68,000 ohms, 1 watt
- R5—27,000 ohms, 1 watt
- R6, 7—180 ohms, 1 watt
- R8—10,000 ohms, 1 watt (Fig. 6 only)
- R9—2 megohms, linear pot (Ohmite type CU or equivalent, Fig. 6 only, see text)
- T—half-wave power transformer, 125 volts @ 15 ma, 6.3 volts @ 600 ma (Stancor PS-8415 or equivalent)
- SEL RECT—selenium rectifier, 130 volts @ 50 ma or more
- NE—NE-51 neon lamp
- Chassis, 4 x 5 x 2 inches with bottom plate, SeeZak (U M & F Mfg. Corp., 10929 Vanowen St., North Hollywood, Calif.) or equivalent
- Rubber feet (4)
- Dual binding posts (2)—Eby 21-R or equivalent
- Socket—single-contact bayonet "bracket up" (1—Dialco 7-05)
- Socket—7-pin miniature with shell (1)
- Socket—for C4 (1 Cinch PS-6 or equivalent)
- Receptacle—female (1—Amphenol 61-MIP-61F or equivalent)
- Receptacle—male (1—Amphenol 61-M10 or equivalent)
- Tube shield (1)

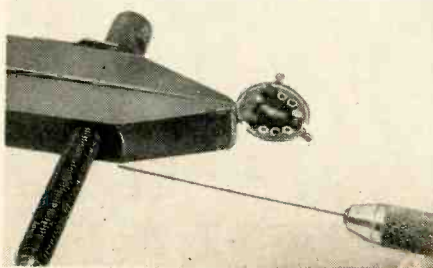
**WAFER SWITCH REPAIR**

**S**URPLUS metal or insulating material can be easily cut away from a wafer switch to make a repair or to adapt it for some other use—such as a non-shortening switch for a shortening switch—by removing part of the metal from each of the contact blade sections. A part of the insulating stops may be removed to permit complete revolution

if desired. Where the blade shorts another terminal due to wear, a repair can be made by removing some of the excess metal.

The photo shows a rotor element that has too much metal on one section's contact rotor. The entire rotor assembly is held in a mechanic's clamp, a very handy device for holding such small parts. The saw blade may be held in one's hand or in a pin vise.

If hand-held, a small piece of tape, friction, electrician's or adhesive, may be used to hold the blade more securely. The small size of the blade and its teeth make the jeweler's saw blade a very useful tool for such work. It may be twisted a little to make it follow a curve. When using, pull the blade to you—do not push away as you would a hacksaw blade!—James A. McRoberts



(Reduction of gain by strong signals. So called after the automatic Transmit-Receive switch which shorts the input of a receiver, connected to the same antenna as a transmitter or radar.) It may be adjusted for a wide range of signal strengths.

If the T-R function is not desired, the grid of the second triode (pin 5 in Fig. 6) is grounded directly.

Adjustment and operation are the same as that of the single-triode front end. The high-gain circuit gives a gain of about three S numbers when used with a reasonably good receiver in good condition. This circuit has a high-impedance output and should be connected directly to the input grid of the receiver. The lead should be unshielded and not more than 1 foot long. Shielding adds shunt capacitance that detunes the receiver's input stage. A lead longer than about 1 foot acts as an antenna, providing undesirable signal pickup.

For urban broadcast listening, the single-triode front end gives optimum results, eliminating some of the "all-over-the-dial" interference due to re-radiation at intermediate frequency. For isolated locations far from standard broadcast stations or where a deficient antenna must be used for other reasons, the high-gain front end is desirable. In the average large city, the added gain of this dual-triode front end is not an advantage as it both permits and encourages overloading of the first tuned circuit, with a loss in both real and apparent selectivity. At several airports and Army installations, the T-R feature was found most desirable. In extreme cases, the input coil can be tuned to the frequency of the local transmitter instead of 455 kc, to eliminate severe receiver blocking. In desert and tropical locations, the neon-tube static drain was most useful for eliminating sandstorm and snow static. END

<sup>1</sup> Sam Canter, "The S-9er," CQ, Vol. 12, No. 5, May, 1956. PP 21-22.



Ellen Shunaman, daughter of our managing editor, with the Heathkit crystal set she assembled just after her sixth birthday. Called by *Proceedings of the IRE* "the youngest exhibitor" at their 1957 show, she also appeared in numerous periodicals here and abroad as well as in person on the NBC-TV show "Today."

# You Have More TO SELL WITH A Winegard

The more sound selling facts you can put before a customer, the more chance you have of closing a sale! And the Winegard Color'Ceptor gives you selling points no other antenna can offer . . . exclusive buying appeals that clinch 9 out of 10 sales!

## They See the Gold and They're Sold

The gold-anodized finish of the Color'Ceptor gives it a rich, quality appearance not found in any other antenna. When you show the Color'Ceptor alongside competitive models, the Color'Ceptor is so distinctive, so *finished-looking* that it is invariably selected by your customers. Gold anodizing has a practical sales advantage, too. It provides immunity to corrosion—prevents deterioration in performance.

If the Winegard Color'Ceptor won't bring in a station you want to see . . . nothing will! Proof of performance was dramatically illustrated when Robert Seybold of Dunkirk, New York—using a Winegard Antenna—broke all long distance reception records in 1956 (see Radio-Electronics Magazine Jan. '57). Equipped with optional signal-boosting Power-Pack and patented "Electro-Lens"\* focusing the Color'Ceptor is second to none for long distance reception and clear, watchable pictures in both black-and-white and color!



## The Sign of Better Business

The Winegard Authorized-Dealer decal (pictured above) is proving a real business-builder for every dealer who displays it. Heavily promoted in Winegard's national advertising, the decal tells the world that "here's the place to buy the gold-anodized Color'Ceptor."

## Want More Details?

Mail coupon below for all the facts on Color'Ceptor's spectacular success story! Winegard gives you everything you need to make antenna sales boom—the product, free display, national advertising, proven sales techniques. Join the swing to Winegard—it's the best move you can make!

**WINEGARD COMPANY**  
Dept. A-8, 3000 Scotten Blvd.  
Burlington, Iowa

Name \_\_\_\_\_

Please rush me free 4-color descriptive literature on your gold-anodized Color'Ceptor and information on display material.

I'm interested in the complete line of new 1957 Winegard antennas.

Company \_\_\_\_\_

Address \_\_\_\_\_

City \_\_\_\_\_

State \_\_\_\_\_

# Winegard Color'Ceptor TV Antenna

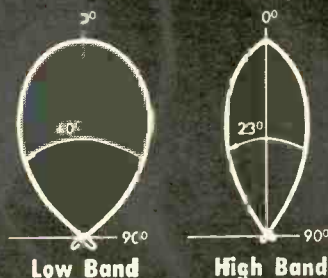
all 12 VHF Channel  
Reception For Both  
Black-and-White  
and Color

## Color so bright they sell on sight!

### Note:

Each gold Color'Ceptor you install helps sell another. Once folks see these bright gold antennas sprouting up in their neighborhood, they won't be satisfied until they own the gold antenna, too!

### Horizontal Directivity



Gain Chart  
CL-4X with Power-Pack

Color'Ceptor Model CL-4X — \$44.90      Color'Ceptor Model CL-4 — \$29.95

If Color'Ceptor won't bring in a station you want to see . . . nothing will!

### Exclusive Color'Ceptor features

- Completely non-corrosive gold-anodized finish.
- Power-Pack—up to 47.1% more sensitivity.
- Pat. "Electro-Lens"\*—clearer pictures at greater distance.

\*Winegard Color'Ceptors are consistently advertised in leading national magazines your customers read!



**Winegard Co.**

3000 Scotten Blvd., Burlington, Iowa  
Cable Address: Western Union JRWCO

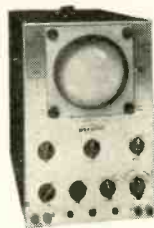
\*Pat. No. 1,700,105 Copyright USA, 1957



# Now You Can Order precise KITS BY MAIL... from Your Local Parts Distributor!

Thousands of satisfied purchasers have bought PRECISE kits from their local parts distributors, knowing that they were receiving engineered instruments of unmatched value, each one designed to provide a complete test service.

Now, you can buy these kits by mail... and benefit from faster delivery, lower price, postage savings, and the personal local service of your nearby parts distributor... and if you are close enough, drop by your PRECISE parts-distributor and see the top-quality parts included in each kit.



Precise  
Engineered

## 5" SCOPE

UP to 9 mc  
FLAT to 5 mc  
for color work

After you've built this 'scope, you'll be amazed at its versatility. No other 'scope below a \$100.00 can meet all of its specifications. Design features include push-pull vertical and horizontal... high sensitivity... 5CP1 tube with post acceleration... frequency compensated stepping attenuators for both vertical and horizontal... focus, intensity and astigmatism controls... and calibration output voltage. Vertical amps are flat through 5 mc  $\pm$  8 db through 9 mc. Sensitivity is 10 mv/cm. Horizontal amps within  $\pm$  5 db through 500 kc, have frequency compensated stepping attenuator input and cathode follower to assure linear horizontal trace. Hard vacuum sweep frequencies with sufficient expansion to see color bursts clearly, and a sensitivity approximately 40 mv/cm, made this instrument the exceptional buy of the year.

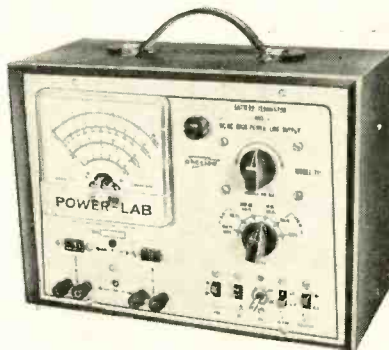
Precise Model 3151K Kit Form ..... \$ 59.95  
Precise Model 3151W Factory Wired ..... 109.95

## Precise Engineered POWER LAB

For all your electrical needs!

For the first time in the industry, one instrument takes the place of more than 11 pieces of equipment... Here's what you get:

- A BATTERY ELIMINATOR for 6v and 12v radios
- A BATTERY CHARGER up to 24 volts
- A HIGH CURRENT LINE VOLTAGE VARIAC - up to 10 amperes
- AN AC LINE VOLTAGE METER
- AN AC LINE AMMETER
- AN AC LINE WATTMETER
- AN AC LINE ISOLATION TRANSFORMER - 100w or 300w
- A LOW VOLTAGE, HIGH CURRENT AC SUPPLY - 24v at 10 amperes
- A DC LINE VOLTAGE VARIABLE SUPPLY
- A DC HIGH CURRENT AMMETER
- AN AGC BIAS BOX



Precise Model		Isolation
711K	KIT FORM	\$49.95 100w
711W	FACTORY WIRED	64.95 100w
713K	KIT FORM	62.95 300w
713W	FACTORY WIRED	79.95 300w

## Mutual Conductance and Emission TUBE TESTER

Here is a tester that actually checks a tube for its applications, not whether it is just good or bad. On the Model 111, GM and Emission are checked separately. It is the first and only device that measures 600-mil tubes on a meter. Sweeps from 0 through the normal testing range when making measurements, which gives an average evaluation for the tube over an extended range of operation. Connects test voltages to each tube element. Uses a single rotary switch to check each element against every other element for shorts, whether they're hot or cold. Measures tube bias directly on a meter. Features a no-backlash roll chart. Includes provisions for testing all prong types. Cathode-Ray tubes may also be checked with the use of an adaptor. An exceptional instrument for the shop, one that has won an impartial independent scientific survey hands down.



Precise  
Engineered

Precise Model 111K Kit Form ..... \$ 79.95  
Precise Model 111W Factory Wired.... 139.95

HERE ARE 8 PRECISE parts distributors who are ready to serve you by mail. Their comments prove the value of the PRECISE products they have to sell.

Use the handy coupon below to order your PRECISE kits by mail from the jobber nearest to you.



GRAHAM ELECTRONICS  
SUPPLY, INC.  
102 S. Pennsylvania St.  
Indianapolis 4, Ind.

H. H. Thompson... Creative Engineering and quality components assure customer satisfaction with PRECISE equipment.

LEUCK RADIO SUPPLY  
243 South 11th St.  
Lincoln, Nebraska

L. H. Soderholm... We have found that the advanced engineering of PRECISE kits offers design features comparable with many laboratory instruments.



RADIO ELECTRIC SERVICE  
CO. OF PENNA., INC.  
N. W. Corner 7th & Arch Sts.  
Philadelphia 6, Penna.

Albert N. Kass, vp & gen. mgr... For quality and precision, we always recommend PRECISE in test equipment.



STANDARD PARTS  
277 N. Franklin St.  
Hempstead, N. Y.

William Hull... Refreshing original design built into every PRECISE kit.



THRIFTY ELECTRONIC  
SUPPLY CO.  
3647 Burbank Blvd.  
Van Nuys, California

Al Ex... PRECISE engineered kits give you more value for your money.

WHOLESALE RADIO PARTS  
CO., INC.  
308 West Redwood St.  
Baltimore 1, Maryland

Manuel Freeland, vp... We have found that PRECISE's Mack for giving quality and value - economically - goes hand-in-hand with our pursuits.



WINTERADIO  
INCORPORATED  
1468 West 25th St.  
Cleveland 13, Ohio

Edward J. Gorceya... PRECISE kits—a quality line that has no equal.

TEE VEE SUPPLY CO.  
3211 Washington St.  
Jamaica Plains, Mass.

Herbert Gamer... Everyone who buys a PRECISE kit is always satisfied.

Mr. Precise Distributor:

I would like to order the following Precise kits:

5" Scope      Powerlab      Tube Tester  
Model      Model 711K      Model 111K  
 3151 Kit       Model 711W       Model 111W  
 3151 Wired       Model 713K  
                          Model 713W

Please send kits COD  Bill my account   
Remittance Enclosed, Ship Prepaid

Print Name Clearly \_\_\_\_\_

Street Address \_\_\_\_\_

City & State \_\_\_\_\_

**Model TD-55 — Terms:**  
\$6.95 after 10 day trial then  
\$5.00 per month for 4 months.

OPERATING INSTRUCTIONS  
FOR MODEL TD-55  
TUBE TESTER



**Model TV-12 — Terms:**  
\$22.50 after 10 day trial then  
\$10.00 per month for 5 months.



**Model TV-40**  
— Terms: \$3.85  
after 10 day trial  
then \$4.00 per  
month for 3  
months.

**Model TW-11 — Terms:**  
\$11.50 after 10 day trial then  
\$6.00 per month for 6 months.

# SHIPPED ON APPROVAL NO MONEY WITH ORDER NO C.O.D.

## Superior's New Model TD-55 EMISSION TYPE TUBE TESTER

FOR

The Experimenter or Part-time Serviceman, who has delayed purchasing a higher priced Tube Tester.  
The Professional Serviceman, who needs an extra Tube Tester for outside calls.  
The busy TV Service Organization, which needs extra Tube Testers for its field men.

Speedy, yet efficient operation is accomplished by:

1. Simplification of all switching and controls.
2. Elimination of old style sockets used for testing obsolete tubes (26, 27, 57, 59, etc.) and providing sockets and circuits for efficiently testing the new Novel and Sub-Minar types.

You can't insert a tube in wrong socket. It is impossible to insert the tube in the wrong socket when using the new Model TD-55. Separate sockets are used, one for each type of tube base. If the tube fits in the socket it can be tested.

"Free-point" element switching system. The Model TD-55 incorporates a newly designed element selector switch system which reduces the possibility of obsolescence to an absolute minimum. Any pin may be used as a filament pin and the voltage applied between that pin and any other pin or even the "top-cap."

Checks for shorts and leakages between all elements. The Model TD-55 provides a super sensitive method of checking for shorts and leakages up to 5 Megohms between any and all of the terminals. Continuity between various sections is individually indicated. This is important, especially in the case of an element terminating at more than one pin. In such cases the element or internal connection often completes a circuit.

Elemental switches are numbered in strict accordance with R.M.A. specification. One of the most important improvements, we believe, is the fact that the 4 position fast-action snap switches are all numbered in exact accordance with the standard R.M.A. numbering system. Thus, if the element terminating in pin No. 7 of a tube is under test, button No. 7 is used for that test.

Complete with carrying case.....

**\$26<sup>95</sup>**  
NET

## Superior's New Model TV-40 PICTURE TUBE TESTER

Not a Gadget—Not a Make-Shift Adapter, but a Wired Picture Tube Tester With a Meter for Measuring Degree of Emission—at Only \$15.85

Of course you can buy an adapter for about \$5—which theoretically will convert your standard tube tester into a picture-tube tester; or a neon type instrument which sells for a little more and is supposed to be "as good as" a metered instrument. Superior does not make nor do they recommend use of C.R.T. adapters or neon gadgets because a Cathode Ray Tube is a very complex device, and to properly test it, you need an instrument designed exclusively to test C. R. Tubes and nothing else.

Tests ALL magnetically deflected tubes . . . in the set . . . out of the set . . . in the carton!

- Tests all magnetically deflected picture tubes from 7 inch to 30 inch types.
- Tests for quality by the well established emission method. All readings on "Good-Bad" scale.
- Tests for inter-element shorts and leakages up to 5 megohms.
- Test for open elements.

EASY TO USE: Simply insert line cord into any 110 volt A.C. outlet, then attach tester socket to tube base (ion trap need not be on tube). Throw switch up for quality test . . . read direct on Good-Bad scale. Throw switch down for all leakage tests.

Only.....

**\$15<sup>85</sup>**  
NET

## Superior's New Model TV-12 TRANS-CONDUCTANCE TUBE TESTER

TESTING TUBES

- Employs improved TRANS-CONDUCTANCE circuit. An in-phase signal is impressed on the input section of a tube and the resultant plate current change is measured. This provides the most suitable method of simulating the manner in which tubes actually operate in Radio & TV receivers, amplifiers and other circuits. Amplification factor, plate resistance and cathode emission are all correlated in one meter reading.
- NEW LINE VOLTAGE ADJUSTING SYSTEM. A tapped transformer makes it possible to compensate for line voltage variations to a tolerance of better than 2%.
- SAFETY BUTTON—protects both the tube under test and the instrument meter against damage due to overload or other form of improper switching.
- NEWLY DESIGNED FIVE POSITION LEVER SWITCH ASSEMBLY. Permits application of separate voltages as required for both plate and grid of tube under test, resulting in improved Trans-Conductance circuit.

### Extra Feature

Model TV-12 Also Tests Transistors!

A transistor can be safely and adequately tested only under dynamic conditions. The Model TV-12 will test all transistors in that approved manner, and quality is read directly on a special "transistor only" meter scale.

The Model TV-12 will accommodate all transistors including NPN's, PNP's Photo and Tetrodes, whether made of Germanium or Silicon, either point contact or junction contact types.  
Housed in hand-rubbed oak cabinet.....

**\$72<sup>50</sup>**  
NET

## Superior's New Model TW-11 STANDARD PROFESSIONAL TUBE TESTER

- Tests all tubes, including 4, 5, 6, 7, Octal, Lockin, Hearing Aid, Thyatron, Miniatures, Sub-miniatures, Novals, Sub-minars, Proximity fuse types, etc.
- Uses the new self-cleaning Lever Action Switches for individual element testing. Because all elements are numbered according to pin-number in the RMA base numbering system, the user can instantly identify which element is under test. Tubes having tapped filaments and tubes with filaments terminating in more than one pin are truly tested with the Model TW-11 as any of the pins may be placed in the neutral position when necessary.
- The Model TW-11 does not use any combination type sockets. Instead individual sockets are used for each type of tube. Thus it is impossible to damage a tube by inserting it in the wrong socket.
- Free-moving built-in roll chart provides complete data for all tubes. All tube listings printed in large easy-to-read type.

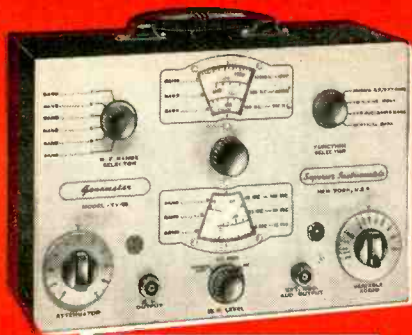
NOISE TEST: Phono-jack on front panel for plugging in either phones or external amplifier will detect microphonic tubes or noise due to faulty elements and loose internal connections.

EXTRAORDINARY FEATURE: SEPARATE SCALE FOR LOW-CURRENT TUBES. Previously, on emission-type tube testers, it has been standard practice to use one scale for all tubes. As a result, the calibration for low-current types has been restricted to a small portion of the scale. The extra scale used here greatly simplifies testing of low-current types. Housed in hand-rubbed oak cabinet.....

**\$47<sup>50</sup>**  
NET

USE APPROVAL FORM ON NEXT PAGE





**Model TV-50** — Terms: \$11.50 after 10 day trial then \$6.00 per month for 6 months.



**Model 76**—Terms: \$6.95 after 10 day trial then \$5.00 per month for 4 months.



**Model 770-A** — Terms: \$3.85 after 10 day trial then \$4.00 per month for 3 months.



**Model 670-A** — Terms: \$7.40 after 10 day trial then \$3.50 per month for 6 months.

# TRY FOR 10 DAYS

**before** you buy! **then** if satisfactory pay in easy, interest free, monthly payments. See coupon below.

## Superior's New Model TV-50 **GENOMETER**

7-Signal Generators in One!

- ✓ R.F. Signal Generator for A.M.
- ✓ R.F. Signal Generator for F.M.
- ✓ Audio Frequency Generator
- ✓ Bar Generator
- ✓ Cross Hatch Generator
- ✓ Color Dot Pattern Generator
- ✓ Marker Generator

R. F. SIGNAL GENERATOR: 100 Kilocycles to 60 Megacycles on fundamentals and from 60 Megacycles to 180 Megacycles on powerful harmonics.

VARIABLE AUDIO FREQUENCY GENERATOR: Provides a variable 300 cycle to 20,000 cycle peaked wave audio signal.

BAR GENERATOR: Pattern consists of 4 to 16 horizontal bars or 7 to 20 vertical bars.

CROSS HATCH GENERATOR: Pattern consists of non-shifting horizontal and vertical lines interlaced to provide a stable cross-hatch effect.

DOT PATTERN GENERATOR (FOR COLOR TV): The Dot Pattern projected on any color TV Receiver tube by the Model TV-50 will enable you to adjust for proper color convergence.

MARKER GENERATOR: The following markers are provided: 189 Kc., 262.5 Kc., 456 Kc., 600 Kc., 1000 Kc., 1400 Kc., 1600 Kc., 2000 Kc., 2500 Kc., 3579 Kc., 4.5 Mc., 5 Mc., 10.7 Mc., (3579 Kc. is the color burst frequency.)

Complete with shielded leads.....

**\$47<sup>50</sup>** NET

## Superior's New Model 670-A **SUPER-METER**

A Combination VOLT-OHM MILLIAMMETER PLUS Capacity, Reactance, Inductance and Decibel Measurements.

ADDED FEATURE: Built in ISOLATION TRANSFORMER reduces possibility of burning out meter through misuse.

**SPECIFICATIONS:**

D.C. VOLTS: 0 to 7.5/15/75/150/750/1,500/7,500 Volts  
 A.C. VOLTS: 0 to 15/30/150/300/1,500/3,000 Volts  
 OUTPUT VOLTS: 0 to 15/30/150/300/1,500/3,000 Volts  
 D.C. CURRENT: 0 to 1.5/15/150 Ma. 0 to 1.5/15 Amperes  
 RESISTANCE: 0 to 1,000/100,000 Ohms 0 to 10 Megohms  
 CAPACITY: .001 to 1 Mfd. 1 to 50 Mfd. (Good-Bad scale for checking quality of electrolytic condensers.)

REACTANCE: 50 to 2,500 Ohms 2,500 Ohms to 2.5 Megohms

INDUCTANCE: .15 to 7 Henries 7 to 7,000 Henries

DECIBELS: -6 to +18 +14 to +38

+34 to +58

Complete with test leads.....

**\$28<sup>40</sup>** NET

## Superior's New Model **76**

- ✓ IT'S A CONDENSER BRIDGE
- ✓ IT'S A RESISTANCE BRIDGE
- ✓ IT'S A SIGNAL TRACER
- ✓ IT'S A TV ANTENNA TESTER

**SPECIFICATIONS**

✓CAPACITY BRIDGE SECTION 4 Ranges: .00001 Microfarad to .005 Microfarad; .001 Microfarad to .5 Microfarad; .1 Microfarad to 50 Microfarads; 20 Microfarads to 1000 Microfarads. Will also measure the power factor of all condensers from .1 to 1000 Microfarads.

✓RESISTANCE BRIDGE SECTION 2 Ranges: 100 ohms to 50,000 ohms; 10,000 ohms to 5 megohms.

✓SIGNAL TRACER SECTION With the use of the R.F. and A.F. Probes included with the Model 76, you can make stage gain measurements, locate signal loss in R.F. and Audio stages, localize faulty stages, locate distortion and hum, etc.

✓TV ANTENNA TESTER SECTION Loss of sync., snow and instability are only a few of the faults which may be due to a break in the antenna, so why not check the TV antenna first? Locates a break in any TV antenna and measures the location of the break in feet from the set terminals.

Complete with R.F. and A.F. probes and test leads.....

**\$26<sup>95</sup>** NET

## Superior's New Model 770-A **POCKET-SIZED VOLT-OHM MILLIAMMETER**

● USING THE NEW "FULL-VIEW" METER 71% MORE SCALE AREA—Occupies exactly the same space used by the older standard 2 1/2" Meters, yet provides 71% more scale area. As a result, all calibrations are printed in large easy-to-read type and for the first time it is now possible to obtain measurements instead of approximations.

● Compact—measures 3 1/8" x 5 7/8" x 2 1/4". ● Uses "Full View" 2% accurate, 850 Microampere D'Arsonval type meter. ● Housed in round-cornered, molded case. ● Beautiful black etched panel.

Specifications: 6 A.C. VOLTAGE RANGES: 0-15/30/150/300/1500/3000 Volts.

6 D.C. VOLTAGE RANGES: 0-7.5/15/75/150/750/1500 Volts. 2

RESISTANCE RANGES: 0-10,000 Ohms, 0-1 Megohm. 3 D.C.

CURRENT RANGES: 0-15/150 Ma., 0-1.5 Amps. 3 DECIBEL

RANGES: -6 db to + 18 db, + 14 db to + 38 db,

+ 34 db to + 58 db.

Complete with test leads.....

**\$15<sup>85</sup>** NET

We invite you to try before you buy any of the models described on this and the preceding page. If after a 10 day trial you are completely satisfied and decide to keep the Tester, you need send us only the down payment and agree to pay the balance due at the monthly indicated rate.

### NO INTEREST OR FINANCE CHARGES ADDED!

If not completely satisfied, you are privileged to return the Tester to us, cancelling any further obligation.

### MOSS ELECTRONIC DISTRIBUTING CO., INC. Dept. D-367, 3849 Tenth Ave., New York 34, N. Y.

Please send me the units checked. I agree to pay down payment within 10 days and to pay the monthly balance as shown. It is understood there will be no finance or interest charges added. It is further understood that should I fail to make payment when due, the full unpaid balance shall become immediately due and payable.

Name .....  
 Address .....  
 City ..... Zone.....State.....  
 All Prices net. F.O.B. N.Y.C.

- Model TW-11.....Total Price \$47.50 \$11.50 within 10 days. Balance \$6.00 monthly for 6 months.
- Model 76.....Total Price \$26.95 \$6.95 within 10 days. Balance \$5.00 monthly for 4 months.
- Model TD-55.....Total Price \$26.95 \$6.95 within 10 days. Balance \$5.00 monthly for 4 months.
- Model TV-50.....Total Price \$47.50 \$11.50 within 10 days. Balance \$6.00 monthly for 6 months.
- Model TV-40.....Total Price \$15.85 \$3.85 within 10 days. Balance \$4.00 monthly for 3 months.
- Model 670-A.....Total Price \$28.40 \$7.40 within 10 days. Balance \$3.50 monthly for 6 months.
- Model 770-A.....Total Price \$15.85 \$3.85 within 10 days. Balance \$4.00 monthly for 3 months.
- Model TV-12.....Total Price \$72.50 \$22.50 within 10 days. Balance \$10.00 monthly for 5 months.

(Continued from page 78)

change for a chicken ranch or some-thin'. Started out with that little ac-de intercom the feller brought in, 'bout three weeks back. Not near enough volume. Tubes all good, plenty of voltage, no volume. Checked everythin' I could think of, and seven things I couldn't, an' when I finally found it, it was where I hadn't looked at all. Showed you the schematic, remember? Two dual electrolytic condensers in it. One for the regular filter (C2-a), t'other (C2-b) for a cathode bypass on the output tube, and an extra one up in the front end of the thing. Well, the dad-burned thing had a dc leakage between the sections. Both of 'em good; checked 'em one at a time of course. What happened, this dc leakage was enough to raise the bias voltage on the output tube 'til the thing was nearly cut off. Took me half a day to dig that one out, when I should have seen it right off. Measured the bias voltage on the tube, too, but went by it so fast that I didn't notice it was too high. Just goes to show you that we take a lot of read-in's that we don't really read, we just measure!"

"Yep, you never can tell," agreed the Young Ham. He scented a period of reminiscence on the part of the Old-Timer and he was in favor of it. When the Old-Timer was in a talkative mood, he wasn't thinking of things to do, like sweeping the shop, washing windows, and things.

"Yes, sir, you never can tell," mused the Old-Timer, lighting his pipe. "The silly symptoms you get, an' what they actually mean, in some sets. It sure does pay you to check up on what kind of readin's you get, and what they actually mean. 'Member the other day I hauled that 21-inch Zenith all the way to the shop, only to find out it just had a bad tube? I checked all the tubes in that section with my little continuity tester at the house; only trouble was, one of 'em had a short in it!"

"I remember that one," said the Young Ham, laughing. "You just sat there drummin' your fingers on the bench an' hittin' yourself on the head with a screwdriver handle!"

"Right at the time I wished it was a hammer," said the Old-Timer. "It beats all, the dang stupid things a theoretically smart, trained man can do, just from gittin' too dern fast with his diagnoses. Worst part of it all is, *you're* the one who's made the boo-boo, an' they ain't nobody to git mad at but you!"

"Oh well," said the Young Ham, consolingly, "some of these things would take a genius to figure out, the first time, an' you can't win 'em all."

"That's the trouble," growled the Old-Timer. "After you've been in this business fer so long, you git to the point where you figure you ought to know a *little* about it, an' then something like that comes along, an' you're right back where you started! Oh well, you need a stinker now and then to take some of the conceit outa you. I've talked

till I'm dry. Let's go gitta cuppa caw-fee."

As the two ambled toward the corner coffee shop, the Old-Timer continued reminiscing. "Yes, sir, you never know. Look at the REA truck last month. Two-way radio. No output on the transmitter, receiver works good, they said. Naturally, I thought it had to be a bad tube in the transmitter. Tuned it all up, right on the nose. Dip, but no load, in the final. Well, that just *had* to be a bad tube, so I changed tubes and tuned it up again. Still no loadin' on the antenna. Well, I was going back to the shop after some pliers to pull the set an' I happened to glance up at the roof of the cab, at the antenna."

"That's that high-band network, isn't it?" asked the Young Ham. "In the 2-meter band?"

"Yep, Ham-bone," said the Old-Timer, "153 mc, to be exact. Antenna's very thin and about 19 inches long. Anyway, I discovered that it's hard to load an antenna that's layin' by the side of the road about 10 miles out of town!" The Old-Timer shook his head ruefully. "There was about an inch of the thing left, and the receiver would work on it here in town, but I naturally couldn't load the transmitter."

"That would make it a little difficult," admitted the Young Ham.

"That ain't the worst of it," said the Old-Timer. "Not over a week later, here come another truck, with the same complaint; listen, no talkee! Well, you can bet I looked at that antenna first thing. It was there, all right. Opposite symptoms, this time. Lots of load on my meter at the transmitter, but not a dang bit of rf output on my little field-strength indicator."

"You mean that little crystal detector in a box, with a short whip on it, that I tuned my transmitter up with?" asked the Young Ham.

"Yep, that's it," answered the Old-Timer. "If you git a readin' on it, you know your transmitter's putting out, for all it reads is rectified rf. Anyhow, to make a short story long, this time I finally checked the antenna again, an' it had a big fat dead short at the base. Full of water. What I was doin' was feeding the resistance of the short with my rf an' not gettin' any out into the antenna at all. Here we are. Go on in."

"Age before beauty," said the Young Ham, with a bow. "After you," and he held the coffee-shop door open.

"Oh, well, I was gonna buy anyhow," said the Old-Timer, walking in. According to the rules of a little game they had, the first man to enter the coffee shop had to pay for the coffee.

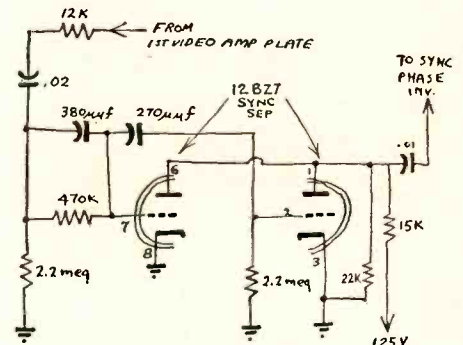
### Dern squelch tube

"Yes, sir," said the Old-Timer, stirring the inky brew the waitress had placed before him, "things sure ain't always what they seem, 'specially in this business. You can find a perfectly good symptom, spend hours chasin' it 'round a chassis, an' then find out your trouble

is somewhere else. Remember that two-way radio that I had where the squelch wouldn't work an' I couldn't get any volume? I checked that dern 12AT7 tube in the squelch three times an' it checked perfectly good every time. Finally replaced it, an' the set's been workin' ever since! So, you never can tell."

"That's right," agreed the Young Ham, deftly snitching the Old-Timer's jug of cream and adding it to his own coffee. "Things are not always what they seem: Shakespeare."

"You sure 'bout that?" grinned the Old-Timer. "If memory serves me well, you was havin' some difficulty with the Bard, 'long about last semester. Say, I remember another dandy. That CBS with no horizontal sync. Changed tubes all over the place and the picture still wandered back and forth. Finally, for some reason, I thought of checkin' the two little condensers that feed the sync pulses into the 12BZ7 sync separator.



Sync separators in CBS 921-12 chassis.

Well, there ain't any voltage at all on them 'cause that big fat .02 capacitor blocks it off, and ordinarily you wouldn't think that they'd be apt to short out. Still, that's what had happened; the 270-µf was dead shorted. So no matter how unlikely it looks, always be sure to check all o' the parts in any given circuit an' you'll usually find the trouble.

"Speakin' of sync troubles, remember the little old G-E 10-inch that came in with no sync at all? Checked all the voltages an' the only thing I could find was a 10-volt differential 'cross the dc restorer, where the diagram called fer only 1 volt or so. Well, sir, I checked that stage till I dang near wore the pins off the tube. Still didn't git anywhere. Eventually wound up lookin' elsewhere, just for somethin' to do, and discovered the sync amplifier stage had a bad tube and a shifted resistor in the plate. Fixed that, an' then I had plenty of sync. Say, how much sugar do you put in a cup of coffee, anyhow? That stuff's like syrup now."

"That's the way I like it," said the Young Ham, stirring in the fourth spoonful. "Thick, rich and juicy!"

"You must," said the Old-Timer. "Personally, I couldn't drink the stuff like that and, incidentally, where's my cream?"

"I dunno," said the Young Ham, looking innocent. "She must have forgotten

to bring you any." He slid the empty jug out of sight behind the sugar bowl.

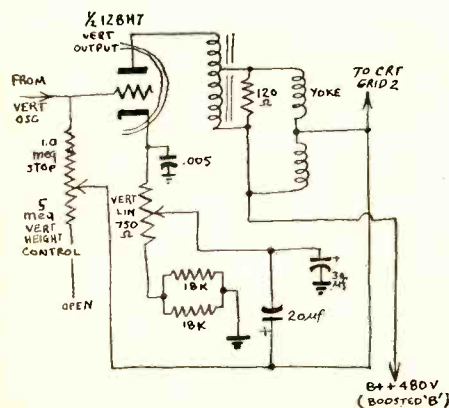
"Oh, well, it's fattenin' anyhow," sighed the Old-Timer, sipping his cup of black coffee. "Eush! What do they make this out of, anyhow? Bull Durham? Phoo!" However, he drank it and went on. "'Member that little Crosley came in Monday? Had a little sound, no picture, no light on the screen. First thing I did was check all the usual things, 1X2, change the horizontal oscillator, look at the fuse an' so on. No good. Found out the horizontal oscillator wasn't workin' at all an' the voltages were a bit low. So, I checked the rectifiers an' filters payin' 'special attention to the doubler condensers. No results! Still no light, no high voltage. Well, I was pokin' 'round the yoke, an' the dang thing bit me. That ain't unusual, on any ac-dc radio or TV, but I got it off the vertical connection. Fer some reason, I decided to check it. When I measured the voltages, I had a great big negative voltage on the grid and also on the plate!"

"On the plate?" asked the Young Ham. "How come?"

"I didn't believe it either," said the Old-Timer, "but there it was. Well, the first thing I did was to look again and see if I had my voltmeter ground clip on the wrong place, as usual. 'Twasn't, for a change, and I still had this negative voltage. Well, I went through that circuit like a fox in a henhouse, an' when I got through I knew less about it than when I started. Everything checked out lovely! Finally put a scope on it, an' discovered that the whole thing was one big ultrasonic oscillator! That's where my big grid voltage was coming from."

"Oh yes," said the Young Ham. "I have 'em, only I call 'em parasitics. I don't have negative plate voltages, though!"

"Yes, you do," said the Old-Timer. "Well, I found out that the cathode bypass condenser on the vertical output stage was as open as an old maid's heart. That caused the whole stage to go into this wild ultrasonic oscillation. Looked like it was up 'round 25-30 kc, on th' scope. I didn't check it, exactly.



Partial vertical output circuit of Crosley 426 chassis.

Didn't care what frequency it was. I just wanted to get rid of it. When I replaced the electrolytic (C), 'bout 30 or 40 mike, everythin' went back to normal except me. I was still a mite dazed. I just sat there and looked at it."

"Don't blame you," sympathized the Young Ham. "That was a rough one."

### Behind the green door

"Well, let's go see what's goin' on behind the green door," said the Old-Timer, rising and fumbling for change. (The Old-Timer had recently repainted the shop in an 'eye-ease green', causing much ribald comment from the Young Ham.) He paid for the coffee and they left, the Young Ham holding the door open for him, with another elaborate bow. As they came back into the shop, the Old-Timer noticed a table-model TV set on the "finished-work" shelf.

"Now, there's another good example of what I've been talkin' about," he said, pointing to it. "That one came in yesterday, while you were still in school. Brand-new set. Dealer brought it in, said it played a while, then quit. Just happened I'd just got the schematics of that series from the company, too. Only thing, this time they hindered more than they helped, which is kinda unusual."

"How d'you mean?" asked the Young Ham. "You're always tellin' me to follow those schematics."

"Well, this time, I was just blindly followin' the diagram, an' not usin' either my eyes nor my head!" said the Old-Timer. "I had me a symptom that looked like a good one. I just grabbed it in my teeth, put my head down and went chargin' back and forth through that circuit like a hound dog goin' through a briar patch, lookin' neither right nor left! Like I been tellin' you, things ain't always what they seem. Trouble was, I got so blinded by this nice obvious symptom that I couldn't see the real trouble!"

"What was it doing?" asked the Young Ham.

"Whited out," answered the Old-Timer. "Nice smooth screen, no sound, no pix. Well, that led me to start lookin' through th' tuner and if strip. Changed all the tubes. No soap. Yanked it out of the box, or rather, yanked the box off of it, bein' that kind of a set, and started checkin' voltages. I was gonna be smart, see? I remembered the time a while ago when I spent a good bit of time lookin' for some very complicated troubles and it turned out to be no screen voltage on the if stages. Well, I go gallopin' through the B-plus network and, sure 'nough, first thing I run across is a B-plus line that feeds the if strip. Supposed to have 150 volts on it. Ain't actually got but 105. 'Ah-ha!' I says, 'here's the trouble!' Over a 35% drop in a supply voltage like this shows I've got a short or leakage somewhere. Somethin's shorted out, 'bout like a screen bypass condenser, if tube or somethin'. Well, the upshot of this clever piece of diagnosis

was that I spent 'bout 2 hours takin' that B-supply apart bit by bit. Of course, I didn't find any nice obvious shorts, all I had was that unexplained drop in the voltage. Substituted new rectifiers, filters, measured all the resistors in the filter networks, even measured the current through some of 'em. Nope. At the end of the time, I was right back where I started; no sound, no pix and still only 105 volts!"

"What did you do then?" asked the Young Ham.

"Just set there," answered the Old-Timer, shaking his head. "At th' moment, I was wonderin' how a man could expect to make a livin' in this kind of business and still be as stupid as I."

"Well, don't leave me in suspense," said the Young Ham. "You *did* find the trouble, didn't you?"

"Yep, I sure did," said the Old-Timer. "You've heard the old sayin' about somethin' right under your nose, haven't you?"

"Yes, sure," said the Young Ham. "What was it?"

"Well, sir, I was settin' there, with the chassis up on one edge, in front of me, like you naturally would have it, to measure voltages and stuff underneath. Just settin' there glarin' at it and wishin' I'd never left the farm. All of a sudden, exactly in front of my nose, I happened to notice a lug on one of the if transformers bent over, lookin' like it was shortin' to the chassis. Without even thinkin', I reached over and pried it up, an' the dang thing bust out playin'! I near fell off my stool. Had the sound wide open."

"Oh, I see," said the Young Ham. "This lug was shorting out your voltage. A plate lug or something?"

"Nope, nothing so simple. I'd already checked the whole B-plus network all the way through four, five times fer shorts, an' I do think I'd have found that. No, this was even worse. It was the grid return lug on the first video if stage! Shorted out the agc. The way the circuit was connected there, that killed the signal input to the if strip completely."

"Oh, yes, I see what it was doing now," said the Young Ham. "The loss of any agc bias was making your B-plus line read low 'cause of the extra current being drawn by the unbiased if stages?"

"That's a good guess," said the Old-Timer, "an' that's what I thought, at the time. First thing I did, in fact, after I checked the set out on all channels, was to go back an' measure that line again. An', do you know what voltage I had on it, with the set playin' perfectly?"

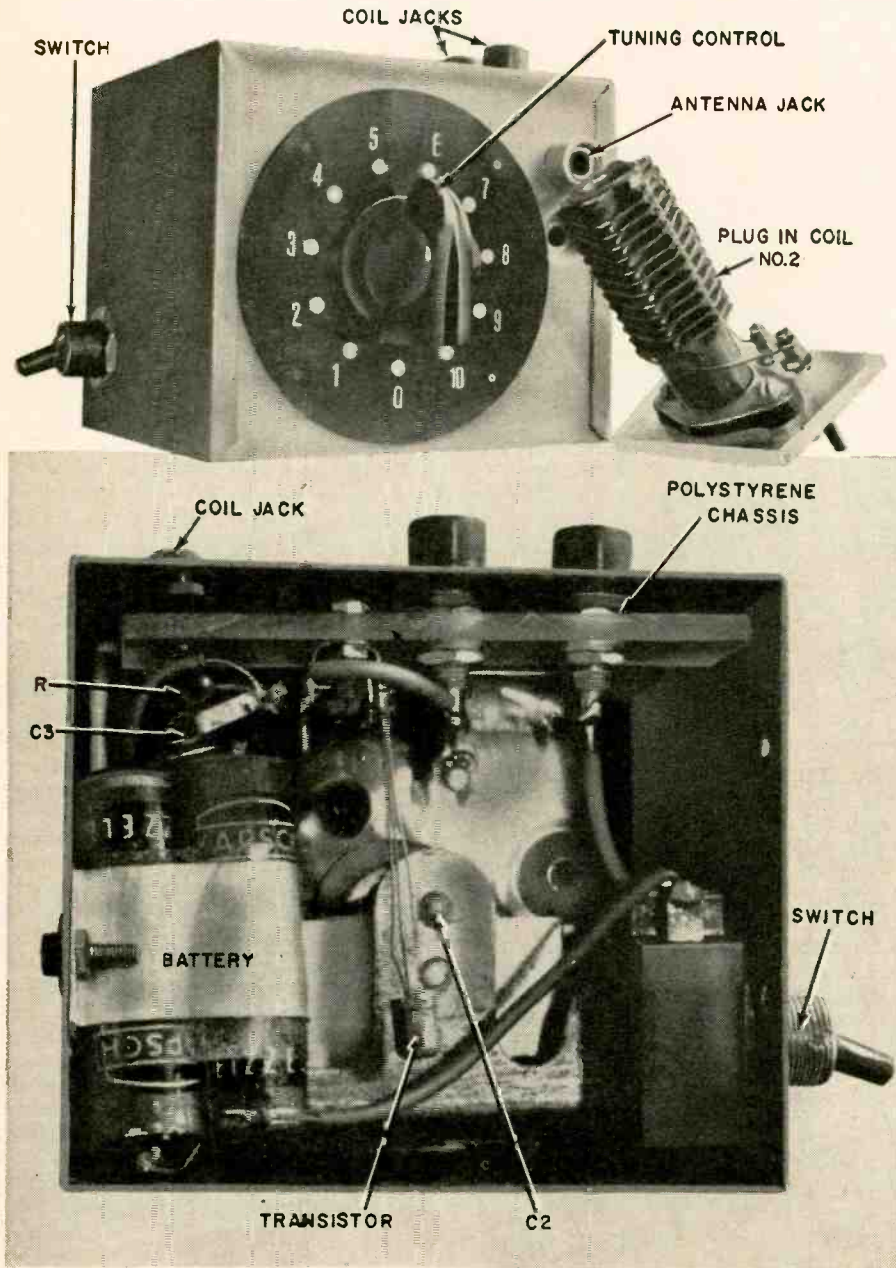
"150 volts, like the schematic said?"

"Nope. Still exactly 105! Don't know where they ever got that measurement, but that's what she read, and the set was workin' like a charm, so that's the way I left it! Like I say, things ain't always what they seem! Now, young sprout, how about gittin' the broom and sweepin' out this rat's nest?" END

# TRANSISTOR

By JOSEPH BRAUNBECK

## shortwave receiver



Top—Shortwave receiver and plug-in coil.

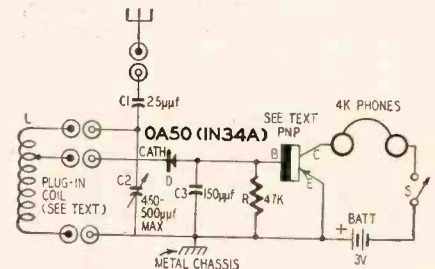
Bottom—The components layout in the receiver.

*A crystal-detector Interflex type of receiver, this compact unit tunes from 13 to 90 meters in two bands*

SEVERAL transistor receivers for medium waves as well as at least one for short waves ("Transistor Shortwave Regenerator," August, 1956) have been described in this magazine, either with point-contact or junction types. This compact shortwave receiver is fundamentally a crystal set, followed by a junction-transistor audio amplifier. As the transistor stage is a grounded-emitter dc amplifier, a dc component proportional to carrier amplitude appears at the output. This makes it possible to use the set for comparing field strength or actuating a relay.

The circuit is shown in Fig. 1. The high-frequency energy from the tuning circuit is rectified by a crystal diode and fed directly into the base circuit of the grounded-emitter junction transistor amplifier. Two penlight cells provide the collector voltage.

Plug-in coils are used as this is the



- R—47,000 ohms, 1/2 watt
- C1—25 µf, ceramic
- C2—500 µf, variable (units of 365 to 500 µf can be used)
- C3—150 µf, ceramic
- L—(see winding data in text)
- D—IN34A diode or equivalent
- V—2N37 or equivalent of transistor
- BATT—3-volt battery (2 penlight cells)
- S—spst switch
- Cabinet
- Coil forms (see text)
- Jack for plug-in coil
- Terminals for headphones
- Terminal for antenna

Fig. 1—Set uses tapped plug-in coils.

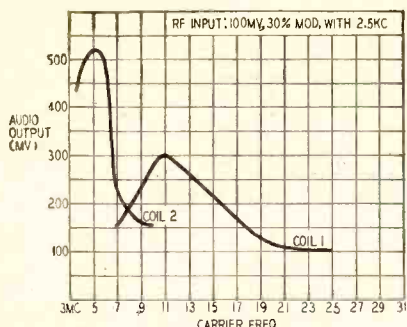


Fig. 2—Audio output voltage as a function of the carrier frequency.

simplest way to change frequency bands quickly. The coils are tapped for correct matching. As the resonance resistance of the circuit depends on the L-C ratio, which is altered by tuning, every tap gives exact matching for one frequency only.

Fig. 2 shows the audio output voltage as a function of the carrier frequency. Every coil has a certain peak where maximum sensitivity is obtained. One might think, then, that you need a lot of coils with different taps, or a rotary switch, to choose best the matching ratio. This is not so critical, as the human ear has a logarithmic characteristic. Experience has shown that two coils are sufficient to cover the entire shortwave band between 3 and 25 mc.

Coil 1 consists of 9 turns of No. 18 wire on a 3/4-inch-diameter plastic form. Tap on the fifth winding from the cold end. This coil covers from 13 to 45 meters. Coil 2 consists of 24 turns of No. 28 wire on the same type form as used by coil 1. Tap the eighth wind-

ing from the cold end. This coil covers 30 to 90 meters. It is also possible to use the set on medium (broadcast) waves. In that case take a standard medium-wave coil and tap it at a tenth of its total winding.

The capacitors have to be good, to prevent energy loss. Antenna coupling capacitor C1 is a small ceramic unit; C2 should have an air dielectric and ceramic insulation. The antenna should be at least 30 feet long. No earth ground is used as most earth leads have too much inductance to improve reception. Just connect the cold end of the resonant circuit to the receiver case.

In the original set, a Philips OA50 was used as a demodulator. This European type is a glass-envelope general-purpose diode similar to the American 1N34A. C3, a ceramic type, bypasses the high-frequency circuit.

The 47,000-ohm resistor provides dc stability when the coil is removed. I used a CBS-Hytron 2N37 junction transistor in the amplifier stage. This type is now obsolete. You can substitute almost any general-purpose audio transistor. Select a high-gain type. The dc component of the rectified carrier is used to obtain bias for the transistor. Therefore, pay attention to the crystal diode polarity. If the diode is reversed, the transistor is blocked by positive base voltage.

In the collector circuit of the 2N37 these are a 3-volt battery, a switch and a pair of headphones, connected in series. The phones have an internal resistance of about 4,000 ohms. The battery consists of two penlight cells

in series. The current drain varies with input amplitude between 0.1 (no signal) and 1 ma (strong signal). If you insert a milliammeter with about 1-ma full deflection in the collector circuit, it serves as a sort of s-meter. Field strengths may be compared, and the set proves useful if a ham's antenna is to be aligned. If a sensitive relay is inserted instead of headphones, the set gives a remote control unit without much standby power consumption.

The receiver fits into a 3 1/2 x 3 x 3-inch metal box with room to spare. All parts with the exception of the amplifier unit are mounted directly on the box. The amplifier has a separate polystyrene chassis, as may be seen in the photograph. The crystal diode and C1 are mounted behind the resistor and C3 and cannot be seen. Terminals for the plug-in coil and headphones are on top of the box. The antenna terminal is in the front near the dial. As C2 is the largest component, it pays to look around for a small one. Tuning is not very critical due to low selectivity.

Though sensitivity is low compared with tube receivers, there are always some stations strong enough to be heard with an antenna of about 30 to 50 feet. As a rule the receiver gets all the stations you hear with a broadcast receiver with the antenna disconnected. At my home in Vienna, Austria, the relay station of Voice of America (Tangier), Radio Free Europe (Munich), BBC-London, Paris, Belgrade, Moscow and several other European and African stations were logged. END

## VTVM MEASURES AC AMPS

By PAUL S. LEDERER

WHEN it becomes necessary to measure ac amperage, you can buy an ac ammeter or, in high-impedance circuits, measure ac voltage across a resistor inserted in the circuit. In many cases the value of this resistor is limited by circuit considerations, resulting in an ac voltage drop too low for measurement without amplification. This is true of low-impedance circuits.

For example, we wanted to measure the current output of the transformer in a model train system. Currents from about 500 ma to as much as 12 amps were to be measured at voltages from 6 to 18. Inserting a large enough resistor for readable output on the 0-3-volt (lowest) range of the vtvm would have resulted in considerable power loss in the resistor and consequent reduction of power available.

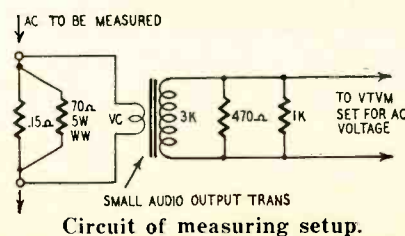
This problem was solved by using a very low value of resistance, overcoming the disadvantage. The ac voltage across it was stepped up with a small audio transformer for measurement on the low ac ranges of the vtvm.

The resistor, about 0.15 ohm, consists of four paralleled 7-inch lengths of No. 26 gauge Advance wire. Although this wire was used primarily

because of its availability, it has some marked advantages. It has a high resistivity, hence only a small quantity is required as compared with copper wire. Also Advance has a zero temperature coefficient. This means that, even if enough power should be dissipated in the resistor to raise its temperature, its resistance and therefore the calibration will not change. These advantages are shared to some extent by other resistance wires such as Nichrome, and as they are hard to get, it will be necessary to use what is obtainable at your local electric repairman's shop, or even to obtain some wire from a discarded hair dryer or other low-wattage heating element. Scientific supply houses also carry resistance wire in small quantities. A 5-watt 70-ohm wirewound resistor is used as the form on which the wire is wound.

The stepup transformer is a small audio output type connected with the voice coil winding across the resistor (see diagram). The plate winding (about 3,000-ohm impedance) is connected to the vtvm. The stepup ratio of about 20 would normally result in a reading of 3 volts ac on the meter for every ampere of current flowing through the resistor. We decided to sacrifice sensitivity for convenience by shunting the plate winding of the transformer until the meter would read exactly 1 volt for every ampere flowing into the circuit. This was done with two carbon resistors: 470 and 1,000 ohms, in parallel.

The simplest way of checking the calibration of such a current transformer is with a regular ac ammeter. If that is not available, a circuit can be set up where voltage drop is measured across a power resistor (25 watts) of 10 to 20 ohms. Applying ac of at least 6 volts (preferably more) will result in sufficient current for calibration. Of course, the resistance must be measured carefully so that the actual current can be calculated. With reasonable care, the accuracy of the current transformer should be within about 10%. END



# How far can you go in Electronics without a Degree?



Bernie Roth examines ribbon from printer during Field Engineering Laboratory period.

Without a formal degree, 24-year-old Bernie Roth is already established as a Computer Units Field Engineer—handling a key responsibility with IBM. At the McGuire Air Force Base, a directional control site for Project SAGE, Bernie is part of a team maintaining an entire electronic digital computer system. In this assignment, he must stay abreast of all the most advanced electronic concepts—developing his professional know-how every day. “That’s what’s different about IBM,” Bernie says. “The graduate engineer has an advantage anywhere—but here at IBM the technician also can grow into managerial positions. IBM is one of the few organizations I know of that is willing to invest time and money in training the technical man—and then gauges his future ability strictly on performance.”

IBM instituted its program for specialized technical training many years ago. The theory behind this built-in educational system asked the question: Why should the capable man be denied the opportunity simply because he lacks a formal degree? The wisdom and foresight of IBM’s decision are reflected in the story of Bernie Roth—in the misgivings of his past—in the certainty of his future.

### The Navy steers Bernie on the right course

When Bernie graduated from Flemington, N.J., High School in 1950, he received a general diploma—mathematics and science made up a small part of his curriculum. Enlisting in the Navy in 1951, Bernie proved his aptitude for technical work and was assigned to the electronics preparatory school in Jacksonville, Fla. Later, he attended the Class A Aviation Electronics School in Memphis, Tenn. . . . probably the most important phase of his naval training because it was in



Here, he scans the schematic of computer circuits.

electronic techniques. First of all, I studied basic circuitry. Then, I actually learned a new way to think—the ability to comprehend the whole from the assorted parts. The student must know how to form logic blocks, and in time, he should be able to design his own circuits. All of this proved especially helpful once I got into the field. Later on, I studied the various input-output devices which are used as auxiliary units to the central computer. Finally, I analyzed the methods that supply the power for this electronic giant. Millions of



Bernie checks a unit in one of the operating consoles.

### How does the future look to Bernie?

A happy and prosperous future is in the offing for Bernie Roth. Based on the records of his older associates, he's confident that in a short time he will qualify as a Systems Engineer, at the very least.\* The next steps going up the ladder are Group Supervisor and then Group Manager. "The real satisfaction in working with IBM is the opportunity to understand more and more about electronic techniques. IBM is quick to recognize and reward improved ability through greater knowledge."



An outdoor man, Bernie takes full advantage of the New Jersey game preserve.

Memphis that he became convinced that a technical career was "Right up my alley." But an event that occurred during a furlough in the spring of 1955 put a brand-new light on Bernie's future.

### Reports for training

Bernie smiled when he mentioned that his mother had a tendency to clip want ads. "It was just pot-luck that one of the ads she spotted was for IBM Kingston and Project SAGE." Soon afterwards, Bernie hopped a bus to Newark for an interview with the IBM representative. He took the required number of tests—talked over his hopes and ambitions, and "That's about all there was to it." In July, Bernie notified IBM that he was definitely available, and supplied the necessary references. Meanwhile, he made a study of IBM's history, its policies, its growth, and its future—all of which impressed him favorably. One day in September, Bernie received instructions to report to Kingston to begin training in the applications of electronic computers.

### The material he studied at Kingston

"The Kingston program is a real experience, and quite an eye-opener in

watts are needed—a phenomenal amount. In general, I'd say that you couldn't find a better training ground for understanding the uses of electronic as well as electro-mechanical equipment."

### How does Bernie feel about his current assignment?

"I'm responsible for the performance of the input-output devices—the auxiliaries that supply information to the central computer. The many Project SAGE outposts—picket ships, reconnaissance planes, Texas towers—flash their signals to the input devices which, in turn, correlate and compile the data. You might say the input devices prepare the food for digestion by the main electronic computer. This, incidentally, is one of the world's largest computers, which is built and tested at Kingston, then disassembled and shipped to a directional control site such as McGuire. Sometimes, I have the chance to assist in systems and displays. Now displays really fascinate me. There's a kind of television screen on which you can detect a plane, determine whether it's friendly or hostile, and where it's headed. My work is always different, never routine, and that's very important to me."

### What about you?

Since Bernie Roth joined IBM Military Products and the Project SAGE program, opportunities are more promising than ever. This long-range program is destined for increasing national importance, and IBM will invest thousands of dollars in the right men to insure its success.

If you have 2 years' technical schooling—or equivalent experience—IBM will train you for 6 months as a *Computer Units Field Engineer*.

If IBM considers your experience equivalent to an E.E., M.E., or Physics degree, you'll receive 8 months' training as a *Computer Systems Engineer*.

After training, you will be assigned to an area of your choice. You receive salary, not wages, plus overtime pay. In addition, every channel of advancement in the entire company is open, and IBM is a leader in a field that is sky-rocketing in growth. And, of course, you receive the famous IBM company-paid benefits that set standards for industry today.

WHY NOT WRITE—today—to Nelson Heyer, Room 3108, IBM Corp., Kingston, N.Y.? You'll receive a prompt reply.

\*Note: Since article was originally prepared, Bernie has been promoted to *Computer Systems Engineer*, and assigned to Santa Monica, Calif.

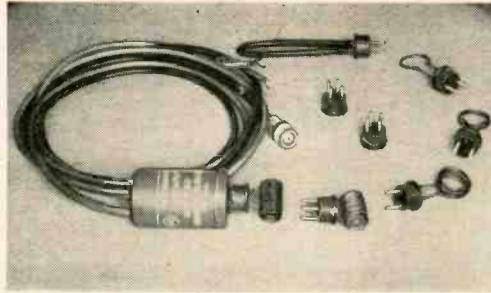
IBM

MILITARY PRODUCTS

DATA PROCESSING • ELECTRIC TYPEWRITERS  
MILITARY PRODUCTS • TIME EQUIPMENT  
SPECIAL ENGINEERING PRODUCTS

## TEST INSTRUMENTS

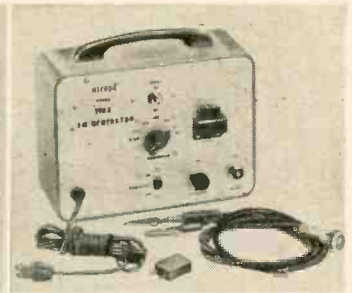
Dynamic model 60 resonance indicator with set of plug-in coils.



Philco 8300A wide-band oscilloscope.



Hickok model 290X AM generator.

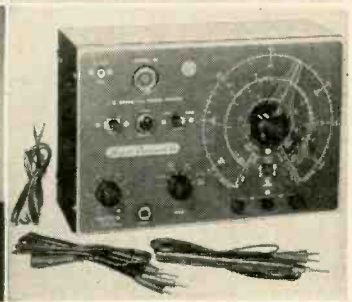


# inexpensive TV-RADIO SERVICE AIDS

By **ROBERT F. SCOTT**  
TECHNICAL EDITOR



Heathkit CC-1 C-R-tube checker.



Superior model 76 signal tracer and bridge.

**O**FTEN the test instruments we discuss are specialized types of interest chiefly to the radio and TV service technicians who will use them. This month, we've selected inexpensive and versatile equipment interesting to practically the whole field of practicing technicians and useful to the experimenter and radio and electronics fan.

### High-speed AM signal generator

The Hickok model 290X AM generator is designed especially for high-speed alignment of AM radios. It is switch-tuned with settings at 600 and 1,400 kc for rf tracking or alignment and at 465, 455 and 262 kc for if alignment. A position for plug-in crystals between 500 kc and 20 mc is also provided. Rf output is variable from 2 to 200  $\mu$ v. Audio and 400-cycle modulated rf are available at a single output jack.

As the schematic (Fig. 1) shows, the L-C oscillator is a basic 1,400-kc Colpitts type with added capacitances switched into the circuit for lower frequencies. When the selector is set to XTAL, the oscillator becomes a Pierce type connected to the crystal socket on the front panel. For either self-excited or crystal operation, output is taken off a potentiometer (RF ATTENUATOR) in the cathode circuit. The rf signal may be modulated by applying B plus to a neon type relaxation oscillator connected across a part of the oscillator grid resistor.

When the function selector is thrown to RF OFF and modulation is turned on, the triode operates as an amplifier, delivering a 400-cycle audio signal at the RF OUTPUT terminal.

### Picture-tube checker

The Heathkit CC-1 cathode-ray-tube

checker measures beam current and overall quality, tests for shorts and provides for visual (shadowgraph) inspection of the gun aperture and the relative condition of the phosphor. The circuit of the CC-1 is shown in Fig. 2.

The tube being tested is plugged into the test socket and the high-voltage lead of the CC-1 is connected. When the FUNCTION selector switch is in the SHORT position, the SHORT switch can be rotated through its various positions to indicate interelectrode shorts and leakage up to 10 megohms. For example, when the SHORT and FUNCTION switches are in the positions shown in Fig. 2, 450 volts ac is applied to grid 4 (the focus electrode, pin 6) through the NE-51 neon lamp and an R-C network. The other side of the 450-volt line is tied to the heater, cathode and grids 1 and 2. If the NE-51 lights, it indicates that the focus electrode is shorted to another element in the gun.

Rotating the SHORT switch to one of its remaining positions applies the test voltage between other elements so that possible shorts can be detected and localized.

In the TEST position, the FUNCTION selector ties the cathode and grid 1 to the common side of the high-voltage winding of the power transformer and all other elements to the 450-volt line. The high-voltage anode connects to the 1,200-volt line through 2.2-megohm and 27,000-ohm limiting resistors and the normally open SLIDE-TO-TEST switch. (Since 450 and 1,200 volts are present on the C-R-tube socket and anode connector, quality tests require simultaneous operation of the spring type SLIDE-TO-TEST and BEAM-EMISSION switches. This is a safety factor to protect the operator against accidental shock.)

When the BEAM-EMISSION switch is held in the BEAM position, the meter is inserted in the circuit and indicates total cathode current. The pointer should deflect well into the GOOD area of the scale. Releasing the SLIDE-TO-TEST switch to remove the second-anode voltage and throwing the BEAM-EMISSION switch to EMISSION now causes the meter to indicate cathode current *minus* the beam current. The pointer should fall in the GOOD or "?" sectors of the scale. Either indication is normal if the previous reading was well into the GOOD area.

When the FUNCTION switch is held in the SHADOWGRAPH position, the tube elements are connected as in the TEST position but the current-limiting resistors are shorted out and the meter is removed from the circuit. Closing the SLIDE-TO-TEST switch applies 1,200 volts to the second anode and causes a spot of light to appear on the screen. The light area will have sharp clean edges if the gun aperture is normal and irregular edges if the aperture has been damaged by an improperly adjusted ion-trap magnet. The shadowgraph test also serves as a comparison between two tubes. The light area will be brighter on the better tube.

### Superior Instruments model 76

This is a combination C-R bridge with facilities for checking breaks and shorts in FM and TV antenna lead-ins. The bridge balancing circuits can also be switched for rf and af signal tracing. The circuit is shown in the diagram of Fig. 3.

When the unit is operated with the FUNCTION switch on TRACER and an rf detector probe plugged into the SIG TRACER INPUT jack, you can trace a modulated signal from the input of a receiver through the rf stages to the





## TEST INSTRUMENTS

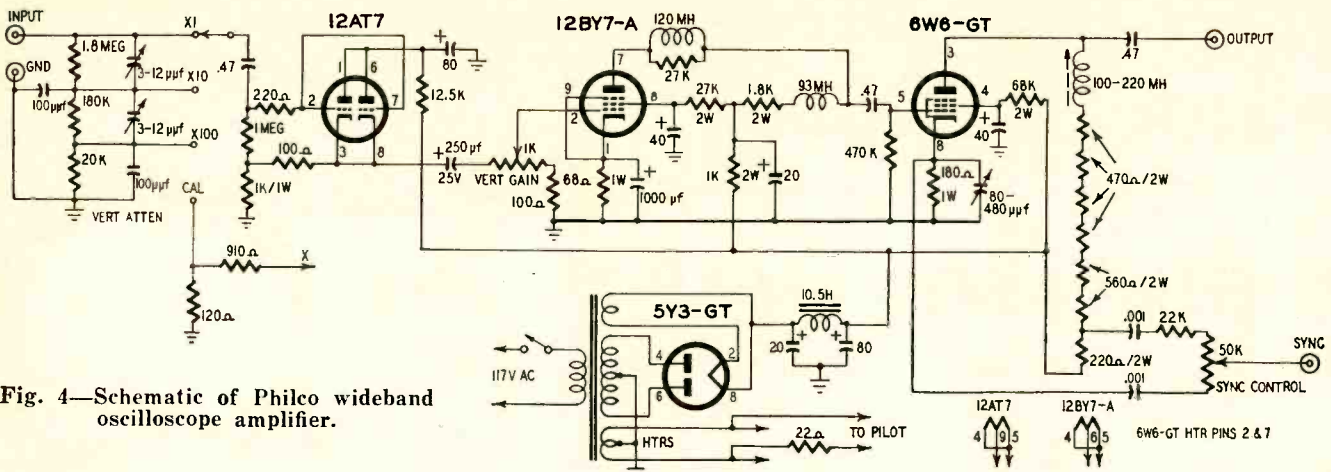


Fig. 4—Schematic of Philco wideband oscilloscope amplifier.

photograph and Fig. 4 is an accessory video amplifier designed to replace the vertical deflection system in existing narrow-band scopes, making them suitable for color TV work. It has a gain of 140 (43 db) and delivers 225 volts peak to peak with response flat within 3 db from 20 cycles to 4.5 mc. Input impedance is 2 megohms shunted by 35  $\mu$ f. The output of the 8300A drives one of the deflection plates of the scope's C-R tube.

The input stage is a 12AT7 cathode follower fed from a three-step frequency-compensated attenuator. Its high input impedance minimizes loading on the attenuator and its low driving impedance minimizes the effects of shunt capacitance across the continuously variable gain control in the grid circuit of the 12BY7-A voltage amplifier.

The 12BY7-A uses series and shunt peaking and is direct-coupled to the 6W6-GT output stage. The 3,220-ohm output load resistance is composed of seven resistors connected in series. This minimizes shunt capacitance across the resistive part of the load and makes it unnecessary to use a noninductive high-wattage wirewound resistor.

Sync voltage for the scope's horizontal sweep oscillator is tapped off a voltage divider between the 6W6-GT cathode and the 220-ohm resistor at the B-plus end of the output load. Rotating the SYNC CONTROL from one end of its range to the other reverses

the polarity of the signal that is available at the SYNC output terminal on the panel.

In normal use, the VERTICAL GAIN control on the 8300A is adjusted for the desired deflection on the scope with a 1-volt peak-to-peak input signal. This adjustment is made with the step attenuator in the calibrate (CAL) position to connect the cathode-follower grid to a voltage divider supplying approximately 1 volt peak to peak to ground.

When adapting a scope for use with the wide-band amplifier, its vertical deflection plates must be isolated from the internal vertical amplifier without disturbing the centering circuit.

The 8300A has a single-ended output so one of the vertical deflection plates of the scope must be grounded—either directly or through a large capacitor—while the signal is fed to the other. Most scopes have facilities for connecting external circuits directly to the deflection plates. Those which do not require minor modifications. These vary with scope circuitry and are described in detail in the 8300A's instruction manual.

### Resonance indicator

Dynamic Electronics—New York, Inc., offers the model 60 resonance indicator as a handy accessory that permits the technician to use his rf signal generator and a sensitive meter as a substitute for a grid-dip meter and wavemeter in servicing. As a grid-dip meter the instrument can be used for finding the self-resonant frequency of rf chokes, to locate parasitic resonances, pretune rf and if circuits within its range, check coils for shorted turns and check the values of capacitors and inductors against production standards. As a wavemeter it checks the frequency of oscillators and other excited circuits. Frequency coverage of this instrument is from below 10 to above 1,000 mc in six ranges.

The signal generator may be any instrument delivering 500,000  $\mu$ v or more in the desired frequency range. A 100- $\mu$ a dc meter is recommended as an indicator but less sensitive movements are useful in some applications. An audio vtm should be used as an

indicator when the signal generator is modulated.

The resonance indicator is 1½ inches in diameter and 2¼ inches long, not including probes. Its small size makes it possible to check circuits in vhf and uhf equipment where space would not admit the probes of most grid-dip meters and wavemeters. The generator cable is RG-58A/U terminated with a BNC type UG-88/U connector and the meter leads are microphone cable with spade lugs. Six plug-in probes (coils) are supplied.

The circuit of the model 60 is shown in Fig. 5. Its application is shown in Fig. 6. When used as a grid-dip meter, the proper coil is plugged in and brought close to the coil or circuit being checked or aligned. The signal generator output is increased until the meter reads one-half to two-thirds full scale and then the generator is tuned slowly through its range until the meter dips. The coupling is loosened and the generator again tuned for a dip. The generator's dial now indicates the frequency of the resonant circuit being checked.

Spurious dips—caused by dips in the generator output voltage—can be detected by moving the probe well away from a resonant circuit and tuning the generator through the frequency where the dip was noticed. If the meter does not dip, the frequency is correct. If it does dip, the indication is spurious and the resonant circuit must be rechecked.

When used as a wavemeter for checking the frequency of an oscillating circuit, the equipment is set up as before with the generator output reduced to zero. Advance the probe toward the tuned circuit so the meter deflects to about one-third of full scale. The generator output is then increased until the meter reads about two-thirds of full scale. The generator is then tuned across the band until the meter dips. The oscillator and signal generator are now tuned to the same frequency.

Oscillating circuits can be tuned to a predetermined generator frequency by using the same procedure and tuning the circuit under test for a dip on the meter. END

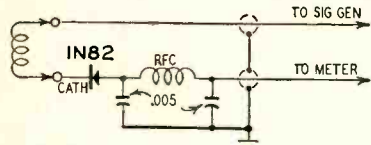


Fig. 5—Dynamic's resonance indicator circuit.

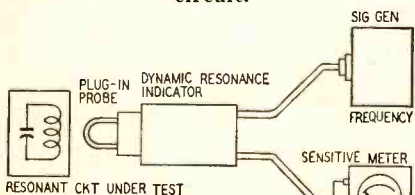


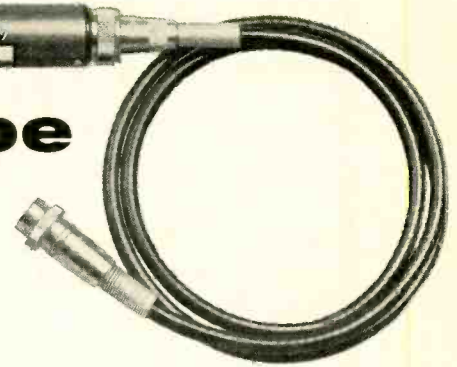
Fig. 6—Using the model 60 resonance indicator.

Oscilloscope probe doubles scope's sensitivity

# Peak-to-Peak

# High-Frequency Probe

By ROBERT G. MIDDLETON



Simpson No. 740 peak-to-peak high-frequency probe.

WITH the advent of color television, technicians find it necessary to expand their test-equipment facilities to some extent. Among the smaller items to find useful application in color TV service is the Simpson No. 740 peak-to-peak high-frequency probe. This probe also provides an additional testing facility in black-and-white servicing and doubles the effective sensitivity of a scope.

Fig. 1 shows the circuit of the probe. Notice that the crystal diodes are connected in a voltage-doubler rectifier circuit. The voltage-doubler action occurs when a symmetrical waveform is applied to the probe. On the other hand, when an unsymmetrical waveform is applied, the output voltage is equal to the peak-to-peak voltage of the unsymmetrical waveform. The distinction between the two situations is based on the fact that an unsymmetrical waveform, such as a pulse voltage, has unequal values of positive-peak and negative-peak voltages. The probe operates on such waveforms by rectifying the ac voltage, adding the positive-peak voltage to the negative-peak value, filtering the resulting pulsating dc to pure dc and delivering the filtered dc at its output. This filtered dc output has a value equal to the peak-to-peak voltage of the applied ac waveform.

If a vtvm is connected to the output cable of the probe, the dc ranges of the instrument can be used to meas-

ure the peak-to-peak voltages of rf, if or video-frequency signals. When the applied voltage is modulated, the dc ranges of the instrument indicate the value of the carrier voltage in the modulated wave while the ac ranges indicate the value of its modulating voltage. (See Fig. 2.)

More information concerning the signal under test is obtained if the output of the probe is fed to the vertical input terminals of a scope. If an ac scope is connected to the output of the probe, the display on the scope screen shows the waveshape and value of the modulating voltage. If a dc scope is connected, the display on the screen shows the value of the carrier voltage, the waveshape of the modulating voltage.

To service color TV receivers the technician must enlarge his idea of a modulated wave to include that of a video-frequency sweep signal. The video-frequency range extends from (theoretically) zero to 4.5 mc. Many circuits in a color TV receiver operate within this range. To check the response of such video amplifier circuits, a video-frequency sweep signal is applied to the input of the circuit. A scope with a flat response to 4.5 mc and a low-capacitance probe (to avoid circuit loading) can be applied directly at the output of the video amplifier. The display is illustrated in Fig. 3.

However, since some of the older service scopes do not have a flat response to 4.5 mc, it becomes necessary to demodulate the waveform shown in Fig. 3 before applying it to the vertical input terminals of the scope. The peak-to-peak high-frequency probe is especially useful for this purpose because

it provides double deflection compared to a conventional half-wave probe and effectively doubles the sensitivity of the scope. This essential operation of the probe is shown in Fig. 4.

We have seen that probes of this type are demodulators in that they operate on a modulated wave like a detector in a radio or television receiver. The chief requirement in TV is that the probe should be able to operate properly on a waveform modulated by a 60-cycle square wave.

The reason for the 60-cycle square-wave specification may not be apparent, but you should recall that sweep generators operate at a 60-cycle repetition rate. One complete sweep is accomplished each 1/60 second. Furthermore, an ideal tuned circuit or filter would have perpendicular sides and a flat top or it would be a square wave. In practice the response of tuned circuits and filters is somewhat less than ideal and the sides are sloping and the top is curved. Nevertheless, the generic waveform to be accommodated is a 60-cycle square wave and this is the design basis of such probes.

To test the demodulating ability of a probe, the outputs from a 60-cycle square-wave generator and an if signal generator tuned circuit or filter would have perpendicular sides and a flat top or it would be a square wave. In practice the response of tuned circuits and filters is somewhat less than ideal and the sides are sloping and the top is curved. Nevertheless, the generic waveform to be accommodated is a 60-cycle square wave and this is the design basis of such probes.

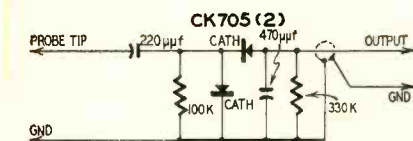


Fig. 1—Circuit of Simpson peak-to-peak high-frequency probe.

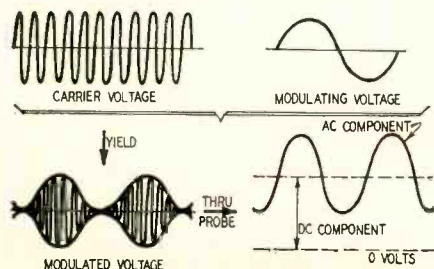


Fig. 2—Probe response to a modulated wave. Probe removes the carrier.

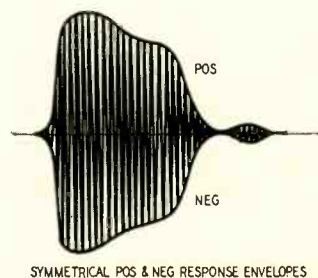


Fig. 3—Signal of video-frequency sweep generator applied to input of video amplifier seen at output of the stage.

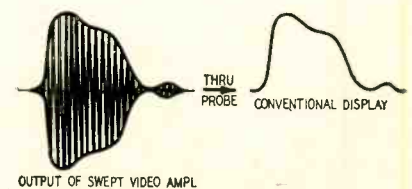
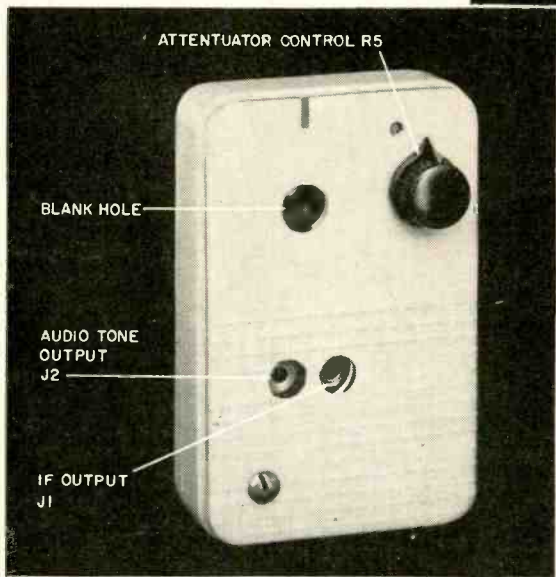
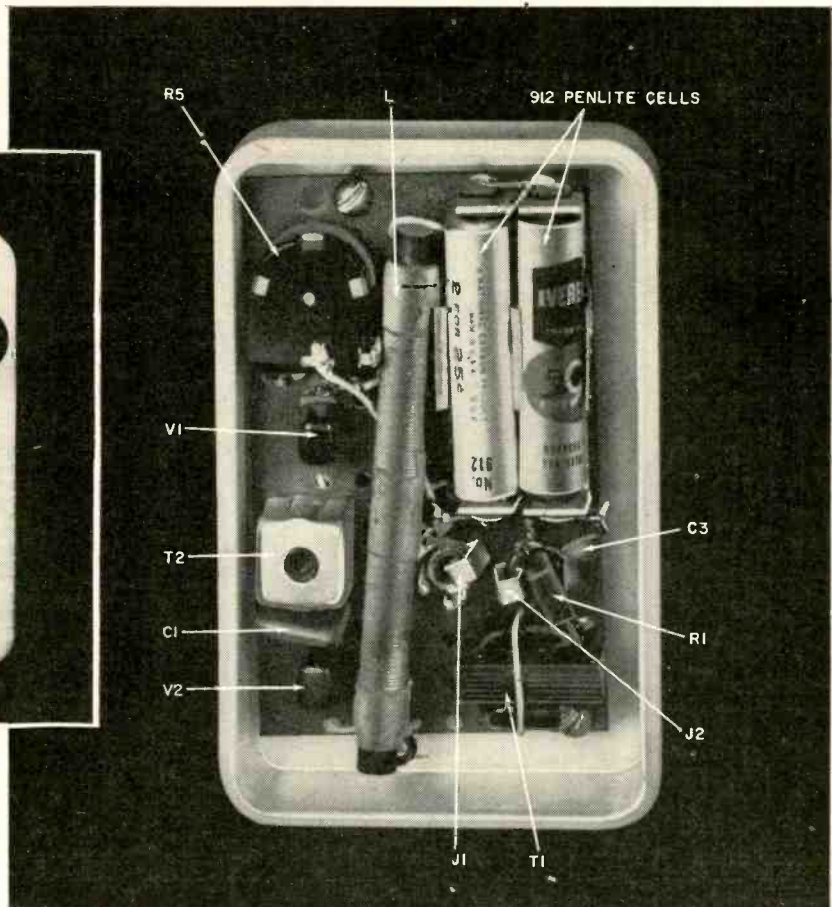


Fig. 4—Video amplifier output of Fig. 3 seen with a demodulator probe.

# A-I-R GENERATOR



*Pocket generator produces audio, if and rf signals*



Left—A-I-R generator built in a transistor radio case. Right—Inside view, indicating parts layout.

By I. QUEEN  
EDITORIAL ASSOCIATE

**T**ECHNICIANS and experimenters who construct, test or troubleshoot radios need a three-way signal generator because a superhet must amplify three frequency bands. In order of increasing frequency, these are: audio, intermediate and radio frequency. Here is a compact transistorized instrument designed for this purpose. A suitable name for it was derived by combining the first letters of each frequency band, making it an A-I-R frequency generator.

The A-I-R generator puts out the following signals:

1. A fixed audio tone of good sine quality is available at a subminiature jack (to the left in photo). It is excellent as a test tone for an audio amplifier, as a signal source for an ac bridge or for code practice. An earpiece may be plugged directly into the jack. Output is approximately 100 mv.

2. An if signal is available at the other jack. The if is modulated internally by the audio tone, making it suitable for if alignment, signal tracing, etc. The desired frequency, commonly 455 kc, is tuned in with a transformer core. However, the instru-

ment can be retuned at any time for off-beat if values, like 450, 465 kc, etc. Later we will show how to tune accurately to the exact frequency you happen to desire.

For most applications, it is important that the if be variable, not only in frequency but in voltage as well. This requirement has been kept in mind here. An attenuator controls the output which may be set for any voltage from 0 to about 100 mv. Maximum output may be required when feeding a signal to the last if stage of a radio set. Preceding stages will require weaker signals if overloading is to be avoided.

In general, a modulated if is desired. This is obtained automatically. If modulation is not wanted at any time, remove the audio transistor, leaving only the high-frequency oscillator.

3. A radio-frequency signal near the low-frequency end of the band is fed into a ferrite-rod antenna. Its signal is propagated through the air, so there is no provision for an rf jack. Like the if, it is modulated by the audio tone. The maximum distance over which the tone may be picked up depends upon the sensitivity of the receiver. A sensitive

commercial transistor set receives the signal more than 12 feet away. A sensitive home-made transistor set picks up the tone up to 10 feet or more. For maximum distance, the antennas in the A-I-R and the receiver should be aligned in parallel planes.

Fig. 1 is the complete circuit diagram of the A-I-R generator. V1 generates the if or rf, while V2 provides the audio and modulation signal. Two penlight cells supply all required power.

V2 is a conventional transformer-coupled stage. Feedback between emitter and collector results in oscillation. It is important that the windings be properly polarized. If one winding is reversed, for example, there can be no oscillation. Reversing *both* windings does not affect operation. In following the color code of the transformer, note there are two "blacks". The emitter black is the lead on the same side of the transformer as the red. If a different tone is desired, change the value of C1 or C2.

The audio tone across R1 may be fed to an earpiece (insert it into the af jack). Also, the audio voltage across the higher impedance winding of T1 is

Another **RAYTHEON** First...

**AN INDEPENDENT SERVICE DEALERS' SPECIAL PROGRAM OF GOOD-WILL BUILDERS**



**E-Z NEEDLE THREADERS**  
End needle  
threading headaches



**METAL BOTTLE-CAPPERS**  
Keep beverages fresh



**KWIK-KLEEN LINT BRUSH**  
Whisks away lint,  
dust, dandruff



**RAIN-MATE**  
Water resistant bonnet



**ALL-PURPOSE SEWING KIT**  
Complete with black and white  
thread, needle, thimble,  
and safety pin.



**KEYCHAIN "FIRST AID KIT"**  
Contains band aids, antiseptic  
cream, first aid instructions



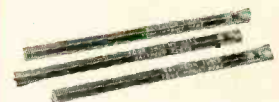
**COMB AND EMERY STIK**  
Pocket comb and stik in case



**FLY SWATTER**  
Lightweight, plastic



**TV SCREEN POLISHING CLOTH**  
Chemically treated



**WOODEN LEAD PENCILS**

In addition to the skill and knowledge you offer your customers, there are many other ways to make a good impression and to help assure repeat calls.

A neat appearance, a friendly smile, a courteous manner, and remembering to clean things up after the work is done — all do a great deal toward having you remembered in the right way! This is good business.

When a job is done and you present your bill, you have a golden opportunity to encourage a feeling of good-will in the home you have visited.

One effective way of doing this is to give your customers something useful that will be appreciated. The fact that your name and telephone number appear on it makes this good business, too!

Good-Will Builders afford an effective, inexpensive way to keep ahead of national service company competition. You may select any of those shown and buy them in minimum quantities of 50 or 100 (depending on the item) at far below normal prices. They are available only through the Raytheon

Good-Will Builder Supply Station. For the complete story, send the coupon to Raytheon Good-Will Builders Supply Station, Box 30, Milford, Connecticut.



**RAYTHEON GOOD-WILL BUILDERS  
SUPPLY STATION**  
Box 30 . . . F  
Milford, Connecticut

Gentlemen: I certainly would like the whole story on the Raytheon Good-Will Builders that will help my business. Please send a FREE copy of the booklet by return mail.

Company.....  
Name.....  
Address.....  
City and State.....

... another  
**MALLORY**  
 service-engineered  
 product

# New MALLORY Dual Controls



Put an end to  
 service delays such  
 as awaiting parts—  
 and those long  
 “shopping tours”  
 and “special orders”  
 for factory built  
 replacements

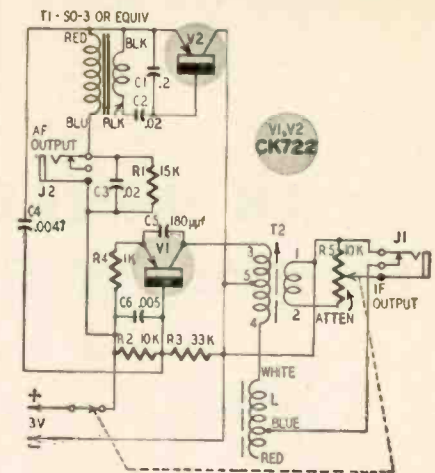
Mallory's new dual replacement controls service just about any standard model TV set and home or auto radio. Your Mallory distributor counter man will build a control to your exact specifications—in just 30 seconds. See your Mallory Distributor—TODAY.

P. R. MALLORY & CO. Inc.  
**MALLORY**

P. R. MALLORY & CO. Inc., INDIANAPOLIS 6, INDIANA

- Capacitors
- Vibrators
- Resistors
- Power Supplies
- Mercury and Zinc-Carbon Batteries
- Controls
- Switches
- Rectifiers
- Filters

## TEST INSTRUMENTS



- R1—15,000 ohms
- R2—10,000 ohms
- R3—33,000 ohms
- R4—1,000 ohms
- \*R5—10,000 ohms, potentiometer, with switch, VC-28
- All resistors 1/2 watt
- C1—0.2  $\mu$ f
- C2, 3—.02  $\mu$ f
- C4—.0047  $\mu$ f
- C5—180  $\mu$ f
- C6—.005  $\mu$ f
- T1—UTC 50-3
- \*T2—MS-268A
- \*L—Ferrite-rod antenna, MS-272
- V1, 2—CK722
- Sockets for transistors (2)
- \*Jacks, MS-282 (2)
- \*Penlight cells (2) (Eveready 912 or equivalent)
- Penlight cell holder, MS-138
- Knob
- Tapped spacers and screws
- \*Plastic case, 4 1/8 x 2 1/2 x 1 1/2 inches, MS-302
- \*Bakelite perforated board, MS-304
- \*Parts available from Lafayette Radio, 165-08 Liberty Ave., Jamaica 33, N.Y.

Fig. 1—Circuit of the A-I-R pocket signal generator.

applied through C4 across R2. Therefore, it biases V1 at an audio rate and modulates the high frequency generated by that transistor.

When there is no plug in the if jack, V1 generates a frequency determined by T2 shunted by L. T2 is an if transformer. L is a ferrite-rod antenna. Actually only a portion of L (between white and blue leads) is across part of T2 (between terminals 3 and 5). The tank frequency is *higher* than the if band because of the loopstick shunt. It will be in the neighborhood of 620 kc. If this rf is to be varied from time to time, a small capacitor across L may be added, but this has not been done here.

When a plug is inserted into the if jack, L is disconnected from the circuit. Then the tank is tuned in the if band since it includes only T2. This transformer may be core-tuned to 455 kc or any other nearby frequency. The low-impedance winding is shunted by the attenuator R5 which controls output voltage, when a plug is inserted into the if jack.

C5 is the regeneration capacitor. Not critical, it should be large enough to support oscillation.

To tune the if transformer correctly, place the A-I-R generator near a calibrated broadcast receiver. Tune the latter to the second harmonic of the desired frequency. For example, if 455 kc is desired, tune the receiver to 910 kc. Adjust the transformer core with an insulated screwdriver till you hear

## TEST INSTRUMENTS

maximum hissing noise in your radio receiver. If pickup is rather weak, connect terminal 2 of T2 directly or through a capacitor to the antenna terminal of your receiver. With T2 tuned to about 455 kc, adding L as a shunt will raise the frequency to a spot within the low end of the broadcast band. If the actual broadcast frequency is immaterial, there is no need to tune L. Otherwise a small capacitor may be shunted across it, or a tunable type antenna should be used.

The circuit of the A-I-R generator is so simple that any type of construction may be followed. For convenience, a perforated plastic board (Lafayette MS-304 cut to 2 $\frac{1}{4}$  x 3 $\frac{3}{8}$  inches) is used to support all parts and batteries. The board is held in place by a pair of threaded spacers which are screwed down inside a plastic case (Lafayette MS-302). This case has two large pre-cut holes on the front. One was used for the rf attenuator, the other left blank. The case drills very easily so the holes for the subminiature jacks are not difficult to make. The holes should be approximately 11/32 inches to accommodate the plug. The attenuator control shaft extends from the perforated board through the front of the case. This shaft and the two screws are the only parts on the front of the case.

Use a small soldering iron, preferably of the pencil type, while wiring the generator. Remove transistors while the hot iron is being used on the conductors and parts, and be sure the transistors are inserted correctly into their sockets. You don't need special tools to construct the A-I-R generator but, if you have a scope, you can observe waveforms and peak values of each signal. The output from the af jack should be a high-quality sine wave. If the scope can operate at fairly high frequencies, you will also see a sine wave from the if jack when the sweep is set to about 100 kc. The *modulated* wave is observed when the sweep is lowered to some audio rate. With values shown in the diagram, the modulation percentage came out to about 80%. It is controlled by the values of R1, R2, C3 and C6 to some extent.

The A-I-R generator will find many uses around the repair shop, hamshack and experimenter's corner of the kitchen. Also, if you go shopping for a transistor radio receiver, it can help you acquire the most sensitive set in the store. Have your friend carry the generator or you may conceal it in your own shirt or vest pocket. As you try out each radio in the store, tune it to the tone being broadcast from the A-I-R generator. For this purpose you need only turn on the switch. Do not insert any plug. The receiver that picks up the tone at the greatest distance is the one to buy. This test procedure is quite important when it is realized that even radios of the same model may vary due to differences in transistors, alignment or merely circuit defects that may arise after the final factory test. END

# MALLORY Clippings



*(A series of service hints  
gleaned from the notebooks of  
Mallory design and application engineers)*

Sometimes you can't find exact-replacement capacitors, especially for some of the older or less popular equipment. Here are a few rules regarding simple substitutions. Obviously, some of these call for physically larger or slightly more expensive capacitors—but that's better than throwing away perfectly good equipment.

In virtually all radio and TV applications, higher voltage ratings or higher capacities can be used at any time.

Individual sections of multiple units can be connected together in parallel to obtain needed capacity, even though they are of different voltage ratings. The lowest voltage rating of all capacitors connected in parallel applies.

Two like capacitors may be connected in series to provide a capacitor with a voltage rating twice as high. The capacity of each section must be twice the actual capacity required. Insulate lead between units and case of capacitor above ground potential. Equalizing resistors are not required.

Regardless of the circuit—you can count on Mallory capacitors to do any service job—right. See your Mallory Distributor, today, and lay in a working replacement stock.

P. R. MALLORY & CO. Inc.  
**MALLORY**

P. R. MALLORY & CO. Inc., INDIANAPOLIS 6, INDIANA

Capacitors • Controls • Vibrators • Resistors • Switches • Rectifiers  
Power Supplies • Filters • Mercury and Zinc-Carbon Batteries

By RICHARD GRAHAM

# Frequency-Marker Inserter

*Two-tube circuit keeps your frequency marker where you can see it*

PERHAPS one of the less serious, but quite common, frustrations of the TV service technician is trying to find the frequency marker pip on the scope when aligning an if amplifier. The pip's amplitude varies with the peaks and valleys of the amplifier response till it diminishes to zero at each end of the curve. The annoyance caused by this vanishing marker pip is quite unnecessary for the simple two-tube device described in this article presents a marker pip on the oscilloscope even when no bandpass pattern is in view. Now the sweep generator can be preset to sweep a certain bandwidth and have a specific center frequency before it is connected to a TV set.

To appreciate what is being done in the marker inserter, let's review the common method of inserting a marker pip. Fig. 1-a shows a basic block diagram of the "old" way of doing it. If the amplifier response is reduced in any way, the amplitude of the low-frequency beat (which we view as the marker pip) will also be reduced. This can occur if the amplifier under test lacks gain or if we are operating out of its bandpass response. In the latter case there is effectively an open circuit between the generators and the low-frequency beat or pip. It's obvious that the marker pip will simply vanish. Another sign of this is the gradually lessening height of the marker as the marker frequency is adjusted down the slope of the amplifier's bandpass curve.

In Fig. 1-b we show how this vanishing marker can be restored. Instead of relying on the signals of both the marker and sweep generators getting through the amplifier under test, which they may or may not do for reasons of mistuning or some component defect, these two generators beat together in a separate detector. The resultant low-frequency beat or marker pip is amplified to compensate for the amplification the two signals would have received if they had gone through a typical if amplifier.

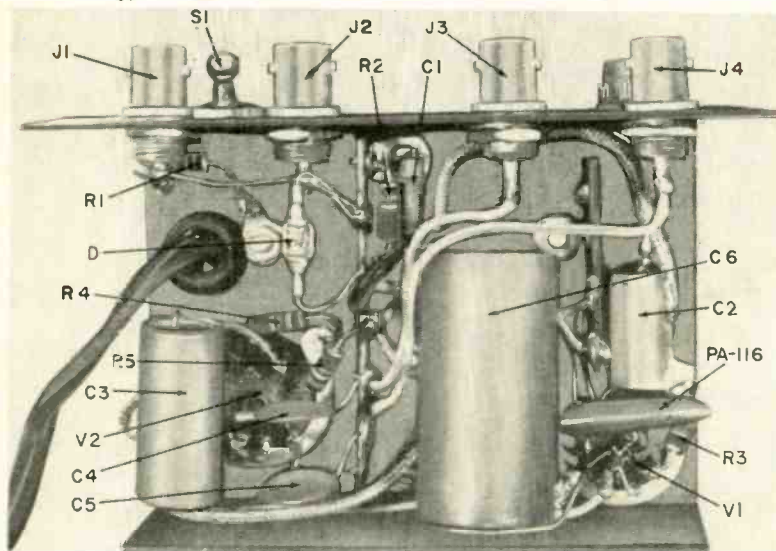
The amplified beat must now be added to the detected video response of the amplifier under test to put the marker back on the response curve. This is done in a dual triode with its plates tied together so the inputs to each grid are added in the common plate circuit of the tube. Now, regardless of the amplifier's response, the marker pip will remain at a constant amplitude.

## Circuit, construction and use

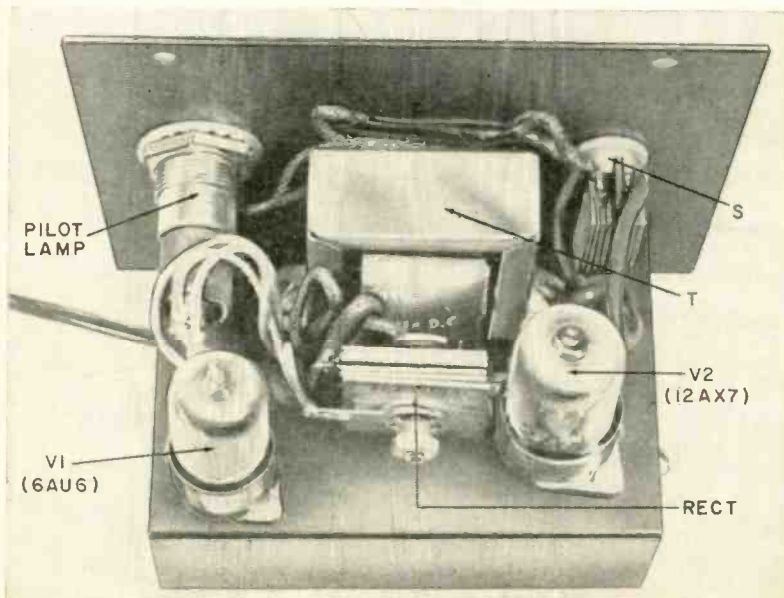
The marker inserter circuit is shown in Fig. 2. The sweep generator output is fed to J1 and the marker frequency generator to J2. These signals are mixed and detected by D, a 1N34 diode detector. The mixed and detected output appears across R2, the diode load resistor. This signal will appear on a scope, placed at this point, as a straight line with a low-frequency beat or marker pip at some point along the base



Front view.



Bottom view.



Top-chassis view.



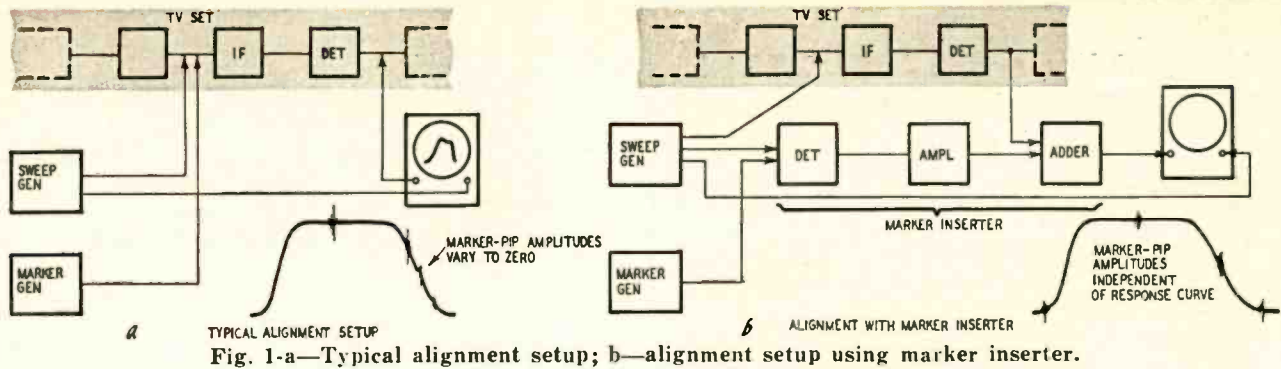


Fig. 1-a—Typical alignment setup; b—alignment setup using marker inserter.

line. The signal is quite weak and for a decent-sized marker pip it needs further amplification. It is comparable to what happens in a typical if amplifier in which both frequencies are amplified before being detected.

In the marker inserter the two signals are detected and then amplified. The amplifier stage is a 6AU6 (V1).

Since the marker pip consists of only the low-frequency components of the beating of the marker and sweep generators, the frequency response of this stage need not be particularly wide. This also means that we can get more gain from the stage if the bandwidth is narrow.

The amplified marker pip must now be added to the detected bandpass response of the amplifier under test. The adder consists of a simple 12AX7 (V2) dual-triode stage. The plates are tied together and fed through a common plate load resistor. The detected bandpass response of the amplifier under test is fed to the grid of one section of V2; the marker-pip response is fed to the other grid. Since the plates are in parallel, the signals fed to each grid are amplified by the tube and added in its plate circuit. This recombined signal, consisting of the bandpass response of the amplifier under test and the marker pip, is fed to the oscilloscope's vertical amplifier in the usual way.

The inserter was built into a 3 x 4 x 5-inch utility box with a built-in chassis. The layout shown in the photographs can serve as a general guide for the constructor. If you wish, any layout can be used if you keep in mind the important points of building high-gain amplifiers. Grid leads of the 6AU6 and its associated coupling capacitor (C2) should be shielded to prevent hum pickup. Rf leads between the sweep generator and marker generator and the diode mixer circuit should be kept short. For compactness a printed-circuit interstage coupler was used between V1's output and V2's input. Values of the components in the coupler are given in the parts list.

To use the marker inserter, plug the rf output of the sweep and marker generators into their respective jacks. Turn the outputs of these generators to maximum. Connect the output of the adder at J4 to the scope's vertical input. Feed the detected bandpass of the amplifier under test to J3. Adjust the frequency controls of the respective

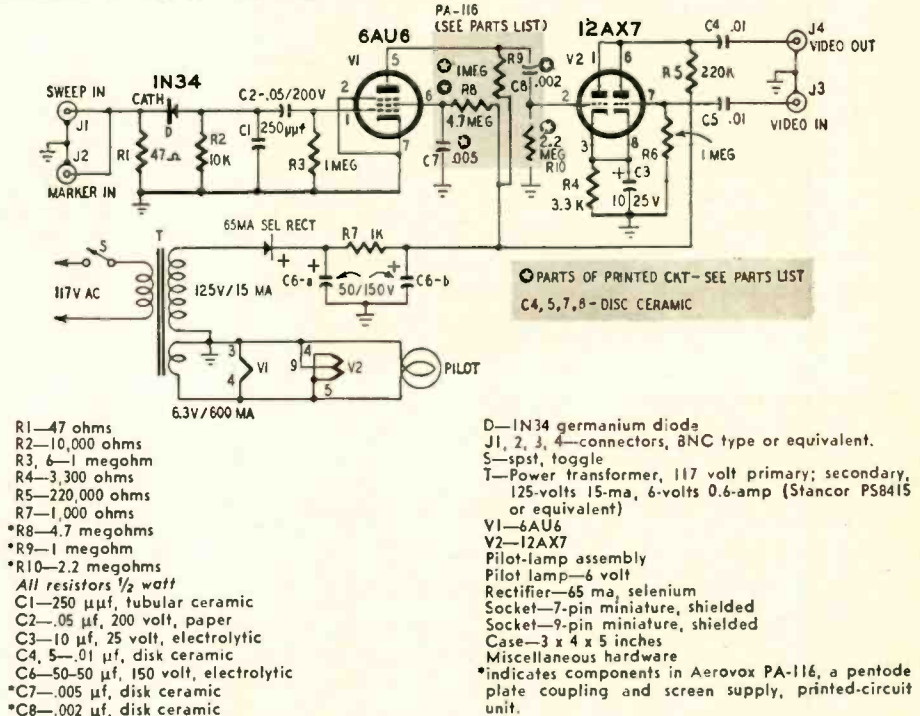


Fig. 2—Circuit of the frequency marker inserter.

- R1—47 ohms
- R2—10,000 ohms
- R3—6-1 megohm
- R4—3,300 ohms
- R5—220,000 ohms
- R7—1,000 ohms
- \*R8—4.7 megohms
- \*R9—1 megohm
- \*R10—2.2 megohms
- All resistors 1/2 watt
- C1—250 μf, tubular ceramic
- C2—.05 μf, 200 volt, paper
- C3—10 μf, 25 volt, electrolytic
- C4, 5—.01 μf, disk ceramic
- C6—50-50 μf, 150 volt, electrolytic
- \*C7—.005 μf, disk ceramic
- \*C8—.002 μf, disk ceramic
- D—1N34 germanium diode
- J1, 2, 3, 4—connectors, BNC type or equivalent.
- S—spst, toggle
- T—Power transformer, 117 volt primary; secondary, 125-volts 15-ma, 6-volts 0.6-amp (Stancor PS8415 or equivalent)
- V1—6AU6
- V2—12AX7
- Pilot-lamp assembly
- Pilot lamp—6 volt
- Rectifier—65 ma, selenium
- Socket—7-pin miniature, shielded
- Socket—9-pin miniature, shielded
- Case—3 x 4 x 5 inches
- Miscellaneous hardware
- \*Indicates components in Aerovox PA-116, a pentode plate coupling and screen supply, printed-circuit unit.

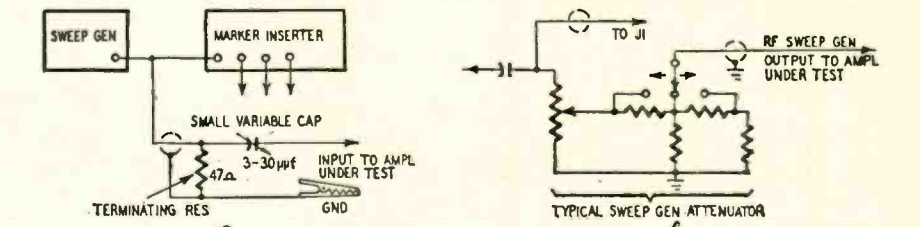


Fig. 3—Two ways to make marker-pip amplitude independent of the sweep generator's attenuation control.

generators to the desired sweep and marker frequencies. The marker pip should now be in view on the scope. Adjust the marker generator output control to produce the desired marker-pip height.

Sweep generator rf input to the amplifier under test can be taken off in parallel with the input to the marker inserter. If this is done, adjusting the output attenuator of the sweep generator will also affect the marker-pip height. To avoid this you can do either of two things. The first and simpler method is to vary the coupling capacitor between the amplifier under test and the sweep generator, leaving the output attenuator set at maximum at all times. This is shown in Fig. 3-a.

A better way, involving a little more work, is to take the input to the marker

inserter at a point in the sweep generator circuit before the attenuator. This method together with a typical sweep generator output circuit is shown in Fig. 3-b. Now the rf output attenuator can be used and the marker height is controlled only by the marker generator's rf output setting.

If you have done much alignment, the first thing you may notice is the higher gain—larger amplitude of the bandpass patterns. This is due to the added gain supplied by the 12AX7 adder stage. This additional gain is valuable when adjusting circuits with little or no gain such as discriminators, or adjusting tuned circuits "cold." The stage can also be used independently of the marker-inserter function for any audio applications where additional scope gain is needed.

END

# BUILD 16 RADIO

CIRCUITS at Home with NEW DELUXE  
PROGRESSIVE RADIO "EDU-KIT"

A Practical  
Home Radio Course

\$22.95

- ★ School Inquiries Invited
- ★ Attractively Gift Packed
- ★ No Knowledge of Radio Necessary
- ★ No additional Parts or Tools Needed
- ★ Excellent Background for TV

Reg. U.S.  
Pat. Off.



Now Includes  
**TRANSMITTER  
SIGNAL TRACER  
SIGNAL INJECTOR  
CODE OSCILLATOR**

**FREE** SET OF TOOLS, PLIERS—CUTTERS, TESTER,  
SOLDERING IRON, ALIGNMENT TOOL

## WHAT THE "EDU-KIT" OFFERS YOU

The "Edu-Kit" offers you an outstanding PRACTICAL HOME RADIO COURSE at a rock-bottom price. Our kit is designed to train Radio & Electronics Technicians, making use of the most modern methods of home training. You will learn radio theory, construction, servicing, basic Hi-Fi and TV repairs, code, FCC amateur license requirements.

You will learn how to identify radio symbols, how to read and interpret schematics, how to mount and layout radio parts, how to wire and solder, how to operate electronic equipment, how to build radios. You will receive a basic education in radio, worth many times the small price you pay, only \$22.95 complete.

## THE KIT FOR EVERYONE

The Progressive Radio "Edu-Kit" was specifically prepared for any person who has a desire to learn Radio. The "Edu-Kit" has been used successfully by young and old in all parts of the world, by many Radio Schools and Clubs in this country and abroad. It is used for training and rehabilitation of Armed Forces Personnel and Veterans throughout the world.

The Progressive Radio "Edu-Kit" requires no instructor. All instructions are included. Every step is carefully explained. You cannot make a mistake.

## PROGRESSIVE TEACHING METHOD

The Progressive Radio "Edu-Kit" is the foremost educational radio kit in the world, and is universally accepted as the standard in the field of electronics training. The "Edu-Kit" uses the modern educational principle of "Learning by Doing." Therefore, you will construct radio circuits, perform jobs and conduct experiments to illustrate the principles which you learn.

You begin by examining the various radio parts included in the "Edu-Kit." You then learn the function, theory and wiring of these parts. Then you build a simple radio. With this first set, you will enjoy listening to regular broadcast stations, learn theory, practice testing and troubleshooting. Then you build a more advanced radio, learn more advanced theory and techniques. Gradually, in a progressive manner, and at your own rate, you will find yourself constructing more advanced multi-tube radio circuits, and doing work like a professional Radio Technician.

Included in the "Edu-Kit" course are sixteen Receiver, Transmitter, Code Oscillator, Signal Tracer and Signal Injector circuits. These are not unprofessional "breadboard" experiments, but genuine radio circuits, constructed by means of professional wiring and soldering on metal chassis, plus the new method of radio construction known as "Printed Circuitry." These circuits operate on your regular AC or DC house current.

In order to provide a thorough, well-integrated and easily-learned radio course, the "Edu-Kit" includes practical work as well as theory; troubleshooting in addition to construction; training for all, whether your purpose in learning radio be for hobby, business or job; progressively-arranged material, ranging from simple circuits to well-advanced topics in Hi-Fi and TV. Your studies will be further aided by Quiz materials and our well-known FREE Consultation Service.

## THE "EDU-KIT" IS COMPLETE

You will receive all parts and instructions necessary to build 16 different radio and electronics circuits, each guaranteed to operate. Our kits contain tubes, tube sockets, variable, electrolytic, paper dielectric, mica and ceramic condensers, resistors, tie strips, coils, hardware, tubing, punched metal chassis, Instruction Manuals, etc.

In addition, you receive Printed Circuit materials, including Printed Circuit chassis, special tube sockets, hardware and instructions. You also receive a useful set of tools: a professional electric soldering iron, and a self-powered Dynamic Radio & Electronics Tester. The "Edu-Kit" also includes Code Instructions and the Progressive Code Oscillator, in addition to the F.C.C.-type Questions and Answers for Radio Amateur License training. You will also receive lessons for servicing with the Progressive Signal Tracer and the Progressive Signal Injector, and a High Fidelity Guide and Quiz Book.

## TROUBLE-SHOOTING LESSONS

You will learn trouble-shooting and servicing in a progressive manner. You will practice repairs on the sets that you construct. You will learn symptoms and causes of trouble in home, portable and car radios. You will learn how to use the Professional Signal Tracer, the unique Signal Injector and the Dynamic Radio & Electronics Tester. While you are learning in this practical way, you will be able to do many a repair job for your friends and neighbors, and charge fees which will far exceed the price of the "Edu-Kit." Our Consultation Service will help you with any technical problems you may have.

J. Statulis, of 25 Poplar Pl., Waterbury, Conn., writes: "I have repaired several sets for my friends, and made money. The 'Edu-Kit' paid for itself. I was ready to spend \$240 for a Course, but I found your ad and sent for your Kit."

## FREE EXTRAS

- SET OF TOOLS • RADIO & ELECTRONICS TESTER • ELECTRIC SOLDERING IRON • TESTER INSTRUCTION MANUAL • MEMBERSHIP IN RADIO-TV CLUB • CONSULTATION SERVICE • HI-FI GUIDE • QUIZZES • TV BOOK • FCC AMATEUR LICENSE TRAINING • RADIO BOOK • PRINTED CIRCUITRY • PLIERS—CUTTERS • ALIGNMENT TOOL

—UNCONDITIONAL MONEY-BACK GUARANTEE—

ORDER FROM AD—RECEIVE FREE BONUS RESISTOR AND  
CONDENSER KITS WORTH \$7.00.

- Send "Edu-Kit" Postpaid. I enclose full payment of \$22.95.
- Send "Edu-Kit" C.O.D. with \$22.95 in advance.
- Send me FREE additional information describing "Edu-Kit."

Name.....  
Address.....

Progressive "EDU-KITS" Inc. 497 Union Ave., Dept. 131 G  
Brooklyn 11, New York

# new Devices



**STEREO CONVERSION DEVICE, Dactron Steradapter.** Converts monaural and staggered tape recorders to full-fidelity playback of in-line

for tilting head 45° forward, 70° backward. — Shure Brothers,



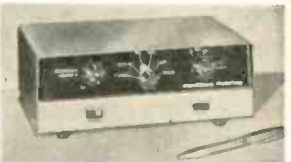
stereophonic tape recordings.—**International Magnetic Electronics Corp., P.O. Box 987, Minneapolis 1, Minn.**



Inc., 222 Hartrey Ave., Evanston, Ill.

**PREAMPLIFIER, Transamp.** All-transistor front end. 1- or 3-

**AMPLIFIER, model 7615.** 15 watts. Built-in preamp, tape head and magnetic phono equalization. Turnover, rolloff, bass, treble, loudness and contour con-



trols. — **Calbest Electronics, 4801 Exposition Blvd., Los Angeles 16, Calif.**



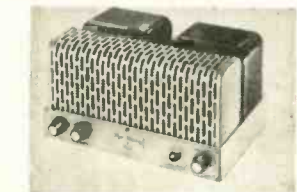
**BASIC AMPLIFIER, Model AA-908.** 40 watts, 20–20,000 cycles ±0.1 db. Harmonic distortion 0.5%. 0.4-volt input for 40-watt output. Hum level 90 db below

volt output. 6 inputs. Bass, treble and volume controls. Rumble and noise filters.—**Madison Fielding Corp., 863 Madison St., Brooklyn 21, N. Y.**

**HI-FI SPEAKER, 503S1.** 60–18,000 cycles. 8 inches. 10-watt



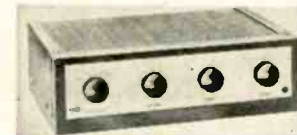
trols. — **Alnico V magnet.—RCA Components Div., Front and Cooper Sts., Camden, N. J.**



**PA SPEAKER, model CJ-44.** Integrally constructed projector. Built-in driver. Handles 30 watts. 16-ohm impedance. 150–9,000-cycle response. Bell 23 x 13

40 watts. 12AX7 (2), EL34/6CA7 (2), 5U4GB (1).—**Pilot Radio Corp., 37-06 36th St., Long Island City 1, N. Y.**

**HI-FI AMPLIFIER, HF-12,** kit or wired. 25–20,000 cycles ±0.5 db at 12-watt output. 20-db feedback. Preamp, equalizer and control sections. Williamson type



amplifier. 3½ x 12 x 8½ inches. 13 pounds.—**Electronic Instrument Co., Inc., 84 Withers St., Brooklyn 11, N. Y.**

**RECORD CLEANER, Dust Bug.** Removes dirt and static charge from record grooves just before playing. Eliminates static pops and crackles, prevents accumula-

**RIBBON MICROPHONE, Uni-tron model 330.** Unidirectional. Multi-impedance. For reduction of reverberation, reflection and pickup of random sound. Swivel

inches; length 19 inches. 19 pounds. — **Atlas Sound Corp., 1451 39th St., Brooklyn 18, N. Y.**



RADIO-ELECTRONICS

Practical CBS Transistor Home-Study Course

# Learn all about transistors by using them



## CASH IN NOW ON EXTRA PROFITS!

Let's face it. Transistors are here . . . now! Extra profits are waiting for service technicians who know all about them. Are *you* ready?

This new, profusely illustrated Transistor Home-Study Course, a CBS first, was written to make it easy for you to learn by using transistors. A residence course at home, it's fast and fascinating. What you learn you remember because you do it yourself . . . by making several practical transistor devices which you can keep and use. Course was written for CBS by A. C. W. Saunders. A well-known educator and author, he knows technicians and how to write for them.

Check the table of contents. Then read how easy it is for you to start your Transistor Course today.

### CBS Transistor Course Includes

- Ten intensive lessons (with 3-ring binder) . . . up-to-date, complete

- Simplified basic theory . . . how transistors work
- Practical experiments and servicing techniques for:
  - Amplifiers . . . applications in all fundamental circuits
  - Oscillators . . . a-f, r-f, relaxation, multivibrator, special TV
  - Rectifiers . . . diode and transistor rectifiers and detectors
  - Practical commercial applications . . . immediate and future
- With free correction and consulting service . . . and up-to-date supplements for certified graduates

### HOW TO GET IT?

See your CBS Tube distributor. He'll tell you how you can get the complete CBS Transistor Home-Study Course, PA-175, *free* with your purchases of CBS tubes: Each lesson with 100 tubes. Or full ten-lesson course with 750 tubes. Or complete course for \$25.00. See him today!



**CBS - HYTRON**, Danvers, Mass.  
A Division of  
Columbia Broadcasting System, Inc.

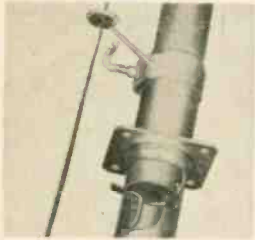


NEW DEVICES

(Continued)

tion of dirt on stylus. Easily adjustable for any turntable.—**Electro-Sonic Laboratories, Inc.**, 35-54 36th St., Long Island City 6, N. Y.

**TELESCOPING MAST, Super-Mast.** High-carbon galvanized steel. Dual T-Nut strap holds



insulator and locking bolt. Separate guy ring and bearing for each section.—**Channel Master Corp.**, Ellenville, N. Y.

**INDOOR ANTENNA, Silver V.** Spring-loaded ball sockets.



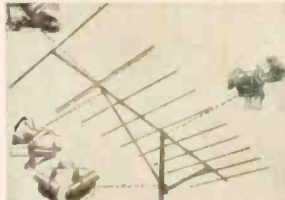
Bronze finish base—**Trio Manufacturing Co.**, Griggsville, Ill.

**TV ANTENNA, Model 5609** attaches to rear of set. 38-inch collapsible elements. Plastic



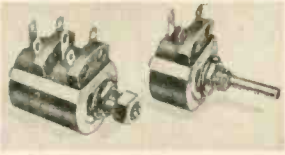
case. **Model 5608** includes a cut-out switch to select indoor or outdoor antenna.—**Brach Manufacturing Corp.**, 200 Central Ave., Newark 3, N. J.

**TV YAGIS, 72- or 300-ohm impedance.** 3/4-inch outside diameter aluminum tubing to fasten to any circular mast of



2- to 2 3/4-inch diameter. 5 and 10 elements.—**Scala Radio Co.**, 2814 19th St., San Francisco, Calif.

**MINIATURIZED CONTROLS, Series 49M.** Wirewound. 3/4-inch



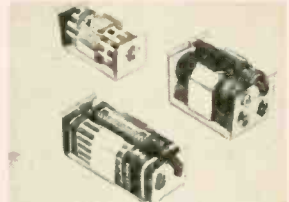
diameter, 1/2 inch deep, 1.5 watts, 4-20,000 ohms.—**Clarostat Manufacturing Co., Inc.**, Dover, N. H.

**BATTERY ELIMINATOR ADAPTER, model BEA.** Adapts battery eliminators for transis-



tor radio checking. Adapter connects directly to battery-eliminator output.—**Electronic Measurements Corp.**, 625 Broadway, New York, N. Y.

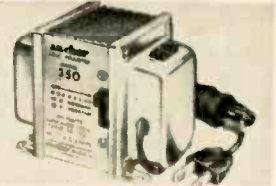
**BATTERY HOLDERS, Ex-**



panded line includes mountings for almost every radio battery.—**Austin Craft Co.**, 988 Market St., San Francisco 2, Calif.

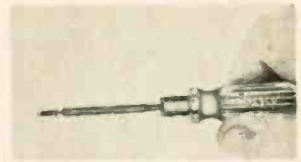
**LINE-VOLTAGE ADJUSTER, LA 350.** Boosts or reduces house voltage. Rated at 300 volts. 4-position switch selects: off, on,

10 volts up, 10 volts down. Input 100-130 volts. Output 110-120 volts.—**Anchor Products**



Co., 2712 W. Montrose Ave., Chicago 18, Ill.

**SCREWDRIVER, Mini-hold.**



Grips tiny screws. 2 7/8 inches long.—**Walsco Electronics Manufacturing Co.**, 100 W. Green Street, Rockford, Ill.

**METER-GUARD,** a transparent protective meter cover for Simpson instruments. **Models 260,**



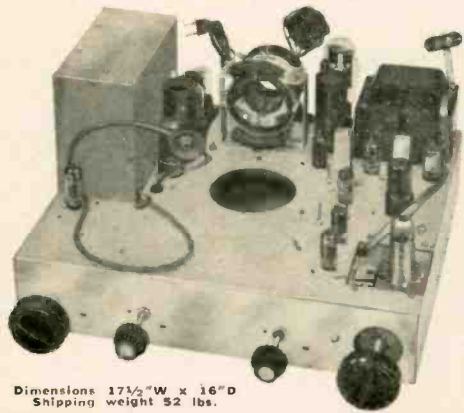
**303, 276 and 880.**—**Electronic Development Laboratories**, 71 Nassau St., New York 38, N. Y.

**POWER SUPPLY, 1050.** All-transistorized. Supplies regu-

# Excitingly new! DX-16 Super Deluxe TV KIT

For the CUSTOM-BUILT CHASSIS that even a high school student can build.

The DX-16 SUPER DELUXE TV KIT is a worthy successor to the famous #630 TV KIT . . . a product in which we took a leading role. In designing and engineering this NEW KIT, we used the #630 as a standard of comparison for POWER, STABILITY and FRINGE AREA RECEPTION . . . resulting in a NEW TV CHASSIS equal in performance and with even greater versatility.



Dimensions 17 1/2" W x 16" D  
Shipping weight 52 lbs.

NEW IN DESIGN—Mounts Horizontally, Vertically or Sideways.

- Produces a Superior 16-Tube Chassis with 30-Tube performance.
- Latest advanced Intercarrier Circuitry and Multi-section Tubes.
- Standard Cascode Tuner for Selectivity and Fine Definition.
- 16KV Output—Operating a 21" and other size 70° Picture Tubes.
- 5 Microvolts Video Sensitivity (20 volts peak to peak at CRT grid).
- Fast Action AGC for Drift Free, Steady and Clear Pictures.
- 3 Hi-gain Video I.F. Stages for excellent Contrast and Details.
- AGC Level and Area Control, for adjusting reception to signal area.
- All Video and I.F. Coils are factory pre-aligned and tuned.
- Horizontal Sweep Circuit is the famous RCA Synchroguide Network.
- New High Efficiency Damper Circuit provide a smooth linear raster.
- Latest circuits for Full Horizontal and Vertical Blanking.
- Large Power Transformer 250ma for dependable service.
- Large 12" Concert-tone 12" Speaker.
- KIT is supplied with all Parts, Wire and LIFE-SIZE Instructions.

<b>DX-16 SUPER DELUXE TV KIT</b>	Complete Set of Parts, including LIFE-SIZE step-by-step Building Instructions, Pictorials, Schematics, etc. (less tubes and CRT).....	<b>\$69.97</b>
<b>DX-16 SUPER DELUXE TV KIT</b>	<b>COMPLETE WITH SET OF WESTINGHOUSE TUBES</b> less CRT	<b>\$79.97</b>
4-6CB6 and 1 of each—6U8, 6T8, 6K6, 6C4, 12B117, 6SN7, 6BQ6, 6W4, 1X2B, 5U4. Tubes alone list for \$33.40. 6J6 and 6RQ7 are included in the Tuner.		
<b>DX-16 SUPER DELUXE TV KIT</b>	<b>ALL COMPLETE with SET of WESTINGHOUSE TUBES and WESTINGHOUSE 21" #21YP4A Aluminized CRT.....</b>	<b>\$99.97</b>

**BROOKS RADIO & TV CORP., 84 Vesey St., New York 7, N.Y.** TELEPHONE CORtland 7-2359

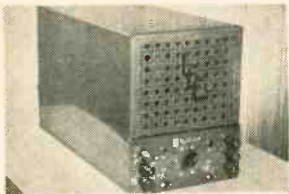
**NEW DEVICES**

lated. Variable dc between 0.5-7 volts. Input 105-125 volts ac. Maximum output current, 300



ma. 5 x 6 1/2 x 6 1/2 inches. 3 1/2 pounds.—Kay Electric Co., 14 Maple Ave., Pine Brook, N. J.

**POWER SUPPLY, model R-10.** Dc output variable from 200-325 volts at 100 ma. Regulation better than .07% from zero to full load. Ripple less than 200



mv rms at 115 volts ac. Ac output, 6.3 volts, 3 amps. Ac input 105-125 volts, 60 cycles.—L. E. E., Inc., 625 New York Ave., N. W., Washington 1, D. C.

**COLOR SCOPE, 3151K kit, 3151W wired.** Flat through 5 mc. Push-pull vertical and horizontal amplifiers. 5-inch scope tube. Frequency-compensated



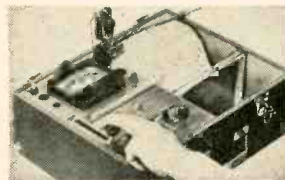
stepping attenuators for vertical and horizontal. Output voltage calibration. Sensitivity: 10 mv/cm vertical; 40 mv/cm horizontal.—Precise Development Corp., 2 Neil Court, Oceanside, N. Y.

**TRANSISTOR TESTER, model**



**TT.** Measures collector current at zero bias times current gain. Used with meter that measures 10 ma.—EBY Sales Co., 130 Lafayette St., New York 13, N. Y.

**TUBE TESTER, WT-110A. Pre-**



punched cards set up tester for tube desired. Tests for transconductance, interelectrode shorts, leakage and gas. 24 pounds.—RCA Components Div., Front and Cooper Sts., Camden, N. J.

**PORTABLE OSCILLATOR.** Utilator covers 4.5-220 mc in



6 bands. Frequency dial calibrated within 1%. Rf output, 0.7 volt rms. 11 x 6 1/2 x 8 1/2 inches. 19 pounds.—Kay Electric Co., 14 Maple Ave., Pine Brook, N. J.

**CERAMIC CAPACITORS.** Disc, tubular, insulated tubular and tubular with axial leads. Most common values.—Skottie Electronics, Inc., Peckville, Pa.

**COMPUTER CAPACITORS, type CQM.** Electrolytics. Her-



metically sealed in aluminum can. Available with cardboard cover or vinyl sleeve.—Pyramid Electric Co., 1445 Hudson Blvd., N. Bergen, N. J.

**PICTURE-TUBE BRIGHTENERS. Model BT-1,** for parallel-



filament sets. **BT-2,** autotransformer type for parallel and series sets. **BT-3** (illustrated) for both types of sets, also relieves cathode-filament shorts.—Raypar, Inc., 7800 W. Addison St., Chicago 34, Ill.

**SELENIUM RECTIFIER: 1263-A,** standard mounting;



**1262-B,** bracket mounting. Ratings for single-phase capacitive load: rms input, 130 volts, 175 ma; peak inverse voltage, 380; peak current 650 ma; output current, 65 ma.—Federal Telephone & Radio Co., 100 Kingsland Rd., Clifton, N. J.

**SILICON RECTIFIER. Unistac**

**Get This Valuable Book** *Just For Examining COYNE'S New Set*

**FREE** *"Applied Practical Radio-Television"*

**on 7 DAY FREE TRIAL!**

**150** Radio Television PICTURE PATTERNS and DIAGRAMS EXPLAINED

**NOW! 7 BIG BOOKS IN ONE GREAT SET!**

Yes, you get this big, brand new book, "150 Radio-Television Picture Patterns and Diagrams Explained", absolutely FREE! Just off the press. Gives complete 11 x 22" Schematic Diagrams on leading models Radio and TV Sets. Easy-to-read, large 8 1/2 x 11" pages, with full instructions on how to use the diagrams. A "must" in every repair kit. You get this book as a FREE Gift for asking to see Coyne's new 7-book set, "Applied Practical Radio-Television"!

**At Last! Money-Making "Know-How" on Transistors, Color TV and Servicing**

Coyne's great 7-volume set gives you all the answers to servicing problems—quickly! For basic "know-how" that's easy to understand you'll find everything you want in Volumes 1 to 5 on over 5000 practical facts and data. Every step from fundamentals to installing, servicing and trouble-shooting all types of radio and TV sets. So up-to-date it covers COLOR TV, UHF and the latest on TRANSISTORS. All this plus Volume 6—NEW Coyne TECHNICAL DICTIONARY with over 4000 definitions of the latest terms, symbols and abbreviations in radio-TV, electronics and electricity.

**EXTRA! 900-Page Television Cyclopedic Included**

And then, for speedy on-the-job use, you get volume 7—the famous Coyne TELEVISION CYCLOPEDIA. It answers today's television problems on servicing, alignment, installation, etc. In easy-to-find ABC order, cross-indexed. Use this 7-volume TV-RADIO LIBRARY FREE for 7 days; get the Servicing Book ABSOLUTELY FREE!

**SEND NO MONEY!** Just mail coupon for 7-volume set on 7 days free trial. We'll include book of 150 TV-Radio Patterns & Diagrams. If you keep the set, pay \$2 in 7 days and \$2 per month until \$24.50 plus postage is paid. (Cash price, only \$22.95). Or you can return the library at our expense in 7 days and owe nothing. YOU BE THE JUDGE. Either way, the book of TV-Radio Patterns is yours FREE to keep! Offer is limited. Act NOW!

**FREE BOOK—FREE TRIAL COUPON!**

Educational Book Publishing Division  
**COYNE ELECTRICAL SCHOOL, Dept. 87-T1**  
 500 S. Paulina St., Chicago 12, Ill.

YES! Send 7-Volume "Applied Practical Radio-Television" for 7 days FREE TRIAL per your offer. Include TV-Radio Patterns & Diagram Book FREE.

Name.....Age.....

Address.....

City.....Zone.....State.....

Where Employed.....

Check here if you want library sent C.O.D. You pay postman \$22.95 plus C.O.D. postage on delivery. 7-day money-back guarantee.

Educational Book Publishing Division

**COYNE** ELECTRICAL SCHOOL

500 S. Paulina St., Dept. 87-T1, Chicago 12, Ill.

# The VOLUME of BUSINESS on OUR "ONE DOLLAR" Buys

Now—brings you added DIVIDENDS  
DEDUCT 10% OFF THE TOTAL  
On ORDERS of \$10 or over.

In addition you will receive  
a FREE GIFT SURPRISE PACKAGE

- |   |  |
|---|--|
| <ul style="list-style-type: none"> <li>□ 15 ASSORTED ROTARY SWITCHES \$1<br/>\$15 worth.</li> <li>□ 100 ASSORTED 1/2 WATT RESIS-<br/>TORS, some 5%.</li> <li>□ 70 ASSORTED 1 WATT RESIS-<br/>TORS, some 5%.</li> <li>□ 35 ASSORTED 2 WATT RESIS-<br/>TORS, some 5%.</li> <li>□ 100 FUSES 1 AMP, standard size<br/>1 1/4" x 1/4".</li> <li>□ 100 TUBULAR CONDENSERS \$1<br/>0.02-100v.</li> <li>□ 100' FINEST NYLON DIAL CORD \$1<br/>best size.</li> <li>□ 200 SELF TAPPING SCREWS \$1<br/>#8 x 1/2".</li> <li>□ 50 ASSORTED TUBULAR CON-<br/>DENSERS for Radio &amp; TV work.</li> <li>□ 5 ELECTROLYTIC CONDENSERS \$1<br/>100/50 - 50/25v.</li> <li>□ 35 ASSORTED RADIO KNOBS \$1<br/>screw and push-on.</li> <li>□ 100 KNOB SPRINGS standard size<br/>3/8" x 1/2".</li> <li>□ 100 ASSORTED KNOB<br/>SET-SCREWS. \$1</li> <li>□ 25 ASSORTED CLOCK RADIO \$1<br/>KNOBS.</li> <li>□ 20 ASSORTED TV KNOBS, ES-<br/>CUTCHEONS, Etc. \$1</li> <li>□ 400 ASSORTED HARDWARE,<br/>screws, nuts, washers, rivets, etc. \$1</li> <li>□ 50 ASSORTED SOCKETS octal and<br/>miniature. \$1</li> <li>□ 50 ASSORTED MICA CONDENSERS \$1<br/>some in 5%.</li> <li>□ 50 ASSORTED CERAMIC CON-<br/>DENSERS. Some in 5%.</li> <li>□ 10 ASSORTED VOLUME CON-<br/>TROLS less switch. \$1</li> <li>□ 5 ASSORTED VOLUME CONTROLS \$1<br/>with switch.</li> <li>□ 20 ASSORTED PILOT LIGHTS \$1<br/>#14, 48, 47, 51.</li> <li>□ 10 PILOT LIGHT SOCKETS, bayo-<br/>net type, wired. \$1</li> <li>□ 50 ASSORTED TERMINAL STRIPS \$1<br/>1, 2, 3, 4 lug.</li> <li>□ 10 ASSORTED RADIO ELECTRO-<br/>LYTIC CONDENSERS. \$1</li> <li>□ 5 ASSORTED TV ELECTROLYTIC<br/>CONDENSERS. \$1</li> <li>□ 10 ASSORTED TV COILS sync.<br/>peaking, R.F., width, I.F., etc. \$1</li> <li>□ 5 TV CHEATER CORDS with both<br/>plugs. \$1</li> <li>□ 4 50' SPOOLS HOOK-UP WIRE \$1<br/>4 colors.</li> <li>□ 100' TWIN LEAD-IN WIRE 300<br/>ohm heavy duty. \$1</li> <li>□ 50' FLAT 4-CONDUCTOR WIRE. \$1<br/>many purposes.</li> <li>□ 1 57 INDOOR TV ANTENNA \$1<br/>hi-gain 3-section.</li> <li>□ 25 ASSORTED MICA TRIMMER<br/>CONDENSERS. \$1</li> <li>□ 50 TUBULAR CONDENSERS \$1<br/>1-200v.</li> <li>□ 50 TUBULAR CONDENSERS \$1<br/>0.02-400v.</li> <li>□ 50 TUBULAR CONDENSERS \$1<br/>0.01-600v.</li> <li>□ 50 TUBULAR CONDENSERS \$1<br/>0.01-100v.</li> <li>□ 20 TUBULAR CONDENSERS \$1<br/>.25-600v.</li> <li>□ 20 TUBULAR CONDENSERS \$1<br/>.047-600v.</li> <li>□ 3 ELECTROLYTIC CONDENSERS \$1<br/>50/30 - 150v.</li> <li>□ 3 ELECTROLYTIC CONDENSERS \$1<br/>40/10/10 - 450v.</li> <li>□ 5 RCA 6' LINE CORDS 550 ohm \$1<br/>with plugs.</li> <li>□ 10 6-FT. ELECTRIC LINE CORDS \$1<br/>with plugs.</li> <li>□ 15 TUBULAR CONDENSERS \$1<br/>.015-1800v.</li> </ul> | <ul style="list-style-type: none"> <li>□ 15 HV TUBULAR CONDENSERS \$1<br/>.006-1800v.</li> <li>□ 15 HV TUBULAR CONDENSERS \$1<br/>.003-2000v.</li> <li>□ 15 HV TUBULAR CONDENSERS \$1<br/>.005-3000v.</li> <li>□ 15 HV TUBULAR CONDENSERS \$1<br/>.001-6000v.</li> <li>□ 15 HV TUBULAR CONDENSERS \$1<br/>.005-8000v.</li> <li>□ 35 MICA CONDENSERS \$1<br/>20-30 mmf &amp; 15-100 mmf.</li> <li>□ 35 MICA CONDENSERS \$1<br/>20-3000 mmf &amp; 15-10K mmf.</li> <li>□ 35 CERAMIC CONDENSERS \$1<br/>20-1 mmf &amp; 13-47 mmf.</li> <li>□ 35 CERAMIC CONDENSERS \$1<br/>20-68 mmf &amp; 15-1500 mmf.</li> <li>□ 35 CERAMIC CONDENSERS \$1<br/>20-250 mmf &amp; 15-880 mmf.</li> <li>□ 50 100-OHM 1/2 WATT RESISTORS \$1<br/>5%. \$1</li> <li>□ 75 470K OHM 1/2 WATT RESIS-<br/>TORS 10%. \$1</li> <li>□ 50 3.3-OHM 1 WATT RESISTORS \$1<br/>10%. \$1</li> <li>□ 50 3900-OHM 1WATT RESISTORS \$1<br/>10%. \$1</li> <li>□ 50 15K OHM 1 WATT RESISTORS \$1<br/>10%. \$1</li> <li>□ 50 470K OHM 1WATT RESISTORS \$1<br/>10%. \$1</li> <li>□ 25 2.2-OHM 2 WATT RESISTORS \$1<br/>5%. \$1</li> <li>□ 25 3.3-OHM 2 WATT RESISTORS \$1<br/>5%. \$1</li> <li>□ 25 100K OHM 2 WATT RESIS-<br/>TORS 10%. \$1</li> <li>□ 10 ASSORTED WIREWOUND RE-<br/>SISTORS 5, 10, 20 watts. \$1</li> <li>□ 3 AUDIO OUTPUT TRANSFORM-<br/>ERS 50L6 type. \$1</li> <li>□ 3 AUDIO OUTPUT TRANSFORM-<br/>ERS 6N6 or 6V8 type. \$1</li> <li>□ 3 I.F. COIL TRANSFORMERS \$1<br/>436kc.</li> <li>□ 3 I.F. COIL TRANSFORMERS \$1<br/>10.7 mc FM.</li> <li>□ 4 OVAL LOOP ANTENNAS assorted<br/>hi-gain types. \$1</li> <li>□ 3 LOOPSTICK ANTENNA, new<br/>fernite, adjustable. \$1</li> <li>□ 12 RADIO OSCILLATOR COILS \$1<br/>456kc.</li> <li>□ 3 1/2-MEG VOLUME CONTROLS \$1<br/>with switch.</li> <li>□ 1 4" PM SPEAKER alnico #5 \$1<br/>magnet.</li> <li>□ 1 5" PM SPEAKER alnico #5 \$1<br/>magnet.</li> <li>□ 5 SETS SPEAKER PLUGS, wired. \$1</li> <li>□ 2 \$2.50 SAPPHIRE NEEDLES \$1<br/>4000 playings.</li> <li>□ 2 SELENIUM RECTIFIERS 1-65ma. \$1<br/>1-100ma.</li> <li>□ 5 DIODE CRYSTALS 2-IN21 \$1<br/>2-IN23 1-IN64.</li> <li>□ 1 TV VERTICAL OUTPUT TRANS-<br/>FORMER 10 to 1 ratio. \$1</li> <li>□ 5 TV CRT. SOCKETS with 18" \$1<br/>leads.</li> <li>□ 5 HI-VOLTAGE ANODE LEADS \$1<br/>with 18" leads.</li> <li>□ 1 TV SYNCHROGUIDE TRANS-<br/>FORMER #205R11. \$1</li> <li>□ 1 TV SYNCHROLOC TRANS-<br/>FORMER #208T8. \$1</li> <li>□ 1 TV RATIO DETECTOR TRANS-<br/>FORMER 4.5mc. \$1</li> <li>□ 1 SET TV KNOBS standard type<br/>including decals. \$1</li> <li>□ 1 POUND SPOOL ROSIN CORE \$1<br/>SOLDER 40/60.</li> <li>□ 6 SPIN TIGHT SOCKET SET 3/16" \$1<br/>to 7/16".</li> <li>□ 3 TV ALIGNMENT TOOLS 7", 12", \$1<br/>18".</li> </ul> |
|---|--|

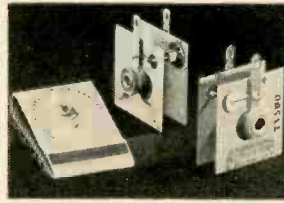
HANDY WAY TO ORDER—Simply tear out advertisement and pencil mark items wanted, enclose with money order or check. You will receive a new copy of this ad for re-orders.

ON SMALL ORDERS—Include stamps for postage, excess will be refunded. Larger orders shipped express collect.

**BROOKS RADIO & TV CORP.**  
84 Vesey St., Dept. A, New York 7, N.Y.

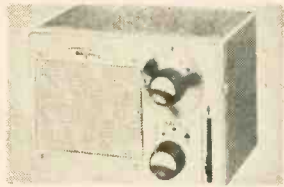
## NEW DEVICES

TV 500. Replaces existing selen-  
ium stacks up to 500 ma. Uses  
silicon diode mounted on heat-  
dissipating fin. Half-wave circuit  
delivers 130 volts dc at 500



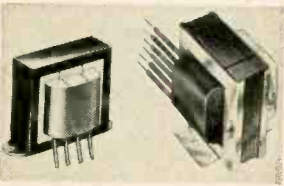
ma. Two units in a half-wave,  
voltage-doubler circuit deliver  
240 volts dc at 500 ma. 117-volt  
ac input.—International Recti-  
fier Corp., 1521 E. Grand Ave.,  
El Segundo, Calif.

CONELRAD MONITOR, CD-2.  
Transistorized. Battery-powered.  
When monitored station goes off



air, audio tone sounded by unit.  
—Regency, Division of I.D.E.A.,  
Inc., 7900 Pendleton Pike, Indian-  
apolis 26, Ind.

VIBRATOR TRANSFORMERS,  
replacement units. Stancor  
P-6493 (right) replaces Motor-  
ola 25C535794. P-6495 for  
Motorola 25K535795. P6465  
(left) small filament trans-



former for low current applica-  
tions. Rated, 6.3 volts at 0.6  
amps. — Chicago Standard  
Transformer Corp., 3501 W. Ad-  
dison St., Chicago 18, Ill.

TRANSFORMERS. 18 new  
items. 14 miniature transistor



transformers (1 illustrated),  
and four filament transformers  
for the amateur.—Triad Trans-  
former Corp., 4055 Redwood  
Ave., Venice, Calif.

FIN-COOLED TRANSFORMER  
for TV receivers. Multiple-fin  
construction increases heat dis-  
sipation. Permits reduction in  
transformer weight. — Zenith



Radio Corp., 6001 W. Dickens  
Ave., Chicago 39, Ill.

(Continued)

IF TRANSFORMERS. Pre-  
packed units. No assembly-line  
adjustment. For all radios  
using printed-circuit wiring



panels. — General Instrument  
Corp., Automatic Mfg. Div., 65  
Gouverneur Ct., Newark 4, N. J.

REPLACEMENT TRANS-  
FORMER, HVO-85. Direct re-  
placement for Emerson parts  
738091, 738096, 738099 and  
738100.—Merit Coil & Trans-  
former Corp., 4427 N. Clark St.,  
Chicago 40, Ill.



PORTABLE PHONOGRAPH-  
RADIO, Rockland Rambler. Four  
flashlight battery-powered set.



Plays 6,000 records or 750  
hours radio without battery  
change. 8 1/2 x 11 inches. 6  
pounds. — Rockland Precision  
Manufacturing Co., Inc., Orange-  
burg, N. Y.

VIBRATOR SUPPLY KITS,  
model VP-1-6, 6-volt input and  
VP-1-12 12-volt input. Supply  
B-plus for communication re-  
ceivers, public address systems.  
Output 260 volts dc at 60 ma.—  
Heath Co., 305 Territorial Road,  
Benton Harbor, Mich.

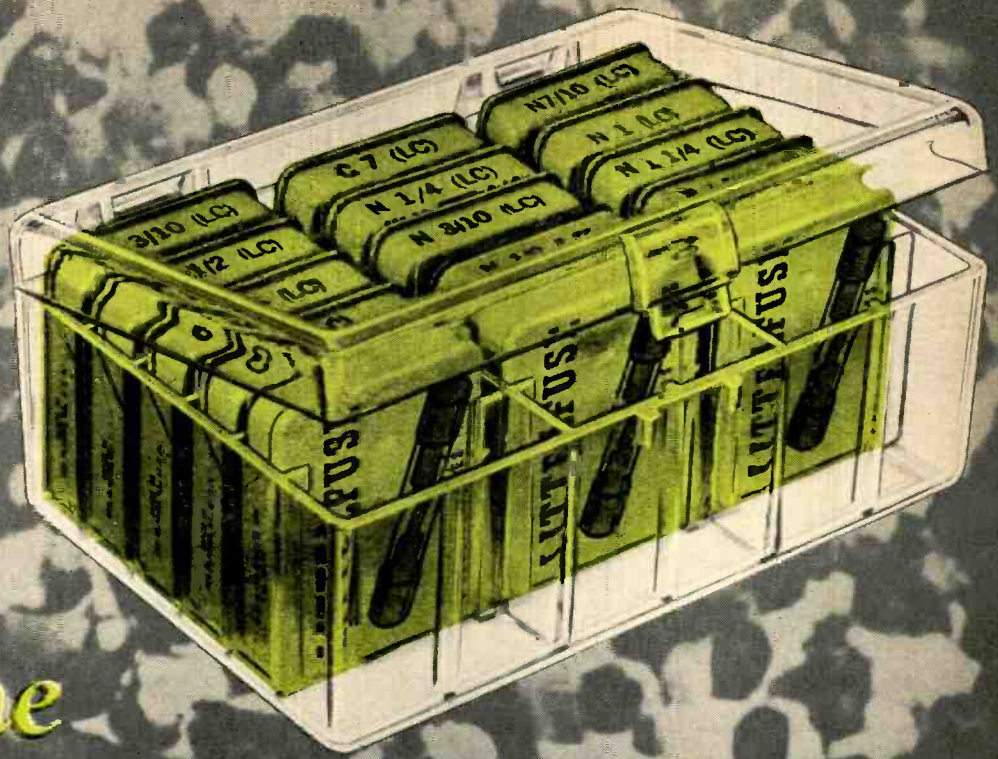
SPEAKER SYSTEM, model  
165B.K. Contains 8-inch dual-  
cone speaker with built-in



crossover network. High-fre-  
quency response up to 16,000  
cycles. Cabinet 40 x 21 x 9 1/2  
inches, 27 1/2 pounds. 10 watts.  
—Reeves Equipment Corp., 10  
E. 52 St., New York, N. Y.

CRIMPING, CUTTING TOOL,  
Crimcut. 8-inches long, chrome  
plated, insulated handles.  
Crimps, cuts and strips wires,  
cuts bolts.—Vaco Products Co.,  
317 E. Ontario St., Chicago 11,  
Ill.

CONSTANT OUTPUT AMPLI-  
FIER. Has avc. Maintains con-  
stant output ±1 db with input  
changes of 30 db. Frequency re-  
sponse, 20-20,000 cycles ±1 db.  
Signal gain, 35-38 db. Self-  
contained power supply. 19 x 7  
x 8 1/2 inches.—Amplifier Corp.  
of America, 398 Broadway, New  
York 13, N. Y. END



*Everyone  
Looks First to*

**LITTELFUSE**

*Whenever there is  
a new fuse need  
for service...*

It is *always* Litte fuse that gives you the complete package for your requirements.

Now—the LC fuse caddy for your tube caddy—an assortment of 15 LC fuse types to cover over 94% of all service requirements for this new fuse which is rapidly becoming *the* TV fuse

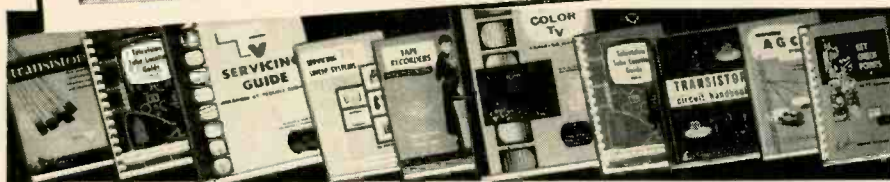
**NEW**

# SAMS "BEST SELLERS"

## "ELECTRONICS REFERENCE DATA"



This valuable reference compilation covers a wide range of interesting subjects. Includes sections on design, theory and application of a variety of TV circuits; various electronic oscillator circuits; waveforms and wave shaping; audio frequency distortion measurements; meters and measurements; specialized equipment such as transistors, Geiger counters, photoelectric cells, printed circuits, SSB, etc.; includes characteristics and proper applications of various electronic components. An interesting and profitable reference book for electronic technicians, engineers, Hams, students and experimenters. 128 pages; 8 1/2 x 11"; illustrated. **\$2.00** Only



### Are These Among Your Reference Books?

**Transistors and Their Application in Television—Radio—Electronics.** The first practical book about transistors for servicemen, engineers, amateurs and experimenters. Easy-to-understand explanation of transistor theory, properties, circuitry, installation, testing techniques and servicing. 100 pages; 5 1/2 x 8 1/2"; illustrated. **\$1.50**

**TV Servicing Guide.** Explains how to apply proper trouble-shooting procedures based on analysis of symptoms (most of which are illustrated by picture-tube screen photos). Shows how to locate and eliminate trouble in every section of the TV receiver circuit. 132 pages; 8 1/2 x 11"; illustrated. **\$2.00**

**Servicing TV Sweep Systems.** Describes the operation, circuit function and circuit variations of vertical and horizontal sweep systems common to most TV receivers. Tells how to analyze circuits; trouble-shoots for you. Explanatory photographs, waveforms, service hints and components description. 212 pages; 5 1/2 x 8 1/2"; illustrated. **\$2.75**

**Tape Recorders—How They Work.** Explains recording theory, tape characteristics, motorboard mechanisms, drive motors, amplifiers, magnetic heads, volume indicators, equalization circuits—covers everything you want to know about recorders and how to get best results from them. 176 pages; 5 1/2 x 8 1/2"; illustrated. **\$2.75**

**TV Tube Location Guides.** Shows tube positions and functions in hundreds of TV receiver models; helps locate faulty tube quickly; cuts trouble diagnosis and replacement time.

Vol. 6. Covers receivers produced in 1955-1956. 236 pages; 5 1/2 x 8 1/2". **\$2.00**

Vol. 5. Covers receivers produced in 1953-1954. 200 pages; 5 1/2 x 8 1/2". **\$2.00**

**Color TV Training Manual.** Prepares the service technician for Color TV work. Covers principles of the Color TV system; Color receiver circuits; installation and servicing of receivers. Includes color blocks outlining use of color test equipment. 260 pages; 8 1/2 x 11"; 300 illustrations. **\$6.95**

**Transistor Circuit Handbook.** This authoritative book completely covers transistor types, construction, characteristics, wiring and testing techniques, basic circuits, circuit applications; includes reference charts, definitions; formulas. 430 pages; 6 x 9"; illustrated. **\$4.95**

**Servicing AGC Systems.** Describes the operation and circuit variations of the different types of AGC systems and explains the servicing techniques that can be applied. Illustrated by actual case histories and photos of symptoms. 132 pages; 5 1/2 x 8 1/2"; illustrated. **\$1.75**

**Key Checkpoints in TV Receivers.** Time-saving information on how to make quick tests at key points in TV receiver circuits to determine the section in which the trouble lies and how to check overall performance of the receiver to insure against callbacks.

Vol. 2. Covers receivers produced in late 1952 and 1953. 184 pages; 5 1/2 x 8 1/2". **\$2.00**

Vol. 1. Covers receivers produced in late 1951 and 1952. 182 pages; 5 1/2 x 8 1/2". **\$2.00**

### 95 OTHER SAMS BOOKS KEEP YOU AHEAD IN ELECTRONICS

There is an authoritative Sams book on virtually any electronic subject in which you're interested. Check below for **FREE** Book List describing all Sams books.

#### USE THIS HANDY ORDER FORM

- Electronics Reference Data..... **\$2.00**
- Transistors and Their Application. **\$1.50**
- Color TV Training Manual..... **\$6.95**
- TV Servicing Guide..... **\$2.00**
- Transistor Circuit Handbook..... **\$4.95**
- Servicing TV Sweep Systems..... **\$2.75**
- Servicing AGC Systems..... **\$1.75**
- Tape Recorders..... **\$2.75**
- Key Checkpoints in TV Sets. Vol. 1. **\$2.00**
- TV Tube Location Guide. Vol. 6..... **\$2.00**
- Key Checkpoints in TV Sets. Vol. 2. **\$2.00**
- TV Tube Location Guide. Vol. 5..... **\$2.00**

Send **FREE** Book List

### HOWARD W. SAMS & CO., INC.

Order from your Parts Jobber today, or mail to Howard W. Sams & Co., Inc., Dept. 2-H7 2201 East 46th St., Indianapolis 5, Indiana.

Send books checked above. My (check) (money order) for \$..... is enclosed.

Name \_\_\_\_\_

Address \_\_\_\_\_

City \_\_\_\_\_ Zone \_\_\_\_\_ State \_\_\_\_\_  
(outside U.S.A. priced slightly higher)

Look for **SAMS BOOKS** on the "Book Tree" at your Parts Distributor



**OVER 1,000,000 SAMS BOOKS SOLD TO DATE**

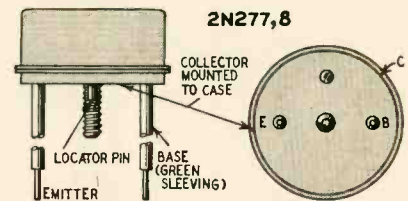
## New Tubes & Semi-conductors



This month brings us power transistors, a series-string picture tube, 12-volt auto radio tubes, a uhf television oscillator and a temperature-limited diode.

### 2N277, 2N278

These two transistors, made by Delco Radio, are alloy-junction p-n-p power units designed for general use with a 12-volt power supply. They are characterized by high output power, high gain and low distortion. The transistors are cooled by conduction and should be connected to a heat sink, an aluminum chassis for example.

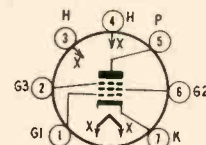


Maximum ratings are:

	2N277	2N278
V <sub>CB</sub>	40	50
V <sub>BE</sub> reverse	40	20
I <sub>O</sub> (amps)	12	12
Collector dissipation with 30°C mounting-base temperature (watts)	55	55
Junction and storage temperature (°C)	95	95

### 12CX6

A seven-pin miniature, sharp-cutoff pentode intended for use as an rf amplifier has been announced by Sylvania. It has a 12-volt 150-ma heater, and is intended for use where heater, plate and screen voltages are supplied directly from a storage battery.



### 12CX6

Typical operating characteristics are:

V <sub>p</sub>	12
V <sub>G2</sub>	12
R <sub>G1</sub> (megohms)	2.2
I <sub>p</sub> (ma)	3
I <sub>G2</sub> (ma)	1.4
g <sub>m</sub> (μmhos)	3,100
R <sub>p</sub>	40,000
V <sub>G1</sub> for I <sub>b</sub> = 10 μa	- 4.5

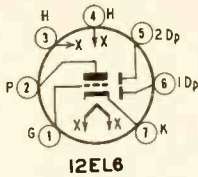
### 12EL6

A seven-pin miniature, double-diode, high-mu triode intended for use as a second detector and audio amplifier,



NEW TUBES & SEMICONDUCTORS (Contd.)

designed for operation where heater and plate voltages are supplied directly from a 12-volt automotive storage battery. This is also a Sylvania tube.



Characteristics and typical operation as a class-A<sub>1</sub> amplifier are:

Heater voltage	12
Heater current (ma)	150
V <sub>p</sub>	12
V <sub>g</sub>	0
I <sub>p</sub> (μa)	750
g <sub>m</sub> (μmhos)	1,200
μ	55
P <sub>o</sub>	45,000
Average diode current with 10 volts applied to each diode (ma)	2

2N148, 149, 150  
2N148A, 149A, 150A

Germanium n-p-n grown-junction transistors designed to provide high gain in 262-kc common emitter if amplifier applications. Announced by Texas Instruments, the closely controlled characteristics of these units assure interchangeability in properly designed circuits.



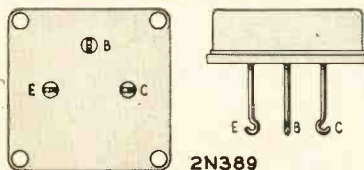
2N148, 2N149, 2N150, 2N148A, 2N149A & 2N150A

Maximum ratings are:

	2N148, 49	48A, 49A,
	50	50A
V <sub>CE</sub>	16	32
I <sub>C</sub> (ma)	5	5
Collector dissipation at 25°C (mw)	65	65
Operating temperature °C	75	75

2N389

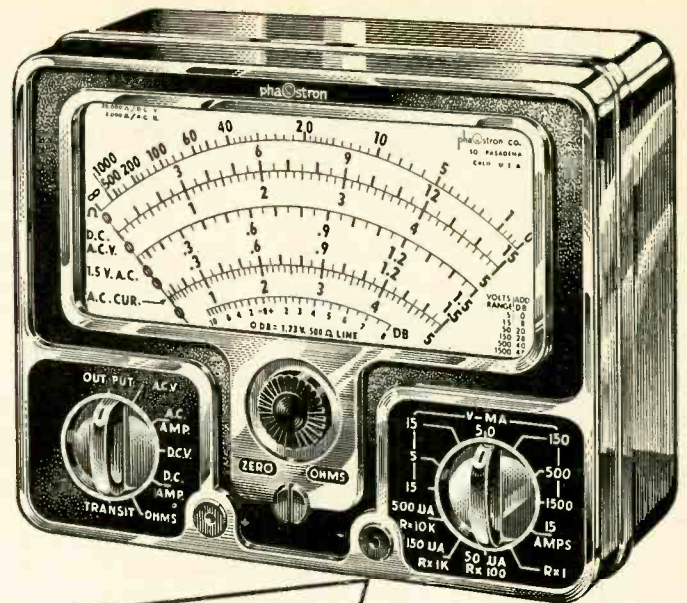
An n-p-n diffused-junction silicon power transistor designed for applications where high power output at high temperatures is required. A typical matched pair (operating at a mounting base temperature of 100°C in a class-B push-pull circuit) will deliver 15 watts of audio-frequency power with less than 10% distortion. Four mounting holes in the base provide a method of mounting the unit with a good thermal contact to an external heat sink. The unit is made by Texas Instruments.



2N389

Maximum ratings are:

V <sub>CE</sub>	60
V <sub>BE</sub> reverse	-2
I <sub>C</sub> (amps)	2
I <sub>B</sub> (amps)	0.5



# 555A VOM

## YOU NEED THESE FEATURES:

Meter Movement Protection up to 500 times overload is provided by a rectifier network.

The 555A Measures: AC Current, DC Current, AC Voltage, DC Voltage, Output, Resistance

43 Unduplicated Ranges

Separate Range and Function Switches

Double Magnetic Shielding

3% DC, 4% AC Permanent Accuracy

Easy to Read, Four Color Scales 4 7/8" long

Metal Case with Die Cast Bezel 6 1/8" x 4 5/8" x 2 1/8"

Sensitivity: 20,000 Ohms/Volt DC, 2000 Ohms/Volt AC

**NEW LOW PRICE**

Not \$49.50, but priced lower than ever before. Complete with probes and batteries. (Replaces former model 555)

**NOW ONLY**

**\$44<sup>95</sup>**

**PHAOSTRON INSTRUMENT AND ELECTRONIC COMPANY**

151 Pasadena Avenue, South Pasadena, California

# BUILD THE BEST— BUILD ALLIED'S OWN knight-kits

Here is a typical Knight-Kit value—available only from ALLIED—one of 45 great Knight-Kits you'll find in our special Supplement No. 165. Write for your FREE copy today.



Luxury quality at modest cost! Williamson-type circuit delivers 25 watts of virtually flawless response. Can be used with any tuner or preamp with a full set of controls (for volume, tone and equalization). Printed circuit wiring board for simplified assembly; balance control for precise matching of output tubes; variable damping control. Response:  $\pm 0.5$  db, 10-120,000 cps at 20 watts. Harmonic Distortion: 0.15% at 30 watts. Intermodulation: 0.4% at 20 watts. Output Impedances: 4, 8 and 16 ohms.  $6\frac{1}{2}$  x 14 x 9" deep. Chrome-plated chassis. With all parts, tubes and easy-to-follow instructions. Shpg. wt., 25 lbs.

Model Y-755. Net, F.O.B. Chicago . . . . \$44.50  
Y-759. Metal top cover for above . . . . \$4.25

## OTHER knight-kit HI-FI VALUES



FM HI-FI TUNER KIT  
Model Y-751  
\$37.50



10-WATT HI-FI  
AMPLIFIER KIT  
Y-753 \$23.50



20-WATT HI-FI  
AMPLIFIER KIT  
Y-750 \$35.75

See our Supplement No. 165 for other knight-kit Hi-Fi values

## free SUPPLEMENT featuring knight-kits



Send for our FREE Supplement No. 165 featuring 45 great Knight-Kits, including Test Instruments, Hi-Fi, Hobbyist and Amateur Kits. Write for your copy today.

ORDER FROM  
**ALLIED RADIO**

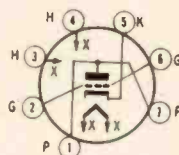
Dpt. O2-H-7, 100 N. Western Ave., Chicago 80, Ill.

## NEW TUBES & SEMICONDUCTORS

Dissipation at 25°C (watts) 37.5  
Dissipation at 100°C (watts) 15

### 3AF4-A

A medium-mu triode of the seven-pin miniature type designed for use as a local oscillator in uhf television receivers covering 470 to 890 mc. Produced by RCA, it has good frequency stability, low interelectrode capacitances, low lead inductance and low rf lead resistance. It has a 3.2-volt 450-ma heater with a controlled warmup time of 11 seconds and is intended for series-string use.



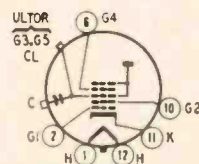
3AF4-A

Characteristics for typical operation as an oscillator at 950 mc are:

$V_p$	100
$V_c$	-4
from $R_c$	10,000
$I_p$ (ma)	22
$I_c$ ( $\mu$ a)	400
Power output (mw)	160

### 14ATP4

This 90° picture tube is designed with a 450-ma 8.4-volt heater with a controlled warmup time for series-string operation. The rectangular glass tube weighs 8½ pounds and has an overall length of 13-3/16 inches. Straight gun design minimizes deflection distortion and eliminates the ion-trap magnet. The 14ATP4 is a low-voltage electrostatic-focus, magnetic-deflection type. It has a Filterglass faceplate and an aluminumized screen.



C-EXTERNAL CONDUCTIVE COATING  
CL-COLLECTOR

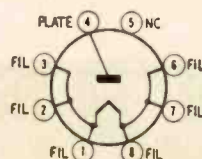
14ATP4

Maximum ratings in grid-drive service are:

Ultor voltage	14,000
$V_{g1}$ (positive value)	1,000
(negative value)	500
$V_{g2}$	500
$V_{k1}$ (negative peak)	200
(negative bias)	140
(positive bias)	0
(positive peak)	2
Peak heater-to-cathode voltage	180

### 1236C

A temperature-limited diode intro-



1236C

(Continued)

duced by the Superior Electric Co. It is designed for service as a rms detector for differential voltmeters; as a rms detector for ac voltage, current stabilizers and similar applications. It has a loctal eight-pin base. Its average operating characteristics are a cathode voltage of 1.9 ac or dc at 400 ma and a plate voltage of 600 dc at 0.7 ma.

### Other types

Amperex Electric has announced a 6939 twin-tetrode designed for vhf transmitter applications. This miniature nine-pin tube delivers 5.5 watts useful power at any frequency up to 500 mc.

A series of seven subminiature tubes for guided-missile application has been released by Sylvania. They are the 6788, 6943, 6944, 6945, 6947, 6948 and 6946.

An infra-red-sensitive multiplier phototube has been developed by RCA. It is the C-7190, a 10-stage head-on type of phototube. Also on the RCA list is a 6198-A Vidicon, a small camera tube intended primarily for industrial television purposes. END

## CORRECTIONS

We regret that a photograph was inadvertently omitted from the item "Phasing Earphones" on page 40 of the June issue. Fortunately, the photo was not essential for complete understanding of the technique being discussed.

We thank Victor Peters, of New York, for calling our attention to the omission.

Our May, 1957, "New Records" listed *Hi-Fi Holiday for Organ*, Music of David Rose, Richard Ellsasser, Organist, as MGM E-490 when it should have been MGM E-3490.

We thank Mr. Loomis of Woodhaven, N. Y., for this information.

## Thirty-Five Years Ago

In Gernsback Publications

### HUGO GERNSBACK, Founder

Modern Electrics	1908
Wireless Association of America	1908
Electrical Experimenter	1913
Radio News	1919
Science & Invention	1920
Television	1927
Radio-Craft	1929
Short-Wave Craft	1930
Television News	1931

Some larger libraries still have copies of ELECTRICAL EXPERIMENTER on file for interested readers.

### In August, 1923, *Science and Invention* (formerly *Electrical Experimenter*)

The Electric Duel, by H. Gernsback.  
Radio Broadcasting Problems, by C. W. Horn (Superintendent, Radio Operations; Westinghouse Electric & Manufacturing Co.).

My First Radio Set, by Dorothy Benkeser.

Vacation Time Radio, by A. P. Peck.

Radio for the Beginner, No. 18, by Armstrong Perry.

Microphone Amplifier, by Bert T. Bonaventure.

Practical Notes on Reflex Amplifier Construction, by Robert E. Lacault.

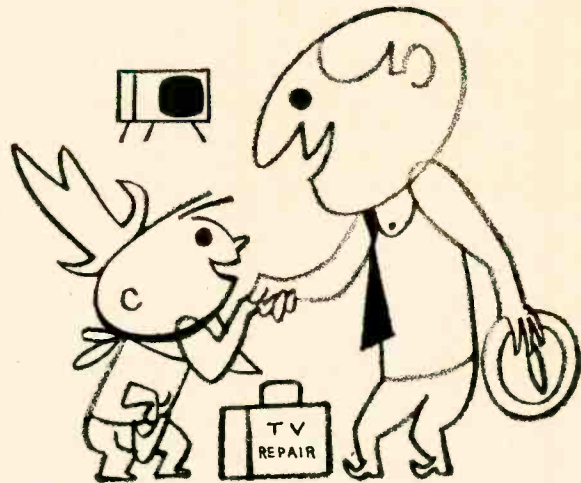
Selective Radio Calling, by Frederick V. Hunt.

700-Foot Radio Tower Balanced on a Point.

## Reputation Builder #3: it pays to be neat

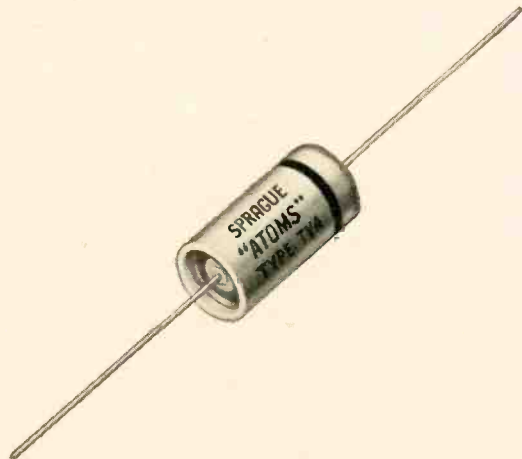


- Treat a set-owner's home like a dog house and you're likely soon to be living in one



- BUT . . . treat his possessions as you would your own, and you'll always be an honored guest

## it pays to replace with Sprague Atom<sup>®</sup> Miniature 'Lytics



don't be vague...insist on

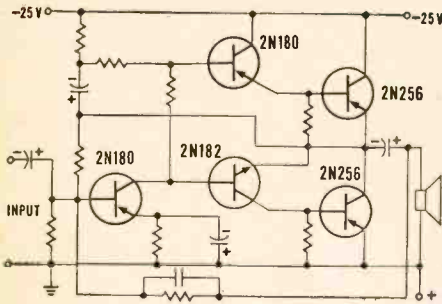
- Another way to build and hold a reputation is to insist on top quality replacement parts. Callbacks due to replacement failures not only cost you *money* . . . they also cost you customers! Replace with less than the best and you place your reputation at stake. In capacitors, the best is *Sprague*.
- Take Atom Tubular Electrolytics, for example. The smallest TV 'lytics made, they're the only small ones for 85°C (185°F) up to 450 VDC. Guaranteed for low leakage and long shelf life, they withstand high temperatures, high ripple currents, high surge voltages. From crowded TV chassis to jam-packed portables, Sprague Atoms fit them all.
- Get your copy of Sprague's latest radio and TV service catalog, C-455. Write Sprague Products Co., Distributors' Division of Sprague Electric Company, 81 Marshall Street, North Adams, Mass.

# SPRAGUE<sup>®</sup>

*world's largest capacitor manufacturer*

SPRAGUE RESEARCH IS CONSTANTLY PRODUCING NEW AND BETTER CAPACITORS FOR YOU

# Transistorized 6-Watt Hi-Fi



New experimental all-transistor hi-fi amplifier delivers 6 watts with:  $\pm 1.5$  db response from 30-15,000 cps, less than 1% harmonic and 2.5% intermodulation distortion, noise level 74 db down. Simple circuit features: pre-driver, driver, and final amplifier using low-cost CBS 2N256 power transistors . . . negative feedback . . . complementary-symmetry driver . . . direct coupling . . . economical power supply.

CBS alloy-junction germanium power transistors 2N255 (6-volt) and 2N256 (12-volt) are useful also in many other economical amplifiers . . . fixed or mobile . . . with up to 10 watts output Class B push-pull. Second Edition of CBS Power Transistor Applications, Bulletin PA-16, helps put them to work. Free, it gives complete data and circuits. Pick it up with your 2N255 and 2N256 transistors at your CBS Tube distributor's — today.



2N255 . . . \$2.60 net

2N256 . . . \$3.00 net

## CBS-HYTRON

Semiconductor Operations, Lowell, Mass.  
A Division of  
Columbia Broadcasting System, Inc.



Note: Records below are 12-inch LP and play back with RIAA curve unless otherwise indicated.

### Spotlight on Strings

**Vox DL-320**  
Vox's Spotlight Series is becoming a definite and almost monumental contribution to the study of music—and sound. This is the fourth unit, and a fifth (on woodwinds) is on the way. This covers the string family from the primitive bow and gourd to the Stradivari, Guarneri and today's Haenel. Indeed, you can hear the difference between a Haenel, a Guarnerius, an Amati and a Strad; decide for yourself whether the viols were unwarrantedly replaced by the violins and even whether you like Bach played with the old curved or the modern straight bow. In many ways, this is the most interesting of the series and is recorded with such close-up realism that the resin is plainly audible.

**STRAVINSKY: Rites of Spring**  
Monteux conducting Paris Conservatoire Orchestra

**RCA-Victor LM-2085**  
Except for one flaw which, however, also has a virtue, this is as perfect a record as this year is likely to bring. This is the most authoritative (by the composer's own estimate) recorded version of this landmark in the history of music. Both the performance and the recording must be called great. At even a moderate volume level, it is capable on a first-class system of giving a close approximation of the full awesomeness of this music and with a definition which almost succeeds in the almost impossible task of giving all the detail of its complexity. It is the most spectacular RCA-Victor release I can remember since Toscanini's *Pictures at an Exhibition* and excels even that. As for the flaw, I suspect that the bass rolloff is not on the RIAA slope but rather on the AES or European. Played back with RIAA equalization the recorder hum is audible but the bass is terrific. The drum should satisfy even the most frustrated appetite for big drums. Certainly, it will rattle the china and windows and might even rupture a woofer. The flaw is easily correctable either by using AES bass equalization or reducing the bass tone or loudness control.

**ROSSINI-RESPIGHI: La Boutique Fantasque**

**IBERT: Divertissement**  
**PISTON: The Incredible Flutist**  
Fiedler Conducting Boston Pops  
**RCA-Victor LM-2084**

Three of the most engaging, delightful and amusing works of this century—one Italian, one French and one American—played with the proper lightheartedness, humor and very well recorded.

Plenty of high highs and a big string bass—especially in *Nocturne Divertissement*: from the very good drums and very big in the finale of the same and in *The Incredible Flutist*. Highly and equally recommended for demonstration, show off, test and, especially, for enjoyable listening.

**Concert Hall Society Sample**

**Concert Hall CHS-SP-56 (\$1.98)**  
Concert Hall was one of the first record-of-

the-month type clubs and now is marketing its new releases through normal trade channels. This sampler is not only a bargain in itself but an excellent introduction to their catalog. All the samples are complete versions of the works: Bach's *Tocatta in F*, Stravinsky's *Firebird Suite*, Vivaldi's *Concerto for Two Trumpets and Orchestra*, Mozart's *Symphony 32* and Franck's *Symphonic Variation*. This provides a nicely balanced program both of music and demonstration material. The *Tocatta* has an excellent pedal, the *Firebird* fine string bass and big drums and a spectacular *Infernal Dance*; the *Vivaldi Concerto* is delightful in its handling of the trumpets. The long program fills the record almost to the label so there is a little distortion in the peaks on the innermost grooves but otherwise it is clean with a fine sound.

**BRITTEN: Matinées Musicales**  
*Soirées Musicales*  
Boult conducting Philharmonic Promenade Orchestra

**Westminster W Lab-7055**  
These very pleasant works are based on the little tunes Rossini left in his notebooks, others of which were arranged by Respighi into the *Boutique Fantasque*. A top-notch example of modern recording technique at its best and very fine demonstration and showoff material. The high highs are outstandingly beautiful in their clarity and sharpness, particularly the glockenspiel, triangles and celeste; the snares, castanets and tambourine are extremely sharp; very fine, very dull bass drums.

**A Bach Recital for the Guitar**  
Julian Bream

**Westminster XWN-18428**  
**Julian Bream Plays Dowling**  
**Westminster XWN-18429**

Though only 24 years old, Bream on the evidence of these recordings must be ranked with the great virtuosi of the guitar as well as its famous precursor, the lute. It seems incredible that one person on one guitar could play Bach's polyphonic music at all, let alone with such complete mastery and faithfulness to the music. In Bream's hands, the guitar becomes a portable harpsichord. The lute recording presents a number of selections of the compositions of Dowling, one of the great masters of that instrument who was lutenist to Queen Elizabeth I and judged the "rarest musician that his age did behold." These are very intimate recordings with high presence and reveal every detail of the playing.

**PISTON: Symphony No. 6**  
**MARTINU: Fantaisies Symphonique**  
Munch Conducting Boston Symphony  
**RCA-Victor LM-2083**

Both of these works were composed for the 75th anniversary of the Boston Symphony. They are far easier to take than most contemporary full-scale symphonies and make keeping up to date not only reasonably painless but interesting. In fact, it would not take many playings of the Martinu especially—to become fond of it. The Piston has some excellent percussion and the Martinu some good string bass as well as some sharp drums in spots. The recording is

## OPPORTUNITY ADLETS

Rates—50¢ per word (including name, address and initials). Minimum ad 10 words. Cash must accompany all ads except those placed by accredited agencies. Discount, 10% for 12 consecutive issues. Misleading or objectionable ads not accepted. Copy for October issue must reach us before August 15, 1957.  
**RADIO-ELECTRONICS,**  
 154 West 14 St., New York 11, N. Y.

HIGH-FIDELITY SPEAKERS REPAIRED. AMPRITE Speaker Service, 70 Vesey St., New York 7, N.Y. BA 7-2580.

CASH PAID! Sell your surplus electronic tubes. Want unused, clean transmitting, special purpose, receiving, TV types, magnetrons, klystrons, broadcast, etc. Also want military & commercial lab test and communications gear. We swap too, for tubes or choice equipment. Send specific details in first letter. For a fair deal write, wire or telephone: BARRY, 512 Broadway, New York 12, N.Y. Walker 5-7000.

SURPLUS ELECTRONICS parts, equipment, etc., approximately 100 pounds, \$9.95 F.O.B. Dayton. Part assortments, \$5 and \$5 kits. #5P2 cathode ray tube \$7.50. Jumbo 4-pin transmitting tube sockets 4 for \$1 postpaid. Remittance with order. ALPINE PRODUCTS, Dept. 8A, 2236 Hephurn, Dayton 6, Ohio.

INSTALL and REPAIR TV Antennas; new book, only 50¢; simple instructions, illustrated. AMERICAN ELECTRONICS, 1203 F Bryant Ave., New York 59, N. Y.

TRANSISTOR wrist radio and shocker schematics both only 50¢. "H" Box 108, Piqua, Ohio.

POLICE RADAR Detector. Stop before those radar speed traps. Fool proof legal system. Complete diagrams and instructions. \$2.75. A. CARRIER CO., 734-15th St., N.W., Washington 5, D.C.

20-50% DISCOUNTS on Hi-Fi tape recorders, tape, accessories, photographic equipment, individual quotations only. No catalogs. COMMAR CAMERA & HI-FI, 121-07 237th Street, Rosedale 22-R, N. Y.

WANTED: Electronics men to qualify for Engineering Degree equivalence by comprehensive examination. No courses. Excellent employment opportunities waiting. CRAWWELL INSTITUTE, RE-7, Adams, Mass.

TELEPHONE Extension in your car. Answer your home telephone by radio from your car. Complete diagrams and instructions. \$1.25. A. CARRIER CO., 734-15th St., N.W., Washington 5, D.C.

DIAGRAMS FOR REPAIRING RADIOS \$1. Television \$2. Give make, Model. DIAGRAM SERVICE, Box 672-R, Hartford 1, Conn.

WANTED: SIGNAL GENERATORS TS-403, TS-497, TS-621, SG-3/U, TS-437, TS-510, TS-588, TS-608, etc.; TS-186 Frequency Meters, AN/APR-4 Tuning Units, other "APR" Receivers, ARC-3, other Surplus; also Hewlett-Packard and other laboratory quality equipment, Weston, etc. instruments; technical manuals; for quiet cash or swap for Zenith Transistor Portables, etc. LITTELL, Fairhills Box 26, Dayton 9, Ohio.

LOOKING FOR CLEAN RESPONSE to 20 Cycles? Listen to the radically new "Racon Hi-C" foam suspension speaker. Write for free literature. RACON ELECTRIC CO., INC., 1261 Broadway, N.Y. 1, N.Y.

ALL MAKES OF ELECTRICAL INSTRUMENTS AND TESTING equipment repaired. HAZELTON INSTRUMENT Co., 128 Liberty Street, New York, N.Y.

TELEVISION Tuner Repairs. DAN'S TELEVISION LABORATORY, 606 Sunrise Highway, Babylon, N.Y.

COMPLETE Television Sets \$11.95. JONES TV, 1115 Rambler, Pottstown, Pa.

WANTED to buy—model 80-R signal generator (measurements corp.). Write M-R ELECTRONIC ENGINEERING, INC., Hays, Kans.

RECORDERS, Hi-Fi. Tapes. Free Wholesale Catalogue. CARSTON, 215-T East 88th St., New York 28, N.Y.

PROFESSIONAL Electronic Projects—Organs, Timers, Intercams, Counters, etc. \$1 each. List Free. PARKS, Box 946 Redwood City, Calif.

LONG PLAYING RECORDS 20 to 50% Discount Brand-New Factory Fresh Unplayed—All Labels—Send 20¢ for catalogue to RECORD SALES, 1110 Winbern, Houston 4, Tex.

FLYBACK Transformers Rewound. Free information. TEE VEE COMPONENTS, Box 263, Akron, Indiana.

Patents, Copyrights. SANDERS, Registered Patent Attorney, 8420 Evans, Chicago 37, Ill.

DIAGRAMS: Repair Information! Radios—Amplifiers—recorders \$1. Televisions \$1.50. Give make, model, chassis. TV MULTIE, Box 101EA, Hicksville, N.Y.

AUGUST, 1957

## NEW RECORDS

(Continued)

for some reason deader than others of this orchestra, but partly on that account the definition is slightly better and the dry tone probably suits the music better.

**CARPENTER: Adventures in a Perambulator**  
 Swoboda conducting Vienna State Opera Orchestra

**Contemporary American Violin Music**  
 Luis Kaufmann, violin; Anette Kaufman, piano  
 (Concert Hall Society CHS-1140)

One of the few modern American works which has become a concert favorite. Amusing programmatic music which gives all sections of the orchestra and particularly the percussion a good opportunity to show off. The recording is excellent.

**BARTOK: Sonata for Two Pianos and Percussion Contrasts for Piano, Violin and Clarinet**  
 (Westminster XWN-18425)

Percussion with music brilliantly recorded. The remarkable effects are sharp and clear; the most delicate nuances are revealed clearly. Very fine percussion and high highs, including tympani, side drums, cymbals, bass drum, triangle and tam-tam. The *Contrasts* was commissioned by Benny Goodman and presents some more remarkable tonal combinations. Also very clean, very close up and high presence.

**VERDI-MACKERRAS: Lady and the Fool**  
 Mackerras conducting Philharmonic Orchestra  
 (RCA-Victor LM-2039)

A recent ballet based on music by an old master—this time from rarely performed operas of Verdi. Very fine recording of pleasant music yielding a spacious sound with excellent balance with plenty of high highs and a few spots of good bass.

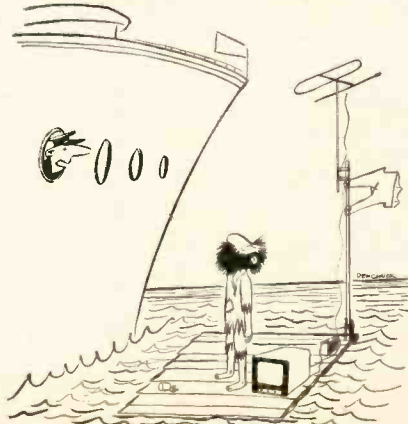
**ARNOLD: Homage to the Queen**  
 Irving conducting Philharmonic Orchestra  
 (RCA-Victor LM-2037)

Another recent ballet first performed on the night of the Coronation of Queen Elizabeth II, but not as tuneful as the above. Lots of fanfares and flourishes, snare drums, celeste and vibraphone.

**BRAHMS: Trio for Piano, Cello and Clarinet, Trio for Piano, Violin and Horn**  
 (Westminster XWN-18449)

Some more very unusual instrumental combinations with a very interesting interplay of tone. Extremely well played horn, resonant piano, rosy cello, very clean and pleasant clarinet. Recorded with a high degree of presence. END

Name and address of any manufacturer of records mentioned in this column may be obtained by writing Records, RADIO-ELECTRONICS, 154 West 14th St., New York 11, N.Y.



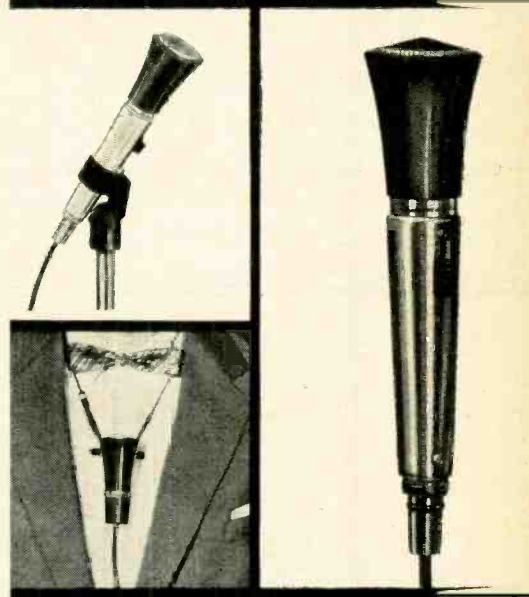
"Sorry, no 12AU7's"

# SHURE

presents the dramatic new

## Commando

a rugged controlled magnetic microphone that provides unusual versatility and excellent performance... for Public Address and Home Recording



This striking, streamlined unit gives you fine voice and music reproduction in a multiplicity of public address and home recording applications. Whether you use it indoors or out, in the hand or on a desk or floor stand, you'll be delighted by its fine response, high output and beauty of design. The Commando offers you such important features as dual impedance, on-off switch, and cable connector.

The Commando is sturdy and rugged. Of patented controlled magnetic construction, it is unaffected by extremes of temperature and humidity; and it can be depended on to maintain its high level of quality through tough, sustained usage, year after year.

The Commando is available in three models:

### DELUXE Model "430"

A dual-impedance unit with A25 swivel adapter, on-off switch, cable connector LIST PRICE \$38.50

### LAVALIER Model "420"

A dual-impedance unit with lavalier cord and clip assembly LIST PRICE \$30.00

### STANDARD Model "415"

A high impedance unit with A25 swivel adapter LIST PRICE \$27.50

# SHURE

The Mark of Quality

IN ELECTRONICS SINCE 1925  
 SHURE BROTHERS INC., 222 HARTREY AVE., EVANSTON, ILL.

# Technicians' News



## OVER-THE-COUNTER SALES

At a fact-finding meeting between Long Island distributors and service dealers, the Radio & Television Guild of Long Island, New York (RTGLI), expressed its concern over distributor sales direct to consumers. Particularly disturbed by sales direct to employees of that area's many defense plants, the guild is considering expansion and stronger enforcement of its distributor shopping report.

The shopping report is carried in the guild's trade paper *Guild News* and is sent to about 2,500 radio-TV technicians throughout Long Island.

In the past, distributors who were selling to defense plant employees were not reported. Murray Barlowe, a former president of the group, said that while the guild did not condemn the practice they did not condone it either.

Until recently this has not been a problem. But defense industries have grown and now employ about 200,000. This market is being lost to many retailers as a result of distributors who solicit trade from these workers.

When asked for the guild's definition of a cooperating distributor, Christopher Stratigos, guild president, defined him as "a jobber who makes a clear effort not to compete for the consumer trade of the individual retailer."

The executive committee of RTGLI took steps to initiate a program to assist distributors who are cooperating with the independent service dealer.

## IN THIS CORNER

Service technicians are gaining new backing from advertisements by P. R. Mallory & Co., in an important weekly magazine. The technician is right up front: his ability and knowledge are clearly brought to the reader's attention.

As an example here is one line from the ad: "Behind his ability to bring the picture back to your screen—and the smile to the children's faces—lies a wealth of specialized knowledge and information, representing a heavy investment in time, training and equipment."

## MINTSE'S ANNUAL MEETING

The Minnesota Television Service Engineers, Inc. (MINTSE) held its annual meeting at the University of Minnesota's Continuation Center. At the meeting MINTSE adopted these proposals:

To allow local service associations to

RADIO-ELECTRONICS

Just what  
the doctor ordered

for a "healthier"  
service  
reputation...

Check these "undoctored" facts yourself to learn why CRL MD (molded disc) ceramic capacitors outlast and outperform conventional "mud" discs—yet cost the same. You'll find that CRL molded discs give you:

1. *Three times* the voltage breakdown — 3000 V.D.C. breakdown to ground.
2. *Eight times* the lead strength—greater than the breaking strength of the No. 22 tinned-copper wire itself.
3. *Ten times* the humidity resistance — .005% or less moisture absorption by the molded casing.
4. *Many times* the resistance of ordinary discs to physical shock and vibration.

The results: more satisfied customers . . . more business for you . . . and a self-assurance that you gave the best.

Pick them up at your CRL distributor who handles these and thousands of other quality components described in Centralab Catalog 30, which is available on request.

# Centralab

© Centralab Trademark

A DIVISION OF GLOBE-UNION INC.  
922H EAST KEEFE AVENUE • MILWAUKEE 1, WISCONSIN  
IN CANADA: 804 MT. PLEASANT ROAD • TORONTO, ONTARIO



0-1750

be formed throughout the state if they use the same qualifications and name as the state group;

To accept subscription to the American Institute of Television Services and cooperate with them by exchanging information on a national basis;

To investigate the possibilities of state registration of engineers which is permissible under state law.

MINTSE also made plans to start a safety inspection program. This would be a service to the public as well as the service dealer.

Mr. John Hemak, association president, said: "Because of the possibility that the service shop is open to damage suits, we are initiating this safety program to avoid being responsible for defects which may not even have been caused by the shop."

**TEXAS ASSOCIATION FAIR**

The Texas Electronics Association (TEA) is holding its Fifth Annual Clinic & Fair in Fort Worth, Tex., at the Texas Hotel and Hall of Exhibits. The 3-day event will be held on Aug. 2, 3 and 4, 1957. Attendance in excess of 1,000 service technicians and dealers from Texas, Arkansas, Oklahoma, Louisiana and New Mexico is expected.

During the fair there will be lectures and demonstrations on topics such as: multiple antenna systems; deflection and sweep circuits; servicing tape recorders; how to protect your accounts legally; color circuitry and trouble, and formula for hi-fi profit. On the lighter side there will be a cocktail party, a tour of Fort Worth and a barbecue.

**ELECTRONICS FAIR**

The Radio & Television Guild of Long Island announced the dates for their second annual Electronics Fair. The trade show for the radio and television service industry will be held on Jan. 17, 18 and 19, 1958, at the Hempstead Armory in Hempstead, N. Y.

Christopher Stratigos, guild president, stated that the location and facilities of the armory will attract about 12,000 spectators and service technicians.

**NEWS FROM RETMA**

J. A. Hatchwell, chairman of the Radio-Electronics-Television Manufacturers Association's (RETMA) service committee, states that the RETMA Vocational Training Program, now in its fifth year of operation, has been adopted at an increasing rate by schools from coast to coast. "Conservative estimates indicate that more than 400 schools are either using the RETMA vocational aids in their entirety or are offering courses based upon one or more of the manuals," reported Mr. Hatchwell.

The first three manuals of the RETMA pre-employment training program were published this year. They are: *Basic Electricity*, *Basic Electronics* and *Basic Radio and Radio-Receiver Servicing*, prepared by the RETMA

**Colorful  
Comfortable**

**Get Kraeuter's  
All New "CG" Pliers**



**in red, blue,  
green, yellow  
& orange**



KRAEUTER has done it again. Now for the first time you can secure comfort and color along with KRAEUTER quality at no increase in cost.

Every KRAEUTER solid joint plier has a cushion grip of thick vinyl to make your tough jobs easy. All KRAEUTER "CG" cushion grips provide easy identification—easy to locate in your tool box—ideal for departmental color coding in your plant. All KRAEUTER "CG" cushion grip pliers assure you comfort and ease on the job.

Whether you use side cutters, diagonals, lineman's or one of the other quality pliers in KRAEUTER's long line, you will find "CG" cushion grips a standard feature at regular prices.

Ask your distributor for KRAEUTER "CG's" today and put ease in your work.

\*CG Cushion Gripped Pliers

**BUY THE FINEST**

**BUY KRAEUTER BUY AMERICAN**

AS MODERN AS TOMORROW

**kraeuter & co., inc**

FOR 100 YEARS THE FINEST IN HAND TOOLS 1860-1960 NEWARK, N. J.



# BUILD THE BEST— BUILD ALLIED'S OWN knight-kits

Here is a typical Knight-Kit value—available only from ALLIED—one of 45 great Knight-Kits you'll find in our special Supplement No. 165. Write for your FREE copy today.

## knight-kit INSTRUMENT VALUE 5" GENERAL-PURPOSE SCOPE KIT



Model  
Y-146  
\$49<sup>50</sup>

Feature for feature, the world's best scope kit value. Equal in performance to wired units several times its price. Ideal for radio and TV servicing, audio work and hundreds of other applications. Phantastron sweep circuit provides extreme sweep linearity; retrace blanking on all ranges eliminates retrace lines; vertical sensitivity is three times that of comparably priced scope kits. Printed circuit and laced wiring harness speed assembly. SPECIFICATIONS: Vertical Response— $\pm 3$  db, 3 cps to 1.5 mc.;  $\pm 6$  db to 2.5 mc. Vertical Sensitivity—.025 rms v/inch. Sweep—15 to 150,000 cps in 4 ranges. Horizontal Sensitivity—.07 rms v/inch. Vertical Input Imp.—3.3 meg shunted by 45 mmfd. Calibrating Voltage: 1 volt peak-to-peak, applied by push-button switch. Complete with 5" CRT, wire, solder, etc.  $9\frac{1}{4}$  x  $13\frac{3}{4}$  x  $17\frac{3}{4}$ ". Shpg. wt. 28 lbs. Model Y-146. Net, F.O.B. Chicago. . . . \$49<sup>50</sup>

## OTHER knight-kit INSTRUMENT VALUES



5" WIDE-BAND SCOPE KIT  
Y-144 \$69<sup>00</sup>



VOLTAGE CALIBRATOR KIT  
Y-136 \$127<sup>5</sup>



HIGH-GAIN SIGNAL TRACER KIT  
Y-135 \$26<sup>50</sup>



TV-FM LINEAR SWEEP GENERATOR  
Y-123 \$447<sup>5</sup>

See our Supplement No. 165 for 18 other knight-kit instrument values

free

## SUPPLEMENT featuring knight-kits

Send for our FREE Supplement No. 165 featuring 45 great Knight-Kits, including Test Instruments, Hi-Fi, Hobbyist and Amateur Kits. Write for your copy today.

ORDER FROM  
**ALLIED RADIO**

Dept. O2-H-7 100 N. Western Ave., Chicago 80, Ill.

## TECHNICIANS' NEWS

(Continued)

author-teaching staff. A related *Instructors Guide* was also published to assist teachers and educators in modernizing their school laboratories, in integrating industry-recommended manuals and programs into their curricula and in providing electronics instruction of the most value to industry.

### RTA-PASADENA

The Radio Television Association (RTA) of Pasadena was addressed by Buzz Bizzele of the Society of Radio & Television Technicians (SRTT), Glendale, on the advantages of affiliation with a national organization.

Bill Yatte was appointed in charge of an employment committee, to keep lists of technicians wanting work and of shops needing technicians. Bill Johnson and Perry Kortkamp were appointed to a committee to prepare a membership campaign. Reports were heard on the Fresno convention of the California State Electronics Association (CSEA).

### L.A. COUNCIL MEETS

At a regular meeting, the President's Council of the Los Angeles area's TV Service Association heard reports on the state convention of the California State Electronics Association (CSEA), held in Fresno, Calif. Reports were also heard on the status of the transfer of the master charter from the Long Beach Radio Television Association (RTA) to the President's Council. CSEA publicity plans and changes in group insurance were discussed. CSEA rules have been changed to provide for six meetings a year of the board of directors and three for the board of delegates.

### TUBE FRAUD PROBE

Three more firms have been indicted by the Bronx Count Grand Jury during the present investigation of tube fraud in New York. The new indictments are against the Dorosin Distributing Corp. and its principal, Sidney Dorosin; National Radio Manhattan Inc. and its principal, Herbert Schneur, and National Radio Distributors Corp. and its principal, Edwin Blumenthal.

They have been charged with attempted grand larceny in the second degree for trying to obtain new electron tubes from RCA in exchange for misbranded used tubes.

### EXTENDED WARRANTY

One distributor in Cincinnati, Ohio, is offering a plan which provides an 18-month warranty on picture tubes. For an additional \$3.95 the customer gets 6 months added to the manufacturer's warranty. This aids the technician, too, as the extended warranty states that only the technician who installed the tube may make the replacement.

### NEW MEMBERS

At a current meeting of the Associated Radio-Television Dealers

(ARTSD) (Columbus, Ohio) seven new members—Aid TV Service, A & B Video, Dan Fisher TV Service, Far East TV Service, Mercury TV Sales & Service, May's TV Service and Ohio TV Service—joined the group.

Louis Boehringer of Time TV was appointed to the board of directors. He replaced Dick Lytle of Universal Service.

Association members voted to rescind an amendment to their constitution which would require a prospective member's business to be located in a district zoned for business. A discussion of drugstore tube testers was held before the meeting ended.

### HIGHER WAGE

A West Coast branch of the International Brotherhood of Electrical Workers, Local 202, has voted to ask for \$3.07 per hour in their new contract. The present wage is \$2.795.

Three week vacations for employes with 5 years' service and increased sick leaves are also sought by the union.

### IESA ELECTS

The Indiana Electronic Service Association has a new chairman, George Roberts. He replaces Robert M. Sickles, the association's first chairman who has served since its inception in April, 1956. Harold L. Crume was elected vice chairman and Edward T. Carroll was re-elected secretary-treasurer.

IEAS membership represents about one-third of the established television service in Indiana.

### NEW SERVICE ASSOCIATION

A new service group made up of radio and TV service dealers in Pennsylvania's Pocono Mountains, the Pocono Electronic Service Association, has been organized.

Harry M. Andrew was unanimously elected president of the group. The vice-chairman of the Federation of Radio & Television Service Associations of Pennsylvania, Dave Krantz, addressed the new organization and extended them an invitation to join the state federation.

The PESA plans to start a local advertising program at the consumer level and to distribute an association newsletter as soon as possible.

### NEW OFFICERS FOR TSA

Michigan's Television Service Association has held its annual election. Karl Heinzman was unanimously re-elected president; Charles D. Judd and Clayton J. Hibbert, vice presidents; Steve Raboczkay, secretary; Ed Ballantine, corresponding secretary; Mike Dallen, treasurer. Harold Chase, Jack Barton, Al Weiss, Russell Vogt, Pat Laforest, and Phillip Fabian were elected directors.

Formal installation of the new officers was held at the Hotel Fort Shelby in Detroit.

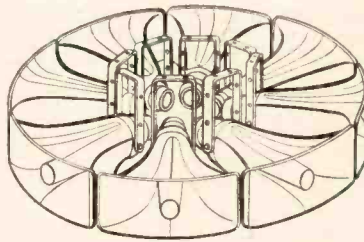
END



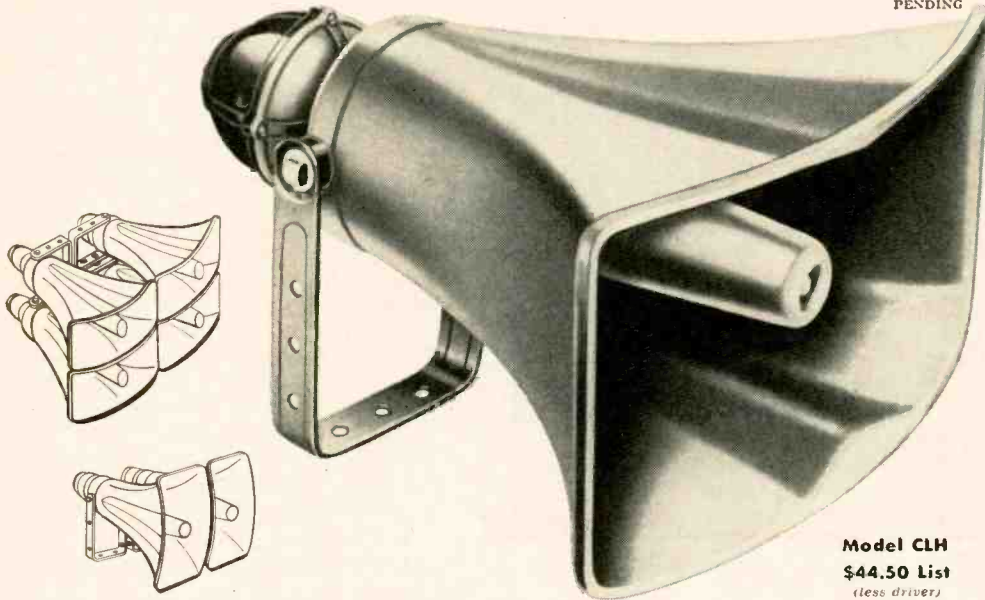
# UNIVERSITY ANNOUNCES THE VERSATILE

MODEL

# CLH WIDE-ANGLE PROJECTOR

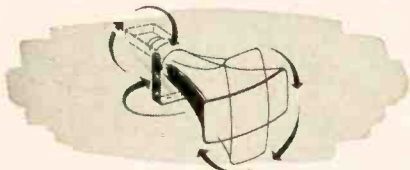


PATENTS  
PENDING



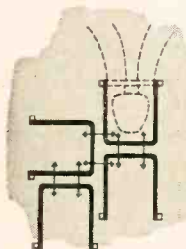
**Model CLH**  
\$44.50 List  
(less drivers)

## EXCLUSIVE OMNI-DIRECTIONAL MOUNTING



Horn bell rotates full 360° on its axis, while the 'U' mtg. bracket provides better than 180° vertical and 360° horizontal adjustment of projector positioning. Thus, sound can be distributed in any direction regardless of projector location.

## USE SINGLY OR STACKED



The 'U' mounting bracket of the Model CLH is specially designed to link two or more projectors into any configuration, achieving exactly the sound distribution pattern required. Even diagonal or alternating projections are just as easy to achieve as "standard" patterns.

## "TUNE OUT" ECHO & REVERBERATION



The unique pin-point adjustment possible with the CLH at last provides the long-awaited answer to coverage of "dead spots" and control over troublesome echo and reverberation—regardless of structural or physical placement limitations!

## VERSATILITY & ADAPTABILITY UNLIMITED



Meets every soundcasting requirement. Use the CLH wide-angle projector with any University driver to get exactly the frequency response, efficiency and power handling capacity you need. Here is dependable performance and real economy—for actual dollar savings you can count on year after year.

THE MOST COMPLETE SELECTION  
OF DRIVERS IN THE INDUSTRY NOW  
AVAILABLE FOR USE WITH THE CLH



**Model PA-50.** Features extended high and low frequency range, highest continuous duty power capacity, greatest conversion efficiency, husky built-in multi-match transformer with terminals conveniently located at base of unit. The answer to the toughest sound problem. Nothing finer!

Response: 70 to 10,000 cps. Power Capacity: Full Range 50 watts; Adjusted Range\* 100 watts; List Price: \$57.50.



**Model PA-HF.** For applications requiring the greatest power handling capacity, maximum sensitivity, widest range frequency response, plus rugged lifetime construction. Completely die-cast aluminum housing. Increased sound output cuts amplifier requirements in half!

Response: 70 to 10,000 cps. Power Capacity: Full Range 50 watts; Adjusted Range\* 100 watts; List Price: \$47.50.



**Model SA-30.** "Battleship" construction for maximum durability against abuse or in hazardous environments. Completely die-cast aluminum housing and built-in matching transformer for connection to high impedance lines or "constant voltage" systems.

Response: 80 to 10,000 cps; Power Capacity: Full Range 50 watts; Adjusted Range\* 60 watts; List Price: \$47.50.



**Model SA-HF.** Will deliver that extra punch needed to cut through heavy noise. Use for speech or high quality music.

Response: 80 to 10,000 cps; Power Capacity: Full Range 30 watts; Adjusted Range\* 60 watts; List Price: \$36.00.



**Model MA-25.** Low in cost, high in quality, featuring high efficiency magnet, tropicalized 2" voice coil, "rim-centered" breakdown-proof bakelite diaphragm.

Response: 85 to 6500 cps; Power Capacity: Full Range 25 watts; Adjusted Range\* 50 watts; List Price: \$27.50.

\*Program response adjusted to horn cut-off.

## ACCESSORIES



2YC CONNECTOR



PMA ADAPTER

**2YC Connector** enables two driver units to be used with one CLH trumpet for up to 200 watts output. Now you can get the Super-Power you want... when you want it, using standard stock drivers.

**PMA Adapter** fits standard 1/2" dia. threaded pipe to the CLH 'U' mounting bracket. Takes the headache out of mounting on pipe!

LISTEN

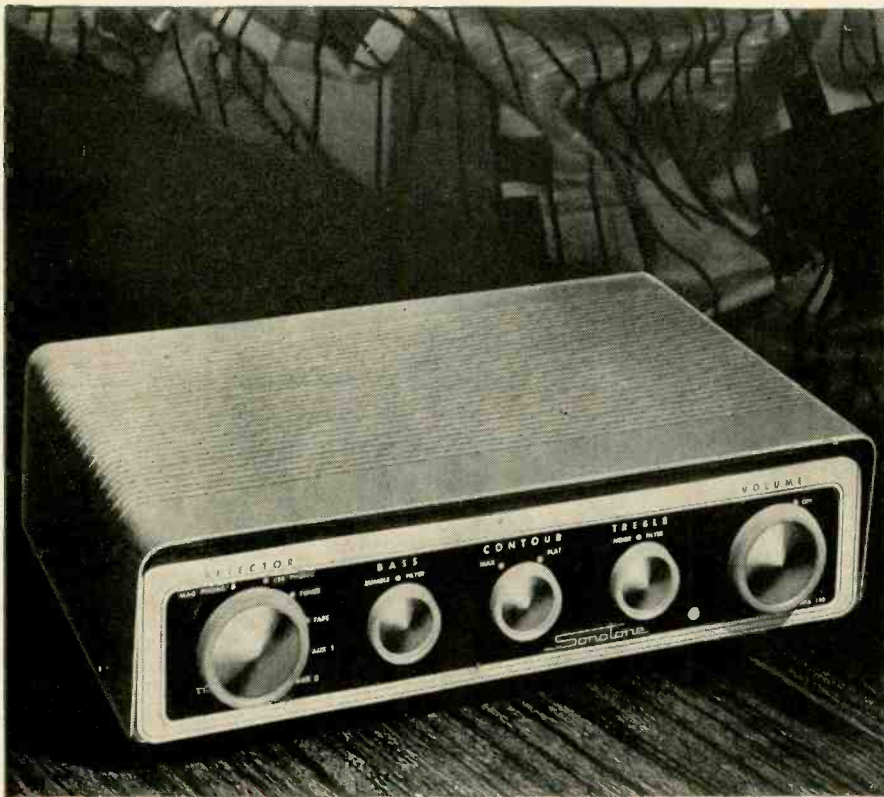
University sounds better



UNIVERSITY LOUDSPEAKERS, INC., 80 SOUTH KENSICO AVENUE, WHITE PLAINS, N. Y.

AUGUST, 1957

# All new ultra-compact amplifier SONOTONE HFA-150



**15-WATT POWER AT A 10-WATT PRICE!**

No amplifier on the market today can compare with the all-new Sonotone HFA-150. Full 15-watt power—superb sound—plus more new, useful “firsts” than any other amplifier at any price.

**ONLY 3" HIGH—12" WIDE!** For the first time, a complete power *and* control amplifier this compact...without an iota of performance being sacrificed to compactness. The ultra-smart cabinet cover is available in a choice of colors—another Sonotone first!

**SIX INPUTS!** For the first time, a quality amplifier in this price range that gives you single switch choice

of 6 inputs. Three of these inputs have *individual pre-set level controls!*

**SEPARATE CONTOUR CONTROL!** For the first time you get new, exclusive push-pull rumble and noise filters. Bass, treble and volume controls with a *separate* continuous contour control, infinitely variable from flat to 26 db of contour compensation.

The Sonotone HFA-150 is, unquestionably, the greatest value in *fine* high fidelity components in many years. Make seeing and hearing it a “must”!

**ONLY \$79<sup>50</sup> NET**

Optional cover \$3.50 Net

Write for detailed information without obligation to:

Electronic Applications Division

**SONOTONE** CORPORATION

ELMSFORD, N. Y.



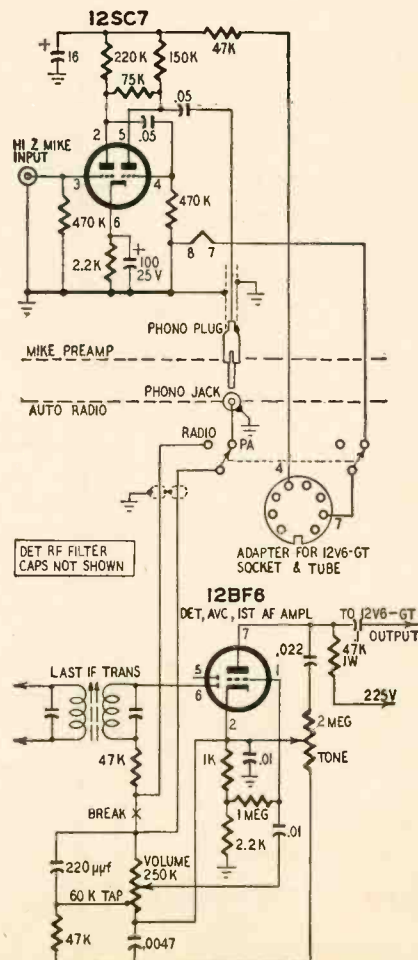
## Question Box

### PA FROM AUTO RADIO

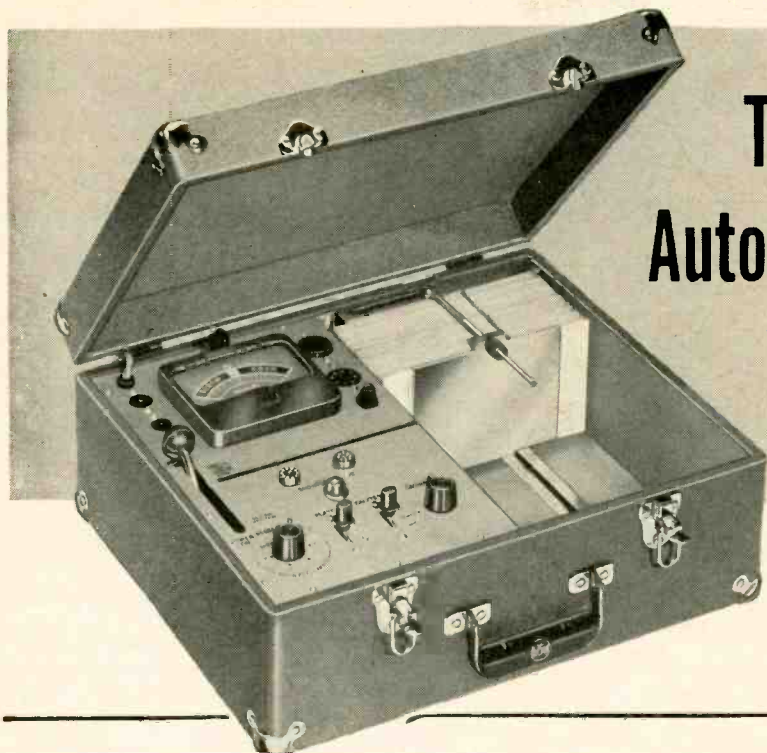
*My Studebaker has a model AC-2745 auto radio that I want to adapt for use as a mobile PA system when working with an outdoor dog-training class. Please show how I can add a plug-in preamplifier for a Shure model 51 Sonodyne magnetic mike. I have added a speaker plug that cuts out the built-in speakers when the external PA speakers are used.—H. P. K., Aurora, Ill.*

The diagram shows a 12SC7 pre-amplifier connected to the audio circuit of the auto radio. Power is taken from an adapter inserted between the socket and base of one of the 12V6-GT output tubes. A function-selector switch opens and closes the heater circuit to the pre-amplifier and connects the first af amplifier in the set to the detector load or to the preamplifier output.

The preamplifier can be constructed on a Vector turret socket and installed in a discarded if or rf transformer can



an announcement of utmost importance to the service industry...



# The RCA WT-110A Automatic Electron Tube Tester

smashing the price barrier  
at . . . **\$199<sup>50</sup>\***!

. . . automated to provide simplicity,  
accuracy and speed never before achieved in a comparable service type tester!

Here—from RCA—is a modern tube tester geared for modern servicing requirements . . . and at a price you can afford. In fact—you can't afford to be without it!

Here is tube testing with no wasted motion—no time-consuming searching and setup of old-fashioned roll charts or socket panels, no dial twisting, no fumbling. It's truly *automatic testing* with speed and simplicity that will amaze you!

Here is virtually an obsolescent-proof design—no roll charts to constantly maintain or replace. All data and setup are supplied on the 241 pre-punched cards provided with the instrument. These cards cover 95% of the currently active TV tube types. In addition, accessory cards and punch are available for punching your own cards, enabling you to keep your instrument current as new tube types are released.

See it . . . test it for yourself . . . at your local RCA Distributor's!

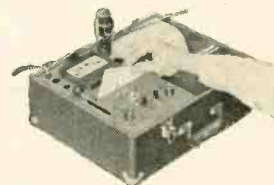
### ACCURATE AUTOMATIC ANALYSIS!

- automatically sets up, not only socket connections, but all operating voltages such as filament, signal, plate and screen voltages, and bias (both fixed and cathode).
- checks tubes for transconductance, gas, and shorts between elements.
- provides 220 combinations of heater voltage, 10 bias voltages, 11 values of cathode resistors, and 50 quality sensitivity ranges.
- tubes tested under heavy load currents, such as rectifiers, at 140 ma per plate.
- leakage test with high and low sensitivity ranges.
- 12-volt plate and screen supply for testing new automobile tubes.
- meter protected against burnout.
- calibration card provided for checking instrument.
- active card magazine capacity—350; storage capacity—350 . . . a total capacity of 700 cards.

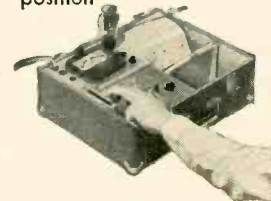
\*User Price (Optional)

### SIMPLE AS A-B-C!

a. merely insert card in matrix.



b. flip power lever to "power-on" position



c. press calibrate lever and adjust calibration control



TUBE IS NOW UNDER TEST!



**RADIO CORPORATION of AMERICA**

COMPONENTS DIVISION

CAMDEN, N. J.

## 2 new CENTURY IN-CIRCUIT time- saving test instruments for the serviceman

### IN-CIRCUIT SELENIUM RECTIFIER

#### TESTER Model SRT-1



The need for an in-circuit rectifier tester is now greater than ever. With the trend for compactness and low prices, manufacturers are resorting more and more to transformer-less TV and radio sets.

only  
**\$29<sup>95</sup>**

THE SRT-1 CHECKS ALL RECTIFIERS BOTH IN-CIRCUIT AND OUT-OF-CIRCUIT — with 100% effectiveness

- ✓ Quality (current emission)
- ✓ Fading (falling emission after warm-up)
- ✓ Shorts
- ✓ Arcing
- ✓ Opens
- ✓ Life Expectancy

ONLY THE SRT-1 CHECKS ALL RECTIFIERS IN-CIRCUIT

### IN-CIRCUIT CONDENSER

#### TESTER Model CT-1

Actually steps in and takes over where all other in-circuit condenser testers fail. The ingenious application of a Double Parallel Balance principle gives the CT-1 a tremendous range of operation.



only  
**\$34<sup>95</sup>**

#### checks in-circuit:

- ✓ Quality of over 80% of all size condensers . . . including leakage, shorts, opens and intermittents.
- ✓ Value of all condensers 200 mmfd. to .5 nfd.
- ✓ Electrolytics for quality — any size.
- ✓ Transformer, socket and wiring leakage capacity.

#### checks out-of-circuit:

- ✓ Quality of 100% of all size condensers . . . including leakage, shorts, opens and intermittents.
- ✓ Value of all condensers 50 mmfd. to .5 mfd.
- ✓ Electrolytics for quality — any size.
- ✓ High resistance leakage to 300 megohms.
- ✓ New or unknown condensers.

See other CENTURY INSTRUMENTS at your local distributor.

## CENTURY ELECTRONICS CO., INC.

111 Roosevelt Avenue, Mineola, N. Y.

Send instruments checked below on a 10 day ironclad money-back guarantee

- In-Circuit Selenium Rectifier Tester.....\$29.95
  - In-Circuit Condenser Tester..... 34.95
- Enclose payment for postpaid delivery — or C.O.D. plus charges. RE-8

Name \_\_\_\_\_  
Address \_\_\_\_\_  
City \_\_\_\_\_ State \_\_\_\_\_

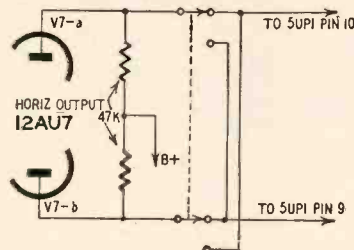
## QUESTION BOX

or suitable shield. The selector switch is shown ganged but it may be necessary to isolate the switches and shield the one in the audio circuit to prevent interference when the motor is running. Shield the audio leads as shown and keep them as short as practical.

### SWEEP REVERSING SWITCH

Is it possible and practical to install a trace-reversing switch on an Eico model 460 scope? If it is, please print the necessary diagram.—W. K., Philadelphia, Pa.

It is practical and easy to install a switch to reverse the trace direction in this and most scopes. The diagram shows a dpdt switch added to reverse the trace or sweep direction. In this scope the output stage incorporates a phase inverter. The reversing switch is located between the deflection plates in the C-R tube and the plates of the push-pull horizontal output tubes.



In scopes with more than one push-pull stage in the horizontal deflection circuit, the switch can be located be-

tween two stages. In this case, one pair of leads goes to the following grids instead of to the deflection plates. The switch should be located on the rear of the scope when it connects to the deflection plates and as close as possible to the related circuitry when between two low-level push-pull stages. This minimizes the danger of feedback, hum and other troubles that develop when long leads are run to low-level high-gain grids. Use a rotary switch with a long shaft to the front or rear panel.

### ELECTROSTATIC TWEETER

I'm planning to install a Lorenz model LSH100 electrostatic tweeter in my reproducing system but I can't find any information on connecting it when installed in an inclosure about 45 feet from the amplifier. Aside from the polarizing voltage which must be supplied I've considered trying a transformer to match the tweeter to a 16-ohm line but haven't any idea as to the required impedance ratio.—E. M., Boyston Park, So. Australia.

A representative of Lorenz reports that the LSH100 is designed for use within about 5 feet from the amplifier. The nature of its impedance-matching network does not permit its use with a matching transformer. For installations where the tweeter must be more than 5-6 feet from the amplifier, they recommend a horn type tweeter such as their LPH65. END



## STOP WONDERING ABOUT HI-FI!

Now—no more need to wonder which equalizer circuit is best or whether fixed or self bias gives less distortion! In his new book UNDERSTANDING HI-FI CIRCUITS, internationally recognized hi-fi authority Norman H. Crowhurst sets your mind at ease about these and other points like—damping, feedback, inverter and driver stages and all the other problems that tend to confuse the audiophile.

He weighs the good and bad points of each circuit and helps you decide for yourself which are best for you. Here's a very brief listing of the wealth of material this remarkable book has in store for you. See for yourself how much it can help you. If you're a true hi-fi fan or if you're in the business of servicing hi-fi, you can't afford to miss this one. Order your copy today.

#### 11 BIG CHAPTERS

- INPUT STAGES
- MATCHING
- EQUALIZATION
- SPEAKER DISTRIBUTION AND CROSSOVERS

- THE APPROACH TO HI-FI
- SPECIAL OUTPUT STAGES
- FEEDBACK AND DAMPING
- INVERTERS AND DRIVER STAGES

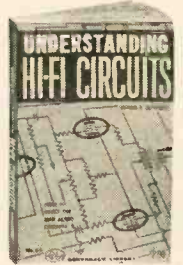
- LOUDNESS AND VOLUME CONTROLS
- TONE CONTROLS
- OVERALL VIEW OF HI-FI Plus complete index

#### OTHER GERNSBACK LIBRARY BOOKS YOU'LL WANT TO READ.

Basic Audio Course. No. 66.....	\$2.75
Servicing Color TV. No. 65.....	\$2.90
TV—It's A Cinch. No. 62.....	\$2.90
Transistor Techniques. No. 61	\$1.50
Rapid TV Repair. No. 60.....	\$2.90
Servicing Record Changers. No. 59	\$2.90
Maintaining Hi-Fi Equipment. No. 58	\$2.90
The V.T.V.M. No. 57.....	\$2.50

High-Fidelity Circuit Design. No. 56. Deluxe hard cover ed. only	\$5.95
Sweep and Marker Generators. No. 55	\$2.50
Probes. No. 54	\$2.50
Radio-Control Handbook. No. 53	\$2.25
The Oscilloscope. No. 52	\$2.25
Transistors—Theory and Practice. No. 51	\$2.00
TV Repair Techniques. No. 50	\$1.50

Radio & TV Test Instruments. No. 49	\$1.50
High-Fidelity—Design Construction. Measurements. No. 48	\$1.50
Radio & TV Hints. No. 47	\$1.00
Television Technotes. No. 46	\$1.50
Radio Tube Fundamentals. No. 45	\$1.00
Basic Radio Course. No. 44. hard cover	\$2.25
Model Control By Radio. No. 43	\$1.00



UNDERSTANDING HI-FI CIRCUITS—By Norman H. Crowhurst. Gernsback Library Book No. 64. 224 pages. Illustrated. Paper cover \$2.90. Deluxe hard cover edition \$5.00.

## GERNSBACK LIBRARY, INC.

154 West 14th Street, New York 11, N. Y.

Dept. 878

- Understanding Hi-Fi Circuits—No. 64
- Paper Cover \$2.90
  - Hard Cover \$5.00
  - 43  44  45  46
  - 47  48  49  50
  - 51  52  53  54
  - 55  56  57  58
  - 59  60  61  62
  - 65  66

Enclosed is my remittance of \$.....  
Please send me the books checked postpaid.  
Prices 10% higher in Canada.

Name \_\_\_\_\_  
Street \_\_\_\_\_  
City \_\_\_\_\_ State \_\_\_\_\_

# Business and People

Belden Manufacturing Co., Chicago, designed a new square spool for its wire and cable. The square spool has a



neater display appearance and will not roll off the shelf or work table.

Allen B. Du Mont Labs. Inc., Clifton, N. J., recently displayed the carton design for its new line of electronic receiving tubes.

Sylvania Electric Products, through its distributors, is presenting service technicians with packages of Wash-'n-Dri towlettes as quick clean-me-ups after in-the-home servicing jobs.

H. H. Scott, Inc., Cambridge, Mass.,

hi-fi component manufacturer, was awarded a Certificate of Merit by the National Federation of Advertising Agencies for outstanding achievement in product advertising. In the photo,



Arnold Z. Rosoff (left) president of Arnold & Co., Scott's advertising agency, is presenting the award to Marvin C. Grossman, sales manager of Scott, while Nancy O'Toole of the Arnold Co. looks on.

National Radio Institute is now located in a new building at 3939 Wisconsin Ave., N.W., Washington, D. C.

Weller Electric Corp., Easton, Pa., introduced a distributor replacement parts kit and a three dimensional plastic identification sign for distributors of its soldering guns. The company also revived its Tip Bucket deal to promote the sale of replacement tips for soldering guns.

Technical Appliance Corp., Sherburne, N. Y., manufacturers of Taco antennas, sponsored a uhf seminar. A group of service technicians from

# BUILD THE BEST— BUILD ALLIED'S OWN knight-kits

Here is a typical Knight-Kit value—available only from ALLIED—one of 45 great Knight-Kits you'll find in our special Supplement No. 165. Write for your FREE copy today.

## knight-kit HOBBYIST VALUE 10-CIRCUIT TRANSISTOR LAB KIT







Model  
Y-299  
\$15.45

One of the most remarkable kits ever developed! You go from one exciting project to another... each circuit has a practical use, and helps to teach you how transistors work. One side of the printed circuit board is screen-printed to show where all components go—after you solder the basic parts in place, you change from one circuit to the next merely by inserting "plug-in" leads into the proper jacks on the board—no additional soldering! Makes any of these 10 circuits: 2-stage AM radio; photo-electronic relay; wireless broadcaster; code practice oscillator; electronic switch; audio amplifier; capacity-operated relay; electronic timer; voice-operated relay; electronic flasher. Includes all parts, 2 transistors, dual headphones (also serve as mike), relay, photo-cell, battery, "plug-in" circuit leads, guide cards, instruction manual. 3 lbs.

Model Y-299. Net, F.O.B. Chicago... \$15.45

## OTHER knight-kit HOBBYIST VALUES

 "SPACE-SPANNER" BC/SW RECEIVER KIT Y-243 \$15.95	 "RANGER" SUPERHET BROADCAST RECEIVER KIT Y-735 \$17.25
 TRANSISTOR RADIO KIT Y-765 \$4.35	 2-STATION INTERCOM KIT Y-295 \$14.75

See our Supplement No. 165 for 12 other knight-kit hobbyist values

## free SUPPLEMENT featuring knight-kits

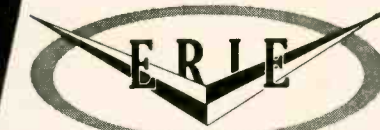
Send for our FREE Supplement No. 165 featuring 45 great Knight-Kits, including Test Instruments, Hi-Fi, Hobbyist and Amateur Kits. Write for your copy today.

## ORDER FROM ALLIED RADIO

Dpt. O2-H-7, 100 N. Western Ave., Chicago 80, Ill.



# Free!



## D-57 CATALOG

at your  
Authorized  
ERIE DISTRIBUTOR

The new ERIE D-57 Catalog, including the complete and enlarged line of ERIE Electronic Components and Corning Glass Works items, is ready. Your authorized ERIE Distributor has a copy for you. If he can't supply you, write us, giving his name.

Make the ERIE Catalog  
Your Catalog

ERIE Electronics Distributor  
DIVISION  
ERIE RESISTOR CORPORATION  
ERIE, PA.

# THE *Brightest* NEWS IN YEARS! NOW... KIT PRICE, KIT FUN, ... WITHOUT KIT PROBLEMS!



350 Watts CW;  
275 Watts Fone  
300 Watts SSB (P.E.P.)\*  
**\$349.00**

wired and tested: \$449.00

\*with any external SSB exciter

## THE NEW WRL Globe Champion 300 Kit!

- ✓ PREASSEMBLED and Tested VFO
- ✓ 75 PAGE INSTRUCTION MANUAL

Here at last is a kit that takes the work out of home assembly. All parts, punched chassis, tubes and pre-cut wiring is included along with a completely pre-assembled VFO, the trickiest unit involved. Dozens of pages, completely detailed, step-by-step assembly manual is included, with numerous schematic drawings. All you need to do is know how to solder. Same top features of the wired form: completely handswitching, push-to-talk and antenna changeover relay. Improved time sequence (grid-block) keying. Pi-Net output circuit, 48-700 ohms. Extensively TVI-shielded, filtered and by-passed. New audio compression circuit holds modulation at high level without usual clipping distortion. Provisions for SSB with any external exciter. The Ham's dream.

### Plus these other Top WRL Transmitters

**Globe King 500B**  
\$69900

540 Watts Fone, CW & SSB (P.E.P.)

**Globe Scout 680**  
\$9995

50 Watts Fone; 65 Watts CW

**Globe Chief 90**  
\$6750

90 Watts

SEE YOUR NEAREST DISTRIBUTOR



AMATEUR RADIO TRANSMITTERS AND ALLIED PRODUCTS!

34th & BROADWAY

COUNCIL BLUFFS, IOWA

LEARN

**Television**  
RADIO-COLOR-TV  
**Electricity**  
ELECTRONICS  
IN THE GREAT SHOPS OF **COYNE**

**TRAIN QUICKLY! OLDEST, BEST EQUIPPED SCHOOL OF ITS KIND in U.S.**

**Veterans and Non-Veterans**—Get practical training in top opportunity fields. Prepare now for a better job and a real future. Advanced education or previous experience not needed. Employment service to graduates.

**Enroll NOW—Pay Later**

Finance Plan and Easy Payment Plan. Also Part Time Employment help for students. *Training in Refrigeration and Electric Appliances can be included.*

**FREE BOOK** Clip coupon for Big Free Illustrated Book. No obligation and No Salesman Will Call. Act NOW.

B. W. Cooke, Jr., President

OPERATED NOT FOR PROFIT  
Established 1899  
500 S. Paulina, Chicago  
Dept. C7-81H

**COYNE**  
ELECTRICAL SCHOOL

B. W. COOKE, Jr., Pres.  
COYNE Electrical School  
500 S. Paulina St., Chicago 12, Ill. Dept. C7-81H

Send FREE BOOK and full details on:

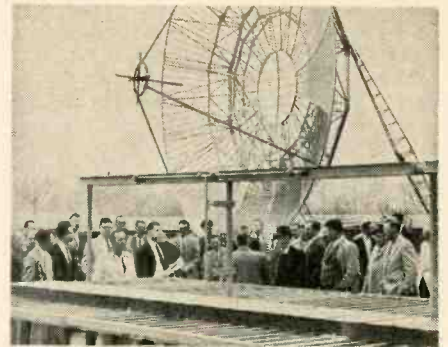
- TELEVISION-RADIO
- ELECTRICITY-ELECTRONICS

NAME.....

ADDRESS.....

CITY.....STATE.....

*"What say we organize a safari and hunt up a JENSEN NEEDLE."*



New York's Southern Tier is shown inspecting a 32-foot dish and a satellite tracking antenna.

American Television & Radio Co., St. Paul, Minn., is packaging its Shav-



Pak inverters for automobile use in a carton which doubles as a point-of-sale display.

Rye Sound Corp., Rye, N. Y., is shipping its personal listening devices and



other items for the electronics industry in attractive point-of-sale display boxes.

Stanley J. Koch (right) and Maj. Gen. Raymond C. Maude (USAF, Ret.) were elected vice presidents of tube operations and government operations, re-



spectively of Allen B. Du Mont Labs., Clifton, N. J. Koch had been general manager of the Television and Industrial Tube Divisions, and Maude, general manager of the Government Division.

W. William Hensler was elected to the new post of vice president in charge of operations for Howard W. Sams & Co., Indianapolis. He



**BUSINESS AND PEOPLE**

(Continued)

will head all operations except finance and industry relations. He has been with the company more than 10 years.

**Raymond E. Ward** of the distributor sales staff of Shure Brothers, Inc., Evanston, Ill., was promoted to sales manager for distributor account.



**Lawrence A. Hyland** (left), vice president and general manager of



Hughes Aircraft, Culver City, Calif., is shown receiving the Pioneer Award of the IRE from Brig. Gen. P. C. Sandretto (USAFR), chairman of the Awards Committee. The presentation, made at the National Conference of Aeronautical Electronics in Dayton, Ohio, honored Hyland for his pioneer work in radar.

**Herman C. Bloom** was appointed sales manager of International Rectifier Corp., El Segundo, Calif. He has been active in electronic distributor sales management for several years.



**Jerry Berger**, plant manager of Brach Manufacturing Division of General Bronze, Newark, N. J. antenna manufacturer, was promoted to director of sales.



**Jack K. Poff**, sales manager, Jobber Div., Pyramid Electric Co., North Bergen, N. J., shows Capital Airlines hostess Bobby Stryker company's model CRA-2 capacitor-resistor analyzer, one



of 10 to be awarded as third prizes in Pyramid's Twist-Mount Capacitor Contest. A weekend at the Waldorf Astoria Hotel in New York is the grand prize. **M. Harvey Gernsback**, RADIO-ELECTRONICS editorial director, is one of the contest judges.

Ram Electronics moved its operation to a new plant in Paramus, N.J. **END**

"miracles with microvolts"



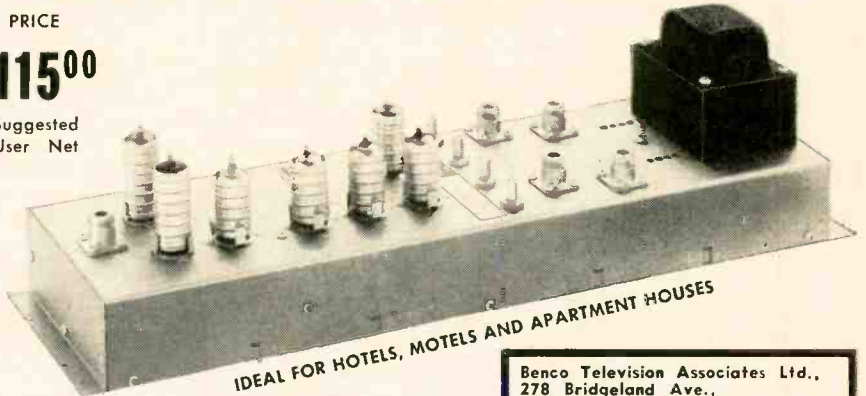
## Super "40" Broad Band TV AMPLIFIER

WITH 4 SEPARATELY CONTROLLED INPUTS

**EQUIVALENT TO AT LEAST FOUR 38DB STRIP AMPLIFIERS**

PRICE  
**\$115<sup>00</sup>**

Suggested User Net



**IDEAL FOR HOTELS, MOTELS AND APARTMENT HOUSES**

- Separate 38DB Hi and Low band amplifiers.
- 4 volts maximum output: 2V. Hi-band, 2V. Lo-band.
- 4 separate inputs: any 2 Hi-band, any 2 Lo-band.
- 0-20DB variable attenuator in each input.
- Useful in areas with from 1 to 8 channels.

**Benco Television Associates Ltd.,**  
278 Bridgeland Ave.,  
**TORONTO 10, Canada.**  
 Please send me complete details on the SUPER "40"  
 Other Benco Equipment  
Name.....  
Address.....  
City..... Prov.....

BENCO

TELEVISION ASSOCIATES LTD.  
278 BRIDGELAND AVENUE, TORONTO 10, CANADA

YOURS NOW -  
The Secrets of  
Profitable Servicing

Send no Money



Free Inspection

Want to make more money in servicing? Here's the secret in three words—**KNOW YOUR STUFF**—today, tomorrow, and the next day! How?—keep up with new methods and techniques. If you read and absorb the information in these two books, you'll be one of the leading service technicians in your neighborhood today—and hold that spot tomorrow!

**RAPID TV REPAIR** by G. Warren Heath shows you how to lick the toughest servicing problem in minutes! Just look up the symptoms in the index and read how to put your finger on the trouble as easy as ABC. Cut your troubleshooting time way down. Make more money!

**SERVICING COLOR TV**—By Bob Middleton. The best practical book on color TV servicing yet! Fact-packed with the kind of tips you need to master this new branch or servicing! Hundreds of charts, photos, and diagrams show you how to find and fix troubles in any set on the market today.

**READ HOW YOU CAN GET THESE VALUABLE BOOKS AT HUGE SAVINGS!**

**HOW TO GET THESE BOOKS WHOLESALE!**  
These two deluxe hard cover books are nationally advertised at \$4.60 each—but through the G/L TECHNICIANS' BOOK CLUB, you can get them—and others like them—for only \$3.35 each—a saving of 27%!

**HOW THE PLAN WORKS**

- To join the club select the book you want on the coupon.
- **SEND NO MONEY NOW**—we'll send you the book postpaid for a FREE 10-day inspection in your own home.
- If you like it send us your remittance—if not send the book back.
- A new book will be sent to you about every three months on the same NO-RISK free inspection plan.
- You agree to take a minimum of four books during your entire membership period—no time limit. You may cancel any time after that.

**OTHER BOOKS TO BE PUBLISHED SOON**

- TV and Radio Tube Troubles
- Working with the Scope
- Servicing Tape Recorders

**DON'T DELAY—JOIN THIS NO-RISK MONEY-SAVING, MONEY-MAKING CLUB TODAY.** Send in this coupon now.

**NO-RISK COUPON**

**Gernsback Library, Inc.** 87  
154 West 14th St., New York, N.Y.

Begin my membership with book checked. Send me the book for a Free 10-day trial.

**RAPID TV REPAIR**

**SERVICING COLOR TV**

Send me more information on the G/L TECHNICIANS' BOOK CLUB.

Name..... please print

Street.....

City..... State.....

REPEATED BY DEMAND

**1.** Your choice of ANY \$1 KIT FREE!

PLUS

**2.** \$15 worth of RADIO PARTS FREE!

**DOUBLE BONUS OFFER**

**FREE WITH \$10. ORDER**

**\$16 WORTH OF RADIO PARTS FREE WITH EVERY \$10 ORDER! FREE! FALL BARGAIN FLYER!**

**WORLD FAMOUS KIT KING DOLLARBUYS!**

- SIX DIODES.** Crystal & silicon: asstd. sizes. **\$1** Reg. \$15.
- 10 "POLY" BOXES.** Asstd. sizes. Clear plastic, hinged w/ snap locks. **\$1** Reg. \$2.50
- WORLD'S SMALLEST RADIO KIT.** 2 1/2 x 1 3/4 x 3/4", w/ permeability tuner-diode, all parts, instructions. **\$1** Reg. \$3.50.
- 15 ROTARY SWITCHES.** ceramic & bakelite: 2, 2, 3-gangs: std. shafts. **\$1** Wt. 3 lbs. Reg. \$10.
- 40 PRECISION RESISTORS.** Carbon, 1/2 & 1w. Asstd. 1%, 1/2, 1/4 lb. **\$1** Reg. \$18.
- THREE MINI TUBES.** Pick any 3: 6AK5 & 6AJ5 RCA, etc. **\$1** Reg. \$3.
- 5 JEWELERS SCREW-DRIVERS** for sub-mini work. 5 different sizes. **\$1** Reg. \$3.
- 30 DISC CONDENSERS** ERS transistor & printed circuit types. **\$1** Reg. \$8.
- 100 RADIO PARTS.** Surprise assortment. Reg. value \$15. **\$1** Wt. 3 lbs.
- 50 PLUGS & RECEPTACLES.** Audio, power, chassis, panel & spkr. types. **\$1** Wt. 2 lbs.
- 15 VOLUME CONTROLS.** Singles, duals to 1 meg. **\$1** Wt. 1 lb. Reg. \$10.
- 10 ELECTROLYTICS.** asstd. can, tubular types to 500 mf. **\$1** Wt. 3 lbs. Reg. \$14.
- 125 RESISTORS.** 1/2, 1w; 40 values: 5 ohms to 10 megs. 5%. **\$1** Reg. \$13.
- 20 PRINTED CIRCUITS.** asstd. Top makes for transistor, radio, hobby circuitry. **\$1** Reg. \$10.
- 60 MICA CONDENSERS.** 30 values, .00001 to .01 mf to 100V. Silver. 5% incl. **\$1** Wt. 1 lb. Reg. \$5.
- 60 STANDARD KNOBS.** Asstd. Colors, bakelite & plastic. Set-screw types, too. **\$1** Wt. 2 lbs. Reg. \$9.
- 10 IF TRANSFORMERS.** Metal can, asstd. freqs. for radio, TV, hobby uses. **\$1** Wt. 3 lbs. Reg. \$15.
- 30 POWER RESISTORS.** W.W. sandohm, sand-coated, vitreous. 15 values: 5 to 50 W, 35 to 11000 ohms. **\$1** Wt. 2 lbs. Reg. \$8.
- 40 POPULAR BULBS.** Asstd. Min screw, bayonet: to 6V. **\$1** Wt. 1/2 lb. Reg. \$4.
- EMERSON TUNER.** Hi-Q, permeability tuned ANT & OSC coils, w/ paddlers on 2x1" plate; variable tuning mech. 500 to 1800 kc. **\$1** Reg. \$2.50.
- 3 AC-DC CHOKES.** 800 ohms, 50ma. Open frame mtr. for power supplies. **\$1** Reg. \$1 each.
- 000-999 COUNTER.** Vee-deer-Root reset type for all counting jobs. **\$1** Reg. \$6.
- 100 COIL FORMS.** Wide variety sizes, insulation. **\$1** Wt. 1 lb. Reg. \$10.
- 15 PANEL SWITCHES.** Push, momentary, power, thermal. **\$1** Wt. 2 lbs. Reg. \$18.
- 100 CERAMIC CONDENSERS.** Asstd. types; top mfrs. 30 values, color-coded. Discs, too. **\$1** Reg. \$15.
- 3 lbs. HARDWARE.** Approx. 2000 pcs., asstd. screws, brackets, etc. **\$1** Reg. \$8.
- 3 OUTPUT XFMRs.** Single & p/p tubes: 35L6, 50B5, 50L6 & 6Y6 to 3/4 ohm 4. **\$1** Wt. 2 lbs. Reg. \$5.
- 175-FT. HOOKUP WIRE** In 25-ft. rolls. Asstd. colors, stranding, insulation. #18 to 24. **\$1** Wt. 2 lbs. Reg. \$3.75.
- 8-PC. NUTDRIVER SET.** Plastic handle, 3/16, 7/32, 1/4, 5/16, 11/32, 3/8, 7/16" steel socket wrenches in plastic case. **\$1** Wt. 1 lb. \$3 value.
- MINI-METER BUY!** 1 3/4" round, chromed, 0-6 amps AC. For model RR, power supplies, mobile. **\$1** Reg. \$3.
- 15-PC. TWIST DRILL SET.** 1/16" thru 1/4" by 64ths in graduated plastic holders. **\$1** Reg. \$4.
- R/C CONTROL SCOOP!** Chassis incl. 3000-ohm mini control relay, 115 to 6.3-1.5A alt. xfmtr., resistors, cond, pot, sock, etc. **\$1** Wt. 2 lbs.
- 6 AC/DC LINE CORDS.** asstd. rubber, plastic. 6-ft. long, molded plugs, tinned ends. **\$1** Wt. 1 lb.
- 60 TERMINAL STRIPS.** Asstd. solder lug types. **\$1** Wt. 1 lb. Reg. \$3.
- 2 MIKE TRANSFORMERS.** ERS, carbon, encased. 200 ohms to grid. **\$1** Wt. 1 lb. Reg. \$4.
- 40 HI-Q CONDENSERS.** Ceramic tubular case! asstd. pop. values. **\$1** Reg. \$8.
- 4 FERRI-LOOPSTICK** cores. Hi-Q, asstd. flat & tubular. 5 to 7" long. **\$1** Wt. 1 1/2 lbs.
- 2 TRANSISTOR XFMRs.** Asstd. 1/2 pencil types. Interstage, 1x3/4x3/4". Imp. ratios unknown. Color coded. **\$1** Reg. \$10.
- POSTAGE-STAMP MIKE.** 3/4" sq. Crystal, clear, clear to 8000 cps. **\$1**
- SUB-MINI P-N-P TRANSISTORS.** 1/2 pencil eraser size! Used in name portables. W/spec. sheets. **\$1** \$5 value.
- 40 MINI CONDENSERS.** Asstd. 1/2, 1w. Asstd. to 0.1 mf. **\$1** Wt. 1/2 lb. Reg. \$8.
- 60 TUBULAR CONDENSERS.** ERS, .0002 to .1 mf. to 2000V. **\$1** Wt. 2 lbs. Reg. \$12.
- 40 MOLDED CONDENSERS.** ERS. Black beauties, porcelain, etc. Oils, too. To 1 mf. to 1000V. **\$1** Wt. 1 lb. Reg. \$8.
- 60 RESISTORS—scoop!** Many 1% & 5%. Insulated: 1/2 to 2W; 10 ohms to 10 megs. 30 values. **\$1** Wt. 1 1/2 lb. Reg. \$18.
- 30 TUBE SOCKETS.** wide variety, 4 to 14-prong. 10 types incl. ceramic & mica filled. **\$1** Wt. 1 lb. Reg. \$8.
- 8 TRANSISTOR SOCKETS.** for sub-mini tubes, too. Mica-filled. **\$1** Reg. \$3.
- 60 XFMRs., COILS.** IF, RF, ant., slug-tuned coils, chokes. 25 types. **\$1** Wt. 3 lbs. Reg. \$15.
- 40 TRANSISTOR RESISTORS.** Only 1/4" long. 20 values: 15 ohms to 10 megs. color-coded. **\$1** Reg. \$6.

Check items wanted. Return entire ad with check or MO. Include sufficient postage, excess returned. C.O.D. order, 25% disc. Rated, net 30 days. Print name, address, amount money enclosed, in margin. (Canada postage 45c 1st lb., 25c ea. add. lb.) **RE-8**

**HOW TO ORDER**

**Lektron Specialties**

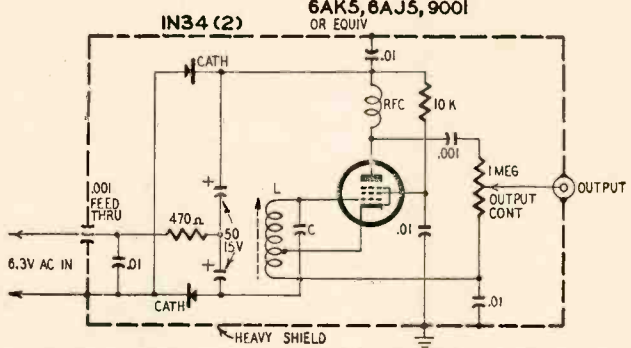
131 Everett Ave. Chelsea 50, Mass.

# radio-electronic Circuits

## LOW-NOISE BFO

Many experimenters and amateurs who have constructed or converted surplus receivers for CW reception above 144 mc or so have found that the receiver's noise level increases with frequency when the bfo is turned on. Writing in *R.S.G.B. Bulletin*, a publication of the Radio Society of Great Britain (London, England) S. F. Weber shows that the extraneous noise is caused by harmonics of the bfo appearing at the mixer (second detector) and by excessive bfo injection voltage. For

The diodes may be 1N34's or similar units. The output is taken from a potentiometer between the plate and B minus and injected into the grid of the first if stage through shielded cable. The low plate voltage combined with the selectivity of the if circuits eliminates bfo harmonics before they can reach the second detector. The use of an independent plate supply and a die-cast shield box for the bfo minimizes radiation. Circuit L-C tunes to if. The author couples the bfo output



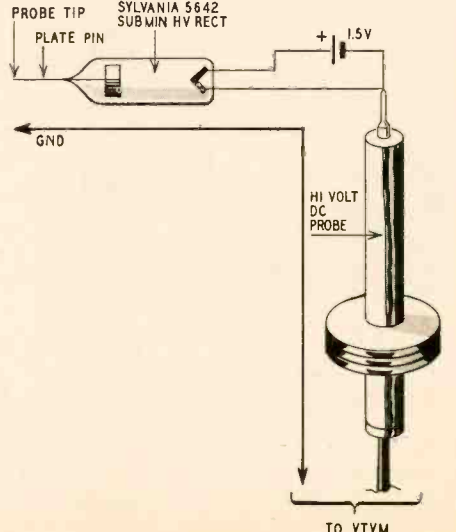
best performance in a uhf receiver a bfo should have good frequency stability, low harmonic content, variable amplitude, freedom from radiation into the rf circuits, and loose coupling to receiver circuits to minimize loading.

into the if circuit by using a coaxial output cable with about 1/4 inch of center conductor exposed and placed near the first if grid. For weak-signal reception the bfo output is gradually increased from zero until the receiver's noise level starts to increase (rises to S1 or S2 on the meter). On a strong signal the bfo output should be increased until the S meter shows a slight increase over the reading obtained on the signal alone.

The circuit diagram shows a low-noise bfo designed for uhf receivers. The oscillator tube is a 6AK5, 6AJ5, 9001 or similar pentode with its plate voltage supplied by a voltage doubler operating from the 6.3-volt heater line.

## PULSE PROBE FOR VTVM

Instrument manufacturers are sometimes asked if a probe can be used to check the pulse voltage at the plate of the high-voltage rectifier tube, using a conventional vtvm. Such probes are not commercially available at present but can be easily constructed by the service technician.



As shown in the drawing, the probe consists of a subminiature high-voltage rectifier tube, such as a Sylvania 5642. The filament of the tube is powered from a small flashlight cell. (Be sure to open the filament circuit when the probe is not in use.)

The unit is arranged to slip on the end of a conventional high-voltage dc probe, and the voltage reading is indicated on the dc scales of the vtvm, as in conventional tests.

The vtvm responds to the positive-pulse voltage of the pulse, which is the



# MAKE MONEY IN COLOR TV NOW!

Make no mistake—color TV is here now! Over 100,000 color TV sets have already been sold and an estimated 250,000 or more will be sold this year—and that's only a drop in the bucket to next year and the year after. Who's going to make the money servicing them—YOU or the "guy around the corner"? The man who has the know-how today can service sets now—and build a reputation for tomorrow—the other fellow will get the leftovers. So prepare yourself now—tomorrow may be too late!

Here's an easy way to get started in color TV now—buy the new Gernsback Library book **SERVICING COLOR TV**—by America's ace engineer-writer-lecturer—Bob Middleton. Let him show you how easy servicing color TV can be. Let him teach you the tricks of the trade that will make you the No. 1 service technician in the neighborhood. **SERVICING COLOR TV** is practical, thorough, accurate—answers all your questions—contains easy-to-follow trouble shooting charts—will help you put your finger on troubles in minutes.

It offers sure-fire techniques based on Middleton's own experience. When you finish reading it you'll be qualified to tackle any color set on the market today! **SERVICING COLOR TV** may be the key to your future. Get your copy today!

## SERVICING COLOR TV—No. 65

By Robert G. Middleton

224 pages. Paper cover ed. \$2.90. Hard cover ed. \$4.60.

### HERE ARE SOME OF THE HIGHLIGHTS

- Preliminary servicing
- Color sync servicing
- Chroma circuit servicing
- Servicing chroma demodulators
- Matrix testing
- Servicing the IF amplifier
- The flyback system
- Signal tracing
- Test equipment
- Complete Index



SEE YOUR DISTRIBUTOR  
OR USE THIS COUPON

**GERNSBACK LIBRARY, Inc., Dept. 87A**  
154 West 14th St., New York 11, N.Y.

Payment of \$..... enclosed. Please send me books checked, postpaid.  
65—SERVICING COLOR TV

paper cover  hard cover

**ORDER OTHER GERNSBACK LIBRARY BOOKS TOO**  
Paper covered editions—unless otherwise specified.

- Basic Audio Course, No. 66.....\$2.75
- Understanding Hi-Fi Circuits, No. 64.....\$2.90
- TV—It's a Cinch, No. 62.....\$2.90
- Transistor Techniques, No. 61.....\$1.50
- Rapid TV Repair, No. 60.....\$2.90
- Servicing Record Changers, No. 59.....\$2.90
- Maintaining Hi-Fi Equipment, No. 58.....\$2.90
- The V.T.V.M., No. 57.....\$2.50
- High-Fidelity Circuit Design, No. 56.....\$2.50
- Deluxe hard cover ed. only.....\$5.95
- Sweep and Marker Generators, No. 55.....\$2.50
- Probes, No. 54.....\$2.50
- Radio-Control Handbook, No. 53.....\$2.25
- The Oscilloscope, No. 52.....\$2.25
- Transistors—Theory and Practice, No. 51.....\$2.00
- TV Repair Techniques, No. 50.....\$1.50
- Radio & TV Test Instruments, No. 49.....\$1.50
- High-Fidelity—Design Construction Measurements, No. 48.....\$1.50
- Radio & TV Hints, No. 47.....\$1.00
- Television Technotes, No. 46.....\$1.50
- Radio Tube Fundamentals, No. 45.....\$1.00
- Basic Radio Course, No. 44, hard cover only.....\$2.25
- Model Control By Radio, No. 43.....\$1.00

Prices 10% higher in Canada.

Name .....  
Street ..... please print  
City ..... State .....

## RADIO-ELECTRONIC CIRCUITS (Continued)

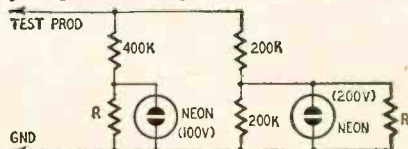
value of interest. This test shows the pulse voltage which is being applied to the input of the high-voltage power supply of the receiver.—Robert G. Middleton

### NEON VOLTAGE-STEP INDICATOR

When compactness is needed and exact voltage indication is not necessary, a neon voltage-step indicator makes a convenient volt meter. Ranges up to 10,000 volts can be provided.

As shown in the diagram, a neon bulb set to fire at 100 volts is connected in series with a 400,000-ohm resistor. Shunt resistor R is connected across the bulb, to adjust the firing point to exactly 100 volts. Since the characteristics of neon bulbs vary, the value of R is determined by experiment. However, its value will be much greater than the 400,000 ohms of the series resistor.

The neon bulb which fires at 200 volts is connected across one section of a voltage divider consisting of two 200,000-ohm resistors in series. Parallel resistor R1 sets the firing point at exactly 200 volts. Its value will be relatively high and can be determined by experimenting.



Additional branches can be added in which the bulb shunts progressively smaller values of resistance in the dividers. The limit is reached when the first bulb draws the maximum allowable current as the last bulb is fired. The hookup can be mounted in a transparent plastic tube about the length of a fountain pen and makes a handy juice stick to carry in the pocket.

The device is also an ac-dc indicator since both sides of the bulbs light on ac voltage and only one side lights on dc.

When the system is used for high-voltage indication, suitable high-value resistors are required. They must be capable of withstanding the applied voltage without breaking down. If small composition resistors are used in series, allow no more than 600 volts drop across any one. Also, be sure that adequate insulation is provided throughout circuit.—R. M. Centerville END

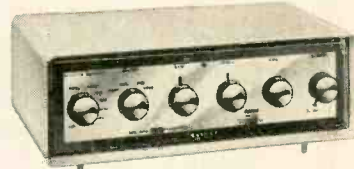


"Not so much flux, Harley!"

# BUILD THE BEST— BUILD ALLIED'S OWN knight-kits

Here is a typical Knight-Kit value—available only from ALLIED—one of 45 great Knight-Kits you'll find in our special Supplement No. 165. Write for your FREE copy today.

## NEW knight-kit HI-FI VALUE SENSATIONAL PREAMPLIFIER KIT



- Printed Circuit Switches!
- 8 Inputs • Self-Powered
- 2 Printed Circuit Boards!
- With Custom Styled Case

Model Y-754

\$3875

Advanced Hi-Fi design at new low cost! Features precise equalization guaranteed within ½ db of recommended accuracy! Exclusive new printed-circuit switches and two printed-circuit wiring boards for easy, error-proof construction; built-in power supply; response, ± 0.5 db, 10-50,000 cps; 8 inputs (including Tape Head); separate Bass and Treble controls; separate Level and Loudness controls; Rumble Filter Switch; DC on all tube filaments; 2 extra AC outlets. With beautiful custom styled case. Complete with step-by-step instructions for easy, money-saving assembly. Shpg. wt., 12½ lbs.

Model Y-754. Net F. O. B. Chicago . . . \$3875

### OTHER knight-kit HI-FI VALUES



FM HI-FI TUNER KIT  
Y-751 \$3775



30-WATT AMPLIFIER KIT  
Y-762 \$7495



10-WATT HI-FI  
AMPLIFIER KIT  
Y-753 \$2350



20-WATT HI-FI  
AMPLIFIER KIT  
Y-750 \$3575

See our Supplement No. 165 for other  
knight-kit Hi-Fi Values

## free SUPPLEMENT featuring knight-kits

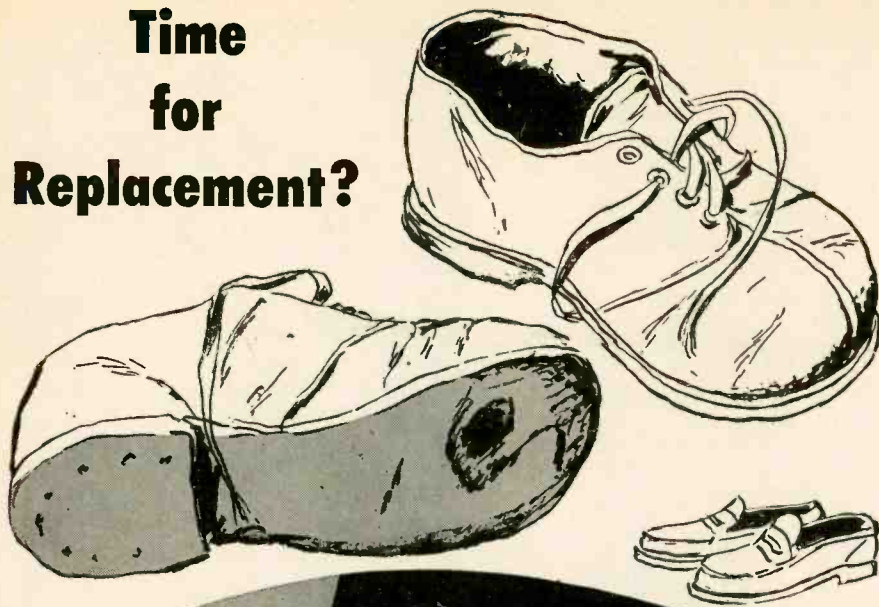


Send for our FREE Supplement No. 165 featuring 45 great Knight-Kits, including Test Instruments, Hi-Fi, Hobbyist and Amateur Kits. Write for your copy today.

## ORDER FROM ALLIED RADIO

Dpt. O2-H-7, 100 N. Western Ave., Chicago 80, Ill.

**Time  
for  
Replacement?**



**Specify**

**OXFORD  
SPEAKERS**

"Put the right shoe on the right foot" by demanding the most exact replacement speakers . . . OXFORD.

Proven for replacement and preferred for original equipment, OXFORD offers you the best from 2" to 15" . . . a streamlined, complete line of speakers constantly improved over more than twenty-five years of speaker leadership.

TIME for REPLACEMENT . . . specify OXFORD SPEAKERS . . . you'll be glad you did.

**OXFORD Components, Inc.**

Subsidiary of Oxford Electric Corp.

556 West Monroe Street • Chicago 6, Illinois

In Canada: Atlas Radio Corp., Ltd., Toronto

Export: Roburn Agencies, New York City



**ENGINEERING**

**B. S. DEGREE  
IN 27 MONTHS**



Prepare for unlimited opportunities of the Electronic Age! Earn your B.S. DEGREE IN 27 MONTHS in Aeronautical, Chemical, Civil, Electrical or Mechanical Engineering; in 36 MONTHS in Mathematics, Chemistry, Physics. Intensive, specialized courses. Comprehensive training in electronics, television, advanced radio theory and design, math, nuclear physics and elec. eng. Engineering Science preparatory courses. Low rate. Graduates in demand. Spacious campus: 20 bldgs., dorms, gym, playing field. Earn part of your expenses in Fort Wayne while studying. G.I. approved. Enter September, December, March, June. Write for catalog.

**INDIANA TECHNICAL COLLEGE**

1787 E. Washington Blvd., Fort Wayne 2, Indiana  
Please send me free information on B.S. ENGINEERING DEGREE IN 27 MONTHS as checked.

Electronics  Chemical  Aeronautical  
 Civil  Mechanical  Electrical  
B.S. DEGREE IN 36 MO. in:  Math.  Chem.  Physics

Name.....

Address.....

**NEW! 4-Transistor Pocket Radio!**



Size of cigarette pack. No external antenna needed. Brings in stations 800 miles away at night. Loud volume. Uses 12¢ flashlight battery that lasts 1500 hours. Printed circuit. Free literature.

Complete kit, \$23.50. Fully wired, \$29.50.

**SEND FOR YOURS TODAY!**

Order now from

**GARDINER ELECTRONICS CO., Dept. 12**

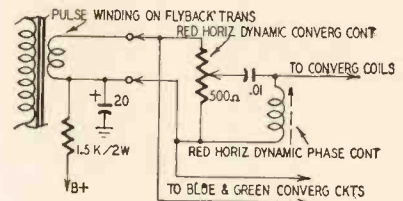
2545 East Indian School Road • Phoenix, Arizona

**Technotes**



**MOTOROLA TS-902**

The trouble was color fringing at the right- and left-hand edges of the screen. Our first thought was adjustment of the horizontal dynamic convergence controls had drifted and only touchup adjustments would be required. However, any adjustment of the horizontal amplitude and phase controls made the misconvergence worse. Tube replacements in the horizontal circuits did not help.



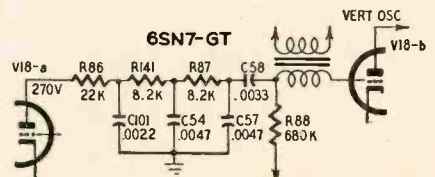
We started checking operation of the individual horizontal amplitude and phase controls. The green and blue controls operated satisfactorily, but the red amplitude control lacked normal range. With the blue and green amplitude controls turned to minimum and the red amplitude to maximum, the slug in the horizontal dynamic phasing coil was then turned through its range while watching the dot lineup curve as the coil went through its resonance peak. Here we found a clue: the horizontal line of red dots would approach resonance and not go through the peak. Green and blue coils would go through resonance peaks, with their amplitude controls advanced to maximum.

The capacitor in series with the red horizontal phasing coil was suspected and replaced. When the response remained the same, only the coil itself was left suspect. The phasing coil was replaced and good convergence obtained without difficulty.—R. M. Centerville

**BENDIX MODEL FM27C**

A pronounced vertical jitter was observed whenever the set was turned on or off or tuned to a new channel. The jitter could be temporarily increased or cured by switching stations. Shaking would not affect the jitter.

The jitter was present in all sync stages except the plate of V18-a which was the last tube in the vertical sync

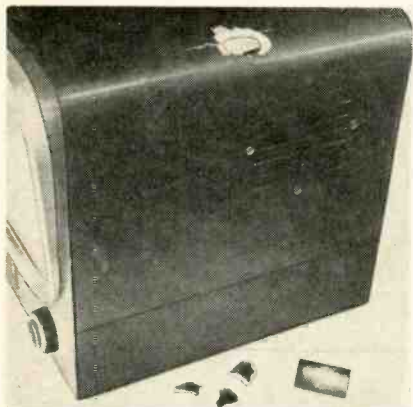


string feeding the vertical integrator. A check showed normal resistances in the intergrator circuit. The coupling capacitor C58 was replaced and the trouble was gone.—James A. McRoberts

**FILTERS CAN BE DANGEROUS**

Much publicity has been given to the dangers involved in handling picture tubes but little has been said about some of the other dangers involved in TV servicing—such as exploding filter capacitors.

This picture should serve as a word of caution to those who would short a fuse in a set or substitute a much larger fuse than that recommended by the manufacturer. The condition shown was the result of some unknown person's substituting a jumper wire for a fuse resistor.



This capacitor "let go" with such force that it pierced not only the case, but the Celotex ceiling of the repair shop as well.

Pity the poor guy who might have been leaning over this set at the time of the explosion! Let this serve as a lesson to all service technicians to be more careful—the set you save may be your own.—Carleton A. Phillips

**EICO 221 VTVM**

Complaints of low voltage readings when one hand is on the probe and another on a ground or chassis are usually caused by grease or film on the probe. Applying cleaning fluid to the probe will make the meter work like new.

If the meter is kept on for long periods, drilling ventilating holes in the back upper portion of the cabinet will make it more stable. This applies to other instruments as well. Added holes were drilled in the back of my Eico 425 oscilloscope to stabilize drift of centering adjustments—G. P. Oberto END



"Well, I don't like it!"

# NEW

at Ward...

## REAR FIN ANTENNA

Newest, smartest, pace-setting rear fin on the market. Heavy chrome plated—3 sections extend to 27". 15-ft. lead with built-in signal booster.



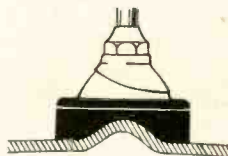
**MODEL NO. TFL-1**

Also available as dummy mount.—Model TFD-1

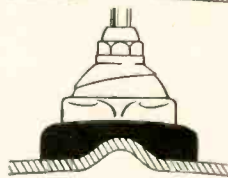
**...AND HERE'S MORE!**

**NEW FENDER PADS ... for 1957 cars**

**Fender Pads—**  
For mounting 8-Ball mount antennas on front fenders of 1957 cars: C-61



**Fender Pads—**  
For mounting Tear Drop mounts on front fenders of 1957 cars: C-62

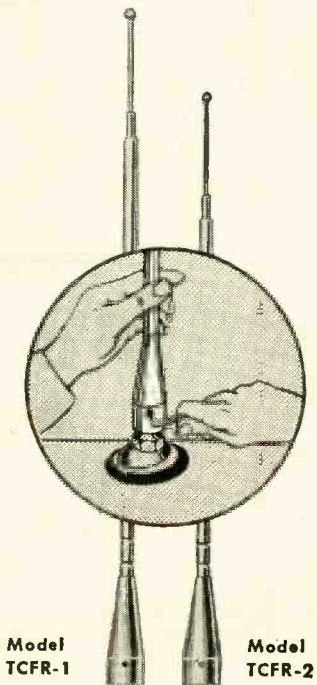


**Fast-Selling Ward**



**TEAR DROP MOUNT**

The fastest selling style leader of them all ... the replacement antenna with original equipment styling. Mounts completely outside the car ... easily ... quickly. Heavy chrome plate ... 3 sections extend from 22" to 56".



Model TCFR-1

Model TCFR-2

**Smart NEW Replacement Masts**

No need to disturb the mast. Just slip on and tighten. Easiest, quickest replacement ever developed. Bell-shaped collar on mast fastens to stub of original antenna mast with set screws.

Just a few of Ward's new quality leaders that have joined the famous Ward family—8-Ball, Majorette, and Silveramic®. Order TODAY. For complete information, write: Dept. RE-8

# Ward PRODUCTS CORPORATION

DIVISION OF THE GABRIEL COMPANY

1148 EUCLID AVE. • CLEVELAND 15, OHIO

IN CANADA, ATLAS RADIO CORPORATION • 50 WINGOLD AVE. • TORONTO, ONTARIO



NOW! Hi-Fi units also available  
WIRED & TESTED  
Ready-to-hear!

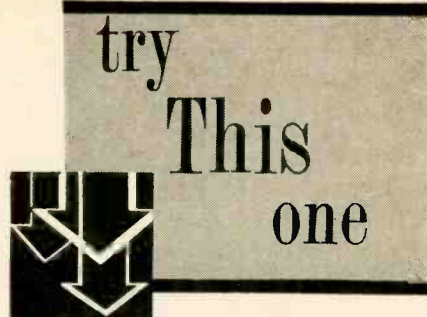
## SUMMER TIME IS KIT BUILDING TIME

# ARKAY takes the blind spots out of kit buying!

NEWS! . . . If you've always wanted to save the money and have the fun of building your very own HI-FI system or radio, here's sensational news:

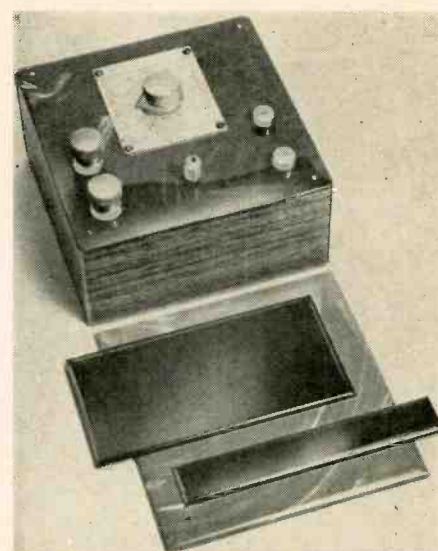
ARKAY the world's leading name in audio kits now lets you "HEAR IT-BEFORE YOU BUILD IT" . . . ARKAY takes all the gamble out of kit building . . .

See your favorite ARKAY dealer . . . ask for a demonstration unit of any model in the line . . . examine it, play it, give it any test you wish . . . then compare and you'll agree that an ARKAY kit is easiest to build and the best dollar value!



### COLORFUL PANELS

I find that plastic bathroom wall tiles make economical and colorful panels for small radios, test apparatus and other small electronic gear. These Styron tiles come in a variety of colors and designs and, when used with plastic-covered cabinets, many beautiful color combinations can be worked out.



The photo shows a 4 1/4 x 4 1/4-inch red marble plastic tile (Homart P-23, Sears Roebuck, 5c each) used as a panel on a wood cabinet covered with Con-Tact, a self-adhesive plastic material that has a black walnut grain. Con-Tact is available in many colors and designs and is ideal for covering radio cabinets.

Plastic tiles are made by several manufacturers and can be purchased in small quantities. The Styron (polystyrene) tiles have low-loss properties and can be used for uhf gear. The tiles are not as rugged as thicker polystyrene would be, but I find that they are quite serviceable.—Art Trauffer

### CRYSTAL MARKER GENERATOR

A crystal marker generator is an indispensable item for the electronics experimenter and amateur radio station operator. Unfortunately a good one is expensive, some running into the hundreds of dollars. It is possible to build a medium-quality generator for less than \$2 (see diagram.) . . . Although overtone type crystals are not applicable in this circuit, it is a very worth-while addition to your equipment lineup.

RADIO-ELECTRONICS



#### ARKAY MODEL FL-5 HI-FI AMPLIFIER

Full 5 watt amplification for true Hi-Fi performance in average rooms. Accepts tuner or phono of your choice, provides unusual tonal realism. Freq. response 20-18,000 cps. at ±1.5 db. Uses 4 miniature tubes for low hum & noise level.

Cover \$1.50  
Fed. Excise Tax Incl.

**\$10.75**



#### ARKAY Model B-8 Hi-Fi Speaker System

Frequency Response: 10 to 20,000 cps. Crossover Frequency: 1600 cps. Power Rating: 25 watts. Impedance: 16 ohms. Features a bass reflex, ducted port enclosure with a low frequency speaker and a compression driven horn of special design. A variable balance control w/network provides smooth continuous adjustment of the H/F speaker

**\$35.95**

Federal Ex. Tax Incl.



#### ARKAY Model FL-30 HI-FI AMP- PRE-AMP

with transistorized front end

An acclaimed engineering masterpiece for use with variable reluctance pickup, assures you of finest high-gain low noise front end. Record equalization for more than 30 labels. Freq. response 10-40,000 cps. ±½ db. Power: 30 watts (40-watt peak). Features include 5 position balance control, 2 AC outlets, inputs for tuner, tape, phono, 2 Aux. tape output plus many exclusive engineering techniques. It's a real dream!

Model FL-30 Kit . . . . . \$49.95  
Wired and Tested \$74.95

#### NEW! ARKAY FM-8

#### FM TUNER

The ARKAY FM-8, the FM tuner that's the STANDARD OF THE PROFESSIONALS—designed for those desiring the very best in FM tuners. Accordingly, the FM-8 has only the very best of specifications: ARKAY "Miracle Ear" sensitivity—1.9uV for 20 db quieting; Frequency Response—20 to 20,000 cps; 7.5 microsecond de-emphasis control; 3 tuned RF stages; Dual limiters; Armstrong FM-Foster Seeley discriminator; Variable AFC; Silent tuning system—eliminates switch noise between stations; Tuning meter—VTVM circuit; 3 outputs—cathode follower, high level, and binaural FM (Multiplex); Level control on the output—Balance control on the tuning meter; 0-100 logging scale for pinpointing stations; Edge lighted slide rule dial; Self-contained AC power supply.

TRULY THE BUY OF THE CENTURY!  
Kit—\$39.95

Wired and Tested . . . . . \$59.95

#### NEW! ARKAY AM-5 AM TUNER

Fresh off the board, the AM-5 is the hottest AM tuner ever designed for HI-FI reproduction of the standard broadcast band. The new AM-5 has the most power-packed features to be found yet! Features like ARKAY "Miracle Ear" sensitivity—2uV for 20 db signal to noise ratio; Wide & narrow band reception (20 to 8500 cps. wide band, 20 to 3500 cps. narrow band); 3 section ramped tuning condenser; Tube Compliment—6BA6 RF amplifier, 6BE6 osc.-mixer, 6BA6 IF amplifier, 12AT7 detector—audio, 6X4 full wave rectifier. Audio output—1 volt, 10 kc. whistle filter to eliminate whistles caused by flats between adjacent stations.

Kit \$21.45

Wired and Tested . . . . . \$32.95

#### ARKAY HFT-7 AM-FM TUNER

4uV for 20 db S/N; Foster-Seeley Discr.; AM Loop Stick Ant.; Temp. Comp. Osc. Circuit; Tube Compl.—(2) 12AT7, (1) 6BE6, (1) 6BA6, (2) 6AU6, (1) 6AL5, sel. rect.

Kit \$32.00

Wired and Tested . . . . . \$49.95

#### ARKAY FM-6 FM TUNER

6uV for 20 db S/N; Foster-Seeley Discr.; Gr. Grid Front End; Temp. Comp. Osc. Circuit; 3 Double Tuned IF Stages; AFC plus defeat.

Kit \$25.75

Wired and Tested . . . . . \$44.95

Cover for Above Models \$3.95  
Fed. Ex. Tax Incl.

SEE 'N' HEAR the unmatched quality of the ARKAY line at your dealer. Ask for the new, big FREE CATALOGUE of AUDIO, HI-FI & TV units.

\*Prices 5% higher West of Miss.

# ARKAY · 120 Cedar Street · N.Y.

## Say you saw it in Radio-Electronics

Save time, money and worry . . .

### CONVERT YOUR STANDARD TEST PRODS

to a self-holding connector in seconds

with the handy, new E-Z HOOK TIP!

Frees Your Hands • Won't Slip Off • Shock-Proof

ORDER THROUGH YOUR PARTS DISTRIBUTOR



E-Z HOOK TEST PRODUCTS  
Dept. C, 1538 Woodburn Ave.  
Covington, Ky.

Pat No. 2702892

### LMB "SAL-MET"

LMB Presents The New

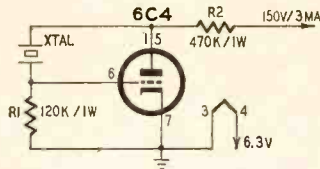
FREE 1957 CATALOG covering the full precision engineered line of original box chassis as manufactured by LMB including new Miniature, new Jiffy, new T.F., new Utility Boxes. Eleven different types, 160 different shapes and sizes. A ready reference for engineers, experimenters or anyone using metal boxes. Send for your FREE CATALOG now! "SAL-MET" Non-corrosive Flux—solders copper to aluminum, aluminum to aluminum, any metal to any metal using conventional solder and regular soldering methods. Send for both LMB and "SAL-MET" Catalogs.

LMB, 1011 Venice Blvd., Los Angeles 15, Calif.

**TRY THIS ONE**

(Continued)

All you need is a 6C4, a crystal to cover the desired frequency range, a miniature seven-pin socket, a bakelite board to mount the parts on and three alligator clips to hook it into a circuit. Power is obtained from the equipment being checked.



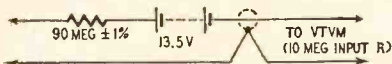
I have used this marker generator extensively in radio and TV service work with considerable success. Some applications and the fundamental crystals necessary are as follows.

1. Color TV receiver servicing: 3.579 mc.
2. AM broadcast receiver servicing: 455, 456, and 1400 or 1600 kc.
3. FM receiver servicing: 10.7 mc.
4. Conelrad marker: 640 or 1240 kc.
5. BFO for communications receiver: 1 kc higher or lower than if frequency of receiver for 1,000-cycle beat note; 2 kc for 2,000-cycle note, etc.
6. Amateur band marker: 3.5 mc crystal will mark lower end of the 80-, 40-, 20- and 10-meter bands.—Warren J. Smith.

**MEASURE HIGH RESISTANCES**

From time to time, arrangements for measuring extra-high resistance values with a vtvm have been described. Such setups use an external battery, and generally external resistors. All these arrangements are difficult to use because calculations are needed to find the value of resistance under test.

The vtvm can be made direct-reading by using the arrangement shown in the diagram and extra-high resistance values can be read directly on the ohm-meter scale. The accessory (which is now available commercially in probe form) utilizes a 13.5-volt battery and a 90-megohm precision resistor. When plugged into the vtvm in place of the conventional ohms lead, an extra-high  $R \times 10$  megohms range is provided. For example, if the last calibration on the ohms scale is 2,000, it becomes 20,000 megohms when the accessory arrangement is used.



The zero-ohms and infinity-adjust control operate exactly as if a conventional test lead were being used. You may find that operation appears erratic and that indication drifts when this accessory is attached. To stabilize the high-ohms indication, run a lead from the vtvm ground to a water-pipe ground and the difficulty will clear up.

If you choose to build your own high-ohms probe, remember that the insulation in the probe construction must be maintained unusually high to avoid leakage and inaccurate indication.—Robert G. Middleton. END

**LZX 280SW** (shown right)

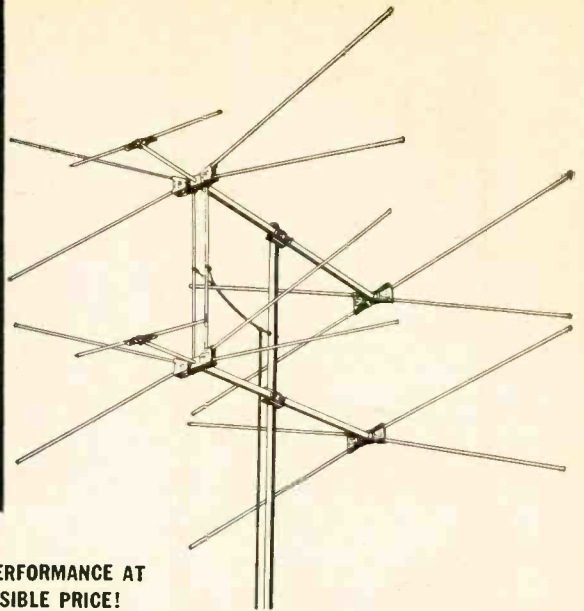
- QUICK-RIG design for speedy one man installation... Brand NEW!
- Double stacked array PLUS high frequency elements.
- All Aluminum Construction.
- Mounts on any mast up to 1 3/4"
- Complete with stacking bars.

(not shown)

**LZX 180SW**... same as 280SW (single stacked)

**LZX 180**... QUICK-RIG 8 element "Mighty-X" Conical.

**LZX 280**... QUICK-RIG double stacked "Mighty-X" Conical.

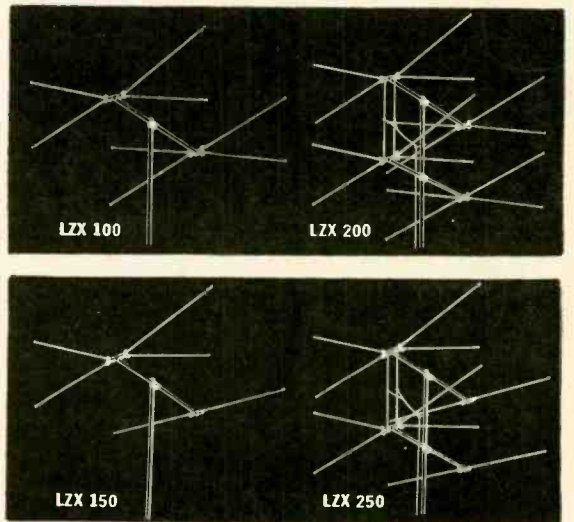


HIGHEST QUALITY PERFORMANCE AT THE LOWEST POSSIBLE PRICE!

# 12 new C-D TV antennas

Carefully tested under all conditions... each of these new models is guaranteed to be the best performing at the lowest possible price. QUICK-RIG... snap!! and its up.

- LZX 100 single array
- LZX 101 single array, unassembled
- LZX 200 8 element conical assembled, stacked array
- LZX 201 8 element conical unassembled, stacked array
- LZX 150 single array
- LZX 151 single array, unassembled
- LZX 250 6 element conical assembled, stacked array
- LZX 251 6 element conical unassembled stacked array



**CORNELL-DUBILIER**

Plants in South Plainfield, N. J.; New Bedford, Worcester and Cambridge, Mass.; Providence and Hope Valley, R. I.; Indianapolis, Ind.; Sanford, Varina and Fuquay Springs, N. C.; and Venice, California. Subsidiary: The Radiart Corporation, Cleveland, Ohio.



SERVICE MEN KNOW THERE IS JUST ONE

## HUSH

Reg. U.S. Pat. Off.

Chemically engineered for tuners and switching mechanism



Hush comes in a 6 oz. pressure can with sufficient pressure to reach all contacts to wash-away that dirt, leaving clean and positive contacts, protected with a lasting lubricant film.

**\$2.25 net**

Hush also available in 2 oz., 8 oz. and 32 oz. containers.

See your distributor or write to

## EVER-QUIET

Reg. U.S. Pat. Off. Pend.

Since 1949 the Original Volume Control and Contact Restorer



EVER-QUIET is a free-flowing liquid that leaves no powder residue. Scientifically designed to seep around the shaft and penetrate the control or potentiometer, cleaning and contacts and leaving a safe protecting film. Harmless to metals, wire or carbon. Will not affect inductance, capacitance or resistance.

2 oz. bottle with handy dispenser (32 oz. size available)

only **59c** Net

**CHEMICAL ELECTRONIC ENGINEERING, INC.** Matawan, New Jersey

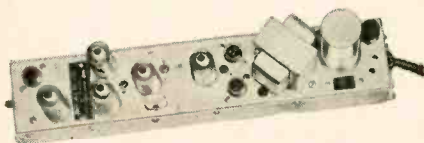
# 8 NEW B-T LABS PRODUCTS

... just a few of the many new B-T precision engineered products



## FIELD STRENGTH METER Model FSM-1

A portable precision instrument for accurate measurement of RF signals. Continuous tuning from 54 mc to 216 mc covering VHF-TV, FM, mobile, aircraft, ham, industrial and CD. Use of B-T UHF converter extends range to entire UHF band. **\$310 net**



## 3 MASTERLINE CRYSTAL-CONTROLLED CONVERTERS

- Model MVC: Hi-to-Lo channel VHF converter.
- Model MLC: Lo-to-Lo channel VHF converter.
- Model MUC: UHF to VHF converter.

**List \$300 Each**

Extremely stable, self-powered with two matched 75 ohm outputs. All channel VHF mixing network. Flat within 1/2 db over full 6 mc output. For color and black and white TV.

## 4 INDOOR TV SYSTEM TAPOFFS

Easy to install, matched low cost tapoffs

Model TO1-75: single isolated tapoff for recessed mounting. For RG-11/U or RG-59/U, with 75 ohm jack. **List \$4.50**

Model TO1-300: has 300 ohm terminals. **List \$4.50**

Model TO2-75: two 75 ohm outlets from RG-11/U or RG-59/U cable. **List \$9.00**

Model TO2-300: two 300 ohm isolated outlets from RG-11/U or RG-59/U cable. **List \$9.00**

sold by electronic parts distributors

for further information use coupon below

**BLONDER-TONGUE LABS, INC.**  
9-25 Alling Street, Newark 2, N. J. Dept. RE-8

Please send me literature covering:

- Field Strength Meter  Masterline Converters  
 Indoor TV System Tapoffs

Name.....

Address.....

City..... Zone..... State.....

# Patents



## 3-DIMENSIONAL CATHODE-RAY TUBE

Patent No. 2,749,480

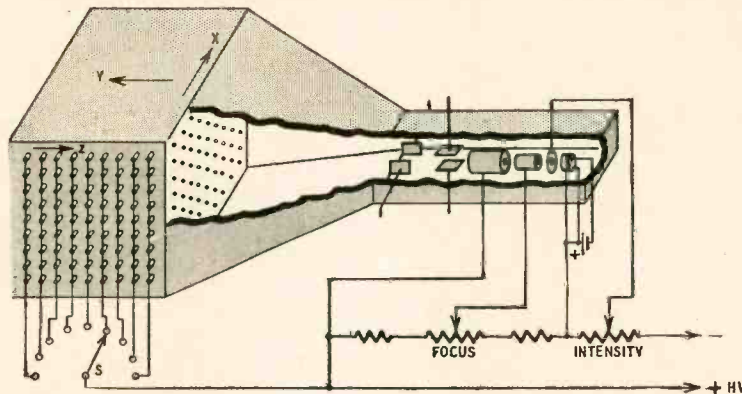
Martin Ruderfer, Kew Garden Hills, Flushing, N. Y.

This device appears crude, but it is a basic idea and may be the forerunner of 3-D television. It also has possibilities for displaying a radar target in true perspective.

The diagram shows a special cathode-ray tube. Its front end is filled with horizontal conductors. Some extend parallel to the tube axis and may be identified as Y rods. The electron beam can ter-

minate at any desired Y rod by suitable deflection. Other rods, perpendicular to the Y conductors, may be called X rods. These are energized (through switch S) by a high-voltage dc source.

Naturally, for 3-D television, a mechanical device cannot be used for S. This must be an electronic switch controlled by the TV signal. Such a switch will determine the depth of the



minate at any desired Y rod by suitable deflection. Other rods, perpendicular to the Y conductors, may be called X rods. These are energized (through switch S) by a high-voltage dc source. X and Y rods cross over close to each other so a breakdown and luminous discharge may occur where the particular rods are energized. In the

scanned image and it must operate instantaneously. The electron beam will function as in conventional kinescopes, being swept to scan the image line by line.

The patent does not disclose the exact means for obtaining the necessary luminous discharge, the electronic-switch design or other details.

## TWO-TONE AUDIO OSCILLATOR

Patent No. 2,761,909

Robert L. Wallace, Jr., Plainfield, N. J. (Assigned to Bell Telephone Labs., Inc., New York)

This generator is designed to replace the common bell for telephone ringing. Two audio oscillators are operated alternately and in rapid succession to generate a pleasing and distinctive signal. A transistor device, it requires little maintenance and power, and is compact.

Fig. 1 shows the telephone instrument across the line. Beyond are two Zener diodes D1 and D2, which are processed to absorb up to 50 volts. Being oppositely poled, they pass both positive and negative peaks. Voice signals and dial pulses are lower than 50 volts so these do not pass through the diodes. The ringing voltage is 90 volts at 20 cycles, so both negative and positive peaks are transmitted.

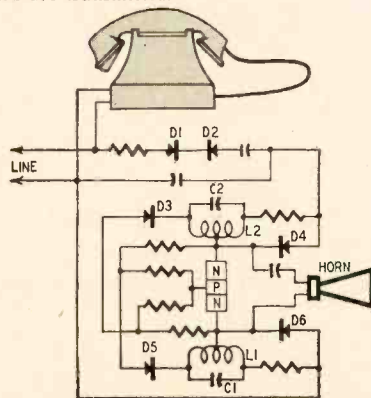


Fig. 1

The oscillators use a symmetrical n-p-n transistor. This semiconductor (because of special processing) passes current in either direction, depending upon which N-zone is biased negative and which is positive. Of course the negative N-zone acts as the emitter and the positive one as the collector.

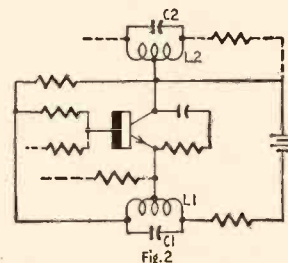


Fig. 2

The ringing current being ac, the oscillator will be supplied with alternating current peaks. Assume an instant when the upper line goes positive and the lower line is negative. D3 and D6 are blocked while D4 and D5 conduct. With these facts in mind, the circuit may now be simplified (see Fig. 2) during this instant. We have a conventional Hartley oscillator with the transistor biased so its upper N-zone acts as a collector and the lower N-zone as emitter. The output frequency is now determined by the tuning of L1-C1.

During the next half-cycle, the transistor is oppositely polarized and the oscillator frequency will be determined by L2-C2, which is tuned to a different audio frequency.

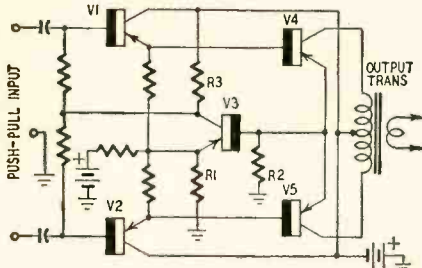
**COMPENSATED CLASS-B AMPLIFIER**

Patent No. 2,761,917

Albert I. Aronson, Collingswood, N. J. (Assigned to RCA)

It is good practice to compensate a transistor amplifier against temperature changes. In a class-B circuit this is a problem because the average output current varies with the signal. Therefore, one cannot use the simple compensation circuits commonly applied to class-A circuits. Here a control transistor, immune to signal variations, is used to guard against temperature changes.

V1 and V2 constitute a common-collector driver coupled to a common-emitter output stage, V4 and V5. Both are class B. A common collector does not reverse phase, so both class-B stages are driven in phase. For example, V1 and V4 conduct at the same instant.



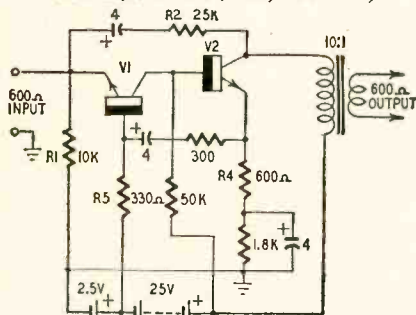
V3 is a control transistor with its bias determined largely by currents through R1 and R2. These resistors carry currents to the driver and output stage, respectively. These resistors are chosen so that they generate equal voltages. As the net bias at V3 is zero, this transistor is immune to changes resulting from the signal itself.

Since the output stage passes much more current than the driver, it is more seriously affected by temperature. For example, a rise in temperature causes a higher voltage across R2 than across R1. The V3 base goes more negative than its emitter, and conduction is increased. The increased drop across R3 appears as more positive bias on the driver bases. Collector output from both driver and output stages is reduced. This compensates for increased current due to temperature rise.

**WIDE-BAND TRANSISTOR AMPLIFIER**

Patent No. 2,760,007

John C. Lozier, Short Hills, N. J. (Assigned to Bell Telephone Labs, Inc., New York)



This transistor amplifier is designed for carrier telephony. Its response must be flat from 10 to 100 kc and its gain should be approximately 20 db. These requirements are met by combining a common-base stage with a common emitter. Two feedback paths are used to reduce distortion and increase frequency band.

The low input impedance of a common-base stage gives it a good match to a 600-ohm source. Furthermore, this circuit has an excellent frequency response. Desirable characteristics of the second-stage common emitter are high gain and high input impedance. Also, its output impedance is high, necessitating a transformer to reduce it to line impedance—600 ohms.

R1 passes bias current into V1 which (like V2) is an n-p-n transistor and may be type M1752. Overall negative feedback occurs through R2. R4 and R5 carry, respectively, the amplified output and the input signal currents, which are out of phase. A feedback network couples R4 and R5 for desired degeneration.

END

**NEW AUTOMATION PUNCHED CARD TV TUBE TESTER**

**PROVED!**

IN OVER 1 1/2 MILLION TUBE TESTS!



Smallest, lightest tube tester ever made!



Model DM456

Speed-test complete set of tubes in minutes with the new DynaMatic Tube Tester

- So simple to use—a customer can operate it!
- LIGHTEST and SMALLEST Gm tester available. Take it on ALL house calls.
- Perforated plastic cards set up socket pin connections and test voltages.
- Permits full-complement tube testing.
- DynaMatic is a dynamic mutual conductance tester—NOT an emission checker.
- Accurately measures mutual conductance in micromhos on 2 ranges. 0-6000, 0-18000.
- Also checks battery tubes

Dealer Net

**149<sup>95</sup>**

**IMMEDIATE DELIVERY!**



136-10 31st Road, Flushing 54, N. Y.

**TAPE RECORDERS**

Tapes—Accessories  
Nationally Advertised Brands  
**UNUSUAL VALUES**  
Send for Free Catalog  
**DRESSNER**  
69-02 RE: 174 St.  
Flushing 65, N. Y.



**FREE! COMIC AD CARD KIT**

**FREE CATALOG TOO!**—shows our complete line of TV Service Reports, Call Books, Phone Message Books, Job Tickets, Service Pricing Guide, File Systems, Service Contracts, Parts Warranties, P O Forms, Statement Books, Label Books, Sketch Pads, Cash Books, etc. See them at your parts jobber. **WRITE NOW!**  
4308 Milwaukee Ave.  
Chicago 41, Illinois

**Oelrich Publications**

**INVENTORS**

Send for **PATENT INFORMATION**  
Book and **INVENTORS RECORD**  
without obligation  
**GUSTAVE MILLER**  
87-RE WARNER BUILDING  
WASHINGTON 4, D. C.

**REGISTERED PATENT ATTORNEY**  
**ASSOCIATE EXAMINER**  
U.S. PAT. OFF. 1922-1929  
Patent Attorney & Advisor  
U.S. Navy Dept. 1930-1947  
**PATENT LAWYER**



And they have the finest features and specs. Fully illustrated step-by-step 28-page manual makes assembly a snap! **WRITE FOR FREE CATALOG!** Add 10% for Federal Tax.  
**QUALITY ELECTRONICS**  
319 Church Street Dept. RE-8 New York 13, N. Y.

another



quality  
engineered  
product



*all channel UHF converter*

Model 99 is your best buy in a UHF converter. Features include tuned input, precise impedance match, UL approval, one-knob tuning and drift-free performance. Largest selling UHF converter in the country at \$19.95 list...In difficult reception areas use the BTU-2.....only \$39.95

another



quality  
engineered  
product



*2 - set coupler*

Model TV-42 a 2-set coupler approved for color, UHF, VHF and FM. Matched resistive circuit with 12db interset isolation and flat response—0-900 megacycles. Another quality TV accessory engineered by B-T Labs.....\$2.95 list

Sold by electronic parts distributors  
for further information  
use coupon below

BLONDER-TONGUE LABS, INC. RE-8  
9-25 Alling Street, Newark 2, N. J.

Please send me literature covering

B-T TV Accessories

Name.....

Address.....

City..... Zone..... State.....

# technical Literature



### FUSES

A large variety of fuses and their specifications are described in *Catalog 56*. Of particular interest is a line of fuses that contain a neon bulb. When the fuse blows, the bulb lights.

*Sightmaster Corp., 111 Cedar St., New Rochelle, N. Y.*

### TRANSFORMERS, CHOKES AND COILS

This 1957 catalog *TR-57* describes and illustrates over 700 transformers. New items include toroids, pulse, transistor, hermetically sealed, geophysical, power, filament and audio transformers, chokes and television components.

*Triad Transformer Corp., 4055 Redwood Ave., Venice, Calif.*

### PUBLICATION INDEX

March, 1957 index lists RETMA-recommended standards and engineering publications and their prices. Publications are classified numerically and alphabetically.

RETMA Engineering Office, Room 650, 11 W. 42 St., New York 36, N. Y.

### TAPE RECORDINGS

Vol. 1 of this manufacturer's 1957 catalog, a comprehensive catalog of all recorded tapes available from the concern, features stereophonic and monaural recordings.

*Livingston Audio Products Corp., Livingston, N. J.*

### LOGLIFE TUBES

This illustrated 24-page booklet highlights Ericsson 10,000-hour electron tubes. Complete characteristics, including basing diagrams, typical operation ratings, etc., are given.

*State Labs Inc., 649 Broadway, New York 13, N. Y.*

### RESISTORS AND RHEOSTATS

This illustrated multicolor catalog lists the manufacturer's complete line. A section on resistor selection data is included and many power resistors and rheostats are described.

*Tru-Ohm Products, 2800 N. Milwaukee Ave., Chicago 18, Ill.*

### RETMA STANDARDS

Three new standards have been published. *RS-180, Power Transformers for Electronic Equipment*, from *Standards Proposal No. 510*, a revision of *TR-102-B*; *RS-184, Drive Pulleys*, from *Standards Proposal No. 527*, a revision of *REC-102-A*; *RS-186, Standard Test*

*New profit-builder for you...*

# Metaltone... Metaltone\* Trade Mark

*the new kind of sprayhammer finish paint*

...sprays a hammered-metal-looking finish on wood, leather, metal, etc.

- \* PROTECTS...flexible coating resistant to water, acids, alkali, corrosion.
- \* GREAT DO-IT-YOURSELF item for home, car, crafts, workshop, furniture, appliances, etc.



### FULL 40% PROFIT

Six beautiful colors...Silver, Blue, Copper, Charcoal Gray, Golden Chartreuse, Green...and Clear Plastic. Assorted colors packed in special counter display carton.

Suggested list .....\$21.48 Doz.  
Your cost .....\$12.89 Doz.  
40% PROFIT FOR YOU ...\$ 8.59 Doz.

Also packed in solid colors in plain shipper.

Ask your local distributor or write for further information about METALTONE.

**FLAMEMASTER CHEMICALS, INC.**

*Division of Ideal Chemical Products, Inc., Culver City, Calif.*



TECHNICAL LITERATURE

Methods for Electronic Equipment, from Standards Proposals No. 467 and 497.

RETMA, Engineering Dept., 650 Salmon Tower, 11 W. 42 St., New York, N. Y. RS-180, 50¢; RS-184, 25¢ and RS-186, \$1.10.

TANTALUM CAPACITORS

Bulletin 148B contains details of new ultra-small capacitors designed for transistor circuits. The S size is only 3/16 inch long and 5/64 inch in diameter.

Ohmite Manufacturing Co., 3601 Howard St., Skokie, Ill.

REFERENCE CHART

Ceramicon Data Chart, a plastic card 7 5/8 x 4 1/8 inches, shows dielectric qualities and temperature coefficients of tubular and disk ceramic capacitors and maximum available capacitances.

Erie Resistor Corp., Electronics Div., Erie, Pa.

TRANSFORMERS AND COILS

Supplement to Catalog 5611 lists many kinds of transformers and coils for radio, TV and industrial applications. Its 24 pages are well illustrated.

Merit Coil and Transformer Corp., 4427 N. Clark St., Chicago 40, Ill.

GENERAL EQUIPMENT

Catalog No. 58 describes a line of nearly 1,000 different replacement parts for radio and TV sets. It contains list-

(Continued)

ings of rf chokes, line filters, if transformers, industrial coils and other parts.

J. W. Miller Co., 5917 S. Main St., Los Angeles 3, Calif.

PRICING DIGEST

Spring and Summer, 1957 is a detailed guide to flat-rate and hourly service charges and component prices for TV and radio servicing. It is based on regional and national averages.

Electronic Publishing Co., Inc., 180 N. Wacker Drive, Chicago 6, Ill. \$2.50

CONTROLS AND RESISTORS

Illustrated Catalog No. 57 offers a comprehensive listing of many types of controls, potentiometers, resistors and switches. It describes, also, some ballast tubes and line-voltage regulators.

Clarostat Manufacturing Co., Inc., Dover, N. H.

ENCLOSURES

High-fidelity speaker enclosures are featured in a new illustrated catalog that offers both factory-built units and prefinished kits.

Argos Products Co., 310 Main St., Genoa, Ill. END

Any or all of these catalogs, bulletins, or periodicals are available to you on request direct to the manufacturers, whose addresses are listed at the end of each item. Use your letterhead—do not use postcards. To facilitate identification, mention the issue and page of RADIO-ELECTRONICS on which the item appears. UNLESS OTHERWISE ETATED, ALL ITEMS ARE GRAT. ALL LITERATURE OFFERS ARE VOID AFTER SIX MONTHS.

Another Sencore Time-Saver

the ALL NEW SENCORE Align-O-Pak TV BIAS SUPPLY



For BLACK and WHITE and COLOR

Just Dial any DC Voltage from 0 to 18 volts positive or negative—For AGC trouble shooting and alignment—Do away with messy bias batteries.

Completely isolated. Recommended by TV manufacturers. Wire wound control for calibration accuracy. For AGC trouble shooting, connect to AGC buss and vary voltage from 0 to 18 volts negative. If picture stabilizes at any voltage, AGC is defective. Complete with test leads.

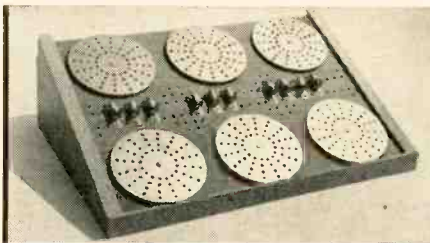
MODEL BE3 \$785 Dealer Net Leather Carrying Case...\$2.95

Mfg by SERVICE INSTRUMENTS CORP. 171 OFFICIAL RD. ADDISON, ILL.

POPULAR SENCORE PRODUCTS

- Transistor Tester
- Leakage Checker
- Filament Tester
- Handy "36"
- Vibra-Dapter

Can you think faster than this Machine?



Control Panel of GENIAC set up to do a problem in check valve research.

Be careful before you answer. GENIAC the first electrical brain construction kit is equipped to play tic-tac-toe, cipher and encipher codes, convert from binary to decimal, reason (in syllogisms) as well as add, subtract, multiply and divide. Specific problems in a variety of fields—actuarial, policy claim settlement, physics, etc., can be set up and solved with the components. Connections are solderless and are completely explained with templates in the manual. This covers 33 circuits and shows how new ones can be designed.

You will find building and using GENIACs a wonderful experience; one kit user wrote us: "This kit has opened up a new world of thinking for me." You actually see how computing, problem solving, and game play (Tic-tac-toe, nim, etc.) can be analyzed with Boolean Algebra and the algebraic solutions transformed directly into circuit diagrams. You create from over 400 specially designed and manufactured components a machine that solves problems faster than you can express them.

Schools and colleges, teachers of science or math, engineering, philosophy or psychology will find these excellent demonstrators of circuitry, solutions in symbolic logic, theory of numbers, cybernetics, and automation.

Note: Teachers take advantage of our 10% discount to educational institutions and for group purchases.

SEND for your GENIAC kit now. Only \$19.95 with over four hundred components and parts, fully illustrated manual and wiring diagrams. We guarantee that if you do not want to keep GENIAC after one week you can return it for full refund plus shipping costs.

MAIL THIS COUPON

SCIENCE KITS, Dept. RE87A, Oliver Garfield Co. 126 Lexington Ave., N.Y. 16, N.Y.

Please send me:

1 GENIAC Electric Brain Construction Kit and Manual. \$19.95 (East of Mississippi) .....

\$20.95 (Elsewhere in United States) .....

\$21.95 (Outside the United States) .....

Returnable in seven days for full refund if not satisfied. I enclose \$..... in full payment. My name and address are attached.

BUILD THE BEST— BUILD ALLIED'S OWN knight-kits

Here is a typical Knight-Kit value—available only from ALLIED—one of 45 great Knight-Kits you'll find in our special Supplement No. 165. Write for your FREE copy today.

knight-kit INSTRUMENT VALUE PRINTED CIRCUIT VTVM KIT



Model Y-125 \$24<sup>95</sup>

Tops for stability, accuracy and value. Greatly simplified wiring—entire chassis is a printed circuit board. Uses low-leakage switches; 1% film-type precision resistors. Balanced-bridge, push-pull circuit permits switching to any range without adjusting zero set. SPECIFICATIONS: Easy-to-read 4 1/2" meter with sensitive 200 microamp movement. Zero-center scale and direct-reading db scale. Polarity reversing switch. Response, 30 cycles to 3 mc. Input resistance, 11 megs. Ranges: AC peak-to-peak volts, 0-4-14-40-140-400-1400-4000; AC rms v. and DC v., 0-1.5-5-15-50-150-500-1500; ohms, 0-1000-10K-100K; 1-10-100-1000 megs; db scale, -10 to +5. Complete, including battery and test leads. Size, 7 3/4 x 5 1/4 x 4 1/4". Shpg. wt., 7 lbs.

Model Y-125, Net, F.O.B. Chicago. . . . \$24<sup>95</sup>

OTHER knight-kit INSTRUMENT VALUES

 20,000 OHMS/VOLT VOM KIT Y-140 \$29 <sup>50</sup>	 1000 OHMS/VOLT VOM KIT Y-128 \$16 <sup>95</sup>
 TUBE CHECKER KIT Y-143 \$29 <sup>75</sup>	 RF SIGNAL GENERATOR KIT Y-145 \$19 <sup>75</sup>

See our Supplement No. 165 for 18 other knight-kit instrument values

free SUPPLEMENT featuring knight-kits

Send for our FREE Supplement No. 165 featuring 45 great Knight-Kits, including Test Instruments, Hi-Fi, Hobbyist and Amateur Kits. Write for your copy today.

ORDER FROM ALLIED RADIO

Dpt. O2-H-7, 100 N. Western Ave., Chicago 80, Ill.

# COMPLETE TRAINING FOR BETTER RADIO-TV SERVICE JOBS



Let these two world-famous Ghirardi training books teach you to handle all types of AM, FM and TV service jobs by approved professional methods—and watch your efficiency and earnings soar!

Completely modern, profusely illustrated and written so you can easily understand every word, these books pave the way to fast, accurate service on any type of home radio-TV-electronic equipment ever made. Each book contains the latest data on the latest methods and equipment—NOT a relish of old, out-of-date material. Each is co-authored by A. A. Ghirardi whose famous RADIO PHYSICS COURSE and MODERN RADIO SERVICE were, for 20 years, more widely used for military, school and home study training than any other books of their type!

## THE NEW Ghirardi

### RADIO-TV SERVICE LIBRARY

Almost 1500 pages and over 800 clear illustrations show step-by-step how to handle every phase of modern trouble-shooting and servicing.

#### 1—Radio and Television Receiver TROUBLESHOOTING & REPAIR

A complete guide to profitable professional methods. For the novice, it is a comprehensive training course. For the experienced serviceman, it is a quick way to "brush up" on specific jobs, to develop improved techniques or to find fast answers to puzzling service problems. Includes invaluable "step-by-step" service charts. 820 pages, 417 illus., price \$7.50 separately. See combination offer!

#### 2—Radio and Television Receiver CIRCUITRY AND OPERATION

This 669-page volume is the ideal guide for servicemen who realize it pays to know what really makes modern radio-TV receivers "tick" and why. Gives a complete understanding of basic circuits and circuit variations; how to recognize them at a glance; how to eliminate guesswork and useless testing in servicing them. 417 illus. Price separately \$6.75.

#### New low price... You Save \$1.25!

If broken into lesson form and sent to you as a "course," you'd regard these two great books as a bargain at \$50 or more! Together, they form a complete modern servicing library to help you work faster, more efficiently and more profitably.

Under this offer you buy them both for only \$13.00. You save \$1.25 on the price of the two books—and have the privilege of paying in easy installments while you use them.

#### 10-DAY FREE TRIAL

Dept. RE-87, RINEHART & CO., Inc.,  
232 Madison Ave., New York 16, N. Y.

Send book(s) below for 10-day FREE EXAMINATION. In 10 days, I will either remit price indicated (plus postage) or return books postpaid and owe you nothing.

- Radio & TV Receiver TROUBLESHOOTING & REPAIR, (Price \$7.50 separately)
- Radio & TV Receiver CIRCUITRY & OPERATION (Price \$6.75 separately)

Check here for MONEY-SAVING COMBINATION OFFER. Save \$1.25.

Send both of above big books at special price of only \$13.00 for the two (regular price \$14.25). You save \$1.25. Payable at rate of \$4 (plus postage) after 10 days if you decide to keep books and \$3 a month thereafter until \$13 has been paid.

Name.....

Address.....

City, Zone, State.....

Outside U.S.A.—\$8 for TROUBLESHOOTING & REPAIR; \$7.25 for CIRCUITRY & OPERATION; \$14 for both. Cash with order only, but same 10 day return privilege.

# Books



**FREQUENCY MODULATION**, by L. B. Arguimbau and R. D. Stuart. John Wiley & Sons, Inc., 440 Fourth Ave., New York 16, N. Y. 4 1/8 x 6 1/2 inches, 96 pages. \$2.

The fundamental principles of FM, aided by equations and diagrams, are given in this pocket-sized booklet. Chapters on transmitters and receivers cover such topics as: reactance tubes, automatic control, phase modulation, discriminators, limiters. Noise reduction of FM is treated in another chapter. This also shows how good receiver design can result in minimum noise.

A good, concise book if you like the "shorthand" of mathematical formulas.

**ATTENUATORS EQUALIZERS AND FILTERS**, by Howard M. Tremaine and George K. Tefteau. Howard W. Sams & Co., Inc., Indianapolis 5, Ind. 5 1/2 x 8 1/2 inches. 176 pages. \$2.75.

Some calculations are necessary when designing or testing filters and pads.

In this book, the work has been simplified as much as possible. Formulas for attenuators, equalizers and filters are given and examples are shown. The author tells how these networks are used and what they accomplish. Tables, charts and graphs help out.

Specialized networks such as those used in tape, film and disc recording and playback are described. The filter section covers low- and high-pass, band-pass and crossover circuits.

**COLOR TELEVISION FUNDAMENTALS**, by Milton S. Kiver. McGraw-Hill Book Co., Inc., New York, N. Y. 6 x 9 inches, 312 pages, \$6.

A guide to the basic principles of color television and color television receivers. Prior knowledge of monochrome TV is necessary.—LS

**SERVICING TV SWEEP SYSTEMS**, by Jesse Dines. Howard W. Sams & Co., Inc., Indianapolis 5, Ind. 5 1/2 x 8 1/2 inches, 212 pages. \$2.75.

Many technicians feel that TV sweep circuits are probably the most difficult to understand and the place where many complicated troubles originate. This book tackles the subject with vigor and does a commendable job.

All circuits remotely connected with sweep are dealt with in detail. High-voltage generation, flyback transformers, yokes, width and linearity coils are discussed. Not only are the functions of



**MERIT DOES NOT carry water on both shoulders MERIT SELLS**

its entire Production to Independent Electronic Parts Distributors for re-sale to Independent Service Dealers!

## MERIT

MERIT COIL & TRANSFORMER CORP.

4427 N. CLARK ST., CHICAGO 40, ILLINOIS

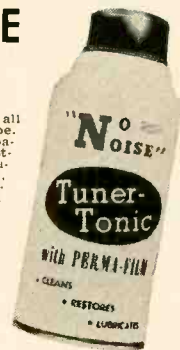
## BEWARE OF IMITATIONS

There Is Only One Original, Dependable

### NO-NOISE Tuner-Tonic with PERMA-FILM

Cleans, lubricates, restores all tuners, including water type. Won't change or affect capacities, inductance or resistance. Won't harm insulations or precious metals. Nor attack plastics. Eliminates all noise, oxidation and dirt indefinitely. For television, radio and FM.

Non-toxic, non-inflammatory, insures trouble-free performance. 6 oz. Acrosol Can. Net to servicemen. **\$3.25**



Extra economical because a small amount does the job! And does it well!

Volume Control and Contact Restorer with Perma-Film

Cleans, lubricates, protects... NOT A CARBON-TET SOLUTION. Still available in the new 6 oz. spray can. Net to servicemen.....**\$2.25**



## "NO-NOISE"

2 oz. bottle. Net to servicemen. **\$1.00**

Also available in 8 oz. bottles and quart cans.

At Your Nearest Distributor

**ELECTRONIC CHEMICAL CORP.**  
813 Communipaw Avenue Jersey City 4, N. J.

circuits and components described, but much space is devoted to troubleshooting these sections. A chapter covers service hints and adjustments for optimum performance.

**PROFITABLE RADIO TROUBLESHOOTING**, by William Marcus and Alex Levy. McGraw-Hill Book Co., Inc., New York, N.Y. 6x9 inches, 330 pages. \$5.95.

Definitely not just another theory book, this is for service technicians who wish to increase their efficiency and earning power. To this end, it shows how to speed diagnosis and shorten repair time. Special emphasis is placed on the tougher problems, intermittents, noise, distortion and weak reception. Several chapters describe effective use of the oscilloscope, vtvm and signal generator.

Many technicians are strong on radio, weak on business. For them the authors tell how to attract and keep customers, how to keep records and figure service charges. Also, the reader learns how to note customer's complaints for a clue to possible defects in the set.—IQ

**KEY CHECK POINTS IN TV RECEIVERS**, Howard W. Sams & Co., Inc., Indianapolis 5, Ind. Booklet KCP-1, 165 pages. KCP-2, 158 pages. Each 5½ x 8½ inches, 2.

All TV receivers are built for the same purpose—to display images. But

(Continued)

each differs as to tubes, circuits, voltages, components. Therefore voltages and waveforms from one set cannot be compared with another if the sets are not the same model.

This manual lists key voltages and illustrates correct waveforms from normal receivers. These can be used to check quickly other sets of the same model. An index gives sets by manufacturer and model number. Plate voltages, high voltage, waveforms at key points, are given for each set.

KCP-1 covers sets produced in late 1951 and during 1952. KCP-2 covers models of late 1952 and into 1953.—IQ

**HOW TO USE A TAPE RECORDER**, by Dick Hodgson and H. Jay Bullen, Hastings House, Inc., 41 E. 50 St., New York 22, N. Y. 5½ x 8¼ inches, 216 pages. \$4.95.

Little need be said on how to operate a tape recorder, it is that simple. However, the machine has many diverse and important applications that should be known for maximum satisfaction and benefit to the owner. The authors have spent considerable time and effort with tape recorders, and they describe many little-known uses for them.

Among the wide variety of ideas are many useful in classrooms and clubrooms, at parties and games and as aids for interviewing and selling. The book tells how to take care of a recorder and (for those who have not yet made

■ "High fidelity" might be defined as the precision reproduction of music by a system of specialist-built components. Among these components—amplifiers, radio tuners, record players—nowhere is precision workmanship more important than it is in the loudspeaker.

■ Consider the function of a loudspeaker. It must vibrate at exactly the same frequency as the electrical signal fed to it by the amplifier. This frequency may vary from 30 to as many as 15,000 times a second! Consider that now we are not dealing with electrons of negligible mass, neither are we working with a tiny phonograph stylus; in a loudspeaker we must control the actual physical movement of a considerable mass of metal and fiber. A moment's reflection will show that in this component precision workmanship is all important.

■ JBL Signature Speakers made by James B. Lansing Sound, Inc., are made with that degree of precision usually associated with scientific instruments or navigational chronometers. Perhaps they should not be called "loudspeakers" at all, but should be given the more technically correct appellation: precision transducers. No matter how difficult the manufacturing operation, if a refinement will result in better sound, it is built into JBL Signature Loudspeakers.

The place to see and hear JBL Signature units is in the component demonstration room of the authorized JBL Signature High Fidelity Sound Specialist in your community.

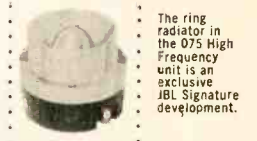


Only JBL Signature speakers are made with 4" voice coils... such as the 15" JBL D130 Extended Range unit.

Only the JBL Signature D123 is made with a frame so shallow that it may be mounted flush with wall surface.

Only JBL Signature High Frequency components are made with acoustical lenses for smooth treble distribution.

*in a high fidelity loudspeaker*  
**PRECISION**  
*...is the measure of*  
**QUALITY**



The ring radiator in the 075 High Frequency unit is an exclusive JBL Signature development.



Most handsome and versatile speaker enclosure made—the JBL Signature Marlan.



Universally acclaimed first choice for high fidelity "Dream Set"—the JBL Signature Hartfield.



Most popular enclosure—the JBL Signature Model C34 back-loaded folded horn.



Speakers of the highest precision bear this trademark. "JBL" means James B. Lansing Sound, Inc.

For his name and address, write to:  
**James B. Lansing Sound, Inc.**  
2439 Fletcher Drive • Los Angeles 39, Calif.

**THE QUICK EASY WAY TO FIGURE SERVICE CHARGES...**

*Pure Riee's* **OFFICIAL PRICING DIGEST**  
Spring-Summer Edition

Flat rate and hourly service charges, based on and showing regional and national averages, plus up-to-date list or resale prices on over 60,000 components. Arranged alphabetically by manufacturers and products, numerically by part number. Compact, convenient size fits in tube caddy, toolbox or pocket. \$2.50 per copy from your distributor.



**ELECTRONIC PUBLISHING COMPANY, INC.**  
180 NORTH WACKER DRIVE  
CHICAGO 6, ILLINOIS

**COYNE**  
TRAINS YOU IN SPARE TIME AT HOME

**COYNE QUALITY TRAINING AT LOWEST COST**

**TELEVISION**  
RADIO - COLOR TV

Only from famous COYNE do you get this modern up-to-the minute TV Home Training. Easy to follow instructions—fully illustrated with 2150 photos and diagrams. Not an old Radio Course with Television tacked on. Includes UHF and COLOR TV. Personal guidance by Coyne Staff. *Practical Job Guides* to help you **EARN MONEY QUICKLY IN A TV-RADIO SALES AND SERVICE BUSINESS—part time or full time. COSTS MUCH LESS—pay only for training—no costly "put together kits."**

**SEND COUPON FOR FREE BOOK**  
SEND COUPON BELOW for *Free Book* and full details including **EASY PAYMENT PLAN. NO COST OR OBLIGATION—NO SALESMAN WILL CALL.**

B. W. COOKE, Jr., **COYNE** FOUNDED 1899  
Pres. **ELECTRICAL SCHOOL**

**A TECHNICAL TRADE INSTITUTE OPERATED NOT FOR PROFIT**  
500 S. Paulina, Dept. C7-HT4, Chicago 12, Illinois

**COYNE ELECTRICAL SCHOOL**  
Television Home Training Div.  
500 S. Paulina St., Chicago 12, Ill., Dept. C7-HT4  
Send **FREE BOOK** and details of your Television Home Training offer.

Name \_\_\_\_\_  
Address \_\_\_\_\_  
City \_\_\_\_\_ State \_\_\_\_\_

# BUILD THE BEST— BUILD ALLIED'S OWN knight-kits

Here is a typical Knight-Kit value—available only from ALLIED—one of 45 great Knight-Kits you'll find in our special Supplement No. 165. Write for your FREE copy today.

## knight-kit HOBBYIST VALUE PHOTO-ELECTRONIC RELAY KIT



Model Y-702 \$13.50

Build your own modern, dependable photo-electric system at low cost! System consists of relay kit and light source. Ideal as counter, announcer, burglar alarm (can be set to ring bell continuously when beam is broken) and for hundreds of other uses. An ultra-sensitive system, easy to assemble and capable of professional results.

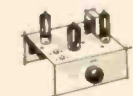
*Relay Kit Only.* SPST contacts, rated 1 amp. Supplies 6.3 v. at 0.6 amps for alarm, counter, etc. Max. counting rate: 600 per minute. Uses sensitive cadmium selenide photocell. Usable distance from light source below: White, 250 ft.; deep-red filter, 125 ft. With 5696 thyratron tube. Size, 5 x 3 x 5". Shpg. wt., 2½ lbs.

Model Y-702. Net, F.O.B. Chicago... \$13.50

*Light Source Kit Only.* Sealed-beam bulb; capped filament; removable dark red filter. 6 x 6 x 4". Shpg. wt., 3½ lbs.

Model Y-703. Net, F.O.B. Chicago... \$6.75

## OTHER knight-kit HOBBYIST VALUES



WIRELESS BROADCASTER KIT  
Y-705 \$9.50



50 W/SEC. ELECTRONIC PHOTOFLASH KIT  
Y-244 \$28.50



PHONO AMPLIFIER KIT  
Y-790 \$8.95



PHONO OSCILLATOR KIT  
Y-760 \$5.85

See our Supplement No. 165 for 12 other knight-kit hobbyist values

## free SUPPLEMENT featuring knight-kits



Send for our FREE Supplement No. 165 featuring 45 great Knight-Kits, including Test Instruments, Hi-Fi, Hobbyist and Amateur Kits. Write for your copy today.

## ORDER FROM ALLIED RADIO

Dpt. O2-H-7, 100 N. Western Ave., Chicago 80, Ill.

## BOOKS

(Continued)

their purchase) how to select a suitable model.

**TV PICTURE TUBES**, by Ira Remer. John F. Rider, Publisher, Inc., 116 W. 14 St., New York 11, N. Y. 5½ x 8½ inches, 154 pages. \$2.40.

A picture tube is one of many components in a receiver, but it certainly merits a complete book in itself. The tube is an expensive item, it has a considerable effect on picture quality and must be properly handled and connected to avoid damage or injury. This book compares different types, lists their mechanical and electrical characteristics and tells how to install them properly. Related subjects such as pincushion magnets, ion traps, focus coils and yokes are discussed in full detail.

There is useful information on tube rejuvenation, repair of intermittent heaters and safety precautions to be taken in handling and disposing of tubes. A short chapter is devoted to color tubes.—IQ

**VACUUM-TUBE CIRCUITS AND TRANSISTORS** by Lawrence B. Arguimbau, transistor contributions by Richard B. Alder. John Wiley & Sons, Inc., New York, N. Y. 9½ x 6 inches, 646 pages, \$10.25.

Primarily concerned with circuitry rather than the physics of the electronic devices used in the circuits this book is written so that the beginner can easily understand its contents. Formalized mathematics are avoided wherever possible, and each chapter starts with simple material and works up into advanced points of view. Many circuits are described. Diode and rectifier, triode, pentode, transistor, power amplifier, oscillator, television and transit-time circuits are among those included.—LS

**TRIGONOMETRY** (629 pages); **CALCULUS** (431 pages), by A. A. Klaf. Dover Publications, Inc., New York, N. Y. 5½ x 8 inches. Each \$1.95.

Each of the above is a "refresher" course for technical readers. Written in question-and-answer style, so bright students may also find them suitable for self-learning. Specific problems are worked out step by step. Other problems are given for the reader to solve with answers at the end of the book. Many pages of formulas and tables appear in both texts.

*Trigonometry* covers both plane and spherical, with emphasis on logarithms, vectors and complex numbers. These topics are essential to a clear understanding of ac theory, the slide rule, transmission lines, etc.

*Calculus* begins with the theory of limits and growth, and includes exponents, differentiation and integration. It ends with an introduction to differential equations. Several applications dealing with electrical circuits are illustrated.—IQ

END

# SCHOOL

## ENGINEERING DEGREES

UNDER AND POSTGRADUATE

E.E.

Option Electronics

Earned through  
**HOME STUDY**

Residence Classes Also Available

PACIFIC INTERNATIONAL UNIVERSITY

5719-M, Santa Monica Blvd., Hollywood 38, Calif.



PACIFIC INTERNATIONAL UNIVERSITY

LET RCA TRAIN YOU FOR A LIFETIME CAREER IN



ADVANCED ELECTRONICS TELEVISION

Resident classes, day and evening, start September 3rd, November 26th, 1957, and February 25th, May 20th, 1958. Free graduate placement service. Approved for Veterans. Send for free catalog now.

RCA INSTITUTES, INC.

A Service of Radio Corporation of America  
350 West 4th St., New York 14, N. Y.



## ELECTRONICS

PREPARE FOR A GOOD JOB!  
BROADCAST ENGINEER  
RADIO SERVICING AUTOMATION

TELEVISION SERVICING  
BLACK & WHITE—COLOR

APPROVED FOR VETERANS AND SURVIVORS OF VETERANS  
BUILDING AIR CONDITIONED  
SEND FOR FREE LITERATURE

BALTIMORE TECHNICAL INSTITUTE  
1425 EUTAW PLACE, BALTIMORE 17, MD.

## ELECTRONIC COMPUTERS

- HOME-STUDY COURSES: computers, relay, analog and digital, automation, robots, electronics. Prices start at \$8 and go to \$52.
- PLANS: BeBe Brain: \$1 miniature computer plans \$3. Digital computer \$3. Light-seeking robot, now transistorized, \$1.
- KITS: Large variety of analog computer kits, for beginners and advanced experimenters. Also for schools and research, write for special prices on kits made-to-order.
- BOOKS: first book on robots, how to build and design them. Small robots and Homo Robotus, the man of metal, that thinks! 200 pages, \$5 ppd.
- EBEX: magazine of popular computers, automation projects, robotics and electronics. Subscriptions \$2.50 per year, 25c single copy.

ELECTRONIC BRAIN ENTERPRISES, INC.  
1015 Atkin Ave., Salt Lake City 6, Utah

# DIRECTORY

**FINISH HIGH SCHOOL AT HOME!**

No classes to attend. Easy spare-time training covers big choice of subjects. Friendly instructors; standard texts. Full credit for previous schooling. Diploma awarded. Write now for FREE catalog! HKE-16.

**WAYNE SCHOOL** (Div. Utilitec Inst.)  
2527 Sheffield Ave., Chicago 14, Illinois

**CODE SENDING SPEED**

Be a "key" man. Learn how to send and receive messages in International Morse code. Communicate with operators around the globe. Learn at home quickly through famous Candler System. Used by best operators. Qualify for Amateur or Commercial License. Write for FREE BOOK.

**CANDLER SYSTEM CO.**  
Dept. 3-J, Box 928, Denver 1, Colo., U.S.A.

**RADIO-TV ELECTRONICS**

CREI graduates in big demand. ECPD-Accredited Technical Institute Curricula. New classes start monthly. Free placement service for grads. Courses: Radio Engineering, Broadcast or TV Engineering; resident studies leading to "Associate in Applied Science" degree. Write for free Residence School catalog. Approved for veterans.

**CAPITOL RADIO ENGINEERING INSTITUTE**  
Dept. RE, 3224 — 11th St., N. W., Washington 10, D. C.

**ELECTRONICS ENGINEERING DEGREE IN 27 MONTHS**

Prepare for unlimited opportunities in electronics! B.S. degree in 27 months, mathematics, electrical engineering, TV, advanced radio theory and design. Modern labs. Low tuition, earn board. Also Aero., Chemical, Civil, Electrical, Mech. Engineering. B.S. degree in 36 mo. in Math., Chem., Physics. Also prep courses. G.I. appr. 20 bldgs., dorms, gym. Enter Sept., Dec., March, June. Catalog.

Keeping Pace With Progress.  
**INDIANA TECHNICAL COLLEGE**  
1587 E. Washington Blvd., Fort Wayne 2, Ind.

**TOP-FLIGHT ELECTRONICS**

Train for technical representative, field engineer, electronic specialist on missiles, computers, radar, automation, radio, color-TV. Basic and advanced theory and laboratory. Mathematics. Major firms select our graduates. Dormitories-campus. 21 months' program. High school grad. or equivalent. G.I. approved. Start September, January, April, July. Write for illustrated catalog today.

**VALPARAISO TECHNICAL INSTITUTE**  
Dept. C., Valparaiso, Indiana

**college grads get ahead faster!**

... have higher incomes... advance more rapidly. Grasp your chance for a better life. Share rewards awaiting college-trained men. Important firms visit campus regularly to employ Tri-State College graduates. Start any quarter. Approved for Vets.

**Bach. Sc. degree in 27 months**

Complete Radio Eng. courses (TV, UHF, FM, Electronics). Also Mech., Civil, Elec., Chem., Aero., Eng. 36-months in Bus. Adm. (Gen. Bus., Acctg., Motor Transport Mgt.). Superior students faster. More professional class hours. Small classes. Enrollment limited to 1550. Beautiful campus. Well-equipped labs. Prep courses. Enter Sept., Jan., Mar., June. Earnest, capable students (whose time and budget require accelerated courses and modest costs) are invited to write Jean McCarthy, Dir. Adm., for Catalog and "Your Career in Engineering and Commerce."

**TRI-STATE COLLEGE**  
2487 College Avenue, Angola, Indiana

**ELECTRONIC TECHNICIANS ARE IN DEMAND TRAINED MEN ARE NEEDED NOW!**

In just 18 months, you can complete Electronic Technicians training to enter this ever-growing industry. Day or evening classes. Opportunity for employment in local industry. Approved for Korean Veterans. Terms beginning September, Jan., April, July. Write for Catalog 111 TODAY.

**INDIANAPOLIS ELECTRONIC SCHOOL**  
312 E. Washington St. Indianapolis 4, Indiana

**Headline: COMPUTER MEN NEEDED!**

Opportunities for men with technical knowhow and theoretical background in computer operation and design are extraordinary. For a detailed picture send for our FREE booklet: "Employment in the Computer Industry."

Our training program is unique: we provide the only course that covers analog and digital computers, memory storage, programming, and mathematical theory commonly used in computer work.

The course is adapted to your previous experience and training and recognizes credits received elsewhere.

WRITE IN AT ONCE for FREE BOOKLET and information about the training program.

**Dept. RE 87B, OLIVER GARFIELD CO., Inc.**  
31 Broadway New Haven, Conn.

**Do you WISH you were EMPLOYED in ELECTRONICS?**

We can train you and place you in an electronics technician job in the short time of only 12 weeks!

**F.C.C. License—the Key to Better Jobs**

An FCC commercial (not amateur) license is your ticket to higher pay and more interesting employment. This license is Federal Government evidence of your qualifications in electronics. Employers are eager to hire licensed technicians.

**Grantham Training Is Best**

Grantham School of Electronics specializes in preparing students to pass FCC examinations. We train you quickly and well. All courses begin with basic fundamentals—NO previous training required. Beginners get 2nd class license in 8 weeks, 1st class in 4 additional weeks.

**Learn by Mail or in Residence**

You can train either by correspondence or in residence at either division of Grantham School of Electronics—Los Angeles, Calif., or Washington, D.C. Our free booklet, "Opportunities in Electronics," gives details of both types of courses. Send for your free copy today.

MAIL TO SCHOOL NEAREST YOU

**Grantham Schools, Desk 74-M**

821—19th Street N.W. OR 1505 N. Western Ave.  
Washington 6, D.C. Los Angeles 27, Calif.

Please send me your free booklet, telling how I can get my commercial FCC license quickly. I understand there is no obligation and no salesman will call.

Name \_\_\_\_\_

Address \_\_\_\_\_

City \_\_\_\_\_ State \_\_\_\_\_

Your choice of school is highly important to your career in

- INDUSTRIAL ELECTRONICS
- RADIO-TELEVISION
- ELECTRONICS COMMUNICATIONS

Become an **ELECTRICAL ENGINEER** or an **ENGINEERING TECHNICIAN** at **MSOE in Milwaukee**

Choose from courses in:

**ELECTRICAL ENGINEERING**  
Bachelor of Science degree in 36 months—Communications or Electrical Power.

**ENGINEERING TECHNICIAN**  
Associate in Applied Science degree in 18 months—Electronics Communications or Electrical Power.

**MSOE**—located in Milwaukee, one of America's largest industrial centers—is a national leader in electronics instruction—with complete facilities, including the latest laboratory equipment, visual aid theater, amateur radio transmitter—offers 93 subjects in electrical engineering, electronics, radio, television, electrical power, and electricity.

Advisory committee of leading industrialists. Courses approved for veterans. Over 50,000 former students. Excellent placement record. Previous educational, military, and practical experience is evaluated for advanced credit.

**QUARTERS BEGIN SEPTEMBER, JANUARY, APRIL, JULY.**

Choose wisely—your future may depend on it. Mail coupon today!

**MILWAUKEE SCHOOL OF ENGINEERING**

Dept. RE-857, 1025 N. Milwaukee St. MS-57 Milwaukee, Wis.

Please send free illustrated career booklet (please print)

I'm interested in.....

Name..... Age.....

Address.....

City..... State.....

Are you eligible for veterans educational benefits?.....

Discharge date..... MS-57

# STAN-BURN E-D-A-R-K-E

FIRST TIME EVER IN KIT FORM!

Build yourself the famous

## BOGEN DB20 DF AMPLIFIER

The finest 20 watt amplifier of 3 dozen brands tested by a famous consumer testing organization. Ideal for any home installation. Build it yourself and save up to one third of the regular price. Detailed STEP-BOOK makes it easy to assemble. All parts packaged in easy steps. No guesswork. No mistakes. All wires pre-cut to proper length.

**KDB20 DF Specifications: CONTROLS** Sep. 5 position loudness contour selector; 4 input nos.; 7 record equalize pos.; cont. var. damping fact. control; sep. cont. var. bass & treble controls; volume control, 0-30% dist. @ 20 W; peak 30 watts; response, 20-20,000 cps ±0.7 db.

COMPLETE WITH DETAILED INSTRUCTIONS, ALL PARTS, TUBES AND SOCKETS Only **\$69.50** Shipped freight prepaid

## CATHODE RAY TUBE SPECIALS

ONE YEAR GUARANTEE

G.E.	Type	STAN-BURN	G.E.	Type	STAN-BURN
\$15.80	10RP4	\$10.00	\$30.75	17CP4	\$20.50
19.10	12LP4	10.50	33.90	17GP4	21.50
		10.20	24.75	17LP4	18.00
18.75	12UP4	15.00	37.00	19AP4A	24.00
20.75	14CP4	12.75	28.35	20CP4A	18.95
		14.50	32.10	20CP4B	21.95
33.75	10AP4	18.50	36.00	21AP4	25.00
32.20	10DP4	15.25	29.75	21EP4	20.15
23.50	16KP4	15.75	33.50	21EP4B	23.25
27.20	16KP4A	18.75	30.90	21FP4	21.15
33.75	10GP4	18.75	37.00	21MP4	22.00
31.50	16LP4	15.25	29.75	21VP4	22.00
31.50	16WP4	15.25	100.00	21AP4	56.00
23.50	17BP4	15.75	46.60	24CP4A	38.00
27.50	17BP4B	18.75	48.20	24DP4A	39.00

\*Aluminized—INQUIRE FOR ANY TUBE TYPE NOT LISTED. STAN-BURN CRT TUBES RCA LICENSED—MFD. BY LINCOLN. All orders of 6 or more STAN-BURN CRT are subject to additional 10% discount. PRICES SUBJECT TO CHANGE WITHOUT NOTICE.

\$20 WORTH OF ELECTRONIC PARTS IN GRAB-BAG consisting of: Porcelain sockets, coils, speaker, transistors, cond. ONLY \$1.98 (plus 50c postage)

## TAPE RECORDERS—Famous Brand

Special	List Pr.	Special	List Pr.
Special	\$249.95	Special	\$129.95
Special	\$169.00	Special	\$79.95

Write for complete illustrated details.

**KITS!** We stock the following manufacturers complete line of kits—see EICO see pages 27-28 DYNAL see page 135 QUALITY see page 127 ARKAY see page 124 PRECISE DEVELOP. ELECTRO-VOICE inside Back Cover MENT see page 79 All domestic orders will be shipped prepaid. Send us your list. Order by Mfr. and Model No. of item.

## RECORD CHANGERS

Collaro and Garrard changers will be shipped prepaid. All other changers F.O.B. N.Y.C.

### COLLARO

RC 456	\$53.81
RC 456 with GE RPX050 cart.	51.95
RC 456 with GE RPX052 Diam/Sap.	55.37
RC456 with Bonnett Cart.	36.80

### GARRARD

RC 88	\$53.41
RC 88 with GE RPX050	61.45
RC 88 with GE RPX052 Diam/Sap.	74.97
RC 98	65.15
RC 98 with GE RPX050	74.19
RC 98 with RPX052 Diam/Sap.	87.71
45 R.P.M. Spindles.	\$2.98 ea.

**FREE!** 32-page illustrated booklet—"Speaking of Loudspeakers" by University Co. Packed with info on the history and mysteries of speakers. Write today to Dept. RE-8

**HI-FI DIAMOND NEEDLES—1 Yr. Guar.**  
SINGLE DIAMOND NEEDLES \$9.49 ea.  
DIA/SAPP TANDEM \$11.49 ea.  
(Dual Needles).  
Shipped PPD. (Specify cartridge make)

**NEW—AUDAX TONE ARM KIT—**  
Accommodates any make cartridge.  
For all popular cartridges, specify make. Shipped PPD.  
KT-12-12" KIT \$14.55 Fact. Assem. \$24.00  
KT-16-16" KIT 17.55 30.00  
Assemble in 20 minutes. Save 50%.

**WHY PAY MORE?**  
HI-FI COMPONENTS • KITS  
RECORD PLAYERS • TAPE RECORDERS • TUNERS  
AMPLIFIERS • SPEAKERS  
ELECTRONIC PARTS & TUBES • Etc.

Top brand nationally adv. merchandise in this and other Radio & TV mags. is yours at low, low cost. Send us your list. Give Mfr's name and Model No. of item. Write for '57 catalogs to Dept. RE-8 today.

Export inquiries and offers invited. Terms: 20% with order. Balance C.O.D. All Prices F.O.B. NEW YORK Warehouse. Minimum order \$5.00. Write for our latest price list and Hi-Fi Catalog RE-8. All Prices Subject to Change Without Notice

**STAN-BURN RADIO and ELECTRONICS CO.**  
558 CONEY ISLAND AVE. • B'KLYN 18, N. Y.

## ADVERTISING INDEX

Radio-Electronics does not assume responsibility for any errors appearing in the index below.

Allied Radio Corp.	9, 16, 20, 106, 112, 117, 121, 129, 132, 135
Amphenol Electronics Corp.	6
Arky Inc.	124
B & K Manufacturing Co.	14
Barry Electronics Corp.	134
Bell Telephone Labs.	26
Benco Television Associates, Ltd.	119
Blonder-Tongue Labs.	126, 128
Brooks Radio & Television Corp.	100, 102
CBS-Hytron	99, 108
Capitol Radio Engineering Institute	21
Centralab Division of Globe Union	110
Century Electronics	116
Chemical Electronic Engineering Inc.	125
Cleveland Institute of Radio Electronics	11
Cornell-Dubilier Electric Corp.	125
Coyne Electrical School	101, 118, 131
Deutschmann (Tobe) Corp.	24
DeVry Technical Institute	7
Dressner	127
Dyna Co.	135
Electro-Voice, Inc.	Inside Back Cover
Electronic Brain Enterprises	132
Electronic Chemical Corp.	130
Electronic Instrument Co. (EICO)	27, 28
Electronic Publishing Co., Inc.	131
Erie Resistor Corp.	117
E-Z Hook Test Products	124
Flamemaster Chemicals, Inc.	128
Gardiner Electronics	122
Garfield (Oliver) Co.	129
General Industries Co.	12
Gernsback Library, Inc.	116, 119, 121
Heath Co.	62-75
Hughes Aircraft & Development Labs.	138
IBM	86-87
Indiana Technical College	122
Jensen Industries	118
Jones & Laughlin Steel Corp.	20
Krauter & Co., Inc.	111
Kuhn Electronic Products	135
LMB	124
Lafayette Radio	136-137
Lansing (James B.) Sound, Inc.	131
Lektron Specialties	120
Littelfuse, Inc.	103
Mallory (P.R.) & Co., Inc.	94-95
Merit Coil & Transformer Corp.	130
Miller (Gustave)	127
Moss Electronics Distributing Co., Inc.	80-81
National Radio Institute	3, 13
National Schools	5

HQ for the 5 TOP QUALITY brands of

# TUBES

AT SENSIBLE PRICES!

- Individually boxed • First quality only
- Brand New • 90-DAY RETMA guarantee
- No rebrands • No private brands • No rejects

WRITE FOR LATEST TUBE CATALOG FREE!

1B35	\$ 3.35	GL299	1.00	CK102B	2.35
1Q22	4.50	GL299	1.00	20S1	.65
2B7	9.75	307A	.60	5517	1.35
CL-2	10.00	355A	11.00	5636	2.95
2C35	2.00	357A	14.00	5636A	2.95
2C39A	1.00	371B	1.20	5642	1.00
2C40	7.00	403A	3.25	5642	1.00
2C51	3.25	403B	12.50	5651	1.40
2C53	9.75	404A	25.00	5654	1.40
2E24	2.34	416A	39.00	5675	8.00
2K25	13.50	416B	3.50	5676	.85
2K45	15.00	417A	44.00	5687	1.85
3824	1.50	417A/5842	12.00	5691	4.75
		KU-610	3.50	5693	5.00
3B24W	4.75	450TH	4.00	5693	4.75
3B29	4.75	WL/655/658	5.00	5703WA	4.50
3B31	1.95	500	1.25	5719	2.00
3C23	1.95	GL673	12.50	5719	2.00
3C31	1.00	703A	1.10	5725	2.00
3C45	7.00	717A	.90	5726	.75
3J30	25.00	CK722	.90	5749	1.25
3K20000LK	75.00	750TL	32.50	5749	1.25
		Write 800	.90	5763	1.25
				5812	1.00
*4-65A	15.00	803	2.00	5814	1.00
*4-125A	30.25	805	4.00	5819	25.00
*4-250A	35.00	807	1.10	5840	4.00
4-400A	45.00	807W/5933	1.75	5876	8.00
4B24/EL3C	4.50	813	9.50	5881	2.95
4PR60A	30.00	814	2.50	5910	.50
4X500A	25.00	836	1.25	5911	1.00
5C22	25.00	837	1.25	6112	4.95
		838	1.25	6112	4.95
6AK5W	1.20	866A	1.20	6130/3c45	6.00
6C21/450TL	1.20	872A	1.00	6161	52.50
		872B	1.00	6201	3.00
6J4	13.50	917	1.10	6350	10.00
15E	1.20	918	1.10	6359	9.00
FG32	4.35	927	1.00	6359	3.25
*357G	2.00	930	1.00	8020	1.00
VC50/32V	8.00	930	1.50	9001	.75
RK-60/1641	1.25	954	.40	9002	.60
		955	.35	9003	1.35
RK-65/5D23	7.50	958A	.35	9005	1.25
HY69	35	991	.25	9006	.20
RRK72 or 73	35	991	.25		
F123A	3.95	CK1005	.35		
VXR-130	1.50	CK1007	1.45		

and many others, over 1000 types in stock! WRITE! WE ARE FACTORY AUTHORIZED DISTRIBUTORS OF CBS-HYTRON, EIMAC, PENTA, etc.

## 2-COLOR TUBE CARTONS

Keeps your tube stock neat. New safety partition prevents tube breakage. Distinctively lithographed in glossy red and black. The most distinctive tube carton available today. Minimum quantity: 100 of any one size. Write for case lot prices.

SIZE	FOR TUBE	PER 100
Miniature	6AU6, etc.	\$1.00
GT	6SN7, etc.	1.25
Large GT	1B3, etc.	1.50
Large G	5U4G, etc.	2.00

WHITE GLOSSY BOXES  
Completely blank. No printing or color. Otherwise same as above. Same high quality, same low prices. Specify "WHITE" when ordering. When color is not stated, 2 color cartons will be shipped.

**TUBE STACKERS**  
White glossy only. Ministacker holds 10 Mini. tube cartons; "GT" stacker holds 10 "GT" cartons.  
SIZE PER EACH  
Ministacker 1 1/2c  
GT .02

**\$10.00 Per Case of 1000 FOB NYC.**  
All cartons & stackers f. o. b. NYC

## AIRPORT or PHOTOGRAPHIC FLASH EQUIPMENT

Flash visible up to 3 miles, even in bright sunlight. May be used for portable (48 lbs.) photo-flash, visual signals, experiments, etc. Consists of a very high voltage converter, electronic flash lamp & holder, cables, mounting brackets, spare parts kit with extra flash lamp included, and detailed technical manual. Unused, complete. Some require paint touch-up. Can be made to operate from 115 VAC, 60 cycles with circuit modifications. All tested & working when shipped.

Model AN/VVX-1 for 6 or 12 V. DC  
**\$75.00**  
Model AN/VVX-1X for 24 or 48 VDC  
**\$65.00**

WRITE FOR "BARRY'S GREEN SHEET" FREE!

NOTE: Even Barry is not infallible! Try as we might to prevent it, on rare occasions, our sources of supply do send in a bad tube that escapes our careful examination. So, if at any time one does slip by to you, please advise us at once so that we can make prompt and cheerful correction.

TERMS: 25% deposit with order, balance C.O.D. All merchandise guaranteed. F.O.B. N.Y.C. Subject to price variation and stock depletion. MINIMUM ORDER \$10.00. TRADES ACCEPTED—OPEN MON. TO SAT.

**BARRY ELECTRONICS CORP.**  
512 Broadway, Dept. RE, N.Y. 12, N.Y.  
Phone: Walker 5-7000

# DYNACO

## OUTPUT TRANSFORMERS

A great new line of super-fidelity output transformers designed by David Hafler to provide the finest quality at moderate cost. These units use advanced pulse techniques for wide bandpass, lowest distortion, and outstanding transient response. All units can be operated *continuously* at double the nominal power ratings.

A-410* 10 watts for 6V6, 6AQ5, EL-84	<b>\$14.95</b> net
A-420* 25 watts for KT-66, 807, 5881	<b>\$19.95</b> net
A-430* 50 watts for 6550, EL-34, KT-88	<b>\$29.95</b> net
A-440** 100 watts for 6550, 6CA7/EL-34	<b>\$39.95</b> net
A-450* 100 watts for pp pay EL-34, 6550, KT-88	<b>\$39.95</b> net

\*tapped primaries  
\*\*tertiary winding for either screens or cathodes

These transformers are available nationally through leading parts distributors and audio jobbers. If your dealer cannot supply you, we will be pleased to turn your order over to our closest stocking distributor or to supply you directly.

Write for complete data on  
*Dynaco Transformers*

### DYNA COMPANY

617 N. 41st St., Phila, 4, Pa.  
Dept. RE

Please Mention  
Radio-Electronics  
When Answering  
Advertisements

## CRYSTAL CONTROLLED CONVERTERS

POLICE • FIRE • COMMERCIAL



- ✓ Precision—Stability
- ✓ Sensitivity
- ✓ Easy Installation

**\$32.50**

• A compact converter supplied with commercial tolerance crystals, self contained automatic noise limiter. Also models with squelch. Ideal for mobile or home use.

## TUNERS

Enjoy FM Programs  
While You Drive.

- FM BROADCAST
- 30-50 MC
- 108-176 MC

from **\$22.50**

WRITE FOR LITERATURE



### KUHN ELECTRONICS

20 GLENWOOD CINCINNATI 17, OHIO

Oelrich Publications .....	127
Opportunity Adlets .....	109
Oxford Components, Inc. ....	122
Phaotron Instrument & Elec- tronic Co. ....	105
Precise Development Corp. ....	79
Progressive "Edu-Kits," Inc. ....	98
Quality Electronics .....	127
RCA Electron Tube Division .....	Back Cover
RCA Institutes .....	17
RCA Test Equipment .....	115
Radiart Corp. ....	10
Raytheon Manufacturing Co. ....	93
Rinehart & Co., Inc. ....	130
Sams (Howard W.) & Co., Inc. ....	15, 104
Service Instruments Corp. ....	129
Shure Brothers, Inc. ....	109
Sonotone Corp. ....	114
Sprague Products Co. ....	107
Sprayberry Academy of Radio ...	23
Stan-Burn Radio & Electronics ...	134
Sylvania Electric Products, Inc.	18-19
Teletest, Inc. ....	127
Tobe Deutschmann Corp. ....	24
Triplett Electrical Instrument Co. ....	Inside Front Cover
Tung-Sol Electric Co. ....	8
University Loudspeakers, Inc. ....	113
Ward Products Co. ....	123
Wen Products, Inc. ....	25
Winegard Co. ....	77
Winston Electronics, Inc. ....	16
WRL Electronics .....	118

### SCHOOL DIRECTORY PAGES 132-133

Baltimore Technical Institute  
Candler System Co.  
Capital Radio Engineering Institute  
Garfield (Oliver) Co.  
Grantham Schools  
Indiana Technical College  
Indianapolis Electronic School  
Milwaukee School of Engineering  
Pacific International University  
RCA Institutes, Inc.  
Tri-State College  
Valparaiso Technical Institute  
Wayne School, Inc.

BRANCH ADVERTISING OFFICES: Chicago: 1413 Howard St. Tel. Rogers Park 4-8000. Los Angeles: Ralph W. Harker and Associates, 600 South New Hampshire. Tel. DUnkirk 7-2328. San Francisco: Ralph W. Harker and Associates, 414 Market St. Tel. GARfield 1-2481.

FOREIGN AGENTS: Great Britain: Atlas Publishing and Distributing Co., Ltd., 18 Bride Lane, London E.C. 4. Australia: McGill's Agency, Melbourne. France: Brentano's, Paris 2e. Belgium: Agence et Messageries de la Presse, Brussels. Holland: Trilectron, Heemstede. Greece: International Book & News Agency, Athens. So. Africa: Central News Agency, Ltd., Johannesburg. Capetown, Durban, Natal: Universal Book Agency, Johannesburg. India: Broadway News Centre, Dadar, Bombay #14. Pakistan: Paradise Book Stall, Karachi #.

# BUILD THE BEST— BUILD ALLIED'S OWN knight- kits

LOWEST COST because our giant buying power passes biggest savings on to you... you do the easy assembly, get professional results and SAVE!

## knight-kits

EASIEST TO BUILD because KNIGHT-KIT "Step-and-Check" instruction manuals are marvels of clarity—it's just like having a good instructor at your side.

## knight-kits

MONEY-BACK GUARANTEE: When properly assembled, KNIGHT-KITS fully meet published specifications, or we refund your money.

EASY TERMS AVAILABLE

### knight-kit HI-FI VALUE SENSATIONAL HI-FI FM TUNER KIT



Model Y-751 ★ Deluxe custom hi-fi styling  
**\$37.75** ★ AFC and Flywheel tuning  
★ Printed circuit—easy wiring

The best-looking, best-performing tuner kit your money can buy. Covers 88 to 108 mc; features AFC (with special disabling circuit); pre-adjusted RF coils; pre-aligned IF's; cascode broad-band RF amplifier; drift-compensated oscillator; illuminated lucite pointer. Sensitivity is 10 microvolts for 20 db of quieting across entire band. Ideal for use with Knight-Kit 20-Watt Amplifier or any amplifier with phono-tuner switch. 13 x 8 x 4". Complete, ready for easy assembly. Shpg. wt., 12 lbs.  
Model Y-751. Net, F.O.B. Chicago **\$37.75**

See our Supplement No. 165 for additional  
knight-kit Hi-Fi values

### free SUPPLEMENT featuring knight-kits



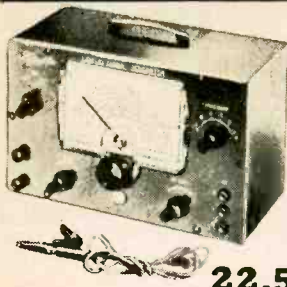
Send for our FREE Supplement No. 165 featuring 45 great Knight-Kits, including Test Instruments, Hi-Fi, Hobbyist and Amateur kits. Write for your copy today.

ORDER FROM

## ALLIED RADIO

Dept. 02-H7, 100 N. Western Ave., Chicago 80, Ill.

# LAFAYETTE SENSATIONAL VALUES! IN COMPLETELY WIRED TEST EQUIPMENT at LESS than the PRICE of KITS!



**LAFAYETTE SIGNAL GENERATOR**  
NEVER BEFORE HAS A COMPLETELY WIRED AND TESTED INSTRUMENT OF SUCH ACCURACY AND QUALITY BEEN OFFERED AT SUCH A PRICE!

- FREQUENCY 120 KC TO 260 MC
- 120 KC TO 130 MC ON FUNDAMENTALS
- LABORATORY ACCURACY AND QUALITY

A completely wired and tested instrument not to be confused with units sold in kit form at almost the same price, but with a quality and accuracy of instruments 3 to 4 times its price. Six overlapping ranges generate signals of 120KC - 320KC, 320KC - 100KC, 1MC - 32MC - 11MC, 11MC - 38MC and 37MC - 130MC all on fundamentals with calibrated harmonics from 120MC to 260MC. Selector switch gives instant choice of ranges. Switch gives choice of internal modulation of 400 CPS or use of any external source at other frequencies. For audio testing the 400 cycle signal can be used separately. Outputs are unmodulated RF, modulated RF and 400 CPS audio. microvolts and jacks are provided for choice of either high or low RF output. Stability is insured by special circuit design. Has a fine adjustment RF control. AF output is 2-3 volts, AF input is 4 volts across 1 megohm. Large clear 5 inch etched dial plate and pointer are protected by transparent plastic bezel. Common AF terminals for EXT-MOD input and INT-AF for audio tests eliminate need for special AF output connectors. Machine engraved panel lettering. Handsome gray metal case with carrying handle. Measures 6 1/2" x 10" x 4 1/2". Comes complete with pair of leads. AC line cord and plug. Operates on 105-125V 50-60 cycle AC. Shpg. wt., 8 lbs.

**22.50**

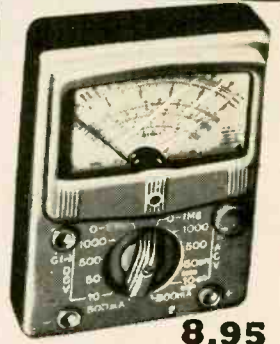
**LAFAYETTE LSG-10 SIGNAL GENERATOR** **22.50**

**NEW POCKET AC-DC VOM MULTITESTER**  
2,000 ohm per volt Sensitivity on both DC and AC

- 160 ua 3" METER
- 1% PRECISION RESISTORS
- SILVER CONTACT SELECTOR SWITCH

**FULL SCALE RANGES**

DC Volts: 0-10; 0-50; 0-500; 0-1000 Volts - AC Volts: 0-10; 0-50; 0-500; 0-1000 Volts - DC Current: 500 ua and 500 ma - Resistance: 0-10K; 0-1 Meg - Decibels: -20 to +22; +20 to 36 db (0 db = 0.775 V) - Capacity: 250 mmfd to .2 mfd - .005 Mfd to 1 mfd - Output Ranges: 0-10; 0-50; 0-500; 0-1000 volts



**8.95**

Best Buy in America! A very accurate and sensitive VOM. This Multitester is a complete instrument (not a kit) with high quality and sensitive 160 microamp meter; 2000 ohm per volt on both AC and DC. Single selector switch, 1% precision resistors, 3" meter. Features extreme versatility, accuracy and ruggedness. In attractive plastic front panel, with metal bottom for ruggedness and shielding. First capacity range requires 50 volt AC source. Second capacity complete requires 10 volt AC source. Size 4 1/4" x 3 1/2" x 1 3/4". 4 lbs. Complete with test leads and batteries. Shipping weight **8.95**

**NEW!**

**LAFAYETTE CAPACITANCE-RESISTANCE TESTER WITH "IN-SET QUICK CHECK"**

**COMPLETELY WIRED AND TESTED**



- TWO INSTRUMENTS IN ONE
- CHECKS ELECTROLYTIC, PAPER, MICA AND CERAMIC CONDENSERS
- 4 DIRECT READING CAPACITY SCALES FROM .00001 MFD TO 1000 MFD
- CHECK FOR OPEN SHORTS, LEAKAGE AND INTERMITTENTS
- 2 RESISTANCE RANGES FROM 100 TO 5 MEGOHM

Here is a "must" for servicemen and lab technicians. A completely self-contained AC checker for capacitance and resistance bridge, plus a quick check feature in the set testing. Large 5 direct reading scale has 4 ranges of .00001 - .005 MFD, .001 - .5 MFD, 1 - 50 MFD and 20 - 1000 MFD. Resistance ranges are 100-50,000 OHMS and 10,000 to 5 megohm. Quick check feature enables you to check capacitors for shorts, open or intermittent while in circuit - no need to remove them from the set until you're sure they need replacement. Leakage test switch gives you choice of 25, 150, 250, 350 or 450 volts for checking leakage under correct potential. Separate power factor control with continuous settings from 0 to 50%. Operation is simple and accurate, using a magic-eye tube as the null detector. Attractively finished steel case with etched panel and rounded corners, measures 14 1/2" L x 8 3/4" H x 5" D. Shpg. wt. 19 lbs.

**34.50**

**MODEL LC-4** **NET 34.50**

**NEW!**

**LAFAYETTE CAPACITOR-RESISTANCE TESTER**

**COMPLETELY WIRED AND TESTED**



**21.50**

- COMPLETELY WIRED AND TESTED
- CHECKS ALL TYPES OF CONDENSERS FOR CAPACITY, LEAKAGE, OPEN SHORTS OR INTERMITTENT CONDITION
- DIRECT READING SCALES FROM .00001 TO 1000 MFD AND 100 TO 5 MEGOHMS

A stable and accurate bridge type circuit measures capacitance in 4 ranges of .00001-.005 MFD, .001 to .5 MFD, .1 to 50 MFD and 20 to 1000 MFD. Two resistance ranges of 100-50,000 and 10,000 to 5 megohms. Check leakage under actual load with choice of 25, 150, 250, 350 or 450 volts available by selector switch. Power factor control from 0 to 50%. Checks for leakage, open, short, or intermittent operation. All readings taken directly off scales after setting magic eye to maximum. Completely self-contained power supply. Attractively finished steel case with rounded corners and etched panel. Operates from 110V AC. Size 9 3/4" L x 7 1/2" H x 5 1/4" D. Shpg. wt. 10 lbs.

**MODEL LC-15** **NET 21.50**

**HIGH SENSITIVITY 20,000 OHM PER VOLT DC 10,000 OHM PER VOLT AC MULTITESTER**



**19.95**

**LOOK AT THESE FULL SCALE RANGES!**

D.C. Volts: 0-6; 0-30; 0-120; 0-600; 0-1200; 0-6000 Volts - A.C. Volts: 0-6; 0-30; 0-120; 0-600; 0-1200 Volts - RESISTANCE: 0-10K; 0-100K; 0-1 Meg; 0-10 Megohms - D.C. CURRENT: 0-60 Microamp; 0-6; 0-60; 0-600 Milliamps - DECIBEL: -20 to +27 db (0 db = 0.774V) - CAPACITY: .0001-.01; .005-.15 mfd - INDUCTANCE: 20-2000 heavy - OUTPUT RANGES: 0-6; 0-30; 0-120; 0-600; 0-1200 Volts

The new Lafayette high sensitivity Multitester is a complete instrument (not a kit). In addition to its unusual sensitivity of 20,000 OHMS PER VOLT ON D.C. AND 10,000 OHMS PER VOLT ON A.C., and the extraordinary number and scope of its ranges, it is packed with features that would make it cost at least twice as much if made in this country. Uses 1% precision resistors, silver contacts on selector switch, 35 ua 3" meter. Dependable, rugged and accurate. Even the test leads are heavy duty with high voltage insulation. Voltage source required for low capacity range is 120V A.C., for high range capacity and inductance scale is 6V A.C. Attractive plastic front with metal bottom. Size 6 1/4" x 4 1/4" x 2 1/2". Complete with batteries and leads. Shipping weight 4 1/2 lbs. **19.95** Singly, **19.95** In lots of 3, **19.25**

**Lafayette Import Special!**

**TRANSCRIPTION TYPE MANUAL PLAYER**

- MAGNETIC BRAKE FOR FINE ADJUSTMENT OF EACH SPEED
- 4-POLE, HEAVY DUTY TRANSCRIPTION-TYPE MOTOR
- STYLUS WEIGHT ADJUSTMENT SCREW ON TONE ARM

Here is a new manual player for the audiophile who wants noiseless, "wow-free" and rumble-free reproduction of recorded music at nominal cost. All the important features of professional transcription players have been incorporated in this precision turntable. The lightweight pickup arm is an integral part of the mounting plate and requires no installation. Player is equipped with a heavy duty, 4-pole, 3-speed motor for 78, 45 and 33 1/3 RPM records. An exclusive magnetic brake controlled by knob on the base plate, permits instantaneous fine adjustment of each speed. Stroboscope disc included with unit, checks speeds. Extremely smooth and quiet operation. No hum even with the most sensitive cartridges. Speed selector safety switch protects mechanism by making it necessary to pass through an OFF position when switching from one speed to another.

10" diameter, heavy turntable is supplied with a rubber traction mat for positive grip of record. Stylus pressure adjustment can be made easily and quickly with the conveniently located adjusting screw on the underside of the tone arm. Mounting plate is also equipped with pickup rest and ON-OFF switch. Dimensions of mounting plate: 12-15/16" left to right, and 10 1/2" front to rear. Requires 2 3/4" clearance below motor board and 3" above. Supplied with AC line cord, two plug-in heads, output cable for connection to amplifier and 45 RPM adapter. For 105-120 volts, 60 cycle AC. Shpg. wt., 12 lbs. Less cartridge. (NOTE: For protection in shipping, tone arm is separate. Just fasten to mounting plate.)

- PK-160 Manual Player **Net 24.50**
- PK-164. Same as above except equipped with genuine GE triple-play magnetic cartridge and dual diamond-sapphire stylus **Net 36.50**
- Wood base, cut out for PK-160 Manual Player. Top quality veneer attractively finished in mahogany or blonde (Specify).
- PK-162. Shpg. wt., 5 lbs. **Net 3.95**
- Unfinished mounting board only, cut out for PK-160 player. Strong, durable 3/8" gumwood, ready for stain or paint.
- PK-163. Shpg. wt., 1 lb. **Net .95**

**Complete Turntable and Tone Arm Assembly at the lowest price Ever for Such High Quality**



**24.50**  
Less Base

**with TWO PLUG-IN HEADS**

**LAFAYETTE RADIO**

DEPT. JH-1

JAMAICA 33; N. Y. 165-08 Liberty Ave. Write for FREE Bargain Packed Catalog!

100 SIXTH AVE., NEW YORK, N. Y.  
BOSTON, MASS., 110 Federal St.  
PLAINFIELD, N. J., 139 West 2nd St.  
NEWARK, N. J., 24 Central Ave.  
BRONX, N. Y., 542 E. Fordham Rd.



# FREE! LAFAYETTE CATALOG

JUST  
OFF  
THE  
PRESS!



## NEW 180 PAGE ELECTRONIC CATALOG FEATURING THE BEST BUYS IN THE BUSINESS

The newest and largest assortment of Electronic, Radio and TV parts, Hi-Fi and Public Address Components and systems, Test Equipment, tubes, Transistor Kits and miniaturized components for transistor circuitry, Ham Equipment, Builders Kits, Tools, Books, Microscopes, Binoculars, Telescopes, Cameras, and Drafting Equipment—ALL AT LOWEST PRICES—Catering to the economy minded dealer, serviceman, engineer, technician, experimenter and hobbyist. **CRAMMED FULL OF MONEY SAVING BUYS. SEND FOR YOUR FREE COPY TODAY.**

## PROFESSIONAL TRANSCRIPTION TURNTABLE AND VISCOUS-DAMPED TONE ARM

THE FINEST TRANSCRIPTION TURNTABLE AND TONE ARM FOR THE PROFESSIONAL USER AND THE AUDIOPHILE



PK-300 TURNTABLE,  
PK-90 TONE ARM  
AND G. E. CART-  
RIDGE WITH GEN-  
UINE DIAMOND  
AND SAPPHIRE  
STYLI.

**72.50**

PK-300

ILLUMINATED BUILT-IN  
STROBOSCOPE & VIEWER

COMBINATION

DEAL



PK-90

### LATEST IMPROVED MODEL PK-300 TRANSCRIPTION TURNTABLE

New 3-speed instrument with built-in stroboscope and viewer for exact speed determination, and magnetic brake for instantaneous speed variation. Precision engineered to meet professional standards for wow, rumble and flutter content. Heavy 12" cast aluminum rim-driven turntable. Variable speed control permits adjustment of each speed within  $\pm 7\%$  using efficient frictionless magnetic brake. Heavy-duty constant speed 4-pole induction motor freely suspended and isolated by shock-mountings to eliminate vibration transfer. R-C filter network suppresses "pop" in speaker. Truly a delight for the connoisseur. Size: 13 1/2" x 14" and requires 2 3/4" clearance above and 3 3/4" below motorboard. For 110-130V and 60/50 cycle AC. Power consumption 12 watts. Handsome hammertone gray finish. Shpg. wt., 20 lbs.

Net 49.50

### PK-90 VISCOUS-DAMPED "ONE ARM"

This transcription arm assures dependable and stable operation, utilizing the "floating action" principle of "viscous damping." The arm is supported at a single point by a pivot and jewel bearing having negligible friction. Damping is accomplished by a silicone fluid occupying the gap between a ball and socket. This damping control permits high compliance and negligible tracking error, and prevents damage to either record or stylus should the tone arm be accidentally dropped. Low frequency resonance, skidding and groove-jumping are likewise minimized. The tone arm accepts all records up to 12" and accommodates virtually all hi-fi cartridges by means of precisely engineered adapters which simplify installation and provide proper stylus pressure.

This tone arm is a quality companion to the PK-300 with matching finish. Shpg. wt., 2 1/2 lbs.

Net 15.95

## LAFAYETTE'S FM-AM TUNER KIT

- SIMPLIFIED DETAILED INSTRUCTION MANUAL
- MEETS FCC REQUIREMENTS FOR RADIATION
- GROUNDED GRID TRIODE AMPLIFIER
- ARMSTRONG FM CIRCUIT WITH FOSTER-SEELEY DISCRIMINATOR
- AFC DEFEAT CIRCUIT WITH FRONT PANEL CONTROL

The excellence of its design and the quality of its components combine to provide this compact high-fidelity FM-AM tuner with superb characteristics normally found in units costing several times as much, and with performance unbelievable at this low price. Features Armstrong FM circuit with limiter and Foster-Seeley discriminator. Simplified tuning with slide-rule dial and flywheel counterweighted mechanism. AFC defeat circuit combined with tuning control. Attractive etched copper-plated and lacquered finish.



### SPECIFICATIONS

FREQUENCY RANGE: FM, 88-108 MC; AM, 530-1650 KC. ANTENNA INPUT: FM, 300 ohms; AM, Ferrite loopstick and high impedance external antenna. CONTROLS: 2—a function control for AM, FM, PHONO, TV and a tuning/AFC defeat control. DISTORTION: Less than 1% rated output; FREQUENCY RESPONSE: FM,  $\pm 5$  db 20 to 20,000 cps; AM,  $\pm 3$  db 20 to 5000 cps. SENSITIVITY: FM, 5  $\mu$ V for 30 db quieting; AM, Loop sensitivity 80  $\mu$ V/meter. SELECTIVITY: FM, 200 KC bandwidth, 6 db down — 875 KC FM discriminator peak to peak separation; AM, 8 KC bandwidth, 6 db down. IMAGE REJECTION: 30 db minimum. HUM LEVEL: 60 db below 100% modulation. TUBE COMPLEMENT: 2-12AT7, 1-6BA6, 1-6BE6, 2-6AU6, 1-6AL5 plus 1-6X4 rectifier. SIZE: 5 1/2" high x 9 1/2" wide x 9 1/2" deep (excluding knobs). CONSUMPTION: 30 watts. For 110-120V 60 cycles AC. Less metal case. Shpg. wt., 9 lbs.

KT-100 kit, less case ..... Net 34.95  
ML-100—Metal case for above, shpg. wt., 3 lbs. .... Net 5.00

NEW!



### IMPORTED 12" HI-FI COAX. SPEAKER

- FREQUENCY RANGE 30-15000 CPS
- HANDLES 20 WATTS OF POWER
- COMPLETE WITH LEVEL CONTROL
- POWERFUL TSK-5 MAGNETS
- SPECIAL SHEEPSKIN-EDGED CONE

A Lafayette exclusive import and exceptional value. Consists of a 12" woofer, coaxially mounted 2 1/2" tweeter and a built-in crossover network. The specially processed fibre cone has a sheepskin edge to suppress unwanted nodal vibrations and insure beautiful tone quality. Highly efficient TSK-5 magnets. Level control provides variation to 6 db cut. Maximum input 20 watts. Impedance 8 ohms. Rugged all-metal frame. If made in this country, would cost at least \$49.50. Shpg. wt., 11 lbs.

SK-58 ..... Net 29.50

### LAFAYETTE HI-FI LP TEST RECORD

Ideal for audiophile who is building a bass reflex speaker enclosure, or wants to check the components already in use. Two-side, 12" LP record covers cartridge and stylus test, turntable rumble test, average and minimum recording levels, stylus and tone arm resonance check, equalization checks, sound effects, tuning bass reflex enclosures, and a group of delightful music box selections. Specially recorded with painstaking care at 33 1/3 RPM, and master cut on a mechanism that produces the quietest grooves in industry. Complete with instructions for use and colorful protective envelope. Shpg. wt., 1 lb.

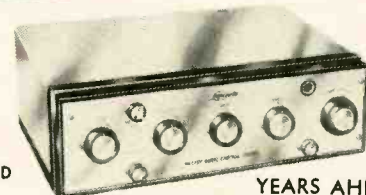
PR-10. Hi-Fi Test Record ..... Net 2.25

New!

## LAFAYETTE MASTER AUDIO CONTROL CENTER WITH BINAURAL CHANNEL AND DUAL VOLUME CONTROL

\$39.50  
IN KIT FORM  
KT-300

\$59.50  
WIRED & TESTED  
LT-30



YEARS AHEAD OF EVERY  
OTHER PREAMPLIFIER CONTROL UNIT

The Lafayette Master Audio Control Center is not only the finest high fidelity preamplifier, characterized by unmatched features, but it has been functionally designed to keep pace with the conversion of your present hi-fi system to binaural (Stereo) sound.

### FEATURES

- Incorporates an extra channel and dual volume control for binaural reproduction.
- DC on all tube filaments for minimum hum, and negative feedback in every stage.
- IM distortion and harmonic distortion so low, it is practically unmeasurable at normal operating level. IM is below 0.09% at 1V; HM approximately 1/4 of 1% even at 3V.
- Dual cathode follower output stages.
- High gain for low level pickups.
- Separate turnover and roll-off controls — 24 positions of equalization.
- Printed circuit construction.
- Tasteful styling, brilliantly executed.
- Designed for ease of installation and operation.

### SPECIFICATIONS

INPUTS: 7 inputs accommodate every type of phono, tuner and tape. CONTROLS: 9 front and 2 rear panel controls make for ultimate versatility. FREQUENCY RESPONSE: Uniformly flat frequency response over the entire audible spectrum. TAPE EQUALIZATION: Tape head playback equalization both NARTB and adjustable. SENSITIVITY-GAIN: 54db on magnetic input (2mv input produces 1V output); 14db on radio tape and auxiliary inputs (0.2V produces 1V output). HUM & NOISE: 80db below 3V output at full gain on radio, tape and auxiliary inputs; better than 60db below effective program level at full gain with 10mv input. TUBES: 3 premium type 6XCS3 tubes plus 2 selenium rectifiers. POWER SOURCE: 105-125V 50-60 cycles AC. SIZE: 12 3/4" L x 3 3/4" H x 9 1/2" D from front panel to rear jacks—knobs project 1". Shpg. wt., 10 1/2 lbs.

FOR FURTHER DETAILS WRITE FOR BULLETIN ST-74.

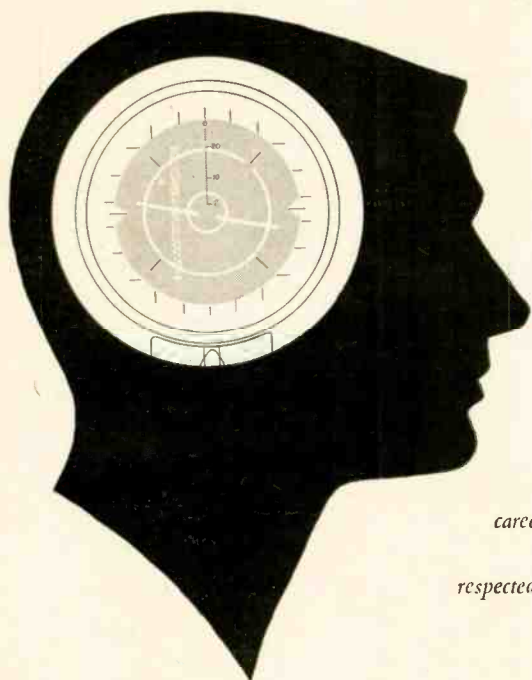
Lafayette  
Radio  
DEPT JH-2

165-08 LIBERTY AVE.  
JAMAICA 33, N. Y.

NAME \_\_\_\_\_  
ADDRESS \_\_\_\_\_  
CITY \_\_\_\_\_  
ZONE \_\_\_\_\_  
STATE \_\_\_\_\_  
SEND  
FREE  
LAFAYETTE  
CATALOG

CUT OUT AND MAIL TODAY!

**Systems  
Career:** a  
laboratory  
for  
learning



*... an exciting and rewarding  
career awaits the E.E. or Physics  
graduate who joins this highly  
respected Engineering team.*

As a Field Engineer at Hughes, through training and assignment you will become familiar with the entire systems involved, including the most advanced electronic computers. With this knowledge you will be ideally situated to broaden your experience and learning for future application in either the military or commercial field.

The national respect which Hughes commands in the field of advanced electronics is in no small part due to the technical support provided by the Field Engineers. Other contributors to the suc-

cess of the Field Service and Support Division are the Technical Manuals Engineer, Training School Engineers, Technical Liaison Engineers, and Field Modification Engineers.

This Hughes activity is a highly trained organization of expert engineers, giving support to the armed services and air-frame manufacturers using the company's equipment. Locations are in Southern California, continental U.S., overseas. We invite you to join this team. For further information write us at the address below.

**HUGHES**

VACATIONING IN  
SOUTHERN CALIFORNIA?  
YOU ARE INVITED  
TO VISIT HUGHES.

**Some extra advantages for  
Field Engineers include:**

Training at full salary for 3 months before assignment.

Generous moving and travel allowance between present location and Southern California (Culver City).

Additional compensation plus complete travel and moving on assignments away from Culver City.

Ideal living conditions in the unsurpassed climate of Southern California.

Reimbursement for after-hours courses at UCLA, USC, or other local universities.

Employee group and health insurance paid by company, retirement plan, sick leave, and paid vacations.

*Scientific Staff Relations*

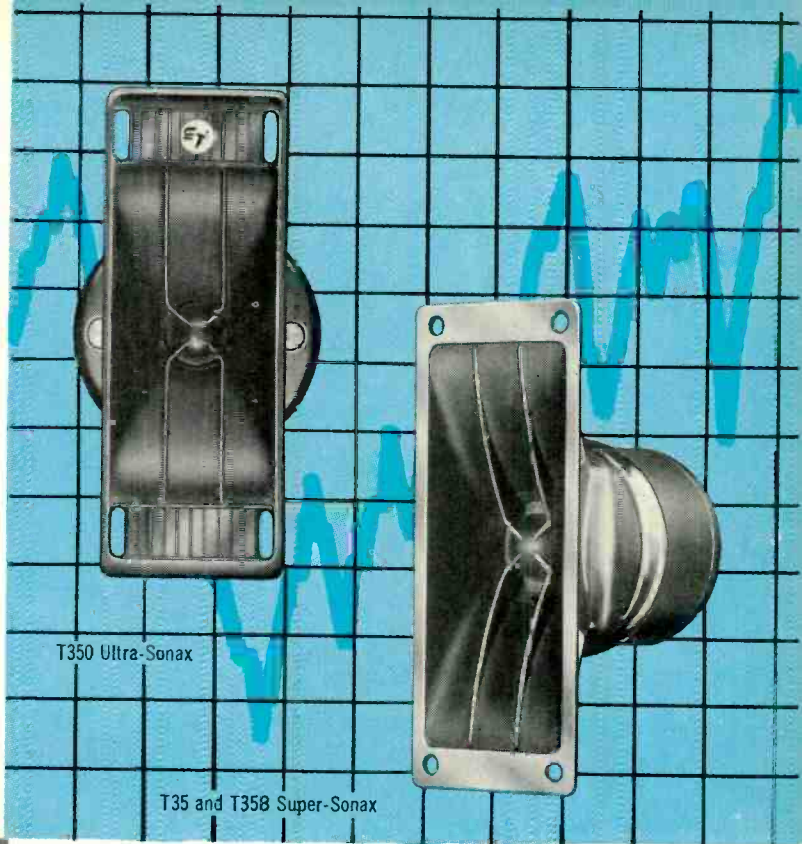
RESEARCH AND DEVELOPMENT LABORATORIES  
HUGHES AIRCRAFT COMPANY  
Culver City, California

# Electro-Voice®

## NEW Ultra-Sonax and Super Sonax Very High Frequency Drivers, Diffraction Horns and Revolutionary E-V Sonophase Throat Design

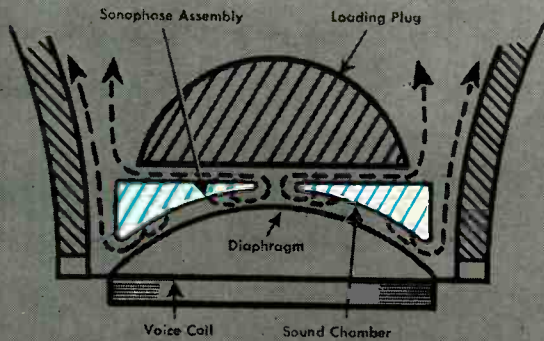
No other manufacturer gives you very high frequency drivers combining all the customer benefits of these unique new Electro-Voice models. Today's folded horn and phase loaded speaker systems with their low first-octave response require flat, extended high range response beyond the very limit of audibility if essential musical balance is to be achieved. These very high frequency drivers, employing the time-tested diffraction principle and the new Avedon Sonophase throat design, overcome range and sensitivity limitations, function without distortion at the highest ranges.

All three models—T35, T35B and T350—have 180° dispersion patterns, program capacities of 50 watts, peak 100 watts, voice coils one inch in diameter and 16 ohms impedance. Chart shows other characteristics of each model.



T350 Ultra-Sonax

T35 and T35B Super-Sonax



Specifications	T35	T35B	T350
Frequency Response:	± 2 db 2 kc—19 kc	± 2 db 2 kc—18 kc	± 2 db 2 kc—21 kc
RETMA Sensitivity			
Rating:	57 db	54 db	60 db
Magnet Weight:	7 oz.	4 oz.	1 lb.
Gauss	13,500	9,000	20,000
Size:			
Horn:	5½ in. long x 2 in. wide		7½ in. long x 2½ in. wide
Pot Diameter:	2¼ in. maximum		3½ in. maximum
Depth:	3¼ in. overall	3 in. overall	4½ in. overall
Shipping Weight:	3 lbs.	3½ lbs.	9½ lbs.
Net Price:	\$35.00	\$22.00	\$60.00

### And These are the Reasons Why

#### The Avedon Sonophase Throat Design

The unique throat design illustrated here overcomes a problem common in conventional high frequency drivers. This is diaphragm deformation at high frequencies, occurring at frequencies above 5 kilocycles. Piston action is destroyed, the phase is shifted and the result is destructive interference.

These Electro-Voice UHF drivers solve the diaphragm deformation problem with a longer sound path from the center of the diaphragm. This restores proper phase relationship. This is important above 12 kilocycles, where sound must be taken from the center of the diaphragm and from the outer edge simultaneously. The diagram shows E-V's Sonophase construction.

#### The Hoodlin Diffraction Horn

This is the Electro-Voice development which is used in all E-V horns to disperse sound equally in all lateral directions from a single point source. This is especially important in stereophonic reproduction to preserve the undistorted depth and width of the original sound. Diffraction horns insure balanced levels of both right and left stereo speakers. These drawings tell the diffraction horn story:

# Electro-Voice

ELECTRO-VOICE, INC. • BUCHANAN, MICHIGAN  
Export: 13 East 40th Street, New York 16, U.S.A. Cables: ARLAB

This is just one example of the 'Listeneered' superiority of Electro-Voice products which makes them easy to sell. Just one more reason why more dealers sell more E-V products at more profit than any other line. See your E-V Rep TODAY.

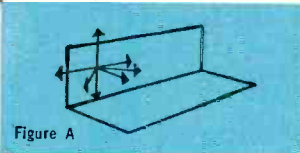


Figure A

Figure A—This shows how sound disperses equally in all directions from a single point source.

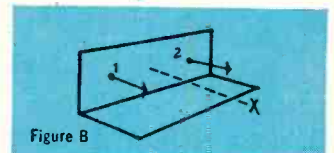


Figure B

In Figure B two sound sources are shown. On the axis, at point "X," double the sound power results as the resultant pressures are in phase.

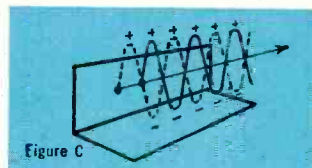


Figure C

But in Figure C, if the distance between the two sources is ½ wavelength or greater, the sound from the two sources will be considerably out of phase for points off the axis, resulting in decreased sound pressure.

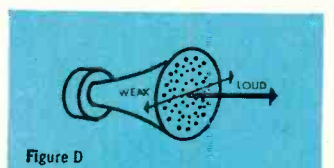


Figure D

Figure D will show the deficiencies in horns of wide lateral dimensions compared to the wavelength being emitted. Any horn mouth can be considered as a group of small point sources of sound. They must beam the sound down the axis by their very nature.

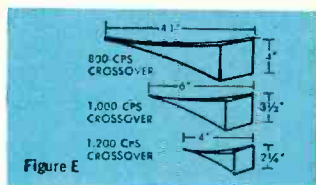


Figure E

Figure E shows representative horns, illustrating that horns must have a certain length, as well as cross sectional area along this length and at the mouth to load the driver diaphragm down to the lowest frequencies to be reproduced. The lower we go, the longer must be the horn and the greater the mouth area.

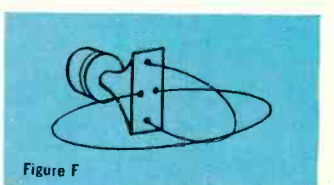
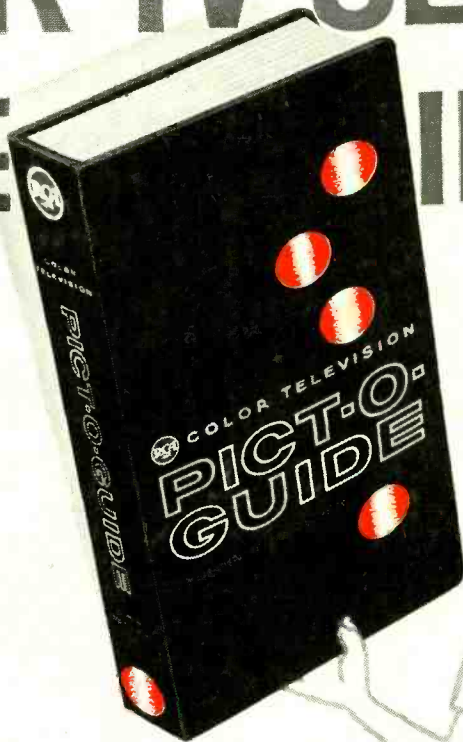


Figure F

Figure F shows that narrowing the horizontal area and extending the vertical dimension of the horn mouth preserves the loading area necessary for good low end response, disperses the sound perfectly in the horizontal direction where it is so necessary, and keeps interfering reflections off the floor and ceiling.

**Just Arrived!**

# THE MOST USEFUL, PRACTICAL AID TO COLOR-TV SERVICING IN THE INDUSTRY



- Speeds up, simplifies installation, adjustment, and servicing of color-TV receivers
- Saves time in localizing color-TV troubles
- Profusely illustrated in full color, and monochrome
- Sturdily bound in lie-flat, multiple-ring covers

**FREE OF EXTRA CHARGE WHEN YOU BUY RCA TOP-QUALITY RECEIVING TUBES!**

Here's practical information on Color TV. Clearly written by John R. Meagher, RCA's nationally recognized authority on TV servicing and originator of the famous RCA Pict-O-Guide for black-and-white TV. It's profusely illustrated with full-color photos taken from an operating color-TV receiver. Step-by-step instructions and diagrams provide many labor- and time-saving short-cuts for profitable color-TV servicing. Build up your share of the dynamic color-TV service market with the new PICT-O-GUIDE. Get your copy from your RCA tube distributor...today!

**NEW COLOR-TV PICT-O-GUIDE**  
CONTAINS SECTIONS ON:  
• Color Mixing • RCA  
Compatible Color TV System  
• Purity • Convergence •  
Gray-Scale Tracking • Color  
Operating Controls • Antenna  
Considerations • RF-IF-  
Bandpass Alignment • Color  
Test Equipment • Color-Bar  
Patterns • Troubleshooting •  
Signal Tracing • Interference  
• "Green Stripe" Test Signals



**RECEIVING TUBES**

RADIO CORPORATION OF AMERICA  
Electron Tube Division Harrison, N. J.