

TROUBLESHOOTING HORIZONTAL A.F.C. CIRCUITS

# RADIO - ELECTRONICS

OCTOBER 1955

TELEVISION • SERVICING • HIGH FIDELITY

MUGO GERNSBACK, Editor



*In this issue:*

Adding Feedback  
to  
Old Amplifiers

An FM  
Wireless Intercom

Build a Marlson  
Enclosure

Extend Your  
Ohmmeter Range

35¢

U. S. and  
CANADA

Radiophones for Small Craft

(See page 4)

# ACTUAL SIZE

complete with selector switch...

## TRIPLET

ELECTRICAL INSTRUMENT CO.  
Bluffton, Ohio

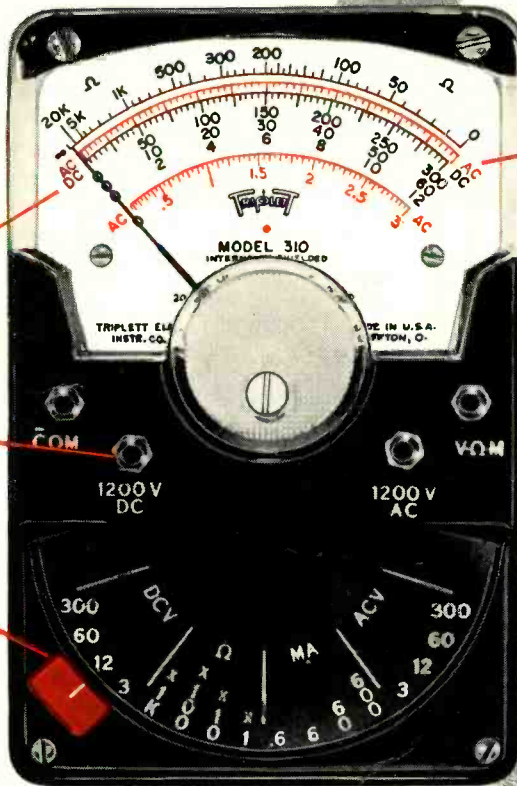

• 5,000 ohms per volt. A.C.

• 20,000 ohms per volt. D.C.

• BANANA-TYPE JACKS—positive connection and long life.

• EXCLUSIVE SELECTOR SWITCH speeds circuit and range settings. The first and only miniature VOM with this exclusive feature for quick, fool-proof selection of all ranges.



### CARRYING CASE

Handsome leather carrying case with adequate space for Model 310 tester and accessories. Trousers belt slips through loop on back of the case for out-of-the-way carrying. MODEL 369 CASE—U.S.A. Dealer Net ..... \$2.90

• SELF-SHIELDED FOR CHECKING IN STRONG MAGNETIC FIELDS. Self-shielded, rugged, higher-torque Bar-Ring instrument movement (exclusively Triplet).

Model **310** MIGHTY MITE

the only complete miniature  
**V-O-M (AC-DC)**

### LOOK AT ALL THESE RANGES

DC VOLTS: 0-3-12-60-300-1200 at 20,000 Ohms/Volt.  
AC VOLTS: 0-3-12-60-300-1200 at 5,000 Ohms/Volt.  
DC MICROAMPERES: 0-600 at 250 Millivolts.  
DC MILLIAMPERES: 0-6-60-600 at 250 Millivolts.  
OHMS: 0-20,000-200,000 (200-2000 at center scale);  
MEGOHMS: 0-2-20 (20,000-200,000 Ohms at center scale).  
OUTPUT: Convenient chart in instruction book.

SEE IT AT YOUR JOBBER

AND IT'S ONLY ONE OF TRIPLET'S MIGHTY NINE VOM LINE!

ONLY **\$29<sup>50</sup>** Dealer Net



**631**  
Combination  
V-O-M—VTVM



**630-NA**  
For Best Testing  
Around The Lab,  
Production Line  
or Bench



**630**  
The Popular  
All-Purpose  
V-O-M



**630-A**  
A Good Lab and  
Production Line  
V-O-M



**310**  
The Smallest  
Complete V-O-M  
With Switch



**630-T**  
For Telephone  
Service



**666-HH**  
Medium Size  
For  
Field Testing



**625-NA**  
The First V-O-M  
With 10,000  
Ohms/Volt AC



**666-R**  
Medium Size  
With  
630 Features

BURTON BROWNE ADVERTISING

# Learn to Service TV Sets— any make or model—Quickly

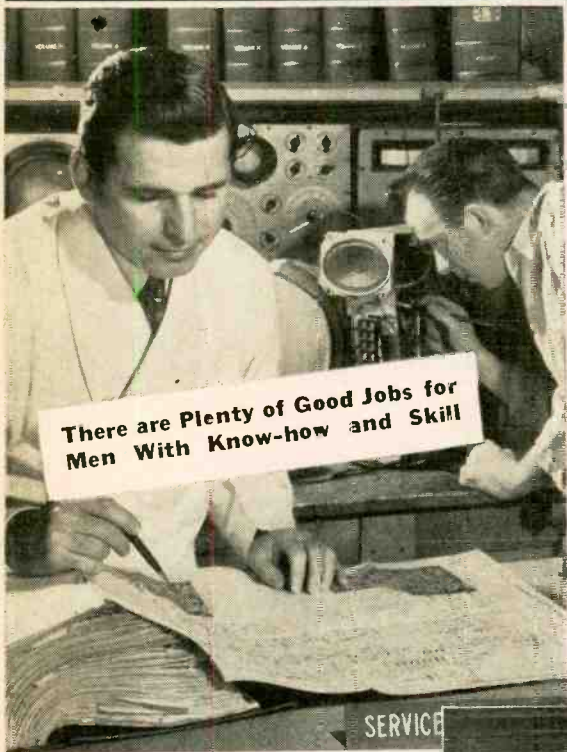

**There are Plenty of Good Jobs for  
Men With Know-how and Skill**

## New ALL PRACTICE Method trains you at home to become a Professional TV Serviceman

**You learn the time saving techniques,  
methods used by top TV Servicemen**

This is 100% learn-by-doing, practical training. NRI supplies all necessary equipment, all tubes, including a 17-inch picture tube; and comprehensive manuals covering a thoroughly planned program of practice. You learn how experts diagnose TV receiver defects quickly. You easily learn the causes of defects—audio and video—and how to fix them accurately.

You get actual experience aligning TV receivers, isolating complaints from scope patterns, eliminating interference, using germanium crystals to rectify the TV picture signal, adjusting the ion trap and hundreds of other valuable Professional techniques.

## UHF and COLOR Create Growing Opportunities

To cash in on the present UHF and the coming COLOR TV boom you'll need the kind of knowledge and experience NRI's Course gives. You'll get practice installing front-end channel selector strips in modern UHF-VHF receivers. You learn UHF servicing problems and their solution. Mail the coupon now. Discover how NRI's new course in PROFESSIONAL TELEVISION SERVICING meets the needs of the man who wants to get ahead in TV Servicing.

## Not for Beginners

If you have some knowledge of Radio-TV fundamentals, or have had some Radio Shop experience or some Radio school training, this course IS FOR YOU. Mail coupon today.

Address National  
Radio Institute,  
Dept. 5KFT, 16th  
and U Sts., N. W.,  
Washington 9, D. C.

**MAIL  
NOW**

**17" Picture Tube, Components  
for a TV Receiver, Scope,  
Signal Generator, HF Probe—  
all included in introductory  
price under \$200—Easy Terms**

If you want to go places in TV servicing, you will act quickly to find out what you get, what you practice, what you learn and how NRI's new course in Professional Television Servicing will help you advance through better technical knowledge and training. See pictures of equipment supplied, read what you practice in book offered FREE to ambitious men with some knowledge of Radio or TV fundamentals. Find out about this ALL PRACTICE Professional TV Servicing Course now.

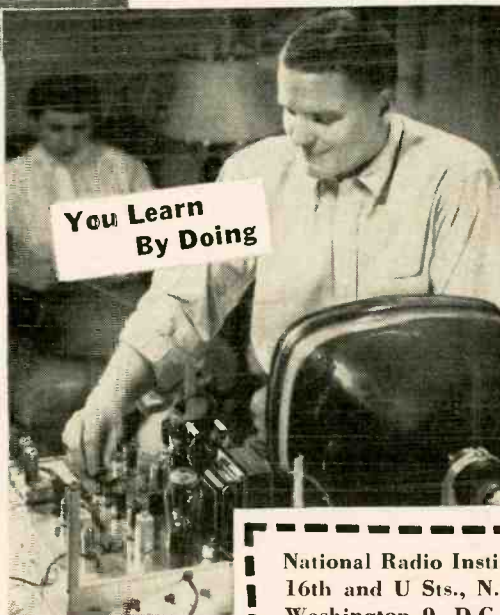

**You Learn  
By Doing**

## COUPON BRINGS IMPORTANT BOOK FREE

**HOW TO  
REACH THE  
TOP  
IN TV  
SERVICING**

Get this book and judge for yourself how this course will further your ambition to reach the top in TV Servicing or help to build a more secure business of your own in TV. Many of tomorrow's top TV Servicemen . . . men who can service any make, any model, UHF, VHF or Color TV . . . will be graduates of this training. Mail the coupon now. There is no obligation.

National Radio Institute, Dept. 5KFT,  
16th and U Sts., N.W.  
Washington 9, D.C.

Please send my FREE copy of "How to Reach the Top in TV Servicing." I understand no salesman will call.

Name..... Age.....

Address.....

City..... Zone..... State.....

Approved Member National Home Study Council

# RADIO - ELECTRONICS

Formerly RADIO CRAFT • Incorporating SHORT WAVE CRAFT • TELEVISION NEWS • RADIO & TELEVISION\*

Hugo Gernsback  
Editor and Publisher  
M. Harvey Gernsback  
Editorial Director  
Fred Shunaman  
Managing Editor  
Robert F. Scott  
W2PWG, Technical Editor  
Jerome Kass  
Associate Editor  
I. Queen  
Editorial Associate  
Matthew Mandl  
Television Consultant  
Angie Pascale  
Editorial Production  
Wm. Lyon McLaughlin  
Tech. Illustration Director  
Sol Ehrlich  
Art Director

Lee Robinson  
General Manager  
John J. Lamson  
Sales Manager  
G. Aliquo  
Circulation Manager  
Adam J. Smith  
Director, Newsstand Sales  
Robert Fallath  
Promotion Manager

## GERNSBACK PUBLICATIONS, INC.

Executive, Editorial and Advertising Offices, 25 West Broadway, New York 7, N. Y. Telephone REctor 2-8630.

Hugo Gernsback  
Chairman of the Board  
M. Harvey Gernsback  
President  
G. Aliquo  
Secretary

### ON THE COVER:

(Story on page 50) Barbara Brainard assists in a routine service check on ship-to-shore radiophone equipment.

Color original arranged by Phaostron Co., So. Pasadena, Calif.



## OCTOBER 1955

Vol. XXVI, No. 10

### Editorial (Page 33)

Electronic Alarms ..... by Hugo Gernsback 33

### Test Instruments (Pages 34-43)

Dual-Frequency Crystal Calibrator ..... by Ronald L. Ives 34  
A Voltage-Measuring Electronic Switch ..... by William Austin 37  
An Accessory for Your Signal Generator ..... by David John Lewis 40  
Extend the Range of Your Ohmmeter ..... by Donald H. Rogers 42

### Radio (Pages 44-53)

Failure-Proof Conelrad Alarm ..... by Harold Schaaf 44  
FM Wireless Intercom ..... by J. P. Neil 46  
A.C. Supply Circuitry ..... by L. B. Hedge 49  
Communications—Ship to Shore (Cover Story) ..... by Sidney S. Konigsberg 50  
DX Tiny Tuner ..... by I. Queen 53

### Audio—High Fidelity (Pages 54-80)

Constructing a Karlson Enclosure ..... by Don V. R. Drenner 54  
Variable Height Fidelity ..... by Vladimir Kenn 57  
Acquiring a Hi-Fi Amplifier ..... by Eric Leslie 58  
Adding Feedback to an Old Amplifier ..... by Norman H. Crowhurst 61  
For Golden Ears Only: The Ampex 620 amplifier-speaker; Gray viscous-damped tone arm; new records review ..... by Monitor 65

### Television (Pages 82-103)

Troubleshooting Horizontal A.F.C. Systems ..... by Cyrus Glickstein 82  
Television . . . it's a Cinch. Eighteenth conversation, second half: The color tube; three guns or one; TV is just starting out; a sure future ..... by E. Aisberg 88  
Convergence Not Impossible . . . but Difficult, Part II ..... by Harold Davis 92  
TV Service Clinic ..... Conducted by Jerry Kass 96  
TV DX—October—December ..... 103

### Electronics (Pages 105-120)

Travel Aid for the Blind ..... by T. A. Benham 104  
Electronic Indicator Aids Emulsification ..... by Harry Peach 114  
An Induction-Operated Garage Door Opener ..... by Richard Friedman 116

### DEPARTMENTS

Books .....	161	People .....	153
Business .....	154	Question Box .....	142
Corrections .....	158	Radio Month .....	6
Correspondence .....	10	Radio-Electronic Circuits .....	138
New Devices .....	128	Technical Literature .....	159
New Tubes and Transistors .....	134	Technicians' News .....	136
Patents .....	147	Technotes .....	122

Try This One ..... 150

Average Paid Circulation over 175,000

RADIO-ELECTRONICS, October, 1955, Vol. XXVI, No. 10. Published monthly at Mt. Morris, Ill. by Gernsback Publications, Inc. Second-class mail privileges authorized at Mt. Morris, Ill. Copyright 1955 by Gernsback Publications, Inc. Text and illustrations must not be reproduced without permission of copyright owners.

SUBSCRIPTIONS: Address correspondence to Radio-Electronics, Subscription Dept., 404 N. Wesley Ave., Mt. Morris, Ill., or 25 West Broadway, New York 7, N. Y. When ordering a change please furnish an address stencil impression from a recent wrapper. Allow one month for change of address.

SUBSCRIPTION RATES: U. S., U. S. possessions and Canada, \$3.50 for one year; \$6.00 for two years; \$8.00 for three years; single copies 35c. Pan-American countries \$4.00 for one year; \$7.00 for two years; \$9.50 for three years. All other countries \$4.50 a year; \$8.00 for two years; \$11.00 for three years.

BRANCH ADVERTISING OFFICES: Chicago: 7522 North Sheridan Road, Tel. ROGers Park 4-8000. Los Angeles: Ralph W. Harker and Associates, 600 South New Hampshire, Tel. DInkirk 7-2328. San Francisco: Ralph W. Harker and Associates, 582 Market St., Tel. GARfield 1-2181. FOREIGN AGENTS: Great Britain: Atlas Publishing and Distributing Co., Ltd., London E.C. 4, Australia: McGill's Agency, Melbourne, France: Brentano's, Paris 2e, Belgium: Agence et Messageries de la Presse, Brussels, Holland: Trilectron, Heemstede, Greece: International Book & News Agency, Athens, So. Africa: Central News Agency Ltd., Johannesburg, Capetown, Natal, Universal Book Agency, Johannesburg, Middle East: Steimatzky Middle East Agency, Jerusalem, India: Broadway News Centre, Dadar, Bombay #14. Pakistan: Paradise Book Stall, Karachi #3. POSTMASTER: If undeliverable send form 3578 to: RADIO-ELECTRONICS, 25 West Broadway, New York 7, N. Y. \*Trademark registered U. S. Patent Office.



## National Schools brings you a new dimension in training for **TELEVISION-RADIO-ELECTRONICS**

### YOU CAN LEARN BY HOME STUDY, IF—

- you are ambitious to increase your earning power.
- you want to broaden your knowledge and skill.
- you choose the school with the most complete training and service.

### 50 Years of Successful Training

National Schools has been training men for success since 1905. Our graduates are located around the globe, in good-paying jobs in servicing, installation and manufacturing... in public and private industry, or in their own businesses. All this experience and background are your assurance of success.

### What This New Dimension in Home Study Means to You

As a National Schools student, with Shop Method Home Training, you master *all phases* of the industry—TV, Radio, Electronics—theory and practice. You learn HOW and WHY, in one complete course at one low tuition.

Because National Schools' world headquarters are in Los Angeles—"capital city" of TV-Radio-Electronics—our staff is in close touch with industry. Our lessons and manuals are constantly revised to keep you up-to-the-minute on latest developments. We show you how to make spare time earnings as you learn, and we give you free placement assistance upon graduation. National Schools is approved for G. I. Training. Both Resident and Home Study courses are offered. If you are of draft age, our training helps you achieve specialized ratings and higher pay grades.

This *new dimension* enables us to train you as you should be trained at home, regardless of your age or previous education.

### Your Course Includes Valuable Units

We send you important equipment, including a commercial, pro-

fessional Multitester... plus parts to build Receivers, Oscillators, Signal Generator, Continuity Checker, other units, and Short Wave and Standard Broadcast Superhet Receiver.

### Mail Coupon for Complete Information

Get these two free books about this new dimension in Home Training. A comprehensive, illustrated fact-book and a sample National Schools lesson. No obligation, so mail coupon today.

### NATIONAL SCHOOLS

TECHNICAL TRADE TRAINING SINCE 1905  
Los Angeles: 37, Calif. • Chicago: 323 W. Polk St.  
In Canada: 811 W. Hastings St., Vancouver, B.C.



### MAIL NOW TO OFFICE NEAREST YOU!

[mail in envelope or paste on postal card]

NATIONAL SCHOOLS, Dept. RG-105

4000 S. FIGUEROA STREET OR 323 W. POLK STREET  
LOS ANGELES 37, CALIF., CHICAGO 7, ILL.

Rush FREE BOOK, "Your Future in Radio-TV-Electronics," and FREE LESSON. No obligation, no salesman will call.

NAME \_\_\_\_\_ BIRTHDAY \_\_\_\_\_ 19\_\_

ADDRESS \_\_\_\_\_

CITY \_\_\_\_\_ ZONE \_\_\_\_\_ STATE \_\_\_\_\_

Check if interested ONLY in Resident Training at Los Angeles.

VETERANS: Give date of discharge \_\_\_\_\_

**NEW High Fidelity  
INTEGRATED  
3-WAY  
TRIAXIAL  
15" and 12"  
REPRODUCERS**

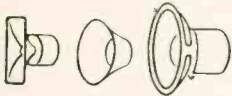

Concentrically  
Combines E-V  
Super-Sonax,  
Radax Propagator,  
and Bass Cone

**Brings advantage of distortion-free  
wider range found in E-V separate  
3-way systems, in one compact speaker**

E-V concentric Triaxial design gets the most from specialized driving media for each portion of the audio spectrum. Augmented bass response, full bodied mid-range and silky-smooth upper octaves to the highest audible frequencies provide excellent musical balance without masking effects or imposed distortions.

- Model 12TRXB. 12 $\frac{1}{4}$ -in. diameter.  
Magnet wt. 1 lb. 2 oz. Net, \$59.70
- Model 12TRX. 12 $\frac{1}{4}$ -in. diameter.  
Magnet wt. 3 $\frac{1}{2}$  lb. Net, \$114.00
- Model 15TRXB. 15 $\frac{1}{8}$ -in. diameter.  
Magnet wt. 1 lb. 2 oz. Net, \$78.00
- Model 15TRX. 15 $\frac{1}{8}$ -in. diameter.  
Magnet wt. 5 $\frac{3}{4}$  lb. Net, \$135.00

Each speaker includes brilliance control

- Exclusive E-V Concentric Mounting  
Insures Smooth, Full Range,  
Complete Room Coverage
- Balanced Response Characteristic  
Provides Realism and Presence
- Adjustable Brilliance Control  
for Remote Mounting. Allows  
Matching to Room Acoustics
- Edgewise Wound Voice Coil Design  
Affords 18% More Efficiency  
and Lower Distortion

Write for Descriptive Literature

**Electro-Voice®**  
BUCHANAN, MICHIGAN

the  
**Radio  
month**



**TUBE RACKET CURB** is aim of Philco plan which would offer service technicians 5 cents' credit for each worn-out tube turned in. In announcing this policy, James J. Shallow, general manager of Philco's accessory division, stated that discarded radio and TV receiving tubes are "being resold by unscrupulous concerns" to the public. It is estimated that this practice amounts to a \$100 million take annually with the tubes being completely worthless in many cases.

Under the plan the service technician can bring to a Philco distributor any brand tube and receive his 5-cent credit toward the purchase of a new tube. The old tube will be destroyed in the presence of the technician. It is believed that industry-wide adoption of this plan would greatly reduce or eliminate the tube racket.

The racket practice generally consists of purchasing worn-out tubes for 1 to 3 cents, cleaning and relabeling them and selling them to dealers and technicians by mail at huge profits.

**NEW COLOR TV SYSTEM**, demonstrated recently at Gimbel's New York City store, may make closed-circuit store telecasting feasible by making it cheaper. The system, introduced earlier this summer by Du Mont under the name *Vitascan*, in effect reverses present TV camera methods. What appears to be a camera is a flying-spot light source, and the signals are picked up by devices that look like banks of lights (see photos).

The principle of the flying spot is

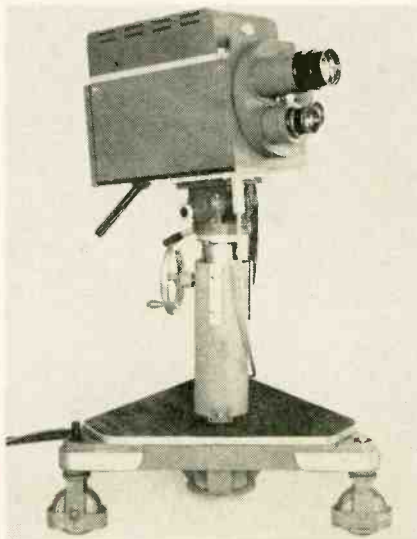

The camera-like mobile light source.

simple: instead of having a camera scan the object, a bright spot of light does so. A phototube pointed at the scene receives a signal proportional to the brightness of the spot being scanned. The principle was used in early black-and-white TV, but the camera was found more efficient. The story is different with color. Instead of three cameras combined in one unit and carefully registered with each other, all that is needed are "buckets" consisting of four phototubes. Two of these are made sensitive to red light, one to green and one to blue.

Since ambient light cannot be permitted to reach the phototube clusters, the studio must be kept in darkness while the signal is being picked up. This could make it very difficult for the performers, but the problem is resolved by illuminating the area brightly with strobe lights during each vertical blanking period. Thus—due to persistence of vision—the studio is brightly lighted as far as the performers are concerned.

**G. A. BRIGGS**, British audio book author and manufacturer of the Wharfedale speaker, is coming to the United States. Encouraged by the results of two demonstrations of high-fidelity equipment in Festival Hall, London, he has engaged Carnegie Hall in New York City for a similar lecture—demonstration on Oct. 9 at 3 pm. Mr. Briggs states that his object is to show what can be done with high-fidelity equipment—rather than reproduce music absolutely true to life—and to provide an opportunity of listening to records under conditions free from room effects.

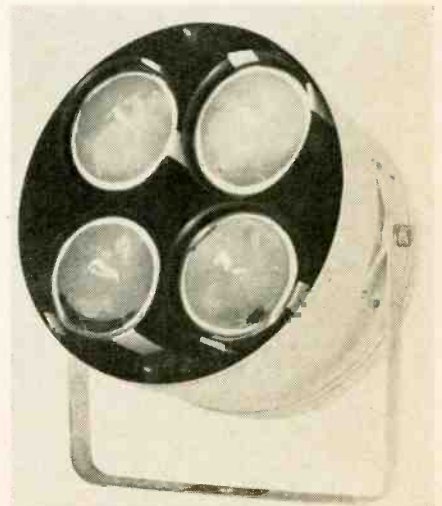

One of the "buckets" of phototubes.

Now IN YOUR OWN HOME Learn

# TELEVISION RADIO ELECTRONICS

*the Amazingly Effective*

## D. T. I. WAY

—with the aid of BOTH  
HOME EQUIPMENT  
and HOME MOVIES

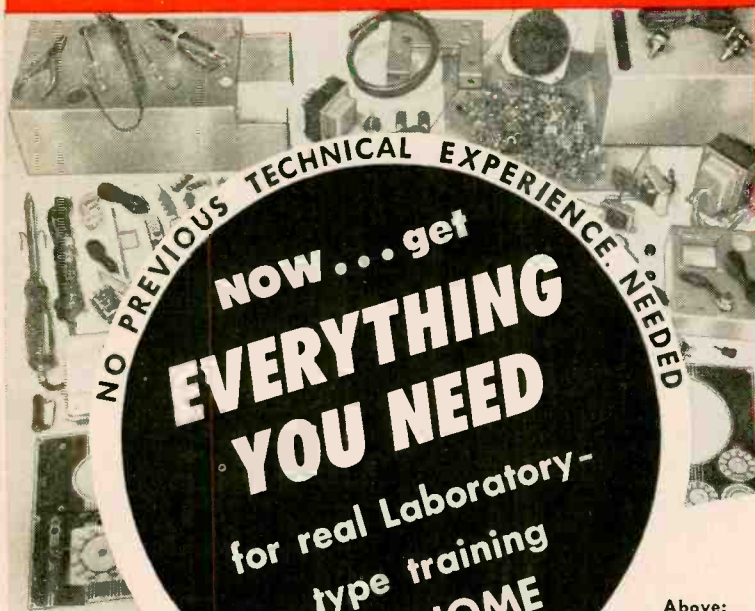

NO PREVIOUS TECHNICAL EXPERIENCE NEEDED

NOW... get  
**EVERYTHING  
YOU NEED**

for real Laboratory-  
type training  
**AT HOME**

Above:  
Work over  
**300**  
fascinating  
experiments  
with this  
equipment

1. Build over 300 fascinating experiments from 16 BIG SHIPMENTS of Electronic-Radio parts which you KEEP.
2. Build valuable commercial-type test equipment—as shown to the left—which you KEEP. This includes a quality 5 INCH oscilloscope and vacuum tube voltmeter—both highly useful for Television work.
3. Build and keep a big 21 INCH TV Set. (D.T.I. offers another home training in Television-Radio-Electronics, but without the TV set.)
4. Use a 16 mm. movie projector and new series of highly instructive movies—a wonderful aid to help you grasp important fundamentals faster... easier... better.
5. Enjoy well-illustrated, easy-to-read lessons with handy FOLD-OUT diagrams.
6. Get an honest-to-goodness EMPLOYMENT SERVICE to help you get a good job after graduating—or assistance in starting your OWN SALES AND SERVICE BUSINESS. Mail coupon today for the complete details.

D.T.I.'s Training is available in Canada

Get this  
information-  
packed  
publication

**FREE!**

*Mail Coupon Today*



OSCILLOSCOPE

VACUUM TUBE  
VOLT METER



**21 INCH**

Build and keep this BIG DTI Engineered TV set—easily converted to U.-I.F. (DTI offers another home training, but without the TV set.)



"ONE OF  
AMERICA'S FOREMOST  
TELEVISION  
TRAINING  
CENTERS"



HOME MOVIES

**89 WAYS  
TO  
EARN  
MONEY  
IN TELEVISION  
RADIO-ELECTRONICS**

**DEVRY TECHNICAL INSTITUTE**  
CHICAGO 41, ILLINOIS  
FORMERLY  
DEFOREST'S TRAINING, INC.

DEVRY TECHNICAL INSTITUTE  
4141 BELMONT AVE., CHICAGO 41, ILL.

MEMBER OF NATIONAL  
HOME STUDY COUNCIL

I would like your Opportunity News Bulletin showing "89 Ways to Earn Money In Television-Radio-Electronics"; also, complete facts about the training opportunity made possible by your organization.

Name \_\_\_\_\_ Age \_\_\_\_\_  
(PLEASE PRINT)  
Address \_\_\_\_\_ Apt. \_\_\_\_\_  
City \_\_\_\_\_ Zone \_\_\_\_\_ State \_\_\_\_\_  
D.T.I.'s Training is available in Canada Dept. RE-10-L

Movie Screen Brightness  
for Your TV Picture

Magic  
Mirror

**TUNG-SOL**  
**Aluminized**  
**PICTURE TUBE**

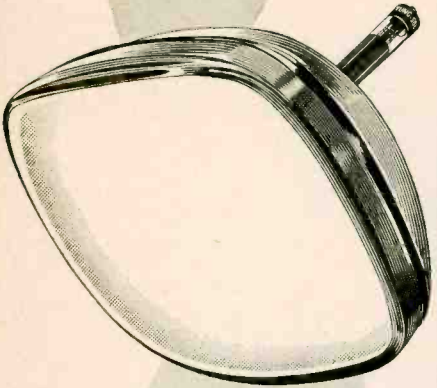

Yes, you can have a sharper, clearer TV picture . . . a picture with all the depth and detail you enjoy on the movie screen.

The Tung-Sol "Magic-Mirror" Aluminized Picture Tube gives you deeper blacks, more brilliant highlights and in-between tones that will make your picture fairly come alive. So treat yourself to new TV viewing pleasure with a Tung-Sol "Magic-Mirror" Aluminized Picture Tube.

The finest TV sets are factory-equipped with receiving and picture tubes made by Tung-Sol—one of America's leading electron tube manufacturers.

**TUNG-SOL ELECTRIC INC.,** Newark 4, N. J.  
Sales Offices: Atlanta, Chicago, Columbus, Culver City (Los Angeles), Dallas, Denver, Detroit, Montreal (Canada), Newark, Seattle.

**TUNG-SOL** Automotive and Electronic Products

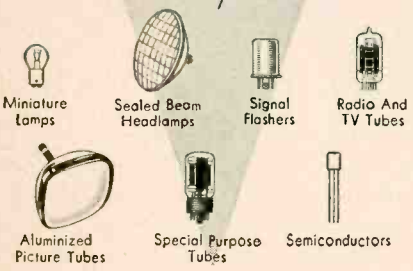

THE RADIO MONTH

**TEN NEW TV STATIONS** have gone on the air since our last report:

KNTV	San Jose, Calif.	11
WTHS-TV	Miami, Fla.	2
WILL-TV	Champaign-Urbana, Ill.	12
WNDU-TV	Notre Dame-South Bend, Ind.	46
KSTF	Scottsbluff, Neb.	10
WFLB-TV	Fayetteville, N. C.	18
KFJZ-TV	Fort Worth, Tex.	11
WXEX-TV	Petersburg-Richmond, Va.	8
WHIS-TV	Bluefield, W. Va.	6
WJPB	Fairmont, W. Va.	35

WEEU-TV, Reading, Pa., channel 33, and WACH-TV, Newport News-Norfolk, Va., channel 33, have gone off the air. WTVH-TV has changed its call letters to WTVH, Peoria, Ill., channel 19. Canada's 28th station, CJON-TV, St. John's, Newfoundland, channel 6 has gone on the air.

**WEATHER RADAR** is being installed on all United Air Lines planes that will enable pilots to peer deep into thunderstorms, normally appearing as a dense mass, and to navigate through smooth

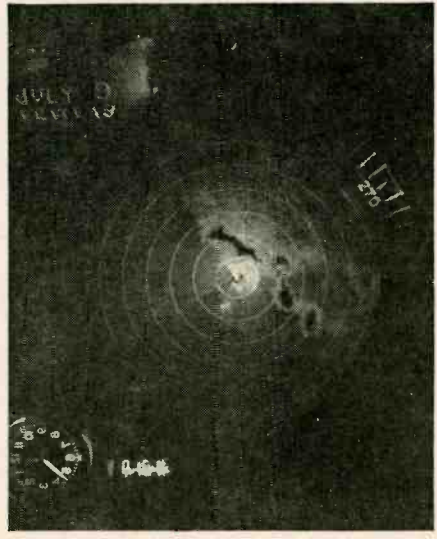

corridors (see photo) around the cores of storms. Designed primarily for weather mapping, the new C-band radar (5.5 cm) also gives pilots a clear picture of terrain features such as streams, mountains and shorelines. It will keep pilots informed of changing weather conditions as far as 150 miles ahead.

The radar equipment, made by RCA, has its antenna and gear mechanism installed in the plane's nose.

**BELL SOLAR BATTERY** installed in Americus, Ga., this past summer has



(Continued)

undergone its first practical test as part of the telephone system. The experimental unit, essentially identical to the model shown in the photo, supplied power to terminal equipment on rural telephone lines. The heart of the solar battery is a silicon disc that converts sunlight into electricity.

The model contains 432 discs, arranged in 48 units of 9 each. During daylight hours the solar battery powers terminal equipment directly and, at the same time, charges a storage battery to provide power for nighttime operation and periods of lowered sun intensity. The mounting permits the face of the battery to be tilted to the most favorable angle for maximum sun exposure.

**TWO TELEVISION PROGRAMS** on a single channel is a plan proposed by Paramount Pictures in their bid for FCC approval of pay-as-you-see TV. The Paramount plan, which does not use scrambling as part of their system, would show a photo advertising a motion picture on a given channel. When a coin is inserted, the continuous commercial would be replaced on the screen by the movie.

Dr. King, head of Telemeter's engineering department, a subsidiary of Paramount, indicated that the quality of the continuous commercial might be degraded as compared to the motion picture. He added, however, "Ultimately, I think it will be possible to send two full programs simultaneously on the same channel—our present use of the TV channel is very wasteful."

In its technical paper filed with the FCC, Paramount stated that its system is roughly similar to that of color TV transmission. By a system of frequency interleaving, signals of program A are dropped between those of program B. With a switching circuit, either set of signals can be selected.

**NEW FREQUENCY RECORD** for transistors has been set by the Bell Telephone Laboratories, with a junction tetrode transistor that oscillates at 1,000 mc (1,000,000,000 cycles) per second.

The new transistor is an n-p-n type in which the central p-layer has been made very thin, as a result of new production techniques. In the 1,000-mc transistors the layer is less than .0002 inch wide, 10 times narrower than was previously possible. A fourth electrode is also attached to this layer. It concentrates the current flow in only a part of the layer, making it electrically even smaller and narrower.

Telephone engineers are especially interested in the new transistors, since it may be possible to use them in the relay systems which now beam television programs and large bundles of phone conversations across the country. Previous transistor types could not be made to operate at the high frequencies used in such systems.

Commercial production of the at-present experimental transistors is scheduled to begin this year. END



Prepare for a Good Paying Job — Or Your Own Business

Learn **PRACTICAL RADIO-TV**  
with **25 BIG KITS**

of equipment I send you while  
you train with me . . . for valuable  
shop bench experience . . .

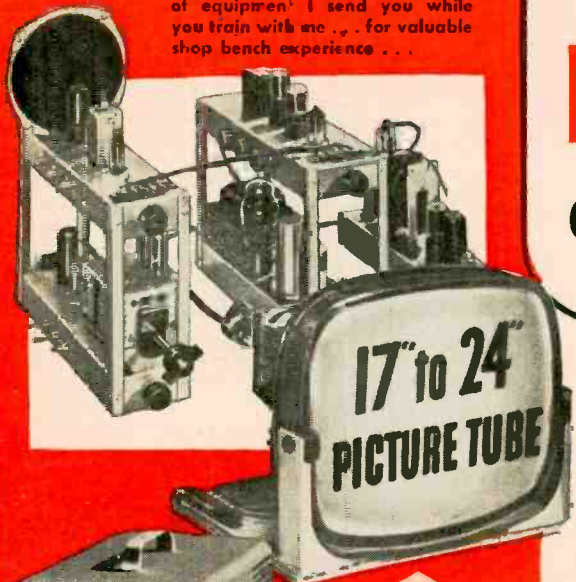

This is the new Sprayberry Training  
Television receiver, built and tested  
in sections for greatest instruction  
value.

Now offer this fine modern oscil-  
loscope to help you learn practical  
Television servicing.

You will build this powerful short  
wave and broadcast superhet radio  
scope for valuable shop instruc-  
tion practice.

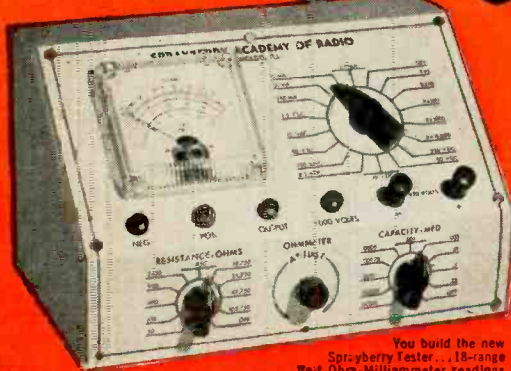
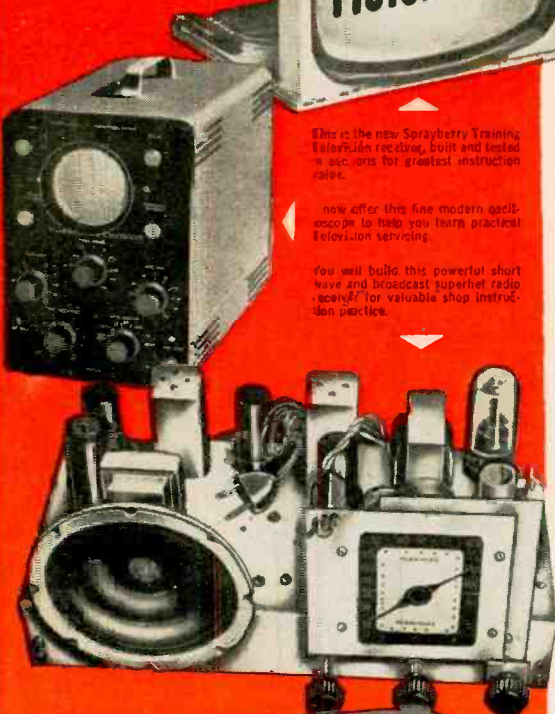

You build the new  
Sprayberry Tester . . . 18-range  
400-Ohm-Ohmmeter readings  
plus output meter and condenser  
and resistor substitution selector.

In addition to modern lesson training, I also give you  
plenty of home practice on actual Radio-Television  
equipment . . . you will build and use the units shown  
here plus many more. All this equipment is yours to  
keep . . . keep everything you need to set up your shop.

"I Will Train You at Home in  
**RADIO-TELEVISION**  
On Liberal No Obligation Plan!"

New Equipment! New Lessons! Enlarged  
Course! The true facts are yours in my  
big new catalog . . . **YOURS FREE . . .**

**JUST MAIL COUPON!**



Frank L. Sprayberry  
President, Sprayberry  
Academy of Radio

I can train and prepare you in as little as  
10 months to step into the big opportunity  
Radio-Television service field. Train *without*  
signing a binding contract . . . without obli-  
gating yourself to pay any regular monthly  
amounts. You train entirely at home in spare  
hours . . . you train as fast or as slowly as  
you wish. You'll have your choice of **THREE SPRAYBERRY TRAINING  
PLANS . . .** planned for both beginners as well as the more experienced  
man. Get the true facts about the finest most modern Radio-Training avail-  
able today . . . just mail the coupon for my big new 56 page fact-filled  
catalog plus sample lesson—both **FREE.**

**Train the Practical Way—with Actual Radio-Television Equipment**

My students do better because I train both the mind and the hands. Sprayberry  
Training is offered in 25 individual training units, each includes a practice giving  
kit of parts and equipment . . . all yours to keep. You will gain priceless practical  
experience building the specially engineered Sprayberry Television Training Re-  
ceiver, Two-Band Radio Set, Signal Generator, Audio Tester and the new Spray-  
berry 18 range Multi-Tester, plus other test units. You will have a complete set  
of Radio-TV test equipment to start your own shop. My lessons are regularly  
revised and every important new development is covered. My students are com-  
pletely trained Radio-Television Service Technicians.

**NEWEST  
DEVELOPMENTS**

Your training  
covers U H F, Color  
Television, F M,  
Oscilloscope  
Servicing, High  
Fidelity Sound  
and Transistors.

**See for Yourself . . . Make Your Own Decision  
. . . Mail Coupon Today!**

The coupon below brings you my big new catalog plus  
an actual sample Sprayberry Lesson. I invite you to read  
the facts . . . to see that I actually illustrate every item  
I include in my training. With the facts in your hands,  
you will be able to decide. *No salesman will call on you.*  
The coupon places you under no obligation. Mail it now,  
today, and get ready for your place in Radio-Television.

**SPRAYBERRY ACADEMY OF RADIO**  
111 North Canal Street, Dept. 20-D, Chicago 6, Illinois

**Mail This Coupon For Free Facts and Sample Lesson**



**SPRAYBERRY ACADEMY OF RADIO**  
Dept. 20-D, 111 N. Canal St., Chicago 6, Ill.

Please rush all information on your **ALL-NEW** Radio-Television  
Training Plan. I understand this does not obligate me  
and that *no salesman will call upon me.* Include New Catalog  
and Sample Lesson **FREE.**

Name \_\_\_\_\_ Age \_\_\_\_\_  
Address \_\_\_\_\_  
City \_\_\_\_\_ Zone \_\_\_\_\_ State \_\_\_\_\_

# Gives your customers brilliant results ...pays off for you!

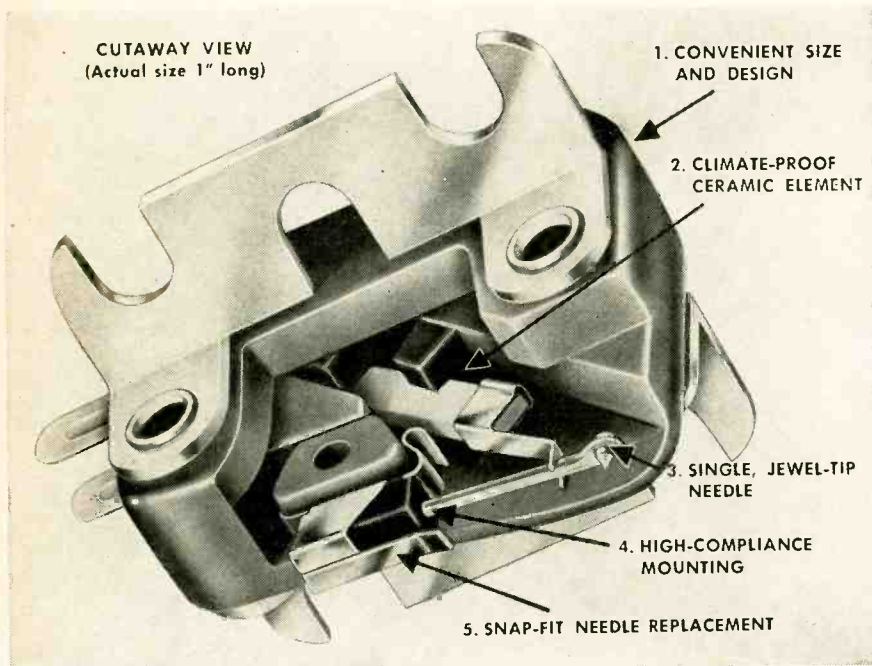

## New Sonotone 1P Cartridge

1. Easy to install. Just two models fit most arms now in use. Cartridge is less than 1" long, 8/10" wide with bracket. Time-saving hardware included.
2. Ceramic element gives flat response (see curve)—requires no preamplification or equalization. No deterioration problems as with other types...virtually immune to hum pickup.
3. Replaceable needle, diamond or sapphire. Models for 33-45 rpm, or 78 rpm.
4. Extreme lateral compliance and low-mass design give superior tracking, low wear.
5. Needles snap in, snap out easily.

### Tap the Huge 45 RPM Changer Market!

Install this new Sonotone 1P, and give your customers exciting, true, wide-range response. At one stroke, you make a good sale, cut installation time, avoid problems found with other types of cartridges...and build your reputation for quality work and professional advice. No other cartridge has all the advantages this 1P gives you! With sapphire, \$7.50; with diamond, \$25.00.

RESPONSE 30-15,000  $\pm$  3 DB!

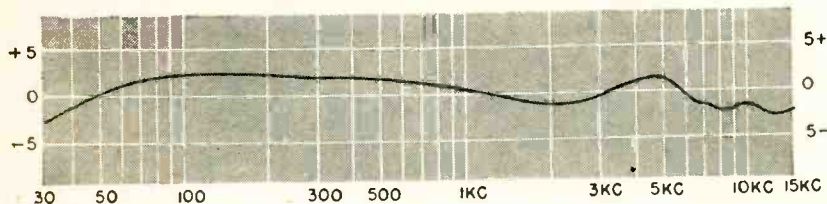

# SONOTONE CORPORATION

ELMSFORD, N. Y.

Write Dept. CE-105 for free Phono Modernization Manual



### TRANSISTOR SYMBOLS

Dear Editor:

I agree with Mr. Aisberg (June, 1955, page 14) on the need of standard symbols for transistors. They should be as simple as possible. I like the idea of putting a circle around the elements because transistors are encased in a material just as tubes are enclosed in glass or metal.

A small square or triangle could be inserted within the circle to indicate that there is no vacuum, as a small dot now indicates gas in a tube. [Why not simply enclose the transistor symbol in a square or triangle instead of this extra complication?—Editor]

A circle simplifies schematic reading—imagine TV schematics without circles around the tube elements, especially drawings that have been reduced!

T. L. BARTHOLOMEW

Bridgeport, W. Va.

### LOUDSPEAKER ENCLOSURE

Dear Editor:

I was pleased to see Mr. Coates' article "A New Loudspeaker Enclosure" (June, 1955). His cabinet is similar in principle to one I built some months ago, but he has gone much farther with his muslin diaphragm.

While I am no expert on acoustics, I have not been content with expensive speakers and multiple-port cabinets. I remembered that years ago our console radio seemed to sound better when turned to face the wall.

I decided to rework my open-face phonograph cabinet. I removed the speaker mounting panel from the front and cut another from 3/4-inch plywood to fit the back and put in an inexpensive 8-inch speaker. The speaker faces forward and protrudes out the back. The inside is lined with Fiberglas.

Performance has been very satisfactory; the bass response is smooth and sensitive to the lowest notes. On the treble end it is not shrill nor harsh and violins or trumpet solos stand out loud and clear.

Since Mr. Coates and myself agree that the open box type of enclosure gives pleasant listening, I feel that the complicated constructions and multiple-speaker systems are of no great advantage. My medium-priced 12-incher reposes on a shelf in the basement.

JOHN S. MCLEAN

Detroit, Mich.

### ELECTRONIC EMPLOYMENT

Dear Editor:

As a person who has occasion to be

**free**

**1956 VALUE PACKED ALLIED**

**324-PAGE ELECTRONIC SUPPLY CATALOG**

the only **COMPLETE** catalog for everything in TV, Radio, Hi-Fi and Industrial Electronics

**send for it today**

Get ALLIED's 1956 Catalog—it's *complete*, up-to-date—324 pages packed with the world's largest selection of quality electronic equipment at lowest, money-saving prices. Select from the latest in High Fidelity systems and components; P.A. systems and accessories; recorders and supplies; TV tubes, antennas and accessories; Amateur receivers, transmitters and station gear; specialized industrial electronic equipment; test instruments; new build-your-own kits; huge listings of parts, tubes, transistors, tools, books—the world's *most complete* stocks of quality equipment. Get *every* buying advantage at ALLIED: fastest shipment, expert personal help, lowest prices, assured satisfaction. Send today for your **FREE** copy of the big 1956 ALLIED Catalog.

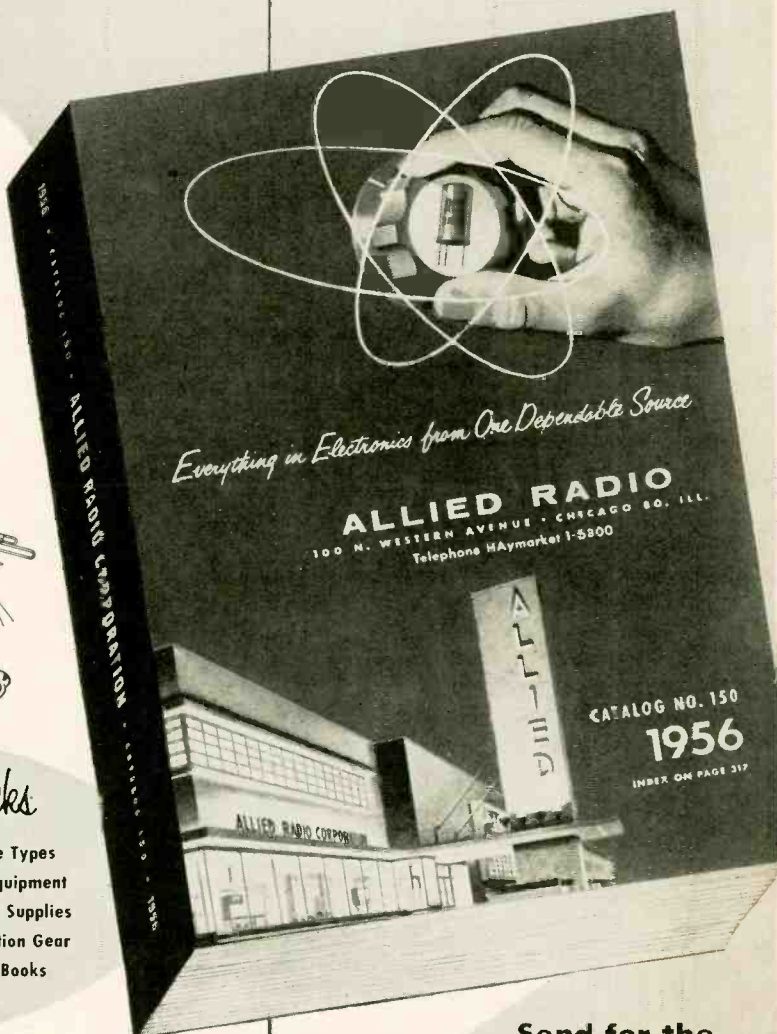

*World's Largest Stocks*

- All TV & Radio Parts
- All Electron Tube Types
- Test & Lab Instruments
- High Fidelity Equipment
- Latest Build-Your-Own Kits
- Recorders & Supplies
- P.A. Systems, Accessories
- Amateur Station Gear
- TV Antennas, Accessories
- Tools and Books
- Equipment for Industry

**ALLIED RADIO**

*World's Largest Electronic Supply House*

**EASY-PAY TERMS**

Use our liberal Easy Payment Plan—only 10% down, 12 months to pay—no carrying charges if you pay in 60 days. Available on Hi-Fi and P.A. units, recorders, TV chassis, test instruments, kits, Amateur gear, etc.

**HI-FI SPECIALISTS**

To keep up with the latest and best in High Fidelity, look to ALLIED. Count on us for *all* the latest releases and largest stocks of Hi-Fi equipment. We specialize, too, in TV supply—and are foremost in the field of Builders' Kits.

**ultra-modern facilities for the FASTEST SERVICE IN ELECTRONIC SUPPLY**

**free**

Send for the leading Electronic Supply Guide

ALLIED RADIO CORP., Dept. 2-K-5  
100 N. Western Ave., Chicago 80, Illinois

Send FREE 324-Page 1956 ALLIED Catalog

Name .....

Address .....

City ..... Zone ..... State .....



**For Best RESULTS**

Use

*Permoflux*  
**Hi-Fi Accessories with Your Tape Recorder**

**Diminutive Speaker System**



Popular 2-way Hi-Fi Speaker System. For wide-range tape playback. Ultra compact. Uses 2 Royal

6 inch speakers, 32KTR Super tweeter and hi-pass filter. Response: 50 to 16,000 cycles. Size: 23½" W x 11½" H x 12" D. In Korina Blonde or Mahogany ¾ inch veneers.

NET ..... **\$49.50**

**High-Fidelity Headphones**



Ideal for monitoring tape recordings . . . assure professional results. Perfect for every hi-fi listening application . . . use with the

Permoflux Maestro. (See below.) Impedance: 8 ohms. (Plug-in transformers for other impedances available.)

Model HD-1. NET ..... **\$29.85**

Deluxe Model. DHS-28B. 24 ohms. NET ..... **\$40.00**

**Maestro Speaker-Headset Control Box**

For connecting Hi-Fi headphones (or extension speaker) to tape recorder or amplifier. With volume control. Distinctive styling. Mahogany-finish cabinet; gold-finish raised front panel. Size: 5" H x 10¼" W x 6¾" D.

NET ..... **\$10.50**

**M-53A Telephone Pickup**



For recording both sides of telephone conversation on tape with crisp, clean response. Fits any type of phone. Plugs into mike jack of recorder. Complete with

6 feet of shielded cable. NET ..... **\$10.50**

*Permoflux* CORPORATION

Dept. C, 4912 Grand Ave., Chicago 30, Ill.  
4101 San Fernando Rd., Glendale 4, Calif.  
Canadian Licensee: Campbell Mfg. Co., Ltd.

CORRESPONDENCE

(Continued)

very close to employment problems in electronics, I feel Mr. Lane's treatment of the subject (July, 1955) was incomplete. He devoted a great deal of space to jobs employing a small segment of the nation's electronic technicians. Some of the biggest areas of opportunity were completely ignored.

He mentioned jobs such as technical writers, shipboard radio officers, etc., but did not bring out the fact that as of last June (1954) there were more than a half-million mobile transmitters in operation—excluding amateur, military and Government equipment. At the present rate of expansion that figure could easily reach the million mark within a year. Imagine how many FCC-licensed men will be needed in that field alone!

The installation and maintenance of electronic business machines (including computers) is rapidly drawing a great many men and the demand exceeds the supply. What about the airlines and their increasing demand for communications personnel? And the increased use of microwave equipment is another direction for electronically-minded men to move.

Mr. Lane should have dwelt less on minority groups and more on a complete coverage of the field.

G. O. ALLEN, Vice President  
Cleveland Institute of Radio Electronics  
Cleveland, Ohio

**NOTE FROM DOWN UNDER**

Dear Editor:

Here in Australia we are patiently waiting for our first TV broadcast. Allocations have been decided upon, and there will be one Government and two commercial stations in each capital city. In about a year we should be on the air. Americans will appreciate our feelings as you experienced a similar state of conditions.

RADIO-ELECTRONICS is highly rated in Australia and regarded as a *must* if one desires to keep abreast of the electronics field. Although we cannot yet follow along practical lines, articles on TV circuits, troubleshooting and antenna installations are very instructive and will be valuable for future reference.

Since the war we have followed the American trend in electronics. Tubes used here are, without exception, American types and circuits follow suit. Industry is fast waking up to automatic electronic control, and again these are mostly American products. I hope the above will be of some interest to your readers.

L. KAY  
Charlestown, New South Wales  
Australia

**PSEUDO-HORN ANTENNAS**

Dear Editor:

With regard to Mr. Julius Green's letter to the editor in the August, 1955, issue of RADIO-ELECTRONICS, we wish to add pertinent comments. Whether or

**WANTED**

**FOR VALUE**

An amateur, P. A. and tape recording microphone known to be in the vicinity of the price people want to pay

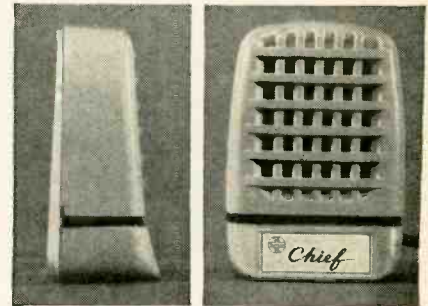

**TURNER**

**MODEL 808 CRYSTAL**

Response: 60—7,000 c.p.s.  
Level: -49 db.

**ALIAS**

**MODEL 807 CERAMIC**

Response: 80—7,000 c.p.s.  
Level: -57 db.

**ALIAS**

**MODEL 809 MAGNETIC**

Response: 100—8,000 c.p.s.  
Level: -52 db.

**ALIAS**

**THE CHIEF**

Subject microphone has been seen in desk, stand and hand use where quality was demanded, accompanied by compact size and low cost. By virtue of its good looks and versatility, the Chief is sought by the public for economical amateur use, public address and paging, and is ideal original or replacement equipment for tape recorders. Chief Model 808 has moisture sealed crystal, is wind and blast proof. Ruggedness, good performance and resistance to high humidity and heat are characteristic of Chief Model 809 with magnetic interior. Chief Model 807 with ceramic interior has heat and humidity resistance at a lower cost.

For complete information, write today to



933 17th Street, N. E.,  
Cedar Rapids, Iowa

AS A DEMONSTRATION

WILL YOU ACCEPT

without charge

ANY ONE OF THESE

HIGH-FIDELITY

MUSIC-APPRECIATION RECORDS

—in a one-month trial subscription



ON ONE SIDE there is a full performance of a great musical work. The records feature artists of recognized distinction. You listen to this performance and then...



ON THE OTHER SIDE is an analysis of the music, with the main features explained and played separately, so that you can learn what to listen for.

SPONSORED BY THE BOOK-OF-THE-MONTH CLUB, this new idea is designed for those who enjoy good music but who are aware, too often, that they do not listen to it with complete understanding and appreciation. There is no doubt about the reason: most of us are not primed about what to listen for. MUSIC-APPRECIATION RECORDS meet this need—for a full understanding of music—better than any means ever devised. This enjoyable form of self-education can be as thorough as the Music Appreciation courses given in many universities.

YOU SUBSCRIBE BUT TAKE ONLY THE RECORDS YOU WANT... A new Music-Appreciation Record is issued—for subscribers only—every month, preceded by an announcement written by the noted composer and music commentator Deems Taylor. After reading this descriptive essay you may take the record or not, as you decide at the time. You are not obligated to take any specified number of records. And you may stop the subscription at any time you please!

TWO TYPES OF RECORDS ARE AVAILABLE... All Music-Appreciation Records are high-fidelity, long-playing records of the highest quality—33 1/2 R.P.M. on Vinylite. They are of two kinds: first, a so-called Standard Record—a twelve-inch disc—which presents the performance on one side, the analysis on the other. This is sold at \$3.60, to subscribers only. The other is an Analysis-Only Record—a ten-inch disc—priced at \$2.40. The latter is made available each month for any subscriber who may already have a satisfactory long-playing record of the work being presented. (A small charge is added to the prices above to cover postage and handling.)

TRY A ONE-MONTH SUBSCRIPTION — WITH NO OBLIGATION TO CONTINUE... Why not make a simple trial, to see if these records are pleasurable and as enlightening as you may anticipate? The first record you choose will be sent to you at once—at no charge. You may end the subscription immediately after hearing this record, or you may cancel any time thereafter.



Schubert's "UNFINISHED" SYMPHONY

Max Rudolf, conducting  
The Stadium Concerts Symphony Orchestra



Richard Strauss' TILL EULENSPIEGEL'S MERRY PRANKS

Smetana's THE MOLDAU (ON ONE 12" DISC)  
George Szell, conducting  
Music Appreciation Symphony Orchestra



Prokofiev's CLASSICAL SYMPHONY

Britten's THE YOUNG PERSON'S GUIDE TO THE ORCHESTRA (ON ONE 12" DISC)  
Alfred Wallenstein, conducting  
Music Appreciation Symphony Orchestra



J.S. Bach's SUITE FOR ORCHESTRA NO. 3 IN D MAJOR

George Szell, conducting  
Music Appreciation Symphony Orchestra



Wagner's OVERTURES TO TANNHAUSER AND DIE MEISTERSINGER

(ON ONE 12" DISC)  
Norman Del Mar, conducting  
London Symphony Orchestra



Mendelssohn's VIOLIN CONCERTO IN E MINOR

FREDELL LACK, VIOLINIST  
Alexander Smallens, conducting  
The Stadium Concerts Symphony Orchestra

YOU WILL ALSO RECEIVE SEPARATELY A GLOSSARY OF MUSICAL TERMS



TYPICAL COMMENT: "Music has been my whole life—but not until I heard my first MUSIC-APPRECIATION RECORD did I realize how much I had been missing when I listened to orchestral music. I subscribed originally for my son, but quickly found that my own enjoyment of orchestral music was increased far beyond what I dreamed possible."

—Jarmila Novotna

STAR OF THE METROPOLITAN OPERA

PLEASE RETURN ONLY IF YOU HAVE A 33 1/2 R. P. M. RECORD PLAYER

MUSIC-APPRECIATION RECORDS

c/o Book-of-the-Month Club, Inc.  
345 Hudson Street, New York 14, N. Y.

R-39-10

Please send me at once, without charge, the MUSIC-APPRECIATION RECORD checked below and enter my name in a Trial Subscription to MUSIC-APPRECIATION RECORDS, under the conditions stated at left. It is understood that, as a subscriber, I am not obligated to buy any specified number of records, but may take only those I want. Also, I may cancel my subscription after hearing this first record, or any time thereafter at my pleasure, but the introductory record is free in any case.

AS MY FREE DEMONSTRATION RECORD PLEASE SEND ME

- Schubert's Symphony
- Strauss' Till Eulenspiegel and Smetana's The Moldau
- Bach's Suite for Orchestra
- Prokofiev's Symphony and Britten's Guide
- Wagner's Overtures
- Mendelssohn's Concerto

Mr. }  
Mrs. }  
Miss } (PLEASE PRINT)

ADDRESS.....

CITY..... ZONE..... STATE.....

MAR 30A

From nursery phonographs . . . to hi-fidelity units

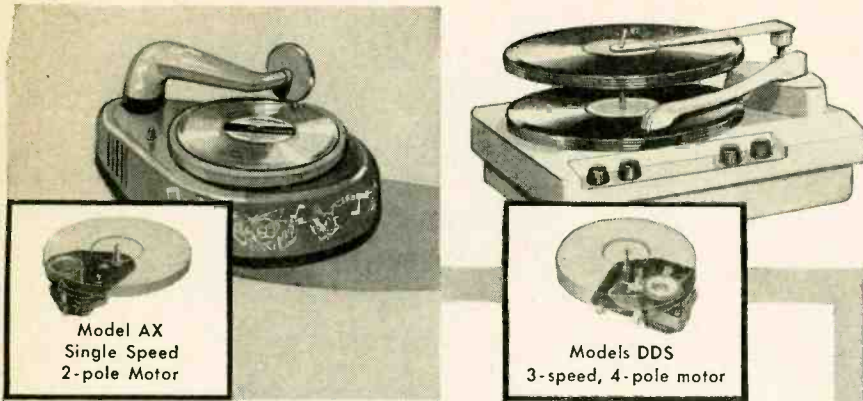

Model AX  
Single Speed  
2-pole Motor

Models DDS  
3-speed, 4-pole motor

## ... ONLY Makes a Phonomotor for EVERY Application!..

World's only complete line . . . one convenient source for every phonomotor need — that's GI! No matter what the application: portables . . . Hi-Fi (2 and 4 pole motors) . . . combinations . . . record changers . . . tape and disc recorders . . . GI has the right motor for the job. First choice of leading original equipment manufacturers, first choice for replacement, GI motors through the years have won a reputation for quality and dependability that is unsurpassed anywhere.

Write today for a complete catalog giving descriptions and specifications of phonomotors in the famous GI "Smooth Power" line.



Model DR  
2-speed,  
4-pole motor



Model SS  
3-speed,  
2-pole motor



Model RM4  
Single speed,  
4-pole motor



Model D-10 — 4-pole,  
shaded pole AC  
Induction type for tape,  
wire or disc recorders.



THE GENERAL INDUSTRIES CO.

DEPARTMENT GE • ELYRIA, OHIO

You  
Are  
Invited  
to .....

# Audiorama 1955

presented by

THE AUDIO FAIR

The largest aggregation of high-fidelity equipment ever displayed under one roof . . . presented by more than 125 manufacturers from all over the world. Their representatives will demonstrate the latest developments in the fast-moving audio field. At AUDIORAMA 1955, your questions will be answered personally and authoritatively. AUDIORAMA 1955 is for music-lovers, broadcast engineers, sound-on-film men, military and municipal agencies, industrial purchasing agents — for everybody interested in quality sound reproduction.

AUDIORAMA 1955 is presented by THE AUDIO FAIR  
Harry N. Reizes, Director of Audio Fairs, 67 W. 44th St., N. Y.  
An AUDIO FAIR-VIDEO FAIR, INC., Management Project

SPONSORED BY



NO ADMISSION  
CHARGE

FOUR DAYS —  
Oct. 13, 14, 15, 16

FOUR FLOORS —  
5th, 6th, 7th, 8th

HOTEL NEW YORKER  
New York City

Daily: 1 to 10 P.M.  
Sun: 12 Noon to 6 P.M.

CORRESPONDENCE

(Continued)

not the antenna referred to in the April issue of RADIO-ELECTRONICS is a true horn is an academic question. The gain-frequency characteristics of the antenna much more closely approximate those of a horn than of a dipole.

One advantage that a cut Yagi has is its rejection of signals at frequencies other than that to which it is tuned. However, if a broad-band Yagi is used, this advantage exists to a lesser degree. It should be pointed out that the pseudo-horn in Mr. O'Leary's article in the April issue has no tuned rejection of signals within itself. The rejection is limited to that of the front end of the TV set and the horn has high gain for "noise signals" as well as the wanted TV signals. There are many advantages, however, to the pseudo-horn, as constructed by Mr. O'Leary. One is that technically it is very easy to build and adjust. Very little adjustment of elements is necessary for proper impedance match and maximum gain, whereas in a Yagi these adjustments are critical and difficult to make without a completely equipped engineering laboratory. The area of space from which a Yagi can abstract signals is limited by the frequency to which it is cut, whereas the pseudo-horn does not have this limitation. This means that the total energy abstracted from space by a pseudo-horn can be very much greater than that by a Yagi.

In some communities where satisfactory signals are required regardless of cost, extremely large pseudo-horns have been constructed. They have given satisfactory TV reception where Yagis had failed completely. These large horns had higher gains than low-frequency Yagis and much higher gains than higher-frequency ones. Therefore, we feel that RADIO-ELECTRONICS readers would be well advised to try these horns in extremely low-signal areas.

GEORGE PRICE  
BRUNO ZUCCONI

San Francisco, Calif.

### TOUGH SITUATION

Dear Editor:

I am in complete agreement with Mr. H. M. Layden's comments (May, 1955) regarding screwdriver mechanics. I am the only service technician in a large rural area jampacked with screwdriver mechanics and can prove with facts, figures and case histories that every word of Mr. Layden's letter is true.

On only one point would I beg to differ. This is one shop where local tube pullers do not get the red-carpet treatment. I reserve a specialty for them called the meat-axe treatment.

Because of this situation, it looks more than likely that this area will be losing shortly its only legitimate service technician as it is impossible to maintain a profitable business when the gravy jobs are going elsewhere and all one has to work with are the headaches.

GORDON MCINTOSH

Crysler, Ont., Canada

RADIO-ELECTRONICS

L. C. Lane, B.S., M.A.  
 President, Radio-Television  
 Training Association  
 Executive Director, Pierce  
 School of Radio & Television.



VETERANS - - NON-VETERANS  
**Do You Want a BETTER  
 JOB with MORE MONEY?**

**I will train you AT HOME in your SPARE TIME  
 for a top-pay lifetime job in TELEVISION**

The world's leading manufacturers, dealers and service organizations employ men I trained. Even if you've never had any experience in the Television-Radio-Electronics field, you'll recognize most

of the names of just a few of the firms where RTTA-trained men are holding down good jobs with a secure future —

**LEARN BY DOING** As part of your training I give you the equipment you need to set up your own home laboratory and prepare for a BETTER-PAY TV JOB. You build and keep an Electromagnetic TV RECEIVER designed and engineered to take any size picture tube up to 21-inch. (10-inch tube furnished. Slight extra cost for larger sizes.) . . . also a Super-Het Radio Receiver, AF-RF Signal Generator, Combination Voltmeter-Ammeter-Ohmmeter, C-W Telephone Transmitter, Public Address System, AC-DC Power supply. Everything supplied, including all tubes.



**STUDY NEWEST DEVELOPMENTS**

My training covers all the latest developments in the fast-growing Television-Radio-Electronics industry. You learn about FM — RADAR — COLOR TV — TRANSISTORS — PRINTED CIRCUITS, etc.

**CHOOSE FROM THREE COMPLETE COURSES**  
 covering all phases of Radio, FM and TV

1. Radio, FM and Television Technician Course — no previous experience needed.
2. FM-TV Technician Course — previous training or experience in radio required.
3. TV Cameraman and Studio Technician Course — advanced training for men with Radio or TV training or experience.

**EXTRA TRAINING IN NEW YORK CITY AT NO EXTRA COST!**

After you finish your home study training in Course 1 or 2 you can have two weeks, 50 hours, of intensive Lab work on modern electronic equipment at our associate resident school, Pierce School of Radio & Television. THIS EXTRA TRAINING IS YOURS AT NO EXTRA COST WHATSOEVER!

**FCC COACHING COURSE**

Important for BETTER-PAY JOBS requiring FCC License! You get this training AT NO EXTRA COST! Top TV jobs go to FCC-licensed technicians.

**EARN WHILE YOU LEARN**

Almost from the very start of your course you can earn extra money by repairing sets for friends and neighbors. Many of my students earn up to \$25 a week . . . pay for their entire training with spare time earnings . . . start their own profitable service business.

**Radio Television Training Association**

52 EAST 19th STREET • NEW YORK 3, N. Y.

Licensed by the State of New York • Approved for Veteran Training

RCA • SYLVANIA • WESTINGHOUSE  
 BOEING • GENERAL ELECTRIC • LEWY  
 EMERSON • DOUGLAS AIRCRAFT  
 CAPEHART-FARNSWORTH • PHILCO  
 CANADAIR, LTD. • WESTERN ELECTRIC  
 OAK RIDGE NATIONAL LABORATORY  
 AMERICAN AIRLINES • COLUMBIA  
 BELL TELEPHONE • ADMIRAL • DUMONT  
 REDIFFUSION, INC. • BELL AIRCRAFT  
 RAYTHEON • CONVAIR

I can do for you what I did for my hundreds of successful graduates. Many of the men I trained are now their own bosses—making a wonderful living in their own growing business.

You, too, can win a place in the booming Television-Radio-Electronics industry . . . earn big money as a trained TV Technician . . . with my famous "Learn by Doing" home study method.

**FREE!**

I'll send you my new 40-page book, "How to Make Money in Television-Radio-Electronics," a free sample lesson, and other literature showing how and where you can get a top-pay job in Television.



**VETERANS!**

My School fully approved to train Veterans under new Korean G. I. BILL. Don't lose your school benefits by waiting too long. Write discharge date on coupon

**MAIL THIS COUPON TODAY!**

Mr. Leonard C. Lane, President  
 RADIO-TELEVISION TRAINING ASSOCIATION  
 Dept. R-10C, 52 East 19th Street, New York 3, N. Y.

Dear Mr. Lane: Mail me your NEW FREE BOOK, FREE SAMPLE LESSON, and FREE aids that will show me how I can make BIG MONEY IN TELEVISION. I understand I am under no obligation and, no salesman will call.

(PLEASE PRINT PLAINLY)

Name \_\_\_\_\_ Age \_\_\_\_\_

Address \_\_\_\_\_

City \_\_\_\_\_ Zone \_\_\_\_\_ State \_\_\_\_\_

I AM INTERESTED IN

- Radio-FM-TV Technician Course
- FM-TV Technician Course
- TV Cameraman & Studio Technician Course

**VETERANS!**

Write discharge date

**NO SALESMAN WILL CALL!**

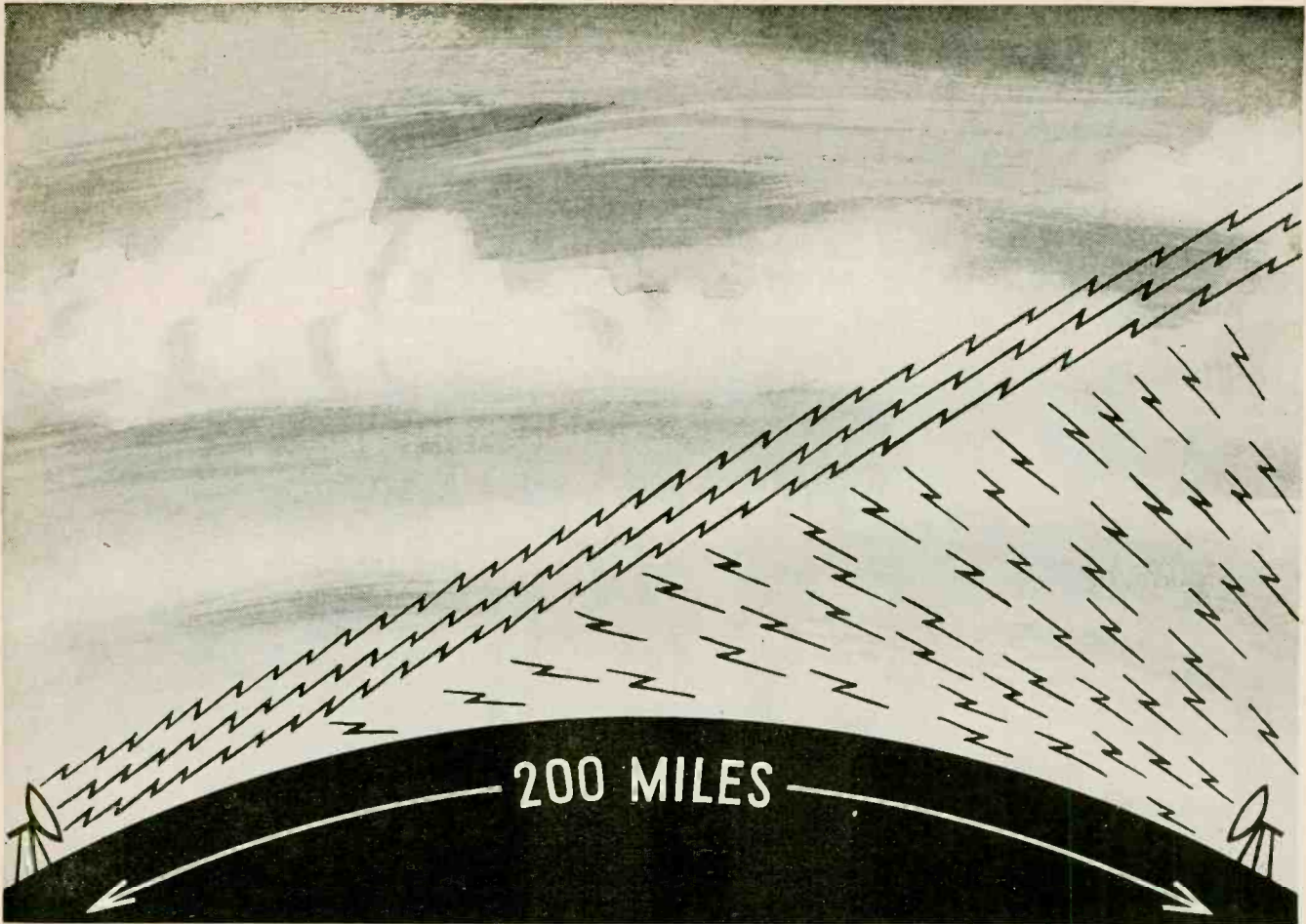

Highly schematic drawing illustrates the possible distribution of energy in ultra-high-frequency "over-the-horizon" transmission. The effect is similar to that of a powerful searchlight whose beam points into the sky. Light can be seen miles away from behind a hill even when the searchlight lens is invisible.

## Something new on the telephone horizon

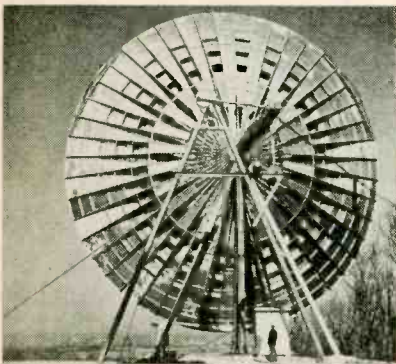

This experimental 60-foot antenna (rear view) photographed at Bell Laboratories in Holmdel, New Jersey, is designed for study of "over-the-horizon" phenomena.

Telephone conversations and television pictures can now travel by ultra-high-frequency radio waves far beyond the horizon. This was recently demonstrated by Bell Telephone Laboratories and Massachusetts Institute of Technology scientists using "over-the-horizon" wave propagation, an important recent development in the radio transmission field.

This technique makes possible 200-mile spans between stations, instead of the 30-mile spans used for present line-of-sight transmission. It opens the way to ultra-high frequencies across water or over rugged terrain, where relay

stations would be difficult to build.

In standard microwave line-of-sight transmission, stations are so spaced that the main beam can be used. But now, with huge 60-foot antennas, and much higher power, some signals drop off this main beam as it shoots off into space. These signals reach distant points beyond the horizon after reflection or scattering by the atmosphere. The greater power and larger antennas of the "over-the-horizon" system permit recapture of some of these signals and make them useful carriers. The system will be a valuable supplement to existing radio relay links.

**BELL TELEPHONE LABORATORIES**

*Improving telephone service for America provides careers for creative men in scientific and technical fields.*



RADIO-ELECTRONICS



Never before — an antenna  
with such utterly . . .

# Fantastic

front-to-back ratios

Low Band: from 15:1 to 50:1 relative VOLTAGE  
(2500:1 relative power)

High Band: up to 13:1 relative VOLTAGE  
(169:1 relative power)

*"Super-assembled"*  
— with  
Channel Master's  
trigger-fast  
Snap-Lock Action

## CHANNEL MASTER'S

new  
**"K.O."**  
all-channel antenna

### Available 3 ways!

**Broad Band** model—model no. 1023  
(includes HI-LO Matching Harness)

**Low Band** only—model no. 1026

**High Band** only—model no. 1073

Full descriptive literature available from your  
Channel Master distributor.

### Knocks out venetian blinds and co-channel interference!

Channel Master's new "K.O." has the highest front-to-back ratios ever recorded for any TV antenna! The sensational "K.O." actually sets up an INVISIBLE BARRIER to signals coming in from the rear. Working with supreme efficiency on both VHF bands, it totally REJECTS rear signals, preventing venetian blinds and other picture problems caused by co-channel interference.

### Spectacular High Gain!

Low Band, 7 to 9 DB, single bay; High Band, 8.5 to 10.5 DB, single bay. True Yagi performance, combined with completely independent High and Low Band operation for maximum efficiency.

LICENSED BY KAY TOWNES-ANTENNA CO., ROME, GA.



**CHANNEL MASTER CORP.**

The World's Largest Manufacturer of TV Antennas and Accessories

ELLENFIELD, N. J.

Copyright 1955, Channel Master Corp.

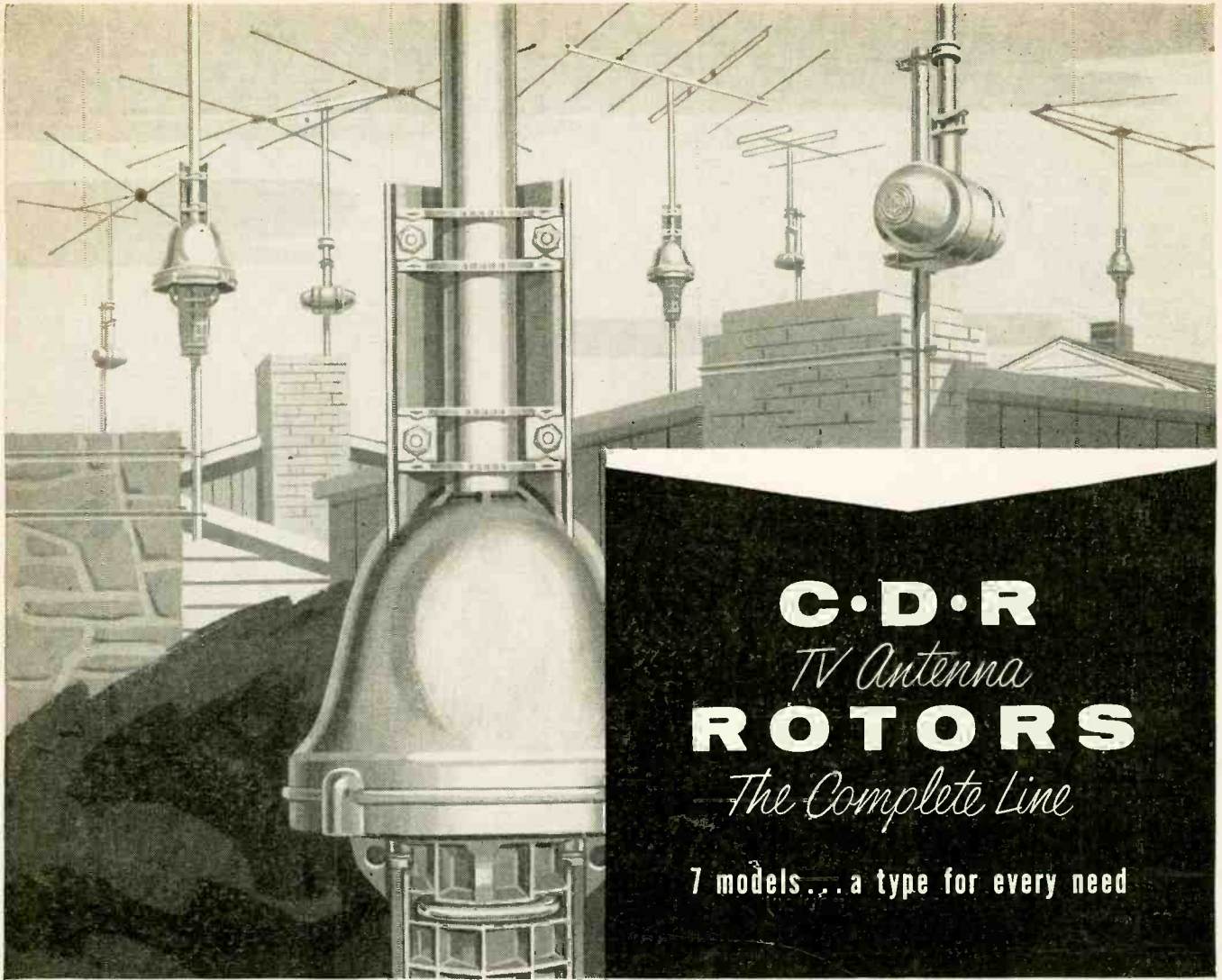

**C·D·R**  
*TV Antenna*  
**ROTORS**  
*The Complete Line*

7 models... a type for every need

featuring **C·D·R automatic ROTORS**

Here they are . . . the fastest selling line of rotors . . . complete in every detail . . . including three models in completely AUTOMATIC rotors! The AR-1 and AR-2 and the AR-22 which is the automatic version of the famous TR-2. ALL FIELD TESTED AND PROVEN BY THOUSANDS OF SATISFIED USERS!

TR-2 The heavy duty rotor with plastic cabinet featuring "compass control" illuminated perfect pattern dial . . . uses 8 wire cable.

TR-12 Complete rotor INCLUDING thrust bearing. Handsome modern cabinet with meter control dial, uses 4 wire cable.

TR-4 The heavy duty rotor complete with handsome new, modern cabinet with METER control dial, uses 4 wire cable.

TR-11 Same as model TR-12 without thrust bearing.

**pre-sold** PRE-SOLD to millions with the greatest concentration of TV Spots in our history.

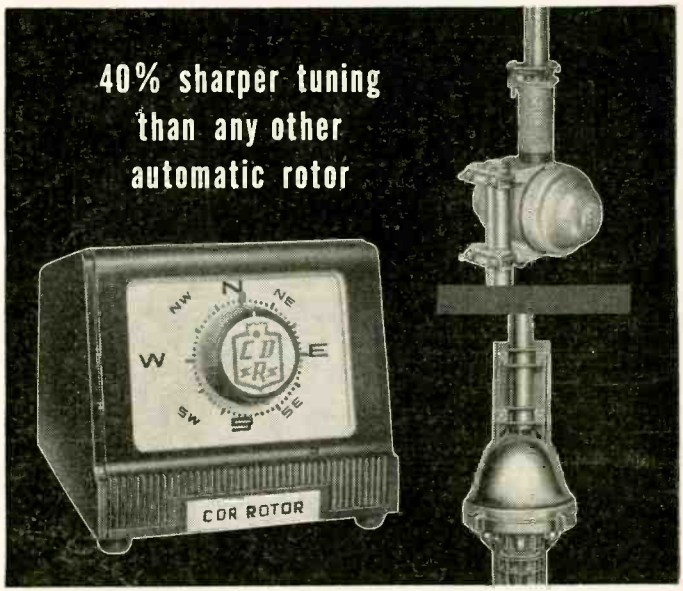

40% sharper tuning than any other automatic rotor

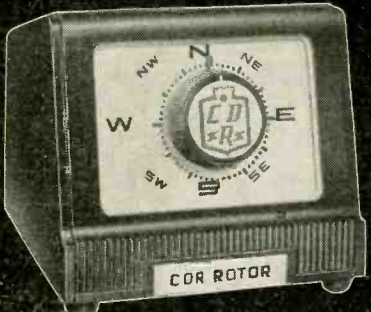

**CORNELL-DUBILIER**  
 SOUTH PLAINFIELD, N. J.



**THE RADIART CORP.**  
 CLEVELAND 13, OHIO

# I Will Train You at Home

## For Good Pay Jobs, Success in

# RADIO-TELEVISION

J. E. SMITH  
President  
National Radio  
Institute  
Washington, D. C.  
40 years of success  
training men at  
home in spare time.



I'll Prove It Is Easy And  
Practical To Learn At Home.  
Sample Lesson FREE.



To See Equipment I Send You  
For Practical Experience...  
Get Illustrated Book FREE.



## Practice Broadcasting with Equipment I Send

It's practical to train at home for good Radio-TV jobs and a brighter future. As part of my Communications Course I send you kits of parts to build the low-power Broadcasting Transmitter shown at the left. You use it to get practical experience performing procedures demanded of Broadcasting Station Operators. An FCC Commercial Operator's License can be your ticket to a better job and a bright future; my Communications Course gives you the training you need to get your license. Mail card below and see in my book other valuable equipment you build. Get FREE sample lesson.

## Practice Servicing with Equipment I Send

Self-confidence, security, earning power come from knowing-how and from experience. Nothing takes the place of PRACTICAL EXPERIENCE. That's why NRI training is based on LEARNING BY DOING. You use parts I furnish to build many circuits common to Radio and Television. With my Servicing Course you build a modern Radio (shown at right). You build a Multitester, use it in conducting experiments, fixing sets in spare time starting a few months after enrolling. All equipment is yours to keep. Card below will bring book showing other equipment you build. Judge for yourself whether you can learn at home in your spare time.

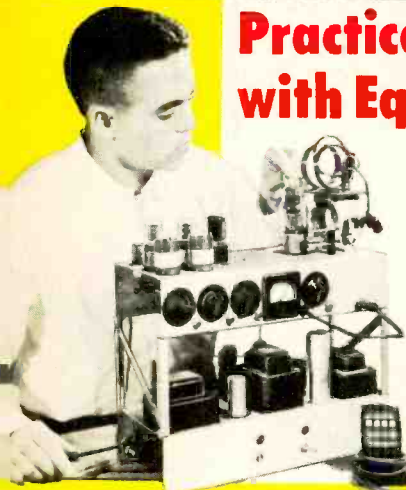

## Television Is Growing Fast Making New Jobs, Prosperity

More than 30 million homes now have Television sets and thousands more are being sold every week. Well trained men are needed to make, install, service TV sets and to operate hundreds of Television stations. Think of the good job opportunities here for qualified technicians, operators, etc. If you're looking for opportunity, get started now learning Radio-Television at home in spare time. Cut out and mail postage-free card. J. E. Smith, President, National Radio Institute, Washington, D. C. Over 40 years' experience training men at home.

AVAILABLE TO  
VETERANS  
UNDER G.I. BILL

Good Jobs  
Good Pay **See Other Side**

Get My SAMPLE LESSON and  
64-Page Illustrated Book

Cut out and mail  
card NOW!

# BOTH FREE

This card entitles you to Actual Lesson on Servicing, shows how you learn Radio-Television at home. You'll also receive my 64-page Book, "How to Be a Success in Radio-Television." Mail card now!

**NO STAMP NEEDED! WE PAY POSTAGE**

Mr. J. E. SMITH, President  
National Radio Institute, Washington 9, D. C.

Mail me Lesson and Book, "How to Be a Success in Radio-Television." (No Salesman will call. Please write plainly.)

NAME.....AGE.....

ADDRESS.....

CITY.....ZONE.....STATE.....

**VETS** write in date of discharge.....

The ABC's of  
SERVICING

How to Be a  
Success  
in RADIO-  
TELEVISION

# Train at Home to Jump Your Pay as a RADIO-TV Technician



J. E. Smith, President

National Radio Institute

The men whose messages are published below were not born successful. Not so long ago they were doing exactly as you are now . . . reading my ad! They decided they should KNOW MORE . . . so they could EARN MORE . . . so they acted! Mail card below now.

## Get a Better Job—Be Ready for a Brighter Future in America's Fast Growing Industry

Training PLUS opportunity is the PERFECT COMBINATION for job security, good pay, advancement. When times are good, the trained man makes the BETTER PAY, GETS PROMOTED. When jobs are scarce, the trained man enjoys GREATER SECURITY. NRI training can help assure more of the better things of life.

Radio-Television is today's opportunity field. Even without Television, Radio is bigger than ever before. Over 3,000 Radio Broadcasting Stations on the air; more than 115 million home and Automobile Radios are in use. Television Broadcast Stations extend from coast to coast now with over 30 million Television sets already in use. Over 400 Television stations are on the air and there are channels for hundreds more.

Use of Aviation and Police Radio, Micro-Wave Relay, Two-way Radio communication for buses, taxis, trucks, etc., is expanding. New uses for Radio-Television principles coming in Industry, Government, Communications and Homes.

### My Training Is Up-to-Date You Learn by Doing

Get the benefit of our 40 years' experience training men. My well-illustrated lessons give you the basic principles you must have to assure continued success. Skillfully developed kits of parts I furnish "bring to life" the principles you learn from my lessons. Read more about equipment you get on other side of this page.

More and more Television information is being added to my courses. The equipment I furnish students gives experience on circuits common to BOTH Radio and Television.

### Find Out About this Tested Way to Better Pay

Read at the right how fellows who acted to get the better things of life are making out now. Read how NRI students earn \$10, \$15 a week extra fixing Radios in spare time starting soon after enrolling. Read how my graduates start their own businesses. Then take the next step—mail card below.

You take absolutely no risk. I even pay postage. I want to put an Actual Lesson in your hands to prove NRI home training is practical, thorough. I want you to see my 64-page book, "How to Be a Success in Radio-Television," because it tells you about my 40 years of training men and important facts about present and future Radio-Television job opportunities. You can take NRI training for as little as \$5 a month. Many graduates make more than the total cost of my training in two weeks. Mailing postage-free card can be an important step in becoming successful. J. E. Smith, President, National Radio Institute, Washington 9, D. C. Training Men for Over 40 years. Approved Member, National Home Study Council.

## I TRAINED THESE MEN



Lots of Spare-Time Jobs

"I do a lot of spare-time Radio and TV servicing. It was fun learning and I don't know how to thank you." B. Goede, Plainview, Minn.



Now TV Trouble Shooter

"I had only gone to 7th grade when I started course. Now have job as TV trouble shooter, also fix sets spare time." M. R. Lindemuth, Fort Wayne, Ind.



Engineer with WHPE

"Thanks to NRI I operated a successful Radio repair store. Then I got a job with WPAQ and now am an engineer for WHPE." V. W. Workman, High Point, N. C.



NRI Course Can't Be Beat

"Am with WCCO. NRI Course can't be beat. No trouble passing 1st class Radiophone license examination." Jesse W. Parker, Meridian, Mississippi.



Quit Job for Own Business

"I decided to quit my job and do TV work full time. I love my work and am doing all right financially." William F. Kline, Cincinnati, Ohio.



Extra Money in Spare Time

"I am a police captain and also have good spare-time service business. Just opened my new showrooms and shop." C. W. Lewis, Pensacola, Fla.

## Start Soon to Make \$10 to \$15 a Week Extra Fixing Sets



Keep your job while training. Many NRI students make \$10, \$15 and more a week extra fixing neighbors' Radios in spare time, starting a few months after enrolling. The day you enroll I start sending you special booklets that show you how to fix sets. The multimeter you build with parts I furnish helps discover and correct troubles.

## SEE OTHER SIDE

## My Training Leads to Jobs Like These

**BROADCASTING:** Chief Technician, Chief Operator, Power Monitor, Recording Operator, Remote Control Operator. **SERVICING:** Home and Auto Radios, P. A. Systems, Television Receivers, Electronic Controls, FM Radios. **IN RADIO PLANTS:** Design Assistant, Transmitter Design Technician, Service Manager, Tester, Serviceman, Research Assistant. **SHIP AND HARBOR RADIO:** Chief Operator, Assistant Operator, Radiotelephone Operator. **GOVERNMENT RADIO:** Operator in Army, Navy, Marine Corps, Coast Guard, Forestry Service Dispatcher, Airways Radio Operator. **AVIATION RADIO:** Plane Radio Operator, Transmitter Technician, Receiver Technician, Airport Transmitter Operator. **TELEVISION:** Pick-Up Operator, Voice Transmitter Operator, Television Technician, Remote Control Operator, Service and Maintenance Technician. **POLICE RADIO:** Transmitter Operator, Receiver Serviceman.

FIRST CLASS  
Permit No. 20-R  
(Sec. 34.9, P. L. & R.)  
Washington, D. C.

### BUSINESS REPLY CARD

No Postage Stamp Necessary If Mailed In The United States

POSTAGE WILL BE PAID BY  
NATIONAL RADIO INSTITUTE

16th and U Sts., N. W.  
Washington 9, D. C.

**SAMPLE LESSON and 64-Page BOOK BOTH FREE CUT OUT AND MAIL POSTAGE-FREE CARD**

## Have Your Own Business

Many NRI trained men start their own successful Radio-Television sales and service business with capital earned in spare time. Joe Travers, a graduate of mine, in Asbury Park, N. J., writes: "I've come a long way in Radio and Television since graduating. Have my own business on Main Street."



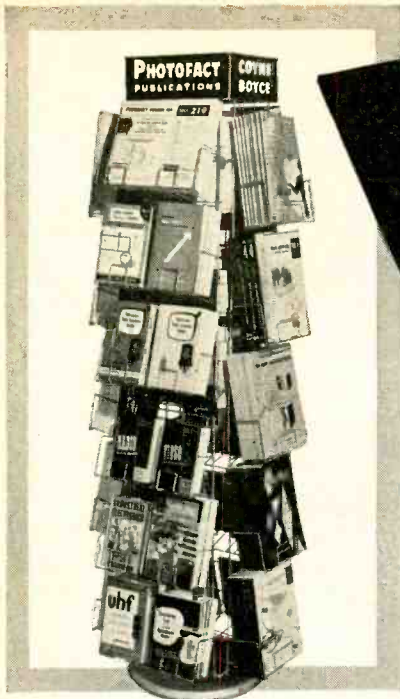

# STAY AHEAD IN ELECTRONICS!

## these SAMS BOOKS show you how

look for them on the Howard W. Sams "Book Tree" displayed at your Electronic Parts Distributor

### POPULAR BASIC MANUALS

**Basic Radio Manual.** A comprehensive training guide, outlining step-by-step a 36-Lesson Course on Basic Radio accompanied by a practical Shop Project section devoted to actual job projects that implement the lessons and clearly translate theory into practice. 248 pages, 8½ x 11", illustrated. Order ED-1 ..... \$5.00

**Basic Electricity Manual.** A complete training course covering basic theory, terms, laws, circuits; includes magnetism, motors, transformers, lighting and many other subjects, supplemented by inexpensive projects which demonstrate theory in action. 264 pages, 8½ x 11". Order ED-12 ..... \$5.00

### HANDY SERVICE GUIDES

**Radio Receiver Servicing.** A book on practical radio receiver servicing covering such basic troubles as dead set, weak set, intermittent and noisy sets, etc. 192 pages, 5½ x 8½". Order RS-1 ..... \$2.50

**AM-FM Servicing Short-Cuts.** Describes actual AM and FM service case histories; shows practical ways to solve similar troubles in any AM or FM receiver. 152 pages, 5½ x 8½". Order RK-1 \$1.50

**Radio Receiver Tube Replacement Guide.** Shows where to replace each tube in 5500 receivers made from 1938 to 1948. 196 pages, 5½ x 8½". Order TP-1 ..... \$1.25

**Dial Cord Stringing Guide, Vol. 4.** Shows correct way to string dial cords in radio receivers made from mid-1951 through 1953. With index. 96 pages, 5½ x 8½". Order DC-4 ..... \$1.00

**Vol. 3.** Covers receivers produced from 1950 through mid-1951, and TV-radio receivers from 1946 through mid-1951. 96 pages, 5½ x 8½". Order DC-3 ..... \$1.00

**Vol. 2.** Covers receivers produced from 1947 through 1949. 96 pages, 5½ x 8½". Order DC-2 ..... \$1.00

**Vol. 1.** Covers receivers produced from 1938 through 1946. 112 pages, 5½ x 8½". Order DC-1 ..... \$1.00

### AUTO RADIO SERVICE MANUALS

**Vol. 4.** Covers 41 chassis (48 models) produced during 1953. 288 pages, 8½ x 11". Order AR-4 ..... \$3.00

**Vol. 3.** Full service data on 47 chassis (80 models) used in 1950, 1951 and 1952 auto radio receivers. 288 pages, 8½ x 11". Order AR-3 ..... \$3.00

**Vol. 2.** Covers 60 chassis (90 models) used in 1948, 1949 and 1950 auto radios. 288 pages, 8½ x 11". Order AR-2 ..... \$3.00

**Vol. 1.** Covers 100 auto radio models made from 1946 to 1949 by 24 manufacturers. 396 pages, 8½ x 11". Order AR-1 ..... \$4.95

### COMMUNICATIONS RECEIVERS

**Vol. 2.** Full analysis of 26 popular communications receivers made during recent years. 190 pages, 8½ x 11". Order CR-2 ..... \$3.00

### INVALUABLE, AUTHORITATIVE TELEVISION BOOKS

**Color Television for the Service Technician.** Written to prepare the service technician for the day when he will be installing and servicing color TV equipment. 116 pages, 8½ x 11". Order SC-1 ..... \$2.50

**Analyzing and Tracing TV Circuits.** A book which presents a new approach to the problems of television servicing. 168 pages, 8½ x 11". Order JA-1 ..... \$3.00

**TV Service Data Handbook.** A compilation of the most frequently needed charts, tables, and formulas as required in TV servicing and installation work. 112 pages, 5½ x 8½". Order JB-1 ..... \$1.50

**TV Servicing Timesavers.** This handy reference summarizes many service techniques found profitable from actual servicing experience. 124 pages, 5½ x 8½". Order JC-1 ..... \$1.50

**Fundamentals of Color Television.** A complete and up-to-date explanation of Color TV written in a simple style to give the reader a clear understanding of the subject. 224 pages, 5½ x 8½". Order BA-1 ..... \$2.00

**Teletesting Operations.** The only complete coverage of every phase of Teletesting, from theory through equipment, operation, maintenance, production—indispensable to anyone interested in Teletesting. 600 p., 6 x 9". Order OH-1 \$7.95

**Phafoact Television Course.** Gives a clear, complete understanding of TV principles, operation and practice. 208 pages, 8½ x 11". Order TV-1 ..... \$3.00

**TV Servicing Short-Cuts.** Describes actual TV service case histories; shows how to solve similar troubles in any receiver. 100 pages, 5½ x 8½". Order TK-1 ..... \$1.50

**TV Test Instruments.** Tells how to operate each test instrument used in TV service work. 175 pages, 8½ x 11". Order TN-1 ..... \$3.00

**UHF Antennas, Converters & Tuners.** Covers all antenna types, transmission lines and matching networks. UHF converters and tuners. 136 pages, 5½ x 8½". Order UHF-1 ..... \$1.50

**Servicing TV in the Customer's Home.** Short-cut methods for repairs in the field. 128 pages, 5½ x 8½". Order TC-1 ..... \$1.75

**Making Money in TV Servicing.** Tells how to set up and operate a profitable TV service business. 136 pages, 5½ x 8½". Order MM-1 ..... \$1.25

**Pay As You See TV.** A clear exposition of the facts that are of vital interest to everyone connected with the television industry. Four informative chapters present the case for this significant new development in TV entertainment. 96 pages, 5½ x 8½". Order KA-1. \$1.50

**TV Tube Location Guides: Vol. 5.** Shows tube positions and functions in hundreds of TV receivers. Helps quickly locate faulty tube. 200 pages, 5½ x 8½". Order TGL-5 ..... \$2.00

**Vol. 4.** Covers receivers produced in 1952-1953. 192 pages, 5½ x 8½". Order TGL-4 ..... \$2.00

**Vol. 3.** Covers receivers produced in 1951-1952. 192 pages, 5½ x 8½". Order TGL-3 ..... \$2.00

**Vol. 2.** Covers receivers produced in 1950-1951. 208 pages, 5½ x 8½". Order TGL-2 ..... \$2.00

**Vol. 1.** Covers receivers produced in 1948, 1949, 1950. 208 pages, 5½ x 8½". Order TGL-1. \$2.00

### Atomic Radiation, Detection and Measurement

This book covers the information necessary for a basic understanding of nuclear science and its applications. The service technician will be particularly interested in those chapters dealing with the circuitry and operation of the many types of detection devices, in case he is called upon to service these units. 160 pages, 5½ x 8½". Order ADR-1 ..... \$3.00

### AUDIO PUBLICATIONS

**Recording & Reproduction of Sound.** Oliver Read's biggest selling volume on all aspects of Audio; fully covers recording and amplifying methods and equipment. Authoritative, complete, 810 pages, 6 x 9". Order RR-2 ..... \$7.95

**Audio Amplifier Service Manuals, Vol. 5.** Covers 37 amplifiers, 12 preamplifiers and 14 custom tuners made during 1952 and 1953. 352 pages, 8½ x 11". Order AA-5 ..... \$3.95

**Vol. 4.** Covers 75 amplifiers and tuners made during 1951 and 1952. 352 pages, 8½ x 11". Order AA-4 ..... \$3.95

**Vol. 3.** Covers 50 amplifiers and 22 tuners made during 1950. 352 pages, 8½ x 11". Order AA-3 ..... \$3.95

**Vol. 2.** Covers 104 amplifiers and 12 tuners made during 1949. 368 pages, 8½ x 11". Order AA-2 ..... \$3.95

### RECORD CHANGER MANUALS

**Vol. 6.** Covers 14 different tape recorders and 6 changers manufactured during 1953 and 1954, with complete index covering all six manuals of the Series. 288 pages, 8½ x 11". Order CM-6 ..... \$2.00

**Vol. 5.** Covers 32 different basic units manufactured during 1952-53. 288 pages, 8½ x 11". Order CM-5 ..... \$3.00

**Vol. 4.** Full service data on 38 changers and recorders made during 1951. 288 pages, 8½ x 11". Order CM-4 ..... \$3.00

**Vol. 3.** Covers 44 changers made in 1949 and 1950. 288 pages, 8½ x 11". Order CM-3 ..... \$3.00

**Vol. 2.** Covers 45 models made in 1948 and early 1949. 432 pages, 8½ x 11". Order CM-2 ..... \$4.95

### COYNE AND BOYCE BOOKS

Distributed by Howard W. Sams & Co., Inc.

BB-1 Radio & Electronics Handbook ..... \$4.95

BB-2 Video Handbook ..... 5.95

CTB-1 TV Servicing Cyclopeda ..... 5.95

CTB-2 Industrial Electronics ..... 3.75

CTB-3 Latest Testing Instruments for Servicing Radio-Television ..... 3.25

CTB-4 Practical Television Servicing and Trouble-Shooting Manual ..... 4.25

CTB-5 Television and Radio Handbook ..... 2.75

CTB-7 Transistors & Their Applications in Radio-Television-Electronics ..... 1.50

CTB-8 Bigger Profits in TV ..... 1.50

CTB-11 Application of Radio & TV Principles ..... 3.25

CTB-12 Radio-TV and FM Receivers ..... 3.25

CTB-13 Radio and TV Circuits ..... 3.25

CTB-50 5 Volume Set Complete of Applied Practical Radio-Television ..... 15.00

CTB-100 Technical Dictionary ..... 2.00

CTB-101 Electrical Trouble Shooting Manual ..... 6.95

CTB-102 Electrician's Handbook ..... 2.75

### HOWARD W. SAMS & CO., INC.

Order from your Parts Jobber today, or write to Howard W. Sams & Co., Inc., 2205 East 46th St., Indianapolis 5, Ind.

My (check) (money order) for \$..... enclosed.

Send the following books.....

Name.....

Address.....

City..... Zone..... State.....

(outside U. S. A. priced slightly higher)

# CABINART '56

- MODEL 10
- MODEL 11
- MODEL 21
- MODEL 22
- MODEL 27
- MODEL 28
- MODEL 27U
- MODEL 28U
- MODEL 65
- MODEL 70
- MODEL 7112
- MODEL 7115
- MODEL 90
- MODEL 91
- MODEL 90U
- MODEL 91U
- MODEL 800
- MODEL 800U
- MODEL KR-3
- MODEL KR-3U
- MODEL KR-4-12
- MODEL KR-4-15
- MODEL KR-5
- MODEL KR-5-U
- MODEL KR-5-P
- MODEL ST-1
- MODEL ST-2
- MODEL ST-3
- MODEL ST-4
- MODEL ST-5
- MODEL ST-6
- MODEL ST-7
- MODEL ST-8
- MODEL ST-9

MODEL 65

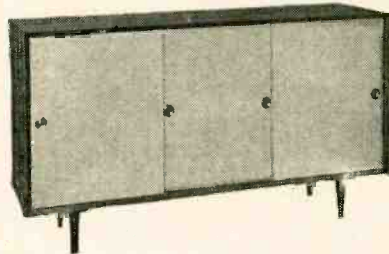

... storage for tape recorder, turntable, record changer, tuner, amplifier and speaker, if desired.

• 16 NEW EQUIPMENT CABINETS

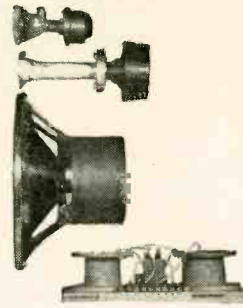

THE THE THE

*Rebel 3* *Rebel 4* *Rebel 5*  
SPEAKERS SPEAKERS SPEAKERS

CABINART SPEAKER SYSTEMS

- KIT 27K
- KIT 28K
- KIT 80
- KIT 8112
- KIT 8115
- KIT K-3
- KIT K-4-12
- KIT K-4-15
- KIT KST-1
- KIT KST-2
- KIT KST-3
- KIT KST-4
- KIT KST-5
- KIT KST-6
- KIT KST-7
- KIT KST-8
- KIT KST-9

MODEL 27K  
MODEL 28K



• TWELVE NEW HI-FI KITS

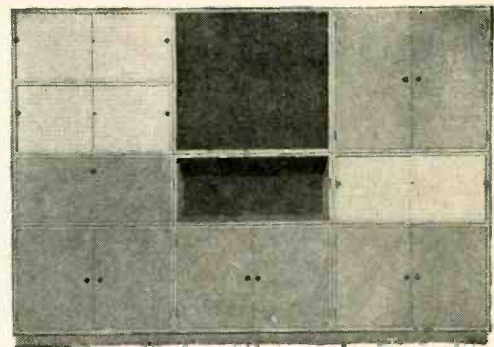

... EVEN A HI-FI STORAGEWALL

- ACC-1
- ACC-2
- ACC-2U
- ACC-3
- ACC-4
- ACC-5
- ACC-6
- ACC-7
- ACC-7A



TURNTABLE BASE WITH LEVEL AND LEVELING DEVICES



RECORD CABINETS ... 3 SIZES

and NINE HI-FI ACCESSORIES FOR THE SOUND ENTHUSIASTS.



Factory and Offices: B'klyn, N. Y.

Each CABINART design is an engineer's answer to an individual hi-fi equipment storage problem. Each cabinet, properly used, is a designer's expression of the elements of good furniture design.

If your hi-fi dealer does not stock Cabinart, write for the name of our nearest Cabinart dealer or mail order house.

**WRITE**

CABINART '56 CATALOGS:

1. EQUIPMENT STORAGE
2. EQUIPMENT/ENCLOSURE KITS
3. REBEL HORNS & SPEAKERS
4. THE CABINART STORAGEWALL
5. HI FI ACCESSORIES



**The pioneers in high fidelity radio furniture**

Cabinart is a division of G & H Wood Products Co., Inc. • 99 N. 11th St. • Brooklyn 11, N. Y.

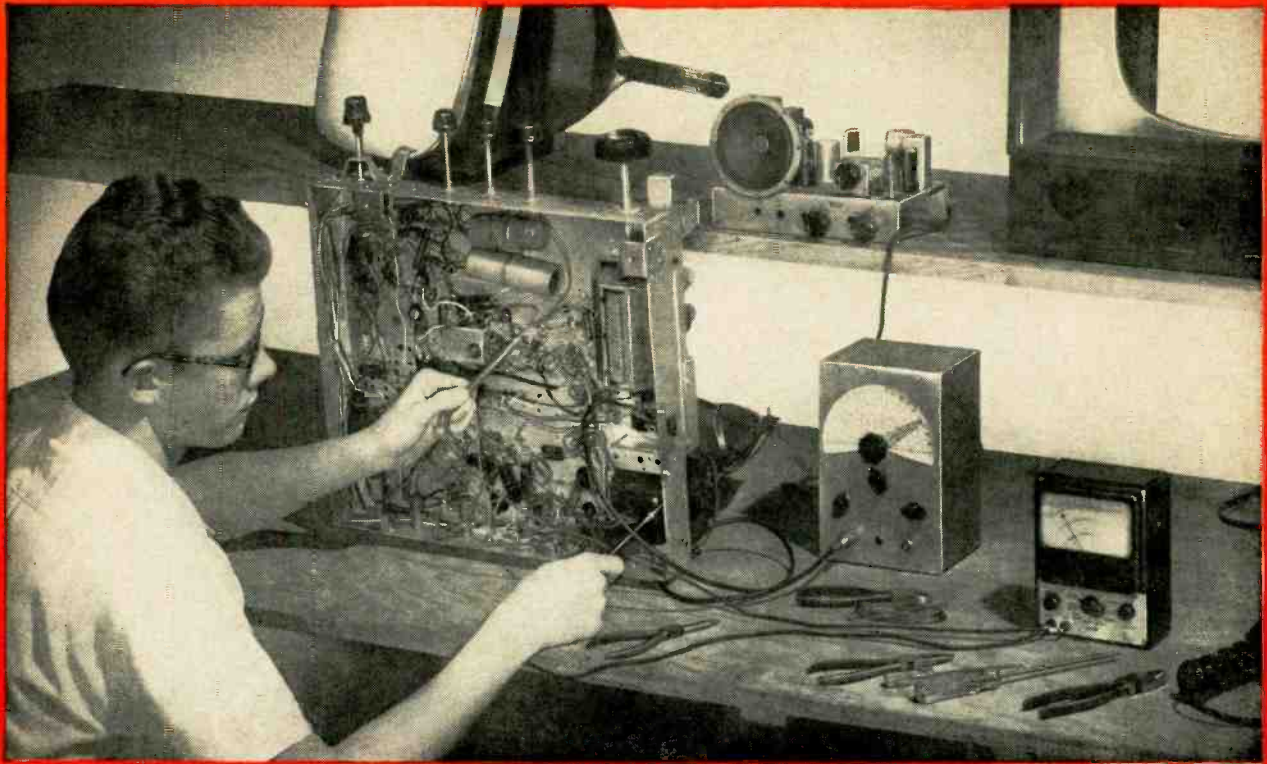

# NOW... RCA trains you at home to be an expert technician in...

**RADIO-TV ELECTRONICS**

**TV SERVICING**

**COLOR TV SERVICING**

**NOW THREE HOME STUDY COURSES**... prepared by instructors of RCA Institutes, engineers from RCA Laboratories, and training experts of the RCA Service Company. Clearly written... easy to understand... the same high caliber instruction as given in the resident classrooms of RCA INSTITUTES.

● **COURSE I—RADIO-TELEVISION ELECTRONICS.**

—starts you from the ground up to a solid working knowledge of electronics. Without any previous experience, you get a thorough training in radio theory and servicing techniques for AM, FM, home and car radios... plus an introduction to the fundamental theory and practices of television.

● **COURSE II—TELEVISION SERVICING**—prepares you to advance from radio into the expanding field of television servicing as a well-trained service technician. If you have completed Course I or are now working in

the field of radio or TV, Course II will show you the many special techniques of troubleshooting, aligning, checking, and repairing modern black and white TV sets.

● **NEW TV KIT AVAILABLE WITH COURSE II**

—there is no better way to learn than by *doing* and RCA Institutes has developed a large-screen TV KIT available to home study students to build while taking Course II. It has the most modern up-to-date circuitry, actually enabling you to apply at home all the latest servicing techniques.

● **COURSE III—COLOR TELEVISION SERVICING**

—covers all phases of color servicing techniques. It is a practical, down-to-earth course in color theory as well as how-to-do-it servicing procedure. A natural move "up" from Course II or for those now employed in TV.

**SINCE 1909, RCA INSTITUTES** has trained thousands for successful careers in elec-

tronics. Many graduates have established their own paying business. Now this opportunity is available to you at home.

**"PAY-AS-YOU-LEARN" PLAN**... you pay for one study group at a time, as you progress through the course. Tuition costs are amazingly low. For full details, mail coupon.

**A SERVICE OF RADIO CORPORATION OF AMERICA—RCA INSTITUTES** is licensed by the N. Y. State Education Department... recommended by radio and television service organizations.

**SEND FOR FREE CATALOG NOW**



**RCA INSTITUTES, INC.**  
A SERVICE OF RADIO CORPORATION of AMERICA  
350 WEST FOURTH STREET, NEW YORK 14, N.Y.

RCA Institutes, Inc., Homes Study Dept. RE-105  
350 West Fourth Street, New York 14, N. Y.

Without obligation, send me FREE CATALOG on Home Study Courses in Radio, TV and Electronics. No salesman will call.

Name \_\_\_\_\_ Please Print

Address \_\_\_\_\_

City \_\_\_\_\_ Zone \_\_\_\_\_ State \_\_\_\_\_



**QUALITY CONTROL  
MANAGER** of Leading Set  
Maker: "In a recent life test,  
every Raytheon Cathode Ray  
Tube tested passed the 1000  
hour test with colors flying".

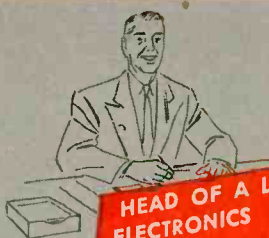

**HEAD OF A LEADING  
ELECTRONICS DISTRIBUTION CO.** "Demand for Ray-  
theon Aluminized Picture Tubes is  
increasing daily. Their superb  
quality and performance is  
rapidly making Raytheon first  
choice. We carry more Ray-  
theons than any other brand".



**BOSS OF TV-RADIO  
SERVICE SHOP**  
"My men prefer to replace with  
Raytheons. They know that Ray-  
theon Picture Tubes will make  
them look good".



Everyone's putting in  
a good word for  
**ALUMINIZED  
PICTURE  
TUBES**  
with  
**LUMILAC\***



**TV SET MANUFACTURERS  
INSPECTION EXPERT:**  
"Raytheon Picture Tubes have  
lowest line returns in the in-  
dustry".



**SET OWNER:**  
"My TV set is better than new,  
since the service man put in a  
new Raytheon Picture Tube".



**DISTRIBUTOR SALESMAN:**  
"Raytheon Picture Tubes are  
selling like hot cakes. Dealers  
have confidence in them and so  
do I".



**LIFE TEST ENGINEER:**  
"Since the introduction of  
LUMILAC, Raytheon Aluminized  
Tubes have outperformed all  
others for brightness and life".

Excerpts from correspondence in Raytheon's files.

\*LUMILAC — a lacquer especially blended and used exclusively  
by Raytheon — is the secret of the superiority of Raytheon  
Aluminized Picture Tubes. It produces a smooth unbroken surface for  
the pure aluminum coating, yet leaves no gas-producing residues  
which could impair cathode emission and shorten tube life.



*Excellence in Electronics*

**RAYTHEON MANUFACTURING COMPANY**

Receiving and Cathode Ray Tube Operations  
Newton, Mass., Chicago, Ill., Atlanta, Ga., Los Angeles, Calif.

RAYTHEON MAKES ALL THESE:

RECEIVING AND PICTURE TUBES • RELIABLE SUBMINIATURE AND MINIATURE TUBES • SEMICONDUCTOR DIODES AND TRANSISTORS • NUCLEONIC TUBES • MICROWAVE TUBES



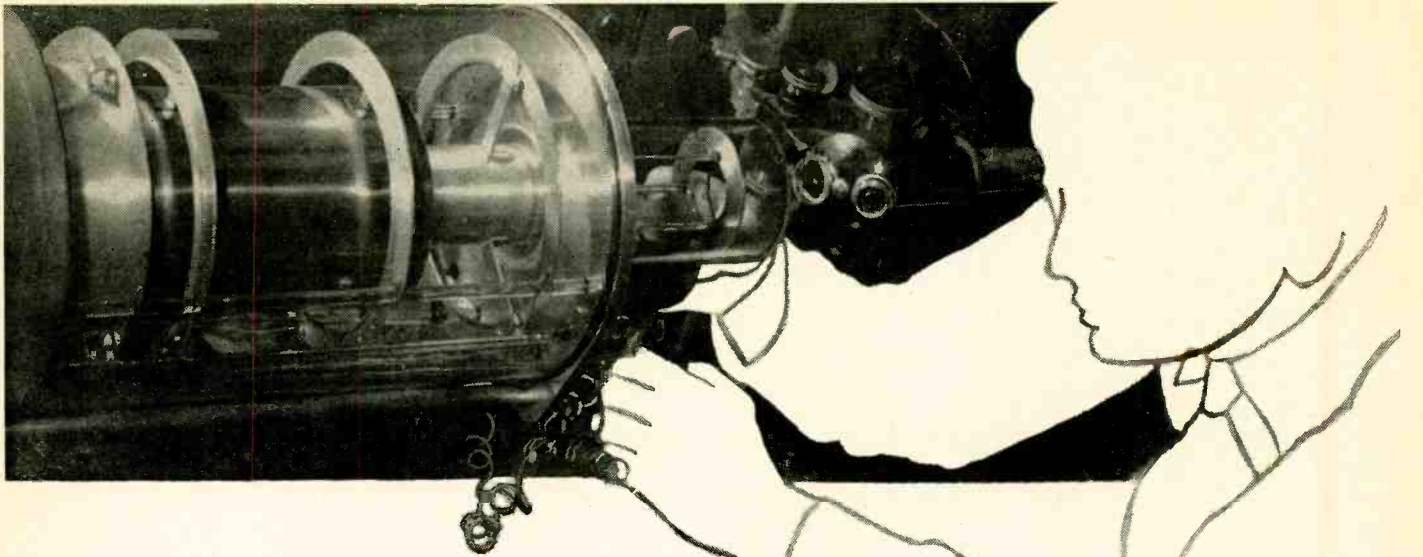

# If you're willing to lose your job tomorrow to a technically-trained man, *turn the page, mister*

But, if you're interested in an honest-to-goodness career in the vigorous young electronics industry, here's how you can step ahead of competition, move up to a better job, earn more money, and be sure of holding your technical job even if the brass is firing instead of hiring.

The "how" is CREI training in radio-television-electronics. You don't have to be a college graduate. You *do* have to be willing to study—at home. You can do it while holding down a full-time job. Thousands have. Since 1927 CREI has provided alert young men with the technical knowledge that leads to more responsibility, more job security, more money. More than a quarter century of experience qualifies CREI to train you.

What qualifies *you* for CREI? If you have a high school education, you're off to a good start. If you have a knack for math, so much the better. If you are currently working in some phase of the electronics industry, you'll get going faster. But remember this: CREI starts with fundamentals and takes you along at your own speed. You are not held back by a class, not pushed to keep up with others who have more experience or education. You set your own pace. Your CREI instructors guide you through the lesson material and *grade* your written work personally. You master the fundamentals, then get into more advanced phases of electronics engineering principles and practice. Finally you may elect training at career level in highly specialized applications of radio or television engineering or aeronautical radio.

How good is CREI training? Here are a few ways to judge. Ask an electronics engineer if you know one. Ask a high-school or college physics teacher. Ask a radio station engineer.

Check up on our professional reputation: CREI home study courses are accredited by the Engineers' Council for Professional Development; CREI is an approved member of the National Council of Technical Schools. Ask personnel managers how they regard a man with a CREI "ticket." Look at this partial listing of organizations *that pay CREI* to train their own personnel: All American Cables & Radio, Inc., Canadian Aviation Electronics, Ltd., Canadian Broadcasting Corporation, Columbia Broadcasting System, Hoffman Radio Corp., Machlett Labs., Glenn L. Martin Co., Magnavox Co., Pan American Airways, Atlantic Division, RCA Victor Division, United Air Lines. Finally, ask a CREI graduate to tell you about our Placement Bureau, which currently has on file more requests for trained men than we can fill.

What's the next step? The logical one is to get more information than we can cram into one page. The coupon below, properly filled out, will bring you a fact-packed booklet called "Your Future in the New World of Electronics." It includes outlines of courses offered, a resume of career opportunities, full details about the school, and tuition details. It's free.

Note: CREI also offers Resident School instruction, day or evening, in Washington, D.C. New classes start once a month. If you are a veteran discharged after June 27, 1950, let the new GI Bill help you obtain resident instruction. Check the coupon for more data.

<b>CAPITOL RADIO ENGINEERING INSTITUTE</b>		
Accredited Technical Institute Curricula • Founded 1927		
<p>3224 16th St., N. W. Dept. 1410-B Washington 10, D. C.</p> <p>Please send me your course outline and FREE Illustrated Booklet "Your Future in the New World of Electronics" . . . describing opportunities and CREI home study courses in Practical Electronics Engineering.</p>	<p><b>CHECK FIELD OF GREATEST INTEREST</b></p> <p><input type="checkbox"/> Practical Radio Engineering</p> <p><input type="checkbox"/> Broadcast Radio Engineering (AM, FM, TV)</p> <p><input type="checkbox"/> Practical Television Engineering</p> <p><input type="checkbox"/> Aeronautical Electronics Engineering</p>	<p>To help us answer your request intelligently, please give the following information:</p> <p>EMPLOYED By .....</p> <p>TYPE OF PRESENT WORK .....</p> <p>SCHOOL BACKGROUND .....</p> <p>ELECTRONICS EXPERIENCE .....</p>
<p>Name.....</p> <p>Street.....</p> <p>City..... Zone..... State.....</p> <p>CHECK: <input type="checkbox"/> Home Study <input type="checkbox"/> Residence School <input type="checkbox"/> Veteran</p>		

# FIELD REPORT NO. 5

Jack Livesay  
Livesay's Music Co.  
Roanoke Rapids, N. C.



We have an eighty-five foot test tower located at our Store for the purpose of comparing the different types of antennas on the market today. The reason we have selected the JFD Star-Helix all channel antenna above all others is that it has the best frequency response and highest gain on channels 2 through 13. Since the birth of the JFD Star-Helix we have installed over 600 Star-Helix and have never had a call back due to the fault of the antenna.

Paul Morrone  
Morrone TV  
Creston, Ia.



Most of my customers are out in the fringe area. We need a lot of gain to pull in the signal, most of all on channel 13. I used every new antenna that came out that was a fringe antenna, but nothing worked until I used the Super-Star Helix made by JFD. The Super-Star Helix is for me now. It's made me a lot of new customers.

Oliver Ewbank  
Plaza Television  
Topeka, Kan.



When the Star-Helix came out, we checked its performance as we do with all new antennas. The exceptional results of those instances have since been verified many times by users who are getting the sharpest, cleanest pictures possible. We know of numerous instances where the Star-Helix delivered excellent pictures at locations where three or four other antennas had failed.

Sam M. Patrick  
Patrick TV & Radio Inc.  
Orlando, Fla.



The JFD Star-Helix is the best antenna I've tried—and I've tried them all—that pulls in clear pictures on channels 8 and 13 from Tampa over 100 miles away. Also channel 4 from Jacksonville which is over 150 miles away. I also know that my Star-Helix customers are ready for Top-notch color reception when it comes their way.

Harry H. Rogers  
Rogers Radio & TV  
Lenox, Ia.



Channel 13 from Des Moines has been a big problem out my way. The other channels came in good but 13 was nothing but ghosts and interference. JFD made the Super-Star Helix and I tried it and now 13 comes in as bright as all the other channels. Now I'm using it in all of my installations.

John D. Sorrentino  
East New York Appliance  
Brooklyn, N. Y.



It sure surprised me. It's the first time I ever got compliments on the looks of my antenna installation. That trim inline build of the JFD Fire-Ball sure looks as good as it works. I don't have to worry about break-down from high winds or ice-loading either. It's got my vote.

## Across the U.S.A. TV Dealers Acclaim these Antennas...

Whether you buy the ultra-sensitive Star-Helix or the new Super-Star Helix or the remarkable Fire-Ball, you know the JFD antenna you install protects your reputation.

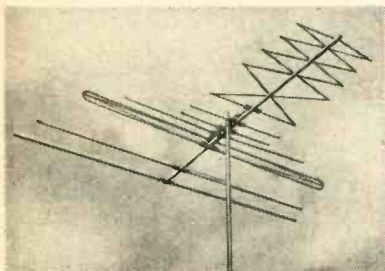

### JFD STAR-HELIX

SX711 single \$25.50  
SX711S stacked \$52.50  
SX711S-96\* 96" stacked \$55.00

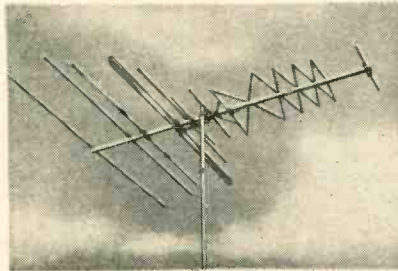

### JFD SUPER-STAR HELIX

SX13 single \$35.00  
SX13S stacked \$72.50

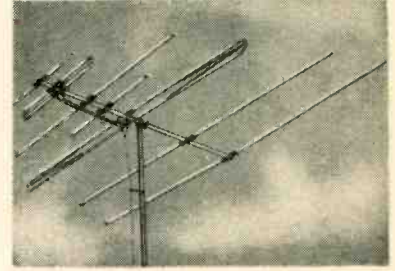

### JFD FIRE-BALL

FB500 single \$17.35  
FB500S stacked \$36.65  
FB500S-68† 68" wide stacked \$36.65  
FB500S-96\* 96" wide stacked \$38.60



"Go Forward with JFD Engineering."  
MANUFACTURING Co. Inc., BROOKLYN 4, N. Y.  
INTERNATIONAL DIVISION, 15 MOORE ST., N. Y.



† for areas with co-channel and cross-channel interference

\* for added channel 2-6 gain

# ALLIED'S own KNIGHT ELECTRONIC KITS... better by far...and you SAVE MORE

Get the most for your money in ALLIED'S KNIGHT Test Instrument Kits. Have the lab precision quality, the dependable accuracy, the professional styling you want—and SAVE MONEY. KNIGHT Kits are the last word in electronic design and the easiest to build. Instruction manuals are a marvel of simplicity and clarity for quick assembly without guesswork. You need only a soldering iron, screwdriver and pliers to assemble and own these professional quality instruments. Build one and you'll want to own more of these fine matched units.

**SAVE!** ALLIED—the reliable name in Electronics—gives you the greatest value for your test instrument dollar in KNIGHT Kits.



**NEWEST  
PRINTED CIRCUITS**

## KNIGHT PRINTED CIRCUIT 5" OSCILLOSCOPE KIT

Model F-144 New wide-band, full-size 5" Oscilloscope; equals or better the performance of commercially-wired scopes costing several times the price. Two printed circuit boards and exclusive laced wiring harness cuts assembly time to minimum. Ideal for the professional Laboratory, for color TV servicing and high frequency applications. Has 6 times the usual sweep range—from 15 to 600,000 cps. Locks in frequencies as high as 9 mc. Vertical response from 5 cycles to 5 mc. Response:  $\pm 1$  db at 3.58 mc;  $\pm 3$  db at 5 mc. High vertical sensitivity of 25 rms millivolts/inch. Input capacitance 20 mmf. Outstanding features: cathode-follower vertical and horizontal inputs; 2nd anode provides 1400 volts for high-intensity trace; push-pull vertical and horizontal amplifiers; positive and negative locking; faithful square wave response; frequency-compensated input attenuator; Z-axis input for high-intensity modulation; one volt peak-to-peak voltage calibration; internal astigmatism control; blanking circuit to eliminate retrace lines; DC positioning control. Complete with all tubes and parts, ready for easy assembly. Handsome professional case finished in blue, with gray control panel. Shpg. wt., 40 lbs.

- Model F-144. Knight Printed Circuit 5" Oscilloscope. Net only ..... \$69.00
- Model F-148. Demodulator Probe. Net ..... \$3.45
- Model F-147. Low Capacity Probe. 12 mmf. Net ..... \$3.45

## BUY WITH CONFIDENCE BUILD WITH CONFIDENCE

KNIGHT Kits are engineered to bring you the latest advances in electronic instrument design. The use of premium quality components assures absolute dependability.

KNIGHT Kits are designed for easiest assembly. It's just like having a good instructor at your side.

You and ALLIED are a team. ALLIED stakes its 30-year reputation in the Electronics field on your complete success and satisfaction.

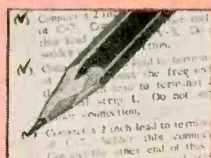

### EXCLUSIVE ALLIED "STEP-AND-CHEK" ASSEMBLY METHOD

You just follow each step and check it off as you complete it. You always know where you are and what to do next with the wonderfully clear KNIGHT Manuals.



### EXCLUSIVE ALLIED "KING-SIZE" DIAGRAMS

Diagrams are duplicated in large wall size to hang conveniently over your work. Helps you see and understand the finest details clearly and easily.

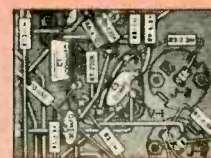

### EXCLUSIVE ALLIED "SPOTLIGHT" PICTORIALS

Special two-tone treatment makes it easy for you to spot the circuit you're working on, separates it from work you've already completed. "You always know where you are."

**NEWEST  
PRINTED CIRCUIT**

## KNIGHT PRINTED CIRCUIT VTVM KIT

Model F-125 New extremely stable, highly accurate VTVM. Greatly simplified wiring—entire chassis is a printed circuit board. Features maximum convenience in arrangement of scales and controls. With peak-to-peak scale for FM and TV work. Ranges: AC peak-to-peak volts, 0-4-40-140-1400-4000; AC rms volts and DC volts, 0-1.5-5-15-50-150-500-1500; ohms, 0-1000, 10K, 100K; 1-10-100-1000 megs; db scale, -10 to +5. Uses low-leakage switches and 1% precision resistors. Balanced-bridge, push-pull circuit permits switching to any range without adjusting zero set.  $4\frac{1}{2}$ " meter, 200 microamp movement. Polarity reversing switch. Input resistance, 11 meg. Complete kit, ready to assemble. Shpg. wt., 6 lbs.

Model F-125. Knight Printed Circuit VTVM Kit. Net only ..... \$24.95

Model F-126. Hi-Voltage Probe; extends DC range to 50,000 Volts. Net ..... \$4.50

Model F-127. Hi-Frequency Probe; extends AC range to 250 mc. Net ..... \$3.45



## EASY PAYMENT TERMS

If your total Kit order is over \$45, take advantage of our liberal Time Payment Plan—only 10% down, 12 full months to pay. Write for application form.

order from **ALLIED RADIO**

300 N. Western Ave., Chicago 80, Ill.

SEE FOLLOWING PAGES

# ALLIED'S own **KNIGHT** ELECTRONIC KITS....



PORTABLE  
TUBE TESTER

Model F-143  
**\$29<sup>75</sup>**

## KNIGHT EASY-TO-BUILD TUBE TESTER KIT—OUTSTANDING VALUE

Expertly designed, up-to-date, ideal for the laboratory or service shop. Remarkably low priced, yet it offers high accuracy, top versatility and convenience. Features provision for testing 600-ma tubes; roll-chart data for all popular series-string types. Tests 4, 5, 6 and 7-pin large, regular and miniature types, octals, loctals, 9-pin miniatures and pilot lamps. Tests for open, short, leakage, heater continuity and quality (by amount of cathode emission). 4½" square meter with clear "GOOD-?-REPLACE" scale. With line-voltage indicator and line-adjust control. Choice of 14 filament voltages from .63 to 117 volts. Blank socket for future type tubes. Universal-type selector switches for any combination of pin connections. Single-unit, 10-lever function switch simplifies assembly. Illuminated roll chart lists over 700 tube types. Complete kit, ready for easy assembly. Shpg. wt., 14 lbs.

Model F-143. Counter type Knight Tube Tester Kit. Net only ..... **\$29.75**  
 Model F-142. As above, but with carrying case. Net only ..... **\$34.75**  
 Model F-141. TV Picture Tube Adapter for above. Net only ..... **\$3.75**

## BUY WITH CONFIDENCE

- Advanced Electronic Design
- New Printed Circuits
- Easy-View, Hi-Legibility Panels
- Professional Streamlined Styling
- Matched Instruments
- Premium Quality Components



Model F-119  
**\$11<sup>65</sup>**

## KNIGHT CAPACITOR CHECKER KIT

Tests capacitors while they are still wired in the circuit! Saves time and trouble. Just press a button and the "magic eye" instantly shows opens and shorts. Checks by-pass, blocking, coupling and filter condensers from 20 mmf to 2000 mfd, even when the capacitor under test is wired with a resistance as low as 60 ohms. Capacitors between .1 mfd and 2000 mfd may be tested even when in parallel with resistance as low as 2 ohms. Housed in the professionally styled Knight Kit case, sturdy steel in blue wrinkle finish with gray control panel. Complete kit, ready for easy assembly. Shpg. wt., 5 lbs.  
 Model F-119. Knight Capacitor Checker Kit. Net only ..... **\$11.65**



## KNIGHT 20,000 OHMS/VOLT VOM KIT

Model F-140 Outstanding quality and performance at extremely low cost. Features 32 ranges; full vision 4½" meter; ± 2% full scale deflection; 50 microampere sensitivity for 20,000 ohms/volt input resistance on DC; front panel "zero adjust". Single switch selects function and range. Range: AC, DC and output volts, 0-2.5, 10-50-250-1000-5000; Resistance, 0-2000-200,000 ohms and 0-20 meg.; DC ma, 0-1-10-100; DC amps, 0-1-10; Decibels, -30 to + 63 in 6 ranges. Uses precision 1% multipliers. Complete kit with bakelite case, batteries and test leads. Shpg. wt., 5 lbs.  
 Model F-140. Knight 20,000 ohms/volt VOM Kit. Net ..... **\$26.50**



## KNIGHT 1,000 OHMS/VOLT VOM KIT

Model F-128 Exceptional accuracy and versatility at amazing low cost. Ideal for service shop, lab and Amateur use. Uses 4½" meter (400 microamp movement) with separate scales for AC voltage and current, DC voltage and current, decibels and resistance. 38 ranges include: AC, DC and Output volts, 0-1-5-10-50-100-500-5000 (1000 ohms/volt sensitivity); Resistance, 0-1000-100,000 ohms and 0-1 meg.; Current, AC or DC, 0-1-10-100 ma and 0-1 amps; Decibels, -20 to + 69 in 6 ranges. Uses 1% precision resistors. 3-position function switch and 12-position range switch. Complete kit with bakelite case, battery and test leads. Shpg. wt., 2½ lbs.  
 Model F-128. Knight 1,000 ohms/volt VOM Kit. Net ..... **\$14.25**



Model F-124  
**\$18<sup>75</sup>**

## KNIGHT RESISTOR-CAPACITOR TESTER KIT

This new highly accurate tester meets the critical requirements of lab and service shop. Measures capacitance and resistance; checks for opens and shorts in paper, mica and ceramic capacitors; shows power factor of electrolytics. Large dial shows capacitance and resistance at a glance; balanced-bridge circuit with "magic eye" for correct dial setting. Measures power factor from 0-50%. Tests capacitors with rated voltages applied. 5 test voltages: 50, 150, 250, 350, 450. Capacity ranges: 10 mmf to .005 mfd, .001 to .5 mfd, .1 to 50 mfd and 20 to 1000 mfd. Resistance ranges: 100 to 50,000 ohms and 10,000 ohms to 5 megs. Accuracy, ± 10%. Automatic discharge feature prevents after-test shock. Complete kit with Knight professional portable case. Shpg. wt., 8 lbs.  
 Model F-124. Knight Resistor-Capacitor Tester Kit. Net only ..... **\$18.75**

**EASY PAYMENT TERMS:** If your total kit order comes to over \$45, take advantage of our liberal Time Payment Plan—only 10% down, 12 full months to pay. Write for application form.

**USE HANDY ORDER FORM  
ON NEXT PAGE**

order from **ALLIED RADIO**

100 N. Western Ave., Chicago 80, Ill.

Everything in Electronics  
from One Reliable Source

# better by far...easiest to build...and you **SAVE MORE**

## KNIGHT LOW-COST RF SIGNAL GENERATOR KIT

An extremely popular kit, noted for its wide range and exceptional stability—saves you two-thirds the cost of a comparable wired instrument. Delivers output on fundamentals from 160 kc all the way out to 110 mc; useful harmonic output to 220 mc. Ideal for aligning RF and IF stages and for audio equipment troubleshooting. Also serves as TV marker generator when used with any sweep generator. Features the famous Colpitts circuit for high accuracy with negligible drift. RF output rated over 100,000 microvolts. Output can be modulated at 400 cycles. Has built-in sine-wave audio oscillator with output jack for 400 cycle output. Maximum audio output, 10 volts. Jack for external modulation; step and continuous-type output attenuators. Complete kit with professional portable case. Shpg. wt., 10 lbs.

Model F-145  
**\$19<sup>75</sup>**

Model F-145. Knight RF Signal Generator Kit. Net only ..... \$19.75



### BUILD WITH CONFIDENCE

- Crystal-Clear Instruction Manuals
- Exclusive "Step-and-Chek" Building Method
- Exclusive "King-Size" Diagrams
- Exclusive "Spotlight" Pictorials

SAVE MONEY! Depend on ALLIED—the world's largest Electronic Supply House—get the most for your test instrument dollar.



Model F-137  
**\$31<sup>50</sup>**

### KNIGHT AUDIO GENERATOR KIT

Save money—have performance equal to instruments at many times the price! Provides an ideal audio frequency source for checking audio circuits of amplifiers and other hi-fi equipment; also checks speaker response. Frequency range: 20 cps to 1 mc in 5 ranges. Output voltage: 10 volts to high imp.,  $\pm 1$  db to 200 kc. Generator imp., 600 ohms. Less than 25% distortion from 100 cps through the audible range; less than .5% when driving 600 ohm load at maximum output. Continuously variable step-attenuated output. Circuit as developed by U. S. Bureau of Standards. Complete kit with professional portable case, ready to assemble. Shpg. wt., 17 lbs.

Model F-137. Knight Audio Generator Kit. Net. \$31.50



**HAM SPECIAL!**  
Model S-725  
**\$27<sup>50</sup>**

### KNIGHT SELF-POWERED VFO KIT

Complete with built-in power supply! Careful design and voltage regulation assure high stability. Excellent oscillator keying characteristic for fast break-in without clicks or chirps. Full TVI suppression. Has plenty of bandspread: separate scales for 40, 20, 15 and 10 meters (11 and 30 meters have combined scale); vernier drive mechanism. 2-chassis construction keeps heat from frequency determining circuits. Output cable plugs into crystal socket of transmitter. Output on 80 and 40 meters. With Spot-Off-Transmit switch for "no swish" tuning. Extra switch contacts for operating relays and other equipment. Complete kit for easy assembly. Shpg. wt., 8 lbs.

Model S-725. Knight Self-Powered VFO Kit. Net. \$27.50



### KNIGHT VISUAL-AURAL SIGNAL TRACER KIT

A remarkable value in a kit which permits visual and aural signal tracing of RF, IF, video and audio circuits—costs no more than an audio signal tracer alone. Traces the signal from the antenna to the speaker. Reproduces signal at plate or grid connection of any stage. Identifies and isolates "dead" stages. Features: high usable gain of 50,000; "magic eye" with calibrated attenuators for signal presence indication and stage-by-stage gain measurements; built-in 4" PM speaker; RF probe for checking all stages; special audio probe tip included; provides noise test; built-in watt meter calibrated from 25 to 1000 watts; provision for external scope or VTVM. Complete kit with portable case. Shpg. wt., 13 lbs.

Model F-135  
**\$23<sup>75</sup>**

Model F-135. Knight Visual-Aural Signal Tracer Kit. Net only ..... \$23.75

## KNIGHT AMPLIFIER KITS FOR HI-FI BUILDERS

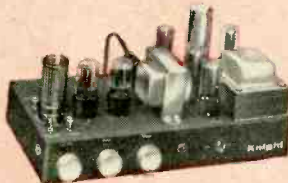

### 10-WATT HI-FI AMPLIFIER KIT

Model S-234 Famous for wide response and smooth reproduction at low cost. Only 0.5 volt drives amplifier to full output. Frequency response:  $\pm 1$  db, 30-20,000 cps at 10 watts. Harmonic distortion less than 0.5% at 10 watts. Intermod. distortion less than 1.5% at full output. Controls: on-off-volume, bass, treble. Input for crystal phono or tuner. Chassis punched to accommodate preamp kit. Matches 8 ohm speakers. Shpg. wt., 14 lbs.

Model S-234. Amplifier Kit. Net. \$20.95  
Model S-235. Preamp Kit for above. Net. \$2.75



### 20-WATT HI-FI AMPLIFIER KIT

Model S-750 True hi-fi for less! Frequency response,  $\pm 1$  db, 20 to 20,000 cps at 20 watts. Distortion, 1% at 20 watts. Hum and noise level: tuner input, 90 db below 20 watts; phono, 72 db below 20 watts. Sensitivity: tuner input, 0.6 volt for 20 watts output; magnetic phono, .007 volts. 4 inputs: magnetic phono, microphone, crystal phono or recorder, and tuner. Controls: Bass, Treble, Volume, Selector. With compensation positions for 78 and LP records, controlled from front panel. Shpg. wt., 23 lbs.

Model S-750. 20-Watt Hi-Fi Amplifier. Net. \$34.75

## ALLIED RADIO

Allied Radio Corp., Dept. 2-K-5, 100 N. Western Ave., Chicago 80, Ill.

Ship me the following KNIGHT Electronic Kits:

Quantity	Description	Model No.	Price

My check , money order , for \$..... is enclosed.

Name \_\_\_\_\_

Address \_\_\_\_\_

City \_\_\_\_\_ Zone \_\_\_\_\_ State \_\_\_\_\_

**ORDER TODAY**

# Terrific Performance

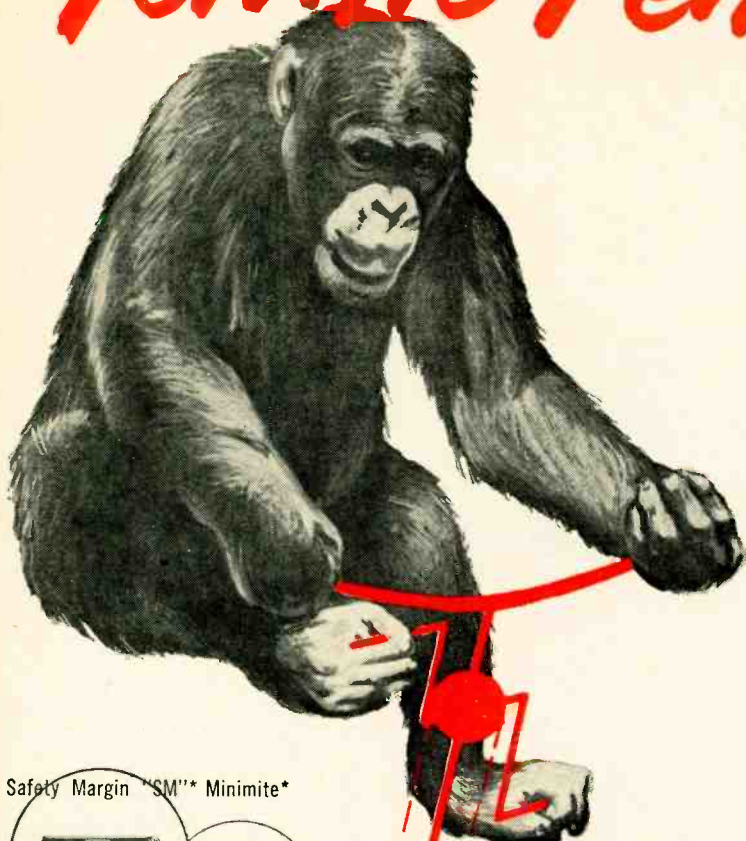

**... EVERYTIME WITH  
"STAMINIZED"  
ASTRON  
CAPACITORS**

Right, everyone's applauding Astron's daring new design concept — "Staminized" capacitors — created specifically to more efficiently fill all servicing requirements.

"Staminized" capacitors are the highest perfection in the art of capacitor manufacturing . . . a unique balance of quality raw materials, selected with infinite care • positively controlled production techniques • surgically-clean assembly plus a score of stringent production tests backed by the famous Astron Guarantee . . . every "Staminized" unit is handcrafted with the precision you would expect to find in a fine watch . . . compact sizes and clear markings for super-easy installation.

The extra-ruggedness of "Staminized" Astron capacitors opens new profit areas for you! Everybody, but everybody, wants to get in on the act . . . you can too, see your jobber for "Staminized" Astron capacitors today!

Safety Margin "SM" Minimite\*

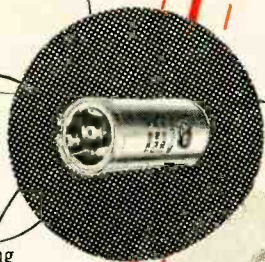
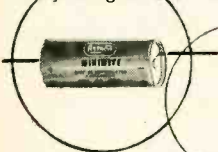

Safety Margin "SM" Twist-Prong

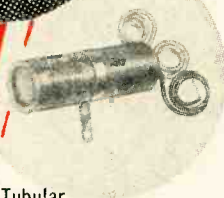

Safety Margin "SM" Cardboard Tubular



Blue•Point® Molded Plastic Paper Tubular



**LAST CHANCE** to get your Swing Bin Jr.

Famous Astron servicing aid plus 90 fabulous Blue•Point® molded plastic paper capacitors — a complete stock — **only \$16.95** You must act at once!

**FREE SERVICING AID**

Save time, use handy Astron, pocket-sized Replacement Catalog and Pricing Guide (AC-4D) — Write for your copy now!



\*TRADEMARK

**ASTRON**  
CORPORATION

255 GRANT AVENUE, E. NEWARK, N. J.

EXPORT: ROCKE INTERNATIONAL CORP., 13 E. 40TH ST., N. Y. C. IN CANADA: CHARLES W. POINTON, 6 ALCINA AVE., TORONTO 10.

BLACK AND WHITE TV

COLOR TV

TRANSISTOR RADIOS  
FM RADIOS  
AM RADIOS

AMPLIFIERS AND TUNERS

AUTO RADIOS

RECORD CHANGERS



# WHAT'S YOUR SERVICE PROBLEM?

## PHOTOFACT HELPS YOU SOLVE IT

### FASTER, EASIER, BETTER, MORE PROFITABLY!

**THE WORLD'S  
FINEST SERVICE DATA**

PHOTOFACT Service Data is the *only* service information based upon first-hand examination of the actual production-run receivers and equipment. It is authentic, uniform data developed through actual study and analysis by service engineers in the Howard W. Sams Laboratories. PHOTOFACT is the *only* data prepared from the practical point of view of the Service Technician.

Thousands of Service Technicians use PHOTOFACT daily for time-saving, profit-boosting service operations. If you've never used PHOTOFACT, you've never realized your full earning power—you've never given such complete customer satisfaction. So get the proof for yourself. Try PHOTOFACT—use it on any job. Your Parts Distributor has the Folder Sets you need for any of the 17,000 TV and radio receivers, changers, recorders, etc., covered in PHOTOFACT. Once you use this great service, we know you'll want the complete PHOTOFACT Library.

**FREE** Send for the PHOTOFACT CUMULATIVE INDEX

IT'S VALUABLE!

Send for it! Your guide to virtually any model ever to come into your shop; helps you locate the proper PHOTOFACT Folder you need to solve any service problem on any model. Once you have the make and chassis number, it takes just 60 seconds to find the applicable PHOTOFACT Folder. Send coupon now for your FREE copy of the valuable Cumulative Index to all the PHOTOFACT Folders you need.



**FREE**

#### EASY-PAY PLAN TO FIT YOUR BUDGET

Ask your PHOTOFACT Distributor . . . he'll show you how you can now own the PHOTOFACT Library through a unique Easy-Pay Plan that exactly fits your needs. Pays for itself as you EARN MORE.

**THESE GREAT FEATURES ARE EXCLUSIVE IN PHOTOFACT—THEY HELP YOU EARN MORE DAILY, HELP INSURE CUSTOMER SATISFACTION**



#### FULL SCHEMATIC COVERAGE

1. Famous "Standard Notation" uniform symbols are used in every schematic.
2. The same standard, uniform layout is used for each schematic.
3. Diagrams are clear, large, easy to read, easy to handle.
4. Wave forms are shown right on the TV schematics for quick analysis by 'scope.
5. Voltages appear on the schematics for speedy voltage analysis.
6. Transformer lead color-coding is indicated on the schematic.
7. Transformer winding resistances appear on the schematic.
8. Schematics are keyed to photos and parts lists.

#### FULL PHOTOGRAPHIC COVERAGE

9. Exclusive photo coverage of all chassis views is provided for each receiver.
10. All parts are numbered and keyed to the schematic and parts lists.
11. Photo coverage provides quicker parts identifications and location.

#### ALIGNMENT INSTRUCTIONS

12. Complete, detailed alignment data is standard and uniformly presented in all Folders.
13. Alignment frequencies are shown on radio photos adjacent to adjustment number—adjustments are keyed to schematic and photos.

#### TUBE PLACEMENT CHARTS

14. Top and bottom views are shown. Top view is positioned as chassis would be viewed from back of cabinet.
15. Blank pin or locating key on each tube is shown on placement chart.
16. Tube charts include fuse location for quick service reference.

#### TUBE FAILURE CHECK CHARTS

17. Shows common trouble symptoms and indicates tubes generally responsible for such troubles.
18. Series filament strings are schematically presented for quick reference.

#### COMPLETE PARTS LISTS

19. A complete and detailed parts list is given for each receiver.
20. Proper replacement parts are listed, together with installation notes where required.
21. All parts are keyed to the photos and schematics for quick reference.

#### FIELD SERVICE NOTES

22. Each Folder includes time-saving tips for servicing in the customer's home.
23. Valuable hints are given for quick access to pertinent adjustments.
24. Tips on safety glass removal and cleaning.

#### TROUBLE-SHOOTING AIDS

25. Includes advice for localizing commonly recurring troubles.
26. Gives useful description of any new or unusual circuits employed in the receiver.
27. Includes hints and advice for each specific chassis.

#### OUTSTANDING GENERAL FEATURES

28. Each and every PHOTOFACT Folder, regardless of receiver manufacturer, is presented in a standard, uniform layout.
29. PHOTOFACT is a current service—you don't have to wait a year or longer for the data you need. PHOTOFACT keeps right up with receiver production.
30. PHOTOFACT gives you complete coverage on TV, Radio, Amplifiers, Tuners, Phonos, Changers.
31. PHOTOFACT maintains an inquiry service bureau for the benefit of its customers.

### HOWARD W. SAMS & CO., INC.

Howard W. Sams & Co., Inc., Dept. 2-K5  
2201 E. 46th St., Indianapolis 5, Ind.

Send FREE Photofact Cumulative Index.

Name .....

Address .....

City ..... Zone ... State .....

**HELPS YOU EARN MORE DAILY**



HARRY R. ASHLEY  
President



**DO YOU OVERPAY  
FOR QUALITY INSTRUMENTS  
LIKE THESE?**

**EICO's mass purchasing and world-wide distribution, together with advanced electronic design, produce values never before possible . . . to give you LABORATORY PRECISION AT LOWEST COST!**

**You build EICO KITS in one evening — but . . . THEY LAST A LIFETIME!**

**GET THE MOST FOR YOUR MONEY!** Don't buy ANY test instrument until you put the EICO INSTRUMENT (kit or wired) equivalent before you — and . . .

★ Compare **ADVANCED ELECTRONIC DESIGN**

★ Examine the **QUALITY PARTS**

★ Notice ease of construction

★ Check EICO's **5-WAY GUARANTEE** on components, instructions, performance, lifetime service and calibration

★ Compare **FEATURE for FEATURE, DOLLAR for DOLLAR**

Then **YOU** decide who's giving you the **MOST** for **YOUR MONEY**.

**46 KITS and Instruments to choose from!**—an instrument for every purpose.

You'll **SAVE 50%** and more . . . when you **BUY EICO!**

In stock at your local jobbers.

Write for **FREE CATALOG C10**



84 Withers St. • Brooklyn 11, N. Y.  
Prices 5% higher on West Coast



KIT \$26.95  
Wired \$39.95

NEW RF SIGNAL GENERATOR #324



NEW  
DC WIDE BAND  
5" OSCILLOSCOPE  
#460  
KIT \$79.95  
Wired \$129.50



5" PUSH-PULL  
OSCILLOSCOPE  
#425  
KIT \$44.95  
Wired \$79.95  
7" PUSH-PULL  
OSCILLOSCOPE  
#470  
KIT \$79.95  
Wired \$129.50



VACUUM TUBE  
VOLTMETER #221  
KIT \$25.95  
Wired \$39.95  
DELUXE VTVM  
#214 (7 1/2" METER)  
KIT \$34.95  
Wired \$54.95



#232 Peak-to-Peak  
VTVM with  
DUAL-PURPOSE  
AC/DC UNI-PROBE  
(pat. pend.)  
KIT \$29.95  
Wired \$49.95



KIT \$34.95  
Wired \$49.95  
TUBE TESTER #625  
Pix Tube Test Adapter ..... \$4.50



#944 FLYBACK  
TRANSFORMER &  
YOKE TESTER  
KIT \$23.95  
Wired \$34.95



KIT \$34.95  
Wired \$49.95  
TV/FM SWEEP GENERATOR #360  
SMC-4.5MC CRYSTAL ..... \$3.95 ea.

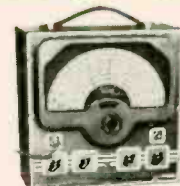

KIT \$39.95  
Wired \$59.95  
DELUXE RF SIGNAL GENERATOR #315

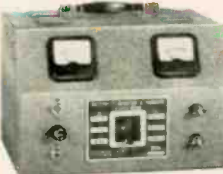

KIT \$29.95  
Wired \$38.95

6V & 12V BATTERY ELIMINATOR & CHARGER #1050

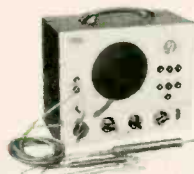

KIT \$24.95  
Wired \$39.95

DELUXE MULTI-SIGNAL TRACER #147



KIT \$19.95  
Wired \$29.95

R-C BRIDGE & R-C-L COMPARATOR #950B



KIT \$24.95  
Wired \$29.95

20,000 Ohms/Volt MULTIMETER #565



KIT \$12.90  
Wired \$14.90

1000 Ohms/Volt MULTIMETER #536



VTVM PROBES	KIT	Wired
Peak-to-Peak	\$4.95	\$6.95
RF	\$3.75	\$4.95
High Voltage Probe-1		\$6.95
High Voltage Probe-2		\$4.95

**SCOPE PROBES**

Demodulator	\$3.75	\$5.75
Direct	\$2.75	\$3.95
Low Capacity	\$3.75	\$5.75



## ELECTRONIC ALARMS

... *A new and lucrative business for technicians* ...

**Sound Barrier.** In Chicago, two burglars who broke into an electronics firm were startled when a booming voice said, "Good evening, gentlemen. We remind you that this place is electronically guarded. We suggest that you turn around and disappear." They fled emptyhanded when loudspeakers all over the building began shouting, "Burglars! Burglars! Call the police!"—*Time Magazine*

**I**N 1953, burglars entered 479,120 times and took over \$78 millions in money and property in the United States. In 1954, this form of crime increased nearly 15%. It will be much higher in 1955.

These figures do not include auto thefts, daytime bank thefts or robbery. Only in about one out of four burglaries committed are the perpetrators convicted while convictions result in only about one out of six auto thefts and other larcenies.

The astonishing part of this sorry state of affairs is, not the crime, but the fatalistic apathy of our people who hardly lift a finger to protect themselves. Not only are householders and business establishments notoriously lax in safeguarding their property, but even big banks. Thus, recently a New York City bank—one of over a dozen in a huge banking chain—was held up and robbed of over \$300,000 in plain daylight. *Yet this huge banking institution, whose assets run into several billions of dollars, had never installed an alarm in any of its branches.*

What is wrong? The answer is: our business people have never been properly educated in the efficacy of modern electronic safety devices. Most people in the business world still think in terms of antiquated burglar alarms. Then, too, our technicians and electronic designers must be accused of not using sufficient ingenuity in devising up-to-date electronic safeguards that can fit ANY variety of conditions.

Obviously, you would not use identical equipment to protect a home, a garage, a jewelry store or a bank. Each demands different treatment. Thus, banks need *two* distinct types of alarms—one for daytime holdups, one for nighttime protection. Banks, too, frown on noisy alarms, which bank officials claim invites gunplay of trigger-happy holdup men. Yet there are literally hundreds of ways in which electronics can be used to give *silent* alarms without thieves ever knowing about it. Such alarms can summon police or guards who can nab the criminals before they reach their getaway car or when they emerge on the sidewalk. Holdup men can also be photographed by comparatively simple electronic triggering devices.

In homes, the mere entrance of a burglar can turn on all house lights, which will often effectively scare away the intruder. The device may also take his picture, too, unbeknown to him.

In jewelry stores—manned often by the proprietor only—*concealed* tear gas devices can be placed in or under the counter, directed upward to hit the burglar square in the face when the proprietor or clerk moves his foot in a certain

manner. The same act could release an outdoor alarm that screams, "Burglar! Holdup! Police!" in a stentorian voice audible for blocks.

With some ingenuity, an unlimited number of such protective devices can be designed by any good technician. Some can be installed at reasonable cost. Other more elaborate ones—depending on requirements—may run into a good deal of money as, for instance, complex installations in banks.

*Designers should, however, always appreciate the fact that the average burglar is not stupid—often he is most ingenious.* He may not enter through a door or window. Thus, to give but one example, in our own building in downtown New York, burglars—always over a weekend—selected the premises of a manufacturing concern which makes gold emblems. Their establishment was raided several times in the past. The firm put up heavy iron grating on the door, with stout steel bars and excellent locks.

What did the burglars do? They left the door untouched, but hacked a large hole in the plaster wall, through which they entered. Invisible infra-red or ultrasonic rays criss-crossing the premises could have controlled a signaling device that would have brought the police on the run or set up a deafening outside alarm which surely would have routed the intruders.

Burglars, too—often suspecting an alarm system—will carefully disconnect the electric supply from outside of the premises, particularly in detached houses. If the alarm depends upon outside electric supply lines, it is thus put out of action. The remedy in this case would be a relay system that operates as soon as the outside current fails, switching on batteries, which in turn sound a loud, outside alarm.

The list is endless, but one thing is certain: with sufficient ingenuity, the burglar can be outwitted in most cases.

**Yet that is not the moral: The main purpose of this article is to alert enterprising technicians, particularly service technicians, to embark upon one of the most lucrative**

**endeavors — the business of making or installing electronic safeguards in their community. Such installations are not only profitable, they also must be serviced and tested periodically. The latter alone is an extra source of income.**

Many such installations can use photoelectric equipment already on the low-price market. Others may require designing capacitance alarms, which have often been described in this magazine. The more elaborate, such as ultrasonic alarms, are available on the market in complete form.

It is essential that if you embark on such a venture, you must prepare some convincing literature to mail to your prospects. The average person, as we mentioned above, is skeptical—he must be convinced before he will place an order. That is why your printed appeal must be educational, explanatory and forceful. Reproduction of newspaper clippings of recent burglaries always helps, too.

Electronic safeguards and alarms is a coming business—**GET IN ON THE GROUND FLOOR NOW!** —H. G.

RADIO-ELECTRONICS will pay from \$50 to \$150 per article accepted on *Electronic Safeguards and Alarms*, depending on article quality, originality and novelty of such a device.

# Dual-Frequency Crystal Calibrator

By RONALD L. IVES

*Sawtooth-pulse oscillation identifies output of instrument*

**A**BOUT 30 years ago, J. R. Pierce and others of the Bell Telephone Laboratories' staff demonstrated the usefulness of quartz crystals as frequency standards. Developed from these findings are the phenomenally accurate time and frequency standards now used by AT&T and the U. S. Bureau of Standards. Less widely publicized—but much more widely used—are the crystal calibration oscillators supplied as integral parts of many communications receivers made during the last 20 years.

A typical calibration oscillator consists of a quartz crystal, a vacuum tube and sundry components so connected and adjusted that the output consists of the fundamental frequency of the crystal and many of its harmonics. A conventional triode oscillator usually gives usable harmonics to about the 30th.

As the frequency spectrum has been expanded upward, harmonic generators have been added to calibration oscillators so that usable outputs beyond the 150th harmonic are now easily attainable.<sup>1, 2, 3</sup>

Identifying the calibration oscillator outputs has been a problem since the device was first used. It is virtually impossible to distinguish between a

steady carrier from an outside source and the calibration oscillator output without some auxiliary identification.

Bliley attempts to produce an identifiable calibration signal by supplying the plate of an electron-coupled crystal oscillator from the first capacitor in the plate-supply filter. This produces an easily detectable 120-cycle modulation which, unfortunately, too closely resembles a TV picture signal or a poorly filtered "outside" oscillator.

Use of sawtooth-pulse oscillation to make calibration signals easily recognizable was suggested by Langford-Smith<sup>4</sup> more than 15 years ago, but nothing seems to have been done with the suggestion despite its apparent merit.

Required components for a workable pulse-identified calibration oscillator consist of a crystal oscillator, a harmonic generator, a pulser and a mixer.

## Crystal oscillator circuitry

The crystal oscillator is a standard electron-coupled device using a dual-frequency crystal (Bliley SMC-100) with outputs at 100 and 1,000 kc. The circuit (Fig. 1) is substantially that recommended by the manufacturer—minor changes have been made to permit frequency switching with a grounded-armature relay. The 25- $\mu$ f trimmer sets the 100-kc frequency exactly, by zero-beating a harmonic with a WWV signal. None of the component values are at all critical, and only a major circuit defect will keep it from operating. If the SMC-100 crystal is not available, you can use a Valpey DFS or similar type with both crystals in parallel.

The harmonic generator consists of a nonlinear input device (1N34 diode) and a pentode amplifier, connected as in Fig. 2. Tube constants and component

values are extremely uncritical and almost any reasonable values will work well.

Relative strengths of the various harmonics can be altered somewhat by changing the values of the coupling capacitors. The higher-frequency harmonics are favored by using small coupling capacitors. With conventional tubes, components and construction, outputs above 500 mc are rather undependable.

Probably the most satisfactory pulser which can be constructed from standard parts is the neon oscillator, a conventional relaxation oscillator, depending for its operation on the difference between the striking and extinction voltages of a gas tube. A basic circuit of a neon oscillator, with representative constants, is shown in Fig. 3. The general formula relating supply voltage, tube characteristics and component values is:

$$f = \frac{1}{2.303 RC \log_{10} \left[ \frac{E_b - E_c}{E_b - E_s} \right]}$$

in which:

- f = frequency in cycles
- R = resistance in megohms
- C = capacitance in microfarads
- E<sub>b</sub> = supply voltage
- E<sub>c</sub> = extinction voltage of tube
- E<sub>s</sub> = striking voltage of tube<sup>5</sup>

it being assumed that discharge time—during which the tube conducts and the voltage across C falls from E<sub>s</sub> to E<sub>c</sub>—is very short relative to charging time, when the tube is nonconducting and the voltage across C rises from E<sub>c</sub> to E<sub>s</sub>.

The useful frequency range with this circuit and stock neon tubes is from about 60 to about 8,000 cycles and can be extended to include a range of from 10 cycles to 12 kc by hand-picking neon tubes and components.

The remaining working element of this calibration oscillator is the mixing device which permits amplitude modulation of the r.f. signals by the neon pulser. Theoretically, the modulating signal can be injected at almost any ungrounded point in almost any circuit. Practically, modulation of the crystal

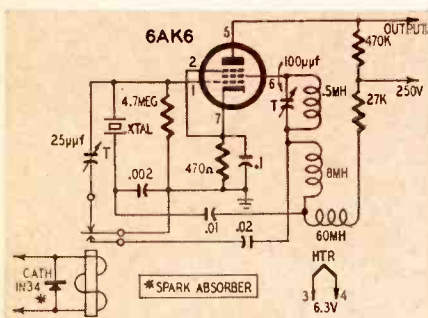

Fig. 1—Dual-frequency calibrator.

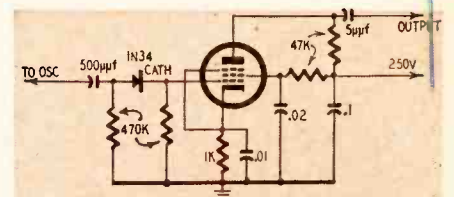

Fig. 2—A harmonic generator circuit.

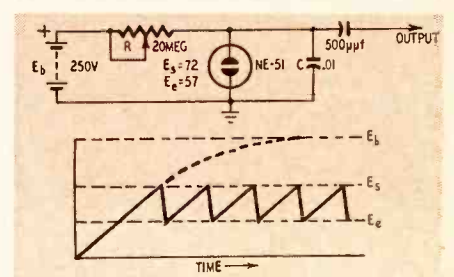
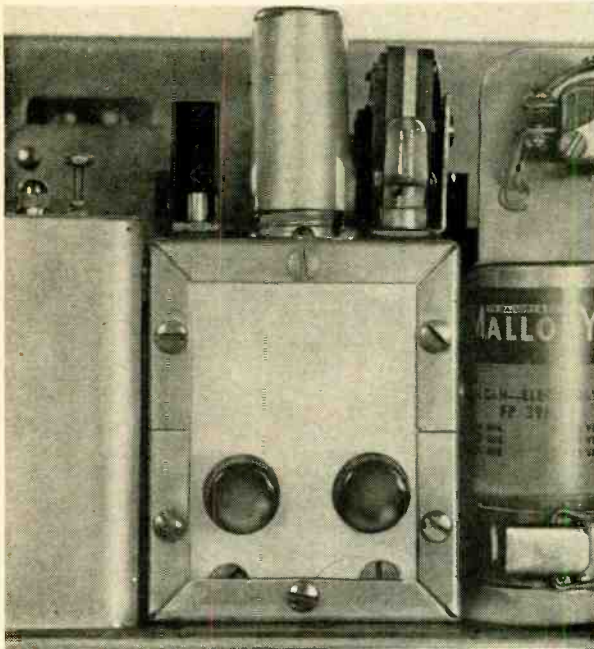
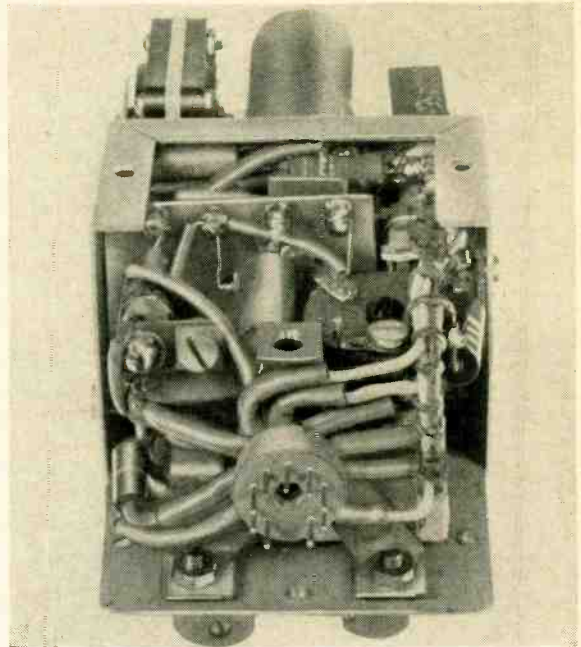

Fig. 3—Circuit of neon oscillator.



The complete oscillator as installed in a receiver.



An internal view of pulse-identified oscillator.

oscillator is undesirable as it tends to frequency-modulate the output, causing the higher harmonics to merge. The cleanest performance was obtained with a pentagrid converter (6SA7, 6SB7-Y, 6BE6), the first grid being coupled to the neon oscillator through a capacitor, the third grid to the crystal oscillator by a 1N34 and a small coupling capacitor.

The final circuit of the pulse-identified calibration oscillator is shown in Fig. 4, with pertinent values. The tube lineup consists of a 6AK6 electron-coupled oscillator, a 6BE6 harmonic generator and mixer, a NE-51 neon oscillator. Rather tight shielding and extremely good circuit isolation were essential to prevent spurious responses. For convenience in servicing, the crystal calibrator was designed as a plug-in unit, all connections being brought out to a noval plug on the base. Pin numbers are circled in Fig. 4, and pins 2 through 7 are bypassed to ground, with respect to r.f., by a .02- $\mu$ f capacitor from socket pin to ground directly under the chassis.

**Construction details**

Available space for the calibration oscillator in my receiver was  $2\frac{1}{4} \times 2\frac{3}{4} \times 5\frac{1}{2}$  inches. The case decided upon

consisted of the covers of two ICA No. 29435 Flexi-mount aluminum cases which formed the top, bottom and ends of the case, and two pieces of .050-inch sheet steel,  $2\frac{5}{8} \times 3\frac{1}{8}$  inches, which form the front and back panels (see photos). The bottom was strengthened by inserting a piece of .050-inch steel to prevent warping when the holding screws were tightened.

To insure mechanical and electrical oscillator stability, all components were mounted rigidly with liberal use of tie points and terminal strips, all of which are firmly bolted to the case. A 100,000-ohm resistor was wired in series with the 20-megohm tone control to prevent neon tube burnout if the knob is turned too far toward the low-resistance (high-frequency) end.

The noval plug, through which all connections except ground are made, is supported by a small steel spider (see photo) bent from .050-inch stock and bolted to the front and back panels. Ground connections are made to the case, grounded to the receiver chassis by two holding screws.

The top side arrangement and construction are fairly straightforward. The tube sockets should be spaced so that the shields do not conflict, and the 25- $\mu$ f trimmer must be insulated from

the case by a pair of fiber washers. When the trimmer is undergoing adjustment, the oscillator is operating at 100 kc and the trimmer shaft is grounded through the relay so that this "hot rotor" connection does not introduce a hand-capacitance problem.

The crystal mounting bracket is insulated from the case top by a thin sheet of Micarta, and its holding screw by a fiber washer. The NE-51 is mounted in a standard bayonet socket, pushed through a  $\frac{3}{8}$ -inch rubber grommet. This, in turn, fits a  $\frac{1}{2}$ -inch hole in the case top. The inner terminal of the socket is held under one of the tube socket mounting screws, giving rigid support and electrical grounding at the same time.

The space available in the receiver did not permit installing the calibrator close to the panel where a crystal-frequency selector switch could be mounted with short leads so a relay was substituted for the switch. I used a Price type 1035-1 relay made especially for radiosonde applications and available only through surplus sources. You can substitute any d.c. relay that will fit into the available space. Potter & Brumfield Super-Midget relays will fit in the same space. A 3-volt supply is not essential. I supply my relay through a half-wave selenium rectifier connected to the heater circuit with a 500- or 1,000- $\mu$ f 6-volt electrolytic for a filter.

The auxiliary crystal shown in the photos is not an electrical part of the calibrator. It is used in a b.f.o. circuit and is mounted on the calibrator chassis for space reasons only.

Traditionally, the calibration oscillator is coupled to the antenna terminal of the receiver through a gimmick. This permits its use not only as a frequency checker, but also as a test oscillator for occasional touching up of receiver alignment. This method of coupling is very

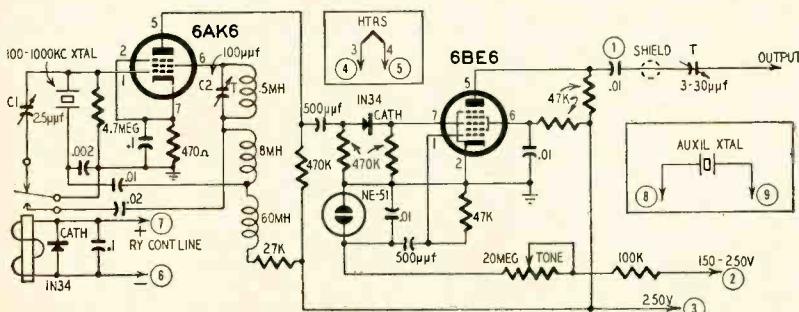
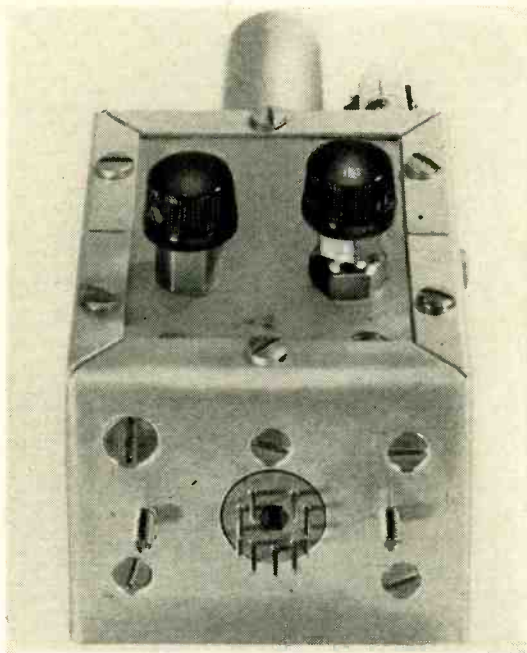
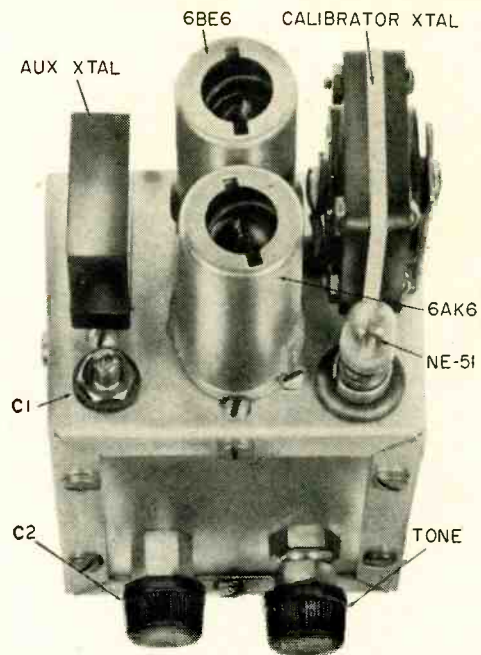

Fig. 4—Schematic diagram of the neon-pulsed calibration oscillator circuit.

## TEST INSTRUMENTS



Bottom view shows the output plug.



Top view shows the major components.

satisfactory so far as the receiver is concerned, but produces interference in neighboring receivers. A more satisfactory coupling method is by a gimmick to the first r.f. grid, on the grid side of the bandswitch. A mixer tube for the first r.f. stage would be even more satisfactory were the tube noiseless.

### Adjustment and operation

Adjustment of the calibration oscillator consists of setting the tone to suit the operator, the screen trimmer for optimum operation on 1000 kc and zero-beating the 100-kc oscillator with WWV.

With the receiver and oscillator on and warmed up center any convenient calibrator harmonic in the i.f. passband by using the S meter or a v.t.v.m. between the a.v.c. line and ground, and then turn on the pulser. The NE-51 in the calibrator should now light, and a musical note be heard in the speaker. Adjust this to suit the operator's taste by varying the 20-megohm rheostat.

With the calibrator set for 1000-kc output (relay in up position), tune in the highest-frequency harmonic that will indicate on the S meter and adjust the screen trimmer (100  $\mu\mu\text{f}$  in Fig. 4) for maximum output. This will be at the highest S-meter reading.

Next, with the calibrator off, tune in WWV on the receiver and center the signal in the i.f. passband. Set the calibrator for 100-kc operation (relay armature in up position), turn on the calibrator but not the pulser, and observe the signal. A heterodyne squeal, modulated by the WWV modulation, should be heard and will change in pitch as the crystal trimmer (25  $\mu\mu\text{f}$  in Fig. 4) is adjusted. The desired setting is zero cycles when the WWV carrier is not modulated (during the long breaks in the announcement intervals). The setting is correct if a slight adjustment

of the trimmer in either direction brings back the heterodyne.

Finally, vary the coupling between the calibrator and the receiver, adjusting it to the amplitude most suitable to your personal taste and operating habits. It is good practice to keep the calibration oscillator signal at a relatively low amplitude to minimize Miller-effect detuning and possible receiver overload.

Calibration oscillators are widely used for checking receiver calibration, for minor realignment work and for indexing the main tuning dial on receivers equipped with electrical bandspread. The calibration oscillator produces a signal at each 100 (or 1000) kc from the crystal fundamental to the limit of the frequency multiplier.

To index for bandspread operation, zero the bandspread dial, set the main dial to the desired band and turn on the calibration oscillator. Adjust the main dial for maximum signal, then lock it. The bandspread dial calibration will now be at optimum accuracy and settings can be recovered within the mechanical limitations of the receiving equipment.

Because of the multiplicity of harmonics in the audio output of this calibrator, the calibration signals are unlikely to be removed by a tunable audio filter. The audio fundamental can be filtered out, but the higher harmonics will be passed, and the operator's ear will reinsert the filtered-out fundamental.<sup>6</sup>

The calibration oscillator here described has been in operation for more than 5,000 hours at the time of writing. No exact information on expected tube and component life can be given because all the original components are still in service. Both tubes test good, even though they have been used more than five times the nominal 1,000 hours'

service cited for most military and aeronautical applications. The only other component likely to fail is the relay, designed for radiosonde service, where a maximum of less than 1,000 operations is usually expected. After considerably more than 10,000 operations the relay is still in perfect condition.

### Parts for calibration oscillator

**Resistors:** 1—470, 1—27,000, 3—47,000, 1—100,000, 3—470,000, 1—4.7 megohms, 1/2 watt; 1—20 megohms, potentiometer.

**Capacitors:** 2—500  $\mu\text{f}$ , 1—.002  $\mu\text{f}$ , 4—.01  $\mu\text{f}$ , 1—.02  $\mu\text{f}$ , 2—.01  $\mu\text{f}$ ; 1—25  $\mu\mu\text{f}$ , 1—3-30  $\mu\mu\text{f}$ , 1—100  $\mu\mu\text{f}$ , trimmers.

**Miscellaneous:** 1—6AK6, 1—6BE6, tubes; 2—shields for tubes; 2—sockets for tubes; 1—NE-51 and socket; 2—1N34 (or equivalent); 1—crystal (Bliley SMC-100 or other usable combination) and holder; 1—choke, 500  $\mu\text{h}$ ; 1—choke, 8 mh; 1—choke, 60 mh; 1—relay, s.p.d.t. (Price 1035-1); 1—chassis (see text); 1—length of shielded wire.

Estimated tube life, based on experience with other equipment, is about 7,000 hours for the 6BE6 and the 6AK6, and more than 10,000 hours for the NE-51. Probable life of the relay in this type of service is 100,000 operations, after which, by replacing a cheap spring, it should be good for another 100,000. All other components, if initially of good construction, chosen with an adequate margin of safety and not mishandled during construction, are substantially immortal and will probably outlast the receiver in which the calibrator is installed. END

### REFERENCES

<sup>1</sup> See instruction sheets supplied by manufacturers of calibration crystals such as Bliley Crystal Type SMC-100, Bliley Electric Co., Erie, Pa.

<sup>2</sup> "The Secondary Frequency Standard," *Radio Amateur's Handbook*, 31st edition, 1954, pp. 467-468.

<sup>3</sup> R. L. Dawley (editor), *Radio Handbook*, 13th edition, 1951, pp. 609-610.

<sup>4</sup> F. Langford-Smith, *Radiotron Designer's Handbook*, 3rd edition, 1940; 4th edition, 1952, p. 1261.

<sup>5</sup> Discussed fully in Rider & Usian's *Encyclopedia on Cathode-Ray Oscilloscopes and Their Uses*, 1950, pp. 218-222.

<sup>6</sup> This is the so-called synthetic bass effect. See F. Langford-Smith, *Radiotron Designer's Handbook*, 4th edition, 1952, pp. 616, 676.

# A VOLTAGE-MEASURING ELECTRONIC SWITCH

*Instrument features use as  
an oscilloscope calibrator*

By WILLIAM AUSTIN

THE electronic switch makes it possible to observe two signals simultaneously with an oscilloscope by switching the scope input rapidly between one and the other. Extending this principle, an instrument can be designed which will also act as an oscilloscope calibrator with the advantage that the voltage of any portion of a signal can be measured, independently of the vertical gain setting, while the signal is on the screen.

The circuit of the instrument is shown in the diagram. A semisquare wave is generated by V1, a cathode-coupled multivibrator. This circuit produces a symmetrical waveform and can be synchronized, an advantage which will be explained later. Two frequency ranges are provided, covering roughly 50 to 700 and 700 to 8,000 cycles. V2 is a phase inverter and amplifier which also clips the wave tops, producing a flat-topped square wave which is applied to the grids of V3.

V3 and V4 have common cathode circuits. When one half of V3 is cut off, the corresponding half of V4 operates normally while its other half is cut off due to the large voltage drop across the cathode resistor. Assume the grid bias to be the same on both halves of V4 so that each draws the same plate current during its operating period. If a signal is applied to both grids, it will be switched from one half of V4 to the other at the repetition rate of the square wave. Since both halves of the tube have a common plate load resistor, the signal will appear across this resistor uninterrupted and can be observed with an oscilloscope. Now, if the bias of one grid is changed with respect to the other, the signal will separate vertically on the screen and will be seen as two signals, one above the other, each being made up of short dashes. Their length and number will depend on the switching rate.

Any two signals of the same frequency or a multiple can be observed this way. If a signal is applied to only one grid and the bias is equal, the signal will appear with a dashed line through its zero axis, and changing the relative bias will cause this line to move up or down with respect to the signal.

Since the position of this line with respect to the signal is proportional to grid voltage, we have a means of measuring the peak voltage or the voltage of any portion of the signal in which we are interested. This is done by varying the bias with a potentiometer having a scale calibrated to correspond with the voltage difference between the grids. For example, if a signal having a peak amplitude of 2 volts is applied to one grid, it will take a 2-volt change in the relative bias between the grids to make the reference line move to the peaks of the signal. The potentiometer has a scale calibrated in volts so we are able to read this 2-volt peak amplitude of the signal on the scale. Amplifier stage V4 will invert signals fed to it. This means that if the oscilloscope normally shows signals with positive peaks up, they will be down when using the electronic switch. So to measure the positive peak voltage, the reference lines moves down to align with the bottom peaks of the signal.

Voltage regulator tube V5 provides a constant 150 volts which is applied to the grid returns of V4 through a resistance bridge containing two potentiometers. One of the potentiometers is calibrated from 0 to 3 volts and the other is used to balance the circuit so that when the calibrated potentiometer is in the zero position, the voltage difference between the grids is zero. The grids are also maintained about 2 volts positive above ground to avoid excessive bias due to the large cathode resistors. A d.p.d.t. switch permits reversing the voltage difference on the grids for

measuring either positive or negative with respect to zero. This switch could be eliminated by making the potentiometer read zero in the center, but the scale would be more crowded and less readable.

Input A has a three-step attenuator with a resistance of 1 megohm. Each step multiplies the dial by 10, making it possible to measure voltages up to 300. The attenuator is frequency-compensated for good transmission of pulses and irregular wave forms; the compensation circuit is simple but effective. Only one variable capacitor is necessary for its adjustment. The 10- $\mu\text{mf}$  capacitor is disconnected in the first position where the grid is connected directly to the signal source. This tends to keep the input capacitance constant at all three settings.

This input is used for the signals which are to be measured. Input B uses only a simple 1-megohm potentiometer. This input—being continuously variable—can be used to set two signals to the same amplitude for comparison.

## Construction and calibration

The instrument is housed in a 10 x 8 x 7-inch utility box. Any layout arrangement can be used which will keep stray capacitance to a minimum, especially in the portions where square waves are involved. In the interest of small size, metallized paper coupling capacitors were used. The two 4- $\mu\text{f}$  electrolytic capacitors which bypass the grid returns of V4 must be separate units. A dual-section capacitor is not satisfactory here because the capacitance between sections will cause coupling between the two inputs. The multivibrator stage should be thoroughly decoupled from the rest of the circuit. This is the reason its plate supply has a separate capacitor.

The dial (see photo) was made by applying several coats of white enamel

## TEST INSTRUMENTS

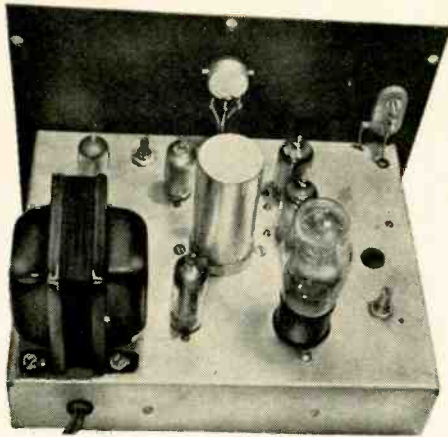

Top-chassis view shows major parts.

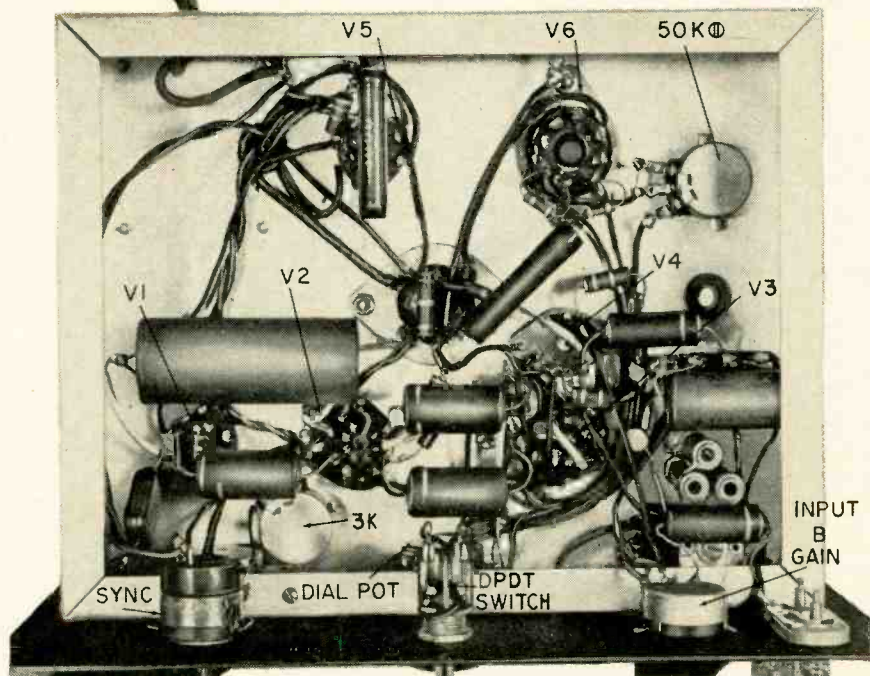

Closeup view of underchassis layout.

around the edge of an aluminum disc held to the panel by the nut which holds the potentiometer.

The calibration marks and figures on the enameled portion were made with india ink. A plastic pointer was attached to a knob to complete the dial assembly.

Calibrating the instrument is relatively simple. Connect a v.t.v.m. on its lowest d.c. range between the grid returns of V4 (from one 4- $\mu$ f capacitor to the other) and set the dial potentiometer a little above the fully counterclockwise position. Adjust the other 50,000-ohm potentiometer for a zero voltage reading. Clockwise rotation of the dial will now cause the voltage to rise to a little over 3 at full rotation. Whether the voltage goes positive or negative depends on the v.t.v.m. connection and the position of the d.p.d.t. switch. The dial can now be marked in 0.1-volt increments as indicated by the meter. With the scope connected to the output a square wave should be seen, variable in amplitude by either the dial or the 500-ohm cathode balance potentiometer. The latter should be adjusted

for zero square-wave amplitude with the dial on zero. Turn the vertical gain of the scope up when making this adjustment.

This cathode potentiometer was mounted on the front panel because its adjustment was found to be somewhat critical. Slight changes in circuit constants and even jarring the instrument will affect the balance noticeably. Having the control on the panel makes it easy to reset. For a symmetrical waveform, the resistance in the cathode circuit of V1 is about 2,000 ohms. It varies somewhat with different tubes, so a 3,000-ohm potentiometer was used. This control, mounted on the chassis near V1, can be set by watching the output square wave on the scope and setting the control for best symmetry.

The easiest way to adjust the attenuator is to feed a 10-kc or higher square wave to input A with the scope connected to the output. The 10-kc signal can be seen as will be explained later. Adjust the 180- $\mu$ f trimmer for the best square wave on all three switch positions. The signal, of course, should not look any better than it does when

fed directly to the scope. It is possible, in making this adjustment, to over-compensate the attenuator in an attempt to make up for deficient high-frequency response in the scope vertical amplifier. If the adjustment is made so that the signal looks the same at all three settings, there is little likelihood of this.

To observe signals of 1,000 cycles or less, use the high switching rate which will give the dashed pattern. For signals of higher frequency, use the low range and turn up the sync control, the amount depending on the amplitude of the signal at the input. When the multivibrator is synchronized with a submultiple of the signal, a stationary pattern can be obtained without the dashed effect. For example, if the signal frequency is 4,000 cycles and the scope sweep is the same, one cycle of the signal will be seen. If the switching rate is 2,000 cycles, one cycle of the signal will occur during each half of the switching cycle. Actually, only every other cycle of the signal occurs on the screen, but persistence of vision will make it appear continuous. In this

example each cycle of the signal is followed by a blank trace, making the reference line we can use for measuring. If desired, the signal could be fed to both inputs. Now the signal appears twice on each half of the switching cycle, either superimposed or separated vertically, depending on the setting of the dial. As the signal frequency increases, the submultiples on the low-frequency switching range get closer together so there are numerous points on the frequency control at which the pattern will be stationary. In fact, at 10 kc and higher, a stationary pattern can be obtained at practically any setting of the control by turning up the sync a little. At intermediate signal frequencies there is some instability when the dial is turned to near maximum because the scope horizontal sweep tends to synchronize with both the signal and the switching square wave. In some cases, it may be necessary to make a few readjustments between the scope sync and horizontal frequency controls.

**Parts list for electronic switch**

- Resistors:** 1—1,000, 1—12,000, 1—22,000, 1—33,000, 1—68,000, 1—470,000 ohms, 3—1 megohm, 2—4.7 megohms, 1/2 watt; 2—1,800, 3—10,000, 1—33,000, 1—47,000 ohms, 1 watt; 1—1,000, 1—2,000, 1—6,000 ohms, 10 watt; 1—10,000, 1—90,000, 1—900,000 ohms, 1%.
- Potentiometers:** 1—500, 1—3,000, 2—50,000 ohms (one a high-quality unit—Ohmite CU-5031 or equivalent); 1—1 megohm (linear); 2—1 megohm (audio, one with on-off switch).
- Capacitors:** 1—10, 1—500  $\mu$ f, 1—.001, 1—.005, 1—.01  $\mu$ f, mica or ceramic; 3—.01, 3—.025  $\mu$ f, 450 volts, metallized paper; 2—4  $\mu$ f, 450 volts; 1—20  $\mu$ f, 450 volts; 1—30—30—20  $\mu$ f, 450 volts.
- Miscellaneous:** 2—6J6, 2—12AU7, 1—6X4, 1—OD3/VR-150; 3—7-pin miniature sockets; 2—9-pin miniature sockets; 1—octal socket; 1—s.p.d.t. switch; 1—d.p.d.t. switch; 1—2-pole 3-position switch (Mallory 3223-J or equivalent); 1—power transformer, 650 volts c.t. @ 55 ma, 5 volts @ 2 amps, 6.3 volts @ 3 amps (Stancor PC-8407 or equivalent); 1—chassis and cabinet; 3—twin jacks; 1—dial (see text); 5—knobs; 1—line cord.

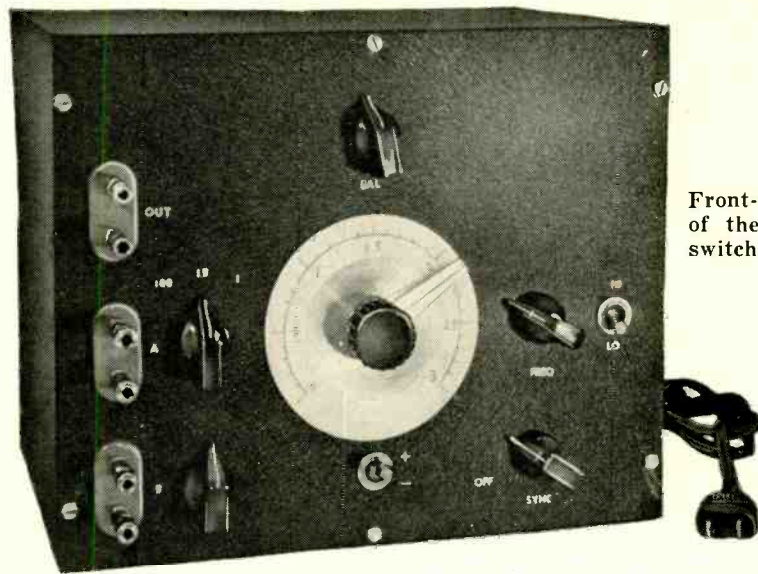

Front-panel view of the electronic switch.

The voltage gain in V4 is about 3. This low gain is due to the low value of plate load resistance and to degeneration in the cathode circuit. Lack of gain here is of no consequence however because the vertical amplifier of the scope contributes all the gain necessary. About 4 volts peak signal can be applied to the grids before any serious distortion occurs. To determine whether an excessive signal exists, it is necessary only to turn the dial to maximum.

If the reference line will not reach beyond the peaks of the signal, turn the attenuator to the next lower range and increase the scope vertical gain to restore the signal to the same size on the screen. When observing two signals that cannot be separated enough with the dial, the vertical gain can be increased to get any separation desired.

The output of this instrument can be used for square-wave testing over its range with the peak amplitude variable to about 9 volts with the calibrated dial. When the scope vertical gain is turned up, a spike or overshoot may be seen at the leading edges of the square waves. This is caused by coupling via the grid-cathode capacitance in V4 and can, of course, be eliminated by turning both gain controls to the minimum setting.

Many uses can be found for this device in radio and TV servicing. For instance, in tracing through the sync circuits of a TV receiver, it is very convenient to be able to see the sync pulses at various points and measure their amplitude without disconnecting the scope to substitute a calibrating voltage.

END

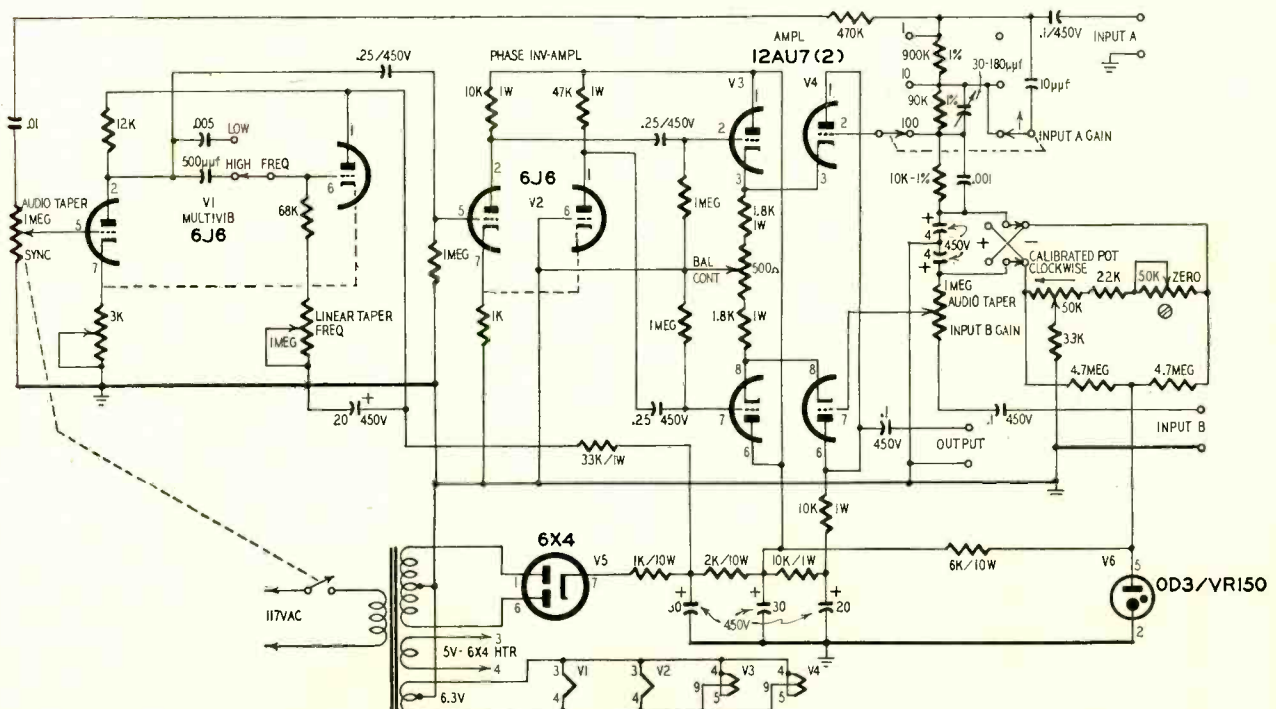

Complete schematic diagram of the voltage-measuring electronic switch.

# ... an accessory for your SIGNAL GENERATOR

*Used with calibrated signal generator, unit takes guesswork out of design of r.f. tuned circuits*

By DAVID JOHN LEWIS, WISLE

**M**OST amateurs and experimenters spend a good deal of time working with tuned circuits. Only a few have the specialized and often expensive instruments needed for more than a cut-and-try approach. Impedance bridges, Q meters and the like are just not practical investments for the nonprofessional.

This accessory, designed primarily for measuring small inductances and capacitances usually found in radio-frequency circuitry, will also function as a grid dip meter over the entire range of the signal generator with which it is used. No modifications or alterations of the signal generator are required. Construction is simple and inexpensive.

The accessory (see schematic) is essentially a crystal receiver coupled to the signal generator through a small capacitance. Variable capacitor C1 is calibrated in 10- $\mu\text{mf}$  steps from minimum to maximum capacitance. Coil  $L_x$  is connected across terminals J1, J2. A high-frequency germanium diode is used as a detector. The r.f. source must be modulated to provide a signal in the headphones.

When measuring inductance the unknown coil and C1 are connected in parallel to form a tuned circuit. The resonant frequency of this tuned circuit can be measured by tuning the signal generator for maximum tone output at the headphones. Since the capacitance of C1 is known, it is then a simple matter to compute the inductance of

the coil from the formula  $L = \frac{1}{4\pi^2 f^2 C}$ .

To eliminate the necessity for mathematics, however, a small chart is used to convert the signal generator readings in megacycles directly into microhenries.

To measure capacitance, connect a coil of arbitrary inductance across the test terminals in parallel with the capacitor under test. Set C1 at minimum capacitance and tune the signal generator, as in the measurement of inductance, for peak output. At this point remove the unknown capacitor. This will detune the circuit and to bring the

output back to a maximum it will be necessary to advance C1. The capacitance this adjustment adds to the circuit is equal to the unknown capacitance and can be read directly from the scale on C1. The largest value of capacitance that can be measured will be equal to the difference between the minimum and maximum capacitance of C1.

A set of plug-in coils covering the desired ranges will be required when the instrument is used directly to measure the resonant frequency of coil and capacitor combinations. With the correct coil across the terminals, set the signal generator for output somewhere in the frequency range of the circuit to be tested. Tune C1 for maximum volume. If the external circuit is now loosely coupled to the coil on the accessory and tuned to the signal generator frequency, there will be a marked drop in volume. Since both the signal generator and the accessory must be tuned to the same frequency, it is not conveniently possible to tune the signal generator for the dip rather than the circuit being measured. For many applications, however, such as calibrating wavemeters, adjusting filters, etc., this is not too important.

## Construction and calibration

A standard utility box measuring 3 x 4 x 5 $\frac{1}{4}$  inches is used for a cabinet. The variable capacitor, phone jack and test terminals are mounted on the cover. The r.f. input lead enters the cabinet through a rubber grommet, near the terminals. The r.f. leads should be kept short to minimize stray inductance and capacitance. The input lead is a standard coaxial instrument cable with a plug to fit the signal generator output jack. Since these cables have a fairly high internal capacitance, its length should not be much over 2 $\frac{1}{2}$  feet.

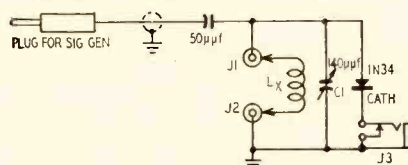

Schematic of signal generator accessory.

A National FWG terminal strip was used for the test terminals. A pair of short test leads can be plugged in the banana jacks at the top, while a coil is held in the holes at the bottom of the binding posts when making capacitance measurements. The terminal strip also serves as a socket for the "grid-dipper" coils.

The scale on C1 should be calibrated in terms of absolute capacitance across the test terminals. Often this will be helpful in determining the capacitance needed to resonate with a given coil at a desired frequency. A bridge is convenient for this calibration if you have access to one, but it is not essential.

One simple method of calibrating the instrument, for example, would be to connect an inductance of known value across the terminals. The signal generator would be tuned as in inductance measurements to find the resonant frequency of the circuit. With the inductance and frequency known, the capacitance will be easy to compute. The capacitance across the terminals for as many positions of C1 as desired can thus be established.

No matter how the instrument is calibrated, it is important that it be completely assembled and connected to the signal generator when the job is finished. Otherwise, the true capacitance will not be obtained. When the plates of C1 are wide open, the capacitance across the test terminals should be about 9  $\mu\text{mf}$ .

The grid dip meter coils are wound 1 inch in diameter. The coils for the two highest frequency ranges are self-supporting. On the lower ranges, the coils are wound on pieces of 1-inch Bakelite tubing and fastened in place with coil dope. No special plug-in arrangement is used; the leads from the coils are stiff enough for support when clamped in the binding posts.

The coil dimensions given (Table I) will cover the most important amateur frequencies. Extra coils can be wound to give any desired coverage. Any one of the coils can be used when making capacitance measurements.

Table II, converting the signal gen-



erator readings from megacycles to microhenries, will be correct when the

**TABLE I  
COIL DATA FOR ACCESSORY**

Frequency MC	Construction		
	Turns	Wire	Wound
3.3-6.5	20	No. 22 enamel	close
6.3-11.5	10	No. 22 enamel	close
11.5-19	6	No. 18 d.c.c.	close*
16-30	3	No. 14 d.c.c.	close*

\*Self-supported

**TABLE II  
FREQUENCY CONVERSION  
(With 100- $\mu$ f capacitance)**

Inductance ( $\mu$ h)	Freq. (mc)	Inductance ( $\mu$ h)	Freq. (mc)
2	11.5	60	2.10
5	7.2	65	2.0
10	5.1	70	1.92
15	4.15	80	1.80
20	3.6	90	1.70
25	3.2	100	1.62
30	2.95	150	1.32
35	2.73	200	1.15
40	2.55	250	1.02
45	2.40	300	0.93
50	2.29	400	0.81
55	2.17	500	0.73

capacitance across the inductance is 100  $\mu$ f, and C1 must be set to this value when the chart is used. For the sake of convenience the chart can be glued to the side or back of the chassis. If you wish, a more complete chart can be easily be made from a capacitance, inductance, frequency nomograph. (See *ARRL Handbook*, 1955 edition, page 534.)

The accessory can be used separately from the signal generator as both an absorption type wavemeter and a modulation monitor, if desired. A rough calibration in terms of megacycles on the scale attached to C1 would be useful in this connection.

Here are a few suggestions for using the accessory. Remember that the accuracy of inductance measurements can be no greater than the accuracy of the calibration on the signal generator. Furthermore, the distributed capacitance present in the coil being measured will have an effect on the results. Don't expect the precision possible with a bridge.

**Parts for signal generator accessory**

1—50- $\mu$ f capacitor; 1—140- $\mu$ f capacitor, variable; 1—terminal strip (National FWG or equivalent); 1—closed-circuit phone jack; 1—plug to fit signal generator output jack; 1—1N34 (or any high-frequency crystal detector); 1—chassis; coils (see Table I).

When using the unit as a grid dip meter, it is advisable to couple the coils as closely as possible to locate the general vicinity of the dip. The coupling can then be decreased to the point where the change in volume is just barely noticeable as the unknown circuit tunes through the signal generator frequency.

The range of capacitance measurements can be extended by adding a small mica capacitor in parallel with the unknown capacitor when C1 is not large enough to retune the accessory. The capacitance of the extra capacitor is then merely added to the increase read from the scale on C1. END

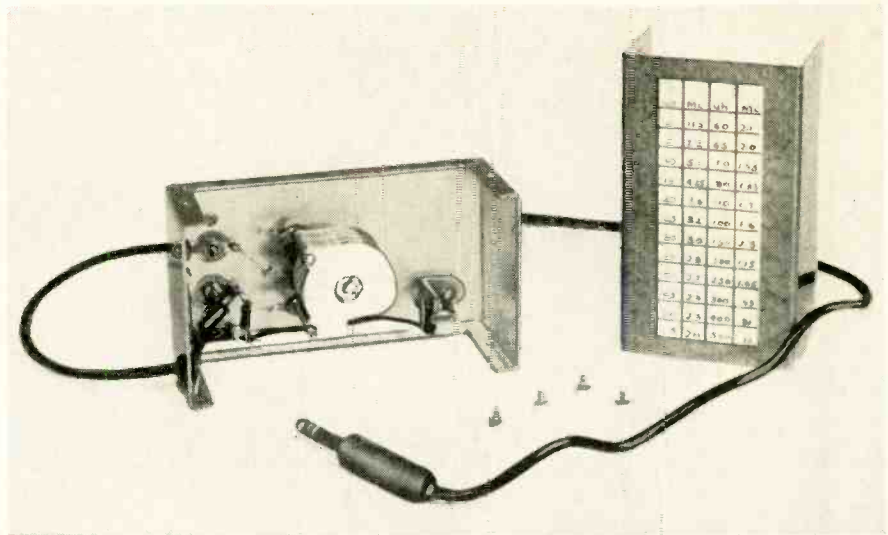

Underchassis view shows parts layout.

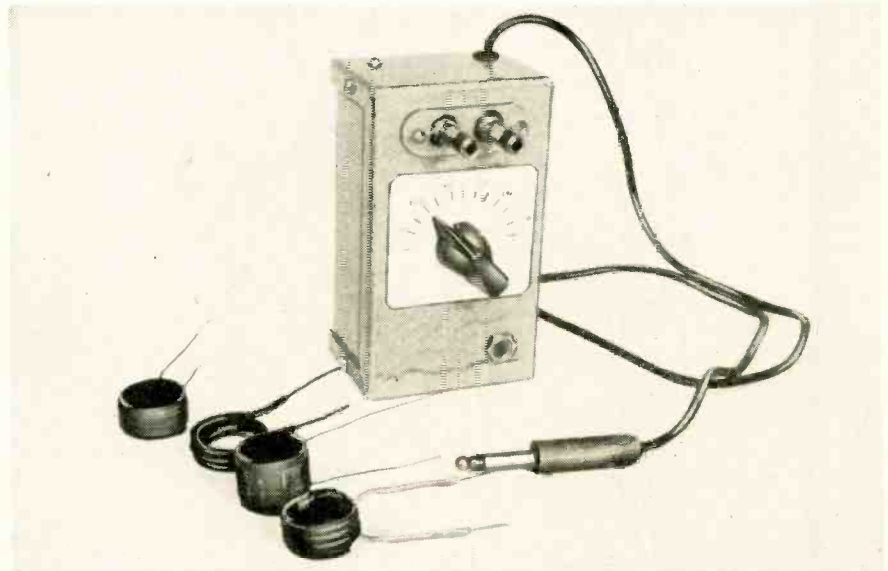

Front view of accessory with coils.

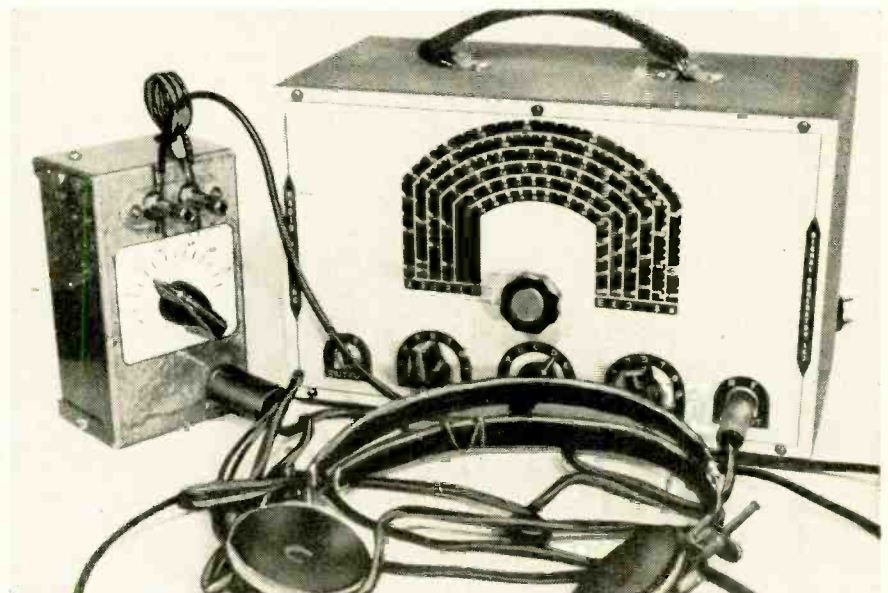

The accessory set up for use. The coil shown covers range of 16 to 30 megacycles.

By DONALD H. ROGERS\*

# EXTEND THE RANGE OF YOUR

# ohmmeter

*Modification permits wide range of resistance measurements*

**T**HE usefulness of almost any ohmmeter can be increased with a simple, easily built range extender.

Most ohmmeters use one of the two circuits shown in Fig. 1. In the series version (Fig. 1-a) the battery, meter and some resistance are connected in series between the test leads. The circuit is open until an unknown resistor is connected across the leads. This completes the series circuit, the current flow depending upon the battery voltage and circuit resistance. The meter reads full scale with the leads shorted. (The zero adjustment is made to an exact full-scale reading.)

The meter will read half-scale when the test probes are connected to an external resistance equal to the internal resistance of the ohmmeter. *This half-scale reading is the true criterion of the sensitivity of the instrument.* Any ohmmeter, regardless of sensitivity, reads

from zero to infinity. But, when the internal resistance is equal to the external resistance, the current will be half the full-scale value and will show the reading at which the scale is most spread out and therefore most useful.

(The above method is accurate for practically all purposes for which a meter would be required in radio-TV service work. But it is worth noting that a slight error is introduced, because the resistance of a meter with a shunt connected across it is lower than that of a meter alone. This error is usually less than 1%. Where more accurate calibration is necessary, refer to the article "Meter Resistance Measurement" on page 100 of the May 1955 issue of RADIO-ELECTRONICS.—*Editor*)

The other circuit, the shunt version shown in Fig. 1-b, shows exactly the same action in reverse. In it the circuit is closed all the time, and full-scale current flows through the meter except when an unknown resistance is connected across the test leads. Lower values of unknown resistance shunt more of the current, the meter reading zero when the leads are shorted. In this circuit also, we get a half-scale reading when the external resistance is equal to the internal.

To increase the sensitivity of the series circuit add more battery voltage and more internal resistance so that you still get a full-scale reading when the leads are shorted. You can make up this battery and resistance in a separate package, convenient to handle and use.

Although it is less obvious, the same thing is true of Fig. 1-b. In both cases the improvement will be proportional to the increase in voltage and resistance.

The first step is to examine the ohmmeter. Determine which circuit it uses, the battery voltage on the highest scale and the half-scale ohms reading. This is the point where the meter movement shows half-deflection. For a 10-times increase in sensitivity, 9 parts more each of voltage and resistance must be added in the same proportions. For an increase of 100 times, 99 parts more of each.

In a vacuum-tube ohmmeter using the shunt circuit, the meter is a v.t.v.m. of relatively infinite resistance, and the calculation may be made directly from the battery voltage and the internal series resistance.

### Building the extender

The simplest sort of range extender is shown in Fig. 2. It is intended for use with an ohmmeter using a 4.5-volt battery and shunted 1-ma meter, and having a mid-scale sensitivity of 3,600 ohms. The addition of a 3,000-ohm potentiometer or rheostat, a 31,000-ohm resistor and 40.5-volt battery (in series-

\*Engineer, Jerrold Electronics Corp., Philadelphia, Pa.

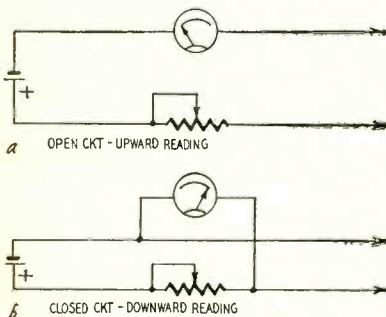

Fig. 1—Two basic ohmmeter circuits.

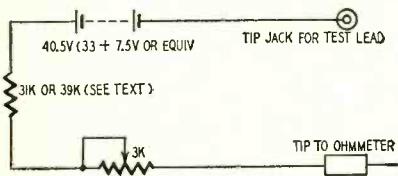

Fig. 2—Simple type of range extender.

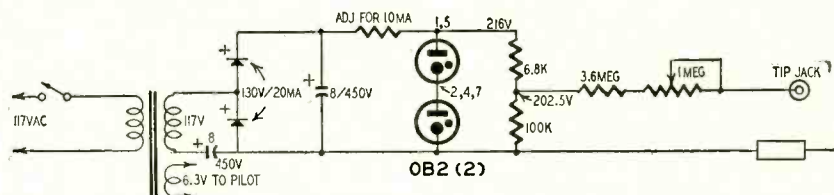

Fig. 3—Electronic range extender supplies exact voltage from the a.c. line.



# Failure-proof CONELRAD ALARM

*CONtrol of ELectromagnetic RADIation  
is an important civil defense measure.  
Here is a very reliable alarm system*

By HAROLD SCHAAF\*



The front panel of the Conelrad alarm.

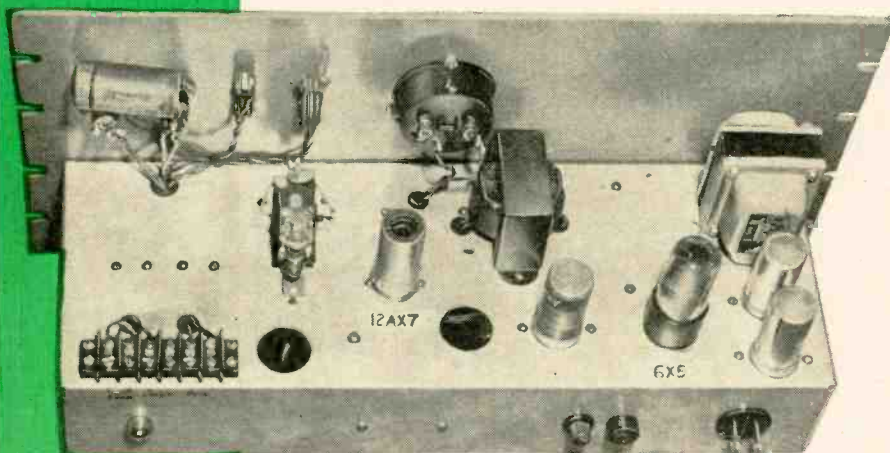

Top and rear-chassis view of the alarm.

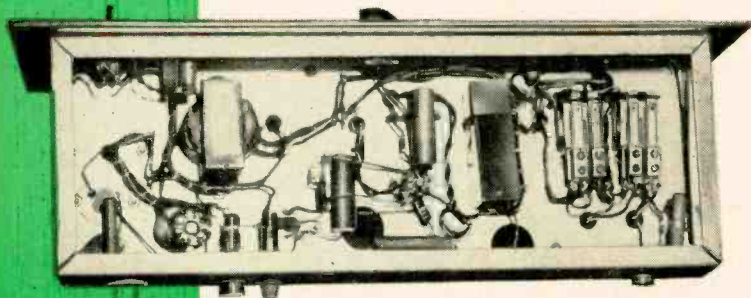

Underchassis view—alarm relays at right.

PERHAPS the most widely used Conelrad alarm consists of a single tube with a control relay in series with one of the current elements of the tube. The tube is biased to cutoff by a.v.c. voltage from a receiver. The relay is not energized, because no current is drawn by the tube. If the tube burns out or the power supply fails there is no warning, because there is no relay action. Such a system cannot be considered reliable, since it can go out of order without the operator knowing it.

Another system adds a thyratron tube to control the relay. Here again the same conditions prevail. In addition, thyratrons go flat rather quickly in spite of current limiting. They are also unstable when used with small voltages unless well regulated power supplies are used.

Some versions of both the above systems are rather insensitive and require a large a.v.c. voltage to work properly.

With these points in mind we at WRFD built an alarm that uses high-vacuum tubes only, is sensitive, operates with all relays energized when a.v.c. is applied and alarms if the tube heaters burn out or the power supply fails.

Since a.v.c. voltage was considered the best means of triggering an alarm, an a.v.c.-biased trigger tube was retained. To operate a control relay in the energized position when a.v.c. voltage is present, a d.c. amplifier was added following the trigger tube. It was also felt that relays in the warning circuits should operate in the energized position so there would be an indication in case of trouble in their circuits. A series-heater dual triode was used so that burnout of either heater section would affect current in the control tube and operate the relay. An over-current relay and resistors and capacitors of higher power and voltage ratings than any encountered in the circuit completed the features needed to make the alarm failure-proof.

Several d.c. amplifiers were checked for operating characteristics. We finally settled on a variation of a circuit

\* Chief engineer, WRFD, Worthington, Ohio

which has been used as a d.c.-controlled a.c. amplifier. The variation is excellent for relay operation as the plate current of the second tube can be varied over a rather wide range by altering the d.c. bias on the first tube.

The schematic of the final version of the alarm is shown in Fig. 1. All relays are shown with a.v.c. applied to the input. It uses a 12AX7 tube, in which the heater sections are connected in series.

The first section of the tube is used for a.v.c. triggering. The second section is for control, to operate a relay which in turn operates the alarm indicator relays. The a.v.c. voltage is fed to the input potentiometer which adjusts the operating point of the alarm. A filter follows the potentiometer to remove audio interference and noise. Capacitor C1 can be varied in size to obtain a time delay so that momentary loss of the key station signal will not operate the alarm. The a.v.c. voltage is then fed to the grid of the trigger tube and biases it toward cutoff. As its plate current drops to a low value, the voltage drop across R2 approaches zero. Since the grid of the control tube is connected to one end of this resistor through R1 and the cathode of the control tube is connected to the other end of the same resistor, the voltage difference between the grid and cathode approaches zero. Current then flows in the control tube plate circuit, energizing the control relay in the circuit.

As the a.v.c. voltage drops, the trigger tube loses its bias and starts to draw plate current. This causes a voltage drop across R2. Since this voltage drop is in series with the grid circuit of the control tube, it causes the grid to go more negative and the plate current to approach zero, causing the control relay to de-energize. Circuits following this relay are then deactivated to give alarm.

A milliammeter and an overcurrent relay are also inserted in the plate circuit of the control tube. The milliammeter is used to adjust the plate current to the desired operating value. The overcurrent relay activates the alarm circuits in case the plate current should rise to an abnormal value. This would be the case if the B voltage divider opened above the cathode tap or if the tube developed an internal short. The overcurrent relay is adjusted to operate at a value between the pull-in current of the control relay and the tube current with the B voltage divider opened.

The control tube plate current vs. trigger tube grid voltage curve is smooth (Fig. 2) from saturation toward cutoff. We adjusted the control relay to pull in at 1.5 ma and to release at 1 ma, the center of the curve. It can be seen that a rather small a.v.c. voltage applied to the grid will operate the alarm. The curve can be shifted along the y-axis by varying the value of R2. It will maintain its slope over a

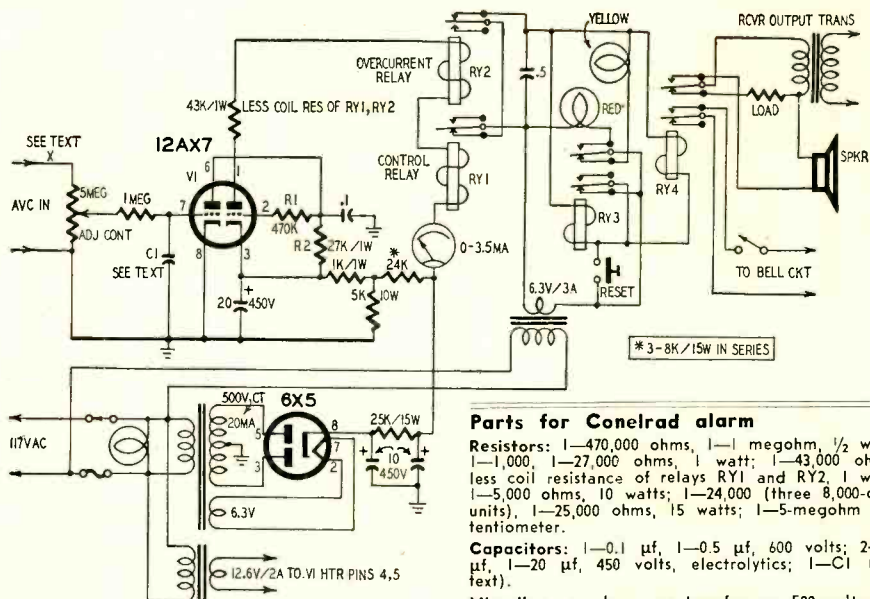

Fig. 1—Schematic diagram of the failure-proof Conelrad alarm system.

rather wide range of shift. If the a.v.c. developed by the key station is so high that the input potentiometer has too small an adjustment range, a series resistor of a few megohms may be inserted at point X on the diagram.

**Adjusting the alarm**

Advance the input potentiometer until the control relay pulls in. Then adjust it for some value of current between the the release current of the relay and the knee of the current curve, allowing for normal variations of the a.v.c. voltage. Since we are in a fairly strong signal area, we adjust ours to run halfway between the pull-in and release currents. Loss of a.v.c. will allow the control relay to release and trip the alarm circuits. We have marked the current values on our meter for easy reset and for use as a check on the overall performance of the alarm.

The warning indicators following the control relay are types that suit our specific needs. There are any number of variations that may be used. A yellow pilot lamp shows when the a.v.c. is holding the relays energized. When the alarm is tripped, a red pilot lamp shows, the receiver output is transferred from a load resistor to a loudspeaker and a bell circuit is energized. The same indications are given when internal trouble develops. A lockout circuit is used through the contacts of one of the warning circuit relays. This is necessary to keep the alarm from re-setting with each application of a.v.c. Manual reset is required once it has tripped.

We experimented with an automatic sequencing alarm and reset for this unit. However we felt manual reset was better since less circuitry is involved and power interruption at the wrong time in a sequencing circuit could render it useless. Before putting the alarm into operation we subjected it to a series of failure conditions that

**Parts for Conelrad alarm**

**Resistors:** 1—470,000 ohms, 1/2 watt; 1—1,000, 1—27,000 ohms, 1 watt; 1—43,000 ohms, less coil resistance of relays RY1 and RY2, 1 watt; 1—5,000 ohms, 10 watts; 1—24,000 (three 8,000-ohm units), 1—25,000 ohms, 15 watts; 1—5-megohm potentiometer.

**Capacitors:** 1—0.1 uf, 1—0.5 uf, 600 volts; 2—10 uf, 1—20 uf, 450 volts, electrolytics; 1—C1 (see text).

**Miscellaneous:** 1—power transformer, 500 volts c.t. @ 20 ma, 6.3 volts @ 1.5 amps (Triad R-3A or equivalent); 1—filament transformer, 6.3 volts @ 3 amps (Merit P-2946 or equivalent); 1—filament transformer, 12.6 volts @ 2 amps (Merit P-2959 or equivalent); 1—6X5; 1—12AX7; 1—octal socket; 1—9-pin miniature socket; 1—relay (RY1), surplus type BK-7B, s.p.d.t., 4,000 ohms, adjustable sensitivity; 1—relay (RY2), 10,000 ohms, s.p.d.t., 3.2 ma. 5-ampere contacts (Potter & Brumfield LMS, adjusted for 3 ma, or equivalent); 2—relays (RY3, RY4), d.p.d.t., 6 volts a.c. (Potter & Brumfield KR1A); 1—milliammeter, 0-5 ma (or 3.5-ma meter from surplus BC-442-A antenna relay unit); 1—switch, push to make; 1—s.p.s.t. switch; 3—pilot lights and assemblies; 1—fuse and holder; 1—terminal strip; 1—shield for 12AX7; 1—jack for receiver input, 1—power cord; 1—chassis and panel.

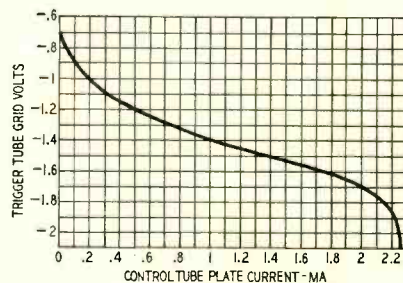

Fig. 2—Control tube characteristic.

might occur. Indication was given for all of them. Since being put into operation it has worked perfectly.

Good grounding and a shielded line from the a.v.c. bus are necessary. The 6X5 should be mounted vertically. Horizontal mounting is permissible, however, if pins 3 and 5 are in the horizontal plane. No other precautions need be used in constructing the alarm.

The parts list shows the components we used. Although it may seem there are more transformers than needed, we had part of them in stock and used what we had. Some of their functions could easily be combined. The relays can be of any make so long as they operate in the current ranges of the circuit.

We also built an alarm using a 12AU7 tube which works equally well. It requires higher a.v.c. voltage and has greater plate current in the control tube. The same circuit configuration was used with changes in some of the component values to account for the difference in tubes. END



# WIRELESS INTERCOM

By J. P. NEIL

*An easy-to-build power line carrier system*

INTERCOM systems are many and varied. Included are some commercial power-line carrier types, but these have certain limitations—inability to pass through watt-hour meter circuits, strictly transceiver operation, line-noise interference. I know of no FM system of the power-line carrier type. This article describes a relatively simple FM power-line carrier transmitter-receiver with a number of important advantages: reduction in line noise; separate transmitter and receiver in the same cabinet permit monitoring only or receiving only when required; carbon mikes give better pickup than speakers used as microphones; lever control switch permits push-to-talk or steady-on operation effective up to several hundred feet beyond meter circuit.

The FM wireless intercom lends itself to many applications. Typical are: monitoring unattended offices or stores; monitoring children's playrooms and bedrooms; adjusting antennas at set and antenna simultaneously.

### Circuitry

A schematic diagram of the transmitter, receiver and power supply is shown in Fig. 1. The transmitter consists of a 12AT7 grounded-grid speech amplifier with the microphone in series with the cathode of V1-a. V1-b is a grounded-cathode amplifier with printed-circuit R-C coupling to the reactance modulator, a 6BE6 capacitively coupled to a 6AG7 electron-coupled oscillator. The oscillator in turn is capacitively coupled to the line at point A.

With the exception of bypass capacitors which are not too critical, all components are optimum values, determined from extensive experimenting. C4 must be connected from the "hot" side of the heater to ground at the oscillator socket. The oscillator coil consists of a J. W. Miller No. 4537 r.f. (four-pie, 2.5-mh, 200-ma) choke, with the cathode of V3 (carefully) connected at the junction of the first and second pies above ground. All leads should be kept short as possible. Switch S2 is in series with the transmitter B plus; S3-a controls only the oscillator stage.

The receiver is conventional except that it uses a single 6BA6 combined r.f. amplifier-limiter and a 6T8 as a combination discriminator-first audio. The 6AR5 output stage is biased to draw less than half its normal plate current, insuring low drain. As with the transmitter portion, printed-circuit R-C coupling is used. The trimmer capacitor originally across the primary of T1, the r.f. input transformer must be disconnected and very carefully wired in series with the primary and connected to chassis ground. S3-b is wired to short the voice coil during transmission. If transmitting and receiving on the same frequency, a switch may be inserted to remove receiver B plus during transmission. S4 is a s.p.s.t. switch on R3, in series with the receiver B plus. The output transformer is a universal type, connected for 14,000 ohms impedance.

The system used here makes it possible to use an inexpensive power transformer rated at only 250 volts c.t. at 25 ma, with a 6.3-volt 1-ampere filament winding. This winding is wired to the transmitter heaters only from point X. An additional small transformer provides the filament supply for the receiver tubes and pilot bulbs from point Y and is located in front of CH1, CH2, on top of the chassis. The 250-volt winding of the power transformer is split to give two separate 120-volt d.c. outputs by use of half-wave selenium rectifiers.

Capacitors C6, C7 and resistors R4,

Front panel view of wireless intercom.

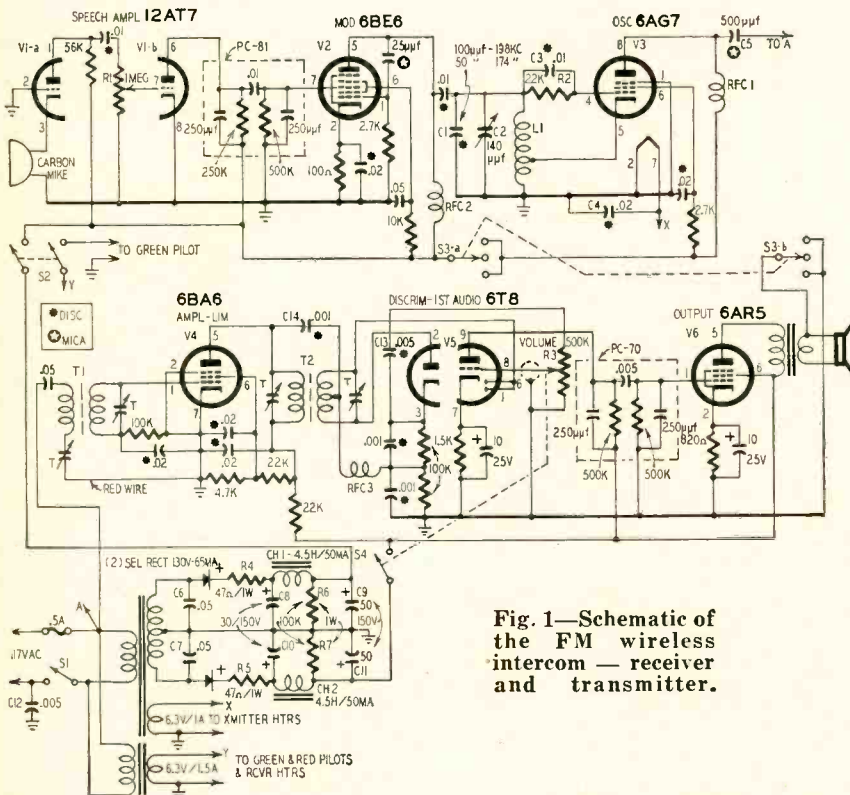
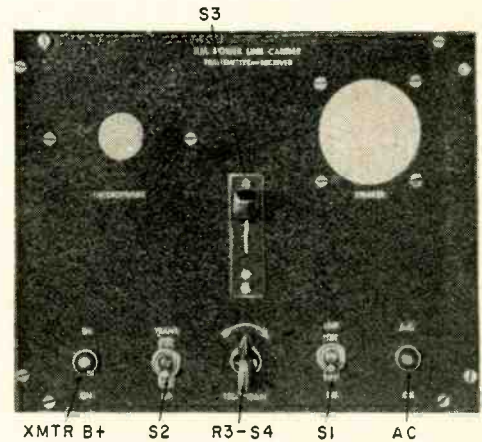

Fig. 1—Schematic of the FM wireless intercom — receiver and transmitter.

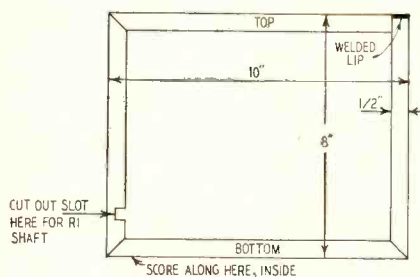

Fig. 2—Layout of intercom cabinet.

R5 are, respectively, voltage and current surge-limiting components. C8, C9 and C10, C11 are dual 30-50- $\mu$ f 150-volt tubular electrolytics. This high capacitance gives good voltage regulation without tube regulators. The value is not critical, but a total of at least 80  $\mu$ f is recommended to keep the hum down to about 0.1%. Resistors R6, R7 discharge the filter capacitors.

**Construction**

A 10 x 8 x 7-inch aluminum utility box serves as a cabinet (Fig. 2) for the complete unit. A slight alteration is necessary so it will accept the 7 x 9 x 2-inch aluminum chassis, with respect to the 7-inch depth. The cabinet is of one-piece construction with separate back and front panels. The welded junction of the box should be at the top, so the bottom will be uniform and plane. Using a heavy knife blade, the bottom front and rear folded lips should be scored heavily along the inside seams. The lips should then be bent back and forth till they break off and the edges filed smooth and touched up with black

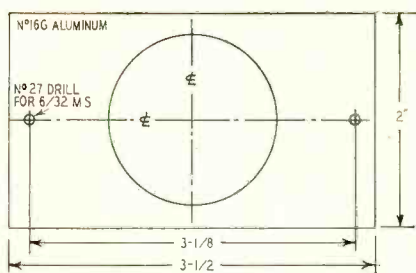

Fig. 3—Layout of microphone clamp.

lacquer. With the chassis in place attached to the front panel, it will be flush at the front of the box and projecting about 1/16-inch at the rear.

Major parts should be laid out as shown in the photos. Chokes CH1, CH2 are surplus microphone filters that were on hand. The companion unit used two Stancor No. C-1706 chokes in the same positions. When mounting the chokes and transformers, they should be placed so that adjacent coils are at right angles to each other where possible. All miniature sockets except that of V6 are shielded. V6 is the saddle type. R1 is located along the center line between V1 and V2. A slot must be cut in the left-hand lip of the cabinet as shown in Fig. 2. The shaft of R1 should be cut off to about 1/4-inch and slotted. Then drill a matching 1/4-inch hole in the side of the box to permit external screwdriver adjustment. S3 should be mounted positive upward, spring-return downward.

Most of the minor components are visible in the underchassis photo. Note particularly the locations of the r.f. chokes (mounted on 1 1/2-inch 6-32 brass

machine screws), L1 and its associated capacitors C1 and C2. C3 and R2 are wired from the top lead of L1 down to pin 4 of the octal socket. This lead of L1 is extended to the stator of C2 by a piece of No. 14 tinned bus wire. The lower strap lead of L1 connects directly to the rotor lead of C2. C1 is wired between the two leads of L1. The r.f. output capacitor C5 is mounted between one lug of RFC1 and a single-lug terminal strip, the mounting lug of which is soldered to pin 1 of the V3 socket. A lead from this strip is then run to point B on the fuse holder, along the rear bottom lip of the chassis.

The filter capacitors are strap mounted. These straps are bent so they can be attached to a common screw in the center of the rear edge of the chassis, with one capacitor staggered above the other. Selenium rectifiers can be placed on the side of the chassis or any convenient place.

The panel components are mounted straightforward. The clamps for attaching the carbon mike capsules are from 16-gage aluminum (Fig. 3). A hole is cut out of the center just large enough to fit over the projecting ring on the back of the capsule. Although surplus mikes will do, Western Electric type F-1 or T-1 units are much better. Grill cloth is placed in front of both microphone and speaker. A piece of aluminum window screen is positioned between the 2-inch PM speaker and the grille cloth to protect the cone.

**Transmitter adjustments**

The transmitter section can be adjusted without instruments, by guess-

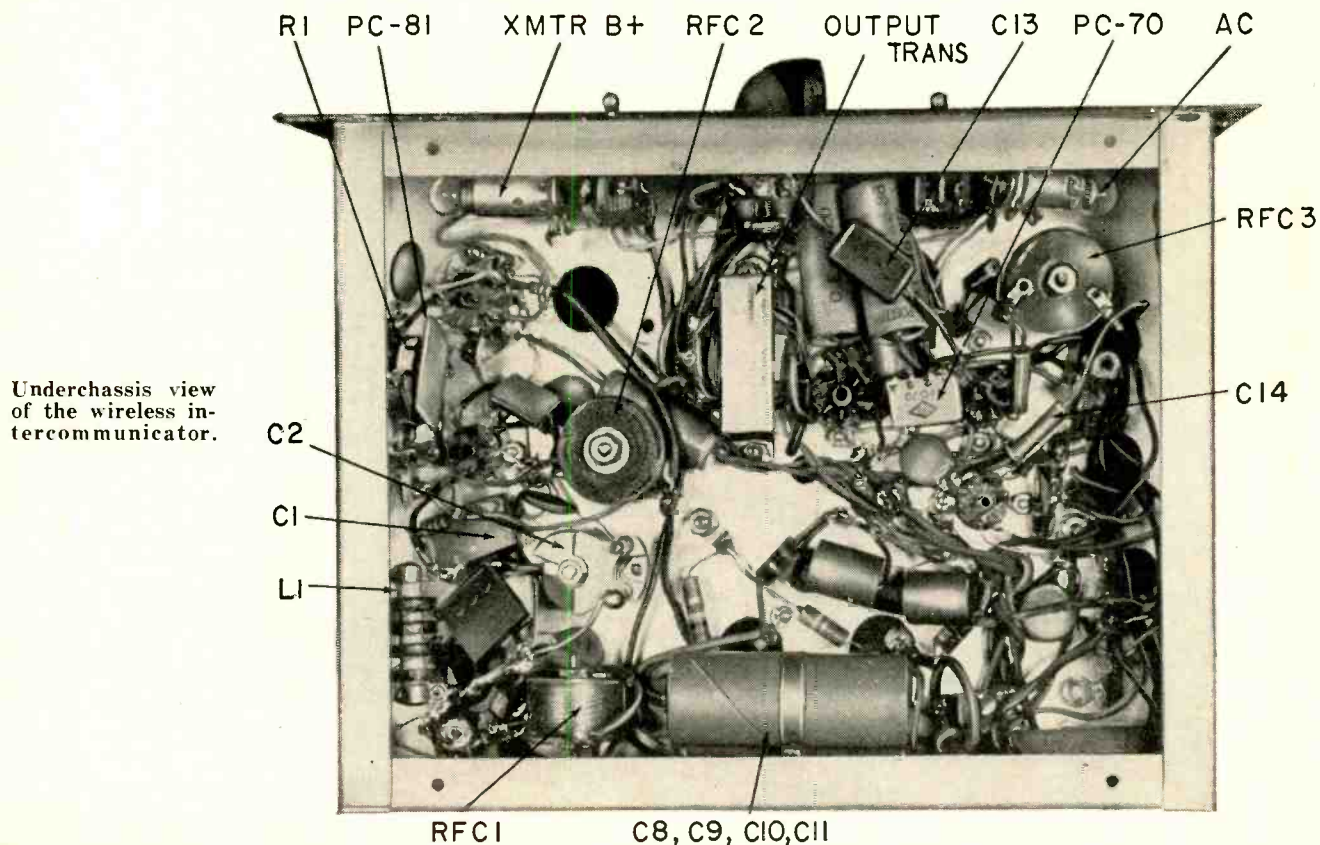

Underchassis view of the wireless intercommunicator.

## RADIO

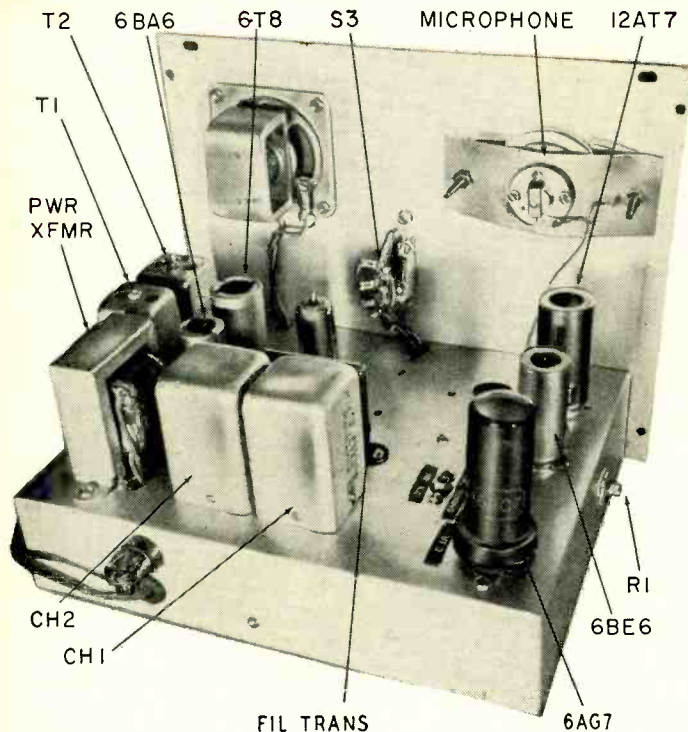

Rear view shows major components. Unmarked tube next to the 6T8 is the 6AR5.

work, if necessary. However, an oscilloscope and an audio generator reaching to the 175-kc region should be used if at all possible. The two companion units are set to operate on 174 and 198 kc, respectively, merely because they were easy decal combinations for chassis marking. Actually, any two different frequencies between about 150 and 205 kc may be chosen as long as the two carriers are at least 20 kc apart. Deviation is narrow, amounting to only about 2 or 3 kc.

To adjust the transmitter using the above instruments, connect the audio generator output to the horizontal

plates of the scope and the vertical plates to a pair of leads. The "hot" vertical lead is loosely coupled near the oscillator circuit under the chassis, the other lead connected to the chassis. An external ground should be used during this process but is not required for normal operation. Also connect the external sync terminal of the scope to the "hot" vertical terminal.

Set the generator to the desired frequency and adjust the vertical and horizontal scope gains to give a pattern of sufficient size. Oscillator tank capacitor C2 should then be varied very slowly until a circle pattern is obtained. If a circle cannot be obtained, set C2 first at minimum, then at maximum and at each position vary the generator to obtain a circle, noting the extreme limits. Should a circle be out of these limits for a given carrier, C1 may be wrongly marked and should be changed. In the event no vertical gain can be obtained, check for r.f. voltage with an a.c. v.t.v.m. at the hot end of L1. There should be 30 or more volts at that point and at least 50 volts r.f. at the 6AG7 plate. If there is no r.f. output, check the cathode current, which should be 14 to 18 ma. A current of only 2 or 3 ma indicates no plate load, hence C5 or C12 may be open. If there is no cathode current at all, check the continuity of L1 in both directions from the cathode tap. An "open" will likely be indicated.

As a double check for r.f. output, a v.t.v.m. across the line terminals will show an increase of 2 or 3 volts if all is well. In checking with the scope, the circle pattern at resonance is very sharp and does not remain stationary for more than a moment at a time.

Thus, a quick shifting of a cycle or so is of no consequence.

Turn R1 to maximum clockwise (full gain) and readjust the oscillator frequency slightly to its correct value. To check deviation place an earphone, fed with a 1,000-cycle note, close to the mike. The circle on the scope should change to a fuzzy square. Detune the generator about 1 to 2 kc higher and lower than the center frequency. A new circle should be obtained at each extremity, though not as sharp as with no modulation (that is to say, the circle pattern may be somewhat broad or fuzzy). If no instruments are available, C2 can be set at about one-third mesh for the higher-frequency carrier and at about two-thirds for the lower.

### Receiver

Receiver adjustment can be carried out by ear or with an a.c. v.t.v.m. connected across the voice coil of the speaker. As in the above deviation check, impress a tone into the microphone of the transmitter in the companion unit. With the receiver gain at maximum start tuning each trimmer in succession until the tone is heard, gradually reducing the gain as it becomes too loud, until all are peaked. If voice reproduction is poor when the two units are separated by at least 30 feet or more, the trimmers can be repeaked to give best results. Transmitter deviation can be reduced by setting R1 of the sending unit a little less than maximum.

The rectifier outputs should be approximately 150 volts d.c. no load and around 120 volts d.c. loaded at C9 and C11.

### Operation

Regardless of the purpose for which this equipment is being used, S2 and S4 should be in the "off" positions when not in use and S3 in neutral. S1 should always be turned on first and S2 and S4 only after a delay of at least 15 seconds. With selenium rectifiers, the plate voltage would otherwise be applied before the heaters have warmed sufficiently.

When used as an ordinary intercom S2 and S4 must both be "on" (after the warmup period). The push-to-talk (downward) position of S3 should be used for this purpose whenever possible to conform with normal practice. In situations requiring monitoring only, the transmitter B plus (S2) of one unit and the receiver B plus (S4) of the other are used. Full duplex operation is not feasible due to acoustic feedback if both transmitters and receivers are on together. This is another reason for muting the speakers. Due to the sensitivity of the microphones, a low voice level should be used when speaking close to them. Conversely, with S3 in the upward position (positive on), one can talk into the unit from some distance away. In the event of severe line noises, reversing the line plugs may help. END

### Parts list for wireless intercom

**Resistors:** 1—100, 1—820, 1—1,500, 2—2,700, 1—4,700, 1—10,000, 3—22,000, 1—56,000, 3—100,000 ohms, 1/2 watt; 2—47, 2—100,000, 1 watt; 1—500,000 ohms (with switch), 1—1 megohm, potentiometers.

**Capacitors:** 1—25  $\mu$ f, 1—C1, (100  $\mu$ f for 198 kc, 150  $\mu$ f for 174 kc), 1—500  $\mu$ f, mica; 3—.001, 2—.005, 3—.01, 6—.02  $\mu$ f, disc; 4—.05  $\mu$ f, tubular; 2—10  $\mu$ f, 25 volts, electrolytic; 2—30, 2—50  $\mu$ f (use dual 30-50 tubulars), electrolytic; 1—140  $\mu$ f, variable (Hammarlund APC-140 or equivalent).

**Miscellaneous:** 1—input transformer T1, 175-kc input i.f. transformer (Miller 162-K1 or equivalent); 1—r.f. transformer T2, 175-kc full-wave i.f. output transformer (Miller 612-K3 or equivalent); 1—universal output transformer, 14,000-ohm primary, 4 watts (Stancor A-3823, Merit A-2900 or equivalent); 1—power transformer, 250 volts c.t. @ 25 ma, 6.3 volts @ 1 ampere (Stancor PS-8416 or equivalent); 1—filament transformer, 6.3 volts @ 1.5 amperes; 2—chokes, 4.5 h @ 50 ma (Stancor C-1706 or equivalent); 1—12AT7, 1—6BE6, 1—6AG7, 1—6BA6, 1—6T8, 1—6AR5, tubes; 2—7 pin, 2—9 pin, miniature sockets; 1—7-pin saddle type socket; 1—octal socket; 1—s.p.s.t. switch; 1—d.p.s.t. switch; 1—2-pole 2-position lever switch (Centralab 1467 or equivalent); 3—r.f. chokes, 60 mh; 1—coil (L1), 2.5 mh, 4 pie (Miller 4537 with strap leads or equivalent); 2—6.3-volt 150-ma pilot lamps and assembly; 1—1-ampere fuse and holder (1/4-ampere slobber can be used); 2—selenium rectifiers, 130 volts, 65 ma; 1—printed circuit, Centralab PC-70; 1—printed circuit, Centralab PC-81; 1—2-inch loudspeaker; 1—carbon microphone capsule (Western Electric F-1 or T1, or surplus types); 1—chassis, 7 x 9 x 2 inches aluminum; 1—cabinet, 10 x 8 x 7 inches; 4—tube shields.



# A.C.

# Supply circuitry

By L. B. HEDGE

SINCE most of our listening, viewing and test equipment is a.c.-operated, the power-line connection is a common element in most electronic design. Its function is to get electrical energy from the power line into the electronic unit with reasonable safety and efficiency and to bring in or let out a minimum of energy not useful in powering the device (noise, extraneous radiation, etc.). These objectives are straightforward and simple and not difficult to achieve. But a tendency to follow established practice has had some strange effects on what might be called the "back end" of a.c.-powered electronic equipment design.

Fig. 1-a shows a typical a.c. input circuit with a balanced filter for suppressing incoming noise and outgoing radiation. More elaborate variants of this basic scheme are shown at Fig. 1-b, c. Each of these arrangements has a nice symmetrical look. Since the power-line connection is usually made with a plug which may be inserted into the power outlet receptacle either way, this symmetry is deceptively appealing.

Virtually all 117-volt power supply lines in this country are connected to 117/234-volt, grounded-center, three-wire distribution circuits. Most industrial and many home power lines bring the 234-volt three-wire line into the meter and customer distribution center and provide 117-volt power outlets from both "sides" of the three-wire system (Fig. 2).

This three-wire, grounded-center system provides, at the 117-volt level, an unbalanced supply line—one side of the line is grounded. This ground connection

is insured by a connection, on the customer side of the meter, between the common center line and the cold water line of the building. The metallic conduit system—if metallic conduit is used—is also connected to this grounded center line.

When the unit shown in Fig. 1-a is connected to the power line, this results in one of the alternative situations shown in Fig. 3. The chassis is maintained at an a.c. potential of approximately 58.5 volts above ground by the capacitive voltage divider of the filter when the switch is closed. With the connection shown at Fig. 3-b the chassis potential goes up to 117 volts when the switch is opened or the fuse blows. If two devices with Fig. 1 type "back ends" are plugged into outlets fed from opposite sides of the supply line, the two chassis will come up with a 117-volt difference of potential between them. If they are plugged in as in Fig. 3-b, this potential will rise to 117 volts when one switch or fuse is opened and to 234 volts when both units are "off" (Fig. 4).

These discrepancies are disconcerting and may be dangerous. Although the impedance of the capacitor filters of Fig. 1 is likely to be high enough at 60 cycles to prevent a large current flow through them, you can pick up a nasty shock by touching two chassis connected as shown in Fig. 4—especially if both of the units are turned off!

If these two units are, for example, a signal generator and an oscilloscope, the 60-cycle current flowing in an interconnecting "ground" lead may well introduce a troublesome 60-cycle signal at the scope. If a scope is not part of

the setup, the spurious signal may appear as an unsuspected contribution to a meter reading or a hum which is credited to more conventional causes.

The key to a rational correction of these anomalies of conventional "back-end" design lies in the use of polarized power plugs. These plugs are obtainable from electrical supply houses or they can be easily and economically provided by simple modification of standard plugs (see "Polarized Power Plugs for the Experimenter," January, 1953). With the wide blade of the power plug connected directly to the power unit of the device, and the switch and fuse in the lead to the narrow blade, the switch and fuse will provide real protection (Fig. 5). With the power supply wiring now realistically unbalanced, the filter systems of Fig. 1 may be modified (Fig. 6-a, b) to provide the same filtering action without raising the a.c. potential of the chassis. The conversion is easily and quickly made on existing equipment—the unbalanced filter in no sense complicates a new design.

A special word is in order regarding the scheme shown in Fig. 1-b: *don't do it!* Fusing both leads to a grounded-center power supply connection is an invitation for unsafe failure—a short to the chassis which blows the fuse in the ground lead will leave the chassis hot with a solid connection through the short! END

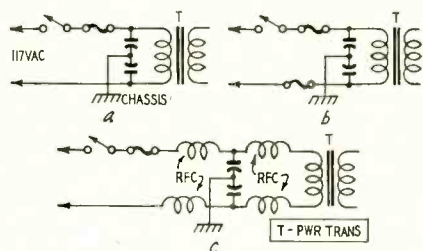

Fig. 1—Diagrams show common variations in standard power-line filters.

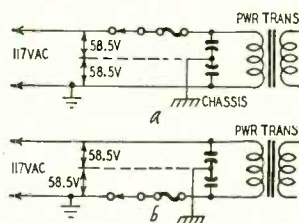

Fig. 3—Diagrams show how balanced filter places chassis above ground.

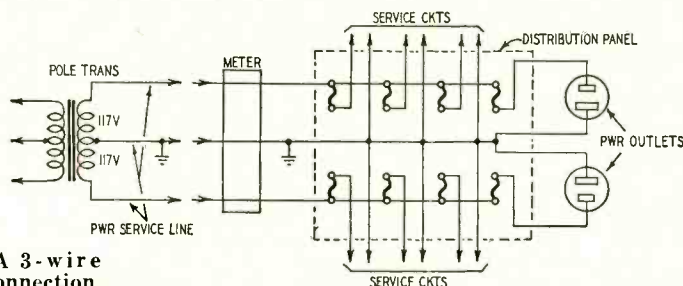

Fig. 2—A 3-wire service connection.

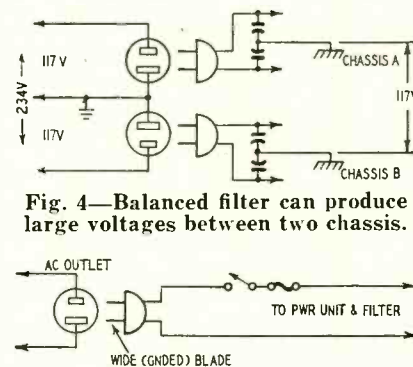

Fig. 4—Balanced filter can produce large voltages between two chassis.

Fig. 5—Switch and fuse are in hot lead.

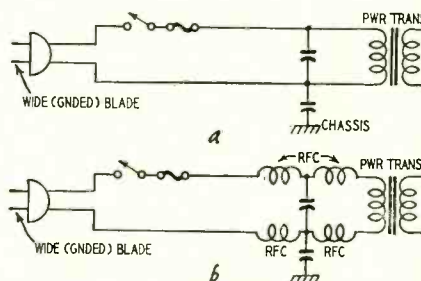
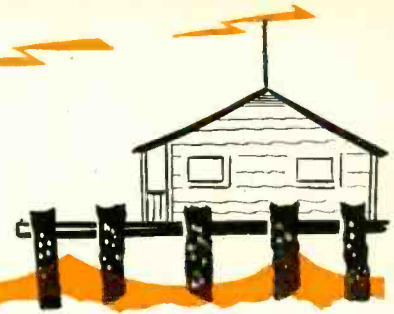

Fig. 6—Schematic of an unbalanced filter—chassis is bypassed to ground.

## COMMUNICATIONS



## SHIP TO SHORE

*The radiotelephone story: applications, regulations, equipment*

By SIDNEY S. KONIGSBERG\*

**R**ADIO people whose business or interests are not primarily in the marine field are often surprised to learn the important role of the radiotelephone on pleasure and commercial craft of all types.

\*President, Applied Electronics Co., San Francisco.

From the smallest power cruiser to the most pretentious sea-going yacht, from the lowly harbor barge to the speedy, long-ranging tuna clippers, all are radio-equipped. Significantly, none but the largest boats employ radio operators with first- or second-class commercial operators' licenses. Radio-

telephone (voice) is used predominantly, the design of the equipment being such that nontechnical people with easy-to-obtain third-class licenses can operate it without difficulty.

Radiotelephone operation on any boat is not to be considered in the hobby class. It is important, functional, vital. It can, and often does, offer a craft in distress the only means of summoning aid. The effectiveness of small-boat radiotelephones in this regard is pointed up by a recent, nationally publicized news item. Many readers will recall the story of the false distress signals which sent the Navy and Coast Guard on a futile, costly search covering a very wide area. Apprehension and prosecution of the guilty parties followed in due course. However, the story's pertinence to this discussion lies in the effectiveness of the illicitly used boat radiotelephone equipment in summoning aid. Had the emergency been a real one, lives and property would surely have been saved.

A business man comfortably relaxed on his boat in the Florida Keys can, with his marine radiotelephone, speak to his office in New York. It is necessary only that the radiotelephone-equipped boat be within range of the nearest land station maintained by AT&T.

Marine operators answer the call from the vessel and patch the signal into land-line telephone circuits. Conversation thereafter proceeds in the same manner as a conventional telephone call with this exception: it is impossible for both parties to speak at the same time. The boat equipment operates on a press-to-talk, release-to listen basis.

The ability to converse directly with parties on shore is of extreme value to many commercial boat operators. Fishing fleets in particular use the radiotelephone to exchange spotting information on schools of fish, to inform shore canneries as to tonnage of catch, to arrange refrigeration, etc. The marine radiotelephone has come of age, evolved from a cumbersome, uncertain-in-operation curiosity to the present-day dependable, streamlined package.

Design problems in equipment for

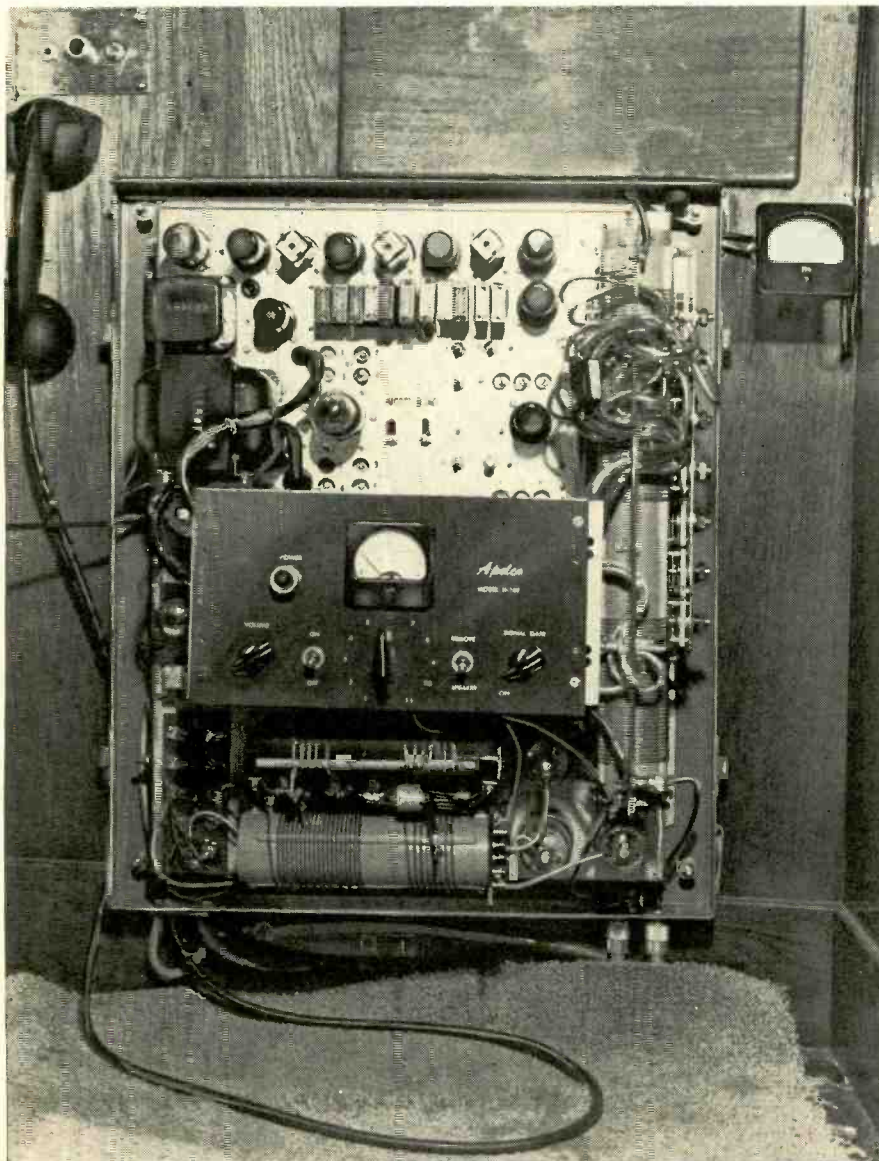

Topside view of the Apelco H-160.

marine service are unique. For example, a typical installation operating from a 12-volt power source must be capable of functioning from between 10 to 16 volts. As mentioned, radiotelephone equipment is usually operated by non-technical personnel having only an FCC third-class radiotelephone operator's license. The laws governing this type of service require that the equipment design must be such that the operator cannot make interior circuit adjustments. He is permitted merely to turn the primary power on or off, set the channel selector switch to the desired frequency and actuate the press-to-talk button on the microphone. In other words, the equipment must be foolproof, tamperproof and must be pre-tuned by a duly licensed technician.

No restrictions are imposed on receiver operation however. Most present-day equipment contains a multirange tunable receiver which includes the standard broadcast band. In addition, the receiver high-frequency oscillator is generally quartz-crystal-controlled, the operator automatically selecting the correct receiving channel when setting the master selector switch to the desired transmitting channel.

The frequency of operation may vary widely depending upon the type of boat and the cruising radius over which reliable communication is required. In addition to those on the Great Lakes, the telephone company has stations geographically arranged to provide overlapping coverage of the entire United States coastline. For example, on the East Coast there are stations in Boston, New York, Norfolk, Charleston and Jacksonville; on the Gulf, stations in Tampa and Galveston; on the Pacific Coast, San Pedro, San Francisco, Astoria and Seattle. These various shore stations have sufficient transmitting power and antenna systems for adequate reception by boats at substantial distances. The need for equivalent transmitting range from the boat is minimized by installation of telephone receiving stations at interim coastal points.

Many such stations operate with efficient directional antennas. Additional, and important, frequency channels provide for a general boat-to-boat calling frequency at 2182 kc. After establishing contact on this channel both boats shift frequency to 2638 or 2738 kc for further communication. Of great importance to the boat owner is the fact that the 2182-kc frequency is continuously monitored by the U. S. Coast Guard and thus serves as an emergency channel for ships in distress.

Where the cruising radius of a boat is limited to U. S. coastal waters, the required ship-to-ship, ship-to-shore and distress frequencies are encompassed within the frequency range from 2000 to 3000 kc (except in the Great Lakes area). Another group of telephone stations provides high-seas, extended-range, ship-to-shore radiotelephone communications.

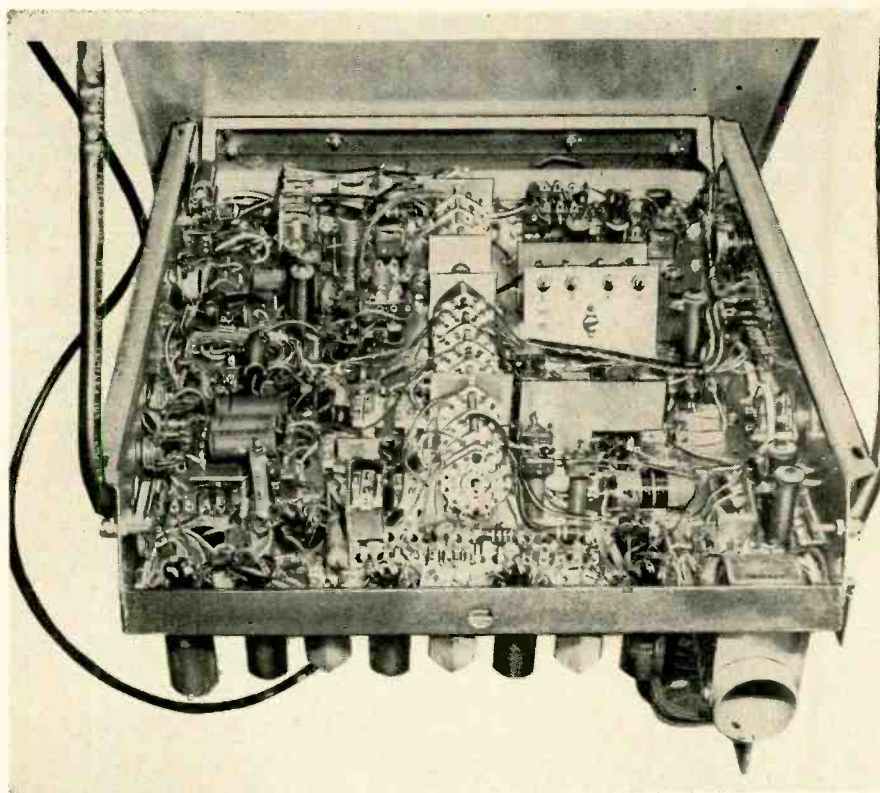

Underchassis of the Apelco H-160.

The Apelco H-160 installed in the craft shown in the cover picture, has a total of 11 channels, some of which may extend as high as 18,000 kc. Therefore this equipment is sufficiently versatile to provide coastal or long-range ship-to-shore (telephone-company) operation by using the higher-frequency channels. It is not unusual to communicate several thousand miles on daily scheduled transmissions from boats so equipped.

In small-boat radiotelephone service numerous technical problems exist for the design engineer.

Power input in this equipment is limited both by FCC regulations and by the amount of current that can be drawn practically from a storage battery. Transmitters with inputs to approximately 50 watts are feasible from a 6-volt battery source. Higher powers, to 200 watts input, normally call for 12- 32- or 110-volt d.c. installations. With power inputs necessarily restricted and with antenna length dictated by the size of the craft, it is highly important that the equipment be as electrically efficient as possible. This is particularly true with regard to the final amplifier plate and output loading circuits.

#### Radiotelephone circuits

Marine transmitters of the above type always use precision, low-drift quartz crystals for maintaining frequency accurately. Rigid FCC regulations forbid self-controlled oscillator operation. A

typical crystal-controlled oscillator circuit is shown in Fig. 1. This is a modified Pierce type in which no tuned L-C circuit is required. All crystals switch in on the master selector switch.

Buffer amplifiers are used in all but the smallest transmitters. Since the operator has no control over the interior circuits and no "touch up" is possible, it is important that drive to the final amplifier be sufficient at all times on all frequency ranges. This points up another consideration—the need for avoiding marginal adjustments. The buffer amplifier must receive adequate grid drive from the oscillator, use tubes with ample extra plate dissipation and supply proper drive to the amplifier even when its own tuned L-C circuits are not exactly "on the nose." In a word, safety factor—extra margin—must be everywhere in marine radiotelephone equipment.

The final amplifier tubes and output circuitry are of great importance for a number of reasons. When operation is in the 2000–3000-kc range, the average length of antenna that can be used usually represents only a frac-

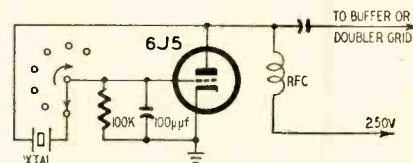

Fig. 1—Modified Pierce oscillator

tion of a quarter-wavelength at the lowest end of the operating range. All such antennas are necessarily of the Marconi type operating against a ground plate. It is necessary to load these antennas to a quarter-wavelength by adding suitable values of base inductance. (This procedure may be compared to an amateur automotive mobile installation operating in the 3500-4000-kc range and using a whip antenna.) A short antenna of this type looks electrically like a small capacitor (high capacitive reactance) in series with a small resistance. Generally speaking, the shorter the antenna compared to a quarter-wave-length at a given frequency, the smaller its capacitance, the higher its capacitive reactance and the lower its radiation resistance.

The transmitter output circuit must operate to transform the proper load impedance for the output tubes to the very low antenna base resistance (perhaps less than 5 ohms). This in itself may impose some knotty loading problems. The output circuit must also provide sufficient inductance to cancel the capacitive reactance introduced by the short antenna. In extreme cases the value of the loading inductance may be very large, making it mandatory that the "Q" of the loading inductor be very high if excessive losses are to be avoided. 
$$Q = \frac{2\pi f L}{R}$$

Heavy-duty, space-wound inductors are used in the Apelco model H-160 (see photo).

Since there is a definite limit to inductor Q's that can be practically obtained in a compact transmitter, the trend is toward special antennas using built-in loading. Essentially, these are vertical antennas with built-in center-loading inductors above which

are mounted flexible top whips for added height and additional (and desirable) top capacitance. Antennas of this type present a higher base load resistance to the transmitter and require much less base-loading inductance. They (or other base-loaded antennas) are precisely resonated by the technician for each channel, with proper taps being brought to the master range switch.

While many different types of output circuits are used by different manufacture, virtually all of them fall into two basic categories: First, some configuration of a conventional L-C tuned circuit to which the antenna is either tapped or inductively (link) coupled. These circuits may or may not use a supplementary loading inductor. Second, a pi-network output circuit using either single or double output sections. A single channel of a typical Apelco final amplifier and output circuit is shown in Fig. 2.

The output circuits in marine radiotelephone equipment are also called upon to provide a high degree of rejection to second- and higher-order harmonics to comply with current and proposed FCC regulations. In this regard, high-C circuits with direct, low-impedance harmonic paths to ground or harmonic traps are often used. Harmonics may be reduced further by bias and drive adjustments which provide class-C operation and r.f. plate current flow over approximately 120° of the input signal. Special circuits similar to pi-L combinations are used in some equipment. These circuits provide more than the required amount of harmonic rejection, are uncritical and insure output impedance matching to all conventional marine antenna types.

As mentioned, all equipment of the type discussed is pretuned, the initial

tuning being done at the time of installation by a duly FCC-licensed marine service technician. Each channel is individually set up for resonance and for proper loading with the common antenna. Amplifier resonance is obtained through taps which change the inductance by adjustments of individual variable capacitors which are switched in parallel with a fixed value of inductance for each channel. Actual tune-up is not normally a difficult process, particularly when a center-loaded vertical antenna is used.

The technician requires equipment for measuring frequency and modulation and a means of checking harmonic suppression. He also requires an accurate test instrument for indicating all d.c. currents and voltages. The cover photograph shows the technician and his winsome assistant using a multimeter manufactured by Phaostron.

Amplifier loading is indicated both by d.c. plate current rise and by maximum r.f. current in the antenna. Most higher-power transmitters have a d.c. milliammeter on the front panel. Some equipment has a flashlight bulb in shunt with the antenna circuit wiring to indicate antenna current and modulation. Panel r.f. ammeters are rarely used in present-day equipment inasmuch as over the frequency ranges in use the indications are nonuniform.

Modulation systems have not been discussed since for the most part they are entirely conventional, using high-level plate modulation. Carbon microphones are generally used because of their ruggedness and freedom from adverse affects of humidity.

Almost all marine radiotelephones use full press-to-talk control. Depressing a button on the microphone housing actuates relays which apply transmitter B power to r.f. and a.f. circuits, switch common antenna from receive to transmit and mute the receiver.

The receivers, part of most marine radiotelephones, will not be discussed here since with a few notable exceptions they are conventional. An interesting and functional feature in the H-160 is the "signal-gate" circuit which mutes background noise in the absence of incoming signals. For the benefit of those who might find it useful in their mobile receivers, this circuit is shown in Fig. 3.

Space limitations in the average boat make it essential to minimize all equipment dimensions. This can be seen in the photos which show the vertical chassis type of construction used in the H-160. The chassis and housing are arranged for bulkhead mounting. Maximum accessibility is assured since the outer housing can be removed without disturbing the main control subpanel which remains attached to the chassis. The technician's job is further simplified by a removable side panel which permits touchup of tuned circuits after the cabinet is in its final position. END

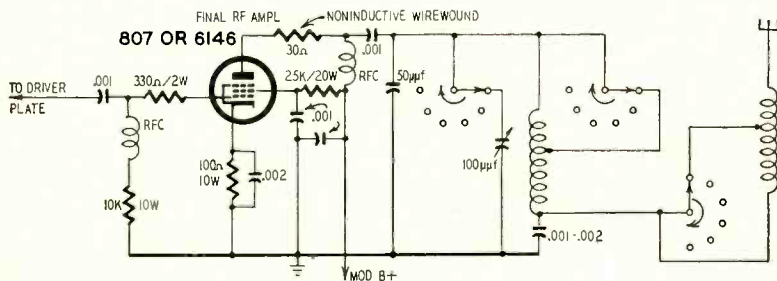

Fig. 2—Schematic of Apelco final amplifier and antenna coupling circuit.

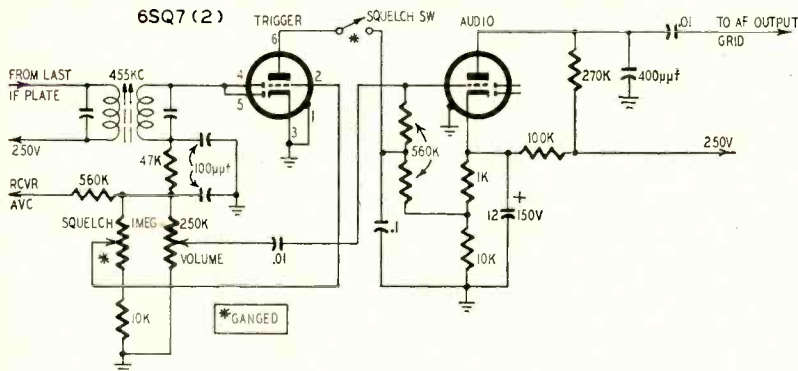
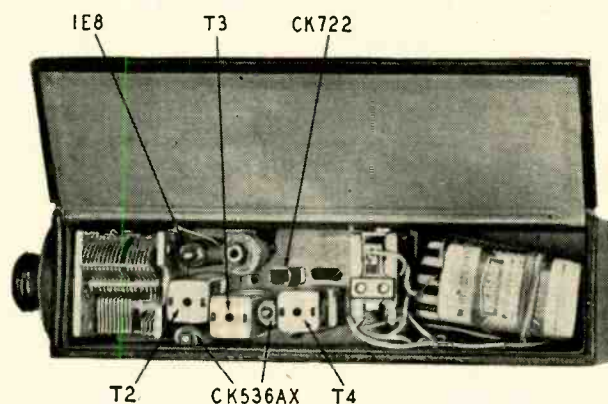

Fig. 3—Schematic of the "signal-gate" squelch circuit in the Apelco H-160.

# DX TINY TUNER

By I. QUEEN  
EDITORIAL ASSOCIATE

*Miniaturized unit  
is designed for  
long-distance  
reception*



Top view of the  
miniaturized receiver.

A HOME MADE portable radio is not ordinarily very sensitive or selective. If it can receive all the locals without an external antenna, and if it picks up distance under favorable conditions, that is about all we can ask. If you want still more, try this broadcast tuner (see photo). It uses three tubes and one transistor and is designed especially for long-distance reception or use where reception is difficult. Stripped of all nonessentials like a.v.c. and volume control, it is self-contained with its own antenna and power supply.

The tuner is so simple that little description is needed. It is important, however, to point out that it contains subminiaturized parts only recently available to experimenters. Everything has been built into a leather box  $2\frac{3}{8} \times 1\frac{7}{8} \times 7\frac{1}{4}$  inches. Only headphones or an earpiece is needed externally.

This set has undergone many tests alongside two other radios—one, an all-transistor set (using an earpiece); the other, an expensive commercial receiver tuned to the broadcast band and using headphones. Here are some typical results.

The tiny tuner picks up, with satisfactory volume, stations in Bridgeport (600 kc), Philadelphia (610 kc) and

Newark (620 kc). These are received *any time of day or night* (in a New York City suburb) and without interference between them. The transistor set picks up the 600-kc station weakly and only with a background of the 620-kc station. It fails to receive the 610-kc signal at all.

The tuner will pick up any station heard on the commercial set that is S2 or better. Any signal whose strength is S5 or better comes in on the tuner very satisfactorily. The big set uses a 30-foot outdoor antenna while the tuner depends only on a ferrite-rod antenna coil! In any normal position, the dx set should pick up 35 or more stations very well and many more should be audible.

Many tiny parts are used. Coil L1 is a Keith *Superloop*; T1 is a J. W. Miller oscillator coil 70-OSC. These are tuned by a dual capacitor made by Radio Condenser Co. It uses cut plates and is designed for 455-kc i.f.'s. Its largest dimension is only  $1\frac{3}{8}$  inches!

The i.f. transformers are Miller K-Tran types (T2, T3 are type 10-C1; T4 is type 10-C2). These are only  $1\frac{1}{2}$  inches high,  $\frac{1}{2}$  inch square. Note the direct-coupled transistor audio stage which brings up the volume for satisfactory earpiece level. Plugging in

the phones switches on the set's tuner.

Potentiometer R1 is used to reduce the A battery voltage to 1.25 or less for the tubes. If you have a partly used cell whose voltage is low, you don't need this dropping resistor. A cell too old for flashlight service will be suitable here. R2 protects the tube filaments against errors in wiring or shorts. Both batteries should last about 100 hours or more.

#### Parts list for tiny tuner

1—1,000-ohm resistor; 1—82,000-ohm resistor; 1—20-ohm potentiometer; 1—47- $\mu$ f capacitor; 1—2- $\mu$ f filter capacitor, 25 volts; 1—IE8 and socket; 2—CK536AX's and sockets; 1—CK722 and socket; 1—1N34 diode; 1—1.5-volt cell (size D); 1—22.5-volt battery, size U; 1-coil L1 (Keith Superloop or equivalent); 1-oscillator coil T1 (J. W. Miller 70-OSC or equivalent); 2-input transformers, T2, T3 455 kc (Miller 10-C1 or equivalent); 1-output transformer T4, 455 kc (Miller 10-C2 or equivalent); 1-dual capacitor, variable, cut plates for 455-kc i.f. (Radio Condenser Co.); 1-jack for earpiece; 1-chassis.

One surprising thing is the use of Raytheon type CK536AX tubes in the i.f. stages. These are audio tubes but were found to perform excellently at the 455-kc i.f. All three tubes will operate with a total of 0.5-ma input at 10 volts on the plates.

Some portables have to be oriented for sufficient pickup from a broadcaster. This one may have to be oriented to prevent overloading on powerful locals. Another way to prevent overload is to reduce filament power with R1. Filament current can be made as low as 50 ma total for local reception.

A 1-volt d.c. meter may be connected across the headphones for aligning the set. Average stations will show about 0.5 volt. Very strong nearby stations will show 1 volt or even more.

If you are a dx hound you will get lots of fun from this tiny tuner. It can be carried about in a pocket. The entire unit weighs less than 1 pound. END

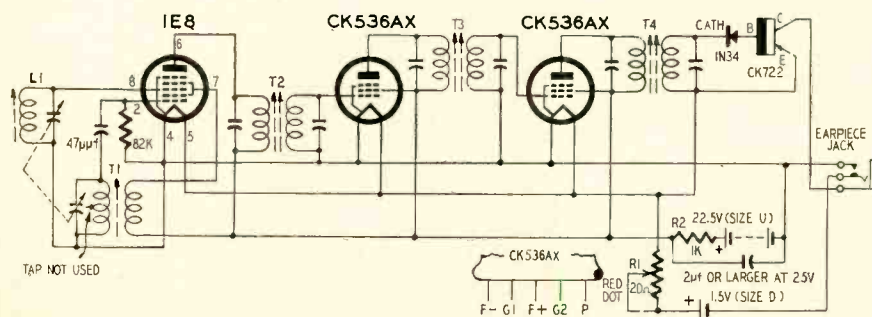

Schematic of the tiny tuner. Unit contains three tubes and one transistor.

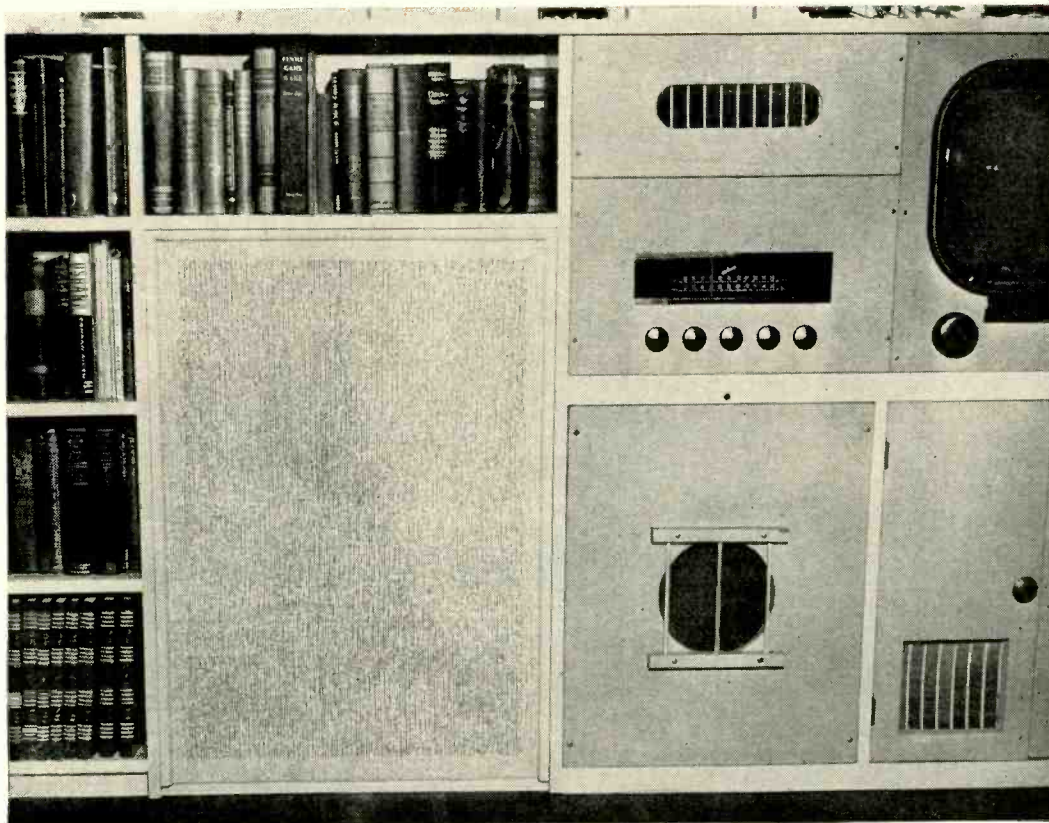

Karlson enclosure installed in wall of room, with grille cloth over ports.

# Constructing a KARLSON ENCLOSURE

*Dimensions and details  
on the layout of this  
popular loudspeaker housing*

By DON V. R. DRENNER

It has always seemed to me that the complexities of most modern speaker housings are intriguing puzzles suitable for an engineer to fathom. To construct one that would sound as the designer intended, or claimed, would require an equally complex array of power tools and an ability to visualize abstract drawings. So, for these and downright contrary reasons, I have been well satisfied with a simple enclosed box—lined with quilting cotton—to house my Western Electric 728-B 12-inch speaker. (I'm still satisfied with that, and no praise of tweeters and crossover networks will sway me.)

But Monitor, writing in the January, 1955, issue of RADIO-ELECTRONICS, offered some praise for an enclosure invented by John E. Karlson and gave a refreshing account of his experiences.

"A novel and successful one is the Karlson which . . . claims and (to cut the suspense) can in fact deliver a response down to 16 cycles . . ."

If Monitor was correct, the Karlson seemed to be what I had always wanted—good, smooth bass without 50 watts to make it audible.

I unearthed a copy of a magazine containing Karlson's own exposition of his system, some nice design considerations and drawings. Constructing one didn't appear too difficult, and the overall size wouldn't require rebuilding the house. (This is not funny: I rebuilt my living room once to accommodate a speaker housing. And a 30-foot horn would in most cases require a complete new house.) Sadly lacking, however, in Mr. Karlson's explanation was a complete and definite series of "how to" steps. More important, not all dimensions were given. This is understandable, since the Karlson is a commercial product and completed units and kits<sup>1</sup>

<sup>1</sup>Full-scale plans for complete kits are available from John E. Karlson, 423 Bedell Terrace, West Hempstead, N. Y.

are for sale. You can buy one, too, if you prefer, but I like to build my amplifiers and speaker housings—the speaker too, if I could!

To see what the thing would look like on paper, full-scale drawings were made using the dimensions given in Karlson's article. Thus it was possible actually to measure the dimensions for fitting the inside pieces and to measure the angles and placement. A sheet of Kraft wrapping paper was used to make the drawings. These full-size templates make for higher accuracy.

Karlson emphasizes that the sizes of many parts are critical, but my experience indicates that an allowable 1/8-inch leeway in cutting—just so the same error is made on all parts—doesn't affect the performance. Similarly, the placement of the pads (in this case Fiberglas 1 inch thick) was generally followed as Karlson recommends but the pads were thickened to 2 inches by gluing and extended to the side walls

of the enclosure. This, in effect, completely filled the spaces surrounded by the reinforcing 1 x 2 pieces.

**Cutting the pieces**

The general dimensions can be taken from the drawings shown in Figs. 1, 2, 3 and 4, but I would make a full-scale drawing as outlined above before cutting any of the pieces. This is especially true if other than a full 4 x 8-foot sheet of 3/4-inch plywood is used, as many possible combinations of cuts might be worked out to save time and lumber. The layout of cuts from a full sheet of plywood is shown (Fig. 1).

In cutting the various pieces, don't try to sand or plane smooth the saw corrugations: they provide a better gluing surface. And, except for those outside surfaces—such as the side edges—no sanding should be done until the assembling is started.

As shown in Fig. 1 all the pieces except the shelf and the 1 x 2-inch stiffeners can be cut from a 4 x 8-foot 3/4-inch plywood panel. First, carefully measure and mark SIDE A. The finished measurements will be 33 inches long and 18 inches wide. Next, cut SIDE B exactly the same size. Finish off the end of the panel by cutting FRONT B. Mark the pieces so you won't get confused.

Now measure, mark and cut the two 21 x 18-inch TOP and BOTTOM pieces.

Then cut FRONT A. The two front pieces can be laid aside, as working them into the tapered aperture will come after the cabinet has been completed.

The next cut should be the BACK, exactly 22 1/2 x 33 inches. The piece for the TOP ANGLE can be cut at the same time. Then, cut the SPEAKER BOARD, making the 21-inch cut exact. Don't worry about the 26 1/2-inch length as this will later be mitered to form a 60° angle. The remaining cuts are the two 8 1/4 x 11 1/2-inch port pieces—these should be exact.

The piece for the shelf, 21 x 9 3/4 inches, will have to come from an extra board. It could have been cut out of the 4 x 8-foot sheet by pruning the front pieces, but this would make for several staggered cuts and be more difficult.

Having made all the cuts, take SIDE A, SIDE B, TOP, BOTTOM and SPEAKER BOARD and clamp them together the 18-inch way—the speaker board the 21-inch way—so you can lightly sand one edge of all the pieces. The sanded edges of the sides, top and bottom will be at the front of the cabinet. The sanded edge of the speaker board will be the first edge to be mounted against one side.

The next two pieces to be worked should be cut on a power saw for accuracy. These are the TOP ANGLE and the SPEAKER BOARD. First, the top angle piece (which is about 9 inches wide by 21 inches long) should be mitered the

long way 45°. Then, exactly 6 11/16 inches from the top lip of this cut, miter again 45°. The finished piece will now be 21 inches long and 6 11/16 inches wide on one side. (See Fig. 3.) The speaker board piece should be exactly 21 inches wide and 20 1/4 inches across one face. The bottom miter (where it

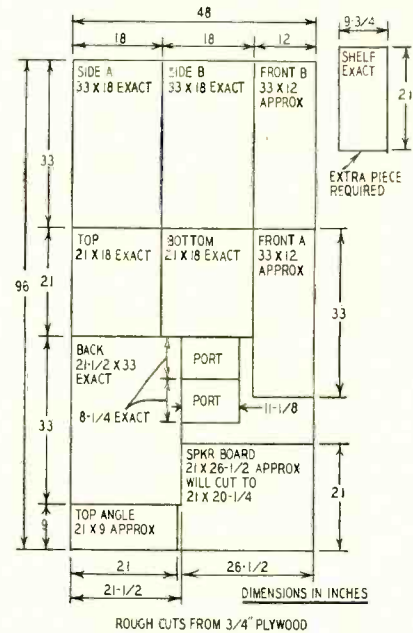
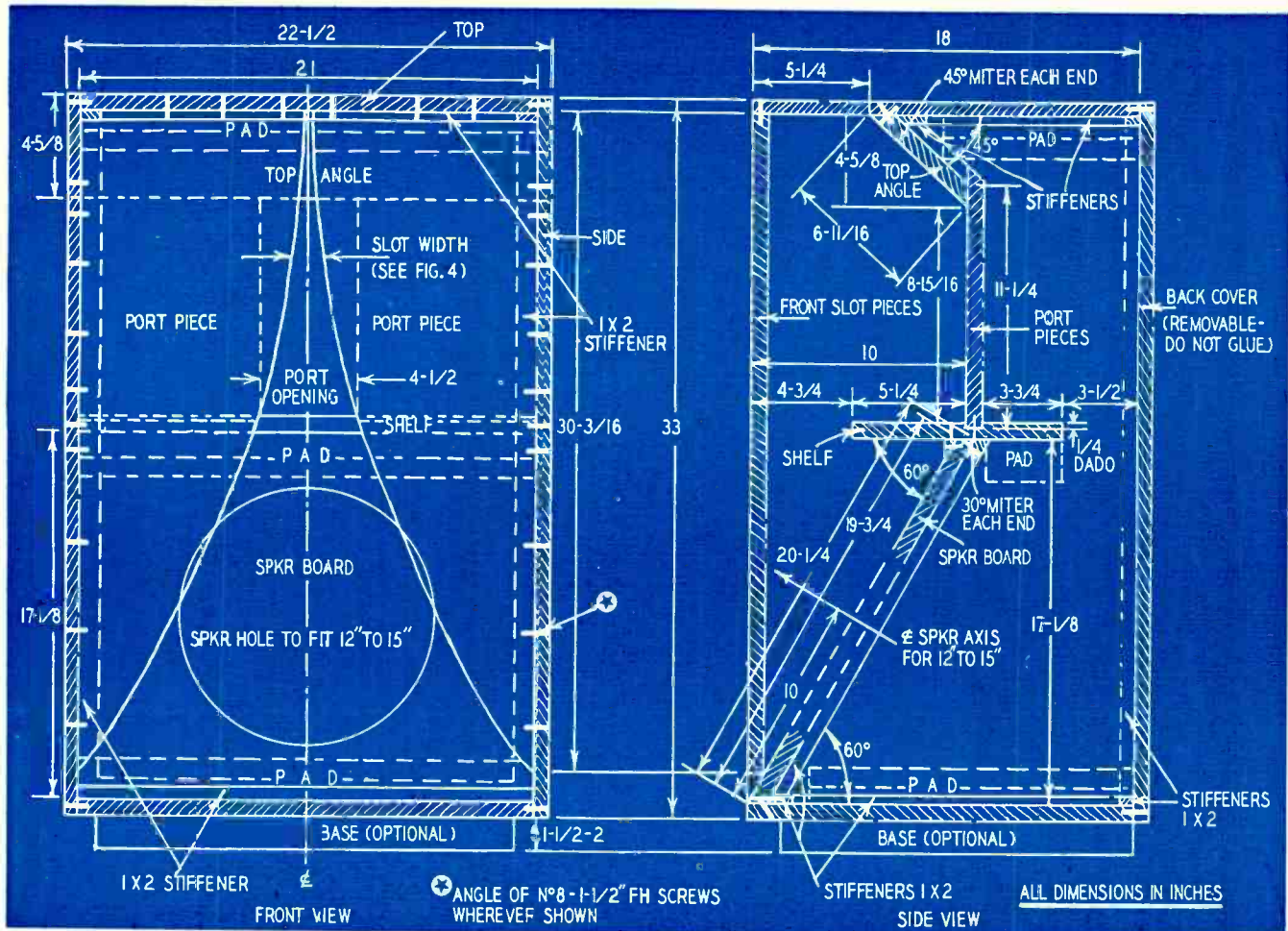
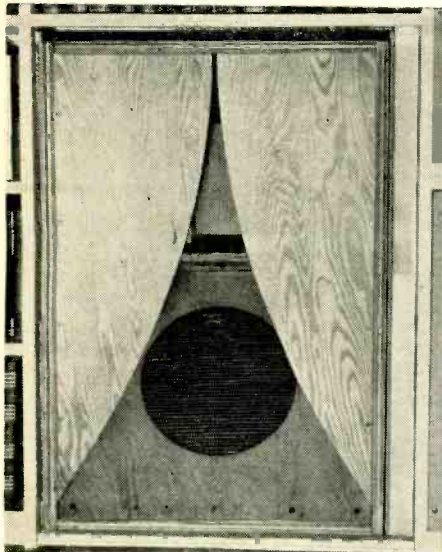

Fig. 1—Plywood panel layout—supplies all pieces except shelf and stiffeners.



Figs. 2, 3—These front and side views of the Karlson enclosure show various dimensions and the miter directions.



Front view of unit with grille cloth removed.

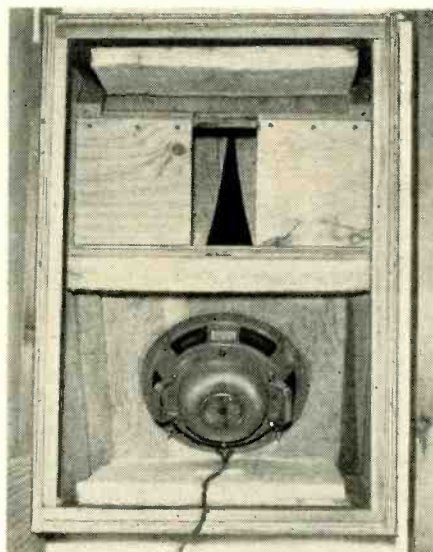

Rear view shows the construction details.

fits against the bottom of the cabinet) is 30°—this will give it an incline of 60°. Make this cut on a power saw. Then measure exactly the 20 1/4 inches across the face and make another 30° miter. Refer to Fig. 3 for the direction of the miters. If you are in doubt about making these two miter cuts, have them done at a cabinet shop rather than ruin the boards.

The shelf piece, cut exactly 21 x 9 3/4 inches, has a 1/4-inch deep dado to receive the two PORT pieces. You can do this with a handsaw or a wood chisel or have the cabinet shop do it for you. Fig. 3 gives the location of the dado (5 1/4 inches from the front).

The hole in the speaker board (Fig. 2) for the speaker should now be cut. The diameter will depend upon whether you have a 12- or 15-inch speaker or whether you have a 12-inch and want, later, to install a 15-inch. If you think you'll ever install a 15-inch speaker (or have one now), cut the hole for the larger size and use a conversion board for the smaller (present) size. Otherwise it will be extremely difficult to enlarge the hole once the cabinet is assembled. In my own case, for the Western Electric 728-B speaker which I love and cherish, the hole is 10 15/16 inches in diameter.

**Assembling the pieces**

Nail lightly *one* side to the TOP and BOTTOM. Tack a piece of 1 x 2 across the open side to steady the pieces. Now fit the speaker board in position against the side and scribe with a pencil on both sides and at the top where it meets the shelf. This will serve as a guide when the gluing process begins.

Assemble the SHELF and the two PORT pieces. The 1/4-inch dado is swabbed with glue and the port pieces fitted flush with each end (leaving the port opening in the center) and nailed lightly. Then about six No. 8 flat-head, 1 1/2-inch screws are driven through the bottom of the shelf into the port pieces.

This will give you a rigid piece which now may be inserted above the speaker board (see Fig. 3) and, once in exact position, scribed for future fastening to the sides.

The TOP ANGLE should now be inserted and tested for fit. Some slight variations can be expected due to the wood and sawing. If the fit is not perfect against the top and port pieces, some slight sanding or planing may help. But the additional 1 x 2 braces (added later) and the glue and screws will hold it solid even if the miter isn't perfect.

At this stage you should have one side, the top and bottom and the internal structure positioned exactly as in Fig. 3, but no nails or glue applied except to the shelf and port pieces.

Having carefully marked the position of the parts which make up the internal structure, remove all of them and take apart the side, top and bottom.

In the center of the scribed lines where the speaker board, shelf, the edge of one port piece and the top angle fit against one side, drill a series of small holes (about 1/16 inch) through the side. These will serve as guides for drilling from the opposite side (the outside) larger holes to take the No. 8 flat-head screws. Use six screws for the speaker board side, four for the shelf, four for the port side, and three for the top angle. Countersink the larger holes so that the flat-head screws will drive flush with the surface of the plywood.

Now, glue and finish-nail the BOTTOM piece to SIDE A. Drill and insert six to eight screws along the edge to hold the bottom firmly against the side. Repeat the same with the TOP piece. Nail a 1 x 2 as a brace across the open side.

Before gluing the SPEAKER BOARD against SIDE A, attach a 1 x 2-inch strip completely around the inside face of the speaker board, using glue and screws. The bottom piece of 1 x 2 will project beyond the 30° miter: it should be planed flush with the board.

Now, glue the bottom and side of the

speaker board, and attach it to the bottom and side pieces. Note that the leading edge of the speaker board is exactly flush with the edge of the bottom piece at the front of the cabinet.

Next glue and screw the shelf and port assembly into place, being sure that the bottom of the shelf—where it meets the speaker board—is coated with glue. After you have attached the shelf firmly to the side, drill a series of holes at an angle through the back of the speaker board into the shelf and draw the speaker board snugly up to meet it. Notice that a small wedge-shaped brace is inserted under the shelf, against the speaker board at the front. This is one of the pieces cut from the end of the speaker board when it was mitered and is an additional stiffening measure.

Before attaching the TOP ANGLE piece, glue and screw 1 x 2-inch stiffeners along the back edges. The ends of the stiffeners should be cut or planed to conform to the 45° miter and to fit against the surface of the port pieces which project up back of the top angle piece. Once the 1 x 2 pieces are attached and the whole thing fits, glue and attach the TOP ANGLE piece.

You should now have SIDE A, the top, bottom and all the internal structure securely glued and attached with screws. If your miter cuts were accurate and all pieces square, the cabinet should be ready to glue and attach SIDE B. However, in my own case, some slight errors occurred, and to correct them is a matter of sanding and planing the outer edges of the internal structure so everything is flush to receive SIDE B. When this is ready, coat all the edges of the top, bottom, speaker board, etc., with glue and place SIDE B in position. Nail at several points with finishing nails before marking and boring the screw holes. Then drive all screws home.

The inside of the cabinet should be stiffened with 1 x 2-inch strips, glued

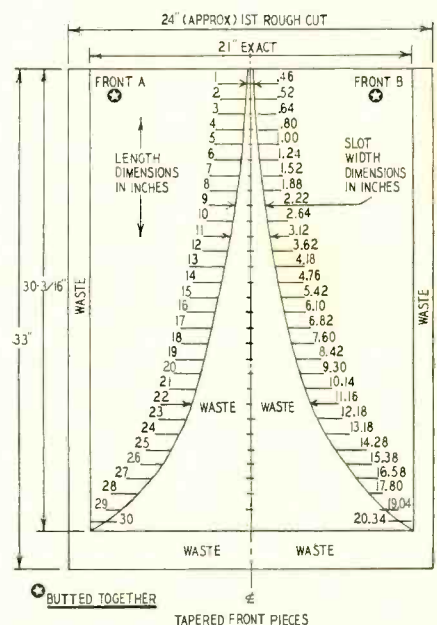

Fig. 4—Dimensions for laying out the curve of the tapered front pieces.



# Variable-Height Fidelity

By VLADIMIR PENN

and screwed in the position shown in Fig. 3.

The back should be temporarily fitted, marked for screw holes, and the holes drilled and countersunk. Be sure to put screws, not only into the edge of the plywood sides, but also into the 1 x 2 stiffeners. This will give you a "staggered" effect on the back where the screws hold and will increase the rigidity.

Before marking and cutting the two front tapered pieces, measure carefully the inside width of the cabinet. It should be exactly 21 inches. If it isn't, don't worry. Whatever the measurement is, use this to lay out the two front pieces. Fig. 4 gives the dimensions for laying out the curve of the pieces. Use a carpenter's square for this as you'll need the tenths scale. When you have the curve drawn—the two pieces will have been butted together—turn them so that the front of each piece is facing out (back to back) and nail together for sawing. This way, one cut will make both pieces exactly the same. I recommend having the curve cut on a band-saw.

The inside of the front chamber and the inside faces of the tapered pieces are given six coats of shellac.

The pads I used are made of 1-inch thick Fiberglas cut to fit in the spaces shown in Fig. 3. I glued them in with linoleum cement and put two layers to make a 2-inch thick pad.

## Materials for Karlson enclosure

1—sheet, 4 x 8 feet, 3/4-inch plywood; 1—piece, 21 x 9 1/2 inches, 3/4-inch plywood; 1—12-foot length of 1 x 2-inch white pine; 1—quart can cold-mix resin glue (Weldwood); 1—pint white shellac; 1—lot of sandpaper; 1—1/2 pound 8-penny finishing nails; 6—dozen No. 8 1/2-inch flat-head wood screws; 4—dozen No. 8 1/4-inch flat-head wood screws; 1—1/2 dozen No. 8 2-inch flat-head wood screws; 1—piece Fiberglas insulation for pads.

After the speaker is mounted, the back can be screwed on and the two front tapered pieces mounted. I did not glue the front tapers, but instead used 2-inch screws along the top and down the sides to hold them. They are rigid with this treatment and no vibration or rattle is heard.

You will now have a heavy, solid cabinet, one that shows traces of dirt, glue, nail heads, screw heads, etc. Not a pretty thing for the living room. I solved this by covering the front with a very porous grille cloth and mounting the cabinet flush in the wall (the rear projects into the attached garage). If you haven't a wall to tear into, I suggest covering the sides, top and back with veneer or, more cheaply, with some suitable cloth or upholstery material to conform to your wife's disposition.

About that: I have a friend who is blind and gifted, not with only acute hearing, but perfect pitch and the ability to "see" color when he hears music. His opinion after a session with the Karlson I constructed (using the Western Electric 728-B speaker) was that he had never heard such absolute fundamental bass response and such "ringing" highs. I agree. END

BY now, the world of music lovers, technicians and their long-suffering friends is well aware of high fidelity.<sup>1</sup> But, to paraphrase the ancient query, exactly how far up is high? To study the problem in a precise and scientific manner, it becomes necessary to establish a system of measurement. It is proposed in this paper to use an arbitrary unit of fidelity which shall be called the *fid*. However, as this unit is too large to be handled in practical calculations, a subdivision called the *decifid*<sup>2</sup> shall be used.

Many articles on how to choose the components of a so-called high-fidelity system are available in the literature.<sup>3</sup> These components can be bought separately and installed in the music lover's home.<sup>4</sup> The problem generally resolves itself into two parts: first, a limit as to the cost of the system must be decided upon. Second, the choice of the components must be made within the limits of this price.<sup>5</sup> Even if the solution to the second part of this problem is left in the capable hands of a helpful salesman,<sup>6</sup> the decision concerning the first part is left in the hands—or at least in the pocketbook—of the eager purchaser.

So far, it has not been established just exactly what the height of the high-fidelity system is to be.<sup>7</sup> For this reason,<sup>8</sup> it is proposed to set up the aforementioned system of fidelity measurement and further to correlate a system's fidelity with its cost.

To facilitate the thinking,<sup>9</sup> we shall consider four broad ranges of fidelity called: "low fidelity," "medium fidelity," "high fidelity" and "very high fidelity indeed."<sup>10</sup> At this point, the quotation marks can be dropped from the discussion since the terms have been defined.<sup>11</sup> This system of fidelity ranges should be of great value to the apparently confused manufacturers of table-model radios and radio-phonographs who advertise high-fidelity equipment.<sup>12</sup>

It becomes necessary at this point to set up a scale for our proposed decifid meter. This presents a bit of a problem, engineering-wise, since it has not yet been shown that decifids bear any simple relation to measurable units such as volts, amperes, etc., but we can try. If we select a panel of judges composed of

music lovers, technicians and laymen<sup>13</sup> in equal numbers and let them vote a mark from 0 to 100 for the fidelity of a system, the average would then be the official fidelity of the system. The broad fidelity ranges mentioned above could be assigned numerical values—low fidelity might correspond to a rating of 0 to 25, medium fidelity to a rating of 25 to 50 and so on.

This method could be used until sufficient research and development<sup>14</sup> has led to a transistorized device to replace all the aforementioned good people.

Having now developed a method of accurately determining the fidelity of a sound system, it remains to make an analysis of the variation of fidelity vs. cost. The simplest<sup>15</sup> way to do this would be to buy every piece of sound-reproduction equipment, measure its fidelity in decifids and plot this value against cost. This process could be repeated every year to account for the new products offered for sale. The project could then be directly affiliated with the government, perhaps under a new secretariat called the Office of the Secretary of Fidelity or perhaps the Fidelity Commission.<sup>16</sup>

At this point, when a system can be rated as to its exact fidelity, the prospective buyer of a "fidelity system"<sup>17</sup> should have no trouble in reaching a decision. As an intelligent consumer, he can ascertain the fidelity of the system, consider which brand has the most appealing advertisements, take into consideration the amount of chromium plating on the device, ask his friends' advice and make a choice.<sup>18</sup>

If, however, the primary concern is listening to music, a season ticket to the Boston Symphony<sup>19</sup> is highly recommended. END

<sup>13</sup>Laymen being defined as all members of the people class not included in the first two classes.

<sup>14</sup>Preferably government-sponsored.

<sup>15</sup>Although the most expensive.

<sup>16</sup>Not to be confused with the Loyalty Program.

<sup>17</sup>The new generic term for: "Sound Reproduction System", which can be preceded by the proper modifier such as: low, medium, etc.

<sup>18</sup>Better consult the wife, too: she may have a few words on the subject.

<sup>19</sup>Or similar organization in other cities.

<sup>1</sup>The term is interchangeable with hi fi.

<sup>2</sup>This subdivision is equal to 1/10 fid.

<sup>3</sup>The best way to avoid giving references.

<sup>4</sup>Generally over his wife's dead body, unless the works are encased in a cabinet.

<sup>5</sup>In theory only. In practice, the original cost limit has been altered, generally in the up or more expensive direction.

<sup>6</sup>Refer to footnote 5.

<sup>7</sup>Some high-fidelity systems have higher fidelity than others.

<sup>8</sup>See footnote 7.

<sup>9</sup>If this phrase insults your intelligence, disregard it!

<sup>10</sup>Respectively abbreviated: "lo fi", "med fi", "hi fi" and "v.h.f.i."

<sup>11</sup>Not really, but maybe nobody will notice.

<sup>12</sup>Meaning lo fi or possibly med fi.



"Just call Joe's TV Service if your set acts up again!"

# ACQUIRING A HI-FI AMPLIFIER

By ERIC LESLIE

*Solving the problem of the man who needs the basic component of an audio system*

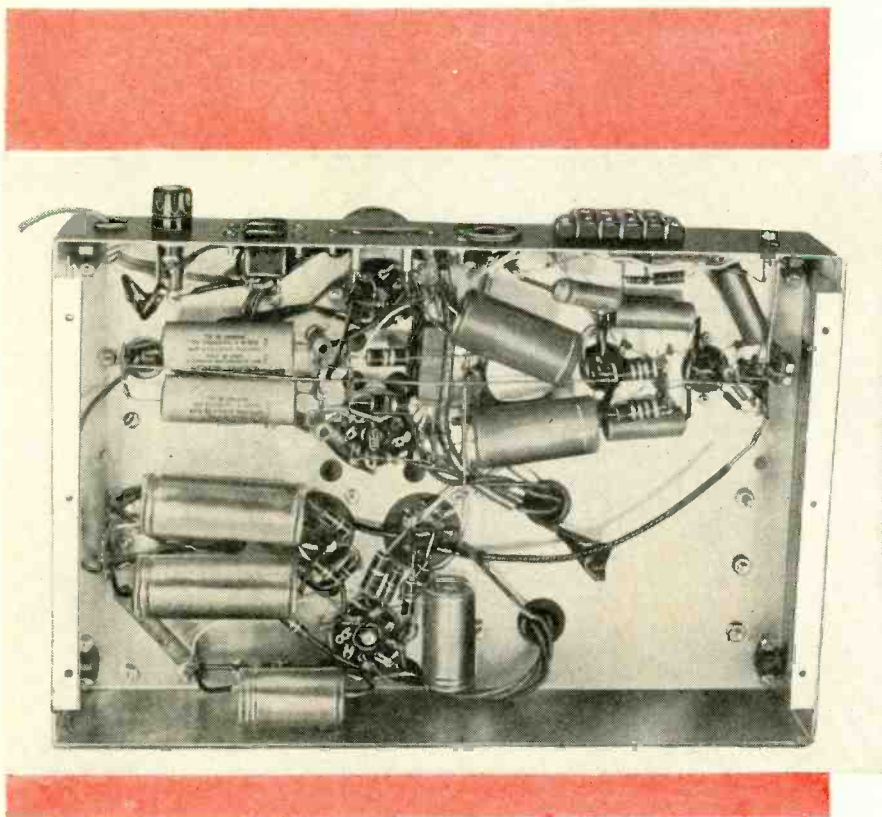

Chassis wiring is uncluttered.

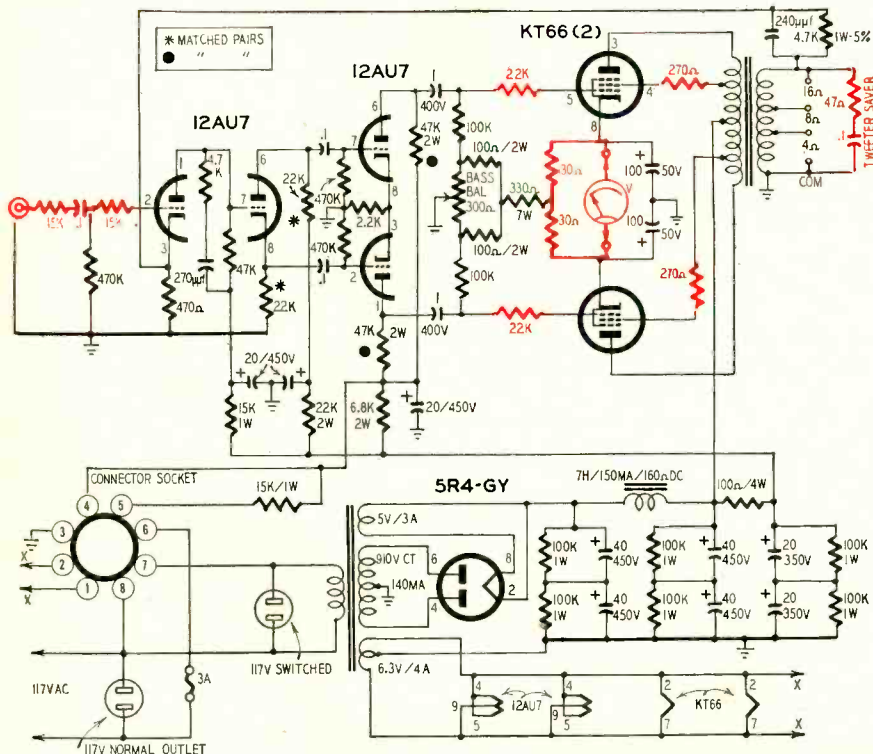

Fig. 1—Schematic of the Heathkit amplifier. Interesting features are in red.

**T**O buy or to build—that is the question more than one high-fidelity enthusiast is now asking himself. In the past it was considered almost necessary to build one's own audio equipment if one were to have the latest and best circuitry. It has also been considered possible to build a better piece of equipment than could be bought for the same money.

Today the best of audio results can be obtained from amplifiers on the market—some of them at very decent prices. On the other hand, it is possible to approximate the results of the best ready-made equipment with complete kits which are often obtainable for about the same price the parts would cost. The main problem becomes one of time against money. Is it cheaper for a given individual to build his own equipment or to buy it? And just how much time does it take to build?

I needed a new amplifier and decided to find out some of the angles. I was using an excellent job—said to have been built by Collins for his personal use before he started making high-fidelity equipment commercially. With Western Electric 310's in the output, it had "triode quality." But the main amplifier, preamplifier and equalization circuits were all combined in the same

unit. And more often than occasionally I wanted to test a single component or part of a system, a job that called for a perfectly linear main amplifier.

The very completeness of the pre-Collins was against it. With its built-in high and low boosts, its voltage and power amplifier (plus the power supply) all in one unit, it was difficult to pin down any particular effect or even to tell if it came from within or without the amplifier proper. What was needed was an amplifier which could be depended on to be absolutely flat, would be used with separate preamplification and equalization and would deliver as much power as might be needed with negligible distortion.

Since you can't figure out the differences between building and buying an amplifier by purchasing one, it was decided to construct one. Parts for an oversize power supply were obtained from various surplus houses, and magazines, friends and the inner mind consulted as to the design of the new amplifier. Should it have a Williamson or Hafler-Keroes type front end? Or is there anything wrong with straight resistance-capacitance coupling? What inversion system? Output tubes? Ultra-linear? Feedback system?

#### The ultimate amplifier?

Midway in these deliberations came the 1955 IRE convention and a little work, the *Heathkit Reference Booklet*. It described the latest Heathkit amplifier, the W-5M, just being put on the market. The amplifier was on exhibition at the Heath booth and—according to its designer, who was in attendance—was the ultimate; not only the most, but the nearest (to exact reproduction of the signal). The graphs in the booklet indicated that at 1 watt it was flat from roughly 10 cycles to 100 kc and only slightly less than that at 10 watts output (its rated power output is 25 watts).

Distortion figures were not so clear, because expressed in several charts, but harmonic distortion appeared to be practically imperceptible within the range of hearing at powers lower than about 15 watts, and IM distortion below the "extremely high-fidelity" level at the same power.

This seemed to be the "main amplifier" for which I was looking, especially since a preamplifier adapted to working with it was also available. The main amplifier alone, or amplifier and preamplifier together, would be useful standards of comparison for other equipment. The parts I had obtained for my ideal amplifier were carefully placed in the junkbox and the main amplifier and preamp were ordered. Both kits were obtained (with a slight delivery delay since the W-5M was just reaching the market) and wiring the main amplifier commenced.

A carefully kept log indicated that it took me almost exactly 18 hours to wire the amplifier. The wiring was done in short spurts—in no less than 12



Amplifier without its cover. Output transformer is at left—power at rear right.



The Flewelling air coupler from below. From above it looks like a hot-air register.

sittings—so the time was probably considerably longer than if I had been able to get in two or three 4-hour sessions. The time also included short breaks for such things as answering the phone or doorbell.

#### Intriguing features

When I put my first Heathkit (a v.t.v.m.) together, I reasoned that an old radioman would be further ahead following the schematic rather than the childish step-by-step instructions. I learned my lesson then, and this time followed the instructions literally, without looking at the schematic, so I didn't know what role many of the components played till I checked the hookup. After the wiring was finished one of the results was that the amplifier (unlike

the voltmeter) worked immediately it was plugged in. Another was that a number of things that had been accepted without question at the first pre-purchasing glance at the schematic now looked puzzling and intriguing.

For one thing, the input looked unique, with a network whose purpose was not readily apparent. Note the two 15,000-ohm resistors (Fig. 1). The output tubes had rather high-value parasitic suppressor resistors on both screen and grid. The "tweeter-saver," though it obviously put a load across the output at high frequencies, still was not too clear. Why isn't it equally necessary to put a load across the output at low frequencies? The little 240- $\mu$ f capacitor across the feedback resistor was also a little puzzling.

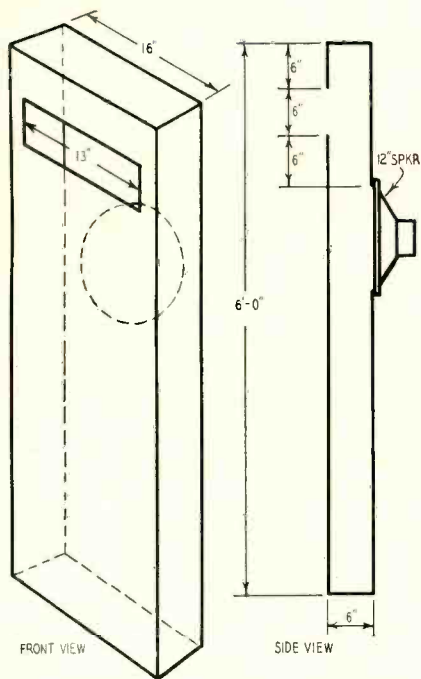

Fig. 2—The air coupler. Dimensions are Flewelling's; my own variation measured 14 x 9½ inches x 7 feet.

Obviously it is intended to feed back more energy at high frequencies than at low, but 240 μf seems small even in the high end of the audio spectrum. A letter to Heath brought back some answers:

The tweeter-saver—that 47-ohm resistor in series with an 0.1-μf capacitor across the 16-ohm output secondary—imposes a load at high frequencies precisely because that's where it's needed. Most crossover networks or speakers have an impedance characteristic that rises with frequency. In some cases the impedance can become so high—usually at frequencies *above* the audio range—that the amplifier sees no load and “takes off.” The tweeter-saver is a very high impedance in the audio range—the 0.1-μf capacitor has a reactance of 1,600 ohms at 1,000 cycles—but at 40,000 cycles its reactance is about the same as that of the resistor, and at the high frequencies where phase relations make the feedback positive the resistor is practically the whole load. Thus oscillation is prevented.

The rather complex input network was developed, I was told, so that the amplifier would not be affected by the source impedance of the unit feeding into it. Two 15,000-ohm resistors are used: one as an impedance raising device, the other as a damping resistor to suppress parasitic oscillation. The total result is that the amplifier looks into a high input impedance at all times, which eliminates feedback instability dangers.

The suppressor values used were recommended by the manufacturer and were chosen about midway of the range specified for the KT's. Explanation of the little capacitor across the feedback resistor was equally simple—it adds

extra high-frequency stability and damps out ringing on high-frequency pulse signals.

Another point the boys at Heathkit were so proud of that they mentioned it in their reply (though I had not asked) is the “bass balance” (BASS BAL) circuit. Many amplifiers provide means for balancing the output tubes, as unbalance is highly productive of distortion, especially on the lower frequencies. In the W-5M a meter is connected across the hot ends of two 30-ohm resistors branched from the common cathode resistor. If both tubes draw the same current, a voltmeter connected between the two points shows no reading. The beauty of this circuit is that the meter need not be accurate—all it has to do is register a null. If the tubes are not balanced, the current they draw is adjusted by varying their grid bias with a 300-ohm potentiometer in the common grid-cathode circuit (see Fig. 1). They also pointed out that a lot of inductance and capacitance is used in the power supply to reduce low-frequency intermodulation effects. The filter is truly phenomenal—if the amplifier is turned off with the turntable still running, it plays for a full half-minute on the electricity stored in the filter capacitors before dropping below audibility.

The rest of the system

Once wired and checked, the W-5M was inserted—without benefit of pre-amp—between available equipment and the speaker system. Fortunately the TV set's output—taken off before the volume control—and that of the little G-E type phone preamplifier were about right. We couldn't turn volume up or down, but in the main the level was well within tolerable limits. Quality had a slight edge on the supposedly superlative pre-Collins, even without any frequency compensation controls. Construction on the preamplifier was hurried—it's nice to be able to adjust the volume and the bass.

The speaker system consists of a 12-inch Jensen, installed in a Flewelling air coupler built under the floor, and a tweeter made from a small cone speaker from a piece of surplus equipment—probably sonar. The Flewelling coupler is a simple way of getting a good enclosure cheaply—if you can cut a hole in the floor and install a hot-air register. Details are shown in Fig. 2. The crossover network was also constructed with the aid of surplus—some small iron-core coils with an inductance of about 1.75 mh each and a number of a.c. electrolytic capacitors in the order of 40 μf each. Purists may frown on iron-

cored coils and electrolytics in crossover networks, but results are good. Perhaps the two neutralize each other's bad effects! The circuit—Fig. 3—follows Crowhurst's article on crossover networks in the July, 1952, issue.

We'd like to see them . . .

After buying, building or using any piece of equipment, there's always something we'd “like to see them do.” In this case, the most important thing would be to print a warning in large letters, telling the assembler to look on both sides of his wiring charts. I found the instructions to check out every part against the bill of materials, but had finished checking out and had started wiring before I found that one of the sheets had pictorials which would have helped me identify unfamiliar parts.

A little more explanation on the vertical dimension would also have helped. Should I mount capacitors close over wires “dressed close to chassis” or space them clear? I spaced 'em.

The builder cannot issue instructions to himself but, if I'd had that chance, I'd have told myself to read clear through to the end of each separate instruction before starting to follow it. It's embarrassing to put a wire where it's supposed to go and cut it off, only to find that the last sentence of the instruction tells you to carry it over to another point. Another self-instruction would have been to classify all resistors and capacitors while checking them. Heathkit's suggestion to use the corrugated cardboard edge of one of the cartons to hold resistors is an excellent one. I did that later, when wiring the preamp, keeping the resistors more or less in an ascending order of value, and wrote the values on the cardboard.

Another thing I would tell myself is not to try immediately to improve on the instructions. I decided that the a.c. leads to the connector into which the preamp plug was inserted could well be heavier. So I put in some really good stiff wire—and broke a prong in the connector. A small accident in these days of standardization—a prong from an octal socket was an exact replacement—but it taught me a lesson again.

Only one question is now open—is it better to build or to buy audio equipment? To a person who gets a great deal of joy out of pure construction, there is only one answer. The pleasure of building, the pride of workmanship and the satisfaction of having a well-turned-out job are worth as much as possession of the equipment. But to the man who wants music and whose time is worth money—or who may have things to do with his leisure that he would like much better than handling a soldering iron—it might well be better to purchase one of the many excellent amplifiers now on the market. For the person with a low income and plenty of spare time the answer is easy: building offers him the opportunity of owning equipment he could otherwise never afford.

END

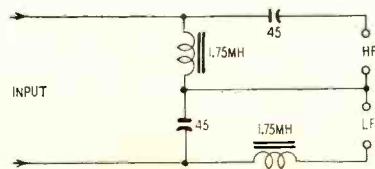

Fig. 3—Output crossover network.

# ADDING FEEDBACK TO AN OLD AMPLIFIER

*Improving frequency response,  
damping factor and reducing distortion  
in older audio equipment*

By NORMAN H. CROWHURST

**N**O doubt a modern feedback amplifier provides much better quality than the older non-feedback types. A great many old units are still giving good service and their owners frequently ask how feedback could be added to improve their performance and bring them nearer the standards of a modern feedback amplifier.

George Fletcher Cooper, in one of his articles on feedback, referred to the "cookbook" approach to amplifier design and suggested that some adopt the attitude of adding a little feedback for good measure. It certainly does seem that many still have rather a vague idea as to just what feedback will do when it is added to an amplifier. The main things we shall be looking for are:

1. reduction in distortion
2. improvement of the damping factor
3. improvement of the frequency response.

To achieve any or all of these objectives, care is required. Just slapping a feedback resistor from the output back to the input is unlikely to achieve any of these objectives, for reasons which we will see.

The first thing to remember about putting on feedback is that it will reduce the gain of the amplifier. And if

an amplifier had only enough, or just a little to spare, previously, then more gain must be provided to make up for the amount to be sacrificed in feedback. This most probably will involve adding an extra stage because amplifiers are generally designed for maximum gain.

Adding an extra stage at the front end should not be too difficult. The filament supply will probably stand an extra tube heater, and the B plus supply will almost certainly provide sufficient extra current for a front-end stage which will only take a milliampere or

so. Of course we need to find a place to put the extra stage—knock a hole in the chassis, mount the tube socket and wire it in. This is a mechanical problem and should not be too difficult.

The next thing is to figure out how we are going to make use of the extra stage to get the full advantage of the extra gain it provides in applying feedback.

Often we are so impressed with the idea that getting some feedback is going to reduce distortion, that we overlook the possibility of its actually in-

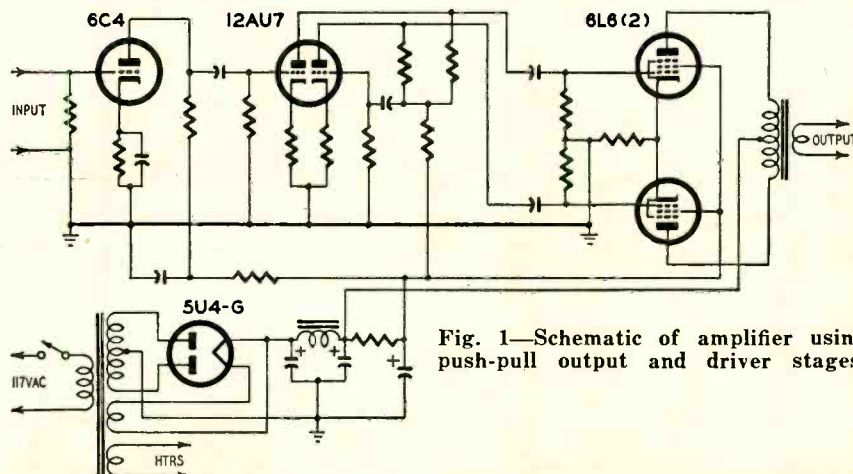

Fig. 1—Schematic of amplifier using push-pull output and driver stages.

## AUDIO—HIGH FIDELITY

creasing distortion. Fig. 1 illustrates this. It represents a typical amplifier using a push-pull output and drive stage. Feedback will be taken from the plates of the output stage back to the cathodes of the drive stage and then some more feedback from the output transformer secondary back to the cathode of the input stage, as shown in Fig. 2.

This is a conventional method of cleaning up a well known kind of amplifier. The point to watch for is this: we clean up the output stage by using feedback, but in doing so we need to push the stage feeding the driver stage to a higher level to obtain the full output. Supposing the amount of feedback from the output plate to drive-stage cathode is 12 db. This means that the stage before the driver has to provide four times more swing at the grid of the drive tubes than it did before. In this case the drive stage is itself a phase inverter of the double-triode type and it should not introduce too much distortion, especially since it is included in the output feedback loop. But the previous stage may not be capable, as it stands, of providing four times the swing it did before. It may run into very serious distortion before full output is reached—so serious in fact that no amount of feedback will be capable of cleaning it up.

So in adding feedback—especially a short-loop arrangement—we must see that every stage is capable of handling the new signal level that the feedback will involve. The best way to do this is to work back from the output, with the aid of tube data, and see just what swing is required and then check whether the preceding stage is capable of delivering that swing at each point through the amplifier.

Sometimes it may be possible to alter the circuit to improve the handling capacity of a stage. If a stage has been designed to give maximum gain, it will probably use a low value of cathode bias resistor so as to operate on the maximum slope of the tube. The handling power can be increased by raising the value of bias resistor. Increasing the plate coupling resistor may possibly yield larger swing.

Sometimes of course the swing required is more than the tube will give at all, using the particular plate voltage it happens to be getting. In such a case it may be possible to use a higher B plus voltage, for example, by going up to the value used for the output stage, together with a higher value of coupling resistor which will give a greater maximum handling power for the tube.

### Feedback loops

The next question is how to distribute the feedback. We can use a long loop, a short loop or a combination of both. We have already shown a reason for limiting the amount of short-loop feedback: the fact that it may involve the use of higher signal level than the

stages are able to handle. But how much long-loop feedback can we use, and how should we determine the proper amount of each?

Besides seeing that all the stages operate at about their best signal level—that is, high enough to keep background noise low and not too high so as to introduce distortion—there is the question of stability of the overall arrangement. This is not a question only of making sure that the amplifier is stable while you are making tests on it with a resistance dummy load across the output, but also of making sure that the amplifier is stable under practical working conditions.

Some of the early feedback amplifiers were rather dubious from this point of view. For example, the one-time popular Williamson circuit which concentrates on using a large amount of feedback on a long loop is conditionally stable, depending upon the load used. It may be stable with one loudspeaker and unstable with another. And the feedback resistor needs adjusting to get best results for every individual condition.

This kind of amplifier is often critical of the kind of input circuit connected to it. For example, it may be very stable when operating from a radio input but give harsh reproduction when operated from phonograph input, or maybe vice versa, because the source impedance connected to the input of the amplifier is affecting its frequency response if not actually its stability.

This property of feedback amplifiers was pointed out in my article, "Why Feed Back So Far?" (September, 1953). So how are we going to arrive at the feedback arrangement that will give us the best overall result?

To get a picture of what we want to do, the best way to view the problem is to consider that we need the short-loop feedback to reduce the source impedance of the output stage to a value where the long-loop feedback will be reasonably independent of the output loading. Use of a low source impedance will mean the output voltage is not very dependent upon the load impedance

connected and, hence, if the long-loop feedback is stable under one condition, changing the load condition is not likely to vary stability or response appreciably. So we want to use enough short-loop feedback to bring the output stage source impedance down to something at least as low as a triode output stage will give—that is, an effective damping factor of from 3 to 5. Short-loop feedback goes over only two stages and, for this reason, cannot become unstable by itself.

Then the long-loop feedback can be used to push the damping factor on out to 10, 20 or 30, as desired, without so much fear of introducing instability. To see how the short-loop feedback by itself is doing in this regard, use an audio oscillator and an output meter. Check the amplifier's frequency response, feeding into the nominal value of resistance load. Particularly watch what happens at the ends of the response. Down at the 20-cycle end, for instance, it is preferable that the amplifier should be rolling off slightly rather than showing a boost. At the high end—20,000 cycles—it should also be doing the same. If a rise shows up at one or both ends, with only short-loop feedback applied, it is a waste of time to try and apply the overall feedback. You are bound to run into instability troubles before you have added very much. The best thing to do is to see how the short-loop feedback can be modified so as to get a better condition before applying long-loop feedback.

This test checks the stability and frequency characteristic of the short-loop feedback. We also want to make sure, at the same time, that it has sufficiently reduced the output source impedance. This can be done by disconnecting the output load and seeing how much the output voltage rises. If  $E_L$  is the voltage with the output load connected and  $E_0$  the voltage with the output disconnected, the damping factor is  $E_L$  divided by  $E_0 - E_L$ . In other words, to represent a damping factor of not less than 3, the rise in voltage when the load is disconnected should not be greater than one-third of the voltage with the load connected.

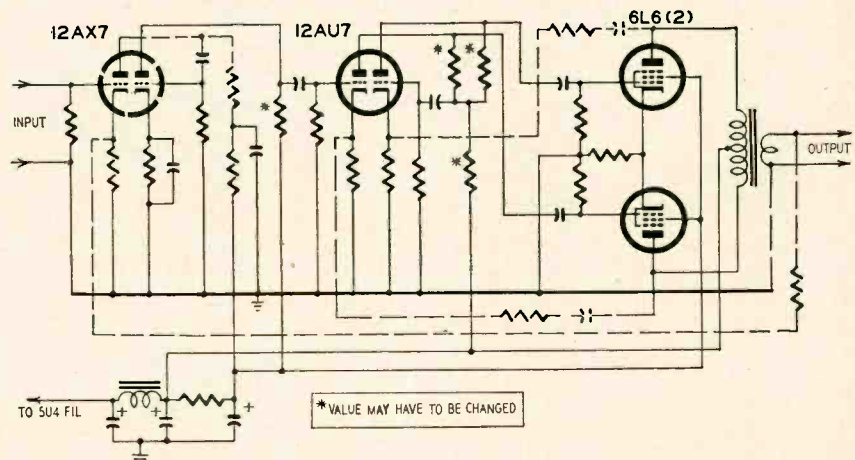

Fig. 2—The dashed lines show additions to Fig 1 circuit when adding feedback.

If either the frequency run test or the load test does not give satisfactory results at this stage, we need to work more on the short-loop feedback before thinking about applying long-loop feedback.

The damping factor can be pushed up by increasing the amount of feedback. If some stage will not handle the increased level which this involves, it will be necessary to redesign that stage to improve its handling capacity, as mentioned earlier. If level handling is not the limitation, but frequency response and stability are, then circuit coupling constants need attention.

If there is a rise in response at the low end, coupling capacitors may be reduced in value until the circuit begins to show a slight rolloff at the low end instead of a rise. If the rise occurs at the high end, the natural stray capacitance of the amplifier should be augmented by some artificial capacitance such as connecting a capacitor across the primary of the output transformer.

### Long-loop feedback

Having under control the short-loop feedback, it is then a relatively simple matter to apply a little more feedback by means of a longer loop to raise the damping factor a little more and improve the frequency response still further.

This method of approach will also take care of the question of achieving a minimum value of distortion. In an amplifier without feedback the stage that will show most distortion is either the drive or output. So a short-loop feedback over these two stages should effectively minimize the distortion they produce. However, having reduced the distortion in these stages to a low level, it is probable that the residual distortion may now be controlled by one of the earlier stages in the amplifier. This is where the long loop or overall feedback can help by providing even further reduction in distortion.

If you have a distortion meter handy it can be used to check just how much reduction in distortion is achieved at each point. Then you will know whether the balance of feedback you have chosen is the best choice for this purpose also.

Besides the practical method just outlined of determining how near the amplifier is to its peaking or its instability condition, it is possible to see just where you are going by doing some simple calculations following the general method outlined by George Fletcher Cooper in his series of articles on feedback design (October, 1950–November, 1951). The important criterion in this is the time constant of the various coupling circuits.

The total series resistance, in conjunction with the coupling capacitor, gives the low-frequency time constant of the coupling circuit. This means that if you take the parallel combination of the plate resistance and the plate cou-

Fig. 3—Amplifier suitable for feedback design—operates on a.c. and battery.

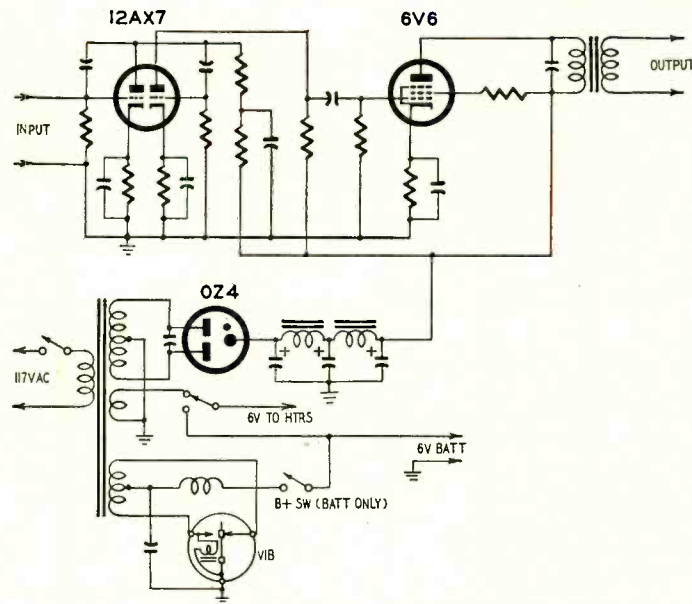

pling resistance, in series with the grid resistance, and multiply this value by the coupling capacitor in farads, you get the time constant of the coupling circuit in seconds. For example, suppose a tube has a plate resistance of 7,700 ohms, a plate coupling resistance of 47,000 ohms, and the following grid uses a resistor of 220,000 ohms. The parallel combination of 7,700 and 47,000 gives 6,600 which, in series with 220,000, adds up to 226,600 ohms. For all practical purposes this is the same as 220,000 ohms. If the coupling capacitor is 0.1  $\mu$ f, the time constant works out to be .022 second, or 22 msec.

If you feed back from plate to cathode, a coupling capacitor will be necessary to block the B plus voltage from the output plate. The total resistance to ground from the output plate in combination with the blocking capacitor used will give the second time constant.

If it is necessary to improve the stability at the low end, steps must be taken to move the time constants of these two circuits farther apart. Most probably the best way is to reduce the time constant of the plate-grid coupling circuit (less than 0.1 in the example quoted).

At the high end, working out time constants is a little bit of guess work because the exact value of stray capacitances is not usually easy to arrive at. So the simplest method, if there is high-frequency peaking, is to add some additional capacitance, such as across the output transformer primary, as suggested.

### Connecting feedback loops

Now we come to another often asked question concerning the advantages of connecting the feedback, whether short or long loop, from the primary or secondary of the output transformer. There seems to be a prevalent opinion that connecting the feedback to the sec-

ondary of the output transformer will help eliminate any distortion introduced by the transformer. This obviously arises from a misunderstanding of how transformers introduce distortion.

The only way in which transformers can introduce distortion is through the nonlinearity of their magnetizing current. This nonlinear current flows only in the primary, so feedback from the primary is just as capable of compensating for this distortion as feedback from the secondary. Feedback from primary or secondary of a transformer makes little difference to the distortion, but it can make a considerable difference to the stability of the arrangement due to the fact that the leakage inductance and winding capacitances of the transformer contribute considerably to the frequency response.

If you connect to the primary of the transformer, the modifying effect of the leakage inductance occurs outside of the feedback loop. This is unlikely to have appreciable effect in normal audio circuits for the simple reason that the voice coil inductance of the average loudspeaker is considerably larger than the leakage inductance of an output transformer. As the two are virtually in series, the voice coil inductance will swamp any effect due to the leakage inductance of the transformer.

However, connecting the feedback to the secondary winding of the transformer includes the leakage inductance in the feedback loop, introducing another possible phase shift and making it more difficult to achieve overall stability.

As we are thinking at the moment of applying a large amount of short-loop feedback with a smaller amount of long-loop feedback, it is usually feasible to apply the short-loop feedback from the plate and the long-loop feedback from the transformer secondary. Using this method it may be possible to compensate in some measure for the

## AUDIO—HIGH FIDELITY

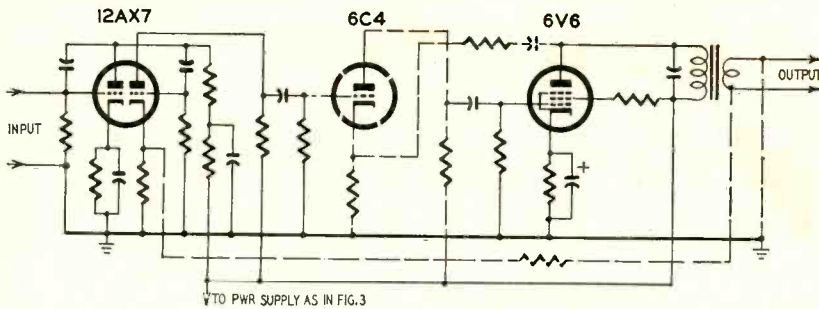

Fig. 4—Dashed lines show two-loop feedback design for Fig. 3 amplifier.

frequency response of the transformer. But do not bank too much on this possibility, because, if the transformer has poor frequency response, adding feedback over the transformer is likely to make the frequency response worse.

This is why transformers for use in feedback amplifiers have been designed to a much higher quality standard than output transformers formerly were. As your old amplifier output transformer was not designed with feedback in mind, it is possible you may run into difficulty here and so you should consider the possibility that you may not be able to use any feedback from the transformer secondary. In this case it may be well to content yourself with only short-loop feedback.

Before concluding this article let's take another example. Suppose we have the circuit of Fig. 3, an amplifier for use either with a regular 117-volt a.c. supply or a 6-volt battery. Here, an extra stage capable of handling a reasonably high level seems to be advisable. A 6C4 should be inserted between the 12AX7 and the 6V6, as shown in Fig. 4. Short-loop feedback can then be applied from the plate of the 6V6 to the cathode of the 6C4 and long-loop feedback from the output transformer secondary to the cathode of half of the 12AX7.

As the first stage is designed to operate at very low level, and hence is not likely to introduce much distortion, the feedback should be taken to the second cathode of the 12AX7 rather than to the first. This will usually permit a larger amount of feedback without instability.

### Modern feedback amplifiers

Before leaving this subject a few comments on the trend of modern feedback amplifier design might be helpful in showing what to expect. This may save trading in your old amplifier unnecessarily and enable you to achieve results almost as good by the method just outlined. For the past many months—if not years—the trend in feedback amplifiers has been to push the response way out at both ends, down to a few cycles and up somewhere around a megacycle, even though the amplifier was required only for audio. Also phenomenal amounts of feedback have been applied, some advertising a total feedback of 80 or more db.

Such amplifiers may be wonderful for laboratory purposes because they are extraordinarily flat, working into

a resistance load, and have a very low distortion so that extreme fidelity in the laboratory sense is achieved. But this does not always agree with extreme fidelity as listened to over a practical system feeding the amplifier into a loudspeaker. Many have noticed that amplifiers of this type seem to have a higher background noise than ones using less feedback; there seems to be what has been described as grittiness.

Experiments have shown that a cleaner-sounding amplifier is obtained by rolling the response off gradually at the two ends of the audible spectrum, say 20 and 20,000 cycles. This results in a lower apparent noise level because the feedback doesn't retain the amplification of the system way out beyond the range and hence does not continue amplifying spurious components which we can never hear directly but which may interfere through some intermodulation effect around the loop.

Also the very high figures of feedback do not necessarily have as much improvement in quality as may be expected. For example, modern circuit and tube design can produce an amplifier which will give a distortion figure as low as 2% without any feedback. Applying a total of 80 db of feedback to an amplifier which has this initial

amount should knock the distortion figure down to .0002%. In practice it is found that the distortion has not been reduced by this much and the reason is that, when such extremely small figures are striven for, the order of distortion multiplies, introducing components of distortion not present in the original amplifier.

To give a simple example of this suppose that our original arrangement produces a distortion of 2% second harmonic and we apply feedback to the extent of 40 db. This will knock the second harmonic from 2% down to .02%. However, in doing this, since the input is now 99% feedback signal from the output, there is practically 2% of second harmonic present in the input which was not there before. And this 2% second harmonic will also generate second harmonic of itself on its way through the amplifier, to the extent of 2% of 2%. So there will be .04% fourth harmonic in the output—that is, assuming that there was no fourth harmonic in the original setup. Thus, in using 40-db feedback, we have reduced second harmonic distortion from 2% to .02% but raised a previously non-existent fourth harmonic to .04%.

This is the kind of thinking that is going into modern feedback design and will undoubtedly result in an increase in the number of amplifiers designed with a rolloff at the end of the audio spectrum instead of miles beyond; and amplifiers with only enough feedback to achieve optimum performance on audio signals.

And the writer believes that a good many of the better class older pre-feedback amplifiers can, by judicious application of feedback as suggested in this article, achieve results as good from a listening point of view as many of the modern feedback amplifiers. END

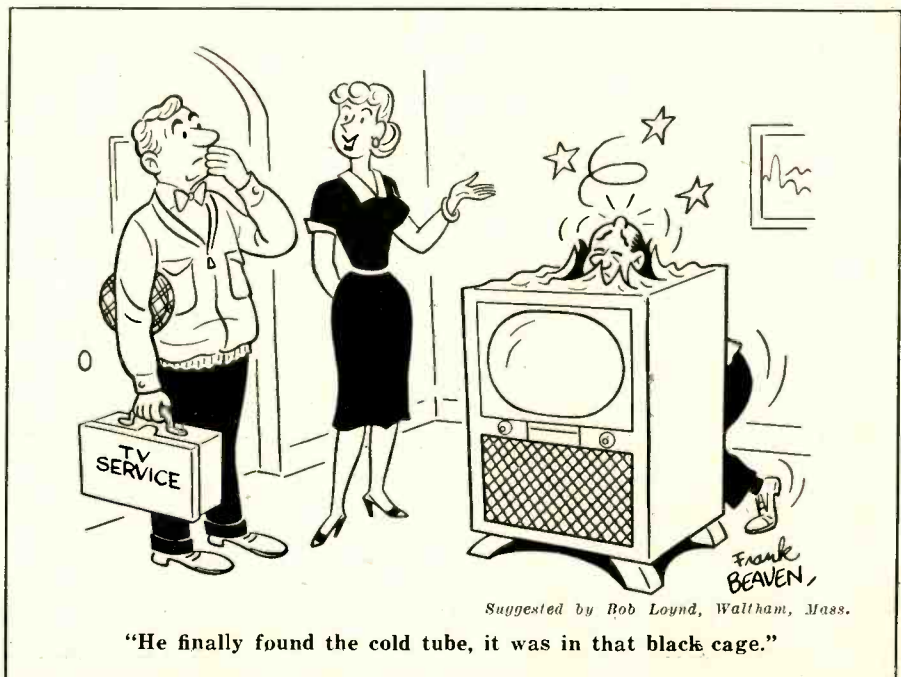

Suggested by Bob Loynd, Waltham, Mass.



# FOR GOLDEN EARS ONLY

The Ampex 620 amplifier—speaker;  
Gray viscous-damped  
tone arm; new  
records review

By MONITOR

SIX months ago, asked when it would be possible to buy a genuine high-fidelity system no bigger than a good sized table-model radio (say 1.5 cubic feet and 25 pounds), I would have replied categorically, "Never." Today, I think it safe to predict that it won't be more than a year and possibly only 6 months. The system won't bring the big bass drums into the room in all their awesomeness (but neither do most of the big hi-fi systems) and it might elicit some slightly carping criticism from the most exquisite Golden Ears. But most people, including many of today's high-fidelity cranks, will be justifiably happy with it.

What principally changed my mind was the Ampex 620 amplifier—speaker system which is exactly 1.3 cubic feet in outside volume, weighs 26 pounds, yet meets the specifications and standards for genuine high fidelity in every respect except possibly one: The distortion across a resistive load is 4.4% at 10 watts (Fig. 1). Though this is as good as or better than most 6V6 amplifiers. It is higher than today's standards call for, particularly limiting because both ends are severely boosted and audible distortion is therefore increased. (Where IM with a resistive load is only 0.4% at 1 watt, it rises to just about

1% when measured across the voice coil.) Otherwise the 620 takes very little backtalk from much bigger and heavier jobs. What's more it sounds even better to the ear than the curves look to the eye.

Ampex claims the response of each specific 620 is production-adjusted and tested to be *acoustically* flat from 65 to 10,000 cycles. I am glad to report that in an age of hyperbolic advertising claims, this one is not only conservative but, unless my ears are abnormal, understated. They hear it just about flat from 50 to at least 12,000 cycles. On the high end the response continues with less slope, if anything, than bigger systems to about 16,000 cycles to my own ears and to nearly 20,000 cycles to my daughter's younger and sharper ones. On the low end, the response doesn't seem more than 3 db down at 50 cycles. Below that point doubling sets in, but there is a trace of fundamental response to some point between 30 and 35 cycles. The doubling is not unpleasant and probably deliberately designed into the speaker-enclosure system—the speaker itself in free space is relatively free of doubling. Since the ear has the curious property of imagining it hears the fundamental when it hears only the second or third harmonic of it, the doubling has the effect of making the bass seem a good octave lower than it really is. This is an old trick; the thing which earns respect for Ampex engineers is that the doubling is so thoroughly confined to the final octave that the illusion is produced without any really significant effect on the definition above 50 cycles. In fact, the bass definition of the whole system is superior to that of most amplifier-speaker combinations regardless of size.

The transient response on both ends is also excellent. The only thing lost in Ampex reproduction is the awesome dullness of the very low bass. All the drums and even the organ come through with amazing cleanness and sharpness and a very commendable lack of hang-over. Nothing of musical value is lost. Indeed, you almost have to hear it in

A-B comparison with a system genuinely capable of reproducing fundamentals down to 25 cycles to be aware that the bottom octave is represented only by the proxy of its harmonics. I suppose one cannot help being somewhat overimpressed by hearing so much good clean sound coming from so small a package; but allowing for that I judge it to be an excellent amplifier. Although designed primarily as a playback system for the 640 tape recorder, it should have much greater usage wherever excellent quality in the smallest package is needed.

The design is notable from beginning to end. The amplifier design is based on the Mullard circuit, which achieves high gain, excellent self-balancing and only one internal time constant (wherefore the excellent low-frequency square waves as shown in Fig. 2). A low-noise pentode is used as a voltage amplifier (Fig. 3), direct-coupled to a long-tailed pair phase inverter—a neat trick in itself. The long-tailed pair is, most authorities agree, superior in every respect to the split-load inverter: it has more gain, better initial balance and is self-balancing because of the large common cathode resistance. The 6V6's are used as pentodes.

Though the constants for the feedback loop used with the internal speaker are not given, it is clear from the loss of gain that an extraordinarily high amount of feedback is applied at mid-frequencies. The amplifier is kept stable, however, because the feedback is tapered at both ends to control the overall response. The overall curve (Fig. 4) shows the response at the voice coil and indicates 12 db less feedback at 20 cycles and 20 db less at 20 kc than at 1,000 cycles. The boost at both ends is intended to make up for the deficiencies of the speaker enclosure, but it also has the incidental benefit of achieving a high degree of stability and of avoiding the transient instability of amplifiers with a lot of uncontrolled feedback at the extremes of the range.

The speaker, manufactured to Ampex specifications, has a husky pot, a heavy

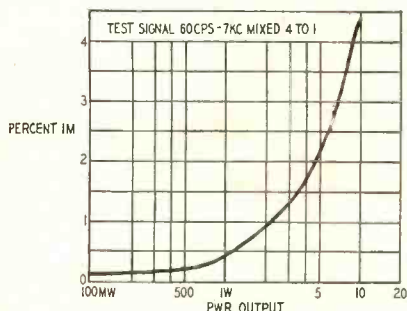

Fig. 1—The 620 IM distortion curve.

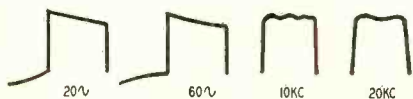
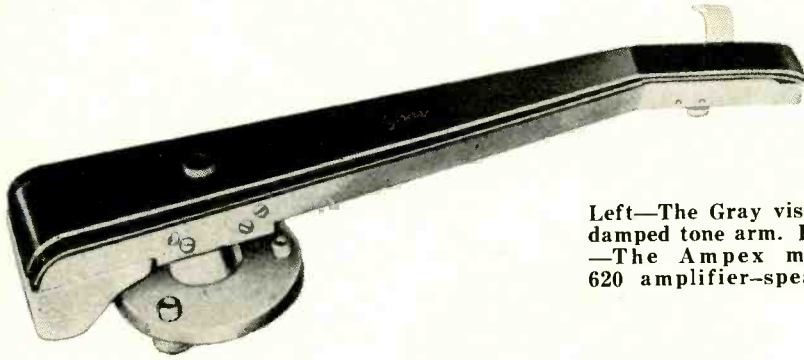

Fig. 2—Response with resistance load.



Left—The Gray viscous-damped tone arm. Right—The Ampex model 620 amplifier-speaker.



die-cast frame, a 1.5- or 2-inch voice coil, a dome for high-frequency extension and a shallow straight-sided cone with treated edges. In many ways it looks like a smaller model of the excellent Western Electric 755. The resonant point in free space is about 80 cycles and this rises in the enclosure to around 120 cycles. The combination is then acoustically compensated by the filters in the feedback loop to provide boosts of 12 db at 20 and 20 db at 20,000 cycles. I rather doubt the speaker system itself needs all that treble boost and I suspect that a good part of it is built-in Fletcher-Munson compensation.

Another oddity is the use of a ring cushion of glass fiber between the edge of the cone and the speaker grille so that the suspension works into the resiliency of the cushion. Probably this equalizes, on the front of the cone, the heavy stiffness provided on the rear by the small volume of enclosed air. No doubt it provides heavy mechanical damping at low frequencies and, as in the RCA speakers, minimizes peaks and dips in the mid-range caused by reflection from the edge of the cone. The in-

terior of the speaker enclosure is liberally coated with some sort of smelly, black mastic and half-filled with a pad of glass wool.

The 620 has a level or volume control and a simple tone control which changes the slope of the response curve to provide a good measure of equalization of tapes made on recorders which do not use Ampex-NARTB recording curves, and also a boost at one end or the other to suit the taste or playback conditions. Unfortunately, the input load is only 25,000 ohms and this makes it impossible to obtain good equalization or loud volume from hi-fi ceramic or crystal cartridges. If Ampex would redesign the input for a 500,000-ohm load, the Ronette cartridge would provide very fine record reproduction with enough volume for most living rooms and school rooms. The amplifier would then be ideal for use by music teachers and wherever a portable but very good high-fidelity system is needed.

There is a jack for an external speaker (for those few who really have better speaker systems) and an attached switch disables the speaker equalization to provide the response indicated

by the curves and square waves. Square-wave response with the internal speaker is, of course, entirely different. It indicates the severe boost at both ends and a peak at around 50 kc. Nevertheless, despite the peak, the stability remains good, there is no sign of oscillation and very little hangover

**Gray viscous-damped tone arm**

The two problems in tone arm design are: avoiding resonance of the arm which would produce peaks in the response and high distortion; preventing

*(Continued on page 79)*

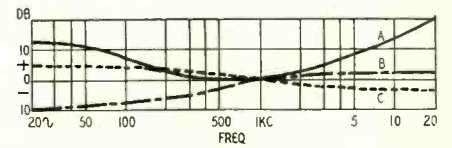

A—OVERALL; B—MAX TREBLE; C—MAX BASS

Fig. 4—Response of the 620 amplifier.

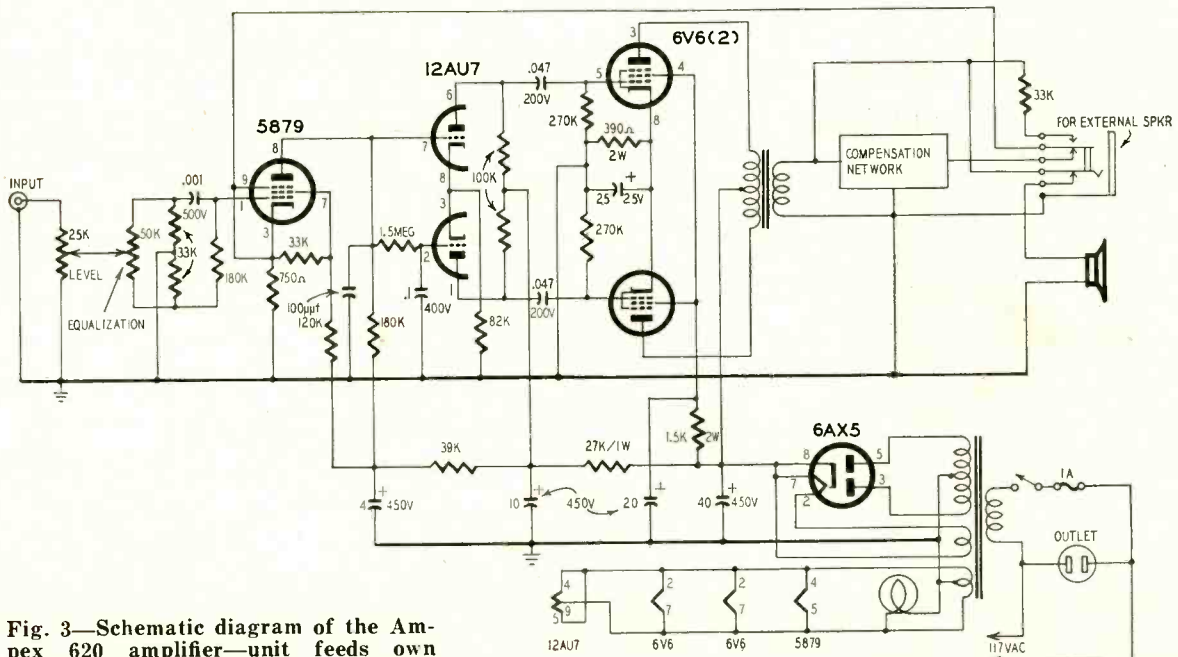

Fig. 3—Schematic diagram of the Ampex 620 amplifier—unit feeds own speaker.

# Heathkits

FOR THE ENTIRE ELECTRONICS INDUSTRY

more than 65 top-quality models to choose from, including such outstanding kit designs as . . . .

THE  
**WORLD'S LEADING  
MANUFACTURER**  
OF ELECTRONIC  
KITS . . .

AMATEUR  
RADIO



RADIO & TV  
SERVICEMEN



INDUSTRIAL  
LABORATORIES

TRAINING  
SCHOOLS



HI-FI  
ENTHUSIASTS



**V-7A VACUUM TUBE VOLTMETER:** Easily the world's largest selling VTVM. Features peak-to-peak scales—etched metal circuit board—1% precision resistors—full wave rectifier and AC input circuit—reads rms and peak-to-peak AC, DC, and ohms.

**O-10 LABORATORY TYPE OSCILLOSCOPE:** The world's largest selling oscilloscope kit, and the most successful oscilloscope in history. Designed especially for color and black-and-white TV service work. Its 5 megacycle bandwidth and new 500 Kc sweep generator readily qualify it for laboratory applications. Features easy-to-assemble etched metal circuit board construction.

**WA-P2 HIGH FIDELITY PREAMPLIFIER:** This is the world's largest selling hi fi preamplifier kit. Features complete equalization, 5 separate switch-selected inputs with individual pre-set level controls, beautiful modern appearance, high-quality components.

**HIGH FIDELITY AMPLIFIERS:** Five Heathkit Models to choose from at prices ranging from \$16.95 to \$59.75. Power output range from 7 to 25 watts.

**DX-100 TRANSMITTER:** A 100 watt phone and CW ham transmitter, offering the greatest dollar value available in the ham radio field today.

*Greatest Dollar Value Through Factory-To-You Selling!*

**ONLY**

# Heathkits

**CAN GIVE YOU ALL**  
**OF THESE DISTINCTIVE ADVANTAGES!**

- ▶ *The Most Complete Construction Manuals for Easy Assembly.*
- ▶ *Originality of Design—Developed Through Pioneering in the Kit Instrument Field.*
- ▶ *Greatest Dollar Value—Finest Quality with Real Economy.*
- ▶ *Direct Contact with Manufacturer—Lower Price, Guaranteed Performance.*
- ▶ *Etched Metal, Prewired Circuit Boards—Save Construction Time, Improve Performance.*
- ▶ *High Quality Standard Components for Long-Life Service.*

**HEATH COMPANY**

*A Subsidiary  
of Daystrom, Inc.*

**BENTON HARBOR 20, MICHIGAN**

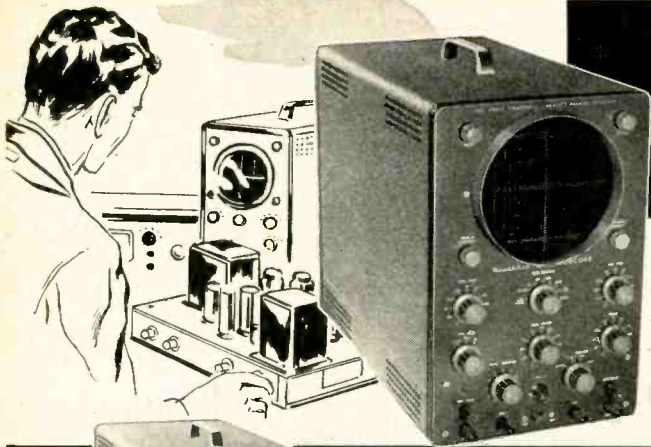

# there is no substitute for HEATHKIT QUALITY

YOU GET MORE: All first-run, top quality parts—the latest in electronic design—complete and comprehensive step-by-step assembly instructions with large pictorial diagrams and assembly drawings. Proven performance through the production of thousands of kits.

MODEL  
O-10

1



2

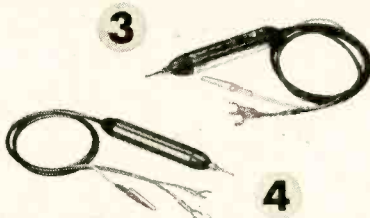

3

4



5

## 1 Heathkit ETCHED CIRCUIT COLOR-TV 5" OSCILLOSCOPE KIT

This deluxe quality oscilloscope has proven itself through thousands of operating hours in service shops and laboratories. Features the best in components—and the best in circuit design.

Features amplifier response to 5 Mc for color TV work, and employs the radically new sweep circuit to provide stable operation up to 500,000 cps. In addition, etched metal, pre-wired circuit boards cut assembly time almost in half, and permit a level of circuit stability never before achieved in an oscilloscope of this type.

Vertical amplifiers flat within +2 db -5 db from 2 cps to 5 Mc, down only 1½ db at 3.58 Mc. Vertical sensitivity is 0.025 volts, (rms) per inch at 1 Kc. 11 tube circuit employs a 5U1 CRT.

Plastic molded capacitors used for coupling and bypass—preformed and cabled wiring harness provided.

Features built-in peak-to-peak calibrating source—retrace blanking amplifier—push-pull deflection amplifiers and step-attenuated input.

MODEL O-10  
**\$6950**

Shpg. Wt. 21 Lbs.

## 2 Heathkit ETCHED CIRCUIT 5" OSCILLOSCOPE KIT

This is a general purpose oscilloscope for the more usual applications in the service shop or lab, yet is comparable to scopes costing many dollars more.

Features full size 5" CRT (5BP1), built-in peak-to-peak voltage calibration—3 step input attenuator—phasing control—push-pull deflection amplifiers—and etched metal pre-wired circuit boards.

Vertical channel flat within ±3 db from 2 cps to 200 Kc, with 0.09 V. rms/inch, peak-to-peak sensitivity at 1 Kc. Sweep circuit from 20 cps to 100,000 cps. A scope you will be proud to own and use.

MODEL OM-1  
**\$4950**

Shpg. Wt. 21 Lbs.

## 3 Heathkit LOW CAPACITY PROBE KIT

Scope investigation of circuits encountered in TV requires the use of special low capacity probe to prevent loss of gain, circuit loading, or distortion. This probe features a variable capacitor to provide correct instrument impedance matching. Also the ratio of attenuation can be controlled.

NO. 342  
**\$350**

Shpg. Wt. 1 lb.

## 4 Heathkit ETCHED CIRCUIT SCOPE DEMODULATOR PROBE KIT

Extend the usefulness of your Oscilloscope by observing modulation envelope of R.F. or I.F. carriers found in TV and radio receivers. Functions like AM detector to pass only modulation of signal and not signal itself. Applied voltage limits are 30 V. RMS and 500 V. DC.

NO. 337-C  
**\$350**

Shpg. Wt. 1 lb.

## 5 Heathkit ETCHED CIRCUIT 3" OSCILLOSCOPE KIT

This compact little oscilloscope measures only 9½" H. x 6½" W. x 11¾" D., and weighs only 11 lbs! Easily employed for home service calls, for work in the field or is just the ticket for use in the ham shack or home workshop. Incorporates many of the features of the Model OM-1, but yet is smaller in physical size for portability.

Employing etched circuit boards, the Model OL-1 features vertical response within ± 3 db from 2 cps to 200 Kc. Vertical sensitivity is 0.25 V. RMS/inch peak-to-peak, and sweep generator operates from 20 cps to 100,000 cps. Provision for r.f. connection to deflection plates for modulation monitoring, and incorporates many features not expected at this price level. 8-tube circuit features a type 3GP1 Cathode Ray Tube.

MODEL OL-1  
**\$2950**

Shpg. Wt. 14 lbs.

**HEATH COMPANY** A Subsidiary of Daystrom, Inc. **BENTON HARBOR 20, MICHIGAN**

# fill your test requirements WITH HEATHKITS

DESIGNED FOR YOU: Heath Company test equipment is designed for the maximum in convenience. Besides being functional, Heathkits represent the very latest in modern physical appearance, and incorporate all the latest circuit design features for comprehensive test coverage.

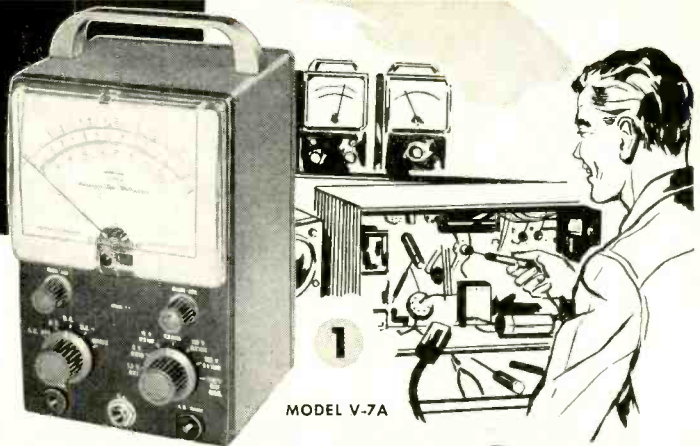

MODEL V-7A

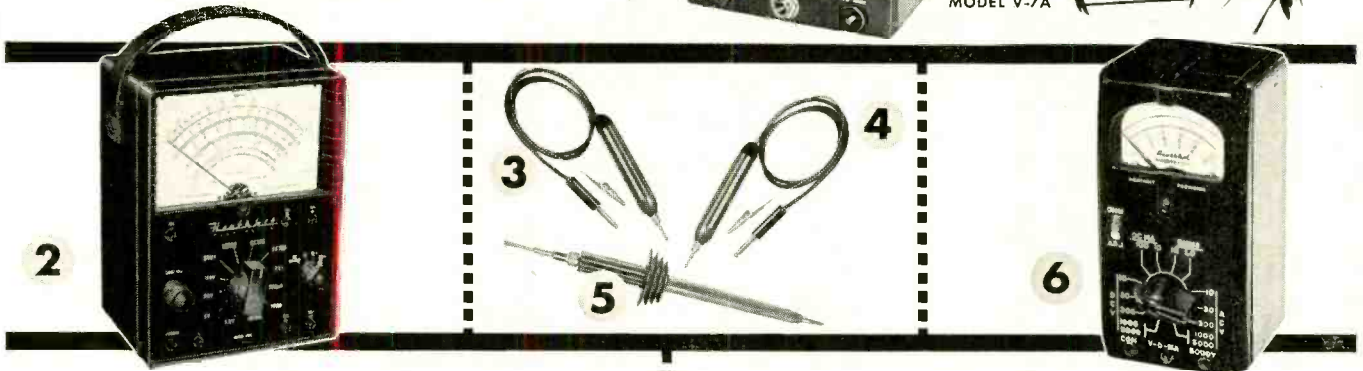

## 1 Heathkit ETCHED CIRCUIT VACUUM TUBE VOLTMETER KIT

Besides measuring AC (rms), DC and resistance, the modern-design V-7A incorporates peak-to-peak measurement for FM and television servicing.

AC (rms) and DC voltage ranges are 1.5, 5, 15, 50, 150, 500, and 1500. Peak-to-peak AC voltage ranges are 4, 14, 40, 140, 400, 1400, and 4000. Ohmmeter ranges are X1, X10, X100, X1000, X10K, X100K, and X1 megohm. Also a db scale is provided. A polarity reversing switch provided for DC measurements, and zero center operation within range of front panel controls. Employs a 200  $\mu$ a meter for indication. Input impedance is 11 megohms.

Etched metal, pre-wired circuit board for fast, easy assembly and reliable operation is 50% thicker for more rugged physical construction. 1% precision resistors for utmost accuracy.

MODEL V-7A  
**\$24.50**  
Shpg. Wt. 7 Lbs.

## 2 Heathkit 20,000 OHMS/VOLT MULTIMETER KIT

The MM-1 is a portable instrument for outside servicing, for field testing, or for quick portability in the service shop. Combines attractive physical appearance with functional design. 20,000 ohms/v. DC, and 5000 ohms/v. AC. AC and DC voltage ranges are 0-1.5, 5, 50, 150, 500, 1500 and 5000 volts. Direct current ranges are 0-150  $\mu$ a., 15 ma., 150 ma., 500 ma., and 15 amperes. Resistance ranges are X1, X100, X10,000 providing center scale readings of 15, 1500 and 150,000 ohms. DB ranges cover -10 db to +65 db.

Features a  $4\frac{1}{2}$ " 50  $\mu$ a. meter. Provides polarity reversal on DC measurements. 1% precision resistors used in multiplier circuits. Not affected by RF fields.

MODEL MM-1  
**\$29.50**  
Shpg. Wt. 6 Lbs.

## 3 Heathkit ETCHED CIRCUIT RF PROBE KIT

The Heathkit RF Probe used in conjunction with any 11 megohm VTVM will permit RF measurements up to 250 Mc with  $\pm$  10% accuracy. Uses etched circuits for increased circuit stability and ease of assembly.

NO. 309-C  
**\$3.50**  
Shpg. Wt. 1 Lb.

## 4 Heathkit ETCHED CIRCUIT PEAK-TO-PEAK PROBE KIT

Now read peak-to-peak voltages on the DC scale of any 11 megohm VTVM with this new probe, employing etched circuit for stability and low loss. Readings made directly from VTVM scales, from 5 Kc to 5 Mc. Not required for Heathkit Model V-7A VTVM.

NO. 338-C  
**\$5.50**  
Shpg. Wt. 2 Lbs.

## 5 Heathkit 30,000 VOLT D.C. HIGH VOLTAGE PROBE KIT

For TV service work or similar application for measurement of high DC voltage. Precision multiplier resistor mounted inside plastic probe. Multiplication factor of 100 on the ranges of Heathkit 11 megohm VTVM.

NO. 336  
**\$4.50**  
Shpg. Wt. 2 Lbs.

## 6 Heathkit HANDITESTER KIT

The Model M-1 measures AC or DC voltage at 0-10, 30, 300, 1000, and 5000 volts. Measures direct current at 0-10 ma. and 0-100 ma. Provides ohmmeter ranges of 0-3000 (30 ohm center scale) and 0-300,000 ohms (3000 ohms center scale). Features a 400  $\mu$ a. meter for sensitivity of 1000 ohms/volt. Because of its size, the M-1 is a very handy portable instrument that will fit in your coat pocket, tool box, glove compartment, or desk drawer. Makes a fine standby unit in the service shop when the main instruments are in use, or is ideal for the hobbyist or beginner. An unusual dollar value.

MODEL M-1  
**\$14.50**  
Shpg. Wt. 3 Lbs.

**HEATH COMPANY**

A Subsidiary  
of Daystrom, Inc.

**BENTON HARBOR 20, MICHIGAN**

# Heathkit TV ALIGNMENT GENERATOR KIT



1



2



3



4

# HEATH COMPANY

A SUBSIDIARY OF DAYSTROM INC.

The Model TS-4 features a controllable inductor for all-electronic sweep, improved oscillator and automatic gain circuitry, high RF output, center sweep operation, and improved linearity. It sets a new high standard for sweep generator operation, and is absolutely essential for the up-to-date service shop doing FM, black-and-white TV, and color TV work.

Voltage regulation and effective AGC action insure flat output over a wide frequency range. Electronic sweep insures complete absence of mechanical vibration. Sweep deviation controllable from 0 up to 40 Mc, depending upon base frequency. Effective two-way blanking.

Fundamental output from 3.6 Mc to 220 Mc in 4 bands. Crystal marker provides markers at 4.5 Mc and multiples thereof. Crystal included with kit. Variable marker covers from 19 Mc to 60 Mc on fundamentals, and up to 180 Mc on harmonics. Provision for external marker.



MODEL TS-4  
**\$4950**  
Shpg. Wt. 16 Lbs.

1

## Heathkit LINEARITY PATTERN GENERATOR KIT

The new-design Model LP-1 produces vertical or horizontal bar patterns, a cross-hatch pattern, or white dots on the screen of the TV set under test. No internal connections required. Special clip is attached to the TV antenna terminals. Instant selection of the pattern desired for adjustment of vertical and horizontal linearity, picture size, aspect ratio, and focus. Dot pattern presentation is a *must* for color convergence adjustments on color TV sets.

Extended operating range covers all television channels from 2 to 13. Produces 6 to 12 vertical bars or 4 to 7 horizontal bars.

MODEL LP-1  
**\$2250**  
Shpg. Wt. 7 Lbs.

2

## Heathkit LABORATORY GENERATOR KIT

The Heathkit Model LG-1 Laboratory Generator is a high-accuracy signal source for applications where metered performance is essential. It covers from 100 Kc to 30 Mc on fundamentals in 5 bands. Modulation is at 400 cycles, and modulation is variable from 0-50%. RF output from 100,000  $\mu$ v. to 1  $\mu$ v. 200  $\mu$ a. meter reads the RF output in microvolts, or percentage of modulation. Fixed step and variable output attenuation provided.

Features voltage regulation, and double copper plated shielding for stability. Provision for external modulation. Coaxial output cable (50 ohms).

MODEL LG-1  
**\$3950**  
Shpg. Wt. 16 Lbs.

3

## Heathkit CATHODE RAY TUBE CHECKER KIT

This new-design instrument holds the key to rapid and complete picture tube testing, either in the set, on the work-bench, or in the carton. Tests for shorts, leakage, and emission. Features Shadow-graph test (a spot of light on the screen) to indicate whether the tube is capable of functioning.

The Model CC-1 tests all electromagnetic deflection picture tubes normally encountered in television servicing. Supplies all operating voltages to the tube under test, and indicates the condition of the tube on a large "GOOD-BAD" scale. Features spring loaded test switches for operator protection.

The CC-1 is housed in an attractive portable case and is light in weight - ideal for outside service calls.

MODEL CC-1  
**\$2250**  
Shpg. Wt. 10 Lbs.

4

## Heathkit DIRECT READING CAPACITY METER KIT

Not only is this instrument popular in the service shop, but it has found extensive application in industrial situations. Ideal for quality control work, production line checking, or for matching pairs.

Features direct reading linear scales from 100 mmf to .1 mfd full scale. Necessary only to connect a capacitor of unknown value to the insulated binding posts, select the correct range, and read the meter. The CM-1 is not susceptible to hand capacity, and has a residual capacity of less than 1 mmf.

MODEL CM-1  
**\$2950**  
Shpg. Wt. 7 Lbs.

BENTON HARBOR 20, MICHIGAN

RADIO-ELECTRONICS



MODEL SG-8 **\$1950**  
Shpg. Wt. 8 Lbs.

This is one of the biggest signal generator bargains available today. The tried and proven Model SG-8 offers all of the outstanding features required for a basic service instrument. High quality components and outstanding performance.

The SG-8 covers 160 Kc to 110 Mc on fundamentals in 5 bands, and calibrated harmonics extend its usefulness up to 220 Mc. The output signal is modulated at 400 cps, and the RF output is in excess of 100,000 uv. Output controlled by both a continuously variable and a fixed step attenuator. Also, audio output may be obtained for amplifier testing. Don't let the

low price deceive you. This is a professional type service instrument to fulfill the signal source requirements in the service lab.

## 1 Heathkit . . . IMPEDANCE BRIDGE KIT

The IB-2 features built-in adjustable phase shift oscillator and amplifier, and has panel provisions for external generator. Measures resistance, capacitance, inductance, dissipation factors of condensers, and storage factor of inductance.

D, Q, and DQ functions combined in one control. 1/2% resistors and 1/2% silver-mica capacitors especially selected for this instrument. A 100-0-100 microammeter provides null indications. Two-section CRL dial provides 10 separate "units" with an accuracy of .5%. Fractions of units read on variable control.

MODEL IB-2 **\$5950**  
Shpg. Wt. 12 Lbs.

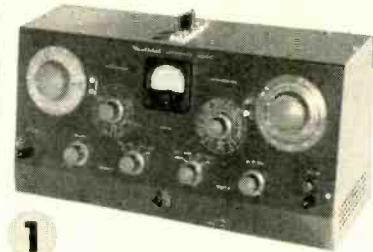

## 2 Heathkit "Q" METER KIT

The Heathkit Model QM-1 will measure the Q of inductances and the RF resistance and distributed capacity of coils. Employs a 4 1/2" 50 microampere meter for direct indication. Will test at frequencies of 150 Kc to 18 Mc in 4 ranges. Measures capacity from 40 mmf to 450 mmf within ± 3 mmf. Indispensable for coil winding and determining unknown condenser values. A worthwhile addition to your laboratory at an outstandingly low price. Useful for checking wave traps, chokes, peaking coils, etc. Laboratory facilities are now available to the service shop and home lab.

MODEL QM-1 **\$4450**  
Shpg. Wt. 14 Lbs.



## 3 Heathkit 6-12 VOLT BATTERY ELIMINATOR KIT

This modern battery eliminator will supply 6 or 12 volt output for ordinary automobile radios as well as 12 volts for the new models in the latest model cars. Output voltage is variable from 0-8 volts DC, or 0-16 volts DC. Will deliver up to 15 amperes at 6 volts, or up to 7 amperes at 12 volts. Two 10,000 microfarad filter capacitors insure smooth DC output. Two panel meters monitor output voltage and current. Will double as a battery charger. Definitely required for automobile radio service work.

MODEL BE-4 **\$3150**  
Shpg. Wt. 17 Lbs.



## 4 Heathkit DECADE RESISTANCE KIT

Twenty 1% precision resistors provide resistance from 1 to 99,999 ohms in 1 ohm steps. Indispensable around service shop laboratory, ham shack, or home workshop. Well worth the extremely low Heathkit price.

MODEL DR-1 **\$1950**  
Shpg. Wt. 4 Lbs.

## 5 Heathkit VIBRATOR TESTER KIT

Tests vibrators for proper starting and indicates the quality of the output on a large "GOOD-BAD" scale. Checks both interrupter and self-rectifier types in 5 different sockets. Operates from any battery eliminator delivering variable voltage from 4 to 6 volts DC at 4 amps. Ideal companion to the Model BE-4.

MODEL VT-1 **\$1450**  
Shpg. Wt. 6 Lbs.

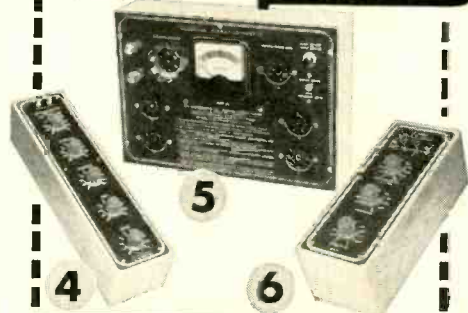

## 6 Heathkit DECADE CONDENSER KIT

Provides capacity values from 100 mmf to 0.111 mfd in steps of 100 mmf. ± 1% precision silver-mica condensers used. High quality ceramic switches for reduced leakage. Polished birch cabinet. Extremely valuable in all electronic activity.

MODEL DC-1 **\$1650**  
Shpg. Wt. 3 Lbs.

**HEATH  
COMPANY**

A SUBSIDIARY OF DAYSTROM INC.

BENTON HARBOR 20, MICHIGAN

# Heathkit TUBE CHECKER KIT

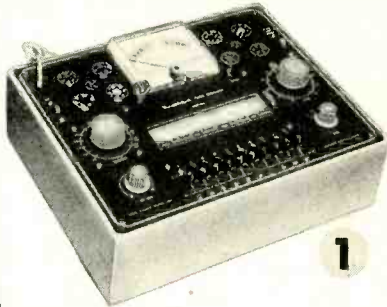

1

1 The Heathkit Model TC-2 is an emission type tube tester that represents a tremendous saving over the price of a comparable unit from any other source. At only \$29.50, you can have a tube tester of your own, even if you are an experimenter, or only do part time service work. Extremely popular with radio servicemen, it uses a 4½" meter with 3-color meter face for simple "GOOD-BAD" indications that the customer can understand. Will test all tubes commonly encountered in radio and TV service work.

Ten 3-position lever switches for "open" or "short" tests on each tube element. Neon bulb indicates filament continuity or short between tube elements. Line adjust control provided. The roll chart is illuminated.

Sockets provided for 4, 5, 6, and 7-pin, octal, and loctal tubes, 7 and 9 pin miniature tubes, and the 5 pin Hytron tubes. Blank space provided for future socket addition. Tests tubes for opens, and shorts, and for quality on the basis of total emission. 14 different filament voltage values provided.

MODEL TC-2

**\$29.50**

Shpg. Wt. 12 lbs.

## 2 Heathkit PORTABLE TUBE CHECKER KIT

The Model TC-2P is identical to the Model TC-2 except that it is housed in a rugged carrying case. This strikingly attractive and practical two-tone case is finished in proxylin impregnated fabric. The cover is detachable, and the hardware is brass plated. This case imparts a real professional appearance to the instrument. Ideal for home service calls, or any portable application.

MODEL TC-2P

**\$34.50**

Shpg. Wt. 15 lbs.



3

2

## 3 Heathkit TV PICTURE TUBE TEST ADAPTER

The Heathkit TV picture tube test adapter is designed for use with the Model TC-2 Tube Checker. Test picture tubes for emission, shorts, and thereby determine tube quality. Consists of 12-pin TV tube socket, 4 ft. cable, octal connector, and necessary technical data. (Not a kit.)

MODEL 355

**\$4.50**

Shpg. Wt. 1 lb.

## 4 Heathkit . . . CONDENSER CHECKER KIT

Use this Condenser Checker to quickly and accurately measure those unknown condenser and resistor values. All readings taken directly from the calibrated panel scales without any involved calculation. Capacity measurements in four ranges from .00001 to 1000 mfd. Checks paper, mica, ceramic and electrolytic condensers. A power factor control is available for accurate indication of electrolytic condenser efficiency. Leakage test switch—selection of five polarizing voltages, 25 volts to 450 volts DC to indicate condenser operating quality under actual load conditions. Spring-return test switch automatically discharges condenser under test and eliminates shock hazard to the operator.

Resistance measurements can be made in the range from 100 ohms to 5 meg-ohms. Here again, all values are read directly on the calibrated scales. Increased sensitivity coupled with an electron beam null indicator increases overall instrument usefulness.

For safety of operation, the circuit is entirely transformer operated. An outstanding low kit price for this surprisingly accurate instrument.

MODEL C-3

**\$19.50**

Shpg. Wt. 7 lbs.



4

## 5 Heathkit VISUAL-AURAL SIGNAL TRACER KIT

This signal tracer is extremely valuable in servicing AM, FM, and TV receivers, especially when it comes to isolating trouble to a particular stage of the circuit under test.

This visual-aural tracer features a high gain RF input channel to permit signal tracing from the receiver antenna input clear through all RF, IF, detector, and audio stages to the speaker. Separate low-gain channel provided for audio circuit exploration. Both visual and aural indication by means of a speaker or headphone, and electron beam "eye" tube as a level indicator. Also incorporates a noise locator circuit for DC noise checks, and a built-in calibrated wattmeter (30-500 watts). Panel terminals provided for "patching" output transformer or speaker into external circuit for test purposes. Designed especially for the radio and TV serviceman. Cabinet size: 9½" wide x 6½" high x 5" deep. A real test equipment bargain.

MODEL T-3

**\$23.50**

Shpg. Wt. 9 lbs.



5

# HEATH COMPANY

A SUBSIDIARY OF DAYSTROM INC.

BENTON HARBOR 20, MICHIGAN

RADIO-ELECTRONICS





MODEL HD-1

Shpg. Wt. 13 Lbs. **\$4950**

Used with a sine wave generator, the Model HD-1 will check the harmonic distortion output of audio amplifiers under a variety of conditions. Reads distortion directly on the meter as a percentage of the input signal. Operates between 20 and 20,000 cps. High impedance VTVM circuit for initial reference settings and final distortion readings. Ranges are 0-1, 3, 10, and 30 volts full scale. 1% precision resistors. Distortion scales are 0-1, 3, 10, 30 and 100% full scale. Requires only .3 volt input for distortion test.

# Heathkit HARMONIC DISTORTION METER KIT

## 1 Heathkit AUDIO ANALYZER KIT

This instrument consists of an audio wattmeter, an AC VTVM, and a complete IM analyzer, all in one compact unit.

Use the VTVM to measure noise, frequency response, output gain, power supply ripple, etc. Use the wattmeter for measurement of power output. Internal loads provided for 4, 8, 16, or 600 ohms. VTVM also calibrated for DBM units. High or low impedance IM measurements made with built-in 6KC and 60 cps generators. VTVM ranges are .01, to 300 volts in 10 steps. Wattmeter ranges are .15 mw. to 150 w. in 7 steps. IM scales are 1% to 100% in 5 steps.

MODEL AA-1  
**\$5950**

Shpg. Wt. 13 Lbs.



## 2 Heathkit AUDIO GENERATOR KIT

This new Heathkit Model features step-tuning from 10 cps to 100 Kc with three rotary switches that provide two significant figures and multiplier. Less than .1% distortion. Frequency accurate to within  $\pm 5\%$ .

Output monitored on a large  $4\frac{1}{2}$ " meter that reads voltage or db. Both variable and step-type attenuation provided. Meter reads zero-to-maximum at each attenuator position. Output ranges (and therefore meter ranges) are 0-.003, .01, .03, .1, .3, 1, 3, 10 volts. Step-tuning provides rapid positive selection of the desired frequency, and allows accurate return to any given frequency.

MODEL AG-9  
**\$3450**

Shpg. Wt. 8 Lbs.



## 3 Heathkit AUDIO OSCILLATOR KIT

(SINE WAVE — SQUARE WAVE)

The Model AO-1 features sine wave or square wave coverage from 20-20,000 cps in 3 ranges. It is an instrument specifically designed to completely fulfill the needs of the serviceman and high fidelity enthusiast. Offers high level output across the entire frequency range, low distortion and low impedance output. Features a thermistor in the second amplifier stage to maintain essentially flat output through the entire frequency range. Produces an excellent sine wave for audio testing, or will produce good, clean, square waves with a rise time of only 2 microseconds.

MODEL AO-1  
**\$2450**

Shpg. Wt. 10 Lbs.

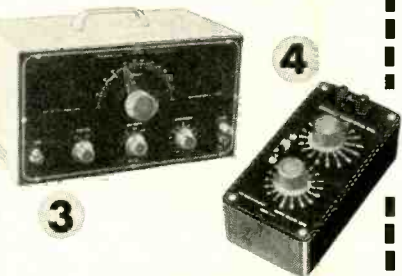

## 4 Heathkit RESISTANCE SUBSTITUTION BOX KIT...

Provides switch selection of 36 RTMA 1 watt standard 1% resistors ranging from 15 ohms to 10 megohms. Numerous applications in radio and TV work, and essential in the developmental laboratory.

MODEL RS-1  
**\$550**

Shpg. Wt. 2 Lbs.

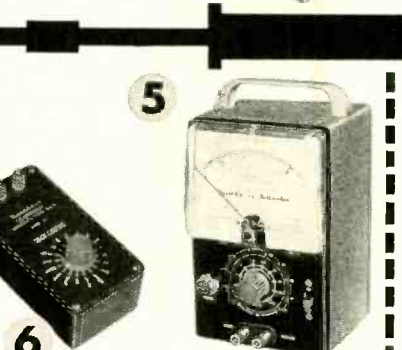

## 5 Heathkit AC VACUUM TUBE VOLTMETER KIT...

The Heathkit AC VTVM features high impedance, wide frequency range, very high sensitivity, and extremely wide voltage range. Will accurately measure a voltage as small as 1 mv. at high impedance. Excellent for sensitive AC measurements required by laboratories, audio enthusiasts and experimenters. Frequency response is substantially flat from 10 cps to 50 Kc. Ranges are .01, .03, .1, .3, 1, 3, 10, 30, 100, and 300 v. RMS. Total db range -52 to + 52 db. Input impedance 1 megohm at 1 Kc.

MODEL AV-2  
**\$2950**

Shpg. Wt. 5 Lbs.

## 6 Heathkit CONDENSER SUBSTITUTION BOX KIT...

Very popular companion to Heathkit RS-1. Individual selection of 18 RTMA standard condenser values from .0001 mfd to .22 mfd. Includes 18" flexible leads with alligator clips.

MODEL CS-1  
**\$550**

Shpg. Wt. 2 Lbs.



BENTON HARBOR 20, MICHIGAN

OCTOBER, 1955

**HEATH  
COMPANY**

A SUBSIDIARY OF DAYSTROM INC.



MODEL DX-100

# HEATHKIT HAM GEAR

for high quality at moderate cost

**DOLLAR VALUE:** You get more for your Heathkit dollar because your labor is used to build the kit instead of paying for someone else's. Also, the middleman's margin of profit is eliminated when you deal directly with the manufacturer.



2



3



4

## 1 Heathkit DX-100 PHONE & CW TRANSMITTER KIT

The reception given this amateur transmitter has been tremendous. Reports from radio amateurs using the DX-100 are enthusiastic in praising its performance and the high quality of the components used in its assembly. Actual "on the air" results reflect the careful design that went into its development.

The DX-100 features a built-in VFO, modulator, and power supplies, and is completely bandswitching for phone or CW operation on 160, 80, 40, 20, 15, 11, and 10 meters. All parts necessary for construction are supplied in the kit, including tubes, cabinet, and detailed step-by-step instructions. Easy to build, and a genuine pleasure to operate.

Employs push-pull 1625's modulating parallel 6146's for RF output in excess of 100 watts on phone and 120 watts on CW. May be excited from the built-in VFO or from crystals (crystals not included with kit). Features five-point TVI suppression: (1) pi network interstage coupling to reduce harmonic transfer to the final stage; (2) pi network output coupling; (3) extensive shielding; (4) all incoming and outgoing circuits filtered; (5) inter-locking cabinet seams to eliminate radiation except through the coaxial output connector. Pi network output coupling will match 50 to 600 ohm non-reactive load. Illuminated VFO dial and meter face. Remote control socket provided.

The chassis is made of extra-strong #16 gauge copper-plated steel. It employs potted transformers, ceramic switch and variable capacitor insulation, solid silver loading switch terminals, and high-grade well-rated components throughout. Features a pre-formed wiring harness, and all coils are pre-wound.

High-gain speech amplifier for dynamic or crystal microphones, and restricted speech range for increased intelligence. Plenty of audio power reserve. Measures 20 7/8" W. x 13 3/4" H. x 16" D. Schematic diagram and complete technical specifications on request.

MODEL DX-100

**\$189.50**

Shpg. Wt. 120 Lbs.

Shipped Motor Freight Unless Otherwise Specified  
\$50.00 Deposit Required on C.O.D. Orders

## 2 Heathkit VFO KIT

The Model VF-1 covers 160-80-40-20-15-11 and 10 meters with three basic oscillator frequencies. Better than 10-volt average RF output on fundamentals. Features illuminated and pre-calibrated dial scale. Cable and plug provided to fit crystal socket of any modern transmitter.

Enjoy the convenience and flexibility of VFO operation at no more than the price of crystals. May be powered from plug on the Heathkit Model AT-1 transmitter, or supplied with power from most transmitters. Measures: 7" H. x 6 1/2" W. x 7" D.

MODEL VF-1

**\$19.50**

Shpg. Wt. 7 Lbs.

## 3 Heathkit CW AMATEUR TRANSMITTER KIT

The Model AT-1 is an ideal novice transmitter, and may be used to excite a higher power rig later on.

This CW transmitter is complete with its own power supply, and covers 80, 40, 20, 15, 11, and 10 meters. Features single-knob bandswitching, and panel meter indicates grid or plate current for the final amplifier. Designed for crystal operation or external VFO. Crystal not included in kit. Incorporates such features as key click filter, line filter, copper-plated chassis, pre-wound coils, 52 ohm coaxial output, and high quality components throughout. Instruction book simplifies assembly. Employs a 6AG7 oscillator, 6L6 final amplifier. Operates up to 35 watts plate power input.

MODEL AT-1

**\$29.50**

Shpg. Wt. 15 Lbs.

## 4 Heathkit ANTENNA COUPLER KIT

The Model AC-1 will properly match your low power transmitter to an end-fed long wire antenna. Also attenuates signals above 36 Mc, reducing TVI. 52 ohm coax. input—power up to 75 watts—10 through 80 meters—tapped inductor and variable condenser—neon RF indicator—copper plated chassis and high quality components. Ideal for use with Heathkit AT-1 Transmitter.

MODEL AC-1

**\$14.50**

Shpg. Wt. 4 Lbs.

**HEATH COMPANY** A Subsidiary of Daystrom, Inc.

**BENTON HARBOR 20, MICHIGAN**

# "AMATEUR-ENGINEERED"

## Equipment For The Ham

MODERN DESIGN: You can be sure of getting all the latest and most desirable design features when you buy Heathkits. Advanced-design is a minimum standard for new Heathkit models.

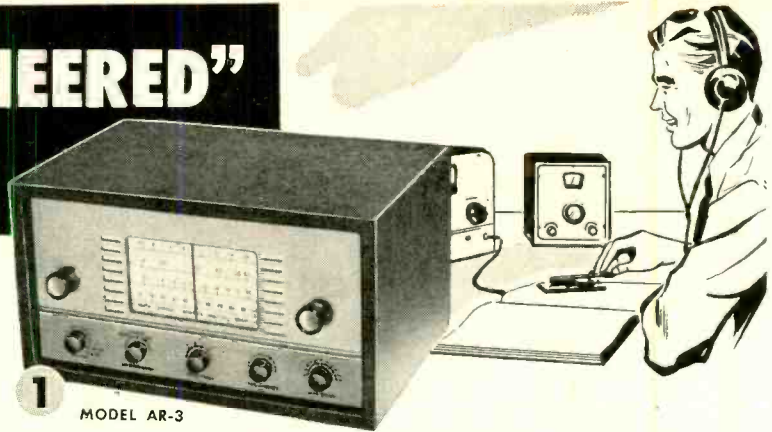

1 MODEL AR-3

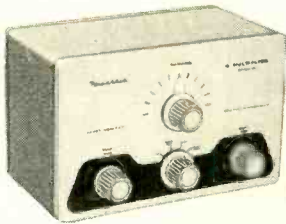

2



3



4



5

### 1 Heathkit COMMUNICATIONS-TYPE ALL BAND RECEIVER KIT

The new Model AR-3 features improved IF and RF performance, along with better image rejection on all bands. Completely new chassis layout for easier assembly, even for the beginner.

Covers 550 Kc to 30 Mc in four bands. Provides sharp tuning and good sensitivity over the entire range. Features a transformer-type power supply—electrical bandspread—separate RF and AF gain controls—antenna trimmer—noise limiter—AGC—BFO—headphone jacks—5½" PM speaker and illuminated tuning dial.

CABINET: Fabric covered cabinet with aluminum panel as shown. Part No. 91-10, shipping weight 5 lbs. \$4.50.

MODEL AR-3  
**\$27<sup>95</sup>**

Shpg. Wt. 12 Lbs.  
(Less Cabinet)

### 2 Heathkit "Q" MULTIPLIER KIT

Here is the Heathkit Q Multiplier you hams have been asking for. A tremendous help on the phone and CW bands when the QRM is heavy. Provides an effective Q of approximately 4,000 for extremely sharp "peak" or "null." Use it to "peak" the desired signal or to "null" an undesired signal, or heterodyne. Tunes to any signal within the IF band-pass of your receiver. Also provides "broad peak" for conditions where extreme selectivity is not required.

Operates with any receiver having an IF frequency between 450 and 460 Kc. Will not function with AC-DC type receivers. Requires 6.3 volts AC at 300 ma. and 150 to 250 VDC at 2 ma. Derives operating power from your receiver. Uses a 12AX7 tube, and special High-Q shielded coils. Simple to connect with the cable and plugs supplied. Measures only 4-11/16"H.x7¾"W.x4¼"D. A really valuable addition to the receiving equipment in your ham shack.

MODEL QF-1  
**\$9<sup>95</sup>**

Shpg. Wt. 3 Lbs.

### 3 Heathkit VARIABLE VOLTAGE REGULATED POWER SUPPLY KIT

Provides well filtered DC output, variable from zero to 500 volts at no load and *regulated* for stability. Will supply up to 10 ma. at 450 VDC, and up to 130 ma. at 200 VDC. Voltage or current monitored on front panel meter. Also provides 6.3 VAC at 4A. for filament. Filament voltage isolated from B+, and both isolated from ground. Invaluable around the ham shack for supplying operating potentials to experimental circuits. Use in all types of research and development laboratories as a temporary power supply, and to determine design requirements for ultimate power supply.

MODEL PS-3  
**\$35<sup>50</sup>**

Shpg. Wt. 17 lbs.

### 4 Heathkit ANTENNA IMPEDANCE METER KIT

Use in conjunction with a signal source for measuring antenna impedance, line matching, adjustment of beam and mobile antennas, etc. Will double as a phone monitor or relative field strength indicator. 100 µa. meter employed. Covers the range from 0-600 ohms. An instrument of many uses for the amateur.

MODEL AM-1  
**\$14<sup>50</sup>**

Shpg. Wt. 2 lb.

### 5 Heathkit GRID DIP METER KIT

This is an extremely valuable tool for accomplishing literally hundreds of jobs on all types of equipment. Covering from 2 Mc to 250 Mc, the GD-1B is compact and can be operated with one hand. Uses a 500 µa. meter for indication, with a sensitivity control and headphone jack. Includes prewound coils and rack. Indispensable instrument for hams, engineers, or servicemen.

MODEL GD-1B  
**\$19<sup>50</sup>**

Shpg. Wt. 4 lbs.

**HEATH COMPANY**

A Subsidiary  
of Daystrom, Inc.

**BENTON HARBOR 20, MICHIGAN**

*Heathkits*  
**PROVIDE THE  
 "CONSTRUCTIVE"  
 APPROACH TO  
 HIGH-FIDELITY**



**EASY TO BUILD:** *The assembly instructions supplied with Heathkits are so complete and detailed that anyone can assemble the kits without difficulty. Plenty of pictorial diagrams and step-by-step instructions. Information on resistor color codes, soldering, use of tools, etc. Build-it-yourself with confidence!*



1

1 *Heathkit* **ADVANCED-DESIGN  
 HIGH FIDELITY AMPLIFIER KIT**

The 25 Watt Model W-5 is one of the most outstanding high fidelity amplifiers available today—at any price. Incorporates the very latest design features to achieve true "presence" for the super-critical listener.

Features a new-design Peerless output transformer, and KT66 output tubes handle power peaks up to 42 watts. The unique "tweeter-saver" suppresses high frequency oscillation. A new type balancing circuit results in closer "dynamic" balance between output tubes. Features improved phase shift characteristics and frequency response, with reduced IM and harmonic distortion. Color styling harmonizes with the Heathkit WA-P2 Preamplifier and the FM-3 Tuner.

Frequency response—within  $\pm 1$  db from 5 cps to 160 Kc at 1 watt. Harmonic distortion only 1% at 25 watts, 20-20,000 cps. IM distortion only 1% at 20 watts, using 60 and 3,000 cps. Output impedance 4, 8, or 16 ohms. Hum and noise—99 db below rated output. Uses two 12AU7's, two KT66's and a 5R4GY.

**KIT COMBINATIONS:**

W-5M Amplifier Kit: Consists of main amplifier and power supply, all on one chassis. Complete with all necessary parts, tubes, and comprehensive manual. Shpg. Wt. 31 lbs. Express only.

**\$59<sup>75</sup>**

W-5 Combination Amplifier Kit: Consists of W-5M Amplifier Kit listed above plus Heathkit Model WA-P2 Preamplifier Kit. Complete with all necessary parts, tubes, and construction manuals. Shpg. Wt. 38 lbs. Express only.

**\$79<sup>50</sup>**



2

2 *Heathkit* **DUAL-CHASSIS WILLIAMSON TYPE  
 HIGH FIDELITY AMPLIFIER KIT**

This is a very popular high fidelity amplifier kit that features dual-chassis type construction. The resulting physical dimensions offer an additional margin of flexibility in installation. It features the famous Acrosound TO-300 "ultra-linear" output transformer, and has a frequency response within  $\pm 1$  db from 6 cps to 150 Kc at 1 watt. Harmonic distortion only 1% at 21 watts. IM distortion at 20 watts only 1.3% at 60 and 3,000 cps. Rated power output is 20 watts. Output impedance 4, 8, or 16 ohms. Hum and noise—88 db below 20 watts. Uses two 6SN7's, two 5881's, and a 5V4G.

**KIT COMBINATIONS:**

W-3M: Consists of main amplifier and power supply for separate chassis construction. Includes all tubes and components necessary for assembly. Shpg. Wt. 29 lbs., Express only.

**\$49<sup>75</sup>**

W-3: Consists of W-3M Kit listed above plus Heathkit Model WA-P2 Preamplifier described on opposite page. Shpg. Wt. 37 lbs., Express only.

**\$69<sup>50</sup>**



3

3 *Heathkit* **SINGLE-CHASSIS WILLIAMSON TYPE  
 HIGH FIDELITY AMPLIFIER KIT**

This is the lowest priced Williamson type amplifier ever offered in kit form, and yet it retains all the usual features of the Williamson type circuit. Main amplifier and power supply combined on one chassis, and uses a new-design Chicago output transformer. Frequency response—within  $\pm 1$  db from 10 cps to 100 Kc at 1 watt. Harmonic distortion only 1.5% at 20 watts. IM distortion at rated output, 2.7% at 60 and 3,000 cps. Rated power output is 20 watts. Output impedance 4, 8, or 16 ohms. Hum and noise—95 db below 20 watts. Uses two 6SN7's, two 5881's, and one 5V4G.

Instructions are so complete that the kit may be assembled successfully even by a beginner in electronics.

**KIT COMBINATIONS:**

W-4AM: Consists of main amplifier and power supply for single chassis construction. Includes all tubes and components necessary for assembly. Shpg. Wt. 28 lbs. Express only.

**\$39<sup>75</sup>**

W-4A: Consists of W-4AM Kit listed above plus Heathkit Model WA-P2 Preamplifier described on opposite page. Shpg. Wt. 35 lbs. Express only.

**\$59<sup>50</sup>**

**HEATH  
 COMPANY**

A SUBSIDIARY OF DAYSTROM INC.

**BENTON HARBOR 20, MICHIGAN**

RADIO-ELECTRONICS

**ATTRACTIVELY STYLED:** *Heathkit high fidelity instruments are not only functional, but are most attractive in physical design. Such units as the preamplifier and the W-5 main amplifier are designed for beauty as well as performance. They blend with any room decor and are the kind of instruments you will be proud to own.*



*enjoy...*  
**THE VERY BEST  
 IN AUDIO WITH  
 "BUILD-IT-YOURSELF"  
 HEATHKITS**

**1** *Heathkit* HIGH FIDELITY  
**PREAMPLIFIER KIT**

This outstanding preamplifier is designed specifically for use with the Heathkit Williamson type amplifiers. It completely fulfills the requirements for remote control, compensation and preamplification, and exceeds even the most rigorous specifications for high fidelity performance.

Features five separate switch-selected input channels (2 low level and 3 high level), each with its own input control. Full record equalization with four-position turnover control and four-position rolloff control.

Output jack for tape recorder — separate bass control with 18 db boost and 12 db cut at 50 cps. — treble control offering 15 db boost and 20 db cut at 15,000 cps — special hum control to insure minimum hum level — and many other desirable features. Overall frequency response (with controls set to "flat" position) is within 1 db from 25 cps to 30,000 cps. Will do justice to the finest available program sources. Beautiful satin-gold finish.

Power requirements from the Heathkit Williamson type high fidelity amplifier — 6.3 VAC at 1 amp., and 300 VDC at 10 Ma. Uses two 12AX7's and one 12AU7.

MODEL WA-P2  
**\$1975**  
 Shpg. Wt. 7 Lbs.



**1**

**2** *Heathkit* 20-WATT HIGH FIDELITY  
**AMPLIFIER KIT**

This Heathkit Model offers you the least expensive route to high fidelity performance. Frequency response is  $\pm 1$  db from 20-20,000 cps. Features full 20 watt output using push-pull 6L6's, and incorporates separate bass and treble tone controls. Preamplifier and main amplifier are built on the same chassis. Four switch-selected compensated inputs and separate bass and treble tone controls provide all necessary functions at minimum investment. Features miniature tube types for low hum and noise.

Uses 12AX7, two 12AU7's, two 6L6G's and a 5V4G. A most interesting "build-it-yourself" project, and an excellent hi-fi amplifier for home use. Well suited, also, for public address applications because of its high power output and high quality audio reproduction. Another Heathkit "best-buy" for you!

MODEL A-9B  
**\$3550**  
 Shpg. Wt. 23 Lbs.

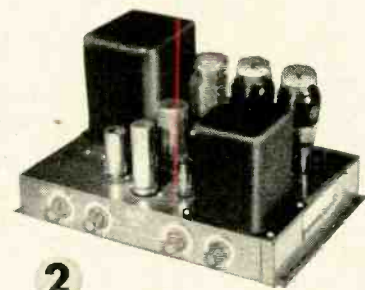

**2**

**3** *Heathkit* 7 - WATT  
**AMPLIFIER KIT**

The redesigned Model A-7D features a new type output transformer for tapped screen operation, and provides improved sensitivity, reduced distortion, and increased power output.

The full 7-watt output of the Model A-7D is more than adequate for normal home installations. Frequency characteristics are  $\pm 1\frac{1}{2}$  db from 20 to 20,000 cps. Potted output and power transformers employed. Push-pull output — detailed construction manual — top quality parts — high quality audio without great expense. Output transformer tapped at 4, 8, and 16 ohms. Bass and treble tone controls provided on the front chassis apron.

MODEL A-7D  
**\$1695**  
 Shpg. Wt. 10 Lbs.



**3**

Model A-7E: Provides a preamplifier stage with two switch-selected inputs and RIAA compensation for variable reluctance or low level cartridges. Preamplifier built on same chassis as main amplifier. Model A-7E. Shipping weight 10 lbs. \$18.50.

**HEATH  
 COMPANY**  
 A SUBSIDIARY OF DAYSTROM INC.

**BENTON HARBOR 20, MICHIGAN**

OCTOBER, 1955



the mass of the arm from affecting the compliance of the needle. Since modern hi-fi systems in many cases respond over a range of 10 to 100,000 cycles and since practically any material suitable for an arm of any size or form imaginable is capable of resonating somewhere in this range, the problem of resonance is a serious one and has stimulated many solutions.

The most novel solution is offered by the Gray viscous-damped arm which minimizes resonance effects by damping the arm with a film or pool of viscous fluid. The arm proper is supported by a single needlepoint pivot in the center of a ball and socket which are normally separated by a few thousandths of an inch. The needlepoint suspension insures virtually zero mechanical friction. The gap between the socket and ball is then filled with a special silicone fluid about the consistency of Vaseline, carefully chosen for its viscous properties. This layer of fluid serves as a sort of shock absorber to absorb and dissipate any vibrations transmitted by the arm. Varying the separation between the ball and socket, by a knurled adjusting screw, controls the thickness of the layer of fluid and thereby the amount of damping the film supplies. The farther apart the two surfaces, the less the damping; the closer together, the greater the damping.

I don't have any special facilities for measuring arm resonance but it usually shows up on the low-frequency sweeps of the Cook series 10 record, the five tracking bands of the Dubbings 100 or the low-frequency band of the Cook White Noise record. The natural resonance of the Gray arm is specified to be 18 cycles, but apparently it is all but completely damped out because I could find no noticeable trace of it.

But what happens to the compliance of the needle and the pickup? The viscous-damped arm appears to have an extremely high amount of friction when compared with arms using only low-friction bearings. In fact, the superficial friction of the Gray arm is so great that it takes several seconds for the arm to fall 1 inch. One would think that this would offer so much drag to the needle that compliance would be seriously affected. It is—for sudden or violent shocks or movements. But when a record revolves, the lateral movement of the arm is very slow and minute. The viscous fluid easily "falls into the groove" of this movement and offers no resistance to it. On the other hand, the vibrations produced by the modulations in the record groove are too rapid to overcome the friction; therefore, the needle and the needle only is affected by them.

This is the special virtue of the viscous damping—that its compliance is excellent at the slow rate needed to move the arm in the grooves, but poor for rapid fluctuations and shock. So it holds the needle firmly in position to be set in motion by the modulations of the

groove, without, as it were, stealing any of the vibrations from the needle as a friction-free arm would do, especially at low frequencies. In this way the arm achieves excellent damping without affecting the compliance of the pickup.

Aside from the minimization of resonance, the unconventional stiffness of the Gray arm has several very practical advantages of great value. For one thing, it is almost impossible to ruin a needle or record or cartridge by accidentally dropping the arm. For another, it is equally difficult for the arm to jump, skip or skate, making it almost immune to shock or vibration from speakers at low frequencies.

The first quality makes the arm especially useful when diamond needles are used in systems operated part of the time by children or unskilled operators. The second makes it equally useful where turntable and speakers have to be mounted in the same cabinet. There is a possible hazard. When a badly warped record is encountered, if the damping is high, it is possible that the stylus could either leave the groove at the high end of its travel, being suspended in air for an appreciable period before coming down, or it could even dig into the record and plow the groove.

However, on present-day equipment such distorted records are virtually unplayable anyhow because the warp produces high-amplitude thumps. Moreover, modern microgroove records seldom acquire so violent a warp. If it is desired to play such a warped record, it is possible to reduce the damping by turning the adjustment screw up. This will remove the friction and the arm will operate as a conventional undamped arm.

The Gray arm is very convenient to mount and to use. There are knurled nuts on the base, above the table, which can be adjusted to change the height above the table as well as to produce exact leveling and cartridge alignment with the record surface. Cartridges are mounted in quick-change slides. Weight or pressure is determined by weights on the slide, so that cartridges can be changed and the pressure maintained at optimum for each cartridge without the need for further adjustment. The arm comes with a wide assortment of slides and weights, sufficient to take care of just about every cartridge in use today. One precaution is likely to be overlooked by those who don't read the instructions carefully: the damping fluid insulates the arm from the base. The arm has three wire leads; one of these is to ground the arm—if it is not grounded, hum pickup will be marked.

**New records review**

*Note: Records below are 12-inch LP and play back with RIAA curve unless otherwise indicated.*

**STRAUSS (Johann, Jr., and Josef)**  
*Vienna Bonbons*  
**Anton Paulik and Vienna State Opera Orchestra**  
**Vanguard VRS-459**  
 Another in the really wonderful series of

Vanguard's Strauss recordings. *Egyptian March* (band 1, side 1) is an unsurpassed showoff and demonstration record. If you have one of those \$500 speaker systems that goes down at least to 30 cycles, the drum on this will split your shirt with puffed pride and even perhaps convince the missus that the speaker system was worth going without a new mink coat. It may not be true next month but, as of now, this is the lowest, dullest and biggest drum on records. There is also a beautifully sharp snare drum and plenty of all kinds of clean high-highs. The other Strauss waltzes, gallops and polkas will also please one and all both musically and from the standpoint of gorgeous sound.

**COPLAND: *El Salon Mexico***  
*Appalachian Spring*  
**Franz Litschauer and Vienna State Opera Orchestra**  
**Vanguard VRS-439 (NAB curve)**

Back in the old shellac days I considered the RCA Victor recording of *El Salon Mexico* the best single test material, and ever since LP's I've been waiting for a microgroove version profiting from modern techniques. This is it. The recording may be used to test the quality of almost any system but it is especially useful for testing for low distortion and cleanness. Copland wrote this in his best cliff-hanging style—teetering on the verge of violent dissonance but never quite going over. The horns especially are chorded exquisitely close to outright anarchy. But if the playback system is virtually undistorted and flat, the result is merely amusing and interesting—never painful or unpleasant. The definition should permit the distinction of the horns in the choirs and the clever polyphony. The bass is nicely dull and free of boom, the drum is prodigious, there are excellent percussive transients and plenty of high-highs. Despite the dissonances there should be nothing harsh or unpleasant about this. If there is, it's 100 to 1 your system is distorting badly somewhere.

*Appalachian Spring* is a happy coupling from all points of view. A sustained note in the opening is excellent for testing wow—very delicately "dissonant" choirs of strings, winds and brass should always sound clean and pleasant. In addition, there are some sharp transients in section four, plenty of high-high shimmer and again a fine bass. Once you've become acquainted with the sound of this music on a top-notch system, you can test any equipment for just about anything. The music is possibly the easiest of all "modern" music to take. There is a touch of distortion on a couple of peaks; otherwise, it is beautifully clean.

**RESPIGHI: *The Birds***  
*Ancient Airs and Dances*  
**Franz Litschauer and Vienna State Opera Orchestra**  
**Vanguard VRS-533 (LP curve)**

*The Birds* is another old favorite of mine both for the music and for testing and this is a grand recording of it. Of all recent composers Respighi was probably the most fascinated by sound as such. It seems to me that melody to him was always a mere vehicle on which to parade a variety of astonishing sound effects. Here he gives some very impressionistic but nevertheless highly faithful imitations of various birds. The melodies are from scores by ancient composers; the orchestration is pure Respighi. Especially notable in the *Dove* is the extremely high bird-talk by a solo fiddle—it must be about as high as a fiddle can go. *Ancient Airs and Dances* is extremely pleasant music. In the *Bells of Paris* the double basses imitate the beat notes of multiple church bells. This needs a response to 40 cycles or lower but is most impressive when you've got it. There is some recorder noise under the music. If you listen just before and just after the music starts, you will hear it—if your own system is free of noise.

**ROSSINI: *Seren Great Overtures***  
**Mario Russo and Vienna State Opera Orchestra**  
**Vanguard VRS-456**  
*Tancredi, Siege of Corinth, Turk in Italy, Italian in Algiers, Semiramide, Cinderella, Journey to Rheims* cover Rossini's strange composing career thoroughly and this is unquestionably the most spectacular version of these works. There is a little of everything here

INSURE CUSTOMER SATISFACTION . . .

# OHMITE®



*Little Devil*®  
**COMPOSITION  
RESISTORS**

Provide an  
**EXTRA MARGIN  
OF SAFETY**

• You can eliminate "call-backs" and insure customer satisfaction by standardizing on Ohmite "Little Devil" composition resistors. These tiny units provide an *extra margin of safety* on your repair jobs. For example, they are rated at 70C instead of the usual 40C . . . and they meet all test requirements of MIL-R-11A, including salt water immersion and high humidity tests without wax impregnation. Ohmite "Little Devil" resistors are available in 1/2, 1, and 2-watt sizes ( $\pm 5\%$  or  $\pm 10\%$  tolerance) in all RETMA values. Order from your distributor, today.

Other Dependable  
OHMITE Products

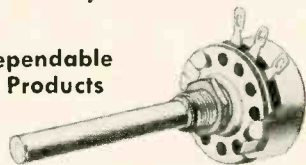

Type AB Noise-Free Potentiometers

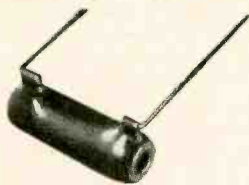

BROWN DEVIL Wire-Wound Resistors

Be Right with  
**OHMITE®**

**DEPENDABLE RESISTANCE UNITS**



Write for  
Stock  
Catalog

OHMITE MANUFACTURING CO.  
3646 Howard Street, Skokie, Illinois  
(Suburb of Chicago)

## AUDIO—HIGH FIDELITY

from that wonderful big drum, excellent string bass to an occasional touch of brassy highs. Above all this is at least as good as any record I know of for testing power output capacity. There are some very terrific but clean peaks (especially on the *Siege of Corinth*). If you set gain controls to give an output about 25 db below maximum on average material, the peaks will just about break into the maximum power output level and you can see what happens.

**PROKOFIEFF: Peter and the Wolf**  
**BRITTEN: Young People's Guide to the Orchestra**

Hans Swarowski and Pro Musica Symphony of Vienna Vox PL-9280

Here is one of the most sensible and happy couplings on records. The two works are outstanding examples of their type. *Peter and the Wolf* is now an old favorite with everyone from 6 to 90. The Britten piece is more recent but coming up fast. Each introduces the listener to the orchestra in a different way. Thus the instruments play solo on the Prokofieff side but in choirs on the Britten side; the Peter is closely miked, the other more remotely. The tonal color of the instruments (presumably they are identical) is very different. This is fine stuff for testing "naturalness" and instructive and enjoyable as music. Again there is a little recorder noise under the music which provides a good test for signal-to-noise ratio. I have only one objection: the voice dubbed in New York, apparently, is out of scale. If you play the record loud enough to hear the music plainly, the voice is like the wrath of God.

**PROKOFIEFF: Chou (complete)**

*Lieutenant Kije Suite*

Jascha Horenstein and Paris Philharmonia Orchestra Vox PL-9180

*Chou* is rather esoteric music which will appeal most to fanciers of Prokofieff, like myself. *Lieutenant Kije*, however, is very easy to take and one of the best examples of Prokofieff's ironic humor. The sound is brilliant. The solo instruments have great presence and a beautiful tone. The bass outdoes Vox' previous best. They have also, it seems, abandoned the LP treble equalization so that with RIAA equalization the highs are no longer shrill. Those who enjoy the double bass may like to have this because *Lieutenant Kije* there are several examples of melody lead by the double basses.

**LISZT: Les Preludes**

**BRAHMS: Academic Festival Overture**

**SIBELIUS: Finlandia**

**WAGNER: Siegfried Idyll**

Heinrich Hollresiser and Bamberg Symphony Vox PL-9350

Excellent versions of these old symphonic war horses. A full round sound; clean nice bass, sharp strings, samples of triangles, etc., well defined and with good overall presence. Just a touch of distortion in *Finlandia*.

**BIZET: Roma (Ballet version)**

**CHABRIER: Bourrée Fantastique (Ballet version)**

Leon Bazin and New York City Ballet Orchestra Vox PL-9320

Another of the new series of Vox records made in the U. S. and very good indeed, with a very live, resonant and opulent sound. The music is pleasant, stressing strings on the Chabrier side and brass on the Bizet.

**Brute Force Steel Bands Cook 1042**

In the West Indies since the end of the war an amazing music has grown rapidly around instruments fabricated entirely from oil drums, wonderfully tuned chromatically and made in consorts from counter-bass up and simulating the sound of such normal instruments as plucked double basses, xylophone, celeste, etc. To these consorts of drums are added typical Caribbean rattlers, a few voices, the pervasive chirping of a cricket and in one spot the sound of the surf on the beach. You will enjoy this thoroughly and on the best systems the bass will be astonishing.

END  
Names and addresses of manufacturers of any items mentioned in this column may be obtained by writing Monitor, RADIO-ELECTRONICS, 25 West Broadway, New York 7, N.Y.



**She:** *But, how do I know this is a good tube?*

**You:** *Because, this is a CBS aluminized Mirror-Back picture tube. There aren't any better.*

**She:** *And I see it has the Good Housekeeping Guaranty Seal, too. That's proof enough for me.*

Customer confidence really counts when it comes to the big tube. That's when CBS tube advertising helps you most. For CBS tubes have the Good Housekeeping Guaranty Seal and are nationally advertised to 76.9% of your customers . . . the women of America. And 53% of these women are influenced in their purchases by that seal of approval. You protect yourself and gain your customer's good will when you install a new CBS aluminized Mirror-Back picture tube.

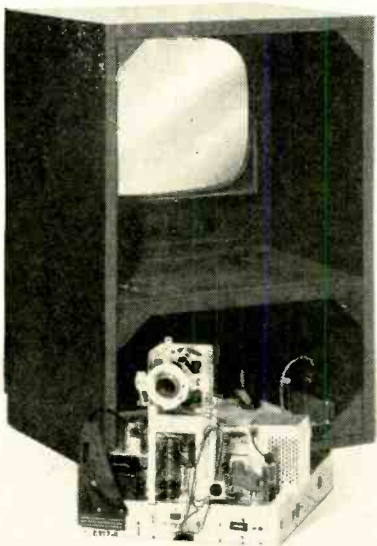

Show her the CBS carton with the Good Housekeeping Guaranty Seal.



**CBS-HYTRON**, Danvers, Massachusetts . . . A DIVISION OF COLUMBIA BROADCASTING SYSTEM, INC.

# TROUBLESHOOTING HORIZONTAL A.F.C. SYSTEMS



By CYRUS GLICKSTEIN

Fig. 1—Cogwheel or piecrust pattern.

**M**OST troubles originating in horizontal a.f.c. circuits cause poor horizontal synchronization. This includes horizontal instability (horizontal bend, pulling or picture twist; touchy horizontal hold; tearing; horizontal jitter; intermittent loss of horizontal sync); hunting (Fig. 1); complete loss of horizontal sync; out-of-phase picture (Fig. 2); phasing ghost (Fig. 3). Occurring less often, due to horizontal a.f.c. circuit troubles, are horizontal foldover and, in some types of a.f.c. systems, a blank screen.

Methods for localizing horizontal circuit troubles were discussed in detail in a previous article ("Tracking Down Horizontal Instability," August and September, 1954), and it is assumed the source of trouble has been localized to the a.f.c. circuit.

The purpose of that circuit is to stabilize the horizontal sweep frequency by comparing the incoming horizontal sync pulses with the internally generated horizontal sweep frequency in the receiver. If the frequencies are different, a d.c. correction voltage (either positive or negative) is developed. This voltage is applied to the grid of the horizontal oscillator (or to a reactance tube in the Synchrolock system) to return it to the correct frequency.

The four most popular a.f.c. systems in use are:

1. *Phase detector* (Fig. 4). In this system, a square wave is taken from the horizontal output circuit and integrated (fed through R5-C5 with the output taken across the capacitor). The resultant sawtooth wave is applied to one plate and one cathode of a dual diode (pins 5 and 7 of a 6AL5). Positive horizontal sync pulses are applied to the other diode plate (pin 2) and negative horizontal sync pulses to the other cathode (pin 1) of the 6AL5. When the sync pulses and sawtooth are the same frequency and in phase, no a.f.c. output voltage is developed. When the horizontal sawtooth is at a different frequency or out of phase compared to the sync pulses, one or the other of the diodes conducts. Either a positive or a negative d.c. voltage is then developed at the grid of the horizontal oscillator.

This brings the oscillator back to the correct frequency or phase.

2. *Synchroguide (pulse width)* (Fig. 5). This system consists of a horizontal control tube which varies the bias at the grid of the horizontal oscillator, varying its frequency accordingly.

A signal consisting of a horizontal sync pulse and a horizontal sawtooth wave from the horizontal oscillator is applied to the grid of the control stage. The horizontal sync pulse riding on the top portion of the composite waveform is large enough to bring the control tube out of cutoff. When this tube conducts, a positive d.c. voltage is developed at the cathode and the junction of R2-R3. This bucks the negative voltage across R4, part of the grid return of the horizontal oscillator tube. The frequency and phase relationship between the horizontal sync pulse and the horizontal sweep waveform determines the width of the most positive part of the composite waveform. The pulse width, in turn, determines how long the control tube conducts, and therefore how much positive voltage is developed at the cathode and applied to the grid return of the oscillator to cancel out part of the negative voltage at this grid.

A change in the positive voltage at the control tube cathode means a change in the amount of negative voltage at the horizontal oscillator grid, thereby changing the horizontal frequency.

3. *Synchrolock* (Fig. 6). The oldest of the a.f.c. systems is still used in 630 type receivers, among others. One input, a sine wave at the horizontal sweep frequency, is generated in the horizontal oscillator and applied to the sync discriminator through the sync discriminator transformer. This is compared with a second input, the incoming horizontal sync pulses from the sync amplifier. If the sine-wave voltage changes frequency or goes out of phase with the horizontal sync pulses, a d.c. correction voltage is generated and applied to the grid of the horizontal oscillator control (reactance) tube. This d.c. voltage varies the reactance of the tube, which is in parallel with the horizontal oscillator tank circuit, and corrects the oscillator frequency. The sine wave at the grid of the

horizontal oscillator is squared off at the plate and differentiated by C4 and R3. The resulting pulses trigger the discharge stage (sawtooth generator) at the correct horizontal frequency.

4. *Triode phase detector* (Fig. 7). The general operation of this circuit is similar to the phase detector of Fig. 4. A triode is used instead of a dual diode. The negative horizontal sync pulse input is applied to the cathode of the phase detector. The horizontal sweep waveform is applied to the plate. When the frequency is too low, the sawtooth voltage at the plate is negative when the sync pulse is applied to the cathode. The grid draws current, producing a negative voltage at the phase detector grid. The grid and cathode act very much as a diode rectifier circuit. The pulsating negative voltage is filtered by the R-C circuit connected to the phase detector grid and the resulting negative d.c. voltage is applied to the oscillator grid, increasing the frequency to the original value.

When the frequency is too high, the plate of the phase detector is positive and more cathode current flows. The higher cathode voltage makes the grid more positive since R1 connects grid to cathode. The filtered positive d.c. voltage is applied to the horizontal multivibrator grid, making the frequency decrease to the correct value.

## Horizontal instability

This is one of the most usual symptoms resulting from a horizontal a.f.c. circuit defect. The most common cause in all systems is a defective a.f.c. tube (this includes the reactance tube in the Synchrolock system). Another common cause is misalignment of the horizontal sweep circuit resulting from aging of tubes or other circuit components. If tube changes do not cure the condition, realign the horizontal sweep circuit according to manufacturer's specifications. If realignment is not effective, then test for a defective component.

Horizontal bend can be caused by an unbalance of horizontal sync pulses to the phase detector tube (pins 1 and 2, Fig. 4). To check for unbalance note the peak-to-peak amplitude of incoming

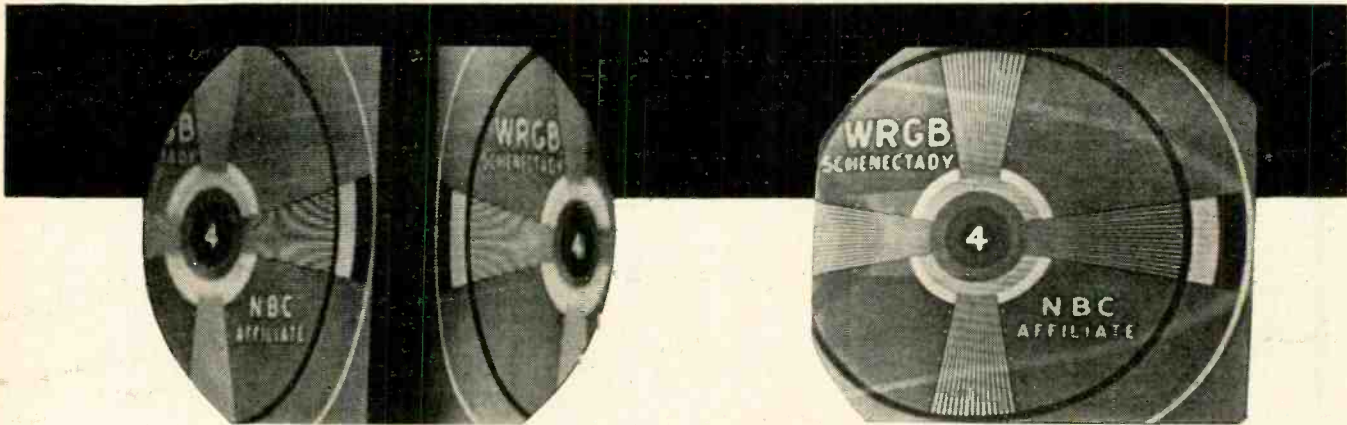

Fig. 2—This picture is out of phase.

Fig. 3—A horizontal phasing ghost.

Photos courtesy G-E Techni-talk

horizontal sync pulses with an oscilloscope and see whether they are within tolerance of the manufacturer's specifications. If not, the component values in the sync circuit should be checked.

In some cases, manufacturers have recommended modifications of the a.f.c. circuit to improve stability. For example, two of the many causes of horizontal bend are insufficient filtering of the d.c. correction output voltage from the a.f.c. stage and poor choice of capacitor value at various points in the a.f.c. circuit. If there is a bend or hook in the top of the picture in a receiver with a phase detector, triode phase detector or Synchrolock circuit, it may be helpful to change the output filter capacitor from .05 to 0.1  $\mu$ f (C4, Fig. 4; C2, Fig. 6; C2, Fig. 7). Increasing the value of this capacitor improves the filtering of the d.c. control voltage of the a.f.c. system.

When bend appears in sets which have been functioning normally for some time, one possible cause is a decrease in the capacitance of the output filter capacitor in the a.f.c. stage.

Replacing the output filter capacitor can cause bend or other kinds of instability. This capacitor is usually a molded-phenolic paper-dielectric type. The outside foil should be connected to ground. If the leads are reversed, stray pulses can be picked up, causing instability. In these capacitors the outside foil is indicated by a solder or plastic bump at the base of one pigtail just outside the plastic case. Leads should be short and the capacitor mounted close to the chassis.

To reduce horizontal pulling at the top of the picture in some triode phase detector circuits, one manufacturer recommends adding a .001- $\mu$ f capacitor between the cathode of the phase detector and ground (Fig. 7). This provides additional filtering of the a.f.c. correction voltage in this circuit.

Other modifications suggested by various manufacturers to improve a.f.c. action as it affects horizontal stability are:

1. In the Synchrolock circuit (Fig. 6), add another .004- $\mu$ f capacitor in parallel with C1 if C2 is changed to 0.1  $\mu$ f.

2. To minimize erratic horizontal sync (flagging at the top of the picture), change C1, C2 (Fig. 4) to 500  $\mu$ f.

3. To eliminate all trace of jitter, a 1.3-ohm resistor in series with the phase detector heater is recommended in some circuits to lower the heater voltage and minimize the effect of changing tubes.

**Hunting**

The horizontal oscillator keeps going above and below the correct frequency—"hunts" for it. The effect may range from a cogwheel or pierce pattern in severe cases (Fig. 1) to a mild horizontal bend. Hunting is caused by a failure in the anti-hunt circuit or associated components.

In Fig. 4, the anti-hunt circuit C3, R4 operates with R1, R2, R3 and C4 to develop the output correction voltage. This is true in all a.f.c. systems. The

anti-hunt circuits in the other systems are: R1, C1 in Fig. 5 and R2, C1 in Fig. 7.

In servicing receivers with a cogwheel pattern or horizontal bend, the anti-hunt circuit and associated components should be checked for correct values and for capacitor leakage. While the prime suspect is the anti-hunt circuit, the other components may also be responsible. To eliminate flag waving or bending at the top of the picture, one manufacturer recommends that a 10,000-ohm resistor in series with a 0.22- $\mu$ f capacitor be placed across C2 (Fig. 6).

**Loss of horizontal sync**

A complete loss of horizontal sync may be due to an open or shorted a.f.c. output filter capacitor which charges to the d.c. control voltage; an open or shorted coupling capacitor applying

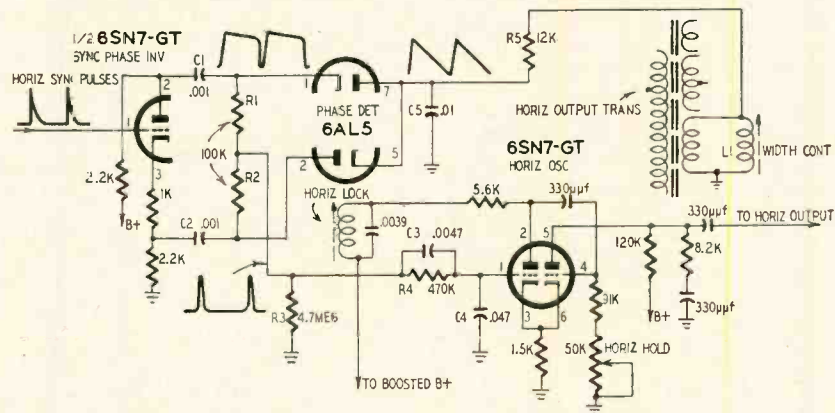

Fig. 4—Diagram of diode phase detector automatic frequency control circuit.

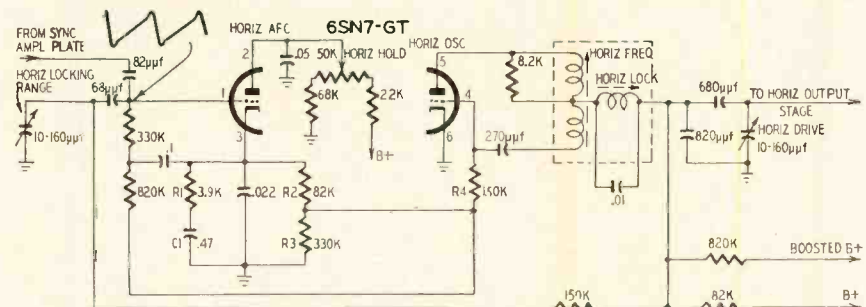

Fig. 5—Diagram of RCA's popular Synchroguide (pulse width) a.f.c. circuit.



Let me send you the entire story—FREE

Just fill out the coupon and mail it. I will send you, free of charge, a copy of "How to Pass FCC License Exams," plus a sample FCC-type Lesson, and the valuable booklet, "Money-Making FCC License Information."



CARL E. SMITH, E. E.  
President

I can train you to pass your FCC License Exams in a minimum of time if you've had any practical experience—amateur, military, radio servicing, etc. We can put you on the road to success.

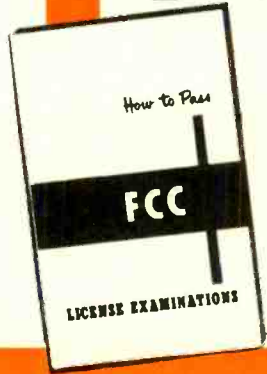

**FREE**

Tells where to apply and take FCC examinations, location of examining office, scope of knowledge required, approved way to prepare for FCC examinations, positive method of checking your knowledge before taking the examination.



GET YOUR FCC TICKET IN A MINIMUM OF TIME

Get this Valuable Booklet **FREE**

**TELLS HOW**

**WE GUARANTEE YOUR FCC LICENSE**

TO TRAIN AND COACH YOU AT HOME IN SPARE TIME UNTIL YOU GET YOUR FCC LICENSE.

If you have had any practical experience—amateur, military, radio repair, experimenting, etc.



**TV ENGINEERING INCLUDED IN OUR TRAINING & COACHING**

THE ONLY HOME STUDY COURSE WHICH SUPPLIES FCC TYPE EXAMINATIONS WITH ALL LESSONS AND FINAL TESTS.

Your FCC ticket is recognized by employers in all phases of Electronics as proof of your technical ability.

**HERE IS YOUR GUARANTEE**

If you fail to pass your Commercial License exam after completing our course, we guarantee to continue your training without additional cost of any kind, until you successfully obtain your Commercial license.

**TELLS HOW**

**Our Effective JOB FINDING Service Helps CIRE Trainees Get Better Jobs —**

**Here are a few recent examples of Job-Finding results.**

**ELECTRONICS TECHNICIAN:**

"I am now employed by the Collins Radio Company as a Lab Technician. (This job was listed in your bulletin). I have used the information gathered from your course in so many ways and I know that my training with CIRE helped me a great deal to obtain this job."

Charles D. Sindelar, Cedar Rapids, Iowa

**AIRLINES**

"I replied to the Job Opportunities you sent me and I am now a radio operator with American Airlines. You have my hearty recommendation for your training and your Job-Finding Service."

James A. Wright, Beltsville, Md.

**INDUSTRIAL ELECTRONICS**

"Upon my discharge from the Navy I used your Job-Finding Service and as a result I was employed by North American Aviation in electronic assembly (final checkout)."

Glen A. Furlong, Fresno, Calif.

**TELLS HOW**

**Employers make JOB OFFERS**

**Like These To Our Graduates Every Month**

**Broadcast Station in Illinois:**

"We are in need of an engineer with a first class phone license, preferably a student of CIRE; 40 hour week plus 8 hours overtime."

**West Coast Manufacturer:**

"We are currently in need of men with electronics training or experience in radar maintenance, and we would appreciate if you will refer interested persons to us."

**HERE'S PROOF FCC LICENSES ARE OFTEN SECURED IN A FEW HOURS OF STUDY WITH OUR COACHING AT HOME IN SPARE TIME.**

	License	Time
A/1C Ronald H. Person, St. Louis 20, Mo.	1st	25 weeks
Carl Verboomen, Wrightstown, Wis.	1st	18 weeks
Marvin F. Kimball, Lafayette, Ind.	2nd	21 weeks
L. M. Bonino, Hurlington AFB, Tex	2nd	16 weeks
John E. Hutchison, Bluefield, W. Va.	1st	27 weeks

An Approved Member



**Mail This Card Now**  
NO POSTAGE REQUIRED

**Get All 3 FREE**



**CLEVELAND INSTITUTE OF RADIO ELECTRONICS**  
Desk RE-81, 4900 Euclid Bldg., Cleveland 3, Ohio

I want to know how I can get my FCC ticket in a minimum of time. Send me your FREE booklet, "How to Pass FCC License Examination" (does not cover exams for Amateur License), as well as a Sample FCC-type lesson and the amazing new booklet "Money-Making FCC License Information." Be sure to tell me about your Television Engineering Course.

PLEASE PRINT CAREFULLY

NAME \_\_\_\_\_ AGE \_\_\_\_\_

ADDRESS \_\_\_\_\_

CITY \_\_\_\_\_ ZONE \_\_\_\_\_ STATE \_\_\_\_\_

Special tuition rates to members of the U. S. Armed Forces.  
Electronic Training Available To Canadian Residents.

**CLEVELAND INSTITUTE OF RADIO ELECTRONICS**

CARL E. SMITH, E. E., Consulting Engineer, President

4900 Euclid Bldg., Cleveland 3, Ohio

See our ad on next page



CARL E. SMITH, E.E.,  
President

# INTERESTED IN

# ELECTRONICS- TV-RADIO

THEN YOU  
WILL WANT  
TO KNOW

## What is the FCC?

How Can I get a Valuable  
**FCC** COMMERCIAL Radio Operator **LICENSE**  
MY PASSPORT TO FUTURE SECURITY

It's amazing what the future holds for you in this modern world of electronics. Let me send you the entire story—FREE!

Find out how your FCC License will be your guarantee of a bright future and employment security in all branches of Electronics—the world's fastest growing industry!

JOIN THE LIST OF SUCCESSFUL **HERE'S PROOF**  
ELECTRONIC TECHNICIANS

	License	Time
Harry G. Frame, Charleston, W. Va.	2nd Class	13 weeks
Charles Ellis, Charles City, Iowa	1st Class	28 weeks
Omar Bibbs, Kansas City, Mo.	1st Class	34 weeks
Kenneth Rue, Dresser, Wisconsin	2nd Class	20 weeks
B. L. Jordan, Seattle, Washington	1st Class	20 weeks

AND THOUSANDS MORE!

## GET THESE FREE



These Three Booklets Tell You . . .

1. Where to apply to take FCC Examinations.
2. Scope of knowledge required.
3. Necessary FCC exam preparation.
4. Positive knowledge check.

And additional data of great value.

## IMPORTANT

SEE OTHER SIDE FOR MORE INFORMATION

## HERE IS YOUR GUARANTEE

WE GUARANTEE to train and coach you at home until you pass the all-important FCC examination . . . If you fail to pass after completing our course, we will continue your training without additional cost until you successfully obtain your commercial license.

THROUGH US—START BUILDING FOR A PROFITABLE LIFE-TIME PROFESSION.



NATIONAL HOME  
STUDY COUNCIL  
Approved Member

EMPLOYERS MAKE JOB OFFERS EVERY MONTH!  
YOUR FCC TICKET IS RECOGNIZED BY MOST EMPLOYERS IN THE ELECTRONICS FIELD AS PROOF OF YOUR TECHNICAL ABILITY. PAVE THE WAY FOR YOUR SHARE OF THE BETTER THINGS IN LIFE.

If You're in the Armed Forces PLAN NOW for

### PRESENT and FUTURE SECURITY

- 1 Use your spare time, NOW, while you are in the armed forces, to prepare for the FCC license examinations, and get your FCC Commercial License.
  - 2 Shortly before discharge, use our EFFECTIVE JOB-FINDING SERVICE to get your choice of good-pay jobs.
- Special tuition rates to members of the U. S. Armed Forces.

### FORMER NAVY MAN GETS JOB AT COLLINS RADIO

"Since my discharge from the Navy, I have been working for Collins Radio Company at Cedar Rapids, Iowa, one of the job opportunities you listed. I am giving a lot of credit to your course for helping me in passing the qualifications exam at Collins."  
Howard Johnson, Marion, Iowa

### NORTH AMERICAN EMPLOYERS EX-ARMY MAN

"I am employed by North American Aviation as an electronic technician. Their name was received from you while I was in the service overseas. The lessons I completed played a big part in helping me pass their screening examinations.  
Vernon Skovgaard  
Los Angeles 6, Calif.



### BUSINESS REPLY CARD

FIRST CLASS PERMIT No. 8885, Sec. 34.9, P.L.R., Cleveland, Ohio

Cleveland Institute of Radio Electronics  
4900 EUCLID AVENUE  
CLEVELAND 3, OHIO

TEAR OUT AND MAIL THIS CARD NOW!

Desk RE-81



## TELEVISION

the picture extends beyond the visible portion of the screen.

(Other types of horizontal foldover originate only as the result of defects in the horizontal sweep circuit. These can be easily identified by indications on the picture or raster—wide vertical stripes or broad vertical foldover sections. When the horizontal sawtooth output is distorted, a definite horizontal nonlinearity is evident in the picture.)

### Out-of-phase picture

In the Synchrolock system (Fig. 6), an out-of-phase condition may simply indicate aging of circuit components and may be eliminated by readjusting the phasing control (secondary of T1). If rotating this control does not bring the picture back into phase, the most likely causes of trouble are: defective 6AC7, 6AL5 or 6K6; change of value in R2, R4, R5 or R3; C3 open; defective discriminator transformer.

The other a.f.c. circuits do not have phasing adjustments as such. Therefore, an out-of-phase condition in these circuits indicates a defective component. If tube changes—a.f.c. and horizontal oscillator—do not cure the trouble, the fault is generally at the point where the horizontal sweep voltage is fed to the a.f.c. circuit. In these systems a portion of the horizontal sweep voltage is fed back to the a.f.c. circuit for comparison with the incoming sync pulses. The R-C network which feeds the sweep voltage to the a.f.c. stage affects the phase relationship between the sawtooth voltage and the incoming sync pulses; for example, R5, C5 in Fig. 4.

Any change of component value in this network or a component breakdown can cause incorrect phasing, a phasing ghost or horizontal foldover even though the horizontal hold and lock controls are correctly adjusted. The most likely causes for an out-of-phase condition in the phase detector system (Fig. 4) are: a defective C5, R5, L1 or secondary from which the waveform is tapped off.

In a receiver using the triode phase detector circuit of Fig. 7, an early value of C3 was .0047  $\mu$ f. The manufacturer subsequently recommended the value be changed to .002  $\mu$ f (1,000 volts) to cause the picture to start at a point farther to the right and permit easier centering without neck shadows.

### Phasing ghost and horizontal foldover

These may be due to incorrect adjustment of the horizontal hold or lock control or to a defective part. If the horizontal hold is rotated to one extreme and just fails to make the phasing ghost disappear, and a tube change (a.f.c. or horizontal sweep) does not help, realign the horizontal circuit. If realignment fails to eliminate the phasing ghost, the components which can cause an out-of-phase condition should be checked. These components can also be responsible for the type of horizontal foldover which is an exaggerated form of a phasing ghost. END

# 64% of the top Engineers

## PREFER AND USE

# HICKOK

### DYNAMIC MUTUAL CONDUCTANCE

# TUBE TESTERS

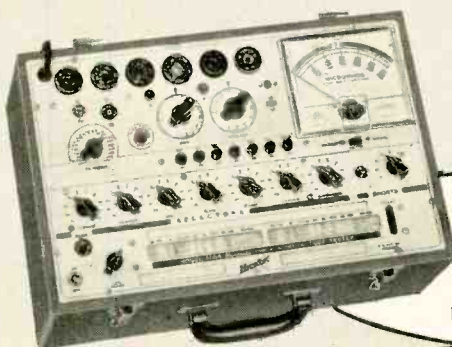

MODEL  
600A

World's most popular  
Tube Tester

"... that 600A is certainly unbeatable! I have sold 4 for you by just letting service centers use mine for part of one day."

Harold F. Tolles, St. Johns, Mich.

"I purchased a 600A last Fall and have found it to be one of the best investments in test equipment that I have ever made."

R. Lytwyn, Nytl Electronics

All tube testers manufactured today fall into four major classifications.

If you use vacuum tubes in your profession, and if you ever intend to purchase a tube tester please write today for the 28 page book of Tube Tester Facts and learn the advantages of each classification in order that you will be able to more efficiently select for your requirements.

This detailed, illustrated and descriptive book also contains circuit diagrams and formulas.



## THE HICKOK ELECTRICAL INSTRUMENT CO.

10531 DUPONT AVE.

CLEVELAND 8, OHIO

Gentlemen:

Kindly send me free of charge your new 28 page book of Tube Tester Facts.

NAME \_\_\_\_\_

COMPANY \_\_\_\_\_

STREET \_\_\_\_\_

CITY \_\_\_\_\_ ZONE \_\_\_\_\_ STATE \_\_\_\_\_

# TELEVISION . . . it's a cinch

*Eighteenth conversation, second half:  
The color tube; three guns or one; TV  
is just starting out; a sure future*

By E. AISBERG

From the original "La Télévision? . . . Mais c'est très simple!" Translated from the French by Fred Shunaman. All North American rights reserved. No extract may be printed without the permission of RADIO-ELECTRONICS and the author.

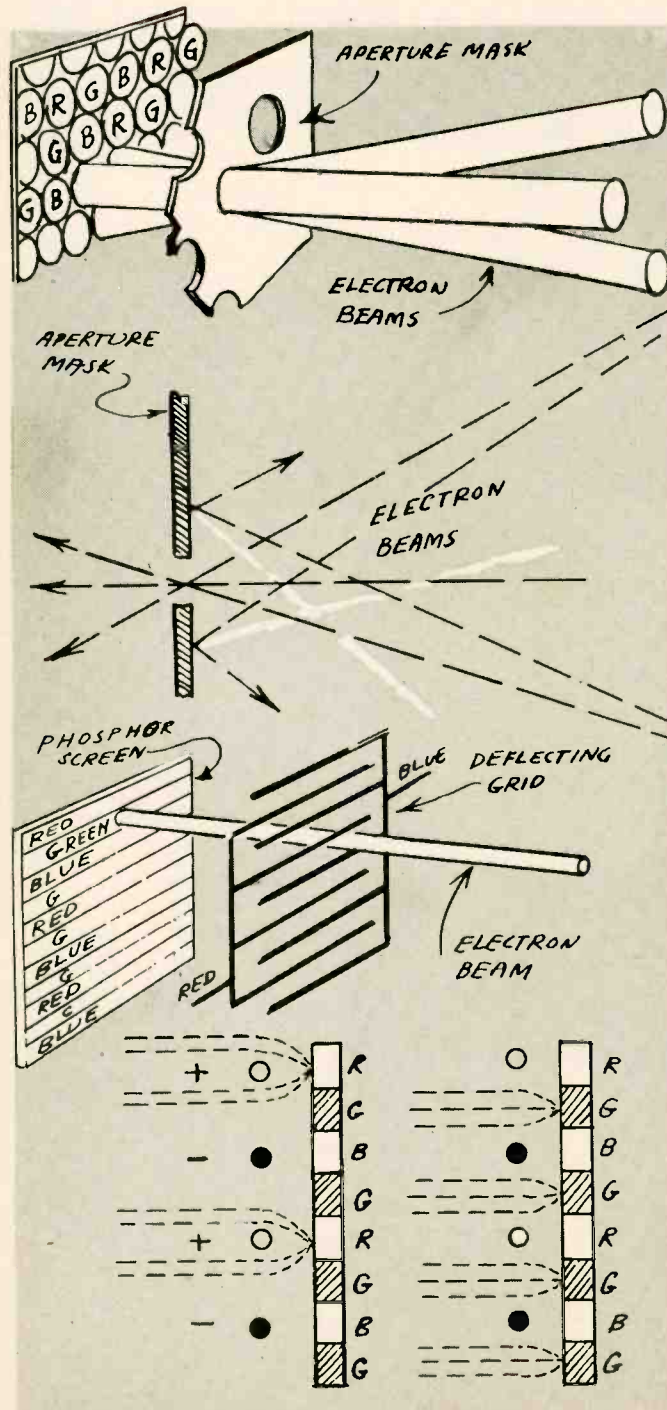

WILL—Could you go over the receiving picture tube lightly? Just how does it work?

### A three-gun battery

KEN—In the three-gun tube, the screen is composed of a pattern of phosphor dots, each of which luminesces in one of the three primary colors. Each of the three guns is triggered by one of the primaries and is so "aimed" that its beam contacts the dots of its own primary color.

WILL—That must be some aiming! The dots would be at least as small as those at my color printer's. And the beam is skipping along from one to the other at several miles a second. Just how is this miracle aiming done?

KEN—It's not so much a matter of good aiming at the desired spots as an ingenious method of keeping the beam from one gun off the other guns' territory. That's done by inserting a "mask" between the guns and the screen—close to the screen. It's a sort of partition pierced with thousands of tiny holes. Each beam, after it goes through one of the holes, must fall on a spot of the correct color.

WILL—That is a bright idea. Ingenious is right!

KEN—Yes, and it also takes a lot of ingenuity to work out the idea, particularly in mass production!

WILL—Is the one-gun tube simpler or easier to make?

### Three in one

KEN—The one-gun tube is the invention of Dr. Lawrence of Cyclotron fame. Its screen is divided into color stripes instead of the dots of the color-mask tube. A little ahead of this striped screen is a grid of fine wires. I should say two grids, because half of the wires are connected together and are directly behind the blue stripes in the screen. The other half—also connected in parallel—are behind the red stripes. If—say—the red grid is positive, electrons passing just above one of the red grid wires will be bent down and those passing just below will be bent up, so they'll both strike the red strip . . .

WILL— . . . and the same is true of the blue. But how about the green?

KEN—If the two grids are at the same potential, electrons passing halfway between go straight ahead to the green strip. And—because the screen is at a potential of several thousand volts higher than the grid, electrons passing near the red and blue grids are actually bent away from them and turned toward—or focused on—the green strip.

WILL—Aha! the post-deflection tube?

KEN—Exactly. Now the electrons are kept moving up and down at a frequency of 3.58 mc by a power amplifier coupled to a coil between the two grids. That coil and the grids form a resonant circuit at approximately 3.58 mc, making it easier to drive.

WILL—But wait a minute! According to that, the spot will be moving up and down all the time as it sweeps across the line. Your red and blue grids will simply be acting like a spot wobbler, whether the color is red, green or something else. Surely the beam will sweep along the red line only when there is a red signal . . .



KEN—No, Will, just the opposite. You get a red signal only when the beam is on the red line. The tube is *gated* so that the red signal comes in only when the beam is on the red strip. For example, if you were receiving a pure saturated blue, the beam would be cut off all the time it was on the red and green stripes and would be at maximum strength when it was on the blue.

WILL—But that fine detail you were telling me about?

KEN—Fine detail is black-and-white and is handled the same on both kinds of tubes. White is produced by all color signals working together. In other words, you get the fine detail by feeding it to all color areas—whether dots or stripes—at the same time in proportions which give a black-and-white picture. And if you want a *desaturated* color—a pink for instance—you simply feed some signal into the blue and green channels as well as the red. Part of the red then combines with the green and blue to make white. That dilutes or desaturates the red signal and you get pink.

WILL—Yeah, sounds plausible. I guess we *will* have to get together for another series of conversations on color. But, who knows, maybe something else will turn up before I learn all about color?

KEN—You can be almost certain something will, for TV is still a long way from its final form and studying it is a permanent job. That's one of its main attractions—it's anything but static. Television has now reached about the same degree of perfection as the movies. Like them, it has sound and color. Like the movies, too, it will have little trouble conquering the third dimension for some of the 3D techniques used in moving pictures work just as well on TV. TV is also like the movies in that it has much wider fields of use than mere entertainment. It is being widely used in its closed-circuit form for instruction, conferences, inspection and control, and its capabilities along these and possibly other now unknown lines can't even be guessed at. There's plenty to be done. If you make a career of television, you won't be bothered by limits to your chosen field!

WILL—Do you really think that with what I've learned so far I could go in for a career of, say, television research?

KEN—Modesty was never one of your faults, Will! No, you certainly haven't got enough out of our conversations to make you a laboratory technician. I didn't try to show you all the circuits used in TV transmitters and receivers nor even teach you how to design or repair a receiver. But I think I did give you a fair idea of the various elements of a TV receiver and their functions as well as all those of a transmitter you need to know to understand how a receiver works. Today, no schematic—no matter how complex it may appear at first—can give you any trouble if you study it a little.

WILL—I think I know what you're trying to get across. You are advising me to decompose the diagram into a certain number of elementary circuits that I can compare with the ones we've talked about. Isn't that what they call the analytic method?

KEN—Exactly. And if you get the habit of analyzing and synthesizing, if you continue to follow the progress of television, if you keep reading the best books and the latest issues of the technical magazines, you'll find that television isn't unsurmountably difficult.

WILL—Difficult? Television? It's a cinch!

END

The series "Television . . . it's a Cinch" will soon appear in book form, Gernsback Publications, Inc. expects to release it early in 1956.

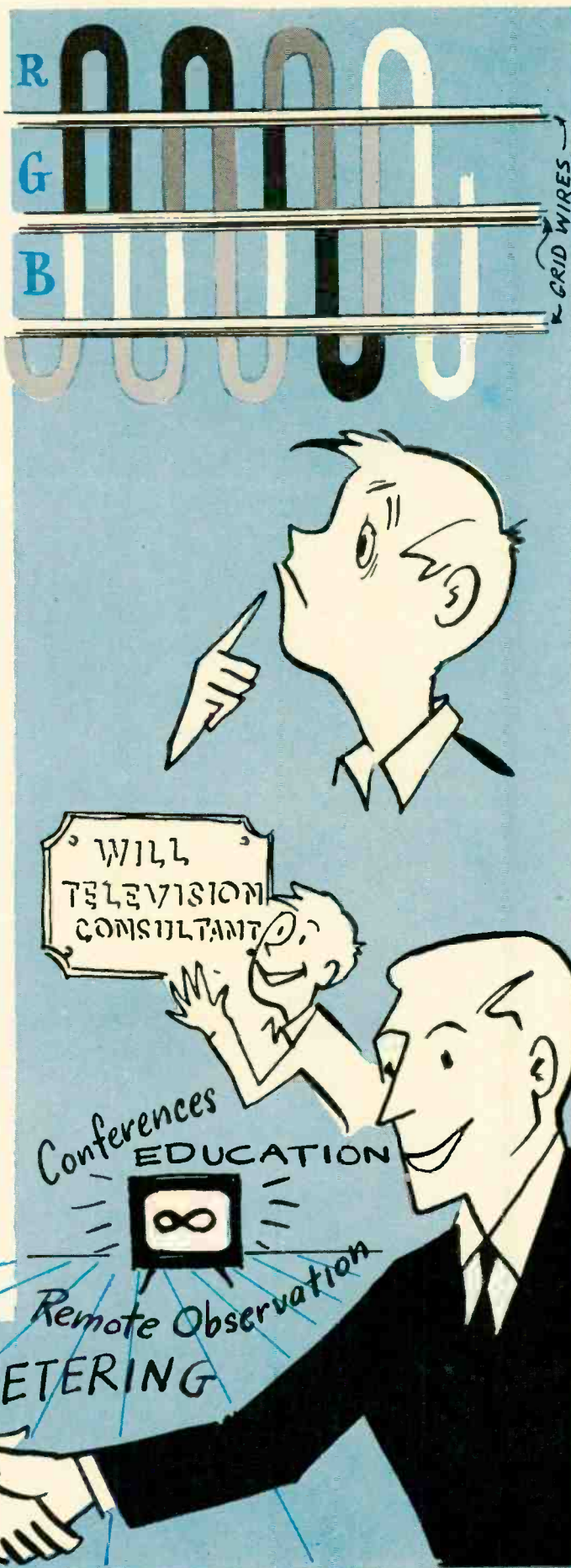



Measures 6 1/4" x 9 1/2" x 4 1/2"

Superior's new  
Model 670-A

# SUPER METER

A COMBINATION VOLT-OHM MILLIAMMETER PLUS  
CAPACITY REACTANCE INDUCTANCE AND DECIBEL MEASUREMENTS

**SPECIFICATIONS:**

D.C. VOLTS: 0 to 7.5/15/75/150/750/1,500/7,500 Volts  
 A.C. VOLTS: 0 to 15/30/150/300/1,500/3,000 Volts  
 OUTPUT VOLTS: 0 to 15/30/150/300/1,500/3,000 Volts  
 D.C. CURRENT: 0 to 1.5/15/150 Ma. 0 to 1.5/15 Amperes  
 RESISTANCE: 0 to 1,000/100,000 Ohms 0 to 10 Megohms  
 CAPACITY: .001 to 1 Mfd. 1 to 50 Mfd. (Good-Bad scale for checking quality of electrolytic condensers.)  
 REACTANCE: 50 to 2,500 Ohms 2,500 Ohms to 2.5 Megohms  
 INDUCTANCE: .15 to 7 Henries 7 to 7,000 Henries  
 DECIBELS: -6 to +18 +14 to +38 +34 to +58

**ADDED FEATURE:**

Built-in ISOLATION TRANSFORMER  
reduces possibility of burning out  
meter through misuse.

The Model 670-A comes housed, in a rugged crackle-finished steel cabinet complete with test leads and operating instructions.

**\$2840**  
NET

Superior's new  
Model TV-11

# TUBE TESTER

**SPECIFICATIONS:**

- ★ Tests all tubes including 4, 5, 6, 7, Octal, Lock-in, Peanut, Bantam, Hearing Aid, Thyatron Miniatures, Sub-miniatures, Novals, Sub-minars, Proximity fuse types, etc.
- ★ Uses the new self-cleaning Lever Action Switches for individual element testing. Because all elements are numbered according to pin-number in the RMA base numbering system, the user can instantly identify which element is under test. Tubes having tapped filaments and tubes with filaments terminating in more than one pin are truly tested with the Model TV-11 as any of the pins may be placed in the neutral position when necessary.
- ★ The Model TV-11 does not use any combination type sockets. Instead individual sockets are used for each type of tube. Thus it is impossible

to damage a tube by inserting it in the wrong socket.

- ★ Free-moving built-in roll chart provides complete data for all tubes.
- ★ Newly designed Line Voltage Control compensates for variation of any Line Voltage between 105 Volts and 130 Volts.
- ★ NOISE TEST: Phono-jack on front panel for plugging in either phones or external amplifier will detect microphonic tubes or noise due to faulty elements and loose internal connections.

The model TV-11 operates on 105-130 Volt 60 Cycles A.C. Comes housed in a beautiful hand-rubbed oak cabinet complete with portable cover.

**\$4750**  
NET

EXTRA SERVICE — The Model TV-11 may be used as an extremely sensitive Condenser Leakage Checker. A relaxation type oscillator incorporated in this model will detect leakages even when the frequency is one per minute.



## About Testing Picture-Tubes . . .

Of course you can buy an "adapter" which theoretically will convert your standard Tube Tester into a picture-tube tester. Sounds fine—but—it simply doesn't work out that way! We do not make nor do we recommend use of C.R.T. adapters because a Cathode Ray Tube is a very complex device and to properly test it, you need an instrument designed exclusively to test C. R. Tubes and nothing else. As compared to a make-shift adapter, which sells for about five dollars, our Model TV-40

C.R.T. Tube Tester sells for \$15.85. But, if you believe that Television is here to stay, then you must agree that the difference in price is more than justified by the many years of valuable service you will get out of this indispensable instrument.

Incidentally, the Model TV-40 is the ONLY low-priced C.R.T. Tube Tester, which includes a real meter. Neons are fine for gadgets and electric-line testers, but there is no substitute for a meter with an honest-to-goodness emission reading scale.

Superior's  
New Model  
TV-40

# C.R.T. TUBE TESTER

Tests ALL magnetically deflected tubes . . . in the set . . . out of the set . . . in the carton !!

- Tests all magnetically deflected picture tubes from 7 inch to 30 inch types.
- Tests for quality by the well established emission method. All readings on "Good-Bad" scale.
- Tests for inter-element shorts and leakages up to 5 megohms.
- Test for open elements.

**EASY TO USE:** Simply insert line cord into any 110 volt A.C. outlet, then attach tester socket to tube base (Ion trap need not be on tube). Throw switch up for quality test . . . read direct on Good-Bad scale. Throw switch down for all leakage tests.

Model TV-40 C.R.T. Tube Tester comes absolutely complete—nothing else to buy. Housed in round cornered, molded bakelite case. Only

**\$1585**  
NET



**SHIPPED ON APPROVAL  
NO MONEY WITH ORDER — NO C.O.D.**

Try any of the above instruments for 10 days before you buy. If completely satisfied then send down payment and pay balance as indicated on coupon. No Interest or Finance Charges Added! If not completely satisfied return unit to us, no explanation necessary.

MOSS ELECTRONIC DISTRIBUTING CO., INC.  
Dept. D-167, 3849 Tenth Ave., New York 34, N.Y.

Please send me the units checked. I agree to pay down payment within 10 days and to pay the monthly balance as shown. It is understood there will be no finance, interest or any other charges, provided I send my monthly payments when due. It is further understood that should I fail to make payment when due, the full unpaid balance shall become immediately due and payable.

Model 670-A.....Total Price \$28.40  
\$7.40 within 10 days. Balance \$3.50  
monthly for 6 months.

Model TV-11.....Total Price \$47.50  
\$11.50 within 10 days. Balance \$6.00  
monthly for 6 months.

Model TV-40.....Total Price \$15.85  
\$3.85 within 10 days. Balance \$4.00  
monthly for 3 months.

Name .....  
Address .....  
City..... Zone..... State.....

The Model  
TV-50

# GENOMETER

A versatile all-inclusive GENERATOR which provides ALL the outputs for servicing:

**A. M. Radio    F. M. Radio    Amplifiers    Black and White TV    Color TV**



## 7 Signal Generators in One!

- ✓ R. F. Signal Generator for A.M.
- ✓ R. F. Signal Generator for F.M.
- ✓ Audio Frequency Generator
- ✓ Bar Generator
- ✓ Cross Hatch Generator
- ✓ Color Dot Pattern Generator
- ✓ Marker Generator

### SPECIFICATIONS:

#### R. F. SIGNAL GENERATOR:

The Model TV-50 Genometer provides *complete* coverage for A.M. and F.M. alignment. Generates Radio Frequencies from 100 Kilocycles to 60 Megacycles on fundamentals and from 60 Megacycles to 180 Megacycles on powerful harmonics. Accuracy and stability are assured by use of permeability trimmed Hi-Q coils. R.F. is available *separately*, modulated by the fixed 400 cycle sine-wave audio or modulated by the variable 300 cycle to 20,000 cycle variable audio. Provision has also been made for injection of any external modulating source.

#### VARIABLE AUDIO FREQUENCY GENERATOR:

In addition to a fixed 400 cycle sine-wave audio, the Model TV-50 Genometer provides a variable 300 cycle to 20,000 cycle peaked wave audio signal. This service is used for checking distortion in amplifiers, measuring amplifier gain, trouble shooting hearing aids, etc.

#### BAR GENERATOR:

This feature of the Model TV-50 Genometer will permit you to throw an actual Bar Pattern on any TV Receiver Screen. Pattern will consist of 4 to 16 horizontal bars or 7 to 20 vertical bars. A Bar Generator is acknowledged to provide the quickest and most efficient way of adjusting TV linearity controls. The Model TV-50 employs a recently improved Bar Generator circuit which assures stable never-shifting vertical and horizontal bars.

#### CROSS HATCH GENERATOR:

The Model TV-50 Genometer will project a cross-hatch pattern on any TV picture tube. The pattern will consist of non-shifting, horizontal and vertical lines *interlaced* to provide a stable cross-hatch effect. This service is used primarily for correct ion trap positioning and for adjustment of linearity.

#### DOT PATTERN GENERATOR (For Color TV):

Although you will be able to use most of your regular standard equipment for servicing Color TV, the one addition which is a "must" is a Dot Pattern Generator. The Dot Pattern projected on any color TV Receiver tube by the Model TV-50 will enable you to adjust for *proper color convergence*. When all controls and circuits are in proper alignment, the resulting pattern will consist of a sharp white dot pattern on a black background. One or more circuit or control deviations will result in a dot pattern out of convergence, with the blue, red and green dots in overlapping dot patterns.

#### MARKER GENERATOR:

The Model TV-50 includes *all* the most frequently needed marker points. Because of the ever-changing and ever-increasing number of such points required, we decided against using crystal holders. We instead adjust each marker point against precise laboratory standards. The following markers are provided: 189 Kc., 262.5 Kc., 456 Kc., 600 Kc., 1000 Kc., 1400 Kc., 1600 Kc., 2000 Kc., 2500 Kc., 3579 Kc., 4.5 Mc., 5 Mc., 10.7 Mc. (3579 Kc. is the color burst frequency.)

The Model TV-50 comes absolutely complete with shielded leads and operating instructions. Only

**\$47<sup>50</sup>**  
NET

**SHIPPED ON APPROVAL**  
**NO MONEY WITH ORDER — NO C.O.D.**

Try it for 10 days before you buy. If completely satisfied then send \$11.50 and pay balance at rate of \$6.00 per month for 6 months. **No Interest or Finance Charges Added!** If not completely satisfied return unit to us, no explanation necessary.

OCTOBER, 1955

MOSS ELECTRONIC DISTRIBUTING CO., INC.  
Dept. D-167, 3849 Tenth Ave., New York 34, N.Y.

Please rush me one Model TV-50. I agree to pay \$11.50 within 10 days and to pay \$6.00 per month thereafter. It is understood there will be no finance, interest or any other charges, provided I send my monthly payments when due. It is further understood that should I fail to make payment when due, the full unpaid balance shall become immediately due and payable.

Name \_\_\_\_\_  
Address \_\_\_\_\_  
City \_\_\_\_\_ Zone \_\_\_\_\_ State \_\_\_\_\_

# convergence...

*not impossible, but difficult*

*Part II—After much frustration  
rainbow's end is within reach*

By HAROLD DAVIS

**T**HE next day I went through all the back issues of the popular trade journals on hand and laid out everything that had articles pertaining to color convergence. One was very enlightening. It read as if the author had at least seen a color set, which is more than I can say for most of the stuff I've read.

Among other things it stated that the new color tubes have "beam converging pole pieces inside over which the converging coil magnet assembly" must be aligned. Checking the instruction book carefully, I found a diagram showing the position of this assembly. It should be adjusted so that the "blue" coil sits directly over the "blue" pole piece, which would also align the other two coils over their respective pole pieces.

As soon as I saw this, I knew one thing that was wrong with my setup. *The coil was not over the pole piece.* I remembered it was to one side, having presumably slipped over in shipment. With the magnet not over the pole piece, the adjustments would naturally have little or no effect.

It was Sunday before I had time to tackle the set again, and I invited a friend to come along. I was sure I could lick it this time.

4:30—We arrived and I started taking the back off.

"Plenty of screws," Paul remarked.

"Yes," I answered, "and it's a well known fact that sets that need the most servicing have the most screws in the back. Hope it's not true here."

On the way over I had explained to Paul about the position of the magnet assembly, so that was the first thing we looked for. Sure enough, it was over to one side. However, the neck of the tube around the area where the assembly fit was completely black, and we were unable to see the pole pieces.

"That's the trouble with books," Paul cracked. "They never say what to do when you can't do what you're supposed to."

Checking the diagram again, I instructed Paul to set the blue coil straight up and slip it horizontally directly over the black shaded area. Paul pulled on the assembly to make the adjustment, and I heard something fall onto the chassis.

"What was that?" we both asked.

It didn't take long to find out. I stooped over and picked up a knurled knob. It had broken off the "red" cylindrical magnet which is turned to converge the dots. My spirits slumped!

"Well," Paul asked meekly, "how long

do you think it would take to get one of those?"

"Just about the same length of time it took the man to perfect the thing in the first place," I answered dejectedly.

"Let's push the end out and turn it with a tuning tool," Paul suggested.

Having no choice, I told him to try.

We took a small wrench and pushed the magnet out a bit. We tried all kinds of tools, but ended up with a pair of pliers. Every so often a bit would crumple off making the magnet shorter.

Finally, I suggested that we pull the broken magnet out of the red coil and put it in the blue one and vice versa. The blue was easier to position and in addition had the blue lateral positioning magnet which I had already discovered could be rolled like an ion trap and would have some effect on up-and-down motion.

This looked like it was going to work so we decided to go through the whole convergence procedure.

During the excitement, I had forgotten to try the dynamic convergence. Now I checked it and, sure enough, with the magnet assembly correctly placed, the amplitude controls moved the dots about handily.

We checked purity and screen ad-

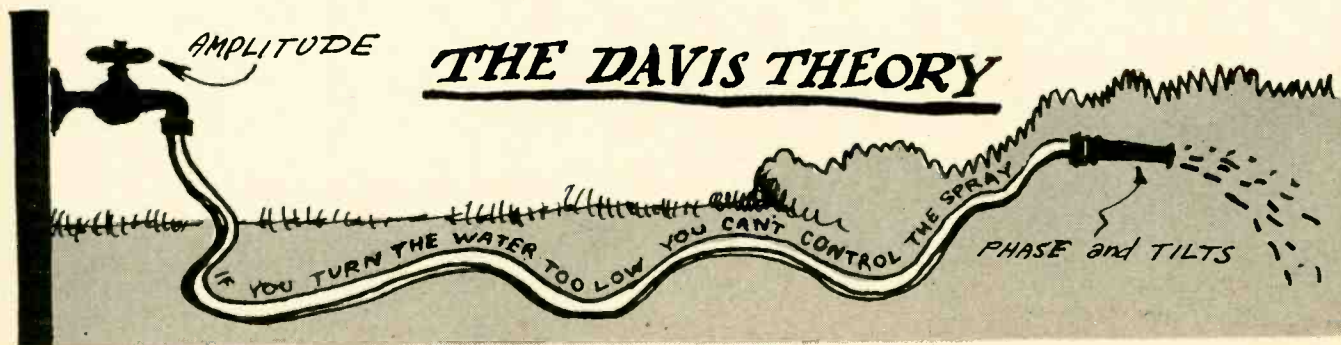

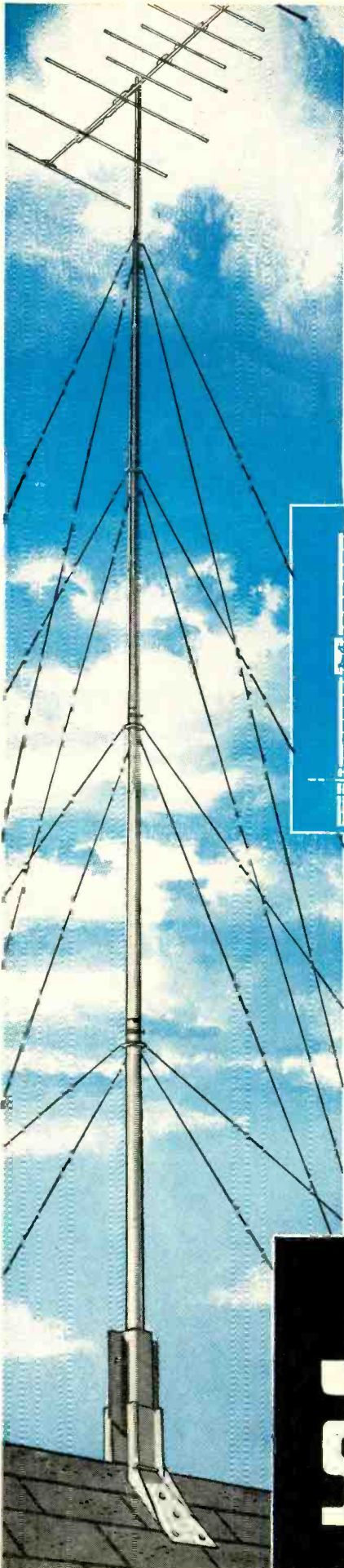

New concept in telescoping TV masting  
... utilizes J & L Perma-Tube

# REDUCE YOUR TV MAST COST OVER 20%

Use high-strength, corrosion-proof J & L Perma-Tube 10-foot telescoping sections to easily construct 30 to 50-foot masts

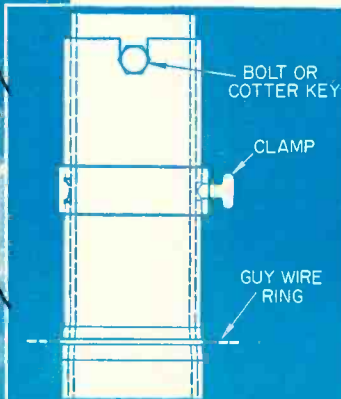

Only J&L Telescoping Perma-Tube offers:

- Joint design which provides instant field assembly
- Machine-fitted joints that insure close tolerance for high strength and rigidity
- Guy wire ring position that eliminates all binding and guy wire interference

No longer is it necessary to buy expensive, ready-made masts. Now you can "tailor-make" your own with standard 10-foot lengths of 16-gage J&L Perma-Tube—and save money.

It's available in cartons from your local distributor in five diameters. The largest base section OD is 2¼ inches and each telescoping section is ¼-inch smaller, the smallest section having an OD of 1¼ inches.

J&L Perma-Tube in the 1¼-inch size can be used interchangeably as a fitted-joint section for smaller masts or as the smallest and topmost piece of longer telescoping masts.

Corrosion-proof J&L Perma-Tube is treated with Vinsynite—then coated both inside and outside with a metallic vinyl resin base. It successfully passes ASTM's 500-hour-minimum salt spray test—which guarantees Perma-Tube's longer life on the job.

Sturdy J&L Perma-Tube is made of a special, high-strength, J&L-produced steel. A 10-foot section of 1¼-inch diameter by 16 gage can support a weight at its center point of 200 pounds with a minimum of deflection and permanent set.

Order these new telescoping sections along with your regular 1¼-inch J&L Perma-Tube. Hardware—cotter keys or bolts, clamps and guy rings—may also be secured from your local distributor. For more information write J&L direct.

# J&L STEEL

*Jones & Laughlin*

STEEL CORPORATION — Pittsburgh

## TELEVISION

justments and proceeded with the convergence. Paul read the procedure step by step and I made the adjustments. When we got through we turned to a station and, while the picture had less fringing, it still was far from being acceptable in my estimation.

6:30—Jack Benny came on on our high-frequency station (channel 25) in color but, as we were 40 miles out and picking up a lot of snow, I was not disappointed that the reception was poor. Snow has more effect on color than it does on black-and-white. It seems to trigger the color sync pulses.

9:30—I instructed the dealer to send the set over to my shop and Paul and I started for home.

On the way I asked Paul, "What do you think is wrong?"

"I kind of think that color is getting in through the color circuits."

"No, you're wrong. The color circuits are actuated only by a signal that comes in at 3.58 mc. And, besides, with the color control off, even that signal is killed. The whole trouble is convergence."

"Maybe so," Paul shrugged. He wasn't committing himself.

The next day I learned that a dealer had received a 19-inch Motorola. I called him and asked about the color fringing on black-and-white pictures.

"We got it," he told me.

I also went to see another dealer who had a 19-inch Capehart. I turned it on and he also had bad color fringing. He stated, however, that when the set first came in it had very good black-and-white pictures. His service technician went to a color school and when he came back decided to try his newly acquired knowledge on the set and since then the pictures had been poor.

I decided then that convergence was something that had to be mastered if we were to have color reception.

I spent several more hours plowing through trade journals and came back to the article where I had discovered the positioning of the magnet assembly over the pole pieces. Reading carefully, I was impressed with several pointers. One was that the yoke had to be positioned correctly or it would be impossible to converge the dots on the edge of the tube. With these I was having trouble. It stated further that, if the yoke was positioned correctly, any one set of dots on the tube could be converged.

Another impressive statement was that *the horizontal hold should be set on a weak station and not moved during the convergence procedure.*

I also studied the diagrams showing the effect of the dynamic convergence controls and from them surmised that *the amplitude controls affected the dots near the center of the screen, while phase and tilt affected those near the edges.* It also stressed that the dots must be in a straight line *both horizontally and vertically.*

This was further emphasized the next

day when the manufacturer's representative in this area came to town.

"You can't trust your eyes," Herb said, "you have to use a reference line."

Paul played with the set during the week and reported no progress. He had worn the controls slick.

Sunday afternoon I went by and decided to give it a fling. Before I could touch it, Paul said, "You needn't try any more. That is as good as it will do. It just wasn't intended to do any better."

I hooked up the dot generator and adjusted everything carefully. The dots in the center and out to within three of the edge looked pretty good. The last three on each end were not converged, showing red and green dots.

"I hate to disagree with you, my good man," I said, "but this is not as good as it will do."

I took an alligator clip and shorted the red gun. I took another and shorted the green. Stepping back about 10 feet, I looked carefully to see if the remaining blue dots were in a straight line. They looked pretty good vertically, but resembled an S on a "Sears" sign horizontally.

I pointed this out to Paul. He wouldn't agree. "They look straight to me," he remarked.

I went to my truck and found a piece of masking tape. Measuring down the same distance on each side, I stuck the tape across the glass.

"Now come see if the dots are straight," I invited. Paul scrutinized the screen carefully and admitted they weren't. However, he also argued that being in a straight line wasn't important as long as the red, blue and green dots were in the same relationship to each other. (This impression was why we were having so much trouble.)

I attempted to line up the blue dots to the masking tape by turning the BLUE PHASE. This phase was as far as it would go in that direction. I turned BLUE AMPLITUDE and moved the center dots down some. Then with the phase control I jacked up the ends. With both controls in extreme position the dots made an S shape.

I discovered another important thing that I hadn't read anywhere. I hope it will become known as the "Davis theory" for it certainly took me long enough to discover! *When the amplitude is turned to minimum, the phase and tilts have little or no effect.*

Examination of the diagram reveals why. The amplitudes are series pots that select the amount of signal fed into the convergence box. The phase and tilts shape the signal into the required form. The horizontal amplitudes and phases receive a signal from the horizontal output section. The vertical amplitudes and tilts receive a signal from the vertical section. After passing through the convergence box, they are fed into the electromagnets located on the convergence assembly—blue into the blue coil, red into the red, etc.

By alternately turning AMPLITUDE and PHASE, I arranged the blue dots along a straight line as indicated by the masking tape.

I uncorked the red dots and with the red converging magnet placed the red dots in the center of the screen in the upper *right-hand* corner of the blue dots. This is highly important.

I then proceeded to arrange all red dots in the center line across the screen in the same relationship. This required lots of turning of the RED AMPLITUDE and RED PHASE, but it worked.

I turned the green gun loose and with the green convergence magnet placed the green dots in the upper *left-hand* corner of the blue dots. (Important!)

Alternately turning GREEN AMPLITUDE and GREEN PHASE, I took the wiggle out of the S.

The dots looked straight and in good relationship when viewed vertically, so I did not readjust these. Had they been out, I would have put a piece of masking tape vertically and proceeded to make a straight line by adjusting vertical amplitudes and vertical tilts. (Some sets use different names for the controls, but their functions are the same.)

Being satisfied that I had perfect triangles in perfectly straight lines, I reached for the red convergence magnet. It was like waiting for an important chemical mixture to jell. The results of two weeks of work and study were about to be revealed. The whole future of color television, so far as I was concerned, was now at stake.

With the red convergence magnet, I kicked the red dots down slightly and to the left. With the green convergence magnet, I slipped the greens down and to the right the same amount. I moved the reds a little more and then the greens. When they were about half-meshed with the blues, I pulled the latter up with the blue convergence magnet. About three times around on all three of the above adjustments did the trick. The dots converged almost perfectly except on the extreme outer edge, which I understood could be expected.

6:00 p.m.—We had a good color program just starting. I hooked up the antenna excitedly and tuned in the station.

No color.

I was so excited I had forgotten to open the color control. I turned the color knob a bit and the brilliant colors burst forth in a magnificent spectacle.

Adjusting FINE TUNING and HUE carefully, we sat back and enjoyed our first real color show. It was an exciting experience, and when it was over there was only one opinion—color is here to stay.

P. S.—My secretary, when typing this story said, "It ends good, but what I want to know is: did you still have rainbows?"

To which I answered meekly, "Yes." But 'twern't so bad, brother, 'twern't so bad!"

END

LITTELFUSE

EASY TO MOUNT

1 Determine the most handy location above or near your work bench.

2 Using one channel as a guide locate the position for the screws for the number of channels required—single, double or triple bank.

3 Insert screws in position—do not force all the way down. Slide channel down, letting screw head come through large part of the keyhole slot. Slip narrow part of slot behind the screw head and tighten.

VERSATILE

Each channel can be made to dispense two types of fuses simply by folding in the tabs cut out in the middle of the channel. Fuses now dispense from the middle or the bottom of the channel.

**LITTELFUSE** To serve you... to increase your profits... again streamlines your fuse service operation with a program that makes sure you have the right fuse at your fingertips at all times—time saved, effort saved build up your service profits.

ASK YOUR JOBBER about the Littelfuse Single Channel Fuse "Stocker" Package: 10 single (double dispensing) fuse channels, 10 boxes (50) 3 AG 1/4 fuses and 10 boxes (50) 3 AG 1/2 fuses in one complete package FOR THE COST OF THE FUSES ALONE.

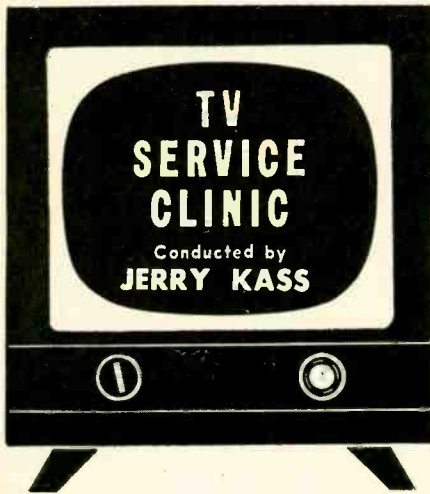

**M**ANY demands are made of the r.f. amplifier stage in a TV receiver: It should provide uniform frequency response over any particular channel, attenuate local-oscillator radiation, provide proper selectivity and image rejection, properly match the impedance of the transmission line and provide a high signal-to-noise ratio. Of these functions, most important is the task of providing high gain while introducing a minimum of noise (see TV Clinic, June, 1955).

The most effective and practical circuit yet found to satisfy these conditions is the cathode-driven grounded-grid r.f. amplifier, popularly known as the *cascode* circuit. It is shown in its basic form in Fig. 1. Grounded-grid triode amplifier V2 is cathode-driven by triode V1. The amplification in this circuit is provided almost entirely by V2: V1 acts as a driver for V2 and has a gain of about unity. The input impedance of V2 acts as the load impedance for V1. This impedance being fairly small makes the gain of V1 so low as to minimize feedback problems greatly.

The cascode circuit arrangement provides the low noise level of a triode r.f. amplifier, with approximately the same gain and stability as a pentode r.f. amplifier. In addition, energy feed-through from the local oscillator is attenuated by the shielding action of the grounded grid—isolating the input and output circuits—to about the same extent as the screen grid of a pentode amplifier. The cascode circuit lends itself nicely to the use of twin-triode amplifier tubes such as the 6BQ7-A, 6BZ7, 6BK7-A, having a very low plate-to-cathode capacitance. An internal shield separates each triode. The shield is connected to pin 9 and should be grounded.

The two triodes (Fig. 1) being d.c. coupled, form a d.c. voltage divider consisting of the plate-to-cathode resistance of both tubes across the B plus supply. Therefore, the plate of V2 receives the full B plus voltage (usually about 250) while the plate of V1 is at approximately one-half this potential.

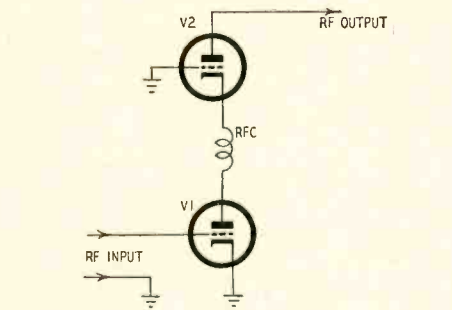
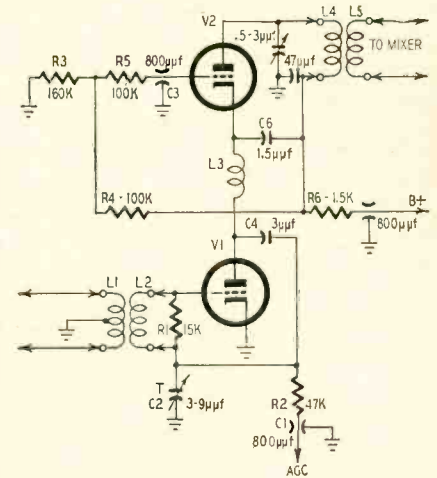

Fig. 1—Above, basic cascode circuit.

Fig. 2—Right, schematic of practical cascode amplifier in Standard tuner.



In this arrangement, the cathode of V2 being at a potential of about 125 volts, it is necessary to provide the grid of V2 with a voltage of approximately the same value as its cathode. Otherwise V2 would be deep into cutoff. Placing a potential on the grid of V2 makes it impossible to ground the grid directly. However, this is of no great importance since the grid is effectively at ground potential when bypassed to ground with a capacitor which at v.h.f. would act virtually as a short circuit.

The inductor between the plate of V1 and the cathode of V2 serves a very important function. Its inductance, together with the input capacitance of V2 and the distributed wiring capacitance, forms a series-resonant circuit. The value of inductance is such as to make the circuit resonant at the high end of the v.h.f. band, where additional gain is most needed.

#### Practical cascode circuit

Easily the most popular tuner now in use is the Standard Coil cascode unit. Its r.f. amplifier circuit is shown in Fig. 2. A short strip of 300-ohm transmission line is connected to the center-tapped input transformer. The grounded center tap provides a balanced input and aids in noise attenuation. The transformer secondary feeds the signal to the grounded cathode stage of the cascode amplifier. Resistor R1 damps the input circuit, lowering the Q and permitting the necessary 6-mc r.f. bandwidth. An a.g.c. voltage is applied to V1 through decoupling network R2-C1. Trimmer C2 is used to align the grid circuit of V1.

With the cathode of V2 at approximately 125 volts, voltage divider R3-R4 supplies the necessary d.c. grid potential for the normal operation of V2. Resistor R5 isolates the grid of V2 from the B plus line. Since the grid of V2 is at r.f. ground through C3, the input signal fed to V2 is developed across the distributed cathode capacitance of V2 to ground. L3 is the plate load for V1 and cathode load for V2.

To increase stability at the higher channels, energy is fed back from the

plate circuit of V1 to the grid circuit through C4. This capacitor forms an a.c. voltage divider with C2, placing the voltage developed across the trimmer in series with L2 as part of the signal voltage. Since this feedback voltage cancels the plate signal voltage that is fed to the grid through the plate-to-grid capacitance, C4 is generally called the neutralizing capacitor. The signal developed across L4 is the cascode amplifier output signal and is coupled to the mixer stage. V2 is neutralized by C6.

#### Servicing the cascode amplifier

Cascode circuitry creates certain characteristic troubles. While the cathode of V1 (Fig. 2) is at ground potential, the cathode of V2 is about 125 volts above ground. Thus, while a heater-cathode leakage is of little consequence in V1, it can cause a great deal of trouble in V2. Because of the large potential difference between heater and cathode of V2 these elements frequently short. A somewhat less common occurrence is a short between cathode and the internal shield.

A heater-cathode short in V2 grounds its cathode, thus eliminating the input signal to V2 and placing a positive bias of about 125 volts on the grid (this bias voltage will read much less because of heavy grid current flow). More important, however, is the great increase in plate current which in most cases will burn out R6, the plate resistor. Thus, in cases of snow, replacement of this tube should be in the first order of business.

A burnt-out R6 should never be considered positive proof of a shorted tube. A shorted 47-µf bypass capacitor will produce the same effect since it would ground the B plus line through R6.

As the result of excessive current flow due to tube or component failure R6 often decreases in value, shortening the life of all subsequent tubes used in this circuit. Thus, measurement of this resistor is a most important check when servicing this circuit. If a 1/2-watt resistor is being used,



# WIRE AND CABLE FOR EVERY ELECTRONIC PRODUCT

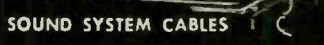
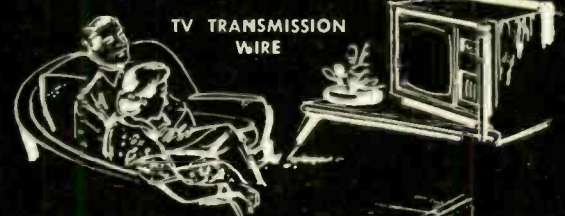
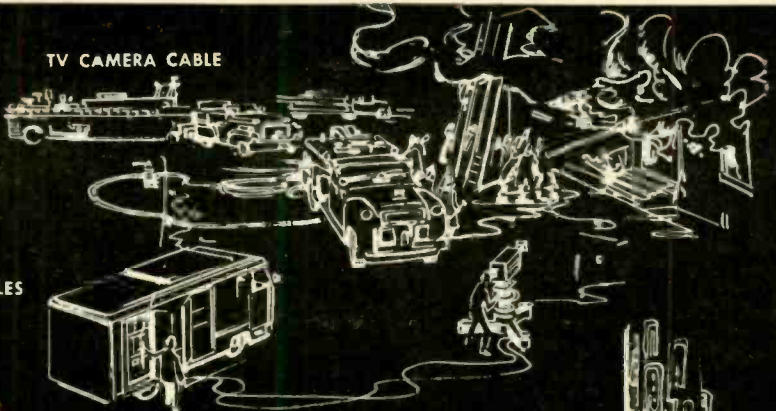
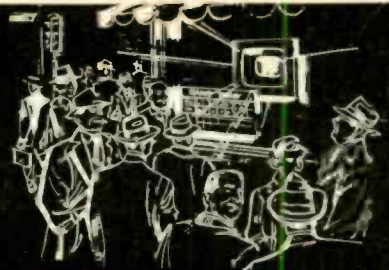

# Belden

WIREMAKER FOR INDUSTRY  
SINCE 1902

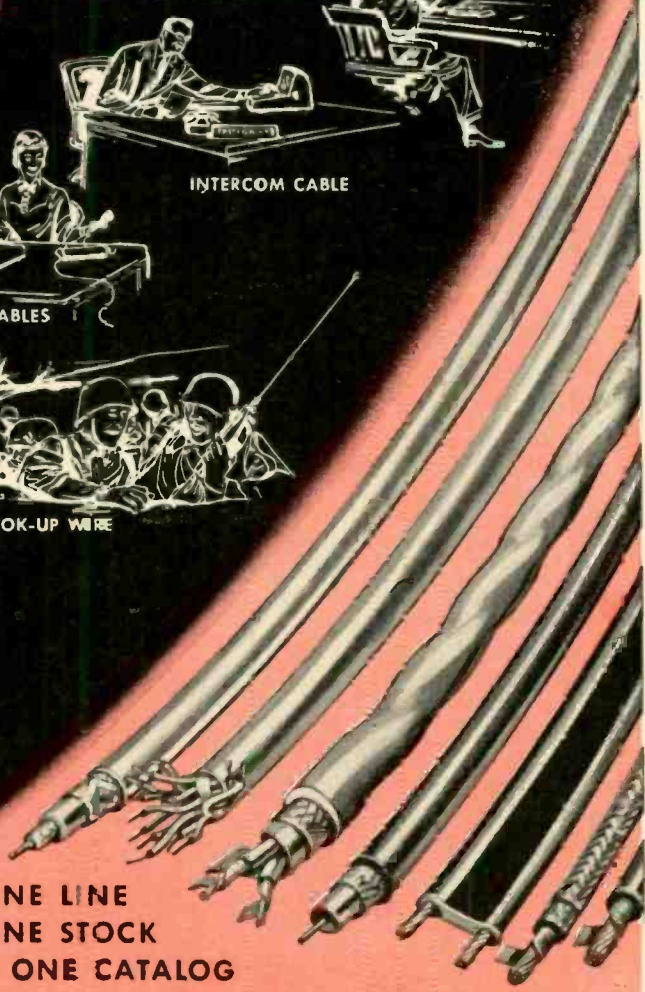
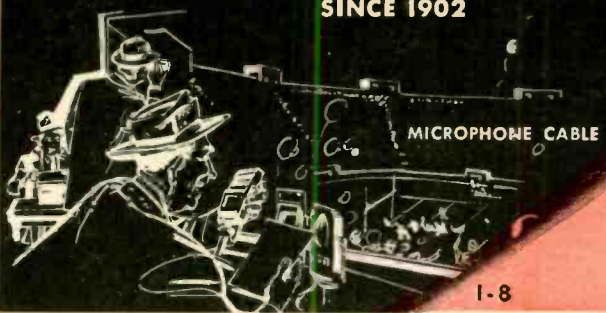

ONE LINE  
ONE STOCK  
ONE CATALOG

I-8

# BUY BY MAIL

## Direct From Manufacturer

### AND SAVE

# NEW Approved policy...

eliminates percentages to "middlemen"—brings equipment direct from factory to you for buys that can't be beat... anywhere! Approved kits are NOT AVAILABLE FROM DISTRIBUTORS OR JOBBERS.

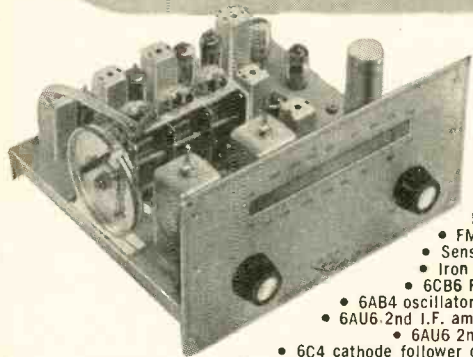

### New Imperial V— 12-tube AM-FM Tuner Kit

- Band width-200 kc
- Tuned RF stage
- Frequency Response FM-20-20,000 CPS  $\pm$  .5DB
- FM Tuning Range 88-108 mc
- Sensitivity 5-10 u/v, 20-30 DB
- Iron core tuned I.F. disc trans.
- 6CB6 RF amplifier • 6AB4 mixer
- 6AB4 oscillator • 6AU6 1st I.F. amplifier
- 6AU6 2nd I.F. amplifier • 6AU6 1st limiter
- 6AU6 2nd limiter • 6AL5 detector
- 6C4 cathode follower output • AM tuning range 530-1650 kc • Frequency response AM-20-7,500 CPS  $\pm$  3DB
- 6BA6 RF amplifier • 6BE6 converter
- 6BA6 1st I.F. amplifier • IN34 crystal diode detector • Tuned RF stage
- Chassis dimensions: 9 3/4" long, 5" high, 8" wide.

Complete kit of parts including tubes, step by step, pictorial and schematic diagrams, less power supply ..... **\$37.50**  
 Wired and tested extra ..... **\$10.00**  
 Power Supply—6.3V-4 Amp., 190 Volts 55 MA—117V. 50-60 cycles ..... **\$12.00**  
 Tuning Eye Kit ..... **\$ 2.95**

Shipping Weight 10 lbs.

### New Binaural Twin Channel Amplifier Kit

#### Channel 1 and 2

- 1-6SC7-Pre Amp. Common to both Chan.
- 2-6F5—1st Stage Amp.
- 2-6F5—Voltage Amp.
- 2-6V6—Power Amp.
- 1-5Y3—Rectifier Amp.
- 2-Cathode Ray Output Indicators
- Individual Channel Volume controls
- Individual Bass control boost 12DB
- Individual Treble control boost 12 DB
- Inputs for Radio, Tape, Crystal, GE Reluctance
- Chrome plated chassis

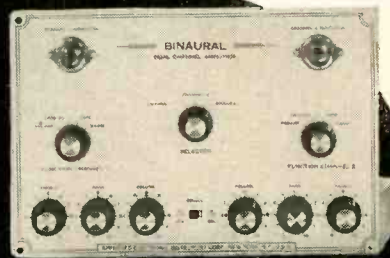

- Hum levels—78 DB below full output
- Frequency response each Channel  $\pm$  1 DB 40-12,000 CPS
- Maximum power output each channel, 4 Watts
- Output, 4-8-16 ohms
- Size 13" Long x 9" Wide x 8 1/2" High

Complete kit of parts including AC power supply, tubes, step by step pictorial and schematic ..... **\$39.95**  
 diagrams Shipping Weight 18 lbs.

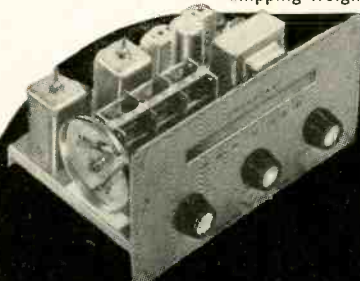

### New V-5 Am Tuner Kit

## THE BINAURAL TWINS

Start Your Hi-Fi Installation the Economical Way

- Self-contained AC power supply
- Tuning range 530-1650 kc-
- 6BA6 RF Amplifier
- 6BE6 converter
- 6BA6 1st I.F. amplifier
- 6AL5 detector
- 6C4 cathode follower output

• #65 selenium rectifier • Sensitivity 5 microvolts  
 • Frequency response 20-20 000 CPS  $\pm$  .5DB  
 • 3 section variable cond. • Tuned RF stage  
 • Iron core tuned coils throughout • Dimensions 9 3/4" x 5" x 5 7/8"  
 Complete kit of parts, including AC power supply, tubes, **\$24.50**  
 step by step, pictorial and schematic diagrams .....  
 Wired and tested extra ..... **\$5.50**  
 Tuning Eye Kit ..... **\$2.95**

Shipping Weight 9 lbs.

### New V-9 FM Tuner Kit

- Self-contained AC Power Supply
- 3 section variable condenser
- Tuning range 88-108 mc
- Band width 200 kc
- Sensitivity 10 microvolts 20 DB
- Tuned RF stage
- Iron core tuned I.F.—disc. trans.
- 6CB6 R.F. amplifier
- 6AB4 mixer
- 6AB4 oscillator (temp. compensated)
- 6AU6 1st I.F. amplifier
- 6AU6 2nd I.F. amplifier
- 6AU6 1st limiter



- 6AU6 2nd limiter
- 6AL5 detector
- 6C4 cathode follower output
- 65 MA selenium rectifier
- Dimensions 9 3/4" x 5" x 5 7/8"
- Frequency response 20-7,500 CPS  $\pm$  3 DB

Complete kit of parts including AC power supply, tubes, **\$29.50**  
 step by step, pictorial and schematic diagrams .....  
 Wired and tested extra ..... **\$7.50**  
 Tuning Eye Kit ..... **\$2.95**

Shipping Weight 10 lbs.



### New Push Pull 6 Watt Amplifier Kit

- 1-12J5—1st stage Amp.
- 1-12SL7—Phase Inverter
- 2-12A6—P.P. Beam Power
- 1-5Y3—Rectifier
- 1-Cathode Ray Output indicator
- Tapped outputs, 4-8-16 ohms
- Volume, Continuously variable
- Chrome plated chassis

• Bass Control Boost 12 DB • Treble Control Boost 12 DB • Hum level—78 DB below full output • Frequency response  $\pm$  1.5 DB 20-20,000 CPS  
 • Size 5 1/2" high x 6 1/2" wide x 11" long  
 Complete kit of parts, including AC power supply, tubes, **\$15.45**  
 step by step pictorial and schematic diagrams .....  
 Shipping Weight 13 lbs.

### New 20 Watt Williamson Type Hi-Fi Amplifier Kit

- New Chicago Kit of transformers
- Chrome plated chassis
- 1-6SN7—1st stage Amp.
- 1-6SN7—Phase Inverter
- 2-5881—Push Pull Power Output
- 1-5V4G—Rectifier
- Frequency Response  $\pm$  1 DB, 10-100,000 CPS
- Output 4-8-16 ohms
- Volume control
- On-off power switch



- IM Distortion—.1% using 60 and 3000 cycles sine wave output, at 12 watts indicated
- Hum Level—78DB below full output
- Pre Amp., Voltage supply outlet
- Size 15" Long x 9" Wide x 7" High

Complete kit of parts, including AC power supply, tubes, **\$39.55**  
 step by step pictorial and schematic diagrams .....  
 Shipping Weight 32 lbs.

ORDER DIRECT FROM  
**APPROVED**  
 ELECTRONIC INSTRUMENT CORP.  
 928 BROADWAY, NEW YORK 10, N. Y. • AL 4-7266

## FREE CATALOG AVAILABLE!

APPROVED ELECTRONIC INSTRUMENT CORP.; 928 Broadway, Dept. E, N. Y. 10, N. Y.

NAME .....

ADDRESS .....

CITY ..... STATE .....

Downtown Sales Office: 51 Vesey St., N.Y.

RADIO-ELECTRONICS

## TELEVISION

replace it with a 1-watt unit (space permitting).

Except for the d.c. relationship of V1 to V2 and the relatively high potentials on the grid and cathode of V2, the cascode amplifier is aligned and serviced in all other respects the same as other r.f. amplifiers.

Increasing width and high voltage

*An Emerson receiver is lacking about 1 inch in width and is not producing sufficient brightness. I have replaced the flyback transformer and the horizontal output tube without success. Up to this point everything checks all right because the grid drive to the output tube is normal and the waveshape looks typical for this circuit. Experiment with the width and linearity controls has not given me the picture I want.*

*Upon the suggestion of another service technician I increased the voltage on the screen grid of the horizontal output tube—the picture widened and good brightness appeared. Is this a good solution or am I overdriving any circuits?—N. C., St. Paul, Minn.*

When the screen grid voltage of the horizontal output tube is increased moderately, it is an effective and safe way to obtain additional width and high voltage. Your present circuit contains a 15,000-ohm 2-watt voltage dropping resistor in the screen circuit. I wouldn't recommend decreasing by more than one-third. Install a 10,000-ohm 2-watt unit. This should increase the picture width and the second-anode voltage.

### Distorted sound

*A model 416 Sentinel is in my shop for the second time with a complaint of distorted sound. The audio is also weak and occasionally cuts off. The first time I corrected the trouble by adjusting the ratio detector transformer. I made one house call and again corrected the trouble by this adjustment. I would like to fix it once and for all and I have replaced the transformer. In addition, the oscillator circuit has been checked for drift, but it appears to be in good shape and varying it does not correct the sound. Short of changing every component in the sound section, what is my best bet for fixing this defect?—A. R., Erie, Pa.*

The most likely component that would be causing the trouble you describe is the 10- $\mu$ f electrolytic capacitor across the ratio detector output. As this capacitor ages it becomes increasingly leaky and changes the impedance of the ratio detector tuned circuit, shifting it out of alignment. When this capacitor is shorted, it will completely kill the audio.

Replace this capacitor with a new 10- $\mu$ f 25-volt unit and adjust the ratio detector secondary for best sound—between the two buzz peaks. The trouble is almost certainly related to the ratio detector tuned circuit so, if replacing

# MAKE MORE MONEY ON SERVICE!

## TELEVISION • RADIO • ELECTRONIC



Learn to handle ANY job easier, better and lots **FASTER** this modern professional way!

ONLY \$12 FOR THE COMPLETE TRAINING *You Save \$1.25*

THESE two big fact-packed Ghirardi training books make it easy for you to become expert on all types of home radio and television receiver service—at absolute minimum cost!

Ask the men who already have good-pay jobs! They'll tell you that Ghirardi training is the finest — AT ANY PRICE — because it is so outstandingly complete, and because it makes even the

toughest subjects so easy to understand.

Each of these two books is entirely new, completely modern in every respect—NOT a re-bash of old, outmoded material. Together, they form a complete service library written so you can easily understand every word—and designed to serve either as a complete training course or as a handy reference for experienced servicemen who want to look up puzzling jobs or develop new and faster methods.

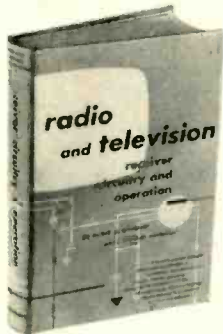

Radio and Television Receiver **CIRCUITRY AND OPERATION**

By Ghirardi and Johnson  
669 pages, 417 helpful illustrations; Price \$6.50



Radio and Television Receiver **TROUBLESHOOTING AND REPAIR**

By Ghirardi and Johnson  
822 pages, 417 clear illustrations; Price \$6.75

## SPECIAL money-saving OFFER!

Save \$1.25 by ordering both of the above big books. Make your service library complete!

### Learn all about Circuits . . . AND WATCH SERVICE "HEADACHES" DISAPPEAR

Years of experience plus hundreds of talks with service technicians proved to Mr. Ghirardi the need for a book that got right down to earth in explaining the basic circuits and operation of modern radio and television receivers. Radio & Television Receiver Circuitry and Operation is the result. Backed by what you can learn from it, you'll find that 9 out of 10 service jobs are tremendously simplified. You'll work faster with less testing—and make more money in the bargain! Guesswork is eliminated. Starting with AM and FM proc-

esses and characteristics, the book progresses to a complete understanding of basic circuits, how they operate, how to recognize them quickly and what is likely to go wrong with them. By making it easy for you to understand each circuit and its relation to other circuits, the book helps you go right to the seat of trouble in far less time. You'll know what different trouble symptoms mean — and you'll know how to repair troubles lots faster and more efficiently.

Sold separately for \$6.50. Try it for 10 days on our FREE examination offer.

### Complete Training in MODERN PROFESSIONAL SERVICE METHODS

This big book makes the tough service jobs easy, makes the easy ones a cinch!

Actually, Radio & Television Receiver TROUBLESHOOTING AND REPAIR is a complete guide to modern professional methods.

First you get a full analysis of components, their functions, their troubles and their remedies. Next you learn modern troubleshooting methods from "static" tests to dynamic signal tracing and injection techniques. You learn basic procedures and how to interpret performance data. Four big chapters show how to realign Television, FM and AM receivers in less time. You'll learn how a glance at a TV set may quickly tell you what is wrong. Special hard-to-fix service problems are explained. Puzzling "intermittent" troubles and their remedies are clearly outlined. Step-by-step service procedure charts

demonstrate many operations almost at a glance. In short, from the simplest troubles to the most difficult ones, nothing has been omitted—nothing has been condensed. Everything is carefully explained—and the entire book is fully indexed so you can find exactly what you want in a jiffy.

Read it 10 days FREE! See for yourself how this great book can pave your way for bigger pay. Sold separately for \$6.75. Save money by ordering special combination offer.



Dept RE-105, RINEHART & CO., INC.  
232 Madison Ave., New York 16, N.Y.

Send books below for 10-day FREE EXAMINATION. In 10 days, I will either remit price as indicated (plus a few cents postage) or return books postpaid and owe you nothing.

Check here to order books singly:

Radio & TV Receiver **CIRCUITRY & OPERATION** (Price \$6.50 separately)  Radio & TV Receiver **TROUBLESHOOTING & REPAIR** (Price \$6.75 separately)

Check here for MONEY SAVING COMBINATION . . . SAVE \$1.25!

Both of the above big books at the special price of only \$12.00 for the two. (Regular price \$13.25—you save \$1.25.) Payable at the rate of \$3 after 10 days if you decide to keep books and \$3 a month thereafter until the total of \$12 plus postage has been paid.

Name .....

Address .....

City, Zone, State .....

OUTSIDE U.S.A.—\$7.25 for TROUBLESHOOTING & REPAIR book; \$7.00 for CIRCUITRY & OPERATION; \$13.00 for both books. Cash with order only. Money refunded if you return books in 10 days.

RINEHART BOOKS ARE SOLD BY LEADING BOOK STORES

for servicing **color**

## YOU NEED SOMETHING EXTRA

For instruments actually *ahead* of today's circuitry... ready for the day when color TV becomes as general as today's black-and-white sets... look at the Hycon line, designed with the electronic serviceman in mind. Accurate enough for critical work in the shop, you'll also find these test instruments rugged, compact, lightweight... just what you need for those money-making house calls.

### MODEL 616 COLOR-BAR/DOT GENERATOR

... for adjusting and testing color receivers and transmitting equipment by manufacturer, station or serviceman. Features: Seven output forms of bars, dots, cross-hatch, phase and color-difference signals, including NTSC color bars. **PANEL PRESENTATION SHOWS ACTUAL COLOR AND SEQUENCE OF GENERATOR OUTPUT. \$415.00**



### MODEL 614 VTVM

Convenience at unprecedented low cost sums up this rugged, serviceable instrument. Hycon plus features include: 21 ranges (28 with peak-to-peak scales); large 6½" meter; 3% accuracy on DC and ohms, 5% on AC; AC frequency response to 250 mc (auxiliary probe extra) **AND TEST PROBES STOW INSIDE CASE, READY TO USE. \$87.50**

### MODEL 617 3" OSCILLOSCOPE

Designed both for color TV servicing and laboratory requirements. Features high deflection sensitivity. (.01 v/in rms); 4.5 mc vertical bandpass, flat within ±1 db; internal 5% calibrating voltage. Small, lightweight... but accurate enough for the most exacting work. **SPECIAL FLAT FACE 3" CRT PROVIDES UNDISTORTED TRACE EDGE TO EDGE. \$269.50**



See these latest Hycon money-makers — all in matching, bench-stacking cases — at your local electronic parts jobber.

# Hycon Mfg. Company

2961 East Colorado Street  
Pasadena 8, California

"Where accuracy counts"

ORDNANCE · ELECTRONIC TEST INSTRUMENTS  
ELECTRONIC SYSTEMS · AERIAL SURVEYS  
BASIC ELECTRONIC RESEARCH · AERIAL CAMERAS  
GO NO-GO MISSILE TEST SYSTEMS

## TELEVISION

the capacitor doesn't help, replace all components that could affect this circuit's tuning.

### Trailing whites

The picture on a G-E model 806 appears to have a smear that I can best describe as trailing whites. Details are also very poor. The vertical and horizontal sync is perfect so I have not checked these circuits. All tubes in the tuner, i.f. amplifier and video amplifier have been checked. I have a schematic of this receiver and have checked many of the d.c. and signal voltages but still have not been able to come up with the answer.

I have made an attempt at alignment and the bandwidth of the r.f. and i.f. circuits is apparently correct. I tried changing one of the peaking coils in the video amplifier but that made matters worse.—T. W., Odgen, Utah

It appears that you have a lot of checking ahead of you in the video amplifier circuit. The trailing whites generally indicate phase shift and poor low-frequency response in the video amplifier. This is a general trouble and not restricted to this receiver. Replace the 5,100-ohm detector load resistor and the 3,300- and 4,700-ohm video amplifier load resistors. In some cases a change in value of as little as 20% can seriously deteriorate the picture. Often the peaking coils maintain the high-frequency response when this occurs. But since you also have poor detail, you should carefully check or replace these coils as well.

In the first video amplifier there is a 10-μf capacitor decoupling an 18,000-ohm resistor from the plate circuit—replace it. If its capacitance should decrease, its decoupling action falls off and the effective plate load resistance is increased, degrading the picture. In addition, check all coupling and bypass capacitors.

Despite your alignment it is still barely possible that this is the trouble. In checking the i.f. response, carefully locate the video carrier and be sure that it is approximately 50% down on the i.f. response curve.

### Delayed a.g.c.

A Sylvania 508 chassis came in with a complaint of a negative picture. A bench check showed the trouble to vary from a negative picture to one with a great deal of snow. Because of the snow we suspected that the tuner was at fault and replaced the tubes and checked for low plate voltage. Further checks included the video i.f. amplifiers, but no luck. Would appreciate suggestions.—E. R. M., New Haven, Conn.

Snow in the picture is generally a tipoff of trouble in the tuner. However you did not mention measurement of an important voltage, the a.g.c. This chassis has a 2-μf capacitor in the a.g.c. line that frequently becomes leaky or open, developing excessive a.g.c. voltage. This attenuates the sig-

RADIO-ELECTRONICS

# it's a snap! \* with laboratory tested kits by **ARKAY**

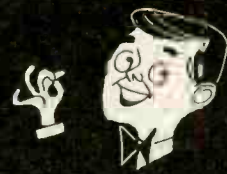

## SPECIAL FOR OCTOBER Only Vertical Chassis T.V. Kit —Standard Coil Tuner

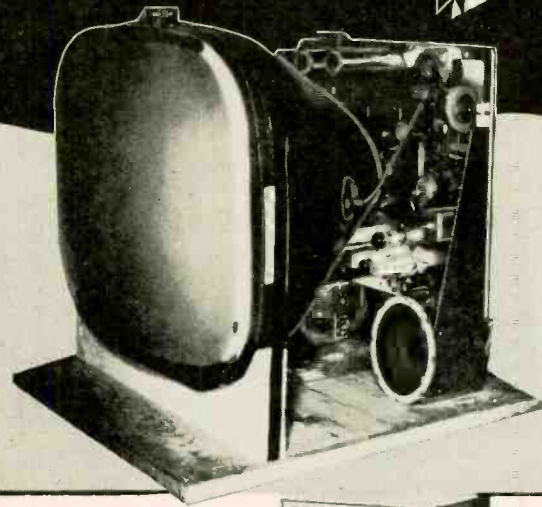

### Arkay FL-10 High Fidelity Amplifier Pre-Amp Kit

Unity coupled pushpull 12 watt output; frequency response  $\pm 2\text{db}$  20-20,000 cps with extremely low IM and Harmonic distortion; 5 position input selector with record equalizer; loudness, bass, and treble controls; tapped output; extremely low noise level; completely enclosed—in cabinet problem; for clean, flexible, brilliant audio. **\$28.95**



### Arkay Model Q5X 2 Band AC/DC Radio receiver kit

Broadcast 550-1700 kc and short wave 6-18mc bands; superheterodyne circuit of modern design; special tone chamber for utmost realism in listening; magic glow lucite dial actuated by pilot light when set turned on; a smart functional set. **\$19.95**



### Arkay Model TB2X—2 band Battery operated Portable Radio Kit;

Receives broadcast band 550-1700kc plus short wave band 6-18mc; superheterodyne circuit operated from a long life (1000 hour) battery pack; handsome cabinet with slide rule dial; low battery drain miniature tubes throughout. **\$19.95**

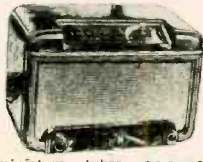

### Arkay Model S5E superheterodyne receiver Kit;

designed especially for the beginner—educational as well as functional; 5 tube AC DC radio with built in loop antenna and plastic cabinet; as in all Arkay Kits, contains detailed manual with exclusive 3D Eye-O-Gram technique for simple assembly. **\$14.95**



### Arkay 2X4 3-way 2 band portable receiver Kit.

Foreign Band of 6-18mc; broadcast band 550-1500kc; excellent for beach or camping; indoors or out; foreign stations, marked on semi-airplane dial; housed in handsome leatherette cabinet; superheterodyne circuit with low battery drain tubes. **\$24.95**



### Arkay 3W10P 3-way portable receiver Kit.

4 low battery-drain miniature tubes in an efficient superheterodyne circuit of extreme sensitivity; AC, DC, and battery operation for utmost convenience; selenium rectifier for instantaneous operation on AC or DC; 2 tone attractive plastic cabinet; built in loop antenna. **\$18.95**



Arkay Model 14T21 Advanced design T. V. Kit Featuring — Modern Vertical Chassis construction; transformerless operation; turret type tuner (Factory wired and tested); Full 14kv, electrostatically focused 21" picture tube operation; field tested circuitry of latest design and innovation for stable, clear, trouble free reception under all conditions; excellent fringe area performance. A first rate Kit anyone can easily assemble at a low price anyone can afford. **\$79.50**

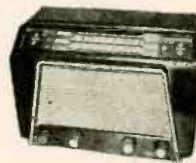

Arkay Model P120 3 Band Radio Receiver Kit. Frequency range 550kc-18mc in 3 bands; police, fire, amateur and foreign stations; slide rule dial; special tone control and phono switch on front cabinet; 6" speaker; quality throughout; latest transformerless design. **\$25.75**



Arkay Model 10-1 Electronic Experimenters Kit. 10 projects to construct include, a broadcast receiver, audio amplifier, phono oscillator, code practice oscillator, home broadcast station, capacity relay, photo cell relay, signal tracer, electronic timer, electronic switch; learn circuitry the practical way. **\$13.95**

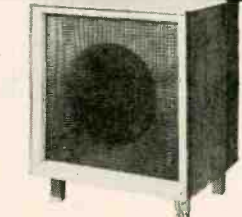

Arkay Model B12 Baffle Kit. Infinite impedance type for 12" speaker maximum size; cabinet is exact replica of very expensive commercial sound chamber giving excellent full frequency sound response; enclosure is acoustically tuned; this unit is attractive and is mounted on Hollywood legs; assembled by anyone with hammer and nails; easily finished. **\$11.95**

## HIGH FIDELITY SPECIALS FOR OCTOBER

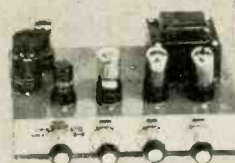

Arkay A-12 High Fidelity Amplifier Kit Featuring — 12 watt output-push pull 6V6's; frequency response  $\pm 1\text{db}$  20-20,000 cps with low distortion; 5 inputs, master controlled at front panel; tapped output transformer; separate bass and treble control, each with maximum db boost and cut; built-in Pre-Amplifier; Ideal for home installations. **\$22.95**



Arkay FM-AM Tuner Kit Featuring— 7 tube circuit plus selenium rectifier includes separate mixer and oscillator stages, 3 double tuned IF stages with Foster-Seely discriminator and grounded grid amplifier for excellent response characteristics.

Sensitivity & Selectivity—FM 5mv for 30db quieting, 200 kc bandwidth 6db down. AM 25mv with 8 kc bandwidth 6db down.

Frequency Response —  
 FM  $\pm .5\text{db}$  20-20,000 cps  
 AM  $\pm 3\text{db}$  20-5000 cps  
 Image rejection —30db minimum  
 Hum Level — .65db.  
 AFC control and defeat. **\$24.95**  
 FM—only kit available. **\$18.95**

## FREE

Master catalogue of Arkay Kits sent free of charge upon request. To obtain these fine Kits see your local dealer or write directly to Arkay.



\* Arkay invites you to see for yourself how simple it is to construct these fine Kits. A sample Construction Manual and Pictorial Exploded views illustrated above (Model 3W10P Portable Radio) will be sent for just 10c (to cover postage and handling).

Radio Kits Inc. Dept. 10-R  
 120 Cedar St., N. Y., N. Y.

Gentlemen:

- Please send me sample Manual. Enclosed is 10c.
- Please send me Free master catalogue of Arkay Kits.

Name.....  
 Address.....  
 City..... State.....

# RADIO KITS INC.

DEPT. 10-R 120 CEDAR ST., N.Y.C.



have you got

# "the LOWS"?

"The Lows" is a dread disease, always found in dealers carrying low-priced antennas, accessories and twin-lead. Symptoms are alarming. Such dealers have acute pocketbook pallor and sad faces. "The Lows" is a contagious business disease. Customers buying from dealers with "Lows" can be easily spotted by their belligerent air of dissatisfaction.

The cause of "The Lows" is easily found. Low priced merchandise. For low price means low profit (hence the dealer's blues) and low quality (hence the customers' complaints).

Fortunately the remedy is simple—sell quality products at a fair profit margin. Dealers who have switched to selling AMPHENOL antennas, accessories and twin-lead have instantly improved their condition. They have found the AMPHENOL line to be the high profit line, with good mark-ups on every item. They have found the AMPHENOL line to be the high quality line, with resultant customer satisfaction. Be immune to this dread disease—"The Lows".

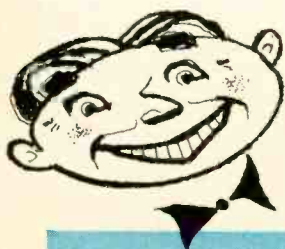

help your business grow PROFITABLY . . .

**SELL** 

AMERICAN PHENOLIC CORPORATION *chicago 50, illinois*  
In Canada: AMPHENOL CANADA LTD., Toronto

## TELEVISION

nal, causing snow. Try shorting the tuner a.g.c. to ground; if the snow clears up and the picture returns to normal, that capacitor is almost surely the trouble.

If replacing this capacitor fails to clear up the trouble, measure the a.g.c. voltage. If it appears high or if shorting the a.g.c. line to ground clears up the trouble, check every component in the a.g.c. circuit. Should the a.g.c. line be functioning properly, you can best pinpoint the trouble by tracing out the signal path, starting at the r.f. amplifier, by using an oscilloscope and suitable demodulator probe.

### 60-cycle hum

*An Emerson TV receiver, model 651C (chassis 120124), came in recently that seemed like a routine affair. The trouble was hum in the picture with approximately half the screen fairly dark. The field man replaced every tube in the set while in the home, but nothing helped. At the shop all tubes were rechecked on the possibility that he had replaced a tube with heater-cathode leakage with another defective tube. All checked O.K.*

*Checked with a scope, the video amplifier revealed nothing. I then looked over all wiring for possible stray coupling, with particular attention to the vertical sweep circuits. There was no hum in the audio and the shading appeared on the raster and with a picture. I would appreciate some hints on what could be causing this trouble.*  
—K. S., Tampa, Fla.

You were certainly on the right track in checking all tubes for heater-cathode leakage. However, with the hum appearing on the raster without a signal, it would more or less eliminate all tubes in the tuner and i.f. section. Hum passes through them only by signal modulation.

The video amplifier will pass a 60-cycle signal since it must pass the vertical sync pulses. Thus any heater-cathode leakage originating in any tubes in the video amplifier will be passed on to the picture tube. The video detector should be considered as part of the video amplifier. However, the i.f. amplifiers are designed to pass signals in the i.f. 20- or 40-mc band and will not pass a 60-cycle signal. But when a signal is passing through the i.f. amplifier, the hum modulates it and it is detected in the video amplifier.

You did not mention checking the picture tube itself. Do this first, as it is a very likely source of this type trouble. Also, make sure the hum is 60-cycle and not 120-cycle. Should there be two bars on the screen, the trouble could very well be coming from some defective B supply capacitor or some other component in the plate or screen circuit of one of the tubes.

A most probable source is a defective .002- $\mu$ f capacitor in the vertical retrace blanking circuit. This circuit feeds the picture-tube cathode. Open this circuit and observe the screen. END

## TELEVISION



October-December

TV dx in the final quarter of the year will be largely of a tropospheric nature in the first part of the period, with the short winter sporadic-E dx season coming along in the last two or three weeks of 1955. October will see some of the best v.h.f. and u.h.f. weather of the year, particularly along both coasts and over the Middle West. This sort of thing is associated with warm days and cool nights, so Southern areas will experience quite a bit through November and even into December.

Sporadic-E skip (signals usually heard or seen over distances of 600 to 1,200 miles) will show up rarely until well into December. The winter period, spaced either side of the shortest day of the year, usually features short openings. These are likely to be scattered geographically and of a single-hop nature. There is little of the country-wide dx that so many of our observers reported during June and July, but the dx-er who keeps a close watch of the low TV channels only during the summer season misses some good bets.

The Over-50 TV DX Club boasts a dozen new members whose complete records, along with those of the original group, will be published in the summary of 1955's dx, to appear in a later issue. If you have logged more than 50 different TV stations, and report dx catches to us regularly, send in your totals with each report. Include the number of stations you have identified positively, listing v.h.f. and u.h.f. separately. Be sure to include date and time.

New members: Gordon Simkin, Fort Lee, Va.; Donald Sanford, Viola, Wis.; Richard Lowry, Temple, Tex. (who has some prize dx including YVKS-2, Caracas, Venezuela; KENI, Anchorage, Alaska, and PRF-3, Sao Paulo, Brazil); Parissa Cox, Visalia, Calif.; Barry Rossum, Mohall, N. D.; Michael O'Rourke, Mesick, Mich.; Frank Greene, Roswell, N. M.; Larry Velhorn, Indianapolis, Ind.; W. C. Stallard, Chambersburg, Pa.; Dennis Smith, Wasco, Calif.; Billy Sevier, Corpus Christi, Tex.; Don Martin, De Ridder, La.; Donald Middleton, Sanford, Fla.

Quite a few letters received by your TV dx Editor ask questions of various kinds. We'd like nothing better than to correspond with each of you individually, but the volume of mail is so great that it is out of the question. Sorry, gang, we simply cannot answer mail, except through the medium of these dx forecasts and summaries. END

# PREASSEMBLED—



## TWIN LEAD HANKS

### Save Time & Labor Costs On The Job

The do-it-yourself trend gets a new impetus with AMPHENOL preassembled Twin Lead Hanks. Three of the most popular AMPHENOL Twin Leads are now available in 50, 75 and 100 foot lengths—complete with lugs attached on one end. 14-056 Flat, 14-100 Century and 14-298 Four Conductor Rotator Cable are the Twin Leads and you can buy them in their colorful new Hank put-ups at your distributor.

Because *all* AMPHENOL wire products are made with 100% virgin polyethylene dielectrics, and because only the finest, purest copper is used for conductors, dealers and installers throughout the country know that there are no finer Twin Leads.

We back them up with this guarantee: *every foot of AMPHENOL Twin Lead is guaranteed for top performance.*

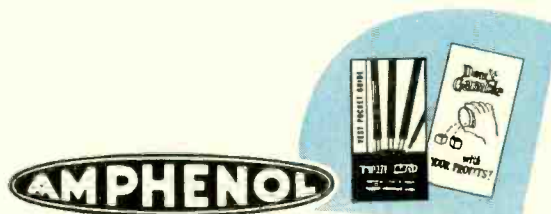

At your AMPHENOL Distributors: *Vest Pocket Guide to Twin Leads* and *"Don't Gamble with Your Profits."* Both are interesting and informative.

AMERICAN PHENOLIC CORPORATION  
chicago 50, illinois  
In Canada: AMPHENOL CANADA LIMITED, Toronto

# TRAVEL AID for the BLIND

By T. A. BENHAM



Left—The Signal Corps Sensory Aid; above—as it looks in actual use.



**M**ANY people have given much thought to the special problems pertaining to helping the blind get along in a society geared for sighted people. One major problem is concerned with making it possible for blind people to travel in safety and with assurance.

In 1943 the Signal Corps began the development of a travel aid to help blinded World War II veterans in their rehabilitation program. The scope of the problem soon included all blind people. Research went through several stages to a point where RCA was contracted by the Signal Corps to manufacture 25 prototypes of their Sensory Aid for testing and evaluation.

The Signal Corps Sensory Aid (see photo) is an electronic device intended

to aid blind people in travel by warning the user of discontinuities in the terrain and obstacles in his path. The principle of operation is as follows: A beam of light interrupted 500 times per second is projected in a narrow beam from an optical system, strikes an object or the ground and is partially reflected into a second optical system. This second optical system focuses the reflected image on a perforated coding disk behind which is located a photoelectric cell. The output of the cell is fed through a four-stage amplifier to a vibrator in the handle of the instrument. The amplifier and vibrator are resonant at 500 cycles, the same frequency at which the light beam is

“chopped.” The coding disk interrupts the reflected light 4, 8, 16 or 32 times per second, depending on the distance to the object.

Thus, the repetition rate of the 500-cycle pulses in the handle informs the user as to the distance to an obstacle or discontinuity in the terrain; the position of the handle indicates the azimuth—that is, whether the obstacle is to the left, right or straight ahead. Fig. 1 is a block diagram of the device; Fig. 2 shows how the instrument is used to locate a curb. When looking for curbs, the light from transmitting lens T (Fig. 2) strikes the ground at the edge of a down curb at point A and is reflected to receiving lens R, giving a distance signal of 6 feet (the instrument is held so that the light from T strikes the ground about 6 feet in front of the user). As the user advances slightly the beam of light from T misses the edge of the curb and hits the ground at B and reflects to R. This causes the distance signal to increase suddenly from 6 feet (T to A) to approximately 7 feet (T to B).

This sudden change in range of 1 foot is detected by a very subtle change in the vibrator signal in the handle of the instrument. Furthermore, obstacles cannot be detected until they are closer than 6 feet although, if stepdowns are neglected and the beam is projected horizontally, obstacles can be de-

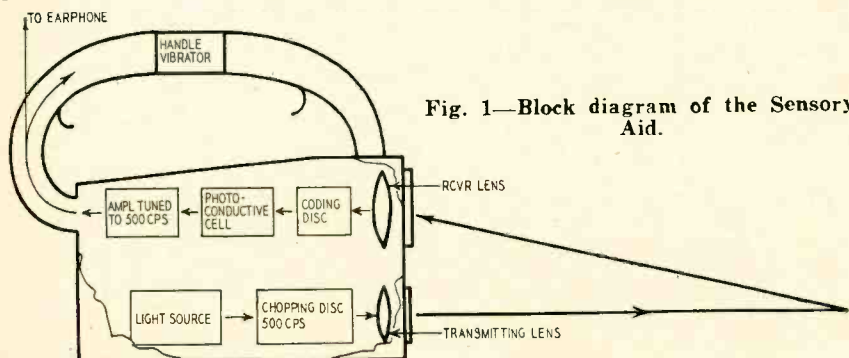
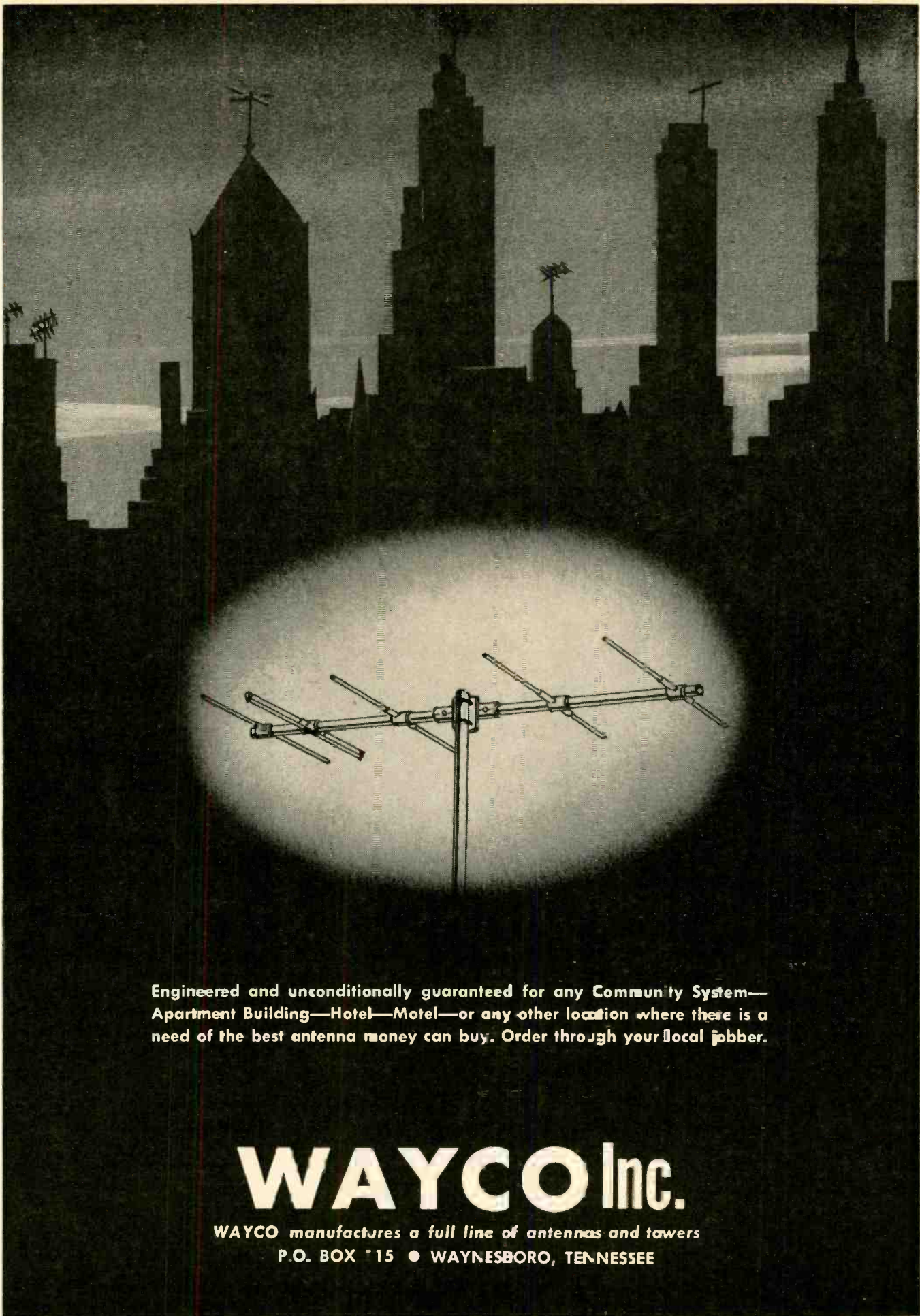

Fig. 1—Block diagram of the Sensory Aid.





Engineered and unconditionally guaranteed for any Community System—  
Apartment Building—Hotel—Motel—or any other location where there is a  
need of the best antenna money can buy. Order through your local jobber.

# WAYCO Inc.

WAYCO manufactures a full line of antennas and towers  
P.O. BOX 15 • WAYNESBORO, TENNESSEE

# TROLMASTER

**CLEANS  
AND  
LUBRICATES**

**TV-RADIO  
CONTROLS  
IN**

**60  
SECONDS**



Now you can completely clean and lubricate volume, tone, brightness and contrast controls without removing chassis or back from cabinet. Simply remove knob at front of control, screw solvent-loaded TROLMASTER onto control, push the plunger in, remove TROLMASTER, work the control back and forth and the job is done—in 60 seconds or less! TROLMASTER thoroughly cleans either single or dual controls. Constructed of solid brass, TROLMASTER will not corrode when used with any chemical normally used in the electronics industry. User's Net, **\$395**

**KLEENTROL MAGIC SOLVENT**

Cleans, lubricates TV-Radio controls and tuner, push-button and switch contacts. Non-inflammable. Will not harm surfaces or finishes of wood, metal or acetate. Recommended for use with TROLMASTER. Full Pint. User's Net, **\$195**

See your Distributor or write.

Manufactured by  
**R-COLUMBIA  
PRODUCTS CO., INC.  
HIGHWOOD, ILLINOIS**

tected when they are 10 or 12 feet away. If the instrument is used for locating curbs, the user must be constantly attentive to a continual signal in which very subtle changes occur.

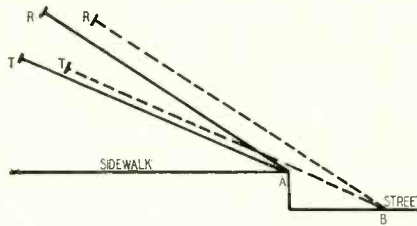

Fig. 2—Diagram illustrates how the Sensory Aid is used to locate curbs.

**The testing program**

Representing a cross-section of the blind population, 67 subjects were tested: 9 used seeing-eye dogs as guides before trying this electronic travel aid, 16 used a cane, 40 a sighted person and 2 no guide. Of the cane users 8 were willing to change from cane to Sensory Aid; 3 of the 8 who preferred the cane said, "I prefer the feeling of firm contact with the ground which a cane affords."

Subsequent to the testing program, the 67 subjects were classified as follows: 9 excellent, 9 good, 23 fair, 15 poor, 11 dropped. Of the "dropped" category 6 resulted from sickness of the trainer. Each subject was required to travel an unknown course at the end of his training.

It was decided to choose  $\pm 20\%$  of the normal time for a sighted person as a maximum permissible deviation; anyone who traveled slower than this was considered too slow for proper evaluation of the instrument. This does not mean that the instrument was not of considerable value or aid to such a subject. Nineteen came within this  $\pm 20\%$  tolerance.

Of those tested 37 had difficulty in detecting curbs. This was chiefly due to the fact that the curb signal was an extremely subtle and fleeting change in the distance signal which occurred when the beam of light passed over the edge of either an "up" or "down" curb. An "up" curb appeared as a momentary slight decrease in distance; a "down" curb as a momentary increase in distance. False curb signals were frequently obtained because of the change in distance to the point where the light fell on the ground (a result of instrument jiggling).

It was evident that there is a need for a curb detector not affected by the irregular movements of the hand as the user walks. Eight had no particular trouble, 12 had difficulty detecting obstacles. Six were unable to perform the necessary scanning motion with the wrist to "see" obstacles slightly to the right or left. Four found the change in reflectivity of different surfaces bothersome. The difference in reflectivity appeared as a change in the intensity of the reflected signal.

# INTERNATIONAL'S NEW TV RECTIFIER REPLACEMENT BONUS PACK!



**FREE!  
NYLON TV TOOL**

**With every pack of 4 TV  
Selenium Replacement Rectifiers...  
A PAIR and a SPARE PAIR!**

You can't miss with International's New "BONUS PACK"! You'll get the best in TV replacement rectifiers. Each BONUS PACK contains a pair for immediate use, and a spare pair for your next job—PLUS a Nylon TV Alignment Tool worth \$1.00—ABSOLUTELY FREE!

**SPECIFY INTERNATIONAL RECTIFIERS** for long, dependable performance—the Widest Range in the Industry! Best for you... Best for your service customers!



Ask your distributor  
for details about  
"Bonus Pack" today!

# International Rectifier

CORPORATION  
1521 East Grand Avenue, El Segundo, California • Oregon R-6281  
IN CANADA: Atlas Radio Corp., 50 Wingold Ave. W., Toronto, Ontario  
**WORLD'S LARGEST SUPPLIER  
OF INDUSTRIAL METALLIC RECTIFIERS  
RADIO-ELECTRONICS**

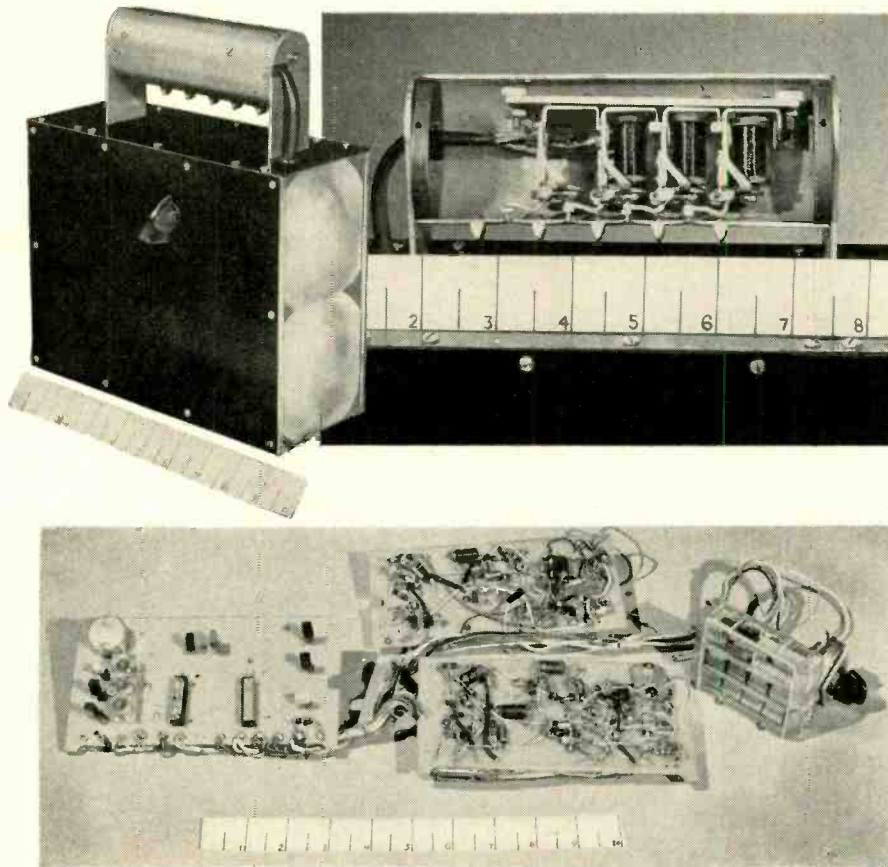

Top left—The recently developed guidance device; top right—closeup of the interior of handle; below—interior construction of the guidance device.

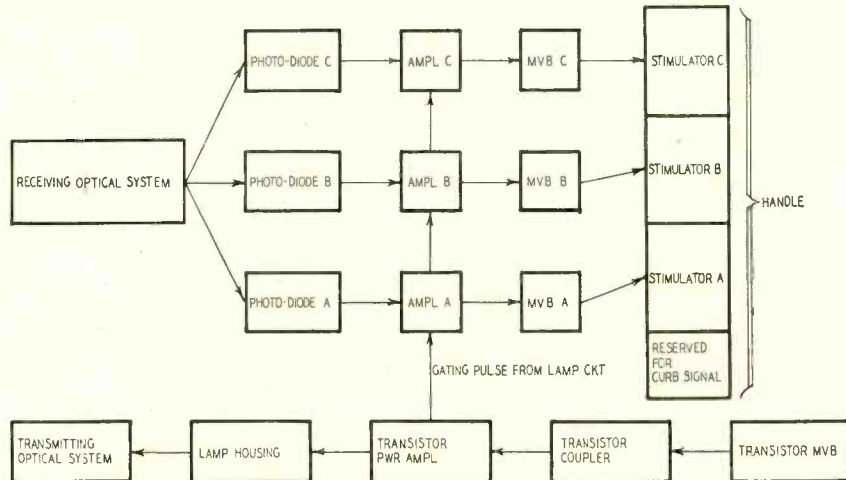

Fig. 3—Block diagram of a recently developed type of obstacle detector.

The change in intensity was sometimes interpreted as a change in distance. Twenty said that the weight of 4.5 pounds was excessive. All subjects found the continual signal presentation tiring.

To discover what would happen if the instrument were used over a prolonged period, 5 subjects used it in their everyday life over a period of 6 months to a year. The novelty did not wear off, the subjects became more and more dependent on the Sensory Aid. They were most anxious to have the instrument repaired when a failure occurred and they used it as much, or more, than their previous travel aid.

The results of this program indicate that the two most important improvements required for future development are: separate curb and obstacle detectors, which remain quiescent until there is information to be transmitted; separate curb and obstacle signals (stimulae) sufficiently distinct so that the user has no difficulty recognizing them. The slight changes in the continual signal were not sufficiently emphatic to alert the subject under all conditions, especially after the first 10 or 15 minutes, when fatigue set in.

The testing program has indicated conclusively that in the final production of a satisfactory travel aid, models

**LOWEST PRICES  
HIGHEST QUALITY**

**100 TUBES \$44<sup>50</sup>**

TUBES—PREMIER Unconditionally Guarantees All Tubes For One Full Year. Very Best Brands Available for Immediate Delivery. Individually Boxed.

1A5GT	6AL5	6V7	12SN7GT
1A6	6AQ5	6W4GT	12SQ7GT
1A7GT	6AU5GT	6W6GT	12X1
1B3GT	6AU6	6X5GT	12Z3
1D8GT	6AV5	7A5	14B6
1F4	6AV6	7A6	14B8
1F5G	6AX1GT	7A7	14Q7
1H5GT	6AX5GT	7A8	14W7
1H6G	6B4G	7AD7	14X7
1L4	6BA6	7B6	24A
1LAJ	6BD6	7B7	25A6
1LA6	6BE6	7B8	25AC5GT
1LC5	6BF6	7C4	25RQ6GT
1LC6	6BG6G	7C5	25C6G
1LD5	6BQ6GT	7C6	25W4GT
1LH4	6BY5G	7C7	25Y5
1LN5	6C4	7E5	25Z5
1NSGT	6C5GT	7E6	26
1P5GT	6C6	7E7	27
1Q5GT	6C8G	7J7	32L7GT
1R5	6C8G	7L7	35/51
1S5	6CB6	7N7	35A5
1T4	6CD6G	7Q7	35B5
1U4	6D6	7V7	35C5
1V4	6D8G	7W7	35L6GT
1V4	6F6GT	7X7	35Y4
1X2A	6G6G	12A7	35Z5GT
2A7	6J6	12AU6	39/44
2X2	6K6	12AU7	41
3A4	6L6G	12AV7	42
3B7	6P5GT	12AX4GT	43
3C6	6Q7GT	12AX7	45
3Q4	6S4	12AY7	45Z5GT
3Q5	6SA7GT	12BA7	46
5U4G	6SD7GT	12BD6	47
5Y3GT	6SF5	12BE6	50AX6
5Z3	6SJ7GT	12BH7	59L6GT
6A7	6SH7GT	12F5GT	56
6A8GT	6SK7GT	12I7GT	57
6AB4	6SL7GT	12Q7GT	58
6AB7	6SN7GT	12S8GT	70L7GT
6AC5GT	6SQ7GT	12SA7GT	77
6AC7	6SS7	12SC7	78
6AG5	6U7GT	12SG7	117L7GT
6AK5	6U8	12SK7GT	117Z3
6AK6	6V6GT	12SL7GT	117Z6GT

ANY ASSORTMENT—TAKE WHAT YOU WANT  
5c per tube extra FOR ORDERS LESS THAN 100 TUBES

**NEW PICTURE TUBES**

SIZE	PRICE	SIZE	PRICE
10BP1B	11.95	17LP4	\$21.95
12LP4A	13.95	17TP3	
12UP4A	\$18.95	19AP1B	\$27.95
14BP4		19DP4B	
14CP4		20CP4	\$26.95
16AEP4	17.95	20DP4	
16AP1A	\$19.95	20HP4	\$28.95
16DP4A		21AP4	
16EP4A		21EP4	27.95
16GP4A		21FP4	28.95
16JP4A		21MP4	29.95
16KP4	17.95	21WP4	27.95
16LP4A	19.95	21YP4	28.95
16RP4	\$17.95	21ZP4	27.95
16TP4		24CP4	19.95
16W4A	19.95	27EP4	6R 50
17BP4A	17.95	27GP4	\$69.50
17CP4	\$21.95	27LP4	
17GP4		27NP4	\$69.50
17HP4		27RP4	

ALL TUBES THROUGH 21" GUARANTEED 1 YEAR  
24" AND 27" GUARANTEED 6 MONTHS

**One Hundred Assorted RESISTORS**  
All Good Values & Sizes. 1/2-1-2 Watt Insulated. All American—No Foreign!  
**\$1.89**

**SURPRISE KIT** 10 lbs. Net of Reliable Radio and T. V. Parts—Each Kit includes a new Radio Cabinet—Good for 5 to 8 Tube Chassis. **All for \$1.98**

**PICTURE TUBE BRITENERS 95c EACH**  
10 for \$7.50

**TERMS:** 25% DEPOSIT with order. balance C.O.D. All shipments F.O.B. Chicago. **ORDERS LESS THAN \$5.00—\$1.00 SERVICE CHARGE.** CABLE ADDRESS: CONTULAB. These prices supersede all previous advertised prices, subject to change.

**PREMIER**  
**TV Radio Supply**  
3241 W. North Ave.  
Chicago 47 • ARmitage 6-5550  
Write for FREE Bargain Catalogs

for faultless playback  
of pre-recorded tape!

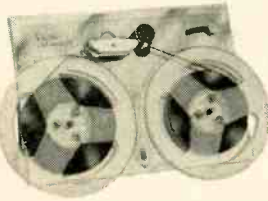

PROVIDING  
FULL FIDELITY  
PERFORMANCE—  
40-14,000  
CPS at 7.5"

**\$59<sup>95</sup>**

USER NET



- Meets broadcast requirements for minimum distortion, flutter, and wow.
- The Viking innovation of a belt-driven capstan eliminates vibration and flutter—*tape speed is constant!*
- The basic monaural unit pictured can be easily converted to full fidelity *bi-aural* playback or *erase-record* playback, ideal for tape duplicating.
- Check Viking's coordinated line of NARTB standard pre-amps, erase bias oscillators, record/playback amplifiers.

Sold thru dealers; write for information



**VIKING OF MINNEAPOLIS**

Dept. RE-10

3540 E. 43rd St., Minneapolis, Minn.



**DON'T  
THROW  
OLD  
RADIOS  
AWAY!**

Here's the data you need  
to fix them **FAST**—good as new!

Just look up the how-to-do-it data on that old radio you want to fix!

Four times out of 5, this giant, 3½-pound, 744-page Ghirardi RADIO TROUBLESHOOTER'S HANDBOOK gives exactly the information you need to fix it in a jiffy. Tells what is likely to be causing the trouble . . . shows how to fix it. No useless testing. No wasted time. Handbook covers common troubles and their remedies in practically every radio receiver model made by 202 manufacturers between 1925 and 1942. Using it, even beginners can easily fix old sets which might otherwise be thrown away because service information is lacking. With simple repairs, most of these old sets can be made to operate perfectly for years to come.

**THE ONLY GUIDE OF ITS KIND!**

Cuts service time in half!

Included are common trouble symptoms and their remedies for over 4,800 models of old home, auto radios and record changers. Airline, Apex, Arvin, Atwater Kent, DeHout, Iosch, Brunswick, Clarion, Crosley, Emerson, Fada, G-E, Kolster, Majestic, Motorola, Philco, Pilot, RCA, Silvertone, Spartan, Stromberg and dozens more. Gives how-to-do-it data on SPECIFIC jobs—NOT general theory. Includes hundreds of pages of tube and component data, service short cuts, etc. No longer available from any other source still in print.

...TRY IT 10 DAYS . . . at our risk!

Dept. RE-10S, RINEHART & CO., Inc.  
232 Madison Ave., New York 16, N. Y.  
Send Ghirardi's RADIO TROUBLESHOOTER'S HANDBOOK for 10-day free examination. If I decide to keep book, I will then remit the full price of only \$6.50 plus a few cents postage. Otherwise, I will return book postpaid and owe you nothing.

NAME.....

ADDRESS.....

CITY, ZONE, STATE.....

Outside U. S. A.—Price \$7.00, cash only. Same return privilege

Rinehart Books are sold by leading book stores

## ELECTRONICS

of varying complexity should be provided. Some blind people are not capable of assimilating information at as high a rate as others and are confused by having more information presented than they are capable of interpreting.

A three-year development program got under way on Feb. 1, 1953, with the signing of a contract between the Veterans Administration and Haverford College at Haverford, Pa.

It was desired to construct a travel aid that did not have any moving parts and which required much less battery power. To make a simple, probe type obstacle detector would not be too difficult; a satisfactory curb finder much more so.

### Recent design

Since the contract got under way, considerable progress has been made. The third experimental obstacle detector (Fig. 3) is nearing completion. Instead of the relatively cumbersome motor, chopper and incandescent lamp which consume about 900 mw, a pulsed gas-discharge lamp is used having a power consumption of about 50 mw. A xenon lamp is operated by a transistorized power supply consisting of a multivibrator, a coupling transistor and a power amplifier. This circuit produces a pulse of 200- $\mu$ sec duration at a repetition rate of 20 pulses per second with a peak value of about 40 volts. This pulse is superimposed on 80 volts of battery potential to provide a peak of 120 volts, the potential required to "fire" the lamp.

After the lamp "fires," the voltage drops to about 100 where it stays for 200  $\mu$ sec. When the transistor power supply "turns off" at the end of the pulse, the voltage drops to 80 and the lamp extinguishes. Thus, the transistor power supply has to supply only about one-third of the voltage required to "fire" the lamp.

The light reflected from an obstacle is focused on one of three photosensitive germanium diodes, depending on the distance to the obstacle. If the obstacle is closer than 4 feet, the reflected light falls on diode A; between 4 and 7 feet, on diode B and between 7 and 10 feet on diode C. The signal from each of these diodes passes through separate transistorized transformer-coupled amplifiers. The output of each of these amplifiers triggers a transistor multivibrator, the output of which drives the stimulator in the handle of the instrument.

Thus, if diode A is illuminated, amplifier A triggers multivibrator A which in turn operates stimulator A. Stimulator A in turn communicates with the index finger of the hand. Channel B stimulates the middle finger and channel C the fourth finger. Such a three-channel parallel system (see photo) should be a distinct improvement over a one-channel system because, even if one channel fails for some reason, the other two can still operate. The signal amplifier does not

## WHILE THEY LAST!

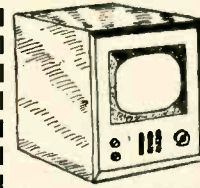

10" TV REMOTE  
"SLAVE" SETS

HERE'S YOUR  
CHANCE TO GET  
THAT EXTRA SET  
FOR PLAYROOM,  
BEDROOM, KITCHEN,  
ETC.!!

These are COMPLETE, OPERATING slave units. Hook up to any standard TV receiver (only 4 soldered connections) to reproduce any tuned TV channel. COMPLETE SCHEMATIC & HOOK-UP DATA SUPPLIED. Operates on 110V. DC: AC conversion data included.

**FEATURES:** • 45 TUBES including 10FP4. ALL 90 DAY GUARANTEED.  
• H.V. OSC. POWER SUPPLY . . . detachable unit  
• 4" HVY. DUTY PM SPEAKER.  
• MAJOR STANDARD PARTS INCLUDE: Def. Yoke, Focus Coil, Horiz. & Vert. Outputs, two 10H-100 ma Chokes, 150ma Sel. Rect., Electrolytics, Controls, etc.  
• HANDSOME WALNUT VENEER & LEATHERETTE CABINET (20½" x 17" x 14½").  
• PARTS ALONE WORTH SEVERAL TIMES THE PRICE!! Perfect Condition —used. Shipped Railway Exp. (Sorry No C.O.D.'s)

**\$23.95**

\*\*\*\*\*  
GLOSSY BLACK PLASTIC PANELS . . .

18"x24"x1/8", Opaque. Exc. for Control \$1.29

CLEAR SHEET PLASTIC 20"x4¼"x

030"—ca. 29c

RUBBER TAPE (T1192) 15' x¾" 4/1.00

ca. 19c

PLASTIC "SARAN" GRILLE CLOTH . . .

Beautiful Gold, Blonde, Mahog. & Walnut weaves.

49c sq. ft. 10 sq. ft. or more—40c sq. ft.

TUNGAR BULBS . . . Brand new; orig. cartons.

0.6 Amp (GE-289881) ea. \$1.49, 4/55.00

15 Amps (Cetron CE-235)—ea. \$2.95

\*\*\*\*\*  
!! TV CABINETS !!

Beautiful MAHOGANY WOOD veneer black models.

Inside: 19½" W. x15½" H. x19" deep. Opening 13¼" x

10½" H. With safety glass & 12" mask. Adaptable to

LARGER SCREEN SETS or CONSOLE.

MAKES HANDSOME 12" or 15" HI-FI

SPEAKER CABINET . . . WHILE THEY

LAST

\*\*\*\*\*  
!! TELEPHONE HANDSETS !!

Rugged moulded bakelite. Perfect for Radio, Phone or

Intercom. Made of plastic. carbide mike. Long cord

& plug. (Navy CYH51019)—ea. \$4.95 pair \$8.95

CHROMALOX DISC HEATER . . . 450W., 115V. AC/DC.

3-3/16" O.D. x 3/8" D.C. Ceram. insul. \$1.29

PORTABLE UTILITY CASE . . . All steel;

lock, hinged cover. 65" web carrying strap. Overall:

10" x 14" x 4" . . . \$1.29

SPDT SLIDE SWITCH (1½" x ½") . . . ¾ A/125V . . . 15

DPDT BALL TOGGLE SWITCH (AHH) . . . 6A/125V.

¾" L. shank. Split ball. . . ea. 35c 10/52.98

\*\*\*\*\*  
HEY FOLKS! . . . BIG NEWS!!!

and we mean B-I-G!

Hundreds of useful & valuable items have just been

ADDED to our famous

"JUMBO RADIO-ELECTRONICS PARTS KIT"

to give it a "New Look." . . . You'll get

17 FULL LBS. OF: SWITCHES, WIRE, \$3.95

PHOTOFACTS, CONTROLS, COILS, SOCK-

ETS, CAPACITORS, RESISTORS, SPEAKERS ACCES-

SORIES, PLUS DOZEN OF OTHER ITEMS WORTH

MANY TIMES THE PRICE!! (shpg. wt. 20 lbs.)

\*\*\*\*\*  
SHAFT COUPLINGS . . . Brass, ½" O.D. x ¾"

3/8" to 1/4" — 3/8" — ea. 15c

3/16" to 1/4" — 5/16" or 3/8" . . . 10/\$1.25

1/4" to 3/16" — 5/16" . . . ea. 29c

5/16" to 3/16" — 1/4" or 3/8" . . . 4 for

3/8" to 3/16" — 5/16" . . . \$1.00

Min. Order \$3.00—20% deposit required on all orders

Please add sufficient postage—excess refunded

**LEOTONE RADIO CORP.**

67 Dey Street

New York 7, N. Y.

**Build it Yourself!**



Spinet, two-  
manual and  
three-manual  
electronic  
organs.  
Save hundreds  
of dollars  
with our  
easy-to-  
assemble kits.  
Designed to  
sound and  
look like a  
pipe organ.

Send \$1.00 for  
"Organ Builders  
Manual." Full  
plans for home,  
church and  
concert models.  
Includes parts  
catalog.



ELECTRONIC ORGAN ARTS Dept. 10  
4878 Eagle Rock Blvd. • Los Angeles 41, Calif.  
RADIO-ELECTRONICS

NEW!

NOISELESS!

ELECTRONIC!



**Thompson Products**

*Automatic*

**Superotor®**



**INTERCHANGEABLE ROTORS** . . . . .

Famous time-proved Superotor models "100" and "500" have both been adapted for automatic operation!



World's only *silent* automatic antenna rotator! No gears, no click, no clatter. Electronic fingertip VP\* tuning. Antenna rotation and control is smooth, not in "steps" like ordinary automatics — provides a new standard of tuning accuracy for Fringe, UHF and Color reception. Write today for specifications.

\*VP (Vernier Precision)

**OTHER THOMPSON PRODUCTS  
ELECTRONIC AFFILIATES**

- Bell Sound Systems • Dage Television
- Ramp-Woodriddle Corp. • Pacific Semi-Conductors, Inc.

**ELECTRONICS DIVISION**

**Thompson Products, Inc.**



2196 CLARKWOOD ROAD • CLEVELAND 3, OHIO

Available in Canada thru Atlas Radio Corp., Ltd., 50 Wingold Ave., Toronto

this TV serviceman uses

# STANCOR

## EXACT REPLACEMENT TRANSFORMERS

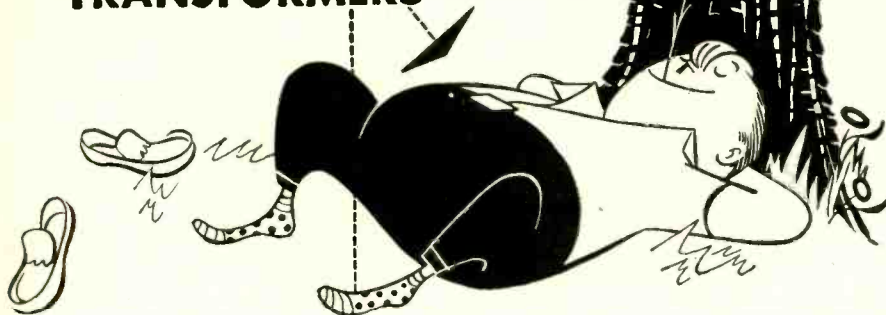

There are now 59 Stancor exact replacement flybacks covering all major TV set manufacturers and many private label brands. The latest units include 6 new Zenith replacements that give you

**71% ZENITH EXACT REPLACEMENT FLYBACK COVERAGE**

and 6 new General Electric replacements that give you

**79% G. E. EXACT REPLACEMENT FLYBACK COVERAGE**

You too can take life easy and have time to spare when you use Stancor exact replacements. No changing of circuits, no drilling of holes . . . you just take out the defective unit and replace it with a Stancor Transformer that exactly duplicates the original.

**FREE** The New Stancor TV Transformer Replacement Guide, listing accurate replacement data on almost 8500 TV models and chassis of 116 manufacturers. If you haven't received your copy see your Stancor distributor or write Chicago Standard Transformer Corporation.

### CHICAGO STANDARD TRANSFORMER CORPORATION

3592 ELSTON AVENUE  
CHICAGO 18, ILLINOIS

Export Sales:  
Roburn Agencies, Inc.  
431 Greenwich Street  
New York 13, N. Y.



## ELECTRONICS

have to supply power to the stimulator but simply serves as a switch to turn on the multivibrator. Since this amplifier is gated by the lamp pulse, the vibrator is silent except when there is information to be given to the user. This gating action affords an additional advantage because the amplifier is "turned off" so that no transient signals can get through except during the 200- $\mu$ sec period that the lamp is on.

The total battery drain for the complete system with one stimulator operating is about 165 mw broken down as follows: lamp, 80 ma at 100 volts, consumes 8 watts peak. With a duty cycle of 250 this corresponds to an average power of 32 mw. The lamp drive circuit is approximately 70% efficient so that the total power required to drive the lamp is about 50 mw. Each channel consumes approximately 7 mw and each stimulator plus multivibrator 75 mw. Of course, if all three stimulators are operating simultaneously, which might occur occasionally, the total power drain would be approximately 300 mw. The stimulus for warning curbs and steps would come from a fourth channel activating the little finger.

In the Signal Corps device the lamp was on all the time. This is a waste of power since it is necessary to take a "look" only occasionally and for a brief instant. In the above model a "look" is taken for 200  $\mu$ sec only 20 times per second.

It may be possible to use even shorter duration using surface-barrier transistors recently developed by Philco, producer of a special photosensitive surface-barrier diode for this project. At the present writing results are promising. The noise level of this transistor is comparable to and perhaps better than previous types and the frequency response characteristic appears satisfactory for pulse durations as short as 50  $\mu$ sec. A channel using pulse durations as short as this would require surface-barrier transistor amplifiers. A preliminary model of such a channel has been constructed having a gain of 60 db and which appears to have a frequency response flat to about 0.5 mc with a noise level no higher than the Johnson noise.

Thus, the obstacle detector seems pretty well established. However, the curb-locating problem is far from settled. We are planning to project a portion of the otherwise-wasted light through an optical system which would focus it on the ground about 6 feet in front of the user. A second receiving lens mounted at the top of the instrument would be focused on this spot. The image of the spot would fall on a photosensitive surface-barrier transistor, the output of which would be treated in a manner similar to that in channels A, B and C. The output of the curb channel would be applied to a multivibrator, with the output operating the fourth stimulator in the handle. This channel would work in

## LEARN TV in KC

UNIVERSAL TV FAMOUS FOR 24 YEARS  
1,000'S OF SUCCESSFUL GRADS COAST TO COAST

Easy, quick, fascinating. Learn TELEVISION in 36 short weeks of enjoyable companionship in shop training. Wonderful job opportunities. Graduates have choice of many jobs or can establish their own TV repair shop. YOU CAN START EARNING AS MUCH AS \$150 PER WEEK. NO limit as time goes on. U.T.S. is an old established school (TV exclusive for 24 years) staffed by expert instructors, headed by one of America's first TV broadcasters. Costs so little to prepare yourself for life. No previous experience needed. Fully approved for Korean Veterans. Also fully approved course in color TV (1st in U. S.) Send coupon now for FREE BOOK on TV and Electronics opportunities.

WRITE FOR  
**FREE CATALOG**

FILL OUT COUPON

UNIVERSAL TV SCHOOL  
1220R Admiral Boulevard, Kansas City, Missouri  
PLEASE SEND ME INFORMATION FREE. Age \_\_\_\_\_

Name \_\_\_\_\_

Address \_\_\_\_\_

City \_\_\_\_\_ State \_\_\_\_\_

Check here if Korean veteran.

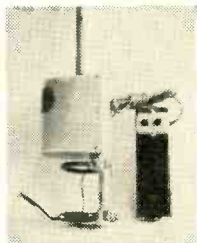

## TV ROTOR!

8-95

Uses 2 standard Flashlight Cells. Operates either direction on 2 wire Lamp Cord. Top Mast ready to mount any balanced single Bay Antenna not a toy. Ideal for conicals, QTs, Rainbows, etc. Return if not 100% pleased! Jobbers—Dealers write for more information. Send cash check or M.O.

**KELTNER MFG. CO., Seymour, Mo.**

Mention  
**RADIO-ELECTRONICS!**

*All New!*  
**RCA WO-91A**  
**5" 'SCOPE FOR**  
**BLACK and WHITE**  
**and COLOR TV**

**Only \$229<sup>50</sup>**  
 User Price (Optional)

**RCA WO-91A 5" OSCILLOSCOPE**  
 Complete, ready-for-use, including new  
 WG-300A low-capacitance, dual-purpose  
 probe, shielded input cable and  
 instruction book.

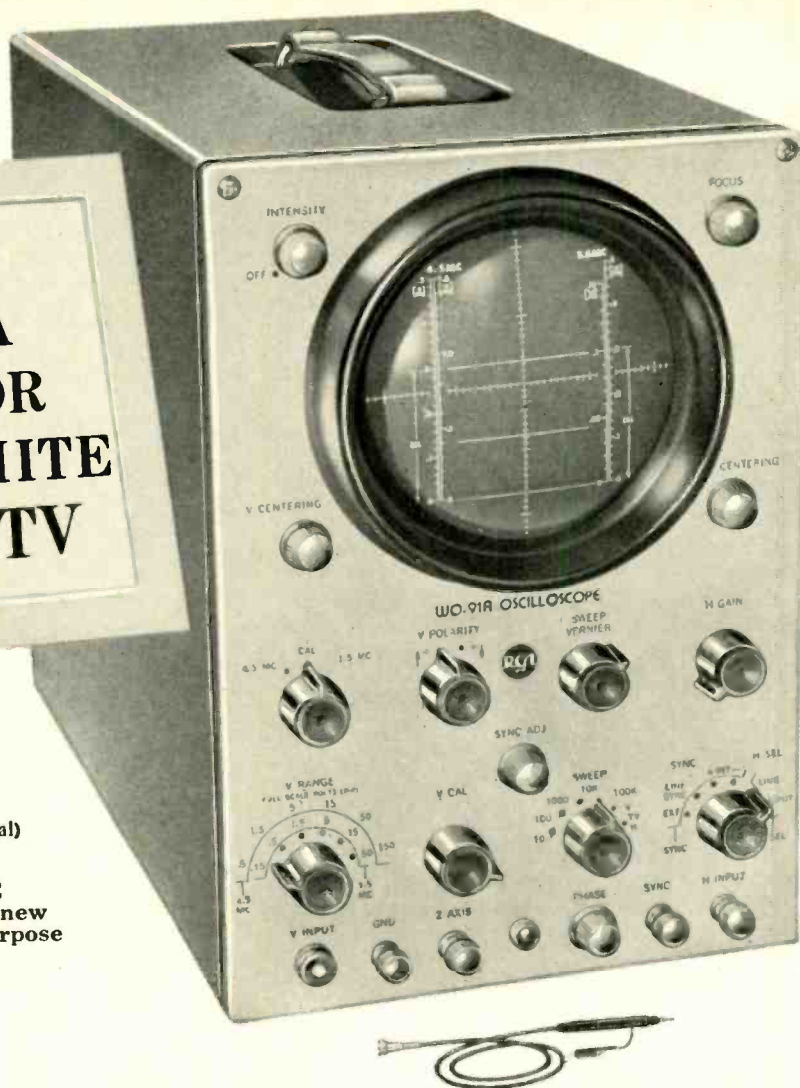

**N**OW—AN ALL-NEW OSCILLOSCOPE with features usually found only in more expensive instruments. It has all the 'scope functions you need to do both black-and-white and color TV service work . . . speedily and with top-grade results! Check a few of these work-simplifying features . . . "low-capacitance/direct" probe . . . preset "V" and "H" sweep positions . . . automatic probe-disconnect calibration control. And look at the added features of this instrument:

- Dual-band response. Response flat to 4.5 Mc in wide-band position.
- Voltage-calibrated, frequency-compensated, 3-to-1 step attenuator for "V" amplifier.
- Simplified, semi-automatic voltage calibration for simultaneous voltage measurement and waveshape display.
- VTVM-type graph scales marked in peak-to-peak volts—read voltage amplitude directly from screen.
- Vertical-polarity reversal switch for "upright" or "inverted" trace display.
- Sturdy one-piece low-capacitance/direct probe minimizes circuit loading.
- Z-AXIS input facilities permit direct modulation of the cathode-ray tube grid.
- Preset "V" and "H" sweep positions for speedy, automatic lock-in at "vertical" and "horizontal" frequencies.
- "Plus" or "minus" internal-sync selector.
- Shielded vertical-input connector and shielded cable for minimizing hum and stray field pick-up.
- Positive-lock internal sync.

**FREQUENCY RESPONSE:** Wide-band position, within-1 db from 10 cps to 4.5 Mc; Narrow band position, within-1 db from 10 cps to 0.5 Mc; within-6 db at 1.5 Mc.

**SENSITIVITY:** 0.05 volt peak-to-peak per inch (0.018 volt rms) in narrow-band position; 0.15 volt peak-to-peak per inch (0.053 volt rms) in wide-band position.



**RADIO CORPORATION of AMERICA**  
 TEST EQUIPMENT  
 HARRISON, N. J.

See the ALL-NEW  
 WO-91A at your  
 RCA Distributor.  
 Order now for  
 early delivery.

# Hi-Fi and Hi-Price aren't Siamese Twins

THE NEW IMPORTED *Fen-tone*<sup>Hi-Fi</sup> IS OUT TO PROVE THIS TO YOU. NOW YOU CAN GET PROFESSIONAL FEATURES YOU ALWAYS WANTED — AT PRICES YOU WILL GLADLY PAY.

SEE THIS "BEST VALUE" SELECTION OF DANISH, ENGLISH AND W. GERMAN HI-FI EQUIPMENT AT THE CHICAGO HIGH FIDELITY SHOW SEPTEMBER 30-OCTOBER 2, ROOM 709 and THE NEW YORK AUDIO FAIR OCTOBER 13-16, ROOM 502, OR CONTACT YOUR AUDIO DISTRIBUTOR.



**REX** RECORD CHANGERS ARE PREFERRED BY OVER 85% OF THE CONTINENTAL HI-FI MANUFACTURERS.

A truly mechanical brain, plays any odd size record between 6" and 12"  
 • Long professional type pick-up arm with plug-in shell to American standards • World's best shaded 4-pole phono motor • Factory tuned spring suspension double chassis • Practically free of rumble and acoustic feedback • Muting switch • Automatic shutoff • Two spindles — long for changer and short for manual player use • Many other features and models. Audiophile Net \$59.50

45 RPM Automatic Spindle (ADD.) Net \$3.50

## NEW *Fen-tone* B&O 350 LO-Z PROFESSIONAL MAGNETIC CARTRIDGE

Works on any load over 1000 ohms • 30 mV/4.4 cm/sec. output, due to 8-poles • Highest 5x10<sup>-6</sup> cm/dyne lateral compliance • Response 20—16,000 cps flat ± 2 db then gradually rising to over 20,000 cps.

Audiophile Net:

B&O Reversible, Silver Label (2 sapphire jewels) .....\$ 7.95  
 B&O Reversible, Gold Label (1 diamond, 1 sapphire) .....\$19.95  
 B&O Single, Silver Label (1 sapphire jewel) .....\$ 7.50  
 B&O Single, Gold Label (1 diamond jewel) .....\$18.95



SYMPHONY

B&O-50

CELESTE

THE NEW MINIATURE *Fen-tone* BLUE RIBBON STUDIO TYPE VELOCITY MICROPHONES. TRULY PROFESSIONAL MIKES AT INCOMPARABLE LOW PRICES.

"RESLO" DUAL IMPEDANCE MIKES — PROPER IMPEDANCE SELECTED BY PLUGGING IN PROPER CABLE. • Shockproof miniature duraluminum ribbon with no audible resonance. • Response 30 — 15,000 cps ± 2 db. • Bi-directional pattern easily changed to directional or close talk by use of internal pads. • Triple blast screening. • Sensitivity — 58 db.  
 "B&O"-50 A BI-DIRECTIONAL MIKE WITH CHARACTERISTICS SIMILAR TO THE RESLO BUT WITH EVEN GREATER SENSITIVITY. INSTEAD OF PADS IT HAS A 3-WAY SWITCH: "T" (Close talk); "M" (music) and "O" (off).

Reslo "Celeste" 30/50 ohms and HI-Z with muting switch — Audiophile Net \$48.95  
 Reslo "Symphony" 250/600 ohms (no muting switch) — Audiophile Net \$48.95  
 B&O-50 50 ohms impedance — Audiophile Net \$48.95

## *Fen-tone* MOTEK K5 TAPE DECK

Driven by three AC motors. • 7½ ips speed, dual tracks. • 3¾ ips conversion pulley available. • All-electrical push-button switching and braking. • Frequency response better than 50 — 10,000 cps. • WOW and FLUTTER less than .3%.

Audiophile Net: \$59.50

## *Fen-tone* TPR-1 TAPE PREAMPLIFIER

Bias frequency 50 — 60 kc, adjustable. • Signal to noise ratio: better than — 55 db. • Power supply on separate chassis. • High impedance (1 volt) output.

Audiophile Net: \$39.50 — In prefabricated kit form: \$34.50

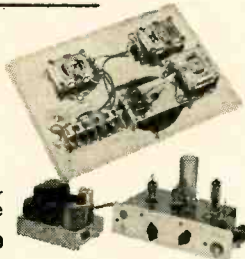

THE NEW LARGE MOTEK K7 2-SPEED UNIT WILL SOON BE AVAILABLE ALSO

## *Fen-tone* "BRENELL" HI-FI TAPE DECK

A FOOLPROOF 3-SPEED UNIT FOR LIFETIME USE.

• Three speeds:	3¾ ips	7½ ips	15 ips
• Frequency Response:	50-6500	50-12000	30-15000
• Playing Time:	2 hours	1 hour	½ hour

• Three independent AC motors. • Dual tracks — 7" reels. • Positive interlock of all switching and braking mechanisms, including automatic pinch-roller and pressure pad assembly. • Instantaneous mechanical braking. • Simple two-knob operation: The left for "Fast Forward" and "Rewind" (within 45 seconds); the right for "Record/Playback" and "Off." • WOW and FLUTTER less than .2%. • High fidelity heads have

mumetal shields for hum-free operation. Hi-Z Record/Playback head with adjustable azimuth, ideal for all makes of pre-recorded tapes. • Heavy Duraluminum base plate 15" x 11½". • Highest quality precision workmanship. Audiophile Net \$79.50



### ATTENTION PRERECORDED TAPE USERS:

Our PRO-2 Hi-Fi Pre-amplifier for Motek and Brenell decks featuring 3 independent equalization curves is now also available. All prices slightly higher on the West Coast.



**FENTON COMPANY**

15 MOORE STREET  
 NEW YORK 4, N. Y.

## ELECTRONICS

reverse to the other three channels in that, as long as a signal was received, the multivibrator would not operate. When a curb came into the region where the spot of light struck the ground, the signal would disappear because no light would be reflected into the curb receiving system. This would allow the multivibrator to operate the stimulator, not an ideal solution for three reasons: It requires that the instrument be held reasonably steady, which may not be easy to do in normal walking; changes in reflectivity of the surface of the ground may cause false signals (one particularly bad change in reflectivity is that produced by a mud puddle); the system will not detect "up" curbs.

The stimulators located in the handle of the instrument (see photo) are somewhat unique. The handle is shaped to fit a wide range of hand sizes. The four fingers fit into small finger grooves in the bottom of the handle. The fingers are separated by a thin partition. Inside the handle are four small solenoid-operated plungers. When the armature moves, it pushes a small round probe through a hole in the bottom of the handle. This probe pokes against the skin of the finger between the first and second joints.

The region between the first and second joints was chosen because the weight of the instrument comes naturally on this area so that it is a relatively fixed position between the finger area and handle. It was found that, if the user became tense and began to squeeze the handle, the operation of the probing stimulator was not seriously affected.

The coil of the stimulator was designed to match the output of the transistor circuit. The multivibrator triggered by the signal and which operates the stimulator is adjusted to have a duty cycle of approximately 0.5; that is, it is on half the time and off half. This is necessary because it would not be practical to use the same duty cycle as for the lamp pulse.

The obstacle problem will not be completely solved by any electronic device under consideration at this time. A blind person would be warned of an impending danger by the obstacle detector, 8 or 10 feet in advance. It would enable him to make measures to "skirt" around" the obstacle, thus avoiding embarrassment and potential injury. One of the problems encountered in testing the Signal Corps Sensory Aid was the tendency for the blind to stop to analyze the obstacle in an effort to determine its nature. He was constantly reminded, "Don't identify it, miss it."

END

### REFERENCES

<sup>1</sup> Franklin Cooper, "Guidance Devices for the Blind," *Physics Today*, Vol. 3, No. 7, pp. 6-14. July, 1950.

<sup>2</sup> For a technical discussion of the instrument, see *Electronics*, March, 1946, page 116. McGraw-Hill.

<sup>3</sup> F. E. Terman, *Radio Engineering*. McGraw-Hill, 2d edition, page 229.



WORLD'S MOST *Exciting* TV ANTENNAS

*Originals* by **WINEGARD**



Ends neatly closed to eliminate wind whistle and vibration.

New High  $\phi$  Loading Coils and High Impact Polystyrene Molded Insulators.

Permanent Anodized Coating eliminates corrosion.

Exclusive Twin-Lock Hardware with Stainless Steel Snaps.

Boom ends plugged for noise elimination.

*Colors so Bright... They Sell on Sight*

When it comes to antennas, you, as a technician, are naturally interested in gain, directivity, front-to-back ratios — all of the electrical and mechanical features that make antennas tick. But think of it from your customer's viewpoint. He is interested in only two things: (1) performance — getting the best possible pictures on his TV set; and (2) appearance — how the antenna looks on his roof. **Only Winegard Interceptor TV Antennas give you both unequalled performance plus neat, colorful appearance.**

Color is something people understand and *want!* That's why you should start installing Winegard anodized Interceptors NOW! Wait till people see these shimmering metallic colors sparkling in the sun! One installation and you'll have the whole neighborhood talking — asking who did the job. **You'll sell at least a dozen Winegard Interceptors from each one you install!**

Ask your jobber or clip coupon



*Winegard*

**SUPER-INTERCEPTOR** — designed for superior performance in extreme fringe areas. Gleaming gold finish or regular aluminum.

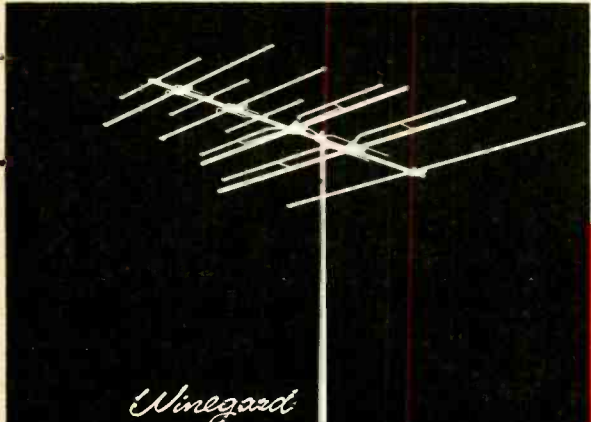

*Winegard*

**INTERCEPTOR\*** — world's most imitated all-channel Yagi. Available in beautiful metallic shades of red, blue, green and gold.

© 1955

\*Patent No. 2700105

Mail Today



**WINEGARD COMPANY, Dept. A**  
**3000 Scotten Boulevard, Burlington, Iowa**

Please rush bulletin No. WL21455 on Anodized Antennas  Send complete technical information on Winegard Interceptors

\_\_\_\_\_  
 FIRM NAME

\_\_\_\_\_  
 ADDRESS

\_\_\_\_\_  
 CITY

\_\_\_\_\_  
 STATE

\_\_\_\_\_  
 SIGNATURE



*Auto-Radio Technicians:*

# DELCO RADIO

TRAINING COURSES MEAN MORE BUSINESS FOR YOU



Working in small groups under factory-trained Delco instructors, alternate lecture and lab periods keep radio technicians up to date on latest radio and repair developments at a General Motors Training Center Delco Radio course.



Typical of the thirty General Motors Training Centers across the country is this one at Tigard, Oregon, a Portland suburb. Ample parking areas help to make this center popular throughout the Northwest.

Week-long courses for experienced service technicians provide latest radio and repair information—enable you to do the job faster and more efficiently.

Quick, accurate auto radio diagnosis and repair to factory specifications boosts your profits. That's why so many qualified auto radio technicians attend these Delco Radio training courses at no cost for tuition, school supplies, or equipment.

Factory-trained instructors, using latest equipment and instruction methods, conduct these intensified week-long courses, designed to familiarize repairmen with modern auto radio developments and factory-approved repair techniques.

The Delco Radio diploma, awarded only to those who successfully complete the course, is proof that you're equipped to give more and better service to more people—and that means more business.

If you're an auto radio service dealer, come yourself, or send your technicians. There's one of 30 GM Training Centers near you. Apply through your local Delco Electronic Parts Distributor or write Delco Radio Division of General Motors, Kokomo, Indiana.

**DELCO RADIO**  
DIVISION OF GENERAL MOTORS  
KOKOMO, INDIANA

**HERE'S THE COURSE OF STUDY** — (1) Circuitry differences between home and auto radios. (2) Dead radio trouble-shooting procedure and lab. (3) Noisy radio trouble-shooting and lab. (4) Weak radio trouble-shooting and lab. (5) Distorted radio trouble-shooting and lab. (6) Intermittent trouble-shooting and lab. (7) Push-pull lock-up tuner lecture and lab. (8) Mechanical operation of Signal Seeking Tuner. (9) Electrical operation and trouble-shooting of Signal Seeking Tuner. (10) Autronic-Eye operation trouble-shooting procedure and lab. (11) Autronic-Eye installation and adjustment procedure. (12) Transistors and printed circuits.

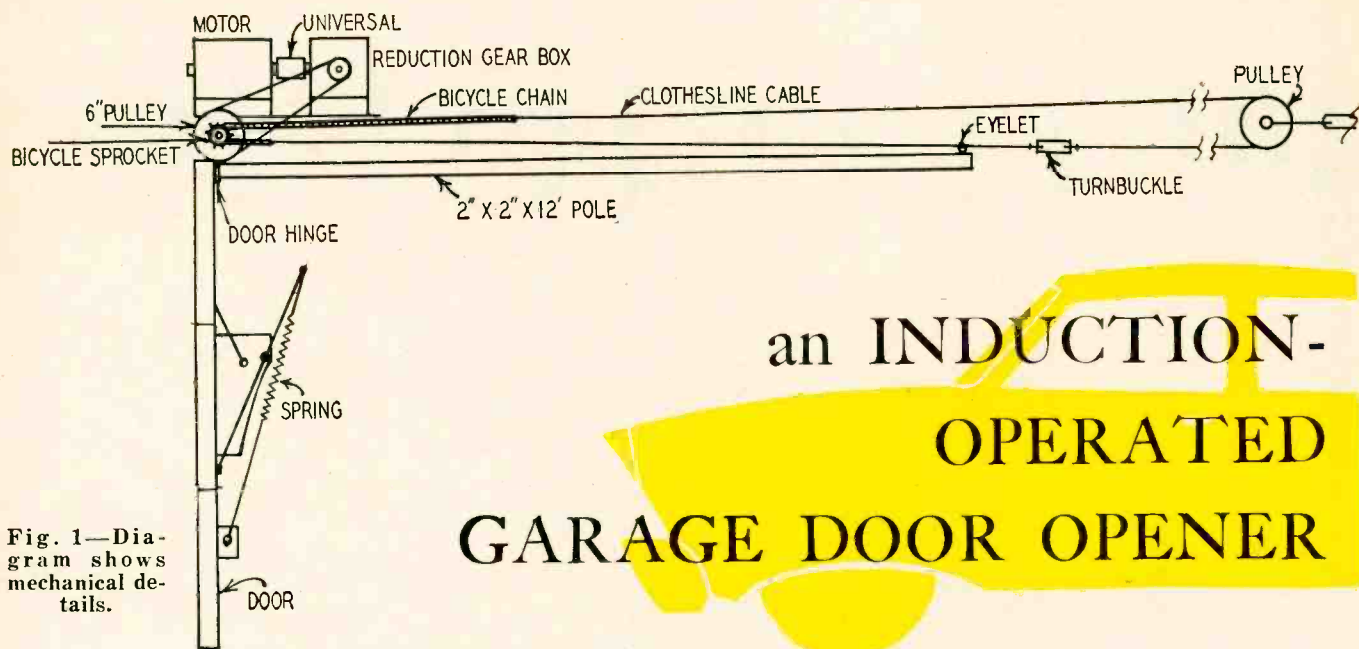

Fig. 1—Diagram shows mechanical details.

# an INDUCTION-OPERATED GARAGE DOOR OPENER

By RICHARD FRIEDMAN\*

**A**UTOMATION in the home is one of the fields in which great strides have been made in recent years. We accept automatic heaters, refrigerators, stoves, clock-radios and even television receivers as commonplace, but the grin-and-bear-it task of opening and closing the garage door is, in most homes, a manual operation. After many years of involuntary servitude to the garage door, from which temporary relief was too often found by leaving the car out "just tonight," the inherent laziness that fosters all inventiveness finally took over.

Immediately the problem reduced itself to two phases: the selection of a suitable linkage that would be simple, trouble-free and inexpensive, and, second, a means of remote control from the car which would be simple, foolproof and again inexpensive.

### The linkage

The design of a simple linkage to open and close the garage door will vary depending upon the type of door used and whether it folds open, opens sideways or overhead. Of the overhead variety, there are several types. The most popular seem to be those in which the door pivots about two centers as it is raised or lowered. This type is in my home. It is a particularly difficult linkage to mechanize as the motion of the door is not about a single pivot point and is not linear.

This problem was resolved by using a system of driven cables and pulleys (Fig. 1). A 12-foot 2 x 2 was attached to the top center of the door by a door hinge, and the other end connected to a galvanized-iron clothesline cable by a 1/2-inch eyelet screw and two cable clamps (all from Sears Roebuck).

\*Coleman Engineering Co., Los Angeles, Calif.

The prime mover for the system was obtained by purchasing a second-hand agitator type washing machine with a gear-driven wringer for \$10. This furnished an excellent 1/4-horsepower induction motor, easily reversible and with a good gear reducer.

An induction motor will run continuously in either forward or reverse direction, depending only upon the direction in which it is started. There are two windings in this type of motor—a "run" and a "start" winding. To reverse the motor merely requires that the "start" winding be reversed with respect to the "run" winding. It is, therefore, necessary to modify the motor to the extent of bringing both wires from both windings out of the motor separately. Do not tamper with the centrifugally operated switch. It is used to disconnect the "start" winding when the motor has reached running speed.

The gear reduction is not sufficient in itself and requires an additional 3:1 reduction in a V-belt drive system. A 2-inch pulley is attached to the output shaft of the gear reducer and in turn drives a 6-inch pulley attached to an arbor. The clothesline cable is driven by the arbor which has a 2 1/2-inch diameter bicycle sprocket attached to the other end. A 10-foot portion of the cable is replaced by standard bicycle chain which provides a positive drive for the system.

The induction motor, gear and V-belt speed reducers are placed on a shelf which is solidly mounted to the frame work of the garage just above the center of the door.

Limit switches to control the operator are placed on one of the door hinges (see photo) and should operate before the door reaches the end of its travel, as the door requires a short

overtravel to coast to a halt after being shut off. This adjustment is not critical, but should be provided so as not to subject the entire system to excess and unnecessary stress which might cause damage.

Due to the irreversibility of the worm-gear drive in the washing-machine speed reducer, manual operation of the door will no longer be possible. This has the advantage of self-locking, though an emergency override should be provided.

The control circuit is shown in Fig. 2 with the door fully closed. War surplus

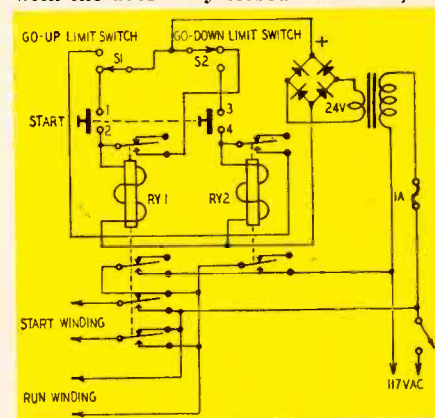

Fig. 2—Garage door control circuit.

28-volt relays may be used throughout with sufficient power being provided by a 24-volt filament transformer with a full-wave bridge rectifier. All the operations can be handled by two relays, RY1 and RY2, in which RY1 could be called the "go-up" relay as it is operated during the going-up operation and RY2 the "go-down" relay by the same reasoning. (The four-pole relay specified for RY1 was not immediately available so I used two double-pole units with coils in parallel.) Motor reversal is



 **SYLVANIA**  
**SILVER SCREEN 85**

**more profit for you in  
"Silver Screen 85's"**

*Stepped-Up  
Selling Power*



Sylvania puts you in the driver's seat and backs you with more promotional horsepower than ever before. This Fall, it's *all out* on *all fronts* to make your selling job easier and your servicing job more profitable. Here's how:

**Stepped-up TV power**—"Beat the Clock's" fabulous prize contest makes all your customers and prospects potential prize winners. 10 new prizes, 10 new winners every week. Week after week you'll win new customers who come to you for their free entry blank. And as a Sylvania Dealer only you can supply them with an official entry blank.

**Stepped-up magazine power**—Sylvania's selling the "Silver Screen 85" in the biggest consumer magazine campaign of 1955. Full schedules in *This Week* and *TV Guide* will presell your customers on the three outstanding features of the "Silver Screen 85" picture tubes. 11 million readers are reached by *This Week* through the combined distribution of 35 great American newspapers. Over 3 million TV viewers use *TV Guide* every week for TV news and program listings.

**Stepped-up promotional power for you.** A complete package of Sylvania promotion material is available so you can fill in the important final link in this promotional chain reaction. Window and counter displays, new direct-mail material, the important "Silver Screen 85" booklet, and new ad mats are included to help you capitalize on the prize contest and national magazine program.

**Stepped-up profits for you.** Sylvania supplies selling power that adds up to more profit for you. Think with Sylvania—work with Sylvania—promote with Sylvania—and you can't help but profit with Sylvania.

SYLVANIA ELECTRIC PRODUCTS INC.  
1740 Broadway, New York 19, N. Y.

In Canada: Sylvania Electric (Canada) Ltd.  
University Tower Bldg., Montreal

LIGHTING • RADIO • ELECTRONICS  
TELEVISION • ATOMIC ENERGY



**SYLVANIA**<sup>®</sup>

**...fastest growing name in sight**

# ELECTRONICS

handled by the contacts of RY1 with power being controlled by either relay. The two relays are wired so that when the door is down and the pushbutton actuated, RY1 operates through the contacts of S1 and will "lock in" through the contacts of the "go-down" limit switch S2 which will release RY1 when the door has reached the "up" position. The pushbutton need be only momentarily depressed as lock in is almost instantaneous.

## The remote controller

The problem of operating the garage door operator by remote control is a real tough one. Photoelectric circuits, radio and ultrasonic transmitters, pressure plates, capacitance relays and sonic-operated devices are nothing new and are fairly easy to design and build. But each of these falls down in some respect in meeting the standards of a good remote control—simple, trouble-free, and, above all, foolproof. None of the aforementioned systems are in themselves fool- or tamperproof. For examples, the photoelectric system is usually actuated by any opaque object interrupting the beam or by light from reflections or headlights on the sensing element. Radio is by nature subject to other transmitters on the same frequency. Ultrasonic devices can be operated by a great many ultrasonic sounds which are commonplace, but, of course, never heard. To achieve a fool-proof system almost any of the above can be elaborated upon, but it is doubtful whether the more elaborate system would still be simple.

Of all the systems considered, the old, faithful key-operated switch attached to a pipe set in the driveway entrance seemed the most suitable. However, the seldom-used induction transmitter soon showed itself to be the best means of remote control when considered from all aspects.

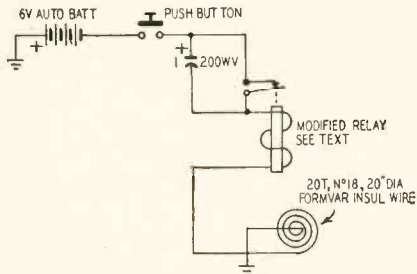
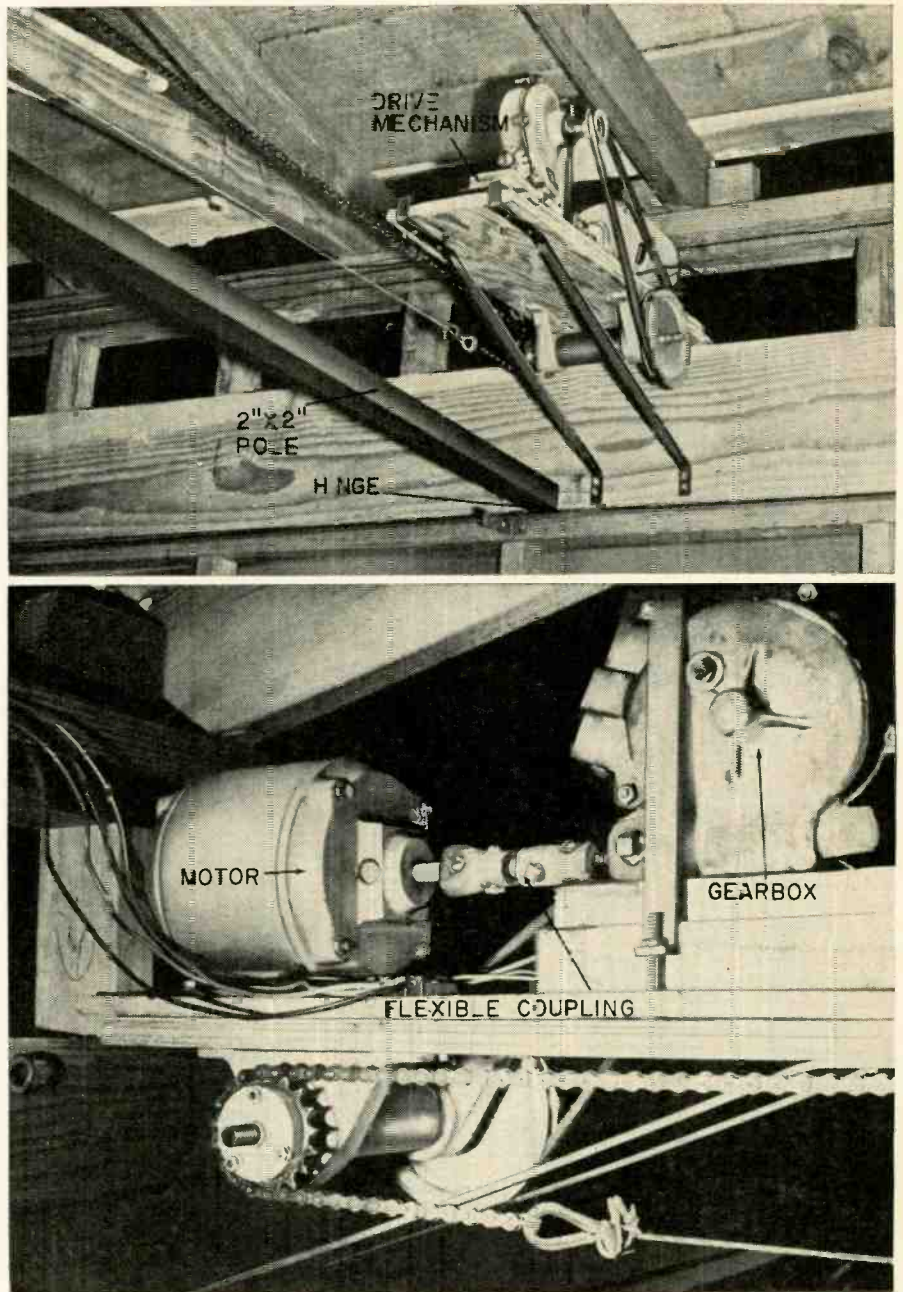

Fig. 3—Induction transmitter diagram.

The induction transmitter (Fig. 3) requires a simple buzzer-excited coil suspended underneath the car. When the pushbutton, mounted just under the dashboard, is depressed, the buzzer excites the coil with pulsating direct current which sets up a field detectable from a considerable distance. Reliable operation was obtained with as much as 6 feet of separation between transmitting and pickup coils.

The buzzer is a war-surplus, midget power type relay rewound with No. 20 Formvar insulated wire to provide a



Top—The completed garage door operator.

Center—A closeup of the operator assembly.

Right — Physical layout of receiver chassis.

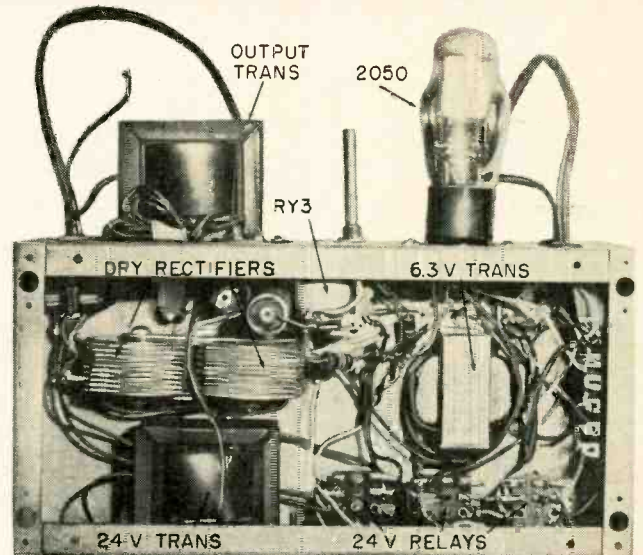

# EXCLUSIVE "PHASE-REVERSER" GUARANTEES

## THE NEW WALSCO WIZARD

### THE MOST ADVANCED, MOST POWERFUL

### SUPER FRINGE ANTENNA

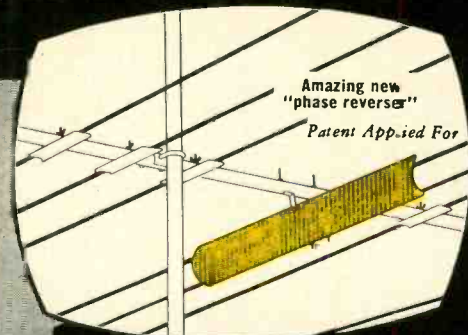

*here's positive proof!*

### IN THE WORLD

The new WalSCO Wizard performs as 3 separate antennas combined in one to give the very finest all-channel picture reception ever seen on any television screen. Extra dipoles, complicated harnesses, or phasing stubs are completely eliminated. And the Wizard is the easiest to assemble and install.

WalSCO guarantees the Wizard for 3 years.

Model	Price
Wizardette #4110	\$13.90 list
Wizard #4220	13.50 list
Wizard Imperial #4230	34.90 list

Actual comparison of fringe antenna performance

Channels	Gain (db) Single Bay											
	2	4	6	7	9	11	13					
WalSCO Wizard Imperial	6.1	6.9	8.2	11.9	11.6	10.8	12.6					
Antenna "A" With 5 Phase Reversing Dipoles	6.3	6.6	8.1	10.5	10.2	10.6	12.4					
Antenna "B" - Yagi Type with Phasing Loops	5.1	5.5	6.8	7.5	9.6	8.8	11.2					
Antenna "C" - Yagi Type with Loading Coils	5.9	6.9	8.6	9.1	8.6	9.6	7.8					



3602 Crenshaw Blvd.,  
Los Angeles 16, California  
IN CANADA: Atlas Radio Corp., Ltd.

**ASK YOUR JOBBER FOR FULL INFORMATION AND TECHNICAL BROCHURE ... OR WRITE DIRECT TO WALSCO.**

## ELECTRONICS

high-current pulse. The capacitor shown across the relay points protects them against arcing and provides a good clean square wave to excite the transmitter coil. Failure to include this capacitor will materially shorten the life of the contact points and lessen the transmitter's effectiveness.

Because of the comparatively long range of the system, reliable operation was obtained by burying the coil in the grass just alongside the driveway. Thus there was no need to tear up concrete or asphalt.

The receiving station (Fig. 4) uses a small thyratron type tube, a 2050 or 2D21. Do not use the cold-cathode types as they cause insensitive and erratic operation. The saving in heater stand-by current is not worth the extra trouble and spontaneous operations.

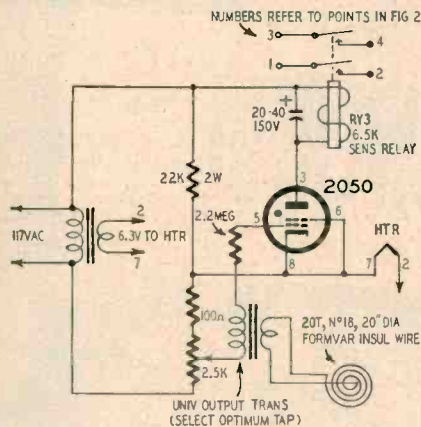

Fig. 4—Diagram of receiver circuitry.

Any sensitive type relay having an impedance between 5 and 15,000 ohms may be used in this circuit. Use a reasonable high-capacitance filter capacitor across the relay to filter the current during the conduction half-cycles.

### Parts for garage door opener

1—100-ohm resistor, 1/2 watt; 1—2.2-megohm resistor, 1/2 watt; 1—22,000-ohm resistor, 2 watts; 1—2,500-ohm potentiometer; 1—1-μf 200-volt capacitor; 1—20-40-μf capacitor, 150 volts, electrolytic; 1—2050 or 2D21 tube and socket; 1—pushbutton switch for transmitter; 1—power type relay, modified (see text), for transmitter; 2—coils, 20 turns No. 18 Formvar insulated wire, 20-inch diameter; 1—filament transformer for tube; 1—universal output transformer; 1—relay, d.p.s.t., RY3, 6,500 ohms, sensitive; 1—24-volt filament transformer; 4—selenium rectifiers for bridge (size to suit relays); 1—pushbutton, d.p.s.t.; 2—snap-action switches; 1—relay, RY2, d.p.s.t., surplus 28-volt unit; 1—relay RY1, 4-pole double-throw, surplus 28-volt unit; 1—1/4-hp induction motor; 1—length galvanized-iron clothesline cable, eyelet screw and cable clamps; gear-reduction assembly, V-belt system (see text); bicycle sprocket and chain; 1—12-foot 2 x 2 pole.

Since the remote controller has been installed there have been no failures. One rather amusing incident did arise—a form of relaxation oscillation took place within the thyratron when the standby bias was advanced near the firing threshold. The oscillations do not close the relay so they are not objectionable, although an ominous ticking can be heard on a broadcast receiver when it is slightly detuned—it certainly had everyone wondering about it for a while. END

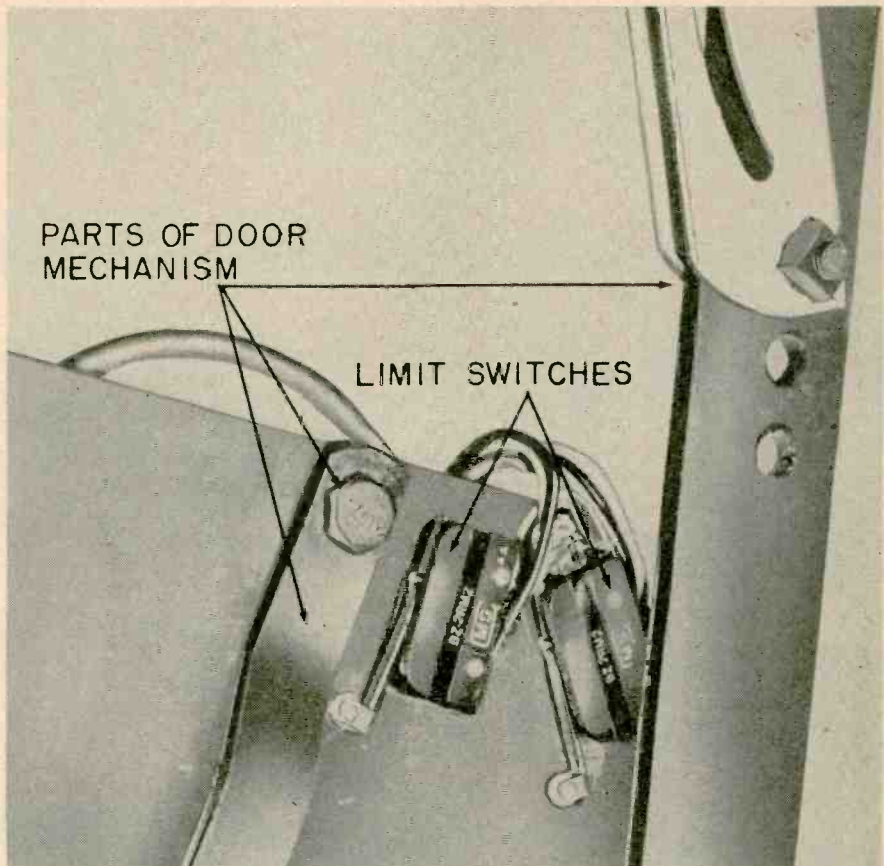

Snap-action switches on mechanism control motor operation and direction.

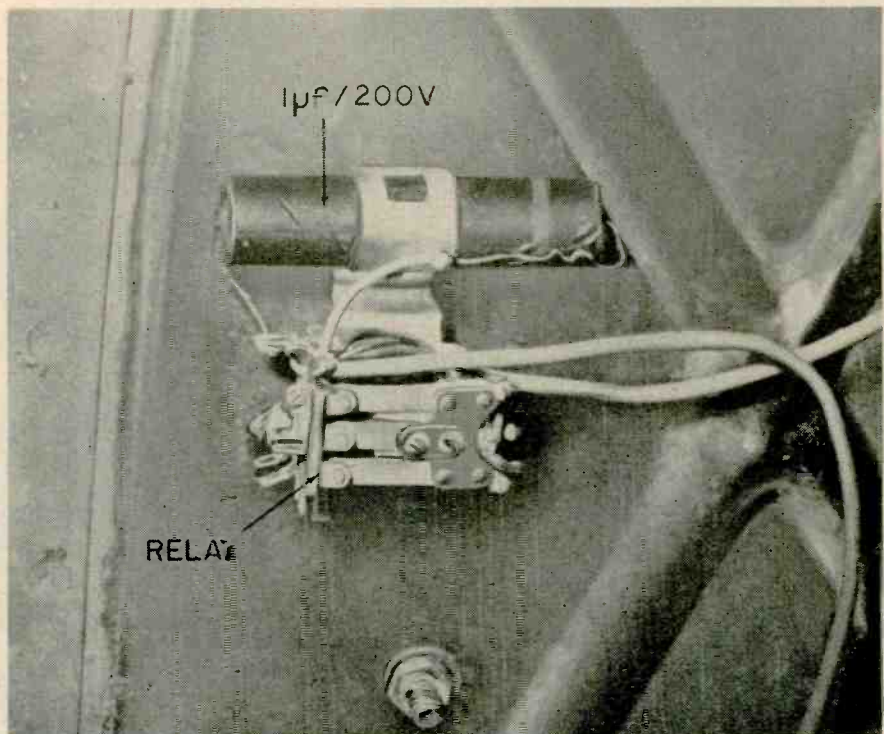

The control transmitter on the splashpan or similar surface below the car.



# a LOW COST ALL-CHANNEL ANTENNA & ROTOR for ATTIC INSTALLATIONS!

## The **VEE-D-X** ROTEENNA

- Complete Kit—Antenna—Rotator—Console—50 ft. 300 ohm transmission line—50 ft. 4 wire rotator line— isolation network for UHF-VHF—4 dual-line stand off insulators—Aluminum Mast
- Rotenna requires only 56" of radial space to rotate.
- Rotating Speed 1½ R.P.M.
- Easy to stock
- Can be installed 365 days of the year.

**MODEL R02-83**  
ALL CHANNEL UHF-VHF

**\$34<sup>95</sup>** COMPLETE

**MODEL R0-2-13**  
ALL CHANNEL VHF

**\$29<sup>95</sup>** COMPLETE

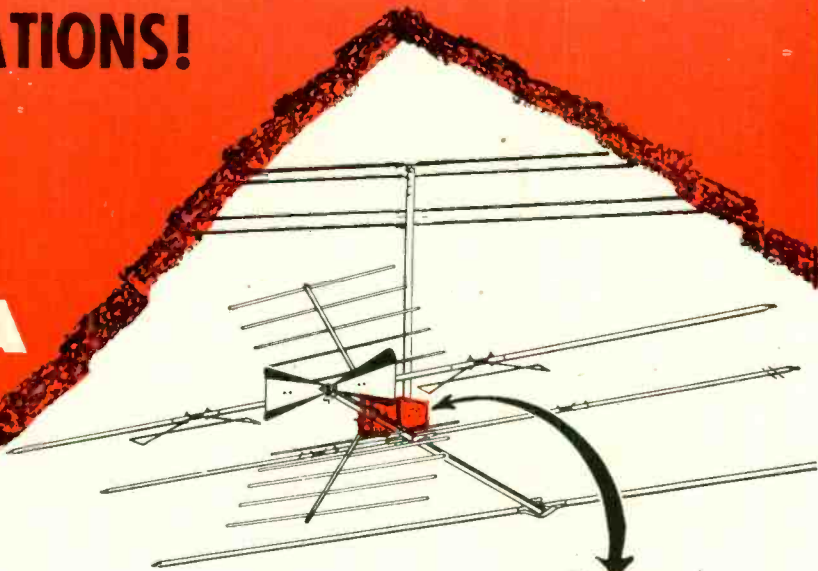

### MODEL R02-83 ILLUSTRATED

Nothing else to Buy! This amazing **VEE-D-X** Rotenna includes a powerful all-channel antenna, built in Rotator, decorator styled console and all the necessary transmission line for a complete, effortless installation.

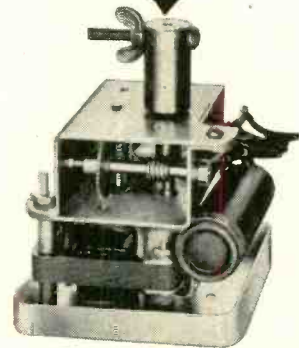

Compact enough to fit in all attics, this **VEE-D-X** Rotenna provides Better Picture Quality than the average outdoor antenna . . . without climbing on Rooftops . . . marring the appearance of the house.

Installed within minutes—never affected by Rain, Sleet, Snow or Windstorms. Compact Rotator unit has long life motor—rotates in either direction.



Beautifully designed control console operates with convenient downward pressure, available in Heather Green or Cordovan Mahogany.

*Write*  
**NOW...**

**LaPointe ELECTRONICS, INC.**  
ROCKVILLE, CONN.

Please send me specification sheets on RE-2  
 R02-83                       R0-2-13  
 Name.....  
 Address.....  
 City..... State.....

# TAKE A GOOD LOOK

YOU CAN ACTUALLY SEE THE DIFFERENCE!



What Does This  
Super-Smoothness  
Mean To You?

**irish**  
BRAND  
**FERRO-SHEEN**  
HAS THE  
*Smoothest Surface*  
**OF ALL RECORDING TAPES**

### 1 GREATLY REDUCED HEAD WEAR:

The mirror smooth FERRO-SHEEN surface virtually eliminates disastrous head wear caused by the abrasive surface of ordinary tapes.

### 2 NO SHEDDING OF OXIDE:

Unlike ordinary tapes which shed oxide particles that gum up the heads, the FERRO-SHEEN process anchors the oxide to the base so that it cannot come off and deposit itself on the head.

### 3 FLATTER FREQUENCY RESPONSE:

THE SUPER-SMOOTH SURFACE OF FERRO-SHEEN tape makes better contact with the recording head, resulting in flatter frequency response.

### 4 REDUCED 'PRINT-THROUGH'

'Print-Through' is virtually eliminated, even at excessive input levels, because of unparalleled oxide uniformity in FERRO-SHEEN process tape.

### MAKE YOUR OWN TEST IN 20 SECONDS...

Place strips of all the leading tapes side by side for your own visual comparison—you will see the difference at a glance! **The difference you see is responsible for the improvement you hear...** the smoother surface of the FERRO-SHEEN tape results in vastly improved contact between recording head and tape and gives optimum magnetic performance... all the highs, all the lows.

**FERRO-SHEEN** is Now Available in these four quality **irish** tapes.

**SHAMROCK #300:** The ultimate in professional tape for broadcast and studio use. 1200'...\$3.80 Hi-Fi Net

**LONG-PLAY #600:** Extends playing time 50% over conventional tapes; Mylar base. 1800'...\$5.50 Hi-Fi Net

**SOUND PLATE #220:** The super-tough tape for masters and recording under adverse climate conditions. 1200'...\$5.50 Hi-Fi Net

**DOUBLE-PLAY #7-2400:** Doubles your playing time on standard 7" reel; Mylar base. 2400' on 7" reel...\$7.50 Hi-Fi Net

If Not Available at Your Local Dealer, Write:  
**ORRADIO INDUSTRIES, INC.**  
World's Largest Exclusive Magnetic Tape Manufacturer  
Opelika 3, Alabama



**EXPORT DIVISION:**  
Morhan Exporting Corp., N.Y.C.  
**IN CANADA:**  
Atlas Radio Corp., Ltd., Toronto

## know your ABC's



If you know the ABC's of publishing, you will recognize this as the insignia of the Audit Bureau of Circulations. You see it every month on the contents page of RADIO-ELECTRONICS.

This voluntary, non-profit association was founded 41 years ago to insure accurate and dependable circulation statements.

**October is ABC month.**

RADIO-ELECTRONICS is proud to be a member. When we tell advertisers our average net paid circulation for the year ending Dec. 31, 1954, was 175,906, they accept it as absolute fact because of the reputation of honesty and accuracy won by the strict ABC code. They know there is no substitute for net paid audited circulation.

**RADIO-ELECTRONICS salutes the ABC on its 41st anniversary.**

## Technotes



### NO RASTER, NO SOUND

A Motorola chassis TS-292C-00 uses the audio output tube (a 6W6-GT) as a voltage dropper in a form of stacked B supply distribution system. Low emission of this tube results in no sound and no raster since the B plus bus, fed through this tube, supplies the screen of the horizontal output tube and plates and screens of some of the i.f. amplifiers.—J. A. McRoberts

### EARLY STROMBERG-CARLSONS

In models prior to the 116, the focus control action can be improved by removing the 47,000-ohm resistor (R286) shunted across the focus potentiometer and series resistor R285. This change will permit proper focus near the mid-range of the focus control.

To reduce the area of the beam spot on the picture-tube screen for improved focus, increase the voltage supplied to the picture-tube screen. This can be done by disconnecting the screen lead from the video amplifier screen supply and connecting it through a 100,000-ohm resistor to the boosted d.c. voltage at the No. 3 terminal of the horizontal output transformer. The screen side of the resistor is bypassed to ground with a .01- $\mu$ f capacitor. This modification was made in later models.—E. M. Breckenridge

### RCA KCS 49

A customer complained of no control of brightness and picture tear and general instability. A voltage check on the picture tube socket showed 230 volts on the control grid. The trouble was a defective .015- $\mu$ f coupling capacitor connected to the grid of the picture tube. A 400-volt unit, it was replaced with a 600-volt capacitor.—Jacob Dubinsky

### HIGH-VOLTAGE RESISTORS

Some Philco receivers have come up with burned out high-voltage resistors. The resistor is a 2-megohm unit connected from pin 1 of the first 1x2 to the plate cap of the second rectifier. Usually, replacing one or both of the rectifier tubes will eliminate the trouble. If this does not help, adjust the horizontal drive control.

This adjustment is very important, and many service technicians simply adjust for maximum picture width. This should never be done. Besides causing the resistor failure, it often

P. R. MALLORY & CO. INC.  
**MALLORY**  
APPROVED PRECISION PRODUCTS

P. R. MALLORY & CO. INC.  
**MALLORY**  
APPROVED PRECISION PRODUCTS

P. R. MALLORY & CO. INC.  
**MALLORY**  
APPROVED PRECISION PRODUCTS

# Always right ...either way

Whichever way you prefer Dual Controls, Mallory can supply you with Exact Duplicates.

#### GET THEM READY-TO-USE . . .

completely assembled in all the combinations of resistance values, tapers, taps, switches and shaft lengths to fit most of the popular TV sets.

#### GET THEM AS SUB-ASSEMBLIES . . .

and combine factory-made sections, switches and shaft tips to match the job at hand. You don't need much stock . . . a small inventory equips you to make 10,000 different combinations. And you don't need much time . . . assembly takes less than five minutes.

#### SUIT YOURSELF, AND SUIT YOUR CUSTOMERS

Either way, Mallory dual controls give you an exact match of the electrical and physical characteristics you need . . . plus qualities of precision, quiet operation and long life that equal or exceed the original equipment control.

*Your Mallory distributor carries Mallory Exact Duplicate Dual Controls in the style you like. Order from him today.*

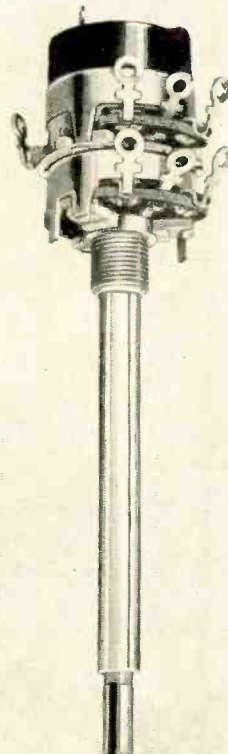
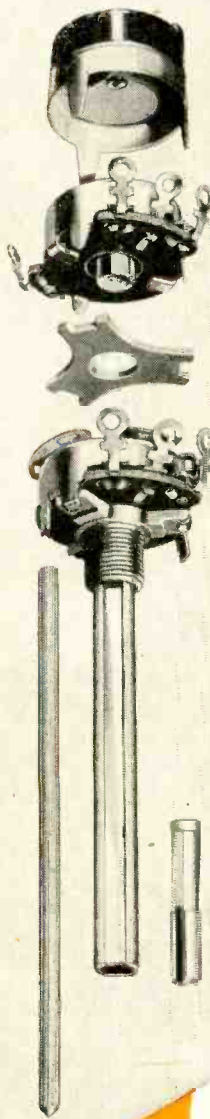

P. R. MALLORY & CO. INC.  
**MALLORY**

CAPACITORS • CONTROLS • VIBRATORS • SWITCHES • RESISTORS  
RECTIFIERS • POWER SUPPLIES • FILTERS • MERCURY BATTERIES  
**APPROVED PRECISION PRODUCTS**

**P. R. MALLORY & CO. Inc., INDIANAPOLIS 6, INDIANA**

P. R. MALLORY & CO. INC.  
**MALLORY**  
APPROVED PRECISION PRODUCTS

P. R. MALLORY & CO. INC.  
**MALLORY**  
APPROVED PRECISION PRODUCTS

P. R. MALLORY & CO. INC.  
**MALLORY**  
APPROVED PRECISION PRODUCTS

# TACO TRAPPERS

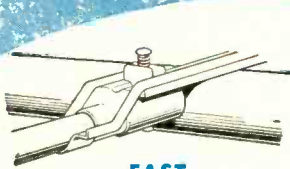

**FAST**  
Positive tension  
booster design



**DRY-CLEANED**  
No greasy hands  
or clothing

## MAKE YOUR JOB PROFITABLE

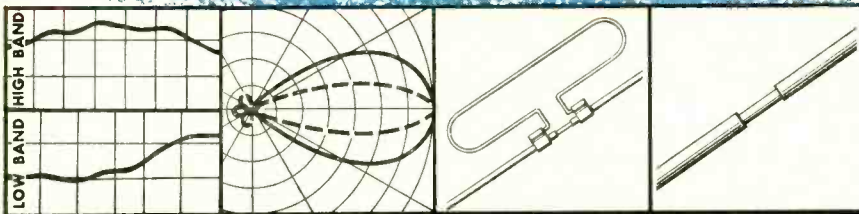

**RESULTS** — Excellent gain for better pictures on all channels.

**SHARP** — Trappers eliminate unwanted signals, give higher signal-to-noise level.

**BROAD** — Patented phase reversing traps for better response — black and white or color.

**RUGGED** — Tops in ruggedness. Finest aluminum alloy, shock absorbers and fiberglass used in all Trappers.

In every respect, Taco Trapper antennas make your job easier and more profitable. Streamlined, modern design plus extra features save you time, trouble and give greater user acceptance.

These Trapper designs were originated and patented by Taco engineers. † Improved Staying-Power, so important in distorted signal areas, is derived from multiple driven elements and Penta-Phase tuning.

Stacking lines, close spaced and wide spaced, are available to meet any area requirement. Use a Trapper for that next installation and find out for yourself, how much easier and more profitable your work can be.

† U. S. Patent 2,705,283

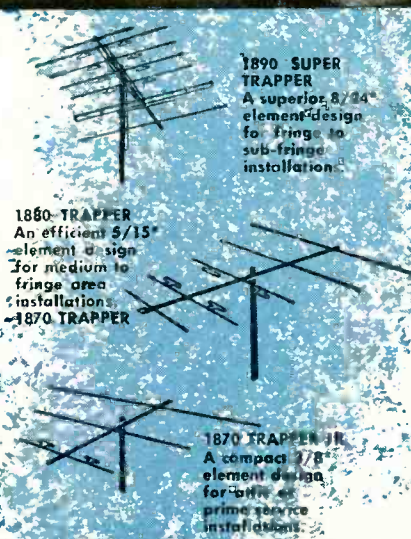

**1890 SUPER TRAPPER**  
A superior 8/24 element design for fringe to sub-fringe installation.

**1860 TRAPPER**  
An efficient 5/15 element design for medium to fringe area installations.  
**1870 TRAPPER**

**1870 TRAPPER JR.**  
A compact 7/8 element design for prime prime service installations.

† U. S. Patent 2,705,283

TECHNICAL APPLIANCE CORPORATION • SHERBURNE, N. Y.  
In Canada: Hackbusch Electronics, Toronto 4, Ont.

## ATLAS Cobra-Jectors

- wide angle dispersion
- indestructible fiber-glass
- all-weather construction



CJ-30  
Net \$24.00

Weatherproof universal line transformer, \$5.10 Net.

CJ-14  
Net \$16.80



Designed for wide angle coverage, paging, high efficiency, intercom, sensitive talk-back. Tops in articulation. Convenient omni-directional mounting bracket. In appearance, they're "beauts".

SPECIFICATIONS	CJ-30	CJ-14
Input pwr (cont.)	15 w	5 w
Input imp.	4 or 8 Ω	4, 8 or 45 Ω
Response (cps)	250-9,000	400-10,000
Dispersion	120° x 60°	120° x 60°
Bell Size	14" x 6"	9½" x 5½"
Over-all length	14"	8½"

Amazing "power packages"—use the Cobra-Jectors for the "tough" jobs.



WRITE FOR COMPLETE CATALOG  
**ATLAS SOUND CORP.**  
1443—39 St., Bklyn. 18, N. Y.

In Canada: Atlas Radio Corp., Ltd., Toronto, Ont.

## New Gernsback Books

See also coupon Page 148

**RADIO-CONTROL HANDBOOK**  
No. 53

R/C expert Howard G. McEntee, W2SI, gives you all the necessary practice details on how to build R/C systems and mechanical components to control model planes, boats, etc. 192 Pages. 175 Illustrations.



\$2.25

**THE OSCILLOSCOPE**  
No. 52

A practical book that tells you how to use the scope to best advantage in all types of servicing. Gives you tips on use and warns about pitfalls to avoid. 192 Pages. Over 100 illustrations. \$2.25



**Gernsback Publications, Inc.**

Publishers of RADIO-ELECTRONICS  
25 West Broadway New York, N.Y.

## TERRIFIC! SENSATIONAL!

SEE THE **precise** SEND FOR CATALOG S-5

**5" ECONOMY SCOPE KIT**  
PRECISE DEVELOPMENT • DCEANSIDE, N. Y.

RADIO-ELECTRONICS

damages the horizontal output tube. However, if everything checks O.K., just replace the resistor. Do not use standard type resistors. The manufacturer's type are usually longer, high-voltage types, to prevent possible flashover.—*Milo Bannister*

**BUZZ IN CROSLY**

Buzz in Crosley's 10, 11 and DU series is often caused by a low-capacitance 10- $\mu$ f 25-volt capacitor connected between pins 2 and 7 of the 6T8. Replace the unit and touch up the ratio detector adjustments till sound is O.K.—*Vincent Maniccia*

**INSUFFICIENT WIDTH**

In RCA chassis KCS-92 and KCS-93 there may be a considerable reduction in width due to a change in the inductance of the width coil.

If the width shrinks about 3 inches, it is possible that the inductance of the width coil has changed due to heating of the core. In this case it should be replaced.—*RCA Service Co.*

**EMERSON MODEL 673B**

This set was very troublesome because it had several defects at once. The complaints were no picture or sound and smoke pouring from the set. The 6J6 and 6AG5 tubes in the tuner were checked. The 6J6 was shorted, the other burned out. Re-

placing these restored voltage to the heaters, but still no picture or sound.

A check showed no a.c. going to the selenium rectifiers. An open plug-in 3.5-ohm ballast was found on top of the chassis. This was corrected by connecting a 5-ohm 10-watt resistor in place of the ballast. We now had plate voltage but found the 12AU7 video output tube getting red hot. This was caused by a shorted .05- $\mu$ f capacitor connected between pin 2 of the 12AU7 and pin 6 of the 12AT7.

Replacing the tube and capacitor restored the video and audio, but the picture had a peculiar negative quality. This was traced to the 5,600-ohm resistor in series with the plate of the 12AU7. The positive grid on that tube had caused excessive current flow through the resistor, burning and cracking it—its resistance had dropped to 200 ohms. Replacing this capacitor corrected the trouble.—*Jacob Dubinsky*

**RCA AM-FM 6-RF-9**

Some early production models have an abnormal amount of hum, especially when the volume control is operated at or near the low-tap position.

This is caused by incorrect lead dress of R17, a 27,000-ohm resistor, from the low tap of the volume control. This resistor, in some receivers, was dressed very close to an a.c. lead from the power transformer.

To correct this trouble dress R17 away from the transformer and other a.c. leads and toward the chassis.—*RCA Service Co.*

**TVI ON EMERSON 712F**

Interference appeared on the screen of an Emerson chassis 120169B (model 712F) on channel 7. It looked similar to 4.5-mc grain. Other sets have shown the same type of interference with bars on the screen or whistles in the sound. A common horizontal output circuit causing this trouble is the direct-drive type.

The trouble is caused by a parasitic in the plate circuit of the horizontal output tube which resonates at about 160 to 200 megacycles. In this particular case, the frequency was in the pass-band of channel 7, some 4 megacycles removed from the picture carrier. Other frequencies will cause different patterns or sound TVI on other channels. This trouble may be suspected if removing the antenna lead-in results in a great reduction of the station signal but only a very small reduction in interference.

Insert an r.f. choke (about 2 $\mu$ h, or a few turns of wire) in the plate lead of the horizontal output tube.

If this doesn't help, insert a 1-watt resistor of about 47 to 100 ohms in the plate lead of the output tube. A piece of plastic spaghetti should be slipped over the inserted resistor or coil for insulation.—*James A. McRoberts*

Just Out



These two 1955 TV volumes cover practically all sets of ALL makes. The new ADDITIONAL 1955 TV manual includes material almost to the minute. Each giant manual has 192 pages of service data, changes, double-size circuits. Special price, each manual only **\$3**

**New ADDITIONAL 1955 TV Volume  
LARGE MANUAL COVERS NEWEST 1955 TV SETS  
EARLIER TV VOLUMES STILL SOLD AT ONLY \$3**

**AMAZING BARGAIN**

Supreme twin 1955 TV manuals are the scoop of the year. Cover all sets of all important makes. New ADDITIONAL 1955 TV volume gives you the very latest material. Your price for this mammoth manual is only \$3. Supreme super values defy competition. Each prior-year manual (at only \$3) has a whole year of service material. Each volume covers different material, from 1947 to latest 1955 sets. Include circuits, alignment, waveforms, voltage charts, service hints, changes, and double-spread diagrams.

**ALL NEEDED TV DATA**

Supreme TV manuals supply all needed service material on every TV set of every important manufacturer. Here is helpful, practical, factory-prepared data. It will really make TV servicing and adjustment easy for you. Join 146,000 servicemen who use, benefit, and save with SUPREME service manuals. In these manuals you get correct factory-checked circuits, alignment procedure, response curves, service hints, recommended changes, voltage charts, waveforms, and dozens of double-page diagrams. Here is your TV service material to help you do expert work double-quick: and priced at only \$3 per annual volume. Be ready to repair any model by carrying in your car all ten TV volumes listed in coupon below. Or try one of the new 1955 TV manuals to see what an amazing bargain you get for only \$3. Send coupon for prompt shipment or ask your jobber.

Practically tell you how to make every repair. More pages, more diagrams, more service data per dollar of cost. Get the best for less. Get SUPREME.

**TELEVISION SERVICING COURSE**

Let this new course help you in TV servicing. Amazing bargain, complete, only \$3, full price for all lessons. Giant in size, mammoth in scope, topics just like a \$200.00 correspondence course. Lessons on picture faults, circuits, adjustments, short-cuts, UHF, alignment facts, hints, antenna problems, trouble-shooting, test equipment, picture analysis. Special, only **\$3**



Newest

**RADIO DIAGRAMS**

Here is your complete source of all needed RADIO diagrams and service data. Covers everything from most recent radios to pre-war old-timers; home radios, auto sets, combinations, changes, and portables. Sensational values. Still sold at pre-Korean prices. Only \$2 for most volumes. Every Radio manual contains large schematics, all needed alignment facts, parts lists, voltage values, trimmers, dial stringing, and helpful service hints. All volumes are large in size, 8 1/2 x 11 inches, about 190 pages. See coupon at right for a complete list of these low-priced manuals.



**NO-RISK TRIAL ORDER COUPON**

**SUPREME PUBLICATIONS, 1760 Balsam Rd., Highland Park, ILL.**

- Radio Diagram Manuals**
- New 1955 Radio Manual, \$2
  - 1954 Radio Manual, \$2.50
  - 1953 Diagrams
  - 1952 Radio
  - 1951 Diagrams } **ONLY \$2.50 EACH**
  - 1950 Manual
  - 1949 Radio
  - 1948
  - 1947
  - 1946
  - 1942
  - 1941
  - 1940
  - 1939
  - 1926-1938 Manual, \$2.50
  - Radio and TV Master Index, 25c

Rush today TV manuals checked  below and Radio manuals at left. Satisfaction guaranteed.

- Additional 1955 TV, \$3.
- Early 1955 TV, \$3.
- 1954 TV Manual, \$3.
- 1953 TV Manual, \$3.
- 1952 Television Manual, \$3.
- 1951 TV, \$3.
- 1950 Television Manual, \$3.
- 1949 TV, \$3.
- 1948 TV, \$3.
- 1947 TV & FM, only \$2.
- New Television Servicing Course, complete, . . . \$3.

- I am enclosing \$ . . . . . Send postpaid.
- Send C.O.D. I am enclosing \$ . . . . . deposit.

Name: . . . . .  
Address: . . . . .

**Supreme Publications**  
Sold by All Leading Parts Jobbers

# Better Restore the Original Sound with Better Replacement Speakers

## OXFORD SPEAKERS are Better

### Because:

Oxford specializes in the designing and manufacturing of a complete line of speakers and has been doing so for many years.

Since speakers is our business . . . since we supply more of the BEST manufacturers of original equipment . . . since we have quality replacement speakers for any and every application . . . you will actually better the original sound with OXFORD SPEAKERS.

Why wait . . . find out TODAY why more and more servicemen are switching to OXFORD SPEAKERS . . . truly the BETTER SPEAKERS in every way!

## OXFORD

### ELECTRIC CORPORATION

3911 SOUTH MICHIGAN AVENUE  
CHICAGO 15, ILLINOIS

EXPORT — ROBURN AGENCIES NEW YORK CITY  
IN CANADA — ATLAS RADIO CORP. LTD., TORONTO

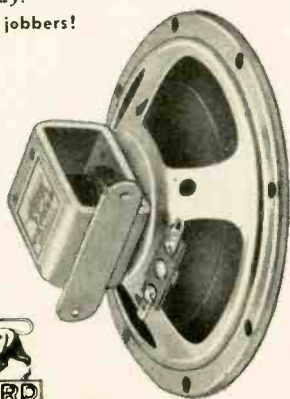

Our latest catalog  
is available . . .  
write today!  
...at better jobbers!



## EASY TO LEARN CODE

It is easy to learn or increase speed with an Instructograph Code Teacher. Affords the quickest and most practical method yet developed. For beginners or advanced students. Available tapes from beginner's alphabet to typical messages on all subjects. Speed range 5 to 40 WPM. Always ready—no QRM.

### ENDORSED BY THOUSANDS!

The Instructograph Code Teacher literally takes the place of an operator-instructor and enables anyone to learn and master code without further assistance. Thousands of successful operators have "acquired the code" with the Instructograph System. Write today for convenient rental and purchase plans.



## INSTRUCTOGRAPH COMPANY

4701 Sheridan Rd., Dept. RC, Chicago 40, Ill.

## COUNT WITHOUT NUMBERS

More laws of thought are based on counting than we recognize. Logic Mirror-Wise, 4 pages. Send 25c.

W. J. MALLORY

616 N. 34th St. Omaha 3, Nebr.

## SOLAR BATTERIES



now available. \$2.00 each. Electric energy direct from the sun. Power for transistor radios, microphones, photo cells, exposure meters, hearing aids and the like, direct from the sun. No batteries needed. Light from a 60 watt lamp will furnish enough power to operate our famous MYSTERY BUTTON as a telephone. A KIT of one solar battery, one mystery button, and one hearing aid type ear phone. ALL for only \$4.95. Also 5000 word booklet on mystery button and an 8 page booklet on transistors, included with order. ELECTRONIC PRODUCTS CO., St. Charles 1, Ill.

### PHILCO AM-FM RECEIVER

This eight-tube unit came into the shop with a complaint of interference. After spending a lot of time searching for the trouble, it was found that when the set was switched in the FM position, the primaries and secondaries of the first AM and FM i.f. transformers were shorted out. Cleaning the switch contacts eliminated the trouble and prevented the i.f. signals from entering the amplifier, causing the interference.

—John Flint

### STROMBERG-CARLSON NOTES

To improve the range of the focus control in model 16T, the resistance in series with the control should be changed to 68 ohms. The present 220-ohm unit can be paralleled with another for satisfactory results if a 68-ohm resistor is not available.

In the TC-125 model there has been considerable trouble with the locking-in action of the vertical hold control. This can be considerably improved by changing the resistors in the cathode circuit of the 12AU7 sync clipper. The original 560-ohm unit should be changed to 1,200 ohms; the 3,300-ohm resistor should be decreased to 2,500 ohms.

To eliminate a noisy volume control in the TV12 model, add a 0.1- $\mu$ f capacitor between the range switch and the top of the volume control. This will prevent any d.c. from flowing through the potentiometer.—George Anglado

### 16-INCH MAJESTIC

The complaint on this set was no picture. A check showed the high voltage working O.K. and the 1X2 lit. The screen voltage and grid bias were as they should be, but still no raster. I then disconnected the grid lead and the raster appeared.

A check of the circuits around the 12AU7 video output tube showed the .05- $\mu$ f coupling capacitor from the plate to the grid of the 12AU7 measured only 1,200 ohms. The capacitor was replaced with a 600-volt unit and the set worked perfectly—that is, after also replacing the 12AU7 and the picture tube which were damaged by the component failure.—Jacob Dubinsky

### TESTING 1X2's, 1B3's

Many old tube testers do not give accurate tests on rectifiers of the 1X2 and 1B3 type because more than one base pin is connected to the same filament terminal, creating a sort of internal corona ring. This arrangement reduces the filament voltage, giving an inaccurate reading.

To overcome this, make two adapters—use octal tube bases with an octal socket for the 1B3 and a nine-pin noval socket for the 1X2. In the 1B3 adapter, pins 2 and 7 of the socket are connected to pins 2 and 7 of the base. In the 1X2 adapter, pins 4 and 5 of the socket are connected to pins 2 and 7 of the base. Both tubes can thus be tested regardless of the internal connections of the tubes.—Hyman Herman

END



**TELCO E-Z "SWINGIN" STAND-OFF**

Wood screw type, 3 1/2"; UHF-VHF  
No. EZ-8027 \$4.80/C

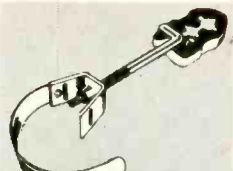

**TELCO E-Z "KANT-STRIP" STAND-OFF**

"Swing In" type; 3 1/2", 9" strap  
No. EZ-8253 \$0.13

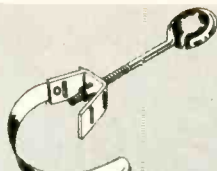

**TELCO "KANT-STRIP" STAND-OFF**

Round insulator, 3 1/2" 9" strap  
No. 8253 NET \$0.11

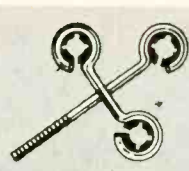

**TELCO 3-WAY STAND-OFF**

For 3-line use, 7 1/2", wood screw  
No. 8397 NET \$0.21



**TELCO NUT-TYPE STAND-OFF**

Welded 10-23 nut, 3 1/2", 9" strap.  
No. 8253-N \$0.12

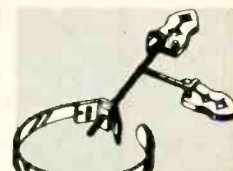

**TELCO E-Z NUT-TYPE STAND-OFF**

Tougher, inline duplex, 7 1/2", 9" strap.  
No. EZ-8258-N \$0.24

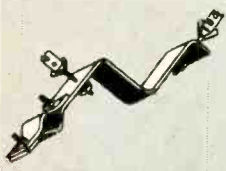

**TELCO CHIMNEY QUICK MOUNT**

Easy to install; complete

No. 8005 NET \$1.35

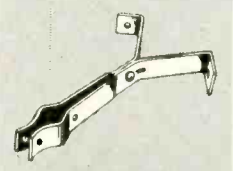

**TELCO SNAP-IN CHIMNEY MOUNT**

Fits masts to 1 3/4" complete.

No. 8610 NET \$1.71

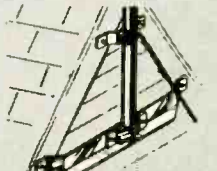

**TELCO PEAK MOUNT**

Masts to 1 3/4" 30" lower support

No. 8625 NET \$2.37

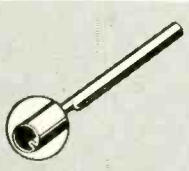

**TELCO GALVANIZED ANTENNA MASTS**

1 1/4" OD x 5' crimped end

No. 9013 NET \$0.78

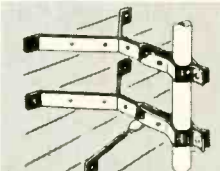

**TELCO DELUXE SNAP-IN WALL MOUNT**

Extra sturdy, 12" clearance

No. 8312 NET \$2.10



**TELCO UNIVERSAL LIGHTNING ARRESTOR**

Easy to install; UL approved

No. 8642 NET \$0.75



**TELCO UHF-VHF GLOBE-TENNA**

Handsome 12" globe plus built-in antenna

No. A-9265 \$11.97

*Ask For These*



# SERVICE AIDS

*...at Your Jobber*



**TELCO UHF-VHF LIGHTNING ARRESTOR**

Universal type, UL approved

No. 9242 NET \$0.42

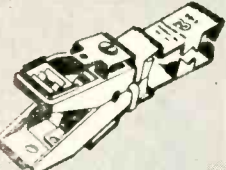

**TELCO 3-WAY TV LINE KLIP**

For straight side or plug-in

No. 9015 NET \$0.12

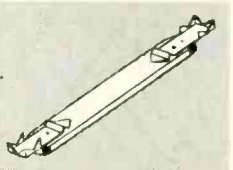

**TELCO LOW-LOSS LINE KLIP**

All one piece, plastic, metal ends

No. 9055 NET \$0.15

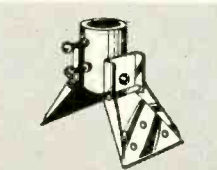

**TELCO HINGED TYPE RIDGE MOUNT**

Fits masts to 1 1/2" assembled

No. 9021 NET \$1.17

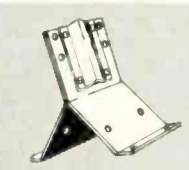

**TELCO ALL-PURPOSE MAST BRACKET**

Fits masts to 1 3/4" use every where

No. 8575 NET \$1.65

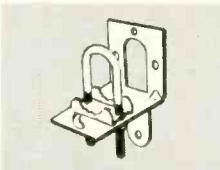

**TELCO MAST HANDY MOUNT**

For masts to 1 1/2", extra support

No. 8800-U \$0.33

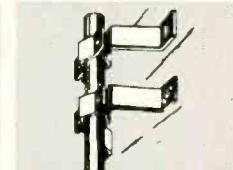

**TELCO SPECIAL WALL MOUNT**

For close-in (4") mounting.

No. 9241 NET \$0.45

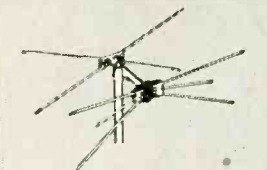

**TELCO MASTER-LINE VHF CONICAL ANTENNA**

Single bay, 10 element; all-channel

No. A-8700 \$4.20

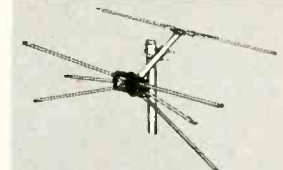

**TELCO RANGER COLOR CONICAL ANTENNA**

Single bay, 8 element, VHF-UHF.

No. A-110 NET \$3.45

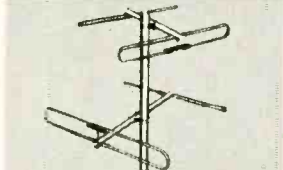

**TELCO HI-LOW DIPOLE ANTENNA**

VHF, covers channels 2 to 13

No. A-250 NET \$4.41

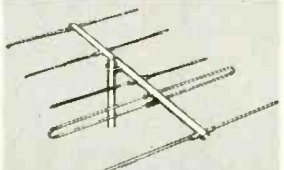

**TELCO 5 ELEMENT VHF YAGI ANTENNA**

12 models, custom cut to each

No. A-302 Ch. 2 \$7.35  
No. A-313 Ch. 13 4.35

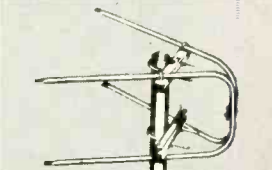

**TELCO UHF-VHF DOUBLE V ANTENNA**

Covers channels 2 through 83.

No. A-9017 \$3.15

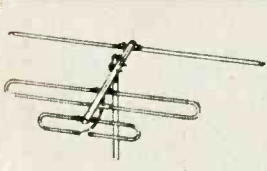

**TELCO VHF INLINE ANTENNA**

Channels 2-13; 1/2" seamless elements

No. A-9046 NET \$5.97



**TELCO INDOOR UHF-VHF ANTENNA**

DeLuxe brass, nickel-plated elements

No. A-8160-TP \$2.97

**FREE!**

Your copy of the complete, illustrated  
TELCO Catalog. Send postcard today.





# TELEVISION HARDWARE MFG. CO.

Division of General Cement Mfg Co.

910 TAYLOR AVENUE • ROCKFORD, ILLINOIS



**LEARN MORE — EARN MORE  
WITH H. G. CISIN'S TV SERVICE BOOKS**

**FAMOUS 1955 TV CONSULTANT!**

NEW! Easy way to solve toughest TV troubles. New rapid methods of pin-pointing faults. New alignment methods shown by pictures, diagrams and easy to follow directions. TV CONSULTANT tells exactly WHAT TO DO and HOW TO DO IT. UHF section includes conversion, installation, and servicing. Lists instruments needed for servicing COLOR TV. Practical pointers on use of TV Test Instruments. 300 pix, raster and sound symptoms. Detailed directions tell WHERE and HOW to find faulty parts. Over 135 RAPID CHECKS including many using picture tube as trouble locator. Over 125 illustrations of scope wave-forms, diagrams, station patterns showing various defects — make TV servicing a pleasure. NO MATH. NO THEORY — NO FORMULAS — just practical servicing information covering all types of TV sets.



TV Serviceman's Silent Partner—No. L1.....\$2

**SHOOT TV & RADIO TROUBLE FAST**



This latest edition of H. G. Cisin's world famous Rapid TV Trouble Shooting Method has been enlarged, revised and brought up to date. Enables you to locate faults in record-breaking time, regardless of make or model. Includes section on RAPID TROUBLE SHOOTING OF AC-DC RADIO SETS and servicing of PRINTED CIRCUITS.

QUICKEST TV TROUBLE SHOOTER—No. T2.....\$1.50

**TV TUBE LOCATOR**

TROUBLE INDICATING TUBE LOCATION GUIDES cover 3000 most popular models. Admiral to Zenith. Shows PIX tubes used in each model. Covers products of over 110 different TV manufacturers. Over 135 common TV troubles are listed with explicit directions for locating defective tubes which cause each fault.



SPEED SERVICING—No. K1.....\$1

**PIX GUIDE**



Sect. 1 is a fully illustrated Guide to oft-recurring picture faults. Causes and cures explained. Copyrighted Illustrated CHART tells where troubles start in typical TV set. Illustrations show resulting faulty TV pictures. Sect. 2 explains hundreds of TV terms in non-technical language.

PIX SHOW FAULTS—No. G1...\$1

**1955 TV DOCTOR**

How to Diagnose and Remedy TV Troubles: Useful Info About TV Sets; Easy Trouble Checks; UHF Servicing; Antenna Know-how; Servicing Hints; Color TV; Troubles Due to Defective Tubes; How to Read Schematic Diagrams. Practical hints for prospective TV servicemen.



BEGINNER'S BEST BUY—No. D5.....\$1

**RCA TV TUBE LOCATION GUIDES**

1947-1955 Models

Contains hundreds of Trouble Indicating Tube Location Guides of RCA TV models. Uses new, simplified method to tell tube functions. Includes RCA color models and also valuable tables.

FITS ALL TUBE CADDIES—No. A1.....\$1

**TV TROUBLE TRACER**

Each vol. has different TROUBLE INDICATING TUBE LOCATION GUIDES of hundreds of popular TV models. Each has over 70 Illustr. & Guides, 40 most common pix. troubles illustrated.

Vol. 1 (No. TT1) older models  
Vol. 2 (No. TT2) 1952-1953 sets  
Vol. 3 (No. TT3) 1953-1954 sets  
Vol. 4 (No. TT4) 1954-1955 models  
EACH VOL.....50c

**TV & RADIO TUBE SUBSTITUTION GUIDE**



1st section gives tube replacements for TV sets, radio's and other electronic devices. all FIT SAME SOCKET, & WITHOUT CHANGES IN WIRING. 2nd section gives TV PICTURE TUBE replacements, many directly, others with only slight changes.

SUBSTITUTE WITH CERTAINTY—No. S1.....50c

**ABC of COLOR TV**

H. G. Cisin's remarkable new book takes the mystery out of Color TV. All explanations in easily understandable language. Fully illustrated. Covers basic color principles, color transmission & reception, the color signal, color tubes will help you cash in on this rapidly expanding new field.

COLOR TV SIMPLIFIED—No. R1.....\$1

**FREE:** TV TROUBLE TRACER—Vol. 4 with every purchase of \$5 or over.  
TV & RADIO TUBE SUBSTITUTION GUIDE plus TV TROUBLE TRACER—Vol. 4, with every purchase of \$8 or over.

**If jobber is out of stock send coupon to:  
H. G. Cisin, Dept. E-35, Amagansett, N.Y.**

Enclosed find \$..... RUSH POSTPAID following books

- |                                 |                                    |                                  |  |
|---------------------------------|------------------------------------|----------------------------------|--|
| <input type="checkbox"/> L1—\$2 | <input type="checkbox"/> D5—\$1    | <input type="checkbox"/> TT3—50c | Order \$5 or over INCLUDE FREE TT4<br>Order \$8 or over SEND BOTH FREE BOOKS |
| <input type="checkbox"/> A1—\$1 | <input type="checkbox"/> T2—\$1.50 | <input type="checkbox"/> TT4—50c |  |
| <input type="checkbox"/> K1—\$1 | <input type="checkbox"/> TT1—50c   | <input type="checkbox"/> R1—\$1  |  |
| <input type="checkbox"/> G1—\$1 | <input type="checkbox"/> TT2—50c   | <input type="checkbox"/> S1—50c  |  |

Name.....  
Address.....  
City..... Zone..... State.....

**new  
Devices**

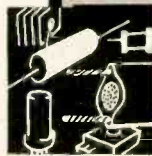

**FINCO GEOMATIC ANTENNAS** for broadband v.h.f. reception. Model B-1: for metropolitan and suburban areas. Model B-2 (suburban and semi-fringe areas): pre-assembled, all-aluminum collinear high-band reflector.

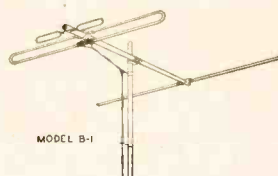

MODEL B-1

**ANTENNA, Telrex Super Thunder Bird model T-120:** single bay. Model T-122: 2-bay array, quarter-wave stacked for gain increases averaging 3 db on all

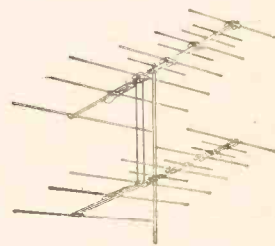

Model B-3 (suburban to fringe areas—75 miles or more): low-band and 3-element collinear high-band reflectors; inductance-tuned combination director for

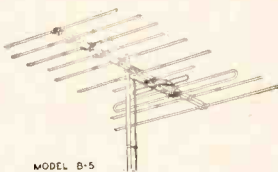

MODEL B-3

channels. Model T-122-S: half-wave stacked 2-bay array for low-channel emphasis, provides gain increases over single-bay unit to 4.5 db on channels 2 to 6.—Telrex Inc., Asbury Park, N. J.

**CONICAL V.H.F. ANTENNAS, Welco Zee-Beam,** for efficient high- and low-band v.h.f. reception. Anodized elements of red, green, blue, gold.—Welco Mfg. Co., Burlington, Iowa

low and high band. Model B-4 (deep fringe areas—150 miles or more): low-band and 3-element high-band reflectors; low-band full half-wave and two 3-element collinear high-band directors. Model B-5 (fringe area—200 miles or more): multiple low-band reflectors and directors, high-band collinear reflectors and directors.—Finney Co., 4612 St. Clair Ave., Cleveland 3, Ohio



**ANTENNAS, Taco.** Omnidirectional S-type, has broadband folded dipole tuned to cover FM band. Model 624L: single antenna. Model 624ST-L 2-stacked version for added gain.

A patented antenna (single-bay model 644 and double-bay

**HI-FI ACCESSORIES, Cabinart,** includes 20 cabinet kits, 11 unpainted hi-fi cabinets, 15 designs in several woods, Klipsch-designed Rebel speaker enclosures, 10-unit storage wall. Model

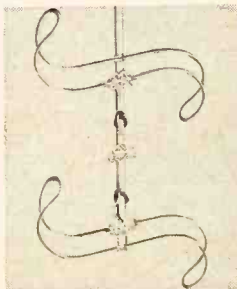

model 645) with Twin-Driven feature, for use where greater gain is required.—Technical Appliance Co., Sherburne, N. Y.



ACC-1 (illustrated) is an assembled record changer or player box, pre-cut, with phono slides pre-mounted for installation.—Cabinart, 99 N. 11 St., Brooklyn 11, N. Y.



# A SENSATIONAL NEW IDEA in a Low-Cost Tube Tester

## JACKSON

## Customatic "Forty-Niner"

### with Plug-In Accessories

#### One Meter—One Power Supply For a Wide Variety of Tests

Here's what makes the Jackson Forty-Niner truly unique. You remove this one panel, and plug-in any of the accessories now available or to be announced. Thus the single 5-inch meter and rugged power supply serve as the basis for all kinds of testers. And, regardless of which tester is plugged in, the tube test function is not disturbed in any way. You can use any of the low-cost Jackson 49 Accessories with this instrument.



Only **\$49<sup>95</sup>**

For the Complete  
Tube Tester  
Accessories Extra.

#### Feature for Feature—There's No Tester Like the Forty-Niner

- Quickly checks all modern tubes.
- Lever-action shows which pins are connected or disconnected.
- Big 5-inch meter for GOOD-BAD or percent-quality indication.
- Sensitive shorts test.
- Line Voltage adjustment shows actual line voltage.
- All steel carrying case finished in amazing new, scratch-resistant JACKSONITE.
- Zig-Zag Chart prevents unnecessary chart twirling.
- Plug-in accessories have fast airplane-type fasteners.

### "Service Engineered"

#### FOR FAST, ACCURATE TUBE TESTING

From its scuff-resistant Jacksonite finish to the sensational new plug-in accessory feature, the Jackson Forty-Niner has been "service-engineered" from start to finish. All modern tubes—even the very latest 600 mil types are tested rapidly and accurately. Accessories are installed or removed in jiffy time. You have in one instrument the basis for making all kinds of tube and component checks. See it at your distributor's today. Learn how you can buy the basic tester now, then add your choice of low-cost accessories at any time.

These Low-Price Plug-In Accessory Kits Now Available—More To Be Announced Soon



**Model P49B Plug-In Kit**—Readies your Jackson Forty-Niner for any of the plug-in accessories. Includes 10-contact socket, and complete wiring instructions. Shorting plug included so tester may be used without any accessory plugged in. Only \$2.95 net.



**Model 49N High Resistance Shorts Tester**—Shows the value of interelement leakage from 250,000 ohms to 2 meg-ohms. Lets you select tubes to any predetermined leakage value. Uses Model 49 Shorts Test Lamp as indicator. Only \$6.95 net.



**Model 49C Filament Current Tester**—Shows the actual filament current being drawn by the tube under test. Has three ranges from 500 mils full scale, to 5 amps full scale. An important test especially with series-string filament tubes. Only \$14.95 net.



**Model 49R Selenium Rectifier Tester**—Accurately tests all selenium rectifiers rated from 20 to 650 ma. at 25 to 300 volts. Automatically returns to tube test position when not in use. Plug-in convenience. Includes test leads. Only \$17.95 net.

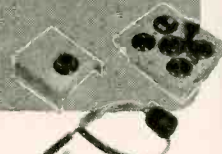

**Model 49S Auxiliary Tube Socket Kit**—Includes panel with sockets for 4, 5, 6, combination 7, and subminiature 7 and 8 pin tubes. Plug-in convenience for regular and auxiliary panels. \$11.95 net. Subminiature sockets only, for regular panel; \$1.95 net.

## JACKSON

ELECTRICAL INSTRUMENT CO.

### "Service Engineered" Test Equipment

16-18 SOUTH PATTERSON BOULEVARD, DAYTON 2, OHIO

Sold by leading electronics distributors

# THIS IS IT!

TEST EQUIPMENT YOU CAN'T BEAT FOR  
VALUE — PERFORMANCE — PRICE

## RCP

ONLY \$39.75 net

### The original FLYBACKER

Fast, reliable testing of flyback transformers and yokes

Incredibly sensitive, the model 123 Flybacker, made ONLY by RCP, immediately forms up a shorted turn in a flyback transformer or yoke. The light, portable design as the shop. All tests can be carried out under operating conditions with the common substitutes in place in the TV receiver. Accept Flybacker. . . only RCP makes the



## RCP MODEL 123

## RCP

ONLY \$14.85 net

### AC-DC MULTITESTER

All molded—unequaled by any other in its class

ready to operate

Greater multitester value than ever before at a far lower price. 3" square meter with 800 ampere D'Arsonval movement gives 1000 ohms per volt sensitivity on DC. Battery for ohmmeter circuit is readily removable and unsolderable without soldering or resoldering. Truly a must for every laboratory, shop and serviceman's kit; its smart appearance is matched only by its high performance.



## RCP MODEL 480

## RCP

ONLY \$51.95 net

### Portable TUBE TESTER

Meets all today's needs . . . plus tomorrow's color requirements

Positively the greatest testing performance ever built into a tube tester. Tests all tubes in current radio and television receivers, as well as in color TV receivers. Checks transmitting, hearing aids, ballasts, gaseous rectifiers and tuning indicators. With CR adapter cable (available at slight additional cost), will check CR picture tubes . . . both black and white and color.

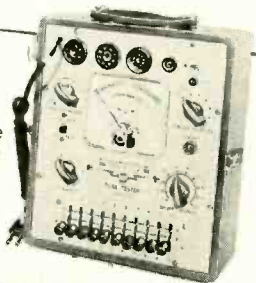

## RCP MODEL 327P

See your distributor or write  
Dept. RE-10 for latest RCP Catalog.

**RADIO CITY PRODUCTS CO., INC.**



EASTON, PENNSYLVANIA

### NEW DEVICES

**MASTER AUDIO CONTROL**, Fisher series 80-C, includes complete mixing and fading facilities for from 2 to 5 channels, tape input to operate directly from tape playback head, 16 combinations of phonograph equalization, calibrated loud-

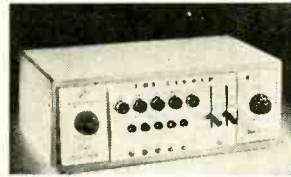

ness balance control, pushbutton channel selectors which select audio input channels and operate a.c. power to auxiliary equipment, individual channel-indicator pilot lights. Frequency response: 10 to 100,000 cycles.—Fisher Radio Corp., 21-21 44 Dr., Long Island City, N.Y.

**STACK-A-RACK**, Leslie Creations, holds either 225 single 45-r.p.m. records, more than 160 extended-play albums, or over 30 recorded-tape or 45-r.p.m. album boxes. 22 x 14 x 9 inches.

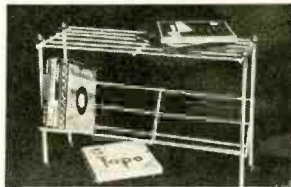

Top shelf will hold radio, record player, etc.—Leslie Creations, P. O. Box 9516, Dept. 194, Philadelphia 49, Pa.

**HI-FI SPEAKER**, Jensen TV Duette, replaces small speaker of table model TV's. 3-position switch allows comparison with original TV speaker; third po-

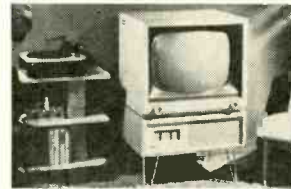

sition transfers Duette to other equipment. Model DU-500 has compression-driver horn-loaded tweeter, 6 x 9-inch oval woofer. DU-400 has direct radiator tweeter. Both 24 inches deep with top surface 17 1/4 inches above floor.—Jensen Mfg. Co., 6601 S. Laramie Ave., Chicago.

**DYNAMIC LAVALIER MICROPHONE**, Turner model 58, for TV, broadcast, recording and PA. Uses versatile Dynaflex diaphragm. Response 60-13,000 cycles; level -57 db at high impedance. For high or low impedance by matching proper conductors at terminal end of cable. Model 58A wiring permits selection of 50- or 200-ohm imped-



(Continued)

ances only by same method. Supplied with neck cord and support clip, but can be used in hand.—Turner Co., 933 17th St., N. W., Cedar Rapids, Iowa.

**BINAURAL TUNER**, Electro-Voice model 3303, AM-FM tuner and music control center. Covers broadcast and FM bands. Preamp; 6-position equalizer for phono records; 5 inputs with 4 chassis level controls, 2 chassis hum adjustments. Output is cathode follower. Total tubes 19; output 1.25 volts. FM sensitivity 1 μv for 20 db quieting; AM section



5 μv for 2 volts a.v.c. Three-position presence switch, bass control -20 to -15 db at 50 cycles, treble control -15 to -20 db at 10 kc.—Electro-Voice, Inc., Buchanan, Mich.

**KNIGHT GEIGER COUNTER Kit**, supplied with precut wire, solder, leather carrying handle, shoulder strap, headphone, batteries, radioactive sample, AEC manual on uranium prospecting. High-voltage switch is flipped occasionally to build up

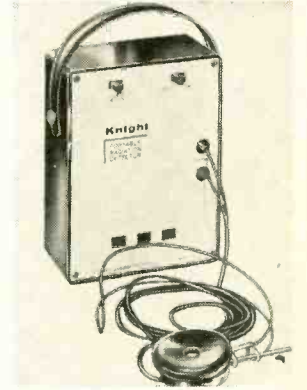

operating voltage for activating Geiger tube. 1B85 G-M tube provides sensitivity of 0.2 milliroentgen. A 22 1/2-volt hearing-aid and 1 1/2-volt A battery provide 80 hours of continuous operation.—Allied Radio Corp., 100 N. Western Ave., Chicago 80, Ill.

**ELECTRONIC PHOTOFLASH KIT**, Illini 500, uses standard batteries, provides high-quality 100-watt-second output from its 300-volt operation range. For daylight color film. Battery-capacitor unit in leatherette-covered carrying case. Lightweight universal mounting bracket. Instructions and pictorial diagrams are supplied. May be powered by AC-2-300 power pack (another kit).—



Illinois Condenser Co., 1616 N. Throop St., Chicago, Ill.

DEPARTMENT OF COMMERCE  
BUSINESS AND DEFENSE SERVICES ADMINISTRATION  
WASHINGTON 25

AUG 11 1955

Mr. George Eannarino  
Director, Rectifier Division  
Sarkes-Tarzian, Incorporated  
415 North College Avenue  
Bloomington, Indiana

Dear Mr. Eannarino:

The current work stoppages in the copper industry have very seriously affected the production of selenium. A survey made by the Business and Defense Services Administration has found that there is sufficient high-purity selenium available for less than a month's average production of rectifiers.

In view of the seriousness of the situation, I am asking you to help yourself, the rectifier industry as a whole, and those industries to which you supply vital components by making every effort to recover all discarded selenium rectifiers. The program I suggest is as follows:

- (a) Immediately contact all your distribution outlets to request their customers to return discarded rectifiers to them.
- (b) Immediately request your distribution outlets to collect and return to you all discarded rectifiers of your brand.
- (c) You have the selenium in the discarded rectifiers reclaimed for your account.

Such a program should result in an annual reclamation of approximately 20 per cent of the total amount of high-purity selenium used. This will somewhat ease the seriousness of the shortage which we face.

Your wholehearted cooperation in this recovery program is of importance to the national economy.

Very truly yours,

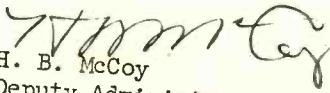
  
H. B. McCoy  
Deputy Administrator

SARKES TARZIAN INC.  
RECTIFIER DIVISION  
AUG. 15, 1955

SARKES TARZIAN, INC.  
rectifier division

415 N. COLLEGE AVE. BLOOMINGTON, IND.

MAIL TODAY. LEARN RADIO AT HOME WITH THE PROGRESSIVE RADIO "EDU-KIT".

# BUILD 15 RADIO CIRCUITS AT HOME ONLY

With the New (Improved) Deluxe 1956 Progressive Radio "EDU-KIT" **\$19.95** Complete

**NOW INCLUDES RECEIVER, TRANSMITTER, CODE OSCILLATOR, SIGNAL TRACER CIRCUITS**

- ATTRACTIVELY GIFT PACKED
- FREE SOLDERING IRON
- NO ADDITIONAL PARTS NEEDED
- EXCELLENT BACKGROUND FOR TV
- 30 DAY MONEY-BACK GUARANTEE
- SCHOOL INQUIRIES INVITED
- ABSOLUTELY NO KNOWLEDGE OF RADIO NECESSARY



## WHAT THE "EDU-KIT" OFFERS YOU

Our Kit is designed to provide a fundamental background in radio, with the basic facts of Radio Theory and Construction Practice expressed simply and clearly. You will gain a knowledge of basic Radio Principles involved in Radio Reception, Radio Transmission and Audio Amplification. You will learn how to identify Radio Symbols and Diagrams; how to build radios, using regular radio circuit schematics; how to mount various radio parts; how to wire and solder in a professional manner. You will learn proper chassis layout. You will learn how to service and trouble-shoot radios. You will learn code. You will receive training for F.C.C. Novice License. You will learn High Fidelity.

In brief, you will receive a practical basic education in Radio, worth many times the small price you pay.

## THE KIT FOR EVERYONE

The Progressive Radio "Edu-Kit" was specifically prepared for any person who has a desire to learn Radio. The Kit has been used successfully by young and old in all parts of the world. It is not necessary that you have even the slightest background in science or radio.

The Progressive Radio "Edu-Kit" is used by Armed Forces Personnel and Veterans throughout the world.

The Progressive Radio "Edu-Kit" requires no instructor. All instructions are included. All parts are individually boxed, and identified by name, illustration and diagram. Every step involved in building these sets is carefully explained.

## PROGRESSIVE TEACHING METHOD

The Progressive Radio "Edu-Kit" comes complete with instructions. These instructions are arranged in a clear, simple and progressive manner. The theory of Radio Transmission, Radio Reception, Audio Amplification and servicing by Signal Tracing is clearly explained. Every part is identified by illustration and diagram. You will learn the function and theory of every part used.

The Progressive Radio "Edu-Kit" uses the principle of "Learn by Doing". Therefore you will build radio circuits, perform jobs, and conduct experiments to illustrate the principles which you learn. These circuits are designed in a modern manner, according to the best principles of present-day educational practice. You begin by building a simple radio. The next set that you build is slightly more advanced. Gradually, in a progressive manner, you will find yourself constructing still more advanced multi-tube radio sets and doing work like a professional Radio Technician. Altogether you will build Receiver, Transmitter, Code Oscillator and Signal Tracer Circuits—15 in all. These sets operate on 105-125 V. AC-DC. For use in Foreign Countries having 210-250 Volt Source, an Adaptor for 210-250 V. AC-DC operation is available.

## THE PROGRESSIVE RADIO "EDU-KIT" IS COMPLETE

You will receive every part necessary to build 15 different radio circuits. Our "Edu-Kit" contains tubes, tube sockets, variable electrolytic and paper condensers, resistors, tie strips, coils, hardware, tubing, etc. No solder or wire included.

Every part that you need is included. These parts are individually packaged, so that you can easily identify every item. A soldering iron is included, as well as an Electrical and Radio Tester. Complete, easy-to-follow instructions are provided. All parts are guaranteed, brand new, carefully selected and matched.

In addition, the "Edu-Kit" now contains lessons for servicing with the Progressive Signal Tracer, F.C.C. instructions, quizzes, High Fidelity instructions.

## TROUBLE-SHOOTING LESSONS

Trouble-shooting and servicing are included. You will be taught to recognize and repair troubles. You will build and learn to operate a professional Signal Tracer. You receive an Electrical and Radio Tester, and learn to use it for radio repairs. While you are learning in this practical way, you will be able to do many a repair job for your neighbors and friends, and charge fees which will far exceed the cost of the "Edu-Kit". Here is your opportunity to learn radio quickly and easily, and have others pay for it.

## FREE EXTRAS

- ELECTRICAL & RADIO TESTER ● ELECTRIC SOLDERING IRON
- TV BOOK ● QUIZZES ● FREE CONSULTATION SERVICE
- HI-FI GUIDE

Progressive "Edu-Kits" Inc. 497 Union Ave., Brooklyn 11, N.Y.

MAIL TODAY—Order shipped same day received.

30-Day Money-Back Guarantee. Include ALL FREE EXTRAS

- Send "Edu-Kit" Postpaid. I enclose full payment of \$19.95 (U.S.A. only).
- Send "Edu-Kit" Postpaid. I enclose full payment of \$20.95 (Outside U.S.A.).
- 210-250 V. Foreign Line Voltage Adapter for "Edu-Kit"—\$2.50.
- Send "Edu-Kit" C.O.D. I will pay \$19.95 plus postage (U.S.A. only).
- I wish additional information describing "Edu-Kit". No obligation.
- Send me FREE Radio-TV Servicing Literature. No obligation.

Name.....  
Address.....

## PROGRESSIVE "EDU-KITS" INC.

497 Union Ave., Room 109-G, Progressive Bldg., Brooklyn 11, N. Y.

## NEW DEVICES

**REPLACEMENT TRANSFORMERS, Merit HVO-38** (illustrated) replaces Admiral 79C60-1, 79C60-5, 79C60-7. **HVO-54** replaces Admiral 79C60-2, 79C60-3, 79C60-4. **HVO-40** replaces



Silvertone T80-320. **HVO-37** replaces Silvertone 55B253, 55D-253; Hallicrafters 55D251, 55B-253, 55D253, 55B266, 55D266; Crosley 157820-5-1, 157820-6, 158481-1, 158481-2, 158481-5, 158481-3-5; Sentinel 20E995.—**Merit Coil & Transformer Corp.**, 4427 N. Clark St., Chicago 40, Ill.

**TUBE-TESTER KIT, General Electronic Equipment 327A**, tests all tubes in use in modern radio, FM and television sets including color TV. For reactivating picture tubes, testing for shorts and leakages; transmitting, hearing-aid, magic-eye,



voltage regulator, miniature tubes, etc. Free-point selector system circuitry. Double fuse protection for meter and transformer. Loose-leaf book with tab-indexed tube chart cards allows for insertion of additional cards. Illustrated detailed instructions for building-it-yourself.—**General Electronic Equipment Co.**, Mantua and Glendale Sts., Easton, Pa.

**TV TUBE CHECKER, U. S. Electronic Research & Development**, checks TV picture and

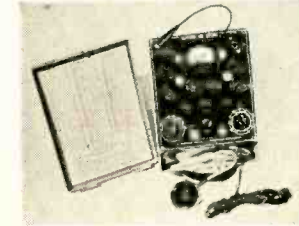

other tubes in 20 seconds. Steel-cased, weighs 6½ pounds.—**U. S. Electronic Research & Development Corp.**, 1605 W. Lafayette, Detroit, Mich.

**LINEARITY PATTERN GENERATOR, Heathkit model LP-1**, for adjusting monochrome or color TV receivers. Extended operating range covers channels 2-13; unused channel can be used for linearity ad-

(Continued)



justments. Regulated power supply. Compact and self-contained. Produces 6 to 12 vertical or 4 to 7 horizontal bar, cross-hatch or white dot pattern. Individual horizontal and vertical frequency controls allow synchronization and establish aspect ratio. R.f. carrier modulated with video and sync signals.—**Heath Co.**, Benton Harbor, Mich.

**COLOR BAR AND DOT GENERATOR, Hycon model 616**. Three color sequences identified and selected on front panel. Color band A is the complete



NTSC sequence. Band B has four bars: G-Y at 90°, R-Y, B-Y, black. Band C consists of black, I, Q, black. Quadrature signals held within 1°. Black vertical or horizontal bars or black cross-hatch pattern, with number of bars independently variable. Convergence adjustments made with white dot pattern, number of dots variable.—**Hycon Mfg. Co.**, 365 S. Arroyo Parkway, Pasadena, Calif.

**TUBE TESTER, Seco GCT-5**, detects positive grid in amplifier tubes where circuit has high grid resistance. Checks



grid emission, leakage, gaseous conditions and shorts.—**Seco Mfg. Co.**, 5015 Penn Ave. So., Minneapolis, Minn.



RADIO-ELECTRONICS

NEW DEVICES

**DOT GENERATOR, Triplett model 3438**, checks video r.f., i.f., sync and color circuits with modulated r.f. (channels 2 to 6) and i.f. (20 to 55 mc) outputs available. Horizontal (15, 750 cycles) and vertical (60 cycles) sync pulses for checking sync circuits. Horizontal bars (480 to 600 cycles) and vertical bars (crystal controlled at 189 kc) for checking linearity on black-and-white and color. Cross-hatch used to check overall linearity with 11 vertical and 8 horizontal bars. Square block produced for cross-hatch pattern. White dots to check convergence of color TV. Will produce red, blue and green spectrum and colors corresponding to phases of R-Y, B-Y, I and Q axes.—Triplett Electrical Instrument Co., Bluffton, Ohio.

**METERS, Weston model 1331**. Self-shielded movement eliminates intereffect of closely mounted instruments, permits mounting on magnetic or non-

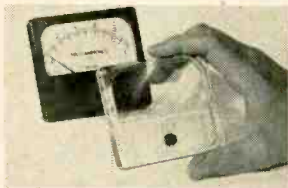

magnetic panels. One piece snap-on front with zero corrector. Front surface, except for window area, in any color. In d.c., rectifier type a.c.—Weston Electrical Instrument Corp., 614 Frelinghuysen Ave., Newark 5, N. J.

**HIGH-CAPACITANCE CERAMICONS, Erie Resistor**. Phenolic-dipped coating, wax-impregnated No. 22 hot-tinned copper leads. Rectangular; 3 sizes: style 892, 0.34 x 0.34 inch; style

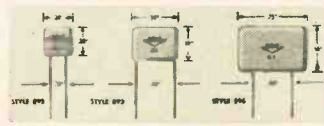

893, 0.58 x 0.43; style 896, 0.75 x 0.56. For transistor and other miniaturized circuitry. Value range from .0022 to 0.1  $\mu$ f; 200-volt rating.—Erie Resistor Corp., Erie, Pa.

**REMOTE CONTROL DEVICE, Hallicrafters Tun-o-magic**, cylindrical control, with 20-foot



cord to TV set. Pushing control button switches channels. Switch on side turns set on or off. Can be used on most TV sets.—Hallicrafters Co., 4401 W. 5th Ave., Chicago, Ill.

**SELENIUM CARTRIDGE RECTIFIER, International Rectifier 60-6979**, for strobe flash units and similar instruments requiring high transient peak currents for capacitor charging.

All specifications given on these pages are from manufacturers' data.

Single-phase full-wave bridge selenium unit. Delivers 9.6 ma average current, 190 ma peak pulse current at 495 volts with

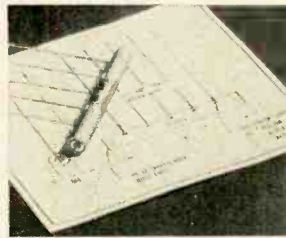

d.c. capacitive load. 3 1/4 inches long, 3/8 inch O.D. with 3/4-inch radial pigtail leads. 6-32 threaded brass inserts at both ends for easy mounting.—International Rectifier Corp., 1521 E. Grand Ave., El Segundo, Calif.

**WIRE-WOUND RESISTORS** with axial leads, steatite cores, vitreous enamel coating in extensive range of sizes and watt-

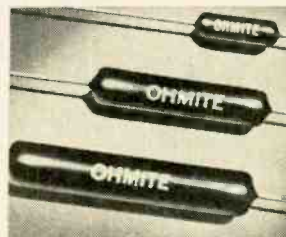

age ratings. Smallest only 1/4 inch diameter by 19/32 inch length overall, rated at 3 watts. Two sizes, rated at 5 and 10 watts, in wide range of resist-

ance values.—Ohmite Mfg. Co., 3678 Howard St., Skokie, Ill.

**SELENIUM RECTIFIERS, 5 RCA universal types** for general replacement use in TV receivers, radios, phonographs, etc. Cover all current-handling requirements from 50 to 500 ma. Corrugated metal separators (between each pair of plates and anchored firmly to U-clamp surrounding the stack of plates), conduct current from

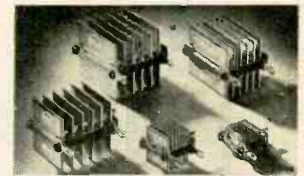

one rectifying surface to next while their open-work construction permits better heat radiation.—Tube Division, Radio Corp. of America, Harrison, N. J.

**POCKET ROLL KIT, Xcelite 99 Junior**, combination handle and 11 tool bits: 7 smaller-size nut driver shafts (3/16 through 3/8 inch), 3/16- and 1/4-inch slotted screwdriver bits and Nos. 1 and



2 Phillips. Two extra pockets for extra tools.—Xcelite, Inc., Orchard Park, N. Y. END

Get This Valuable Book

Just for Examining COYNE'S New 6-Volume Set

**FREE**



"Applied Practical Radio-Television"

Yes, you get this big, brand new book, "150 Radio-Television Picture Patterns and Diagrams Explained", absolutely FREE! Just off the press! Gives complete 11x22" Schematic Diagrams on leading models Radio and Television Sets. Easy-to-read, large 8 1/2 x 11" pages, with full instructions on how to read and use the diagrams. A "must" in every Radio and Television service-man's repair kit. You get this valuable book as a FREE Gift for asking to see Coyne's great new 6-book set, "Applied Practical Radio-Television"!

ON 7 DAY FREE TRIAL!



**At Last! Money-Making "Know-How" on Transistors, Color TV and Servicing**

Coyne's great new 6-volume set gives you all the answers to servicing problems—quickly! For basic "know-how" that is easy to understand, you'll find everything you want in volumes 1 to 5 which contain over 5000 practical facts and data. They cover every step from principles to installing, servicing, trouble-shooting and aligning all types of radio and TV sets. So up-to-date it includes COLOR TV and UHF, adapters, converters. Also covers latest data on TRANSISTORS.

**SEND NO MONEY!** Just mail coupon for 6-volume set on 7 days free trial. We'll include book of 150 TV-Radio Patterns & Diagrams. If you keep the set, pay \$2 in 7 days and \$2 per month until \$22.50 plus postage is paid. (Cash price \$20.95). Or you can return the library at our expense in 7 days and owe nothing. **YOU BE THE JUDGE.** Either way, the book of TV-Radio Patterns is yours FREE to keep! Offer is limited. Act NOW!

**Extra! 900-Page Television Cyclopeda Included**

And then, for speedy on-the-job use, you get volume 6—the famous Coyne TELEVISION CYCLOPEDIA. It answers today's television problems on servicing, alignment, installation and others. In easy-to-find ABC order, cross indexed. Use this 6 volume TV-RADIO LIBRARY free for 7 days; get the valuable Servicing Book ABSOLUTELY FREE!

**FREE BOOK—FREE TRIAL COUPON!**

Educational Book Publishing Division  
COYNE ELECTRICAL SCHOOL, Dept. A5-T1  
500 S. Paulina St., Chicago 12, Ill.

YES! Send 6-volume "Applied Practical Radio-Television" for 7 days FREE TRIAL per your offer. Include TV-Radio Patterns & Diagram Book FREE.

Name ..... Age .....

Address .....

City ..... Zone ..... State .....

Where Employed .....

( ) Check here if you want library sent COD. You pay postman \$20.95 plus COD postage on delivery. 7-day money-back guarantee.

Educational Book Publishing Division  
**COYNE** ELECTRICAL SCHOOL  
500 S. Paulina St., Dept. A5-T1, Chicago 12, Ill.

# DOUBLE MANPOWER WITH SAME PAYROLL



**\$97<sup>50</sup>**

Dealer Net  
Less Batteries

by using a **Radion**  
**BATTERY OPERATED**  
Field Strength Meter  
on TV Antenna Jobs

Let one man do the work of two—in less time, with greater accuracy. He can take the meter on the roof, locate and orient the antenna by himself—even before running lead-in. On master antenna systems he checks each outlet, quickly, without guesswork. This efficiency reduces call-backs, builds confidence, makes larger profits.

If you are using two men on antenna jobs now, a Radion FSM No. 5000 can pay for itself in three weeks time. Ask your parts distributor or write for folder.



**THE RADION CORPORATION**  
Dept. 5, 1130 W. Wisconsin Ave., Chicago 14, Ill.

134

## new Tubes & Transistors

**L**ARGE-SIZE television picture tubes requiring no external ion-trap magnets have been announced by G-E. They include four 21-inch types—the 21BAP4, 21BCP4, 21BDP4 and 21BNP4—and one 24-inch unit, the 24ZP4.

TV picture-tube operation without the use of external magnets is made

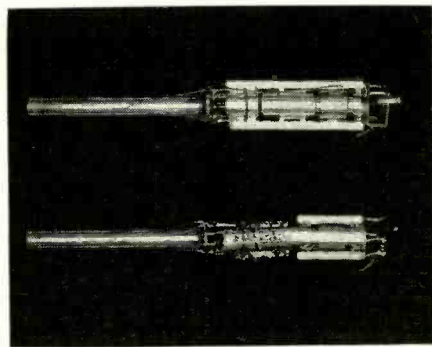

possible by a new straight gun (see photo) and an improved processing technique controlling the thickness of the aluminum coating inside the tube face. The aluminum coating is thin enough to permit the electrons to penetrate and activate the phosphor, but thick enough to stop the larger ions that cause phosphor burns.

### 6AU4-GTA

A half-wave vacuum rectifier tube of the glass octal type, the 6AU4-GTA, has been announced by RCA. It is particularly suited for use as a damper diode in monochrome and color television receivers.

The 6AU4-GTA is rated to withstand a maximum peak inverse plate voltage of 4,500. It can supply maximum peak plate current of 1,150 ma (1,050 ma for the 6AU4-GT) and maximum d.c. plate current of 190 ma (175 ma for the 6AU4-GT). Negative peak pulses between heater and cathode of as much as 4,500 volts, with a d.c. component of as much as 900 volts, may be used when the heater is operated negative with respect to cathode.

### 12AB5

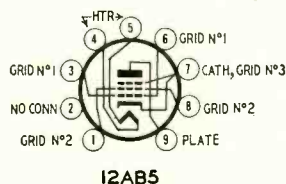

A beam power tube of the nine-pin miniature type, the 12AB5, has been

## NEWEST ELECTRONIC SENSATION!



the **SUPERKIT TRANS-ATOMIC**

# TRANSISTOR RADIO \$8.95

(completely wired \$9.95)

Enjoy your favorite programs at ball games, at the beach, in the country . . . wherever you may be! Be prepared for Conelrad emergency programs. The amazing Trans-atomic featherweight Transistor Radio brings in all stations loud and clear . . . is so small that it fits easily into pockets, the palm of your hand or even into a purse. Attractively packaged in a smart, unbreakable case, it operates for months on 10c flashlight batteries.

Real quality thru & thru . . . features the miracle Germanium Transistor and Germanium Diode, a slide rule dial for precision tuning and the powerful, world-famous Loopstick for unsurpassed reception. Comes complete with instructions . . . prepunched for quick, easy assembly. Only a screwdriver is needed.

**GET YOUR ORDERS IN TODAY!** Give it as a gift . . . ideal for Boy Scouts and similar organizations.

*You'll want these other  
Superex BEST BUYS, too!*

### Grayburne **VARI-LOOPSTICK**

**1.00**  
List



World's most sensitive, compact radio antenna. Replaces inefficient loops . . . pulls in stations strong, and clear. **DON'T ACCEPT IMITATIONS!** Ask for the **VARI-LOOPSTICK** by name.



### NEW Homogenized

**"Q-T" 95c**  
net

for  
**Quiet Controls  
Quiet Contacts**

No finer product of its type anywhere! Cleans and preserves all controls and contacts . . . eliminates noise . . . retards corrosion.

At your Dealer, or write  
Dept. E

**SupereX** CORP.  
4 Radford Pl., Yonkers, N.Y.

RADIO-ELECTRONICS

NEW TUBES AND TRANSISTORS (Continued)

announced by RCA. It is designed for use in the output stage of an automobile radio receiver operating from a 12-volt storage battery. The base connections of the 12AB5 are shown in the diagram. Its electrical ratings are identical with those of the octal-based 12V6-GT.

5604

A general-purpose, forced-air-cooled triode for communication and industrial service, the 5604, has been announced by RCA. It has a maximum plate dissipation rating of 10 kw and can be operated with full ratings at frequencies as high as 25 mc.

In unmodulated class-C service, the tube has a maximum plate voltage rating of 12.5 kv and a maximum plate input rating of 32.5 kw. When operated class C at a plate voltage of 12 kv, a single 5604 has a power output of approximately 22.5 kw. END

HARD-HITTING TRANSMITTER

To demonstrate the ruggedness of their surface barrier transistors, Philco has built a miniature transmitter using these semiconductors into the head of a hammer (see photo). The hammer is banged on a hard surface and the transmitter continues to operate, indicating the ability of this type of transistor to take hard shocks without disturbing its operation. Philco is using these transistors in computer development.



Radio Thirty-Five Years Ago  
In Gernsback Publications

HUGO GERNSBACK  
Founder

Modern Electrics	1908
Wireless Association of America	1908
Electrical Experimenter	1913
Radio News	1919
Science & Invention	1920
Television	1927
Radio-Craft	1929
Short-Wave Craft	1930
Television News	1931

Some of the larger libraries still have copies of ELECTRICAL EXPERIMENTER on file for interested readers.

In October 1921 *Science and Invention* (formerly *Electrical Experimenter*)

Testing Insulators and Controlling Power Systems by Radio  
Home-Made Electric Phonograph, by Carl Mayer, Jr.  
A Practical Radio Telephone Set, by Arthur H. Lynch

# NOW... the Service Dealer can make HI-FI PROFITS

**ONLY  
TRANSVISION  
OFFERS THIS  
4-POINT PROGRAM  
to the  
SERVICE  
DEALER**

- 1. FULL PRICE PROTECTION.**
- 2. NEGLIGIBLE INVENTORY INVESTMENT.** A Sales Kit\* gets you started!
- 3. FINEST MATCHED HI-FI UNITS** for custom-building or complete in beautiful furniture cabinets.
- 4. PRICES THAT ENABLE YOU TO UNDERSSELL COMPETITION.**



You sell the Finest Matched Hi-Fi Components such as these:



RC101  
**RECORD CHANGER** (famous English Collaro) with **DIAMOND NEEDLE** and **RELUCTANCE PICKUP.**



A102  
**AMPLIFIER: Superb Transvision 17 watt unit with built-in Pre-Amp.**

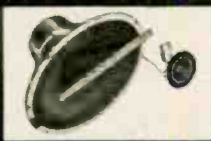

S101  
**15" Transvision DUAL SPEAKER SYSTEM** with cross over network

The Service Dealer sells the above complete system for only \$159!

\*SALES KIT for \$4.95 gets you started. Rush coupon for full details.

BEAUTIFUL FURNITURE plus SUPERB HI-FI:

You can offer Hi-Fi quality equal to many \$1000 jobs on the market — for as little as \$159 to \$299. In component form for custom-building, or in complete "package" including fine furniture as shown above. (Bass reflex corner cabinet and lovely chairside end table.)

**SOLD ONLY THRU  
SELECTED DISTRIBUTORS**  
Write for name of the one in your area.

DISTRIBUTORS: Some areas still available. Write, wire, phone for complete program.

TRANSVISION, INC. • NEW ROCHELLE, N. Y.

TRANSVISION, INC., NEW ROCHELLE, N. Y. RE-10

Please send name of your nearest Distributor.

Rush full details on your Hi-Fi Dealer Program.

Name \_\_\_\_\_

Address \_\_\_\_\_

City \_\_\_\_\_ State \_\_\_\_\_

# NOW! TEST TUBES IN SECONDS! MAKE NEW PROFITS *in MINUTES!*



on every  
service call

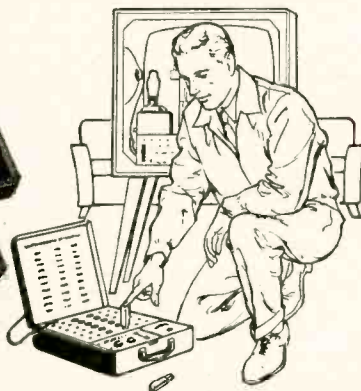

**B&K** NEW PORTABLE  
**DYNA-QUIK** MODEL  
500  
DYNAMIC MUTUAL CONDUCTANCE TUBE TESTER

ONLY  
**\$109<sup>95</sup>**  
NET

Now you can easily cut servicing time—make more on-the-spot tube sales—prevent costly call-backs—and give a better service guarantee! **DYNA-QUIK**—the new top quality, low cost, portable tester quickly locates all weak and in-operative tubes—and easily does the complete job with laboratory accuracy right in the home! You create greater customer confidence because your customer sees for himself the true tube condition. Easy to operate—in just a few minutes you can quickly check all the tubes in a TV set. You can depend upon **DYNA-QUIK** because it tests under the dynamic heavily loaded conditions that are the actual operating conditions of the set. At such low cost **DYNA-QUIK** quickly pays for itself—and continues to make money for you every day!

### **DYNA-QUIK DOES IT FASTER, EASIER, MORE ACCURATELY**

- Makes complete tube test in as little as 12 seconds per tube—faster than any other tester!
- One switch tests everything! No multiple switching—no roll chart.
- Laboratory accuracy right in the home! Large 4½" plastic meter has two scales calibrated 0-6,000 and 0-18,000 micromhos.
- Shows customer true tube condition and life expectancy on "Good-Bad" scale!
- Automatic line compensation! Special bridge continuously monitors line voltage.
- 7-pin and 9-pin straighteners mounted on panel!
- Never Obsolete! New overlay panels with up-to-date markings available from factory, when required.

## TESTS 99%

OF ALL TUBES\*  
in use today for:

**DYNAMIC  
MUTUAL CONDUCTANCE  
SHORTS  
GRID EMISSION  
GAS CONTENT  
LEAKAGE  
LIFE EXPECTANCY**

\*Including new 600 mil series tubes,

### **PORTABLE—CAN BE USED ANYWHERE**

Handsome, rugged, luggage style carrying case, covered in durable, black leatherette. Removable slip-hinged cover. Size: 15½ x 14½ x 5¾ in. For 105-125 volts, 60 cycle, A.C. Net wt. 12 lbs.

**SEND FOR BULLETIN 500-E**

Made by the makers of  
the famous CRT 350



**B&K MANUFACTURING CO.**  
3726 N. SOUTHPORT, CHICAGO 13

## Technicians News



### UNITY CONFERENCE SET

At a meeting of delegates from electronics service organizations held in Pittsburgh on Aug. 7, it was decided to hold a conference in Indianapolis on Oct. 9 to discuss and implement unity of all electronic service groups.

The Pittsburgh meeting was attended by representatives from service associations in Indiana, Minnesota, Missouri, New York, Ohio and Pennsylvania. Chairman was Bert Bregenzler of Pittsburgh, one of the chief organizers of the gathering. Prominent among those who took part in the discussions were Max Liebowitz, president of the National Electronic Technicians and Service Dealers Association (NETS-DA); Vincent Lutz, vice president of the National Alliance of Television and Electronic Service Associations (NATESA) who read a letter from Frank Moch, and John Hemak, recently very active in the formation of the Minnesota state organization, Minnesota Television Service Engineers, Inc. (MINTSE).

An encouraging letter was read from the National Appliance and Radio Dealers Association (NARDA) which had been invited to send representatives but had been unable to do so. Letters were also read from secretaries of service associations in Alabama and Connecticut.

The group organized to forward the work of unity and especially to make arrangements for the coming Indianapolis conference, under the temporary name Television Service Council, with unity of the whole radio-television service industry as its objective. Bert Bregenzler was named chairman, with the provision that the chairmanship be rotated. Gordon Vrooman of Syracuse was elected secretary pro tem.

### PIX TUBES ON CREDIT

A plan by which the service dealer can sell his customer a picture tube on credit and be reimbursed immediately by the distributor has been announced by J. T. Thompson, General Electric manager of distributor sales. The plan, says Mr. Thompson, will cover not only the cost of a G-E picture tube, but also any G-E receiving tubes and parts required to complete the service job, including the labor charges, even if the job is a complete TV overhaul. The customer may pay as little as \$5 down, with 6 months to pay the balance.

An important benefit from the service viewpoint, Mr. Thompson stated, is that it will create new service business. Set owners who have been postponing



# HERSHEL'S PRICE BUST!!!

<b>ALL-PURPOSE FIL. TRANSFORMER</b> For Model Trains, Welding, Transmitters, etc. PRI. 117 v. 60 cyc. sec. 6.4 v. ....12A 6.4 v. ....10A 5 v. ....3A 5 v. ....3A 5 v. ....3A 2.5 v. ....1.75A <b>\$4.95</b>	<b>MYSTERY PACKAGE ELECTRONIC PARTS</b> The Surprise of Your Life 20 pounds of BRAND NEW USABLE GOVT SURPLUS IDEAL gift for the ham, etc. Worth \$50. Our price <b>\$3.95</b>
--	--

<b>KIT 1, HARDWARE</b> Over 1,000 Pieces. 2 1/2 lbs. of Assorted RADIO & TV HARDWARE. <b>99c</b>	<b>KIT 5, RESISTORS</b> 100 ASSORTED TYPES. Range from 1 ohm to 5 meg. 1/2 to 5 watts. <b>\$1.75</b>
--	--

<b>KIT 2, CERAMICONS</b> 100 ASSORTED. Range from 75 mmd. to 6,000 mmd. <b>\$2.50</b>	<b>KIT 6, R.F. CHOKES</b> 25 ASSORTED Ranges from 5 mh. to 25 mh. <b>95c</b>
---	--

<b>Kit 3, Volume Controls</b> 25 ASSORTED Range from 2 ohm to 3 meg. 5 o m e with switch. <b>\$2.75</b>	<b>KIT 7, TOGGLE &amp; SLIDE SWITCHES</b> 25 ASSORTED D.P.S.T. DPDT SPST. etc. <b>\$3.25</b>
---	--

<b>Kit 4, Rotary Switches</b> 25 ASSORTED TYPES. A Real Buy at only <b>\$2.50</b>	<b>KIT 8, PAPER &amp; CAN CONDENSERS</b> 25 ASSORTED Range from 4 mfd. 150 v. to 80 mfd. 450 v. <b>\$2.75</b>
---	---

## BUTTERFLY COND.

TYPE A Freq. Range 106 to 330 MC. 4 1/4" diameter Aluminum Plates (open loop type with acorn socket mounted on stator).  
 TYPE B Freq. Range 135 to 485 MC. 4 3/8" DIAMETER. Silver Plated brass Plates.  
 TYPE C Freq. Range 300 to 1000 MC. 2 1/2" diameter. Can use 368AS Tube, Silver Plated.  
 TYPE D Freq. Range 300 to 1000 MC. 2 1/2" diameter. Has clip for Xtal Detector.

Note: The wide frequency range available. These units made the finest tuners for ultra-high frequency transmitters, receivers, frequency meters and oscillators.

**Your Choice \$4.95**

## HI GAIN DYNAMIC MIKE KIT

Uses UTC. Transformer and Western Electric Mike. Ideal for Hams, PA. CAP, Recording, Mobile Equip.

—50 DB/80-7500 CPS. **\$1.95**  
 Diagram Furnished

## SELL-OUT OFFER

**COMMAND TRANSMITTER \$6.95**  
 ARC-5 2.1 to 1 MC—7 to 9 MC  
 BRAND NEW W/TUBES YOUR CHOICE

**VARIABLE COND. 95c**  
 100 MMFD. DOUBLE SPACED.  
 2 1/4 x 3 1/4 W. 1 1/2 H.

TERMS: Cash with order or 25% down—Balance C.O.D. All orders shipped F.O.B. Detroit. Minimum order \$2.00.

## HERSHEL RADIO CO. Dept. B

5245 Grand River, Detroit 8, Mich.  
 ALL ITEMS SHIPPED F.O.B. DETROIT

## TERRIFIC! SENSATIONAL!

SEE THE NEW **precise** SEND FOR CATALOG S-5

**5" ECONOMY SCOPE KIT**  
 PRECISE DEVELOPMENT - OCEANSIDE, N. Y.

## LMB BOX CHASSIS

Flangelocking Precision Engineered Interlocking

65 sizes and shapes for the laboratory, manufacturer, industrial, experimenter, builder, and general applications where metal boxes are required. Stocked by all electronic and geophysical distributors. Send for free catalog.

**LMB** 1011 Venice Blvd. Los Angeles 15, Calif.

## RADIO-ELECTRONIC CIRCUITS (Continued)

grid and ground leads in through a hole in the back cover and connect to the antenna through Fahnestock clips so the back cover can be removed without unsoldering wires. The 2.2-megohm resistor and .01- $\mu$ f capacitor (see Fig. 2) can be mounted in the box. Slip the coil over the rod terminals inward; leave enough slack in the connections to allow the coil to be slid along the rod for alignment. A good starting position for alignment is with the end of the rod flush with the end of the winding. Its final position will not deviate more than 1/4 inch from this.

The second major change made in the set is the modification of the gain control system. The a.v.c. was not completely satisfactory. The 1G6 has a rather early cutoff so, when used as a grid-leak detector, it distorts on signals larger than a volt or so. The a.v.c. system did not limit signals to that low a level and distortion was sometimes noticed on strong local stations. The a.v.c. system was removed and the volume control transferred from the audio stage to the screen circuit of the i.f. amplifier as in Fig. 2. Now the detector and audio stages operate at full gain and the input to the detector is limited by the volume control setting so distortion caused by detector overload can be eliminated. The detector grid resistor is reduced to 2.2 megohms and returned to the positive filament line to improve linearity. R-C networks were added to the converter input and i.f. amplifier grid returns to provide grid-leak bias. This change greatly increases the i.f. gain and selectivity and a 0.1- $\mu$ f capacitor was added across the B supply to prevent oscillation. The on-off switch was changed to a double-pole type to open the B supply line and prevent the B batteries from discharging through the volume control.

Align the set in the original article. Make the low-frequency r.f. adjustment by sliding the antenna coil over the ferrite rod. This adjustment is critical and should be made carefully, keeping the fingers away from the terminals or the winding.—Charles Erwin Cohn

## HIGH-GAIN PRESELECTOR

If your present shortwave superhet has less than two stages of r.f. amplification, its performance can be greatly improved by the addition of a high-gain preselector. The improve-

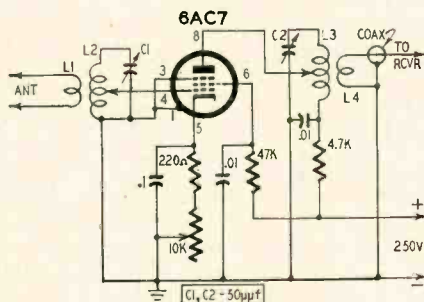

## WANT POWER & VERSATILITY?

## FOLLOW THE LEADER...



**KIT \$29.95**  
 Wired \$38.95

## 6V & 12V BATTERY ELIMINATOR & CHARGER #1050

- operates 6V and 12V auto radios for servicing and sales demonstration.
- charges 6V and 12V storage and Edison Batteries.
- operates mobile and marine receivers, transmitters, boat lights, electric trains, projection and other equipment.

### SPECIFICATIONS

- 6-Volt range: 0.8V (up to 20 Amp.)
- 12-Volt range: 0.16V (up to 10 Amp.)
- variac-type transformer for continuously variable voltage adjustment.
- reads volts and amperes at same time on 2 separate meters.
- Transformer primary and secondary fully protected.

In stock at local jobbers throughout the world. Write for free Catalog CB-10.

Prices 5% higher on West Coast



84 Withers Street  
 Brooklyn 11, N. Y.

## GET INTO ONE OF THESE GREATER OPPORTUNITY FIELDS

# Electricity or Radio-Television

## TRAIN IN THE GREAT SHOPS OF COYNE

OLDEST, BEST EQUIPPED SCHOOL OF ITS KIND IN U. S.

Prepare for your future NOW. Get practical training in TELEVISION—RADIO—ELECTRICITY—ELECTRONICS—all vital in industry. Prepare now for a better job that also offers a real future in the years ahead. Learn on real equipment at Coyne—no advanced education or previous experience needed.

Approved for Veterans—finance plan—enroll now, pay most of tuition later. Part time employment service while training if needed.

FREE BOOK Clip coupon for Big Free Illustrated Book. No Salesman will call. Act NOW.

B. W. COOKE, President  
**COYNE** FOUNDED 1899  
**ELECTRICAL SCHOOL**

A TECHNICAL TRADE INSTITUTE OPERATED NOT FOR PROFIT  
 500 S. PAULINA, CHICAGO, Dept. 75-81H  
 ELECTRICITY • TELEVISION • RADIO • REFRIGERATION • ELECTRONICS

B. W. COOKE, Pres.  
 COYNE ELECTRICAL School  
 500 S. Paulina St., Chicago 12, Ill. Dept. 75-81H  
 Send FREE BOOK and details on:

RADIO-TELEVISION  ELECTRICITY

NAME .....

ADDRESS .....

CITY ..... STATE .....

**THE #630 TV RECEIVER** remains unmatched for quality and performance • • • RCA designed and developed this set quality-wise *not* price-wise • • • The original 10" set retailed at \$375.00 • • • Subsequent TV sets serve to prove the sacrifice of quality for price • • • what better proof can there be of its superiority than the fact that it is the choice of TV engineers and TV technicians! Herewith we offer you—YOUR BEST BUYS IN TV!—All you pay is the price shown • • • Excise taxes have already been paid by us.

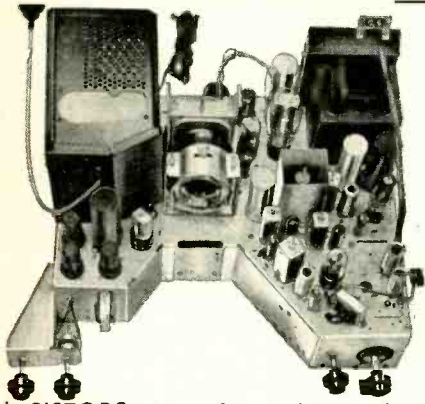

# Build your own #630 Super De Luxe TV CHASSIS

With a #630 SUPER DE LUXE 31-TUBE TV KIT

**OPERATES 16" to 21" PICTURE TUBES** • Engineered in strict adherence to the genuine RCA #630 plus added features • **FULL 4MC BANDWIDTH** • **CASCADE TUNER** • **COSINE DEFLECTION YOKE** • **LARGER POWER TRANSFORMER** • **KEYED AGC** • **12" SPEAKER** • **CONDENSERS and RESISTORS** at rated capacities and tolerances. You receive a **COMPLETE SET of PARTS and TUBES**, everything needed is included (less CRT & wire). All I.F. Coils and Transformers are factory pre-aligned and tuned. You will enjoy building it with "LIFE-SIZE easy to follow step-by-step ASSEMBLING INSTRUCTIONS" included with each KIT.

slashed to **\$99.99** Same KIT for 27" and ALL 90° CRT's **\$110.39**

## #630 SUPER DE LUXE TV CHASSIS

LICENSED UNDER RCA PATENTS  
**COMPLETE READY TO PLUG IN AND PLAY**  
Similar in features to the 16" to 21" TV KIT above.  
Slashed to **\$142.27** (less CRT)

## DUMONT OR THOMAS PICTURE TUBES

BRAND NEW in Factory Sealed Cartons — With a Full Year Guarantee

17" #17BP4A \$22.66 | 21" #21EP4B Aluminized \$32.21 | 24" #24CP4A Aluminized \$48.99 | 27" #27EP4A Aluminized \$74.31

## CUSTOM-BUILT CABINETS for #630 and all Other TV SETS—from FACTORY to YOU

**5 NEW 1956 STYLES** in genuine mahogany or walnut (blond 10% extra) • Ready drilled for any #630 TV chassis and cutout for any 16", 17", 19", 20" or 21" picture tube at no extras in price • Also supplied with undrilled knob panel for any other TV set • **EVERYTHING NECESSARY** for an easy perfect assembly is included • Each cabinet is delivered complete as pictured with mask, safety glass, mounting brackets, backboard, backcup, hardware and assembling instructions • Each cabinet is shipped in an air cushioned carton from **FACTORY to YOU!**

**The GEM**  
Popular Table Model



H-25", W-26", D-22"

**\$35.91**

GEM also available for 24" or 27" picture tube.  
H-31", W-27", D-24"

**\$59.54**

**The FUTURAMIC**  
Latest sensation in styling with tambour roll-in door.

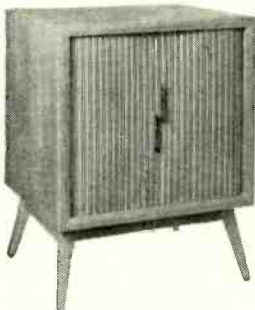

H-37", W-28", D-24 1/4"  
Undershelf mounting for 12" speaker

Slashed to **\$79.34**

**The MANHATTAN**  
Style, Quality, Price



H-39", W-25", D-23"

**\$53.43**

MANHATTAN  
.....for 24" or 27" \$79.22  
H-46", W-30", D-24"

**The WESTCHESTER**  
Choice of Interior Decorators, truly superb in every detail.

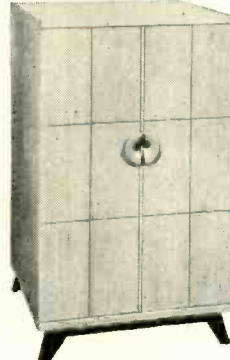

H-41", W-26", D-25"

**\$88.70**

**The TOWN & COUNTRY**  
Patterned after the popular credenza. Available for all size picture tubes 14" to 27"

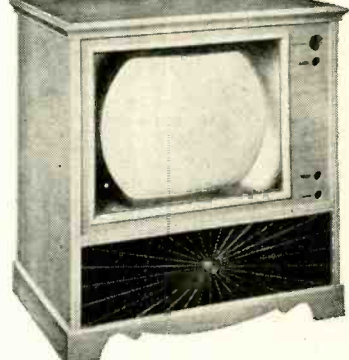

H-42", W-36", D-24"

Slashed to **\$98.65**

## #630 BASIC PARTS KIT

**PUNCHED & DRILLED CHASSIS PAN** ALL for only  
**BRACKET & SHIELD KIT** (18 items)  
**VIDEO & I.F. KIT** (19 items)  
**POWER TRANSFORMER #201T6**  
**VERTICAL OUTPUT TRANSFORMER**  
**VERTICAL BLOCKING TRANSFORMER** Including  
**FLYBACK TRANSFORMER #211T5** LIFE-SIZE  
**FOCUS COIL, 470 ohms #202D2** Instructions  
**COSINE DEFLECTION YOKE 70°**

**\$29.97**

## 21" TV CONVERSION KIT

Convert ANY MAKE TV RECEIVER including #630 to operate the 21" or ANY 70° PICTURE TUBE  
**COMPLETE SET OF ESSENTIAL PARTS** includes matched set of Todd 70° COSINE DEFLECTION YOKE and TODD HV FLYBACK TRANSFORMER

List Price \$33.50

Your price... **\$13.97**

Incl. CONVERSION MANUAL with Step-by-Step Instructions & Diagrams.

## 27" TV CONVERSION KIT

Convert ANY MAKE TV RECEIVER including #630 to operate the 27" or ANY 90° PICTURE TUBE  
**COMPLETE SET OF ESSENTIAL PARTS** includes matched set of Todd 90° COSINE DEFLECTION YOKE and TODD 1BKV FLYBACK TRANSFORMER

List Price \$39.75

Your price... **\$15.98**

Incl. CONVERSION MANUAL with Step-by-Step Instructions & Diagrams.

**BROOKS LIFE-SIZE TV INSTRUCTIONS** for building any #630 TV Receiver from the original 10" to the latest 27". **\$1.25** postpaid

**90° TV CONVERSION MANUAL**, how to convert any TV SET to 24", 27", etc. illustrating wall-type TV mountings. **50¢** postpaid

**HINTS FOR BETTER PERFORMANCE** on your #630 TV receiver **50¢** postpaid

**70° TV CONVERSION MANUAL**, how to convert any TV SET to 17", 21", etc. **50¢** postpaid

**BROOKS CASCADE MANUAL**, how to install Cascade Tuner in any make TV set. **25¢** postpaid

**A.G.C. STEP-BY-STEP INSTRUCTIONS**, how to add A.G.C. to any make TV Receiver. **25¢** postpaid

**BROOKS RADIO & TV CORP., 84 Vesey St., Dept. A, New York 7, N.Y.** TELEPHONE CORland 7-2359

# PRICES SPEAK FOR THEMSELVES

Everything NEW, all STANDARD BRANDS sold with a MONEY BACK GUARANTEE... Some items in thousands, others limited... rush your orders.

- \$15 CRT UNIVERSAL MTG. BRACKETS....S 4.97
- \$10 AGC KIT, complete with 6AU6..... 2.99
- \$49.95 REGENCY UHF TUNER, complete...\$15.00
- \$24.95 REGAL RADIO, comp. w/5 tubes... 13.99
- WEBSTER 3 SPEED CHANGER, complete... 24.19
- \$12 CONICAL TV ANTENNA..... 2.99
- \$20 CONICAL TV ANTENNA double..... 5.46
- \$40 UNDERDASH AUTO RADIO, complete, 19.50
- \$22 TV POWER TRANS. 250 ma..... 3.97
- #630 CHASSIS PAN with sockets..... 3.79
- UHF STRIPS Q-33, 39, 41, 45, 46, 48, 54, 55... 2.98
- 100'-ROLL 72 OHM CO-AX..... 3.58
- PHONO AMPLIFIER, including 3 tubes.... 4.68
- 3 SPEED PHONO MOTOR, complete..... 4.47
- 3 SPEED PICKUP, incl. flipover cartridge... 3.98
- \$2 PHONO SAPPHIRE NEEDLE..... .46
- \$39 TV TEST PATTERN GENERATOR..... 19.50
- TV 90° DEFLECTION YOKE, wired..... 5.98
- LATEST FLYBACK TRANS. for 90°..... 4.42
- LATEST FLYBACK TRANS. for 70°..... 3.98
- \$5 TV PICTURE TUBE BOOSTER..... .69
- #630 TV POWER TRANSFORMER..... 8.78
- TV 70° DEFLECTION YOKE, wired..... 2.97
- \$10 RCA FLYBACK TRANSFORMER..... .99
- TV 50° DEFLECTION YOKE, wired..... .95
- TV CHEATER CORD, w/both plugs..... .21
- TV 21" OPEN MASK, grey finish..... .99
- TV FOCUS COIL #202D1..... .85
- 15 TV ASST. ELEC. CONDENSERS..... 4.97
- VERTICAL OUTPUT TRANSFORMER..... 1.29
- VERTICAL BLOCKING TRANSFORMER..... .47
- TV 21" LUCITE MASK, best made..... 6.92
- TV WIRE & SOLDER KIT..... .98
- TV RIVETS, SCREWS, ETC. KIT..... 1.14
- TV COMPLETE SET OF DECALS..... .09
- TV ION TRAP, universal type..... .52
- #3AG QUARTER AMP FUSE..... .01
- TUBULAR CONDENSER .02-400v..... .02
- TUBULAR CONDENSER .047-400v..... .05
- TUBULAR CONDENSER .01-600v..... .05
- TUBULAR CONDENSER .1-600v..... .07
- TUBULAR CONDENSER .25-600v..... .08
- AUDIO OUTPUT TRANSFORMER, (50L6)... .29
- AUDIO OUTPUT TRANSFORMER, (6K6)... .34
- ONE POUND ROSIN SOLDER..... .59
- NEW S1 HANDY 10 WAY WRENCH..... .39
- 6 FOOT LINE CORD, with plug..... .11
- 5" PM ALNICO #5 SPEAKER..... .99
- 6" PM ALNICO #5 SPEAKER..... 1.39
- 8" PM ALNICO #5 SPEAKER..... 1.99
- 12" PM ALNICO #5 SPEAKER..... 3.42
- SELENIUM RECTIFIER 75ma..... .49
- SELENIUM RECTIFIER 100ma..... .62
- SELENIUM RECTIFIER 150ma..... .74
- SELENIUM RECTIFIER 250ma..... 1.08
- SELENIUM RECTIFIER 300ma..... 1.19
- SELENIUM RECTIFIER 350ma..... 1.26
- SELENIUM RECTIFIER 500ma..... 1.49
- AUTO VIBRATOR, 4 prong non-sync..... .99
- LOOP ANTENNA..... .39
- LOOPSTICK ANTENNA..... .39
- VARIABLE CONDENSER, 460/162..... .57
- TV CRT SOCKETS, w/18" leads..... .19
- TV 18" KINESCOPE LEADS..... .19
- 100' ROLL TV 100 OHM WIRE..... .98
- I.F. TRANSFORMER COIL, 456kc..... .39
- I.F. TRANSFORMER COIL, 10.7mc..... .39
- 100-ASST. TUBULAR CONDENSERS..... 3.49
- 100-ASST. 1/2 WATT RESISTORS..... 2.88
- 100-ASST. CERAMIC CONDENSERS..... 3.72
- 100-ASST. MICA CONDENSERS..... 3.72
- \$60 AUTO RADIOS at \$34.62 each: for FORD, DODGE, CHEVROLET, PLYMOUTH, HUDSON, HENRY J
- RADIO TUBES at 39c each: 1H5, 1LD5, 1LE3, 1Q5, 1T5, 1H5, 6C5, 6H6, 6SF7, 6SF5, 6SD7, 12SJ7, 35Z5

**BROOKS, 84 Vesey St., N.Y. 7, N.Y.**

OCTOBER, 1955

## RADIO-ELECTRONIC CIRCUITS (Continued)

ment in image ratio and signal-to-noise ratio will be most noticeable on the higher-frequency bands, and will be especially noticeable if your receiver has no r.f. stage at all.

The unit shown in the schematic uses a high-gain 6AC7 pentode with a low noise level and high transconductance. The tuned plate circuit is link-coupled to the input terminals of the receiver with coaxial cable. This efficient coupling system makes the unit greatly superior in performance to the simple more common type of 1-stage preselector in which the plate of the preselector tube is capacitance-

### COIL TABLE

Band (Meters)	Coil	Turns	Tap from ground	Length (Inches)
160	L1	12	—	—
	L2	80	4	CW
	L3	80	4	CW
	L4	3	—	—
80	L1	8	—	—
	L2	44	7.5	CW
	L3	44	7.5	CW
	L4	3	—	—
40	L1	5	—	—
	L2	24	10	1.5
	L3	24	12	1.5
	L4	3	—	—
20	L1	3	—	—
	L2	15	15	1
	L3	15	15	1
	L4	2	—	—
15, 11, 10	L1	2	—	—
	L2	8	20	1
	L3	8	20	1
	L4	2	—	—

NOTE: Use 1/2-inch diameter coil forms for 10, 80 and 40 meters and 1 1/8-inch forms for 20, 15, 11 and 10 meters. Use No. 26 enameled wire for 160 meters, No. 22 for 80 and 40 and No. 20 for the others. Coils are closewound (cw) on 160 and 80 meters and spaced as indicated on the remaining coils. Antenna and output windings (L1 and L4) are wound about 1/8 inch below the ground and B plus ends of L2 and L3 respectively.

coupled to the receiver's antenna post.

The unit is moderately regenerative, and tends to oscillate unless the input circuit is tightly coupled to the antenna. The 6AC7 has a rather low input resistance around 30 mc, so the grid is tapped down on the input coil approximately to the center. This reduces the grid loading without appreciably reducing the input voltage. Tapping the grid and plate leads down on the coils also reduces the shunt capacitances allowing a greater tuning range with a given tuning capacitor.

With the 50- $\mu$ f tuning capacitors each set of coils covers a tuning range of approximately 2 to 1. The coils—listed in the table by the amateur bands that they cover—give continuous coverage from about 1.7 to 33 mc.

Should oscillation occur even when tight coupling is used, move the plate tap down a little farther towards the ground end.

The voltages for operating the unit may be taken from the receiver, as most present day sets will stand a slight additional drain on the plate and filament supplies without overheating. However, if the receiver power supply already runs hot, a separate power supply should be used.—George R. Anglado. END

# High Fidelity with COLLINS AUDIO PRODUCTS CO. 'PRE-FAB' TUNERS

Collins Audio Products Co. is in no way affiliated with Collins Radio Co.

Each Collins Tuner Kit is complete with punched chassis, tubes, power transformer, power supply, components, hardware, dial assembly, tuning eye, knobs, wire, etc., as well as the completed sub-assemblies: FM tuning units, AM tuning units, IF amplifiers, etc. All sub-assemblies wired, tested and aligned at the factory make Collins Pre-Fab Kits easy to assemble even without technical knowledge. The end result is a fine, high quality, high fidelity instrument at often less than half the cost—because you helped make it AND BOUGHT IT DIRECT FROM THE FACTORY.

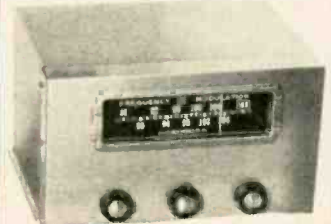

### NEW FM TUNER KIT

New decorative gold front. New cascade front end—3 mv sensitivity, IF amplifier mounted, wired and tested in the chassis. You mount completed RF tuning unit and power supply. 11 tubes, 20 to 20,000 cycle response, A.F.C. and switch. Size: 12 1/2" x 9 1/2" x 7" high. Shipping weight: 15 pounds. Manual supplied. Gold screen cover available at \$3.50 extra. PRICE: **\$59.50**



### NEW FM-AM TUNER KIT

New, decorative gold front like FM tuner above. New cascade front end on FM—3 mv sensitivity. 15 tubes. Comprises chassis, power supply parts, AM unit, FM unit, IF amplifier, all wired and tested, ready for mounting in chassis. A.F.C. with switch. Kits include all parts and hardware. Size: 14" x 12" x 7 1/2" high. Shipping weight: 19 pounds. Manual supplied at \$2.50 extra. Gold screen cover available at \$3.75 extra. PRICE: **\$82.50**

### FMF-3B Tuning Unit with Cascade

Permeability tuned. 3 tubes, A.F.C. 3 microvolts sensitivity. May be used with any 10.7 MC IF amplifier such as our IF-6. 2 pounds. PRICE: **\$19.50**

### AM-4 Tuning Unit

3-gang tuning condenser. Unit covers 530 to 1600 KC. Completely wired and tested with tubes. 4 tubes. Chassis plate measures: 4" x 7 3/8", 2 1/2" high. 2 pounds. PRICE: **\$24.50**

### IF-6 Amplifier

6 tubes, 10.7 MC. Low distortion, high gain. 3 pounds. PRICE: **\$21.50**

--- MAIL COUPON TODAY! ---

To: Collins Audio Products Co., Inc.  
P. O. Box 368  
Westfield, N. J. RE-10  
Tel. Westfield 2-4390

FM Tuner Kit  FM-AM Tuner Kit  
 FMF-3B Tuning Unit  IF-6 Amplifier  
 AM-4 Tuning Unit  COVER

Name \_\_\_\_\_  
Address \_\_\_\_\_  
City \_\_\_\_\_ State \_\_\_\_\_  
Amount for Kit \$ \_\_\_\_\_  
See weights, add shipping cost \$ \_\_\_\_\_  
Total amount enclosed \$ \_\_\_\_\_  
 Check  Money Order

**WHEN YOU THINK OF TUNERS, THINK OF COLLINS AUDIO PRODUCTS**



# ALL-ALUMINUM Conical ANTENNAS

WITH THE NEW AND AMAZING

## "Presto"

### INSTANT MOUNT ASSEMBLY

Opens as easily,  
quickly as an umbrella!

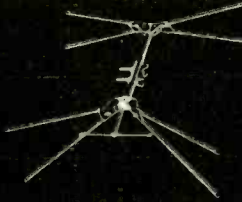
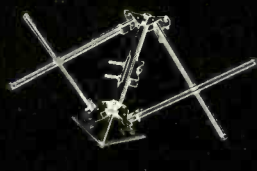

REMOVE FROM BOX • OPEN ELEMENTS • AND PRESTO, IT'S READY!

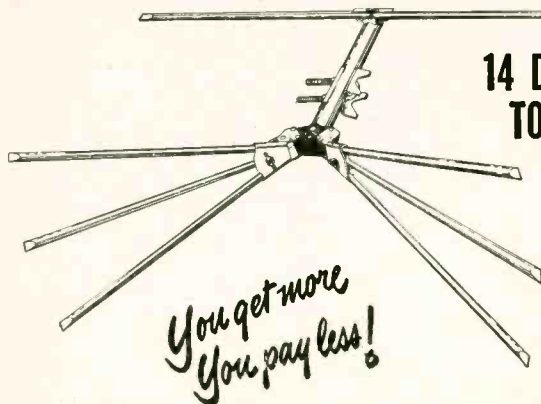

14 DIFFERENT MODELS  
TO CHOOSE FROM!

MODEL  
T-771

5<sup>00</sup>  
LIST

*You get more  
You pay less!*

### Here's what you get!

Complete line of 14 full size, all aluminum conicals with Instant Mount assemblies to fill every installation need • Completely preassembled and ready for the mast • Molded plastic insulator of high impact polystyrene • Seamless aluminum boom • Doweled elements • Highest electrical efficiency • Traditional TENNA quality at lowest prices.

### ...and here's all you pay!

MODEL	ELEMENTS	LIST	MODEL	ELEMENTS	LIST
T-801	4×2	\$4.17	T-851	4×2+Dir. Bar	\$4.72
T-791	4×2+Stubs	4.44	T-781	6×2+Dir. Bar	5.56
T-811	4×4	5.00	T-751	4×4+Dir. Bar	5.56

ALSO AVAILABLE IN STACKED MODELS.  
WRITE FOR NEW CATALOG SHOWING LATEST MODELS.

**Tenna** Manufacturing Co.

7580 GARFIELD BLVD. • CLEVELAND 25, OHIO



### BURGLAR ALARM

I want to construct a simple battery-operated burglar alarm to protect a gun collection that is displayed horizontally in a large cabinet. I would like a system that will trigger the alarm whenever one of six guns is lifted off a sensitive switch concealed beneath it or whenever one of three cabinet doors is opened. Once activated, even momentarily, the system must lock on and continue to sound the alarm until it is silenced manually. A remote OFF-TEST-ALERT switch should bypass the lock-in operation and permit momentary testing of the individual switches. —C. D. H., Tokyo, Japan.

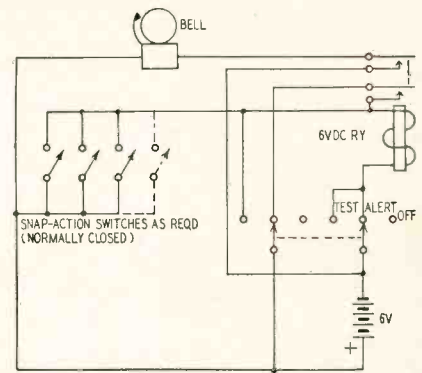

Fig. 1

Two circuits are shown. Fig. 1 is the simplest. Normally closed snap-action switches are held open by the cabinet doors and the weight of the guns. Closing any switch operates the relay that immediately locks in through one set of its contacts. The other contacts close the circuit to the alarm bell. Throwing the switch to TEST checks condition of battery, bell and relay.

The circuit in Fig. 2 uses normally

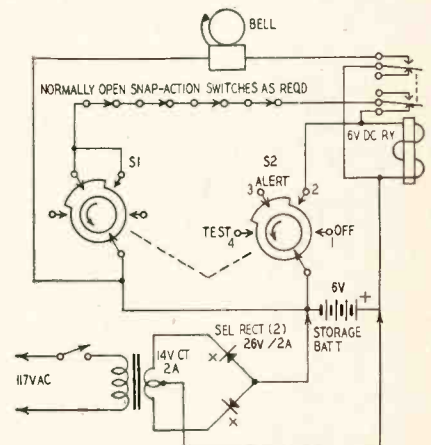

Fig. 2

open switches, held closed by the weight of the guns. Opening a switch or cutting switch leads releases the relay and sounds the alarm. A small 6-volt storage battery is recommended for this circuit because a constant current flows through the relay coil while the protective circuit is in operation. A trickle charger keeps the battery fully charged and permits the alarm to remain in operation during reasonably short power interruptions. The charger may be used periodically or may be connected permanently across the battery.

Sections S1 and S2 of the function switch should be a shorting (make-before-break) type. As the blade of S2 touches contact 2 the relay coil is momentarily connected directly across the battery so the armature pulls in and locks in through S1 and the detector switches. Throwing the switch to TEST interrupts the holding circuit and sounds the alarm. The circuit is reset by rotating the switch through OFF to ALERT.

**RE: WIDE-RANGE OSCILLATOR**

*I'm having trouble with the wide-range audio oscillator described by Mr. Graham in the July, 1954 issue and would appreciate help. I have followed his parts layout and have shielded the heater leads as recommended.*

*I can't adjust R11—in the oscillator tube cathode circuit—and eliminate distortion plainly visible on a 3-inch scope. I start with an unsymmetrical wave with a pip on top and the leading edge considerably steeper than the trailing edge. Varying R11 improves the waveshape. But, just as the pattern begins to approach a sine wave, it suddenly disappears. After about 10 seconds it reappears for about a second and then disappears again. This occurs on the lowest range. Operation is normal on the others.*

*In calibrating the first three ranges I find that they do not correspond to those given in the article. I get 24-200, 210-2,000 and 2,000-19,000 cycles on bands A, B and C, respectively, with the specified variable capacitor.*

*Hum is a problem in the range of about 30-80 cycles. In this region I cannot get a stable circular trace when calibrating the oscillator with another. I get tearing and several distorted superimposed circles.—H. K., Santa Barbara, Calif.*

Mr. Graham believes that the peculiar waveshape is probably caused by a defect in the feedback circuit. Check the lamp and make sure that it is the type specified. Since the trouble occurs only on the lowest range, it is possible that there is a defect in its frequency-determining circuit. Perhaps the resistors for this range are reversed.

The upper end of each range is determined by the minimum capacitance of the tuning capacitor. Your tuning ranges will not correspond to

For the

**Finest TV Master or Community System**

Send us Your  
Installation  
Problem for  
**FREE**

Engineering Advice

**FREE:**

Write for "Technical Information Pamphlet" on TV Master and Community Systems.

**TRANSVISION**

Master Systems  
have been proven

**BEST IN  
PERFORMANCE**

**LOWEST IN COST**

in hundreds of im-  
portant installations

**BEST IN PERFORMANCE  
BECAUSE Transvision  
Master Units have spe-  
cialized Broadband  
and individual Chan-  
nel Amplifiers for each  
purpose.**

**SOLD THRU SELECTED DISTRIBUTORS**

Write for the name of the one in your area.

**SPECIALIZED BROADBAND UNITS**

with 1 or 2 outputs—each with full power  
Built-in cable loss equalization on com-  
munity broadband units. Largest line of  
strip amplifiers, channel changers, etc.  
Send us your problem.

Transvision offers you the choice of the  
best Broadband Amplifier — at lowest  
cost—for any particular community TV  
job.



DISTRIBUTORS: Some areas still available.  
Write, wire, phone for complete program.

**TRANSVISION  
FIELD STRENGTH METER**  
For Battery Operation and 110 V AC

Saves 50%  
of installa-  
tion cost



Model FSM-5B, for Battery Opera-  
tion and 110 V AC. Weight 22 lbs. **\$89**  
net

**TRANSVISION, INC. • NEW ROCHELLE, N. Y.**

TRANSVISION, INC., NEW ROCHELLE, N. Y. RE-10

Please send name of your nearest Distributor.  
 FREE copy of Pamphlet on TV Master Systems.

Name \_\_\_\_\_  
Address \_\_\_\_\_  
City \_\_\_\_\_ State \_\_\_\_\_

**ELECTRONICS**



Prepare for un- ENGINEERING DEGREE  
limited oppor- IN 27 MONTHS  
tunities of the  
Electronic Age!  
Earn your B.S. degree in 27 months at Indiana Technical  
College. Intensive, specialized course. Comprehensive  
training in math and electrical engineering, advanced  
radio theory and design, television, electronics, Modern  
laboratories. Low rate. Also B.S. DEGREE IN 27  
MONTHS in Aeronautical, Chemical, Civil, Electrical  
and Mechanical Engineering, G.I. approved. Enter Decem-  
ber, March, June, September. Earn part of your expenses  
in Fort Wayne while studying. Write for catalog.

**INDIANA TECHNICAL COLLEGE**  
1710 E. Washington Blvd., Fort Wayne 2, Ind.  
Please send me free information on B.S. ENGINEERING  
DEGREE IN 27 MONTHS as checked.  
 Electronics  Chemical  Aeronautical  
 Civil  Mechanical  Electrical

Name \_\_\_\_\_  
Address \_\_\_\_\_

**ENJOY 3 COLOR TELEVISION  
FILTER SCREEN NOW**

Changes dull eye-straining black and white pictures  
into beautiful color tones. Seconds to attach. No tools  
used. Helps eliminate glare and snow in fringe areas.  
Order direct. Send \$1 for screen size up to 16", \$1.25  
size 17", \$1.50 size 20", \$2 size 21", \$2.50 size 24",  
\$3 size 27". We pay postage except on C.O.D. orders.  
Satisfaction guaranteed. Inquiries from dealers also  
welcomed.  
**Zingo Electronics, Johnstown 13, New York**

**TV TUNER REPAIRS**

**48-HOUR SERVICE**  
Defective tuners rebuilt to factory standards.  
New tuner guarantee. Ship prepaid.  
**RADIO PRODUCTS CO.**  
College Point 56 • New York  
We carry a full stock of  
Replacement Tuners for all makes of T.V.

Announcing the first

# BASIC

books ever to be published  
on Synchros and Servos!

## "BASIC SYNCHROS AND SERVOMECHANISMS"

by Van Valkenburgh, Nooger & Neville, Inc.

A NEW 2-VOLUME "PICTURE BOOK"  
SERIES DERIVED FROM THE U.S.  
NAVY'S TRAINING PROGRAM!

Synchros and servomechanisms are the heart of Automation! In addition to wide military use (aiming guns, controlling ship's rudders, etc.) they do an ever-increasing variety of tasks for industry . . . faster and more accurate than is possible manually.

To understand what Automation is . . . what it can do . . . you must know the basics of these important devices—and nothing tells the story like these Rider Picture Books! As with our easy-to-understand "Basic Electricity" and "Basic Electronics" series (described below) "Basic Synchros and Servomechanisms" is derived from the U.S. Navy's present training program; tried, proven, and successfully used to train more than 25,000 Navy men in record time.

Here's how easy it is to learn: every page covers one complete idea. On that same page, there's at least one big, crystal-clear drawing to illustrate and explain it. Using simple, everyday English, these new Picture Books guide you along a carefully planned, step-by-step explanation of the basics of synchros and servomechanisms, making everything picture clear. The way these books tell their story—everyone can understand! Order your set now!

"Basic Synchros and Servomechanisms" consists of 2 (6" x 9") paper bound volumes, totaling 270 pages, with more than 300 illustrations.  
2 VOLUME SET . . . . . ONLY \$5.50

LEARN BASIC ELECTRICITY AND  
BASIC ELECTRONICS THE EASY  
PICTURE BOOK WAY!

## "BASIC ELECTRICITY" "BASIC ELECTRONICS"

by Van Valkenburgh, Nooger & Neville, Inc.

The fabulous Picture Book training courses derived from the Navy's Basic Electricity-Electronics training program! Over 1,700 big clear pictures to guide you every step of the way! 25,000 Navy students have successfully mastered the fundamentals of these vital subjects in record time . . . and now YOU can do the same! Imagine—a complete idea on every page—at least one big drawing on that same page to illustrate and explain it—review pages at the end of every section to highlight the subjects just covered. There's never been an easier, better way to learn basic electricity and electronics!

"BASIC ELECTRICITY" 5-vol. set . . . . . Only \$9

"BASIC ELECTRONICS" 5-vol. set . . . . . Only \$9

### ORDER TODAY!

Rider books are sold by electronics parts jobbers and book stores throughout the country. If YOUR dealer doesn't have them, mail this coupon to us!

JOHN F. RIDER PUBLISHER, INC.  
Dept. RE-10, 480 Canal St., N.Y. 13, N.Y.

Enclosed is \$ . . . . . Send me:

Basic Synchros & Servomechanisms 2-vol. set \$5.50

Basic Electricity . . . . . 5-vol. set \$9.00

Basic Electronics . . . . . 5-vol. set \$9.00

Add state & city sales tax where applicable.  
In Canada, prices approx. 5% more

Name . . . . .

Address . . . . .

City & State . . . . .

### QUESTION BOX

(Continued)

the original if the trimmer capacitors are set too tight. Try loosening them up a bit and then recalibrating.

Your hum problem is serious because it is a matter of layout and wiring. A simple check will show if the hum originates in the heater circuits. Turn on the oscillator and then open one side of the heater circuit at the power transformer while observing the pattern on the scope before the heaters cool. If hum is still present, it is coming from the power transformer and can be eliminated by re-orienting and remounting it. If the hum disappears when the circuit is opened, look for heater-to-cathode leakage in the tubes and around the tube sockets. Dress all a.c. leads away from the variable capacitor, range switch and all components associated with them.

### CIVIC PATROL CONVERSION

*I use a Hallicrafters S-81 Civic Patrol receiver for reception on 154.37 mc. The set drifts badly after it warms up so I want to convert to crystal control for single-frequency operation.*  
—W. K., Brooklyn, N. Y.

The diagram shows how the oscillator circuit can be converted for crystal control. The variable oscillator section of the 12AT7 is removed and replaced by a regenerative type crystal oscillator circuit operating at about 33 mc. A 6C4 tripler must be installed close to the 12AT7 and wired as shown.

L1 is a Cambridge Thermionic type LS-3 30-mc coil. L2 consists of 3-5 turns of No. 18 wire around the B plus end of L1. Adjust the coupling and number of turns in L2 for reliable starting as the receiver is turned on and off. Make the coupling sufficiently tight so the circuit does not oscillate with the crystal removed from its socket.

The 6C4 quintupler supplies the oscillator injection voltage to the converter half of the 12AT7. Its plate coil is a National type AR-2 with its slug and the tuning capacitor set for resonance at 165.07 mc. A small capacitor may be needed for coupling to the mixer grid. You can use two 1.5- $\mu$ f ceramics in series or a gimmick adjusted to give optimum converter performance.

Short out or remove the heater dropping resistor and connect the 6C4 heater (pins 3 and 4) between pin 5 of the 12AT7 and ground.

This circuit can be used for single-channel crystal-controlled operation on any frequency within the range of the receiver. The oscillator (crystal)

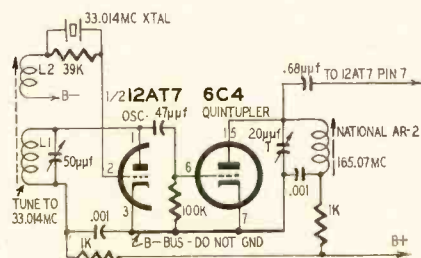

## STEEL ANTENNA TOWERS

need no  
GUY WIRES

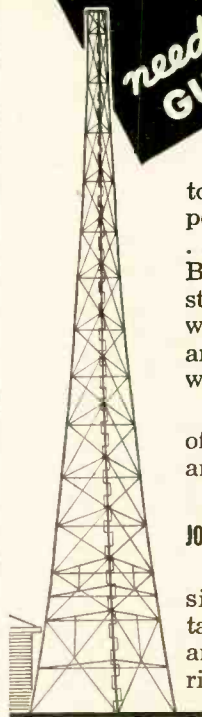

Improve radio and TV reception. Easy to erect . . . self-supporting 3 post towers . . . last a lifetime. Built of galvanized steel sections—no guy wires necessary—safe and resistant to high wind.

Available in heights of 33, 47, 60, 73, 87, and 100 feet.

TERRITORIES OPEN FOR  
JOBBER-DEALER FRANCHISE

Write for dimensions, structural details, prices, discounts, and available territorial assignments.

## AERMOTOR COMPANY

Dept. 7010, 2500 Roosevelt Rd., Chicago 8, Ill.  
BUILDERS OF STEEL TOWERS SINCE 1888

FREE! a copy of  
"Forming Sheet Metal"



tells you how to make  
CHASSIS - BRACKETS  
CHANNELS - BOXES  
with the A. B. Parker  
sheet metal folding machine

Write for your free copy plus our catalog of unusual tools - shears, riveters, notchers, punches. Ask for Catalog 36.

Telvac-1412 Great Northern Bldg.-Chicago 4, Ill.

## Important Notice to SUBSCRIBERS

If you're moving, please don't forget to send us your address as it appears on the copy of the magazine, including the numbers shown beside your name, as well as your new address. If possible, send us your address label which is pasted on the upper left hand corner of the back cover.

If we receive this information before the 20th of the month, you will continue getting the magazine without interruption.

Your cooperation will be most helpful and greatly appreciated.

Please send your new address to:

Circulation Department  
RADIO-ELECTRONICS  
25 W. Broadway, New York 7, N. Y.

frequency is equal to  $(F1 + F2)/5$ , where F1 is the desired signal frequency, F2 the receiver's i.f. (10.7 mc) and the 6C4 operates as a quintupler. Coil and capacitor values hold for frequencies in the 152-173-mc band.

**IMPROVING AM TUNER**

*I want to modify an inexpensive AM tuner to provide variable selectivity and a whistle filter. Do you have any simple circuits that I can use?—J. P. B., New York, N. Y.*

The circuit shows modifications that can be made in most AM tuners and receivers. C1 and R1 form the decoupling circuit for the last i.f. amplifier. If your set has these components, you need not change their values. If the set does not include them, use a 0.1- $\mu$ f capacitor for C1 and 15,000 ohms for R1. C2 is the r.f. bypass capacitor for the detector load consisting of R2 and R3. Lift one end of C2 from ground and connect it to the B plus side of the transformer primary as shown.

Connect the d.p.d.t. switch so it shorts the transformer windings in the BROAD position. In this position R1 is the plate load resistor and C2 the coupling capacitor in a resistance-coupled amplifier circuit. In the SHARP position C2 returns to ground through C1. The volume will be lower in the BROAD position but you can compensate for it by increasing the value of R1.

The whistle filter is a parallel-tuned L-C circuit inserted between the detector load and the volume control. If

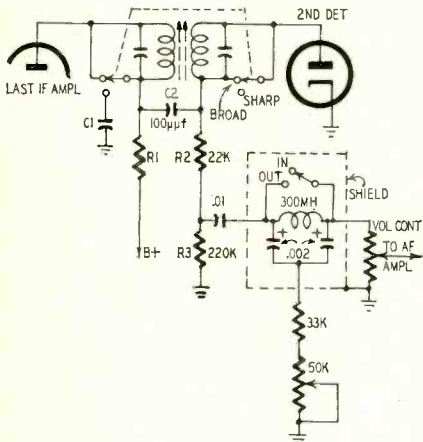

you use a 300-mh r.f. choke, each of the .002- $\mu$ f capacitors may be made up of a .0015- $\mu$ f mica capacitor shunted by a 360-1,000- $\mu$ f mica padder. The 300-mh r.f. choke may be hard to find so you can use a 150-mh unit with .003- $\mu$ f fixed capacitors paralleled by 360-1,000- $\mu$ f padders.

Tune the filter for maximum interference rejection and then adjust the variable resistor for minimum interference with least deterioration of the desired signal.

The components shown within dashed lines must be well shielded to prevent hum pickup and feedback. END

# Use Your Military Training

The time was never more opportune than now for becoming associated with the field of advanced electronics. Because of military emphasis this is the most rapidly growing and promising sphere of endeavor for the young electrical engineer or physicist.

E.E. or PHYSICS GRADUATES with experience in RADAR or ELECTRONICS or those desiring to enter these areas...

Since 1948 Hughes Research and Development Laboratories have been engaged in an expanding program for design, development and manufacture of highly complex radar fire control systems for fighter and interceptor aircraft. This requires Hughes technical advisors in the field to serve companies and military agencies employing the equipment.

As one of these field engineers you will become familiar with the entire systems involved, including the most advanced electronic computers. With this advantage you will be ideally situated to broaden your experience and learning more quickly for future application to advanced electronics activity in either the military or the commercial field.

Positions are available in the continental United States for married and single men under 35 years of age. Overseas assignments are open to single men only.



Hughes-equipped Convair F-102 all-weather interceptor.

Scientific and Engineering Staff

**Hughes**

RESEARCH AND DEVELOPMENT LABORATORIES

Culver City, Los Angeles County, California

**NEW!** All Channel VHF-UHF TV RECEPTION IN ALL DIRECTIONS

**Our Greatest BARGAIN**

**2 BAY 16 ELEMENT CONICAL ARRAY**

**Only \$23.50**

MODEL AX-524  
**ROCKET DIRECTRONIC MOTORLESS TV ANTENNA 360° ELECTRONICALLY SWITCHED BEAM**

In the fringe or ultra-fringe, the NEW 1955 Motorless Directronic will out-perform any ordinary antennas. This sensational new 360° UHF-VHF TV Antenna offers "around the compass" reception WITHOUT Rotors. Provides superb ghost-free picture clarity. Model AX-524 "Serviceman's Array" contains 16 hi-tensile aluminum elements, including 6 Multi-purpose Reflector-directors, 1 set matched tie rods, Universal Mast Clamps, 6-position Beam Selector Switch, 75' Low-loss UHF-VHF Tubular TRI-X Cable.

Antenna offers "around the compass" reception WITHOUT Rotors. Provides superb ghost-free picture clarity. Model AX-524 "Serviceman's Array" contains 16 hi-tensile aluminum elements, including 6 Multi-purpose Reflector-directors, 1 set matched tie rods, Universal Mast Clamps, 6-position Beam Selector Switch, 75' Low-loss UHF-VHF Tubular TRI-X Cable.

**Super UHF RECEPTION HI-GAIN YAGI**

Provides guaranteed sensational UHF fringe reception. Amazing sensitivity provides up to 30 db gain, using 2, 4, or 6 bay stacked arrays. Ghosts, interferences minimized or eliminated. Each serviceman's array provides 4 directors, 2 folded dipoles, 2 reflectors. And our low price insures a low cost installation. Select the model required in your area.

**CONICAL KITS** only \$4.99 each in lots of 3 Kits

A wonderful value for installers. You get 8-element conical array, 3' dia. galvanized steel mast, 60' twin-lead, stand-off, chimney mount. Instructions—EVERYTHING NEEDED FOR THE INSTALLATION PACKED IN INDIVIDUAL BOXES. NO MORE TO BUY. Shipping weight 6 lbs. Order K-12C Kit. Net \$5.95 in Single Lots

**FAMOUS ROCKET ZOOM-UP TOWERS**

Sturdy • Reliable • Easiest Installation  
 Economize with Rocket Zoom-up Towers. Offers quickest, easiest way to make an installation up to 50'. Each section telescopes inside the other—to erect simply slide out each section in its turn—insert bolt thru section below—tighten to keep mast from turning. Each tower complete with guy rings, bolts, and mounting base suitable for peak or flat roof. Handsome and sturdy. Rocket Zoom-ups offer you economy and long life. Order by size.

20' .... \$ 9.95    30' .... \$15.95  
 40' .... 19.95    50' .... 29.95  
 (Deduct 10% discount in lots of 3)

100 ft. UHF Tubular Lo-Loss Lead..... \$4.95  
 PAM-9 Chimney Mount with Strapping..... 1.49  
 TWA Lightning Arrestor..... .69  
 BO Parkhausen Eliminator..... .69

**UHF CORNER REFLECTOR** ONLY \$2.99 EACH IN LOTS OF 6 SINGLE LOTS \$3.50 EACH

This hi-gain UHF Corner Reflector can only be offered you at this low price for a short time. 8 to 11 db gain across UHF band. Order Model F-6.

**National Electronics OF CLEVELAND THE HOUSE OF TV VALUES**  
 6608 Euclid Ave., Dept. E-10, Cleveland 3, Ohio

**WHICH ONE ARE YOU?**

I have a speaker I'd like to keep.

I'd like to start from scratch.

I have a system I'd like to improve.

I custom-build systems for resale.

the answer to all is P.S.E

Now you can buy a speaker and never worry about it becoming obsolete . . . or improve your present speaker or system without discarding what you have.

P.S.E (University's Progressive Speaker Expansion plan) is the most revolutionary concept in speaker history.

University speaker components, enclosures and networks have been so uniquely designed that it is possible to start an excellent basic system, at low cost, and add to it later—while enjoying immediate listening satisfaction.

P.S.E makes it possible to build up to a great variety of magnificent sounding systems in successive, inexpensive stages regardless of budget or space limitations.

A complete selection of speakers and components enables you to build (or have assembled for you) a system to suit your musical taste or hearing requirements.

You owe it to yourself to learn what P.S.E can do for you.

Simplified, easy to follow instructions called TECHNIGRAMS are available free. Fill out and mail coupon immediately for further information.

**University LOUDSPEAKERS, INC.** Desk B3  
 80 South Kensico Avenue, White Plains, N.Y.

Please send me further details.

I have a speaker I'd like to keep.  
 I'd like to start from scratch.  
 I have a system I'd like to improve.  
 I custom-build systems for resale.

NAME \_\_\_\_\_  
 ADDRESS \_\_\_\_\_  
 CITY \_\_\_\_\_ STATE \_\_\_\_\_

**MAKE MORE MONEY!**

Greater ability means more pay. An F.C.C. Commercial Operator License is recognized as proof of technical ability and is required for many high-paying jobs in radio, television, and industrial electronics. Add theoretical knowledge and a commercial F.C.C. license to your practical experience, and make more money.

**The Grantham F.C.C. License Course Prepares You, in a Minimum of Time, To Pass F.C.C. LICENSE EXAMINATIONS**

Our license training is available by correspondence or in residence. Either way, you are completely prepared, in every detail, to obtain the particular class of FCC license you want. Our training includes constant practice with FCC-type tests.

**Our Guarantee:**  
 We guarantee to train and coach you either until you obtain your First Class FCC License or for a period not to exceed two years from the day you begin work on the course, at no additional cost. Read details of this guarantee in our free booklet.

**MAIL COUPON FOR FREE BOOKLET**

(Mail in envelope, or pasted on postal card, to office nearest you)

**GRANTHAM SCHOOL OF ELECTRONICS, Dept. 101-RT**

737 11th Street N.W. Washington 1, D.C. OR 5910 Sunset Blvd. Hollywood 28, Calif.

Send me your FREE booklet, telling how I can get my commercial FCC operator license quickly and what job opportunities are available to licensed technicians.

NAME \_\_\_\_\_  
 ADDRESS \_\_\_\_\_  
 CITY \_\_\_\_\_ STATE \_\_\_\_\_

**MODEL PRECISION 612 RELIABLE TUBE TESTING AT MODERATE COST**

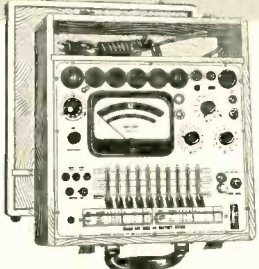

- ★ Absolute Free-Point 10 element lever selection.
- ★ Dual Short-Check Sensitivity. ★ Ballast Unit Tests.
- ★ Tests Each Section of Multi-Section Tubes.
- ★ Noise and Condenser Test pin jacks.
- ★ Hi-Speed Roll Chart ★ Micro-Line Adjustment.
- ★ 5/4" PACE Meter, 2% Accuracy.
- ★ Dynamic "Under-Load" Test for all popular radio A, B, and C dry batteries.

Model 612-P Deluxe: (Illustrated) Modern 2 color satin brushed aluminum panel. Rubbed natural finish, hardwood cabinet. Net Price: \$89.50  
 Model 612-P Standard. Net Price: \$84.50

PRECISION Test Equipment is available and on display at leading electronic parts distributors.

Ask for latest complete catalog.

**Precision Apparatus Co., Inc.**  
 70-31 84th STREET • GLENDALE 27, L. I., N. Y.  
 Export: 458 B'way, N.Y.C., U.S.A. Cables: MORHANEX  
 In Canada: Atlas Radio Corp. Ltd., Toronto 10, Ontario



# Patents



## R.F. NOISE ELIMINATOR Patent No. 2,705,759

Robert W. Taggart, Indianapolis, Ind. (may be manufactured or used by the U. S. Government without payment of royalties)

This simple network to reduce noise caused by motors, vibrators, etc. is especially effective where a radio or TV receiver is on the same power line as the noise source. The network, containing one capacitor and two coils, has been found much more effective than the usual pi filter.

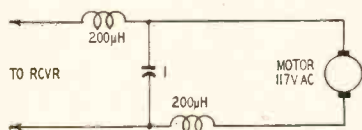

The table below shows noise output (in µv) at various frequencies.

Frequency (mc)	Without Filter	With Pi Filter	With New Network
1	300	12	1.2
2	450	45	.0
6	100	2.5	.0
20	6	3.5	.0

## WIEN-BRIDGE STABILIZER Patent No. 2,704,330

Thomas F. Marker, Sandia Base, Albuquerque, N. M. (Assigned to U. S. Atomic Energy Commission)

This circuit may be used to stabilize the output of an R-C oscillator. It replaces the usual incandescent lamp regulator — which uses considerable power — with a pair of crystal diodes.

If power input to V1 increases, more current flows through the diodes. This increases their temperature, lowering their impedance. The product of higher current and lower impedance

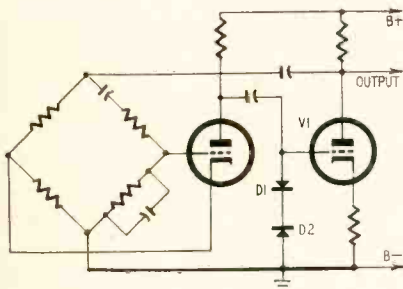

tends to maintain a steady voltage input to the tube.

The back-to-back connection of D1, D2 means that the same impedance is offered to both halves of the wave so there can be no distortion. At frequencies above 100 cycles, the temperature variation during any one cycle may be neglected.

## GATED TIMING OSCILLATOR Patent No. 2,705,287

Arthur Wu-Nien Lo, Elizabeth, N. J. (Assigned to RCA)

This circuit triggers an n-type point-contact transistor into and out of oscillation. When negative signal A is applied to the base of the transistor, oscillations begin. It is blocked when positive signal B is applied. By counting the number of cycles, it is possible to measure the time interval between A and B. The circuit is shown in Fig. 1. Fig. 2 shows how the pulses

# WANTED

## ELECTRONIC Technicians

### TO BE TRAINED

# for NEW

## Nation-Wide Service Program!

### CAREER OPENINGS

## Await Qualified Technicians

... at BOTH the Junior and Senior Level, in the installation and maintenance of Electronic Equipment.

These are definitely of interest to exceptionally capable men of above average intelligence who are anxious to PROVE their capacity to advance to posts of greater responsibilities in the e-x-p-a-n-d-i-n-g, challenging field of electronics.

Salaries commensurate with your experience plus liberal per diem living costs & travel allowances, plus these company benefits: Cooperative Educational Aid — Liberal Pension Plan and all the usual Health and Hospitalization Benefits for YOU and your Family.

### BURROUGHS MEANS BUSINESS!

Get The Details Now. Call or Write The Burroughs Placement Manager For An Appointment.

# Burroughs

RESEARCH CENTER

Paoli, Pa. • Suburban Philadelphia • Paoli 3500

## FREE

Find out how to obtain TV and Radio diagrams and service data. Factory material, in large yearly volumes, only \$2 and \$3 per manual. Send for new 48-page Master Index and full information free.

### SUPREME PUBLICATIONS

1760 BALSAM ROAD. HIGHLAND PARK, ILL.

### REPAIR TV PICTURE TUBES WITHOUT COSTLY EQUIPMENT

Give new life to old or defective tubes. Remove shorts. Restore emission and brightness. Months of extra service.

Complete instructions **ONLY \$1**

Order now

**TELEPARTS CO.** Dept. A  
P.O. Box 74 Providence 5, R.I.

## don't stand on your head!

let the **MASTER** show you the easy way . . . see pg. 153



Made in Cambridge, England  
THE CENTER OF SCIENTIFIC RESEARCH

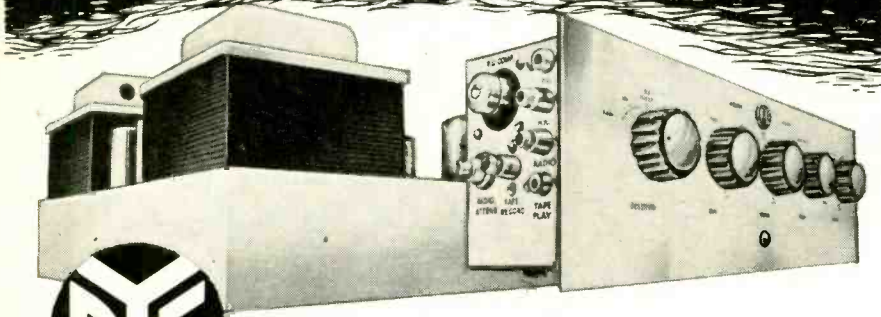

**PYE** Hi Fi  
**PROVOST**  
POWER AMPLIFIER HF25  
**PROCTOR**

REMOTE CONTROL UNIT HF25A

A top-grade High Fidelity Amplifier and Remote Control Unit from the world-famous Pye Research Laboratories in Cambridge, England. Smooth, highly flexible controls and facilities for record player, tape recorder, microphone and radio tuner inputs. Frequency response substantially flat from 2 to 160,000 c.p.s. Infinite damping factor. Intermodulation distortion under 1% at output of 25 watts.

PYE LTD., CAMBRIDGE, ENGLAND

**DISTRIBUTORS** U.S.A. ▶ **BRITISH RADIO ELECTRONICS**  
1883 JEFFERSON PLACE, N.W. WASHINGTON 6 D.C.  
CANADA ▶ **PYE CANADA LTD. AJAX, ONTARIO**

**NOW COYNE TRAINS YOU IN SPARE TIME AT HOME**

**TELEVISION RADIO-ELECTRONICS**

Only from famous COYNE do you get this modern up-to-the minute TV Home Training. Easy to follow instructions—fully illustrated with 2150 photos and diagrams. Not an old Radio Course with Television tacked on. Includes UHF and COLOR TV. Personal guidance by Coyne Staff. *Practical Job Guides* to help you EARN MONEY QUICKLY IN A TV-RADIO SALES AND SERVICE BUSINESS—part time or full time. COSTS MUCH LESS—pay only for training—no costly "put together kits".

**SEND COUPON FOR FREE BOOK**  
SEND COUPON BELOW for Free Book and full details including EASY PAYMENT PLAN. NO COST OR OBLIGATION—NO SALESMAN WILL CALL.

B. W. CODKE, Pres. **COYNE ELECTRICAL SCHOOL** FOUNDED 1899

A TECHNICAL TRADE INSTITUTE OPERATED NOT FOR PROFIT  
500 S. Paulina Dept. 75-HT4 Chicago 12, Illinois

**COYNE ELECTRICAL SCHOOL**  
Television Home Training Div.  
500 S. Paulina St., Chicago 12, Ill., Dept. 75-HT4

Send FREE BOOK and details of your Television Home Training offer.

Name .....

Address .....

City ..... State .....

**Pic Tube Brightener!**

Full socket 6 leads  
For electrostatic or electromagnetic parallel circuits

**95¢**

Order Marvelite A-6 Lots of 6..75c ea.

**TRANSISTOR RADIO KIT**

Kit of parts includes attractive Styrene cabinet. Transistor operated audio amp. stage. Sharp tuning. Wt. 4 oz. 3 3/4" x 2 1/2" x 1 1/8". Order Kit TR-101.

Dynamic (hearing aid type) earphone, 2,000 ohms ..... \$1.95  
Penlite battery for the set ..... 8c

**\$5.95**

**No Motors! No Electricity!**  
**ROTATES ELECTRONICALLY**  
360° Reception VHF Channels 2-13

**NEW Low Price \$14.95**

No roof orientation, no ghosts—it's electronically beam-steered by Directonix 6-position Selector Switch on or near TV set. Around the compass, 360° electronic rotation gives bright sharp pix on all channels. Complete, double stacked array with 18 hi-tensile double alloy aluminum elements. Includes Selector Switch, 7 1/2 ft. 9 cond. cable. Guaranteed.

TX-599 same as AX 599 but includes 3 3 1/2 ft. masts, guy ring & mtg. base. Terrific buy, \$16.95.

Model AX-599  
For Fringe Area

Write for FREE FYI Bulletin 239

**WHOLESALE RADIO PARTS CO., Inc.**

311 W. Baltimore St. • Baltimore 1, Md.

**new-middleton on sweep and marker GENERATORS**

Bob Middleton, well-known author-engineer, takes you behind the dials and shows you how and why sweep and marker generators operate. In the same free and easy style in which he speaks to thousands of technicians all over the country, he clarifies all the fundamental concepts which are frequently misunderstood.

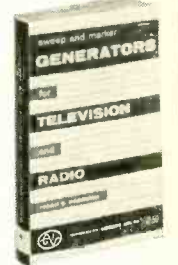

**Sweep and Marker Generators for Television and Radio.**  
No. 55. By Robert G. Middleton. 271 Pages. Over 200 illustrations. Paper cover. \$2.50

**For more efficient servicing**

Sweep and marker generators are standard servicing tools today, and unless you understand fully how they work, you're not getting all you can out of them. This book will give you confidence in your instruments and show you how to put them to uses you never before thought possible. No service technician can afford to be without this book—especially with color TV on the way!

- 10 BIG CHAPTERS**
- The sweep generator signal.
  - Generating a sweep signal.
  - Attenuating the output.
  - Shielding the output.
  - Aspects of sweep output.
  - Marker generators.
  - Marker signal generation.
  - Marker signal calibration.
  - Receiver alignment.
  - Visual alignment methods.

**GET THE COMPLETE GERNSBACK LIBRARY**

PROBES — \$2.50  
RADIO-CONTROL HANDBOOK — \$2.25  
THE OSCILLOSCOPE — \$2.25  
TRANSISTORS — THEORY AND PRACTICE — \$2.00  
TV REPAIR TECHNIQUES — \$1.50  
RADIO & TV TEST INSTRUMENTS — \$1.50  
HIGH-FIDELITY—Design, Construction, Measurements — \$1.50  
RADIO & TV HINTS — \$1.00  
TELEVISION TECHNOTES — \$1.50  
RADIO TUBE FUNDAMENTALS — \$1.00  
BASIC RADIO COURSE — \$2.25  
MODEL CONTROL BY RADIO — \$1.00  
HIGH-FIDELITY TECHNIQUES — \$1.00  
PUBLIC-ADDRESS GUIDE — 75c  
PRACTICAL DISC RECORDING — 75c

**See your distributor—or mail this coupon**

**GERNSBACK PUBLICATIONS, INC., Dept. 105**  
25 West Broadway  
New York 7, N.Y.

Enclosed is my remittance of \$.....

Please send me the following books postpaid.

39  41  42  43  44  45  46  
 47  48  49  50  51  52  53  
 54  55 Sweep and Marker Generators.

Name .....  
(Please print clearly)

Street .....

City ..... Zone ..... State .....

control oscillation of this gated timing oscillator. The transistor tends to oscillate at a frequency determined by tank L-C in its base circuit (Fig. 1). When A drives the base negative (through D1), the transistor conducts and oscillates. To block it, B is fed through D2. During half a cycle, C will discharge through L and from base to emitter. During the other half-cycle, current would block the transistor and interfere with oscillations. To prevent this, D3

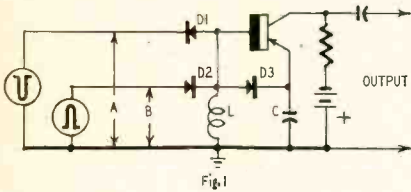

conducts this current during the second half of each cycle.

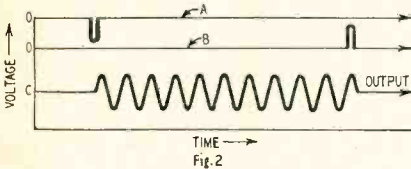

**SEMICONDUCTING ALLOY**  
Patent No. 2,710,253

Robert K. Willardson, Harvey L. Goring and Arthur E. Middleton, Columbus, Ohio (Assigned to Battelle Development Corp., Columbus, Ohio)

Early transistors were made of germanium. Within the past year or two, silicon types were put on the market. More recently, alloyed types have begun to appear. This patent discloses several efficient alloys suitable for transistors.

The important characteristics of a semiconductor are energy band separation, melting point and charge mobility. Germanium has low band separation so it is not suitable for operation at high temperature. Silicon is better in this respect, but its high melting point makes it difficult to

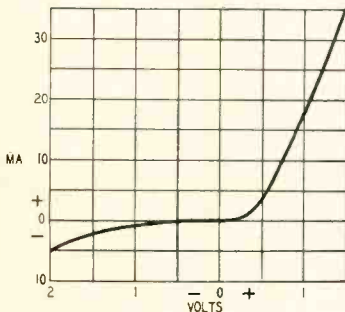

process and form.

These inventors find that alloys combining gallium, aluminum and antimony, are excellent semiconducting materials.

The diagram shows a typical rectification curve using one of these alloys. END

**PHASE SHIFTER**  
Patent No. 2,702,365

Abraham Hyman, New York, N. Y.)

(May be manufactured or used by U. S. Government without royalty payment)

This phase shifter provides a range of 180° and maintains constant output impedance. It is a bridge containing two current paths. One path (L-R1), passes a lagging current I<sub>1</sub>. The other current, I<sub>2</sub>, is leading and flows through C-R2. R1, R2 are ganged, so their sum remains constant.

When R1 is near zero, R2 is near maximum. I<sub>1</sub> is large and I<sub>2</sub> negligible. The output of the bridge is a current that lags the bridge voltage by nearly 90°. With R1 maximum, the bridge current leads by nearly 90°, so a shift of 180° is available.

Reversing either winding of either transformer, shifts phase through the remaining 180°.

# WIN-TRONIX

## Makes Sweep and Sync Circuit Trouble-Shooting Easy! LOW-COST DYNAMIC SWEEP CIRCUIT ANALYZER

for  
Black-and-White TV  
and color too!  
only

**\$69<sup>95</sup>** dealer net



Model 820

TWO  
INSTRUMENTS  
IN ONE

1. Horizontal and vertical sawtooth-square wave and sync pulse generator.
2. Complete compatible flyback and yoke tester.

### ISOLATE SWEEP/SYNC TROUBLES RAPIDLY IN FIVE EASY STEPS!!!

1. VERTICAL TROUBLESHOOTING  
Inject 60 cps on vertical output grid from "vertical grid drive" jack.
2. HORIZONTAL TROUBLESHOOTING  
Inject 15,734 cps on horizontal output grid from "horizontal grid drive" jack.

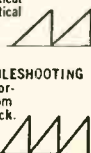

3. HORIZONTAL TROUBLESHOOTING  
Drive horizontal output xfmr directly from "xfmr drive" jack.
4. COMPONENT TESTING  
Test flyback transformer and deflection yoke in receiver with Model 820.
5. SYNC CIRCUIT TROUBLESHOOTING  
Inject vertical and horizontal sync pulses, stage by stage, in sync amplifiers, with accessory probes.

**SPECIFICATIONS**

Signal Outputs  
15,734 cps sawtooth and pulse adjustable.  
15,734 square wave adjustable.  
60 cps sawtooth locked to line.  
Overload indicator for safety and test.  
Oscillating neon indicator with D.C. amplifier for flyback/yoke test.  
Calibrated for color and black-and-white.  
Test leads supplied.  
Operates on 105-125 VAC.

### OTHER WIN-TRONIX LOW-COST TV TEST INSTRUMENTS— Buy Now for Bl. & Wh. Service—be ready for color!

WHITE DOT—Linearity Generator

Model 160  
**\$79.95**

RAINBOW GENERATOR

Model 150  
Patent Pending **\$49.95**

COMPATIBLE FIELD STRENGTH METER

Model 330  
**\$129.95**

FLYBACK AND YOKE TESTER

Model 810  
**\$29.95**

- Compatible advanced design prevents obsolescence!
- Low cost with high quality!
- Portability!
- Standard warranty on all instruments!

SEE YOUR PARTS JOBBER!  
WRITE FOR FREE LITERATURE!

COMPATIBLE CRYSTAL CALIBRATOR

Model 120  
**\$59.95**

# WINSTON ELECTRONICS, INC.

RE-1055 4312 Main St., Philadelphia 27, Pa.

more  
Cannon lines  
now available  
at jobbers'  
shelves!

get the full story...

Write for ICC  
and RJC catalogs TODAY!

Twenty pages of  
information on 14  
different lines of  
Cannon connectors,  
including list prices  
on more than 850  
individual items.  
130 illustrations.

Audio, military, general industrial.  
Get your copies... NOW!

When you write for our catalogs... Please refer to this magazine or Dept. 144

## CANNON PLUGS



CANNON ELECTRIC COMPANY  
3209 Humboldt St., Los Angeles 31, California  
Factories in Los Angeles; East Haven; Toronto,  
Canada; London, England. Representatives and  
distributors in all principal cities.



AN3108B Plug AN3102A receptacle

### "AN" (Air Force-Navy) Series Connectors

Proved in military service. World-wide  
standard. Lightweight. Uniform in  
quality. Interchangeable inserts.  
Threaded coupling nut. Rapid  
and easy disconnect. Cable  
clamps and other  
accessories.

typical lines newly offered...



K-21C Plug K-32S receptacle

### Cannon "K" Series

All-purpose... Adapted to a variety of  
general electrical and electronic  
applications. Special Acme thread.  
Rugged. 220 contact layouts  
available.

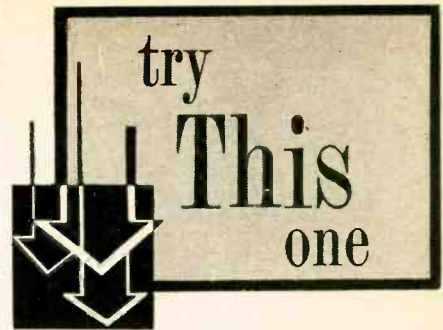

### COPPER TUBE SHIELD

Often it is desirable to run shielded  
leads between chassis in a permanent  
installation or between shield boxes  
or subchassis on a single large chassis.  
When the standard shielding braid  
does not provide sufficient protection  
against accidental damage to the lead,  
try using soft copper tubing and flare  
type fittings as shown in the drawing.

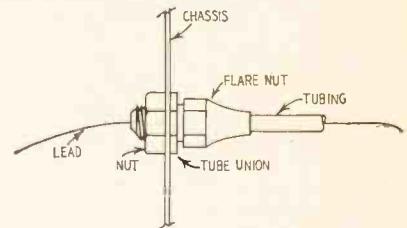

It is easier to bend than rigid conduit,  
is neater than BX and comes in smaller  
sizes.

A union (connector) with a suitable  
nut anchors the tubing to the chassis.  
A flared nut joins the tubing and union.  
Soft copper tubing is sold in coils and  
may be bent by hand. Do not use rigid  
tubing that comes in straight lengths.  
It cannot be shaped without special  
bending tools.

The tubing size depends on the number  
of conductors to be shielded.—  
*Charles Erwin Cohn*

### FUSE INDICATOR

Every technician knows that there  
is some reason for a blown fuse. Find-  
ing that cause is not always simple  
and can often require several trips to  
the customer's home. That can become  
expensive.

I recently devised the gadget shown  
in the diagram. It consists of a *blown*  
pigtail fuse, a short piece of well in-  
sulated wire, a fuse extractor post  
and a small neon lamp.

Connect the pigtails of the blown fuse  
to the contact points on the fuse hold-  
er and solder the neon lamp across  
the latter. Ream a hole in the TV  
back to accept the holder. Stick the  
neon lamp in one of the small ventila-  
ting holes on the back cover. Insert  
the *blown* pigtail fuse into the fuse  
holder in the set.

Show the customer how to unscrew

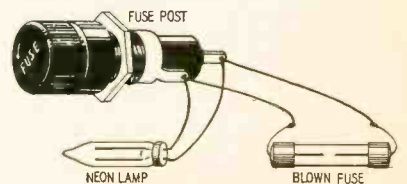

## 6-VOLT BATTERY SOLDERING IRON AND WELDER

U.S. Army release. Brand  
New—Never Used. Fully  
Guaranteed. This soldering  
iron can be used to solder  
or weld when connected to  
any six-volt storage battery.  
Uses approximately 200 to 300  
watts. The high intensity arc  
created between the metal to  
be soldered and the carbon  
electrode (carbons supplied  
free with iron) can be used to  
heat tin or aluminum solder.  
Suitable also for  
light brazing and spot welding. Arc can be used

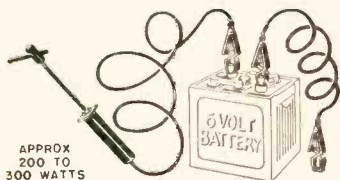

APPROX  
200 TO  
300 WATTS

for melting metals, cutting  
holes and soldering seams in  
chassis. Also useful for ana-  
lyzing metals and minerals.  
Battery soldering iron out-  
fit includes 2 carbons, 3  
heavy duty spring clips, 2  
pieces 5 ft. heavy duty wire  
cable. (Battery not included.)  
Ideal for use where current is  
not available.  
Ship wt. 4 lbs. **\$1.95**

ITEM NO. 126  
UNUSUAL BUY (P.P. & Hdg. Chgs. 50c)

### VARIABLE SPEED UNIVERSAL MOTOR

FOR 110 VOLTS, A.C. OR D.C.  
Used, but in excellent condition.  
Special lever control permits varia-  
ble speeds up to 3000 r.p.m. 1/4"  
shaft extends from both sides of  
motor. Measures 7/2 x 3/4" diam. overall Shp. Wt.  
6 3/4 lbs.  
ITEM NO. 127  
Your Price **\$2.45**  
PP. & Hdg. Chgs. 75c



### WATT HOUR METER



Leading makes — reconditioned.  
Ideal for trailer parks. 100-110  
volts, 60 cycles, 2-wire A.C. 5  
amp. Heavy metal case 8 1/2" x  
6 1/4" x 5". Easy to install. Ship.  
wt. 14 lbs.  
ITEM NO. 33 **\$4.50**

(P.P. & Hdg. Chgs. \$1.25)

### AMAZING BLACK LIGHT

250-watt ultra-violet light  
source. Makes fluorescent  
articles glow in the dark.  
Fits any lamp socket. For  
experimenting, entertaining,  
unusual lighting effects.  
Ship. wt. 2 lbs. **\$2.45**  
ITEM NO. 87  
(P.P. & Hdg. Chgs. 35c)



### BLAK-RAY SELF-FILTERING ULTRA-VIOLET LAMP



BLAK-RAY 4-watt lamp,  
model X-4, with U-V tube.  
Lamp has a wave-length of  
3654 to 4000 angstrom units.  
Some of the substances made  
to fluoresce are certain  
woods, oils, minerals, milk-  
stone, cloth, paints, plastics,  
yarn, drugs, crayons, etc.  
Self-filtering and harmless.  
Equipped with aluminum reflector. 110 volt 50-60  
cycle A.C. 2000 to 3000 hours of service. Approved  
by Underwriters has a built-in transformer.  
ITEM NO. 125 **\$16.75**  
(Shp. Chgs. 80c)

HUDSON SPECIALTIES CO.  
25 West Broadway, Dept. RE-105  
New York 7, N. Y.

I am enclosing full remittance for items circled  
below. (Be sure to include shipping charges.)  
OR, my deposit of \$..... Ship balance C.O.D.  
MINIMUM C.O.D. ORDER \$5.00.  
C.O.D. ORDERS ACCEPTED ONLY WITH 20% DE-  
POSIT. INCLUDE SHIPPING CHARGES.  
87 147 33 126 123 125 127

Name \_\_\_\_\_ Please Print Clearly

Address \_\_\_\_\_

City \_\_\_\_\_ Zone \_\_\_\_\_ State \_\_\_\_\_

### POWERFUL ALL PURPOSE MOTOR

Sturdy shaded pole A.C. induc-  
tion motor. 15 watts, 3000 rpm.  
3"x2"x1 3/4"; 4 mounting studs;  
7/8" shaft, 3/16" diameter; 110-  
120 volts, 50-60 cycles. A.C. only.  
ITEM NO. 147 **\$2.45**  
UNUSUAL BUY  
(P.P. & Hdg. Chgs. 35c)



### 250 POWER TELESCOPE LENS KIT

Make your own high powered 6 ft. telescope!  
Kit contains 2" diam., 75" focal length, ground  
and polished objective lens  
and necessary eye pieces.  
Magnifies 50x to 250x. Full  
instructions.  
ITEM NO. 123 **\$2.95**  
(Shp. Chgs. 10c)



TRY THIS ONE

(Continued)

the cap and replace the fuse when the lamp lights and indicates that the fuse has blown. Instruct him to call for service only after the fuse has blown repeatedly.—Harold Davis

### RADIO KNOB PULLER

Sometimes the hardest part of taking a TV or radio chassis out of the cabinet is getting tight knobs off without breaking them or scratching the cabinet. A simple but very useful knob puller that won't harm the knob, cabinet or fingernails is shown in Fig. 1.

Take a length of heavy dial cord about 22 inches long and thread on

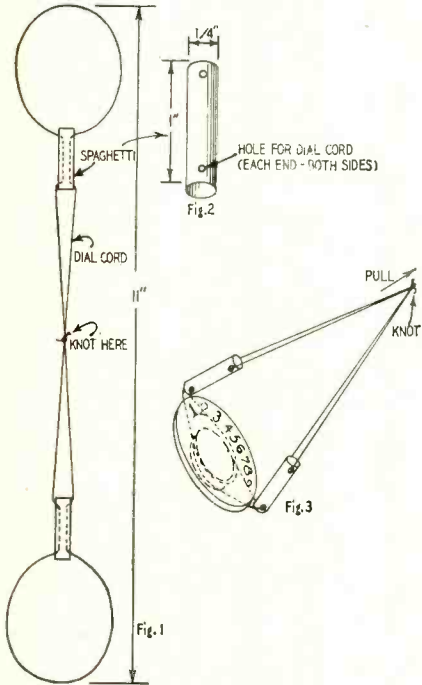

two pieces of 1-inch long, 1/4-inch diameter flexible spaghetti. Small holes are punched in the walls of the spaghetti as in Fig. 2. Then tie the ends of the cord together at the center of the assembly between the two pieces of spaghetti. Next tie the entire assembly in a knot also at the center. This knot keeps the knotted ends of the cord from snagging in the spaghetti.

To use, insert the loop, at one end, behind the knob to be pulled and slide the spaghetti up to the knob as far as it will go. Insert the other loop in the same manner but from the opposite side of the knob. With both pieces of spaghetti slipped up tight, put the fingers of one hand around the center of the cord and pull straight out. See Fig. 3.

It's a good practice to keep the other hand on the front of the set above the knob with the thumb in front of the knob to keep the set from pulling forward and the knob from scattering when it pulls off.—Charles Garrett

### USEFUL HAND TRUCKS

The purchase of a few discarded grocery carts from a self-service

## BACH

Toccata and Fugue in D Minor  
Alexander Schreier at the Organ of the Tabernacle, St. Luke City

## CHOPIN

Fantasia-Impromptu, Opus 66  
Robert Goldsand, Pianist

## MOZART

Symphony No. 26 in E Flat, K. 184  
Netherlands Philharmonic Orch.,  
Otto Ackermann, Cond.

## BRAHMS

The Academic Festival  
Utrecht Symphony, Paul Hupperts, Conducting

## BEETHOVEN

Piano Sonata No. 24 in F Sharp, Opus 78  
Grant Johnson, Pianist

## MUSSORGSKY

Night on Bald Mountain  
Netherlands Philharmonic Orch., Walter Guehr, Conducting

## VIVALDI

Concerto in C for Two Trumpets and Orchestra  
H. Sevast'yan and F. Haendler, Trumpeters,  
Netherlands Philharmonic Orch., Otto Ackermann, Cond.

## BERLIOZ

The Roman Carnival  
Netherlands Philharmonic, Walter Guehr, Cond.

## WAGNER

Die Meistersinger, Prelude, Act 1  
Zurich Tonhalle Orch., Ackermann, Cond.

## DUKAS

Sorcerer's Apprentice  
Utrecht Symphony, Hupperts, Cond.

# 10 Masterpieces

TO INTRODUCE YOU TO THE MIRACLE OF TRUE HIGH-FIDELITY RECORDINGS

COMPLETE TO THE  
LAST NOTE!

Yes, all works complete on two EXTRA-Long Playing High Fidelity Discs.

**\$1**

Take all 10 for just one dollar!

try them FREE

Don't pay a penny until AFTER you've heard them on approval.

## NO STRINGS ATTACHED!

All the advantages of Trial Membership—but no obligations.

Take these 10 great masterpieces for a free 5 day home trial, and if you decide to keep them pay not \$1 each but—only \$1.00 for all ten.

### Why We Make This Amazing Offer

We want you to hear for yourself the exciting performances... the outstanding value of our recordings... Performed by internationally renowned artists and orchestras. Reproduced with a tone fidelity encompassing the entire range of human hearing... 50 to 15,000 cycles. Custom pressed on noise free vinylite.

### Mail Coupon Now

As a Trial Member you are under no obligation to buy any record from us ever. Future selections will be described to you in advance. You may audition any of these free of charge and you don't have to keep those you try. Pay only for those you keep at the Member's low price of just \$1.65 per 33 1/3 rpm disc, containing about 40 minutes of music. A saving of 40% off usual retail price. Memberships are limited. Mail coupon—without money—and get all 10 masterpieces for just \$1.00.

The Musical Masterpiece Society, Dept. 52-10  
43 West 61st Street, New York 23, N. Y.

Send me 10 Masterpieces for free home trial. Enroll me as a Trial Member. After 5 days I will return discs or send only \$1 plus few cents shipping as payment in full.

Privileges: No purchase obligation ever. Monthly advance notice of releases, 5 day free trial on any discs. I may reject records before or after release; may cancel membership at any time. For future long-play discs I keep I'll pay only \$1.65 each, plus shipping. Saving 40% off usual retail price. LIMIT: Only one sample package per customer.

Name \_\_\_\_\_  
Address \_\_\_\_\_  
City \_\_\_\_\_ Zone \_\_\_\_\_ State \_\_\_\_\_  
Canada, 105 Bond Street, Toronto 2, Ont.

INTERNATIONALLY ACCLAIMED  
"The recording is of such perfection it seems to bring the artist into your living room."—Glorious Sounds, Amsterdam, Holland.  
"Uncommonly fine, even for these days of technical advancement."—Los Angeles Examiner, Calif.  
"The discs can be recommended without reservation to record lovers."—The Action, Zurich, Switzerland

"They're really tough to resist since they started using JENSEN NEEDLES."

## PUT YOUR OSCILLOSCOPE TO WORK!

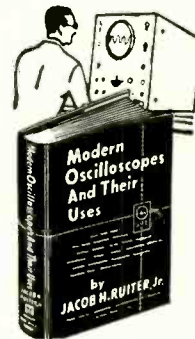

Dust off that oscilloscope of yours! Put it to work fully on the dozens of jobs it can do better than any other service instrument.

Handle jobs TWICE AS FAST, better and lots more profitably!

This big book, MODERN OSCILLOSCOPES AND THEIR USES shows you how... in a way you can really understand. Clearly and simply, it explains exactly where and how to use your 'scope on all types of AM, FM and TV service... from trouble-shooting to set realigning and everything in between. No fancy theory. You quickly learn how to make connections; how to adjust circuit components; how to set the controls; and how to analyze patterns fast and right!

The book that REALLY TEACHES YOU TO USE 'SCOPES!

Modern Oscilloscopes and Their Uses  
326 pages  
370 pictures

Practice from it 10 days... at our risk! See for yourself how much this clear, easy instruction can mean!

RINEHART & CO., Inc., Dept. RE-105  
232 Madison Ave., New York 16, N. Y.

Send MODERN OSCILLOSCOPES AND THEIR USES for 10-day FREE EXAMINATION. If I decide to keep book, I will then send you \$6.00 plus a few cents postage in full payment. If not, I will return book postpaid and owe you nothing.

Name \_\_\_\_\_  
Address \_\_\_\_\_  
City, Zone, State \_\_\_\_\_

OUTSIDE U.S.A.—Cash with order only. Price \$6.50. Money back if book is returned in 10 days.

Rinehart Books are sold by leading book stores

The Sensational

Granco

"Music Hall"  
FM TUNER



Model T-160



For those who already have audio and speaker facilities either separately or in a radio, TV or phonograph. High sensitivity, exclusive Granco NO DRIFT coaxial-tuning and built-in antenna. Housed in beautiful plastic cabinet.

Compares Favorably With  
High Priced Tuners!

AMAZING  
VALUE... \$34<sup>95</sup>\*  
in walnut

TWO MORE SENSATIONAL "Music Hall" VALUES

● The GRANCO FM RADIO-Model 610 in the same compact cabinet has exclusive Granco coaxial-tuning for DRIFT-FREE performance. A real quality radio with superb tone, sensitivity and selectivity. AC-DC. Only \$29.95\* in ebony.

● The GRANCO FM-AM RADIO-Model 720 has all the fine FM features of Model 610 plus fine AM reception. Two built-in (AM and FM) antennae. Terrific value. \$39.95\* in ebony.

Both available in decorator colors at slightly higher prices.

\*Prices slightly higher in West and South.

For name of your nearest dealer, write: **GRANCO PRODUCTS INC.**

36-07 20th Avenue, Long Island City 5, N. Y.

ONE Generator covers 150 kc-435 mc!  
WORLD'S BEST GENERATOR BUY!



New! EICO SIGNAL GENERATOR #324  
KIT \$26.95 Wired \$39.95

- 6 fundamental bands: 150-400 kc, 400-1200 kc, 1.2-3.5 mc, 3.5-11 mc, 11-37 mc, 37-145 mc, 1 harmonic band 111-435 mc. Covers AM, FM, TV, & Amateur freqs.
- ±1.5% frequency accuracy; 6:1 vernier tuning knob & excellent spread at most important alignment frequencies.
- Etched tuning dial, plexiglass windows, edge-lit hairlines.
- Variable depth of int. mod. 0-50% by 400 cps Colpitts osc.
- Variable gain ext. mod. ampl.; only 3.0 v for 30% mod.
- Colpitts RF oscillator plate-modulated by cathode follower.
- Turret-mounted, slug-tuned coils.
- Fine & Coarse (3-step) RF attenuators; 50-ohm output Z.
- RF output 100,000 uv; AF output to 10 v.

In stock at local parts distributors coast to coast.  
Write for free Catalog CG-10



Prices 5% higher  
on West Coast

84 Withers Street • Brooklyn 11, N.Y.

© 55

Ronette  
CARTRIDGES

First Choice of  
Hi-Fi Equipment  
Makers...

First Choice of  
Sound Servicemen  
for Replacement



There is a quality Ronette Cartridge that will instantly improve the performance of practically every changer and arm now in use. Ronette Cartridges, acclaimed by the audio experts as the most outstanding development in pickup history, deliver full frequency range, high compliance, negligible intermodulation distortion and true tracking with low stylus pressure.

Ronette Cartridges are available in high or low output, turnover or single needle models and come in a variety of mountings and brackets to fit virtually every record changer in use.

From \$5.40 to \$7.50 net

Diamond needles available at extra cost.

At All Sound Dealers.

**RONETTE**  
ACOUSTICAL CORPORATION  
135 Front Street, New York 5, N. Y.

In Canada:  
Audio Tool & Eng. Ltd., Toronto



TRY THIS ONE

(Continued)

market has simplified the problem of loading and unloading chassis and appliances from our pickup trucks. We removed the top basket and welded four pieces of 2 x 3/16 x 28-inch flat steel on the top rack to form a platform.

We haul large assemblies on the top platform. The bottom basket is for parts and smaller appliances. The top platform being high enough for easy loading and unloading of items from our trucks, it is now much easier to wheel heavy parts, materials and appliances to the shop than to carry them.  
—Stanley Clark

HANDY MAGNIFIER

Many shops have obsolete 7- or 10-inch bubbles lying around idle. The photo shows how we put one to work. In addition to its usefulness in chassis



work, it is invaluable in "blowing up" to a readable size the ridiculously small schematics issued by some companies. The upright supports are adjustable for height by nails through holes drilled every 1/2 inch.

This type of TV screen magnifier is also useful during demonstrations and servicing lectures where oscilloscope patterns are shown to a large audience such as a class or meeting of service technicians. Rig the magnifier so it does not obstruct the scope's controls and make rapid adjustments difficult.  
—R. W. Reid

MAKING MARKING DECALS

To make your own professional-looking decals for marking controls and instrument panels, apply two coats of clear or colored nail polish to the gummed side of ordinary paper tape and then draw in the dial scale or print the desired legend. When the treated paper is thoroughly dry, soak it in warm water and then transfer the collodion base to the desired surface just as you would a commercial decal. I use a pen and waterproof marking ink on the lacquer base but it might be worth while to try a typewriter.—A. W. Moyes

(Model airplane dope or automobile touchup lacquer will probably work as well as nail polish.—Editor) END

# People

Larry H. Kline, joined Thompson Products, Cleveland, in the newly created position of manager of commercial products sales for the Electronics Division. He was formerly general sales and merchandising manager for Ward Products Corp. In his new position, he will direct sales of the company's new Superotor antenna rotor.



L. Kline



Dr. Benjamin H. Alexander was appointed manager, semiconductor operations, for CBS-Hytron, Danvers, Mass. He will make his headquarters at the Lowell, Mass., Plant. He was formerly with Sylvania.

Dr. B. H. Alexander at the Lowell, Mass., Plant. He was formerly with Sylvania.

Samuel W. Archer, service manager of the Delco Radio Division of United Motors Service, was promoted to assistant general merchandising manager of United Motors Service Division of General Motors Corp., Detroit, Mich.



S. W. Archer

Ralston H. Coffin was elected vice president in charge of advertising and sales promotion for RCA. He was formerly director of advertising and sales promotion.

Carl E. Smith, president of Cleveland Institute of Radio Electronics, Cleveland, was awarded a Fellowship in the IRE. Mr. Smith is at the left in the photograph below.



## Obituary

Richard W. Cotton, assistant to the president of National Co., Malden, Mass., died of a heart ailment while visiting his summer home in Jefferson, Mo.

## Personnel Notes

... Roy G. True, treasurer of I.D.E.A., Inc., Indianapolis, was given additional responsibilities as executive vice president and chairman of the management committee. Richard C. Koch, senior project engineer and acting assistant chief engineer of the company, was promoted to chief engineer of I.D.E.A.

... Morris S. Lewis was named manager of market planning and analysis of the RCA Tube Division, Harrison, N. J. He was formerly manager, sales administration. Donald R. Weisenstein, heretofore administrator of sales budgets and analysis, succeeds Lewis in his former position.

... Kenneth B. Bryden was promoted to manager, government coordination and services, for the RCA Tube Division, Harrison, N. J. He was formerly manager of research and financial controls.

... Curtis B. Hoffman was appointed vice president-sales of Brush Electronics Co., Cleveland, a division of Clevite Corp. He comes to the company from Foote Bros. Gear and Machine Corp.

... C. A. Swanson, former director of West Coast Sales for Standard Coil Products Co., Inc., Chicago, was promoted to general sales manager. J. R. Johnson, general manager of the Los Angeles plant, was advanced to the post of technical assistant to the president. Oden Jester, former distributor sales manager of the company, is now assistant general sales manager.

... Wilfred L. Larson, Switchcraft, Inc., was elected chairman of the Association of Electronic Parts and Equipment Manufacturers, Chicago.

J. Wayne Cargile of Permo, Inc., was elected vice chairman. Helen Staniland Quam, Quam-Nichols, was re-elected for her 18th annual term as treasurer.

... P. Newton Cook was named general sales manager of Chicago Standard Transformer Corp., Chicago. He was formerly sales manager of both the Chicago and Stancor Catalog divisions. R. J. Reigel was promoted to Cook's former position.

... E. W. Carlson, vice president of Phaotron Co., South Pasadena, Calif., heads the company's new relay engineering team for the design and manufacture of subminiature relays. Phillip Chamberlain, chief engineer, and Chester R. Rhodes, chief research engineer, were also appointed to the new group.

... Sid Weiss was named regional sales manager of Berlant-Concertone, Audio Division of American Electronics, Inc., Los Angeles. He joined the company in 1954 as Los Angeles service manager.

END

## The MASTER SETS YOU UP!

here's what's in it for you . . .

**DOLLAR-WISE PURCHASING** Shop before you buy! Do it right at your own bench through the supermarket pages of the industry-wide MASTER. Compare specs and prices first—then buy and save

**A GOLD MINE OF FACTS** All the latest info on new products—new models—changes in specs. You name it and it's in the MASTER catalog file of the electronic parts industry

- 100,000 items • Complete descriptions
- Specifications—Prices • 11,000 illustrations • 350 mfrs. • 8 x 11", 6 lbs

UNITED CATALOG PUBLISHERS, INC.  
110 Lafayette St., New York 13

List \$7.50  
As low as  
**\$2.95**  
from parts distributors

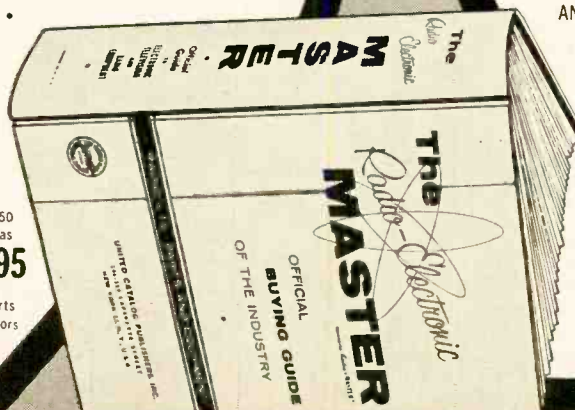

## 1956 edition

FULLY CATALOGS

TUBES — TRANSMITTERS

TEST EQUIPMENT — COMMUNICATION

ANTENNAS — RESISTORS — COILS

RECEIVERS — TRANSFORMERS

RECORDING & PA SYSTEMS

CAPACITORS — HARDWARE

RELAYS — TOOLS, ETC

1456 pages

OFFICIAL  
BUYING GUIDE  
OF THE  
INDUSTRY

# SENSATIONAL CHANGER SALE

Repeated by Popular Request  
Our Lowest Prices Ever . . .

OCTOBER ONLY

Order Now And Save

630 FA9 FOR 24" & 27"  
CUSTOM INSTALLATION

- |  |  |
|--|--|
| (1) 630 FA9 Chassis                                    | (1) 630 FA9 Chassis                                    |
| (2) 24" Sylvania aluminized silver screen picture tube | (2) 27" Sylvania aluminized silver screen picture tube |
| (3) Heavy duty tube mounting brackets                  | (3) Heavy duty tube mounting brackets                  |
| (4) Knobs, ion trap, hardware, etc.                    | (4) Knobs, ion trap, hardware, etc.                    |

**\$214<sup>95</sup>**

with 12" RCA Spkr.

**\$239<sup>95</sup>**

with 12" RCA Spkr.

630 FA9 FOR 21"  
CUSTOM INSTALLATION

**\$159<sup>95</sup>**

With 21" Sylvania Alumin. tube (silver screen), heavy duty tube mounting brackets, knobs, ion trap, hardware, etc. 12" RCA speaker

**\$199<sup>95</sup>**

TRIPLE PLAY CARTRIDGE TYPE GE RPX050 \$4.99

RECORD CHANGER BASES & BOARDS  
Bases—\$3.49 Mounting Boards—\$1.87

10 Watt Hi-Fi Amplifier  
Push-pull, pre-amp., bass, treble, \$23.95

FREE CATALOG  
Of latest hi-fi equipment  
Sent Upon Request

All merchandise is brand new, factory fresh & guaranteed. Mail & phone orders filled on receipt of certified check or MO of 20% of items as a deposit. Balance C.O.D., F.O.B. factory N. Y. Prices & specifications subject to change without notice.

AIREX RADIO CORP., 171 Washington St., N. Y. 7

CO 7-5218



**\$2.95 EACH or 2 For \$5.00!**

Genuine Telephone Company Upright Telephones, complete with cords, in tested and guaranteed condition with 50 ft. of wire, intercommunication instructions. Complete line of telephones and parts, dial, magneto, extension, intercommunication, army surplus communication equipment, etc. Write for free list. All shipments F.O.B. Simpson, Pa.

TELEPHONE ENGINEERING CO.  
Dept. 10C55 SIMPSON, PA.

**TERRIFIC! SENSATIONAL!**

SEE THE **precise** SEND FOR  
NEW CATALOG 5-5

**5" ECONOMY SCOPE KIT**

PRECISE DEVELOPMENT • OCEANSIDE, N. Y.

Don't miss  
these features  
scheduled in  
early issues of  
**RADIO -  
ELECTRONICS**

- **LOSS OF SYNC IN DC RESTORERS.**  
By James A. McRoberts.
- **BUILD THIS MINIATURE RECEIVER FOR MODEL CONTROL.**  
By Rufus Turner.
- **THE SYMMETRICAL VOLTAGE DOUBLER**  
By George P. Pearce.
- **MAKING PHOTOETCHED CIRCUITS IN YOUR OWN WORKSHOP.**  
By Richard H. Dorf.
- **A TRANSISTORIZED SCOPE CALIBRATOR.**  
By Edwin Bohr.
- **CONVERTING TABLE RADIOS INTO HI-FI TUNERS.**  
By Joseph Marshall.
- **TRANSISTOR OPERATED GEIGER COUNTER.**  
By Thomas G. Knight.
- **THE FIRST DECADE OF RAILROAD RADIO.**  
By Leo G. Sands.
- **TREMOLO CIRCUITS FOR ELECTRONIC MUSIC INSTRUMENTS.**  
By Thomas Jaski.

On sale at better parts distributors and newsstands.  
Reserve your copy now.

The November issue of **RADIO-ELECTRONICS** goes on sale  
October 25

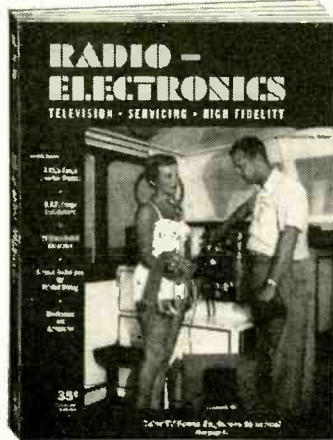

Merchandising and Promotion

Oxford Electric Corp., Chicago, designed two new point of sale displays for distributors handling its line of re-



placement speakers. One is a window streamer and the other, which may be read from either side, may be hung over a wire or line in the store.

RCA Tube Division, Harrison, N. J., prepared an "Across America" 1956 calendar as consumer advertising for its dealers, showing scenes from all sections of the country.

Electronic Instrument Co., Inc., Brooklyn, N. Y., is offering distributors of its



Eico kits a satin banner as a point-of-sale display.

Vaco Products Co., Chicago, manufacturer of a line of screwdrivers, nut drivers and other tools, is offering a miniature six-piece toy tool kit to its



dealers for distribution to customers. The firm name of the donor may be imprinted on the real screwdriver and on the plastic carrying case.



# EDLIE for TOP VALUES

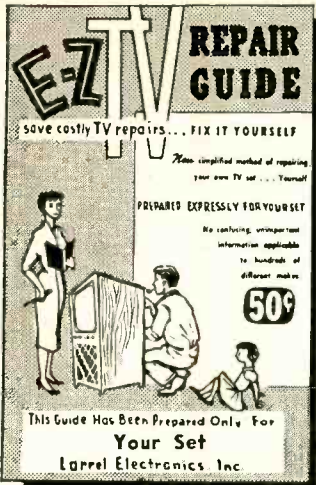

## Larrel's E-Z TV REPAIR GUIDE

The Only **FIX-IT-YOURSELF** Guide Made expressly for **YOUR TV Set!**  
 Now you can save costly TV repairs with this new, simplified method which includes all necessary data for just **YOUR** set. No confusing, unimportant information applicable to hundreds of other makes. Simplifies detection of faulty tubes in your TV receiver quickly, accurately.  
 It's a terrific idea—it's a terrific guide! Order today and have your set back in perfect condition at once. Be sure to send us make and model of your TV when ordering.  
 For Most TV Sets—Old & New

only **50¢**

### SAVINGS ON KITS

#### 5 TUBE AC/DC Superhet Kit



Kit #1: 5 tube superhet kit, AC/DC includes all quality components required to construct this latest design, highly sensitive superhet broadcast receiver, complete with black, glistening bakelite cabinet (excludes wire & solder). Kit of 5 tubes. 12A76, 2 12BA6, 12BE6, 35W4, 50B5.  
 Price, Less Tubes..... **\$7.95**  
 Extra for Tubes..... **\$3.25**

#### 6-TUBE RADIO KIT

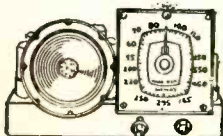

Kit #2: Low priced 6-tube kit designed for extra high sensitivity, excellent selectivity and good, rich tone quality. Uses 251L, 25Z6, 68Q7, 6SA7.  
 2/68K7 in an easily constructed circuit. Includes all parts: punched chassis, resistors, condensers, coils, sockets, PM speaker, hardware, etc.  
 Special closeout price. (Less tubes & cabinet)..... **6.95**  
 Matched set of 6 tubes for kit..... **\$3.25**

#### 3-Way Portable RADIO KIT



**AC/DC Batteries**  
**NEW**, compact, lightweight portable radio kit with the very latest super-sensitive superhet, circuit. Wonderful reception from either batteries, or 115 V., 50-60 cycle AC or DC. Includes all complete parts (except wire & solder) necessary to build a great sounding radio.  
 Also includes circuit diagrams and simplified, complete step-by-step instruction folder which makes assembling easy. Housed in a beautifully high-glossed Catalin cabinet in two delightful and distinctive colors: maroon or alabaster (ivory). Size: 9 1/2" x 5 1/2" x 4 3/4".  
**BATTERY KIT:** add..... **\$2.59**

Write today for **FREE** Catalog. All mdse. shipped F.O.B. New York City, prices subject to change without notice. Include 20% deposit with C.O.D.'s.

**EDLIE ELECTRONICS**  
 154 Greenwich St., New York 6, N.Y.  
 DI. 9-3143

# XCELITE Hand Tools

REFERRED BY THE EXPERTS

It's the "99 Junior"

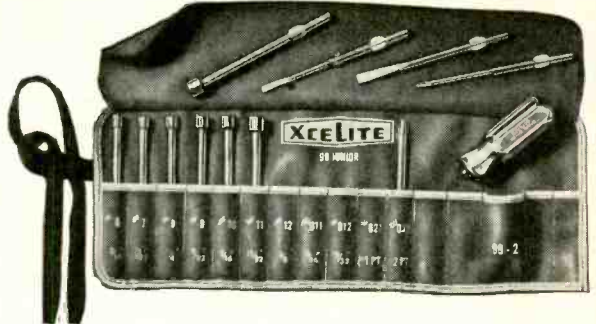

—Pocket Edition of a **BEST SELLER!**

**XCELITE, INCORPORATED**  
 Dept. J, Orchard Park, N. Y.

For Originality  
**LOOK TO XCELITE**

The big XCELITE 99-PR screwdriver-nut driver set has been on the best seller list for many years—and now you can get it in the pocket edition! It's the popular new 99 JUNIOR, with ELEVEN quick-change tools in a really compact roll kit—7 nut drivers (sizes 3/16" thru 3/8"), 2 Phillips and 2 slotted screwdrivers. And—there's an extra pocket for the new XCELITE chrome-plated SUPEREAMER! Ask your supplier today, or write for literature!

### OPPORTUNITY ADLETS

Rates—45c per word (including name, address and initials). Minimum ad 10 words. Cash must accompany all ads except those placed by accredited agencies. Discount, 10% for 12 consecutive issues. Misleading or objectionable ads not accepted. Copy for December issue must reach us before Oct. 15, 1955.

**Radio-Electronics**  
 25 W. Broadway, New York 7, N. Y.

COMPLETE HIGH SCHOOL at home in spare time with 53-year-old school; texts furnished; diploma; no classes; booklet free. Write American School, Dept. X69, Drexel at 58th, Chicago 37, Ill.

HIGH-FIDELITY SPEAKERS REPAIRED. Amprite Speaker Service, 70 Vesey St., New York 7, N.Y.

TAPE RECORDERS, ACCESSORIES, BEST BUYS. Boynton Studio, 10 E. Pennsylvania, Tuckahoe, N.Y.

BUY Surplus Radio, Electronic Equipment direct from Government. List \$1.00. Box 169RAC, East 11th St. Conn.

\$200 WEEKLY CLEANING Venetian Blinds. Free book. Burt, 2434HX, Wichita 13, Kansas.

SPEAKER RECONING: Guaranteed workmanship. C&M Recone Co., 255 Tiosa St., Trenton 9, N.J.

ELECTRIC GUITARS, amplifiers, parts, wholesale. Free catalog. CARVIN, RE-287, Covina, Calif.

RCA, Motorola, Link, GE and Kaar new and used two-way radio equipment bought and sold. Communications Associates, 138-17 Springfield Blvd., Springfield Gardens, N. Y. Phone LA 7-2727.

PRINTED Circuits made from your drawings. J. C. Devlin, Trucksville, Pa.

TELEVISION Tuner Repairs. DAN'S Television Laboratory, 2 West 183 St., N.Y. 53, N.Y.

DIAGRAMS FOR REPAIRING RADIOS \$1.00. Television \$2.00. Give Make, Model. Diagram Service, Box 672-RE, Hartford 1, Conn.

FIDELITY UNLIMITED: AUTHORIZED DISTRIBUTORS OF HIGH-FIDELITY COMPONENTS. SHIPMENTS PREPAID AND INSURED. SPECIALS: NEW COLLARO RC-54 with Mounting Board, 45 spindle, dual Blank Heads, \$38.75. Accessories: RPX-050, dual sapphires, \$6.50. Diamond and sapphire Stylus, \$10.75. WRITE US YOUR HI-FI REQUIREMENTS. FREE AUDIO GUIDE. COMPLETE STOCK. FIDELITY UNLIMITED, 63-03 39th Ave., WOODSIDE 77, N.Y. Dept. RE.

U. S. CIVIL SERVICE JOBS: Men-Women, 18-55. Start high as \$350.00 monthly. Qualify NOW! 16,000 jobs open. Experience often unnecessary. Get FREE 36-page book showing jobs, salaries, requirements, sample tests. WRITE: Franklin Institute, Dept. G-54, Rochester, N.Y.

TUBES—TV, RADIO, TRANSMITTING, AND SPECIAL PURPOSE TYPES BOUGHT, SOLD AND EXCHANGED. Send details to B. N. Gensler W2LNL, 512 Broadway, N.Y. 12, N.Y.

ALL MAKES OF ELECTRICAL INSTRUMENTS AND TESTING equipment repaired. Write for free catalog on new and used instruments at a savings. Hazelton Instrument Co., 128 Liberty Street, New York, N. Y.

CRYSTAL-RADIO EXPERIMENTERS Write Leslie Hulet, 305 Hope, Lakewood, N. J.

TELEVISION sets \$14 up. Jones, 1115 Rambler, Pottstown, Pa.

USED COURSES and books bought, sold, rented and exchanged. Catalog free. Lee Mountain, Henagar, Ala.

WANTED: AN/APR-4, other "APR", "TS", "IE", ARC-1, ARC-3, ART-13, RC-348, etc. Microwave Equipment. Everything Surplus. Special tubes. Tec Manuals, Lab Quality Equipment, Meters, Fast Action, Fair Treatment. Top Dollar! Littell, Fairhills Box 26, Dayton 9, Ohio.

EARN ESTIMATED \$2,000.00—GIANT RADIO PACKAGE \$2.00. MASTER KIT COMPANY, BOX 206, BELLEVILLE, ONTARIO.

BUY WHOLESALE, 25,000 Items, Catalog 25c. Matthews, 1472-P1, Broadway, N.Y.C. 36.

SURPLUS METERS, WALKIE-TALKIES, PARTS, BARGAIN LIST 5 cents. MESHNA, 580 LYN, MALDEN 48, MASS.

Your choice \$1.35 postpaid: T49C radiosonde transmitter less tube, 25 assorted mica capacitors, 100 insulated carbon resistors, 10 assorted switches or 20 wirewound resistors. All five for \$4.95; bargain list on request. PALMER, 1440 Las Salinas Way, Sacramento 21, Calif.

SPEAKER RECONING, low prices. Michigan Speaker Reconing Service, 930 Metropolis, Marine City, Michigan.

DIAGRAMS: Professional Model Timers, Counters, Intercoms, Organs, etc. \$1.00 each. List free. Parks, 101 S.E. 57th, Portland 15, Oregon.

POWER TRANSFORMERS REBUILT—all makes. TV-Radio or Special. Red Arrow Radio, 924 Metropolis, Marine City, Michigan.

RADIOS, New, \$13.46 net and up. Details 10c. SONO-RET, Box A, 36 Woodbury St., Wilkes-Barre, Pa.

25-50% DISCOUNT, guaranteed. Factory Fresh LP records; 69¢ and up; pre-recorded tapes. Send 30¢ for catalogue. SOUTHWEST RECORDS, 1108 Winburn, Houston, Texas.

FREE BOOKLET "Forming Sheet Metal." Also catalog unusual bench tools. TELVAC, 1412-B Great Northern Bldg., Chicago 4, Ill.

TELEVISION RECEIVERS \$28.80 UP. W4AP1 1420 South Randolph, Arlington 4, Va.

TV FM ANTENNAS, ALL TYPES INCLUDING UHF. Mounts, accessories. Lowest prices. Wholesale Supply Co., Lunenburg 2, Mass.

# Sangamo wire lead mica capacitors



Now!

Packaged for your convenience!

Save time—do away with the cluttered mess of tangled wire leads. Use Sangamo Mica Capacitors, now mounted on space-saving cards.

These high quality mica capacitors are the finest available anywhere—at any price. They are fabricated with carefully selected premium grade imported mica and are molded in Humidite for

unequaled moisture resistance. You can depend on these wire leads for completely trouble-free TV replacements.

Each card of five capacitors has capacity rating and wvdc clearly marked. Each card shows the new RTMA Standards and the new MIL-C-5-A color code.

Stock up now—see your Sangamo distributor, or write us.

High quality wire lead micas for trouble-free TV replacements

**SANGAMO  
ELECTRIC  
COMPANY**

MARION, ILLINOIS



SC55-128

BUSINESS

(Continued)

Wendell Plastic Fabrics Corp., New York, has prepared two new Mellotone grille-fabric merchandising displays



for its distributors. One is a display stand for square-yard packages and the other a roll display for larger quantities.

Tekni-Labels Co., Burbank, Calif. introduced a kit containing 10 packages of its *Universal* decals for titling electronic equipment. It is merchandising the new kit in a self-service counter display.

#### Production and Sales

RETMA reported the production of 3,828,793 TV sets and 7,058,889 radios for the first 6 months of 1955. TV set production was better than 34% higher than for the 1954 period and radio production increased by more than 44%.

RETMA reported a record sale of 3,202,995 TV sets for the first six months of 1955. This compares with 2,805,760 for the same period last year. Exclusive of automobile sets, 2,429,018 radios were sold for the same period compared with 2,410,893 for the first half of 1954.

#### Calendar of Events

High-Fidelity Show, Sept. 30-Oct. 2, Palmer House, Chicago. (RADIO-ELECTRONICS will exhibit in Room 746.)

3d Annual Northern California High-Fidelity Audio Show, Sept. 30-Oct. 2, Sheraton-Palace Hotel, San Francisco, Calif.

National Electronics Conference, Oct. 3-5, Hotel Sherman, Chicago.

Audio Fair, Oct. 13-16, Hotel New Yorker, New York City. (RADIO-ELECTRONICS will exhibit in Room 716.)

1955 Radio Fall Meeting, Oct. 17-19, Hotel Syracuse, Syracuse, N. Y.

1st Annual Technical Meeting of the IRE Professional Group on Electron Devices, Oct. 24-25, Shoreham Hotel, Washington, D. C.

High-Fidelity Show, Nov. 4-6, Benjamin Franklin Hotel, Philadelphia, Pa.

#### New Plants and Expansions

Astron Corp., East Newark, N. J., opened new West Coast distribution facilities in Los Angeles under the direction of its Southern California representative, Harry A. Lasure Co.

Phaotron Corp., South Pasadena, Calif., moved its Engineering, Drafting and Meter Departments into its new 13,000-square-foot building adjacent to its present plant.

(Continued)

**RETMA** Engineering Department moved into larger quarters in Suite 650, 11 West 42nd St., New York City. David Kaufman, formerly with Sylvania, joined the department to work on tube registration and standardization.

**Corning Glass Works**, Corning, N. Y., established a new department in its Electrical Products Division to accommodate the demands of the growing electronics industry. The new Components Department will be headed by Forrest E. Behm, former manager of the Pressware Plant.

**General Electric Tube Department** is planning to build a new receiving tube plant in Owensboro, Ky.

**Raytheon Manufacturing Co.**, Waltham, Mass., is expanding its Chicago equipment operations engineering facilities. It has already tripled the space available to engineering personnel and an intensive recruitment program is under way to enlarge the engineering and research staff.

**G & H Wood Products (Cabinart)** moved to expanded quarters at 99 No. 11th St., Brooklyn, N. Y.

**CBS-Columbia**, Long Island City, N. Y., has converted about one-quarter of its manufacturing facilities to government and industrial operations within a 3-month period.

**Business Briefs**

... **RCA** president Frank M. Folsom praised the TV service industry for the quality of its work, on the occasion of the presentation of the President's Cup to the four top branches of the RCA Service Co.

... The U. S. Department of Commerce Business and Defense Services Administration issued a report which indicated that production of electronic products in 1955 would reach \$6.2 billions. Black-and-white TV set production attained a near record-level of 3,750,000 units for the first half of the year.

... **Shure Bros., Inc.**, Chicago, announced that 10 of its new Concert-Line 333 studio microphones were used in the first outdoor hi-fi system installed at the Music Theater of the Villa Park Moderne Restaurant in Highland Park, Ill.

... **1956 Electronic Parts Distributors Show** management sent out a questionnaire to exhibitors and distributors asking their preference for show dates, duration, location, registration, and opinion on a new educational program.

... **Erie Resistor Corp.**, Erie, Pa., is producing a line of special assemblies engineered and produced on a custom basis at its new Electromechanical Division.

... **Blonder-Tongue Laboratories**, Westfield, N. J., was granted two patents covering its wide-band r.f. amplifying circuits.

... **Bell & Howell**, Chicago motion-picture equipment manufacturer, entered the high-fidelity field with a series of radio-phono-tape recorder instruments.



**FREE! BA's NEW 1956 CATALOG**

**YESSIR-IT'S THE KING-SIZE CATALOG—164 "KING-SIZED" (8 1/4 x 10 1/2) PAGES OFFERS MORE ITEMS PER PAGE--IT'S EASIER TO USE..IT'S EASIER FOR YOU TO ORDER**



**1956 ANNUAL CATALOG NUMBER 561**

**BA SINCE 1927**

*A Complete Buying Guide for Everything in-*  
**RADIO TELEVISION ELECTRONICS**

**COMPLETE GUIDE TO EVERYTHING IN RADIO, TV, ELECTRONICS**

**100'S OF BRAND NEW ITEMS LISTED HERE FOR THE VERY FIRST TIME**

**INCLUDES 21 BIG PAGES OF BARGAINS NOT FOUND IN ANY OTHER CATALOG**

**Guarantee**  
We guarantee everything in our catalog to be of the quality and value represented. It is our policy to make it possible to return any item in the catalog and give you a refund for each item.

**for**  
DEALERS, SERVICE MEN, SCHOOLS, BROADCASTERS, INDUSTRIALS, THEATRES, MANUFACTURERS, CHURCHES, HOTELS, PUBLIC UTILITIES, EXPERIMENTERS, ENGINEERS, LABORATORIES, AMATEURS.

**BURSTEIN-APPLEBEE CO.**  
1012-14 McGEE ST., KANSAS CITY 6, MISSOURI

**RUSH COUPON FOR THIS BIG CATALOG NOW!**

**BURSTEIN-APPLEBEE CO. Dept. S, 1012-14 McGee St., Kansas City 6, Mo.**

Send Free B-A Catalog No. 561.

NAME \_\_\_\_\_

ADDRESS \_\_\_\_\_

CITY \_\_\_\_\_ STATE \_\_\_\_\_

**GARAGE DOOR REMOTE CONTROL**

Actuator Mechanism \$24.50

Write for information  
**P. E. HAWKINS CO.**  
631 PROSPECT KANSAS CITY 24, MO.

**BUILD COLOR TV**

**COLORDAPTOR** . . . Simple 9 tube circuit and rotating color wheel converts any black and white TV, direct view or projection, to receive compatible color TV. Specifications, including theory of operation, complete simplified construction plans, schematic, and sample color filters. **\$2.95**

**COLORDAPTOR**, 3471 Ramona, Palo Alto, Calif.

**USED RECORDING TAPE (PLASTIC BASE)**

**ATTENTION:** Radio Station, electronic calculators, Industrial users: We have the new 1 1/2" or 2 mil mylar "Sound-Plate," "Lifetime," or "P.E." tapes and we will buy or exchange your present 1 mil mylar or plastic tapes.

1.79	for 7" — 1200 foot
.93	for 5" — 600 foot
.53	for 4" — 300 foot
.27	for 3" — 150 foot

(extra 10% in Lots of 12)

**USED "MYLAR" TAPE (1 Mil)**

300 ft. (3" reel)	.....59
900 ft. (5" reel)	.....1.69
1800 ft. (7" reel)	.....2.99

New empty plastic reels in boxes for easy labeling. 3" 10c; 4" 22c; 5" 24c; 7" Professional reel (2 1/4" hub) 29c ea. 10 1/2" Aluminum Reel \$2.24. **EMPTY BOXES:** 3" 3c; 4" 5", 7" 5c ea.

Send for new Price List, "Tape Recording" magazine and back issues available. Please include Sufficient Postage

**COMMISSIONED ELECTRONICS CO.**  
2503 Champlain St. N.W. Washington 9, D.C.

# STAN-BURN E. D. ARKE

## CATHODE RAY TUBE SPECIALS

ONE YEAR GUARANTEE

G.E.		STAN-BURN	
10BP4A	\$14.95	10BP4	\$10.20
10FP4A	21.10	12LP4	11.90
12KP4A	24.45	12LP4A	13.95
12LP4A	18.75	12QP4	11.90
12QP4A/B1014		12JP4	11.90
Dumont	25.10	12UP4A	14.50
12UP4B	34.25	14CP4	15.60
14CP4	24.25	15DP4	17.50
15DP4/B1014		16KP4	17.50
Dumont	26.75	16DP4 or A	17.50
16PA4A	28.50	16JP4 or A	17.50
16DP4A (N.U.)	25.25	16CP4 or A	17.20
16GP4 A or B	33.25	16FP4	17.50
16KP4/16RP4	24.20	16WP4	17.50
16K4A (Aluminum)	28.35	16PA4	17.50
16JP4A (N.U.)	27.95	16EA4	23.00
16LP4A	28.50	16EP4	19.00
16WP4A	27.50	16EP4A	23.50
16GP4B	33.95	16GP4 or A	21.00
17BP4A	27.50	17BP4	18.50
17BP4B	29.75	17CP4A	21.60
17CP4	29.95	17GP4B	22.60
17CP4B (Aluminum)	38.50	19FP4	23.00
19AP4A	39.75	19PA4A	24.00
20CP4	30.00	19AP4	23.90
20LP4	37.50	19AP4A	24.90
21AP4	39.75	20CP4	23.95
21EP4	31.80	21EP4	25.50
21EP4A	36.35	21AP4	26.50
24AP4A	89.75	24AP4	49.00

Prices Subject to Change Without Notice

AUTHORIZED DISTRIBUTORS for General Electric, Kenrad, Tung-Sol, Hallicrafters, De Wald, Techmaster, Automatic and General Motors.

### PORTABLE RADIOS

JEWEL—Battery only	\$12.99 net
Case for same	1.50
Batteries	1.95
CABANA 3 way portable, 5 tube, Batteries	\$16.75
	2.50
JEWEL 5 tube Super Het—Red, Ivory, Walnut and Ebony	12.50
with Clock—5 tube AC-DC	
Ivory	\$15.95
Walnut	\$15.45

### RECORD PLAYERS

Manual 3 speed record player—single needle	\$14.50
Manual 3 speed with flip-over cartridge	\$16.95
Automatic 3 speed with VM changer	\$37.50

### PENTRON TAPE RECORDERS

Model CT1	\$81.50
Model TR4	119.00
Model HT225	140.00

(catalogs on request)

### '55 FORD, PLYMOUTH, CHEV. Automatic Radio

Manual	\$41.97
Push Button	45.47

630 ANSLEY 29 tube Chassis. \$115.00

### TURNER AU Phono cartridge—Universal replacement

\$1.59 ea.	6 @ \$1.49 ea.
------------	----------------

### VM CHANGER—with Honette flip-over cartridge.

BRAND NEW—Hi-Fi original cartons.	\$21.49
-----------------------------------	---------

We invite export inquiries and offers. Our export department will give special attention to expediting foreign orders at minimum commissions. We are authorized distributors for United Motors, all Delco and Gen. Motors Auto Radio parts in stock.

We also carry a complete line of Popular makes of Radio Tubes at 50/10 discount. Also many other special purpose and transmitting types, and all electronic parts and equipment at lowest prices. Send us a list of your requirements for prompt quotations. Terms: 20% with order. Balance C.O.D. All prices F.O.B. NEW YORK Warehouse. Minimum order \$5.00. Write for our latest price list and Hi-Fi catalog to Dept. RE-10.

## STAN-BURN RADIO and ELECTRONICS CO.

1697 BROADWAY • NEW YORK 19, N.Y.

BUSINESS

(Continued)

... Technical Appliance Corp., Sherburne, N. Y., awarded four engineering scholarships valued at \$2,500 each to four central New York high school graduates.

... General Electronic Equipment Co., a division of Radio City Products, Easton, Pa., introduced a line of electronic instrument and geiger counter kits which will be sold through distributors.

... Telrex, Inc., Asbury Park, N. J., signed licensing agreements with S & A Electronics, Toledo, Ohio, and Sky-sweeper, McHenry, Ill., for the manufacture of conical antennas under the Telrex patent.

... ORRadio Industries, Opelika, Ala., was granted a U. S. Government contract exceeding \$200,000 for the manufacture of magnetic tape.

... Hamner Electronics, Inc., Princeton, N. J., was formed by a group of Princeton physicists, chemists, engineers and physicians to develop, manufacture and market advanced design instruments for research, testing, medical and industrial applications.

... Ampex Corp., Redwood City, Calif., and John F. Rider Publisher, Inc., New York City, joined the Institute of High-Fidelity Manufacturers, New York City, bringing total membership to 34.

... The NBC Department of Research and Planning reported that there were 36,477,000 TV installations in the U.S. as of July, 1955, an increase of 2,661,000 since January 1. The Bureau of Census of the U. S. Department of Commerce reported that about 32,000,000, or 67% of the homes in the U. S. had one or more TV sets as of June, 1955.

... Audak Co., New York City, and Presto Recording Corp., Paramus, N. J., joined the Institute of High-Fidelity Manufacturers, New York City. END

### CORRECTION

There are errors in the parts list of the C-R tube tester and rejuvenator on page 74 of the August issue. All resistors are 10-watt units in the following values: 1—10, 1—100,000 ohms, potentiometer; 1—500, 2—10,000 ohms. Capacitors are: 1—50 and 1—150µf, 150 volts.

Our thanks to the readers who reported the error.

In the circuit of the Simpson model 383 capacitor checker, on page 46 of the September issue, the 10-megohm resistor shown across the 1-µf charging capacitor should have been shown connected between pins 3 and 6 of the thyatron. When connected as originally shown, this resistor passes the d.c. pulse component through the meter and causes erroneous pointer drift in low-impedance circuit tests. When the 10-megohm resistor is connected between pins 3 and 6, only the a.c. component of the test pulse is admitted to the meter circuit and no erroneous pointer drift occurs even when the instrument is operated on a dead short circuit. We thank the author of the article for this correction.

## Save time—Step up efficiency in ELECTRONICS DESIGN



Here's a wealth of technical help for efficiently handling electronics design problems—help that gives you answers already worked out by the country's top electronics men!—help that can save you hours of research and experimentation!

You'll find electronics mathematics and theory in concise form—design practices for hundreds of pieces of electronics equipment—and even the results of advanced electronic experiments! Radio, television, facsimile, sound, and scores of other phases of electronics are covered—and it's all condensed, classified, and indexed for quick, easy use.

### ELECTRONICS DESIGN LIBRARY

Edited by Markus and Zeluff, Electronics Magazine  
4 vols. 2151 pp., 9 x 12, 3534 illustrations

Contains 1083 articles culled from recent issues of *Electronics*—the cream of information essential to design of electronics equipment. The 4 big volumes are: *Electronics for Engineers*, *Handbook of Industrial Electronic Circuits*, *Electronics Manual for Radio Engineers*, and *Electronics for Communication Engineers*.

Special price saves you \$6.00

Regular catalogue price of books totals \$39.00; under this offer, price is only \$33.00, on easy terms.

EASY TERMS!

Mail coupon today to McGraw-Hill Book Co., Inc., Dept. RE-10, 330 W. 42nd St., New York 36, N.Y.

### 10 DAYS' FREE EXAMINATION

McGraw-Hill Book Co., Inc., Dept. RE-10  
330 West 42nd St., New York 36, N. Y.

Send me for 10 days' examination the ELECTRONICS DESIGN LIBRARY. In 10 days I will remit \$8.00, plus few cents delivery; then \$3.00 a month until \$33.00 is paid. If not satisfied, I will return books postpaid. (We pay delivery if you remit with this coupon; same return privilege.)

(PRINT)

Name .....

Address .....

City ..... Zone ..... State .....

Company .....

Position .....

For price and terms outside U.S. write McGraw-Hill Int'l., N.Y.C. RE-10

## KLIPSCH SHORTHORN corner horn speaker system

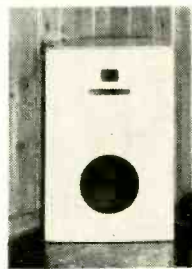

Designed and manufactured by the originator of the Klipschorn speaker system, the Shorthorn is second only to the Klipschorn system in performance. Using coordinated acoustic elements, including filters, it offers exceptionally smooth response, free from distortion. Back loading horn extends bass range without resonance.

Available in kit form, with or without drive system. Prices from \$39 for the do-it-yourself horn kit to \$209 for assembled horn with Klipsch Ortho 3-way drive system installed. Write for literature.

KLIPSCH & ASSOCIATES  
HOPE, ARKANSAS

### ADAPTER

Write for Bull. 3548

TYPE 7B \$2.25

TYPE 8B \$2.50

TYPE 9B \$2.75

(ILLUSTRATED)

plus shipping chgs.



- Min. size for use in crowded spaces
- RETMA color coded terminals
- Uses (All above chassis)

1. Modify circuits for max. performance and testing without soldering or unsoldering.
2. Break into any circuit for trouble shooting.
3. Measure voltage, resistance and current in conjunction with standard instruments.

A. L. PRODUCTS CO., INC.

311 Hickory St., Kearny, N.J.

# TeleMatic

The Professional Line

Two Set Couplers

C.R.T. Boosters

TV Service Extensions

Hi-Pass Filters

Wave Traps

Extension Speakers

Free Literature:

## TeleMatic

16 Howard Avenue  
BROOKLYN 21, N. Y.

# technical Literature

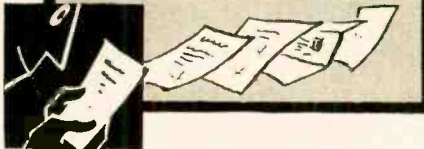

## PULSE TRANSFORMERS

Data sheet PD 4-220 describes high-power pulse transformers and supplies technical information on distortion minimization, high-temperature capability, windings and construction as well as a specification list and outline drawings of typical transformers.

Bernard Levin, Technical Information Representative, Equipment Marketing Div., Raytheon Mfg. Co., Waltham, Mass.

## TELEVISION

Tung-Sol's 16-page color cartoon book *The Finest TV Picture Ever Seen in the American Home* presents the TV service dealer, his skill, his fair charging and his importance as a member of the community. The integrity of service dealers and the reasonableness of their charges are stressed. The story of making and aluminizing the Magic Mirror picture tube is also told.

Sales Promotion Dept., Tung-Sol Electric Inc., Newark 4, N. J.

Any or all of these catalogs, bulletins, or periodicals are available to you on request direct to the manufacturers, whose addresses are listed at the end of each item. Use your letterhead—do not use postcards. To facilitate identification, mention the issue and page of RADIO-ELECTRONICS on which the item appears. UNLESS OTHERWISE STATED, ALL ITEMS ARE GRATIS. ALL LITERATURE OFFERS ARE VOID AFTER SIX MONTHS.

## KLYSTRON FACTS

Eitel-McCullough's booklet *Klystron Facts—Case #2*, discusses klystron power amplifier applications as well as new Eimac developments in the klystron field. The pamphlet is a continuation of *Klystron Facts* published in 1954.

Both available from Eitel-McCullough, Inc., Technical Services Dept., San Bruno, Calif.

## CAPACITORS

Mallory's book *Birds, Bees and Capacitors* describes in detail, along with illustrations what a capacitor is, what it does, its history, what causes it to fail, and other interesting facts about capacitors.

P. R. Mallory & Co., Inc., Indianapolis 6, Ind.

## MOLDED PRINTED CIRCUITS

Type MCR molded printed electronic circuits are described in *Bulletin M-1*. It contains comprehensive data on types, construction, applications, dimensions, design service, leads and terminals, and charts.

International Resistance Co., 401 N. Broad St., Philadelphia 8, Pa.

# HUGE DOLLAR SALE!

LEKTRON SPECIALTIES



KITS!

Use This "Ordogram" as an Order Blank. Simply check items wanted, fill in coupon and enclose entire ad with remittance.

**BONUS!**  
Your choice of  
**ANY KIT FREE**  
with each  
**\$10 order!**

**KIT OF THE MONTH!**  
10 Twist-Lock Electrolytics  
Imagine 10 different values! ALL multiple sections all popular TV and radio values. Servicemen, note! Wt. 3 lbs. Reg. \$18 **\$1**

- 125 Carbon Resistors, 40 values! 100 ohms to 1 meg. 1/2, 1 & 2w. Many 5% uncalibrated. A rare buy! Wt. 1 lb. Reg. \$21
- 2000 Pieces Hardware. Screws, nuts, lugs, grommets, washers, etc. Wt. 3 lbs. Reg. \$11
- 40 Mica Condensers. All best known makes! .0005 to .05 mf. up to \$1 600V. Wt. 1/2 lb. Reg. \$13
- 20 Power Resistors. Wirewound, 20 values: 5 ohms to 10,000 ohms. 5 to 50 w. Candohm and tubular. Wire & lug terms. Wt. 2 lbs. Reg. \$10
- 4 Popular Diodes. Exclusive! Handy Shop asst.: 1N34A, 1N48, 1N58, 1N81. Order now. Reg. \$4.16
- 60 Tubular Condensers. .00035 to 1mf up to 1600V. 25 values. Wt. 2 lbs. Reg. \$10
- R & C Assembly on term. strips; 70 moulded, paper & mica capacitors. 0001 to .047 mf. to 600V; 45 1/2w resistors. Wt. 1 lb. Reg. \$15
- 200 Coil Forms, ceramic & bakelite. 50 sizes and styles, some worth \$2 ea. \$20 value! Wt. 2 lbs. Reg. \$8
- 10 Panel Lite Assemblies. Builders' must! Ass'd. colored jewels. Dialco, Drake, etc. Some w/built-in neon lamp for 110Vac. Reg. \$8
- 50 Coils & Chokes. Wide ass't. osc., peaking, slug-tuned coils. RF, parametric chokes. 20 sizes. Wt. 1 lb. Reg. \$25
- 1500 Pieces Spaghetti tubing. Ass'd. sizes. Wt. lengths to 4'. Reg. \$7
- 10 Precision Resistors. 10 values. 1/2, 1 & 2w. Wt. 1 & 2 w. Carbon & WRC. LRC. Wilkor. Dia. Some \$1 worth \$12. Reg. \$25
- 70 Term. Posts & Strips. Builders' special! Ass'd. binding posts, screw & lug strips (1 to 10 term.). \$1 Reg. \$5. Wt. 1/2 lb.
- 75 Knobs, TV, Radio. Lab. Some worth 25¢ each. 15 types, push-on, set screw. Wt. 1 lb. Reg. \$4.50
- 10 Tubular Electrolytics, all different! Popular values. Axial leads. From 10 to 40 mf up to 500V. Multiple sections, too! \$1 Wt. 2 lbs. Reg. \$8
- 10 Battery Dils. Long lasting! 8 values. 0.1 to 2 mf. up to 600 VDC. Reg. \$25. Wt. 4 lbs.
- 15 Switches. Rotary. push, micro—wide variety. Experimenters, note! \$1 Wt. 2 lbs. Reg. \$12
- 25 Ceramic & Mica Trimmers. Eite TS2a etc., plus Eimoco. 50 types. Singles, duals; 12 sizes. Wt. 1 lb. Reg. \$16
- 60 Mica Condensers. Rare bargain! Postage stamp type. 20 values: .0001 to .01 mf. Many silver, 5%! Wt. 1/2 lb. Reg. \$17
- 50 Fuse Posts. Mounting & Clips for 3AG, 4AG & cartridge 30 amp. fuses. An unusual value! \$1 Wt. 1 lb. Reg. \$6.50
- 60 Insulated Resistors. 35 popular values: 15 ohms to 20 meg, 1/2, 1 & 2 w. Many 5%. Wt. 1/2 lb. Reg. \$15
- 50 Ceramic Condensers. Shop must! Tubular & button types. 20 values. 2 to 3000 mf. Wt. 1 lb. Reg. \$13
- 15 Controls. Up to 1 meg, 12 TV, radio, lab. values, some w/switch. Concentric type, too! Wt. 2 lbs. Reg. \$12
- 25 Tube Sockets, 4 & 9 pin. Some ceramic, mica, some shield base, 10 types. Wt. 1 lb. Reg. \$8.50
- 10 Radio Chassis, 5 & 6 & 7 tube punched chassis. New! Shop must! \$1 Wt. 1 lb. Reg. \$8.50
- 40 Tubular Oil Cond. Metal & paper clad. 2 to 5mf up to 350V. Generator types, too. Wt. 3 lbs. Reg. \$22
- Do-It-Yourself Kit #1. Threaded iron slugs and forms to make 50 micro slug-tuned coils, plus 50 extra slugs! Wt. 2 lbs. Reg. \$10
- 10 Panel Switches. Toggle, but handle, momentary push, w/10 NON-OPER. switch plates. Wt. 1 lb. Reg. \$8
- Ten 25-ft. Rolls Wire. Plastic & cloth insulated, solid & stranded. #18 to 24. Ass'd. colors. Wt. \$1 2 lbs. Reg. \$5.50
- Wire by the Pound! Hundreds of pre-cut, thin lengths (5" to 18"). Ass'd. sizes, colors, insulation; mostly stranded. 4 lbs. Reg. \$10
- 200 Cable Clamps. Handy ass't. of Adel, Tinnerman harness, cable, condenser clamps. Many sizes. Rubber insulated, too. Wt. 1 lb. Reg. \$6
- 8-Pc. Nutdriver Kit. Shop must! Amber plastic handle; 3/16, 7/32, 1/4, 3/8, 7/16" steel socket wrenches in clear plastic case. \$3.50 value. Wt. 1/2 lb. Reg. \$1

Please send check or M.O. Include postage, excess will be returned. C.O.D. orders, 25% down payment. Rated accounts, net 30. Simply check items wanted, fill in below and mail entire ad with remittance to:

**LEKTRON SPECIALTIES** RE10  
28 Gardner Street Chelsea 50, Mass.  
(Please print in pencil)

NAME \_\_\_\_\_  
STREET \_\_\_\_\_  
CITY \_\_\_\_\_ ZONE \_\_\_\_\_ STATE \_\_\_\_\_

I enclose \$\_\_\_\_\_ for merchandise; \$\_\_\_\_\_ for postage.  
 Ship C.O.D.

# LEARN TV

the practical way..



## BUILD the New TRANSVISION TV KIT

**\$15.00** ONLY gets you started\*

- PROFIT 3 WAYS:
- 1 Learn TV
  - 2 Save up to 50%
  - 3 Prepare for COLOR TV

**FREE CATALOG**

Shows 8 Great TV Kits:  
EXCLUSIVE: Only Transvision TV Kits are adaptable to UHF. Ideal for FRINGE AREAS. No Previous Technical Knowledge required. Write now!

**TRANSVISION**  
THE OLDEST NAME IN TV KITS  
NEW ROCHELLE, N. Y.

MAIL THIS COUPON TODAY —  
TRANSVISION, INC., NEW ROCHELLE, N. Y. Dept. RE-10

I'm enclosing \$\_\_\_\_\_ deposit. Send standard kit PACKAGE #1, with all Instruction Material. Balance C.O.D.  
 Send FREE copy of your new TV Kit Catalog.

Name \_\_\_\_\_  
Address \_\_\_\_\_  
City \_\_\_\_\_ State \_\_\_\_\_

# stop knockin' yourself out!

let the MASTER make life easier for you... see pg. 153

# AUDEL'S TV TELLS HOW TO ANSWER RADIO T.V. QUESTIONS SERVICE LIBRARY

HERE IS LATE INFORMATION IN A HANDY FORM FOR TELEVISION AND RADIO REPAIRMEN, SERVICEMEN AND STUDENTS



**AUDEL'S T.V. RADIO SERVICE LIBRARY**—Highly Endorsed—Over 1500 Pages—1048 Illustrations & Diagrams, 1001 Important Facts & Figures on Modern Television, Radio, Electronic Devices at your finger ends.

**INCLUDES TRANSISTORS & Transistor Circuits, Record Changers, Rectifiers, P.A. Systems, Tape Recorders, Phonograph Pick-ups, F.M., Auto Radio: Radio Compass, Short Wave, Radar, etc.**

**ASK TO SEE IT! IT WILL PAY TO KNOW**—The Basic Principles—Construction—Installation—Operation—Repairs—Trouble Shooting. Shows How to get Sharp, Clear T.V. Pictures. Install Aerials—How to Test. Explains Color Systems, Methods of Conversion, Terms, etc. Includes Ultra High Frequency—Valuable for Quick Ready Reference and Home Study.

**\$6 COMPLETE 2 VOLUMES**

Get this Information for Yourself.

**7 DAY TEST—PAY ONLY \$1 A Month**

**MAIL ORDER**

AUDEL Publishers, 49 W. 23 St., N.Y. 10, N.Y. MAIL AUDEL'S T.V. RADIO SERVICE LIBRARY (2 Volumes) \$6 on 7 days free trial. If O. K. I will remit \$1 in 7 days and \$1 monthly until \$6 is paid. Otherwise I will return them.

Name \_\_\_\_\_  
 Address \_\_\_\_\_  
 Occupation \_\_\_\_\_  
 Employed by \_\_\_\_\_ RE



Need a Tube Tester?

**FOLLOW THE LEADER...**

Buy **EICO**

**TUBE TESTER #625  
 KIT \$34.95 Wired \$49.95**



More Servicemen buy EICO TUBETESTERS—in KIT and wired form—than any others sold through distributors. Why? Because EICO gives you the MOST value at LOW-EST cost.

- Test all conventional & TV tubes and pilot lights.
- 10 individual lever-type element switches.
- Illuminated anti-backlash rollchart kept up-to-date by EICO's Engineering Dept.
- 4½" meter, 3-color "Good-Bad" scale.
- Line-adjust control. Blank socket for new tubes. Protective overload bulb.

In stock at your local jobber. Write for free Catalog CT-10 Prices 5% higher on West Coast.

**ELECTRONIC INSTRUMENT CO., INC.**  
 84 Withers Street • Brooklyn 11, N. Y.

## TECHNICAL LITERATURE (Continued)

### PRINTED CIRCUITRY

*Mechanize Your Wiring With Copper-Clad Phenolite* (2nd edition) in 12 pages covers the advantages of printed circuitry for electrical and electronic systems. Photographs, schematics and tables illustrate the advantages of printed circuitry over conventional hand-wiring methods. It also includes a discussion of their economies and a description of the ways in which printed circuits are produced.

*National Vulcanized Fibre Co., 1055 Beech St., Wilmington 99, Del.; also available from National Fibre Co. of Canada Ltd., 107 Atlantic Ave., Toronto, Canada.*

### SERIES PTW POLAR RELAY

*Bulletin RH* gives data on Automatic Electric's series PTW polar relay with new mounting. Electrical characteristics, travel time and other details are given.

*Automatic Electric Sales Corp., 1033 W. Van Buren St., Chicago 7, Ill.*

### GEIGER COUNTERS

Nuclear Measurements' 8-page bulletin on *Geiger and Scintillation Counters* describes and illustrates portable units for uranium prospecting, covering specifications and construction features. A cartoon booklet *Cyril Buys a Geiger Counter* describes the adventures of a clerk who bought and used a prospecting instrument.

*Nuclear Measurements Corp., 2460 N. Arlington Ave., Indianapolis 18, Ind.*

### TRANSFORMERS

Linear variable-differential transformers are described in *Bulletin LVDT-100-A*. Complete data includes dimensional drawings, test circuit diagram, actual-size photo, a graph showing displacement of core from null point vs. output voltage, applications, temperature range, sensitivity, voltage and frequency range, d.c. resistance, impedance and weight.

*Gudeman Co., 340 W. Huron St., Chicago 10, Ill.*

### MOUNTING BASES

Detailed descriptions of standard and special mounting bases and a wide selection of vibration and shock controls—which meet JAN and MIL specifications—are contained in *Catalog No. AB-35*.

*T. R. Finn & Co., Electronics Div., 200 Central Ave., Hawthorne, N. J.*

### CONNECTORS

*Bulletin PN-1* describes the fields of application for Deutsch AN connectors and provides general information on performance requirements, size and handling capacity, basic parts and the numbering system used.

A detailed description is presented on the shell construction for wall- and box-mounting, cable-connecting receptacles—straight, solid shell and 90° angle, split-shell plugs.

*Deutsch Co., 7000 Avalon Blvd., Los Angeles, Calif.* END

**PRICED AMAZINGLY LOW  
 FOR BIGGER MARK-UP  
 ... FASTER TURNOVER**

## Sky-Ray ANTENNAS

offer you more profits! How? By giving quality equal to or better than other TV antennas plus amazingly low prices that provide bigger mark-up or faster turnover. This combination of quality and price is achieved by excellent engineering coupled with cost-conscious construction. Standard weight materials are used throughout and none are wasted. Clean, functional design contributes a pleasing appearance but eliminates expensive "gingerbread". The results are all-aluminum antennas... lightweight and rugged... that sell fast. And all Sky-Ray Antennas are pre-assembled.

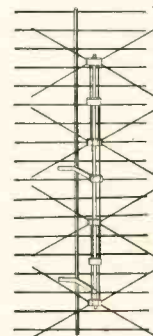
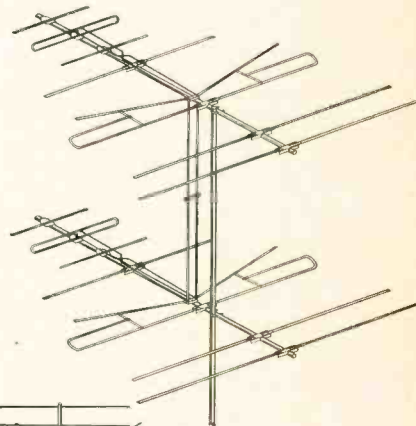

Model ACV-2 "SUPER-RAY". All-Channel VHF Antenna... Sky-Ray's new twin-bay model featuring improved front-to-back ratio and higher gain. Has Snap-In construction, reinforced at the U-bolt connection. Matches 300-ohm transmission line. Suggested list price... \$24.50.

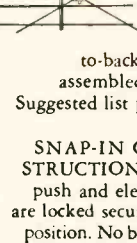

Model UCP All-Channel UHF Array. Highest gain and front-to-back ratio on UHF. Completely pre-assembled; only 4 wing nuts to tighten. Suggested list price... \$10.85.

### SNAP-IN CONSTRUCTION.

One push and elements are locked securely in position. No bolts to tighten. This feature on all Sky-Ray VHF Antennas gives the easiest, fastest installation possible.



Sky-Ray offers complete lines of proven, top-quality, low-priced antennas for all TV bands: for VHF... Snap-In Yagis, Conicals, and In-Lines; for UHF... Bow Ties, and Single and Double Corner Reflector types. Get these big-profit antennas now. Ask your jobber for specifications and price lists or write direct to...

**SKY-RAY MANUFACTURING CO.**

**MCLEANSBORO, ILLINOIS**

RADIO-ELECTRONICS



## New VU Magnemite\*



### Spring-Motor Battery-Operated Portable Tape Recorder

Now you can consistently make professional recordings under the most grueling field conditions. Tapes will faultlessly play back on all professional and home recorders. Ruggedly designed for maximum dependability and top-notch efficiency. Combines unlimited versatility of performance with extreme simplicity of operation. Choice of fourteen models available for every conceivable application.

Incorporates a multi-purpose VU monitoring meter for precise setting of recording level without earphone monitoring. Meter also accurately indicates condition of "A" and "B" batteries. Five single speeds as well as two, three and 4-speed models available. Units weigh only 19 lbs. with batteries and measure 6½" x 9½" x 14¼". Higher speed models meet NARTB standards. All recorders are guaranteed for One Full Year.

For complete technical specifications and direct factory prices write to Dept. RE.

**AMPLIFIER CORP. of AMERICA**  
398 Broadway, N. Y. 13, N. Y.

\*T.M. Reg. U.S. Pat. Off.

## BOOK REVIEWS

**ELECTRONIC MEASURING INSTRUMENTS**, by E. H. W. Banner, Chapman & Hall, 37 Essex St., London W.C. 2, England. 395 pages. 45 shillings.

The author surveys and almost completely covers the field of electronic measuring devices used in research and industry. Part I discusses the characteristics of indicating instruments, Part II describes their electronic circuits and Part III covers applications. The field of electronic and related counters is covered, and there is also a chapter on electromechanical transducers.

The research worker and engineer will find this book helpful in selecting and applying electronic measuring equipment to his particular problem.

**NETWORKS, LINES and FIELDS**, by John D. Ryder. Second Edition. Prentice-Hall, Inc., 70 5th Ave., New York, N. Y. 5½ x 8½ inches, 593 pages. \$7.65.

This new edition discusses the transmission of energy through networks, lines, guides and space. Algebra is used throughout but rigor is avoided. Determinants and vector analysis are introduced to the reader when needed.

The first chapters describe the basic network, T and pi. More complicated networks are studied here (and in subsequent chapters) in terms of these two. The very important Foster's theorem is explained in connection with resonant

networks.

Several chapters are devoted to transmission lines. Radiomen will be particularly interested in the material on stubs, impedance matching, power and impedance measurements. The Smith transmission-line chart and stub design charts are fully explained and examples given. The chapters on guides and antennas, necessarily short, form an excellent basis for further study.

—IQ

**FUNDAMENTALS OF ELECTROMAGNETIC WAVES**, by Paul C. Shedd. Prentice-Hall, Inc., New York, N. Y. 5½ x 8½ inches, 191 pages. \$5.65.

In this very unusual book the author restricts himself to only four simple postulates and the fact that charged particles exert force on each other. From these bits of information, the basic equations and fundamentals of electromagnetism are derived by mathematics and logic. Yet the reader is assumed to know only as far as elementary calculus. All other math is developed by the author as needed.

The book is divided into very short chapters, averaging about five pages each. This permits important principles and theorems to be developed by themselves and aids the reader. Each chapter has its own summary. Practical applications of field theory—waveguides and antennas—are described in the last chapters.—IQ END

at your fingertips...

CLEAR BEAM'S

# 5

**"EASY WAY" ANSWERS  
FOR TOUGH FRINGE  
INSTALLATIONS!**

**CLEAR ANTENNA CORP.**  
**BEAM**

CANOGA PARK, CALIF. • CHICAGO, ILL.

Your Clear Beam distributor has all 5 antennas — contact him today!

It's an established fact (and you know it, too) that no one antenna can lick every fringe area problem.

In view of this, Clear Beam manufactures five different types of fringe antennas — each tops in its field!

All five Clear Beam fringe antennas provide easy installation, improved picture quality and happy customers.

One of the five is the tailor-made answer to your installation headaches — and a faster way to higher profits!

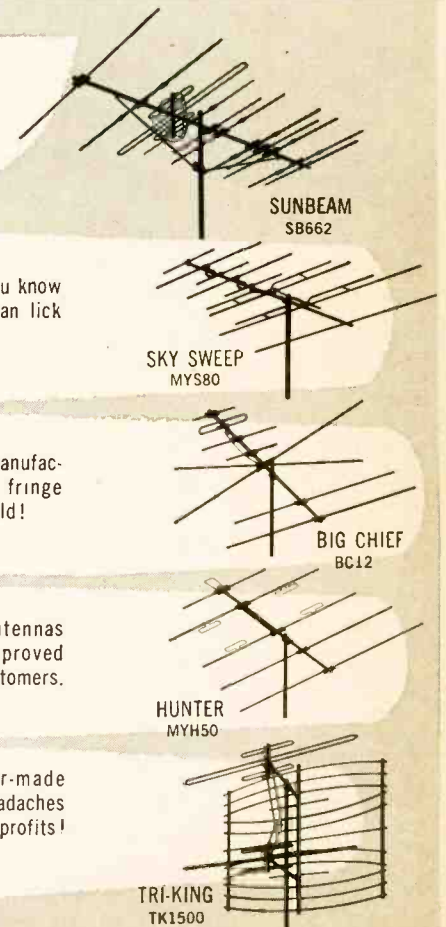



# RADIO SCHOOL DIRECTORY

**RCA INSTITUTES, INC.**  
 A service of Radio Corporation of America  
 350 West 4th St., New York 14, N. Y.

**OFFERS COURSES IN ALL TECHNICAL PHASES OF RADIO, TELEVISION, ELECTRONICS**  
 Approved for Veterans  
 Write Dept. RE-55 for Catalog

**Get Your F.C.C. LICENSE Quickly!**  
 Guaranteed preparation, in a MINIMUM OF TIME, for F.C.C. commercial operator examinations. Our highly specialized training is available by correspondence, or in resident classes in

**WASHINGTON, D. C. and HOLLYWOOD, CALIF.**  
 Write for our free booklet with complete details.  
**GRANTHAM School of Electronics**  
 Dept. 101-T, 737 11th Street N.W., Washington 1, D.C.

**TV REPAIRMEN EARN TOP MONEY!**  
 IN JUST 12 MONTHS, COMPLETE TV SERVICE TRAINING, INCLUDING COLOR TV. Streamlined course gives you all essentials for a good job as service technician. Graduates in great demand; jobs are plentiful in this growing field. Other electronic courses in radio operation and maintenance. Day or evening classes. Opportunity for employment in local industry. Approved for Korean veterans.

Write for Catalog 111 Today  
**INDIANAPOLIS ELECTRONIC SCHOOL**  
 312 E. Washington, Indianapolis 4, Ind.

**MORE JOBS than graduates**  
 Demand for our engineering graduates exceeds supply. *Effective placement service.* Study in this world-famed college established 1884. Quarters start Jan., March June, Sept. Approved for Veterans.

**Bach. Sc. degree in 27 months**  
 Complete Radio Eng. course includes TV, UHF and FM. Also Mech., Civil, Elec., Chem., Aero. and Adm. Engr.; Bus. Adm., Acct. Small classes. Well-equipped labs. Modest costs. Prep. courses. Write Jean McCarthy, Director of Admissions, for Catalog, View Book and "Your Career" Book.

**TRI-STATE COLLEGE**  
 24105 College Avenue, Angola, Indiana

**LEARN TV SERVICING**  
 Send for free 24-page illustrated booklet which tells you how to become a successful TV technician. America's leading TV servicing school offers you a specialized training program that omits non-essential math & design theory. You concentrate on radio & TV servicing only. You get professional training & experience right in our fully-equipped shops & laboratories. Write Dept. E-10-55.

Approved for Veterans  
**WESTERN TELEVISION INSTITUTE**  
 341 W. 18th St. Los Angeles 18, Calif.

**LEARN TV** "At the most practical school in the west"  
 Work on late model sets—using modern equipment and techniques; under qualified technician instructors. Short resident and correspondence courses—no unnecessary math or theory—also UHF and Color TV.

APPROVED FOR VETERANS... day and night classes.  
 Write for free literature, Dept. 1 A  
**V.S.I. TELEVISION SCHOOL** 4570 Firestone Blvd. South Gate, California

**UNITED COMMUNITY CAMPAIGNS**  
 Give... the United way

**SENDING CODE RECEIVING SPEED**  
 Be a "key" man. Learn how to send and receive messages in code by telegraph and radio. Commerce needs thousands of men for jobs. Good pay, adventure, interesting work. Learn at home quickly through famous Candler System. Qualify for Amateur or Commercial License. Write for FREE BOOK.  
**CANDLER SYSTEM CO.**  
 Dept. 3L, Box 928, Denver 1, Colo., U.S.A.

**RADIO-TV ELECTRONICS**  
 CREI graduates in big demand. ECPD-Accredited Technical Institute Curricula. New classes start monthly. Free placement service for grads. Courses: Radio Engineering, Broadcast or TV Engineering; TV, FM, AM Servicing; resident studies leading to "Associate in Applied Science" degree. Write for free catalog. Approved for vets.  
**CAPITOL RADIO ENGINEERING INSTITUTE**  
 Dept. RE, 3224—16th St., N.W., Washington 10, D.C.

**ELECTRONICS ENGINEERING DEGREE IN 27 MONTHS**  
 Prepare for un-limited opportunities in electronics! B.S. degree in 27 months. Intensive, specialized courses. Math, electrical engineering, TV, advanced radio theory & design. Mod. labs. Low tuition. Self-help. Also Aeronautical, Chemical, Civil, Electrical, Mechanical Engineering. G.I. approved. Enter Dec., Mar., June, Sept. Catalog.  
**INDIANA TECHNICAL COLLEGE**  
 1510 E. Washington Blvd. Fort Wayne 2, Ind.

**GET INTO ELECTRONICS**  
 You can enter this uncrowded, interesting field. Defense expansion, new developments demand trained specialists. Study all phases radio & electronics theory and practice: TV; FM; broadcasting; servicing; aviation, marine, police radio. 18-month course. Graduates in demand by major companies. H.S. or equivalent required. Begin Jan., March, June, Sept. Campus life. Write for catalog.  
**VALPARAISO TECHNICAL INSTITUTE**  
 Dept. C Valparaiso, Ind.

**TELEVISION**  
 PREPARE FOR A GOOD JOB!  
 BROADCAST ENGINEER  
 ELECTRONICS  
 RADIO SERVICING

**Television Servicing**  
 (Approved for Veterans)  
 SEND FOR FREE LITERATURE  
**BALTIMORE TECHNICAL INSTITUTE**  
 1425 BUTAW PLACE, BALTIMORE 17, MD.

## Become an ELECTRICAL ENGINEER

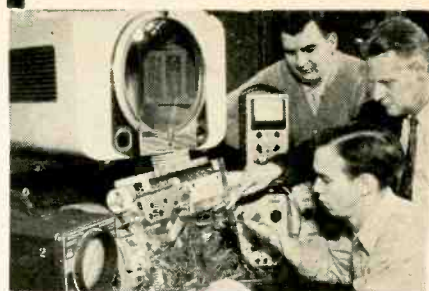

**Major in Electronics or Power BS Degree in 36 months**  
 Prepare now for a career as an electrical engineer or engineering technician — and take advantage of the many opportunities in these expanding fields.

You can save a year by optional year 'round study. Previous military, academic, or practical training may be evaluated for advanced credit.

**Enter Radio and Television — courses 12 to 18 months**  
 You can be a radio technician in 12 months. In an additional 6-months you can become a radio-television technician with Associate in Applied Science degree. Color television instruction is included in this program.

These technician courses may form the first third of the program leading to a degree in Electrical Engineering. Twenty-one subjects in electronics, electronic engineering and electronic design are included in these courses. Courses also offered: radio-television service (12 mos.); electrical service (6 mos.); general preparatory (3 mos.).

Terms — September, January, April, July  
 Faculty of specialists. 50,000 former students—annual enrolment from 48 states, 23 foreign countries. Non-profit institution. 52nd year. Courses approved for veterans. Residence courses only.

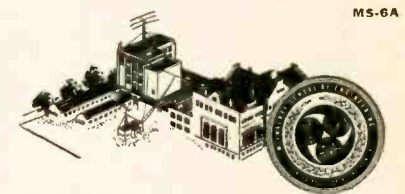

## MILWAUKEE SCHOOL OF ENGINEERING

MILWAUKEE SCHOOL OF ENGINEERING  
 Dept. RE-1055, 1025 N. Milwaukee Street  
 Milwaukee 1, Wisconsin  
 Send FREE illustrated booklets  
 Career in Electrical Engineering.  
 Career in Radio-Television.

I am interested in \_\_\_\_\_ (name of course)  
 Name \_\_\_\_\_ Age \_\_\_\_\_  
 Address \_\_\_\_\_  
 City \_\_\_\_\_ Zone \_\_\_\_\_ State \_\_\_\_\_  
 If veteran, indicate date of discharge \_\_\_\_\_

# GET BETTER HIGH FIDELITY RESULTS at less cost!



Whether you specialize in high fidelity service, custom building or simply want to build a top-notch outfit for yourself, this big 512-page book will guide you every step of the way.

Helps you get better results at less cost. Shows what to do... what mistakes to avoid. Gives you a full understanding of the many different methods, circuits, designs, equipment, components and other subjects that are debated whenever hi-fi fans get together.

## High Fidelity Techniques

by John H. Newitt

The book that says goodbye to guesswork in choosing, building and servicing hi-fi equipment.

512 pages  
203 pictures

## CASH IN ON HI-FI SERVICE AND CUSTOM BUILDING PROFITS!

High Fidelity Techniques is complete, authentic and easy to understand. From beginning to end, it is chock full of how-to-do-it tips, service data, charts and diagrams of the most helpful sort.

## 10-DAY FREE EXAMINATION!

Dept. RE-105, RINEHART & CO., INC.

232 Madison Ave., New York 16, N.Y.

Send HIGH FIDELITY TECHNIQUES for 10-day FREE EXAMINATION. If I like book, I will then promptly send \$7.50 (plus a few cents postage) in full payment. Otherwise, I will return book post-paid and owe you nothing!

Name \_\_\_\_\_

Address \_\_\_\_\_

City, Zone, State \_\_\_\_\_

OUTSIDE U.S.A.—Price \$8.00 cash with order only. Money back if book is returned in 10 days.

Rinehart Books are sold by leading book stores

# NEW IMPROVED

## Senco

### Filament CHECKER



NOW ONLY \$2.75

DEALER NET With Leads \$2.95

MORE VERSATILE

LOWER COST

COMPLETELY NEW

- Automatically checks ALL TUBES including locals and pix tube.
- Continuity and voltage tester—no switches, merely plug in test leads.

Ask your Jobber to see the New Senco Checker.

**SERVICE INSTRUMENTS CO.**  
ADDISON, ILLINOIS  
"ADDISON INDUSTRIAL DISTRICT"

## ADVERTISING INDEX

Radio-Electronics does not assume responsibility for any errors appearing in the index below.

A. L. Products Co.	158
Aermotor Co.	144
Airex Radio Corp.	154
Allied Radio Corp.	11 27-29
American Phenolic Corp.	102, 103
Amplifier Corporation of America	162
Approved Electronics	96
Arkay Radio Kits, Inc.	101
Astron Corp.	30
Atlas Sound Corp.	124
Audel, Publishers	160
Audio Fair	14
B & K Manufacturing Co.	136
Bell Manufacturing Co.	97
Bell Telephone Labs.	16
Book-of-the-Month Club, Inc.	13
Books Radio & TV Corp.	140-141
Burroughs Research Labs.	147
Burstein-Applebee Co.	157
CBS-Hytron	81
Canon Manufacturing Co.	22
Cannon Electric Co.	150
Capitol Radio Engineering Institute	25
Channel Master Corp.	17
Chicago Standard Transformer Co.	110
Cisin (H. G.)	128
Clear Beam TV Antenna Co.	162
Cleveland Institute of Radio Electronics	85, 86
Collins Audio Products	141
Coloridaptor	157
Commissioned Electronics	157
Coyne Electrical Co.	133, 139, 148
Delco Radio Division of General Motors	115
DeVry Technical Institute	7
Edlie Electronics	155
ElectroVoice, Inc.	6
Electronic Instrument Co. (EICO)	32, 139, 152, 160
Electronic Organ Arts	108
Electronic Products Co.	126
Fenton Co.	112
Ford Electronics Co.	114
G. & H. Wood Products Co.	22
General Cement Manufacturing Co.	127
General Industries Co.	14
Gernsback Publications, Inc.	124, 148
Granco Products	152
Grantham School of Electronics	146
Haltcrafters Co.	114
Hawkins (P. E.) Co.	157
Heath Co.	67-78
Henshel Radio	139
Hickock Electrical Instrument Co	87
Hudson Specialties Co.	150
Hughes Research & Development Labs.	145
Hycor Manufacturing Co.	100
Indiana Technical College	143
Instructograph Co.	126
International Rectifier Corp.	106
JFE Manufacturing Co.	26
Jackson Electrical Instrument Co.	129
Jensen Industries	151
Jones & Laughlin Steel Corp.	93
Kellogg Manufacturing Co.	110
Klipsch & Associates	158
LMB	139
Lafayette Radio	165
La Pointe Electronics	121
Lektron Specialties	159
Leotone Radio Corp	108
Littelfuse, Inc.	95
Macmillan Co.	137
Major Brand Tube Co.	137
Mallory (P. R.) & Co.	123
Mallory (William J.)	126
McGraw-Hill Book Co.	158
Moss Electronics Distributing	90-91
Musical Masterpiece Society	151
National Electronics of Cleveland	146
National Radio Institute	3, 19-20
National Schools	5
Ohmite Manufacturing Co.	80
Opportunity Adlets	155
ORRadio Industries	122
Oxford Electric	126
Permotlux Corp.	12
Precise Development Corp.	124, 139, 154
Precision Apparatus Co.	165
Premier Radio-TV Supply	107
Presto Recording Corp.	161
Progressive Edu-Kits, Inc	132
Pye, Ltd.	146
Pyramid Electric Co.	Inside Back Cover
RCA Institutes, Inc.	15
RCA Test Equipments	111
RCA Tube Division (Radio Corp. of America)	Back Cover
R-Columbia Products Co.	106
Radiart Corp.	18
Radio City Products	140
Radio Products Co.	143

## RADIO SCHOOL DIRECTORY PAGE 163

Baltimore Technical Institute	
Candler System Co.	
Capitol Radio Engineering Institute	
Grantham School of Electronics	
Indiana Technical College	
Indianapolis Electronic School	
Milwaukee School of Engineering	
RCA Institutes, Inc.	
Tri-State College	
V.S.I. Television School	
Valparaiso Technical Institute	
Western Television Institute	
Radio-Television Training Association	23
Radion Corp.	134
Raytheon Manufacturing Co.	24
Rider (John F.), Inc.	144
Rinehart Books, Inc.	99, 108, 151, 164
Rockbar Corp.	164
Ronette Corp.	152
Sams (Howard W.) & Co.	21, 31
Sangamo Electric Co.	156
Sarkes-Tarzan, Inc.	131
Service Instruments Co.	164
Shure Brothers, Inc.	144
Sky-Ray Manufacturing Co.	160
Sonotone Corp.	10
Sprayberry Academy of Radio	9
Stan-Burn Radio & Electronics Co.	158
Stanley Electronics Corp	161
Superelex Electronics	134
Supreme Publications	147
Sylvania Electric Products, Inc.	125, 117
Tab	166
Technical Appliance Co.	124
TelMatic Industries Inc.	159
Teleparts Co.	147
Telephone Engineering Co.	154
Television Hardware Mfg. Co.	127
Telvac	144
Tenna Manufacturing Co.	142
Thompson Products Co.	109
Transision, Inc.	135, 143, 159
TriPlett Electrical Instrument Co.	Inside Front Cover
Tung-Sol Electric Co.	8
Turner Co.	12
United Catalog Publishers	147, 153, 159
Universal Television School	110
University Loudspeakers	146
Viking of Minneapolis	108
Waisco Electric Sales	119
Wayco, Inc.	105
Wholesale Radio Parts	148
Winegard Co.	113
Winston Electronics, Inc.	149
Xcelite, Inc.	155
Zingo Electronics	143

# Especially

where

space

is

limited



the **GOODMANS**

*Axiette*  
**8 inch**  
**HIGH FIDELITY**  
**LOUDSPEAKER**

MADE IN ENGLAND

ROCKBAR CORPORATION, Dept. LK-9

215 East 37th St., New York 16, N. Y.

Please send complete description of the Goodmans Axiette.

Name \_\_\_\_\_

Address \_\_\_\_\_

City \_\_\_\_\_ Zone \_\_\_\_\_ State \_\_\_\_\_

My Dealer is \_\_\_\_\_

# LAFAYETTE

## Leads the Field in TRANSISTORS

## Circuits Kits & Components



### TWO TRANSISTOR RADIO RECEIVER KIT

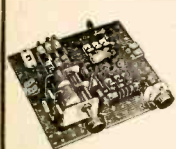

This regenerative two Transistor Radio has given more than ample earphone volume on broadcast stations located several hundred miles away. When used with 80 ft. outside antenna, well beyond 1000 miles have been repeatedly heard. Kit comes complete with two transistors, Argonne transistor audio transformer, condensers, resistors, masonite board, etc.; schematic diagram plus 1 1/2 page book, showing more than 50 practical transistor circuits and "How-to-do-it-instructions".

**KT-70 Complete Kit with Batteries** ..... Net ..... **10.95**

### 3 TRANSISTOR PUSH-PULL AUDIO AMPLIFIER KIT FOR SPEAKER OPERATION



With the New Lafayette KT-69 kit you can now build a self-powered, push-pull Class "A" transistor audio amplifier for speaker operation, having a frequency response of 100-8000 cps. The Argonne Transistor transformer were especially designed for transistor circuits. Kit comes complete with 3 transistors, push-pull input and output transformer, resistors, condensers, resistors, battery holders, etc., schematic diagram.

**KT-69 Complete with batteries**.....Net **17.95**

### TWO TRANSISTOR PREAMP KIT



With the Lafayette KT-71 you can now build a simple Transistor preamp in a matter of hours. The overall result will be a noiseless, humless and virtually distortionless amplifier. The complete unit is mounted on an aluminum chassis size 3"x4"x1". The Kit comes complete with two transistors, condensers, resistors, battery holders, batteries, etc., and schematic diagram.

**KT-71 Complete Kit** .....Net ..... **8.95**

### 2 TRANSISTOR POCKET RADIO KIT



Packed into a 2 1/2"x3 1/4"x1 1/4" plastic case, this Two Transistor plus crystal diode radio kit offers many surprises, utilizing a regenerative detector circuit with transformer coupled audio stage, gives you high gain and excellent selectivity. Fully in distant stations with ease with more than ample earphone volume. Kit comes complete with two transistors, crystal diode, loopstick, Argonne Transistor audio transformer, resistors, condensers, plastic case, etc. Including schematic and instructions.

**KT-68 Complete kit with Miniature Dynamic Earphones** ..... Net **13.75**  
Less Earphones ..... Net **11.80**

### LAFAYETTE GEIGER COUNTER KIT WITH HIGH SENSITIVITY VICTOREEN TUBE 1B85

Lafayette Geiger Counter Kit with High Sensitivity Victoreen 1B85 tube, makes this one of the most outstanding kit buys in the country. This tube is used only in the most expensive equipment. Easy to build, at only a fraction of the price, of commercial instruments of this type. Just turn it on, flip the high voltage switch and listen to the clicks. Kit includes all parts, tube, carrying case, 22 1/2 and 1 1/2 batteries. Complete Instructions for quick assembly. Shpg. wt., 1 1/2 lbs.

**KT-75** ..... Net **14.95**



**TRANSISTOR 455 KC I.F.**  
Specially designed for transistor circuits, only 1/2" square by 3/4" high.  
**MS-126**—  
In lots of 10, each **79¢**  
Single, Each ..... **89¢**

**NEW TRANSISTOR TYPE 2N222 P-N-P 99c HERMETICALLY SEALED**

### IMPORTED BINOCULARS

All have coated lenses — clamped in prisms — light weight all metal bodies. Complete with case and straps. Fully guaranteed for 6 mos. against mechanical and optical defects.

Includes Hard Pigskin case

F-182	6x.15 I.F.	NET 10.75
F-105	8x.30 I.F.	NET 17.95
F-115	7x.35 I.F.	NET 17.95
F-183	7x.35 C.F.	NET 20.95
F-184	7x.35 C.F. Wide Angle	NET 29.50
F-103	7x.50 I.F.	NET 21.50
F-104	7x.50 C.F.	NET 24.95
F-117	10x.35 C.F.	NET 23.95
F-104	12x.50 I.F.	NET 31.50
F-118	10x.50 C.F.	NET 27.95
F-185	20x.50 C.F.	NET 37.50

Add 10% Fed. Tax to Above Prices

### MONEY BACK GUARANTEE

### TELEPHONE PICKUP

**FOR RECORDING TELEPHONE CONVERSATIONS**  
Induction telephone pickup. Telephone conversations can now be picked up with no tapping of wires or special telephone circuits. Simply place the phone base, either cradle or upright type, on a pickup platform and connect the leads to the high impedance input of any medium gain audio amplifier or directly to any tape disc or wire recorder.

**MS-16**..... **2.95**

### NEW POCKET AC-DC VOM MULTITESTER

1,000 ohms per Volt

**AC-DC MULTITESTER**. An ideal portable unit that meets the need for a compact, yet rugged, test instrument. Uses full 3" rectangular meter with large easy to read scale. Uses 1 1/2 precision resistors, few-wired D'Arsonval microamp meter movement. Ranges: AC-DC and output volt. 0-5, 0-10, 0-100V. DC current 0-1, 0-10, 0-100. MA; Resistance 0-100k ohms. Size: 2 1/4" x 3 1/4" x 1 1/4". Supplied complete with test leads and batteries. Shpg. wt. 2 1/2 lbs.

**MODEL RW-27C** Complete — Singly, ea. **7.95**

### WEBSTER • GARRARD • COLLARO 3-SPEED—HI-FI RECORD CHANGER

Now Lafayette makes it possible for you to save money on the three most popular makes of 3 speed Record changers.

**WEECOR Diskchanger**: It's completely automatic. 33 1/2, 45 and 78 RPM, automatic shut off after last Record, balanced tone arm, etc. Size 13 3/4" x 12 x 8 1/4". Shpg. wt., 16 lbs.  
Stock No. **PK-49**—With Dual Turnover Cartridge ..... **24.95**  
Stock No. **PK-46**—With G.E. RPX 060 Triple Play Cartridge ..... **27.95**

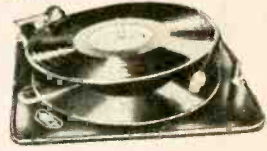

### COLLARO, THE WORLD'S FINEST 3 SPEED INTERMIX CHANGER:

Collaro Model 3/532—3 speed Intermix changer designed and engineered to meet the most exacting requirements of the finest audio systems. While our stocks last. Shpg. wt., 23 lbs. with G.E. RPX-050 Triple play cartridge  
With G.E. RPX-052A Triple play latest Golden Treasure cartridge with Diamond and Sapphire styl installed ..... Net **34.50**  
Collaro RC-54: Latest Collaro 3 speed Intermix less cartridge ..... Net **44.95**  
With G.E. RPX-050 Triple play cartridge ..... Net **47.77**  
With G.E. RPX-052A Triple play Golden Treasure cartridge with Diamond and Sapphire styl installed ..... Net **49.95**  
Garrard Model RC-80 3 speed Record changer less cartridge ..... Net **59.95**  
Model RC-80 with G.E. RPX-050 Triple play Cartridge ..... Net **48.51**  
Model RC-80 with G.E. RPX-052—A latest triple play Golden Treasure cartridge with Diamond and Sapphire styl installed ..... Net **51.95**  
and Sapphire styl installed ..... Net **62.53**

### TOP QUALITY CRYSTAL MICROPHONE

COMPARE IT WITH ANY MIKE AT 2 to 3 TIMES THE PRICE



A quality crystal Microphone for PA systems, house recorders, etc. Frequency response 30 to 10,000 cycles. Output level —52 db. Provides ample output for use with low gain amplifiers. Complete with 5 ft. of shielded cable. Shpg. wt., 3/2 lbs.

**PA-24** — in lots of 3 ..... **3.95 ea.**  
singly, each **4.25**

### High Output Dynamic Microphone

List Price ~~\$47.00~~ **\$12.95**



High quality Dynamic microphone exceptionally fine for Public address recording, etc. Flat response 60-10,000 cps. Impedance 40,000 ±15%. Comes with 1,000 cps. output level —55 db. Die cast metal case equipped with 6 ft. of shielded cable. Shpg. wt., 3 lbs.

**PA-19** — in lots of 3 ..... **12.45 ea.**  
singly, each **12.95**

### REMOTE CONTROL FOR SILENT TV VIEWING

- For Hard-of-Hearing.
- For Late Listening

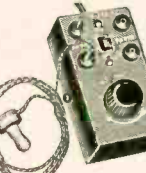

The hard-of-hearing can listen to radio or TV without turning the volume so high that others can't stand the noise. They can listen with loud speaker cut off, or if others want to listen with normal speaker volume. Excellent for noisy programs. Let the kids listen and view with speaker cut off. Comes complete with miniature phone, fits snugly in ear, 20 feet of cable and instructions.

**MS-125** ..... **6.50**

TWO CAN LISTEN WITH ADDITIONAL EAR PHONE 1.95

### Lafayette Greatest Tape Buy Ever!



1200 FT. REEL HIGH FIDELITY RECORDING TAPE Shpg. Wt. 14 oz.

1.69 per roll plus postage (99¢ min)

LAFAYETTE made a terrific deal with one of the leading manufacturers of recording tape to supply us with their regular tape which sells for almost twice our price. **WE GUARANTEE ABSOLUTE SATISFACTION OR YOUR MONEY BACK.** The finest, professional-quality recording tape obtainable. Highest performance for thousands of playings. Red Oxide Base in a smooth, uniform coating; greater signal strength; with maximum fidelity: uniform frequency response from 40-15,000 cps.

In lots of 10 rolls - **1.59 ea**

### LAFAYETTE EXCLUSIVE! DYNAMIC EAR PHONE



A new lightweight plastic ear phone especially imported by Lafayette to bring you the high quality of a dynamic ear phone with the ease and comfort of an almost weightless unit—at a price less than half that of any comparable unit. Fits right into ear. Excellent sensitivity of 65 db. Ideal for use with miniature sets, hearing aids, transcribing, etc. DC resistance 2000 ohms, impedance 5000 ohms at 1000 cycles. Complete with 3 ft. plastic covered cord.

**MS-72** ..... Net **1.95**

Will replace speaker on any radio set or T.V. for silent listening, by direct connection to secondary of output transformer. Impedance 8 ohms

**MS-100** ..... Net **1.95**

### 5" Tweeter AND Crossover Network



**7.95**

A specially designed 5" Tweeter and Crossover Network that will assure high frequency response when used with any speaker you now possess. You can now make your present speaker into a 2-way speaker system increasing the high frequency range up to 15,000 cycles. Diagram included. Shpg. Wt. 5 lbs.

**STOCK NO. SY-14** ..... Net **7.95**

### SONOTONE TURNOVER CERAMIC PHONO CARTRIDGE WITH DUAL SAPPHIRE NEEDLES



Replacement for Columbia 360-VM-Webster and Crescent Record Changers

**SPECIFY STOCK NO. PK-40**  
In lots of 5, each ..... **3.50**  
Singly, each ..... **3.98**

### TRANSISTOR TYPE 2N107

P-N-P **\$1.25**

**TIMER-SWITCH SALE 3.95**  
Automatically turns on radio, television sets, toasters, coffee-makers, etc. — at any pre-set time within 12 hour period; also tells time. Requires 3 1/2" diameter round hole. Depth behind dial face 3 1/4". Shpg. wt. 1 1/2 lbs. **MS-62**, for 110V/60 Cy AC

send for **FREE CATALOG**

132 page electronic buying Guide. Transistors, radio, TV, Hi-Fidelity, Drafting supplies, microscopes, check full of buys at great savings. Write today for **FREE COPY**.

**Lafayette Radio** DEPT. JJ  
BRONX, N.Y. 542 E. Fordham Rd.  
NEWARK, N.J. 124 Central Ave.  
PLAINFIELD, N.J. 239 2nd St.  
NEW YORK, N.Y. BOSTON, MASS. 110 Federal St.  
Include postage with order.

# "TAB" THAT'S A BUY

## HI-FI AUDIO CENTER

**NEW "Clip In Tip" GE Cartridges**  
**\*GE Original Boxed, \$ S \$ Back Gtd**  
 RPX050A\*.001 & .003...\$6.98  
 RPX052A\* Gold Treas...\$19.98  
 RPX053A\* Gold Treas...\$28.98  
 RPX040A\* Single (.003) \$5.25  
 RPX041A\* Single (.001) \$5.25  
 \*\*\*\*\*  
**Replcment Needles "TETRAD"**  
 Diamond†  
 RPJ010A Dual (.001 & .003 Gd)...\$1.98  
 RPJ012A Dual (D).001 & .003 Tetrad† \$18.99  
 RPJ013A Dual (DS).001 & .003 Tetrad† \$10.99  
 Replcmts for New A Cartridge Only  
 RPJ010 or RPJ030 Single (D) Tetrad† \$9.99  
 RPJ015 or RPJ035 Single (S).....\$1.35  
 Replcmt Styl for RPJ040 & 041 Only  
 RPJ001 or RPJ005 Single (S) GE.....\$1.35  
 RPJ003 or RPJ004 Single (D).....\$9.99  
 Complete Stock of Replcmt Needles  
 Send Cartridge Name and Number  
 MC or 78 Single Sapphire Styl.....\$1.15  
 MC and 78 Dual Sapphire \$1.98...4/57 \$0  
 MG or 78 Single Dia. "TETRAD".....\$9.89  
 MG and 78 Dual Dia. "TETRAD".....\$20.89

**ALL NEW DUAL VOLTAGE PHONO CARTRIDGE**  
**\$1.55 ea. LOTS OF 6**  
**Replaces 127 Popular Make G Type Cartridges 95% of All 78 RPM's**  
 Sold Singly.....\$1.65 ea.

**HI-FI RECORDING TAPE**  
**Finest, S. S. S. Back Gtd**  
**PRECISION COATED & SLIT.**  
 Gtd Splice free. Quality Controlled. Plastic Base. Gtd Constant Output. Freq. 7.5 IPS. 40-15K Oxide Wnd In 7 1/2" reel; 1200 ft. per reel  
 Twelve Tapes \$1.58 ea.  
**HI-FI SPEAKERS**  
 Inbuilt network, 2 wires needed for HF & LF Response. Famous HI FI Speaker Mfgs. 15" Coaxial 1M & 1/2" Tweeter 25 Watt/20-17500 cycles.  
 MODEL P25C0 Coaxial PM.....\$19.50  
 12" Coaxial PM.....\$19.50  
 Tweeter 1/2" Watt/45-15000 cy. Special \$12.75; 3 for \$35  
 12" Coaxial PM & 1/2" Tw/Bw/20-15Kc MODEL PRC01.....\$7.98; 2 \$15  
 12" HI-FI PM 10W/35-14Kc.....\$10; 2 \$18  
 8" HI-FI PM 7W/45-14Kc.....\$7.25; 2 \$13

**"TAB" Carries All The Leading Name Brands in The Electronics Industry—All Available to You at GREAT SAVINGS**  
 ELECTRO-VOICE, HICKOCK, WEBSTER, STEPHENS, ICA, Sylvania, RCA, JENSEN, ALTEC, FISHER, GE, UMG, THOR, NATIONAL, HALLICRAFTER & MANY OTHERS.

**COMPLETE LINE OF HI-FI Speakers, Tuners, Amplifiers, Record Changers & Components**  
**GET OUR PRICE B-4-U-BUY**

**FOTOFASH & STROBE LAMPS**  
 "TAB" W-Sec. Each  
 No. Replaces Mak. Each  
 TH1 FA 104 FT118 150 \$ 5.98  
 TH1 ANGL0 5804X 150 \$ 10.98  
 23ST GE FT 210 200 9.98  
 THVA STVL 4330 200 9.98  
 74X4 2400 200 10.98  
 TLX DX & FA100 150 9.00  
 TD DC/250-350 150 10.00  
 353GT TT 2000 49.98  
 Trigger Coll for LO Volt Flash \$1.47  
 Write for "TAB" Flash Tube Data.....\$0c

**NEW 212W/SEC PHOTOFASH AC & Dry Battery Kit**  
 Includes four 925MFD-450V capacitors. Total 212W/Secs. Resistors, condensors, rectifiers, flash tube in indicating flash green, guide #80 Daylight Kodachrome. 240 on Extinction Loss Battery P/V AC. 38' micro ampere movement. 8 easy to use. Complete w/batteries & leads. RF Diode Probe included for signal measurement. shpr. wt. 4 lbs.  
 Sold Singly.....\$22.95 ea.  
 Vol. 30,000 Volt Probe. Special \$5.95 ea.

**NEW 6KV HI SENSITIVITY DC & AC 27 Range MULTITESTER**  
**"TAB" \$21.95**  
 Lots of 3 (Not A Kit)  
 A complete precision test instrument. 20,000 Ohms per Volt. AC 10,000 Ohms P/V AC. 38' micro ampere movement. 8 easy to use. Complete w/batteries & leads. RF Diode Probe included for signal measurement. shpr. wt. 4 lbs.  
 Sold Singly.....\$22.95 ea.  
 Vol. 30,000 Volt Probe. Special \$5.95 ea.

**Pocket AC-DC MULTITESTER "TAB" 27C \$9.45**  
 Lots of 3  
 HI-accuracy precision VOM 1000 Ohms per V. Reads AC & DC Volts 0.5 to 25. 250, 1000 Ohms DCMA. 0.1 to 100 MA. Ohms 0.1 to 100 K. Size 1 1/4" x 4 3/8". Complete w/batteries & leads. RF Diode Probe included for signal measurement. shpr. wt. 4 lbs.  
 Sold Singly.....\$22.95 ea.  
 Vol. 30,000 Volt Probe. Special \$5.95 ea.

**THAT'S "TAB" THAT'S A BUY**  
 Dept. 10RE5 111 LIBERTY STREET, NEW YORK 6, N.Y., U.S.A.

# CASH IN NOW AT "TAB'S" WAREHOUSE CLEARANCE AT UNBELIEVABLE PRICES

**TERMINAL STRIP KIT**  
 48 pcs  
**Terrific Value 95¢**  
 You get a large variety of 48 tie points, terminal strips & lug strips

**WIREWOUND RESISTOR KIT**  
**50 FOR \$5**  
 Assorted Kit in wide range of popular values—5 to 100 watts. Famous mfg.

**20 ASSORTED SWITCHES**  
**\$1.89**  
 Always in demand is this Ass'tmt of SPST, DPDT, push button, bat handle & micro switches.  
 Per Kit

**PANEL LAMP KIT**  
 Kit contains 10 Type 41 Now Only 10 Type 44 10 Type 55  
**\$2.39**  
 Here's a terrific offer on genuine GE. Tungston panel lamps you can't afford to pass up—

**50 TV & POPULAR KNOB Assortment**  
**\$3**  
 While they last "TAB" offers you set screw & push on knobs in plastic, wood & bakelite—

**GRAIN OF WHEAT LAMPS**  
 Kit of 20 Ass't'd \$4  
 You get an ass'tmt of: #323-3V Clear, 323-3V Red, 321R-28V & Shutter Red, & 321G-28V & Shutter Green.

**VOLUME CONTROL KIT**  
 Handy ass'tmt of 15 for 15  
**\$2.70**  
 of single & dual Radio & TV Controls with & without switches. A must for every Service Shop.

**TV HI VOLT CERAMIC COND.**  
 Kit of 5  
**\$2**  
 500MMF 20,000V

**SOLDERING LUG & EYELET KIT**  
 500 Ass't'd  
**98¢**  
 In Plastic Box  
 Every type soldering lug & eyelet needed in any service shop. Includes solderless types too.

**POWER RHEOSTAT**  
 250 OHM 69¢  
 25 WATT 10 for \$6.

**BATHTUB OIL CONDENSER KIT**  
 20 Ass't'd BATHTUBS \$1.89  
 Contains 20 most widely used bath tubes from .01 mfd to 2 mfd & voltages to 1500VDC.

**CRYSTAL DIODE DEAL**  
 10 For **\$1.49**  
 Singly 25c ea.

**ELECTROLYTIC COND. KIT**  
 Kit of 20 \$3  
 Here's your chance to save on top quality electrolytics. Included are single, dual & triple sections, from 10 to 80 mfd & 25 to 450 Volts.

**ROTARY SWITCH KIT**  
 Kit of 12 12 For **95¢**  
 Fine selection of single, dual & quadruple circuits. Ideal for set builders & lab.

**OIL CONDENSER BUY**  
 4 MFD 1200 VDC \$1.25  
 or 10 MFD 600 VDC Lots of 24 @ \$1.50 ea. @ \$1.79 ea. Singly

**TUBE SOCKET KIT**  
 25 Ass'td Sockets Now **85¢**  
 Includes 25 of the most popular size sockets. STOCK UP!

**KIT OF 100 RESISTORS**  
 1/2-1/2 Watt Selected Ass'tmt of 100 popular insulated resistors. Standard IMA color code. Per Kit **\$2.49**

**50 ASSORTED INSULATORS**  
 Only **87¢**  
 This versatile kit contains ass't'd types, sizes & shapes including threaded steelites, porcelain & bakelite pillar & stand-off insulators.

**NEW "TABTRON" SELENIUM BRIDGE RECTIFIERS**  
 Dated  
**ONE YEAR GUARANTEE**  
 We mfg. Power Rectifiers to your specs. From 1 Amp up to and above 1000 Amps. Following list. Full Wave Bridge.  
 Curr. 18/14 36/28 54/42 130/100  
 Cont. Volts Volts Volts Volts  
 1AMP \$ 1.40 \$ 2.35 \$ 3.75 \$ 8.25  
 2AMP 2.10 2.95 5.35 10.00  
 3AMP 3.00 4.15 5.85 12.75  
 4AMP 3.70 5.15 7.15 12.75  
 6AMP 4.45 8.75 12.85 32.00  
 10AMP 6.50 12.50 19.50 41.35  
 12AMP 8.00 13.00 21.00 41.35  
 20AMP 13.05 25.05 37.25 78.50  
 24AMP 16.00 31.95 44.50 85.00  
 30AMP 19.75 33.50 56.50 109.00  
 36AMP 24.75 50.65 65.00 134.00  
 50AMP 29.50 54.35 97.35 174.00

**RECTIFIER & XFMR COMBO, Up to 28VDC at 24 Amps Cont. Duty... \$60**  
**HEAVY DUTY BATTERY "FAST" Charger Rectifier**  
 13-0-13V(CT) 100 Amp Fan Cooled or 34 Amp Air Cooled—Repl'mt 6V Booster Charger. Model CR2000 10V/24V/24V 10-0-10V (CT) Fan Cooled. For 12V/60A and 6V/100A Booster Chargers. Model CR300.....\$11; 3/530

**New Rectifier Xfmsr**  
 Primary 115V 60 cyc  
 5 Amp.....\$8.65; 2/25.75  
 12 Amp.....\$16.65; 2/29.95  
 24 Amp.....\$35.75; 2/69.95  
 50 Amp.....\$59.00; 2/112  
 100 Amp.....\$108.00; 2/210  
 18 Volt, 2 Amps.....\$1.98; 2/3.50  
 1 Wound in Series ratings shown; Parallel 2 Secondary, Voltage 1/2 max. Dual Pri 115 & 220V 60 cy; Tapped 36VCT

**New Rectifier Chokes**  
 CR6001 1AMP/0.1MV/1.4R 3#.....\$3.95  
 CR6002 2AMP/0.1MV/6.7R 3#.....\$5.95  
 CR6003 5AMP/0.1MV/6.0R.....\$7.95  
 CR6004 12AMP/0.1MV/1R 12#.....\$14.95  
 CR6005 24A/0.04MV/0.25R/20#.....\$29.95

**230 to 115V Autoformers**  
 For 220-240 V/50-60 cy in. To 110-120 v or step-up. 1 1/2" Cord, Plug & Receptacle.  
 TPA050 50W\*.....\$2.55  
 TPA075 75W\*.....\$3.60  
 TPA100 100W\*.....\$5.12  
 TPA200 200W\*.....\$5.75  
 TPA250 250W\*.....\$6.75  
 TPA300 300W\*.....\$7.75  
 TPA500/500W8.25: TPA750/750W8.11.75  
 Model TPA1000/1000W/1KW\*.....\$16.95  
 Model CPA2000/2000W/2KW\*.....\$34.00  
 \$100 Order Take 10% Disc. \*Less C. P&R

**New Variable 0 to 6 & 12 Volt/12A DC Power Supply**  
 Battery Eliminator, Charger, Model RR, Flatter, Aircraft, Marine or any DC Req. Extra Hvy Duty Selenium Rectifier, 2 Meter, 10V & A. Designed for Cont. Service & up to 20 Amps intermittent overload.  
**New Model T612V12AC...\$29.95**

**Write For New "TABTRON" Rectifier & Power Supply Catalog PR655**

**NEW HIGH CURRENT POWER SUPPLIES—ONE YEAR GTD**  
 Variable 0-28VDC. Completely Built. Full Wave Selenium Rectifier, Transformer, Variable Volt & Amp Meters, Switch, Terminals & Fuse. Housed In Heavy Duty Steel Cabinet. 115V/60cy input. 110 or 220V/1 and 3 phase to order. Specify  
 Sth No. Cont. Rating W-Meters  
 T28V5A 0-28VDC at 5 Amp \$ 45  
 T28V5ACC 0-28VDC (3% Ripple) \$ 75  
 T28V12A 0-28 VDC at 12 Amp \$108  
 T28V12ACC 12 Amp (1% Ripple) \$145  
 T28V24A 0-28 VDC at 24 Amp \$135  
 T28V24ACC 24 Amp (1% Ripple) \$195  
 T28V50A 0-28 VDC at 50 Amp \$260  
 T28V100ACC 0-28VDC at 100 Amp \$370  
 T28V100AT 0-28 VDC at 100 Amp \$469

**New Variable Voltage Xfmsr**  
 Superior—Gr—Staco—Ulc  
 0-132V 1.25A.....\$ 7.99  
 0-135V 3A.....11.99  
 Cased 0-135V 7.5A.....21.95  
 Uncased 0-135V 15A.....17.25  
 Cased 0-270V 3A.....24.95  
 Uncased 0-270V 3A.....18.95  
 Cased 0-135V 15A.....41.98  
 Cased 0-270V 9A.....41.98  
 Six or more 100% Disc

**NEW! Quality VOLTAGE REGULATOR**  
**\$ \$ Popularly Priced \$ \$ ONLY \$16.98**

**LINE VOLTAGE STABILIZER**  
 Stabilizes line voltage with 24 in. plus or minus. 1/2" gain. Regardless of voltage or Freq. shift. Insures full size, strength, & sync of TV picture. Careless of line voltage. Automatically operated. regulator turns on & off with set or equipment.  
**TROUBLE FREE, QUIET,** needs no adjustment. Universal use from 100 to 300 watts. Input 100-125V plus or minus 3%. 50-60 Cy. SOLD WITH "TAB" MONEY BACK GUARANTEE.  
 Order Six and Take 10% Discount

**Money Back Guarantee (Cost of Mfg. Only) \$5 Min. Order F.O.B. N.Y.C. Add Shpg. Charges or for C.O.D. 25% Dep. Tubes Gtd. via R-Exp. only. Prices subject to Change Without Notice. Phone Recorder 2-6245. CABLE: "TABPARTS"**

**Get Our New "TABOGRAM" BONUS SHEET Crammed Packed With Un-Advertised Specials**

# TUBES!! "TAB" TESTED & GUARANTEED

0A2.....74	2X2A.....1.15	6BD6.....74	6T4.....1.15	12H6.....48
0A3.....98	3A4.....48	6BE6.....46	6TR.....78	12J5.....48
0B2.....74	3BA.....2.70	6BG6.....1.24	6U8.....99	12K8.....48
1B5.....1.19	3Q4.....48	6B7.....52	6T7.....64	12SA7.....64
0C3.....88	3Q5.....68	6B8.....68	6V6GT.....56	12SF7.....78
0D3.....78	354.....46	6BK7A.....1.11	6W4.....32	12SJ7.....54
0Z4.....50	3V4.....79	6B7B.....57	6X4.....1.19	6X5.....46
1A5GT.....64	4B2T.....1.55	6BNG.....1.19	6X5.....46	12SK7.....48
1A7GT.....96	5AX4.....1.22	6B06.....96	7A4.....78	12SL7.....56
1A04.....3.95	5A24.....54	6C4.....38	7A5.....74	12SN7.....56
1A4E.....3.75	5R4GYW.....1.56	6C5.....68	7A7.....79	12SQ7.....54
1A4H.....1.07	5T4.....1.48	6C6.....56	7A8.....68	12SR7.....46
1A4X.....1.25	5U4.....46	6C7.....52	7A0T.....1.41	12T3.....89
1B3.....66	5V4.....1.28	6C8.....1.08	7A4.....81	14A7.....89
1E5.....69	5X4G.....78	6D6.....84	7B6.....72	14AF7.....95
1G4GT.....69	5Y3.....36	6D8.....81	7B8.....82	19B06.....1.38
1G5.....69	5Y4.....36	6D9.....76	7C4.....26	19T8.....1.49
1G6GT.....69	5Y5.....2.98	6F8.....86	7E6.....54	19V8.....1.96
1H4GT.....49	6A7.....1.09	6G6.....92	7F7.....76	25A6.....1.79
1H5GT.....72	6A8GT.....42	6J4.....4.59	7F8.....1.18	25B06.....99
1M6.....69	6A84.....62	6J5.....42	7H7.....72	25L6.....84
1I6G.....79	6A87.....78	6J7.....72	7S7.....1.29	25Z6.....60
1I4E.....1.19	6A95.....46	6K7.....49	7V7.....1.06	280T.....1.29
1L4A.....1.01	6A97.....68	6J7.....72	7S7.....1.29	25Z6.....60
1L8A.....1.09	6A9F.....1.18	6K6.....49	7V7.....1.06	280T.....1.29
1L9E.....89	6A9S.....50	6K7.....46	7X6.....89	35A1.....71
1L05.....98	6A9T.....1.14	6L5.....1.09	12A6.....48	35A5.....54
1L3E.....99	6A9H.....88	6L6.....98	12A8.....79	35B5.....54
1L4E.....1.01	6A9K.....62	6L7.....80	12A7.....92	35C5.....71
1L4H.....1.01	6A9S.....46	6L7.....80	12A6E.....68	35Z4.....64
1L4S.....1.01	6A9K.....74	6N7.....80	12A12A5.....54	35V4.....58
1Q5.....1.19	6A9L.....42	6S4.....42	12A7E.....42	35Z3.....69
1R4.....96	6A9T.....1.22	6S7.....54	12A7T.....68	35Z4.....46
1U5.....42	6A9E.....46	6S7.....54	12A6E.....68	35Z5.....46
1S4.....88	6A9Q.....54	6S7.....54	12A7.....74	39A4.....56
1S5.....42	6A9R.....2.74	6S7.....54	12A7E.....68	35Z3.....46
1U5.....42	6A9S.....46	6S7.....54	12A6E.....68	35Z4.....46
1T5.....98	6A9T.....3.48	6S7.....54	12A7.....74	39A4.....56
1U4.....46	6A9T.....42	6S7.....54	12A7E.....68	35Z3.....46
1U5.....42	6A9S.....46	6S7.....54	12A6E.....68	35Z4.....46
1V2.....42	6A9V.....84	6S7.....54	12A7.....74	39A4.....56
1X2A.....62	6A9V.....48	6S7.....54	12A7E.....68	35Z3.....46
2A5.....2.37	6A9X.....81	6S7.....54	12A6E.....68	35Z4.....46
2V3.....2.90	6A9C.....60	6S7.....54	12A7.....74	39A4.....56
			12C8.....62	11Z3.....68



Burton Browne / Ne



**He's proving Pyramid Imps are better!**

**These molded paper tubular capacitors are smaller and better; will operate at full rated voltage at 100°C with less than 2% change in capacitance; will meet test requirements of Government specifications MIL-C-91A; copperweld leads are securely imbedded.**

**These features, plus an almost indestructible thermo-setting plastic encasement make Pyramid Imps your best molded paper tubular capacitor.**

For full information on Pyramid capacitors and rectifiers, see your local distributor or write 13

**DISTRIBUTOR DIVISION  
PYRAMID  
ELECTRIC CO.**

1445 Hudson Blvd., North Bergen, N. J.



# THE GREAT NEW NAME IN ALUMINIZED PICTURE TUBES!



**RCA**  
**Silverama**

**your new  
replacement  
profit-maker**

**sizes to fit  
virtually all  
sets**

**heavily  
consumer  
advertised**

**RCA "SILVERAMA" MEANS BRIGHTER, CLEARER, SHARPER TV PICTURES FOR YOUR CUSTOMERS—MORE REPLACEMENT BUSINESS, SALES AND PROFITS FOR YOU!**

It's the great, new replacement line of RCA aluminized picture tubes and RCA is telling the world, your city and neighborhood about it. Radio & TV announcements, national magazines, direct mail, posters, streamers, counter cards and other powerful sales aids will bring the remarkable story of RCA "SILVERAMA" right into your customers' homes—bring customers into your store! Order RCA "Silverama" Aluminized Picture Tubes now. Your customers will ask for them. Get on board this new profit-maker!

**SEE YOUR RCA TUBE DISTRIBUTOR TODAY FOR FULL DETAILS ON THE EXCITING RCA SILVERAMA WINDOW DISPLAY CONTEST FOR SERVICE DEALERS!**



**RADIO CORPORATION of AMERICA**

**TUBE DIVISION**

**HARRISON, N. J.**