

PRINTED CIRCUITS ARE EASY!

SEPTEMBER 1955

# RADIO - ELECTRONICS

TELEVISION • SERVICING • HIGH FIDELITY

HUBB GERNSBACH, Editor



In this issue:

• Tube-and-Transistor  
Radio

• More Efficiency with  
Multiple Speakers

• More on the  
Color Matrix

• Demodulator Probe  
with Transistor

35¢

U. S. and  
CANADA

Scientific Record

(See page)

www.americanradiohistory.com

ELIZABETH I N J  
434 FULTON ST  
% PAUL S BOLLARO  
FULTON T V 3-57



**TWIN-SCREEN**  
**HI-LITE**  
**Picture-Tubes**

*Every one is bright and sharp!*

It's no accident that Du Mont's new Twin-Screen Hi-Lite picture tubes provide richer contrasts and sharper focus. They feature the sharp focus of the Hi-R gun design plus the extra brightness of an aluminized screen. Furthermore, *each* Twin-Screen Hi-Lite is purposely put through the same stringent tests to assure only the best of quality in outgoing products.

These outstanding uniform qualities are your guarantee that you always get a better picture tube when you specify Du Mont Twin-Screen Hi-Lite — And they cost no more than ordinary aluminized replacement types!

Ask your distributor for Du Mont "Twin-Screen Hi-Lite" the next time you buy picture tubes.

**DU MONT**

Cathode-ray Tube Division, Replacement Sales, Allen B. Du Mont Laboratories, Inc., Clifton, N. J.

**DU MONT**  
**HI-R ELECTRON GUN**

Exclusive with Du Mont! Recognized  
by customers and competitors alike as  
the finest gun available today.





# I Will Send You BOTH FREE

J. E. SMITH, President  
National Radio Institute  
Washington 9, D. C.

**ACTUAL LESSON**

**The ABC's of SERVICING**

**How to be a SUCCESS in RADIO-TELEVISION**

**64 PAGE BOOK**

## See How I Train You at Home in Spare Time for Good Pay Jobs in RADIO-TELEVISION

### You Practice Broadcasting with Equipment I Send



As part of my Communications Course I send you kits of parts to build the low-power Broadcasting Transmitter shown at left. You use it to get practical experience putting this station "on the air," to perform procedures required of broadcasting station operators. An FCC Commercial Operator's license can be your ticket to a better job and a bright future. My course gives you the training you need to get your license. Mail coupon below. See in my book other valuable equipment you build and keep.

### You Practice Servicing with Equipment I Send

Nothing takes the place of PRACTICAL EXPERIENCE. That's why NRI training is based on LEARNING BY DOING. You use kits of parts I furnish to build many circuits common to both Radio and Television. With my Servicing Course you build the modern receiver shown at right. You also build an Electronic Multimeter which you can use to help fix sets while training at home. Many students make \$10, \$15 a week extra fixing neighbors' sets in spare time, starting soon after enrolling. I send you special booklets that show you how to fix sets. Mail coupon for 64-page book and actual Servicing Lesson, both FREE.



TRAINING plus OPPORTUNITY is the PERFECT combination. The sample lesson I send will prove to you that it is practical to keep your job while TRAINING right in your own home for better pay and a brighter future. My 64-page book should convince you that Radio-Television is truly today's field of OPPORTUNITY.

### TELEVISION MAKING JOBS, PROSPERITY

Radio, even without Television, is bigger than ever. 115 million home and auto Radios create steady demand for service. 3000 Radio stations give interesting, good pay jobs to operators, technicians. NOW ADD TELEVISION. 25 million Television homes and the total growing rapidly. 200 Television stations on the air and hundreds more under construction. Color Television soon to be a reality. Government, Aviation, Police, Ship, Micro-wave Relay, Two-way Communications for buses, taxis, trucks, railroads are growing fields providing good jobs for men who know Radio-Television. All this adds up to good pay now, a bright future later for men who qualify.

### START SOON TO MAKE \$10, \$15 A WEEK EXTRA

An important benefit of Radio-Television training is that you can start to cash in fast. Many men I train fix neighbors' sets, make extra money, starting soon after they enroll. Multimeter built with parts I send helps locate and correct set troubles. Read at left how you build actual equipment that gives you practical experience, brings to life what you learn from my lessons.



### MEN OF ACTION NEEDED MAIL COUPON TODAY

Act now to enjoy more good things of life. Get the benefit of my 40 years' experience training men at home. Take NRI training for as little as \$5 a month. Many NRI graduates (some with only a grammar school education) make more in two weeks than the total cost of training. Find out about this tested way to better pay. Mail coupon below today for Actual Lesson and 64-page Book—BOTH FREE. J. E. SMITH, President, National Radio Institute, Dept. 5JFT, Washington 9, D. C. OUR 40TH YEAR.

### I TRAINED THESE MEN AT HOME



"Started repairing Radios six months after enrolling. Earned \$12 to \$15 a week spare time."—ADAM KRAMLIK, JR., Summertown, Pennsylvania.



"Am with WCOC. NRI course can't be beat. Passed exam for first class Radio-telephone license with no trouble at all."—JESSE W. PARKER, Meridian, Miss.



"I've come a long way in Radio and Television since graduating. Have my own business on Main Street."—JOE TRAVERS, Asbury Park, New Jersey.



"Am with WNBZ as video control engineer on RCA color project. Owe a lot of my success to your textbooks."—WARREN DEEM, Malverne, N. Y.



"Manager of meat market when I began. Answered ad for Radio serviceman. Got job. Pay increased 50% in year."—C. CARTER, San Bernardino, California.

**AVAILABLE TO VETERANS UNDER GI BILLS**

### Good for Both—FREE

Mr. J. E. SMITH, President, Dept. 5JFT, National Radio Institute, Washington 9, D. C.

Mail me Sample Lesson and 64-page Book, FREE. (No salesman will call. Please write plainly.)

Name.....Age.....

Address.....

City.....Zone.....State.....

**VETS** write in date of discharge

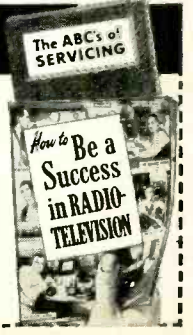

# RADIO - ELECTRONICS

Formerly RADIO CRAFT • Incorporating SHORT WAVE CRAFT • TELEVISION NEWS • RADIO & TELEVISION\*

Hugo Gernsback  
Editor and Publisher  
M. Harvey Gernsback  
Editorial Director  
Fred Shunaman  
Managing Editor  
Robert F. Scott  
W2PWG, Technical Editor  
Jerome Kass  
Associate Editor  
I. Queen  
Editorial Associate  
Matthew Mandl  
Television Consultant  
Angie Pascale  
Editorial Production  
Wm. Lyon McLaughlin  
Tech. Illustration Director  
Sol Ehrlich  
Art Director

Lee Robinson  
General Manager  
John J. Lamson  
Sales Manager  
G. Aliquo  
Circulation Manager  
Adam J. Smith  
Director, Newsstand Sales  
Robert Fallath  
Promotion Manager

## GERNSBACK PUBLICATIONS, INC.

Executive, Editorial and Advertising Offices, 25 West Broadway, New York 7, N. Y. Telephone REctor 2-8630.

Hugo Gernsback  
Chairman of the Board  
M. Harvey Gernsback  
President  
G. Aliquo  
Secretary

### ON THE COVER:

(Story on page 64) Oceanographer Marie Poland Fish records the sounds made by a deep-water fish, at the Narragansett Marine Laboratory in Kingston, R. I.

Color original by Dan Rubin



SEPTEMBER 1955

Vol. XXVI, No. 9

### Editorial (Page 33)

The Giant Electronics Industry..... 33

### Radio (Pages 34-43)

Making Printed Circuits Is Easy..... by Tom Jaski 34  
Common-Collector Transistor Amplifiers..... by Rufus P. Turner 37  
Flexible Radio Control System, Part II—  
The radio receiver and control system..... by Richard H. Dorf 38  
Contact Potential..... by H. P. Manly 41  
Tube and Transistor Radio..... by Irving Gottlieb 42  
A.C. Voltbox..... by Rufus Turner 43

### Test Instruments (Pages 44-50)

New Test for Capacitor Leakage..... by Robert G. Middleton 44  
Transistor Demodulator Probe..... by Homer L. Davidson 47  
Transistor Performance..... by Edward D. Padgett 48

### Television (Pages 51-63)

Convergence . . . Not Impossible but Difficult,  
Part I—Rainbows in black-and-white picture;  
author suspects convergence troubles..... by Harold Davis 51  
More on the Matrix..... by Robert G. Middleton 53  
Television . . . it's a Cinch, Eighteenth conversation, first half:  
The trichromatic principle; transmission problems;  
simultaneous or sequential; saving the fine detail;  
how to carry the color inside the 6-mc band..... by E. Aisberg 56  
Converting 630 Receivers to Intercarrier Operation..... by Howard Bierman 59  
TV Service Clinic..... Conducted by Jerry Kass 62

### Audio—High Fidelity (Pages 64-108)

Noisy Fishes (Cover Feature)..... by Eric Leslie 64  
Transplanting Amplifiers..... by Charles L. Hansen 65  
Circuit Features in Hi-Fi Power Amplifiers..... by Robert F. Scott 79  
For Golden Ears Only: National's Criterion FM-AM tuner;  
Heathkit audio analyzer; new records review..... by Monitor 84  
Designing an Ultra-Linear Amplifier..... by Edward S. Miller 92  
Multiple Speakers for High Fidelity..... by Joseph Marshall 100

### Electronics (Pages 112-129)

Boat Electrolysis..... by Elbert Robberson 112  
Giant Paraboloid Detects Radio Stars..... by R. Hanbury Brown 120

### DEPARTMENTS

Books .....	162	People .....	154
Business .....	157	Question Box .....	142
Corrections .....	156, 161	Radio Month .....	6
Correspondence .....	14	Radio-Electronics Circuits .....	139
Miscellany .....	151	Technical Literature .....	161
New Devices .....	132	Technicians' News .....	147
New Tubes and Transistors .....	137	Technotes .....	145
Patents .....	149	Try This One .....	152

Average Paid Circulation over 175,000

RADIO-ELECTRONICS, September, 1955, Vol. XXVI, No. 9. Published monthly at Mt. Morris, Ill. by Gernsback Publications, Inc. Second-class mail privileges authorized at Mt. Morris, Ill. Copyright 1955 by Gernsback Publications, Inc. Text and illustrations must not be reproduced without permission of copyright owners.

**SUBSCRIPTIONS:** Address correspondence to Radio-Electronics, Subscription Dept., 404 N. Wesley Ave., Mt. Morris, Ill., or 25 West Broadway, New York 7, N. Y. When ordering a change please furnish an address stencil impression from a recent wrapper. Allow one month for change of address.

**SUBSCRIPTION RATES:** U. S., U. S. possessions and Canada, \$3.50 for one year; \$6.00 for two years; \$8.00 for three years; single copies 35c. Pan-American countries \$4.00 for one year; \$7.00 for two years; \$9.50 for three years. All other countries \$4.50 a year; \$8.00 for two years; \$11.00 for three years.

**BRANCH ADVERTISING OFFICES:** Chicago: 7522 North Sheridan Road, Tel. ROGers Park 4-8000. Los Angeles: Ralph W. Harker and Associates, 600 South New Hampshire, Tel. DUnkirk 7-2323. San Francisco: Ralph W. Harker and Associates, 582 Market St., Tel. GArdfield 1-2481. **FOREIGN AGENTS:** Great Britain: Atlas Publishing and Distributing Co., Ltd., London E.C. 4. Australia: McGill's Agency, Melbourne. France: Brentano's, Paris 2e. Belgium: Agence et Messageries de la Presse, Brussels. Holland: Trilectron, Heemstede. Greece: International Book & News Agency, Athens. So. Africa: Central News Agency Ltd., Johannesburg. Capetown. Natal. Universal Book Agency, Johannesburg. Middle East: Stelmatsky Middle East Agency, Jerusalem. India: Broadway News Centre, Dadar, Bombay #14. Pakistan: Paradise Book Stall, Karachi 3. **POSTMASTER:** If undeliverable send form 3578 to: RADIO-ELECTRONICS, 25 West Broadway, New York 7, N. Y. \*Trademark registered U. S. Patent Office.

# ADVANCE! Raise your earning power—learn RADIO-TELEVISION-ELECTRONICS by SHOP-METHOD HOME TRAINING

## GOOD JOBS AWAIT THE TRAINED RADIO-TV TECHNICIAN

There is a place for *you* in the great Radio-Television-Electronics industry when you are trained as National Schools will train you at home!

Trained technicians are in growing demand at good pay—in manufacturing, broadcasting, television, communications, radar, research laboratories, home Radio-TV service, and other branches of the field. National Schools Master Shop-Method Home Training, with newly added lessons and equipment, trains you in your spare time, right in your own home, for these fascinating opportunities. **OUR METHOD IS PROVED BY THE SUCCESS OF NATIONAL SCHOOLS TRAINED MEN, ALL OVER THE WORLD, SINCE 1905.**

## EARN WHILE YOU LEARN

Many National students pay for all or part of their training with spare time earnings. We'll show you how you can do the same! Early in your training, you receive "Spare-time Work" Lessons which will enable you to earn extra money servicing neighbors' and friends' Radio and Television receivers, appliances, etc.

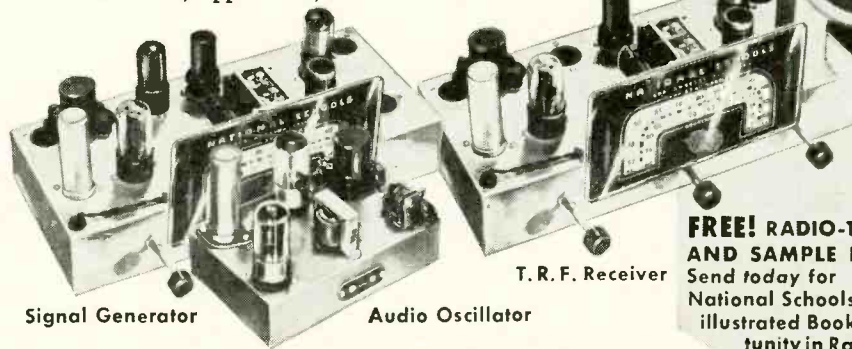

Signal Generator

Audio Oscillator

T. R. F. Receiver

## National Schools Training is All-Embracing

National Schools prepares you for your choice of many job opportunities. Thousands of home, portable, and auto radios are being sold daily—more than ever before. Television is sweeping the country, too. Co-axial cables are now bringing Television to more cities, towns, and farms every day! National Schools' *complete* training program qualifies you in all fields. Read this partial list of opportunities for trained technicians:

- Business of Your Own • Broadcasting
  - Radio Manufacturing, Sales, Service • Telecasting
  - Television Manufacturing, Sales, Service
  - Laboratories: Installation, Maintenance of Electronic Equipment
  - Electrolysis, Call Systems
  - Garages: Auto Radio Sales, Service
  - Sound Systems and Telephone Companies, Engineering Firms
  - Theatre Sound Systems, Police Radio
- And scores of other good jobs in many related fields.

## TELEVISION TRAINING

You get a complete series of up-to-the-minute lessons covering all phases of repairing, servicing and construction. The same lesson texts used by resident students in our modern and complete Television broadcast studios, laboratories and classrooms!



## MASTER ALL PHASES!

Get Master Shop-Method Home Training from an Established School with its own Training with its own Training Successful Experience in Training Ambitious Men.



Shops, Laboratories, Studios — almost 50 Years of Successful Experience in Training Ambitious Men.

**We Bring National Schools To You!**

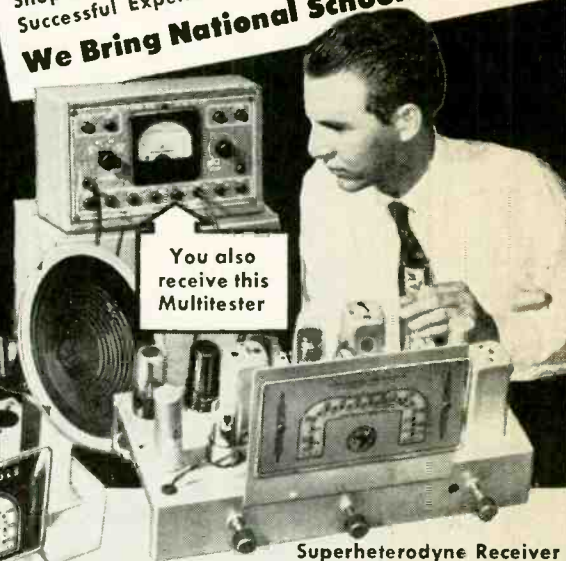

You also receive this Multitester

Superheterodyne Receiver

## LEARN BY DOING

You receive and keep all the modern equipment shown above, including tubes and valuable, professional quality Multitester. *No extra charges.*

## FREE! RADIO-TV BOOK AND SAMPLE LESSON!

Send today for National Schools' new, illustrated Book of Opportunity in Radio-Television-Electronics, and an actual Sample Lesson. **No cost—no obligation.** Use the coupon now—we'll answer by return airmail.

**APPROVED FOR VETERANS AND NON-VETERANS**  
Check coupon below

**Both Resident and Home Study Courses Offered!**

## NATIONAL SCHOOLS

TECHNICAL TRADE TRAINING SINCE 1905  
Los Angeles 37, California • Chicago: 323 W. Polk Street, In Canada: 811 West Hastings Street, Vancouver, B. C.



## GET FACTS FASTEST! MAIL TO OFFICE NEAREST YOU!

(mail in envelope or paste on postal card)

**NATIONAL SCHOOLS, Dept. RG-95**

4000 S. Figueroa Street Los Angeles 37, Calif. or 323 West Polk Street Chicago 7, Ill.

Send FREE Radio-TV Electronics book and FREE sample lesson. No obligation, no salesman will call.

NAME \_\_\_\_\_ BIRTHDAY \_\_\_\_\_ 19\_\_

ADDRESS \_\_\_\_\_

CITY \_\_\_\_\_ ZONE \_\_\_\_\_ STATE \_\_\_\_\_

Check here if interested ONLY in Resident Training at Los Angeles. VETERANS: Give Date of Discharge \_\_\_\_\_

# the Radio month



**TV STATION SATURATION** in the U. S. was placed at 673 by CBS researchers. This includes the approximately 430 stations now in operation as well as prospective ones that now possess construction permits or have applications on file before the FCC. CBS says this is due to economic limitations, the high cost of installation and operation making it too costly to function in small towns and sparsely settled areas. This adds up to an expectancy of fewer than 250 more stations.

**TRANSISTORIZED** phonograph has been demonstrated recently by Philco. The unit, using three transistors, will play up to 3,000 standard 45-r.p.m. records using the power supplied by 4 flashlight cells. Because of the extremely low current drain, 150 hours of continuous operation are possible. Fresh cells can be quickly inserted through a trapdoor at the bottom of the cabinet.

The phonograph uses the smallest turntable motor on the market, a 4-volt unit weighing less than 3 ounces and approximately one-fifth the size of a conventional motor. A printed wire chassis is used (see photo) and the tone arm acts as the on-off switch, stopping the turntable and turning off the phonograph after each record.

This transistorized phonograph fol-

lows shortly the Philco announcement of a transistorized auto radio (Radio Month, July, 1955).

**PROJECT TINKERTOY**, code name for a system of automatic mass production of electronic devices (RADIO-ELECTRONICS December, 1953) developed jointly by the Navy Bureau of Aeronautics and the National Bureau of Standards about 2 years ago, will shortly make its appearance in Du Mont TV receivers. The Compac module made by A. C. F. Industries, Alexandria, Va., is presently undergoing engineering tests at Du Mont. A. C. F. says its module is of a stacked wafer design and will, as a single unit, replace about two-thirds of the components within a TV set at about the same cost.

**ELECTRONIC FISHING** aid has been invented in Japan that has the professional fishermen agog. The device, based on the theory that an underwater radio beam will be followed to its source by fish, consists of a small "radio-beam generator" in the center of a large Y-shaped net.

Professor Ando of Ehime University, Japan, inventor of the unit, said its first tryout was highly successful, "We just dropped the net into the water and the fish swam into it in droves."



The Philco transistorized phonograph—component parts are shown at right.

you are invited by  
*Electro-Voice* to...

## WIN!

1. "WEEK-END WITH HI-FI!"
2. LIFETIME OF HI-FI MUSIC!

As always, Electro-Voice is FIRST! Now E-V sponsors this unique and exciting contest. For a lifetime after this glorious listening experience you will judge music reproduction equipment by its ability to approach the perfection already achieved by E-V sound matched high fidelity components and loudspeaker systems!

### WIN this "Double-Size" FIRST PRIZE!

- 1 **Week-End with High Fidelity ALL-EXPENSE-PAID** week-end trip for two . . . from wherever you enter the contest to Electro-Voice—the Home of High Fidelity! *Take part* in the assembly of your own wonderful prize, if you wish.
- 2 **Lifetime of High Fidelity Music** with your own incomparable *Patrician 4-way* audio reproducer *and* the beautiful *Peerage* console complete with all equipment!

### 9 MORE PRIZES!

- 3 **SECOND PRIZES** . . . magnificent E-V 15TRX 15 in. three-way speakers!
- 3 **THIRD PRIZES** . . . outstanding E-V 12TRX 12 in. three-way speakers!
- 3 **FOURTH PRIZES** . . . powerful E-V 12TRXB 12 in. three-way speakers!

Just two pleasant steps: (A) Hear E-V high fidelity demonstrated by your E-V Distributor. (B) Fill in and mail the official entry blank, provided by E-V Distributor. (Be sure the salesman signs your entry blank.) Contest starts August 1, 1955. Contest closes at midnight, September 30, 1955.

*Electro-Voice* ELECTRO-VOICE, INC.  
BUCHANAN, MICHIGAN

Gentlemen: I want a chance to win a "Week-End with High Fidelity." Please send me the names of nearest *participating* E-V Distributors.

Name \_\_\_\_\_

Address \_\_\_\_\_

City \_\_\_\_\_ Zone \_\_\_\_\_ State \_\_\_\_\_

My nearest large trading center is \_\_\_\_\_



Work over  
**300** projects  
with your  
wonderful HOME  
LABORATORY



**21 INCH**  
Build and keep D.T.I.'s NEW  
2 Unit TV set—ideal for cus-  
tom installation. (D.T.I. also  
offers home training with-  
out the TV set.)

Use and keep ALL these units to get  
all-important PRACTICAL EXPERIENCE

NOW... at home... get D.T.I.'s  
amazingly effective **NEW** training in  
**TELEVISION**

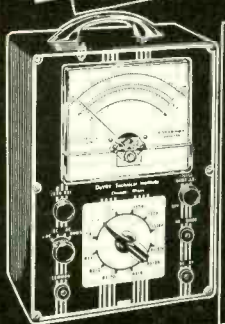

**NEW!**  
Build and keep  
D. T. I.'s new  
VACUUM TUBE  
VOLTMETER...  
one of the most  
useful of all test  
instruments.

**RADIO-ELECTRONICS!** Nothing else like it for providing real LABORATORY-  
TYPE training at home. Get the kind of thorough, practical experience YOU NEED  
for the kind of progress YOU WANT in today's tremendous field of Television,  
Radio and Electronics. Qualify yourself for real money... interesting work...  
a wonderfully promising future. And when you finish, D.T.I.'s active Employment  
Service HELPS YOU GET STARTED! Or open your own profitable Television-Radio  
Service Business.



**5 INCH**  
"SCOPE"

ABOVE: Also build  
and keep this quality  
Oscilloscope—almost  
a "must" for Televi-  
sion servicing.



**Exclusive  
HOME  
MOVIES**  
help you grasp  
important points  
**FASTER...  
EASIER...  
BETTER.**  
A tremendous  
advantage!

**THOUSANDS OF SUCCESSFUL GRADUATES**

WHY has D.T.I. become one of the largest training organizations  
of its kind? Because it provides EVERY MAJOR HOME TRAINING  
AID to help make the subject EASIER to learn... EASIER to re-  
member—the kind of training so helpful for REAL PROGRESS.  
Students get thorough, up-to-date, practical training that TAKES  
ADVANTAGE of new and improved training developments.  
Study the ADVANTAGES shown on this page. Think what they  
can mean to YOU... to YOUR FUTURE! Or come to D.T.I.'s  
big Training Laboratories in Chicago. MAIL COUPON TODAY  
for complete facts—including valuable publication, "89 Ways  
to Earn Money in Television-Radio-Electronics." Also, valuable  
information for men subject to MILITARY SERVICE.

"One of America's Foremost Television Training Centers"

**DeVRY**  
**Technical Institute**  
CHICAGO 41, ILLINOIS  
Formerly DeFOREST'S TRAINING, INC.

Remarkable NEW Styrene  
**ELECTRO-LAB\***

Insert pictorial diagram on transparent styrene  
base. (See insert.) Mount parts to follow  
pattern—using handy "snap in" fasteners.  
Eliminates wiring errors. Tops for speedy  
circuit changes... for providing maximum  
circuit experience in minimum  
time. Build and operate scores of  
interesting projects—such as the  
electronic circuit shown below.

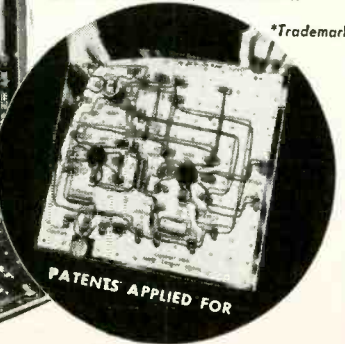

\*Trademark

PATENTS APPLIED FOR

**MAIL COUPON TODAY**

DeVRY TECHNICAL INSTITUTE  
4141 Belmont Ave., Chicago 41, Ill. Dept. RE-9-L

I would like complete facts including "89 Ways  
to Earn Money in Television-Radio-Electronics."

Name \_\_\_\_\_ Age \_\_\_\_\_  
Street \_\_\_\_\_ Apt. \_\_\_\_\_  
City \_\_\_\_\_ Zone \_\_\_\_\_ State \_\_\_\_\_  
1 D.T.I.'s training is available in Canada.



Movie Screen Brightness  
for Your TV Picture

Magic Mirror  
**TUNG-SOL**  
**Aluminized**  
PICTURE TUBE

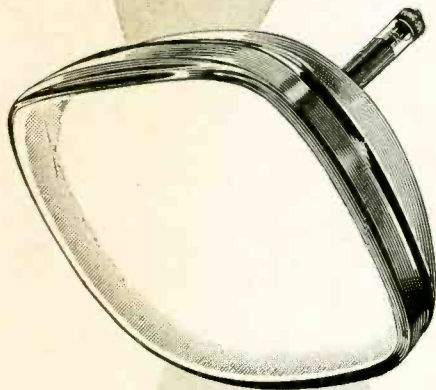

Yes, you can have a sharper, clearer TV picture . . . a picture with all the depth and detail you enjoy on the movie screen.

The Tung-Sol "Magic-Mirror" Aluminized Picture Tube gives you deeper blacks, more brilliant highlights and in-between tones that will make your picture fairly come alive. So treat yourself to new TV viewing pleasure with a Tung-Sol "Magic-Mirror" Aluminized Picture Tube.

The finest TV sets are factory-equipped with receiving and picture tubes made by Tung-Sol—one of America's leading electron tube manufacturers.

**TUNG-SOL ELECTRIC INC., Newark 4, N. J.**

Sales Offices: Atlanta, Chicago, Columbus, Culver City (Los Angeles), Dallas, Denver, Detroit, Montreal (Canada), Newark, Seattle.

**TUNG-SOL** Automotive and Electronic Products

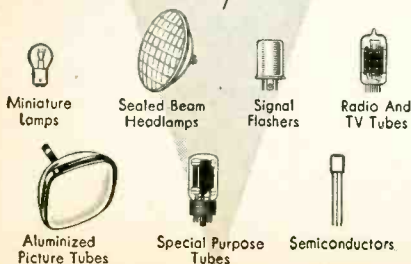

THE RADIO MONTH

**SOLDERLESS CONNECTIONS** are being used in current RCA television chassis. The connections consist of six or seven turns of wire tightly wrapped on a "stake" or terminal (see diagram). The wire is wrapped with a power tool similar to an electric hand drill. The machine spins the wire on the terminal

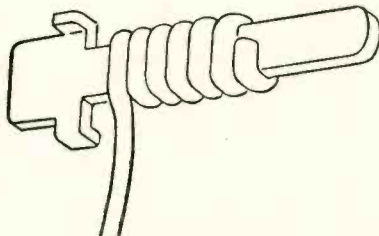

with such force that the corners of the terminal bite into the copper wire, forming a positive contact held in place by the tension of the many turns of wire.

These connections are used in many locations in the receiver, but most frequently on the printed-circuit boards. RCA recommends that should this wire-wrap joint be disconnected, it should be reconnected by soldering, not by rewinding. The wrapped connection is said to be mechanically and electrically equal to soldered connections.

**EDUCATIONAL TV AUDIENCE** will reach almost 46 million when the 13 educational television stations now under construction are completed. This estimate is based on a survey conducted by the National Citizens Committee for Educational Television. About 100 additional cities have shown sufficient interest in educational TV to appoint ways and means committees.

Of the new stations under construction, 6 are community type, owned and operated by nonprofit corporations; 3 will be under the control of educational institutions and 4 will become part of state networks.

Of the 13 stations under construction, 11 will be v.h.f., the other 2 u.h.f. At present, there are 13 educational TV stations on the air; 10 are v.h.f. and 3 are u.h.f.

**TV ON ASIATIC MAINLAND** has swung into action as a powerful supporter of freedom in Asia. The station, located in Bangkok, Thailand, is the first of its kind on the Asia mainland (Japan and the Philippine Islands have TV) and is a Government-sponsored agency known as the Thai Television Co. The Government plans to use TV as a mass-scale education medium.

As announced by Meade Brunet, managing director of the RCA International Division, more than a year ago the Thai Government sent seven Thai engineers to the United States for training with RCA Institutes and the National Broadcasting Co. The Asian station uses modern apparatus, including the latest type RCA 11-kw transmitter, and mobile TV unit for remote telecasts.

(Continued)

**TWO NEW TV STATIONS** began operation and one left the air since last month's report. KRNT-TV, Des Moines, Iowa, began operation June 20, on channel 8. A new Canadian starter, CBOFT, channel 9, Ottawa, Ont., is the only North American station with an unhyphenated five-letter call. It will broadcast in French exclusively.

The station leaving the air is WNET, Providence, R. I., channel 16.

WWLP, Springfield, Mass., changed frequency from channel 61 to channel 22 on July 2.

**VERSATILITY** is the design keynote of a transistorized portable radio demonstrated by Capehart-Farnsworth. The tiny unit, no larger than a pack of king-size cigarettes and weighing only 6.4 ounces, can be operated with a miniature earphone, with a matching speaker about its own size, or installed in an ashtray base with a larger speaker (see photo) and powered by a.c. When used with the "ashtray speaker," the volume and sensitivity compare with that of a five-tube radio.

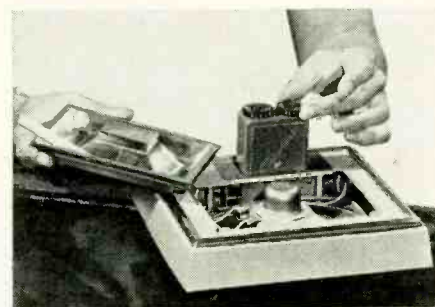

**RADAR SPEED CHECK** has been held admissible in court. In a recent decision by the New Jersey Supreme Court against a bus company, the jurists ruled that evidence of speeding obtained by properly operated radar equipment may be used in court and "may readily support a finding of guilt."

Attorneys for the bus company argued that a recording device attached to the bus showed the speed limit was not exceeded, and that the radar equipment was not calibrated properly.

**FLOATING TV STATION** is the plan of television experts and businessmen for providing video signals for South Africa's four biggest ports. Operated 3 miles offshore, in international waters, the sea-going transmitter will beam programs to Durban, Capetown, Port Elizabeth and East London.

A member of the group planning the project said that it has been proved in the United States that an independent TV station can be an economical proposition in a city with about 50,000 inhabitants. He said further, "Such a station could give excellent service to any of the four cities in turn, and two 'floating stations' could give each of these ports a daily service.

"Operating 3 miles out to sea would also do away with a number of technical difficulties, for there would be no mountains or other such obstacles." END



Six months from today

Which Will  
You Hold?

this-

or this

REGRET TO ADVISE  
YOU FAILED YOUR  
FCC EXAMINATIONS-

1<sup>ST</sup> CLASS  
RADIO TELEPHONE  
OPERATOR'S LICENSE

Add Technical Training  
To Your Practical Experience-  
**GET YOUR FCC LICENSE  
IN A HURRY!**

Then use our Amazingly Effective  
JOB-FINDING SERVICE

Money-Making  
FCC  
Commercial  
Radio Operator  
LICENSE  
Information

ENGINEERING  
INCLUDED IN OUR  
TRAINING & COACHING

Get This  
Valuable Booklet  
**FREE!**

● TELLS HOW-

● TELLS HOW-

**Here Is Your  
GUARANTEE**

If you fail to pass your Commercial License exam after completing our course, we guarantee to continue your training without additional cost of any kind until you successfully obtain your Commercial License.

**WE GUARANTEE**

TO TRAIN AND COACH YOU  
AT HOME IN  
SPARE TIME UNTIL YOU GET

**YOUR FCC LICENSE**

If you have had any practical experience—amateur, Army, Navy, radio repair, or experimenting.

● TELLS HOW-

Employers make **JOB OFFERS** Like These  
to Our Graduates Every Month

Broadcast Station in Illinois: "We are in need of an engineer with a first class phone license, preferably a student of CIRE; 40 hour week plus 8 hours overtime."

West Coast Manufacturer: "We are currently in need of men with electronics training or experience in radar maintenance, and we would appreciate if you will refer interested persons to us."

These are just a few examples of the job offers that come to our office periodically. Some licensed technician filled each of these jobs . . . it might have been you!

HERE'S PROOF FCC LICENSES ARE OFTEN  
SECURED IN A FEW HOURS OF STUDY WITH  
OUR COACHING AT HOME IN SPARE TIME.

Name and Address	License	Lessons
A/IC Ronald H. Person St. Louis 20, Mo.	1st	25 weeks
Carl Verboom Wrightstown, Wis.	1st	18 weeks
Marvin F. Kimball Lafayette, Ind.	2nd	21 weeks
L. M. Bonino Harlingen AFB, Tex.	2nd	16 weeks
John E. Hutchison Bluefield, W. Va.	1st	27 weeks

Carl E. Smith, E.E., Consulting Engineer, President  
CLEVELAND INSTITUTE OF RADIO ELECTRONICS  
DESK RE-80, 4900 Euclid Bldg., Cleveland 3, Ohio

**EFFECTIVE JOB-FINDING SERVICE  
HELPS CIRE TRAINEES GET BETTER JOBS**

Here Are Just a Few Recent Examples of Job-Finding Results:

**INDUSTRIAL ELECTRONICS**

"I have just started my new job at I.B.M. CIRE training helped me get the job. It also helped me get a good starting rate."  
Stanley Renfro, Beacon, New York

**MOBILE SERVICING**

"I am now employed by the Permian Basin Communications, Inc. and now manage the service shop in Odessa, Texas for Motorola 2-way communication equipment. I got the job through your Job Finding Services. My sincere thanks."  
Robert W. Cook, Odessa, Texas

**ELECTRONICS TECHNICIAN**

"I am now employed by the Collins Radio Company as a Jr. Lab Technician. (This job was listed in your bulletin.) I have used the information gathered from your course in so many ways and I know that my training with CIRE helped me a great deal to obtain this job."  
Charles D. Sindelar, Cedar Rapids, Iowa

OURS IS THE ONLY  
HOME STUDY  
COURSE WHICH  
SUPPLIES FCC-  
TYPE EXAMINA-  
TIONS WITH ALL  
LESSONS AND  
FINAL TESTS.

Your FCC Ticket is recognized by employers as proof of your technical ability.

**GET ALL 3 FREE!  
MAIL COUPON NOW**

Cleveland Institute of Radio Electronics  
Desk RE-80—3900 Euclid Bldg., Cleveland 3, Ohio  
(Address to Desk No. to Avoid Delay)

Please send at once, without obligation, your FREE booklet, "How to Pass FCC License Examinations" (does not cover exams for Amateur License); a sample FCC-type lesson and the important new information booklet, "Money-making FCC License Information." Be sure to tell me about your Television Engineering Course.

PLEASE PRINT CLEARLY

NAME..... AGE.....

ADDRESS.....

CITY..... ZONE..... STATE.....

FOR PROMPT RESULTS, SEND AIR MAIL  
Special tuition rates to members of the U.S. Armed Forces  
Electronic Training also available to Canadian Residents

An Approved  
Member



# the first NEW DESIGN of selenium rectifiers IN OVER 20 YEARS

*Kool-SEL*  
Pat. pend.  
by PYRAMID

No center mounting  
Full air ventilation between plates  
Light contact and constant assembly pressure  
No center hot spots  
Lightest weight per unit of output power  
Lower initial forward resistance—better voltage regulation  
Smaller overall size for each rating—cost no more  
Better for all electrical and electronic equipment because of

- Improved convection cooling
- Simpler mounting
- Longer life and minimum aging
- Designed for more rugged service and rated for use in high ambient temperatures

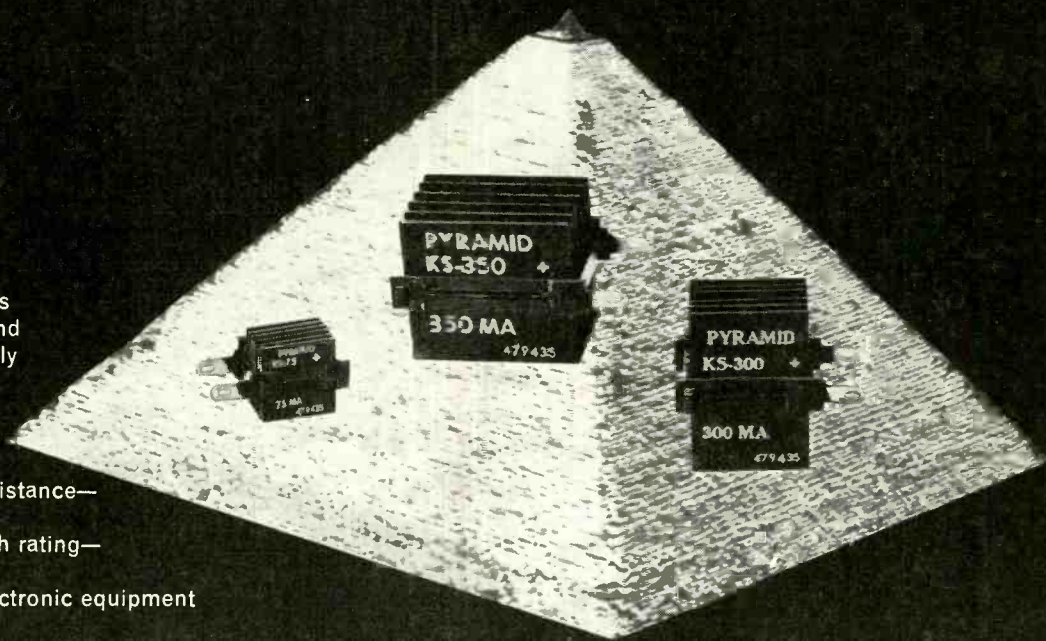

*Kool-SEL* **Important** is the rectifier most readily adaptable to printed circuit applications.

Because of the fixed edge mount yoke, assembly requires only one whist er die, one hole fixed, one hole variable to three dimensions. For complete information write

RECTIFIER DIVISION



**PYRAMID ELECTRIC COMPANY** North Bergen, N. J.

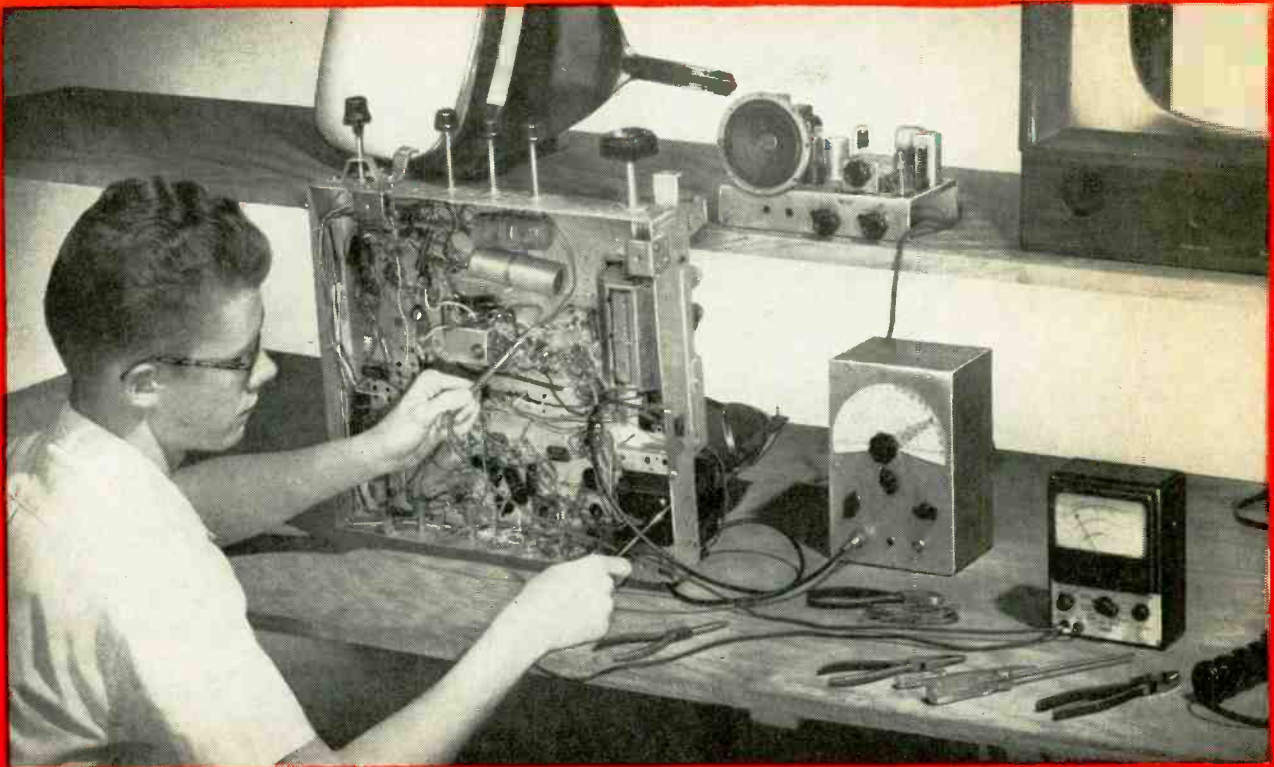

# NOW...RCA TRAINS YOU AT HOME IN RADIO-TV ELECTRONICS

**NEW AND UP-TO-DATE HOME STUDY COURSE** . . . Clearly written by men with years of servicing and teaching experience. Easy to understand . . . step-by-step instruction.

**NO PREVIOUS EXPERIENCE REQUIRED.** This Home Study Course was specifically prepared for students with no previous electronics training . . . for those who want a sound foundation in this exciting field.

**A PRACTICAL COURSE** . . . You receive completely workable kits and perform valuable experiments to demonstrate the theory learned. In fact, many students will be able to do service work *even before* they complete all the lessons.

**YOU BUILD AND KEEP THESE FINE INSTRUMENTS SHOWN**

- a multimeter
- a 6 tube superheterodyne receiver
- an r.f. signal generator
- a television receiver

**SINCE 1909, RCA INSTITUTES** has trained thousands of men in Radio-TV Electronics in our Resident Classes. Many have well-paying jobs in industry; some have established their own business. *Now* this opportunity is available to you at home.

**"PAY-AS-YOU-LEARN" PLAN** . . . There is no binding contract. You pay for one study group at a time, as you progress through the course. The cost for everything—including the high quality equipment that

you receive and build—is amazingly low. RCA INSTITUTES—a service of Radio Corporation of America—is licensed by the New York State Education Department . . . recommended by radio and television service organizations.

**SEND FOR  
FREE  
CATALOG  
NOW**



**RCA INSTITUTES, INC.**  
A SERVICE OF RADIO CORPORATION OF AMERICA  
350 WEST FOURTH STREET, NEW YORK 14, N.Y.

RCA Institutes, Inc., Home Study Dept. E95  
350 West 4th Street, New York 14, N. Y.

Without obligation, send me FREE CATALOG on the Home Study Course in Radio-TV Electronics. No salesman will call.

Name \_\_\_\_\_ Please Print

Address \_\_\_\_\_

City \_\_\_\_\_ Zone \_\_\_\_\_ State \_\_\_\_\_

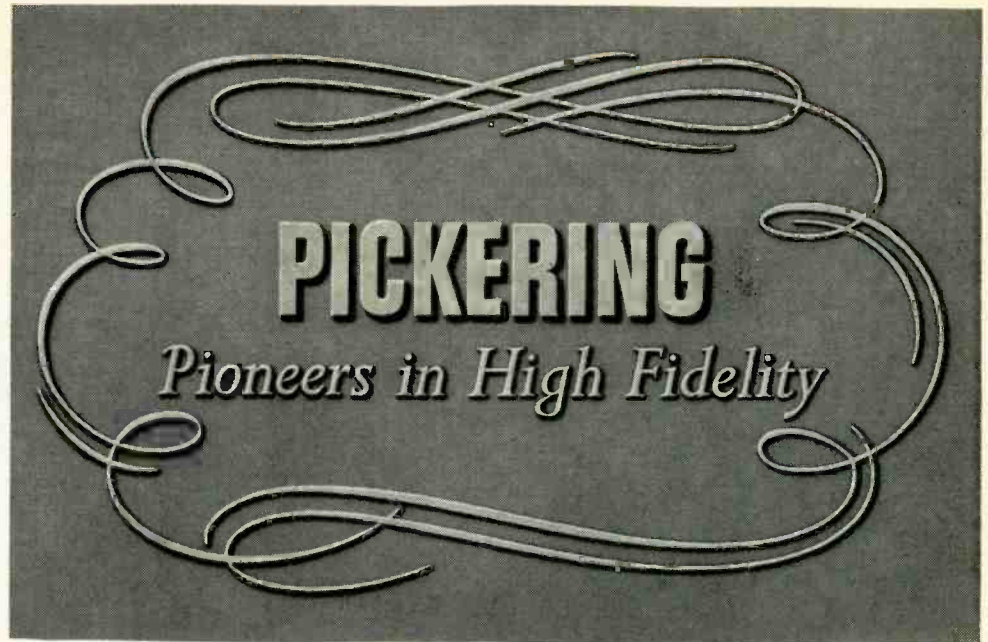
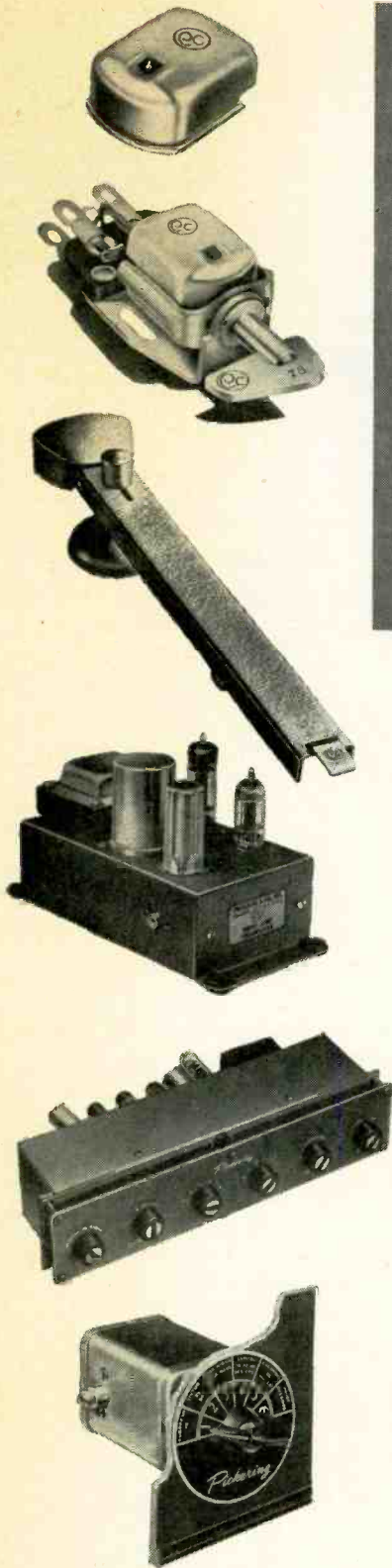

... and leaders today!

Ask those who know—the experienced professionals and the veteran hi-fi owners—and you'll get answers like these:

*"Pickering was first to introduce many high fidelity features that have become accepted standards today."*

*"Pickering has always been the pace-setter in the race for perfection."*

*"Pickering still sets the goals to which others aspire."*

There are good reasons for such praise. Every product bearing the Pickering name is *precision engineered* to give optimum performance. Each individual component is rigidly tested before it reaches the dealer ... subjected to the severest quality control procedures to make sure that every  component comes up to the high standards expected of Pickering equipment.

If you want the *best* that high fidelity can offer ... if you are willing to invest just a *little* more to get a *lot* more listening pleasure, now is the time to ask your dealer for a demonstration with Pickering components. See if you, too, don't *hear* the difference!



**PICKERING** and company incorporated • Oceanside, L.I., New York

**PICKERING PROFESSIONAL AUDIO COMPONENTS**

*"For those who can hear the difference"*

... Demonstrated and sold by Leading Radio Parts Distributors everywhere. For the one nearest you and for detailed literature; write Dept. P-8

*An Invitation to music-lovers*

FROM THE  
BOOK-OF-THE-MONTH CLUB

MAY WE SEND YOU—without charge—ANY ONE OF THESE

# MUSIC-APPRECIATION RECORDS

to demonstrate how much you can enhance your enjoyment of any great work of music when you are properly primed about **WHAT TO LISTEN FOR**



**ON ONE SIDE** there is a full performance of a great musical work. The records feature orchestras and soloists of recognized distinction in this country and abroad. You listen to this performance first, or afterward, as you desire, and then . . .



**ON THE OTHER SIDE** is an illuminating analysis of the music, with the themes and other main features of the work played separately with running explanatory comment, so that you can learn *what to listen for* in order to appreciate the work fully.

**T**HIS NEW IDEA is designed for those who enjoy good music but who are aware, too often, that they do not listen to it with complete understanding and appreciation. It is really a highly enjoyable form of self-education in music—for every member of the family. Here is a letter, typical of thousands received; it came from **JARMILA NOVOTNA**, Metropolitan Opera star. "Music has been my whole life—but not until I heard my first MUSIC-APPRECIATION RECORD did I realize how much I had been missing when I listened to orchestral music. I subscribed originally for my son, but quickly found that my own enjoyment of orchestral music was increased far beyond what I dreamed possible."

**YOU SUBSCRIBE BUT TAKE ONLY THE RECORDS YOU WANT . . .** A new MUSIC-APPRECIATION RECORD is issued—for subscribers only—every month, preceded by an announcement written by the noted composer and music commentator Deems Taylor. After reading this descriptive essay you may take the record or not, as you decide at the time. *You are not obligated to take any specified number of records.* And

you may stop the subscription at any time you please!

**TWO TYPES OF RECORDS ARE AVAILABLE . . .** All MUSIC-APPRECIATION RECORDS are high-fidelity, long-playing records of the highest quality—33 $\frac{1}{3}$  R.P.M. on Vinylite. They are of two kinds: first, a so-called Standard Record—a *twelve-inch* disc—which presents the performance on one side, the analysis on the other. This is sold at \$3.60, to subscribers only. The other is an Analysis-Only Record—a *ten-inch* disc—priced at \$2.40. The latter is made available each month for any subscriber who may already have a satisfactory long-playing record of the work being presented. (A small charge is added to the prices above to cover postage and handling.)

**TRY A ONE-MONTH SUBSCRIPTION—WITH NO OBLIGATION TO CONTINUE . . .** Why not make a simple trial, to see if these records are as pleasurable and as enlightening as you may anticipate? The first record you choose will be sent to you at once—at *no charge*. You may end the subscription immediately after hearing this record, or you may cancel any time thereafter.



**Richard Strauss' TILL EULENSPIEGEL'S MERRY PRANKS**  
**Smetana's THE MOLDAU** (ON ONE 12" DISC)  
George Szell, conducting The Music Appreciation Symphony Orchestra



**Prokofiev's CLASSICAL SYMPHONY**  
**Britten's YOUNG PERSON'S GUIDE TO THE ORCHESTRA** (ON ONE 12" DISC)  
Alfred Wallenstein, conducting The Music Appreciation Symphony Orchestra



**J. S. Bach's SUITE FOR ORCHESTRA NO. 3 IN D MAJOR**  
George Szell, conducting The Music Appreciation Symphony Orchestra



**Wagner's OVERTURES TO TANNHÄUSER** (ON ONE 12" DISC) **and DIE MEISTERSINGER**  
Norman Del Mar, conducting The London Symphony Orchestra



**Schumann's PIANO CONCERTO IN A MINOR**  
Eileen Flissler, *Pianist*  
Thomas Scherman, conducting The Little Orchestra



**Mendelssohn's VIOLIN CONCERTO IN E MINOR**  
Fredell Lack, *Violinist*  
Alexander Smallens, conducting The Stadium Concerts Symphony Orchestra

PLEASE RETURN ONLY IF YOU HAVE A 33 $\frac{1}{3}$  R.P.M. RECORD PLAYER

**MUSIC-APPRECIATION RECORDS** R39-9  
c/o Book-of-the-Month Club, Inc.  
345 Hudson Street, New York 14, N. Y.

Please send me at once, without charge, the MUSIC-APPRECIATION RECORD checked below and enter my name in a Trial Subscription to MUSIC-APPRECIATION RECORDS, under the conditions stated at left. It is understood that, as a subscriber, I am not obligated to buy any specified number of records, but may take only those I want. Also, I may cancel my subscription after hearing this first record, or any time thereafter at my pleasure, but the introductory record is free in any case.

- AS MY FREE DEMONSTRATION RECORD PLEASE SEND ME**
- Strauss' Till Eulenspiegel and Smetana's The Moldau  Prokofiev's Symphony and Britten's Guide  Schumann's Concerto  
 Bach's Suite for Orchestra  Wagner's Overtures  Mendelssohn's Concerto

Mr. } \_\_\_\_\_  
Mrs. } \_\_\_\_\_  
Miss } \_\_\_\_\_  
(PLEASE PRINT)

ADDRESS.....

CITY..... ZONE..... STATE.....

MAR 36

# WANTED

## FOR VALUE

An amateur, P. A. and tape recording microphone known to be in the vicinity of the price people want to pay

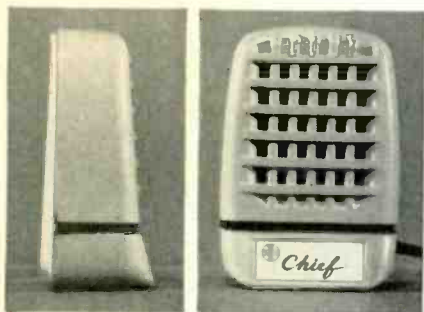

## TURNER

### MODEL 808 CRYSTAL

Response: 60—7,000 c.p.s.  
Level: -49 db.

### ALIAS MODEL 807 CERAMIC

Response: 80—7,000 c.p.s.  
Level: -57 db.

### ALIAS MODEL 809 MAGNETIC

Response: 100—8,000 c.p.s.  
Level: -52 db.

## ALIAS THE CHIEF

Subject microphone has been seen in desk, stand and hand use where quality was demanded, accompanied by compact size and low cost. By virtue of its good looks and versatility, the Chief is sought by the public for economical amateur use, public address and paging, and is ideal original or replacement equipment for tape recorders. Chief Model 808 has moisture sealed crystal, is wind and blast proof. Ruggedness, good performance and resistance to high humidity and heat are characteristic of Chief Model 809 with magnetic interior. Chief Model 807 with ceramic interior has heat and humidity resistance at a lower cost.

For complete information, write today to



## Correspondence

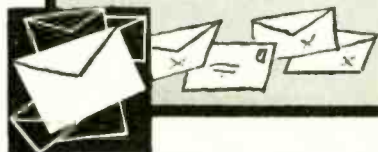

### AUTHOR'S ALTERATIONS

Dear Editor:

In answering readers' letters concerning my article "Improving Low-Priced Tape Recorders" (April, May), I came across the question as to whether I made changes other than those disclosed in the article. I did recently obtain a considerable reduction in hum (6 db or better) by disconnecting the heater center tap from ground and connecting one side of the heater to 70 volts d.c., obtained at the junction of 47,000-ohm resistor and the 15- $\mu$ f capacitor supplying plate and screen current to the playback 6AU6. Try each side of the heater supply to see which gives better results. I had previously tried d.c. heater bias but had given it up because of the frying noises. This used a voltage divider constructed for the purpose, but my later effort requires nothing more than a piece of wire for satisfactory results.

HERMAN BURSTEIN

Wantagh, N. Y.

### FIRE INSURANCE

Dear Editor:

I recently suffered a heavy financial loss as a result of a fire in my home. My radio-TV repair shop, which was in my home, was completely destroyed. The contents of my shop—Rider manuals 1 to 14, Photofact folders 1 to 205, RADIO-CRAFT magazines from 1932 to the present issue of RADIO-ELECTRONICS, several hundred dollars' worth of service data and reference books on radio and television, a complete set of test equipment, welding equipment and a complete set of radio and woodworking tools—were worth about \$6,000. Only about \$2,500 of this loss is recoverable by insurance.

I'm telling you all this for a purpose. Possibly you'd write an article on insurance that would save someone else the headaches I am experiencing. *No one ever carries enough insurance.* It took everything I had to replace the TV sets that were in the shop for repair.

V. K. VANCE

Little Rock, Ark.

(The above seems to us one of the most effective "articles" that could be written.—Editor)

### TECHNICAL EDUCATION

Dear Editor:

I would like to comment on the letter by E. I. Eastwood on technical education, appearing in the May Correspondence column. Perhaps some of us read-

## Your BEST BUYS

Are



Permoflux  
Hi-Fi Speakers  
and  
Components

### THE WORLD FAMOUS *Royal 8*

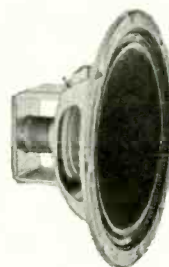

The popular Royal 8—your best value in a hi-fi speaker. Outperforms many larger speakers. Features a slotted, treated, blue cone; high-flux, slug-type magnet; clean reproduction of audio range.

Royal 8, Model 8T-8-1 8" Speaker.

NET ..... \$13.50

ROYAL 12, MODEL 12UP-8-1. 12" version of Royal 8, above. Use with 32KTR-C Kit, below, for coaxial performance at low cost. NET.....\$21.00

### New 32KTR-C Coaxial Tweeter Mounting Kit



NOW—mount the 32KTR Tweeter coaxially on your present 12" speaker, or the Royal 12 described above. Consists of 32KTR Tweeter, arms, hi-pass filter, hdwe., instructions. Easy to install—no soldering.

NET ..... \$12.60

32KTR SUPER TWEETER ONLY. Provides true-to-life highs; uses paper cone—same cone material used in woofers. Crossover range, 2000-6000 cps. NET ..... \$9.45

NK-60 6000-CYCLE CROSSOVER NETWORK. Ideal for use with 32KTR-C Coax Kit, or 32KTR Tweeter and any good woofer. Provides complete separation of lows and highs. NET.....\$9.00

## Permoflux CORPORATION

Dept. F, 4912 Grand Ave., Chicago 39, Ill.

4101 San Fernando Rd. • Glendale 4, Calif.  
Canadian Licensee: Campbell Mfg. Co., Ltd.

# free

## 1956 VALUE PACKED ALLIED

### 324-PAGE ELECTRONIC SUPPLY CATALOG

the only COMPLETE catalog for everything in TV, Radio, Hi-Fi and Industrial Electronics

send for it today

Get ALLIED's 1956 Catalog—it's *complete*, up-to-date—324 pages packed with the world's largest selection of quality electronic equipment at lowest, money-saving prices. Select from the latest in High Fidelity systems and components; P.A. systems and accessories; recorders and supplies; TV tubes, antennas and accessories; Amateur receivers, transmitters and station gear; specialized industrial electronic equipment; test instruments; new build-your-own kits; huge listings of parts, tubes, transistors, tools, books—the world's *most complete* stocks of quality equipment. Get *every* buying advantage at ALLIED: fastest shipment, expert personal help, lowest prices, assured satisfaction. Send today for your FREE copy of the big 1956 ALLIED Catalog.

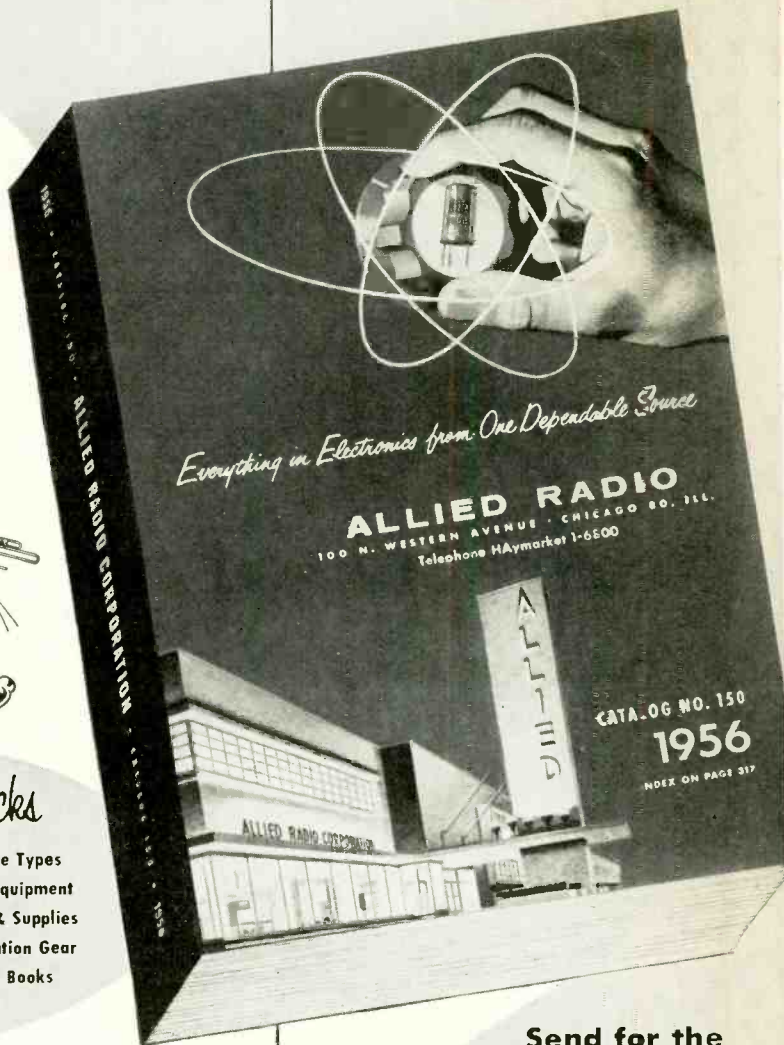

*World's largest Stocks*

- All TV & Radio Parts
- All Electron Tube Types
- Test & Lab Instruments
- High Fidelity Equipment
- Latest Build-Your-Own Kits
- Recorders & Supplies
- P.A. Systems, Accessories
- Amateur Station Gear
- TV Antennas, Accessories
- Tools and Books
- Equipment for Industry

## ALLIED RADIO

World's Largest Electronic Supply House

### EASY-PAY TERMS

Use our liberal Easy Payment Plan—only 10% down, 12 months to pay—no carrying charges if you pay in 60 days. Available on Hi-Fi and P.A. units, recorders, TV chassis, test instruments, kits, Amateur gear, etc.

### HI-FI SPECIALISTS

To keep up with the latest and best in High Fidelity, look to ALLIED. Count on us for *all* the latest releases and largest stocks of Hi-Fi equipment. We specialize, too, in TV supply—and are foremost in the field of Builders' Kits.

ultra-modern facilities for the FASTEST SERVICE IN ELECTRONIC SUPPLY

# free

Send for the leading Electronic Supply Guide

ALLIED RADIO CORP., Dept. 2-J-5  
100 N. Western Ave., Chicago 80, Illinois

Send FREE 324-Page 1956 ALLIED Catalog

Name.....

Address.....

City..... Zone... State.....

*Used the World Over  
more than any other  
Microphone!*

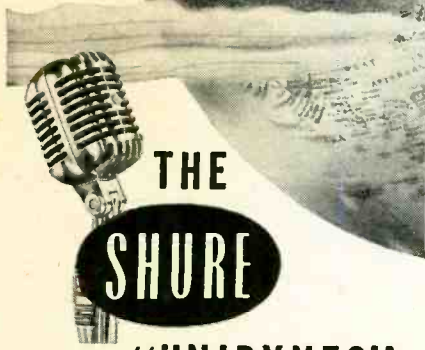

## “UNIDYNES”

are the only small size, all-purpose moving coil Dynamic Microphones that reduce the pickup of random noise energy by 67%.

The Unidynes, 55s and 556s, simplify P. A. installation . . . enhance your reputation . . . insure customer satisfaction by eliminating or reducing callbacks due to critical gain control settings—often necessary when conventional microphones have been installed.

No wonder the Unidynes are used the World over—more than any other microphones—for finest quality public address . . . theater stage sound systems . . . professional recording . . . remote broadcasting.



## SHURE BROTHERS, Inc.

Microphones and Acoustic Devices  
225 W. Huron St., Chicago 10, Illinois  
Cable Address: SHUREMICRO

### CORRESPONDENCE

(Continued)

ers may misinterpret Mr. Eastwood's idea of the term "technical education" or the opportunities it might offer to various age brackets.

Where the paths of Mr. Eastwood and I divided was when I enrolled in a technical trade school and for a sum somewhat in excess of \$100 received a very thorough radio, TV and electronics course. Not content, I recently enrolled in another school to study television servicing exclusively.

I, too, am a family man with two youngsters to look out for, but I was willing to gamble over \$300 and almost all my evenings for the future.

KENNETH C. BUSH

Buffalo, N. Y.

### THE WHY OF THE SUBJECT

Dear Editor:

I found the article "How Much Will a Resistor Take" (July, 1955) by H. P. Manly very thought-provoking. The author gets at the *why* of the subject.

Entirely too many technicians of my acquaintance find themselves completely helpless to cope with a service problem unless someone can supply them with the schematic with all values shown. They simply have never learned the *why*. They consider Ohm's law to be some sort of obscure legislation, not to mention the many useful equations directly or indirectly based upon it.

Mr. Manly has supplied a very handy graph. If the technician knows Ohm's law, he can also use the graph to find how much voltage can be dropped across a given resistor without exceeding the wattage rating ( $E = IR$ ).

H. B. CONANT

Conant Laboratories  
Lincoln, Neb.

### TUBE TESTER

Dear Editor:

There is described on page 47 of the April issue of RADIO-ELECTRONICS "A Laboratory Type Tube Tester." The author states in the first paragraph, which I quote in part, "transconductance is read directly by applying a 1-volt r.m.s. signal on the grid and measuring the output in a.c. milliamperes."

With a grid signal of this magnitude, the a.c. output current will be a measure of the average transconductance over a grid swing of 2.828 volts peak to peak. This may cause a discrepancy between the measured transconductance and the transconductance values which appear in the published ratings as found, for example, in tube manuals. The grid signal used for obtaining the published values is 10 millivolts, and the instrument used is a General Radio vacuum-tube bridge.

This discrepancy between published and measured transconductance values may be the cause for rejection of good tubes in the field by persons who are not aware of the differing measurement conditions.

G. L. QUINT

Sylvania Electric Products  
Enporium, Pa.

## INTERNATIONAL'S

# NEW TV RECTIFIER REPLACEMENT BONUS PACK!



FREE!

## NYLON TV TOOL

With every pack of 4 TV  
Replacement Rectifiers . . .

A PAIR and a SPARE PAIR!

You can't miss with International's New "BONUS PACK"! You'll get the *best* in TV replacement rectifiers. Each BONUS PACK contains a pair for immediate use, and a spare pair for your next job—PLUS a Nylon TV Alignment Tool worth \$1.00—ABSOLUTELY FREE!

**SPECIFY INTERNATIONAL RECTIFIERS** for long, dependable performance—the Widest Range in the Industry! Best for you . . . Best for your service customers!



Ask your distributor  
for details about  
"Bonus Pack" today!

## International Rectifier

C O R P O R A T I O N

1521 East Grand Avenue, El Segundo, California • Oregon 8-6281  
IN CANADA: Atlas Radio Corp., 50 Wingold Ave. W., Toronto, Ontario

**WORLD'S LARGEST SUPPLIER  
OF INDUSTRIAL METALLIC RECTIFIERS**

RADIO-ELECTRONICS



# KINGS of the TV FRONTIER!

## Unmatched for power and performance!

This extraordinary fringe-area powerhouse is still the most sensitive all-channel antenna made today—bar none! The SUPER RAINBOW's many "years-ahead" engineering features include the triple-powered Tri-Pole, separate high and low band operation, 100% aluminum construction, and "Snap-Lock" pre-assembly. Also in great demand . . .

The RAINBOW, Model No. 330.

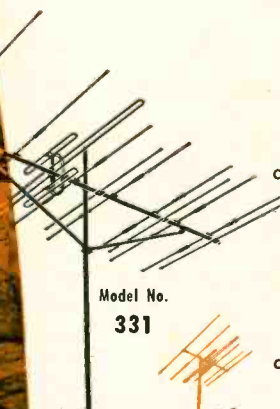

Model No.  
331

**SUPER RAINBOW**

## Extra elements, extra performance!

There may be antennas that resemble our TRAILBLAZER, but none can top its blazing performance. The TRAILBLAZER features extra High and Low Band directors, and full-wave directors on the High Band. It installs faster than any similar antenna, and—it's all aluminum! Especially recommended for areas with front-to-back interference problems, particularly on the Low Band. Count the elements . . . then compare the prices!

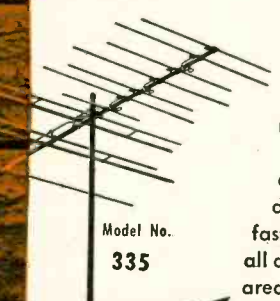

Model No.  
335

**TRAILBLAZER**

## Advanced design — and "Super-Sembled"

Look to the LANCERS for Channel Master "extras": extra elements and extra gain — at no extra cost. Completely "Super-Sembled." The SUPER LANCER gives 1½ db more gain on both the Low Band and the High Band than similar types. The LANCER, Model No. 333, has an extra director that provides 1½ db more Low Band gain. Count the elements . . . then compare the prices!

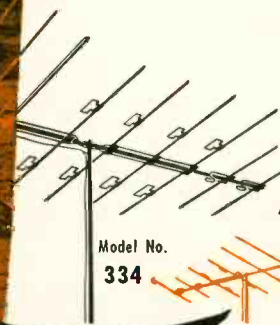

Model No.  
334

**SUPER LANCER**

# CHANNEL MASTER<sup>®</sup>

## All-Channel Yagis

## Unrivalled for power, popularity and price!

Service men everywhere are discovering an entirely new answer to the problem of multi-channel fringe-area reception: Channel Master all-channel yagis. These are the antennas that have what it takes to bring top TV performance to the most distant, isolated locations. And, they're ready for color, too!

Today's leading all-channel yagis are designed — and improved — in the Channel Master Antenna Development Laboratories. Isn't it logical to use Channel Master's famous engineering skill to solve your reception problems?



**CHANNEL MASTER CORP.** ELLENVILLE, N. Y.  
The World's Largest Manufacturer of TV Antennas and Accessories

Copyright 1955, Channel Master Corp.

® Trade Name Registered

# CABINART '56

- MODEL 10
- MODEL 11
- MODEL 21
- MODEL 22
- MODEL 27
- MODEL 28
- MODEL 27U
- MODEL 28U
- MODEL 65
- MODEL 70
- MODEL 7112
- MODEL 7115
- MODEL 90
- MODEL 91
- MODEL 90U
- MODEL 91U
- MODEL 800
- MODEL 800U
- MODEL KR-3
- MODEL KR-3U
- MODEL KR-4-12
- MODEL KR-4-15
- MODEL KR-5
- MODEL KR-5-U
- MODEL KR-5-P
- MODEL ST-1
- MODEL ST-2
- MODEL ST-3
- MODEL ST-4
- MODEL ST-5
- MODEL ST-6
- MODEL ST-7
- MODEL ST-8
- MODEL ST-9

MODEL 65

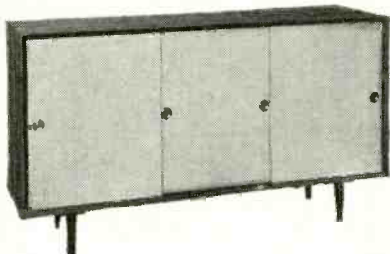

... storage for tape recorder, turntable, record changer, tuner, amplifier and speaker, if desired.

• 16 NEW EQUIPMENT CABINETS

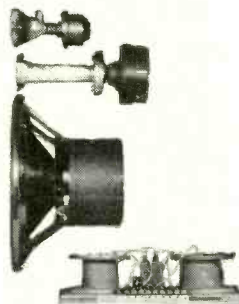

THE REBEL 3 SPEAKERS      THE REBEL 4 SPEAKERS      THE REBEL 5 SPEAKERS

CABINART SPEAKER SYSTEMS

- KIT 27K
- KIT 28K
- KIT 80
- KIT 8112
- KIT 8115
- KIT K-3
- KIT K-4-12
- KIT K-4-15
- KIT KST-1
- KIT KST-2
- KIT KST-3
- KIT KST-4
- KIT KST-5
- KIT KST-6
- KIT KST-7
- KIT KST-8
- KIT KST-9

MODEL 27K  
MODEL 28K

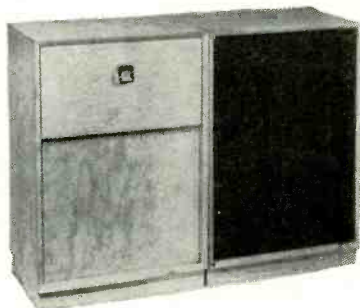

• TWELVE NEW HI-FI KITS

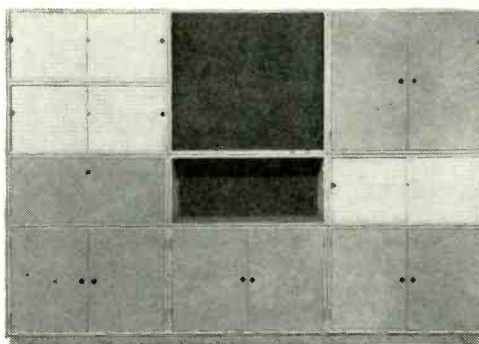

... EVEN A HI-FI STORAGEWALL

- ACC-1
- ACC-2
- ACC-2U
- ACC-3
- ACC-4
- ACC-5
- ACC-6
- ACC-7
- ACC-7A



TURNTABLE BASE WITH LEVEL AND LEVELING DEVICES



RECORD CABINETS ... 3 SIZES

and NINE HI-FI ACCESSORIES FOR THE SOUND ENTHUSIASTS.



Factory and Offices: B'klyn, N. Y.

Each CABINART design is an engineer's answer to an individual hi-fi equipment storage problem. Each cabinet, properly used, is a designer's expression of the elements of good furniture design.

If your hi-fi dealer does not stock Cabinart, write for the name of our nearest Cabinart dealer or mail order house.

**WRITE**

CABINART '56 CATALOGS:

1. EQUIPMENT STORAGE
2. EQUIPMENT/ENCLOSURE KITS
3. REBEL HORNS & SPEAKERS
4. THE CABINART STORAGEWALL
5. HI FI ACCESSORIES

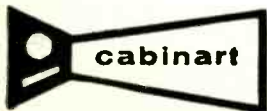

**The pioneers in high fidelity radio furniture**

Cabinart is a division of G & H Wood Products Co., Inc. • 99 N. 11th St. • Brooklyn 11, N. Y.

# I Will Train You at Home

## For Good Pay Jobs, Success in

# RADIO-TELEVISION

J. E. SMITH  
President  
National Radio  
Institute  
Washington, D. C.  
40 years of success  
training men at  
home in spare time.



I'll Prove It Is Easy And  
Practical To Learn At Home.  
Sample Lesson FREE.



To See Equipment I Send You  
For Practical Experience...  
Get Illustrated Book FREE.



## Practice Broadcasting with Equipment I Send

It's practical to train at home for good Radio-TV jobs and a brighter future. As part of my Communications Course I send you kits of parts to build the low-power Broadcasting Transmitter shown at the left. You use it to get practical experience performing procedures demanded of Broadcasting Station Operators. An FCC Commercial Operator's License can be your ticket to a better job and a bright future; my Communications Course gives you the training you need to get your license. Mail card below and see in my book other valuable equipment you build. Get FREE sample lesson.

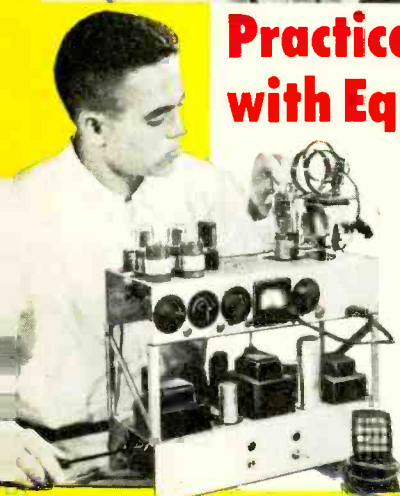

## Practice Servicing with Equipment I Send

Self-confidence, security, earning power come from knowing-how and from experience. Nothing takes the place of PRACTICAL EXPERIENCE. That's why NRI training is based on LEARNING BY DOING. You use parts I furnish to build many circuits common to Radio and Television. With my Servicing Course you build a modern Radio (shown at right). You build a Multitester, use it in conducting experiments, fixing sets in spare time starting a few months after enrolling. All equipment is yours to keep. Card below will bring book showing other equipment you build. Judge for yourself whether you can learn at home in your spare time.



## Television Is Growing Fast Making New Jobs, Prosperity

More than 30 million homes now have Television sets and thousands more are being sold every week. Well trained men are needed to make, install, service TV sets and to operate hundreds of Television stations. Think of the good job opportunities here for qualified technicians, operators, etc. If you're looking for opportunity, get started now learning Radio-Television at home in spare time. Cut out and mail postage-free card. J. E. Smith, President, National Radio Institute, Washington, D. C. Over 40 years' experience training men at home.

AVAILABLE TO  
**VETERANS**  
UNDER G. I. BILL

Good Jobs  
Good Pay **See Other Side**

Get My **SAMPLE LESSON** and  
64-Page Illustrated Book  
**BOTH FREE**

Cut out and mail  
card NOW!

This card entitles you to Actual Lesson on Servicing, shows how you learn Radio-Television at home. You'll also receive my 64-page Book, "How to Be a Success in Radio-Television." Mail card now!

**NO STAMP NEEDED! WE PAY POSTAGE**

Mr. J. E. SMITH, President  
National Radio Institute, Washington 9, D. C.  
Mail me Lesson and Book, "How to Be a Success in Radio-Television." (No Salesman will call. Please write plainly.)

NAME..... AGE.....

ADDRESS.....

CITY..... ZONE..... STATE.....

**VETS** write in date of discharge.....

K L M O P R S T U V

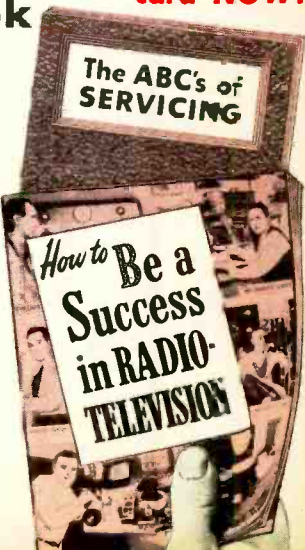

# Train at Home to Jump Your Pay as a RADIO-TV Technician



J. E. Smith, President

National Radio Institute

The men whose messages are published below were not born successful. Not so long ago they were doing exactly as you are now . . . reading my ad! They decided they should KNOW MORE . . . so they could EARN MORE . . . so they acted! Mail card below now.

## Get a Better Job—Be Ready for a Brighter Future in America's Fast Growing Industry

Training PLUS opportunity is the PERFECT COMBINATION for job security, good pay, advancement. When times are good, the trained man makes the BETTER PAY, GETS PROMOTED. When jobs are scarce, the trained man enjoys GREATER SECURITY. NRI training can help assure more of the better things of life.

Radio-Television is today's opportunity field. Even without Television, Radio is bigger than ever before. Over 3,000 Radio Broadcasting Stations on the air; more than 115 million home and Automobile Radios are in use. Television Broadcast Stations extend from coast to coast now with over 30 million Television sets already in use. Over 400 Television stations are on the air and there are channels for hundreds more.

Use of Aviation and Police Radio, Micro-Wave Relay, Two-way Radio communication for buses, taxis, trucks, etc., is expanding. New uses for Radio-Television principles coming in Industry, Government, Communications and Homes.

### My Training Is Up-to-Date You Learn by Doing

Get the benefit of our 40 years' experience training men. My well-illustrated lessons give you the basic principles you must have to assure continued success. Skillfully developed kits of parts I furnish "bring to life" the principles you learn from my lessons. Read more about equipment you get on other side of this page.

More and more Television information is being added to my courses. The equipment I furnish students gives experience on circuits common to BOTH Radio and Television.

### Find Out About this Tested Way to Better Pay

Read at the right how fellows who acted to get the better things of life are making out now. Read how NRI students earn \$10, \$15 a week extra fixing Radios in spare time starting soon after enrolling. Read how my graduates start their own businesses. Then take the next step—mail card below.

You take absolutely no risk. I even pay postage. I want to put an Actual Lesson in your hands to prove NRI home training is practical, thorough. I want you to see my 64-page book, "How to Be a Success in Radio-Television," because it tells you about my 40 years of training men and important facts about present and future Radio-Television job opportunities. You can take NRI training for as little as \$5 a month. Many graduates make more than the total cost of my training in two weeks. Mailing postage-free card can be an important step in becoming successful. J. E. Smith, President, National Radio Institute, Washington 9, D. C. Training Men for Over 40 years. Approved Member, National Home Study Council.

## I TRAINED THESE MEN



### Lots of Spare-Time Jobs

"I do a lot of spare-time Radio and TV servicing. It was fun learning and I don't know how to thank you." B. Goede, Plainview, Minn.



### Now TV Trouble Shooter

"I had only gone to 7th grade when I started course. Now have job as TV trouble shooter, also fix sets spare time." M. R. Hadenuth, Fort Wayne, Ind.



### Engineer with WHPE

"Thanks to NRI, I operated a successful Radio repair store. Then I got a job with WPAQ and now am an engineer for WHPE." V. W. Workman, High Point, N. C.



### NRI Course Can't Be Beat

"Am with WCOG. NRI Course can't be beat. No trouble passing 1st class Radio-phoné license examination." Jesse W. Parker, Meridian, Mississippi.



### Quit Job for Own Business

"I decided to quit my job and do TV work full time. I love my work and am doing all right financially." William F. Kline, Cincinnati, Ohio.



### Extra Money in Spare Time

"I am a police captain and also have good spare-time service business. Just opened my new showrooms and shop." C. W. Lewis, Pensacola, Fla.

## Start Soon to Make \$10 to \$15 a Week Extra Fixing Sets

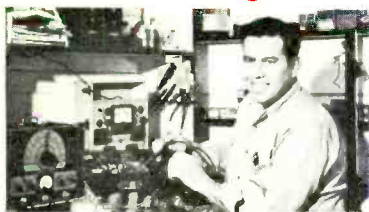

Keep your job while training. Many NRI students make \$10, \$15 and more a week extra fixing neighbors' Radios in spare time, starting a few months after enrolling. The day you enroll I start sending you special booklets that show you how to fix sets. The multimeter you build with parts I furnish helps discover and correct troubles.

## SEE OTHER SIDE

## My Training Leads to Jobs Like These

**BROADCASTING:** Chief Technician, Chief Operator, Power Monitor, Recording Operator, Remote Control Operator. **SERVICING:** Home and Auto Radios, P. A. Systems, Television Receivers, Electronic Controls, FM Radios. **IN RADIO PLANTS:** Design Assistant, Transmitter Design Technician, Service Manager, Tester, Serviceman, Research Assistant. **SHIP AND HARBOR RADIO:** Chief Operator, Assistant Operator, Radiotelephone Operator. **GOVERNMENT RADIO:** Operator in Army, Navy, Marine Corps, Coast Guard, Forestry Service Dispatcher, Airways Radio Operator. **AVIATION RADIO:** Plane Radio Operator, Transmitter Technician, Receiver Technician, Airport Transmitter Operator. **TELEVISION:** Pick-Up Operator, Voice Transmitter Operator, Television Technician, Remote Control Operator, Service and Maintenance Technician. **POLICE RADIO:** Transmitter Operator, Receiver Serviceman.

**SAMPLE LESSON and 64-Page BOOK BOTH FREE CUT OUT AND MAIL POSTAGE-FREE CARD**

## Have Your Own Business

Many NRI trained men start their own successful Radio-Television sales and service business with capital earned in spare time. Joe Travers, a graduate of mine, in Asbury Park, N. J., writes: "I've come a long way in Radio and Television since graduating. Have my own business on Main Street."



FIRST CLASS  
Permit No. 20-R  
(Sec. 34.9, P. L. & R.)  
Washington, D. C.

### BUSINESS REPLY CARD

No Postage Stamp Necessary If Mailed In The United States

POSTAGE WILL BE PAID BY  
NATIONAL RADIO INSTITUTE

16th and U Sts., N. W.

Washington 9, D. C.

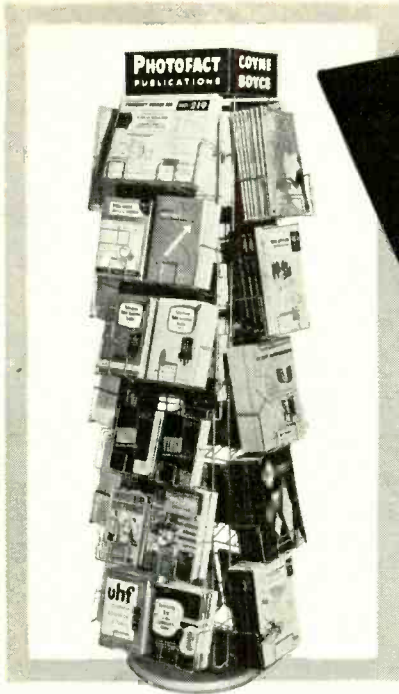

# STAY AHEAD IN ELECTRONICS!

## these SAMS BOOKS show you how

look for them on the Howard W. Sams "Book Tree"  
displayed at your Electronic Parts Distributor

### POPULAR BASIC MANUALS

**Basic Radio Manual.** A comprehensive training guide, outlining step-by-step a 36-Lesson Course on Basic Radio accompanied by a practical Shop Project section devoted to actual job projects that implement the lessons and clearly translate theory into practice. 248 pages, 8 1/2 x 11", illustrated. Order ED-1 ..... \$5.00

**Basic Electricity Manual.** A complete training course covering basic theory, terms, laws, circuits; includes magnetism, motors, transformers, lighting and many other subjects, supplemented by inexpensive projects which demonstrate theory in action. 264 pages, 8 1/2 x 11". Order ED-12 ..... \$5.00

### HANDY SERVICE GUIDES

**Radio Receiver Servicing.** A book on practical radio receiver servicing covering such basic troubles as dead set, weak set, intermittent and noisy sets, etc. 192 pages, 5 1/2 x 8 1/2". Order RS-1 ..... \$2.50

**AM-FM Servicing Short-Cuts.** Describes actual AM and FM service case histories; shows practical ways to solve similar troubles in any AM or FM receiver. 152 pages, 5 1/2 x 8 1/2". Order RK-1 \$1.50

**Radio Receiver Tube Replacement Guide.** Shows where to replace each tube in 5500 receivers made from 1938 to 1948. 196 pages, 5 1/2 x 8 1/2". Order TP-1 ..... \$1.25

**Dial Cord Stringing Guide.** Vol. 4. Shows correct way to string dial cords in radio receivers made from mid-1951 through 1953. With index. 96 pages, 5 1/2 x 8 1/2". Order DC-4 ..... \$1.00

**Vol. 3. Covers receivers produced from 1950 through mid-1951, and TV-radio receivers from 1946 through mid-1951.** 96 pages, 5 1/2 x 8 1/2". Order DC-3 ..... \$1.00

**Vol. 2. Covers receivers produced from 1947 through 1949.** 96 pages, 5 1/2 x 8 1/2". Order DC-2 ..... \$1.00

**Vol. 1. Covers receivers produced from 1938 through 1946.** 112 pages, 5 1/2 x 8 1/2". Order DC-1 ..... \$1.00

### AUTO RADIO SERVICE MANUALS

**Vol. 4. Covers 41 chassis (48 models) produced during 1953.** 288 pages, 8 1/2 x 11". Order AR-4 ..... \$3.00

**Vol. 3. Full service data on 47 chassis (80 models) used in 1950, 1951 and 1952 auto radio receivers.** 288 pages, 8 1/2 x 11". Order AR-3 ..... \$3.00

**Vol. 2. Covers 60 chassis (90 models) used in 1948, 1949 and 1950 auto radios.** 288 pages, 8 1/2 x 11". Order AR-2 ..... \$3.00

**Vol. 1. Covers 100 auto radio models made from 1946 to 1949 by 24 manufacturers.** 396 pages, 8 1/2 x 11". Order AR-1 ..... \$4.95

### COMMUNICATIONS RECEIVERS

**Vol. 2. Full analysis of 26 popular communications receivers made during recent years.** 190 pages, 8 1/2 x 11". Order CR-2 ..... \$3.00

### INVALUABLE, AUTHORITATIVE TELEVISION BOOKS

**Color Television for the Service Technician.** Written to prepare the service technician for the day when he will be installing and servicing color TV equipment. 116 pages, 8 1/2 x 11". Order SC-1 ..... \$2.50

**Analyzing and Tracing TV Circuits.** A book which presents a new approach to the problems of television servicing. 168 pages, 8 1/2 x 11". Order JA-1 ..... \$3.00

**TV Service Data Handbook.** A compilation of the most frequently needed charts, tables, and formulas as required in TV servicing and installation work. 112 pages, 5 1/2 x 8 1/2". Order JB-1 ..... \$1.50

**TV Servicing Timesavers.** This handy reference summarizes many service techniques found profitable from actual servicing experience. 124 pages, 5 1/2 x 8 1/2". Order JC-1 ..... \$1.50

**Fundamentals of Color Television.** A complete and up-to-date explanation of color TV written in a simple style to give the reader a clear understanding of the subject. 224 pages, 5 1/2 x 8 1/2". Order BA-1 ..... \$2.00

**Teletesting Operations.** The only complete coverage of every phase of Teletesting, from theory through equipment, operation, maintenance, production—indispensable to anyone interested in Teletesting. 600 p., 6 x 9". Order OH-1 \$7.95

**Photofact Television Course.** Gives a clear, complete understanding of TV principles, operation and practice. 208 pages, 8 1/2 x 11". Order TV-1 ..... \$3.00

**TV Servicing Short-Cuts.** Describes actual TV service case histories; shows how to solve similar troubles in any receiver. 100 pages, 5 1/2 x 8 1/2". Order TK-1 ..... \$1.50

**TV Test Instruments.** Tells how to operate each test instrument used in TV service work. 175 pages, 8 1/2 x 11". Order TN-1 ..... \$3.00

**UHF Antennas, Converters & Tuners.** Covers all antenna types, transmission lines and matching networks. UHF converters and tuners, 136 pages, 5 1/2 x 8 1/2". Order UHF-1 ..... \$1.50

**Servicing TV in the Customer's Home.** Short-cut methods for repairs in the field. 128 pages, 5 1/2 x 8 1/2". Order TC-1 ..... \$1.75

**Making Money in TV Servicing.** Tells how to set up and operate a profitable TV service business. 136 pages, 5 1/2 x 8 1/2". Order MM-1 ..... \$1.25

**Pay As You See TV.** A clear exposition of the facts that are of vital interest to everyone connected with the television industry. Four informative chapters present the case for this significant new development in TV entertainment. 96 pages, 5 1/2 x 8 1/2". Order KA-1 ..... \$1.50

**TV Tube Location Guides: Vol. 5.** Shows tube positions and functions in hundreds of TV receivers. Helps quickly locate faulty tube. 200 pages, 5 1/2 x 8 1/2". Order TGL-5 ..... \$2.00

**Vol. 4. Covers receivers produced in 1952-1953.** 192 pages, 5 1/2 x 8 1/2". Order TGL-4 ..... \$2.00

**Vol. 3. Covers receivers produced in 1951-1952.** 192 pages, 5 1/2 x 8 1/2". Order TGL-3 ..... \$2.00

**Vol. 2. Covers receivers produced in 1950-1951.** 208 pages, 5 1/2 x 8 1/2". Order TGL-2 ..... \$2.00

**Vol. 1. Covers receivers produced in 1948, 1949, 1950.** 208 pages, 5 1/2 x 8 1/2". Order TGL-1 ..... \$2.00

### Atomic Radiation, Detection and Measurement

This book covers the information necessary for a basic understanding of nuclear science and its applications. The service technician will be particularly interested in those chapters dealing with the circuitry and operation of the many types of detection devices, in case he is called upon to service these units. 160 pages, 5 1/2 x 8 1/2". Order ADR-1 ..... \$2.50

### AUDIO PUBLICATIONS

**Recording & Reproduction of Sound.** Oliver Read's biggest selling volume on all aspects of Audio; fully covers recording and amplifying methods and equipment. Authoritative, complete, 810 pages, 6 x 9". Order RR-2 ..... \$7.95

**Audio Amplifier Service Manuals, Vol. 5.** Covers 37 amplifiers, 12 preamplifiers and 14 custom tuners made during 1952 and 1953. 352 pages, 8 1/2 x 11". Order AA-5 ..... \$3.95

**Vol. 4.** Covers 75 amplifiers and tuners made during 1951 and 1952. 352 pages, 8 1/2 x 11". Order AA-4 ..... \$3.95

**Vol. 3.** Covers 50 amplifiers and 22 tuners made during 1950. 352 pages, 8 1/2 x 11". Order AA-3 ..... \$3.95

**Vol. 2.** Covers 104 amplifiers and 12 tuners made during 1949. 368 pages, 8 1/2 x 11". Order AA-2 ..... \$3.95

### RECORD CHANGER MANUALS

**Vol. 6.** Covers 14 different tape recorders and 6 changers manufactured during 1953 and 1954, with complete index covering all six manuals of the Series. 288 pages, 8 1/2 x 11". Order CM-6 ..... \$2.00

**Vol. 5.** Covers 32 different basic units manufactured during 1952-53. 288 pages, 8 1/2 x 11". Order CM-5 ..... \$3.00

**Vol. 4.** Full service data on 38 changers and recorders made during 1951. 288 pages, 8 1/2 x 11". Order CM-4 ..... \$3.00

**Vol. 3.** Covers 44 changers made in 1949 and 1950. 288 pages, 8 1/2 x 11". Order CM-3 ..... \$3.00

**Vol. 2.** Covers 45 models made in 1948 and early 1949. 432 pages, 8 1/2 x 11". Order CM-2 ..... \$4.95

### COYNE AND BOYCE BOOKS

Distributed by Howard W. Sams & Co., Inc.

BB-1 Radio & Electronics Handbook ..... \$4.95

BB-2 Video Handbook ..... 5.95

CTB-1 TV Servicing Cyclopedea ..... 5.95

CTB-2 Industrial Electronics ..... 3.75

CTB-3 Latest Testing Instruments for Servicing Radio-Television ..... 3.25

CTB-4 Practical Television Servicing and Trouble-Shooting Manual ..... 4.25

CTB-5 Television and Radio Handbook ..... 2.75

CTB-7 Transistors & Their Applications in Radio-Television-Electronics ..... 1.50

CTB-8 Bigger Profits in TV ..... 1.50

CTB-11 Application of Radio & TV Principles ..... 3.25

CTB-12 Radio-TV and FM Receivers ..... 3.25

CTB-13 Radio and TV Circuits ..... 3.25

CTB-50 5 Volume Set Complete of Applied Practical Radio-Television ..... 15.00

CTB-100 Technical Dictionary ..... 2.00

CTB-101 Electrical Trouble Shooting Manual ..... 6.95

CTB-102 Electrician's Handbook ..... 2.75

### HOWARD W. SAMS & CO., INC.

Order from your Parts Jobber today, or write to Howard W. Sams & Co., Inc., 2205 East 46th St., Indianapolis 5, Ind.

My (check) (money order) for \$ ..... enclosed.

Send the following books:.....

.....

Name.....

Address.....

City..... Zone..... State.....

(outside U. S. A. priced slightly higher)

# NOW...the All-purpose 'Scope by WESTON

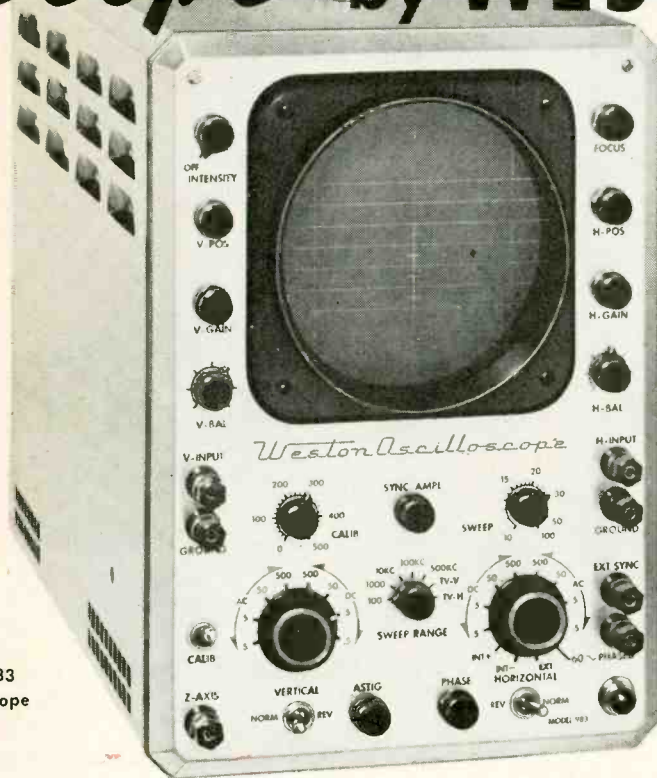

Weston  
Model 983  
Oscilloscope

Model 983 is a high gain, wideband Oscilloscope designed to accurately reproduce waveforms comprising a wide band of frequencies. High sensitivity of 15 millivolts per inch RMS makes this "scope ideal for—**SETTING RESONANT TRAPS...SIGNAL TRACING IN LOW LEVEL STAGES...AS A GENERAL NULL INDICATOR...for PHASE CHARACTERISTIC MEASUREMENT IN INDUSTRIAL APPLICATIONS...and for SWEEP FREQUENCY VISUAL ANALYSIS.**

The 'scope contains identical vertical and horizontal push-pull amplifiers with a choice of AC or DC coupling without affecting either sensitivity or band width. Both amplifiers have compensated step attenuators and cathode follower input. *It has excellent square wave reproduction with overshoot of only 2 to 5%, with a rise time of 0.1 microsecond. The 'scope response is essentially flat throughout the specified range of 4.5 mc and is usable to 6 mc.*

The unit has provisions for internal calibration, internal phased sine wave, and Z-axis intensity modulation. Reversal of polarity of both horizontal and vertical signals is easily accomplished by means of toggle switching. *Tube replacements are non critical, and etched circuitry facilitates quick and rapid maintenance.*

The Model 983 Oscilloscope is now available through local distributors. For complete literature write WESTON Electrical Instrument Corporation, 614 Frelinghuysen Avenue, Newark 5, New Jersey.

## WESTON Instruments

### WAVEFORM ANALYSIS

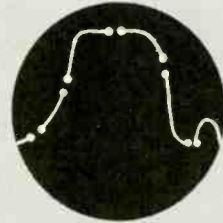

Response curves accurately displayed. Ideal for use with Weston intensity marker display. A fast, retrace sweep circuit with cathode follower output prevents pattern distortion.

### SQUARE WAVE RESPONSE

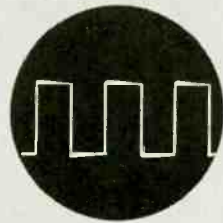

Overshoot is only 2 to 5%. Rise Time is 0.1 Microsecond. Square wave depicted 250 kc.

### PHASE MEASUREMENTS

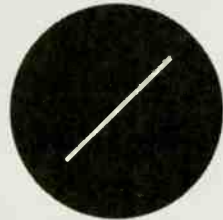

Phase shift between horizontal-vertical amplifiers, 0-500 kc-0°, to 1 mc within 2°; by internal adjustment with gain controls at max 0° phase shift possible on any specific frequency to 6 mc.

### RESPONSE CHARACTERISTIC

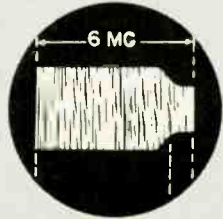

Note flatness throughout specified range; to 3.6 mc down 1.5 db, at 4.5 mc down 3 db, at 6 mc down 6 db.

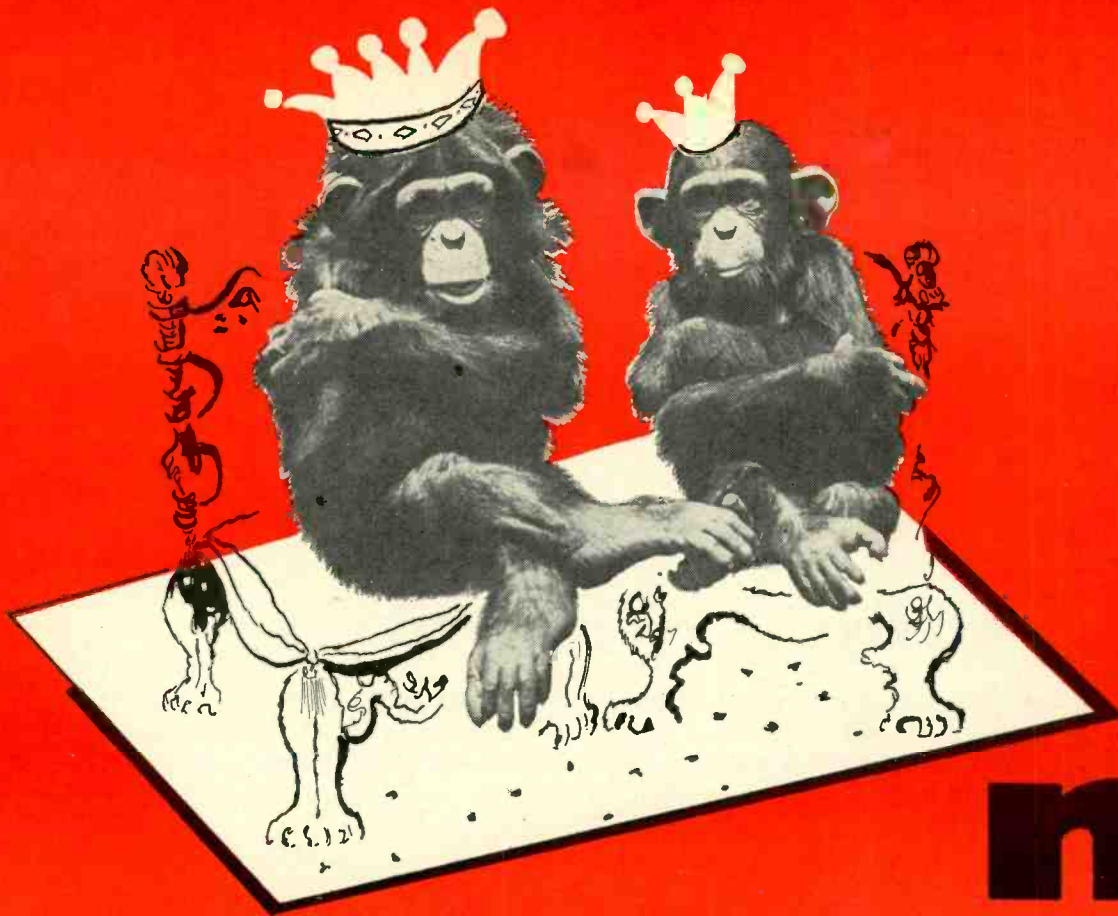

# no!

NOTHING BUT  
"STAMINIZED" CAPACITORS  
 WILL DO...

The consumer is king!

Catering to his wishes is the way to bigger servicing profits.

Set owners depend upon you as a "specialist" to install top-quality replacement parts that will give long, satisfactory service... for this reason, Astron developed "Staminized" capacitors... a special process imparts extra-ruggedness to each unit... it's the protection that lets you install with complete confidence.

This royal quality gained immediate and widespread acceptance among service technicians... it's why Astron "SM" Safety Margin Electrolytics can successfully withstand surge voltages and overloads without permanent damage... their reputation for durability is the sure key to increased consumer satisfaction and faster, more profitable servicing for you.

Easy-to-install, exact replacement Astron "SM" Electrolytics are available in a wide range of styles... one for every servicing requirement... meticulously assembled by contamination-free techniques for dependable 85°C operation, low leakage and long shelf life.

They're backed by the famous Astron guarantee—result of TEN individual production tests and 100% final inspection.

See your local jobber for Astron capacitors—Today!

**FREE SERVICING AID**—Write for your copy of **NEW** handy-pocket-sized replacement capacitor and pricing guide — Now!

# ASTRON

C O R P O R A T I O N

255 GRANT AVENUE EAST NEWARK, N. J.



\*Trademark

BLACK AND WHITE TV

COLOR TV

TRANSISTOR RADIOS

FM RADIOS

AM RADIOS

AMPLIFIERS AND TUNERS

AUTO RADIOS

RECORD CHANGERS



# WHAT'S YOUR SERVICE PROBLEM?

# PHOTOFACT HELPS YOU SOLVE IT

## FASTER, EASIER, BETTER, MORE PROFITABLY!

**THE WORLD'S  
FINEST SERVICE DATA**



**THESE GREAT FEATURES ARE EXCLUSIVE IN PHOTOFACT—THEY HELP  
YOU EARN MORE DAILY, HELP INSURE CUSTOMER SATISFACTION**

PHOTOFACT Service Data is the *only* service information based upon first-hand examination of the actual production-run receivers and equipment. It is authentic, uniform data developed through actual study and analysis by service engineers in the Howard W. Sams Laboratories. PHOTOFACT is the *only data* prepared from the practical point of view of the Service Technician.

Thousands of Service Technicians use PHOTOFACT daily for time-saving, profit-boosting service operations. If you've never used PHOTOFACT, you've never realized your full earning power—you've never given such complete customer satisfaction. So get the proof for yourself. Try PHOTOFACT—use it on any job. Your Parts Distributor has the Folder Sets you need for any of the 17,000 TV and radio receivers, changers, recorders, etc., covered in PHOTOFACT. Once you use this great service, we know you'll want the complete PHOTOFACT Library.

### FREE Send for the PHOTOFACT CUMULATIVE INDEX

**IT'S VALUABLE!**

Send for it! Your guide to virtually any model ever to come into your shop; helps you locate the proper PHOTOFACT Folder you need to solve any service problem on any model. Once you have the make and chassis number, it takes just 60 seconds to find the applicable PHOTOFACT Folder. Send coupon now for your FREE copy of the valuable Cumulative Index to all the PHOTOFACT Folders you need.



**FREE**

### EASY-PAY PLAN TO FIT YOUR BUDGET

Ask your PHOTOFACT Distributor... he'll show you how you can now own the PHOTOFACT Library through a unique Easy-Pay Plan that exactly fits your needs. Pays for itself as you EARN MORE.

### FULL SCHEMATIC COVERAGE

1. Famous "Standard Notation" uniform symbols are used in every schematic.
2. The same standard, uniform layout is used for each schematic.
3. Diagrams are clear, large, easy to read, easy to handle.

4. Wave forms are shown right on the TV schematics for quick analysis by 'scope.

5. Voltages appear on the schematics for speedy voltage analysis.

6. Transformer lead color-coding is indicated on the schematic.

7. Transformer winding resistances appear on the schematic.

8. Schematics are keyed to photos and parts lists.

### FULL PHOTOGRAPHIC COVERAGE

9. Exclusive photo coverage of all chassis views is provided for each receiver.

10. All parts are numbered and keyed to the schematic and parts lists.

11. Photo coverage provides quicker parts identifications and location.

### ALIGNMENT INSTRUCTIONS

12. Complete, detailed alignment data is standard and uniformly presented in all Folders.

13. Alignment frequencies are shown on radio photos adjacent to adjustment number—adjustments are keyed to schematic and photos.

### TUBE PLACEMENT CHARTS

14. Top and bottom views are shown. Top view is positioned as chassis would be viewed from back of cabinet.

15. Blank pin or locating key on each tube is shown on placement chart.

16. Tube charts include fuse location for quick service reference.

### TUBE FAILURE CHECK CHARTS

17. Shows common trouble symptoms and indicates tubes generally responsible for such troubles.

18. Series filament strings are schematically presented for quick reference.

### COMPLETE PARTS LISTS

19. A complete and detailed parts list is given for each receiver.

20. Proper replacement parts are listed, together with installation notes where required.

21. All parts are keyed to the photos and schematics for quick reference.

### FIELD SERVICE NOTES

22. Each Folder includes time-saving tips for servicing in the customer's home.

23. Valuable hints are given for quick access to pertinent adjustments.

24. Tips on safety glass removal and cleaning.

### TROUBLE-SHOOTING AIDS

25. Includes advice for localizing commonly recurring troubles.

26. Gives useful description of any new or unusual circuits employed in the receiver.

27. Includes hints and advice for each specific chassis.

### OUTSTANDING GENERAL FEATURES

28. Each and every PHOTOFACT Folder, regardless of receiver manufacturer, is presented in a standard, uniform layout.

29. PHOTOFACT is a *current* service—you don't have to wait a year or longer for the data you need. PHOTOFACT keeps right up with receiver production.

30. PHOTOFACT gives you *complete* coverage on TV, Radio, Amplifiers, Tuners, Phonos, Changers.

31. PHOTOFACT maintains an inquiry service bureau for the benefit of its customers.

## HOWARD W. SAMS & CO., INC.

Howard W. Sams & Co., Inc., Dept. 2-J5  
2201 E. 46th St., Indianapolis 5, Ind.

Send FREE Photofact Cumulative Index.

Name.....

Address.....

City.....Zone...State.....

**HELPS YOU EARN MORE DAILY**

RADIO-ELECTRONICS





L. C. Lane, B.S., M.A. President, Radio-Television Training Association. Executive Director, Pierce School of Radio & Television.

# VETERANS - - NON-VETERANS LET ME HELP YOU EARN BIG MONEY in TELEVISION — as I've helped these men —

## LEARN TELEVISION AT HOME IN YOUR SPARE TIME

Now, while demand for trained men is rising, you can prepare for a top-pay, lifetime career as an electronic technician, television repairman, or studio technician . . . or set up your own profitable business. You don't need any experience whatsoever to add your name to my list of hundreds of successful graduates.



### LEARN BY DOING

As part of your training I give you the equipment you need to set up your own home laboratory and prepare for a BETTER-PAY TV JOB. You build and keep a professional TV RECEIVER complete with big picture tube (designed and engineered to take any size up to 21-inch) . . . also a Super-Het Radio Receiver, AF-RF Signal Generator, Combination Voltmeter-Ammeter-Ohmmeter, C-W Telephone Transmitter, Public Address System, AC-DC Power Supply. Everything supplied, including all tubes.

### STUDY NEWEST DEVELOPMENTS

My training covers all the latest developments in the fast-growing Television-Radio-Electronics industry. You learn about FM — RADAR — COLOR TV — TRANSISTORS — PRINTED CIRCUITS, etc.

### CHOOSE FROM THREE COMPLETE COURSES

covering all phases of Radio, FM and TV

1. Radio, FM and Television Technician Course — no previous experience needed.
2. FM-TV Technician Course — previous training or experience in radio required.
3. TV Cameraman and Studio Technician Course — advanced training for men with Radio or TV training or experience.

### EXTRA TRAINING IN NEW YORK CITY AT NO EXTRA COST!

After you finish your home study training in Course 1 or 2 you can have two weeks, 50 hours, of intensive Lab work on modern electronic equipment at our associate resident school, Pierce School of Radio and Television. THIS EXTRA TRAINING IS YOURS AT NO EXTRA COST WHATSOEVER!

### FREE FCC COACHING COURSE

Important for BETTER-PAY JOBS requiring FCC License! You get this training AT NO EXTRA COST! Top TV jobs go to FCC-licensed technicians.

### EARN WHILE YOU LEARN

Almost from the very start of your course you can earn extra money by repairing sets for friends and neighbors. Many of my students earn up to \$25 a week . . . pay for their entire training with spare time earnings . . . start their own profitable service business.

**FREE!** I'll send you my new 40-page book, "How to Make Money in Television - Radio - Electronics," a Free sample lesson, and other literature showing how and where you can get a top-pay job in Television.



# Radio Television Training Association

52 EAST 19th STREET • NEW YORK 3, N. Y.

Licensed by the State of New York • Approved for Veteran Training

### AIRCRAFT INSPECTOR

"With RTTA training and through repairing radios and televisions for the right people at the right price, I was able to make the right contacts. I am now an Inspector for Douglas Aircraft at about \$125 a week."



Hugh Maddox, Los Angeles, Calif.

### \$60 A WEEK IN SPARE TIME

"I have the skill and know-how to do the work I love best and to enjoy better things in life, thanks to RTTA. I am now working at TV servicing and making \$60 a week spare time."

Harold Gimlen, Flint, Mich.

### ASSISTANT MANAGER

"I am Assistant Manager of Day and Nite TV Service."

Ronald W. Curry, Tulsa, Okla.



### EARNS EXTRA MONEY

"RTTA training gave me a chance for my own business, extra money earned, and more things that the price of the course could never equal."

Bryce Ruttle, Peterborough, Ontario, Can.

### FEELS FULLY QUALIFIED

"With your training I feel fully qualified to get out and compete with all radio mechanics in this area. I have over \$1,500 invested in test equipment, \$1,000 in tube stock and \$200 in miscellaneous equipment. Since I haven't had one complaint in 9 months I have been servicing sets, your school must have done a good job."



Jim Martin, Collinsville, Ill.

## VETERANS

My School fully approved to train Veterans under new Korean G. I. Bill. Don't lose your school benefits by waiting too long. Write discharge date on coupon.

### MAIL THIS COUPON TODAY!

Mr. Leonard C. Lane, President  
RADIO-TELEVISION TRAINING ASSOCIATION  
Dept. R-9C, 52 East 19th Street, New York 3, N. Y.

Dear Mr. Lane. Mail me your NEW FREE BOOK, FREE SAMPLE LESSON, and FREE aids that will show me how I can make BIG MONEY IN TELEVISION. I understand I am under no obligation and no salesman will call.

(PLEASE PRINT PLAINLY)

Name \_\_\_\_\_ Age \_\_\_\_\_

Address \_\_\_\_\_

City \_\_\_\_\_ Zone \_\_\_\_\_ State \_\_\_\_\_

I AM INTERESTED IN:

- Radio-FM-TV Technician Course
- FM-TV Technician Course
- TV Cameraman & Studio Technician Course

### VETERANS!

Write discharge date

### NO SALESMAN WILL CALL!

*After initial adjustments are made, as in photograph, "Mr. Meticulous" automatically performs critical operations in making junction tetrode transistors—tiny experimental devices which may find important uses in the telephone system.*



## The machine we call "Mr. Meticulous"

Bell Laboratories scientists, who invented the junction transistor, have now created an automatic device which performs the intricate operations required for the laboratory production of experimental model transistors.

It takes a bar of germanium little thicker than a hair and tests its electrical characteristics. Then, in steps of  $1/20,000$  of an inch, it automatically moves a fine wire along the bar in search of an invisible layer of positive germanium to which the wire must be connected. This layer may be as thin as  $1/10,000$  of an inch!

When the machine finds the layer, it orders a surge of current which bonds the wire to the bar. Then it welds the wire's other end to a binding post. Afterward, it flips the bar over and does the same job with another wire on the opposite side!

Once only the most skilled technicians could do this

work, and even their practiced hands became fatigued. This development demonstrates again how Bell Telephone Laboratories scientists work in every area of telephony to make service better.

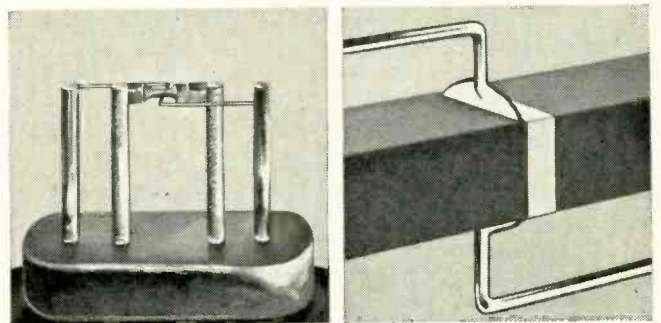

*Transistor made by new machine is shown in sketch at left above, magnified 6 times. At right is sketch of area where wires are bonded. The wires are  $2/1000$  inch in diameter, with ends crimped to reduce thickness.*

BELL TELEPHONE  
LABORATORIES



IMPROVING TELEPHONE SERVICE FOR AMERICA PROVIDES CAREERS FOR CREATIVE MEN IN MECHANICAL ENGINEERING

**MR. SERVICE DEALER:  
you're ridin' high, wide  
an' handsome**

in this RAYTHEON

**LIFE** ad

September 12th

**It takes a heap of  
Know-How to ride herd  
on 36,000,000 TV Sets**

In only a few short years, America has created a new guild of skilled craftsmen... the electronic technicians who service the nation's 36 million television receivers. It's a big job—one that calls for a high order of technical know-how and a substantial investment in training and equipment. Your neighborhood radio and television serviceman takes pride in his ability to serve you with skill and integrity.

He takes special pride when he has qualified as a member of the select group of Raytheon Bonded Electronic Technicians. As such he displays the Raytheon Bonded Seal and adheres to this Code of Ethics:

1. Guarantee all radio and television repair work for 90 days.
2. Use only parts of recognized quality.
3. Charge not over established prices for parts.
4. Charge not over established prices for parts.
5. Test customers' tubes as accurately as possible.
6. Test customers' tubes at a reasonable level.
7. Keep labor charges at a reasonable level.
8. Perform only such work as is necessary.
9. Maintain proper equipment for good repair work.
10. Maintain the highest quality service.

He has the ability and equipment to solve your TV service problems, whatever the make or model of your sets. His work is backed by a bond issued through one of America's largest insurance companies and his standing as a Raytheon Bonded Electronic Technician is your guarantee of satisfaction.



LOOK FOR THIS SEAL  
It's the symbol of Satisfactory Service



RAYTHEON MANUFACTURING COMPANY, Designing and Cashes Buy Tube Operations  
NEW YORK CHICAGO ATLANTA LOS ANGELES  
RAYTHEON MANUFACTURING COMPANY, Designing and Cashes Buy Tube Operations  
NEW YORK CHICAGO ATLANTA LOS ANGELES



**HOT OFF THE PRESS!  
The Sensational New RAYTHEON  
TRANSISTOR APPLICATIONS BOOK**

116 pages — over 50 practical applications — complete how-to-do-it instructions. Available from your Raytheon Tube Distributor or send 50¢ to Department P7, Raytheon Manufacturing Company, Newton 58, Massachusetts.

**MAKE THE MOST OF IT!**

Once again, Raytheon is telling your story, this time to the 26,450,000 readers of LIFE Magazine (September 12 issue) and, once again, you have a golden opportunity to cash in on this great, national promotion. All you need to do is tie in with this dramatic, colorful, full page advertisement. Use Raytheon decals, blow-ups of the ad, displays and local advertising to show customers you are the capable service dealer we're talking about. You'll increase your volume and profit and boost your neighborhood prestige to an all-time high.

Your Raytheon Tube Distributor will be happy to help you plan a tie-in campaign that will prove most effective. Call him today.

# TV CAPACITOR SERVICING DATA

## For Every Manufacturer from A to Z

### FREE FROM SPRAGUE

---

These two pocket-size manuals are the hottest radio-TV servicing guides ever produced. Both contain the most complete—and the most up-to-date—capacitor replacement information available ANYWHERE!

Keep them both handy and you'll never have to thrash around for the right capacitor replacement information. Sprague makes them all, Sprague lists them all, and Sprague distributors know them all—all to help you handle every capacitor job right every time.

What's more, you don't have to pay a red cent for these valuable, expensive-to-prepare, expensive to keep up-to-date manuals. You can get them both FREE from Sprague distributors located in every sales area in the United States. We'll be glad to send you the name of the one nearest you. Or, for 10c to cover postage and mailing, we'll gladly send you the manuals direct from Sprague Products Co., 81 Marshall St., N. Adams, Mass.

**DON'T BE VAGUE...INSIST ON**

**SPRAGUE**®

**WORLD'S LARGEST CAPACITOR MANUFACTURER**

Sprague Products Co. is the Distributors' Division of the Sprague Electric Co.

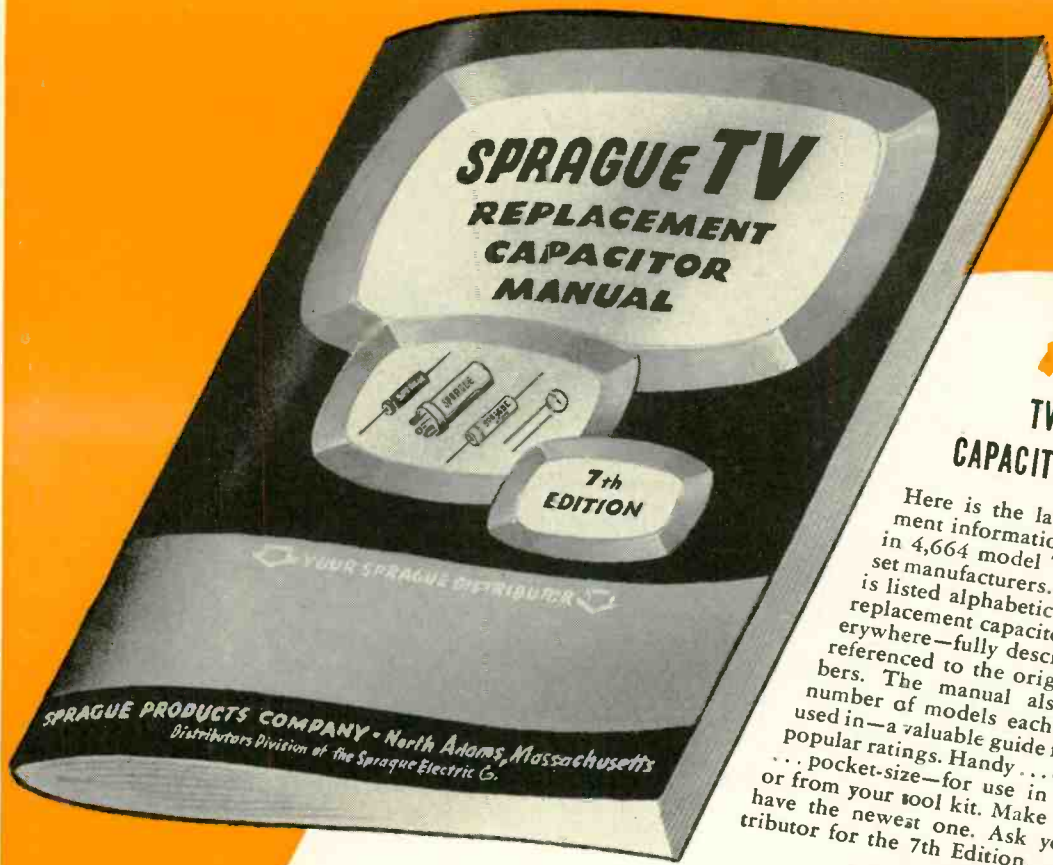

**FREE!**  
**TV REPLACEMENT  
 CAPACITOR MANUAL K-101**

Here is the latest capacitor replacement information for every capacitor in 4,664 model TV sets made by 85 set manufacturers. Every manufacturer is listed alphabetically, with Sprague replacement capacitors—available everywhere—fully described and cross-referenced to the original part numbers. The manual also shows the number of models each capacitor is used in—a valuable guide for stocking popular ratings. Handy... convenient... pocket-size—for use in the shop or from your tool kit. Make sure you have the newest one. Ask your distributor for the 7th Edition.

**FREE!**  
**CERAMIC CAPACITOR  
 REPLACEMENT MANUAL K-200**

This handy little guide is the most informative, the most complete manual of its kind ever published. Pocket-size, like Sprague's TV replacement Capacitor Manual K-101, it lists every conceivable ceramic capacitor and printed circuit replacement... for every television set made... during the past five years. All told, more ceramic capacitor values than can be found in any other manufacturer's line, including discs and tubulars. And each capacitor or printed circuit listed is one you can depend on for a no-call-back replacement. Ask your distributor for it today. It's new!

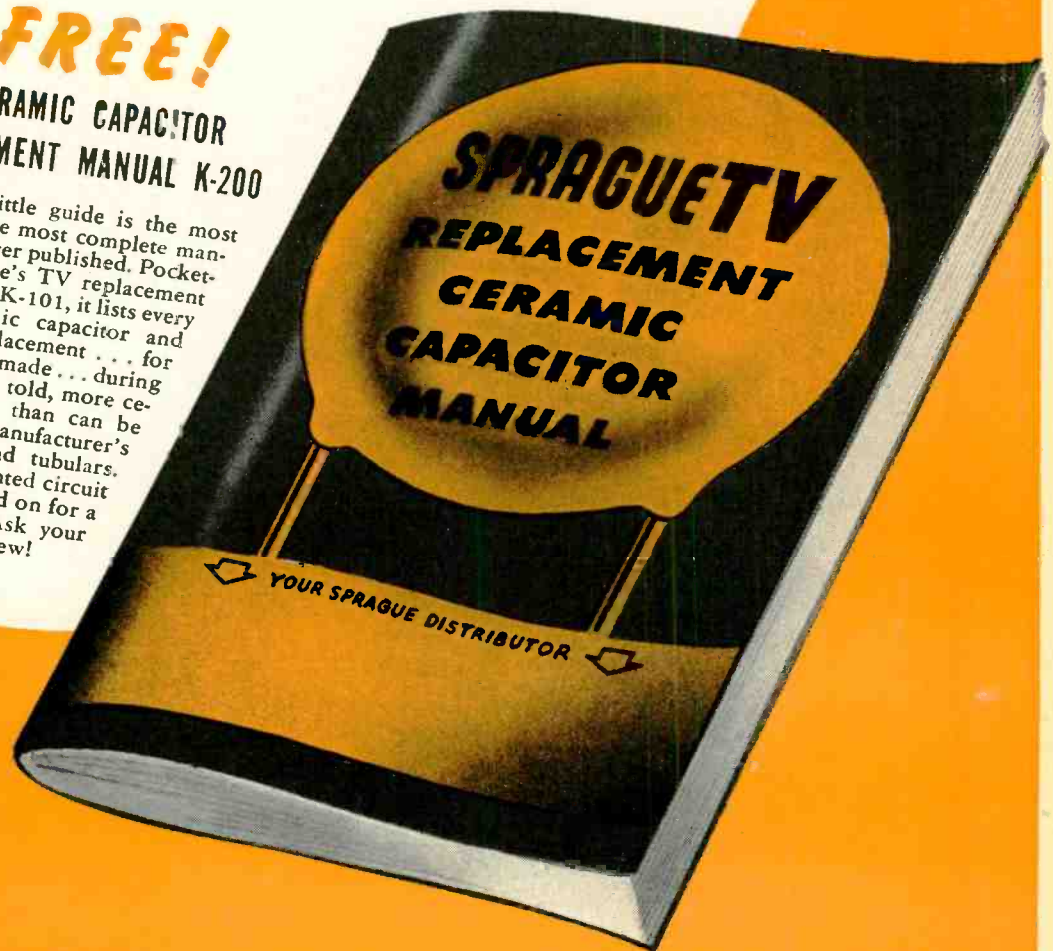

the **BIGGEST**

TV Spot Campaign  
is going to

pre-selling...

# C·D·R·R·o·t

TV  
antenna

the complete line... a model

**TR-4** the heavy duty rotor complete with handsome modern cabinet with METER control dial, uses 4 wire cable.

**TR-2** the heavy duty rotor with plastic cabinet featuring "compass control" illuminated perfect pattern dial, uses 8 wire cable.

**TR-12** a special combination value consisting of complete rotor, including thrust bearing. Handsome new modern cabinet with meter control dial, uses 4 wire cable.

**TR-11** same as TR-12 without thrust bearing.

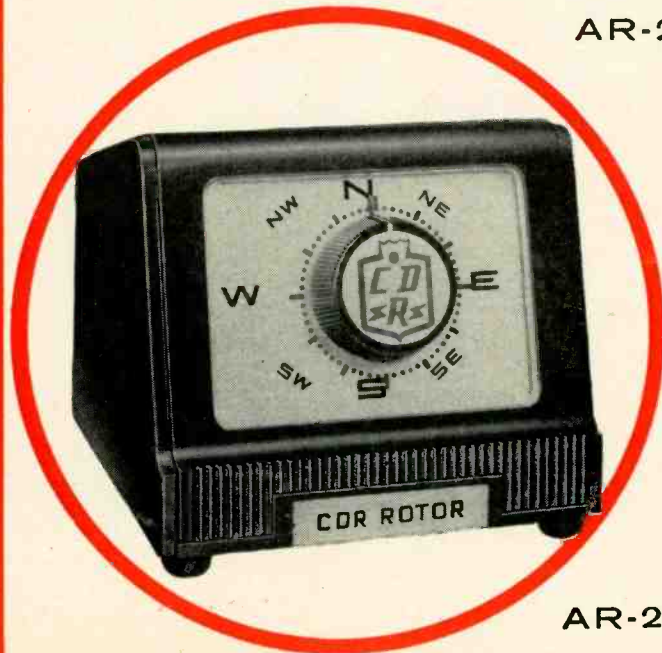

AR-1  
AR-2

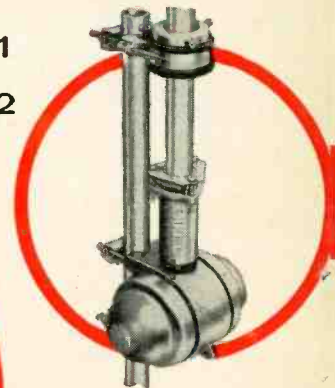

AR-22

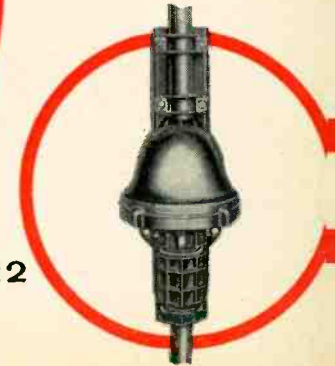

**CORNELL-DUBILIER**  
SOUTH PLAINFIELD, N. J.

**in Our History**  
**work for you**

**ORS...**  
for every need

*featuring*

**C·D·R**  
automatic

**ROTORS**

An outstanding group of rotors... three  
proven and tested models... ALL 40%  
SHARPER TUNING than ANY other automatic  
rotor. Handsome cabinet... dependable  
performance... proven and tested by thousands  
and thousands of satisfied users.

to  
millions of  
TV viewers  
every week

We are going to make this the **BIGGEST** rotor  
year you've ever had! The **CDR ROTOR** line is  
**COMPLETE** in every detail... featuring **SEVEN**  
**MODELS... A TYPE FOR EVERY NEED!** And  
backing up this is the **BIGGEST** and most ex-  
tensive consumer campaign in all our history!  
Millions of TV viewers will see the **CDR** rotor  
announcements on TV, pre-selling them for  
you. And a complete promotional kit of deal-  
er aids to help you sell and feature **CDR**  
**ROTORS!** Plan now... for the **BIGGEST** **CDR**  
**ROTOR** year ever!



THE **RADIART** CORP.  
CLEVELAND 13, OHIO



HARRY R. ASHLEY  
President



DO YOU OVERPAY  
FOR QUALITY INSTRUMENTS  
LIKE THESE?

EICO's mass purchasing and world-wide distribution, together with advanced electronic design, produce values never before possible . . . to give you **LABORATORY PRECISION AT LOWEST COST!**

You build **EICO KITS** in one evening — but . . . **THEY LAST A LIFETIME!**

GET THE MOST FOR YOUR MONEY! Don't buy ANY test instrument until you put the EICO INSTRUMENT (kit or wired) equivalent before you — and . . .

★ Compare **ADVANCED ELECTRONIC DESIGN**

★ Examine the **QUALITY PARTS**

★ Notice ease of construction

★ Check EICO's **5-WAY GUARANTEE** on components, instructions, performance, lifetime service and calibration

★ Compare **FEATURE** for **FEATURE**, **DOLLAR** for **DOLLAR**

Then YOU decide who's giving you the MOST for YOUR MONEY.

46 KITS and Instruments to choose from!—an instrument for every purpose.

You'll SAVE 50% and more . . . when you BUY EICO!

Write for **FREE CATALOG C9**



84 Withers St. • Brooklyn 11, N. Y.

Prices 5% higher on West Coast

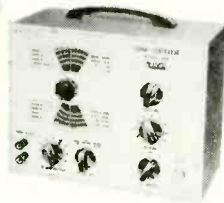

KIT \$26.95  
Wired \$39.95

NEW RF SIGNAL GENERATOR #324



NEW DC WIDE BAND 5" OSCILLOSCOPE #460  
KIT \$79.95  
Wired \$129.50



5" PUSH-PULL OSCILLOSCOPE #425  
KIT \$44.95  
Wired \$79.95  
7" PUSH-PULL OSCILLOSCOPE #470  
KIT \$79.95  
Wired \$129.50



VACUUM TUBE VOLTMETER #221  
KIT \$25.95  
Wired \$39.95  
DELUXE VTVM #214 (7 1/2" METER)  
KIT \$34.95  
Wired \$54.95



#232 Peak-to-Peak VTVM with DUAL-PURPOSE AC/DC UNI-PROBE (pat. pend.)  
KIT \$29.95  
Wired \$49.95

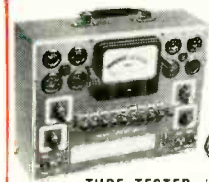

KIT \$34.95  
Wired \$49.95  
TUBE TESTER #625  
Pix Tube Test Adapter ..... \$4.50



#944 FLYBACK TRANSFORMER & YOKE TESTER  
KIT \$23.95  
Wired \$34.95

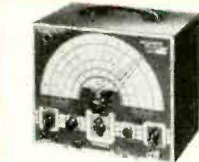

KIT \$34.95  
Wired \$49.95  
TV/FM SWEEP GENERATOR #360  
5MC-4.5MC CRYSTAL ..... \$3.95 ea.



KIT \$39.95  
Wired \$59.95  
DELUXE RF SIGNAL GENERATOR #315

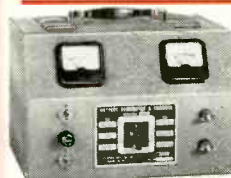

KIT \$29.95  
Wired \$38.95  
6V & 12V BATTERY ELIMINATOR & CHARGER #1050



KIT \$24.95  
Wired \$39.95  
DELUXE MULTI-SIGNAL TRACER #147



KIT \$19.95  
Wired \$29.95  
R-C BRIDGE & R-C-L COMPARATOR #950B



KIT \$24.95  
Wired \$29.95  
20,000 Ohms/Volt MULTIMETER #565



KIT \$12.90  
Wired \$14.90  
1000 Ohms/Volt MULTIMETER #536

VTVM PROBES  
Peak-to-Peak ..... \$4.95 \$6.95  
RF ..... \$3.75 \$4.95  
High Voltage Probe-1 ..... \$6.95  
High Voltage Probe-2 ..... \$4.95  
SCOPE PROBES  
Demodulator ..... \$3.75 \$5.75  
Direct ..... \$2.75 \$3.95  
Low Capacity ..... \$3.75 \$5.75



## THE GIANT ELECTRONICS INDUSTRY

... *Facts and figures of our incredible industry* ...

The future of electronics was discussed recently by W. Benton Harrison, vice president of Sylvania Electric Products, Inc., before the Financial Analysts of Philadelphia. Highly interesting facts and figures were cited. A condensed version of Mr. Harrison's address follows:

**E**LECTRONICS is such an enormous subject that it would require a good many men a good many days to speak on all its aspects. It is relatively new and growing very rapidly. Since electronics encompasses a vast multitude of products and systems and new ones are being developed and introduced almost daily, and since new companies are entering the field all the time, just producing sales-volume figures has been a monumental task.

We are extremely fortunate in having Radio-Electronics-Television Manufacturers Association (RETMA), which compiles most exact and reliable industry reports. Our predictions can come to within at least 85 to 90% of accuracy, and possibly better.

One of the two major fields within the industry today is entertainment electronics. To illustrate, let us consider what trade gossip once had to say about prospects for television in 1954. Dealers sold 6,400,000 sets to the public in 1953. This was an all-time record. When a period of rather severe inventory adjustment began in late 1953, "the trade" mistakenly attributed the setback to a decline in buying by the public. So when 1954 approached, this same "trade" glumly forecast that television set sales in 1954 would be somewhere around 5,000,000. What happened? The public bought approximately 7,300,000 sets last year, once again establishing an industry all-time high.

We expect that some day there will be just as great a percentage of television homes as there are radio homes today, and today there are 46,600,000 radio homes in the United States. Of those radio-set homes, nearly 70% also have television. This high figure, coupled with the fact that by the end of 1955 virtually the entire country will be within range of a good television signal, means that television is rapidly approaching the saturation point—the point at which virtually every home that is going to have a set already has one. But don't let that word "saturation" mislead you.

In fact, we believe that the public will purchase 6,300,000 black-and-white television sets in 1955, in addition to approximately 100,000 color receivers. Let's analyze that figure of 6,300,000 black-and-white sets. If only 4% of those now in use are replaced for wear or obsolescence, that means a sale of 1,300,000 sets. If population growth and establishment of new homes this year proceeds as expected, this might mean the sale of another 600,000 more sets than if the population and number of homes remain static.

The growth of the second-set idea might mean the sale of another 300,000 units. These figures—and I should like to say that in each category the estimate is *very* conservative—add up to a sales potential of 2,200,000 sets in 1955. Subtracting this from the predicted figure of 6,300,000 black-and-white sets, that leaves 4,100,000 to be marketed to established homes that never have had a television set before. *As of right now, there are approximately 15,600,000 homes in the United States without a television set.* This means the industry will have to sell one in every four existing homes currently without television in order to achieve our estimate of 6,300,000 black-and-white sets for 1955. The average

cost of a black-and-white television set is \$140 factory price. Therefore, if we sell a quarter-million more sets than we have estimated, that will mean an additional \$35,000,000 to the industry. If we sell a half-million more sets than those predictions, that will mean an additional \$70,000,000. And an extra million sets would add a whopping \$140,000,000 to the industry's overall volume.

Even though the number of nontelelevision homes declines appreciably each year, these factors indicate to me that the long-term potential for television certainly will range between 6,000,000 to 7,500,000 sets per year through the next decade. At the end of the decade, in 1964, it is likely that somewhere in the neighborhood of 7,300,000 sets will be sold and that annual dollar volume will be around \$1,500,000,000.

In other words, dollar volume of television sets a decade hence will be 40 to 50% greater than it is today. The increase will of course be attributable to a steadily expanding number of color sets. While it is probable, we think, that no more than 150,000 color sets will be produced this year (and only 100,000 of them sold to the public), it is expected that something like 34% of sales will be color sets in the 1958-60 period and that by 1964 color will account for about 61% of all sets produced. As you can see, color is on the way, but it will be some time before color sets will be marketed in large quantities, and at least six years before production for color catches up with black-and-white.

Has television crowded home radio off the map? Hardly. The manufacturers sold 6,400,000 home radios last year for a total volume of about \$136,500,000, and it is expected another 7,000,000 sets, at approximately \$147,000,000, will be sold in 1955. Market surveys show that more people than ever before are listening to radio and that during the daylight hours when the housewife can't stay in one room, the radio is turned on more frequently than the television set. It seems indicated that over the 1958-60 period, nearly 7,800,000 radio sets, grossing over \$148,000,000, will be sold each year and that by 1964, 8,500,000 home radio units will be sold, at a total of nearly \$162,000,000.

The sale of entertainment radios for automobiles will be linked very closely, of course, to automobile production. It seems a certainty that virtually three of every four pleasure cars will be equipped with a radio. Our researches show that 4,100,000 auto sets, totaling nearly \$103,000,000, were sold in 1954 and that another 4,300,000, aggregating \$107,500,000, will be sold this year. Auto-set sales in the 1958-60 period should average 4,800,000 annually at an average volume of \$120,000,000. In 1964, it is expected 5,600,000 auto units will be sold at a dollar volume of about \$140,000,000.

Before the war, the receiving-tube business carried along at a rate ranging from \$10,000,000 to \$12,000,000 a year. But that market has expanded into a business, including both receiving and picture tubes, that exceeded \$170,000,000 last year, is expected to be above \$400,000,000 in the next five or six years and will go to \$575,000,000 or higher by the end of the decade ahead.

The last factor in entertainment electronics devices is records and phonographs, which should maintain a fairly level volume of sales of between \$120,000,000 and \$140,000,000 a year, at a minimum, over the next decade. I have heard the high-fidelity market alone described as potentially a \$200,000,000 business. *(Continued on page 160)*

# Making Printed Circuits Is Easy

*All your needs for  
this type of wiring are  
easily available.*

By TOM JASKI

**F**OR commercial, industrial and military purposes printed circuits and printed-circuit wiring are well established. Some reach the experimenter and the amateur as small enclosed coupling plates or as major parts in the latest instrument kits.

For most of our work however we struggle along with clusters of wires, components and mounting strips, often difficult to lay out, particularly in shallow chassis. After building a few instruments with printed-circuit wiring one begins to wonder why the advantages it presents could not be obtained for most equipment. With components available in smaller sizes, transistors becoming more available and lower in cost, this would be a very desirable advance.

At least one company has put on the market a \$10 kit of conducting and resistance paints. Another firm sells a 6 x 6-inch sheet of copper bonded to plastic, and the covering and etching material to make your own printed circuits.

The paints, although capable of producing a printed circuit in the true sense of the word, are costly and not easy to use.

Conductor lines are very easily damaged by the heat from even a very small soldering iron. The resistors are not

particularly stable and change drastically in value with an application of the insulating lacquer. Figs. 1 and 2 show circuit wiring formed with conducting paints from a kit.

The people selling the bonded sheets offer more hope to the experimenter. The printed-circuit wiring which can be made with these kits, however, can just as well be produced with a few cents' worth of materials from the local hardware and drug stores.

### Constructing printed circuits

One type of printed-circuit board consists of some .001 to .003 inch thick brass shimstock, any type of plastic sheet and a small quantity of suitable adhesive. Professionally, an adhesive film using pressure and heat for bonding can be obtained. But most hardware stores or hobby shops carry some adhesive which will do just as well. I use a cement with the name of GOO which did a fine job without either heat or pressure so long as the directions were followed exactly. The thermosetting plastics such as Bakelite or Micarta will do a better job than most others, but even fishpaper can be used. The thermoplastics may give some trouble by melting locally when attaching connections. The brass and plastic are cleaned thoroughly before gluing,

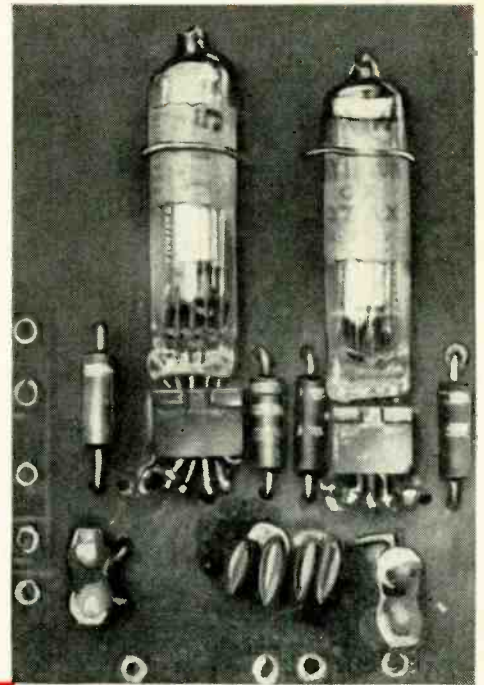

Fig. 1—Subminiature push-pull oscillator parts mounted on circuit board.

and roughening the surface with 8/0 cabinet paper may be helpful.

The circuit is carefully laid out on paper. If you have ever done maze puzzles, this part should be easy. The main trick is to avoid crossovers. Otherwise conventional circuit layout methods are used—placing the parts so that no undesirable coupling takes place and using the shortest possible connections. Provide small holes for component leads. For  $\frac{1}{2}$ -watt resistors these should be spaced  $\frac{1}{2}$  inch apart. For capacitors they will vary greatly with size and voltage rating. Generally the ceramic capacitors will be the most compact.

If a crossover becomes unavoidable, two small holes in the circuit board and a short wire on the other side will turn the trick. For circuits where shielding is desirable and intercapacitances are not critical, as little metal as possible should be removed. For high-frequency circuits or low-level amplifiers requiring very high insulation values, most of the metal should be removed.

To complete the circuit board after bonding the brass and plastic, transfer the design to the brass with carbon paper or pressure with a hard drafting pencil. With a sharp pointed knife remove the metal as required. For

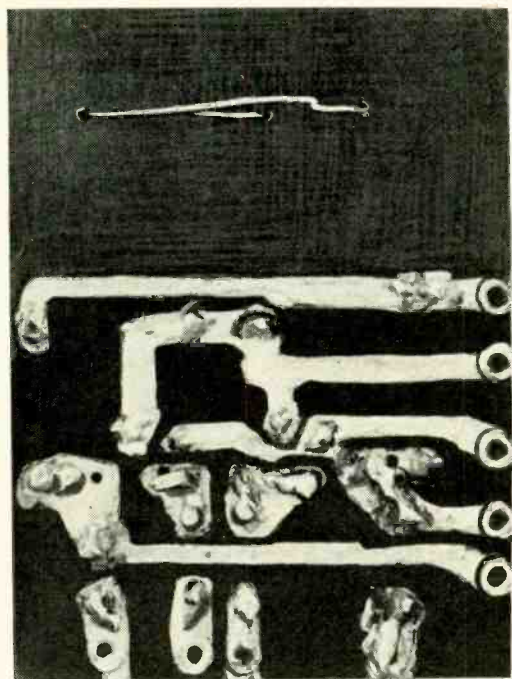

Fig. 2—Rear view of Fig. 1—conductors made with silver conducting paint.

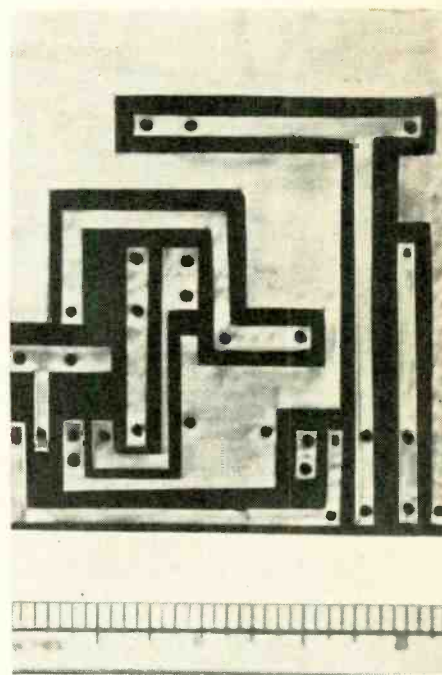

Fig. 3—Circuit board for two-stage amplifier made with knife and drill.

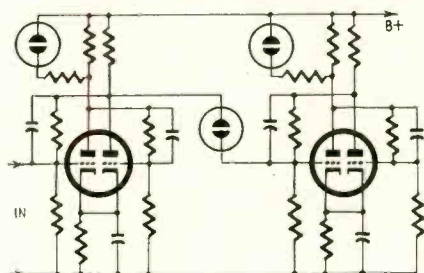
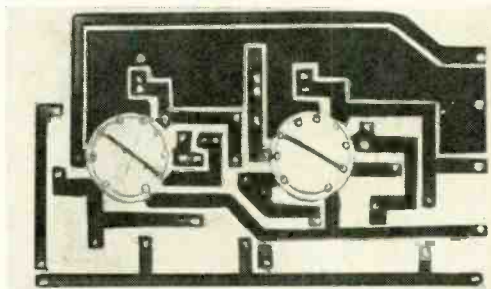

Fig. 4—Schematic diagram and circuit layout for two-step counting circuit



appearances' sake remove excess glue with a solvent recommended by the glue manufacturer. The small lead holes are made with a No. 50 drill and the circuit board is ready for installing components. With reasonable care no damage from soldering iron heat will occur. If the glue should soften locally, it will soon set again. In the meantime the component lead will hold the brass firmly in place.

You will soon learn to keep circuit lines straight and simple if the knife is to be your tool. Fig. 3 shows a circuit board for a two-stage subminiature amplifier produced with no other tools than a knife and a No. 50 drill.

A second method, a little closer to industrial practices, offers advantages for more complicated circuits. It also lends itself very well to repetitive manufacture such as the two-step counting circuit shown in Fig. 4. Start again by bonding a sheet of shimstock to plastic as before. Depending on whether you have to make one or many, either paint on the brass directly all those pieces which are to remain or make a stencil showing the same pieces. With a stencil a small spray gun is helpful but not essential. The paint used can be enamel or lacquer. If desired, various colors may be used for clarity. Fig. 5 shows a stencil and

the painted board. A stencil to be used frequently might well be made from the same shimstock.

Prepare an etching bath consisting of water and a small quantity of sulfuric acid. Submerge the circuit board in it as the anode and any electrode will do as the cathode. Apply a 6-volt direct current, and in a few minutes the brass in the unpainted areas will begin to eat away. If a more lively bath is desired, more sulfuric acid can be added or even a few drops of nitric acid. But a fast etching bath is much harder to control.

All parts of the brass should disappear at about the same rate if it was properly cleaned, and a layer only a few molecules thick will remain which can be wiped off with the glue solvent. However, if brass islands should persist, these can be removed by momentarily connecting them to the positive side of the voltage source. Proper etching may require a little practice, but it is not difficult. Cleanliness of the brass is the single most important factor. A sheet cathode parallel to the circuit board and at least of the same size will give an evenly etched job across the whole area.

After etching, very thorough washing and rinsing, all that remains to complete the circuit board is removal

of the lacquer or paint and the drilling of holes for component leads. Tube sockets are easily installed by bending the lugs forward and removing the metal mounting ring, if any. No special sockets are required. Fig. 6 shows the etched circuit board with one socket installed. It is sometimes desirable to drill the large socket holes before bonding the brass. This avoids serious stress on the brass around the holes.

In a third method the etching bath with the addition of a small quantity of copper sulfate and Rochelle salts is used. These chemicals can be obtained in virtually all drug stores. The copper sulfate can be produced by allowing diluted sulfuric acid to react with some copper in the presence of air, but it takes a long while. The process can be speeded by applying d.c. and two copper electrodes, but that requires careful filtering of the solution. This third method, perhaps the most commonly used, consists of literally growing the circuit by electroplating (Fig. 7) or electroforming. The latter term applies when we provide form walls for the metal to deposit in to the desired thickness.

Start with a very clean piece of plastic and on this paint or draw the desired circuit lines. Paint only those parts which are to remain, using a

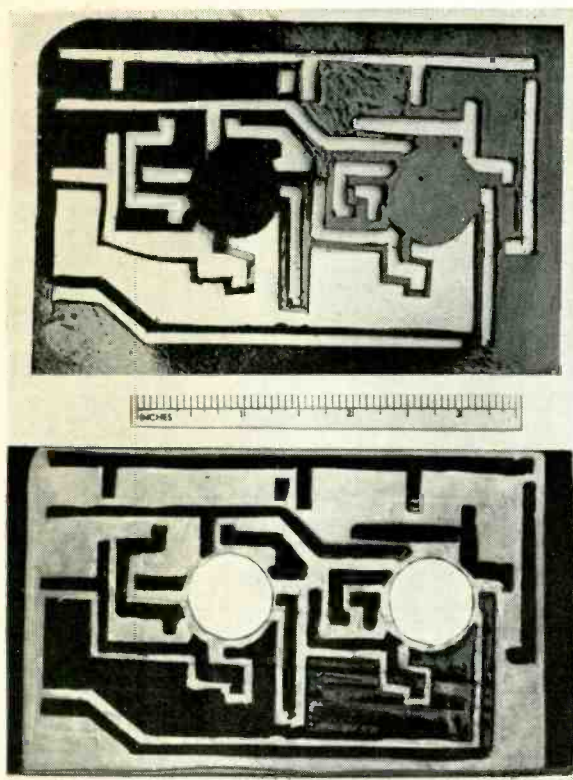

Fig. 5—Top, stencil made from layout. Bottom, the painted circuit board.

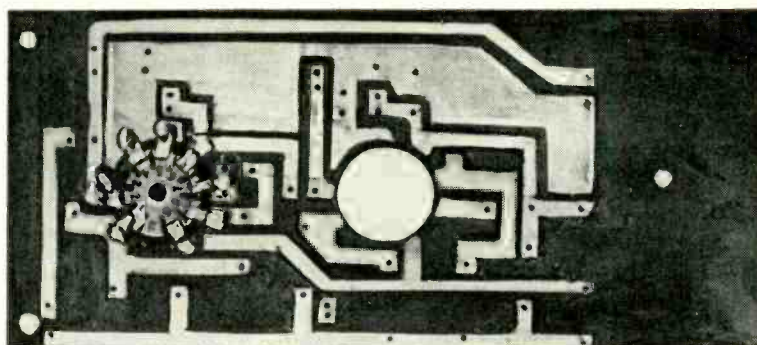
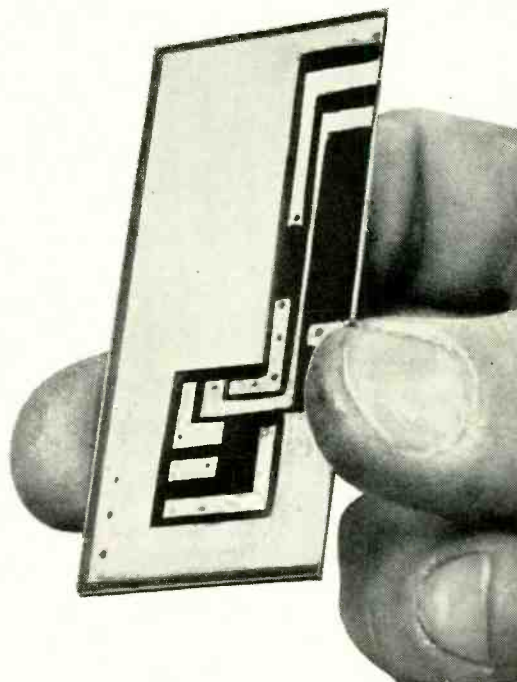

Fig. 6—The etched circuit board.

Fig. 7—Plated circuit board — plating is copper, base is Plexiglas.



conducting paint. If no conducting paint is available, it can quickly be made by removing the carbon rod from a used flashlight cell, powdering it and mixing the powder with some drafting fixative. This makes a conducting paint which shows very excellent bonding and plating characteristics. However, even a soft drafting pencil or an electrographic scoring pencil could be used. They will produce lines which can be plated, but it takes a little longer.

In drawing the circuit, the electrode must be connected to all parts. For this purpose small bridges can be drawn which can be removed later. Connecting bridges drawn on the edge of the plastic are particularly easy to remove. Immerse the circuit board in the bath, connecting it this time to the negative side of the power supply, with a copper electrode connected to the positive side. Only 1 volt is used. More voltage would make the copper porous, resulting in poor adhesion. Lower voltage would not provide "throwing power"—the copper particles would not reach their destination on the board. The bath should be about 100° F. for best results. A hot bath will provide better-quality copper and better bonding. The top limit is about 140° F. These values should provide about .001-inch plating in 45 minutes. Several thousandths thickness is desirable since it permits sanding and polishing of the circuit lines.

Electroforming is not much different

from plating. In this case circuit lines are scribed in the plastic with heat. Narrow and shallow grooves can be made with a plastic cutting tool such as the Ungar type 540 marking tip. Sand the surface of the board smooth and scrape the grooves to remove loose particles. Then paint the grooves with conducting paint. At this point it would be well to check for continuity with an ohmmeter. The next step is the same as plating, with the same ingredients and current values. The formed circuit will be entirely below the surface of the plastic and thus well protected from damage.

Other methods of producing similar circuit boards, such as embedding and casting, have been experimented with but seem to have no great advantages for the experimenter. The processes involved are more complicated and more adaptable to large-scale production.

For those not entirely familiar with the advantages of printed circuits, here is a brief summary: Printed circuit wiring is neat and compact. It is not subject to mechanical shock or vibration and provides a very rigid mounting for component parts as well. It is very constant in intercapacitance relations

and stable with temperature variations, important factors in critical high-frequency circuits.

The following is a list of manufacturers currently producing equipment used in the various methods of making printed circuits. This list is representative of available products and is by no means complete:

*Conducting paints*

- General Cement Co., 919 Taylor Ave., Rockford, Ill. (silver \$4.70 net, per ounce)
- Microcircuits Co., New Buffalo, Mich. (silver and copper, parts of kits)
- Handy & Harman, 82 Fulton St., New York 38, N. Y. (silver)

*Resistance paints*

- Microcircuits Co., New Buffalo, Mich. (in kit form, approximately \$10)
- Inter Electronics Corp., 2432 Grand Concourse, New York 58, N. Y.

*Bonded-sheet kits*

- Tele-Diagnosis Co., 155 W. 72 St., New York 23, N. Y. (kits \$19.95)
- Techniques Inc., 135 Belmont St., Englewood, N. J. (kits, \$4.95-\$25)
- Consultants for Industry, 273 E. 175 St., New York, N. Y.
- Harcon Electronikits, Brandywine, Md.

*Bonded sheets*

- Mica Insulator Co., Schenectady 1, N. Y.
- Continental Diamond Fibre Co., Newark 16, Del.

END

# Common-Collector Transistor Amplifiers

By RUFUS P. TURNER

THE input impedance of the familiar common-base and common-emitter junction transistor amplifiers is notoriously low when compared with the high input impedance of tube type amplifiers. Typical values are 60 ohms for the common base and 1,000 ohms for the common emitter.

The *common-collector* amplifier circuit, least familiar of all three transistor circuit configurations, *does* have high input impedance and can be used as the input stage of transistorized instruments such as multistage amplifiers, signal tracers, a.c. electronic voltmeters, Geiger counters and similar devices. It is useful also, in lieu of a stepdown coupling transformer, between transistor amplifier stages as an interstage impedance-matching device. Unlike the transformer, the common-collector stage provides power gain.

The common-collector amplifier resembles the tube type cathode follower in the following respects: It has high input and low output impedance, voltage gain of less than 1, power gain, excellent frequency response and no phase reversal. The common collector differs from the cathode follower, however, in that its input resistance is not independent of its output resistance, being highest for high output values and vice versa. Also, its output resistance increases as the resistance of the signal source (generator) increases. Another important property is that, for fixed generator and output resistances, the input resistance of the common collector decreases with increasing signal frequency. In spite of these uncommon characteristics, the common collector is quite satisfactory as a source of high input impedance, along with power gain, in the input stage of many transistorized circuits.

In a common-collector circuit, the input signal is applied between the base and collector of the transistor (Fig. 1). The internal base resistance  $r_b$  and collector resistance  $r_c$  thus are in series with the signal source. It is  $r_c$  that gives the common-collector circuit its high input value, since  $r_c$  for a junction transistor is very high with respect to  $r_b$ .

In surveying the characteristics of commercial transistors, the CK725 seemed to have particular merits for common-collector operation, since its collector resistance is 2 megohms and its alpha high. The base resistance of this unit is 1,500 ohms, so offhand one might expect to obtain an input resistance ( $r_c + r_b$ ) of 2,000,000 + 1,500, or 2,001,500 ohms in a common-collector circuit. Actually, however, this value could not be attained practically, since  $r_c + r_b$  must be multiplied by a decimal

$$\text{equal to } \frac{r_c + R_L}{r_c - r_m + r_c + R_L}. \text{ For the}$$

CK725, the maximum calculated input resistance thus will be something less than 2 megohms.

The resistance-capacitance-coupled circuit shown in Fig. 1 was assembled for test. In this arrangement, the base of the transistor "floats" without bias to provide the highest possible input resistance. (A bias-stabilizing resistance network would lower the impedance.) A *low-voltage* d.c. source (1.5) was chosen since the resulting low d.c. emitter current helps keep the input resistance high.

Using a 600-ohm signal generator, the following performance data were accumulated: 1. Input impedance at 20 cycles is 1.2 megohms and decreases to 160,000 ohms at 50 kc. This falloff is shown by the curve in Fig. 2. Individual CK725's might supply higher input impedance. 2. Voltage gain is constant at 0.96 from 20 cycles to 10 kc (Fig. 3) and falls slowly to 0.88 at 50 kc. 3. The maximum input signal voltage  $E_{in}$  before positive-peak clipping appears in the output signal is 0.52 volt r.m.s. 4. The corresponding maximum output signal voltage  $E_{out}$  is 0.499 volt r.m.s. 5. Power gain is 30.74 (14.87 db.).

These data were taken with a high-impedance a.c. vacuum-tube voltmeter and oscilloscope connected in parallel across the signal output terminals. The minimum load which might be connected directly to the output terminals of the circuit in Fig. 1 without upsetting its operation would be approximately 10 times  $R_L$ , or 300,000 ohms.

When this common-collector circuit is used as the input stage of a system, its output should be transformer-coupled to the next stage for satisfactory impedance matching and to maintain the very high input impedance. For example, the circuit in Fig. 1 may be transformer-coupled to the input of a common-emitter voltage amplifier stage (input impedance = 1,000 ohms) with a 30,000-to-1,000-ohm coupling transformer. This transformer would have

a turns ratio of approximately 5.5 to 1. The high-impedance winding of the transformer is connected in series with the emitter and the positive terminal of the battery,  $R_1$  and  $C_1$  being omitted. If no transformer were used and  $R_1$  were made 1,000 ohms, the input impedance of the common-collector circuit would drop to approximately 20,000 ohms at low frequencies and still lower at high frequencies.

The curve in Fig. 3, showing falloff of input impedance with increasing frequency, indicates that this particular common-collector circuit might be useful only with a signal source which would not be loaded badly by the lowest amplifier input impedance (160,000 ohms at 50 kc). Low- and medium-impedance transducers, pickups and microphones would fall into this category. In applications where the operating frequency is either fixed or extends over only a narrow band, the common-collector input impedance is fairly constant. Such applications include bridge null detectors and other single-frequency a.f., r.f., and i.f. amplifiers; signal tracers in which the transistor audio amplifier is preceded by a diode detector and the r.f. test signal is amplitude-modulated at a single audio frequency; Geiger counters; code-signaling circuits.

The common-collector circuit merits attention and exploitation by the experimenter, who up to this time seems to have overlooked its important possibilities while grasping for the higher voltage gain and power gain of the two other common circuits. END

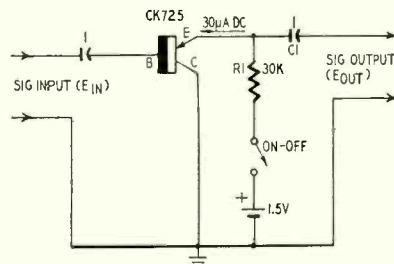

Fig. 1—Schematic diagram of common-collector transistor amplifier circuit.

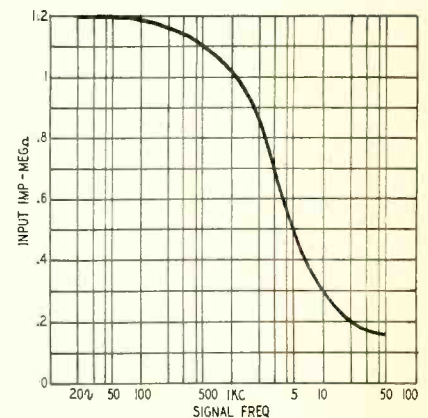

Fig. 2—Variation in the common-collector input impedance with frequency.

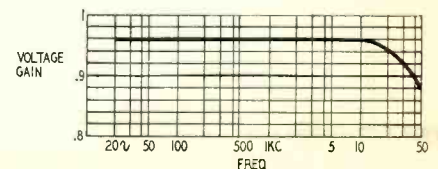

Fig. 3—Common-collector voltage gain.

# Flexible Radio Control System

By RICHARD H. DORF\*

*Part II—The radio receiver  
and control system*

**W**ITH the boat's removable cabin off (see photo) the electric components can be seen. Toward the bow, immediately behind a 90-volt battery, is the 6-meter superregenerative receiver, which includes audio voltage amplifiers and a power output stage. A little aft of midships is the control chassis containing eight relays. Four of these are resonant-reed relays, which operate only when energized by a.c. of the correct frequency. The frequencies used are 416.3, 442.6, 470.5 and 500.2 cycles. They can be so close without any possibility of control errors because the sensitive spectrum of each relay extends over a range equivalent to only 1% of its nominal frequency.

The resonant relays cannot control power directly so they are made to energize auxiliary relays which can. The auxiliary relays control rudder motion and drive. One 90- and one 45-volt B battery are used, plus a 1.5-volt cell for filament heating and a 6-volt miniature storage battery for the drive and steering motors.

Fig. 1 is a schematic diagram of the boat receiver. Isolating stage VI helps prevent superregenerator radiation from causing trouble. The superregenerator is V2-a, with R1 the regeneration control. Stages V2-b and V3-a are voltage amplifiers, and V3-b is the power output stage which feeds the control chassis and the resonant relays.

Fig. 2 shows the top of the receiver chassis. A Bud Minibox 3 x 4 x 5 inches was used for both receiver and control chassis. The receiver chassis is simply the unflanged part of the Minibox, with the tubes mounted underneath (Fig. 3). This was necessary because, when the cabin is replaced on the boat, there is no room for tubes on top. (There is an extra tube socket which later was not needed but was left in place out of laziness.) This method of construction has the advantage that the circuitry is accessible even when the chassis is in operating position, so that adjustments and tests can be made.

\*Electronics consultant, New York.



Top view of boat with cabin removed. Antenna jack is in forward hatch cover.

Fig. 4 is a diagram of the control chassis. This is the flanged part of the Minibox, with two sides removed by the simple process of bending them until they fall off. The result appears in Fig. 5. The legs are angles. The alteration was made so that the control chassis could straddle the propeller drive shaft to conserve space. As Fig. 5 shows there is very little under the chassis so this is no problem.

The relay connections require a little explanation. RY5 and RY6 (which are energized by resonant relays RY1 and RY2) have single-pole double-throw contacts and control the polarity of voltage applied to a small steering motor (of which more later). Tracing the connections, it is seen that if RY5 and RY6 are unenergized, contacts 1 and 2 of J4 go to ground. If RY5 is energized, contact 2 of J4 remains at ground potential while contact 1 goes 6 volts positive. When RY6 is energized, just the reverse happens.

The drive-motor circuit could have been made just the same, and in fact constructors will probably do it that way. However, I just happened to have a double-pole double-throw relay in stock, with only three of the others, so it was used. Here RY8 does the polarity-reversing in the standard way, while the contacts of RY7 stop current from passing to the motor when they are open. With RY8 unenergized polarity is such as to cause the boat to go astern and when RY7 closes that happens.

The relays used for RY5, 6 and 7 were 2,000-ohm G-E surplus units. It is much better for the life of the resonant relays to use 10,000-ohm relays throughout, in which case the values for R1 and C1 should be used with all relays rather than the simple 1- $\mu$ f capacitors necessary to make the less sensitive ones work. The value of R1 can be increased, depending on trial.

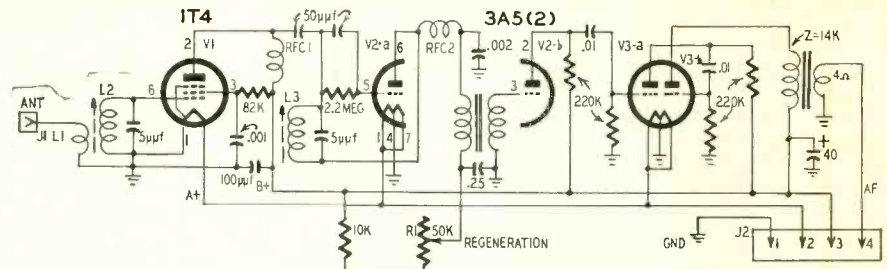

Fig. 1—Receiver diagram—superregenerative with 1 power and 2 voltage stages.

Fig. 6 is a diagram of the wiring installed in the boat. All permanent wires are threaded through small holes made in the boat frame supports to keep them in place. The boat photo shows the battery locations. To get the 1.5-volt cell in place in this model, a couple of the frame supports must be cut away, but remaining strength is sufficient.

Connectors of any kind can be used. The ones used in this boat were made up from an Elco Varicon kit, which permits making connectors of any size. Insulated hookup wire is used.

**The rudder**

This arrangement (Fig. 7) is somewhat special and works out very well, even as constructed by an individual who dislikes mechanical work.

The motor which drives the rudder is a small 4-6-volt d.c. unit with a transparent plastic housing. It rests on its side in the left rear compartment of the boat and is set in place with Duco cement. Its shaft holds a worm which extends in the direction of the bow. A vertical shaft supported in holes in a small metal dual angle has a small pinion gear on each end. The lower gear contacts the worm; the upper gear can be seen in the photo.

The rudder post goes through a small tube and is soldered to the rudder. The upper part is bent so that it forms a sort of tiller. A section of rack is bent into a quarter-circle and a hole drilled

in it to take the end of the tiller, which is fastened in place with solder. The circular rack section contacts the upper pinion gear.

When the motor rotates, the gears are rotated and the rack is swung back and forth taking the rudder with it. The rack section is short enough so that it goes off the gear at the limits of rudder travel. There is thus no problem of

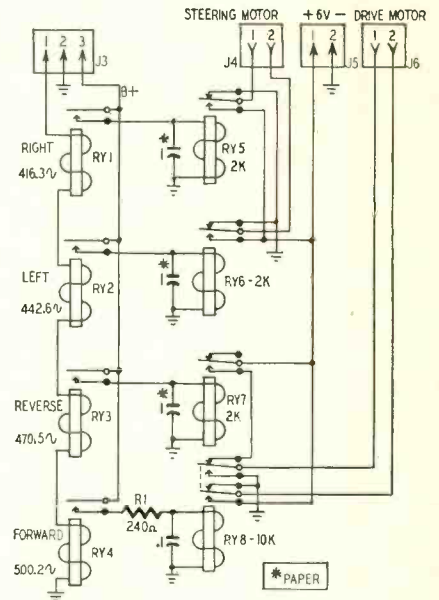

Fig. 4—Schematic of control chassis.

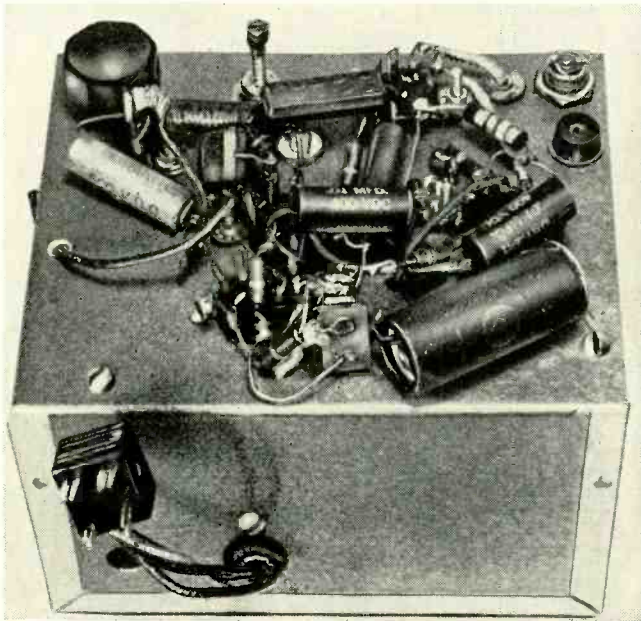

Fig. 2—Topside of the receiver chassis.

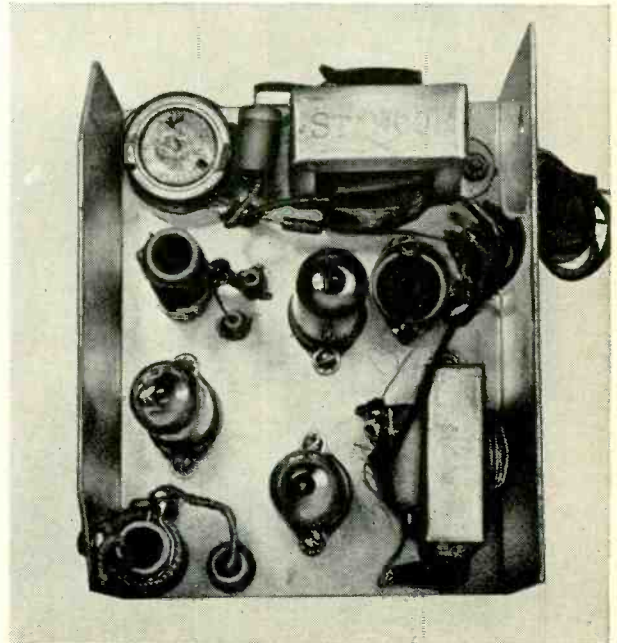

Fig. 3—Underchassis view of receiver.

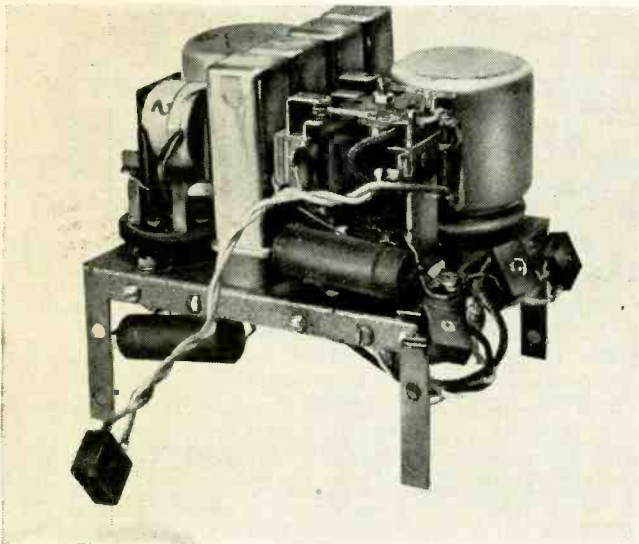

Fig. 5—Control chassis holds relays. It is a modified Minibox (see text).

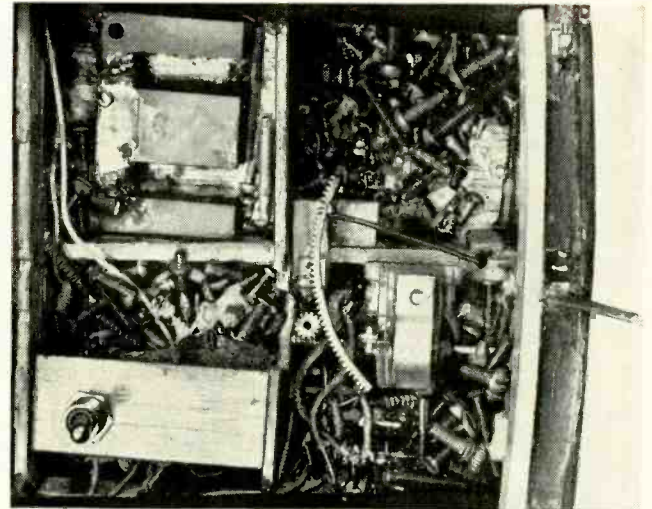

Fig. 7—Rudder drive system under rear deck. Screws and bolts provide ballast.

mechanical binding and there need be no limit switches to stop the rudder motor. Small pieces of foam rubber press the ends of the rack lightly against the gear at the rudder limits so that the rudder immediately starts to move when the steering motor is reversed after overtravel.

The worm, gears and shaft are available in hobby shops where the motor can be bought. They are approximately 48 pitch and the rack is 48 pitch, obtained in 2-foot lengths from Boston Gear or any similar company. All are brass.

The rack should be bent to shape after the motor, gears and rudder are in place. Measure the distance between the vertical rudder post and the gear, then draw a circle on paper with this as a radius. Bend the rack to shape, using the perimeter of the circle as a pattern. Exactness is not necessary—the whole system is far from a precision job but it is adequate. Lubrication of the gear system is not desirable—since it will catch dust—and is not necessary for

low speeds and intermittent operation.

**Final adjustment**

The entire system can be adjusted on the bench before it sees the water. Make a simple stand to hold the boat (see photo in Part I). A banana jack is fastened to a hatch cover on the forward deck and the wire led to the antenna plug. The antenna is a piece of bus wire a couple of feet long, soldered at one end to a banana plug.

Turn on the transmitter (keep it a few feet away) and adjust the oscillator and amplifier tuning for maximum output, switching on any tone for this purpose. Advance the receiver regeneration control about a quarter-turn and tune the oscillator slug (L3 in Fig. 1) for maximum audio as indicated by vibration of a resonant relay or a pair of phones clipped to ground and some wire or plug pin connected to the receiver audio output. Adjust regeneration for a clear tone. Tune the antenna coil for maximum output; this will not be a sharp maximum.

Now, if it has not been done before (and even if it has, do it as a touchup), adjust the values of the tone-tuning capacitors in the transmitter so that the relays operate. There may be spots in the room, especially if it is in a steel-beamed building, where there is poor reception. This is due to standing waves

and will not happen out of doors.

When the receiver battery voltage is low, the steering and drive relays may not operate simultaneously due to lack of sufficient audio power output from V3-b (Fig. 1). While the receiver does not draw more than 20 ma from the B supply, this happens eventually. The batteries can be pepped up by connecting them to an external power supply for a few hours, with the supply voltage adjusted for a current to the batteries of around 30 to 50 ma. The same can be done for the transmitter, which is a principal reason for the test jack.

Besides letting the boat ride the waves, one more thing is necessary—ballasting. The radio equipment will inevitably be out of balance, and probably will cause the boat to be down by the head. Fig. 7 shows a simple ballasting method—adding old screws and bolts in the rear compartment. Fill the bathtub with water and carefully place the boat in it. Then add old screws, bolts and anything else heavy that comes in small pieces to the rear compartment until the boat is balanced. Remove the antenna for this job. Then dump in generous quantities of Duco cement to hold the ballast in place. When dry, put the boat back in the tub and leave it for several hours to see that there are no leaks.

Then off to the nearest body of water and her maiden voyage! END

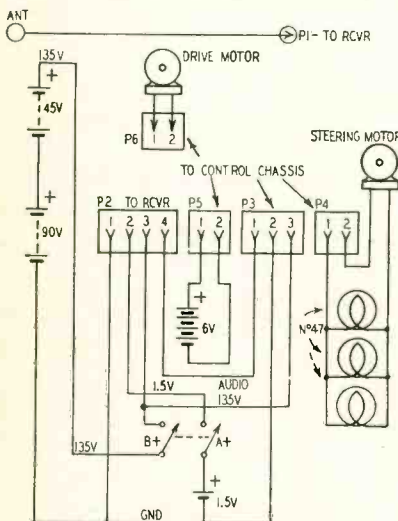

Fig. 6—Permanent boat wiring. Lamps prevent rudder motor from going too fast; when cold, their low resistance passes extra current for motor starting.

**Parts for receiver and control system**

- Resistors:** 1—10,000, 1—82,000, 4—220,000, 1—2.2 megohms, 1/2 watt; 1—240 ohms (see text), 1 watt; 1—50,000 ohms, potentiometer, linear.
- Capacitors:** 2—5 μf, 2—50 μf, 1—100 μf, mica; 1—0.01 μf, 1—0.02 μf, 2—0.01 μf, 1—0.1 μf, 1—0.25 μf, 3—1 μf, 200 volts, paper; 1—40 μf, 200 volts, electrolytic.
- Relays:** 1—resonant, 416.3 cycles (Frahm 3304-8 or equivalent); 1—resonant, 442.6 cycles (Frahm 3304-7 or equivalent); 1—resonant, 470.5 cycles (Frahm 3304-6 or equivalent); 1—resonant, 500.2 cycles (Frahm 3304-5 or equivalent); 3—2,000 ohms (see text), sensitive, s.p.d.t. (G-E surplus); 1—10,000 ohms, sensitive, d.p.d.t. (Potter and Brumfield LM11 or equivalent).
- Miscellaneous:** 1—1T4, 2—3A5's, tubes; 1—coil L1, 3 turns of hookup wire over ground end of L2; 1—coil L2, 12 turns of No. 16 enameled wire on Millen 69046 form; 1—coil L3, same as L2; 1—transformer, interstage, 1:4 turns ratio, primary

- impedance 7,000 to 15,000 ohms, secondary center tap not used (Stancor A-64-C or equivalent); 1—transformer, output, 14,000 to 4 ohms (Stancor A-3496 or equivalent); 2—r.f. chokes, 6 meters; 1—banana jack and plug; 1—phone jack and plug; 1—4-pin male and female connector; 1—3-pin male and female connector; 3—2-pin male and female connector; 1—battery connector for 90-volt battery; 1—battery connector for 45-volt battery; 1—connector for 1.5-volt cell; 1—90-volt battery (RCA VS 090 or equivalent); 1—6-volt battery, wet, miniature (Willard or equivalent); 1—1.5-volt dry cell (Burgess 4F or equivalent); 1—45-volt battery (Eveready 455 or equivalent); 1—6-volt motor, d.c.; 1—4-6-volt motor, d.c.; 3—No. 47 lamps; 3—7-pin miniature sockets; 3—5-pin sockets (for 2,000-ohm relays); 1—aluminum box, 3 x 4 x 5 inches (Bud Minibox CU-3005 or equivalent); 1—gear set, 1 worm, 2 pinions, rack, 48 pitch, brass (Boston Gear); 1—coupling for drive motor; 1—d.p.s.t. switch; 4—crystal sockets, double, for resonant relays (Cinch 2K4 or equivalent).



# Contact Potential

By H. P. MANLY

**S**OMETIME, when you are working on a receiver, disconnect all but the heater leads from the socket of any tube. Set your vacuum-tube voltmeter for measuring negative d.c. volts, on the lowest range. As shown in Fig. 1, connect the positive lead of the v.t.v.m. to the cathode lug on the tube socket and the negative lead to the grid lug. Turn on the power to heat the cathode of the tube. The voltage you read on the meter dial is contact potential.

Negative electrons are boiling out of the hot cathode into the surrounding vacuum to form a space charge. Billions of these electrons collect on the grid which is nearest the cathode and there they form a negative charge. These electrons can escape only slowly through many megohms of resistance in the v.t.v.m. and enough remain to hold the grid decidedly negative with respect to the cathode. In many miniature tubes the difference of potential will read about 1.5 volts.

You will find contact potentials also on plates of triodes and on plates and screens of pentodes, but the values are very small. This is because not many space-charge electrons get past the grid. If, however, you check from the plate to cathode of a diode such as the 6AL5, contact potential will measure as high or higher than those on grids of triodes and pentodes. Electrons in the diode are intercepted by no other elements between cathode and plate.

Next connect a resistor of about 1/2 megohm between cathode and grid of a triode or pentode (Fig. 2) or between cathode and plate of a diode. Measure contact potential across this resistor. It will be only 20 to 30% of the former value for now electrons are returning to the cathode more rapidly through the resistor than they did through only the v.t.v.m. and fewer remain on the grid (smaller negative charge) at any given moment. If you substitute a grid-return resistor of only 10,000 to 20,000 ohms, the contact potential may not be measurable. Here we have one reason why so many tube data sheets warn against grid circuit resistance of more than 1/4 to 1/2 megohm—or even 100,000 ohms. It is to reduce the biasing effect of contact potential.

Contact potential negatively biases

a grid without the help of any external voltage. In many radio receivers the grid resistor on the audio voltage amplifier has a value of about 10 megohms. A familiar circuit is shown in Fig. 3. Contact potential across this high resistance supplies the entire negative bias needed by the amplifier.

When a twin-diode tube is used in a vacuum-tube voltmeter or other service instrument as a rectifier or detector, one section may be employed solely for balancing the contact potential of the other section. A method of doing this is illustrated in Fig. 4. At *a* is a simple shunt rectifier consisting of a single diode which delivers pulsating positive direct current when a.c. voltage is applied. With or without an applied a.c. voltage there is contact potential, and at very small a.c. inputs this contact potential may add materially to d.c. output voltage.

At *b* a second diode is added with its connections reversed. If contact potentials of the two diodes are equal at the d.c. output, they will balance each other. In practice, the contact potentials of two diodes or of two sections of a twin-diode are likely to be different, so we resort to the connections at *c* of Fig. 4.

With these connections, positive and negative contact potentials of the two diodes act at opposite ends of a balancing potentiometer, with rectified d.c. output taken from the slider. Moving the slider will allow picking up enough negative contact potential from the second diode to balance the positive contact potential from the first, and d.c. output will be unaffected.

Contact potential may be balanced also with any available d.c. voltage of opposite polarity which may be adjusted to suitable value. But without some form of balancing, low-voltage measurements may be erroneous. There is no measurable contact potential between elements of a crystal diode, and no balancing is needed. This is an advantage of the crystal over the tube when used in detector probes for service instruments.

Contact potential in a tube becomes less with lower heater voltage and cathode temperature since electrons boil less rapidly out of the cooler cathode and form a weaker space charge. At half normal heater voltage, contact po-

tential may be two-thirds or less its maximum value. Contact potential tends to be greater in tubes of high transconductance than in those of less amplification. The reason is that grid wires are more closely spaced and may be closer to the cathode in a high-gain tube, and the grid collects more negative electrons.

You may wonder why we talk about contact potential when the tube elements are not actually in contact. It is because this effect is similar to that observed when different metals are in close contact, even when surrounded by air. For instance, brass becomes negative to aluminum by almost 0.2 volt. Again, when different metals are immersed in a liquid electrolyte, the metals acquire a difference of potential, called contact potential. In vacuum tubes the grid takes electrons from the cathode through a vacuum when no external voltage is applied, but the effect still is called contact potential. **END**

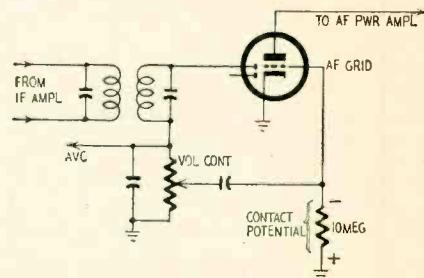

Fig. 3—Conventional audio amplifier circuit biased by contact potential.

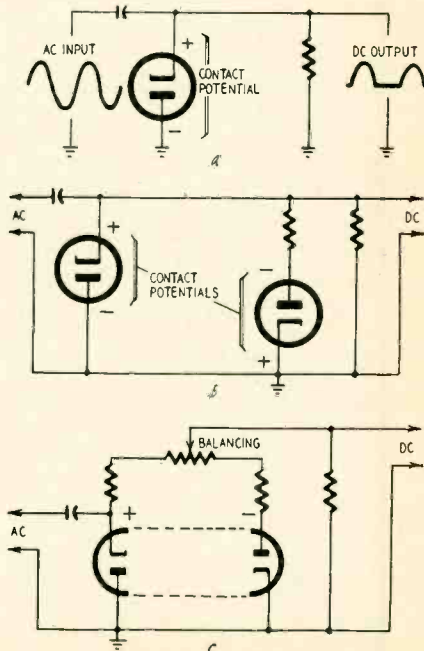

Fig. 4—Balancing contact potential.

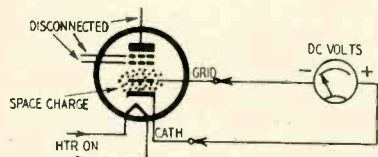

Fig. 1—Negative electrons collect on grid to produce a contact potential.

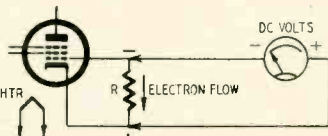
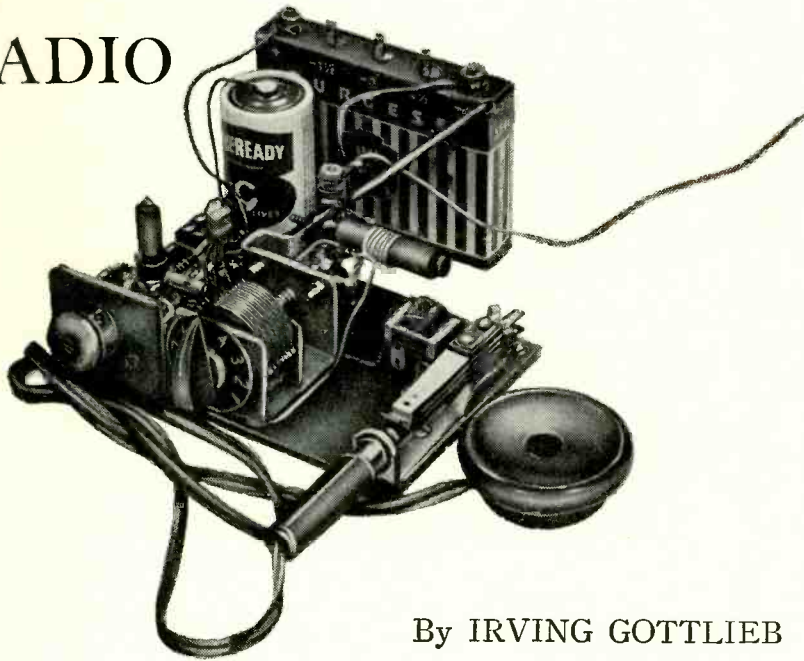
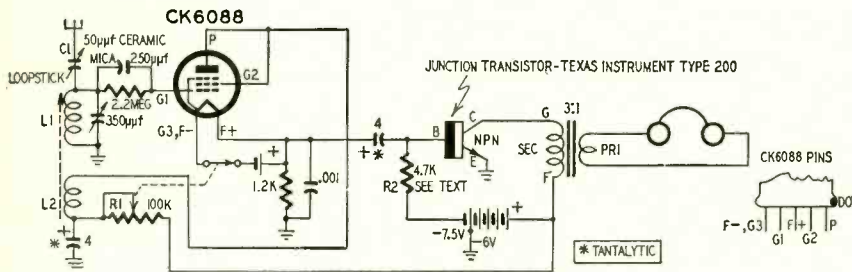

Fig. 2—Measuring the contact potential across a grid-return resistor.

# TUBE and TRANSISTOR RADIO



By IRVING GOTTLIEB



Schematic diagram showing all components in the tube-transistor receiver.

amplification simultaneously in the tube detector.

### Circuit description

The circuitry of the tube-transistor receiver is shown in the diagram. The tube operates as a cathode follower at audio frequencies, at the same time providing radio-frequency regeneration. The reason for this unusual arrangement is that the low input impedance of the grounded-emitter transistor stage must be fed by a signal source also of low impedance if we are to obtain efficient power transfer. In addition the current and power gain developed by a cathode follower is used in driving a transistor amplifier.

In the initial adjustment of this receiver it is important that L2 should have just enough turns so that oscillation starts with R1 practically in its zero-resistance position. Start with L2 having about six turns around the ground end of L1. The tube will not deliver enough power to drive the transistor if its plate voltage is reduced too far below the applied 6 volts despite the fact that—with enough feedback—the detector can oscillate with a plate potential of 2 volts or so. For this reason, the prescribed number of turns for L2 may be a bit skimpy. However, sensitivity and selectivity will be very much improved even if the regeneration is below the value needed to cause the detector to oscillate when R1 is fully advanced. Some experimenting should be done to determine optimum conditions of detector operation. This is easy since the coupling between L1 and L2 can be varied considerably by adjusting the position of the ferrite core. The effect upon the tuning range and Q of L1 will not be great, provided the greater portion of the slug remains within L1. To take advantage of this easy way to establish optimum feedback, it is important that L2 be wound next to one end, preferably the ground end, and not directly over L1.

Most important, keep in mind that the wrong phasing of L2 will produce degeneration, with the very opposite of the benefits desired from regeneration. This can be readily determined by trying the connections to L2 first one way, then the other. The connections which result in oscillation or in the most peppy performance are right and should not be reversed for any subsequent change in the number of turns on L2 or in spacing between L2 and L1.

The antenna, like the feedback adjustment, can be expected to vary with receiving conditions. A 15-foot outdoor antenna should be adequate for good pickup of weak stations, provided a ground is also used. Of course, a longer antenna (within limits) is better. A 4-foot vertical whip without any ground is sufficient for strong and medium-strength stations. Fairly good reception could be obtained by connecting only the ground wire to the antenna terminal of the set. Whatever the antenna

In many respects the transistor is admirably suited for the construction of compact radio receivers. In addition to its space-saving feature, it requires considerably less battery power than does the tube. Unfortunately, it is not easy to use transistors efficiently with resonant circuits. The input impedance of the transistor is, in some arrangements, too low to connect to a conventional parallel resonant circuit; in other configurations it is too high to use the tuning properties of a series resonant circuit. The transistor counterpart of a vacuum-tube regenerative detector is likely to be less sensitive and generally less selective than the tube circuit. This represents quite a problem to the would-be constructor of a small headphone receiver.

A successful solution which overcomes this obstacle is a hybrid circuit consisting of a tube detector and one or two transistor audio amplifiers. The battery economy of such a set, though

not as attractive as the straight transistor circuit, is much better than that of a design based entirely on tubes. The CK6088 is a good tube for this purpose in view of the rather frugal demand of the filament, only 20 ma at approximately 1.5 volts. Such a tube-transistor set consumes 20 ma from a size D flashlight cell and about 3.25 ma from a 7.5-volt C battery.

A two-tube version of this set required 40 ma from the A supply and, for the same performance as the tube-transistor radio, a 22.5-volt B battery was needed. With a tube and two transistors the percentage difference in battery drain between such a combination and a three-tube set is even greater. Furthermore, the tube-transistor combination works as well as straight tube sets. The additional power gain that might be expected from tubes is largely lost because of the low  $g_m$  of subminiature tubes and from the difficulty in obtaining high sensitivity and high audio

# A.C. VOLTBOX

By RUFUS TURNER

used, C1 must be adjusted to find the best coupling conditions. The shorter the antenna, the higher must be the capacitance of C1. For operation with a whip antenna, C1 should be paralleled by an additional 100- $\mu$ f capacitor.

The transistor collector current should be about 1.5 ma. This current is primarily determined by R2. Since transistors differ considerably from unit to unit, it may be necessary to modify R2. The transistor used was a germanium junction n-p-n type. Equal results may be expected from a p-n-p junction transistor but the circuit will have to be altered so that opposite polarities of bias voltage are applied to the emitter and collector with respect to the n-p-n transistor. The point-contact transistor (usually p-n-p) is not recommended because it is not stable in the grounded-emitter amplifier circuit.

### Modifications for the CK722

To use the more popular CK722 p-n-p junction transistor, the following circuitry changes should be made:

1. Reverse the polarity of the B battery so that the -7.5-volt terminal connects to the output transformer.
2. Remove the ground connections from the transistor emitter and from the B battery tap. Reconnect the ground to the negative terminal of the B battery.
3. Remove the R1 connection to the output transformer and reconnect it to the positive pole of the B battery.
4. Connect the emitter to the -1.5-volt terminal of the B battery.

### Parts for tube-transistor radio

**Resistors:** 1—1,200, 1—4,700 (see text), 1—2 meg-ohms, 1/2 watt; 1—100,000 ohms, potentiometer.  
**Capacitors:** 1—50  $\mu$ f, ceramic variable; 1—250  $\mu$ f, mica; 1—350  $\mu$ f, variable (larger section of conventional two-gang tuning capacitor can be used); 1—0.01  $\mu$ f, mica; 2—4  $\mu$ f, G-E Tantalitic (if physical size is not important, a low-voltage paper capacitor of 1  $\mu$ f or larger can be used).  
**Miscellaneous:** 1—Ferri-Loopstick or equivalent; 1—L2, 6 or more turns wound adjacent to ground end of loopstick coil (see text); 1—3:1 audio transformer; 1—size D flashlight cell; 1—tapped 7.5-volt radio C battery (Burgess 5540 or equivalent); 1—CK6088 (Raytheon subminiature); 1—n-p-n junction type transistor (Texas Instrument type 200); 1—phone jack.

The purpose of these modifications is to bias the elements of the p-n-p transistor with the same voltages as the n-p-n unit shown in the schematic, but with opposite polarities. The counterpart to this situation does not exist with tubes; the applied d.c. plate voltage must be positive with respect to the cathode. It is possible that the experimenter might feel more at home with the n-p-n transistor because its base and collector are polarized exactly as the corresponding elements of the tube, the grid and plate, respectively.

The audio transformer provides an approximate impedance match between the transistor collector circuit and the headphones. A fair degree of performance may be obtained by inserting high-impedance headphones directly in the collector circuit if it is desired to eliminate the transformer in the interest of miniaturization.

END

ALL experimenters have occasional need for a source of variable low-voltage, high-current a.c. Common applications include tube heating, relay operation, experimental rectifier type bias supply, line-frequency signal voltage for bridge tests and impedance measurements, low-range a.c. voltmeter calibration, and control voltage in phase-operated electronic devices. Not all experimenters can afford Variacs.

A step type a.c. voltbox can be constructed, using three or more small surplus filament transformers, as shown in the diagram. These transformers are inexpensive and a number of voltages in closely spaced steps can be obtained. It is not necessary to stick to the secondary voltages shown in the diagram but I found that two center-tapped 6.3-volt units and one center-tapped 2.5-volt unit provide a wide combination of output voltages. The various separate voltages are obtained

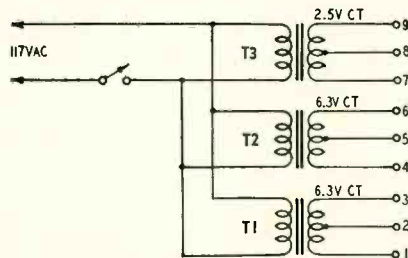

Schematic diagram of the a.c. voltbox.

by connecting the secondaries or halves of secondaries in series, either adding or opposing. As can be seen in the table, the three transformers specified provide any one of 22 voltages ranging from 0.65 to 15.1.

The voltbox may be assembled in a small metal utility box. The transformer secondary leads are connected to nine front-panel insulated binding posts, as indicated in the diagram. The various output voltages are obtained

by connections to these terminals, as detailed in the table. Construction may be simplified and the size of the unit reduced greatly by using a single transformer with multiple secondary windings, instead of three separate transformers.

This procedure must be followed to polarize the transformers correctly: Connect terminals 3 and 4 together. Check voltage between terminals 1 and 6—the voltage should be 12.6, since the secondaries should be series-aiding. If it turns out to be zero or some value lower than 6.3, the secondaries of T1 and T2 are bucking and the primary leads of T2 must be reversed. Connect terminals 6 to 7 and measure the voltage between 4 and 9—this voltage should be 8.8. If it is somewhat less than 6.3, the secondaries of T2 and T3 are bucking and the primary leads of T3 must be reversed.

If a single transformer with multiple secondaries is used, polarizing must be accomplished by manipulating the secondary leads, since there will be only one primary winding.

Although a voltbox of this type is not continuously variable, the output voltage steps are spaced closely enough to compensate for the lack of smooth variation. The use of "free-point" binding post terminals, rather than switching, reduces the complexity of the device. In most applications, one voltage will be used continuously for some time after its selection, so the use of jumpers between terminals should introduce no hardship.

Connect the voltbox to the 117-volt a.c. line through a fuse of around 5 amps. This prevents blowing the main fuses in the event of an overload or a short circuit.

END

TERMINAL CONNECTIONS		
Output Voltage	Connect Terminals	Output Terminals
0.65	3 to 9	2 and 7
1.25	.....	7 and 8
1.90	3 to 9	2 and 8
2.50	.....	7 and 9
3.15	.....	1 and 2
3.80	3 to 9	1 and 7
4.40	3 to 7	2 and 8
5.05	3 to 9	1 and 8
5.65	3 to 7	2 and 9
6.30	.....	1 and 3
6.95	3 to 4 and 5 to 9	1 and 7
7.55	3 to 4 and 5 to 7	2 and 8
8.20	3 to 4 and 5 to 9	1 and 8
8.80	3 to 7	1 and 9
9.45	3 to 4	1 and 5
10.10	3 to 4 and 6 to 9	1 and 7
10.70	3 to 4 and 5 to 7	1 and 8
11.35	3 to 4 and 6 to 9	1 and 8
11.95	3 to 4 and 5 to 7	1 and 9
12.60	3 to 4	1 and 6
13.85	3 to 4 and 6 to 7	1 and 8
15.10	3 to 4 and 6 to 7	1 and 9



"You and your short cuts!!!"

# New Test for Capacitor Leakage

*Dynamic characteristic of leakage resistance is basis for in-circuit capacitor checks*

By ROBERT G. MIDDLETON\*

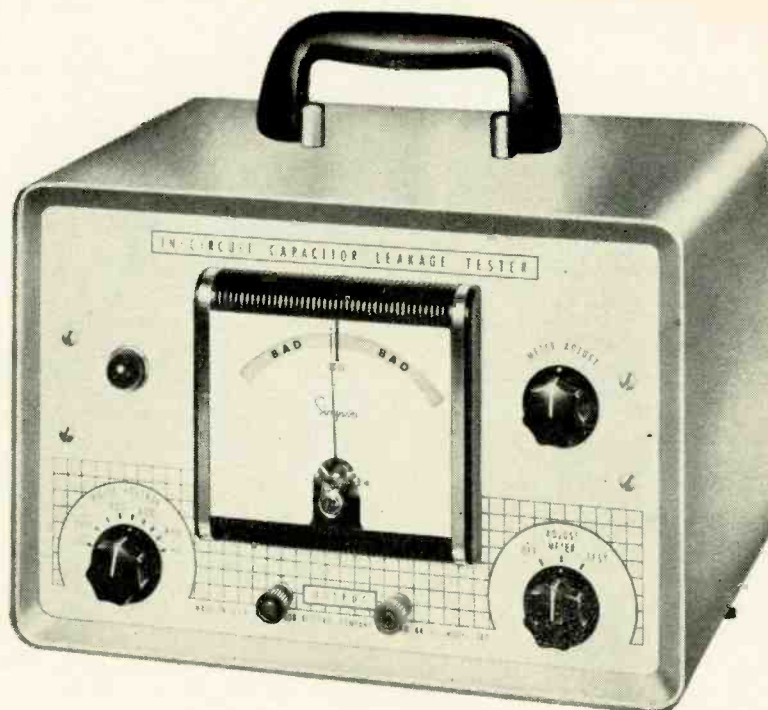

Front view of the Simpson model 383.

FOR years, the radio and TV service technician has dreamed of an instrument that could be applied directly to a fixed capacitor in a receiver circuit to determine whether or not the capacitor is leaky. The problem is illustrated in Fig. 1, which shows a capacitor (paper, mica or ceramic) shunted by circuit resistance R.

This capacitor may be used for interstage coupling or as a screen or a.g.c. bypass for example. When it develops sufficient leakage resistance ( $R_{LK}$ ), circuit operation deteriorates or fails.

The problem is to find the presence of  $R_{LK}$  when shunted by R. A new discovery, which is the basis of a pending patent application, discloses that leakage resistance is in general a *different type of resistance* from circuit resistance and can be distinguished by a definite test. Leakage resistance differs from ordinary circuit resistance in that in some forms it is unstable and non-linear when tested dynamically with a pulse voltage.

These new concepts are not entirely simple, and the graphs in Figs. 2, 3 and 4 will serve to make them more understandable. The fixed capacitor whose leakage resistance is now causing trouble in the receiver was good when installed and the receiver operated satisfactorily. But after a period

of service the initial high value of leakage resistance has gradually declined to the point where it causes trouble. The technician is concerned with this form of leakage resistance that usually drops during the life of the capacitor. This is an important point. There are other forms of leakage resistance such as that of a brand-new poorly made capacitor having a poor dielectric. Such

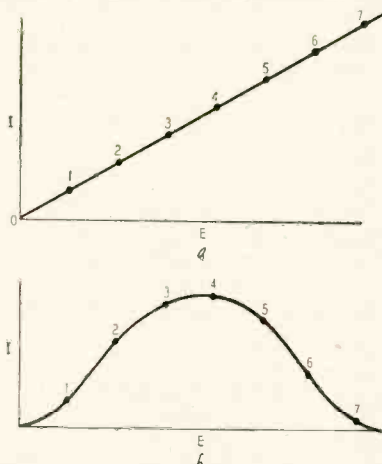

Fig. 2—Circuit resistance (a) is linear but leakage resistance (b) is not.

a capacitor has a low value of leakage resistance that does not have the declining characteristic that makes possible the in-circuit type of leakage test.

Fig. 2-a shows that circuit resistance is linear. The current through it is proportional to the applied voltage. But Fig. 2-b shows that leakage resistance may rise slightly at first and then fall off rapidly to a very low value as the applied voltage is increased. Fig. 3 illustrates another common form of

leakage resistance. Curve A shows leakage currents when different test voltages were applied to a .002- $\mu$ f 600-volt paper capacitor. This capacitor showed infinite leakage resistance when checked with an electric ohmmeter (v.t.v.m.) but leakage currents indicate resistance of 24 megohms at 100 volts and only 7.4 megohms at 200 volts. Curve B shows the result of similar measurements made on a .001- $\mu$ f 600-volt mica capacitor that showed 2 megohms of leakage resistance on the ohmmeter. Incidentally, this characteristic is well known to experienced service technicians, and they do not rely on low-voltage ohmmeter tests.

Leakage resistance is often unstable, fluctuating or drifting when voltage is applied. Fig. 4 is the graph of measurements made on a .005- $\mu$ f 600-volt paper capacitor. When the test voltages were first applied, the leakage resistance was low and then rose suddenly to a higher and more stable value. Initial currents rose to the high levels shown, then fell to lower and more stable values.

By using these characteristics of leakage resistance we can detect it by applying a low voltage—1 volt or so—across the capacitor and measuring the current that flows and then increasing the voltage and again measuring the current.  $E/I$  will be the same in each case if there is no leakage resistance but it will differ if leakage resistance is present. See Fig. 5. Unfortunately, the heavy current flowing at 600 volts will often burn out the circuit resistance so other methods must be used.

## The pulse test

Capacitors in pulse circuits fail sooner than those in sine-wave or d.c. serv-

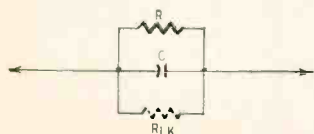

Fig. 1—Leakage resistance  $R_{LK}$  affects set operation and may be hard to detect.

ice, so a pulsed voltage should be ideal for such a test. Furthermore, a pulse may have a peak voltage as high as desired with a short duration. The small amount of energy in the pulse may be integrated for definite tests without endangering circuit resistances. By substituting a narrow pulse for the

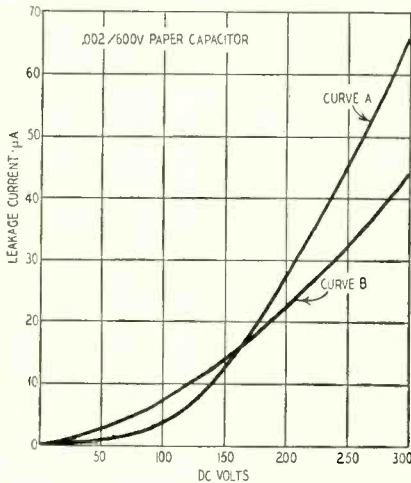

Fig. 3—Other forms of leakage resistance.

battery in Fig. 5 we can briefly charge capacitor C to 600 volts without causing sufficient current flow to overheat resistor R across the capacitor under test. If the pulse (dashed lines in Fig. 6) is generated by a very low impedance source, the capacitor will be raised instantaneously to the peak voltage of the pulse, irrespective of the value of R. Note that the average value of the pulse, as generated, is zero. This means, if the pulse is displayed on the screen of a scope with a sawtooth sweep, that the positive area of the pulse above the zero-volt line will be exactly equal to the negative area of the pulse below that line. The meter is not deflected. But, if leakage resistance  $R_{LK}$  is present, circumstances are altered. The nonlinear characteristic of  $R_{LK}$  causes partial rectification of the pulse voltage and its average value is no longer zero. A d.c. microammeter in series with the pulse circuit will be deflected. The pulse voltage (solid lines in Fig. 6) does not rise to its 600-volt peak because  $R_{LK}$  decreases to a small value as the pulse voltage rises above a certain point. This nonlinear increase in current through  $R_{LK}$  is sufficient to deflect the meter.

After pulsing, the value of  $R_{LK}$  may or may not return to its initial value. When a d.c. voltage is connected in series with the microammeter (Fig. 7) the value of current may change only during pulsing (dynamic testing), but it may in addition show a fixed change as indicated by a continuing greater deflection of the meter pointer after the pulse voltage is removed from the capacitor under test.

Sometimes the value of  $R_{LK}$  increases when the pulse voltage is applied and remains at a higher value when the pulse voltage is switched off, but in most cases the change is to a lower

value. This agrees with the earlier observation that capacitors which are failing in service have declining values of leakage resistance. But this is not the complete picture.

In practice the application of a high-voltage pulse sometimes serves to "burn out" the leakage resistance and to make a good capacitor out of a bad one (Fig. 8). More often, however, the leakage resistance is changed to a much lower value or a dead short and the capacitor is left in worse condition than before. A good capacitor is completely unchanged by application of the test pulse.

Some capacitors whose leakage resistance has dropped to a low value—to several megohms, for example—may produce relatively small deflection of the meter until a certain critical value of pulse voltage is reached, such as 300, 400 or 600. Then the capacitor may break down suddenly, accompanied by a snapping sound from within and a violent kicking of the meter pointer. A capacitor that is not failing in service, however, maintains its original characteristic and does not break down nor show a change in leakage current when pulsed at rated working voltage.

There is not necessarily any close correlation between the amount of deflection obtained on the meter for various values of  $R_{LK}$ . Thus, a capacitor having a relatively low value of leakage resistance may produce a much larger deflection on the meter than a capacitor having a high value of leakage resistance or vice versa. As a rough rule of thumb it can be stated that there is a tendency on the average for high values of leakage resistance (100 or 1,000 megohms) to produce less pointer deflection than low values of 100 or 100,000 ohms. Hence, it is desirable to use a meter of reasonably high sensitivity.

A 25-0-25-μA meter is satisfactory for general service work. However, more capacitors with high-resistance leakage can be detected with a 0.5-0-0.5-μA meter. The latter type costs more and is more expensive to use because auxiliary circuitry is required to protect it against current surges. In general service work a 50-μA zero-center meter is suitable.

A zero-center meter is needed because leakage resistance sometimes goes up instead of down when the capacitor is pulsed. The center line of the scale is marked GOOD, with BAD sectors on either side.

In operation, battery voltage E (see Fig. 7) is adjusted so the flow of current through the circuit brings the pointer up from the OFF position (about ¼ inch from center) to the reference or GOOD line. This permits the operator to determine readily whether there is a permanent change in effective circuit resistance when the circuit is pulsed. Then the pulse generator is started and the meter observed for a second or two. If the pointer moves down or up scale, the capacitor has appreciable leakage

resistance. The pulse voltage is then switched off, and the meter is read again to determine whether the effective circuit resistance has changed permanently. This dynamic test is more definite than the static test.

In practice the simple functional diagram in Fig. 7 is not sufficient. Passage of the pulse through the meter produces only a momentary kick of the needle, so a series of pulses must be integrated for normal observation. The test current consists of both a.c. and d.c. so two electrolytic capacitors are connected back to back across the meter to integrate the pulses of the d.c. and produce a smooth normal meter de-

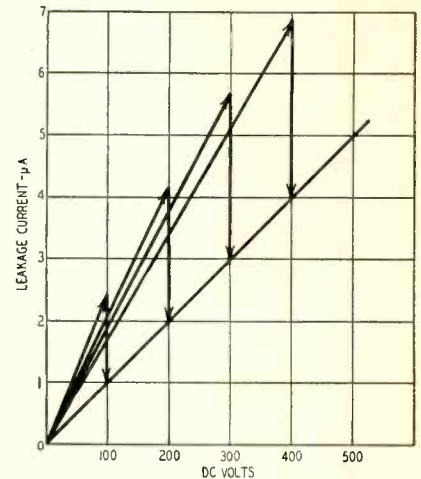

Fig. 4—Drifting leakage resistance.

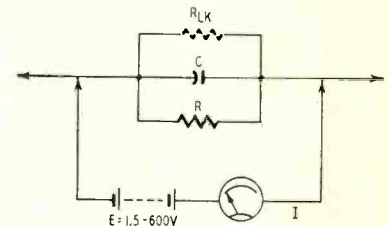

Fig. 5—Varying voltage shows presence and magnitude of leakage resistance.

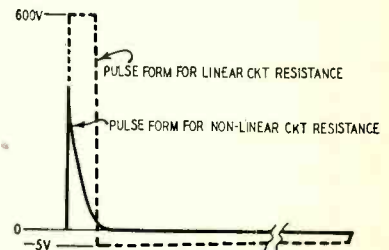

Fig. 6—Leakage resistance affects the pulse shape and peak output voltage.

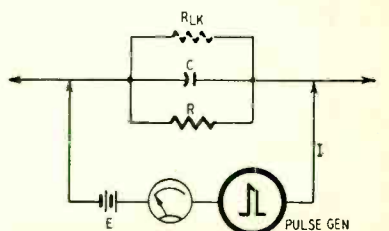

Fig. 7—Pulse voltage provides the dynamic test for leakage in capacitors.

## TEST INSTRUMENTS

flection. The capacitor values are determined by the internal resistance of the meter. The 2,000- $\mu$ f values are suitable for a standard 25-0-25- $\mu$ a meter.

After the pulse is switched off, the meter bypasses and integrators must also be switched out of the circuit. If the meter has been deflected to the end of the scale, considerable time will be required for the pointer to return to the reference position. Accordingly, the switching system of the instrument must open the meter circuit and also short-circuit and discharge the large electrolytic capacitors in preparation for the next test.

### A practical instrument

The new Simpson model 383 In-Circuit Capacitor Leakage Tester uses this principle for checking leakage in capacitors. Its circuit is shown in Fig. 9.

It will be apparent that the varying conditions of test are such that a useful instrument must provide a very-low-impedance pulse. A cathode circuit, for example, has a very low effective resistance and cannot be raised to peak pulse voltage unless the internal impedance of the pulse generator is quite low. Hence, a 2050 thyatron pulse generator is utilized. The repetition

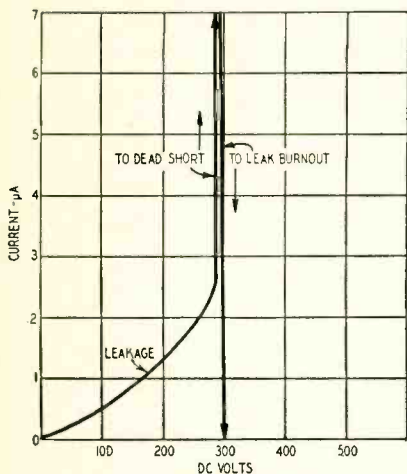

Fig. 8—Pulse voltage may break down leaky capacitors or cure the trouble.

rate of the pulser is fast enough to provide satisfactory integration at 600 volts.

The rise time of the test pulse is also a very important consideration. Although the internal impedance of the pulse generator may be low, the rise time must be fast since a capacitive storage source is used in the generator. It also is desirable because leakage resistance is more unstable in the presence of fast rise. The Simpson model 383 provides a rise time of 1  $\mu$ sec.

The reader will see that, since the tester operates upon the basis of unstable resistance characteristics, that the instrument might serve likewise to locate noisy resistors in receiver circuits. It can. When the test leads are applied across a noisy resistor and the pulse voltage is applied, the pointer responds by moving off into the BAD sector. Thus a BAD indication may be the result of either a bad resistor or a bad capacitor in the circuit. But in most practical situations the capacitor is faulty.

Since radio and television circuits have many branches, the question might arise as to whether the operator can know exactly which capacitor is really being tested when a BAD indication is observed. The answer to this is that even a small value of resistance between the point of pulse application and the capacitor under test reduces the pulse voltage to such a small value that a test is not obtained. This is a consequence of the fast rise of the test pulse. Hence, few situations are encountered in practice wherein the operator is not certain which capacitor in the circuit chain is the bad one.

The energy contained in the test pulse, while small, is not entirely negligible in all cases and certain minimum precautions must be taken in its use. In the first place it gives the operator an uncomfortable shock if contacted. HANDS OFF is the rule while the pulse voltage is on. Also, the pulse has sufficient energy to damage video detector crystals and to burn out 1.5-volt tube filaments. Hence, you must not apply pulse voltage across crystals and you

must remove the tubes from battery portable sets before testing the filament bypass capacitors.

There are some limitations in the practical application of the instrument. For example, when the capacitor under test is shunted by a coil, the effective circuit resistance becomes so low that the microammeter cannot satisfactorily monitor changes. The 383 cannot be used satisfactorily in this application. However, the instrument is useful in checking leakage resistance in other circuits where the value of the leakage resistance is several hundred times greater than the value of the shunting circuit resistance.

The receiver must, of course, be turned off when testing capacitors, as d.c. voltage from the receiver can back up into the microammeter and burn it out. It is also advisable to avoid damage to the thyatron by giving it a few seconds to warm up before the pulse generator is switched on. Likewise, the instrument should be used at line voltages of approximately 117 to obtain normal life expectancy from the thyatron. Do not operate the instrument continuously across a dead short circuit. This damages the cathode coating and the thyatron.

The OFF position of the switch opens the primary circuit of the power transformer and the battery circuit to the meter. In the second position (ADJUST METER), the battery circuit is completed so that the meter can be set with the 500-ohm potentiometer; plate power is applied to the thyatron, but the grid circuit is biased off and the tube does not fire. The meter bypass capacitors are shorted.

In the third (TEST) position of the switch, the bias on the thyatron is reduced to a value previously set by adjustment of the 5,000-ohm potentiometer and pulses are generated across the 600-ohm load. The integrating capacitors are connected across the meter. According to the setting of the thyatron bias control, indicated on the scale plate, the operator can adjust the peak voltage of the pulse from approximately 15 to 900.

If one side of the capacitor under test should be connected to the chassis of the receiver, full pulse voltage is applied by connecting the LOW terminal to the receiver chassis. In most cases, neither side of the capacitor under test is connected to the receiver chassis so the test leads are applied across the capacitor without regard to which side is LOW or HIGH.

The operator who uses the model 383 for the first time will be surprised at the number of leaky capacitors present in older receivers, which nevertheless are not causing trouble because they are operating in noncritical circuits or because their leakage resistance has not yet fallen to a value which impairs circuit operation noticeably. It is not the purpose of this article to assert whether such leaky capacitors should be replaced.

END

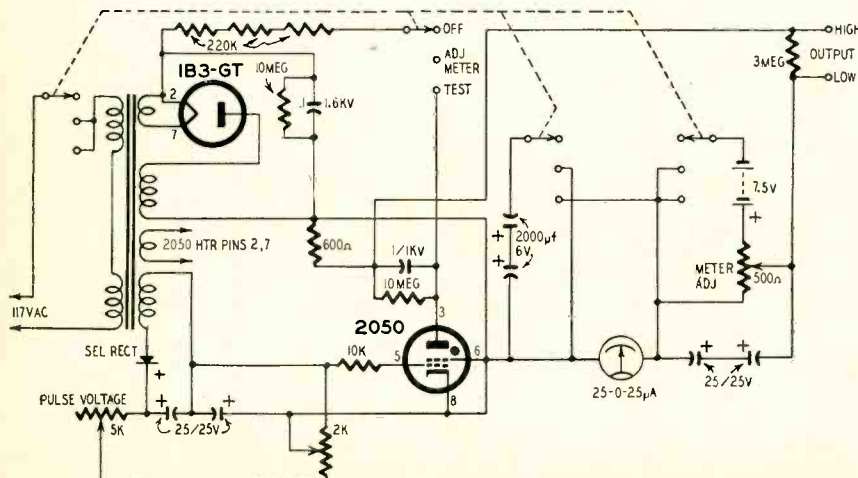
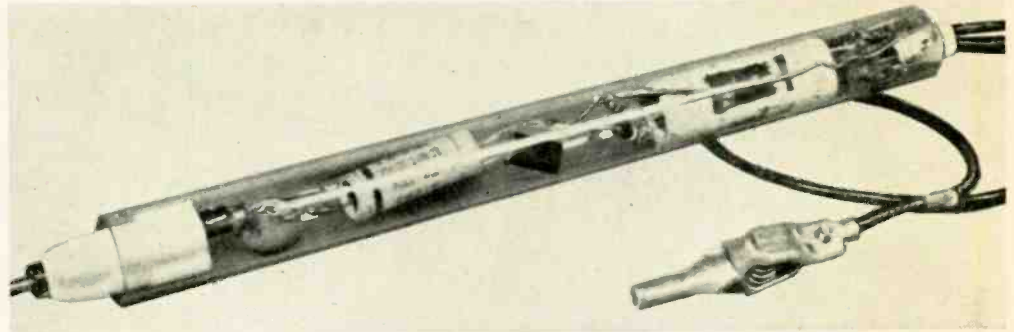

Fig. 9—Circuit of the Simpson 383 In-Circuit Capacitor Leakage Tester.

*High-gain unit  
permits measuring  
signal directly from  
television tuner*



Closeup shows components in probe.

# Transistor Demodulator Probe

By HOMER L. DAVIDSON

THE transistor demodulator probe (see photos) was designed and constructed so greater amplification could be obtained when shooting video trouble in television receivers. Most oscilloscopes do not have enough vertical amplification to display the video signal properly as it appears at the tuner. Generally the signal is amplified enough in the first and second video i.f. stages but this does not always indicate the source of trouble. So from this small want a transistor was chosen for an amplifying stage and placed in a probe type tester.

There are not too many components in this small unit. The input section (see diagram) consists of a 1N34 crystal detector stage with associated resistor and capacitor. Perhaps it would have been best for the demodulator or crystal unit to have been constructed in a metal instead of plastic container but results were gratifying and no 60-cycle or stray signals were picked up by the probe. From the detector the signal is coupled to the CK722 transistor amplifier. The bias return resistor is 220,000 ohms, obtained by placing a 500,000-ohm variable resistance in the circuit and varying it for best results. The 10,000-ohm output resistor was obtained in the same fashion. When doing this, place a 0-10-ma meter in the output circuit and do not permit the CK722 transistor to draw more than 5 ma.

It is best to construct the transistor

demodulator probe in a breadboard style first before final assembly. By doing this the unit can be hooked to a working television receiver and oscilloscope. With the probe in operation it is very easy to vary both the bias and load resistor for best results. It was found that a lot of noise was amplified when the resistors were varied for greatest amplification. So a happy medium was set where two variable resistors permitted high amplification and low grass or noise as seen on an oscilloscope.

After best results were obtained all the leads and components were mounted closer together. The components were laid in a line and soldered so that they didn't occupy more than 10 inches.

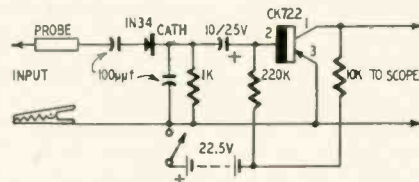

#### Parts for demodulator probe

1—1,000-ohm resistor, 1/2 watt; 1—10,000-ohm resistor, 1/2 watt; 1—220,000-ohm resistor, 1/2 watt; 2—100-µf capacitors, postage type; 1—10-µf capacitor, 25 volts, electrolytic (small as possible); 1—1N34 detector; 1—CK722 transistor; 1—s.p.s.t. slide switch; 1—22.5-volt battery, less than 1-inch diameter; 1—2 feet of microphone cable; 1—alligator clip; 1—1-inch diameter plastic container, 10 inches long; 1—bottle cap for probe tip (see text); 1—6-32 bolt, 1 inch long, and nut.

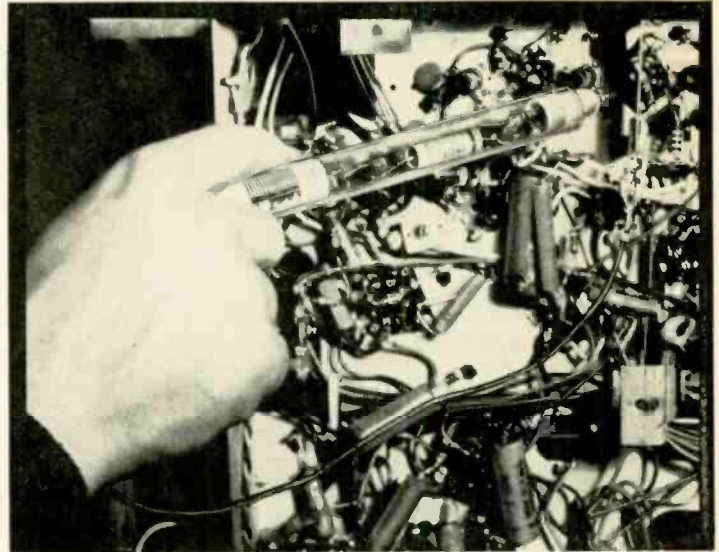

Troubleshooting with transistor probe.

They were mounted so that at any one point along the assembly they could easily be pushed into the 1-inch plastic tubing.

The tip of the demodulator probe was the cap of a nose-drop bottle. A small hole was drilled through it so that a 1-inch 6-32 bolt and nut could enter. The small bolt was ground to a sharp point at one end.

Solder the 100-µf capacitor to the bolt before the parts are placed in the container. After the components are inserted, place the cap in the plastic end and glue it into place. The small 6-32 nut screwed on the outside of the cap forms a sturdy tip probe.

A small battery is at the rear of the demodulator probe. On the positive side of the battery a s.p.s.t. slide switch is soldered directly to it and a small slot is cut into the tubing so the switch could be fitted. The shielded mike cable is then soldered into place and two small lugs are soldered to the other ends.

Comparison tests were made with a commercial type demodulator probe and the small transistor demodulator. The amplification obtained was about 10 times greater than that of the commercial probe. This was plenty of amplification to measure the signal directly from the television tuner. Passing through each stage, the oscilloscope gain should be kept in its lowest position.

END

# TRANSISTOR PERFORMANCE

*Analyzing characteristics;  
the tetrode transistor and  
high-frequency operation*

By EDWARD D. PADGETT

**T**EST methods and specifications are necessary for proper evaluation of transistors because they are temperature-sensitive devices (see Practical Transistor Tests, July, 1955) whose characteristics and parameters vary over wide ranges. Consequently, the operating point of a transistor will vary unless it is "stabilized."

Vacuum tubes operate with constant plate and grid voltages, while transistors operate with constant collector voltage and constant base current. And, like a tube, a transistor operates along a load line. The slope of the collector load line is  $1/R_L$ . The operating point of a transistor can be established either with fixed or self bias. For fixed bias (fixed base-current bias) operation, resistor  $R_B$  is connected between the supply voltage and base electrode (Fig. 1). This resistor should be large enough so it will supply a constant current to the base.

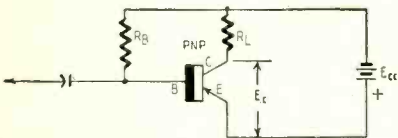

Fig. 1—Circuit operates on fixed bias.

When the operating point is determined by self bias, resistor  $R_S$  is connected between collector and base electrodes (Fig. 2). The base biasing current is determined by Ohm's law.

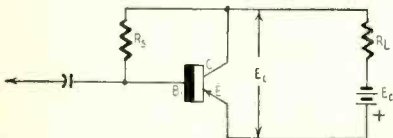

Fig. 2—Circuit for self-bias operation.

That is, base current  $I_b$  is determined by collector operating voltage  $E_C$  and  $R_S$ . If  $E_C$  is 10 volts and  $R_S$  is 400,000 ohms, the base current is  $I_b = E_C/R_S = 10/400,000 = 25$  microamperes.

The collector load line (d.c. load line) is determined by the values of collector supply voltage  $E_{CC}$  and  $R_L$  (Fig. 3). The bias line is included since the base current is known (from the Ohm's law

example) for various values of  $E_C$  and  $R_S$ . The d.c. operating point is given by

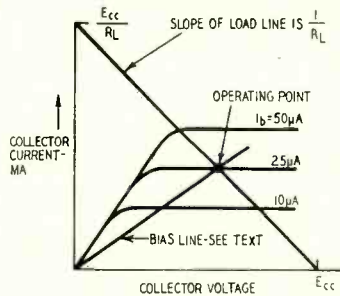

Fig. 3—Typical collector load line.

the intersection of the biasing and collector load lines.

Since transistor characteristics vary with temperature, a shift in the  $I_C$ - $E_C$  curves occurs; that is, the spacing between curves changes with temperature. We know that transistor parameters such as current gain and output impedance vary with temperature (also, transistor parameters vary because of small changes in physical conditions occurring during the manufacturing process). This means that the transistor operating point shifts when the spacing between  $I_C$ - $E_C$  curves changes.

All the above deviations contribute to variations in collector current and voltage from unit to unit of a given transistor type. This can lead to a serious situation unless design practices are good. For example, suppose that a defective collector load resistor decreases in value. If this happens, the collector current can increase beyond the rated value. The excessive dissipation would ruin a transistor (even though the collector voltage is well within safe limits). Similar damage could occur if the leakage currents ( $I_{CO}$  or  $I_{CBO}$ ) increased beyond safe limits because a customer left his transistor radio in the hot sun at the beach (and this will happen, sure as shooting!!).

Consequently, adequate methods for stabilizing the operating point must be used if transistors are to be regarded as reliable electronic devices. Fortunately, several methods of stabilization

are available, and are simple to apply.

Stabilization is obtainable in several ways: with current feedback, combinations of current feedback and fixed bias or current and voltage feedback. Combination current and voltage feedback

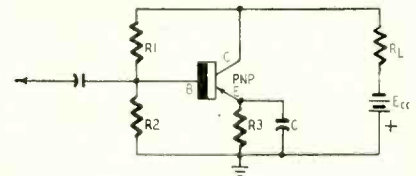

Fig. 4—Stabilization with a combination of current and voltage feedback.

is shown in Fig. 4. Current feedback is obtained from emitter resistor  $R_3$  and resistor  $R_2$  connected between base and ground. Resistor  $R_2$  provides reverse base bias;  $R_1$ , between collector and base electrodes, supplies voltage feedback. Self-biasing resistor  $R_1$  (like  $R_S$  in Fig. 2) supplies forward base bias to establish the operating point.

R. F. Shea<sup>1</sup> has established a mathe-

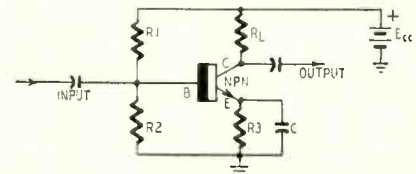

Fig. 5—Circuit for determining stabilization of transistor amplifiers.

matical criterion for stabilization of transistor amplifiers. Fig. 5 shows an R-C-coupled amplifier. It will be stabil-

$$\text{ized if } S_r = \frac{\Delta I_c}{\Delta I_{CO}} = \frac{1 + \frac{R_3}{R_1} + \frac{R_3}{R_2}}{1 + \beta + \frac{R_3}{R_1} + \frac{R_3}{R_2}}$$

where  $\beta$  is the current gain of a grounded-emitter stage;  $S_r$  is an expression of the ratio of changes in collector current  $\Delta I_C$  and leakage current  $\Delta I_{CO}$ . The numerical value of  $S_r$  should be small (in general, values from about 1 to 7 give satisfactory stabilization).

<sup>1</sup>R. F. Shea, *Principles of Transistor Circuits*, p. 103, Wiley & Sons, 1953.



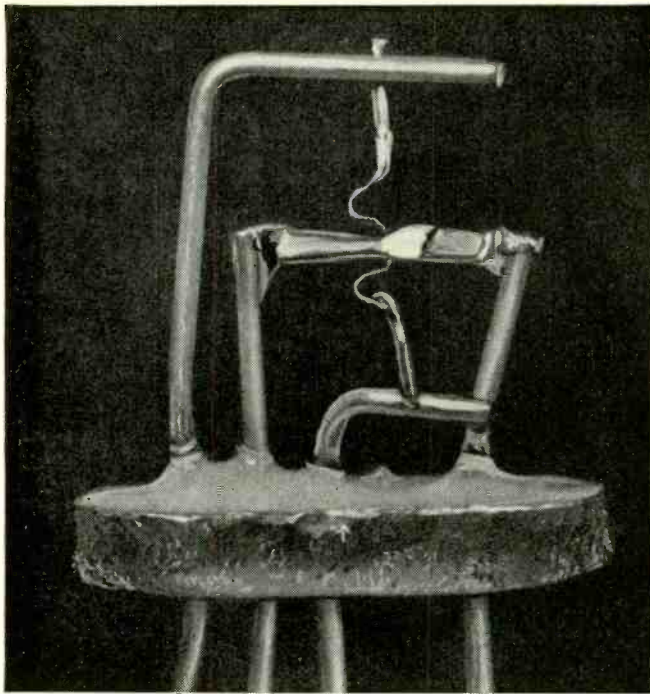

Courtesy Germanium Products Corp.

Internal construction of the RDX-300-A (3N23-C) germanium tetrode transistor.

Additional stability is obtained by *derating* the transistor (collector current and voltage reduced below rated values) and reducing the  $I^2R$  losses in the

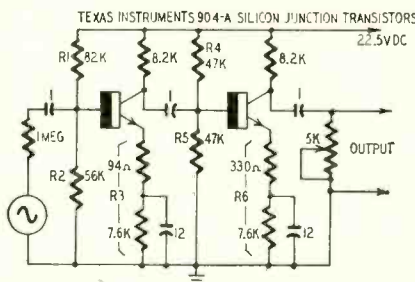

Fig. 6—Stabilized transistor amplifier. stabilizing resistors.

To look at stabilization from a practical viewpoint, consider the following circuits: Fig. 6 shows a *stabilized* amplifier using hermetically sealed silicon junction transistors. In the first stage resistors R3 and R2 provide current feedback, while the *parallel resistance* of R1 and R2 controls the amount of stabilization. The *ratio* of R1 and R2 determines the operating bias.

A similar situation exists for the second stage: R6 and R5 supply current feedback, the parallel value of R4 and R5 controls the amount of stabilization, the ratio of R4 and R5 determines the bias. Also, the  $S_r$  factor is small, and the supply voltage has been derated 25%.

The performance of this amplifier is better than many vacuum-tube amplifiers in several respects. The frequency response of a stabilized silicon junction amplifier, for two different ambient temperature conditions, is shown in Fig. 7. Fig. 8 shows an unstabilized amplifier for comparison with the stabilized unit. It is an R-C-coupled amplifier operating with fixed bias, with some degeneration present because of the resistors in the emitter circuits. The

performance of this amplifier is unsatisfactory and unpredictable since it is unstabilized.

It is interesting to note that hermetically sealed type 904-A silicon junction transistors (Texas Instruments) show an increase in gain at higher temperatures (even when a high percentage of humidity is present) as shown in Fig. 7.

The low-frequency response of an R-C-coupled amplifier depends on the values of coupling capacitor, coupling resistors and the load resistor (Fig. 9).

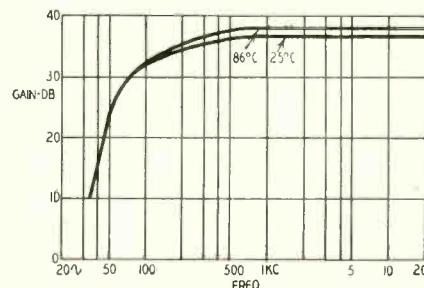

Fig. 7—Response of stabilized amplifier using silicon junction transistors.

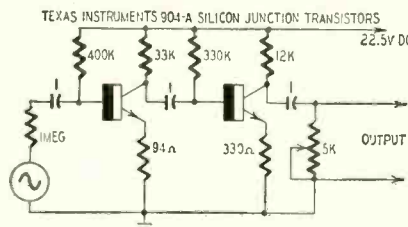

Fig. 8—Unstabilized amplifier circuit.

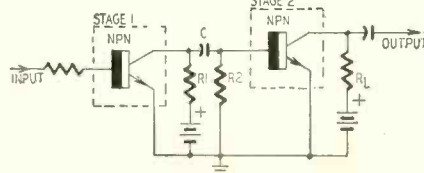

Fig. 9—R-C-coupled amplifier stage.

The coupling resistors reduce current amplification at lower frequencies because the input (base) resistance of most junction transistors (stage two) is small. Also, the impedance of the coupling capacitor is much greater than the input resistance of this stage at lower frequencies. For a bird's-eye view of this, assume coupling resistor R1 equals load resistor  $R_L$ . The frequency at which the response is 3 db down from the mid-frequency value is given by  $f = \frac{1(R_i + R_L)}{(2\pi C)(R_i + R_L)}$ . If C is 1  $\mu$ f and  $R_1 = R_L = 10,000$  ohms, the response is down 3 db at approximately 33 cycles.

Low-frequency transistor circuits are reliable and practical. In designing low-frequency amplifiers, it is convenient to have available some general "rules of thumb" to use as a check. The *conductance* (and current gain) of the first stage should be large; this requires the use of a *grounded-emitter* stage. Sometimes a *grounded collector* (emitter follower, analogous to a cathode follower) is used as the first stage, especially if the generator (source) impedance is large. The grounded emitter is usually used for intermediate stages because the current amplification should be as large as possible.

The final stages require the use of power transistors or stages designed for *maximum power gain*. Single-ended or push-pull grounded-emitter power stages are used here. Sometimes the *grounded-base* configuration is used if the load impedance is large. Low-powered, hermetically sealed, germanium transistors suitable for this are the 2N34, 2N43A and 2N38. Suitable silicon transistors are the hermetically sealed 900 series of Texas Instruments. A satisfactory hermetically sealed germanium power transistor is the Minneapolis-Honeywell 2N57. A satisfactory hermetically sealed silicon power unit is the Texas Instrument type X-15.

The high-frequency response of transistor circuits is complex—it depends on solid-state parameters, collector-junction capacitance (area), phase shift and other variables. Consequently, high-frequency circuits are difficult to design and give less reliable performance. The high-frequency response of a transistor is described on most data sheets by the phrases "alpha cutoff frequency" or "beta cutoff frequency." This language describes when the high-frequency response is 3 db down from the mid-frequency value. For conventional low-powered junction transistors this point is somewhere between 1 and 9 mc.

The tetrode transistor

One of the most promising devices for obtaining improved high-frequency operation is the tetrode transistor. The RDX-300-A (3N23-C) germanium tetrode, made commercially by Germanium Products Corp., Jersey City, N. J., is a hermetically sealed, n-p-n, grown-junction transistor with four electrodes.

## TEST INSTRUMENTS

A tetrode has an emitter electrode, a collector electrode and two base electrodes. The emitter and collector are n type material. Bases 1 and 2 (Fig. 10) are connected to opposite sides of a thin p type layer of germanium. The internal design of this tetrode is shown in the photograph.

There are several reasons for the improved high-frequency response of the n-p-n tetrode. This type design decreases the area of the collector junction, the use of thin layers of p type material increases the high-frequency range, reduction of the base resistance improves the high-frequency response.

In general, the operation of the tetrode transistor is as follows. Base 2 usually is used as the biasing electrode. Base 1 can be used in two ways. It can be the input electrode for grounded-emitter operation (Fig. 10). Or, if emitter input is used, base 1 is grounded (Fig. 11). When a satisfactory bias is applied to base 2, it confines the current flow to the neighborhood of base 1. This action reduces the intrinsic base resistance by an appreciable amount, increasing the upper-frequency response of the tetrode. Fundamentally, a tetrode is a "twin-based triode."

Selected RDX-300-A tetrodes have been used as sine-wave oscillators at frequencies near 100 mc. Also, they have been used as tuned amplifiers at frequencies near 50 mc. No doubt tet-

rodes will be used in future television sets as i.f. amplifiers.

The d.c. leakage currents  $I_{e01}$  and  $I_{e02}$  (emitter open and leakage measured from collector to base 1 and then from collector to base 2) of a tetrode must be less than  $10 \mu\text{a}$  each, at room temperature, with 4.5 volts on the collector. In  $I_{e0}$  leakage current (current between collector and emitter with bases open-circuited) should be less than  $150 \mu\text{a}$  with 4.5 volts on the collector. These leakage currents are uncomfortably high in presently available tetrodes.

A circuit for the measurement of the d.c. characteristics of tetrodes is shown in Fig. 12. Although this circuit can be used to obtain the usual collector current vs. voltage characteristics, it can also be used to obtain other valuable data such as collector current vs. base 2 bias current (for a constant emitter current—1 ma—and collector voltage, 4.5). Such characteristics are similar in shape to series resonance curves (when circuit resistance is large) or somewhat similar in shape to the curve in Fig. 14.

The small-signal current gain  $\beta$  of a tetrode may be obtained with the circuit of Fig. 13. In this case the tetrode is operated with  $E_c$  at 4.5 volts,  $I_e$  is set at -2 ma and an input frequency of 1 kc is used. Beta is read directly from the v.t.v.m. and is derived as follows:

$$\beta = \frac{di_c}{di_b} = \frac{E_2}{E_1} = \frac{(10^6)(E_2)}{(10^2)(E_1)} =$$

$$(10^4)(E_2) = 10,000 E_2$$

since  $E_1$  was set at unity. For example, if the v.t.v.m. reads .004 volt, beta is 40.

Fig. 14 is interesting because it shows the variation in beta as the base 2 bias current is varied. The best r.f. performance is obtained when base 2 bias current is negative.

An experimental tuned high-frequency tetrode amplifier is shown in Fig. 15. The input signal (approximately 1 to  $10 \mu\text{a}$  over the 2- to 50-mc

range, depending on circuit and transistor parameters) is applied to base 1.

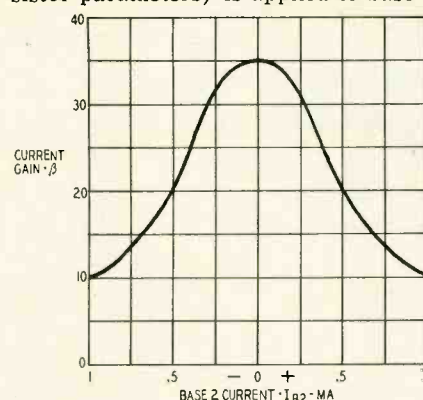

Fig. 14—Beta vs. base 2 current.

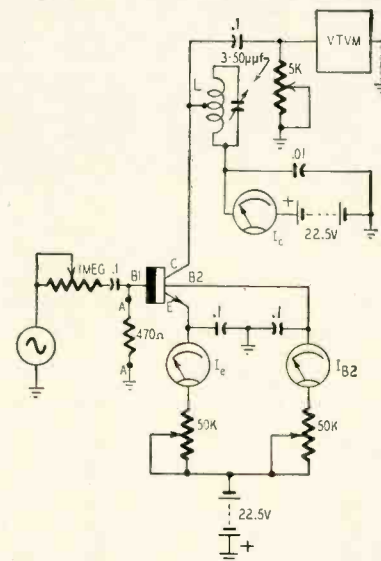

Fig. 15—Circuit of experimental tuned high-frequency tetrode amplifier.

Performance will be improved if the resistor at A-A in base 1 can be replaced with a coil of about 10 turns of No. 20 wire wound on a ferrite toroidal or bar core (obtainable from General Ceramic and Steatite Corp.).

The potentiometers in the base 2 and emitter leads establish a suitable bias (emitter current adjusted from 1 to 2 ma). Base 2 and emitter are bypassed to ground. The collector lead is attached to a tap near the center of output coil L. Experiment a little to find the best point. This coil consists of from about 8 to 10 turns (a few more at lower frequencies) of No. 20 wire wound on another miniature ferrite core (core diameter less than  $\frac{1}{2}$  inch). The tuning capacitor in the output circuit is adjusted for maximum output signal taken from the collector through a  $0.1\text{-}\mu\text{f}$  capacitor. Collector current  $I_c$  should not exceed 5 ma.

The configuration of Fig. 15 can be used as the basic circuit for interesting high-frequency experiments which will lead to the formulation of good design practices for u.h.f. transistor amplifier and oscillator circuits. Power gains of from 15 to 17 db at 5 mc and 8 to 10 db at 25 mc have been obtained from tetrode transistor amplifiers. END

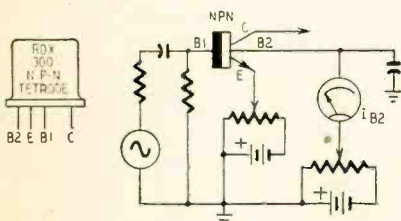

Fig. 10—Tetrode using base 1 input.

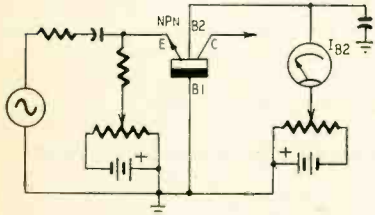

Fig. 11—Tetrode using emitter input.

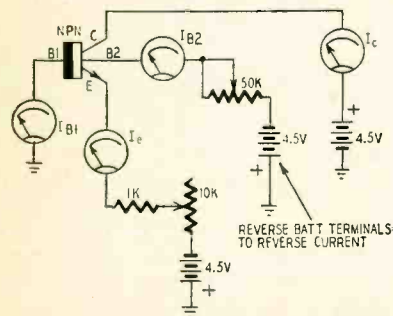

Fig. 12—Circuit used for measuring tetrode transistor d.c. characteristics.

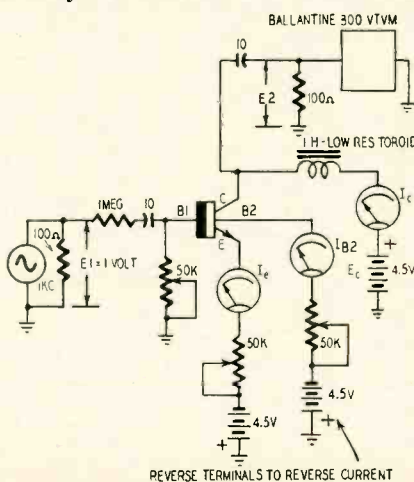

Fig. 13—Circuit diagram for measuring small-signal current gain tetrodes.

# CONVERGENCE..

*not impossible  
but difficult*

By HAROLD DAVIS

*Part I—Rainbows in black-and-white pictures; author suspects convergence trouble*



**M**ONDAY, 8:30 am—One of my out-of-town dealers called. He had just received the first 21-inch color set to be shipped into this area.

"Come over, and let's play with it," he invited.

"Play!" The word was to take on new significance.

11:05 am—Harry and I pulled up in front of the store after a 40-mile drive. On the way over I had rehashed all I had read and heard in a two-day color school. I was pretty sure I could get it going.

When we arrived on the scene, the dealer already had the set unpacked. At a casual glance it looked like a regular 21-inch black-and-white set, except that the round tube with the masked top and bottom seemed to date it back a few years.

"Have you tried it?" I asked.

"We had it on a few minutes. It gets pictures, but everyone has a rainbow around his shoulders."

I reached down and snapped the on-off switch on the volume control. The set came on normally and, as the dealer had said, got pictures but with rainbows around the images.

I dropped the lid on the control box. It contained only two new controls, one marked HUE and the other COLOR. Turning these made little difference.

I opened the service manual I had brought along and read the instructions for black-and-white reception. The only variation from a regular set was that COLOR should be off.

I turned COLOR off, but the figures still had rainbows.

Going through the service manual carefully, I could find no mention of anything that had to do with color in black-and-white pictures. I decided that since the set was getting pictures, the

tuner, i.f.'s, video and sound were O.K. That left the trouble somewhere in the color section. I reasoned that perhaps I could kill the color section by pulling out a tube or two and localizing the trouble.

11:35 am—Harry brought in the tool box and we started taking screws out of a metal back. When we got it loose, there was a noise like a spring flying out of an alarm clock. Harry was halfway to the door before I could tell him it was only some kind of safety switch held down by the back and which flew up when released. Nonchalantly, I worked the lever up and down with my hand.

Harry brought the "cheater" and I plugged it in. In a few seconds I heard a "Pfftt." The tube didn't light.

Back to the instruction manual and I found that the lever wasn't a switch, but a shorting bar that grounded the high voltage. The same job I had been doing with a screwdriver for years.

Harry reluctantly agreed to hold the lever down while I tried it a second time. Still no light on the picture tube. I was sure I had blown a high-voltage rectifier, which I was just as sure I couldn't obtain anywhere nearby.

I started looking for a way to get into the high-voltage compartment and was surprised to find no screws—just one small latch and the lid was released. However, there was another alarm-clock spring noise. This turned out to be a second shorting bar, put there, I suppose, further to discourage the careless from committing suicide.

Before I could start changing tubes, I discovered a blown fuse. It is in the high-voltage line, and blows if the shorting bar or bars are not held open when turned on. This is on page 17 of the instruction manual, I found out later.

I replaced the 0.45-amp fuse with a 0.5-amp unit and closed the lid on the lethal chamber. I then propped the outside shorting bar open with a piece of 2 x 4 about 3 feet long.

12:15 pm—The set came on. I turned it off and examined the tube location chart to see which tube to pull. It had more 6AN8's than my distributor carries in stock, so I decided on one of these.

I pulled one and turned the set back on. Still pictures with rainbows.

I pulled another and another without any effect on picture or rainbows. Harry started pacing the floor and I knew he was getting hungry.

"Go get yourself a bite to eat," I suggested, "while I read this instruction manual. There is bound to be something in here that tells how to get rid of rainbows."

1:00 pm—Harry returned, with a "what now?" expression on his face.

"I have decided that the trouble is either purity or convergence adjustments." I tried to say the two new words smoothly.

"Well," Harry shrugged his shoulders, "it could be either or both and I wouldn't know — I don't even know what you're talking about."

I decided we couldn't do anything about convergence without a dot generator, but we could check purity. I loosened four bolts that held the top of the cabinet and lifted this piece neatly off—to the amazement of the employees.

A ring around the bell of the picture tube held six round magnets described as MAGNETIC FIELD EQUALIZING ASSEMBLY. I set all these the maximum distance away from the tube as instructed. I set the contrast fully off and the brightness fully on. I started looking for the screen controls. Back in another place in the manual I read how

## TELEVISION

to take the control panel out and pull up a wooden wedge beneath it.

The control panel came out, but the wedge was wedged. I dared not use a screwdriver on this \$1,000 piece of merchandise and, after all the strong-fingered guys in the place had failed to unwedge, I discovered a new trick of bumping the removable piece with the palm of my thumb. A few bumps on each side and it came up and out.

I found the control for RED SCREEN wrapped around AGC and turned it full on. The GREEN was wrapped around the BLUE, and I turned them completely off.

Going to the back of the set, I located the PURITY adjustment, a thing that looks like a positioning ring on a black-and-white set. I found it also just as aggravating to adjust. I turned the set on and had a pink screen with some blue and greenish shadows around the edge. By turning the purity ring I could vary these shadows more or less. I also adjusted the two tabs as with a centering ring. Playing with these a while to see their effect, I set them for the purest pink I could get. I then slid the yoke back and forth as instructed and left this at best setting. The individual magnets around the bell were manipulated out, in and turned to eliminate the fringes of blue-green color.

1:45 pm—I backed off and scrutinized the screen. I was fully satisfied that the purity was pure.

I brought up the GREEN SCREEN control and the screen took on a yellowish look. Bringing up the blue turned it into a dirty white. I balanced the three screens to get the whitest possible screen. A little color crept in around the edges which I balanced out with the field magnets.

As per instructions I turned up the contrast and tuned in a picture. I couldn't help but notice it still had rainbows.

I adjusted BLUE VIDEO GAIN and GREEN VIDEO GAIN. I still had rainbows.

As per instructions, I turned the brightness down low and adjusted BLUE BACKGROUND and GREEN BACKGROUND until the background seemed neutral. I still had rainbows.

Now, I'm not a "diddler," but I must be distantly related to one. I decided to risk one little turn on the convergence magnets I found installed on a ring wrapped around the picture-tube neck behind the yoke. The only effect I could see was that it possibly changed the color of the rainbows.

3:30 pm—Pinky Lee came on and would have been delighted with my new version of his checkered coat.

Harry started gathering up the tools and discovered we hadn't put the 6AN8's back. We installed them, but still had rainbows.

I looked at the convergence chassis hung on the side near the top of the cabinet and Harry read my mind.

"Why don't you turn one of those and see what happens?"

Without this suggestion I might not

have, but I did it boldly and bravely.

I turned RED HORIZ AMPL. Nothing happened.

I turned RED VERT AMPL. Nothing happened.

I turned RED VERT TILT. Nothing happened.

I pulled out the RED connecting plug. I pulled out the GREEN. I pulled out the BLUE. Nothing happened.

I pulled the entire master plug to the convergence chassis. Nothing happened. We still had rainbows, and now there was one around Pinky's nose.

4:15 pm—I started thinking about my good black-and-white customers. To heck with color!

10:30 pm—I staggered homeward after having caught only half of my regular calls.

Tuesday—I spent the day catching up on regular work, but took time out to call on one of the local TV stations and borrow a dot generator and a color bar producer.

Wednesday, 11:00 am—Harry and I unloaded the color equipment and my tools and I began my first color convergence setup.

I hooked up the dot generator as best I could without instructions, which I hadn't picked up with the instruments. The instructions in the service manual said something about connections to the video—with a note that oscillators that produced r.f. should be connected to the antenna. This I did and tuned the machine to channel 6. I turned the channel selector to the same number and adjusted the fine tuning. By adjusting the contrast and tuning the generator I finally produced some dots but they were walking both ways.

"So," I said to myself, "no color sync."

I hooked up the color bar generator and turned everything on it. I managed to get some bars but they all looked alike. Breaking out my color book, I found a pattern that looked similar. The caption said it was a color bar pat-

tern with the color section of the set inoperative.

I decided to call the engineer at the TV station, who had had some experience with 15-inch color sets.

12:30—I finally got him on the phone and told him of my predicament.

"What channel are you on?" he asked.

I yelled to Harry to see what channel the set was on.

"Channel 6."

"Channel 6," I repeated.

"Well," the engineer answered sympathetically, "The bar generator is crystal-controlled on channel 3."

"Well, that will probably take care of that, but what about the dot generator having no sync?" I asked.

"You know you have to supply sync to the dot generator." He phrased the sentence, it seemed, to give me a chance to cover my stupidity.

"No," I answered frankly, "I didn't."

"Yes," he continued, "take a piece of wire and run it from H SYNC on the generator to the yoke. Just wrap it around the yoke leads. Do the same for the vertical if you need it."

I thanked him and hung up.

The color bar machine was still hooked up, so I changed the channel selector to 3 and after manipulating the fine tuning carefully was able to produce a set of bars exactly like those described in the color book as "normal."

I then hooked up the dot generator as instructed and, sure enough, the dots were stable as a rock.

The dot generator had controls marked V BARS, H BARS, DOTS and CROSS-HATCH. I tried them all out to see the effect. On V BARS there was another control that increased and decreased the number of vertical bars on the screen. The same for H BARS. When the control was set for DOTS or CROSSHATCH, the size of the dots and crosshatch could be regulated by increasing and decreasing the number of vertical and horizontal bars. I remember reading somewhere



that the small dots were better for convergence setups.

I readjusted the dots and observed the pattern. A few dots were white, but most had some color showing around the edges. The dots on the edges of the tubes were much out, showing little rectangles of red, blue and green. I couldn't help but notice that instead of getting *dots*, I got *squares*.

1:00 pm—I drank a Coke while reviewing the instructions. A note at the beginning said to check the high voltage and adjust it to 25,000 before beginning convergence.

I didn't have a high-voltage probe, so that let that out.

It also said to remove the high-voltage fuse and connect a 500-ma meter in its place to adjust the horizontal drive.

Having never been a switchboard electrician, I didn't have that either.

I knew the horizontal drive needed adjusting because the screen had that tell-tale white vertical line associated with many black-and-white sets when the horizontal drive is excessive.

I had to turn to the chassis layout to find the horizontal drive adjustment. It was just ahead of the high-voltage compartment, and I didn't cherish the thought of playing around so near 25,000 volts. However, I found that the control could be turned with a long plastic screwdriver like that used to adjust oscillator slugs. I backed off on it a bit and the line disappeared.

The set was still in good focus, so I reasoned the high voltage hadn't changed since it was originally set up.

1:30 pm—Convergence was now about to start.

I turned the red, green and blue HORIZ and VERT AMPL controls fully counterclockwise. These comprised half the controls on the convergence box. The others were marked TILT and PHASE. I set the VERT TILT to mid-range as instructed.

At this point the dots should have been displaced, but they were not like the diagram.

As per instructions, I attempted to converge the center dot using the knurled knobs on the convergence magnets. This wasn't too difficult. I now had a few white dots in the center becoming farther displaced as they neared the edges.

Turning the dot generator to STANDBY, I went through the purity, screen, video gain and background adjustments a second time.

3:30 pm—I was anxious to get to the dynamic convergence.

I rechecked the white dots in the center of the screen and following instructions I turned RED VERT AMPL full clockwise. As I did, I looked for movement of the red dot, but there was little. Other controls likewise had little effect. I pulled out the plug to the convergence box. It had little effect. The box just wasn't operating.

4:30 pm—My poor customers!

TO BE CONTINUED

By ROBERT G. MIDDLETON

More  
on  
the

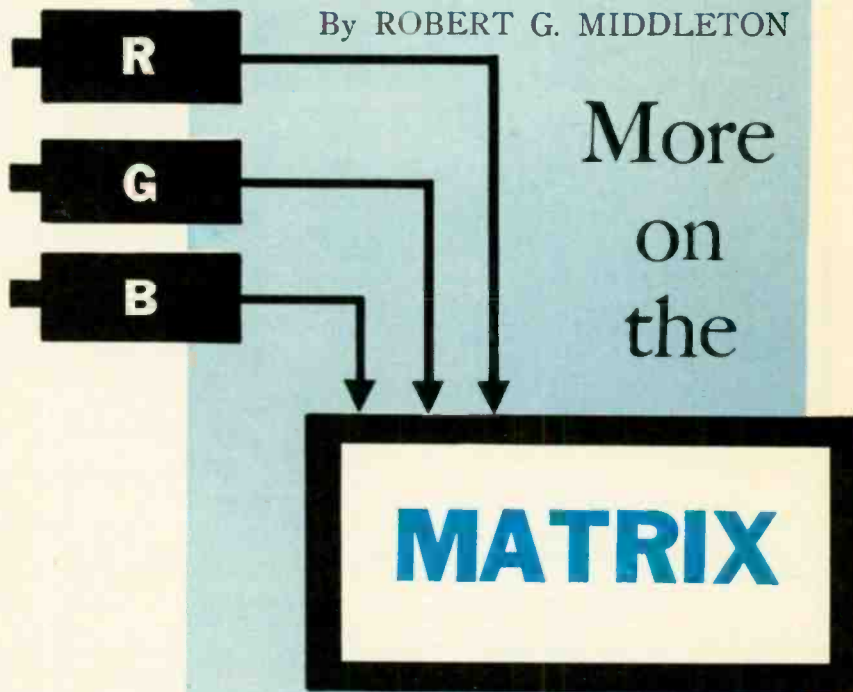

*Matrix operation with balanced and unbalanced color signal; the color intensity control*

IN "How a Matrix Works" (August, 1955) we saw how a simple matrix works—one which largely uses the color TV picture tube itself as the matrix. The discussion thus far has been color signals. However, balanced color signals are *not* transmitted. They are obtained at the receiver by adjusting the color detectors so that the B - Y detector develops more output voltage than the R - Y detector. This adjustment is made with the *color balance* control, a service adjustment.

Before we consider the adjustment of the color balance control in detail, let us very briefly review the operation of a matrix. Fig. 1 shows a simple matrix arrangement illustrating the important points with which we are concerned:

1. The Y signal is applied to all three cathodes. When the cathodes only are energized, a black-and-white picture appears.
2. The output from the R - Y detector is applied to the red grid. When the red grid is energized, a red hue appears.
3. The output from the B - Y detector is applied to the blue grid. When the blue grid is energized, a blue hue appears.

4. Green (not transmitted as such) is obtained at the receiver by compounding R - Y and B - Y in the green matrix. The output from the green matrix is applied to the green grid. When the green grid is energized, a green hue appears.

Why is it that we see a black-and-white picture when the cathodes of the color picture tube are energized by the Y signal? It is because white (or grays) consists of red + green + blue

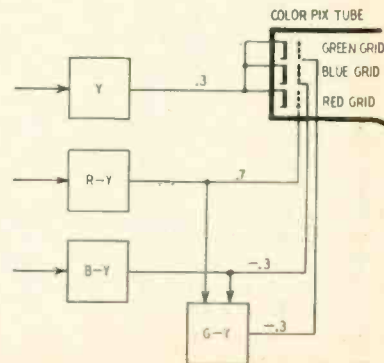

Fig. 1—A simple matrix arrangement.

# TELEVISION

and the screen and brightness controls for the three guns are adjusted so that, when the voltage on the cathodes of the picture tube goes up or down, the proportions of red, green and blue are such as to produce various shades of gray, or white when fully driven.

And why is it that we see a red hue on the screen when the cathodes are driven by the Y signal and the R - Y detector drives the red grid of the picture tube? It is because the red gun delivers more beam current when the grid and cathode are both driven, and more beam current means a resulting red tint on the screen of the color picture tube.

Further, what is the condition for the display of a saturated red hue on the screen? When a saturated red hue is processed by the receiver circuits, the signal appears on the screen of a wide-band scope as shown in the "red" bar of Fig. 2. The important thing to note here is that the red signal has a Y (luminance) component and a 3.58-mc (chrominance) component. The chrominance component is superimposed on the Y component—in other words, the average value of the chrominance component is zero (being an a.c. wave), so that the chrominance waveform is centered on the luminance voltage.

When this saturated color-bar signal proceeds through the receiver circuits, the two components divide, with the Y signal ending up on the cathodes of the color picture tube and the chrominance signal at the inputs of the R - Y and B - Y detectors. A little arithmetic here is very enlightening:

$$\begin{aligned} \text{saturated red} &= \\ 30\% Y + 70\% (R - Y) - 30\% \\ (B - Y) - 30\% (G - Y) \end{aligned}$$

Graphically, a saturated red signal appears as shown in Fig. 3. The color TV transmitter sends out information

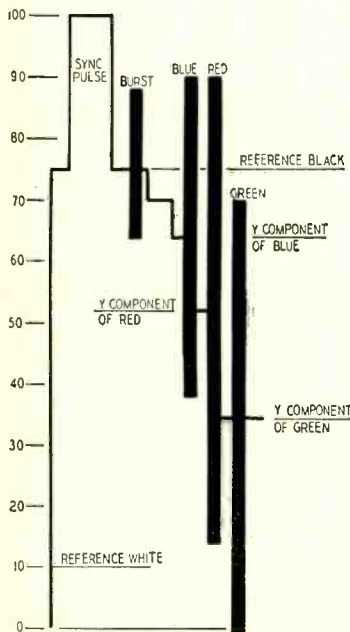

Fig. 2—Waveform showing the voltages of 100% saturated red, blue and green.

on a red field as follows: The R - Y signal is 70% of maximum, the B - Y signal is -30% and the Y signal is 30%. If we prefer, we can say that the -(B - Y) signal is 30% of maximum. In other words, the minus sign indicates a phase reversal. At the receiver, a phase reversal to the input of the B - Y detector results in negative instead of positive polarity output.

These waveforms are all demodulated patterns as seen at the outputs of the R - Y, B - Y and picture (Y) detectors, on a scope screen, and represent relative voltages.

One of the signals, G - Y, is missing from Fig. 3. This is explained in Fig. 4, where the G - Y matrix mixes R - Y with B - Y to produce G - Y. For saturated red R - Y = 70%, B - Y = -30%. The matrix adds:

$$\begin{aligned} -0.51(R - Y) &= \\ -0.51 \times 0.70 &= -0.357 \\ -0.19(B - Y) &= \\ -0.19 \times 0.30 &= +.057 \end{aligned}$$

to produce:  $G - Y = -0.30$

We end up as shown in Fig. 5 with grid and cathode of the red gun adding up to 100%, but with grid and cathode of the blue gun subtracting to 0. So the red gun is running wide open and the blue and green guns are cut off—result, a saturated red hue. (See Fig. 6 for illustration of desaturated red display.)

### Unbalanced color signal

This discussion has been based on the color detectors delivering equal voltages when equal input signal voltages were applied. Unfortunately it is not quite this simple. There is a problem of

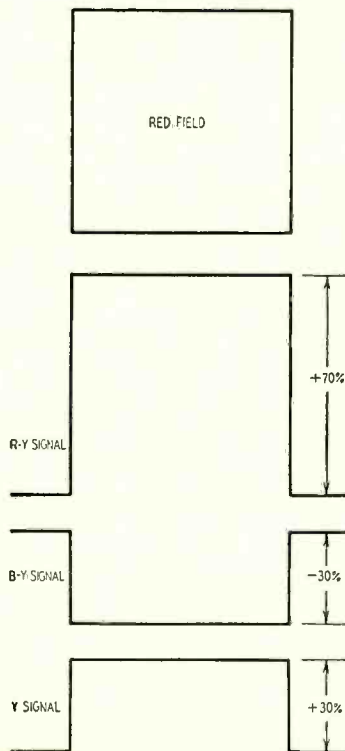

Fig. 3—Color TV signal for red field.

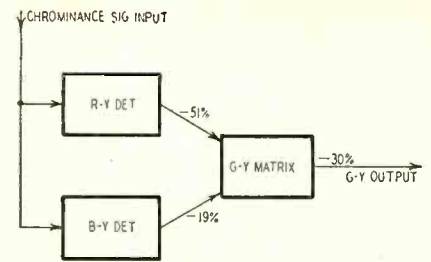

Fig. 4—G - Y matrix input and output.

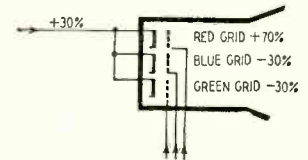

Fig. 5—Voltages on grids and cathodes of color tube for saturated red signal.

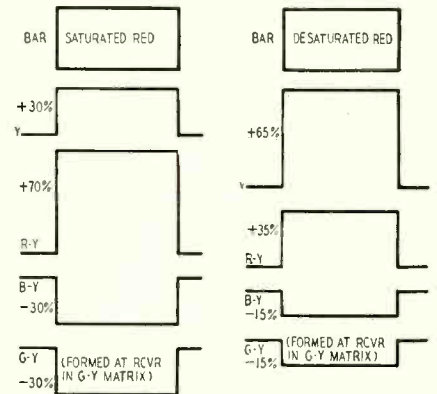

Fig. 6—When saturated red bar is transmitted, B - Y and G - Y cancel against Y. When transmitting a desaturated red bar, partial cancellation occurs.

overmodulation at the transmitter and hence we use what is termed *readjusted chrominance values*.

This means that both R - Y and B - Y are cut down somewhat. In fact, B - Y is reduced more than R - Y. In terms of relative voltages, R - Y is reduced to 87.7%, and B - Y to 49.3% of its original value. Thus, the transmitter does not provide color balance since R - Y is predominant. But this can be easily corrected at the receiver by adjusting the relative outputs of the color detectors so that the B - Y detector puts out more than the R - Y detector. A *color balance potentiometer* is provided for this purpose—it is an important service adjustment.

If you divide 87.7% by 49.3%, you will find that the unbalance amounts to 1.78 to 1, so that the output from the B - Y detector must be adjusted to be 1.78 times greater than the output from the R - Y detector. How is this done? Fig. 7 shows the R - Y output from a color bar generator. In similar fashion, the B - Y output can be switched on instead, and at equal voltage. For color balance, look at the square wave on the scope screen which

results from application of the R - Y signal, for example, and note its height. Then, check the output from the B - Y detector with a B - Y signal input and adjust the output for a square wave with a height 1.78 times the former. Then the color detectors will restore the required color balance. (See Fig. 8.)

This is a process which is analogous to pre-emphasis and de-emphasis in FM transmission.

The color detectors will not operate properly unless the color phase control has been properly set. How do we do this? There are several ways but, since we are working with a scope at the color detectors, here is the best way. Apply an R - Y signal to the input of the receiver and connect the scope at the output of the B - Y. Turn the color phase control until the voltage of the square wave on the scope screen drops to zero. Then, cross-check the operation by applying a B - Y signal to the input of the receiver and connect the scope at the output of the R - Y detector. Again, a zero square-wave voltage should result. If not, there is circuit trouble present, such as a faulty 90° phase-shifter adjustment or leaky capacitors.

Unless the 3.58-mc color subcarrier

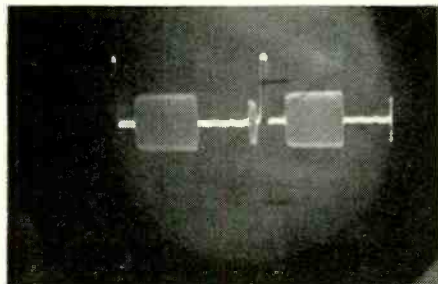

Fig. 7—Appearance of R - Y on a wide-band scope, from color bar generator.

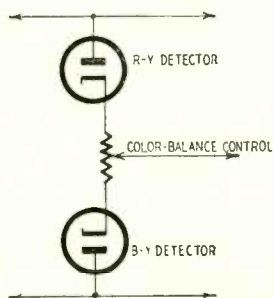

Fig. 8—Color balance control, a simple gain control that permits the technician to adjust output from the detectors.

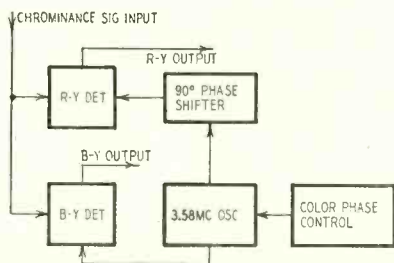

Fig. 9—Diagram shows relationship of 3.58-mc oscillator to other circuitry.

(Fig. 9) is inserted into the chrominance signal in proper phase, the detectors will not demodulate on the R - Y and B - Y axes. The R - Y output will contain B - Y contamination and the B - Y output will contain R - Y contamination. To demodulate along the correct axes, the color phase control must be adjusted properly with exactly 90° of phase shift between the local subcarrier oscillator and the R - Y detector.

This procedure assumes that you have a standard NTSC bar generator. If you are using a keyed rainbow generator, you usually cannot obtain individual R - Y and B - Y signals, so that the output from the detector contains varying outputs of other signals also (Fig. 10). In such case, you must count bars until you come to the R - Y bar and adjust the color phasing

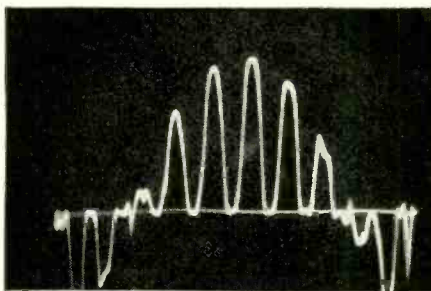

Fig. 10—Keyed rainbow signal at output of color detector, or the G - Y matrix.

control to produce zero output from the B - Y detector. Likewise, to cross-check you must count bars until you come to the B - Y bar and connect the scope at the output of the R - Y detector to see whether the B - Y bar voltage is practically zero (as it should be).

This brings us to the G - Y matrix. How shall we tell whether the G - Y matrix is operating correctly? Remember this important fact: The matrix responds to applied signals like the color detectors. When a keyed rainbow signal is applied to the input of the color receiver, the G - Y bar will appear at maximum if the G - Y matrix is operating correctly. Or, suppose that we are using a standard NTSC bar generator which provides a G - Y  $\angle 90^\circ$  signal. If we switch on this G - Y  $\angle 90^\circ$  signal, the G - Y matrix responds with practically zero output. In other words, the G - Y matrix nulls on a G - Y  $\angle 90^\circ$  signal, just as an R - Y detector nulls on a B - Y signal.

Having checked the G - Y matrix for either maximum output on a G - Y keyed rainbow signal or for zero output on a G - Y  $\angle 90^\circ$  signal, the voltage value of the output can be checked, for example, on a green bar signal. When a green bar signal is applied to the input of the receiver, the G - Y output voltage should be 41%; when a red bar signal is applied it should be -30% and for a blue bar signal -11%. Remember if positive voltages go up

on the scope screen, negative voltages go down. Adjust the vertical gain control of the scope so that the value of the signal can be counted in terms of squares.

Here are the relative output voltages from the R - Y detector and the G - Y matrix for some common colors:

red:	R - Y, +70%
	G - Y, -30%
green:	R - Y, -59%
	G - Y, +41%
blue:	R - Y, -11%
	G - Y, -11%
yellow:	R - Y, +11%
	G - Y, +11%

**Obtaining 100% saturated colors**

Although readjustment of chrominance values at the transmitter or generator results in a signal which does not have 100% saturated colors, it is possible to obtain true 100% saturated colors at the receiver by adjusting the color intensity control.

Chrominance values at the transmitter are adjusted by reducing R - Y to 0.877, and B - Y to 0.493 of its original value. Y is not modified. At the receiver, the luminance and chrominance signals are separately processed. The output from the Y amplifier is applied to the cathodes of the color picture tube. In the chrominance section of the receiver, correct color balance is first obtained by adjusting the B - Y detector for an output 1.78 times that of the R - Y detector. This adjustment results in R - Y and B - Y signals having 0.877 of their original values. The G - Y matrix, which operates on these R - Y and B - Y signals, likewise generates a G - Y signal having 0.877 of its original value.

When the color intensity control is adjusted to raise these signal levels by a factor of 1.14, chrominance signals R - Y, B - Y and G - Y are restored to their original values for application to the red, blue and green grids of the color picture tube. Since Y is also applied to the cathodes of the picture tube at its original value, true 100% saturated colors are reproduced on the picture-tube screen.

Thus, the outputs from the red, blue and green guns of the color picture tube faithfully follow the outputs from the red, blue and green cameras at the transmitter. There is one limitation, however, in the reproduction of some highly saturated colors. In spite of the fact that readjusted chrominance values are used, certain 100% saturated colors such as green will produce overmodulation at the transmitter. In a case of this sort, a prominent dot structure appears in the area of overmodulation and the hue and saturation values are not correct. Sync buzz may also appear in the sound. However, fully saturated greens are rarely encountered in nature, and this is the basis for the compromise in the assignment of NTSC readjusted chrominance values. END

# Television . . . it's a cinch

*Eighteenth conversation, first half: The trichromatic principle; transmission problems; simultaneous or sequential; saving the fine detail; how to carry the color inside the 6-mc band*

By E. AISBERG

From the original "La Télévision? . . . Mais c'est très simple!" Translated from the French by Fred Shunaman. All North American rights reserved. No extract may be printed without the permission of RADIO-ELECTRONICS and the author.

KEN—Well, why the disgusted look? Anything happen?  
 WILL—I've just been thinking that here I've spent all this time learning about television, and now in a year or two we'll have very little but color TV. So all the time I've spent on ordinary television is wasted. I'll have to start all over again.

KEN—Don't let it bother you! Most of the circuits in a color televisor are the old familiar ones we've been studying in black-and-white. Besides, black-and-white will be with us for some time yet. And the color circuits ar'n't going to be too hard—they say!

WILL—Oh, yeah? And can you tell me in a few well chosen words just how they transmit and receive color?

KEN—Well, several systems have been tried. All, of course, based on the trichromatic principle . . .

WILL— . . . in which all the hues are reproduced from three fundamental colors: red, yellowish green and greenish blue. By mixing them in the proper proportions, you can get all the shades and tints you like.

KEN—Wonderful! I didn't know you'd been studying the subject.

WILL—I learned that working in a print shop, where they printed pictures with red, blue and yellow inks. If you look at the pictures through a magnifying glass, you see the dots in those *primary* colors but at a short distance the eye mixes them up to make a solid picture. And, because I already knew a little about it, I was interested to find that the primary colors in TV are red, green and blue. That's because you're working with light and *add* the colors together. But when you print colors one on top of the other, it's equivalent to subtraction, so you have to use different colors to get the same result.

KEN—Boy, you keep right on surprising me! I never thought of you as an artist or color expert.

WILL—Do you take me for an ignoramus altogether? But let's get back to TV. I suppose, to transmit an image in color, we must work the same as in printing. First, we have to *separate* our scene into the three primaries, then transmit them separately and superimpose them at the receiving end to build up our picture.

KEN—That's just about it. So we have to get three images—red, blue and green—from our multicolor scene. How do we do it?

WILL—Easy. By using color filters. For example, if you photograph the scene through a red filter, you get a red image. The brightness of any surface element in it depends entirely on the amount of red light emitted by the corresponding area in the scene. So the red parts are brightest. And the blue and green parts, which emit no red light whatever, are black after they've gone through a good red filter.

KEN—That's right. Now we have three images: red, green and blue. What are we going to do with them?

WILL—Transmit them like any other television signals, of course. Then, at the receiver, we'll bring in each image in black-and-white on a separate picture tube. But in front of the "red" tube I'll put a red color filter (a piece of red

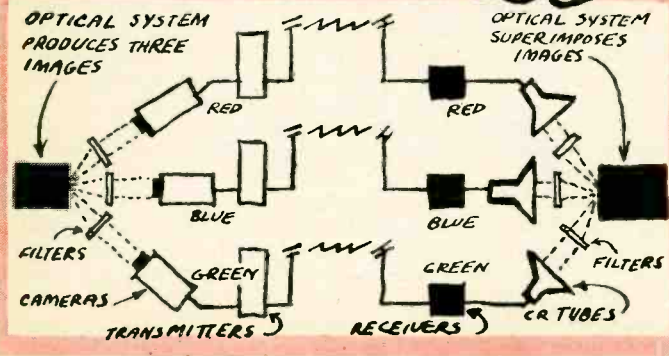
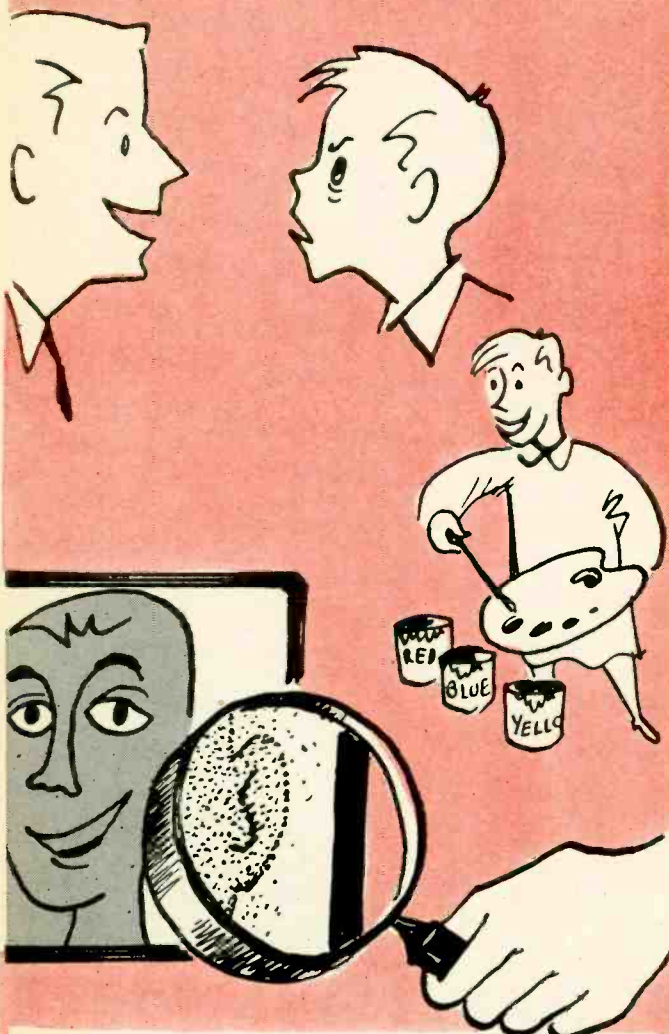



glass probably) and green and blue filters before the other tubes. Then all we have to do is superimpose the three images—it should be easy to do it by projection—to get the original image in true color. I can't see why the idea won't work!

KEN—Neither can I, Will. In fact, one of our big companies experimented with just that system about 10 years ago with some success. In spite of difficulty in registering the three images (as a printer you'd understand that!) they got very satisfactory pictures.

**Simultaneous or sequential**

WILL—From the sound of your voice, there's a "but" in this somewhere!

KEN—And can't you see where? Three cameras, three transmitters, three channels, three receivers and three picture tubes?

WILL—I suppose it would cost a lot. And those three channels! No, with the spectrum as crowded as it is, you'd never get away with that! But what is the solution?

KEN—Remember the first things we learned in television? How, to get all points in a scene to the eye simultaneously . . .

WILL. . . we transmitted them successively! I get it now! The solution is to send the red, blue and green images successively along a single channel. If they follow each other rapidly enough, the eye will blend them into a single picture!

KEN—That's the general idea. But don't think you can transmit the whole green image, then the red, then the blue. Unless you have a very large number of images a second you'll run into *flicker*.

WILL—Why?

KEN—Well, suppose part of your image is pure blue. Then that part would be transmitted only once during the time three images were going across space, for the red and green images wouldn't add a single quantum of brightness to the receiving screen. The eye would get the sensation of a light flicker over that part of the image because that part of the screen would be dark so long between the times the blue area would light up.

WILL—Can't we interlace the same as in black-and-white? First transmit the odd lines, then the even ones . . .

KEN—You're on the right track—you can use the same principle in color.

WILL—Fine! Now just how would we transmit a color picture if we vary the colors for every field?

**The color disc**

KEN—O.K. Here's a system actually used today. It uses a revolving disc which passes red, green and blue filters successively ahead of the lens of the camera, and a similar disc ahead of the picture tube. The discs are kept in step by the sync signals.

WILL—I see that each disc has six filters: red, blue, green; then red, blue, green again. Three filters ought to be enough.

KEN—They are. But if we use six, we can cut the speed in two, which is an excellent idea. You develop a lot of centrifugal force in those discs and, if you quadruple it by doubling the disc speed, you take a chance on the discs flying apart.

WILL—And so, while one color filter is passing ahead of the screen, you're not analyzing a complete color image, but only one color field—either the odd or even lines?

KEN—Exactly. Can you analyze the procedure?

WILL—Let's see. Suppose we start with the red odd lines. Then we have six fields:

1. Red, odd lines / 2. Blue, even lines / 3. Green, odd lines /
  4. Red, even lines / 5. Blue, odd lines / 6. Green, even lines
- and then it starts all over again.

KEN—And in one turn of the wheel, each image is analyzed in each of the three primary colors, both for odd and even lines, and the fields are interlaced.

WILL—But that's six fields for black-and-white's two. Looks like we still might get flicker. But did you say something about more images a second?

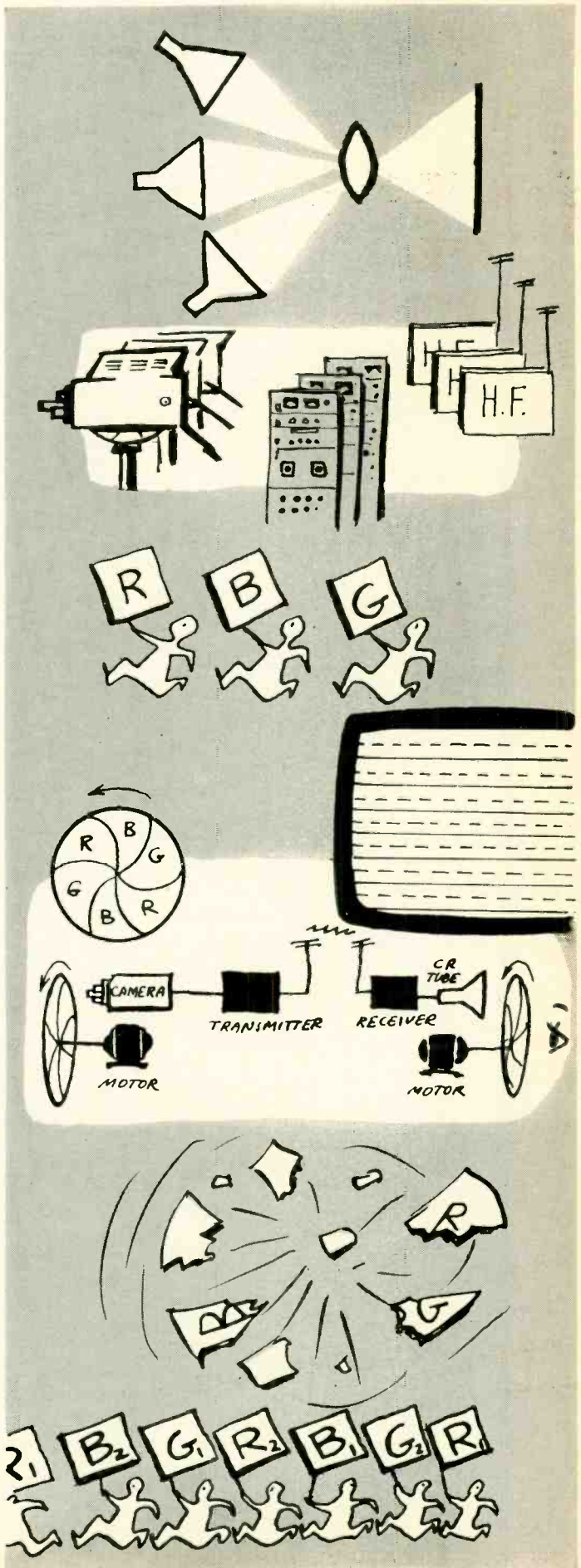

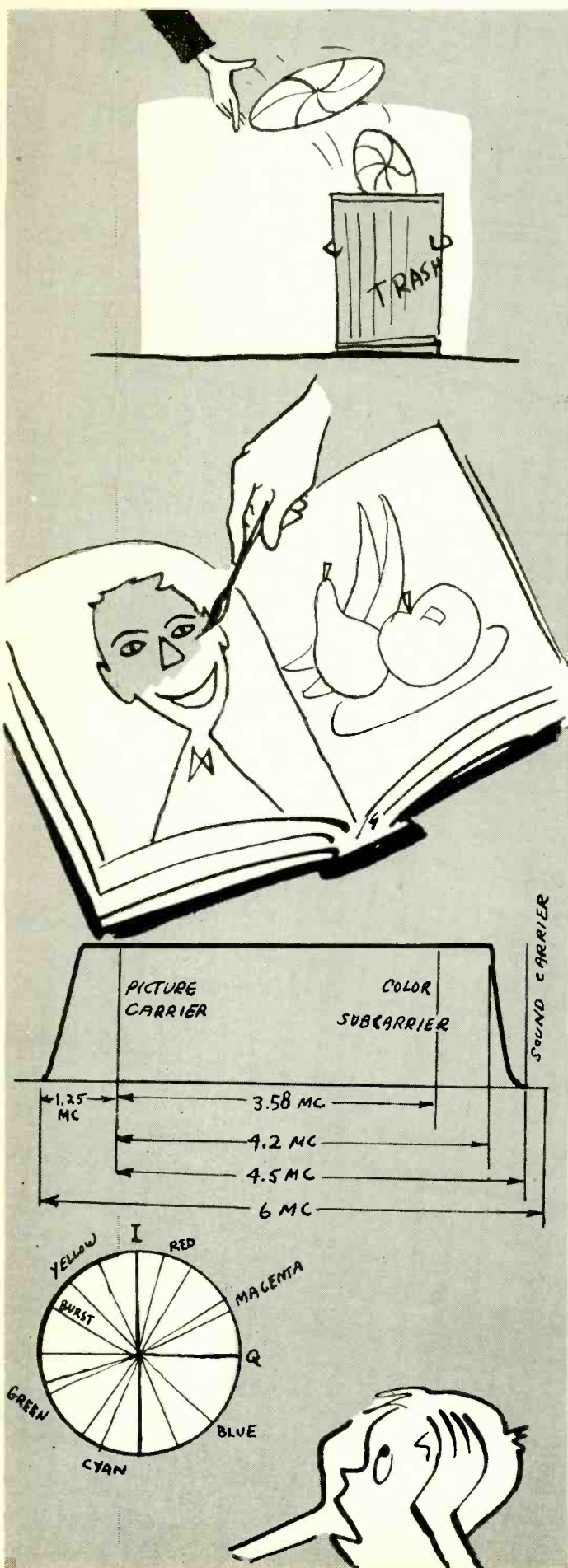

KEN—Well, I have to confess something to you, Will. This system is not the one used by broadcast stations. It was abandoned for broadcasting some years ago. I told you the truth when I said it was used today, but it's used only for closed-circuit television. Different manufacturers can use different standards. Some have gone to very high line and field frequencies for higher definition. But the general rule has been to follow the old standard of 29,160 lines and 144 fields per second that was used when we almost had color television back in 1951.

WILL—But why not stick to the black-and-white standards of 15,750 lines and 60 fields a second?

KEN—You forget that you have to transmit three times as many points or surface elements. Even with the higher line and frame frequencies, you can't squeeze them all in. So—with the old sequential-color standard—the number of lines per frame was cut from 525 to 405. The eye is so satisfied with the sensation of life and depth that you get with color that the poorer definition doesn't bother it. The eye doesn't notice it, in fact.

Saving the fine detail

WILL—So a lot of faults are covered up with a good coloring job. Who was it said television is like a woman?

KEN—But there are ways of limiting the modulation bandwidth without losing too much detail. The most important one is to transmit the fine details in black-and-white and to save color for the relatively larger areas, which of course would not need as high a frequency for their transmission. The result is very satisfactory.

WILL—Of course. I knew that when I was a small child.

KEN—Huh?

WILL—Definitely. My parents used to give me coloring books and I smeared up big areas with water-colors. That never obscured the picture detail, which was printed in black-and-white.

KEN—I can see that color television must look pretty simple to you!

WILL—Maybe. But let's get back on the job again. How's about giving a little on how television really is broadcast in color?

KEN—Well, you've been coming pretty close to it. If we keep our fine details in black-and-white, we find that we can send all our color on a band less than 1500 kc wide. That's quite a bit different from three television channels.

WILL—But you've still got to have an extra channel of some kind to transmit the color?

KEN—That problem has been solved too. The color signals modulate an oscillator at approximately 3.58 mc, in the video band. And this modulated *subcarrier* is part of the video signal that modulates the transmitter frequency. At the receiver, special circuits pick out the 3.58-mc signals, demodulate them, and . . .

WILL—Hold on! You are talking about one color signal, and we have to deal with three colors. Are there any other color subcarriers?

KEN—It's not quite as simple as that. *Two* color signals—I and Q—are sent on the color subcarrier—one at 90° phase difference from the other. These two signals are phase-modulated according to the colors being transmitted. They are detected at the receiver by a phase detector or demodulator, whose output is divided among the color tubes of the receiver so that the original colors are reproduced.

WILL—It's no use! You've been way over my head for the last 10 minutes. And now you're even talking about color tubes in the receiver. I thought there was only one.

KEN—You're right, Will—color is too tough a subject for a single conversation. If you're really interested, maybe we can get together sometime soon and go into it seriously.

WILL—O.K. But what about that tube?

KEN—You're right about it, too. Modern receivers use only one, though the old simultaneous system used three. The one that's almost universally used today reminds one a little of the old three-tube system: it has three guns, one for each color. But there is also a single-gun tube, and some sets using that are now under construction. TO BE CONTINUED

# Converting 630 RECEIVERS

to

# INTERCARRIER OPERATION

By HOWARD BIERMAN\*

**E**ARLY field reports in v.h.f.-u.h.f. areas, as submitted to manufacturers of 630 type receivers, noted excellent signal-to-noise ratio, superior picture quality and above average sync stability. However, one particular problem was considered objectionable — oscillator drift during u.h.f. operation necessitated frequent resetting of the fine tuning control to maintain clear sound reception. It was therefore necessary to redesign the sound and video i.f. sections of the original 630 chassis for intercarrier circuitry, which is substantially immune to oscil-

lator drift problems. The conversion described in this article has been made in several thousand sets during the past year and has proven highly successful in u.h.f. areas under various signal-strength conditions.

Proper design and careful alignment have resulted in clear, crisp audio output free from the annoying and discordant buzz often heard in less expensive intercarrier sets. Several hours' labor and less than \$10 worth of components are the only necessary expenses to convert a 630 set to the newer improved intercarrier circuitry.

Let's compare the operation of split-sound and intercarrier receivers. The

transmitted TV sound carrier is 4.5 mc higher than the video carrier; this frequency difference is closely maintained at the station in accordance with FCC regulations. In split-sound design (such as the original RCA 630 i.f. section shown in Fig. 1) the video and sound i.f. signals developed at the mixer are separated at the tuner output or in one of the first two video i.f. stages, and fed to separate i.f. stages for further amplification. Individual sound and pictures detectors then feed their demodulated output to the audio and video amplifier stages, respectively.

In intercarrier systems, the video and sound i.f. signals are passed through a

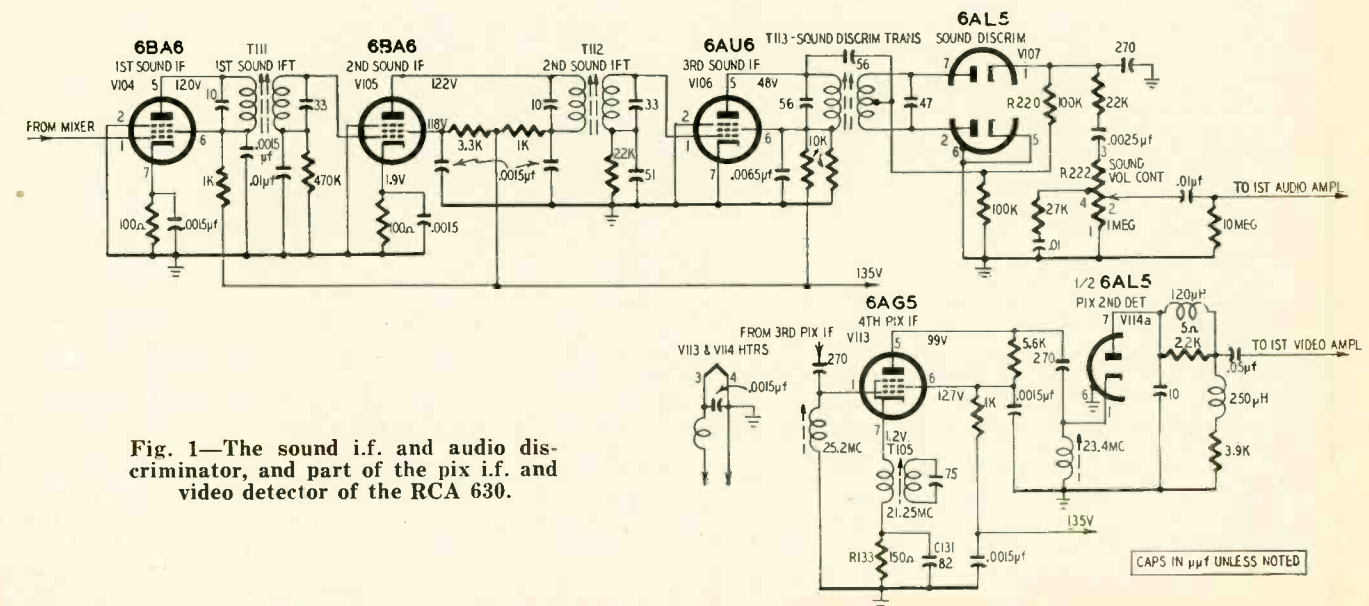

Fig. 1—The sound i.f. and audio discriminator, and part of the pix i.f. and video detector of the RCA 630.

**TELEVISION**

VII5-1ST VIDEO AMP

MOUNT L1

Underchassis view of a 630TS split-sound receiver—before modification.

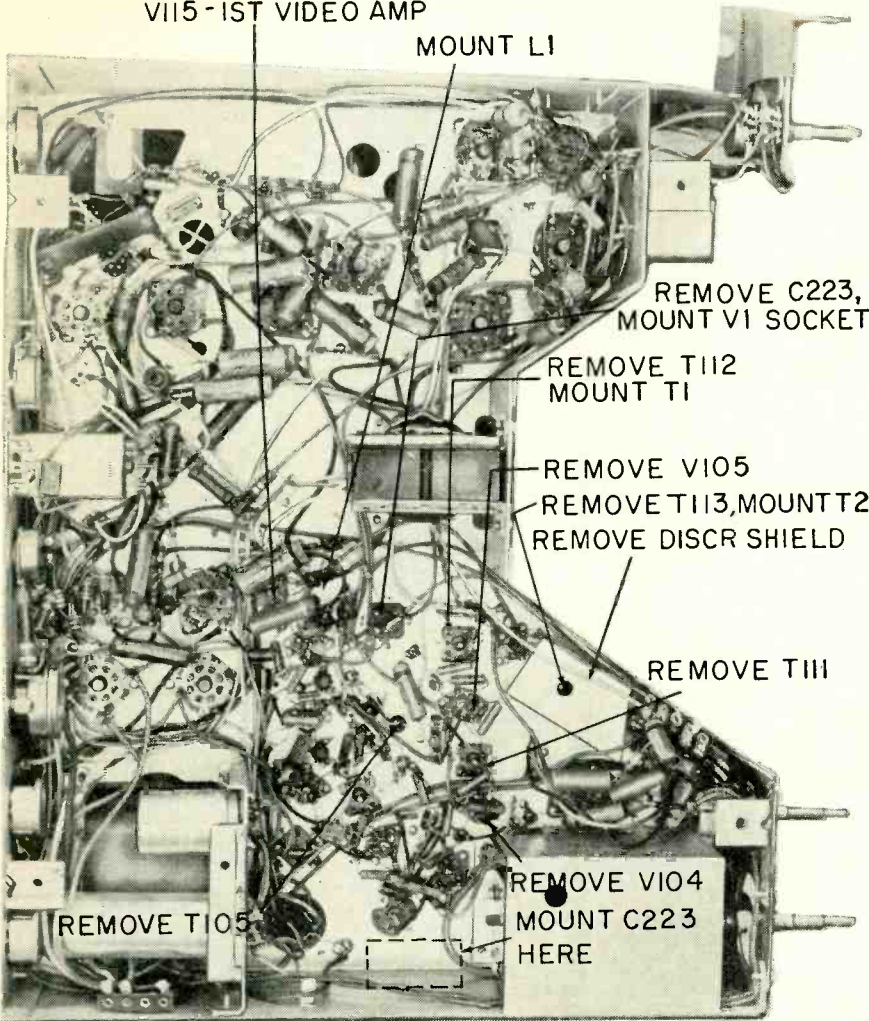

REMOVE C223,  
MOUNT V1 SOCKET

REMOVE T112  
MOUNT T1

REMOVE V105  
REMOVE T113, MOUNT T2  
REMOVE DISCR SHIELD

REMOVE T111

REMOVE V104  
MOUNT C223  
HERE

REMOVE T105

A 630 type chassis after modification for inter-carrier operation.

common wideband i.f. section and applied to a single detector stage. A heterodyne action takes place during the combined detection process, producing a 4.5-mc carrier containing the same frequency-modulated variations as the transmitted sound carrier. This 4.5-mc signal is then amplified and applied to an FM detector—usually a ratio detector type—which produces audio signals for the sound section of the receiver.

In v.h.f., as in u.h.f. operation, the local oscillator stage of the tuner is subjected to thermal changes, B plus variations and humidity effects which produce frequency drift. Since heterodyne action between the incoming sound and picture r.f. carriers and the local oscillator signal determines the i.f. carriers, a shift in oscillator frequency will produce a similar variation in the i.f. signals. In split-sound design this causes weak, distorted or complete loss of sound since the sound i.f. carrier is displaced from the center of its relatively narrow bandpass region. In intercarrier receivers, however, the audio signals are not affected since they are developed from the 4.5-mc beat note, maintained by the frequency difference between video and sound carriers at the transmitter. Regardless of local oscillator drift and shift in i.f. carrier values, the 4.5-mc beat note is unchanged.

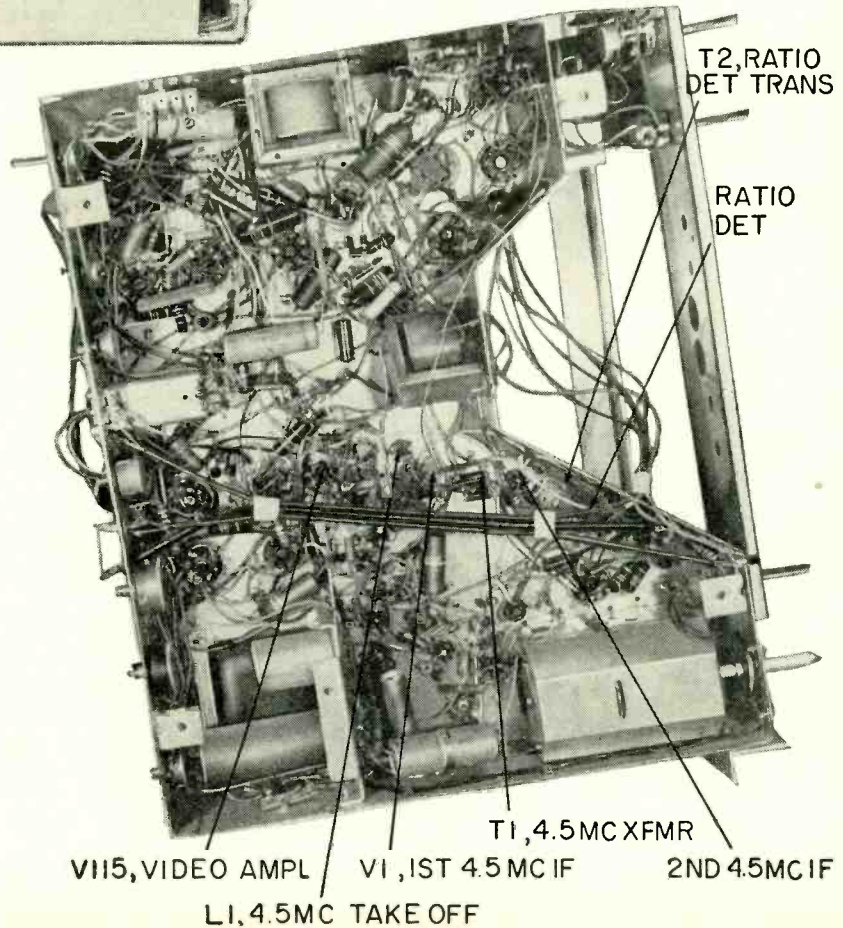

T2, RATIO  
DET TRANS

RATIO  
DET

T1, 4.5MC XFMR

VII5, VIDEO AMPL

VI, 1ST 4.5 MC IF

2ND 4.5MC IF

LI, 4.5MC TAKE OFF

While this article is specifically directed toward 630 type receivers, the principles and practices apply to most models and may be used as a guide for similar conversion jobs. The initial step requires a complete removal of the entire sound section, shown in Fig. 1. (All codes used in Fig. 1 are those used in original RCA diagrams. Codes and values in some 630 type receivers may differ slightly from the original at certain points.

Unsolder the various components of the three sound i.f. amplifiers and discriminator stage, indicated as V104, V105, V106 and V107. Avoid loosening or pulling out any socket pins or it will become necessary to repair the socket or mount a new one. Remove the two sound i.f. transformers (T111 and T112), the discriminator shield cover, the discriminator transformer (T113) and tube sockets V105 and V106. Remove electrolytic capacitor C223 (10  $\mu$ f, 40  $\mu$ f, 450 volts; 10  $\mu$ f, 350 volts) and mount it at the side of the chassis (see photo), extending the wires attached to it by well spliced connections. Finally, remove sound trap T105 located in the cathode circuit of the fourth picture i.f. stage. (The photos are not "before" and "after" shots of the same chassis. One is a 630 type chassis in its original form, the other is a different but similar chassis after conversion. This accounts for the can type C223 in one photo and the tubular type in the other.)

In addition to the various resistors and capacitors shown in the schematic of the intercarrier circuit (Fig. 2) several 4.5-mc transformers are required. Several manufacturer's types are indicated in the parts list. These components are physically interchangeable with the original 630 parts, avoiding unnecessary drilling or filing.

In assembling the new parts, first drill a 5/16-inch hole near the first video amplifier tube V115 (see photos). Be careful to avoid disturbing or damaging any wiring or parts in this area. Mount trap L1 in the 5/16-inch hole. Mount a seven-pin miniature wafer socket in the space previously occupied by electrolytic capacitor C223. The capacitor has been moved to the side of the chassis and the tube socket substituted in this region to keep lead lengths

of the 4.5-mc circuits as short as possible. This tube location is the new first sound i.f. stage, V1. Mount the 4.5-mc sound i.f. transformer T1 in the space previously occupied by the second sound i.f. transformer T112. Then mount ratio detector transformer T2 in the space originally used for discriminator transformer T113. The receiver is now ready for wiring.

Since the cathode trap of the fourth picture i.f. stage has been removed (to prevent excessive attenuation of the sound i.f. carrier before it reaches the detector stage), it is necessary to wire cathode components R133 and C131 (Fig. 1) directly to the cathode of V113. Change C131 from 82 to 1,500  $\mu$ f. Then carefully wire all components contained in the intercarrier section, using the schematic shown in Fig. 2. Keep all lead lengths as short as possible and avoid placing the grid and plate leads adjacent to prevent oscillation. Use high-quality ceramic bypass capacitors and make all ground connections to the closest possible chassis points. Avoid haphazard component layout and careless wiring which may result in instability or faulty operation. Dress the heater leads away from grid and plate leads, as well as from trap L1 to avoid hum modulation.

After completing the wiring, check the finished job carefully against Fig. 2 and place the various tubes in their sockets. To minimize the possibility of power supply overload or component burnout, invest a few minutes in a resistance check at the plate and screen (pins 5 and 6) of the 6AU6 4.5-mc amplifier tubes. If these points measure about 5,000 ohms or so to ground, power may be applied for alignment. Should the ohmmeter reading fall well below this value, carefully recheck the wiring and components before proceeding further.

**Alignment**

The last remaining task in the conversion is accurate alignment of the new 4.5-mc section, as well as the oscillator section of the tuner. Apply power to the receiver and test equipment to be used (v.t.v.m. and signal generator) and allow several minutes' warmup time. If available, an r.f. signal generator equipped with a 4.5-mc

crystal would be the most desirable source of signal input. However, an accurately calibrated r.f. generator or even a station signal is sufficient for a proper alignment job.

Assuming an r.f. generator or crystal calibrator is used, feed a 4.5-mc unmodulated signal to the cathode of the 6AL5 video detector stage V114-a (Fig. 1). Set the receiver station selector to an unused channel to prevent interference beat notes and then connect a v.t.v.m. across ratio detector load resistor R1. The v.t.v.m. selector switch should be placed to its "plus d.c." range; if a v.t.v.m. is not available, a 20,000-ohms-per-volt multimeter will be adequate.

Detune the secondary of ratio detector transformer T2 by rotating its bottom slug several turns. Then adjust the top slugs of T2, T1 and L1 for maximum indication on the v.t.v.m. Following these adjustments, connect the v.t.v.m. across C1 and ground. Slowly adjust the bottom slug of ratio detector transformer T2 for exact zero reading on the v.t.v.m. As the slug is turned, the v.t.v.m. reading will be positive, pass through zero and then

**Parts for 630 conversion**

Resistors: 1-47, 1-100, 1-1,000, 1-33,000, 2-6,800 (5%), 1-39,000, 1-47,000, 1-56,000, ohms, 1/2 watt; 1-39,000 ohms, 1 watt.

Capacitors: 1-2.2  $\mu$ f, 1-47  $\mu$ f, 1-390  $\mu$ f, 2-470  $\mu$ f, 1-.0015 (C131, Fig. 1), ceramic; 4-0.1  $\mu$ f, ceramic, 500 volts, 1-4  $\mu$ f, 50 volts, electrolytic.

Miscellaneous: 1-6AU6; 1-7-pin miniature wafer socket; 1-4.5-mc takeoff coil (Techmaster L308A, Miller 1469, Meissner 17-3402 or equivalent); 1-4.5-mc interstage transformer (Techmaster T212, Miller 1466, Meissner 17-1021 or equivalent); 1-4.5-mc ratio detector transformer (Techmaster T214A, Miller 1468, Meissner 17-1033 or equivalent).

become negative—the point at which it passes through zero is the correct setting.

If an accurate 4.5-mc source is not available, tune the receiver to a strong local station (transmitting a test pattern and tone signal preferably). Set the receiver fine-tuning control until the picture is clearest or just before the point at which sound bars begin to appear on the picture. Follow the previous alignment instructions, using the station signals as the input source.

For receivers that have individually adjustable oscillator slugs for each channel, set the fine-tuning control to its mid-position. Adjust the oscillator slugs of each received channel to the point where sound bars (horizontal lines whose number and intensity vary as the sound modulation changes) just begin to appear.

If the conversion job has been neatly and carefully followed in assembly, wiring and alignment, it should now be possible to enjoy u.h.f. as well as v.h.f. reception without the annoying necessity of constantly retouching the fine-tuning control. Sound and picture quality will be as sharp and clear as before the conversion since no compromise or sacrifice in receiver operation has been made. END

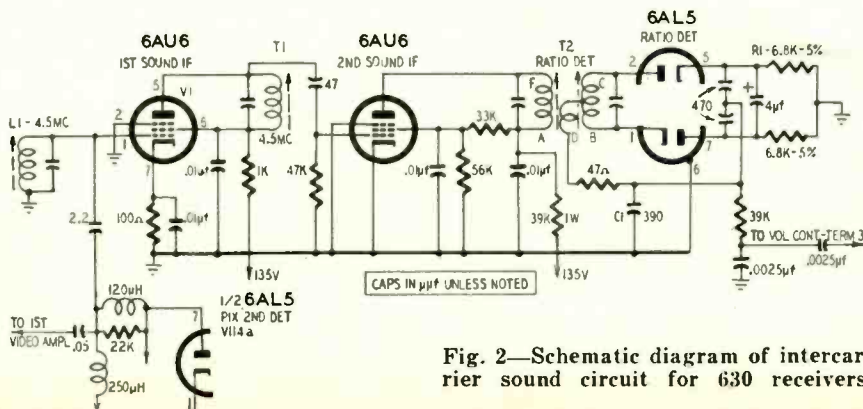

Fig. 2—Schematic diagram of intercarrier sound circuit for 630 receivers.



Retrace blanking (continued)

A circuit somewhat similar to those discussed last month is used in Sparton chassis 23U214 (Fig. 1). Here the retrace elimination pulse is taken from the secondary of the vertical output transformer. This negative pulse of approximately 90 volts peak to peak is applied through a wave-shaping network consisting of integrator R1-C1 and coupling capacitor C2 to the grid of a 21ZP4-B. A 330,000-ohm resistor isolates this circuit from the brightness control, and the video signal is fed to the picture tube cathode. The voltage applied to the grid is a sharply spiked 55 volts peak to peak.

A somewhat more complicated circuit is used in the Admiral 17XP3 chassis (Fig. 2). This circuit contains an autotransformer in the plate circuit of the 6S4-A vertical output tube. A 60-volt peak-to-peak negative pulse is taken from the low end of the vertical deflection coils and fed to the grid of the 17AVP4 through a printed-circuit wave-shaping network. The output of this network consists of a sharp negative pulse approximately 30 volts peak to peak.

Capacitor C1 and resistor R2 form a differentiating circuit that filters out the low-frequency component that often causes picture shading. High-frequency horizontal ringing components are removed by the integrating network R1-C2. Without this network vertical bars may appear. A 120,000-ohm resistor is used between the brightness control and cathode. The video signal is fed to the cathode.

Another variation is shown in the Raytheon 16AY211 chassis (Fig. 3). In this circuit a positive pulse, taken from the high side of the deflection coils, is shaped and fed to the cathode of the picture tube. The video signal from the 12AT7 is fed to the control grid of the picture tube. The brightness control in this circuit is isolated through a 100,000-ohm resistor.

From the previous circuits it can be seen that a retrace elimination circuit can vary from a simple coupling capac-

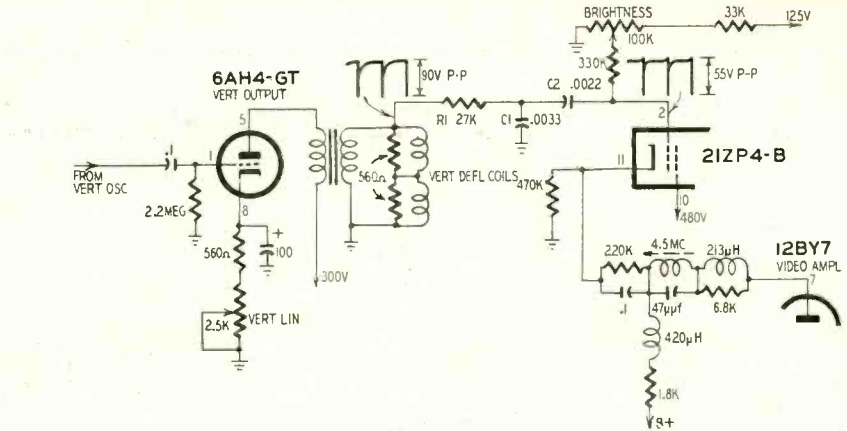

Fig. 1—The retrace blanking circuit used in the Sparton 23U214 TV receiver.

itor to a relatively complex network. In addition, individual component values vary considerably. Thus, due to the circuit variations between TV receivers, each retrace elimination circuit should be custom-made for optimum performance. The circuits shown here form a center value about which variations should be made to obtain a good sharp spike voltage of sufficient amplitude. In experimenting with these circuits, an oscilloscope is almost indispensable for observing pulse shapes.

When working without a scope and not sure of pulse polarity, reverse your connections if retrace lines are not eliminated. As a final check, advance the contrast. At extreme settings the re-

trace lines may be faintly visible. However, for any setting less than full brilliancy, retrace lines will be eliminated.

Audio hum

A Magnavox receiver now on the bench came in with a complaint of hum. The set uses a separate audio amplifier that shows no sign of hum when used without the TV receiver. I have used crystal input and magnetic input (through a preamp) on the amplifier without the slightest trace of hum. However when I connect the amplifier to the TV chassis, there is considerable hum.

The owner says that this set is new and that he has had the trouble since

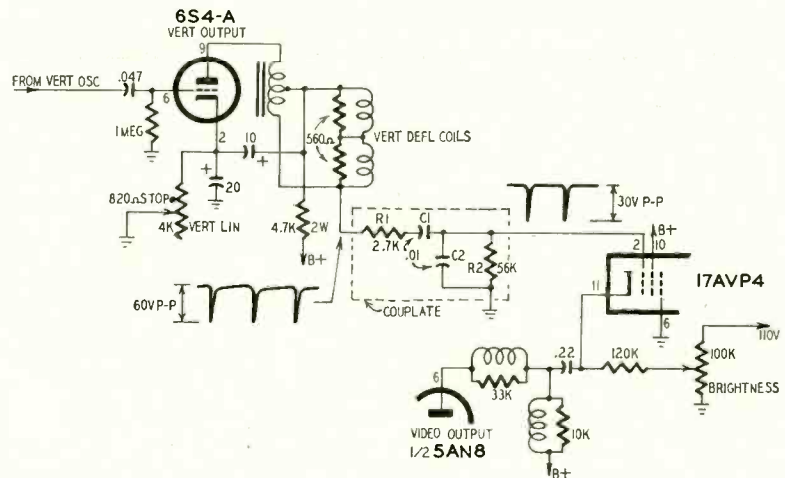

Fig. 2—Admiral 17XP3 blanking circuit.

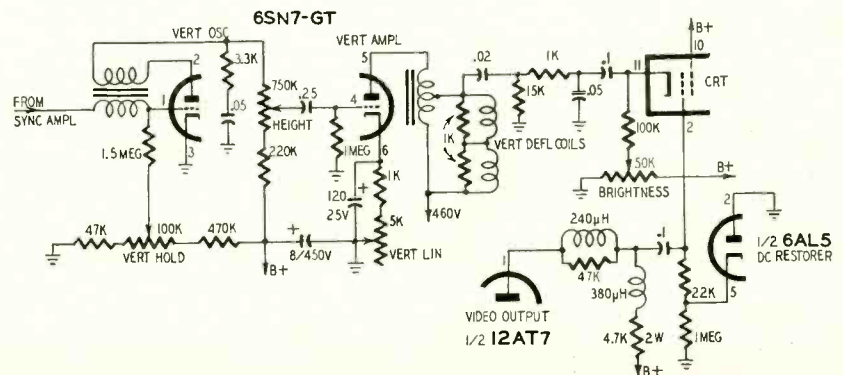
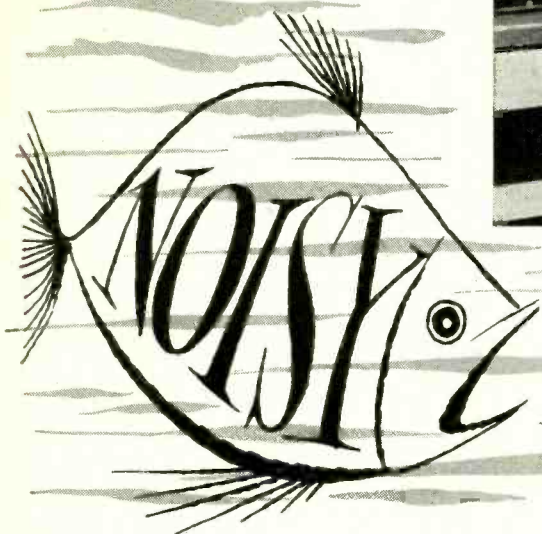

Fig. 3—This circuit blanks retrace lines in Raytheon 16AY211 TV receiver.



The equipment room at the Narragansett Marine Laboratory. All the apparatus in this photograph is used solely for recording the sounds made by fish.

By ERIC LESLIE



**T**HE noisemaking abilities of some fish have long been known—witness such names as “grunter” and “croaker.” Systematic study of their acoustic output has been undertaken only recently, and most of the work has been done since 1949.

Interest in fish sounds began during World War II when sonar-men, submariners and others began to report strange sounds, which at first they attributed to enemy action. The fishy sounds were considered important enough to warrant an extensive program of study, and now the characteristic sounds of the noisier fishes have been recorded for posterity—or study.

Possibly the world's greatest authority on the subject of fish-made sounds is Mrs. Marie Poland Fish, biological oceanographer of the University of Rhode Island's Narragansett Marine Laboratory. Her studies have taken place in most of the oceans of the world and have included other ocean-dwelling noisemakers as well as fish. Mrs. Fish finds that noisemaking is common among many types of marine life: voluntarily as a means of communication, particularly to implement breeding; as an expression of fright; as a measure of defense or offense; as a response to environmental changes or as a means of orientation, and involuntarily in connection with swimming, feeding, collision or other activity.

These conclusions were reached through study of 62 species of temperate coastal and 105 tropical and

subtropical fishes, 20 crustaceans and 2 species of marine mammals. In many cases the marine life was monitored “on location.” For more intensive studies the fish were held captive in tanks, particularly at the laboratory near Kingston, R. I., and in Bermuda and Bimini in the British West Indies.

One such tank is the subject of our cover, which shows one of the star performers near the microphone or hydrophone, and Mrs. Fish operating the tape recorder which preserves the sounds emitted by the subjects in the tank. Not only have simple recordings been made, but frequency spectra have been run with harmonic wave analyzers and octave filters. Some of the equipment used for recording and analysis is shown in the photograph on this page. Incidentally, marine life is studied directly with a hydrophone on a long cable run out the window in the back-ground and down to an arm of the Atlantic 200 feet or so away. Shallow water types are best monitored thus directly—deep-water fishes are more accurately handled by dredging them up and studying them in the tank. Some of the sound recordings—both tank and in natural habitat—have been accompanied with moving picture film, thus positively and permanently identifying the soundmakers.

The project is one of basic research, but has numerous practical angles. The Navy is particularly interested, due to the difficulties in World War II as a result of not expecting or being able to interpret the remarkable variety of

underwater sounds. As a result, the Office of Naval Research is partly sponsoring the work of the laboratory.

The practical applications, says Mrs. Fish, include use of the reference file of recordings to indoctrinate sonar-men and familiarize them with expected animal interference; to collect biological data which show what sonic animals can be expected, in what numbers and in what seasons (useful in predicting sound conditions in strategic areas) and collection of physical data which spot sound levels and frequency ranges (useful in design and operation of acoustic and electronic equipment).

The equipment includes a Magnecord PT63 for permanent tape records, though disc recorders and a converted Gray Audograph Electronic Soundwriter have been used. The microphones are quartz-crystal hydrophones developed for the project. High- and low-pass filters, Navy octave filters and a Hewlett Packard 300A wave analyzer complete the laboratory equipment, though there is also a portable lightweight, self-contained outfit designed for field use. Much of the equipment has been designed or modified from Navy gear by William H. Mowbray, electronics engineer engaged with Mrs. Fish in the project.

Persons in peaceful pursuits—as well as the Navy—may benefit by study of underwater sound. Any new information of this type may be interesting and useful to commercial or sport fishermen, as well as a tool for oceanography and marine life research. **END**



By CHARLES L. HANSEN

# TRANSPLANTING AMPLIFIERS

*The audio portion of old radios provides good phono equipment*

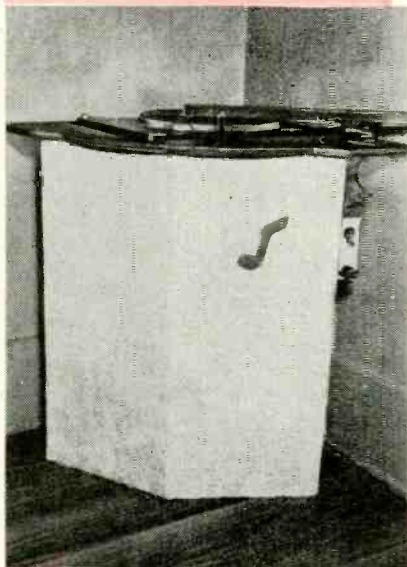

Above — The completed phono graph installation.

Right — Rear view of the completed cabinet together with the amplifier from an old radio.

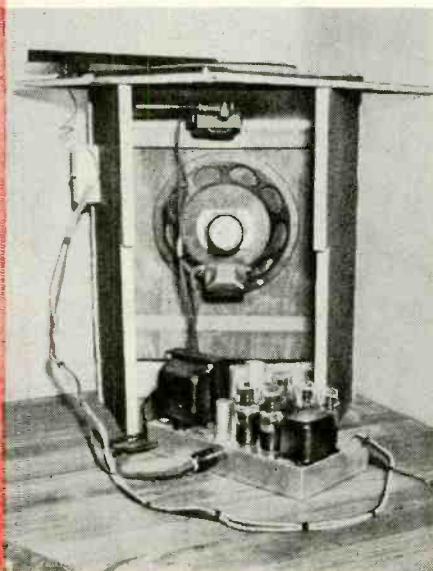

**H**IDDEN in back rooms and basements of radio and television repair shops are forgotten relics of the console radio age collecting dust and taking up valuable space. A great number of these radios have a hidden value; they have the makings of a good-sounding phonograph amplifier. And they can be purchased for only a dollar or two. Many of them, built in the 'Thirties and 'Forties, have excellent amplifier and speaker systems which can be put to use as a phonograph amplifier for practically no cash outlay.

The finished product will be equal in performance to at least a \$50 commercially built phonograph amplifier. This opens a path for constructing a good amplifier for practically the price of time—time for the removal of the amplifier and the power-supply sections from the original chassis and for transplanting the parts to a new aluminum chassis and plywood cabinet.

A socket punch, hand drill, scribe for marking the new chassis and soldering iron are all the tools needed. For the cabinet work, as with the chassis, only simple tools are used. A handsaw, a keyhole saw, some sandpaper and a wood rasp will finish the woodwork. The additions of a phonograph turntable and pickup, coupled with the cabinet, amplifier and speaker, complete the project. A dozen trips to the local radio store for more parts or exchanges are

not necessary because all parts are available. Everything turned out so well on my first project that I built several phonograph amplifiers in a short time and used them as gifts.

The amplifier (see photo) selected for the first job was a Crosley, vintage about 1935. It used push-pull 2A5 tubes and a 12-inch dynamic speaker.

In purchasing an old console radio it might not hurt to ask the radio service technician if it would be possible for you to plug in the set to find out if the audio section is working. In any case give the set a hasty once-over, observe the condition of the speaker and the chassis and notice if any parts or tubes are missing.

You will be able to tell just how good a bargain you got after cleaning up the chassis on your work bench. Chances are that the radio and amplifier will work right from the start. The diagram for your purchase can be found in Rider's or can be traced from the wiring. If the chassis is very old, the electrolytic filter capacitors in the power supply will have to be replaced. For ease of rewiring, use new tube sockets. The chassis selected should be able to hold all the amplifier and power supply parts comfortably.

In sizing up the job of transplanting, look at the diagram and see if the manufacturer wanted this set to do double duty as a phono-radio combination or if it was just for radio use. If it was used only for radio, then the builder may have to insert another stage of amplification ahead of the tube driving the final amplifiers. This can be done simply by choosing a tube similar to the driver. Then add compensation for the type of crystal pickup to be used. Standard equalization diagrams have been published in RADIO-ELECTRONICS in past articles for different types of pickups or the circuits generally supplied with the crystal pickup can be used.

One driver may be enough to work the push-pull tubes if a high-output jukebox type pickup is used (3-4-volt output). If a conventional home type pickup is used, the extra stage of amplification will be necessary. In the Crosley a 56 type tube is used to drive the push-pull 2A5's and another stage of voltage amplification was added as shown in Fig. 1.

A few improvements over the original design can be made after the amplifier has been transplanted. For ex-

# AUDIO—HIGH FIDELITY

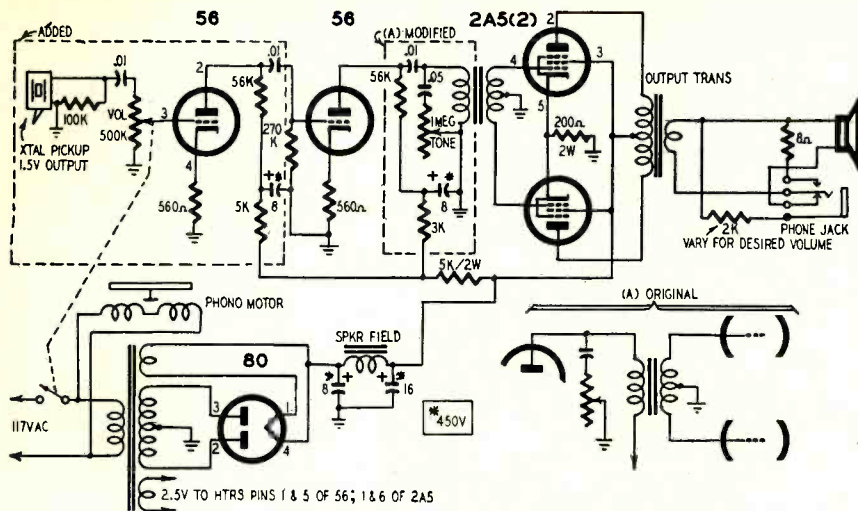

Fig. 1.—Diagram of the Crosley amplifier showing the various modifications.

ample, when transformer coupling is used, and it was used in most amplifier designs of the 'Thirties, a wiring change as shown in the illustration can be made. This minor modification will improve the high-frequency response and is worth while.

The volume and tone controls, on-off switch and phone jack are contained in a small utility box bolted to the side of the cabinet.

The long low-level leads to the control box are enclosed in shielded braid. All wires to controls and the a.c. switch are then taped together, forming one cable. Extending the controls in this manner permits greater flexibility of amplifier location within the cabinet. In my case the amplifier is not mounted permanently or as part of the cabinet. It is resting on the floor within the enclosure. Microphonics and feedback have not been experienced even with the volume turned up as loud as possible. If the amplifier is mounted on the speaker cabinet, acoustical feedback may occur.

Several radio console amplifiers were transplanted and used for phonograph amplifiers. Simple modifications were

made in some of the circuits. In one case a tweeter speaker was added because the original 12-inch speaker did not perform as well as it should at high frequencies. Many different modifications and changes could have been made but the original purpose of this project would have been defeated.

The cabinet work is simple. Notice that the cabinet (see photo) is designed to fit into a corner of a room. There are no parallel surfaces within the enclosure and we therefore do not have to pad the inside. A minimum of wood finishing is needed as the wood area exposed is small. Both of these items

save the builder time and money without any sacrifice in looks or performance. The phonograph turntable and pickup are mounted on top of the cabinet. The remaining exposed wood surfaces are stained mahogany and finished with clear shellac. Other decorative schemes can be used. One novel idea is to use one of the various wood veneers that are applied like wallpaper. Individuals adept in wood finishing can think of a number of ways to better finish the cabinet.

Fig. 2 shows how the front and top may be cut from a single 2 x 4-foot sheet of 3/8-inch or heavier plywood and the sides from a piece of 3/4-inch pine 4 feet long and 10 inches wide. The 12-inch circular cut may be made before or after the 24 x 21-inch front panel is cut in two. Fig. 3 shows the assembly of the sides and front pieces and Fig. 4 is a top view.

A 24-inch long strip of brass is screwed to the front panel pieces to hold them together and to support the grille cloth over the speaker opening. I used felt-lined brass weatherstrip with the felt removed. The sides, top and front are assembled and the speaker board mounted with flat-head screws.

The builder can expect a good-sounding amplifier which does credit to present day standards of good listening. It will not be high fidelity; it uses transformers designed 20 years ago. But for the purpose for which it is built, this amplifier has several advantages over high-fidelity systems. The response in the high-frequency range cannot be expected to exceed 6 kc from pickup to speaker. Perhaps 5 kc would be a better average. Play a shellac record on a hi-fi set and play the same record on this amplifier. Your shellac record sounds best on an outfit that starts to taper off around 5 kc. This has the same effect as adding a scratch filter to the hi-fi system. And for a children's phonograph nothing else could be desired even if all new parts were purchased and the amplifier specifically designed this way. The base response is adequate and an improvement in the low frequencies is obtained by the front and side horn loading design of this cabinet.

Sound through a phonograph amplifier of this kind will be a thousand times better than that obtained from those bargain-store purchases that sell for \$20 to \$50. END

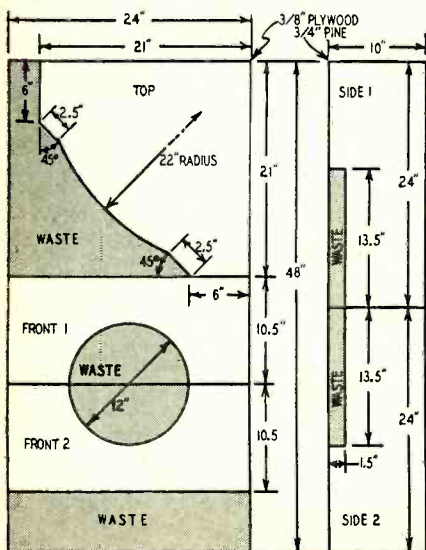

Fig. 2.—Layout of the speaker enclosure.

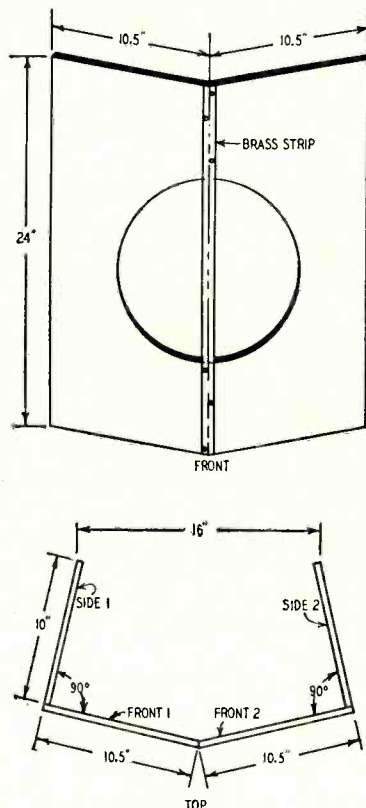

Fig. 3.—Front view of speaker cabinet. Insulator is normally used on door bottoms. Remove felt strip and attach.

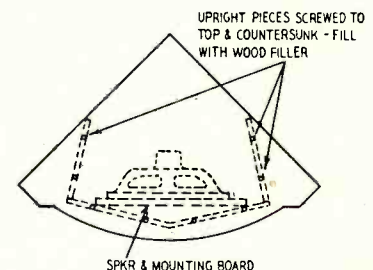
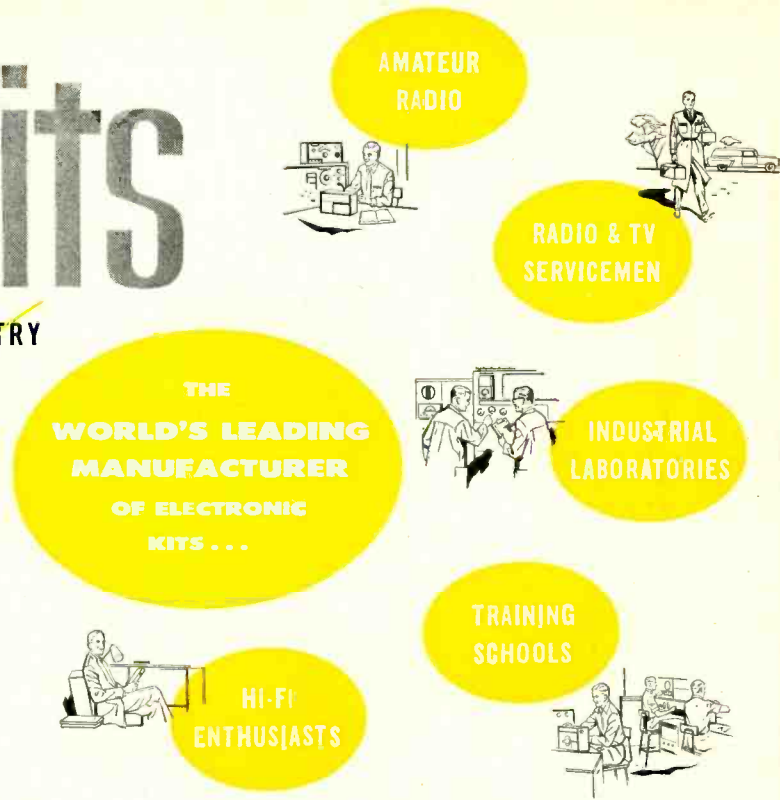

Fig. 4.—Top view of the speaker cabinet. If old speaker is mounted on board, remove it and attach to front of cabinet.

# Heathkits

FOR THE ENTIRE ELECTRONICS INDUSTRY

more than 65 top-quality models to choose from, including such outstanding kit designs as . . . . .



**V-7A VACUUM TUBE VOLTMETER:** Easily the world's largest selling VTVM. Features peak-to-peak scales—etched metal circuit board—1% precision resistors—full wave rectifier and AC input circuit—reads rms and peak-to-peak AC, DC, and ohms.

**O-10 LABORATORY TYPE OSCILLOSCOPE:** The world's largest selling oscilloscope kit, and the most successful oscilloscope in history. Designed especially for color and black-and-white TV service work. Its 5 megacycle bandwidth and new 500 Kc sweep generator readily qualify it for laboratory applications. Features easy-to-assemble etched metal circuit board construction.

**WA-P2 HIGH FIDELITY PREAMPLIFIER:** This is the world's largest selling hi fi preamplifier kit. Features complete equalization, 5 separate switch-selected inputs with individual pre-set level controls, beautiful modern appearance, high-quality components.

**HIGH FIDELITY AMPLIFIERS:** Five Heathkit Models to choose from at prices ranging from \$16.95 to \$59.75. Power output range from 7 to 25 watts.

**DX-100 TRANSMITTER:** A 100 watt phone and CW ham transmitter, offering the greatest dollar value available in the ham radio field today.

*Greatest Dollar Value Through Factory-To-You Selling!*

## ONLY Heathkits CAN GIVE YOU ALL OF THESE DISTINCTIVE ADVANTAGES!

- *The Most Complete Construction Manuals for Easy Assembly.*
- *Originality of Design—Developed Through Pioneering in the Kit Instrument Field.*
- *Greatest Dollar Value—Finest Quality with Real Economy.*
- *Direct Contact with Manufacturer—Lower Price, Guaranteed Performance.*
- *Etched Metal, Prewired Circuit Boards—Save Construction Time, Improve Performance.*
- *High Quality Standard Components for Long-Life Service.*

**HEATH COMPANY** A Subsidiary of Daystrom, Inc. **BENTON HARBOR 20, MICHIGAN**

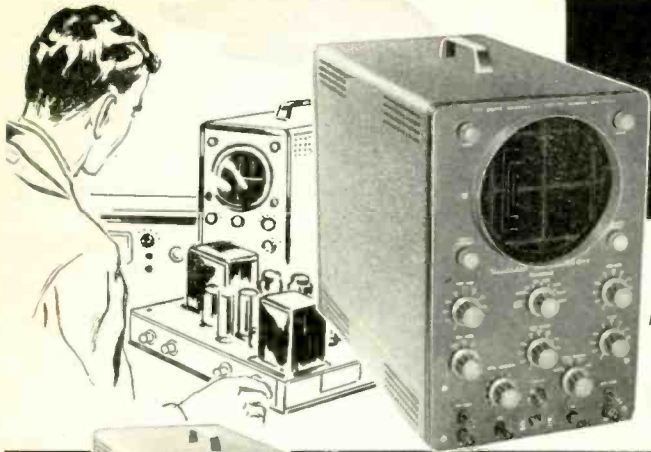

there is no substitute for  
**HEATHKIT QUALITY**

YOU GET MORE: All first-run, top quality parts—the latest in electronic design—complete and comprehensive step-by-step assembly instructions with large pictorial diagrams and assembly drawings. Proven performance through the production of thousands of kits.

MODEL O-10



2

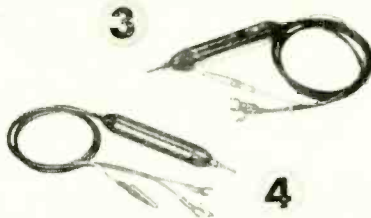

3

4

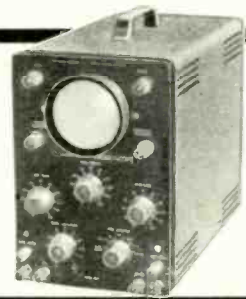

5

**1** Heathkit ETCHED CIRCUIT  
COLOR-TV  
**5" OSCILLOSCOPE KIT**

This deluxe quality oscilloscope has proven itself through thousands of operating hours in service shops and laboratories. Features the best in components—and the best in circuit design.

Features amplifier response to 5 Mc for color TV work, and employs the radically new sweep circuit to provide stable operation up to 500,000 cps. In addition, etched metal, pre-wired circuit boards cut assembly time almost in half, and permit a level of circuit stability never before achieved in an oscilloscope of this type.

Vertical amplifiers flat within +2 db -5 db from 2 cps to 5 Mc, down only 1½ db at 3.58 Mc. Vertical sensitivity is 0.025 volts, (rms) per inch at 1 Kc. 11 tube circuit employs a 5U1 CRT.

Plastic molded capacitors used for coupling and bypass—preformed and cabled wiring harness provided.

Features built-in peak-to-peak calibrating source—retrace blanking amplifier—push-pull amplifiers and step-attenuated input.

MODEL O-10  
**\$6950**

Shpg. Wt. 21 lbs.

**2** Heathkit ETCHED CIRCUIT  
**5" OSCILLOSCOPE KIT**

This is a general purpose oscilloscope for the more usual applications in the service shop or lab, yet is comparable to scopes costing many dollars more.

Features full size 5" CRT (5B1), built-in peak-to-peak voltage calibration—3 step input attenuator—phasing control—push-pull deflection amplifiers—and etched metal pre-wired circuit boards.

Vertical channel flat within ±3 db from 2 cps to 200 Kc, with 0.09 V. rms/inch, peak-to-peak sensitivity at 1 Kc. Sweep circuit from 20 cps to 100,000 cps. A scope you will be proud to own and use.

MODEL OM-1  
**\$4950**

Shpg. Wt. 21 lbs.

**3** Heathkit LOW CAPACITY  
**PROBE KIT**

Scope investigation of circuits encountered in TV requires the use of special low capacity probe to prevent loss of gain, circuit loading, or distortion. This probe features a variable capacitor to provide correct instrument impedance matching. Also the ratio of attenuation can be controlled.

NO. 342  
**\$350**

Shpg. Wt. 1 lb.

**4** Heathkit ETCHED CIRCUIT  
**SCOPE DEMODULATOR PROBE KIT**

Extend the usefulness of your Oscilloscope by observing modulation envelope of R.F. or I.F. carriers found in TV and radio receivers. Functions like AM detector to pass only modulation of signal and not signal itself. Applied voltage limits are 30 V. RMS and 500 V. DC.

NO. 337-C  
**\$350**

Shpg. Wt. 1 lb.

**5** Heathkit ETCHED CIRCUIT  
**3" OSCILLOSCOPE KIT**

This compact little oscilloscope measures only 9½" H. x 6½" W. x 11¾" D., and weighs only 11 lbs! Easily employed for home service calls, for work in the field or is just the ticket for use in the ham shack or home workshop. Incorporates many of the features of the Model OM-1, but yet is smaller in physical size for portability.

Employing etched circuit boards, the Model OL-1 features vertical response within ± 3 db from 2 cps to 200 Kc. Vertical sensitivity is 0.25 V. RMS/inch peak-to-peak, and sweep generator operates from 20 cps to 100,000 cps. Provision for r.f. connection to deflection plates for modulation monitoring, and incorporates many features not expected at this price level. 8-tube circuit features a type 3GP1 Cathode Ray Tube.

MODEL OL-1  
**\$2950**

Shpg. Wt. 14 lbs.

**HEATH COMPANY** A Subsidiary of Daystrom, Inc. **BENTON HARBOR 20, MICHIGAN**

# fill your test requirements WITH HEATHKITS

DESIGNED FOR YOU: *Heath Company* test equipment is designed for the maximum in convenience. Besides being functional, *Heathkits* represent the very latest in modern physical appearance, and incorporate all the latest circuit design features for comprehensive test coverage.

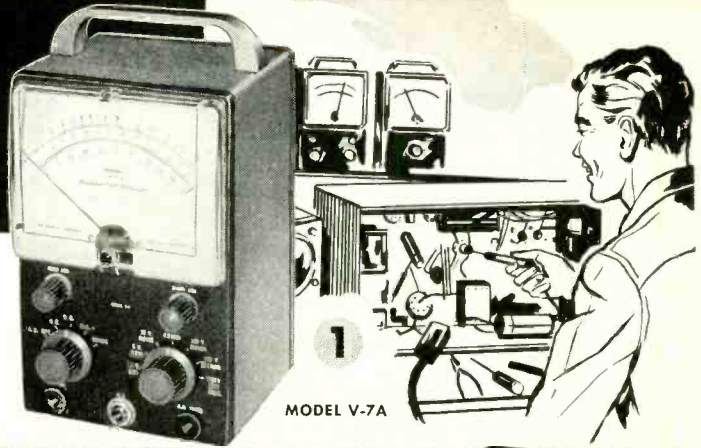

MODEL V-7A



2

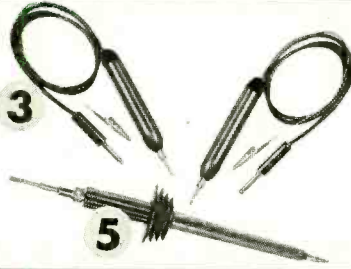

3

4

5



6

## 1 *Heathkit* ETCHED CIRCUIT VACUUM TUBE VOLTMETER KIT

Besides measuring AC (rms), DC and resistance, the modern-design V-7A incorporates peak-to-peak measurement for FM and television servicing.

AC (rms) and DC voltage ranges are 1.5, 5, 15, 50, 150, 500, and 1500. Peak-to-peak AC voltage ranges are 4, 14, 40, 140, 400, 1400, and 4000. Ohmmeter ranges are X1, X10, X100, X1000, X10K, X100K, and X1 megohm. Also a db scale is provided. A polarity reversing switch provided for DC measurements, and zero center operation within range of front panel controls. Employs a 200  $\mu$ a meter for indication. Input impedance is 11 megohms.

Etched metal, pre-wired circuit board for fast, easy assembly and reliable operation is 50% thicker for more rugged physical construction. 1% precision resistors for utmost accuracy.

MODEL V-7A

**\$2450**

Shpg. Wt. 7 Lbs.

## 3 *Heathkit* ETCHED CIRCUIT RF PROBE KIT

The Heathkit RF Probe used in conjunction with any 11 megohm VTVM will permit RF measurements up to 250 Mc with  $\pm 10\%$  accuracy. Uses etched circuits for increased circuit stability and ease of assembly.

NO. 309-C

**\$350**

Shpg. Wt. 1 lb.

## 4 *Heathkit* ETCHED CIRCUIT PEAK-TO-PEAK PROBE KIT

Now read peak-to-peak voltages on the DC scale of any 11 megohm VTVM with this new probe, employing etched circuit for stability and low loss. Readings made directly from VTVM scales, from 5 Kc to 5 Mc. Not required for Heathkit Model V-7A VTVM.

NO. 338-C

**\$550**

Shpg. Wt. 2 Lbs.

## 5 *Heathkit* 30,000 VOLT D.C. HIGH VOLTAGE PROBE KIT

For TV service work or similar application for measurement of high DC voltage. Precision multiplier resistor mounted inside plastic probe. Multiplication factor of 100 on the ranges of Heathkit 11 megohm VTVM.

NO. 336

**\$450**

Shpg. Wt. 2 Lbs.

## 6 *Heathkit* HANDITESTER KIT

The Model M-1 measures AC or DC voltage at 0-10, 30, 300, 1000, and 5000 volts. Measures direct current at 0-10 ma. and 0-100 ma. Provides ohmmeter ranges of 0-3000 (30 ohm center scale) and 0-300,000 ohms (3000 ohms center scale). Features a 400  $\mu$ a. meter for sensitivity of 1000 ohms/volt. Because of its size, the M-1 is a very handy portable instrument that will fit in your coat pocket, tool box, glove compartment, or desk drawer. Makes a fine standby unit in the service shop when the main instruments are in use, or is ideal for the hobbyist or beginner. An unusual dollar value.

MODEL M-1

**\$1450**

Shpg. Wt. 3 Lbs.

## 2 *Heathkit* 20,000 OHMS/VOLT MULTIMETER KIT

The MM-1 is a portable instrument for outside servicing, for field testing, or for quick portability in the service shop. Combines attractive physical appearance with functional design. 20,000 ohms/v. DC, and 5000 ohms/v. AC. AC and DC voltage ranges are 0-1.5, 5, 50, 150, 500, 1500 and 5000 volts. Direct current ranges are 0-150  $\mu$ a., 15 ma., 150 ma., 500 ma., and 15 amperes. Resistance ranges are X1, X100, X10,000 providing center scale readings of 15, 1500 and 150,000 ohms. DB ranges cover -10 db to +65 db.

Features a  $4\frac{1}{2}$ " 50  $\mu$ a. meter. Provides polarity reversal on DC measurements. 1% precision resistors used in multiplier circuits. Not affected by RF fields.

MODEL MM-1

**\$2950**

Shpg. Wt. 6 Lbs.

**HEATH COMPANY** A Subsidiary of Daystrom, Inc. **BENTON HARBOR 20, MICHIGAN**

# Heathkit TV ALIGNMENT GENERATOR KIT



1

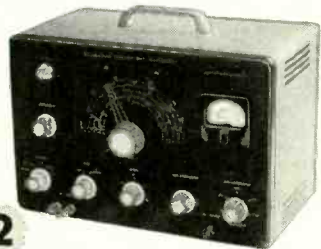

2



3



4

**HEATH  
COMPANY**  
A SUBSIDIARY OF DAYSTROM INC.

The Model TS-4 features a controllable inductor for all-electronic sweep, improved oscillator and automatic gain circuitry, high RF output, center sweep operation, and improved linearity. It sets a new high standard for sweep generator operation, and is absolutely essential for the up-to-date service shop doing FM, black-and-white TV, and color TV work.

Voltage regulation and effective AGC action insure flat output over a wide frequency range. Electronic sweep insures complete absence of mechanical vibration. Sweep deviation controllable from 0 up to 40 Mc, depending upon base frequency.

Fundamental output from 3.6 Mc to 220 Mc in 4 bands. Crystal marker provides markers at 4.5 Mc and multiples thereof. Crystal included with kit. Variable marker covers from 19 Mc to 60 Mc on fundamentals, and up to 180 Mc on harmonics. Provision for external marker.



MODEL TS-4  
**\$4950**

Shpg. Wt. 16 Lbs.

1

## Heathkit LINEARITY PATTERN GENERATOR KIT

The new-design Model LP-1 produces vertical or horizontal bar patterns, a cross-hatch pattern, or white dots on the screen of the TV set under test. No internal connections required. Special clip is attached to the TV antenna terminals. Instant selection of the pattern desired for adjustment of vertical and horizontal linearity, picture size, aspect ratio, and focus. Dot pattern presentation is a must for color convergence adjustments on color TV sets.

Extended operating range covers all television channels from 2 to 13. Produces 6 to 12 vertical bars or 4 to 7 horizontal bars.

MODEL LP-1  
**\$2250**

Shpg. Wt. 7 Lbs.

2

## Heathkit LABORATORY GENERATOR KIT

The Heathkit Model LG-1 Laboratory Generator is a high-accuracy signal source for applications where metered performance is essential. It covers from 100 Kc to 30 Mc on fundamentals in 5 bands. Modulation is at 400 cycles, and modulation is variable from 0-50%. RF output from 100,000  $\mu$ v. to 1  $\mu$ v. 200  $\mu$ a. meter reads the RF output in microvolts, or percentage of modulation. Fixed step and variable output attenuation provided.

Features voltage regulation, and double copper plated shielding for stability. Provision for external modulation. Coaxial output cable (50 ohms).

MODEL LG-1  
**\$3950**

Shpg. Wt. 16 Lbs.

3

## Heathkit CATHODE RAY TUBE CHECKER KIT

This new-design instrument holds the key to rapid and complete picture tube testing, either in the set, on the work-bench, or in the carton. Tests for shorts, leakage, and emission. Features Shadow-graph test (a spot of light on the screen) to indicate whether the tube is capable of functioning.

The Model CC-1 tests all electromagnetic deflection picture tubes normally encountered in television servicing. Supplies all operating voltages to the tube under test, and indicates the condition of the tube on a large "GOOD-BAD" scale. Features spring loaded test switches for operator protection.

The CC-1 is housed in an attractive portable case and is light in weight — ideal for outside service calls.

MODEL CC-1  
**\$2250**

Shpg. Wt. 10 Lbs.

4

## Heathkit DIRECT READING CAPACITY METER KIT

Not only is this instrument popular in the service shop, but it has found extensive application in industrial situations. Ideal for quality control work, production line checking, or for matching pairs.

Features direct reading linear scales from 100 mmf to .1 mfd full scale. Necessary only to connect a capacitor of unknown value to the insulated binding posts, select the correct range, and read the meter. The CM-1 is not susceptible to hand capacity, and has a residual capacity of less than 1 mmf.

MODEL CM-1  
**\$2950**

Shpg. Wt. 7 Lbs.

**BENTON HARBOR 20, MICHIGAN**

RADIO-ELECTRONICS

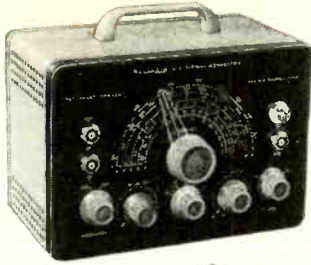

MODEL SG-8 **\$1950**  
Shpg. Wt. 8 Lbs.

This is one of the biggest signal generator bargains available today. The tried and proven Model SG-8 offers all of the outstanding features required for a basic service instrument. High quality components and outstanding performance.

The SG-8 covers 160 Kc to 110 Mc on fundamentals in 5 bands, and calibrated harmonics extend its usefulness up to 220 Mc. The output signal is modulated at 400 cps, and the RF output is in excess of 100,000 uv. Output controlled by both a continuously variable and a fixed step attenuator. Also, audio output may be obtained for amplifier testing. Don't let the

low price deceive you. This is a professional type service instrument to fulfill the signal source requirements in the service lab.

### 1 *Heathkit* . . . IMPEDANCE BRIDGE KIT

The IB-2 features built-in adjustable phase shift oscillator and amplifier, and has panel provisions for external generator. Measures resistance, capacitance, inductance, dissipation factors of condensers, and storage factor of inductance.

D, Q, and DQ functions combined in one control. 1/2% resistors and 1/2% silver-mica capacitors especially selected for this instrument. A 100-0-100 microammeter provides null indications. Two-section CRL dial provides 10 separate "units" with an accuracy of .5%. Fractions of units read on variable control.

MODEL IB-2 **\$5950**

Shpg. Wt. 12 Lbs.

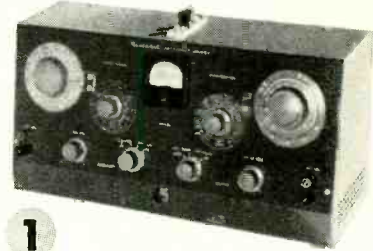

1

### 2 *Heathkit* "Q" METER KIT

The Heathkit Model QM-1 will measure the Q of inductances and the RF resistance and distributed capacity of coils. Employs a 4 1/2" 50 microampere meter for direct indication. Will test at frequencies of 150 Kc to 18 Mc in 4 ranges. Measures capacity from 40 mmf to 450 mmf within ± 3 mmf. Indispensable for coil winding and determining unknown condenser values. A worthwhile addition to your laboratory at an outstandingly low price. Useful for checking wave traps, chokes, peaking coils, etc. Laboratory facilities are now available to the service shop and home lab.

MODEL QM-1 **\$4450**

Shpg. Wt. 14 Lbs.



2

### 3 *Heathkit* 6-12 VOLT BATTERY ELIMINATOR KIT

This modern battery eliminator will supply 6 or 12 volt output for ordinary automobile radios as well as 12 volts for the new models in the latest model cars. Output voltage is variable from 0-8 volts DC, or 0-16 volts DC. Will deliver up to 15 amperes at 6 volts, or up to 7 amperes at 12 volts. Two 10,000 microfarad filter capacitors insure smooth DC output. Two panel meters monitor output voltage and current. Will double as a battery charger. Definitely required for automobile radio service work.

MODEL BE-4 **\$3150**

Shpg. Wt. 17 Lbs.



3

### 4 *Heathkit* DECADE RESISTANCE KIT

Twenty 1% precision resistors provide resistance from 1 to 99,999 ohms in 1 ohm steps. Indispensable around service shop laboratory, ham shack, or home workshop. Well worth the extremely low Heathkit price.

MODEL DR-1 **\$1950**

Shpg. Wt. 4 Lbs.



4

### 5 *Heathkit* VIBRATOR TESTER KIT

Tests vibrators for proper starting and indicates the quality of the output on a large "GOOD-BAD" scale. Checks both interrupter and self-rectifier types in 5 different sockets. Operates from any battery eliminator delivering variable voltage from 4 to 6 volts DC at 4 amps. Ideal companion to the Model BE-4.

MODEL VT-1 **\$1450**

Shpg. Wt. 6 Lbs.



5

### 6 *Heathkit* DECADE CONDENSER KIT

Provides capacity values from 100 mmf to 0.111 mfd in steps of 100 mmf. ± 1% precision silver-mica condensers used. High quality ceramic switches for reduced leakage. Polished birch cabinet. Extremely valuable in all electronic activity.

MODEL DC-1 **\$1650**

Shpg. Wt. 3 Lbs.



6

# *Heathkit* SIGNAL GENERATOR KIT

BENTON HARBOR 20, MICHIGAN

**HEATH  
COMPANY**

A SUBSIDIARY OF DAYSTROM INC.

# Heathkit TUBE CHECKER KIT



**1** The Heathkit Model TC-2 is an emission type tube tester that represents a tremendous saving over the price of a comparable unit from any other source. At only \$29.50, you can have a tube tester of your own, even if you are an experimenter, or only do part time service work. Extremely popular with radio servicemen, it uses a 4½" meter with 3-color meter face for simple "GOOD-BAD" indications that the customer can understand. Will test all tubes commonly encountered in radio and TV service work.

Ten 3-position lever switches for "open" or "short" tests on each tube element. Neon bulb indicates filament continuity or short between tube elements. Line adjust control provided. The roll chart is illuminated.

Sockets provided for 4, 5, 6, and 7-pin, octal, and loctal tubes, 7 and 9 pin miniature tubes, and the 5 pin Hytron tubes. Blank space provided for future socket addition. Tests tubes for opens, and shorts, and for quality on the basis of total emission. 14 different filament voltage values provided.

MODEL TC-2

**\$29.50**

Shpg. Wt. 12 lbs.

## **2** Heathkit PORTABLE TUBE CHECKER KIT

The Model TC-2P is identical to the Model TC-2 except that it is housed in a rugged carrying case. This strikingly attractive and practical two-tone case is finished in proxylin impregnated fabric. The cover is detachable, and the hardware is brass plated. This case imparts a real professional appearance to the instrument. Ideal for home service calls, or any portable application.

MODEL TC-2P

**\$34.50**

Shpg. Wt. 15 lbs.



## **3** Heathkit TV PICTURE TUBE TEST ADAPTER

The Heathkit TV picture tube test adapter is designed for use with the Model TC-2 Tube Checker. Test picture tubes for emission, shorts, and thereby determine tube quality. Consists of 12-pin TV tube socket, 4 ft. cable, octal connector, and necessary technical data. (Not a kit.)

MODEL 355

**\$4.50**

Shpg. Wt. 1 lb.

## **4** Heathkit . . . CONDENSER CHECKER KIT

Use this Condenser Checker to quickly and accurately measure those unknown condenser and resistor values. All readings taken directly from the calibrated panel scales without any involved calculation. Capacity measurements in four ranges from .00001 to 1000 mfd. Checks paper, mica, ceramic and electrolytic condensers. A power factor control is available for accurate indication of electrolytic condenser efficiency. Leakage test switch—selection of five polarizing voltages, 25 volts to 450 volts DC to indicate condenser operating quality under actual load conditions. Spring-return test switch automatically discharges condenser under test and eliminates shock hazard to the operator.

Resistance measurements can be made in the range from 100 ohms to 5 meg-ohms. Here again, all values are read directly on the calibrated scales. Increased sensitivity coupled with an electron beam null indicator increases overall instrument usefulness.

For safety of operation, the circuit is entirely transformer operated. An outstanding low kit price for this surprisingly accurate instrument.

MODEL C-3

**\$19.50**

Shpg. Wt. 7 lbs.



## **5** Heathkit VISUAL-AURAL SIGNAL TRACER KIT

This signal tracer is extremely valuable in servicing AM, FM, and TV receivers, especially when it comes to isolating trouble to a particular stage of the circuit under test.

This visual-aural tracer features a high gain RF input channel to permit signal tracing from the receiver antenna input clear through all RF, IF, detector, and audio stages to the speaker. Separate low-gain channel provided for audio circuit exploration. Both visual and aural indication by means of a speaker or headphone, and electron beam "eye" tube as a level indicator. Also incorporates a noise locator circuit for DC noise checks, and a built-in calibrated wattmeter (30-500 watts). Panel terminals provided for "patching" output transformer or speaker into external circuit for test purposes. Designed especially for the radio and TV serviceman. Cabinet size: 9½" wide x 6½" high x 5" deep. A real test equipment bargain.

MODEL T-3

**\$23.50**

Shpg. Wt. 9 lbs.



# HEATH COMPANY

A SUBSIDIARY OF DAYSTROM INC.

BENTON HARBOR 20, MICHIGAN

RADIO-ELECTRONICS





MODEL HD-1

Shpg. Wt. 13 lbs. **\$4950**

Used with a sine wave generator, the Model HD-1 will check the harmonic distortion output of audio amplifiers under a variety of conditions. Reads distortion directly on the meter as a percentage of the input signal. Operates between 20 and 20,000 cps. High impedance VTVM circuit for initial reference settings and final distortion readings. Ranges are 0-1, 3, 10, and 30 volts full scale. 1% precision resistors. Distortion scales are 0-1, 3, 10, 30 and 100% full scale. Requires only .3 volt input for distortion test.

# Heathkit HARMONIC DISTORTION METER KIT

## 1 Heathkit AUDIO ANALYZER KIT

This instrument consists of an audio wattmeter, an AC VTVM, and a complete IM analyzer, all in one compact unit.

Use the VTVM to measure noise, frequency response, output gain, power supply ripple, etc. Use the wattmeter for measurement of power output. Internal loads provided for 4, 8, 16, or 600 ohms. VTVM also calibrated for DBM units. High or low impedance IM measurements made with built-in 6KC and 60 cps generators. VTVM ranges are .01, to 300 volts in 10 steps. Wattmeter ranges are .15 mw. to 150 w. in 7 steps. IM scales are 1% to 100% in 5 steps.

MODEL AA-1  
**\$5950**

Shpg. Wt. 13 lbs.



## 2 Heathkit AUDIO GENERATOR KIT

This new Heathkit Model features step-tuning from 10 cps to 100 Kc with three rotary switches that provide two significant figures and multiplier. Less than .1% distortion. Frequency accurate to within  $\pm 5\%$ .

Output monitored on a large  $4\frac{1}{2}$ " meter that reads voltage or db Both variable and step-type attenuation provided. Meter reads zero-to-maximum at each attenuator position. Output ranges (and therefore meter ranges) are 0-.003, .01, .03, .1, .3, 1, 3, 10 volts. Step-tuning provides rapid positive selection of the desired frequency, and allows accurate return to any given frequency.

MODEL AG-9  
**\$3450**

Shpg. Wt. 8 lbs.



## 3 Heathkit AUDIO OSCILLATOR KIT

(SINE WAVE — SQUARE WAVE)

The Model AO-1 features sine wave or square wave coverage from 20-20,000 cps in 3 ranges. It is an instrument specifically designed to completely fulfill the needs of the serviceman and high fidelity enthusiast. Offers high level output across the entire frequency range, low distortion and low impedance output. Features a thermistor in the second amplifier stage to maintain essentially flat output through the entire frequency range. Produces an excellent sine wave for audio testing, or will produce good, clean, square waves with a rise time of only 2 microseconds.

MODEL AO-1  
**\$2450**

Shpg. Wt. 10 lbs.

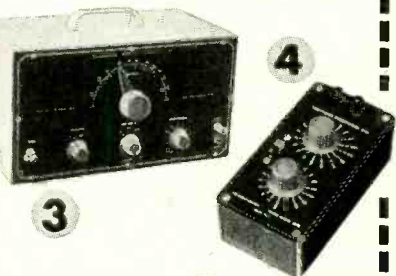

## 4 Heathkit RESISTANCE SUBSTITUTION BOX KIT...

Provides switch selection of 36 RTMA 1 watt standard 1% resistors ranging from 15 ohms to 10 megohms. Numerous applications in radio and TV work, and essential in the developmental laboratory.

MODEL RS-1  
**\$550**

Shpg. Wt. 2 lbs.

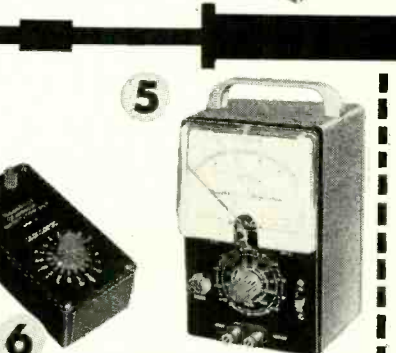

## 5 Heathkit AC VACUUM TUBE VOLTMETER KIT...

The Heathkit AC VTVM features high impedance, wide frequency range, very high sensitivity, and extremely wide voltage range. Will accurately measure a voltage as small as 1 mv. at high impedance. Excellent for sensitive AC measurements required by laboratories, audio enthusiasts and experimenters. Frequency response is substantially flat from 10 cps to 50 Kc. Ranges are .01, .03, .1, .3, 1, 3, 10, 30, 100, and 300 v. RMS. Total db range -52 to + 52 db. Input impedance 1 megohm at 1 Kc.

MODEL AV-2  
**\$2950**

Shpg. Wt. 5 lbs.

## 6 Heathkit CONDENSER SUBSTITUTION BOX KIT...

Very popular companion to Heathkit RS-1. Individual selection of 18 RTMA standard condenser values from .0001 mfd to .22 mfd. Includes 18" flexible leads with alligator clips.

MODEL CS-1  
**\$550**

Shpg. Wt. 2 lbs.

# HEATH COMPANY

A SUBSIDIARY OF DAYSTROM INC.

BENTON HARBOR 20, MICHIGAN



# HEATHKIT HAM GEAR

for high quality at moderate cost

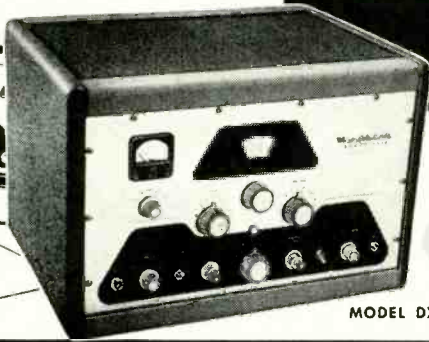

MODEL DX-100

**DOLLAR VALUE:** You get more for your Heathkit dollar because your labor is used to build the kit instead of paying for someone else's. Also, the middleman's margin of profit is eliminated when you deal directly with the manufacturer.

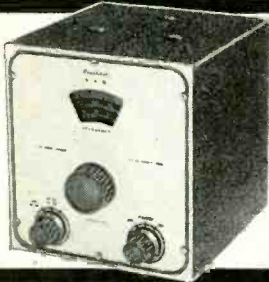

2



3



4

## 1 Heathkit DX-100 PHONE & CW TRANSMITTER KIT

The reception given this amateur transmitter has been tremendous. Reports from radio amateurs using the DX-100 are enthusiastic in praising its performance and the high quality of the components used in its assembly. Actual "on the air" results reflect the careful design that went into its development.

The DX-100 features a built-in VFO, modulator, and power supplies, and is completely bandswitching for phone or CW operation on 160, 80, 40, 20, 15, 11, and 10 meters. All parts necessary for construction are supplied in the kit, including tubes, cabinet, and detailed step-by-step instructions. Easy to build, and a genuine pleasure to operate.

Employs push-pull 1625's modulating parallel 6146's for RF output in excess of 100 watts on phone and 120 watts on CW. May be excited from the built-in VFO or from crystals (crystals not included with kit). Features five-point TVI suppression: (1) pi network interstage coupling to reduce harmonic transfer to the final stage; (2) pi network output coupling; (3) extensive shielding; (4) all incoming and outgoing circuits filtered; (5) inter-locking cabinet seams to eliminate radiation except through the coaxial output connector. Pi network output coupling will match 50 to 600 ohm non-reactive load. Illuminated VFO dial and meter face. Remote control socket provided.

The chassis is made of extra-strong #16 gauge copper-plated steel. It employs potted transformers, ceramic switch and variable capacitor insulation, solid silver loading switch terminals, and high-grade well-rated components throughout. Features a pre-formed wiring harness, and all coils are pre-wound.

High-gain speech amplifier for dynamic or crystal microphones, and restricted speech range for increased intelligence. Plenty of audio power reserve. Measures 20 7/8" W. x 13 3/4" H. x 16" D. Schematic diagram and complete technical specifications on request.

MODEL DX-100

**\$189<sup>50</sup>**

Shpg. Wt. 120 Lbs.

Shipped Motor Freight Unless Otherwise Specified  
\$50.00 Deposit Required on C.O.D. Orders

## 2 Heathkit VFO KIT

The Model VF-1 covers 160-80-40-20-15-11 and 10 meters with three basic oscillator frequencies. Better than 10-volt average RF output on fundamentals. Features illuminated and pre-calibrated dial scale. Cable and plug provided to fit crystal socket of any modern transmitter.

Enjoy the convenience and flexibility of VFO operation at no more than the price of crystals. May be powered from plug on the Heathkit Model AT-1 transmitter, or supplied with power from most transmitters. Measures: 7" H. x 6 1/2" W. x 7" D.

MODEL VF-1

**\$19<sup>50</sup>**

Shpg. Wt. 7 Lbs.

## 3 Heathkit CW AMATEUR TRANSMITTER KIT

The Model AT-1 is an ideal novice transmitter, and may be used to excite a higher power rig later on.

This CW transmitter is complete with its own power supply, and covers 80, 40, 20, 15, 11, and 10 meters. Features single-knob bandswitching, and panel meter indicates grid or plate current for the final amplifier. Designed for crystal operation or external VFO. Crystal not included in kit. Incorporates such features as key click filter, line filter, copper-plated chassis, pre-wound coils, 52 ohm coaxial output, and high quality components throughout. Instruction book simplifies assembly. Employs a 6AG7 oscillator, 6L6 final amplifier. Operates up to 35 watts plate power input.

MODEL AT-1

**\$29<sup>50</sup>**

Shpg. Wt. 15 Lbs.

## 4 Heathkit ... ANTENNA COUPLER KIT

The Model AC-1 will properly match your low power transmitter to an end-fed long wire antenna. Also attenuates signals above 36 Mc, reducing TVI. 52 ohm coax. input—power up to 75 watts—10 through 80 meters—tapped inductor and variable condenser—neon RF indicator—copper plated chassis and high quality components. Ideal for use with Heathkit AT-1 Transmitter.

MODEL AC-1

**\$14<sup>50</sup>**

Shpg. Wt. 4 Lbs.

**HEATH COMPANY**

A Subsidiary  
of Daystrom, Inc.

**BENTON HARBOR 20, MICHIGAN**

# "AMATEUR-ENGINEERED"

## Equipment For The Ham

MODERN DESIGN: You can be sure of getting all the latest and most desirable design features when you buy Heathkits. Advanced-design is a minimum standard for new Heathkit models.

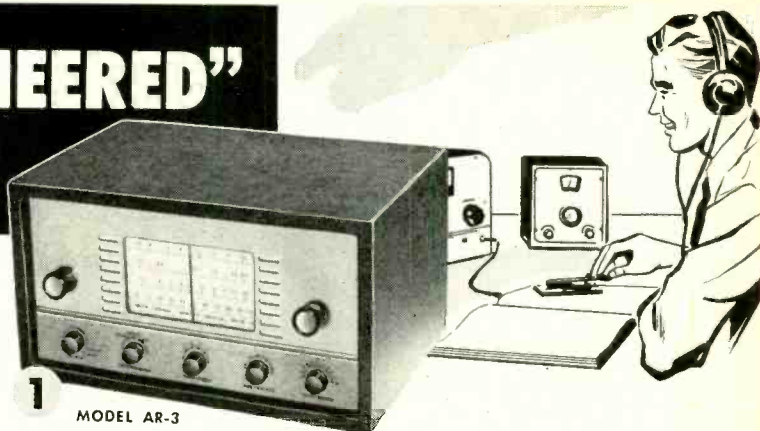

1 MODEL AR-3

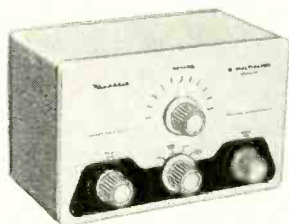

2



3



4



5

### 1 Heathkit COMMUNICATIONS-TYPE ALL BAND RECEIVER KIT

The new Model AR-3 features improved IF and RF performance, along with better image rejection on all bands. Completely new chassis layout for easier assembly, even for the beginner.

Covers 550 Kc to 30 Mc in four bands. Provides sharp tuning and good sensitivity over the entire range. Features a transformer-type power supply—electrical bandspread—separate RF and AF gain controls—antenna trimmer—noise limiter—AGC—BFO—headphone jacks—5½" PM speaker and illuminated tuning dial.

CABINET: Fabric covered cabinet with aluminum panel as shown. Part No. 91-10, shipping weight 5 lbs. \$4.50.

MODEL AR-3  
**\$27<sup>95</sup>**

Shpg. Wt. 12 Lbs.  
(Less Cabinet)

### 2 Heathkit "Q" MULTIPLIER KIT

Here is the Heathkit Q Multiplier you hams have been asking for. A tremendous help on the phone and CW bands when the QRM is heavy. Provides an effective Q of approximately 4,000 for extremely sharp "peak" or "null." Use it to "peak" the desired signal or to "null" an undesired signal, or heterodyne. Tunes to any signal within the IF band-pass of your receiver. Also provides "broad peak" for conditions where extreme selectivity is not required.

Operates with any receiver having an IF frequency between 450 and 460 Kc. Will not function with AC-DC type receivers. Requires 6.3 volts AC at 300 ma. and 150 to 250 VDC at 2 ma. Derives operating power from your receiver. Uses a 12AX7 tube, and special High-Q shielded coils. Simple to connect with the cable and plugs supplied. Measures only 4-11/16"H.x7¾"W.x4¼"D. A really valuable addition to the receiving equipment in your ham shack.

MODEL QF-1  
**\$9<sup>95</sup>**

Shpg. Wt. 3 Lbs.

### 3 Heathkit VARIABLE VOLTAGE REGULATED POWER SUPPLY KIT

Provides well filtered DC output, variable from zero to 500 volts at no load and *regulated* for stability. Will supply up to 10 ma. at 450 VDC, and up to 130 ma. at 200 VDC. Voltage or current monitored on front panel meter. Also provides 6.3 VAC at 4A. for filament. Filament voltage isolated from B+, and both isolated from ground. Invaluable around the ham shack for supplying operating potentials to experimental circuits. Use in all types of research and development laboratories as a temporary power supply, and to determine design requirements for ultimate power supply.

MODEL PS-3  
**\$35<sup>50</sup>**

Shpg. Wt. 17 lbs.

### 4 Heathkit ANTENNA IMPEDANCE METER KIT

Use in conjunction with a signal source for measuring antenna impedance, line matching, adjustment of beam and mobile antennas, etc. Will double as a phone monitor or relative field strength indicator. 100 µa. meter employed. Covers the range from 0-600 ohms. An instrument of many uses for the amateur.

MODEL AM-1  
**\$14<sup>50</sup>**

Shpg. Wt. 2 lbs.

### 5 Heathkit GRID DIP METER KIT

This is an extremely valuable tool for accomplishing literally hundreds of jobs on all types of equipment. Covering from 2 Mc to 250 Mc, the GD-1B is compact and can be operated with one hand. Uses a 500 µa. meter for indication, with a sensitivity control and headphone jack. Includes prewound coils and rack. Indispensable instrument for hams, engineers, or servicemen.

MODEL GD-1B  
**\$19<sup>50</sup>**

Shpg. Wt. 4 lbs.

**HEATH COMPANY** A Subsidiary of Daystrom, Inc. **BENTON HARBOR 20, MICHIGAN**

*Heathkits*  
**PROVIDE THE  
 "CONSTRUCTIVE"  
 APPROACH TO  
 HIGH-FIDELITY**



**EASY TO BUILD:** *The assembly instructions supplied with Heathkits are so complete and detailed that anyone can assemble the kits without difficulty. Plenty of pictorial diagrams and step-by-step instructions. Information on resistor color codes, soldering, use of tools, etc. Build-it-yourself with confidence!*



**1**

**1** *Heathkit* **ADVANCED-DESIGN  
 HIGH FIDELITY AMPLIFIER KIT**

The 25 Watt Model W-5 is one of the most outstanding high fidelity amplifiers available today—at any price. Incorporates the very latest design features to achieve true "presence" for the super-critical listener.

Features a new-design Peerless output transformer, and KT66 output tubes handle power peaks up to 42 watts. The unique "tweeter-saver" suppresses high frequency oscillation. A new type balancing circuit results in closer "dynamic" balance between output tubes. Features improved phase shift characteristics and frequency response, with reduced IM and harmonic distortion. Color styling harmonizes with the Heathkit WA-P2 Preamplifier and the FM-3 Tuner.

Frequency response—within  $\pm 1$  db from 5 cps to 160 Kc at 1 watt. Harmonic distortion only 1% at 25 watts, 20-20,000 cps. IM distortion only 1% at 20 watts, using 60 and 3,000 cps. Output impedance 4, 8, or 16 ohms. Hum and noise—99 db below rated output. Uses two 12AU7's, two KT66's and a 5R4GY.

**KIT COMBINATIONS:**

W-5M Amplifier Kit: Consists of main amplifier and power supply, all on one chassis. Complete with all necessary parts, tubes, and comprehensive manual. Shpg. Wt. 31 lbs. Express only.

W-5 Combination Amplifier Kit: Consists of W-5M Amplifier Kit listed above plus Heathkit Model WA-P2 Preamplifier Kit. Complete with all necessary parts, tubes, and construction manuals. Shpg. Wt. 38 lbs. Express only.

**\$59<sup>75</sup>**

**\$79<sup>50</sup>**

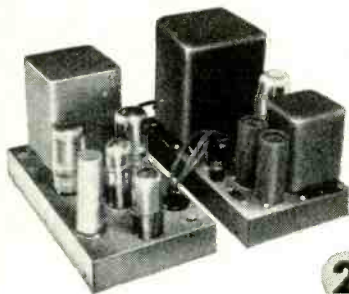

**2**

**2** *Heathkit* **DUAL-CHASSIS WILLIAMSON TYPE  
 HIGH FIDELITY AMPLIFIER KIT**

This is a very popular high fidelity amplifier kit that features dual-chassis type construction. The resulting physical dimensions offer an additional margin of flexibility in installation. It features the famous Acrosound TO-300 "ultra-linear" output transformer, and has a frequency response within  $\pm 1$  db from 6 cps to 150 Kc at 1 watt. Harmonic distortion only 1% at 21 watts. IM distortion at 20 watts only 1.3% at 60 and 3,000 cps. Rated power output is 20 watts. Output impedance 4, 8, or 16 ohms. Hum and noise—88 db below 20 watts. Uses two 6SN7's, two 5881's, and a 5V4G.

**KIT COMBINATIONS:**

W-3M: Consists of main amplifier and power supply for separate chassis construction. Includes all tubes and components necessary for assembly. Shpg. Wt. 29 lbs., Express only.

W-3: Consists of W-3M Kit listed above plus Heathkit Model WA-P2 Preamplifier described on opposite page. Shpg. Wt. 37 lbs., Express only.

**\$49<sup>75</sup>**

**\$69<sup>50</sup>**



**3**

**3** *Heathkit* **SINGLE-CHASSIS WILLIAMSON TYPE  
 HIGH FIDELITY AMPLIFIER KIT**

This is the lowest priced Williamson type amplifier ever offered in kit form, and yet it retains all the usual features of the Williamson type circuit. Main amplifier and power supply combined on one chassis, and uses a new-design Chicago output transformer. Frequency response—within  $\pm 1$  db from 10 cps to 100 Kc at 1 watt. Harmonic distortion only 1.5% at 20 watts. IM distortion at rated output, 2.7% at 60 and 3,000 cps. Rated power output is 20 watts. Output impedance 4, 8, or 16 ohms. Hum and noise—95 db below 20 watts. Uses two 6SN7's, two 5881's, and one 5V4G.

Instructions are so complete that the kit may be assembled successfully even by a beginner in electronics.

**KIT COMBINATIONS:**

W-4AM: Consists of main amplifier and power supply for single chassis construction. Includes all tubes and components necessary for assembly. Shpg. Wt. 28 lbs. Express only.

W-4A: Consists of W-4AM Kit listed above plus Heathkit Model WA-P2 Preamplifier described on opposite page. Shpg. Wt. 35 lbs. Express only.

**\$39<sup>75</sup>**

**\$59<sup>50</sup>**

**HEATH  
 COMPANY**

A SUBSIDIARY OF DAYSTROM INC.

**BENTON HARBOR 20, MICHIGAN**

RADIO-ELECTRONICS

ATTRACTIVELY STYLED: *Heathkit high fidelity instruments are not only functional, but are most attractive in physical design. Such units as the preamplifier and the W-5 main amplifier are designed for beauty as well as performance. They blend with any room decor and are the kind of instruments you will be proud to own.*



*enjoy....*  
**THE VERY BEST  
 IN AUDIO WITH  
 "BUILD-IT-YOURSELF"  
 HEATHKITS**

**1** *Heathkit* HIGH FIDELITY  
**PREAMPLIFIER KIT**

This outstanding preamplifier is designed specifically for use with the Heathkit Williamson type amplifiers. It completely fulfills the requirements for remote control, compensation and preamplification, and exceeds even the most rigorous specifications for high fidelity performance.

Features five separate switch-selected input channels (2 low level and 3 high level), each with its own input control. Full record equalization with four-position turnover control and four-position rolloff control.

Output jack for tape recorder - separate bass control with 18 db boost and 12 db cut at 50 cps. - treble control offering 15 db boost and 20 db cut at 15,000 cps - special hum control to insure minimum hum level - and many other desirable features. Overall frequency response (with controls set to "flat" position) is within 1 db from 25 cps to 30,000 cps. Will do justice to the finest available program sources. Beautiful satin-gold finish.

Power requirements from the Heathkit Williamson type high fidelity amplifier - 6.3 VAC at 1 amp., and 300 VDC at 10 Ma. Uses two 12AX7's and one 12AU7.

MODEL WA-P2  
**\$1975**  
 Shpg. Wt. 7 Lbs.

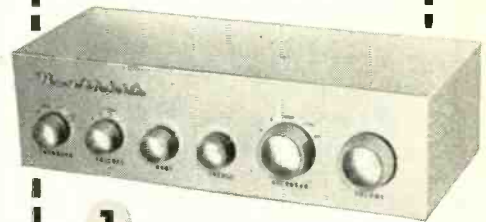

**1**

**2** *Heathkit* 20-WATT HIGH FIDELITY  
**AMPLIFIER KIT**

This Heathkit Model offers you the least expensive route to high fidelity performance. Frequency response is  $\pm 1$  db from 20-20,000 cps. Features full 20 watt output using push-pull 6L6's, and incorporates separate bass and treble tone controls. Preamplifier and main amplifier are built on the same chassis. Four switch-selected compensated inputs and separate bass and treble tone controls provide all necessary functions at minimum investment. Features miniature tube types for low hum and noise.

Uses 12AX7, two 12AU7's, two 6L6G's and a 5V4G. A most interesting "build-it-yourself" project, and an excellent hi-fi amplifier for home use. Well suited, also, for public address applications because of its high power output and high quality audio reproduction. Another Heathkit "best-buy" for you!

MODEL A-9B  
**\$3550**  
 Shpg. Wt. 23 Lbs.

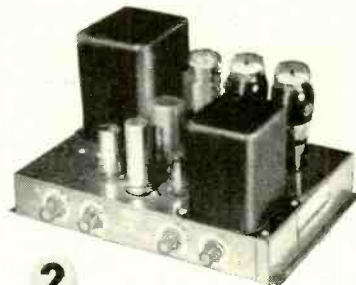

**2**

**3** *Heathkit* 7 - WATT  
**AMPLIFIER KIT**

The redesigned Model A-7D features a new type output transformer for tapped screen operation, and provides improved sensitivity, reduced distortion, and increased power output.

The full 7-watt output of the Model A-7D is more than adequate for normal home installations. Frequency characteristics are  $\pm 1\frac{1}{2}$  db from 20 to 20,000 cps. Potted output and power transformers employed. Push-pull output - detailed construction manual - top quality parts - high quality audio without great expense. Output transformer tapped at 4, 8, and 16 ohms. Bass and treble tone controls provided on the front chassis apron.

MODEL A-7D  
**\$1695**  
 Shpg. Wt. 10 Lbs.



**3**

**HEATH  
 COMPANY**

A SUBSIDIARY OF DAYSTROM INC.

**BENTON HARBOR 20, MICHIGAN**

SEPTEMBER, 1955



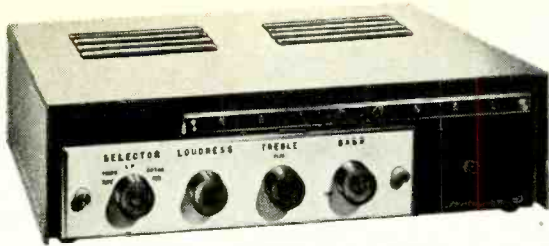

The National Horizon 10-watt amplifier.

By ROBERT F. SCOTT  
TECHNICAL EDITOR

Circuit Features in

# HI-FI Power AMPLIFIERS

*Circuit analysis of the single-ended push-pull amplifier in National's Horizon series*

IN the preceding installment (August) we saw how the McIntosh unity-coupled output circuit solves the problem of switching transients and notch distortion caused by high leakage reactance in output transformers in class-AB and -B service. A different solution is offered by Drs. Donald B. Sinclair and Arnold P. G. Peterson. Theirs is the *single-ended push-pull* circuit used in the National Company's Horizon 10 and Horizon 20 amplifiers.

In the conventional push-pull circuit (Fig. 1) the tubes develop a.c. signal voltages that are series-aiding across the load while the plates are paralleled across the d.c. supply. The new single-ended push-pull circuit is the dual or converse of the conventional in that the tubes are in series for d.c. and supply the load in parallel. Thus the optimum load impedance—as in the McIntosh circuit—is only one-quarter of the plate-to-plate load in the usual push-pull connection.

Fig. 2 shows a basic form of the new circuit. The tubes are in series across a d.c. supply with the load connected between a tap on the B supply and the

plate-cathode junction. Although the load is in its cathode circuit, we cannot consider V1 as a cathode follower because the signal voltage is applied between the grid and cathode rather than between grid and ground as in a cathode follower. The load also appears in the plate circuit of V2 which, like V1, has its grid driving signal applied between grid and cathode.

The voltages at the ends of the secondary of a transformer are 180° out of phase, so that connections to secondary No. 2 are transposed to show that the grids of V1 and V2 are driven in the same manner as in Fig. 1.

The basic single-ended push-pull amplifier with signal voltages supplied by a phase inverter is shown in Fig. 3. We have retained the dual power supply of Fig. 2. Grid excitation for V1 is developed across R1, the phase inverter plate load resistor and the grid return for V1. By careful selection of operating conditions we can use this direct-coupled circuit with V1 being biased by the drop across R1. Tube V2 is driven by an equal but 180°-out-of-phase signal voltage across R2 in the phase inverter cathode return. Battery BA1 supplies operating bias for V2 because grounding R2 directly would make V2's grid positive with respect to its cathode.

Two of the three d.c. supplies can be eliminated by using the variation in

Fig. 4. Battery BA1 is eliminated by using the drop across R3 as cathode bias for V2. Batteries BA2 and BA3 are replaced by a single supply (BA4) delivering a voltage equal to that of BA2 and BA3 in series. The load is connected between the plate-cathode junction and the junction of two large capacitors (C1 and C2) in series across BA4.

Fig. 5 illustrates another variation of the basic circuit. This is used when one side of the load must be grounded.

Although the optimum load impedance of these circuits is only one-quarter that used in conventional push-pull operation, it is still too high for direct coupling to voice coils in the conventional impedance range. A single 6A7-G used for V1 and V2 has an optimum load impedance of around 280 ohms and it may be used to drive two 500-ohm speakers (Stephens or equivalent) in parallel through a direct connection. However, we must still use an output transformer for matching speakers with voice coil impedances in the range of 4 to 16 ohms.

Fig. 6 is the equivalent circuit of Fig. 4 with pentode output tubes transformer-coupled to the load. The output transformer has a split primary. Screen-to-cathode bypass capacitors C1 and C2 and filter capacitor C3 effectively connect the halves of the primary in parallel for audio signal voltages.

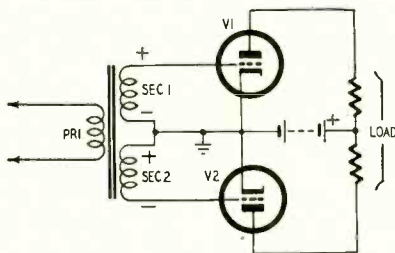

Fig. 1—Conventional push-pull circuit.

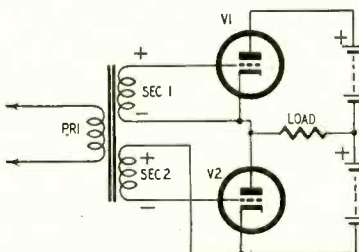

Fig. 2—Single-ended push-pull circuit.

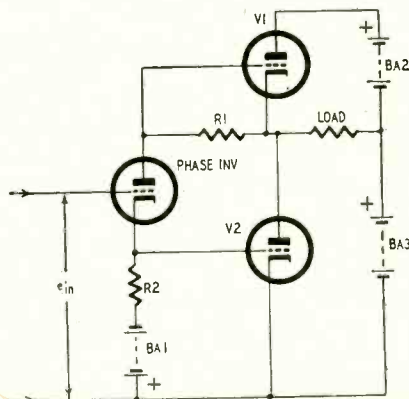

Fig. 3—Phase inverter feeds amplifier.

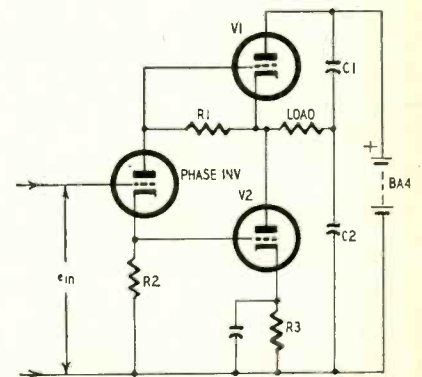

Fig. 4—Amplifier uses single battery.

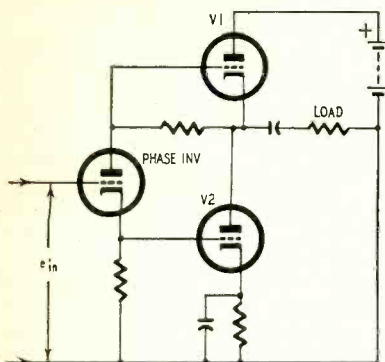

Fig. 5—Variation of single-ended circuit—one side of the load is grounded.

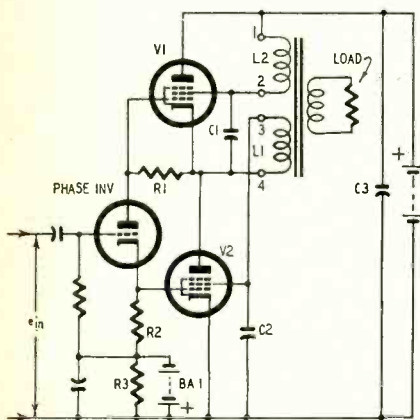

Fig. 6—Single-ended circuit using pentodes transformer-coupled to the load.

Refer to the simplified circuit in Fig. 7. Since the capacitors, at audio frequencies, provide a direct connection, the designers have in effect used capacitive unity coupling and eliminated the need for magnetic coupling. (The designers reported that they verified the fact that magnetic coupling is not needed by using separate chokes in place of the split primary.) Thus, switching transients and notch distortion caused by insufficient magnetic coupling can be eliminated with this circuit.

As in Figs. 2 and 3, V1 and V2 (Fig. 6) are excited by signal voltages applied between their grids and cathodes. The phase inverter tube takes its plate supply voltage from the center of the series-connected output tubes. If its load resistor (R1) is connected di-

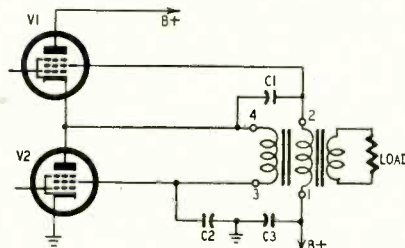

Fig. 7—The capacitors effectively place the primary halves in parallel.

rectly to the B supply, V1's grid excitation voltage would appear between grid and ground thus causing it to operate as a cathode follower. In the Fig. 6

circuit the signal voltage for V1 develops across R1 and that for V2 across R2. Battery BA1 supplies a negative bias voltage that opposes the d.c. drop across R2 and prevents V2's grid from going positive with respect to the cathode. A large filter capacitor prevents an a.c. signal voltage from developing across BA1 and R3.

The screen grid of V1 is supplied by current flowing through L2 from the B supply line, and V2's screen is supplied from the plate-cathode junction through winding L1. The connections are polarized so the magnetic fields produced by the screen currents oppose and cancel each other.

The circuit in Fig. 6 requires twice the voltage and half the current needed for the same tubes in a conventional circuit so the power input is the same for either type. But this particular variation has the disadvantage of requiring power supply and filter components with twice the normal voltage ratings.

### The Horizon series amplifiers

The need for twice-normal plate supply voltage is eliminated by wiring the circuit so direct tube currents flow through the primary windings as in National Company's Horizon 10 and Horizon 20 amplifiers. The circuit of the 10-watt Horizon 10 in Fig. 8 is a simplified version of the experimental 25- and 50-watt amplifiers described by Peterson and Sinclair in *The General*

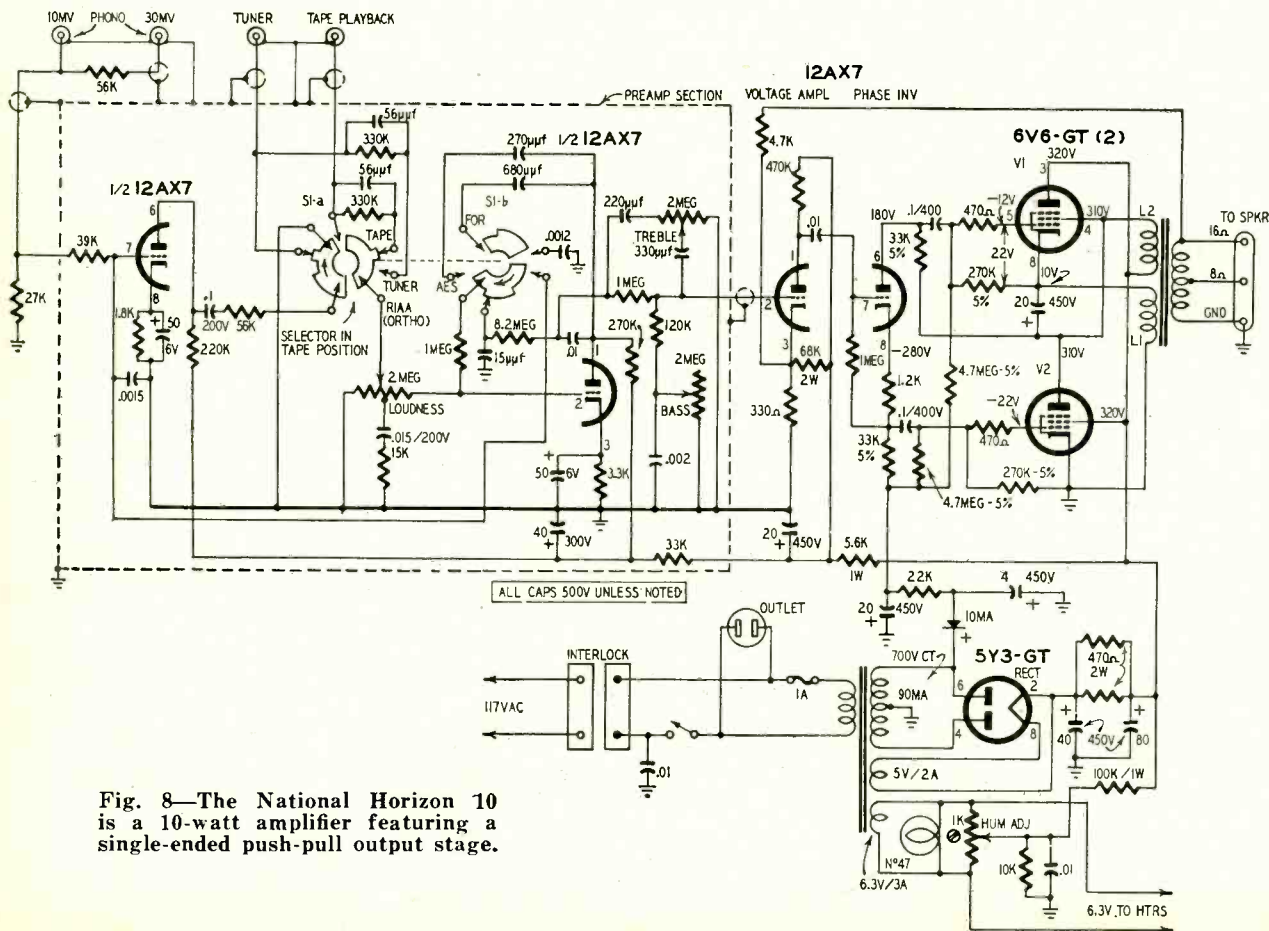

Fig. 8—The National Horizon 10 is a 10-watt amplifier featuring a single-ended push-pull output stage.



## AUDIO—HIGH FIDELITY

*Radio Experimenter*, October, 1951, and in the January, 1952, issue of *Proceedings of the IRE*.

Here the plate currents for the phase inverter and V2 and the screen current for V1 flow through L2. The cathode current (sum of plate and screen currents) of V1 flows through L1. This arrangement causes a difference in the direct-current flow in L1 and L2 and results in a d.c. drop across both windings that reduces the supply voltage for V1's screen and the plate of V2. This circuit and current unbalance is minimized by careful design to avoid flux unbalance in the transformer.

Unlike the basic circuits in Figs. 3 to 7, R-C coupling is used between the phase inverter and the grids of V1 and V2 in the Horizon amplifiers. Fixed grid bias is developed by a half-wave selenium rectifier and a simple R-C filter and applied to the output grids.

The plate supply for the phase inverter is taken from the plate-cathode junction of the output tubes. The output signal developed at the plate of V2 is in series with the phase inverter d.c. plate supply and the negative feedback voltage thus developed reduces the distortion and gain in this stage. The loss in phase inverter gain is minimized by returning its cathode load resistor to the bias supply to increase the effective plate voltage.

The voltage amplifier is conventional and uses fixed bias obtained by returning its cathode to a tap on a B plus voltage divider. Distortion in the power amplifier is further reduced by 16 db of negative feedback from the secondary of the output transformer to the voltage amplifier cathode.

### Preamplifier—equalizer

The preamplifier and equalizer section has four input channels. One for a radio tuner, one for playing back tape recordings and two for magnetic phonograph cartridges. The 10-mv phono input channel is for low-output cartridges such as the G-E variable-reluctance type; the 30-mv channel is for high-output types such as the Pickering and Audak. The tape input channel may be used for crystal cartridges and other devices delivering 0.5 volt or more.

The function selector switch has five positions. One for tape, one for radio tuner and three to select the phonograph input circuits and to provide equalization for AES, RIAA and foreign recording characteristics.

The bass control provides a boost beginning at 1 kc and rising to a maximum of 15 db at 30 cycles. The treble control provides a boost that begins at around 800 cycles and rises gradually to flatten out for a maximum of 12 db between 10 and 15 kc. Treble attenuation begins at 1,500 cycles, reaches 3 db at 5 kc and is a maximum of 17 db at 20 kc.

The next installment will discuss the circuitry in the output stages of the Circlotron amplifiers developed by Electro-Voice. END

## Field-Tested . . . Proven Best!

# Good Service Companions

the miniaturized durable  
portable electronic instruments  
you've waited for . . .

UNITED STATES  
ELECTRONIC

## REN-O-LYZER

**Electronically Analyzes, CORRECTS  
Picture Tube Trouble in 2 Minutes!**

Cleans Picture Tube elements, burns off oxygen, welds open cathodes and filaments . . . automatically and electronically! The TV Serviceman can now RESTORE picture tubes IN THE HOME! Service Charge just \$9.95 to customer—may be sold with minimum guarantee! 7"x9"x4" 6½ lb. steel-cased kit.

Jiffy  
REN-O-LYZER  
F.O.B. Detroit  
\$315.00

UNITED STATES  
ELECTRONIC

## TUBE-CHECKER

**MUTUAL CONDUCTANCE  
AND EMISSION CHECKER**

Accurately checks Picture and Circuit Tubes for filament continuity, emission, gas, shorts and leakage under actual load conditions—in 20 seconds! 7"x9"x4" 7 lb steel-cased kit.

Jiffy  
TUBE-CHECKER  
\$98.50  
price slightly higher  
west of Rockies

### ONLY THE REN-O-LYZER FORECASTS REPAIRABILITY!

Increase your customer-confidence—increase your sales amazingly with these "ON THE JOB" quality-built, electronic companions! You can restore dark, fuzzy pictures to full, bright contrast with the revolutionary REN-O-LYZER! Surveys prove that 90.1% of picture tubes Ren-O-Lyzed are still in use after 1 year's time! Each Ren-O-Lyzing job at \$9.95 is creating an average \$120.00 weekly increased income for every Ren-O-Lyzer unit in use. The TUBE-CHECKER eliminates all guesswork, proving to the customer IN THE HOME, the need for replacement of defective tubes. Order today . . . don't delay this opportunity for increased income. Instruments extremely simple to operate.

UNITED STATES ELECTRONIC  
RESEARCH & DEVELOPMENT CORP.

1605 W. Lafayette Detroit, Mich. Woodward 3-3498

Send me name of nearest dealer and further details.

955 R-E

Name \_\_\_\_\_  
Address \_\_\_\_\_  
City \_\_\_\_\_ Zone \_\_\_\_\_ State \_\_\_\_\_

# WIN NEW CUSTOMERS WEEK AFTER WEEK!

**10** NEW PRIZES—EVERY WEEK  
 NEW WINNERS—EVERY WEEK

It's easy for you to take part—

- Window Displays,
- Streamers,
- Counter Cards,
- and Entry Blanks—

Identify you with Sylvania's big, new business-building prize promotion.  
 "See your Sylvania Distributor."



**OFFER THEM A CHANCE TO  
WIN VALUABLE  
"BEAT THE CLOCK"  
PRIZES AT HOME**

**It's easy for your customers to win...nothing to write  
nothing to buy...but every entry  
blank must be endorsed by you**

**Weekly  
CONTEST  
PRIZES  
for home viewers  
include:**

**TV CONSOLES  
TV TABLE MODELS  
HI FI PHONOGRAPHS  
CLOCK RADIOS  
TABLE RADIOS**

Nothing to write—nothing to buy—and everything to win. Sylvania's big, new "Beat the Clock" prize contest for home viewers is as easy as that. Every week, week after week you can create new contacts with the TV families in your community who want to play "Beat the Clock" at home and win one of 10 valuable prizes given away each week. How do you do it? Just see that they get an official entry blank endorsed by you.

It's the greatest business-building opportunity you've ever had. Make it work two ways for you. Bring new customers to your shop by displaying "Beat the Clock" prize promotion material. Tie in window and counter displays with the Sylvania products you sell.

Bring your service into new customers' homes by mailing entry blanks to your TV community. Tie in the "Silver Screen 85" consumer booklet and other Sylvania direct mail material with your TV service.

Remember, never before has the TV Service Dealer had such a concrete part in a national TV program. Make Sylvania's "Beat the Clock" prize contest click for you. See your Sylvania Distributor for your promotion package.

SYLVANIA ELECTRIC PRODUCTS INC.  
1740 Broadway, New York 10, N. Y.  
In Canada: Sylvania Electric (Canada) Ltd.,  
University Tower Bldg., Montreal

 **SYLVANIA<sup>®</sup>**

LIGHTING • RADIO • ELECTRONICS • TELEVISION • ATOMIC ENERGY

# FOR GOLDEN EARS ONLY

*National's Criterion FM-AM tuner; Heathkit audio analyzer; new records review*

By MONITOR

IN some of its advertising National claims a usable sensitivity of 0.5 microvolt for 20 db of quieting for its Criterion tuner (see photo). This seems so unlikely of realization, especially to those who have tried designing and building supersensitive FM receivers, that I have no doubt many informed readers dismissed the claim as an adman's dream. So the first thing I want to report is this: the Criterion is by a long shot the most sensitive FM broadcast receiver I have ever tested or used. It produced regular, reliable and completely acceptable and noise-free reception of stations radiating as little as 5 kw at a distance of 140 air miles (and at least 40 miles beyond line of sight) with only the indoor antenna supplied with the receiver tacked on the wall 7 feet above ground.

The Criterion uses a cascode r.f. stage plus no fewer than three stages of i.f. amplification and two limiters. Despite this very high gain, the tuner appears to be completely stable. The r.f. stage seems completely indifferent to the length, type or match of the transmission line, and in some two months of use I found no evidence of regeneration, let alone oscillation. The only spurious response noted was that of a local channel-6 TV station (probably a heterodyne with a very strong local FM station) and that was extremely weak and would not be evident at all on a less sensitive receiver.

The capture ratio is as good as the sensitivity. The claim is that any station 25% stronger than another on the same frequency will suppress the weaker. This claim, too, appears to be realized. In any case there is an unusual freedom from co-channel and adjacent-channel and even multiple-path interference. The selectivity is fully as good as one would expect it to be with four i.f. transformers. The wide-band dis-



The Heathkit model AA-1 audio analyzer.

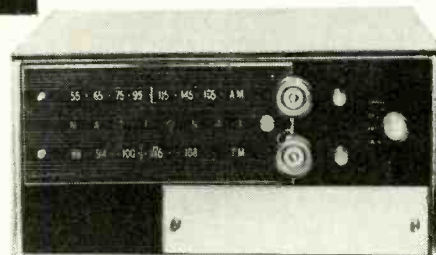

The National Criterion AM-FM tuner.

criminator, moreover, permits a somewhat narrower i.f. bandwidth for the same or lower distortion level. The combination provides highly satisfactory reception of adjacent-channel stations.

Despite this high sensitivity, selectivity and the absence of a.f.c., the Criterion is just as simple and uncritical to tune as receivers using a.f.c. and just as free of drift distortion. This latitude in tuning and the very low distortion are due to the new discriminator which has an operating curve 2 mc wide instead of the 400 or 500 kc of previous high-quality discriminators. The circuit (Fig. 1) is a sort of a cross between the discriminator and frequency-counting detector and might be called a frequency-differential counter. The discriminator curve is established by coils L1 and L2, one of which is self-resonant at about 9.7 and the other at 11.7 mc. With such a wide discriminator curve, the Criterion provides as good or better latitude against drift and casual tuning as tuners using a.f.c. which usually operate over a range of  $\pm 500$  kc. The detector resembles a counter detector at first glance (and has been mistaken for one by experts) but it differs entirely in action though it is just about as free of distortion.

The FM portion uses a squelch in the

mutamatic position to suppress interstation noise which, with so sensitive a receiver, is very high. The squelch is adjustable with a control accessible when the name plate on top the cabinet is removed, and I have been able to set it to provide operation on the weakest station capable of giving an acceptable degree of noise-free reception. Like all squelch circuits it produces high subsonic switching transients as it goes in and out of operation. These may well be sufficient to produce momentary motorboating, breathing or overloading with some amplifiers and it might be good advice for National to include a filter to attenuate these transients in future models. (The National Horizon amplifiers have a filter in their input which will do this and minimize rumble and flutter as well.)

Owners of other amplifiers can reduce the transients to a probably safe level simply by adding another resistor of the same value as the present grid leak at the input of the amplifier. With the output capacitor of the tuner or control unit this will provide a double R-C network (which will increase the slope below turnover to 12 db per octave) as shown in Fig. 2.

The AM portion has a sensitivity of about 10  $\mu$ v—more than sufficient for today's conditions on the broadcast

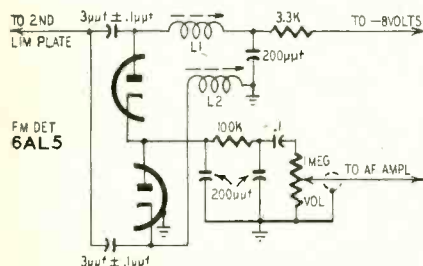

Fig. 1—Schematic of the FM detector.

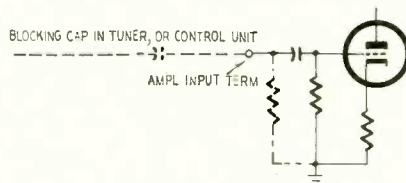
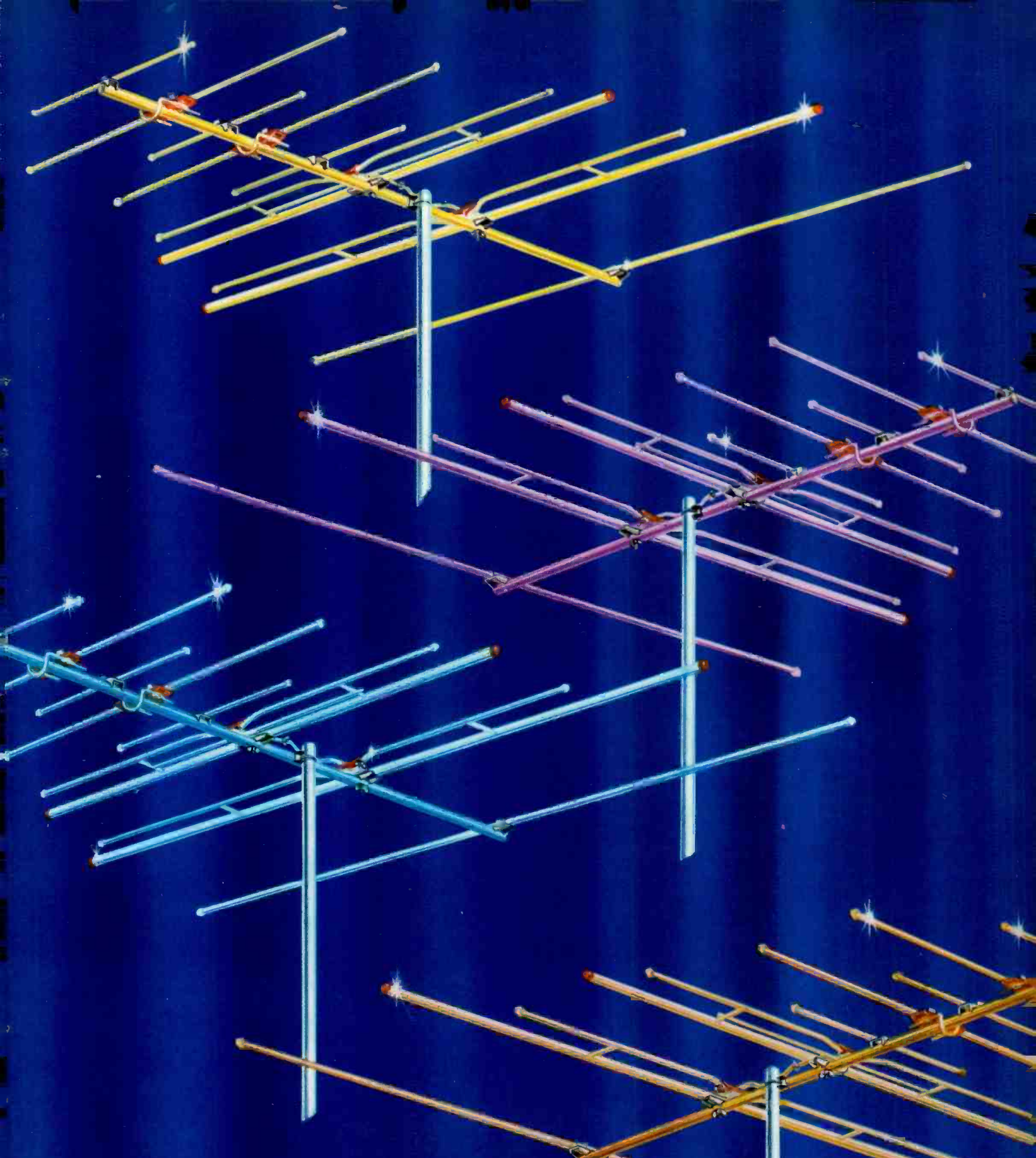

Fig. 2—Schematic diagram of simple circuit for reducing switching transients.



*Originals by Winegard*

# WINEGARD INTERCEPTOR

*world's finest TV antenna*

*now available in* **COLOR**

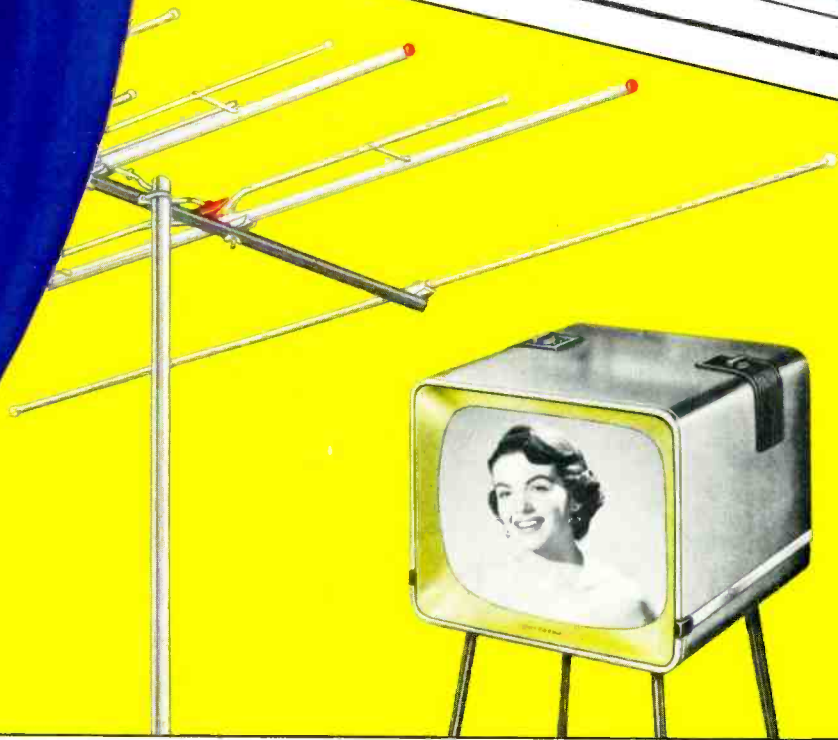

**Now! Antennas  
So Beautiful—  
Display Them  
with the  
Sets you Sell!**

## EYE APPEAL, DURABILITY, TOP PERFORMANCE

Here's a real merchandising story your customers will understand. Never has any antenna given you so much to talk about. Of course you have known for some time of the many superior advantages of the famous Winegard INTERCEPTORS. Thousands of satisfied customers, the world over, have acclaimed the INTERCEPTOR for its amazing performance. But here's a merchandising story your customers can understand completely . . . a story of —eye appeal, of durability and superb performance . . . a story of a protective coating that will keep the INTERCEP-

TOR as trigger-sensitive, as engineering-ly perfect as the day it left the factory.

You'll be proud to display several Winegard color INTERCEPTORS in your finest show rooms where their shimmering, metallic, jewel-like color tones will catch the eye of your customers . . . creating a replacement market for people who would ordinarily be satisfied with the same old, obsolete antenna they now have. Remember, an obsolete antenna or one that will deteriorate rapidly, will make even the finest set you sell unsatisfactory.



**Like  
Colorful Metal  
Drinking  
Tumblers**

Anodized in 5 two-tone shimmering metallic colors. Anodizing provides a permanent protective coating against corrosive agents such as salt air, soot, dust, dampness and natural gases. Locks in practically forever all the matchless performance engineered into the Interceptor to insure perfect reception for years to come.

## AN ENTIRELY NEW CONCEPT IN TV ANTENNA MERCHANDISING!



**WINEGARD**  
INTERCEPTOR ANTENNAS

With Lumalite Color Metallic Coating  
And Exclusive Electro-Lens Focusing

3000 Scotten Blvd., Burlington, Iowa

band. In fact, in most locations it may be advisable to use nearly a 2- or 3-foot length of wire for the antenna, to reduce co-channel interference. A novel feature is that although both AM and FM use the same i.f. channel, both can be used simultaneously and independently. This provides a means for binaural reception in cities like New York where WQXR often offers binaural broadcasts with one channel on AM and the other on FM. AM and FM are tuned with separate knobs and have individual volume controls. Each has its individual dial scale and pointer. There is also an output to provide FM multiplex reception when and if such transmissions should become a reality, and there is a takeoff point for a tape recorder as well.

The Criterion will accept the National preamp control unit and with it makes a highly convenient and compact control center for a high-fidelity system. It is not quite as massively and impressively built as the National ham and communications receiver. This impression is partly the result of the printed or etched circuit construction which for all its virtues is not as handsome and rugged-looking as conventional construction. However, it probably does provide higher insurance that the high specifications will be met and maintained by individual tuners and probably also of higher stability, an important consideration with a receiver as sensitive as this. The good-looking new dial provides a logging accuracy

about as good as possible with a broad-tuning receiver.

**Heathkit audio analyzer**

The new Heathkit audio analyzer (model AA-1, see photo) combines in one instrument the functions previously performed by three: the intermodulation analyzer, a.c. v.t.v.m. and the audio wattmeter. The new combination (Fig. 3) offers better and more flexible performance than the old individual instruments and sells at a price (\$59.95 in kit form) which puts it well within reach of every service technician and many amateur experimenters.

The IM analyzer portion is superior to the old Heathkit IM analyzer in every respect but one: when making rapid runs, the new model is a little less convenient in switching and more care is needed to avoid snapping the needle against the pin. However, the new model has a very much wider useful range and is far more sensitive and more accurate at low IM levels. The low-level sensitivity and accuracy of an IM meter are limited by the residual reading on the lowest scale. This represents partly the internal IM of the instrument itself but largely the hum picked up by the final lowpass filter.

In the old model this residual reading ran as high as 0.3%; in the one I tested it was only .07%, an improvement of more than 400%. This appears to be the result of much more careful and complete internal shielding. The specs list the lowest scale as 1%. In

actual fact there are two lower scales: 0.3% and 0.1% full scale. If the residual distortion or reading is subtracted, it is therefore possible to make readings as low as .01%! Such readings are presumably not as accurate as those on the higher scales (and Heathkit is to be congratulated for not claiming them as part of the useful range) but the development engineer and experimenter will find them of great value since they indicate the slightest relative improvement from changes in adjustment or circuit parameters, especially when working with low-level audio stages where even 0.1% IM is high.

The new model offers a single set of internal frequencies—60 and 6,000 cycles—whereas the old one offered a choice of either 3,000 or 7,000 cycles at the high end. However, the new model has two sets of binding posts on the panel with jumpers through which it is possible to inject any external frequency within range of the filters: 10 to 500 cycles for the low end, 2 to 12 kc for the high end. Thus, with an external generator, almost any conceivable combination can be obtained. The same set of posts permits one to bring out either the 60- or 6,000-cycle signal for external signal tracing, while the output posts provide a combination of both, ideal for normal signal tracing because it gives some indication of overall frequency response.

The method of calibration is very simple and with minimum care can produce accuracy of 10%; while greater

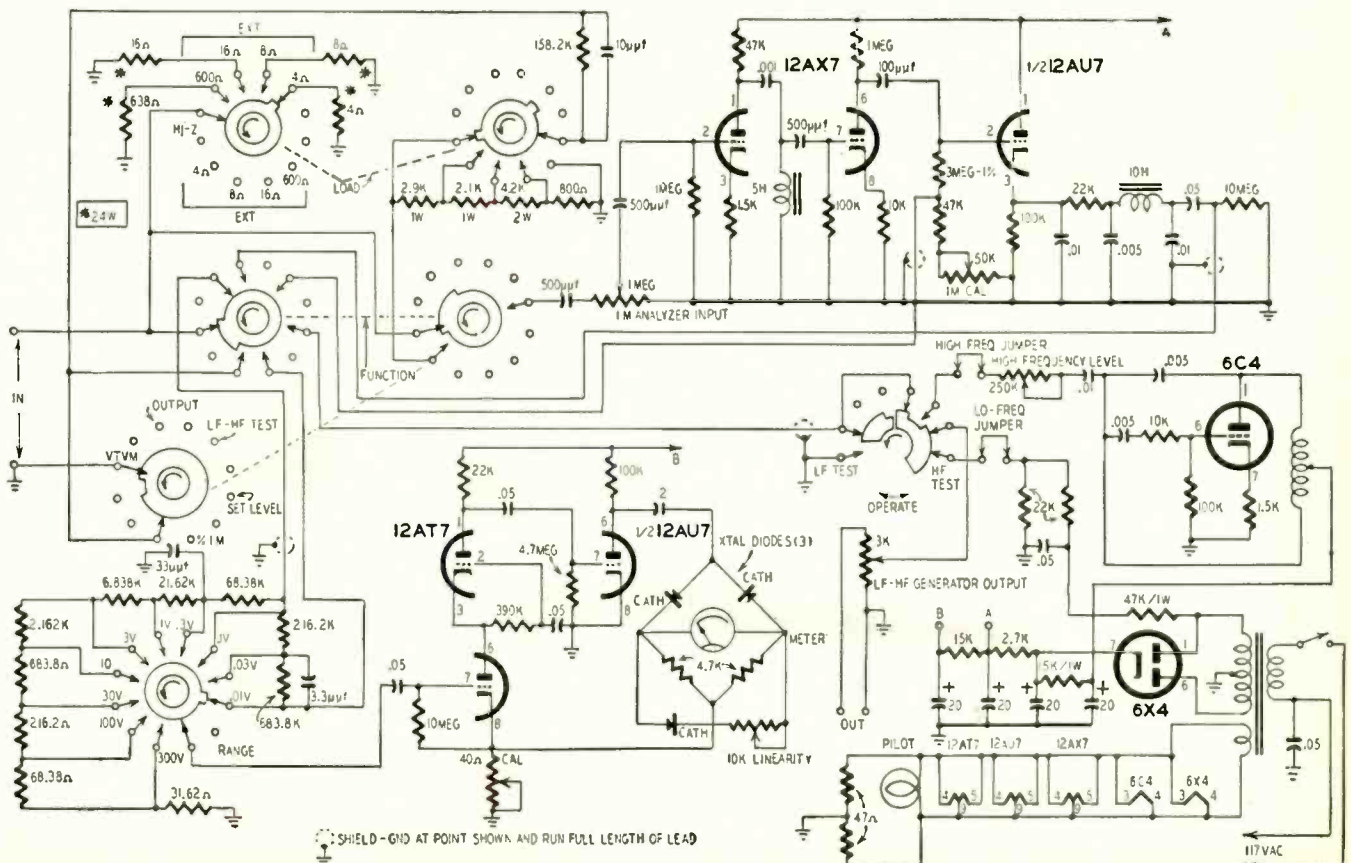

Fig. 3—The Heathkit model AA-1 audio analyzer—unit serves three functions.

## AUDIO—HIGH FIDELITY

care can bring the accuracy down to the tolerance of the meter or about 2 or 3% on the ranges above 1%. The kit includes the resistors needed for calibration.

The a.c. v.t.v.m. has similar superiorities over the older, independent model. For one thing it has a cascade amplifier which reduces residual noise to so low a level that even on the most sensitive scale (10 mv full scale and 200  $\mu$ v per division) there is no perceptible reading with the input shorted. For another, the meter is much more linear. A new linearity adjustment has been added by shunting the meter with a crystal diode and a 50,000-ohm potentiometer. In the model I tested the adjustment produced linearity within 2 or 3%, not only on each individual scale but also on the two adjacent scales or ranges. The frequency response claimed, 10 cycles to 100 kc within  $\pm 1$  db, if the wiring is duplicated exactly.

The wattmeter section also profits from the improved linearity and the useful range has been extended on the low end to provide on the lowest range a full-scale reading of 0.15 mw or 150  $\mu$ w and a low reading of less than 1  $\mu$ w. Technicians will find this most useful for balancing amplifiers without removing the amplifier from the cabinet or opening the chassis. Connect the wattmeter to the amplifier with a suitable load. Remove the driver or inverter tube to disable the feedback loop. The meter will show some reading on one of the low scales. This represents hum in the plate circuit of the output tubes which are fed relatively unfiltered voltage and depend on exact balance in push-pull to cancel hum. Therefore, adjusting the balance control for lowest hum reading will indicate exact balance. The IM analyzer section can also be used for obtaining overall dynamic or a.c. balance. Take a reading at between 1 and 5 watts (for home amplifiers) or just under maximum output for amplifiers operating at high levels. Now adjust the balance control for minimum IM. If the amplifier has a bias control, bias can also be adjusted for minimum IM at just under maximum output.

Very compact and light, the instrument is an ideal tool to take for servicing hi-fi systems at the installation. It can be used for signal tracing, troubleshooting, adjustment and even for tube testing. (Substitute front-end tubes while taking IM readings; if IM is reduced, the new tubes are better. For output tubes, take output reading at near maximum output; if output increases with new tubes, the new tubes are better.)

### New records review

**HOVHANESS: *Khadis Concerto for Piano, 4 Trumpets and Percussion Six Piano Pieces***  
William Masselos, pianist  
Izler Solomon conducting Chamber Ensemble

MGM E-3160

The most novel and provocative recording I have received in many months and one which,

though esoteric, will be a lot of fun at any hi-fi or record party and will interest anyone who likes the different in sound and tonal effects. Hovhannes, an American of Armenian descent who writes in a combination of Near Eastern and early polyphonic classical style, produces music unique in musical and tonal qualities.

The solo piano pieces on side 2, for example, involve, beside the ordinary fingering of piano keys, the production of tones by beating either the keys or the strings themselves with xylophone and tympani hammers, plucking the strings with a guitar pick and in one portion embodying the sound of piano keys hitting bottom into the melodic and tonal pattern as if it were produced by some independent percussion instrument. The piano is made to produce sounds resembling those of drums, organ, guitar, bells, etc.

The concerto on side 1 has some of the wildest or most inspired polyphony I have ever heard. I don't recall when I heard so many piano beat notes on any single record. All in all, this music could not be reproduced accurately without high fidelity. With the warning that the music is very different, though charming when one gets used to it.

### SIBELIUS: *Third Symphony*

Stokowski and NBC Orchestra

RCA-Victor LM-1854

If you (or more likely your family) would like to have a little good music with the demonstrations of big bass, this should go right at the top of your shopping list. Sibelius scored a lot of thunder and lightning (almost literally) into this work and Stokowski, the NBC Symphony and RCA engineers bring it forth just about as big as life and twice as awesome. Though we've had plenty of fine drums lately, the double basses have been rather overlooked.

Here we have a very big double-bass section speaking in full voice and in almost all the language of which it is capable. With some bass boost the effect can be overpowering. Furthermore, I don't think there is anything under 40 cycles in the grooves. Thus, it will produce nearly the full effect with any reasonably good speaker system, although it is very likely to show up any rattles that may have been built into the enclosure. In addition there are some mighty blasts of brasses in the characteristically fiery Sibelius choirs, including one in, I think, the third movement which will almost certainly make you jump. But don't buy this for demonstration purposes if you can't play it loudly; 90% of the effect is lost at low volume levels, though the musical effect remains good.

### BLOCK: *Four Episodes for Piano, Strings and Winds*

Knickerbocker Chamber Players

### BRITTEN: *Sinfonietta for Winds and Strings*

MGM Chamber Ensemble

MGM E-290 (10-inch LP)

Excellent test of system definition, especially for those who like chamber music. The Block piece has a very complex polyphony, some of it tonal polyphony. There is a fine bassoon, a nice gutty bass, and a big piano with vibrate and beat notes. In the first movement a very dull bass is ridden delicately by light strings in the top register, providing an excellent test for IM. The Britten has a very sweet but very naturally windy flute. The strings have a tone which I can only describe as "rosiny." The close-up double bass is of the very best on records and in one spot is sustained like an organ note and will provide a severe measure of wow. For modern music it is not at all hard to take.

### RENÉ: *Passion in Paint*

Andre René and his Orchestra

RCA-Victor LPM-1033

This is modeled on the idea of Mussorgsky's *Pictures at an Exhibition*. Andre René gave his impression in symphonic-popular style of 12 famous paintings, no fewer than 6 of them nudes. Nobody, least of all René, would want to compare the music with Mussorgsky's, but the recording does approach the RCA-Victor recording of the *Pictures* in hi-fi quality and usefulness for demonstration. There is some very spectacular music here with odd and even unique sounds, including that of a choir of brasses giving forth a loud and clear Bronx cheer, some

good drums, a plentitude of crashing cymbals, assorted percussives and a lot of high-high shimmer of various kinds. There are also some odd miking effects, as for instance, a harp which seems to leap out of the orchestra into your lap when it gets its brief moment of solo glory. Though this is a Black Label record, RCA engineers have clearly given it the Red Label works, and withal, it makes a first class sound on a hi-fi system.

## THE KING OF INSTRUMENTS

Vol. 1: *American Classic Organ*

Vol. 2: *Organ Literature*

Vol. 3: *Organ Recital*

Aeolian-Skinner Organ Co.  
Boston 25, Mass.

Those who love the organ cannot conceivably justify not having one or more of these in their library. Between them they pretty well demonstrate the whole gamut of organ capabilities and with practically 100% verisimilitude. Those who own or sell the very few speaker systems capable of going down to 20 cycles or lower will also want these to demonstrate. (Volume 1 has two identified examples of the 16-cycle, 32-foot pipe very faithfully recorded, and also a sweep of the whole organ range which will do a better job of revealing resonances, doubling, rattling, etc., than anything else I know of.) But don't bother demonstrating this on anything less than the almost perfect speaker system; the doubling will be all too evident.

Volume 1 is a lecture with short snatches of musical illustration, on the various resources of the organ and how the individual tones are produced. Of great interest to the organ specialist, it is also an excellent introduction to the theory of musical formation. The recording provides an excellent measure of overall system quality, especially flatness—the cleaner and flatter the system, the greater the audible difference between the various stops.

Volumes 2 and 3, however, are all music and fine music. Both present a wide variety of demonstration and showoff material, with Volume 3 having a slight edge perhaps in Viernic's *Carillon Westminster* and amazing concatenation of sound which taxes the definition and dynamic range of the best of playback systems. Volume 2 has the better examples of Bach's polyphonic genius, which, too, requires superb definition. With the best systems, the reproduction of the organ is positively lifelike.

## GUITAR MUSIC OF SPAIN

Laurindo Almeida, unaccompanied guitar  
Capitol P-8295

The guitar music of Spain requires a virtuosity on the instrument probably unequalled except in the case of the violin playing the works of Paganini. The guitar is elevated in its tonal capacities to a level almost worthy of comparison with the classic organ. Mr. Almeida is not yet a Segovia and his renderings of an excellent sampling of guitar repertoire shows some signs of effort (Segovia is incredibly effortless) but that produces a particularly charming and worth-while hi-fi recording.

The guitar produces a very great variety of intentional or accidental transients. There is, for example, the very highly damped, very dull bass in some effects and the equally damped very high notes which though periodic are of such short duration that they resemble pulses with an echo. Much of Spanish guitar music calls for slapping or drumming on the guitar body and the sound produced this way is almost a pure transient. Furthermore, this music requires such superbly dextrous motions of the fingers that inevitably there is some trace of their passage in the form of squeaks in the range above 7 or 8 kc, the click of fingernails, etc. Finally in some of the bass passages several strings are plucked simultaneously and beat notes are often established. This recording presents samples of all these and this, together with a great faithfulness to the tone of the instrument and extremely fine definition, offers an absolutely first-class example of realism, presence and naturalness of which a fine hi-fi system is capable. END

Note: Records above are 12-inch LP and play back with RIAA curve unless otherwise indicated.



# FREE 10-DAY TRIAL

**ON THE SYLVANIA TEST EQUIPMENT  
OF YOUR CHOICE...**

**then after you decide to buy**

# Pay as you earn!



▲ **Type 403** 7" Television Service Oscilloscope—\$269.50  
—incorporating advanced features of models priced much higher

### Experience without expense

Sylvania offers you an opportunity to experience the pleasure and profit of using high-quality test equipment, without being obligated to buy. Ask your Distributor to let you take the Sylvania Test Equipment you want back to your shop so you can use it for 10 days. If you're not completely convinced that your Sylvania Test Equipment is accurate and efficient to use, take

it back to your Sylvania Distributor. That's all there is to it.

### Painless payment plan

If you decide to buy, your Sylvania Distributor will arrange easy payment terms. After a small down payment, you can take up to 18 months to pay on easy credit terms. Your new Sylvania equipment will bring extra profits which will more than pay for itself as you use it.

This offer is limited so see your Sylvania Distributor right away. He'll demonstrate the outstanding features of the Sylvania Test Equipment you need.

For the complete line of Sylvania Test Equipment you can buy on these new terms, write for the complete Test Equipment Brochure, Address Dept. E 35T.

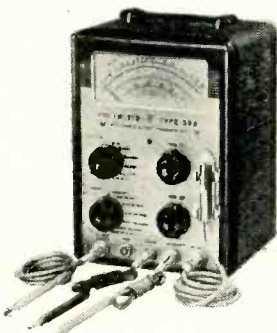

◀ **Type 302** Deluxe Polymeter—\$129.50  
—stabilized against calibration errors due to changing line voltage

▶ **Type 620** New Tube Tester—\$149.50  
—equipped to test 600 ma series string tubes as well as all other conventional tubes.



Sylvania Electric Products Inc.  
Department G-35T  
1740 Broadway, New York 19, N. Y.

Please send Test Equipment Brochure.

Name \_\_\_\_\_

Address \_\_\_\_\_

City \_\_\_\_\_

Zone \_\_\_\_\_ State \_\_\_\_\_



# SYLVANIA

Sylvania Electric Products Inc., 1740 Broadway, New York 19, N. Y.  
In Canada: Sylvania Electric (Canada) Ltd., University Tower Bldg., Montreal

LIGHTING • RADIO • ELECTRONICS • TELEVISION • ATOMIC ENERGY



## ROHN NO. 6 TOWER "All-Purpose" Tower

Self-supporting to 50 ft., or guyed to 120 ft. Utilizes mass production techniques to give you lowest prices, yet highest profits for a tower of this type. Ideal for home and industrial requirements. Permanent hot-dipped galvanized coating inside and out. Dependability — a feature customers demand — is assured with the Rohn No. 6 Tower . . . designed to "stand up" for years to the rigors of weather and climatic conditions. Easy to climb for fast, efficient servicing. In 10 ft. sections.

## ROHN PACKAGED TOWER "Space Saver"

Pat. Pending  
cuts storage space  
**300% or more!**

Popular PT-48 has almost 50' of sturdy tower within a compact 8' x 20" package! "Magic Triangle" design is adapted to a pyramid shape using a wide 19" base with progressively decreasing size upward. Decreases your overhead . . . easy to transport and assemble; cuts shipping costs! Galvanized through-out. Available in heights of 24', 32', 40', 48', 56' and 64'.

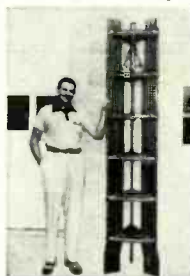

## Both Towers Feature . . .

### 1. MAGIC TRIANGLE CONSTRUCTION

Famous wrap-around design with full 2½" corrugated cross-bracing welded to tubular steel legs.

### 2. INTERLOCKING JOINTS

. . . formed by swaging tower ends so that they overlap each other, becoming a single unit in structure. Proved by tests to be superior.

### 3. WEATHER SEALED

. . . against condensation and moisture.

### 4. HOT DIPPED GALVANIZING

. . . both inside and out gives the finest protective coating known. This sales point is one of the best you can offer . . . the finest quality and at lower than competitive prices!

these two **HOT DIPPED GALVANIZED**  
**Rohn Towers**  
will satisfy 90% of your TV tower needs!

## HEAVY DUTY NO. 30 TOWER

Heights up to 200' or more when guyed  
Self-supporting up to 60'

Sturdy communication or TV tower that will withstand heavy wind and ice loading. Heavy gauge tubular steel, electrically welded throughout.

Weather resistant, non-corrosive double coating provides durable finish.

All sections in 10' lengths. Only 2-4 manhours required for installing 50' tower! Tremendous sales potential for you in this tower!

**SPECIAL INSULATOR SECTIONS** are available to permit the Rohn No. 30 Tower to be used as guyed "series fed" radiators for amateur and commercial uses.

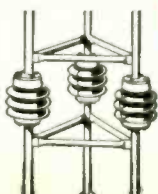

## NEW LINE OF ROHN ROOF TOWERS



Four superior designed "Roof Towers" are available for inexpensive, yet sturdy roof installations. 3', 5' and 10' sizes are available.

These completely galvanized Rohn Towers have unbeatable sales appeal when this type installation is desired.

## HANDLE THE COMPLETE LINE OF ROHN GALVANIZED ACCESSORIES

. . . house brackets, special bases, peak and flat roof mounts, instant drive-in bases, telescoping masts with matching bases, special Rohn Fold-Over Tower, guying brackets, UHF antenna mounts, erection fixtures, variety of mounts and supports for masts or tubing, tower installation accessories, TV service tables, mast and TV hot dipped galvanized tubing, guy rings, etc.

for • larger profits • customer satisfaction • greater ease in ordering, handling and shipping

CALL YOUR ROHN REPRESENTATIVE  
FOR COMPLETE CATALOG, SALES  
LITERATURE AND PRICES — OR WRITE —  
PHONE — WIRE DIRECT

GET ALL YOUR REQUIREMENTS  
FROM ONE RELIABLE SOURCE

# ROHN Manufacturing Company

116 Limestone Avenue, Bellevue, Peoria, Illinois



Courtesy British Industries Corp.

X-ray view of the 6Z79. Shield screen around plate minimizes hum and noise.

characteristics shown. This power is approximately:

$$P_o = \frac{1}{2} (E_b - E_{min}) I_{max}$$

where  $E_{min}$  and  $I_{max}$  describe a point either at the knee of a tetrode type curve or at the intersection of a line from  $E_b$  which has the negative slope of a triode type curve. These points have all been indicated in Fig. 2 and have been connected by a dotted line.

Two similar lines have been drawn

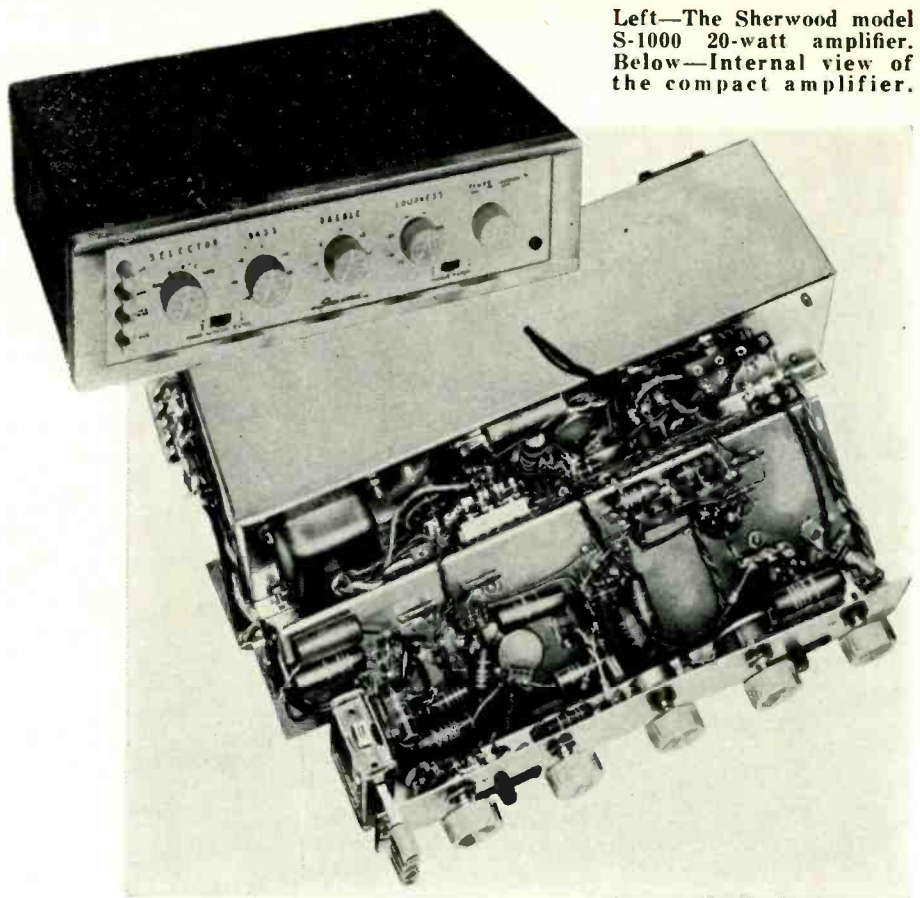

Left—The Sherwood model S-1000 20-watt amplifier. Below—Internal view of the compact amplifier.

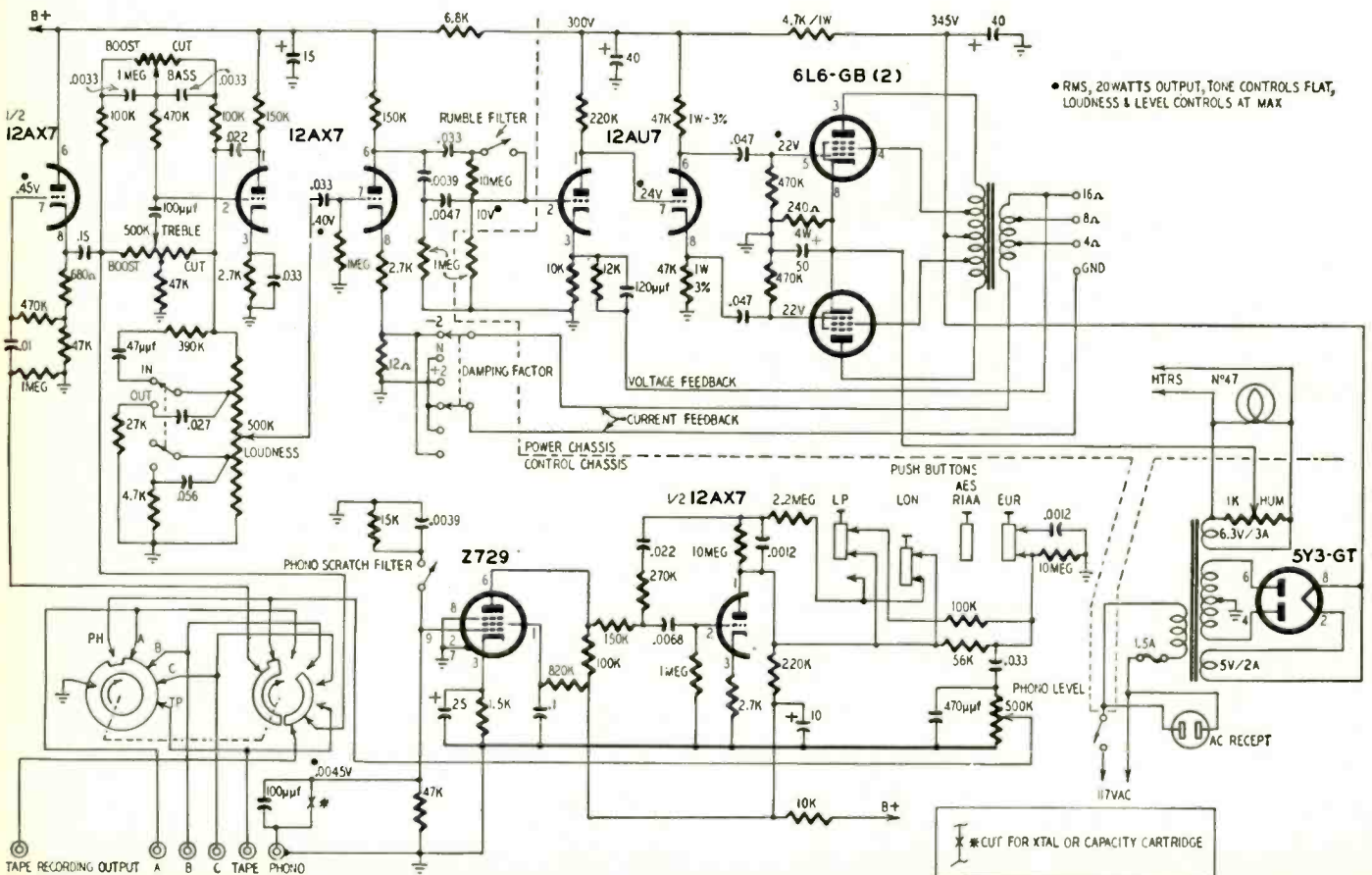

Fig. 3—Schematic diagram of the power and control chassis of the 20-watt high-fidelity amplifier.

*New!  
Revolutionary!*

FIVE STAR  
**General**  
★★★★★

- ★ The GENERAL has a closely spaced screen (7 inches) to minimize pick up off the rear. With more and more stations coming on the air, on the same channel, this is a major problem of today and tomorrow.
- ★ The GENERAL is completely pre-assembled. By simply tightening three wing nuts, the antenna is ready to mount.
- ★ The GENERAL is light in weight with low wind resistance. Not only easy to put up, but easy to KEEP up.
- ★ The GENERAL is packed in a small carton. This makes the antenna more economical to ship, store, and handle.
- ★ The GENERAL sells for less than comparable products. This gives YOU a better mark up and faster moving merchandise.

**Some Exclusive Territories Available  
To Aggressive Jobbers.**

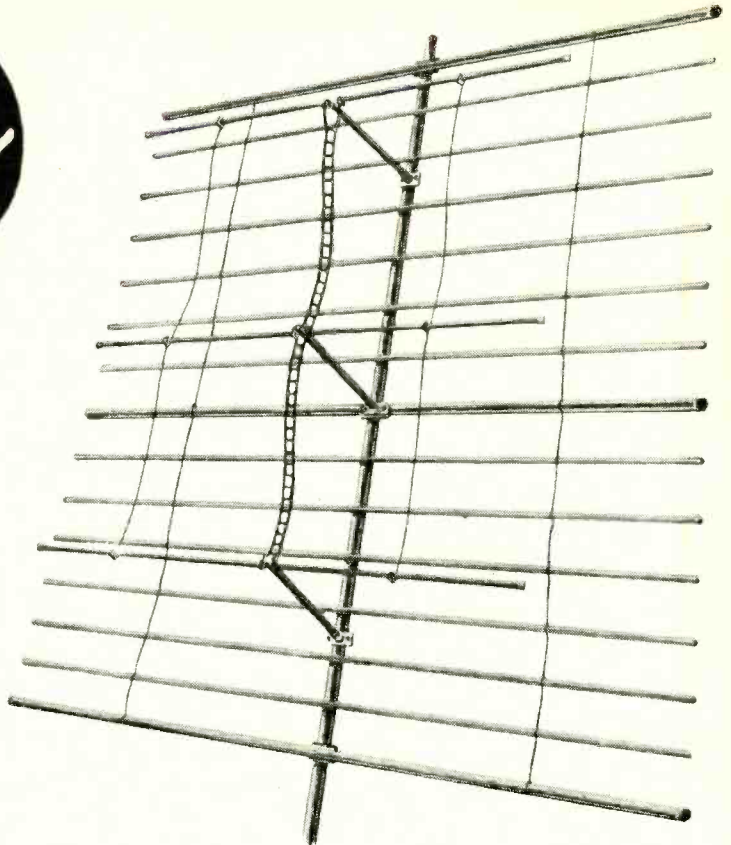

★ The GENERAL is low enough in price to use in the most competitive market and is recommended for all locations.

The GENERAL combines 6 dipoles in a phased collinear array for super gain on channels 7 to 13 and features an interpolated dipole arrangement on channels 2 through 6 for a small physical size, high gain array on these channels. The GENERAL has peak gains of over 15 D.B. and is recommended for use in the most difficult reception areas.

**LIST PRICE 24.95**

**World's Finest TV Antennas and Towers**

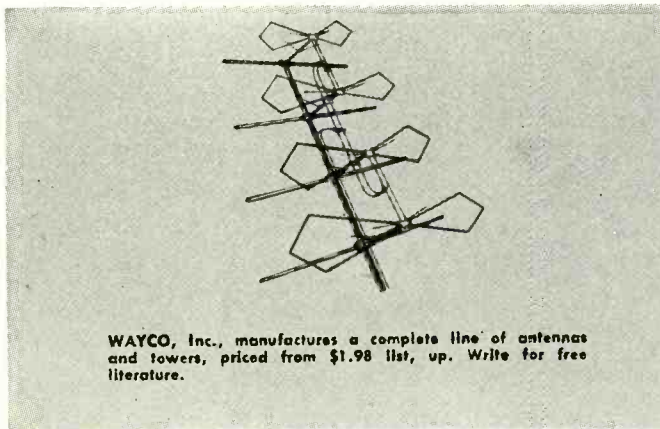

WAYCO, Inc., manufactures a complete line of antennas and towers, priced from \$1.98 list, up. Write for free literature.

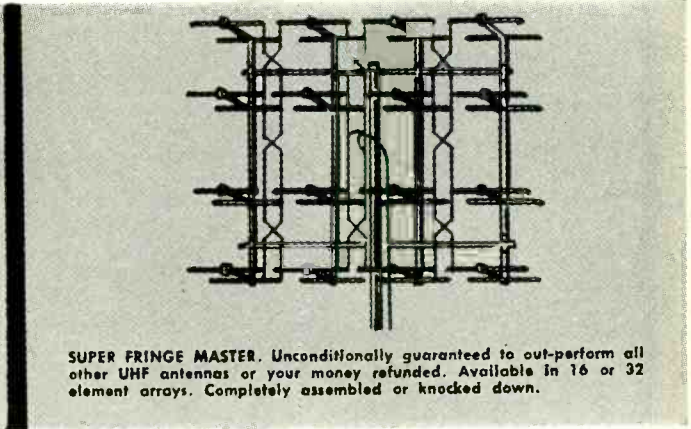

**SUPER FRINGE MASTER.** Unconditionally guaranteed to out-perform all other UHF antennas or your money refunded. Available in 16 or 32 element arrays. Completely assembled or knocked down.

P. O. Box 115  
Phone 7-2981

**WAYCO, Inc.**

WAYNESBORO  
TENNESSEE

Small  
in size and cost  
Big  
in performance



## American's NEW TAPE RECORDER MICROPHONE

Here's a new standard for high fidelity convenience . . . for the home or small studio. Attractively styled, and available in matching colors, this sensational new lightweight champ delivers a heavyweight performance throughout the entire tone range. Omni-directional pick-up pattern provides uniform fidelity when more than one performer or participant is being recorded at one time.

Versatility underscores the modern functionalism of this new design. It weighs only 2 ounces, only  $3\frac{1}{2}$  x  $2\frac{1}{4}$  x  $\frac{3}{16}$  inches in size . . . can be easily handled and used by standing persons, or it can be rested on a flat surface for conference type pick-up such as conference recording.

Quality in construction means quality in tonal reproduction. The microphone element is shielded, with very low hum pick-up. Model B-203, ceramic type, and Model X-203, crystal type are both available with RCA type or miniature phone plugs.

For high fidelity sound that is reproduced to last, use American tape recorder microphones.



full vision . . .  
full sound . . .  
where fidelity  
speaks for itself

**American**  
microphone  
company

370 South Fair Oaks Ave., Pasadena 1, Cal.  
AN ELGIN NATIONAL WATCH  
COMPANY AFFILIATE

## AUDIO—HIGH FIDELITY

through those points which are at 95% of the calculated maximum power output. Note how much farther apart these lines are as they intersect Ultra-Linear or triode  $E_c = 0$  curves. The plate-to-plate load impedance line also passes through the maximum power points from the  $E_p = E_b, I_b = 0$  point. The load line for 20% Ultra-Linear maximum power (6,500 ohms plate to plate) has been drawn on the diagram. Note how much greater variation (swing of the load line on the diagram around the point  $E_p = E_b, I_b = 0$ ) the load values may have without losing power or causing distortion in the Ultra-Linear and triode cases.

There are other important factors which can be observed by more detailed study of these curves.

1. Ultra-Linear operation always results in a considerably lower plate resistance than that obtained with tetrode operation. Consequently, the speaker damping factor is correspondingly lower with Ultra-Linear operation. (This point is not as important as it was at one time. It has been found that low damping factors can be had by proper use of current feedback from the speaker coil. More on this later.)

2. The distortion at maximum power output for 20% Ultra-Linear operation is approximately one-third that of a tetrode connection.

3. The increase of anode current under sustained maximum-power-output conditions is higher with tetrode connection than with Ultra-Linear or triode. Of greater importance, although not indicated in Fig. 2, is the slower rise in screen current at maximum output with Ultra-Linear connection. With the Ultra-Linear circuit, the screen will operate at a more conservative dissipation than a similar tetrode operation. The useful power output from the screen in the Ultra-Linear case further lowers its actual dissipation and further increases the advantage of Ultra-Linear operation over tetrode. Moreover, the B supply and bias methods have less rigid regulation requirements with the reduced current variations.

These considerations seem to substantiate, in general, previous claims of superiority for tapped-screen operation. Consequently, this circuit (Fig. 3) has been used (with 22% taps) in the Sherwood model S-1000 amplifier.

The schematic shows a method of applying current feedback, either positive or negative, from the output transformer secondary. In the S-1000 this results in a damping factor choice of either -2, +2 or the +7 normally obtained without current feedback.

A 12-db-per-octave rumble filter, a continuously variable compensated loudness control and a modified Baxandall tone control system<sup>4</sup> also appear in the circuit. The feedback type control system, with its inherent low-distortion characteristics, is at its best when driven by a cathode follower. This

same cathode follower (which precedes both the tone and loudness controls) then becomes an excellent low-impedance source to meet tape recording requirements. The recording jack, however, is interrupted by an open switch contact when the selector switch is in the tape position. This prevents a feedback circuit through the recorder.

The input capability of the high-impedance input circuit is 10 volts for less than 1% IM distortion. This data is not usually included in amplifier specifications. Poor input capability can lead to distortion which is frequently difficult to analyze (as in the case of an AM tuner producing a 5-volt signal while receiving a local broadcast).

Input capability is also important in considering phono preamplifier specifications since many high-level magnetic cartridges are still used. The model S-1000 can handle 150 mv with less than 1% IM distortion.

Equally important is adequate preamplifier sensitivity, which should be 5 mv or less to meet the requirements of the G-E Professional and the Fairchild cartridges. A Z729-pentode-12AX7-triode feedback pair, with a mid-frequency gain of 20 db, are used in the Sherwood.

Associated with high sensitivity in preamplifier systems are the requirements for minimum hum, noise and microphonics. The British Z729 (see photo), together with the use of proper circuitry and layout, met these requirements without resorting to the added complication of d.c. heater supplies.

The most commonly used preamplifier circuits are based on feedback pairs. Two common types are those with the first tube self-biased with a large grid resistor and a grounded cathode (Fig. 4) and those with feedback to an unbypassed cathode resistor (Fig. 5). In either case, because both the grid and the cathode are not at low impedance to 60 cycles, it is difficult to eliminate hum using a.c. heater supplies.

A more foolproof circuit (Fig. 6) is one with the grid at low impedance (determined by the cartridge), with a self-biased, bypassed cathode resistor. Electrostatic hum pickup by the grid and cathode is thus eliminated. Also, the high-impedance feedback resistor does not tend to load the second plate as is the case with the lower-valued feedback resistor required for cathode feedback.

A 1,000-ohm potentiometer across the

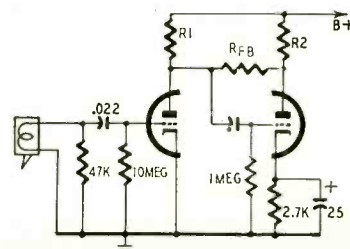
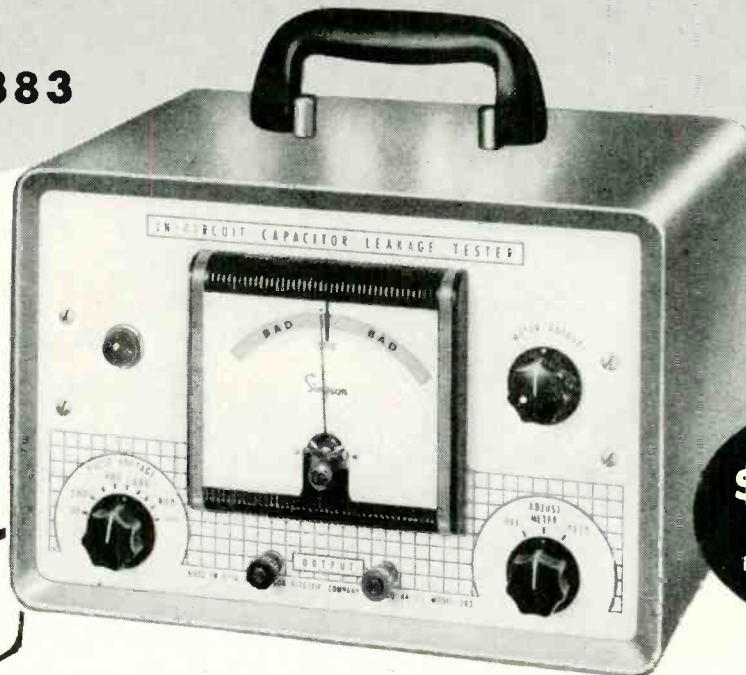

Fig. 4—Input circuit is self-biased.

# NEW!

## Simpson IN-CIRCUIT CAPACITOR LEAKAGE TESTER

model 383



only  
**\$79<sup>95</sup>**

including probe leads  
and manual

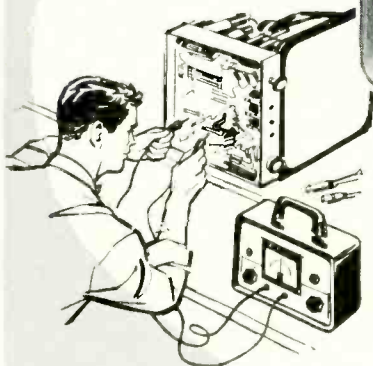

World's first tester that truly checks  
paper, mica, and ceramic capacitors . . .  
**WITHOUT DISCONNECTING THEM  
FROM THE CIRCUIT!**

Here's a new dimension in electronic instrumentation. Detects leakage in paper, mica, or ceramic capacitors, while connected in the circuit. No disconnections of any kind. Checks leakage, even when the shunting circuit resistance is only 1% or less of the leakage resistance value. Uses a new Simpson discovery (patent applied for).

Only two simple test leads to apply. Indication is on a "Good-Bad" scale—your customer can see why new capacitors are needed. Tests capacitors from 1 uuf to 0.25 uf in a jiffy. Indicates leakage resistance from "shorts" to hundreds of megohms. Also detects the presence of unstable resistors right in the circuit.

Be the first technician in your area to cash in on this fabulous Simpson tester. Sell preventive maintenance . . . fix "dog" sets in one-tenth the usual time. Double . . . yes, even triple your service income.

ask your jobber, or write . . .

**Simpson** ELECTRIC COMPANY

5203 W. Kinzie St., Chicago 44, Illinois

Phone: EStebrook 9-1121

In Canada: Bach-Simpson Ltd., London, Ontario

WORLD'S LARGEST MANUFACTURER OF ELECTRONIC TEST EQUIPMENT

# It's as EASY as This

## TO INSTALL A MASTER TV SYSTEM WITH **B-T LABS** Masterline UNITS



LINE SPLITTER



MTO-11

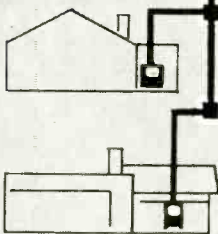

MTO-59

**A** Connect the antenna line to the INPUT of your Masterline MLA Line Amplifier. The signal is now amplified 37db (70 times).

**B** Connect a line splitter or line coupler to the OUTPUT of the MLA. You now have 2 or more branch lines for feeding to TV receivers.

**C** Where the branch line is run out-of-doors, connect a Masterline MTO-11 (outdoor tap-off) wherever a TV set feed line is required.

**D** Where the branch line serves as a riser inside a building, connect a Masterline MTO-59 (wall-plate tap-off) wherever an antenna outlet is required.

This is only one example of a Master TV System, to show the flexibility of Blonder-Tongue distribution equipment. There are many more, all covered in the new B-T INSTALLATION MANUAL.

Write for your Free copy to Dept. FJ-3  
**BLONDER-TONGUE LABORATORIES, INC.**  
WESTFIELD, NEW JERSEY

Manufacturers of TV Cameras, TV Amplifiers, Boosters, Converters, Accessories and Originators of the Masterline and 'Add-A-Unit' Master TV Systems.

## AUDIO—HIGH FIDELITY

heaters and returned to the positive voltage at the output tube cathode completes the circuit essentials. Careful twisting of the heater wires, which are dressed away from grids and plates, and the excellently shielded internal construction of the Z729 tube, make possible an equivalent of 1.5  $\mu\text{V}$  of hum and noise at the input grid. (This is 60 db below maximum output.)

With this circuit it was a simple matter to add a four-button push type switch for record equalization.

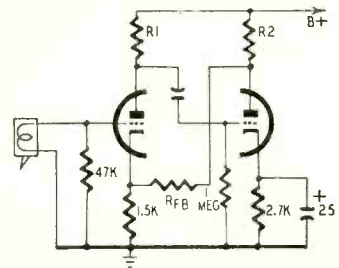

Fig. 5—Feedback preamplifier circuit uses unbypassed cathode resistor.

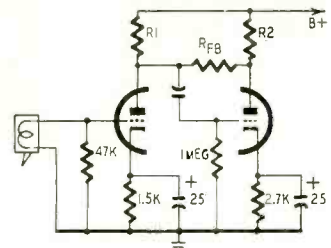

Fig. 6—Cathode resistor is bypassed.

The four-position equalization selector is a four-section locking-type circuit-transfer push-button switch. Each button locks in when depressed and remains latched until released by depressing another button. The equalization complements the RIAA and new AES recording curves when the EUR, LON and LP buttons are out (not depressed) so a dummy AES-RIAA button is added to simplify operation for the uninitiated.

The LON button is shown depressed on the diagram. It shunts a 2.2-megohm resistor across the 10-megohm resistor and .0012- $\mu\text{f}$  capacitor in the feedback network and alters the response on the low end. The LP switch does the same thing and disconnects the 100,000-ohm shunt resistor so the response at 10 kc is -16 db. The EUR position disconnects the grounded .0012- $\mu\text{f}$  capacitor from the circuit and provides more highs. The 10-megohm resistor eliminates the d.c. click as the circuit is opened and closed.

A 15,000-ohm resistor and .0039- $\mu\text{f}$  capacitor can be switched across the pick-up cartridge to form a scratch filter with attenuation of 12 db per octave. END

### References

- <sup>1</sup> D. Hafler and H. Keroes, "An Ultra-Linear Amplifier," *Audio Engineering*, November, 1951.
- <sup>2</sup> D. Hafler and H. Keroes, "Ultra-Linear Operation of the Williamson Amplifier," *Audio Engineering*, June, 1952.
- <sup>3</sup> A. D. Blumlein, British Patent No. 496883, May, 1937.
- <sup>4</sup> P. J. Baxandall, "Negative Feedback Tone Control," *Wireless World*, October, 1952.



...from start

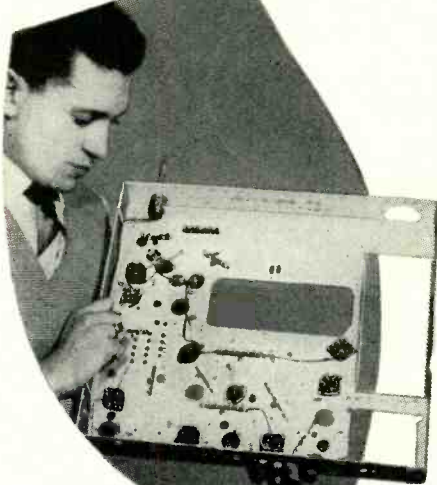

...and step by step

...to finish

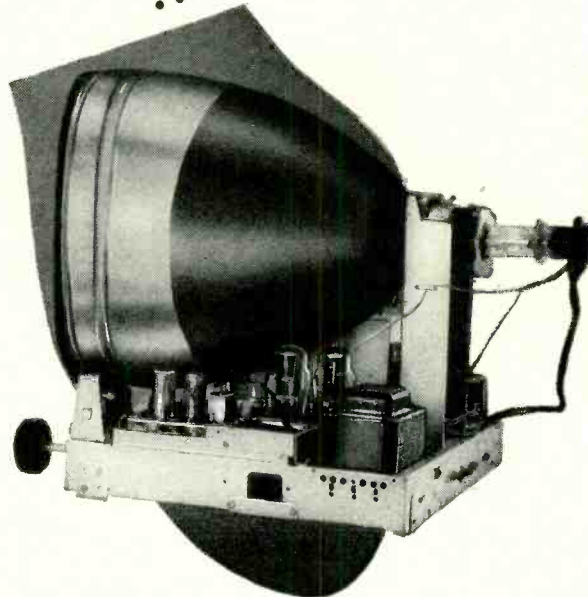

*Become a top-notch television service technician*

**Now . . . RCA INSTITUTES offers modern TV KIT with Comprehensive Television Servicing Course**

START to build with a TV Kit developed by one of America's foremost radio-tv schools—RCA Institutes. LEARN with simple step-by-step instruction how to build a modern, large-screen receiver. TEST each stage, as you build, and see how it works. Learn how "trouble-shooting" is applied. FINISH your Home Study Course ready and able to service all make and model sets!

Easy-to-follow instructions are planned and prepared for you through the efforts of RCA Institutes' instructors, engineers at RCA Laboratories, and training specialists of the RCA Service Company.

*The RCA Institutes' TV Kit utilizes up-to-date circuits including:*

- *Synchro-Guide horizontal automatic frequency control circuit.*
- *Horizontal magnetic reaction scanning.*
- *Latest deflection circuits.*
- *FM sound discriminator.*
- *High-gain, low-noise cascode tuner.*

Join the many thousands who have been successfully trained by RCA Institutes for a good job (or business of their own) in television servicing.

**BASIC KNOWLEDGE OF RADIO NECESSARY  
NO NEED FOR PREVIOUS TV TRAINING**

**FREE BOOKLET! MAIL COUPON NOW.**

RCA INSTITUTES, INC., Home Study Dept. EK-9-55  
350 West Fourth Street, New York 14, N.Y.

With no obligation on my part, please send me a copy of your booklet on the TV Servicing Home Study Course and Kit. I understand no salesman will call.

Name: \_\_\_\_\_ (Please print)

Address: \_\_\_\_\_

City: \_\_\_\_\_ Zone: \_\_\_\_\_ State: \_\_\_\_\_



**RCA INSTITUTES, INC.**  
**A SERVICE OF RADIO CORPORATION of AMERICA**  
**350 WEST FOURTH STREET, NEW YORK 14, N.Y.**

MULTIPLE SPEAKERS

MULTIPLE SPEAKERS

MULTIPLE SPEAKERS  
 MULTIPLE SPEAKERS  
 MULTIPLE SPEAKERS

FOR HIGH - FIDELITY

MULTIPLE SPEAKERS

*Mutual coupling improves audio response*

MULTIPLE SPEAKERS

By JOSEPH MARSHALL

THE biggest difficulty in achieving the fullest possible fidelity in sound reproduction for most audiophiles is presented by the loudspeaker system. The problem is to obtain clean and adequate reproduction of the lowest two octaves, 16 to 64 cycles, and to maintain a smooth and undistorted response for the rest of the range.

Recently—in trying to obtain acceptable results with inexpensive and small systems—many old acoustic and radiation principles have been revived. One of the oldest, soundest and simplest, however, has received little attention. The principle is that of mutual coupling of multiple radiators. It is very simple and proceeds from the general theory of radiation. When two or more identical radiators are mounted close together, the efficiency of the combination at bass frequencies increases as the square of the increase in piston area. Thus, two identical speakers closely coupled are 4 times more efficient than either one would be alone in the same position; four speakers are 16 times more efficient, etc. *This is greater than the improvement provided by a horn in which the radiation efficiency increases as the square of the diameter of the mouth.* (In practice these theoretical efficiencies are only approximated but the relations are maintained closely enough to serve as guides.)

To appreciate the full significance of this, let us look at some other aspects of it. Although two 6-inch speakers have only one-half the piston area of a 12-inch speaker, they are as efficient when mutually coupled as a single 12-

inch speaker of similar characteristics. Two 8-inch speakers have just a little more than half the piston area of a 15-inch speaker but provide greater efficiency. Attempts have been made to build cones 2 or even 4 feet in diameter in an effort to obtain large piston areas; but such large speakers have so much mass and require such large motors that as a rule they are impractical. However, two 15-inch speakers, having only half the area of a 30-inch speaker, will yield the same efficiency, and four of them would be equivalent to a single cone 5 feet in diameter. Also, the distortion characteristics are improved theoretically by the square of the improvement in efficiency.

Furthermore, every increase in horn mouth area requires a corresponding or greater increase in the depth or length of the horn. But in close-coupled multiple speakers, the increase in piston area is obtained with no increase in depth. Increased efficiency in a horn requires an increase in size in all three dimensions; the efficiency increase in multiple speakers is achieved with an increase in size in only two dimensions. So, if you held up your hands in horror at the thought of the space occupied by four 15-inch speakers, consider the space needed for a horn with a mouth 5 feet in diameter!

Finally, assuming that for various good reasons we use a wall type infinite baffle with our multiple speakers, there is another advantage over a horn. A horn has a very odd frequency curve. It is very flat above cutoff (the point

where the mouth area is one-half-wavelength squared), but below cutoff it has a very steep slope, usually 18 db per octave. In an infinite baffle the slope below resonance is at the theoretical rate of 6 db per octave. So that, given a horn with a cutoff at 40 cycles and a multiple-speaker system with resonance at 40 cycles, the multiple-speaker system is superior in the octave below 40 cycles.

Improving frequency response

So far we have considered the effect at low frequencies of mutual coupling of two or more *identical* speakers. There are excellent reasons, however, for departing from similarity or identity. The response curves of speakers, even in anechoic chambers, are noted for their raggedness. One cause of this is speaker resonance which produces harmonically related peaks that are indicated with exaggeration in Fig. 1. Furthermore, more valleys and humps are produced by cancellations and additions due to reflections of the wave at the termination of the cone; others are caused by cone breakup at higher frequencies.

Multiple speakers provide a means of correcting, compensating or, at least, ameliorating some of these effects. For example, speakers with different resonances will have peaks spaced differently; the peaks of one may fall into the valleys of another. I indicate this in Fig. 1a.

Designing speakers of suitable dissimilarity to provide a perfectly smooth curve may or may not be possible.

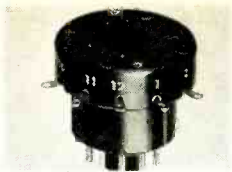

**G-C CRT DUO-DECAL TEST SOCKET ADAPTER**  
For top-of-chassis tests.  
No. 9251 NET \$1.95



**G-C GRILLE CLOTH ASSORTMENT**  
Various sizes and patterns.  
No. 9114 NET \$0.99

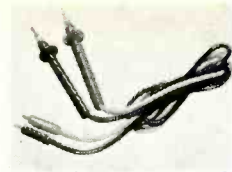

**G-C HIGH-VOLT TEST LEADS**  
Heavy duty TV leads; phone tips.  
No. 9100 NET \$3.00



**G-C POCKET HEX KEY WRENCH SET**  
Seven sizes .050" to 3/16"; case.  
No. 9124 NET \$1.65



**G-C PRINT-KOTE SILICONE RESIN**  
Protects printed circuit repairs.  
No. 14-2 NET \$1.17

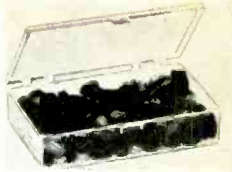

**G-C "99" RUBBER GROMMET ASSORTMENT**  
Many types & sizes; plastic box.  
No. 9121 NET \$0.99

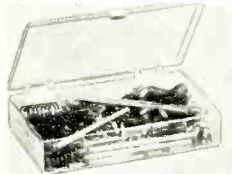

**G-C "99" SPRING ASSORTMENT**  
Styles and sizes for all repairs.  
No. 9118 NET \$0.99



**G-C "99" WASHER ASSORTMENT**  
Metal & fiber washers, all types.  
No. 9119 NET \$0.99

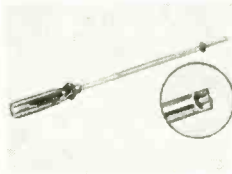

**G-C SCREW-STARTER SCREW DRIVER**  
Starts screws in tight spots.  
No. 9148 NET \$2.10



**G-C SPRAY-KOTE TUBE-KOTE**  
Touch up scratched picture tubes.  
No. 49-12 NET \$2.17



**G-C K-27 PRINT-KOTE**  
Pressure-spray silicone resin.  
No. 14-6 NET \$2.17



**G-C SPRAY-KOTE HAMMER-KOTE**  
Brown hammer finish, air dries.  
No. 83-12 NET \$1.83



**G-C DUAL SPEAKER SWITCH ASSEMBLY KIT**  
Wired, ready to use.  
No. 9188 NET \$1.17

**GENERAL**



*Ask For These*

**RADIO-TV SERVICE AIDS**

**CEMENT**

*... at Your Jobber*



**G-C SPRAY-KOTE APPLIANCE WHITE**  
Snow white finish for ranges, etc.  
No. 9113 NET \$1.30

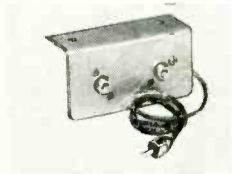

**G-C PHONE DUPLEX JACK AND PLUG**  
For hi-fi and audio, ready-wired.  
No. 9226 NET \$0.90

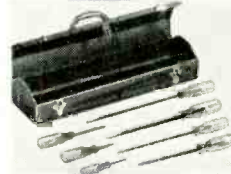

**G-C ALL-STEEL SERVICEMAN'S KIT**  
Large, roomy kit with 7 tools.  
No. 9052 NET \$8.10



**G-C KLEEN-TEX CLEANER**  
Safe, slow-burning, inexpensive.  
No. 11-G NET \$2.10



**G-C HORIZONTAL BAR GENERATOR**  
Simple, accurate TV alignment.  
No. 9149 NET \$1.95

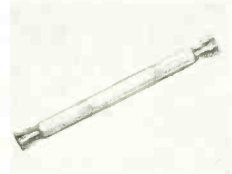

**G-C NUT & HEXHEAD SCREW STARTER**  
For 1/4" & 3/16" hex nuts, screws.  
No. 9147 NET \$1.50

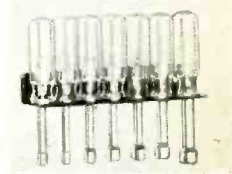

**G-C 7-PIECE NUT DRIVER SET**  
Sizes 3/16" to 1/2", wall rack.  
No. 9208 NET \$3.60



**G-C TV PICTURE TUBE BOOSTER**  
5-wire type, half-moon socket.  
No. 9136 NET \$1.50



**G-C PRINT-KOTE SOLVENT**  
Solvent for silicone resin.  
No. 13-2 NET \$0.33

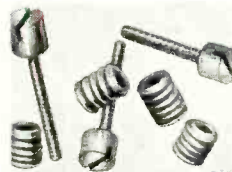

**G-C TV-RADIO IRON CORE KIT**  
7 types, for 90% replacements.  
No. 9141 NET \$0.57



**G-C STANDARD TUNER SLUGS**  
Envelope of 3 replacements.  
No. 9095-E NET \$0.30



**G-C DELUXE TV ALIGNMENT TOOL KIT**  
Roll-type case with 16 tools.  
No. 8280 NET \$7.74

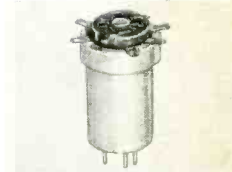

**G-C 7-PIN MIN. TEST SOCKET ADAPTER**  
Saves time on chassis tests.  
No. 9247 NET \$1.65

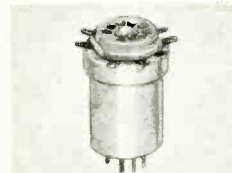

**G-C 9-PIN MIN. TEST SOCKET ADAPTER**  
Use with alligator clips or prods.  
No. 9249 NET \$1.85

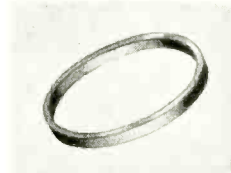

**G-C MOTOROLA TV DIAL BELT**  
Genuine replacement for tuners.  
No. 196 NET \$0.30



**FREE!**

Complete, illustrated G-C Catalog. New service aids. Send postcard today.



**GENERAL CEMENT MFG. CO.**

910 TAYLOR AVENUE • ROCKFORD, ILLINOIS



## AUDIO—HIGH FIDELITY

Fortunately, a very marked improvement can be achieved by trial and error or even by random choice of speakers with dissimilar characteristics. A combination of several speakers differing both in resonance and size is almost always smoother than a single speaker, even the best of the lot.

Multiple speakers provide a simple means of obtaining a smooth extension of the range downward. Several speak-

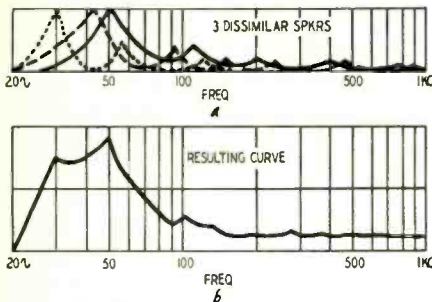

Fig. 1—Smoothing loudspeaker response by using dissimilar speakers

ers might be chosen having resonances differing by 10 cycles—a 30-, 40- and 50-cycle speaker for example. The resonances will combine to produce a fairly smooth curve down to the lowest frequency as indicated in *b* of Fig. 1 (assuming the amplifier provides enough damping to level the peak).

The property of mutual coupling has been extensively applied in the use of "images" of the radiator to increase bass efficiency. When a speaker is positioned close to a flat surface such as a wall or floor so that some of the sound waves are reflected from the surface toward the ear, the effect is precisely the same as if there were another speaker where the floor is. Thus, one speaker close to the floor acquires the same efficiency it would obtain if it were coupled to another speaker. If located in a corner, where images are provided by floor and walls, it has the same efficiency as if coupled to three other speakers. (This does not mean that a single speaker in a corner is as good as four closely coupled speakers—simply that it is as good as *one* of the four speakers in a cluster of four, which in effect makes it four times as good as a single speaker in the middle of a wall.) A good portion of the efficiency of reflex enclosures is due to mutual coupling of port to piston and of both to the floor or walls. Similarly, a good part of the efficiency of corner horns is due to coupling of horn mouths to the walls.

The curve resulting from mutual coupling of multiple speakers or speakers and images varies with the pattern in which they are arranged. Thus, four speakers mounted in a square pattern have only slightly more efficiency (Fig. 2) at 40 cycles than four speakers mounted in a vertical line, one above the other. But the four speakers mounted in a vertical line will have a crossover some 200 cycles lower. That is, the point at which the boost begins is lower and more of the boost is concen-

trated below 100 cycles. This arrangement affects the mid-frequencies less and the low bass can be increased greatly with less effect on voices. The radiation pattern is also affected by the shape of the cluster. The square radiates more or less uniformly in all directions; the vertical slot has a much wider horizontal directivity because a slot spreads radiation in the direction at right angles to its longest dimension. Therefore, vertical stacking makes the point source at low frequencies very much wider.

There is one danger with multiple coupling. When two or more radiators are separated by some multiple of the radius of the cones, cancellation and addition effects are produced due to phase differences. These effects can be used to obtain special slopes, but the relationships are so complex that the

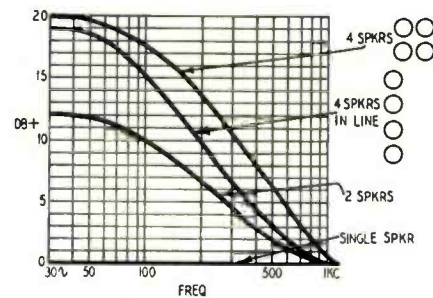

Fig. 2—Theoretical improvement through mutual coupling of speakers.

experimenter should avoid any spacing between speakers (or speakers and images) which is any multiple of the radius of the cone. Using speakers of different sizes also helps because the radii of the cones will differ.

### Application of mutual coupling

The principle can be applied to any of the familiar speaker baffling arrangements from the infinite baffle to the horn. For example, Permoflux in one of the few commercial applications (Diminuette) uses two 6-inch speakers in a very small bass-reflex enclosure. In the Largo they use a pair of 8-inch speakers mutually coupled as direct radiators in front and mutually coupled to load a horn in the rear. The Baruch-Lang system is another similar one. In such cases, the size of the enclosure, the flare of the horn, the size of the reflex port, etc., are determined by the *actual* combined piston area of the speakers used. In general this means that multiple speakers will provide the same efficiency in a much smaller enclosure.

I am not able to give guidance in the application of the principle to such enclosures. My work has been entirely with the infinite baffle provided by mounting the speakers in a wall. Such wall mounting has several advantages. It is a simple way to get good baffling at low frequencies. It is usually the least expensive means of extending bass response, especially when combined with multiple speakers. If the speakers are mounted in a wall between two

rooms or two portions of a house, the method provides good distribution of sound into both areas. Finally, the slope below speaker resonance is more favorable than in a horn.

The basic principle of wall mounting is that of increasing the distance from front to back of the speaker cone and thus eliminating or minimizing the loss at low frequencies which occurs when front and back waves meet out of phase. Cancellation effects set it at a frequency whose wavelength is equal to the distance from the front to back of the cone. (Incidentally, the wavelength of any sound frequency is determined by dividing the velocity of sound in air, about 1,100 feet per second, by the frequency. Thus the wavelength of 50 cycles is 1,100/50 or about 22 feet.)

The speaker mounting requires very few precautions and is not critical. It should be rigid, nonresonant and free of vibration. If the walls are of gypsum board  $\frac{3}{8}$  inch or more thick, one or two small speakers may be mounted directly on it. Gypsum board is fairly nonresonant up to a point. If the wall is of plaster-and-lath construction (or if large speakers are to be used), the best procedure is to cut a square or oblong hole between the 2 x 4 framing somewhat larger than the size needed for the speaker or speakers. Since walls are usually 4 inches deep, and speakers usually exceed this depth, a box will have to be extended into one room or the other. If the opening is furred in with 2 x 6's or 2 x 8's, the box will be rigid.

The speaker board can be  $\frac{3}{4}$ -inch plywood of a size to fit the opening. It would be an excellent idea to use strips of foam rubber between baffle board and frame to damp the mounting board and prevent dissipation of low-frequency energy in wall vibration. When several speakers are to be used, an entire section between adjacent 2 x 4's in the wall should be cut out and replaced with  $\frac{3}{4}$ -inch plywood in which the speaker holes are cut. If the insert is full length, it should be braced with furring at least very 2 feet.

If it is not possible to use the wall between two rooms, the back radiation can be confined to a closet. Closets usually have enough volume so that the air column formed in them will not have a significant effect on the speakers. The door of the closet can be used as a mounting board and then sealed against air leakage with rubber of the type used to seal automobile doors—this can be purchased in long lengths. A good weatherstrip could also be used. If the closet contains a lot of clothing, its interior will not require any treatment since the clothes will absorb most of the back wave.

In choosing a location for wall-mounted speakers, keep in mind the increase in radiation efficiency obtained by coupling with images of the speaker. Speakers located close to the floor, ceiling or an adjoining wall will be re-

(Continued on page 105)

The data that Launched  
Thousands of Careers  
is yours *FREE* to show

**HOW YOU CAN BE SUCCESSFUL  
IN RADIO-TV-ELECTRONICS**

Send for Your Booklet Today!



YOU CAN PLOD ALONG for years, getting a paltry increase now and then, enjoying little security, finding your work dull and drab.

Then something happens. Things look up. You become more confident. Your earnings rise. You feel more important.

"Luck," some may say.

"Contacts," others may suggest.

But in your heart, you will know the answer: "Training." And it all may have started the moment you filled out a coupon requesting a copy of a free booklet named "Your Future in the New World of Electronics." From this data you get knowledge of where you stand in Electronics. Tremendous expansion leaves this gigantic industry pleading for trained men. Top manufacturers sold billions of dollars worth of electronic merchandise in 1953. By 1960, the radio-electronics industry should do no less than 10 billion dollars per year, not counting military orders.

Today there are over 97,000 radio-equipped police cars; an even larger number of taxis are radio equipped (at least 87,000); 26,000 civilian planes have radio; 45,500 American ships have radio.

Today there are over 120,000,000 radios in use. There are 36,000,000 TV sets and 464 TV stations in operation. Color TV is coming into high gear. Countless positions must be filled—in development, research, design, production, testing and inspection, manufacture, broadcasting, telecasting and servicing. To fill these posts, trained men are

needed—men who somewhere along the line take time to improve their knowledge, their skills. Men who, today, perhaps, take two minutes to send for a booklet.

"Your Future in the New World of Electronics" shows you how CREI Home Study leads the way to greater earnings through the inviting opportunities described above.

However, CREI does not promise you a "snap." With an accredited technical school such as this, you must *study* to convert your ambition into technical knowledge you can sell in the fabulous Electronics market.

Since its founding in 1927, CREI has provided thousands of professional radio men with technical educations. During World War II CREI trained thousands for the Armed Services. Leading firms choose CREI courses for group training in electronics, at company expense, among them United Air Lines, Canadian Broadcasting Corporation, Trans-Canada Airlines, Sears, Roebuck and Co., Bendix Products Division, All-American Cables and Radio, Inc., and RCA Victor Division.

CREI courses are prepared by recognized experts, in a practical, easily understood manner. You get

the benefit of time-tested materials, under the personal supervision of a CREI Staff Instructor, who *knows* and *teaches* you what industry wants. This is accomplished on your own time, during hours selected by you, and controlled by your own will power. This complete training is the reason that graduates find their CREI diplomas keys-to-success in Radio, TV and Electronics. CREI alumni hold top positions in America's leading firms. At your service is the CREI Placement Bureau, which finds positions for advanced students and graduates. Although CREI does not guarantee jobs, requests for personnel far exceed current supply.

Now is the time of decision for you. Luck will not propel you forward unless it finds you trained. Contacts won't budge you an inch unless you have the skill to back them up. The answer is: Technical Training . . . and willingness to learn. Together they will bring you increased earnings in this new Age of Electronics. Fill out the postage-free reply card and mail it now. We'll promptly send you your free copy of "Your Future in the New World of Electronics." The rest—your future—is up to you.

**MAIL THIS  
POSTAGE-FREE  
POSTCARD TODAY**

See Our Ad On The Next Page ▶

**MAIL THIS POSTAGE-FREE POSTCARD TODAY**

**CAPITOL RADIO ENGINEERING INSTITUTE**

Dept. 149-B 3224 16th St., N.W., Washington 10, D. C.

Please send me your course outline and FREE Illustrated Booklet "Your Future in the New World of Electronics" . . . describing opportunities and CREI home study courses in Practical Electronics Engineering.

- CHECK FIELD OF GREATEST INTEREST
- Practical Radio Engineering
  - Broadcast Radio Engineering (AM, FM, TV)
  - Practical Television Engineering
  - Aeronautical Electronics Engineering
  - TV, FM & Advanced AM Servicing

Name .....

Street .....

City ..... Zone ..... State .....

CHECK:  Home Study  Residence School  Veteran

To help us answer your request intelligently, please give the following information:

EMPLOYED BY .....

TYPE OF PRESENT WORK .....

SCHOOL BACKGRUND .....

ELECTRONICS EXPERIENCE .....

IN WHAT BRANCH OF ELECTRONICS ARE YOU MOST INTERESTED?

# CREI prepares you quickly for success in

*The future is in your hands!*

The signs are plain as to the future of the trained men in the electronics industry. It is a tremendous industry, and—at the *present time* there are more jobs than there are trained men to fill them. But—when there's a choice between a trained and untrained applicant, the trained man will get the job. Your biggest problem is to decide on—and begin the best possible training program.

## CREI Home Study . . . The Quick Way to Get There.



Since 1927, CREI has given thousands of ambitious young men the technical knowledge that leads to more money and security. The time-tested CREI procedure can help *you*, too—if you really want to be helped. CREI lessons are prepared by experts in easy-to-understand form. There is a course of instruction geared to the field in which you want to specialize. You study at *your* convenience, at *your* rate of speed. Your CREI instructors guide you carefully through the material, and grade your written work personally (not by machine).

## Industry Recognizes CREI Training.

CREI courses are prepared, and taught with an eye to the needs and de-

mands of industry, so your CREI diploma can open many doors for you. Countless CREI graduates now enjoy important, good-paying positions with America's most important companies. Many famous organizations have arranged CREI group training for their radio-electronics-television personnel. To name a few: All America Cables and Radio, Inc.; Canadian Aviation Electronics, Ltd.; Canadian Broadcasting Corporation; Columbia Broadcasting System; Canadian Marconi Company; Hoffman Radio Corporation; Machlett Laboratories; Glenn L. Martin Company; Magnavox Company; Pan American Airways, Atlantic Division; Radio Corporation of America, RCA Victor Division; Technical Appliance Corporation; Trans-Canada Air Lines; United Air Lines. Their choice for training of their own personnel is a good cue for *your* choice of a school.



*Benefits Felt  
Right Away.*

- BROADCASTING
- TELEVISION
- MANUFACTURING
- COMMUNICATIONS
- SERVICING
- AERONAUTICAL ELECTRONICS

Almost immediately, you feel the benefits of CREI training. Your employer, when informed of your step toward advancement (only at your request), is certain to take new interest in you and in your future. What you learn in CREI Home Study can start helping you do a better job immediately.



## CREI also offers Resident Instruction

at the same high technical level—day or night, in Washington, D. C. New classes start once a month. If this instruction meets your requirements, check the coupon for Residence School catalog.

**PAYS FOR ITSELF QUICKLY.** Your very first raise could repay your investment in CREI training, and leave you a profit the very first year. Your increases in pay thereafter are all pure profit, and you'll be prepared for many more promotions and pay raises in the future years of your life.

## INFORMATION FOR VETERANS

If you were discharged after June 27, 1950—let the new G. I. Bill of Rights help you obtain resident instruction. Check the coupon for full information.



*Get this fact-packed  
booklet. It's free.*

Called "Your Future in the New World of Electronics," this free illustrated booklet gives you the latest picture of the growth and future of the gigantic electronics world. It includes a complete outline of the courses CREI offers (except Television and FM Servicing) together with all the facts you need to judge and compare. Take 2 minutes to send for this booklet right now. We'll promptly send your copy. The rest—your future—is up to you.

1st Class

Permit No. 288-R

Sec. 34.9 P.L.R.

Washington, D. C.

### BUSINESS REPLY CARD

No Postage Stamp Necessary If Mailed In United States

3¢ Postage Will Be Paid By

**CAPITOL RADIO ENGINEERING INSTITUTE**

**Dept. 149-B, 3224 16th Street, N.W.**

**Washington 10, D. C.**

## AUDIO—HIGH FIDELITY

enforced at low frequencies. When multiple speakers are used, some caution is necessary. The combined efficiency of multiple speakers plus images can produce overpowering effects in most rooms and intolerable effects in some. I would not advise corner mounting if more than two speakers are used. And when more than two speakers are used I recommend stacking them vertically rather than lining them up horizontally close to the floor.

The most effective location is along the narrow side of rectangular rooms, for in this position the nodes of the room are most completely energized and directional effects minimized. However, when multiple speakers are used, these effects are not so important because of the higher efficiencies. In my own instance, the only practical location was in the middle of one of the long walls of a long narrow room—theoretically a poor location. Yet the results are exceedingly good.

A good way to probe a room is to use any small enclosure and move it around the room, noting the effect of each location on overall quality. The effects will be much the same in any position with multiple speakers, except that effects on the bass will be compounded several times. Be careful, therefore, not to choose a position which with a single speaker produces a very high bass or a boom or sets up standing waves in the room. When this is compounded by the additional efficiency of multiple speakers, it may be completely intolerable. But location in a room is not very important when multiple speakers are used, and it is fairly safe to choose the location most convenient for cutting into the walls.

One virtue of wall mounting is that it can be progressive. You can start with one speaker and improve the installation by adding others as the budget permits. It is wise when making the original installation, no matter how small, to provide for expansion by putting in a larger mounting board, re-enforcing the wall, etc.

### Combining speakers

The benefits of mutual coupling apply to any speakers, from the finest to the cheapest. The better the speakers the better the overall result. But a special virtue of this method is that amazingly good results can be obtained with fairly inexpensive ones. For example, I have used this method in my home for nearly 20 years. I started with two good-quality public-address type 12-inch speakers and later added a 5-inch tweeter. The results were spectacular by the standards of those days. I added two other speakers obtained at bargain sales and this combination was used until a few years ago and produced an overall quality superior to that of systems costing many times more.

Two years ago, two of the speakers were replaced with an RCA 515S2 with a notable improvement both in overall smoothness and in extension of the

# 10 MASTERPIECES

LONG-PLAYING 33 $\frac{1}{3}$  R. P. M. HIGH-FIDELITY

Complete to the last note!

# FREE!



## NO STRINGS ATTACHED!

No obligation to buy any other records—now or later.

**N**OW YOU can get a real start on a complete record collection. You get ALL TEN masterpieces—complete to the last note—and pay NOTHING but the cost of postage.

Of course, this sensational Free Offer bears no relation to the value of the recordings. These ten masterpieces would cost you many dollars at retail prices, in recordings of equal quality.

### Why We Make This Amazing Offer

We were FORCED to make this "give-away" offer . . . for only by putting our recordings in your hands can we convince you how extraordinary their tonal quality is. Performed by internationally-renowned orchestras, conductors, and soloists. Custom-pressed on the purest vinyl plastic. Reproduced with a fidelity of tone which encompasses the entire range of human hearing . . . 50 to 15,000 cycles!

**HOW CLUB OPERATES:** As a trial member, you are not obligated *ever* to buy any recordings from us. You do, however, have the right to try—free of charge—any of the Society's monthly selections which interest you. You receive prior notice of these. You pay nothing in advance. And you are not obligated to keep those you try . . . even after you have played them and read the interesting music notes which accompany each selection. You pay only for those which—*after having tried them*—you decide you really want to own. And for these, you pay only the low member's price of \$1.65 per long-playing disc, embodying on the average about 40 minutes of music by the great masters. *A saving of about 2/3 off the usual retail price!*

Think how much beauty and serenity these recordings will add to your life—at a trifling cost. Think what a cultural advantage your children will gain by having great music as an everyday inspiration.

### Mail Coupon Now

We obviously cannot keep "handing out" such magnificent long-playing recordings indefinitely. Production capacity limits the membership rolls; once filled, the offer has to be withdrawn. So avoid disappointment. Mail coupon with only 25¢ to help cover postage—today! *The Musical Masterpiece Society, Inc., Dept. 52-9 43 West 61st Street, New York 23, N. Y.*

**MOZART**  
Symphony No. 26 in E Flat, K. 184  
*Netherlands Philharmonic Orch.,  
Otto Ackermann, Conducting*

**BEETHOVEN**  
Piano Sonata No. 24 in F Sharp,  
Opus 78  
*Grant Johannesen, Pianist*

**BRAHMS**  
The Academic Festival  
*Utrecht Symphony,  
Paul Huppers, Conducting*

**BERLIOZ**  
The Roman Carnival  
*Netherlands Philharmonic Orch.,  
Walter Goehr, Conducting*

**VIVALDI**  
Concerto in C for  
Two Trumpets and Orchestra  
*Netherlands Philharmonic Orch.,  
H. Sevenster and F. Hausdoerfer,  
Trumpeters, O. Ackermann, Cond.*

**WAGNER**  
Die Meistersinger, Prelude, Act 1  
*Zurich Tonhalle Orch.,  
Otto Ackermann, Conducting*

**BACH**  
Tocatta and Fugue in D Minor  
*Alexander Schreiner at the Organ  
of the Tabernacle, Salt Lake City*

**DUKAS**  
Sorcerer's Apprentice  
*Utrecht Symphony,  
Paul Huppers, Conducting*

**MOUSSORGSKY**  
Night on Bald Mountain  
*Netherlands Philharmonic Orch.,  
Walter Goehr, Conducting*

**CHOPIN**  
Fantasia-Impromptu, Opus 66  
*Robert Goldsand, Pianist*

### Internationally Acclaimed!

"The recording is of such perfection it seems to bring the artists into your living room!"  
—*Glorious Sounds,  
Amsterdam, Holland.*

"Excellent series of records!"  
—*The Saturday Review, New York.*

The Musical Masterpiece Society, Inc. Dept. 52-9  
43 West 61st Street, New York 23, N. Y.

### ALL 10 MASTERPIECES—FREE!

I enclose 25¢ to help cover cost of postage. Please send me ALL 10 of the masterpieces listed above and enroll me as a trial member. Send me notice of future selections which I may try for 5 days without cost or obligation. For those future l.p. discs I decide to keep after I have tried them, I will pay only the special member's price of \$1.65 each, plus few cents shipping. I may cancel my trial membership at any time. This offer restricted to new Trial Memberships—only one sample package per family.

Name.....

Address.....

City..... State.....

In Canada address: 105 Bond St., Toronto 2, Ont.

# Sensational!

## Retract-O-Matic

— the new, foolproof replacement

### Pickup



Even if you drop it... or slide it...

### Retract-O-Matic protects records and needles from damage!

WEBSTER ELECTRIC proudly offers the new, exclusive RETRACT-O-MATIC—the sensational crystal pickup that provides positive protection to record and needle, even when it is dropped or slid across the record surface.

Retract-O-Matic is priced to make it a practical replacement for installation on any manual record player.

#### THE DOME ABSORBS THE SHOCK

The unique spring-mounted construction gives absolute insurance against damage to cartridge, needle, or record. The slightest pressure on the arm automatically lifts the needle from the record's surface, and lets Retract-O-Matic's rounded "dome" absorb the shock.

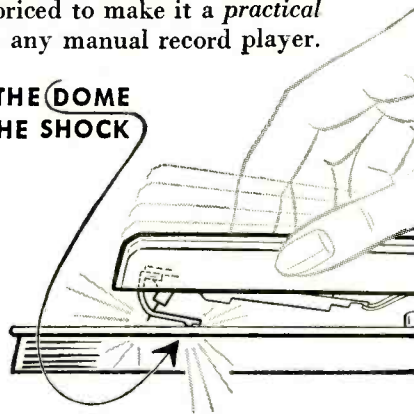

### A BIG PROFITABLE MARKET

Retract-O-Matic is a "natural" as a pickup replacement for record players, children's and portable phonographs. List price of complete assembly (tone arm, cartridge, arm rest and all parts needed for installation) is only \$6.95—little more than the price of the cartridge alone. Order a stock today. Step up your sales with Retract-O-Matic!

**WEBSTER ELECTRIC**  
RACINE WISCONSIN

### AUDIO—HIGH FIDELITY

bass. Since that time I have tried many combinations of very fine and cheap speakers. At the moment I am using a pair of Hartley 215's and an RCA LC1A. Down to 25 cycles I consider this to be equal in response and superior in definition to any horn I have ever heard. However, I have never obtained poor sound, even with the cheapest speakers.

In choosing speakers for multiple coupling apply these basic principles:

1. Use speakers as good individually as you can afford and particularly speakers with low resonant points. (However, I am not sure that the woofers designed for Klipsch type horns will work well in an infinite baffle of this type.)

2. Choose dissimilar speakers. Speakers of the same cone size but different make almost invariably differ in resonance and other characteristics.

3. Stagger the resonance of the speakers. Even if you use speakers with very low resonant points (30 to 45 cycles), it is preferable to have the resonant points of the different speakers vary by from 5 to 10 cycles. (I am presuming that the amplifier used will have a good damping factor to level the resonant peaks.)

Personally I prefer to use wide-range speakers without crossovers—except the blocking capacitor needed to protect a tweeter from low-frequency overloads. It is true that a single wide-range speaker will probably have more intermodulation distortion than a system of two or three speakers with divided frequency range. However, when multiple speakers are used, the individual speakers operate with higher efficiency and at a much lower output level and, therefore, the individual speakers operate over a much more favorable portion of their dynamic curve. Distortion is thus reduced. Elimination of crossovers also eliminates the phasing effects and the distortion produced by the crossover filters.

When it is necessary to limit the frequency range of any speaker, I prefer the simplest possible filter—a capacitor for tweeters and a series inductance for woofers. Unless the individual speakers used have an extremely wide range it will be necessary to add a tweeter or a super-tweeter to cover the upper octave or two. In such cases I use a capacitor chosen to produce rolloff at the low end close to the point where the main speakers begin to roll off at the high end, and an L or T pad to control the tweeter response.

If one or more of the speakers are coaxial or triaxial combinations with dividing networks, use the combination as one unit, paralleling it with other speakers or units.

The speakers are hooked up in series-parallel to make up a net impedance satisfactory for the amplifier in use. By varying the position of the individual speakers in the series-parallel



IT'S NEW  
IT'S POWERFUL

IT'S EFFICIENT  
IT'S COMPACT

IT'S STREAMLINED  
and IT'S PATENTED, TOO!

TRIO<sup>®</sup>  
Zephyr

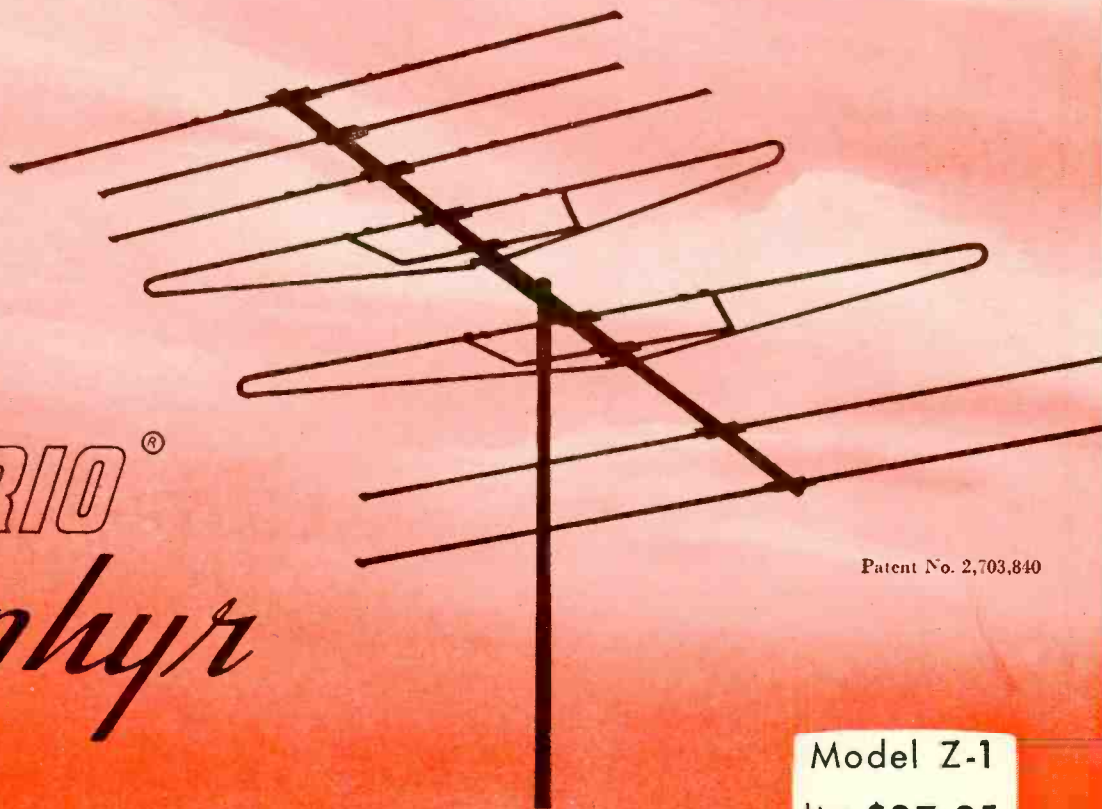

Patent No. 2,703,840

Model Z-1  
list \$27.95

Superior Performance      Fast Assembly  
Trio's recognized top quality construction

Uses Trio's  
Internationally  
Famous Insta-lok  
Clamps



Millions of Insta-loks used! Tested and proven  
to be the best, both here and abroad.

The Trio Zephyr gives top performance on all VHF channels with its revolutionary "Wing Dipole"—three half-wave elements in phase combined with an integrated director element makes each dipole a unidirectional antenna on the high channels.

The two driven elements are self-resonant to a different frequency and the elements are so spaced and so connected with respect to each other that during operation of the array on any one of the frequencies for which an element is resonant all of the elements are energized as active, or driven elements and at the same time each element is also operative as a parasitic element with respect to each of the other elements.

Single bay out-performs bulky stacked arrays but may be stacked in exceptional fringe areas.



**TRIO** Manufacturing Company  
GRIGGSVILLE, ILLINOIS

COPYRIGHT 1955—TRIO MANUFACTURING COMPANY

EXPORT SALES DIV., SCHEEL INTERNATIONAL INC., 4237 N. Lincoln Ave., Chicago, U.S.A. Cable Address: HARSHEEL

# Apply Your Electronics Experience

ENGINEERS AND  
PHYSICISTS WITH  
ELECTRONICS TRAINING  
ARE NEEDED TO  
CONDUCT CLASSROOM  
AND LABORATORY  
PROGRAMS ON ADVANCED  
SYSTEMS WORK IN THE  
FIELDS OF RADAR FIRE  
CONTROL, ELECTRONIC  
COMPUTERS, GUIDED  
MISSILES.

*The proper functioning of the complex airborne radar and computer equipment produced by Hughes requires well-trained maintenance crews in the field.*

At Hughes Research and Development Laboratories in Southern California engineers assigned to this program are members of the Technical Staff. As training engineers they instruct in equipment maintenance and operation for both military personnel and field engineers.

*Prior to assignment, engineers participate in a technical training program to become familiar with latest Hughes equipment. After-hours graduate courses under Company sponsorship are available at nearby universities.*

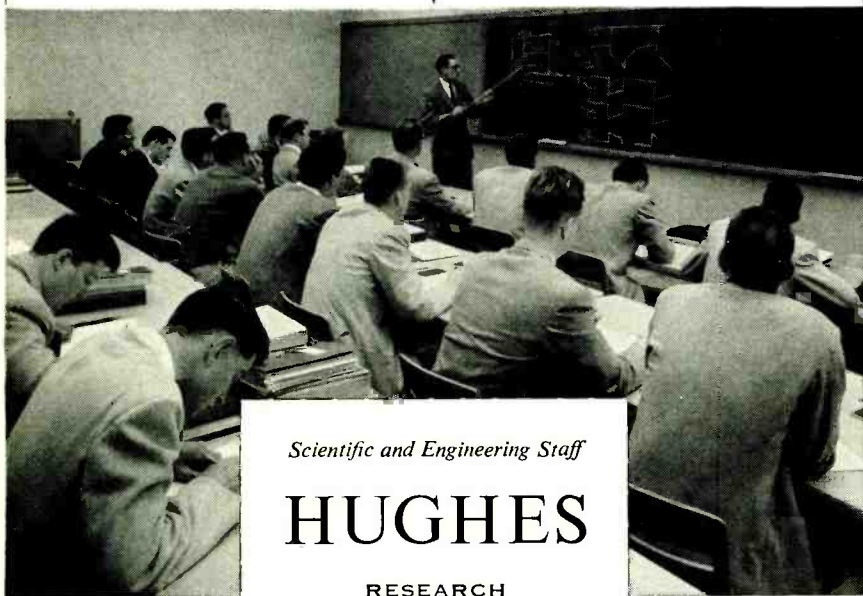

Scientific and Engineering Staff

## HUGHES

RESEARCH  
AND DEVELOPMENT  
LABORATORIES

Culver City, Los Angeles County, California

## AUDIO—HIGH FIDELITY

network, it is possible to proportion the input voltage to each speaker to match its sensitivity or to manipulate the frequency response. For example, just before using the LC1A and the Hartleys, I used an RCA 515S2, two 12-inch speakers of the PA type and a tweeter. These were hooked up as in *a* of Fig. 3. At one point I used an 8-ohm woofer, the two 12-inch speakers and a tweeter and hooked them up as in *b* of Fig. 3. The total impedance at mid-frequencies was about 6 ohms, but at low frequencies the woofer re-

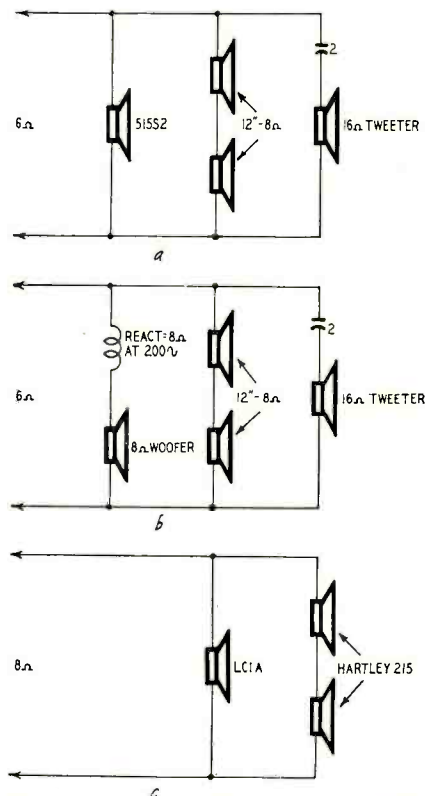

Fig. 3—Series-parallel arrangements.

ceived a higher proportion than the two 12-inch speakers. The present combination of the LC1A and the Hartleys is hooked up as in *c* of Fig. 3 so that the input is divided 50% to the LC1A and 50% to the two Hartleys.

The speakers have to be in phase, of course. This is easily adjusted by feeding the speakers through the amplifier with a low-frequency tone or manipulating amplifier and preamp controls to produce the highest hum and changing speaker leads to produce highest output.

The principle of mutual coupling can be applied to complete speaker systems. Thus two small bass-reflex systems can be stacked or used side by side to provide a considerable increase in bass efficiency. Two of the small K5 horns could be stacked in a corner, one above the other, to obtain an even more dramatic improvement.

In any case I commend the mutual-coupling principle to experimenters and engineers as well. Very little work has been done with it and its capabilities are far from explored. END



## How to hand yourself more business

Whenever you replace a tube, it's smart to hand the lady the CBS carton . . . and yourself more business.

It's smart because CBS tubes are advertised to *women* in Life, Good Housekeeping and on Arthur Godfrey's Talent Scouts.

And it's good business for you because *women* have greater confidence in CBS tubes . . . the tubes with the Good Housekeeping Guaranty Seal.

*There are no better tubes made than CBS tubes.*



**CBS-HYTRON**, Danvers, Massachusetts  
A DIVISION OF COLUMBIA BROADCASTING SYSTEM, INC.

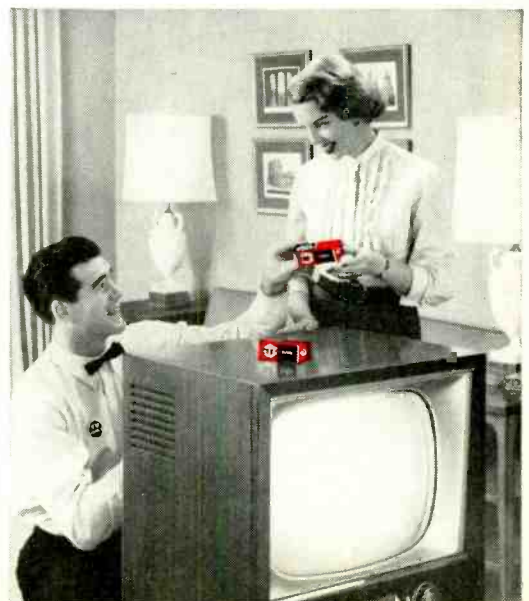

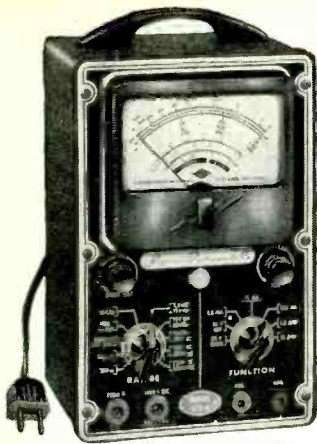

Measures 6 1/4" x 9 1/2" x 4 1/2"

Superior's new  
Model 670-A

# SUPER METER

A COMBINATION VOLT-OHM MILLIAMMETER PLUS  
CAPACITY REACTANCE INDUCTANCE AND DECIBEL MEASUREMENTS

**SPECIFICATIONS:**

D.C. VOLTS: 0 to 7.5/15/75/150/750/1,500/7,500 Volts  
A.C. VOLTS: 0 to 15/30/150/300/1,500/3,000 Volts  
OUTPUT VOLTS: 0 to 15/30/150/300/1,500/3,000 Volts  
D.C. CURRENT: 0 to 1.5/15/150 Ma. 0 to 1.5/15 Amperes  
RESISTANCE: 0 to 1,000/100,000 Ohms 0 to 10 Megohms  
CAPACITY: .001 to 1 Mfd. 1 to 50 Mfd. (Good-Bad scale for checking quality of electrolytic condensers.)  
REACTANCE: 50 to 2,500 Ohms 2,500 Ohms to 2.5 Megohms  
INDUCTANCE: .15 to 7 Henries 7 to 7,000 Henries  
DECIBELS: -6 to +18 +14 to +38 +34 to +58

**ADDED FEATURE:**

Built-in ISOLATION TRANSFORMER  
reduces possibility of burning out  
meter through misuse.

The Model 670-A comes housed, in a rugged crackle-finished steel cabinet complete with test leads and operating instructions.

**\$2840**  
NET



Superior's new  
Model TV-11

# TUBE TESTER

**SPECIFICATIONS:**

- ★ Tests all tubes including 4, 5, 6, 7, Octal, Lock-in, Peanut, Banlam, Hearing Aid, Thyatron Miniatures, Sub-miniatures, Novals, Sub-minars, Proximity fuse types, etc.
- ★ Uses the new self-cleaning Lever Action Switches for individual element testing. Because all elements are numbered according to pin-number in the RMA base numbering system, the user can instantly identify which element is under test. Tubes having tapped filaments and tubes with filaments terminating in more than one pin are truly tested with the Model TV-11 as any of the pins may be placed in the neutral position when necessary.
- ★ The Model TV-11 does not use any combination type sockets. Instead individual sockets are used for each type of tube. Thus it is impossible

to damage a tube by inserting it in the wrong socket.

- ★ Free-moving built-in roll chart provides complete data for all tubes.
- ★ Newly designed Line Voltage Control compensates for variation of any Line Voltage between 105 Volts and 130 Volts.
- ★ NOISE TEST: Phono-jack on front panel for plugging in either phones or external amplifier will detect microphonic tubes or noise due to faulty elements and loose internal connections.

The model TV-11 operates on 105-130 Volt 60 Cycles A.C. Comes housed in a beautiful hand-rubbed oak cabinet complete with portable cover.

**\$4750**  
NET

**EXTRA SERVICE** — The Model TV-11 may be used as an extremely sensitive Condenser Leakage Checker. A relaxation type oscillator incorporated in this model will detect leakages even when the frequency is one per minute.



## About Testing Picture-Tubes . . .

Of course you can buy an "adapter" which theoretically will convert your standard Tube Tester into a picture-tube tester. Sounds fine—but it simply doesn't work out that way! We do not make nor do we recommend use of C.R.T. adapters because a Cathode Ray Tube is a very complex device and to properly test it, you need an instrument designed exclusively to test C. R. Tubes and nothing else. As compared to a make-shift adapter, which sells for about five dollars, our Model TV-40

C.R.T. Tube Tester sells for \$15.85. But, if you believe that Television is here to stay, then you must agree that the difference in price is more than justified by the many years of valuable service you will get out of this indispensable instrument. Incidentally, the Model TV-40 is the ONLY low-priced C.R.T. Tube Tester, which includes a real meter. Neons are fine for gadgets and electric-line testers, but there is no substitute for a meter with an honest-to-goodness emission reading scale.

Superior's  
New Model  
TV-40

# C.R.T. TUBE TESTER

Tests ALL magnetically deflected tubes . . . in the set . . . out of the set . . . in the carton !!

- Tests all magnetically deflected picture tubes from 7 inch to 30 inch types.
- Tests for inter-element shorts and leakages up to 5 megohms.
- Tests for quality by the well established emission method. All readings on "Good-Bad" scale.
- Test for open elements.

**EASY TO USE:** Simply insert line cord into any 110 volt A.C. outlet, then attach tester socket to tube base (Ion trap need not be on tube). Throw switch up for quality test . . . read direct on Good-Bad scale. Throw switch down for all leakage tests.

Model TV-40 C.R.T. Tube Tester comes absolutely complete—nothing else to buy. Housed in round cornered, molded bakelite case. Only

**\$1585**  
NET

**SHIPPED ON APPROVAL  
NO MONEY WITH ORDER — NO C.O.D.**

Try any of the above instruments for 10 days before you buy. If completely satisfied then send down payment and pay balance as indicated on coupon. No Interest or Finance Charges Added! If not completely satisfied return unit to us, no explanation necessary.

MOSS ELECTRONIC DISTRIBUTING CO., INC.  
Dept. D-159, 3849 Tenth Ave., New York 34, N.Y.

Please send me the units checked. I agree to pay down payment within 10 days and to pay the monthly balance as shown. It is understood there will be no finance, interest or any other charges, provided I send my monthly payments when due. It is further understood that should I fail to make payment when due, the full unpaid balance shall become immediately due and payable.

Model 670-A.....Total Price \$28.40  
\$7.40 within 10 days. Balance \$3.50  
monthly for 6 months.  Model TV-11.....Total Price \$47.50  
\$11.50 within 10 days. Balance \$6.00  
monthly for 6 months.  Model TV-40.....Total Price \$15.85  
\$3.85 within 10 days. Balance \$4.00  
monthly for 3 months.

Name .....  
Address .....  
City..... Zone..... State.....

The Model  
TV-50

# GENOMETER

A versatile all-inclusive GENERATOR which provides ALL the outputs for servicing:

**A. M. Radio    F. M. Radio    Amplifiers    Black and White TV    Color TV**

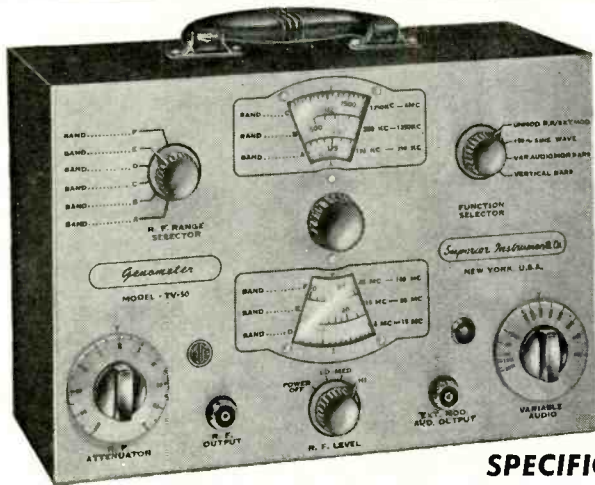

## 7 Signal Generators in One!

- ✓ R. F. Signal Generator for A.M.
- ✓ R. F. Signal Generator for F.M.
- ✓ Audio Frequency Generator
- ✓ Bar Generator
- ✓ Cross Hatch Generator
- ✓ Color Dot Pattern Generator
- ✓ Marker Generator

### SPECIFICATIONS:

#### R. F. SIGNAL GENERATOR:

The Model TV-50 Genometer provides *complete* coverage for A.M. and F.M. alignment. Generates Radio Frequencies from 100 Kilocycles to 60 Megacycles on fundamentals and from 60 Megacycles to 180 Megacycles on powerful harmonics. Accuracy and stability are assured by use of permeability trimmed Hi-Q coils. R.F. is available *separately*, modulated by the fixed 400 cycle sine-wave audio or modulated by the *variable* 300 cycle to 20,000 cycle variable audio. Provision has also been made for injection of any external modulating source.

#### VARIABLE AUDIO FREQUENCY GENERATOR:

In addition to a fixed 400 cycle sine-wave audio, the Model TV-50 Genometer provides a variable 300 cycle to 20,000 cycle peaked wave audio signal. This service is used for checking distortion in amplifiers, measuring amplifier gain, trouble shooting hearing aids, etc.

#### BAR GENERATOR:

This feature of the Model TV-50 Genometer will permit you to throw an actual Bar Pattern on any TV Receiver Screen. Pattern will consist of 4 to 16 horizontal bars or 7 to 20 vertical bars. A Bar Generator is acknowledged to provide the quickest and most efficient way of adjusting TV linearity controls. The Model TV-50 employs a recently improved Bar Generator circuit which assures stable never-shifting vertical and horizontal bars.

#### CROSS HATCH GENERATOR:

The Model TV-50 Genometer will project a cross-hatch pattern on any TV picture tube. The pattern will consist of non-shifting, horizontal and vertical lines *interlaced* to provide a stable cross-hatch effect. This service is used primarily for correct ion trap positioning and for adjustment of linearity.

#### DOT PATTERN GENERATOR (For Color TV):

Although you will be able to use most of your regular standard equipment for servicing Color TV, the one addition which is a "must" is a Dot Pattern Generator. The Dot Pattern projected on any color TV Receiver tube by the Model TV-50 will enable you to adjust for *proper color convergence*. When all controls and circuits are in proper alignment, the resulting pattern will consist of a sharp white dot pattern on a black background. One or more circuit or control deviations will result in a dot pattern out of convergence, with the blue, red and green dots in overlapping dot patterns.

#### MARKER GENERATOR:

The Model TV-50 includes *all* the most frequently needed marker points. Because of the ever-changing and ever-increasing number of such points required, we decided against using crystal holders. We instead adjust each marker point against precise laboratory standards. The following markers are provided: 189 Kc., 262.5 Kc., 456 Kc., 600 Kc., 1000 Kc., 1400 Kc., 1600 Kc., 2000 Kc., 2500 Kc., 3579 Kc., 4.5 Mc., 5 Mc., 10.7 Mc. (3579 Kc. is the color burst frequency.)

The Model TV-50 comes absolutely complete with shielded leads and operating instructions. Only .....

**\$47<sup>50</sup>**  
NET

**SHIPPED ON APPROVAL**  
**NO MONEY WITH ORDER — NO C.O.D.**

Try it for 10 days before you buy. If completely satisfied then send \$11.50 and pay balance at rate of \$6.00 per month for 6 months. **No Interest or Finance Charges Added!** If not completely satisfied return unit to us, no explanation necessary.

SEPTEMBER, 1955

MOSS ELECTRONIC DISTRIBUTING CO., INC.  
Dept. D-159, 3849 Tenth Ave., New York 34, N.Y.

Please rush me one Model TV-50. I agree to pay \$11.50 within 10 days and to pay \$6.00 per month thereafter. It is understood there will be no finance, interest or any other charges, provided I send my monthly payments when due. It is further understood that should I fail to make payment when due, the full unpaid balance shall become immediately due and payable.

Name .....

Address .....

City..... Zone..... State.....

Analyzing and eliminating  
this seagoing scourge

# BOAT

# ELECTROLYSIS

By ELBERT ROBBERSON

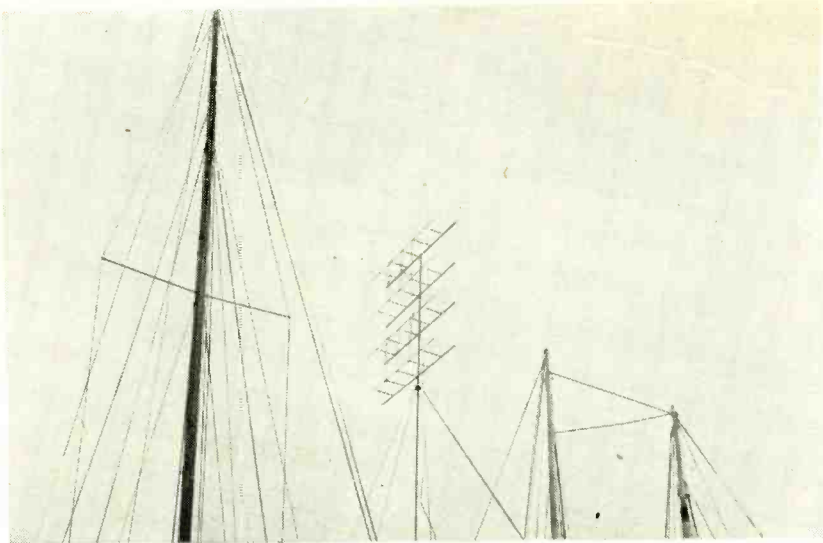

TV antennas between the main and mizzen.

YOU can find pleasure boats almost anywhere. And on these boats, TV masts are sprouting between the main and the mizzen. As a result, radio service technicians are called on for more and more marine electronic work. This is not restricted to marine radiotelephones. If you handle TV, record players, clock radios or battery chargers, some boatmen may call on you for service. The marine market is good, *provided you're checked out on electrolysis*. If not, it can be dangerous. A mistake can sink a boat!

As applied to marine electronics, electrolysis is the decomposition of underwater metal by an electric current. While this condition is most prevalent in salt water, action can also take place in dirty or polluted fresh water. "But all I'm going to do is install a TV set," you say. "How am I involved?"

One of the peculiarities of boat installations is that no matter what kind of electronic equipment you bring aboard, there is a chance that what you do *can* cause electrolysis. And in any event, boatmen are inclined to blame any underwater corrosion on the last piece of electronic gear installed. So if all you do is to sell some skipper an electric razor, if a dirty spot shows up on the boat's propeller you may be called upon to defend the razor and your knowledge of matters marine.

Shipboard electrolysis is of two kinds, which for the sake of simplicity we will call *natural* and *forced*. We are concerned with both of them.

*Natural electrolysis* occurs when two dissimilar metals are placed underwater and then provided with a connection for current flow. The amount of electrolytic activity depends upon the position of the metals in the Galvanic series shown in the table. The farther apart in the series a pair of metals

are, the greater the action between them. Of any two metals in such a combination, the higher one on the list will corrode.

The action can be shown with a simple cell composed of a copper and a galvanized-iron electrode immersed in sea water. The open-circuit voltage of such a cell is about 0.7 volt. When the two electrodes are connected together by a low-resistance conductor, a current of several milliamperes per square inch will flow between them, and the galvanized iron wastes away. Disconnect the electrodes, and the flow of

current and deterioration of the "base" metal electrode will no longer continue.

*Forced electrolysis* is caused by the external application of voltage between underwater metals. With a battery of only 6 volts connected between two underwater boat fittings, the one on the positive side of the battery begins to disappear at an alarming rate—25% per hour is not uncommon. If the disappearing metal belongs to an underwater fitting such as an engine cooling-water intake, water soon starts coming into the boat. In time, it could sink. Knowing this to be the case, you might think anyone would be stupid to connect a battery between any underwater metals. But if you aren't acquainted with some of the peculiarities of small-boat electrical hookups, accidents such as battery cross-connection are easy.

## Natural electrolysis

This form will attack any metal exposed to weather or in contact with water. Any metal, such as antennas, guys, ground plates and fittings, installed under these conditions must be noncorrosive in a salt solution. This rules out using any material such as iron or untreated aluminum, which rusts or corrodes by itself. (Anodized aluminum, galvanized iron are treated to resist corrosion.)

Use only materials which the manufacturers will certify for salt water. The usual hardware-store brass does not qualify. The reason is simple: brass is compounded of copper and zinc. Copper is noble, zinc is base. And as soon as the alloy is wet the closely connected molecules start acting like a battery of zinc-copper cells. De-zincing takes place rapidly, and the metal turns into a soft reddish mass you can cut with a fingernail.

Fastenings are most critical because they can least afford to lose any metal.

### METALS IN GALVANIC SERIES\*

Corroded end (anodic,  
or least noble)

Magnesium  
Magnesium alloys

Zinc

Aluminum 2S

Cadmium

Aluminum 17ST

Steel or iron

Cast iron

Chromium-iron (active)

Ni-Resist

18-8 stainless (active)

18-8-3 stainless (active)

Lead-tin solders

Lead

Tin

Nickel (active)

Inconel (active)

Brasses

Copper

Bronzes

Copper-nickel alloys

Monel

Silver solder

Nickel (passive)

Inconel (passive)

Chromium-iron (passive)

18-8 stainless (passive)

18-8-3 stainless (passive)

Silver

Graphite

Gold

Platinum

Protected end (cathodic,  
or most noble)

\*Groups of metals indicate they are closely similar in properties.



Formerly galvanized shackle was connected to a stainless-steel mooring pennant for one season—blamed on technician.

Use only certified marine fastenings, such as marine bronze, "Everdur," "Monel" or stainless steel. They are more expensive and they may be hard to get in some localities, but they won't pull apart in your hands a month after they are installed on a boat.

Some electronic installations require a ground. This is often done by a connection to the boat's engine, with its cooling-water inlet, the propeller shaft and "wheel" furnishing the required path to "earth." For a better ground, a "ground plate" is fastened on the hull.

Ordinarily, using an engine ground will have no effect on any natural electrolysis which may be going on. If something was dissolving before you brought your gear aboard, it will go on dissolving. A bronze propeller will continue to lose metal to a Monel shaft; iron fittings will give away material to almost anything else around and brass screws will keep on disappearing.

But installing a ground plate on the bottom of a boat can somewhat disturb existing relations. Most underwater metal, such as water scoops, outlets, propellers, rudder fittings, etc., are cast or forged of some alloy. Even the best alloys are not absolutely homogeneous—pockets of impurities are scattered throughout the smoothest-appearing metal. When these impurities face only a small amount of other metal in water, decomposition is slow. But place a pure copper ground plate of several feet area close by, connect the system together electrically and the loss of base metal will accelerate. The closer nonhomogeneous metal is to the ground plate, the more rapid decay will be.

This effect is seldom extensive or rapid enough to cause damage. However, it will cause surface pitting and discoloration, depending upon the amount of impurities involved. Usually, the main effect is psychological. The boatman, knowing that electrolysis can be dangerous, will be upset to find any traces of increased activity.

The magnitude and direction of ground-plate current can be measured with a milliammeter. Although the relation of metal transfer to current

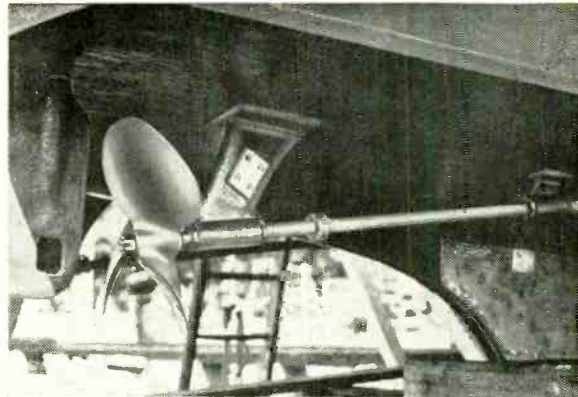

Typical electrolysis "protector" installation with zinc blocks on propeller strut, ground plate and zinc collar on shaft.

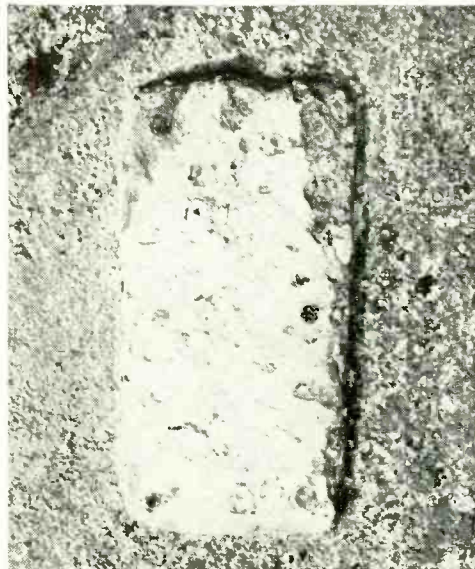

Badly eroded zinc block after much use.

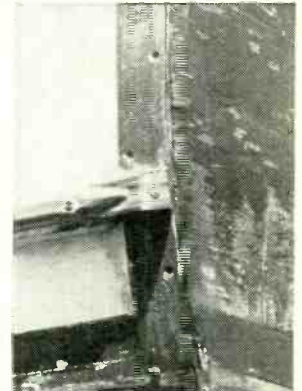

Screws missing from stern—the result of electrolysis between dissimilar metals.



Electrolysis in poor alloy propeller.

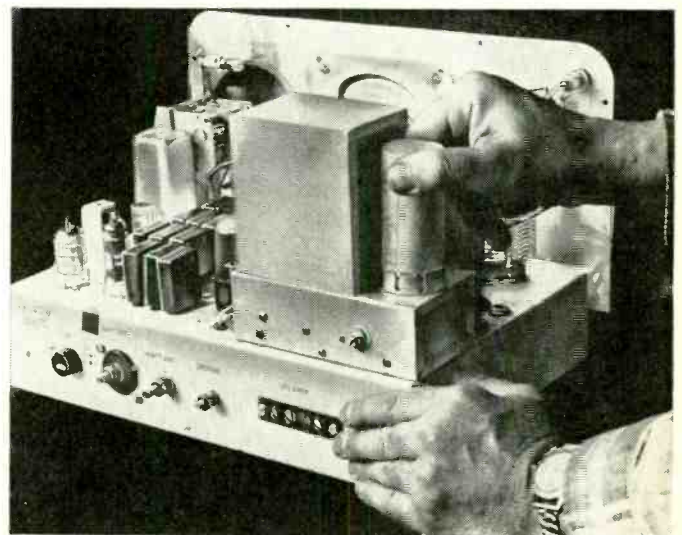

Polarity-sensitive marine equipment such as this radiotelephone can be adapted for boat's ground by reversing vibrator.

150 field tests have proved to  
WARD jobbers:

- \* Good VHF picture at as far as 200 miles on several channels
- \* Excellent results at 100 miles
- \* Good results in areas where no other antenna was able to bring in a picture
- \* More compact—25%-75% less stacking distance
- \* Channel 2-13 response as much as 40% better than any comparable antenna
- \* Unique superior snap-lock bracket
- \* Original WARD design all aluminum supplemented spring pressure bracket—eliminates possibility of intermittent contact

TRY ONE—you'll find why the Invader is superseding all fringe and super-fringe antennas.

WARD Model TVS 356 2 bay and stacking harness \$39.95 list

WARD Model TVS 357 4 bay stacking kit (feed harness only) \$3.95

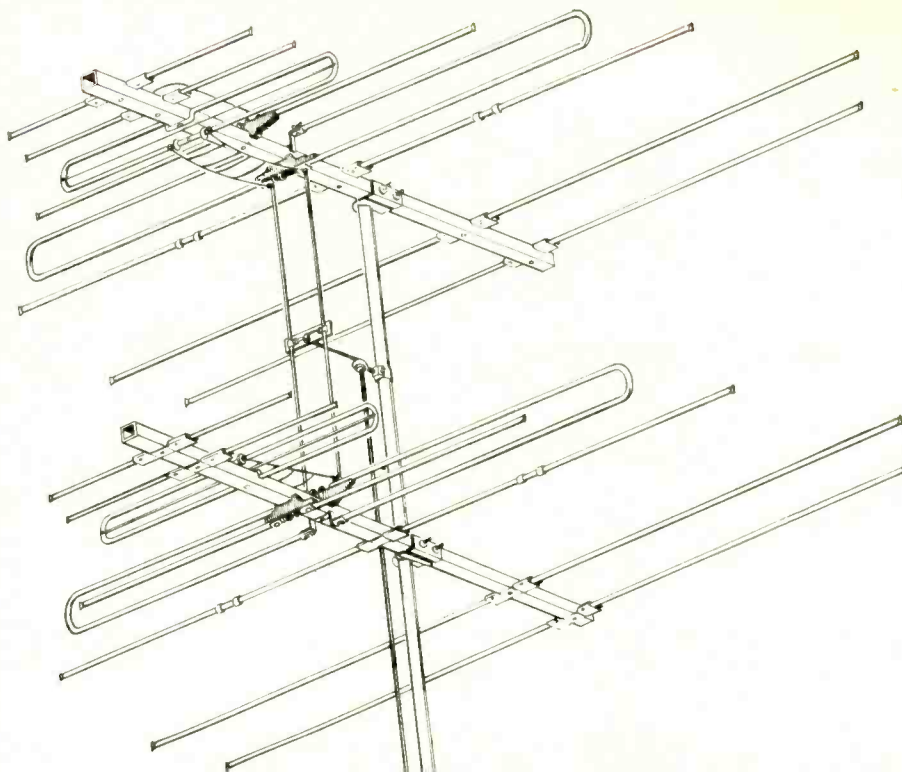

# THE INVADER\* CONQUERS

sweeps all other fringe and super-fringe antennas before it

\* an original WARD design

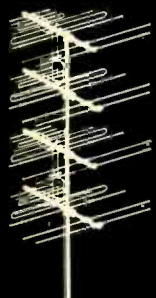

flat type Uni-plane Yagi for fringe area VHF and primary signal area UHF.

\* Documental testimonials in our files



# WARD

Products Corp., Cleveland 15, Ohio

[www.americanradiohistory.com](http://www.americanradiohistory.com)



# NO DUST CATCHERS

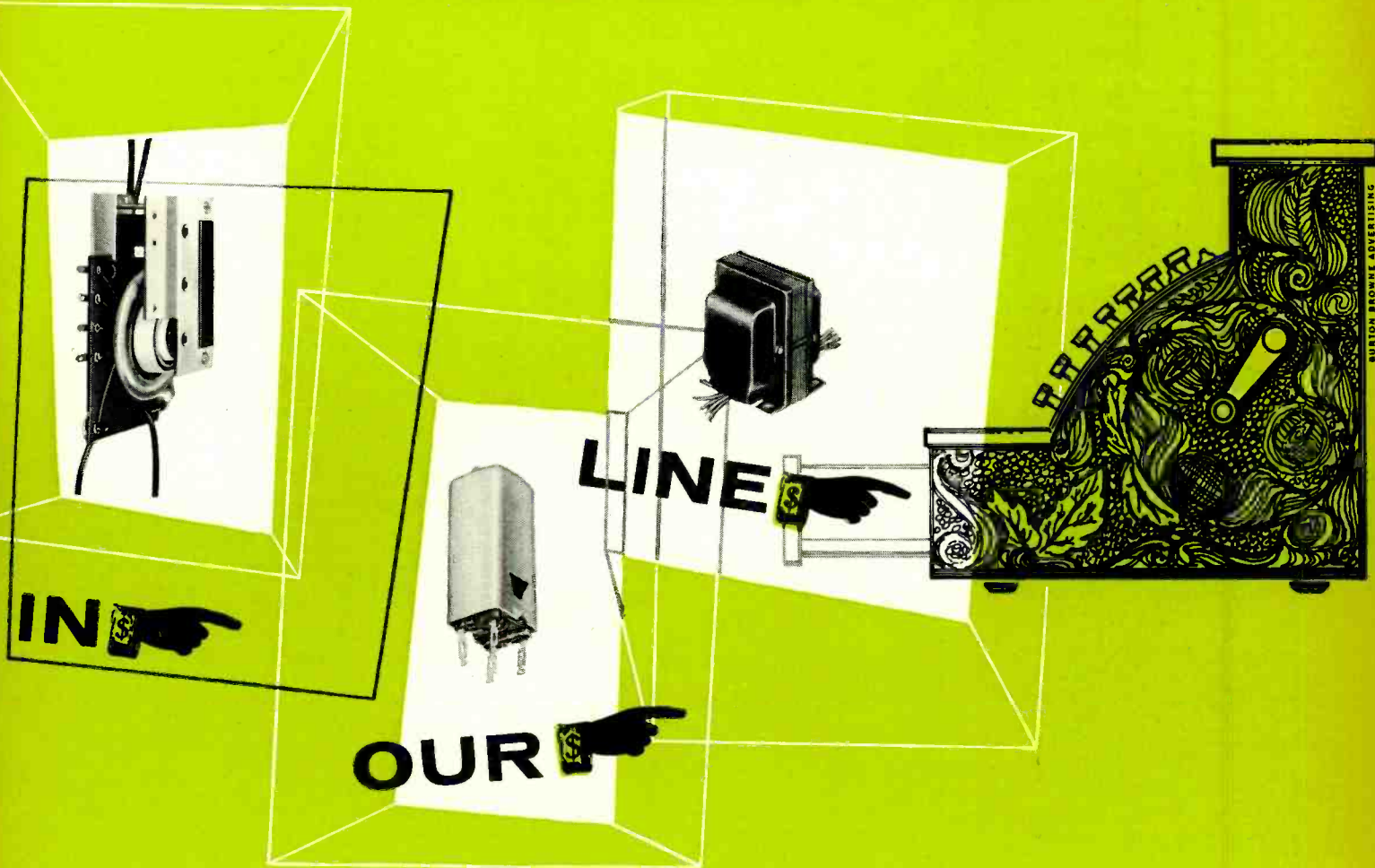

... 101 new items added in the last 300 days keep Merit's line of coils and transformers *the most complete* replacement line in the TV-Radio field ... and that's why more and more servicemen come to Merit for their "Single Source"!

Merit products are listed in Howard Sam's Photofacts and Counter Facts.



MERIT COIL & TRANSFORMER CORPORATION  
4427 North Clark Street, Chicago, Illinois

# Handle Tough Service Jobs

AS "SLICK" AS YOU DO THE EASY ONES!

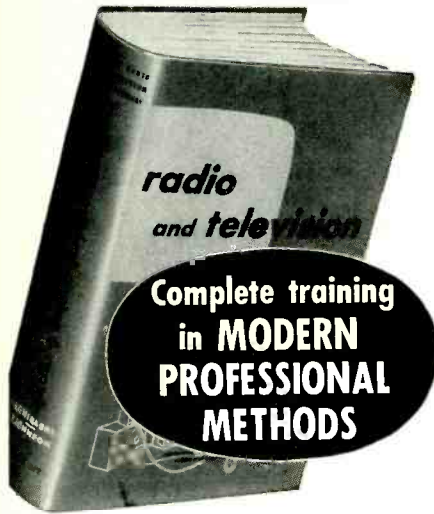

**FIX ANY RADIO OR TV SET EVER MADE . . .**

**Easier . . . Better . . . Faster**

How to trouble-shoot the professional way

AM, FM and TV realignment made easy

Testing tips and ideas

A complete guide to TV service

Component problems and how to solve them

Special problems in Battery Sets, Communications Receivers, Recorders, etc.

Servicing, tuning and switching mechanisms.

...and dozens of other subjects

Owning this big, up-to-the minute book is like having two of the world's greatest electronic experts standing by your side on every job . . . telling you just what to do, exactly how to do it!

Written by Ghirardi and Johnson, Radio & Television TROUBLESHOOTING AND REPAIR is a complete guide to modern professional methods . . . the kind that pay off big.

Step by step, it takes you through service procedures . . . from locating troubles fast and with less testing to making repairs accurately and promptly.

For beginners, this giant book is a complete service training course . . . at only a fraction of the price you might expect. For experienced servicemen, it is the ideal way to "brush up" on specific jobs; to develop better methods and shortcuts; and to find quick answers to problems that will enable you to handle tough jobs as fast and accurately as you now handle the easy ones.

Contains 820 big pages. Over 400 pictures, diagrams and charts make things doubly clear.

Remember! More men now in good servicing jobs get their training from Ghirardi books than any others of their type . . . and this new book is the latest and greatest of them all! Practice from it for 10 full days AT OUR RISK!

## EXAMINE IT FREE!

Dept. RE-95, RINEHART & CO., Inc., 232 Madison Ave., New York 16, N.Y.

Send Ghirardi's new Radio & TV TROUBLESHOOTING AND REPAIR book for 10-day FREE EXAMINATION. If I decide to keep book, I will then promptly remit \$6.75 (plus a few cents postage) in full payment. If not, I will return book postpaid and owe you nothing.

Name \_\_\_\_\_  
Address \_\_\_\_\_  
City, Zone, State \_\_\_\_\_

OUTSIDE U.S.A.—Price \$7.25 cash with order. Money back if book is returned within 10 days.

Rinehart Books are sold by leading book stores

## ELECTRONICS

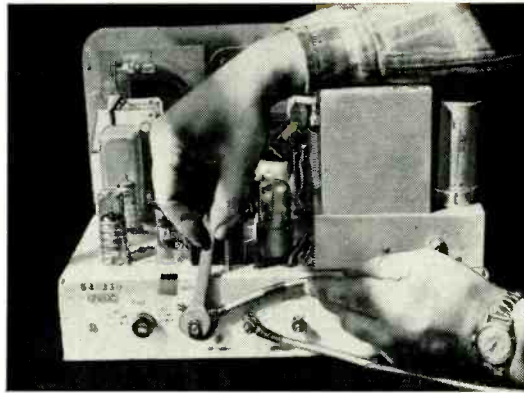

Cross-connections can be avoided by using distinctive marking for "hot" supply wires. In this unit a tape square is used.

flow varies with electrode composition, an idea of the safe limits may be gained from the fact that a typical fitting tested showed a weight loss of about .00005 ounce per milliamperes per hour: a rate of 1 ounce per 2 years of constant action. A current of a few milliamperes is common and won't harm reasonably heavy fittings for years.

Many attempts have been made to devise a method for reducing natural electrolysis. The seriousness of the problem is pointed up by the fact that during one stage of shipbuilding evolution electrolysis would eat whole rows of rivets out of ship bottoms, even causing ships to drop plates! One of the remedies attempted, still with us, is the use of a zinc (or now that the newer metals are plentiful, aluminum and magnesium) "protector" (see photo) in the form of a plate, collar or cap. Having higher electrolytic activity than other nearby metals, the protector is intended to divert activity to itself, absorbing the major flow of current.

There is little evidence that such protectors divert much more than the viewer's attention by their extreme deterioration, but you will find boats with zinc plates plastered all over the hull and its fittings. Naturally, if you install a copper ground plate, base metal facing it in the water is going to disappear faster. The owner will become greatly alarmed. You might have to convince him that the easiest way to keep the zinc plates from disappearing so fast is to leave them on the hardware store's shelf.

### Forced electrolysis

The most spectacular form of electrolysis is the kind forced by externally applied voltage. Accidents leading to this condition are due to the fact that one side of the battery is almost invariably grounded. In performance, ground polarity makes no difference. And in safety from electrolysis, the ground polarity is likewise unimportant—as long as every other device connected has the same ground polarity.

All ground returns must be heavy enough to prevent voltage drops from appearing between grounded points. To prevent insulation failure from making things "hot," motor frames, shells of fixtures and any metal which can con-

tact the water should be bonded to the main ground with wire of at least No. 10 gauge. Of course, this connection can cause a new flow of natural electrolytic current which did not exist before, but the small amount of metal deterioration from this activity is a low price to pay for protection against the much more dangerous possibility of battery current between underwater fixtures.

While the electrical equipment on small boats operates from the engine battery, larger vessels carry auxiliary battery banks of 12, 32 or 120 volts, charged by a separate engine-driven generator. The auxiliary system is usually grounded on the negative side, but installations will be found where the opposite is the case. The largest vessels usually are more wisely designed, with an underground or "floating" electrical system.

Twin-engine boats will have two identical engine electrical systems, with the above auxiliary system. However, twin-engine boats will also be found with the positive side of one engine battery and the negative side of the other grounded. This gives 12 volts between the "hot" sides of the two batteries for lights and accessories. With this circuit, the electrical midpoint of the system is connected to the boat's ground.

The main thing for the electronics technician is to make sure what ground polarity the boat uses. Then, if the equipment has one side of the input circuit grounded, the polarity must agree with that of the vessel. In boats having the battery midpoint grounded, neither side of the auxiliary equipment's input can be grounded for d.c.

Most equipment with grounded input can be modified for either ground polarity by reversing switches, turning vibrators around in their sockets or by wiring changes. Any equipment that can or must be grounded, but which cannot conform to the boat's ground polarity, is unsafe.

You can test for cross-grounds and stray battery current which might cause electrolysis. Turn off everything electrical aboard. Disconnect one lead at the battery post, then insert an ammeter in the circuit at this point. A volt-ohm-milliammeter having a 10-amp range is best for this purpose. If no current flow shows on the 10-amp

Packed with  
**P D Q**



**New!**

**Model U-98**—fully automatic—it's built for the future!  
—incorporates 32 distinct improvements (15 engineering, 17 design and mechanical)—eliminates all arcing and consequent picture distortion—points directly, positively, instantly to target station—"just set it and forget it!"  
List Price **\$39.95**

**New, Improved ALLIANCE TENNA-ROTORS**

- P**erformance  
perfect synchronization,  
perfect alignment.
- D**esign  
years-ahead styling,  
harmonizes anywhere.
- Q**uality  
precision manufacture,  
strictest production control.

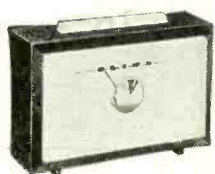

**New!**



**Model T-12** (formerly T-10) — many major improvements in this popular unit—needle stays in position—you always know where antenna points—highly accurate . . . List Price **\$29.95**

**Model K-22**—"economy" model. Product of the same famous Alliance precision manufacture. Neat, compact, modern design. Finger-touch control. Unequaled value! . . . List Price **\$19.95**



**Model BY-90**—the recognized quality converter built for top performance, long, trouble-free service. Superior reception . . . List Price **\$29.95**

**ALLIANCE UHF CONVERTERS**



**Model UC-2**—practically automatic! Single, simple control provides continuous tuning. Modern decorator styling. List Price **\$24.95**



**Model UC-1**—"hideaway" model — mounts out of sight on back of set. Only slide rule tuning dial shows slightly. List Price **\$18.95**

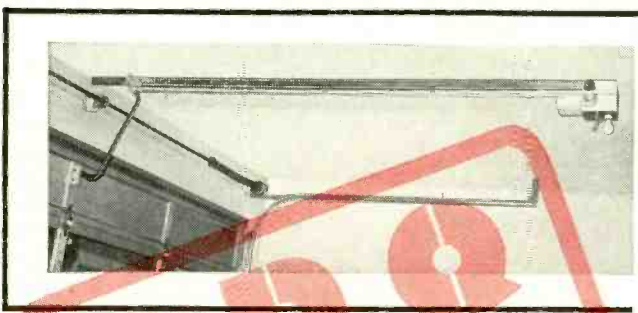

**Alliance Genie**  
**AUTOMATIC GARAGE DOOR OPERATORS**

A "natural" for TV-dealer sales! Watch customers gleam when you tell them how inexpensive "push-button operation" really is! The Alliance **GENIE** Lift-A-Dor is the first, low-cost, quality, automatic operator. Opens, closes, locks, unlocks garage door, turns lights on or off! Long-life, trouble-free, comes pre-assembled, factory-tested. Many exclusive features. List Price from **\$69.95** to **\$219.95** plus installation.

**PUSH ALLIANCE PRODUCTS**  
*"known in every TV home"*  
**FOR PDQ PROFITS**

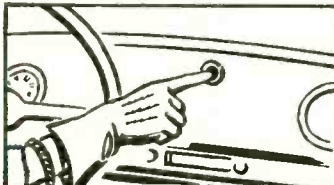

**Radio Control**—operates from push-button on car dash.

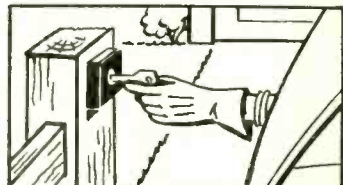

**Key-Switch Control**—operates from driver-level box.

**ALLIANCE MANUFACTURING COMPANY • Alliance, Ohio**

# how to use probes for better servicing

**This brand new Gernsback Library Book—the biggest we have ever published, tells you how to use probes for better servicing with today's complex test instruments.**

PROBES is the most complete book on the subject. Written by a probe manufacturer and a teacher-engineer, it pools their knowledge and the actual experience of service technicians, to tell you how probes are designed, what the various types can or can not do, and when, where and how to use each type. Construction details on building your own, if you so desire. And for the first time in any book, details on a transistorized model.

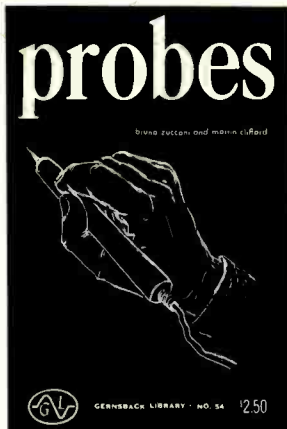

**PROBES.** By Bruno Zucconi and Martin Clifford. Gernsback Library Book No. 54. 224 Pages. Over 200 illustrations. Paper cover. **\$2.50**

## Some of the things you'll learn from this book

Crystal demodulator probes • Classifications and advantages • Working with crystal probes • Signal tracing • Alignment • Testing video amplifiers • Voltage-doubler probes—advantages and limitations

• Peak-to-peak probe • Color TV testing • Balanced probes • TV boosters • Low-capacitance probes • Design and construction of probes • Effect on meter • Isolation and direct calibration • Spe-

cialized probes • Audio tracer • Hum probe • Transistor probe • Chromatic probe • Probe circuits • Vacuum-tube probes • Signal tracer for AM, FM, TV • Television wave-

## GET YOUR COPY AT YOUR PARTS DISTRIBUTOR

### HARD COVER EDITION NOW AVAILABLE

*A limited quantity of PROBES in a deluxe, handsomely bound gold leaf stamped hard-cover edition is now available by mail order only. \$4.00 postpaid. Please use coupon below.*

mail this coupon today

**GERNSBACK PUBLICATIONS, Inc.**  
DEPT. 95A  
25 West Broadway  
New York 7, N.Y.

Gentlemen:

- Please send me postpaid a copy of the deluxe, hard-cover edition of PROBES. My remittance of \$4.00 is enclosed.
- Send me full details on how I can save money on technical books with the new Gernsback Library Club Plan.

NAME..... PLEASE PRINT

STREET.....

CITY..... ZONE..... STATE.....



### SAVE MONEY ON THIS NEW BOOK CLUB PLAN

Now—a practical, thrifty way for you to get the latest and best books on every phase of servicing—just as they roll off the press! Each book is a big, handsomely bound hard-cover volume which regularly sells for \$4.00 and up. But club members can get them for as little as \$2.98 each—a saving of over 25%! Memberships open now! Keep up with the latest servicing methods and techniques. Take advantage of this unique club plan now. Send in the attached coupon for full details.

Publishers of  
**RADIO-ELECTRONICS**

## ELECTRONICS

range, drop down to the 500-ma range. If no current shows, drop down again and continue until the scale is reached where leakage current can be measured. There will usually be some leakage, except in a very new and dry boat. The importance of battery leakage depends upon the current flow, just as in the case of natural electrolysis measuring, described earlier. A few milliamperes won't harm anything—but leakage above a very small value should be traced and eliminated, if possible. Leakage of a good fraction of an ampere or whole amperes means danger—disconnect at once and find the cross-connection before a diving suit is needed!

Modern "marine living" has spawned large fleets of boats using shoreline a.c. while they are tied to the dock. Battery chargers, vacuum cleaners, TV sets and hi-fi systems are only a few of the devices used on such boats. Great care must be used not to ground any part of such equipment's circuits unless the gear is specifically engineered for marine service.

An example of dangerous equipment is a battery charger using an auto-transformer to step the line voltage down to battery level. Connect the charger output to boat batteries, and a.c. up to 117 volts will appear between underwater boat fixtures and the shore. It won't take long for massive destruction of metal to take place! Such equipment must have an isolating transformer.

Another example is the usual radio or TV, which has noise-filter capacitors between the a.c. input and the chassis. These capacitors form a voltage divider, placing the chassis one-half the line voltage above ground. Connecting the chassis to a boat ground puts about 50 volts underwater where it shouldn't be. Ground connections required for such devices should be made only through a mica capacitor just big enough to pass the desired r.f. current.

The a.c. ground currents can be measured in the same manner as d.c. currents. Use the procedure described, with an a.c. meter for heavy flow and an a.c. (or the r.f. variety will work very well) milliammeter to check for smaller currents. If a.c. flow of sizable proportions is detected, the source should be localized and stopped off.

A peculiar case can exist where a well-bonded and blameless boat can lie adjacent to a boat or a dock having improperly grounded a.c. fixtures. Current flowing through the water from the "culprit" can pass through the fittings and ground system of the blameless boat on its path to shore and cause electrolysis. This can be detected by an a.c. reading of ground-plate current. If such a condition is found, the only remedy is to move to a safer location.

The whole matter of preventing electrolysis amounts simply to the prevention of the flow of current through an electrolytic path. On a boat, this means current through the water. Prevent this flow by any means available, and the boat's metal will stay in place. END

# Telrex THUNDERBIRDS

**CONQUERORS  
OF DISTANCE!**

**HI-STRENGTH ALUMINUM,  
QUICK-RIG CONSTRUCTION**

*For high performance,  
low cost, permanent installation,  
choose a Telrex "Thunderbird"—*

TELREX  
MODEL T-120

**For  
All-Channel TV!**



- DUPLEXED ELEMENTS FOR MAXIMUM GAIN
- COMPENSATED "TROMBONE" MATCHING SECTIONS FOR MAXIMUM EFFICIENCY
- FULL VIDEO, AUDIO BANDWIDTH FOR MAXIMUM BLACK AND WHITE AND COLOR FIDELITY

The new Telrex "THUNDERBIRD" multi-element wide-band Beamed Power arrays are engineered for fringe and "sub-fringe" area reception, and for all receiving conditions requiring exceptionally good directivity and high sensitivity.

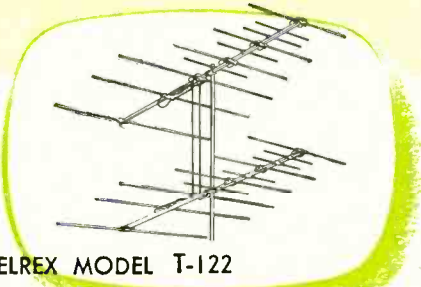

• TELREX MODEL T-122

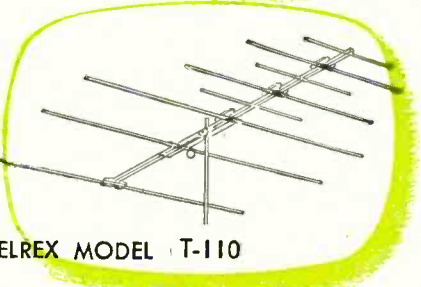

• TELREX MODEL T-110

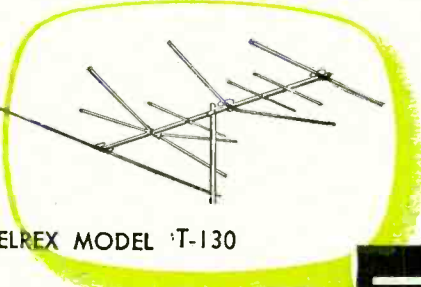

• TELREX MODEL T-130

Producers of famous "BEAMED POWER" Communication Rotaries. Call or write for new catalogs on TV Antennas, Commercial Arrays or Amateur Rotaries.

Super Thunderbird Model T-120 is the finest wide-band, multi-element array ever developed. A system of variable impedance phasing loops permit precision tuning and the duplexing of element functions to provide the equivalent of 6 operating elements on the LO channels; 13 elements on the HI channels. Element for element, they develop greater gain and directivity than many single channel arrays. Model T-120 is accurately matched to 200-300 ohm transmission line for both HI and LO channels with compensated "trombone" sections to yield exceptionally high gain and optimum signal transfer efficiency. LO band gain averages better than 5.5 db; HI band gains exceed 12 db, while front-to-back ratios range to 25 db.

For brilliant, interference-free signals under toughest reception conditions, choose the Telrex Super Thunderbird T-120! Available also in 2 bay units—Model T-122, 1/4-wave stacked for gain increases averaging 3 db on all channels; and Model T-122S, 1/2-wave stacked to provide gain increases up to 4.5 db on LO channels, over single bay units.

Thunderbird Model T-110 incorporates all the high-performance features of the Super Thunderbird T-120 including variable impedance loop phasing, compensated "trombone" matching sections and in-line low wind resistance configuration plus high strength, all alu-

minum, quick-rig construction for dependable, high performance, low cost, long lasting installations. Duplexed elements are equivalent to 5 effective elements on LO channels for average gains exceeding 5 db; and 11 operating elements on the HI channels for gains exceeding 10 db. Front-to-back and front-to-side ratios of better than 22 db minimize interference.

Available stacked 1/4-wave, Model T-112, for all channel gain increases of 3 db; and 1/2-wave stacked, Model T-112S, for increased gains to 4.5 db on LO channels.

Thunderbird T-130 employs Conical Dipole and "V" Beam quadrature phased driven elements to achieve virtually flat, stepless gain characteristics on all VHF channels with minimum number of elements. Model T-130 also employs variable impedance phasing loops, duplexed elements and Telrex compensated "trombone" matching sections. Four effective LO channel elements; 9 operating elements on HI channels, produce gains to 5 db on 2-6, and up to 11 db on channels 7-13. Special trap circuitry used in all Thunderbirds, attenuates interference arising outside the assigned TV bands to assure crisp, smear-free picture quality and full sound response.

Model T-132, stacked 1/4-wave gives average gain increase of 3 db on all channels; 1/2-wave stacked Model T-132S provides up to 4.5 db gain on LO channels over single bay.



ASBURY PARK 9  
NEW JERSEY, U.S.A.  
Tel. Prospect 5-7252

Canadian Distributor:  
DELHI METAL PRODUCTS,  
LTD., Delhi, Ontario

\*"Conical-V-Beams" are produced under U. S. Patent No. 23,346, Canadian Patent No. 500,436 and British Patent No. 691,485 — other patents pending. Sold only through authorized distributors.

# Giant Paraboloid Detects Radio Stars

*Huge "telescope" detects signals from the far reaches of the universe*

By R. HANBURY BROWN\*

**M**OST of man's knowledge of the universe has been gained by the use of his eyes. The human eye is sensitive to electromagnetic waves of lengths between about  $7 \times 10^{-5}$  cm (red) and  $4 \times 10^{-3}$  cm (violet). We can see the sun and the stars because waves of this length are transmitted through the earth's atmosphere with little loss. Fig. 1 shows how the transmission through the atmosphere varies with wavelength. There are two main bands in the spectrum through which electromagnetic waves can reach the earth from outer space. The first band extends from ultra-violet waves through the region of visible light to the infra-red. At each end of this band the transmission is shut off by absorption in the earth's atmosphere. The second band lies in the region of radio waves and extends from waves of about 1 cm to about 60 meters in length. This band is bounded at the shortwave end by absorption in the water vapor and other gases of the earth's atmosphere, and at the long-wave end by absorption high up in the ionosphere.

In 1932 Karl Jansky, working on atmospherics at the Bell Telephone Laboratory, discovered that radio waves are reaching the earth from outer space and that they apparently originate in the Milky Way. This discovery pointed the way to a new branch of science now called "radio astronomy." Today, radio astronomers are exploiting the radio "window" through the earth's atmosphere to gain new knowledge of the

\*Jodrell Bank Experimental Station, Crewe, Cheshire, England.

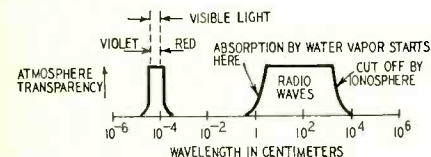

Fig. 1—Diagram shows transmission of electromagnetic energy in atmosphere.

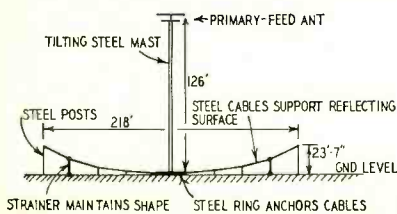
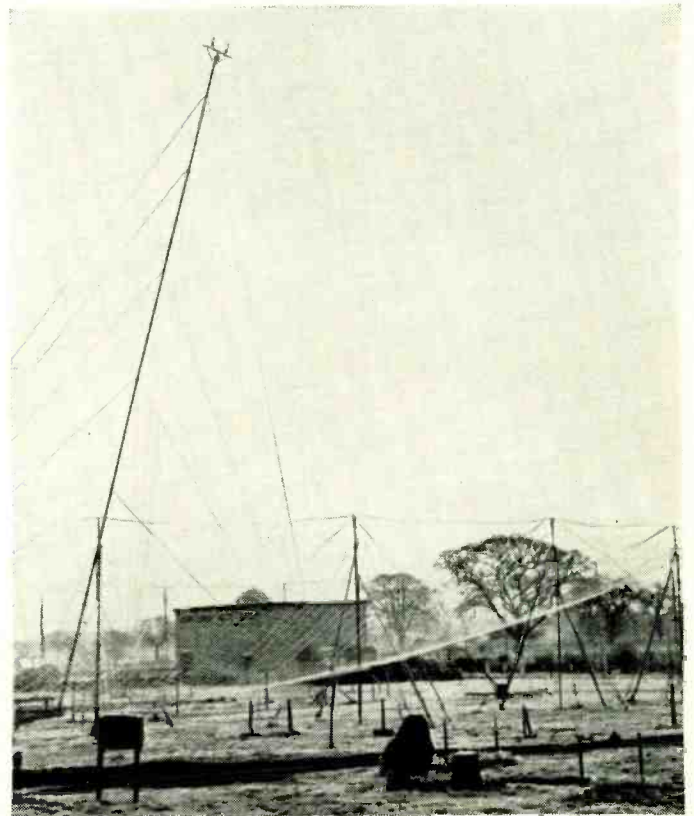

Fig. 2—Cross-section of antenna.



The giant paraboloid — 218-foot diameter.

universe beyond. Perhaps the most interesting discovery that they have made is the existence of the so-called "radio stars." About 150 have been found and the majority of them have not been identified with any known celestial object. They appear to emit radio waves but give little or no light. They present a fascinating problem to modern astronomy.

To collect visible light from the stars the astronomer builds large mirrors

which focus the light onto the eyepiece or onto the photographic plate of his telescope. The largest mirror in existence today is the 200-inch mirror of the Hale telescope at Palomar Mountain. The radio astronomer, working with much longer waves, uses large antenna systems to collect radio waves and calls his instrument a radiotelescope. The largest radiotelescope in existence is at the Jodrell Bank Experimental Station of the University of Manchester (England).

## Jodrell Bank radiotelescope

This large antenna or radiotelescope has a circular paraboloidal mirror 218 feet in diameter. Fig. 2 shows a cross-section of the antenna. The reflecting surface is fixed to the ground with its axis vertical and is supported by a steel ring and three concentric circles of steel posts mounted in concrete blocks. The posts support a web of steel cables which form the outline of a paraboloid. Since the cables run in straight lines

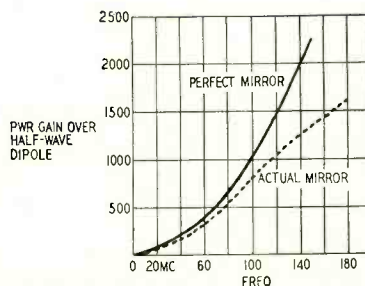
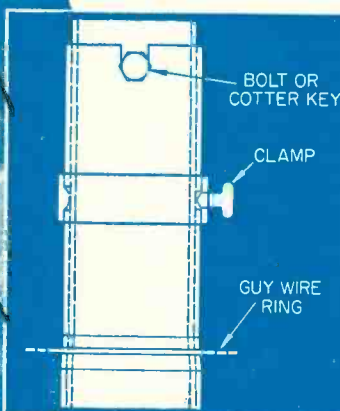

Fig. 3—Power gain of the paraboloid.

New concept in telescoping TV masting  
... utilizes J & L Perma-Tube

# REDUCE YOUR TV MAST COST OVER 20%

Use high-strength, corrosion-proof J & L Perma-Tube 10-foot telescoping sections to easily construct 30 to 50-foot masts



Only J & L Telescoping Perma-Tube offers:

- Joint design which provides instant field assembly
- Machine-fitted joints that insure close tolerance for high strength and rigidity
- Guy wire ring position that eliminates all binding and guy wire interference

No longer is it necessary to buy expensive, ready-made masts. Now you can "tailor-make" your own with standard 10-foot lengths of 16-gage J & L Perma-Tube—and save money.

It's available in cartons from your local distributor in five diameters. The largest base section OD is 2¼ inches and each telescoping section is ¼-inch smaller, the smallest section having an OD of 1¼ inches.

J & L Perma-Tube in the 1¼-inch size can be used interchangeably as a fitted-joint section for smaller masts or as the smallest and topmost piece of longer telescoping masts.

Corrosion-proof J & L Perma-Tube is treated with Vinsynite—then coated both inside and outside with a metallic vinyl resin base. It successfully passes ASTM's 500-hour-minimum salt spray test—which guarantees Perma-Tube's longer life on the job.

Sturdy J & L Perma-Tube is made of a special, high-strength, J & L-produced steel. A 10-foot section of 1¼-inch diameter by 16 gage can support a weight at its center point of 200 pounds with a minimum of deflection and permanent set.

Order these new telescoping sections along with your regular 1¼-inch J & L Perma-Tube. Hardware—cotter keys or bolts, clamps and guy rings—may also be secured from your local distributor. For more information write J & L direct.

# J & L STEEL

*Jones & Laughlin*

STEEL CORPORATION — Pittsburgh

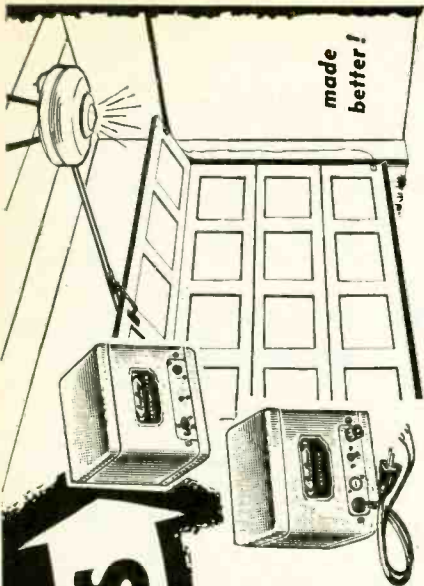

**NEW DESIGN means NEW SALES**

Now, the newest, finest Radio-Control Garage Door Opener styled in a modern spun-aluminum fixture that beautifies garage interiors. Convenience and safety features galore — New automatic shut-off, positive locking of door, FCC authorized radio frequency . . . . . and many more plus qualities! Write today for descriptive literature.

**Perma-Power's**  
**NEW Garage Door Opener**

mfd by **Perma-Power Company**

4727 N. Damen Ave., Chicago 25, Ill.  
Manufacturers of electronic equipment since 1928  
EXPORT: Scheel International, Chicago, Ill.

**ELECTRONICS**

between the poles, the outline of the web is not truly paraboloidal but is an approximation to the correct shape made up of short straight lines.

The actual reflecting surface of the mirror is laid on the steel cables and is formed by a grid of galvanized iron wires parallel to each other and running across the mirror in curves which follow the direction of current flow in the surface. The spacing between adjacent wires in the grid is 8 inches, and the deviation of the reflecting surface from a true paraboloidal shape is nowhere greater than 5 inches. Since the mirror surface is made up of wires running in only one direction and is not a true mesh, it reflects best the component of waves polarized in an east-west direction and is almost transparent to waves polarized in the north-south plane.

The focal length of the mirror is 126 feet, and the reflected energy is collected at the focus by a small antenna system known as the "primary feed." This consists of two half-wave dipoles and their reflectors arranged to have a

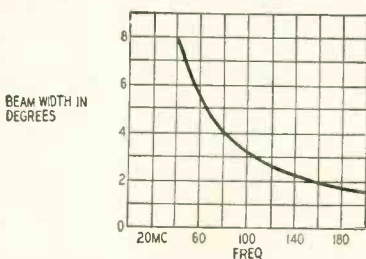

Fig. 4—Bandwidth of the paraboloid.

polar diagram suitable for the reception of energy reflected by the mirror. The primary feed is supported at a height of 126 feet above the center of the mirror by a sectional steel mast guyed by three sets of steel ropes spaced round the mast at intervals of 120°. The base of the mast is supported on a horizontal axle running east-west. By adjusting the length of the supporting guys, the mast can be tilted to 15° north or south of the vertical. The energy received at the primary feed is carried down the mast in an air-spaced coaxial cable which runs to a receiving laboratory close to the rim of the mirror. The photo shows part of the mirror and the central mast carrying the primary feed antenna (which at the time of the photograph was tilted).

The power gain of the antenna is very large. It is shown in Fig. 3, plotted against frequency. The full line shows the theoretical gain calculated on the assumption that the mirror is a perfect paraboloid with a 100%-efficient reflecting surface. The broken line shows the gain after allowing for errors in the shape of the paraboloid and for the loss of energy through the reflecting grid of wires. As the frequency increases, more and more of the energy falling on the mirror passes straight through the mirror surface and is lost. For example, at 75 mc efficiency is about 90%, at 160 mc it has fallen to

70% and at 300 mc the mirror would be almost transparent. The highest frequency which can be used is governed by this factor and is limited to about 200 mc.

The beamwidth of the instrument varies inversely as the frequency (Fig. 4). At 160 mc it is 2° between points of half-power (3 db down from maximum gain). The shape of the beam has been measured at 75 mc using a transmitter carried in an aircraft and also at 160 mc by observations of a radio star. Fig. 5 shows the beam shape measured at 160 mc.

Since the mirror is fixed to the ground with its axis vertical, the beam will normally be directed straight upward. As the earth rotates, it will scan a strip of sky equal in width to the beam. To scan a different strip of sky the beam must be tilted. The only available method of moving it is to displace the primary feed by tilting the central tower. If the primary feed of a circular paraboloid is tilted by an angle  $\theta$ , then the beam will move in the opposite direction by an angle  $\phi$ , where  $\theta = K\phi$ . The value of K depends mainly on the ratio of the focal length to the diameter of the mirror; for the 218-foot mirror  $K = 0.915$ . Thus by tilting the central mast to 15° from the vertical, the beam can be swung about 12½°.

If the beam of an antenna is swung too far by displacing the primary feed from the axis, its shape will be seriously distorted. The principal feature of

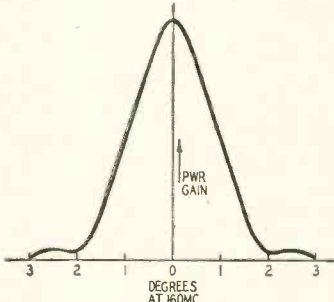

Fig. 5—Paraboloid beam shape at 160 mc.

the distorted shape is the appearance of a subsidiary lobe which corresponds to the "coma" distortion in optical instruments. Experience shows that the beam of the big paraboloid can be swung to at least six times its own width (i.e., about 12° at 160 mc), without serious distortion.

**The receiving equipment**

The radio astronomer is usually concerned with the detection of extremely weak signals. Thus in the u.h.f. band the power received from an average radio star is well below the noise power of the best receiver even when used with the big paraboloid. Thus, one of the main problems in designing the receiving equipment is to maintain the gain of the receiver constant so that minute variations in the received power may be recorded. In the present equipment this problem has been solved by



P. R. MALLORY & CO. INC.  
**MALLORY**  
APPROVED PRECISION PRODUCTS

P. R. MALLORY & CO. INC.  
**MALLORY**  
APPROVED PRECISION PRODUCTS

P. R. MALLORY & CO. INC.  
**MALLORY**  
APPROVED PRECISION PRODUCTS



# HUM HUSHING DESIGN

*makes Mallyory's  
"25th Anniversary" model  
the quietest vibrator ever*

**T**AKE a look inside the Mallyory 25th Anniversary Vibrator\*—and you'll see why it's so free of mechanical hum. The vibrator mechanism "floats" in a bell-shaped rubber liner. Noise produced by the vibrating element just doesn't have a chance of getting to the case or mounting plug.

That's not all. The rubber cup at the plug end also "floats" in place... never touches the can at more than one point. Even the leads are designed to minimize transmitted noise.

The net result is the quietest-running vibrator you've ever seen... or heard. Its mechanical hum is actually less than the electrical noise emitted by the speakers of most auto radio sets. And it costs no more than previous Mallyory models.

On every vibrator replacement job, treat your customers to the quietest performance on the market. Check your stock today... and call your local Mallyory distributor for quick delivery.

\*Pat. Pending

P. R. MALLORY & CO. INC.  
**MALLORY**

CAPACITORS • CONTROLS • VIBRATORS • SWITCHES • RESISTORS  
RECTIFIERS • POWER SUPPLIES • FILTERS • MERCURY BATTERIES  
**APPROVED PRECISION PRODUCTS**

P. R. MALLORY & CO. Inc., INDIANAPOLIS 6, INDIANA

P. R. MALLORY & CO. INC.  
**MALLORY**  
APPROVED PRECISION PRODUCTS

P. R. MALLORY & CO. INC.  
**MALLORY**  
APPROVED PRECISION PRODUCTS

P. R. MALLORY & CO. INC.  
**MALLORY**  
APPROVED PRECISION PRODUCTS

P. R. MALLORY & CO. INC.  
**MALLORY**  
APPROVED PRECISION PRODUCTS

this TV serviceman uses

# STANCOR

## EXACT REPLACEMENT TRANSFORMERS

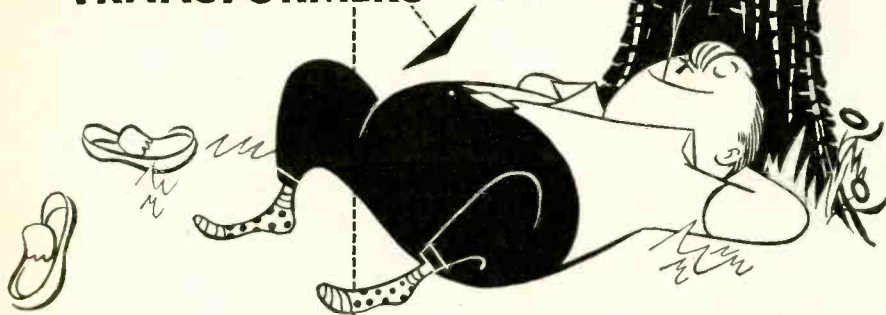

There are now 59 Stancor exact replacement flybacks covering all major TV set manufacturers and many private label brands.

The latest units include 6 new Zenith replacements that give you

### 71% ZENITH EXACT REPLACEMENT FLYBACK COVERAGE

and 6 new General Electric replacements that give you

### 79% G. E. EXACT REPLACEMENT FLYBACK COVERAGE

You too can take life easy and have time to spare when you use Stancor exact replacements. No changing of circuits, no drilling of holes . . . you just take out the defective unit and replace it with a Stancor Transformer that exactly duplicates the original.

**FREE** The New Stancor TV Transformer Replacement Guide, listing accurate replacement data on almost 8500 TV models and chassis of 116 manufacturers. If you haven't received your copy see your Stancor distributor or write Chicago Standard Transformer Corporation.

## CHICAGO STANDARD TRANSFORMER CORPORATION

3592 ELSTON AVENUE  
CHICAGO 18, ILLINOIS

Export Sales:  
Roburn Agencies, Inc.  
431 Greenwich Street  
New York 13, N. Y.



**NEW! For the First Time!**  
**CHECK CAPACITORS UNDER WORKING CONDITIONS!**  
**TEST CONDENSERS IN THE SET!**



SATISFACTION GUARANTEED OR RETURN WITHIN TEN DAYS FOR REFUND

**CAPACITEST**, the result of months in development is a new, compact checker that does a giant job to save you time and money. It will check condensers at 150 Volts, which is approximately the working voltage in a radio or TV set. Meters will not give this type of check since the applied voltage is 20 Volts or less. Avoid call-backs by using CAPACITEST. Accurately, quickly, it shows open, shorted, or intermittent capacitors and leaky electrolytics. Compact: 4"x4"x2"—lightweight, for bench or tool kit.

### CAPACITEST

Quickly, Accurately checks:

- PAPER, MICA, CERAMIC CAPACITORS
- ELECTROLYTICS
- CONTINUITY
- AC/DC VOLTAGES
- FLASHBULBS

\$9.95 postpaid  
Dir. Net complete, ready for operation

NOT A KIT

**FREE** Special Introductory Offer for limited time only! Set of test leads Free with each CAPACITEST. Order direct from manufacturer — include \$3 deposit with C.O.D.'s. Save PP & COD fees, send \$9.95 & we'll pay postage.

**The Barjay Co.** 145 West 40 Street New York 18, N. Y.

## ELECTRONICS

the use of a "servo" type receiver (Fig. 6). The "signal," which from a radio star resembles thermal noise, is fed through an adjustable matching unit to a rotating capacitance switch. This switch revolves at 1,200 r.p.m. and connects the input of the receiver alternately to the antenna and to a noise generator. The rectified output from the receiver is fed to a low-frequency amplifier tuned to the switch rotation frequency (20 cycles), which in turn feeds a phase-sensitive (synchronous) detector. If there is any difference between the power output from the antenna and the output from the noise generator as the switch rotates, the receiver output will vary at 20 cycles.

This 20-cycle component is amplified by a low-frequency amplifier and fed to a phase-sensitive detector. The detector is synchronized by a reference wave generated by a photocell in conjunction with a rotating shutter mounted on the shaft of the switch. It produces a positive or negative d.c. output according to the relative phase of the reference wave and the 20-cycle component in the receiver output. This output is used to increase or to decrease the noise power generated by the noise generator.

The polarity of the circuit is arranged so that the d.c. output from the phase-sensitive detector controls the output from the noise source so that the power received at the input of the receiver in both positions of the switch is equal. Thus the whole equipment forms a servo loop which controls the output of the noise generator, making it closely equal to that from the antenna. The actual record of the variations in the antenna power is made by a recording milliammeter connected to the noise generator.

The function of the receiver is to detect any difference between the output of the antenna and the noise generator, and it thus acts like a null detector in the circuit of a bridge. Provided that the gain of the receiver remains high, small variations in this gain have little

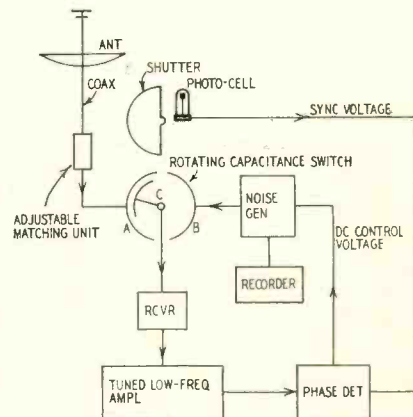

Fig. 6—Block diagram of receiver used for detecting signals from radio stars.

effect on the recorded value of the antenna output power.

The circuit of the rotating r.f. switch is shown in detail in Fig. 7. It consists

**INTRODUCING THE**

# New GEOMATIC TV ANTENNAS

(pat. pend.)

## BY **FINCO**®

with exclusive **Fidelity Phasing**\*

\* Dictionary: the highest degree of accuracy in the reproduction of a signal

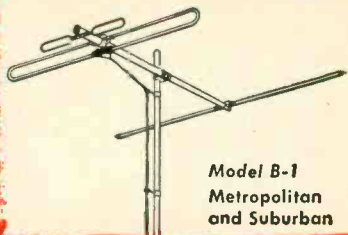

Model B-1  
Metropolitan  
and Suburban

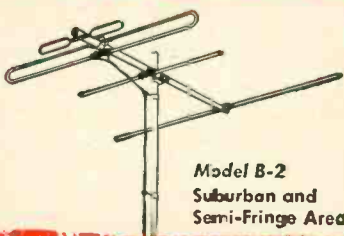

Model B-2  
Suburban and  
Semi-Fringe Area

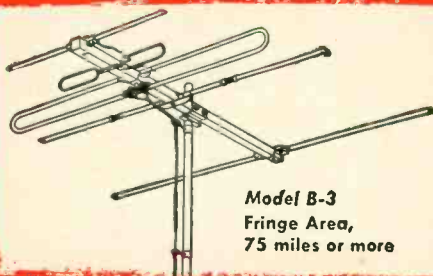

Model B-3  
Fringe Area,  
75 miles or more

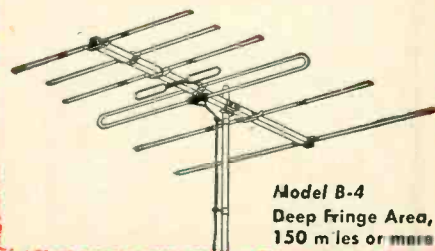

Model B-4  
Deep Fringe Area,  
150 miles or more

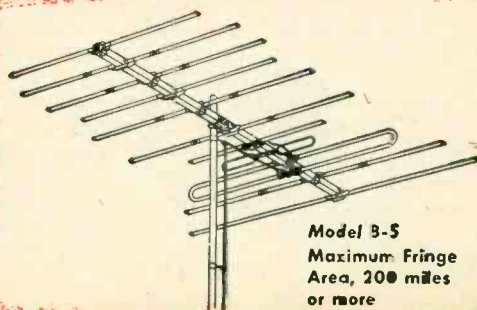

Model B-5  
Maximum Fringe  
Area, 200 miles  
or more

**GEOMATIC** means  
customized for your locality

Now For The First Time —

Regardless of channels, distance from station, or terrain FINCO can deliver a model that is perfectly suited for your area — at no extra cost!

Write, wire or phone  
**The FINNEY Company**

HENDERSON 2-2150 4612 ST. CLAIR AVENUE  
Dept. RE-886 CLEVELAND 3, OHIO

Copyright, 1955  
The Finney Company

# A HIT in High Fidelity with COLLINS

AUDIO PRODUCTS CO. 'PRE-FAB' TUNERS

Collins Audio Products Co. is in no way affiliated with Collins Radio Co. Each Collins Tuner Kit is complete with punched chassis, tubes, power transformer, power supply, components, hardware, dial assembly, tuning eye, knobs, wire, etc., as well as the completed sub-assemblies: FM tuning units, AM tuning units, IF amplifiers, etc. All sub-assemblies wired, tested and aligned at the factory make Collins Pre-Fab Kits easy to assemble even without technical knowledge. The end result is a fine, high quality, high fidelity instrument at often less than half the cost—because you helped make it AND BOUGHT IT DIRECT FROM THE FACTORY.

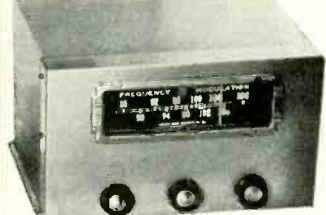

**NEW FM TUNER KIT**  
New decorative gold front. New cascode front end—3 mv sensitivity. IF amplifier mounted, wired and tested in the chassis. You mount completed RF tuning unit and power supply. 15 tubes, 20 to 20,000 cycle response. A.F.C. and switch. Size: 12 1/2" x 9 1/2" x 7" high. Shipping weight: 15 pounds. Manual supplied. Gold screen cover available at \$3.50 extra. **PRICE: \$59.50**



**NEW FM-AM TUNER KIT**  
New, decorative gold front like FM tuner above. New cascode front end on FM—3 mv sensitivity. 15 tubes. Comprises chassis, power supply parts, AM unit, FM unit, IF amplifier, all wired and tested, ready for mounting in chassis. A.F.C. with switch. Kits include all parts and hardware. Size: 14" x 12" x 7 1/2" high. Shipping weight: 19 pounds. Manual supplied. Gold screen cover available at \$3.75 extra. **PRICE: \$82.50**

**FMF-3B Tuning Unit with Cascode**  
Permeability tuned, 3 tubes, A.F.C., 3 microvolts sensitivity. May be used with any 10.7 MC IF amplifier such as our IF-6. **\$19.50**  
2 pounds.

**AM-4 Tuning Unit**  
3-gang tuning condenser. Unit covers 530 to 1600 KC. Completely wired and tested with tubes, 4 tubes. Chassis plate measures: 4" x 7 3/8", 2 1/2" high. **\$24.50**  
pounds.

**IF-6 Amplifier**  
6 tubes, 10.7 MC. Low distortion, high gain, 3 pounds. **\$21.50**

--- MAIL COUPON TODAY! ---  
To: Collins Audio Products Co., Inc.  
P. O. Box 368 RE-9  
Westfield, N. J.  
Tel. Westfield 2-4390

FM Tuner Kit  FM-AM Tuner Kit  
 FMF-3B Tuning Unit  IF-6 Amplifier  
 AM-4 Tuning Unit  COVER

Name \_\_\_\_\_  
Address \_\_\_\_\_  
City \_\_\_\_\_ State \_\_\_\_\_  
Amount for Kit \$ \_\_\_\_\_  
See weights, add shipping cost \$ \_\_\_\_\_  
Total amount enclosed \$ \_\_\_\_\_  
 Check  Money Order

WHEN YOU THINK OF TUNERS, THINK OF COLLINS AUDIO PRODUCTS

## ELECTRONICS

of a revolving capacitor whose rotor plates C move between two sets of stator plates A and B. When the rotor plates are engaged with stator A, their capacitance presents a low impedance at point A. This low impedance is transformed by the quarter-wave line DA into a high impedance at D, which allows the power from the antenna to flow past point D to the input of the receiver at F. Meanwhile disengaged stator plates B present an open circuit which is transformed by the quarter-wave line BE to form a short circuit at E. This short circuit prevents the output from the noise generator from reaching the receiver. The short circuit at E is prevented from affecting the free flow of antenna power to the receiver by the action of the quarter-wave line FE, which transforms the short circuit at E to an open circuit at F.

Thus in the position of the switch

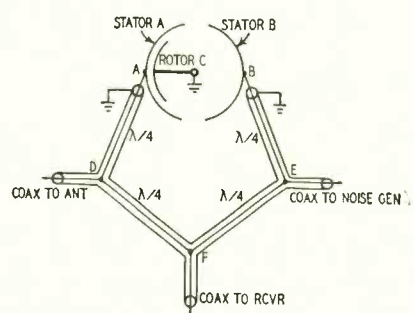

Fig. 7—Rotating capacitance switch.

shown in Fig. 7, the receiver is connected to the antenna and the noise generator is shut off. When the switch rotates so that the rotor engages the opposite set of stator plates, the whole cycle is reversed and the receiver is connected to the noise generator instead of to the antenna. The particular virtue of this type of switch is that it is completely noise-free since there are no rubbing contacts. Its performance can be judged from the following figures: at 160 mc with the switch on, the measured loss between either input terminal of the switch and the receiver input is less than 0.5 db, and with the switch off, the attenuation through the switch is greater than 20 db.

The receiver in use at the present time has five stages of r.f. amplification at 160 mc. The input stage uses a cascode circuit and consists of a type 6AK5 pentode connected as a neutralized triode and followed by four grounded-grid triode amplifiers. These r.f. stages feed a diode mixer and a 30-mc i.f. amplifier of conventional design. The local oscillator works at 130 mc and is crystal-controlled. The overall bandwidth of the receiver is 1 mc and the noise factor is 5.5 db. The selective low-frequency amplifier is tuned to 20 cycles by a "twin-tee" bridge feedback circuit. The phase-sensitive detector is of conventional design and uses a ring of four germanium crystal diodes.

The circuit of the noise generator is shown in Fig. 8. It contains a tungsten-filament diode (British type CV172) connected across a 72-ohm resistor. The

diode is operated at a plate voltage of 120 so that the plate current is limited

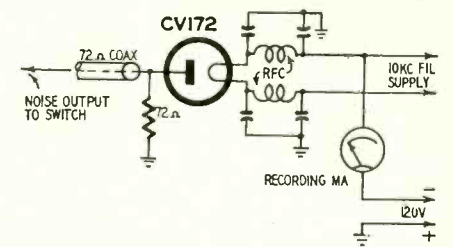

Fig. 8—Diagram of the noise generator.

only by the temperature of the filament and not by space charge. Under these conditions the noise power generated by the shot noise across the load resistor can be calculated exactly and is directly proportional to the plate current.

The plate current of the diode, and hence the noise power output, is controlled by varying the filament voltage which is supplied at 10 kc. (A frequency of 10 kc is used to avoid supply frequency modulation of the noise output by variations in the temperature of the filament whose thermal time constant is very short.) The 10-kc supply is generated by a triode-hexode whose output is controlled by applying the d.c. voltage from the phase-sensitive detector to one of the hexode grids.

All the heater and plate supplies to the equipment are stabilized. The heater supplies are from storage batteries floated across the output of a constant-current charger. The plate supplies are from high-gain regulated packs which stabilize the a.c. power line by a factor of 2,000 times.

In operation, the equipment has proved to be extremely stable and sensitive. When operating at full gain, the recording pen draws a wavy line (Fig. 9). The small ripples in this line correspond to the basic noise in the receiver itself after it has been smoothed by the time constant of the circuits after the receiver. This time constant is adjusted by a simple resistor and capacitor across the output of the phase-sensitive detector and is usually set so that the whole servo loop has a time constant of about 10 seconds. The minimum power which the equipment can detect must produce a deflection of the recording pen at least equal to the small ripples on the record due to the receiver noise. It can be shown that this value of receiver noise power is given roughly by the formula:

$$MDP = NP \times \sqrt{TC \times \text{r.f. bandwidth}}$$

where MDP, NP and TC are abbreviations for minimum detectable power, noise power and time constant, respectively.

Thus for an r.f. bandwidth of 1 mc and a time constant of 10 seconds the minimum detectable power is about 1/3,000 of the receiver noise. This corresponds to a signal power 35 db below receiver noise and to a power at the receiver input of  $5 \times 10^{-16}$  watts.

This tremendous increase in sensitivity over a normal radio receiver is,

**THE #630 TV RECEIVER** remains unmatched for quality and performance • • • RCA designed and developed this set quality-wise *not* price-wise • • • The original 10" set retailed at \$375.00 • • • Subsequent TV sets serve to prove the sacrifice of quality for price • • • what better proof can there be of its superiority than the fact that it is the choice of TV engineers and TV technicians! Herewith we offer you—YOUR BEST BUYS IN TV!—All you pay is the price shown • • • Excise taxes have already been paid by us.

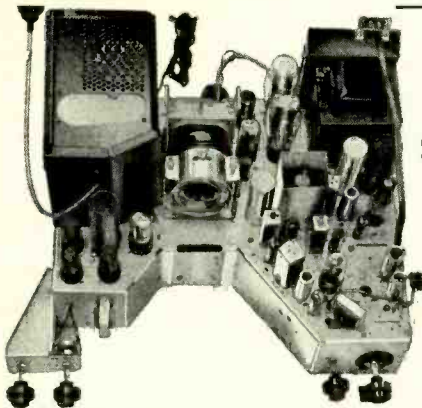

Build your own  
**Super DeLuxe  
31-TUBE  
#630  
TV  
CHASSIS**

**#630 SUPER DE LUXE 31-TUBE TV KIT**  
Engineered in strict adherence to the genuine RCA #630 plus added features • • • OPERATES 16" to 21" PICTURE TUBES • • • CASCADE TUNER • • • COSINE YOKE • • • LARGER POWER TRANSFORMER • • • KEYED AGC • • • 12" SPEAKER • • • CONDENSERS and RESISTORS at rated capacities and tolerances. You receive a COMPLETE SET OF PARTS AND TUBES. Everything needed is included, (less CRT and wire.) You will enjoy building it with "LIFE-SIZE" easy to follow step-by-step ASSEMBLING INSTRUCTIONS" included with each KIT.

slashed to **\$99.99**

Same KIT for 27" and ALL 90° CRT's **\$110.39**

**CUSTOM-BUILT CABINETS FACTORY TO YOU**

**3 LEADING STYLES** in genuine mahogany or walnut (blond 10% extra) • Ready drilled for any #630 TV chassis and cutout for any 16", 17", 19", 20" or 21" picture tube at no extras in price • Also supplied with undrilled knob panel for any other TV set • EVERYTHING NECESSARY for an easy perfect chassis and CRT assembly is included • Each cabinet is delivered complete as pictured with mask, safety glass, mounting brackets, backboard, backup, hardware and assembling instructions • Each cabinet is shipped in an air cushioned carton from FACTORY to YOU!

<p><b>The VOGUE</b> Most Popular Table Model</p> <p>H-25", W-26", D-22"</p> <p><b>\$35.91</b></p> <p>VOGUE also available for 24" or 27" picture tube</p> <p>H-31", W-27" D-23"</p> <p><b>\$59.54</b></p>	<p><b>The MANHATTAN</b> Style, Quality, Price</p> <p>H-41", W-25", D-23"</p> <p><b>\$53.43</b></p> <p>MANHATTAN for 24" or 27" CRT \$79.22 H-46", W-30", D-24"</p>	<p><b>The MAYFAIR</b> Exclusively modern, with an elegance of simplicity in styling.</p> <p>H-41", W-26", D-25"</p> <p>Special this month Mayfair in mahog., walnut or blond, only <b>\$73.26</b></p>
---	--	---

**#630 SUPER DE LUXE TV CHASSIS**

LICENSED UNDER RCA PATENTS  
**COMPLETE READY TO PLUG IN AND PLAY!**  
Similar in characteristics and features to the 70° TV KIT above • Manufactured especially for us by nationally known manufacturers • No efforts or expense have been spared in workmanship or materials, to make this #630 SUPER DE LUXE TV CHASSIS the best obtainable for fringe areas, clarity and all-around performance. Customers report reception better than 200 miles. Each set is factory aligned and air-tested • All parts carry the RMA three month guarantee • Our mass volume of business on this CHASSIS (numbering thousands of pleased customers) now makes it possible for us to reduce the price. (less CRT.)

slashed to **\$142.27**

We Also Sell The **TECH-MASTER** Complete Line of #630 TV CHASSIS. Catalog mailed on request.

**#630 TV BASIC PARTS KITS**

- PUNCHED & DRILLED CHASSIS PAN BRACKET & SHIELD KIT (18 items)
- VIDEO & I.F. KIT (19 items)
- POWER TRANSFORMER #201T6
- VERTICAL OUTPUT TRANSFORMER
- VERTICAL BLOCKING TRANSFORMER
- FLYBACK TRANSFORMER #211T5
- FOCUS COIL, 470 ohms #202D2
- COSINE DEFLECTION YOKE 70°

ALL for only **\$29.97** Inc. #630 LIFE-SIZE TV Instructions

**UNIVERSAL Picture Tube MOUNTING BRACKETS**

Fits All 12 1/2" to 21" picture tubes

Complete — including band that holds picture tube

**\$4.97**

**NATIONALLY KNOWN BRAND PICTURE TUBES**

BRAND NEW in Factory Sealed Cartons—With a Full Year Guarantee  
17" #17BP4A **\$22.66** | 21" #21EP4B Aluminized **\$32.21** | 24" #24CP4A Aluminized **\$48.99** | 27" #27EP4A Aluminized **\$74.31**

Modernize a #630 or any TV Set with a **STANDARD CASCADE TUNER**  
For better all around performance  
Complete with tubes and Brooks CASCADE MANUAL with step-by-step instructions and all extra parts needed. **\$15.97**

**PULSE KEYED AGC KIT**  
Finest, most accurate and the easiest Kit to install in any make TV RECEIVER including the #630. Improves performance and insures a steady picture on all channels.  
**COMPLETE SET OF PARTS \$2.99**  
Including 6AU6 tube & Instructions

**#630 Parts in COMPLETE SETS**

- TV WIRE & SOLDER KIT, for any Set..... \$ .98
- 630-KIT, screws, nuts, rivets, washers, etc..... 1.69
- TERMINAL STRIP KIT, set of 30..... .69
- VIDEO AND I.F. KIT, 19 items..... 4.99
- VARIABLE CONTROL KIT, 9 controls..... 3.97
- CARBON RESISTOR KIT, 107 resistors..... 4.98
- WIREWOUND RESISTOR KIT, 4 resistors..... 1.76
- BRACKET AND SHIELD KIT, 18 items..... 6.44
- ELECTROLYTIC CONDENSER KIT, 6 cond..... 4.96
- TUBULAR CONDENSER KIT, 38 condensers..... 3.63
- CERAMIC CONDENSER KIT, 28 condensers..... 1.98
- MICA CONDENSER KIT, 11 condensers..... .97

**PARTS For #630 TV SETS**

- PUNCHED CHASSIS PAN, cadmium plated..... \$3.96
- COMPLETE SET OF KNOBS, incl. decals..... .99
- POWER TRANSFORMER, 295ma. 201T6..... 9.16
- VERTICAL OUTPUT TRANS. 204T2..... 2.24
- VERTICAL BLOCKING TRANS. 208T2..... .98
- TV FLYBACK TRANS. 211T5..... 2.97
- TV FLYBACK TRANS. with AGC, 211T5..... 4.94
- FOCUS COIL, 470 ohms, 202D2..... 2.93
- DEFLECTION YOKE, Cosine 70°..... 3.45
- TV 90° DEFLECTION YOKE..... 5.98
- TV FLYBACK TRANS., for 90°..... 4.42
- SYNCHROLOC TRANSFORMER 208T8..... .98
- FILTER CHOKE, 62 ohms..... 1.15
- WIDTH CONTROL COIL, keyed AGC..... .52
- ION TRAP BEAM BENDER, single 203D1..... .52

As pioneers in TV Conversion Kits, we bring you 2 NEW CONVERSION KITS, a 70° and a 90°. The quality of the PARTS supplied and the simplicity of the Step-By-Step Instructions are your assurance of successful results.

**21" TV CONVERSION KIT**  
Convert ANY MAKE TV RECEIVER including #630 to operate 21" or ANY 70° PICTURE TUBE  
**COMPLETE SET OF ESSENTIAL PARTS** includes matched set of Todd 70° COSINE DEFLECTION YOKE & HV FLYBACK TRANSFORMER  
\$33.50 List price Your price.... **\$13.97** Inc. CONVERSION MANUAL with Step-By-Step Instructions and Schematic Diagrams.

**27" TV CONVERSION KIT**  
Convert ANY MAKE TV RECEIVER including #630 to operate 27" or ANY 90° PICTURE TUBE  
**COMPLETE SET OF ESSENTIAL PARTS** includes matched set of Todd 90° COSINE DEFLECTION YOKE & 18KV FLYBACK TRANSFORMER.  
\$39.75 List price Your price.... **\$15.98** Inc. CONVERSION MANUAL with Step-By-Step Instructions and Schematic Diagrams.  
Illustration on how to mount TV Sets flush with wall extending into garage, closet or wall recess, included.

Brooks LIFE-SIZE TV INSTRUCTIONS for building any #630 TV Receiver from the original 10" to the latest 27". **\$1.25** postpaid

HINTS FOR BETTER PERFORMANCE on your #630 TV receiver **50¢** postpaid

Brooks CASCADE MANUAL, how to install Cascade Tuner in any make TV Set. **25¢** postpaid

90° TV CONVERSION MANUAL, how to convert any TV SET to 24", 27", etc. illustrating 50¢ wall-type TV mountings. **50¢** postpaid

70° TV CONVERSION MANUAL, how to convert any TV SET to 17", 21", etc. **50¢** postpaid

A.G.C. STEP-BY-STEP INSTRUCTIONS, how to add A.G.C. to any make TV Receiver. **25¢** postpaid

**BROOKS RADIO & TV CORP., 84 Vesey St., Dept. A, New York 7, N.Y.** TELEPHONE CORland 7-2359

# Dealers !

## PROMOTE

# Plus Profits

with

**AMPHENOL**

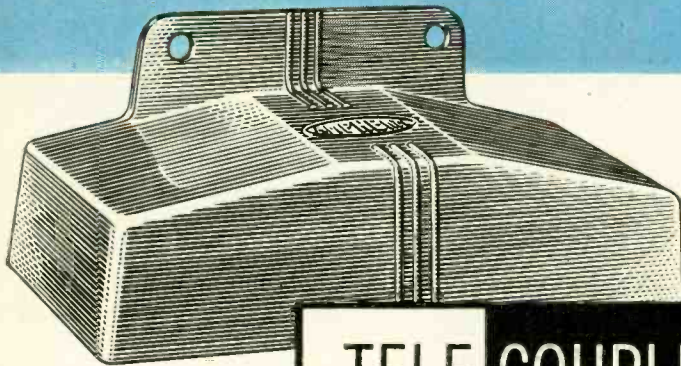

## TELE-COUPPLERS

Are you a dealer in television sets? If you are you have already spotted the trend toward the two set family. You can promote plus profits on the sale of the second set with AMPHENOL Tele-Couplers! These small accessories effectively couple two, three or four tv sets to a single antenna lead-in. Tele-Couplers are easy to sell for they save the customer the expense of an additional antenna installation.

To help you merchandise Tele-Couplers AMPHENOL has prepared an attractive counter display carton containing 12 Tele-Couplers. On your counter this display may help stimulate your customers into the purchase of that second tv set! A small folder describing the Tele-Couplers is also available—to give additional facts and to give additional impetus to your sales of tv and AMPHENOL Tele-Couplers.

114-088 2 Set Tele-Coupler .....List \$3.75  
114-090 4 Set Tele-Coupler .....List 4.75



See Your Amphenol Distributor!

**AMPHENOL**

### ELECTRONICS

of course, gained at the expense of the effective bandwidth. Thus, although the present equipment has an r.f. bandwidth of 1 mc, the time constant of the circuits after the receiver restrict the low-frequency bandwidth to about 0.1 cycle. Thus, the equipment cannot follow any modulation or change in the received power which occurs in a time short compared with 10 seconds. For most work with the paraboloid this response time is satisfactory since a radio star takes about 15 minutes to pass through the aerial beam. If more rapid observations are required, the response time can be decreased at the expense of the sensitivity.

#### Results

During the past four years the big paraboloid and its receiving equipment have been operated at 160 mc and used to survey the strip of sky (about 25° wide) which lies within its field of view. The survey was made by fixing the central mast at some selected angle and recording the intensity of the power received by the antenna over a period of at least 24 hours. When a satisfactory record or series of records had been obtained the mast was moved to a different angle and the observations repeated. This process was continued until the whole of the strip of sky had been covered.

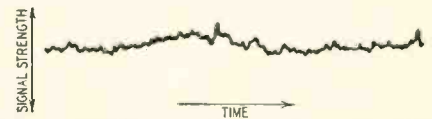

Fig. 9—Recording from faint radio star.

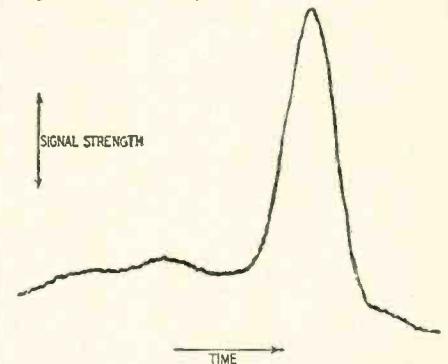
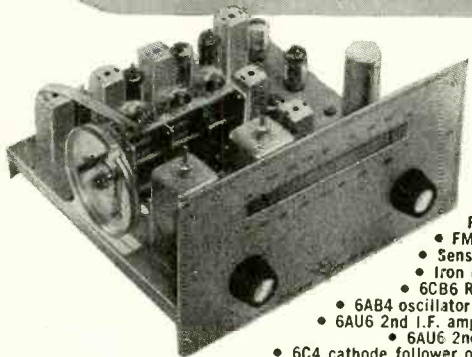

Fig. 10—Partial recording made during passage of Cygnus through aerial beam.

The results have been used to draw a contour map of the intensity of the radio waves from the strip. The map confirms that the bulk of the radio energy comes from the Milky Way and it also shows, superimposed on the diffuse background of radiation, a number of localized sources of radio waves which are the so-called radio stars. It happens, by a fortunate coincidence, that the two brightest radio stars in the whole sky lie in the field of view of the paraboloid. The brightest is in the constellation of Cassiopeia. The second brightest is in the Swan (Cygnus).

Fig. 10 shows a section of chart recorded during the passage of Cygnus through the aerial beam. The large peak in the center of the record cor-

# BUY BY MAIL Direct From Manufacturer AND SAVE



## New Imperial V— 12-tube AM-FM Tuner Kit

- Band width-200 kc
  - Tuned RF stage
  - Frequency Response FM-20-20,000 CPS  $\pm$  .5DB
  - FM Tuning Range 88-108 mc
  - Sensitivity 5-10 u/v, 20-30 DB
  - Iron core tuned I.F. disc trans.
  - 6CB6 RF amplifier • 6AB4 mixer
  - 6AB4 oscillator • 6AU6 1st I.F. amplifier
  - 6AU6 2nd I.F. amplifier • 6AU6 1st limiter
  - 6AU6 2nd limiter • 6AL5 detector
  - 6C4 cathode follower output • AM tuning range 530-1650 kc • Frequency response AM-20-7,500 CPS  $\pm$  3DB
  - Iron core tuned coils throughout • 6BA6 RF amplifier • 6BE6 converter
  - 6BA6 1st I.F. amplifier • IN34 crystal diode detector • Tuned RF stage
  - Chassis dimensions: 9 $\frac{3}{4}$ " long, 5" high, 8" wide.
- Complete kit of parts including tubes, step by step, pictorial and schematic diagrams, less power supply ..... **\$37.50**  
Wired and tested extra ..... **\$10.00**  
Power Supply—6.3V-4 Amp., 190 Volts 55 MA—117V, 50-60 cycles ..... **\$12.00**  
Tuning Eye Kit ..... **\$ 2.95**

Shipping Weight 10 lbs.

# NEW Approved policy...

eliminates percentages to "middlemen"—brings equipment direct from factory to you for buys that can't be beat... anywhere! Approved kits are NOT AVAILABLE FROM DISTRIBUTORS OR JOBBERS.

## New Binaural Twin Channel Amplifier Kit Channel 1 and 2

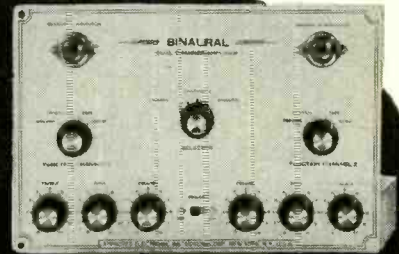

- 1-6SC7-Pre Amp. Common to bot'l Chan.
  - 2-6F5—1st Stage Amp.
  - 2-6F5—Voltage Amp.
  - 2-6V6—Power Amp.
  - 1-5Y3—Rectifier Amp.
  - 2-Cathode Ray Output Indicators
  - Individual Channel Volume controls
  - Individual Bass control boost 12DB
  - Individual Treble control boost 12 DB
  - Inputs for Radio, Tape, Crystal, GE Reluctance
  - Chrome plated chassis
  - Hum levels—78 DB below full output
  - Frequency response each Channel  $\pm$  1 DB 40-12,000 CPS
  - Maximum power output: each channel, 4 Watts
  - Output, 4-8-16 ohms
  - Size 13" Long x 9" W de x 3 $\frac{1}{2}$ " High
- Complete kit of parts including AC power supply, tubes, step by step pictorial and schematic diagrams ..... **\$39.95**  
Shipping Weight 18 lbs.

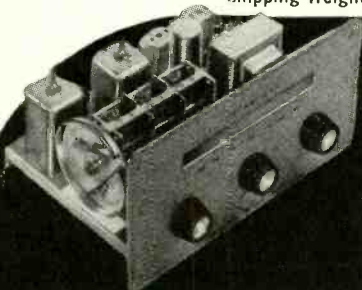

## New V-5 Am Tuner Kit

- ### THE BINAURAL TWINS
- Start Your Hi-Fi Installation the Economical Way
- Self-contained AC power supply
  - Tuning range 530-1650 kc:
  - 6BA5 RF Amplifier
  - 6BE6 converter
  - 6BA6 1st I.F. amplifier
  - 6AL5 detector
  - 6C4 cathode follower output
  - #65 selenium rectifier • Sensitivity 5 microvolts
  - Frequency response 20-20,000 CPS  $\pm$  .5DB
  - 3 section variable cond. • Tuned RF stage
  - Iron core tuned coils throughout • Dimensions 9 $\frac{3}{4}$ " x 5" x 5 $\frac{7}{8}$ "
- Complete kit of parts, including AC power supply, tubes, step by step, pictorial and schematic diagrams ..... **\$24.50**  
Wired and tested extra ..... **\$5.50**  
Tuning Eye Kit ..... **\$2.95**

Shipping Weight 9 lbs.

## New V-9 Tuner Kit



- Self-contained AC Power Supply
  - 3 section variable condenser
  - Tuning range 88-108 mc
  - Band width 200 kc
  - Sensitivity 10 microvolts 20 DB
  - Tuned RF stage
  - Iron core tuned I.F.—disc. trans.
  - 6CB6 R.F. amplifier
  - 6AB4 mixer
  - 6AB4 oscillator (temp. compensated)
  - 6AU6 1st I.F. amplifier
  - 6AU6 2nd I.F. amplifier
  - 6AU6 1st limiter
  - 6AU6 2nd limiter
  - 6AL5 detector
  - 6C4 cathode follower output
  - 65 MA selenium rectifier
  - Dimensions 9 $\frac{3}{4}$ " x 5" x 5 $\frac{7}{8}$ "
  - Frequency response 20-7,500 CPS  $\pm$  3 DB
- Complete kit of parts including AC power supply, tubes, step by step, pictorial and schematic diagrams ..... **\$29.50**  
Wired and tested extra ..... **\$7.50**  
Tuning Eye Kit ..... **\$2.95**

Shipping Weight 10 lbs.

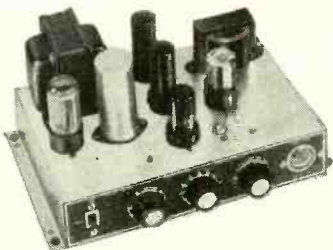

## New Push Pull 6 Watt Amplifier Kit

- 1-12I5—1st stage Amp.
  - 1-12SL7—Phase Inverter
  - 2-12A6—P.P. Beam Power
  - 1-5Y3—Rectifier
  - 1-Cathode Ray Output Indicator
  - Tapped outputs, 4-8-16 ohms
  - Volume, Continuously variable
  - Chrome plated chassis
  - Bass Control Boost 12 DB • Treble Control Boost 12 DB • Hum Level—78 DB below full output • Frequency response  $\pm$  1.5 DB 20-20,000 CPS
  - Size 5 $\frac{1}{2}$ " high x 6 $\frac{1}{2}$ " wide x 11" long
- Complete kit of parts, including AC power supply, tubes, step by step pictorial and schematic diagrams ..... **\$15.45**  
Shipping Weight 13 lbs.

## New 20 Watt Williamson Type Hi-Fi Amplifier Kit



- New Chicago kit of transformers
  - Chrome plated chassis
  - 1-6SN7—1st stage Amp.
  - 1-6SN7—Phase inverter
  - 2-5881—Push Pull Power Output
  - 1-5V4G—Rectifier
  - Frequency Response  $\pm$  1 DB, 10-100,000 CPS
  - Output 4-8-16 ohms
  - Volume control
  - On-off power switch
  - THD Distortion—1% using 60 and 3000 cycles sine wave output, at 12 watts indicated
  - Hum Level—78DB below full output
  - Pre Amp. Voltage supply outlet
  - Size 15" Long x 9" Wide x 7" High
- Complete kit of parts, including AC power supply, tubes, step by step pictorial and schematic diagrams ..... **\$39.95**  
Shipping Weight: 32 lbs.

ORDER DIRECT FROM  
**APPROVED**  
ELECTRONIC INSTRUMENT CORP.

928 BROADWAY, NEW YORK 10, N. Y. • AL 4-7266

## FREE CATALOG AVAILABLE!

APPROVED ELECTRONIC INSTRUMENT CORP.  
928 Broadway, Dept. E, New York 10, N. Y.

NAME .....

ADDRESS .....

CITY ..... STATE .....

*Sure-  
Cure  
for  
Replacement  
Headaches:*



Replace with the **BEST**  
**OXFORD**  
**SPEAKERS**

"No more worrying after you've completed your replacement jobs" . . . that's the saying of more and more servicemen every day because they've switched to OXFORD REPLACEMENT SPEAKERS.

We GUARANTEE you products that are built to be replacement speakers. We stand behind each and every speaker with a 100% guarantee against any mechanical or electrical defects for one full year.

OXFORD Replacement Speakers undergo a rigid inspection to make certain that they are as good or better than the original speaker. That's why more servicemen are switching to OXFORD . . . the replacement speakers for a better job.

*Illustrated literature is available without obligation.*

*. . . at better jobbers!*



**OXFORD ELECTRIC CORPORATION**

3911 SOUTH MICHIGAN AVENUE  
CHICAGO 15, ILLINOIS

EXPORT — ROBURN AGENCIES, NEW YORK CITY  
IN CANADA — ATLAS RADIO CORP. LTD., TORONTO

**PHOTOGRAPHS**

RADIO-ELECTRONICS can use good photographs of service benches, service shops, high-fidelity audio layouts, and any other interesting and original radio-electronic devices.

We will pay \$6.00 each for good professional photos or equivalent, suitable for reproduction.

Full information on subject photographed will increase their acceptability.

**The Editor, RADIO-ELECTRONICS**

**25 West Broadway, New York 7, N. Y.**

**ELECTRONICS**

responds to the power from Cygnus and the shape of the peak represents the polar diagram of the antenna. The general rise of the curve toward the left of the diagram is because, directly after the transit of Cygnus, the beam crossed the Milky Way, giving the picture an asymmetrical appearance. The intensity of the radiation can be found by a simple measurement of the height of the peak.

Cassiopeia and Cygnus can be received easily with the big paraboloid and the record in Fig. 10 shows little trace of receiver noise. In fact, the equipment was operating at a reduced gain. The power flux from the stronger of the two radio stars (Cassiopeia) has been measured and found to be  $9 \times 10^{-23}$  watts per square meter of earth's surface per cycle of bandwidth.

The power received by any antenna and receiver can be found by multiplying this figure by the effective collecting area of the antenna in square meters and by the bandwidth of the receiver in cycles. The value of power flux given is for 160 mc and the few experiments which have been done suggest that the power flux varies almost inversely with the frequency. The radiation from these radio stars appears to be constant in intensity and unpolarized.

The majority of the radio stars are much fainter than the two mentioned above. Fig. 9 shows a record of a very faint radio star (160 times weaker than Cassiopeia) which has been identified with the Great Spiral Nebula in Andromeda. This nebula is called by astronomers a "galaxy" and is a system of stars containing perhaps  $10^{11}$  (100,000,000,000) stars at a distance from us of about 1,000,000 light years. The detection by radio of this nebula was made with the big paraboloid and showed conclusively that radio waves are generated in other star systems besides our own Milky Way.

What are radio stars? So far there is no satisfactory answer to this question. Some of them, such as that corresponding to the Great Spiral Nebula in Andromeda, are known to be caused by the emission of radio waves from distant galaxies. But the mechanism responsible for this emission and for the radio stars in our own Milky Way remains a mystery. It is known that the radio stars are not associated with any common type of visible star. In fact, the only star which has been identified as a source of radio waves is our sun. Furthermore, searches with telescopes have so far revealed that in the majority of cases no visible object can be associated with a radio star. This search must be extended and requires that the celestial coordinates of the radio stars should be measured more precisely and that many more radio stars should be detected. Both these requirements present a challenge to the new science of radio-astronomy and ensure that all the available radiotelescopes will be busy for a long time to come.

END



The **FINEST ALL-CHANNEL (VHF) RECEPTION**  
 at a **NEW-LOW COST!**

The  
**VEE-D-X Performer**

The most efficient, economical All Channel VHF antenna ever developed. Designed for fringe, near fringe and difficult signal areas where yagis or expensive, bulky arrays have previously been necessary for good reception.

Now, at an unbelievably low price, you can install a neat appearing, **VEE-D-X Performer** and receive the Best Reception on ALL VHF channels.

Constructed entirely of the finest aluminum, the **VEE-D-X Performer** has new spring lok hardware. All elements swing out and permanently snap into position. Can be installed within minutes—guarantees a lifetime of trouble-free-all channel VHF reception.

**\$21<sup>65</sup>**  
 SINGLE

**\$45<sup>30</sup>**  
 STACKED

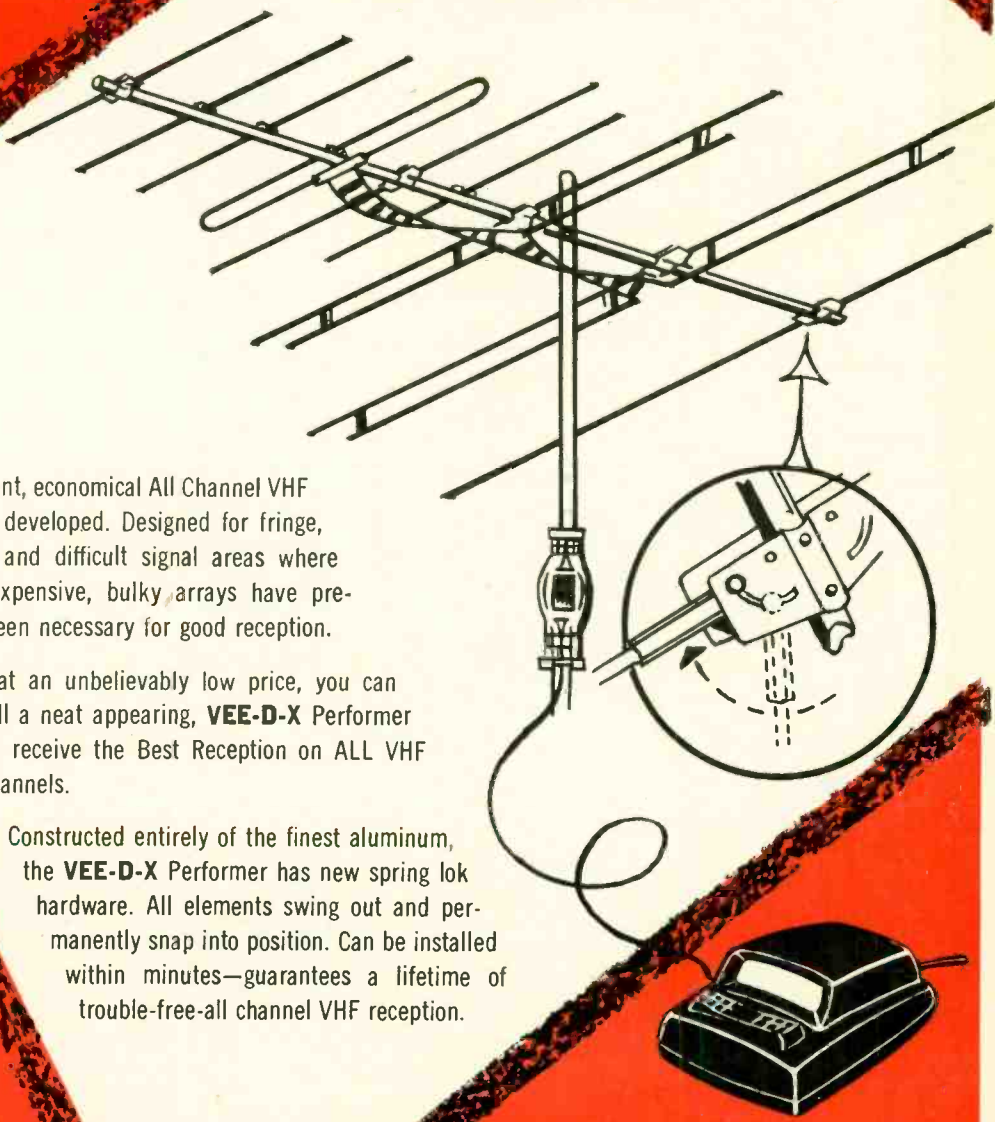

**LaPointe ELECTRONICS, INC.**  
 ROCKVILLE, CONN. RE-1

Please send specification sheets on the Performer  
 I am a  DEALER  DISTRIBUTOR

Name.....

Address.....

City.....State.....

# new Devices



**ANTENNA ROTATORS, Tenna-Rotor models T-12 (formerly T-10) and U-98 (formerly U-83).** Improved synchronization; fast-

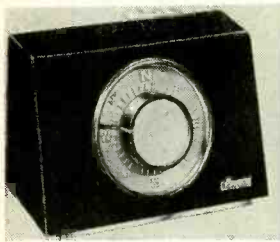

er, more positive rotation; magnetic breaking rotator mechanism; stronger, self-wiping contacts. *Model U-83 deluxe* (see photo), fully automatic.—Alliance Manufacturing Co., Alliance, Ohio.

**TV ANTENNAS, Conical Yagi, model 321-A,** lightweight aluminum construction, preassembled. Elements have seamless sleeves at bracket. All-channel coverage

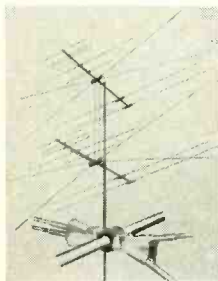

in v.h.f. fringe and u.h.f. primary areas.—Channel Master Corp., Ellenville, N. Y.

**2-SET COUPLER, Federal Electronics Bi-Fi,** for TV and FM. Operates two sets on one antenna. Easily attached—uses knurled brass nut terminals.



Printed circuits throughout.—Federal Electronics Sales, Federal Electronics Bldg., Rockville Centre, N. Y.

**ATTIC ANTENNA, LaPointe Rotenna,** outdoor design for indoor use, with built-in rotator. Available as *model RO2-13* for v.h.f. and as *model RO2-83* for u.h.f., v.h.f. *RO2-13* 5-element single-bay broadband in-line array. *RO2-83* combination of in-line antenna for v.h.f. and corner reflector for u.h.f. Both

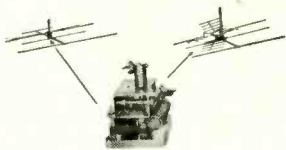

units sold as complete kit—antenna, rotator, control box, 50 feet of rotor and antenna transmission line, standoff insulators and supporting mast. Antennas attach to attic beam by adjustable mast. Snap-construction.—La Pointe Electronics Inc., Rockville, Conn.

**ANTENNA ROTATOR, CDR model AR-22,** fully automatic version of *TR-2*. Control cabinet, 4-wire cable, heavily reinforced housing for the motor handles 150 lbs, mechanical brake with

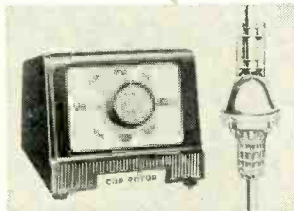

magnetic release, heavy-duty ball bearings and precision gears, and 3 guy-wire lugs.—Cornell-Dubilier Electric Corp., South Plainfield, N. J.; Radiart Corp., 3455 Vega Ave., Cleveland 13, Ohio.

**MAST INSULATOR, Rohn,** permits amateur or commercial use of No. 30 tower as series-fed vertical radiators. New 6½-foot insulator section installable in concrete base or

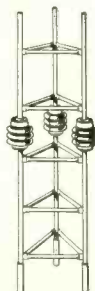

between regular No. 30 sections some distance up tower.

## LEARN MORE — EARN MORE WITH H. G. CISIN'S TV SERVICE BOOKS

### FAMOUS 1955 TV CONSULTANT!

**NEW!** Easy way to solve toughest TV troubles. New rapid methods of pin-pointing faults. New alignment methods shown by Pictures, diagrams and easy to follow directions. **TV CONSULTANT** tells exactly **WHAT TO DO** and **HOW TO DO IT**. UHF section includes conversion, installation and servicing. Lists instruments needed for servicing **COLOR TV**. Practical pointers on use of TV Test Instruments, 300 Pix, raster and sound sym-



ptoms. Detailed directions tell **WHERE** and **HOW** to find faulty parts. Over **135 RAPID CHECKS** including many using picture tube as trouble locator. Over 125 illustrations of scope wave-forms, diagrams, station patterns showing various defects—make TV servicing a pleasure. **NO MATH. NO THEORY—NO FORMULAS**—just practical servicing information covering all types of TV sets.

**TV Serviceman's Silent Partner—No. L1.....\$2**

#### RCA TV TUBE LOCATION GUIDES



**1947-1955 MODELS**

Contains hundreds of Trouble Indicating Tube Location Guides of RCA TV models. Uses new, simplified method to explain tube functions.

**FITS ALL TUBE CADDIES—No. A1.....\$1**

#### TV TUBE LOCATOR

**TROUBLE INDICATING TUBE LOCATION GUIDES** over 3000 most popular models Admiral to Zenith. Shows **PIX** tubes used in each model. Covers products of over 110 different TV manufacturers. Over 135 common TV troubles are listed with explicit directions for locating defective tubes which cause each fault.



**SPEED SERVICING—No. K1....\$1**

#### PIX GUIDE



Part 1 is a fully illustrated Guide to off-recurring picture faults. Causes and cures explained. Copyrighted illustrated **CHART** tells where troubles start in typical TV set. Illustrations show resulting faulty TV pictures.

Part 2 explains hundreds of TV terms in non-technical language.

**PIX SHOW FAULTS—No. G1...\$1**

#### 1955 TV DOCTOR

How to Diagnose and Remedy TV Troubles: Useful Info About TV Sets; Easy Trouble Checks; UHF Servicing; Antenna Know-How; Servicing Hintag; Color TV; Troubles Due to Defective Tubes; How to Read Schematic Diagrams. Practical hints for prospective TV servicemen.



**BEGINNER'S BEST BUY—No. D5.....\$1**

#### RAPID TV TROUBLE SHOOTING METHOD

**NEW TV servicing method speeds location of faults for all models.** Rapid checks and step-by-step directions enable you to:

**SHOOT TV TROUBLE FAST—No. T1.....\$1**

#### TV TROUBLE TRACER

Each vol. has different **TROUBLE INDICATING TUBE LOCATION GUIDES** of hundreds of popular TV models. Each has over 70 Illustr. & Guides, 40 most common pix troubles illustrated.

Vol. 1 (No. TT1) older models; Vol. 2 (No. TT2) 1952-1953 sets; Vol. 3 (No. TT3) 1953-1954 sets; Vol. 4 (No. TT4) 1954-1955 models.

**EACH VOL.....50c**

#### NOW READY!

#### ABC OF COLOR TV

Explains Color TV in plain everyday language.

**Color TV Simplified—No. R1.....\$1**

**FREE:** With every purchase of \$5 or over—Vol. 4 TV **TROUBLE TRACER**.

With every purchase of \$8 or over—Vol. 4 TV **TROUBLE TRACER**—plus—H. G. Cisin's New **TV TUBE SUBSTITUTION GUIDE** of commonly used TV Tubes. Book also contains other valuable data on Pix tubes, color coding, etc.

If jobber is out of stock send coupon to:

**H. G. Cisin, Dept. E-34, Amagansett, N.Y.**

Enclosed find \$..... RUSH POSTPAID following books

- |                                 |                                  |                                  |  |
|---------------------------------|----------------------------------|----------------------------------|--|
| <input type="checkbox"/> L1—\$2 | <input type="checkbox"/> D5—\$1  | <input type="checkbox"/> TT3—50c | Order \$5 or over INCLUDE FREE TT4<br>Order \$8 or over SEND BOTH FREE BOOKS |
| <input type="checkbox"/> A1—\$1 | <input type="checkbox"/> T1—\$1  | <input type="checkbox"/> TT4—50c |  |
| <input type="checkbox"/> K1—\$1 | <input type="checkbox"/> TT1—50c | <input type="checkbox"/> R1—\$1  |  |
| <input type="checkbox"/> G1—\$1 | <input type="checkbox"/> TT2—50c |                                  |  |

Name.....

Address.....

City..... Zone..... State.....

NEW DEVICES

Individual insulators rated 7.5 kv; wet flashover voltage 40 kv.—Rohn Manufacturing Co., 116 Limestone, Bellevue, Peoria, Ill.

GLOBE-TENNA, Telco Electronics Mfg. Co., indoor v.h.f.-u.h.f. TV antenna in form of 12-inch globe with full-color

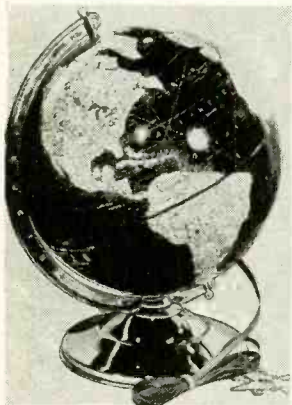

map. Bright brass base. Rotates to any position for best reception. 3-way connector on lead-in for connecting to all TV sets.—Telco Electronics Mfg. Co. (Div. of General Cement Mfg. Co.), 919 No. Wells St., Chicago 6, Ill.

FRINGE-AREA ANTENNA, Pixie, for weak-signal TV reception. Sharp directivity, unilobe pattern on v.h.f. channels, high front-to-back ratio, high

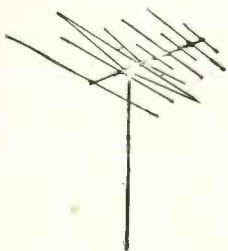

uniform gain, very high signal-to-noise ratio. Aluminum and stainless steel construction, preassembled.—Winegard Co., 3000 Scotten Blvd., Burlington, Iowa.

LOUDSPEAKER SYSTEM, Patricia IV, high-fidelity 4-way unit minimizes intermodulation and transient distortion. Three

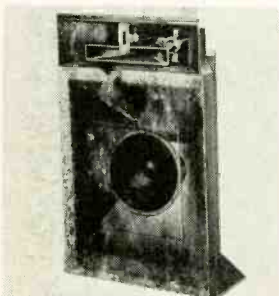

controls permit balance to room acoustics.—Electro-Voice, Inc., Buchanan, Mich.

PHONO CARTRIDGE, Fen-tone B & O Lo-Z, 8-pole magnetic type of Danish manufacture. Frequency range flat ±2 db 20-16,000 cycles, then rises gradually to over 20,000 cycles.

(Continued)

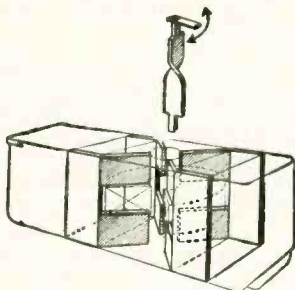
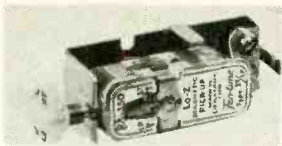

Tracking force: microgroove, 5-7 grams; 78 r.p.m., 9-12 grams. Equivalent stylus mass 4.5 milligrams for dual and 3.5 mg for single stylus. Output voltage 30 mv at 4.4 cm/sec; d.c. resistance to 530 ohms. Cartridge weight about 14 grams. No optimum load necessary; any resistance greater than 1,000 ohms suitable.—Fenton Co., 15 Moore St., New York 4, N. Y.

2-STATION INTERCOM, RMS Double Talk model DT-100, in mahogany Bakelite cabinets. Master has 4-inch PM speaker, 12AT6 voltage amplifier, 50C5



power amplifier with 1.8 watts output, 35W4 rectifier, volume control, press-to-talk and on-off switches. Switch on remote can be locked in talk position for baby sitting and similar applications. Third station with pushbutton selector switch optional. Similar unit, model DT1-100, in ivory cabinets.—Radio Merchandise Sales Inc., 2016 Bronxdale Ave., New York 62, N. Y.

TRANSCRIPTION TURNTABLE, Collaro 2010, 4-pole, dynamically balanced, hum-shielded induction motor. 33 1/3, 45, 78 r.p.m. Motor shock-mounted. Nonmagnetic turntable cast and machined; weighs 8 1/2 lb.; most weight in rim for added fly-wheel effect; covered with rubber mat. Low-mass, nonresonant arm houses crystal cartridge with 2 mechanically isolated sapphire turnover styli. Response smooth 40 to beyond



16,000 cycles. Model 2010 accommodates discs to 16 inches.—Rockbar Corp., 215 E. 37 St., New York 16, N. Y.



“... Serviceman’s BEST FRIEND”

“When I’m trying to analyze and correct a circuit TOUGHIE... it’s a great feeling to reach for my EMC Model 209 Emission-Type Tube Tester and know I’ll get fast, absolutely accurate checks for quality, shorts, leakage, continuity, and opens on all modern and future tubes... that new, modern, 3 1/2” plastic meter makes quick servicing easy. You’ll like this professional, multi-function instrument because it also rejuvenates picture tubes when used with Model CRA Picture Tube Adaptor... a unique flexible switching system assures that you can test all future types too! Best of all, this precision instrument is priced low

... its handy size (6 3/4” x 7 1/2” x 4”) makes it ideal for home calls.”

- EMC MODEL 209 \$35.90\* (as illustrated in Hammertone metal case)
- In oak carrying case 38.50\*
- Kit form 25.90\*
- EMC MODEL CRA (Picture Tube Adaptor) 4.50



\*Complete with plastic-covered, detailed instruction book and tube listings.

Yes, send me full technical information about Model 209 and a complete catalog of other EMC instruments. RE-9

NAME \_\_\_\_\_

OCCUPATION \_\_\_\_\_

COMPANY \_\_\_\_\_

STREET \_\_\_\_\_

CITY \_\_\_\_\_ STATE \_\_\_\_\_

**EMC** ELECTRONIC MEASUREMENTS CORP.  
290 LAFAYETTE STREET  
NEW YORK 12, NEW YORK  
EXPORT DEPT. - 370 BROADWAY, N. Y. 13, N. Y.

**NEW DEVICES**

**14-WATT AMPLIFIER**, Sargent-Rayment SR-14B, uses Ultra-Linear circuitry for high output with low distortion. Harmonic distortion 0.2% at 10 watts, less than 1% at 14 watts; IM distortion 0.8% (40

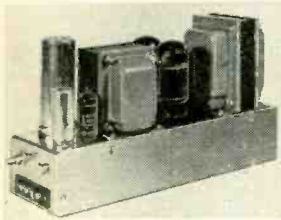

and 12,000 cycles mixed 4:1). Hum and noise better than 86 db below rated output; sensitivity 0.85-volt input for 10-watt output. Output does not rise more than 0.3 db between full load and no load. Output impedances: 4, 8, 16 ohms. 12½ x 4 x 6½ inches. Tubes: 12AU7, 6C4, 5Y3 and two 6L6-GB's. Power consumption 90 watts from 110-120-volt 50-60-cycle line. — Sargent-Rayment Co., 1401 Middle Harbor Rd., Oakland 20, Calif.

**MIDGET MICROPHONES**, Shure, for applications where small size and low weight are important. Available in controlled-reluctance types. New series MC furnished in 1-inch

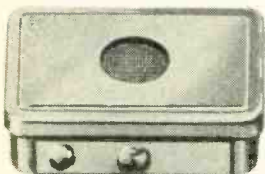

round and rectangular shapes. They are designed for manufacturers of original equipment, but available also to service technicians and laboratories. — Shure Brothers, 225 W. Huron St., Chicago 10, Ill.

**7½-INCH SCALE V.T.V.M.**, Precise Development model 9071, available as kit or factory-wired. VR tube for voltage regulation. 5 voltage ranges: 5, 25, 250, 500 and 1,000; +d.c.,

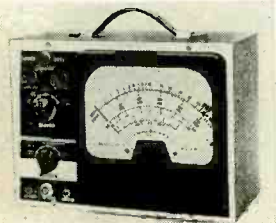

—d.c. and a.c. (separate 5-volt a.c. scale). 5 resistance ranges from 0.2 ohm to 1 billion ohms. Decibels from -20 to +55. True zero-center scale for aligning FM and TV discriminators. 25-megohm input impedance on d.c. Weighs 11 lb. — Precise Development Corp., Oceanside, N. Y.

**REMOTE TV LISTENER**, Lafayette Silent Viewer Model MS 125, permits listening without disturbing others. Also excellent for hard-of-hearing persons, who can adjust volume level to their needs. On-off switch, volume control and jacks

(Continued)

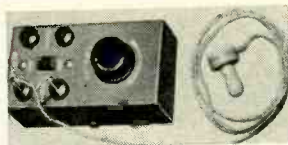

for 2 headphones. Provided with 20-foot cable. Supplied with one pair of headphones; additional pair available at extra cost. Lafayette Radio, Dept. J., 100 6th Ave., New York, N. Y.

**TV AMPLIFIERS**, Transvision, 8 models for master antenna installations and for repeater and distribution service in community systems. Broad-band distribution amplifiers and repeaters with choice of



low band only, high band only or full coverage of channels 2 to 13 with built-in cable-loss equalizers. Dual outputs are provided for systems requiring more than one main line. — Transvision Inc., 460 North Ave., New Rochelle, N. Y.

**TUBE ADAPTERS**, Adapter, inserted in vacuum-tube socket, become integral part of circuit. Test points for voltage, resistance measurements. Removing rod breaks circuit, allowing component or meter insertion. Color-coded terminals; com-



patible; no soldering. — A L Products, Kearny, N. J.

**CAPACITORS**, Astron Series X high-voltage types. Operate up to 150°C without derating, up to 200°C with proper derating and adjustment, as well as from -65° without derating. Characteristics due to combination of Mylar and other dielectric materials including a solid polyester impregnant. Available in wide range of hermetically sealed tubular, metal and bathtub cases with glass-to-metal closure. Excellent radio-frequency

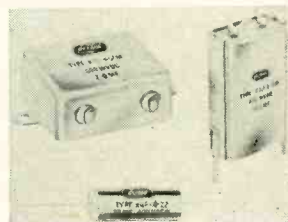

and retrace characteristics. — Astron Corp., 255 Grant Ave., East Newark, N. J.

**CONNECTORS**, printed-circuit applications. 10, 18, 22, 28

# LEARN PRACTICAL RADIO

Construction, Servicing, Theory

ONLY

At Home With New DeLuxe 1956

**\$19.95**  
Complete

Progressive Radio "Edu-Kit"

**Build 15 Receiver, Code Oscillator, Transmitter, Signal Tracer Circuits**



- ATTRACTIVELY GIFT PACKED
- FREE SOLDERING IRON
- NO ADDITIONAL PARTS NEEDED
- EXCELLENT BACKGROUND FOR TV
- 30 DAY MONEY-BACK GUARANTEE
- SCHOOL INQUIRIES INVITED
- ABSOLUTELY NO KNOWLEDGE OF RADIO NECESSARY
- LEARN HIGH FIDELITY

## WHAT THE "EDU-KIT" OFFERS YOU

Our Kit is designed to provide a fundamental background in radio, with the basic facts of Radio Theory and Construction Practice expressed simply and clearly. You will gain a knowledge of basic Radio Principles involved in Radio Reception, Radio Transmission and Audio Amplification. You will learn how to identify Radio Symbols and Diagrams; how to build radios, using regular radio circuit schematics; how to mount various radio parts; how to wire and solder in a professional manner. You will learn proper chassis layout. You will learn how to service and trouble-shoot parts. You will learn High Fidelity. In brief, you will receive a practical basic education in radio, worth many times the small price you pay.

## THE KIT FOR EVERYONE

The Progressive Radio "Edu-Kit" was specifically prepared for any person who has a desire to learn Radio. The Kit has been used successfully by young and old in all parts of the world. It is not necessary that you have even the slightest background in science or radio. The Progressive Radio "Edu-Kit" is used by many Radio Schools and Clubs in this country and abroad. It is used by Armed Forces Personnel and Veterans throughout the world. The Progressive Radio "Edu-Kit" requires no instructor. All instructions are included. All parts are individually boxed, and identified by name, illustration and diagram. Every step involved in building these sets is carefully explained.

## PROGRESSIVE TEACHING METHOD

The Progressive Radio "Edu-Kit" comes complete with instructions. These instructions are arranged in a clear, simple and progressive manner. The theory of Radio Transmission, Radio Reception, Audio Amplification and servicing by Signal Tracing is clearly explained. Every part is identified by illustration and diagram. You will learn the function and theory of every part used. The Progressive Radio "Edu-Kit" uses the principle of "Learn by Doing". Therefore you will build radio circuits, perform jobs, and conduct experiments to illustrate the principles which you learn. These circuits are designed in a modern manner, according to the best principles of present-day educational practice. You begin by building a simple radio. The next set that you build is slightly more advanced. Gradually, in a progressive manner, you will find yourself constructing still more advanced multi-tube radio circuits and doing work like a professional Radio Technician. You will build Receiver, Transmitter, Code Oscillator and Signal Tracer Circuits—15 in all. These sets operate on 105-125 V. AC/DC. For use in Foreign Countries having 230-250 Volt Source, an Adaptor for 230-250 V. AC/DC operation is available.

## THE PROGRESSIVE RADIO "EDU-KIT" IS COMPLETE

You will receive every part necessary to build 15 different radio circuits. The "Edu-Kit" contains tubes, tube sockets, variable, electrolytic, and paper condensers, resistors, tie strips, coils, hardware, tubing, instruction manuals, etc. No wire or solder included. These parts are individually packaged, so that you can easily identify every item. A soldering iron is included, as well as an Electrical and Radio Tester. Complete, easy-to-follow instructions are provided. All parts are guaranteed, brand new, carefully selected and matched. In addition, the "Edu-Kit" now contains lessons for servicing with the Progressive Signal Tracer, F.C.C. instructions, quizzes, High Fidelity instructions.

## TROUBLE-SHOOTING LESSONS

Trouble-shooting and servicing are included. You will learn how to recognize and repair troubles. You will build and learn to operate a professional Signal Tracer. You receive an Electrical and Radio Tester, and learn to use it for radio repairs. While you are learning in this practical way, you will be able to do far more than just repair your own radio. You will be able to do many a repair job for your neighbors and friends, and charge fees which will pay for the "Edu-Kit". Here is your opportunity to learn radio quickly and easily, and have others pay for it.

## FREE EXTRAS

- ELECTRICAL & RADIO TESTER
- ELECTRIC SOLDERING IRON
- TV BOOK
- QUIZZES
- HI-FIGUIDE
- FREE CONSULTATION SERVICE

Progressive "Edu-Kits" Inc. 497 Union Ave., Brooklyn 11, N.Y.

MAIL TODAY—Order shipped same day received.  
30-Day Money-Back Guarantee. Include ALL FREE EXTRAS  
 Send "Edu-Kit" Postpaid. I enclose full payment of \$19.95 (U.S.A. only).  
 Send "Edu-Kit" Postpaid. I enclose full payment of \$20.95 (Outside U.S.A.).  
 210-250 V. Foreign Line Voltage Adapter for "Edu-Kit"—\$2.50.  
 Send "Edu-Kit" C.O.D. I will pay \$19.95 plus postage (U.S.A. only).  
 I wish additional information describing "Edu-Kit". No Obligation.  
 Send me FREE Radio-TV Servicing Literature. No Obligation.

Name.....

Address.....

## PROGRESSIVE "EDU-KITS" INC.

497 UNION AVE., RM. 108-G, PROGRESSIVE BLDG., BROOKLYN 11, N.Y.

RADIO-ELECTRONICS

NEW DEVICES

(Continued)

or 44 gold-plated phosphor-bronze or beryllium contacts. Current rating, 5 amp. Polarized by deleting one or more contacts.—Cannon Electric Co., P. O. Box 75, Lincoln Heights Station, Los Angeles 31, Calif.

**PLUG-IN TUBULARS, type BC,** phenolic-cased paper units, printed-circuit applications. Two parallel-lead wire terminals brought out from end of

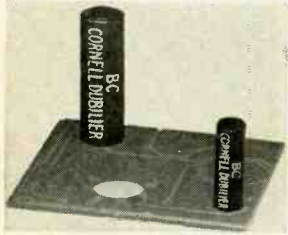

capacitor, spaced fixed distance, plugged directly into printed circuits and dip-soldered.—Cornell-Dubilier Electric Corp., South Plainfield, N. J.

**TUNER CLEANER, Electronic Chemical Tuner-Tonic** for cleaning, lubricating, restoring old tuners, including wafer types. Nontoxic and nonflammable,



will not harm insulation or precious metals, nor attack plastics. Does not affect capacitance, inductance or resistance of components.—Electronic Chemical Corp., 813 Communipaw Ave., Jersey City, N. J.

**SELENIUM RECTIFIERS, Federal Telephone & Radio.** 3 terminal types: square-tipped for printed-circuit boards up to 1/16-inch thick; tapered for boards up to 1/8 inch; snap-in for places where board is sub-

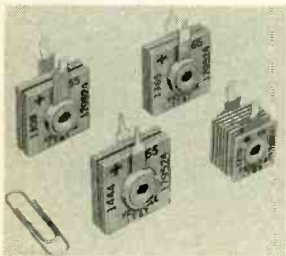

ject to vibration or may be inverted before soldering. Ratings up to 150 ma and for line inputs up to 175 volts a.c.—Components Division, Federal Telephone & Radio Co., 100 Kingsland Road, Clifton, N. J.

**FUSE HOLDERS, Littelfuse LC,** accept only correct size Littelfuse LC fuses. Different lengths of fuses and different widths of bayonet locking tabs make insertion of wrong LC fuses

All specifications given on these pages are from manufacturers' data.

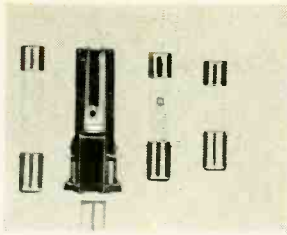

impossible. For example, 1-amp. fuse is 1.25 inches long with 0.115 to 0.120 width tabs. Its holder accepts only slo-blo fuses between 3/4 and 1 1/4 amp. LC fuses not replaceable with regular types.—Littelfuse, Inc., 1865 Miner St., Des Plaines, Ill.

**STURDY CAPACITORS, Pyramid Glasseal** types, withstand severe mechanical shock, vibrations and stresses of high acceleration. Solid dielectric type. Compression type glass-to-metal solder-seal terminals



will not rotate nor work loose under any operating conditions. Capacitor values from .001 to 1.0  $\mu$ f with d.c. voltage ranges of 100 to 600. Both inserted tab and extended foil.—Pyramid Electric Co., 1445 Hudson Blvd., North Bergen, N. J.

**MICROPHONES, American Microphone Co.** for use with tape recorders. Low-cost, high-quality units are small (3 1/4 x 2 1/8 x 1 1/8 inch) and light (2 ounces). Crystal type has response 100-7,000 cycles, output -55 db. Ceramic type has response 100-6,000, output -62 db. Omnidirectional.—American Microphone Co., 370 South Fair Oaks Ave., Pasadena, Calif.

**MATCHING CABINETS, Standard Wood Products,** for speaker and audio equipment stand together or apart as desired. High-grade 3/4-inch select-grain stock; authentically styled, carefully hand-rubbed. Model 200A acoustic cabinet T-braced, Kimsul-padded, vented for smooth low-frequency response

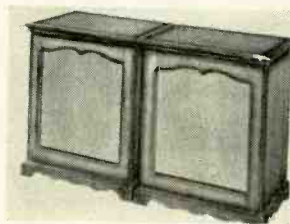

down to 30 cycles. 200E equipment cabinet; universal mounting arrangement to accommodate any combination of electronic equipment; open design for ventilation and convection cooling. In fruitwood or mahogany.—Standard Wood Products, 47 W. 63d St., New York 23, N. Y. END

RCA INSTITUTES

COLOR TV

HOME STUDY COURSE  
trains you in the "why" and "how"  
of Color TV Servicing

Study Color Television Servicing from the very source of the latest, up-to-the-minute Color TV developments. Train under the direction of men who are experts in this field. Take advantage of the big future in Color TV through RCA Institutes' Home Study Course, which covers all phases of Color Servicing. It is a practical down-to-earth course in basic color theory as well as how-to-do-it TV servicing techniques.

This color television course was planned and developed through the efforts of instructors of RCA Institutes, engineers of RCA Laboratories and training specialists of RCA Service Company. You get the benefit of years of RCA research and development in color television.

Because of its highly specialized nature, this course is offered only to those already experienced in radio-television servicing. Color TV Servicing will open the door to the big opportunity you've always hoped for. Find out how easy it is to cash in on Color TV.



SEND FOR FREE BOOKLET  
NO SALESMEN WILL CALL



RCA INSTITUTES, INC.

A SERVICE OF RADIO CORPORATION OF AMERICA  
350 WEST FOURTH STREET, NEW YORK 14, N. Y.

DEPT. RE-9-55

Without obligation on my part, please send me a copy of your booklet on the Home Study Course in Color TV Servicing.

NAME \_\_\_\_\_

ADDRESS \_\_\_\_\_

CITY \_\_\_\_\_ ZONE \_\_\_\_\_ STATE \_\_\_\_\_

# it's a snap!\*

with laboratory tested  
kits by **ARKAY**



**Arkay FL-10 High Fidelity Amplifier Pre-Amp Kit,** Unity coupled pushpull 12 watt output; frequency response  $\pm 2$ db 20-20,000 cps with extremely low IM and Harmonic distortion; 5 position input selector with record equalizer; loudness, bass, and treble controls; tapped output; extremely low noise level; completely enclosed—no cabinet problem; for clean, flexible, brilliant audio. **\$28.95**



**Arkay Model Q5X 2 Band AC/DC Radio receiver Kit.** Broadcast 550-1700kc and short wave 6-18mc bands; superheterodyne circuit of modern design; special tone chamber for utmost realism in listening; magic glow lucite dial actuated by pilot light when set turned on; a smart functional set. **\$19.95**



**Arkay Model TB2X — 2 band Battery operated Portable Radio Kit;** receives broadcast band 550-1700kc plus short wave band 6-18mc; superheterodyne circuit operated from a long life (1000 hour) battery pack; handsome cabinet with slide rule dial; low battery drain miniature tubes throughout. **\$19.95**



**Arkay Model SSE superheterodyne receiver Kit;** designed especially for the beginner—educational as well as functional; 5 tube AC/DC radio with built in loop antenna and plastic cabinet; as in all Arkay Kits, contains detailed manual with exclusive 3D Eye-O-Gram technique for simple assembly. **\$14.95**



**Arkay 2X4 3-way 2 band portable receiver Kit.** Foreign Band of 6-18mc; broadcast band 550-1600kc; excellent for beach or camping; indoors or out; foreign stations marked on semi-airplane dial; housed in handsome leatherette cabinet; superheterodyne circuit with low battery drain tubes. **\$24.95**



**Arkay 3W10P 3-way portable receiver Kit.** 4 low battery-drain miniature tubes in an efficient superheterodyne circuit of extreme sensitivity; AC, DC, and battery operation for utmost convenience; selenium rectifier for instantaneous operation on AC or DC; 2 tone attractive plastic cabinet; built in loop antenna. **\$18.95**



## SPECIAL FOR SEPTEMBER!

**Arkay Model 14721 Advanced design T. V. Kit** Featuring — Modern Vertical Chassis construction; transformerless operation; turret type Tuner (Factory wired and tested); Full 14kv, electrostatically focused 21" picture tube operation; field tested circuitry of latest design and innovation for stable, clear, trouble free reception under all conditions; excellent fringe area performance. A first rate Kit anyone can easily assemble at a low price anyone can afford. **\$79.50**

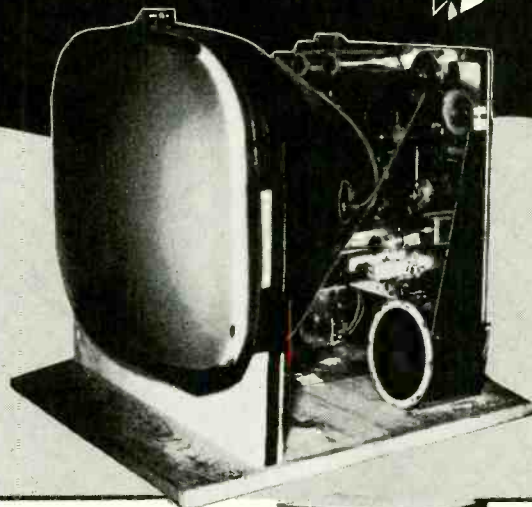

**Arkay Model P120 3 Band Radio Receiver Kit.** Frequency range 550kc-18mc in 3 bands; police, fire, amateur and foreign stations; slide rule dial; special tone control and phono switch on front cabinet; 6" speaker; quality throughout; latest transformerless design. **\$25.75**



**Arkay Model 10-1 Electronic Experimenters Kit.** 10 projects to construct include, a broadcast receiver, audio amplifier, phono oscillator, code practice oscillator, home broadcast station, capacity relay, photo cell relay, signal tracer, electronic timer, electronic switch; learn circuitry the practical way. **\$13.95**

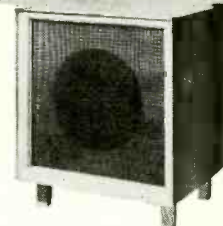

**Arkay Model B12 Baffle Kit.** Infinite impedance type for 12" speaker maximum size; cabinet is exact replica of very expensive commercial sound chamber giving excellent full frequency sound response; enclosure is acoustically tuned; this unit is attractive and is mounted on Hollywood legs; assembled by anyone with hammer and nails; easily finished. **\$11.95**

## SPECIALS FOR SEPTEMBER!

**Arkay A-12 High Fidelity Amplifier Kit** Featuring — 12 watt output—push pull 6V6's; frequency response  $\pm 1$ db 20-20,000 cps with low distortion; 5 inputs, master controlled at front panel; tapped output transformer; separate bass and treble control, each with maximum db boost and cut; built-in Pre-Amplifier; Ideal for home installations. **\$22.95**

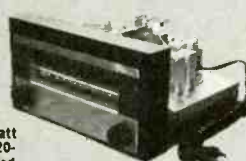

**Arkay FM-AM Tuner Kit** Featuring—7 tube circuit plus selenium rectifier includes separate mixer and Oscillator stages, 3 double tuned IF stages with Foster-Seeley discriminator and grounded grid amplifier for excellent response characteristics:

**Sensitivity & Selectivity**—FM 5mv for 30db quieting, 200 kc bandwidth 8db down. AM 25mv with 8 kc bandwidth 6db down.

**Frequency Response** —  
FM  $\pm 5$ db 20-20,000 cps  
AM  $\pm 3$ db 20-5000 cps  
Image rejection —30db minimum  
Hum level —-65db.  
AFC control and defeat. **\$24.95**  
FM—only kit available. **\$18.95**

## FREE

Master catalogue of Arkay Kits sent free of charge upon request. To obtain these fine Kits see your local dealer or write directly to Arkay.



\* Arkay invites you to see for yourself how simple it is to construct these fine Kits. A sample Construction Manual and Pictorial Exploded views illustrated above (Model 3W10P Portable Radio) will be sent for just 10c (to cover postage and handling).

Radio Kits Inc. Dept. 9-R  
120 Cedar St., N. Y., N. Y.

Gentlemen:

- Please send me sample Manual, Enclosed is 10c.
- Please send me Free master catalogue of Arkay Kits.

Name.....

Address.....

City.....State.....

# RADIO KITS INC.

DEPT. 9R 120 CEDAR ST., N. Y. C.

# new Tubes & Transistors

Sylvania has announced three new 21-inch, aluminized, electrostatic-focus, glass, rectangular picture tubes rated for 20-kv operation. The 21ALP4A/B, 21AUP4A/B and 21AVP4A/B have been produced in line with the higher operating voltages required for greater contrast and brighter television pictures. Other than the 20-kv high-voltage rating, the tubes meet all specifications previously registered with the 18-kv tube types (no B designation).

The 21ALP4A/B has a 90° deflection angle and an outer conductive coating which when grounded forms a 500-750- $\mu$ f capacitor with the inner coating. The 21AUP4A/B has a deflection angle of 72° and forms a capacitor of 500-750  $\mu$ f. The 21AVP4A/B has a deflection angle of 72° and forms a capacitor of 1,200-1,500  $\mu$ f.

**4BC8**  
A miniature twin-triode, the 4BC8,

has been announced by Sylvania. It is a miniature medium- $\mu$  semiremote cutoff twin triode, for use in sets with controlled-warmup 600-ma series heater strings. Except for its heater ratings (4.2 volts, 600 ma) it is identical to the 6BC8 described in the May issue. It is intended for use as a v.h.f. cascode amplifier, functioning very effectively in a.g.c. circuits and minimizing cross-modulation under both strong- and weak-signal conditions.

**3D22-A**  
An improved version of the 3D22 featuring a greatly strengthened mount structure has been announced by RCA. The tube is a sensitive, four-electrode, xenon thyratron for use in relay and grid-controlled rectifier applications, particularly those involving motor-control service.

Like the 3D22, the 3D22-A has a negative-control characteristic essen-

tially independent of ambient temperature over an operating range of -75 to +90° C. It also has small pre-conduction currents, low control-grid-to-anode capacitance and low control-grid current.

When used for d.c. voltage control, two 3D22-A's, in a full-wave circuit with a resistive load, are capable of handling up to 660 watts at a d.c. output voltage up to about 410. When used for a.c. voltage control, two 3D22-A's in a full-wave circuit are capable of handling up to 800 watts.

**5R4-GYA, 6L6-GB**  
Straight-sided button-stem versions of two popular receiving type tubes have been announced by G-E. The 5R4-GYA has the same electrical characteristics as the 5R4-GY, but is 1/2 inch smaller in diameter. The 6L6-GB is about 1/4 inch shorter and 1/4 inch smaller in diameter than the 6L6-GA and a lot smaller than the 6L6-G. Electrical characteristics remain the same.

**Silicon diodes**  
Designed for extremely accurate voltage reference, four new types of silicon diodes have been announced by Texas Instruments. With reverse breakdown voltages (measured at 5 ma) ranging from 3.7 to 8, the silicon voltage reference diodes feature extremely small breakdown-voltage temperature coefficients from -55° to +150° C. This temperature coefficient, which can be positive or negative, is

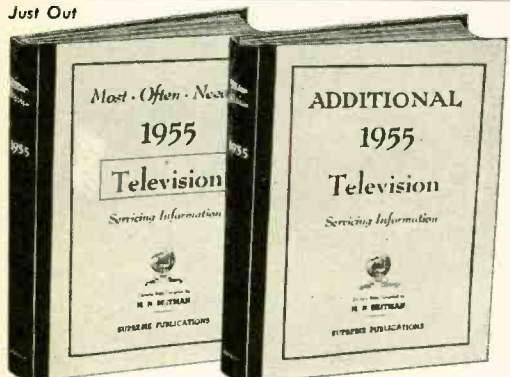

These two 1955 TV volumes cover practically all sets of all makes. The new **ADDITIONAL 1955 TV** manual includes material almost to the minute. Each giant manual has 192 pages of service data, changes, double-size circuits. Special price, each only **\$3**.

## New ADDITIONAL 1955 TV Volume LARGE MANUAL COVERS NEWEST 1955 TV SETS EARLIER TV VOLUMES STILL SOLD AT ONLY \$3

### AMAZING BARGAIN

*Supreme* twin 1955 TV manuals are the scoop of the year. Cover all sets of all important makes. New **ADDITIONAL 1955 TV** volume gives you the very latest material. Your price for this mammoth manual is only \$3. *Supreme* super values defy competition. Each prior-year manual (at only \$3) has a whole year of service material. Each volume covers different material, from 1947 to latest 1955 sets. Include circuits, alignment, waveforms, voltage charts, service hints, changes, and double-spread diagrams.

### ALL NEEDED TV DATA

*Supreme* TV manuals supply all needed service material on every TV set of every important manufacturer. Here is helpful, practical, factory-prepared data. It will really make TV servicing and adjustment easy for you. Join 146,000 servicemen who use, benefit, and save with **SUPREME** service manuals. In these manuals you get correct factory-checked circuits, alignment procedure, response curves, service hints, recommended changes, voltage charts, waveforms, and dozens of double-page diagrams. Here is your TV service material to help you do expert work double-quick; and priced at only \$3 per annual volume. Be ready to repair any model by carrying in your car all ten TV volumes listed in coupon below. Or try one of the new 1955 TV manuals to see what an amazing bargain you get for only \$3. Send coupon for prompt shipment or ask your jobber.

**TELEVISION SERVICING COURSE**  
Let this new course help you in TV servicing. Amazing bargain, complete, only \$3, full price for all lessons. Giant in size, mammoth in scope, topics just like a \$200.00 correspondence course. Lessons on picture faults, circuits, adjustments, short-cuts. UHF, alignment facts, hints, antenna problems, trouble-shooting, test equipment, picture analysis. Special, only **\$3**.

**RADIO DIAGRAMS**  
Here is your complete source of all needed **RADIO** diagrams and service data. Covers everything from most recent radios to pre-war old-timers; home radios, auto sets, combinations, chargers, and portables. Sensational values. Still sold at Pre-Korean prices. Only \$2 for most volumes. Every Radio manual contains large schematics, all needed alignment facts, parts lists, voltage values, trimmers, dial stringing, and helpful service hints. All volumes are large in size, 8 1/2 x 11 inches, about 100 pages. See coupon at right for a complete list of these low-priced manuals.

## NO-RISK TRIAL ORDER COUPON

**SUPREME PUBLICATIONS, 1760 Balsam Rd., Highland Park, Ill.**

- Radio Diagram Manuals**
- New 1955 Radio Manual, \$2
  - 1954 Radio Manual, \$2.50
  - 1953 Diagrams
  - 1952 Radio
  - 1951 Diagrams } **ONLY \$2.50**
  - 1950 Manual } **EACH**
  - 1949 Radio
  - 1948
  - 1947
  - 1946
  - 1942
  - 1941
  - 1939
  - 1938
  - 1926-1938 Manual, \$2.50
  - Radio and TV Master Index, 25¢
- PRICED AT ONLY \$2 EACH**

Rush today TV manuals checked  below and Radio manuals at left. Satisfaction guaranteed.

**Additional 1955 TV, \$3.**     **Early 1955 TV, \$3.**  
 **1954 TV Manual, \$3.**     **1953 TV Manual, \$3.**  
 **1952 Television Manual, \$3.**     **1951 TV, \$3.**  
 **1950 Television Manual, \$3.**     **1949 TV, \$3.**  
 **1948 TV, \$3.**     **1947 TV & FM, only \$2.**  
 **New Television Servicing Course, complete, \$3.**

I am enclosing \$..... Send postpaid.  
 Send C.O.D. I am enclosing \$..... deposit.

Name: .....

Address: .....

**Supreme Publications**  
Sold by All Leading Parts Jobbers

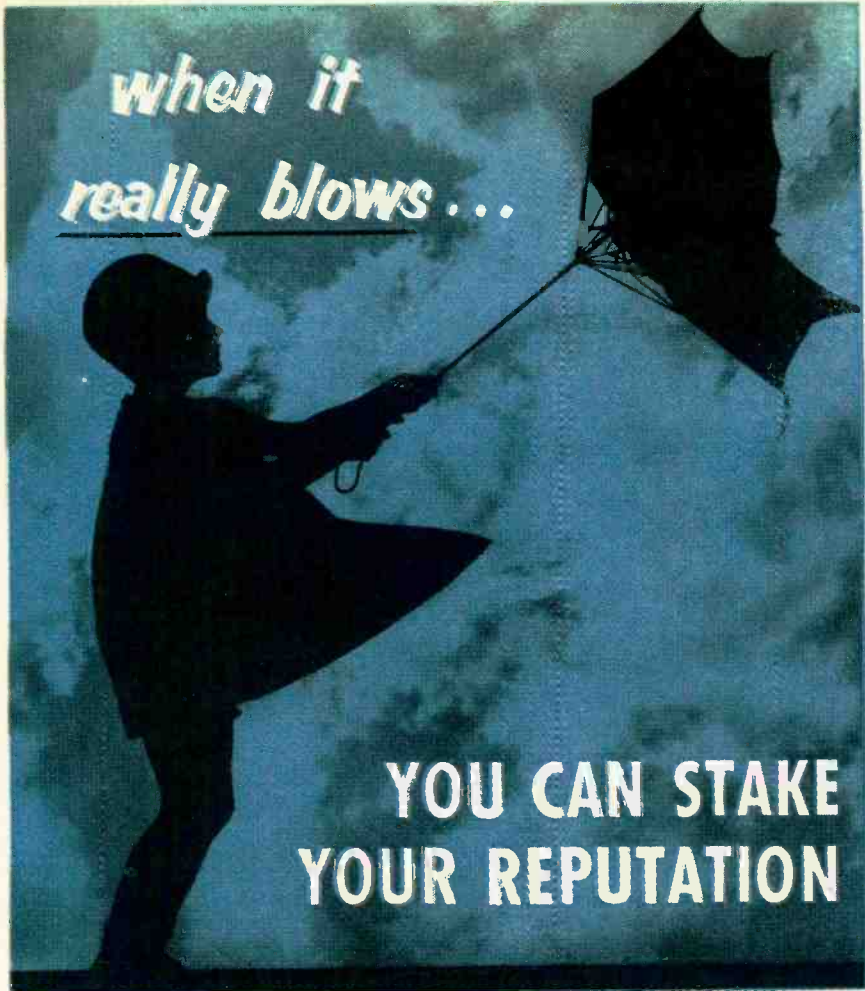

when it  
really blows...

**YOU CAN STAKE  
YOUR REPUTATION**

**on a TACO antenna!**  
**For Color as well as Black and White**

Proved in hurricanes Carol, Edna and Hazel along the East Coast and in many storm areas last year, the Taco spring-loaded assembly is recognized by the trade as the most rugged construction employed in any antenna — at any price! Both Trapper and Super Trapper are high-gain, broad-band antennas, unexcelled in gain across the entire VHF band. These antennas provide phenomenal picture clarity — combined with the most compact and streamlined design.

Get the facts on these two great antennas today. Write or see your Taco distributor.

**WORLD LEADER IN  
TV ANTENNA DESIGN**

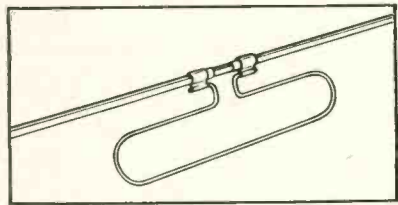

The Taco trap\* provides the means whereby streamlined Trappers outperform bedspring type antennas.

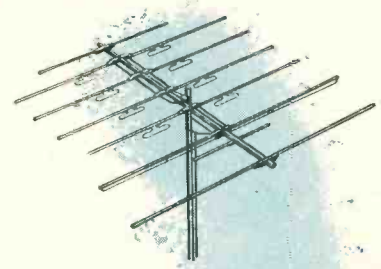

**Super TRAPPER**

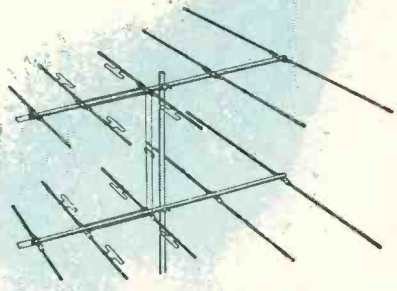

**TRAPPER**

© 1955 \*U.S. Pat No. 2,705,283

**TECHNICAL APPLIANCE CORPORATION • SHERBURNE, N. Y.**

**NEW TUBES AND TRANSISTORS (Continued)**

combined with very low dynamic resistance in the breakdown region to provide an ideal device for constant voltage reference purposes.

The diodes (see photo), types 650, 651, 652, 653, have a power dissipa-

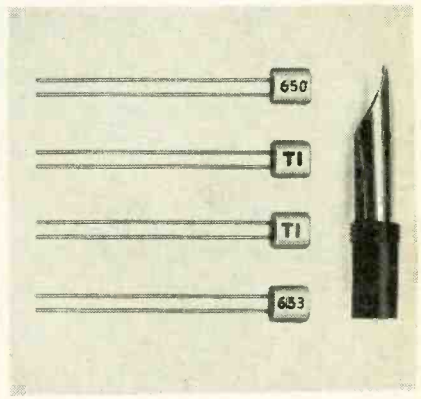

tion rating of 150 mw at 25° C and 40 mw at an ambient temperature of 150° C. Maximum average rectified forward current ranges from 90 to 125 ma at 25° C. Maximum reverse current is 0.1 μa at -1 volt at 25° C.

The new diodes are expected to have wide application wherever there is a need to stabilize accurate electronic circuits.

**6694**

Just released by RCA is a very tiny (see photo), cadmium-sulfide photoconductive cell of the head-on type. Designated as the 6694, this cell features high luminous sensitivity, very low dark current, extremely low background noise and signal output directly proportional to the incident light intensity. The characteristics are not substantially affected by wide changes

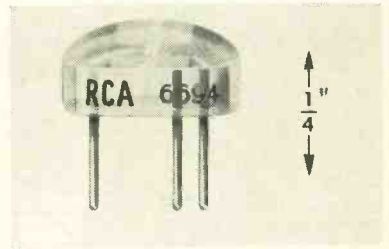

in operating temperature.

Because of its tiny size and high sensitivity, the 6694 is especially useful in light applications where a single tiny photosensitive device is desired—in light-controlled relays, computers and light meters for measuring the brightness of small luminous spots. It can also be used in X-ray intensity measurements.

The spectral response of the 6694 covers the visible range from about 3,500 to 5,500 angstroms, maximum response occurring at about 5,000.

The frequency response of the 6694 falls off with increase in frequency. Its upper limit is about 500 cycles. A wider response is obtained with high light levels than with low. **END**



# radio-electronic Circuits

## AUTOMATIC CW KEYER

Hours before a week-end WAS or WAZ contest or sweepstakes is over the average CW operator is pretty tired of pounding the key. This is particularly true when he sends a lot of long directional CQ's. This type of operating can be much less tiring if you follow

formers should be connected in reverse with the high-impedance winding feeding the grid. The variable resistor in the cathode circuit is set so the tube is biased close to cutoff and RY1 does not close. The germanium diode rectifies the keyed tone and develops a positive

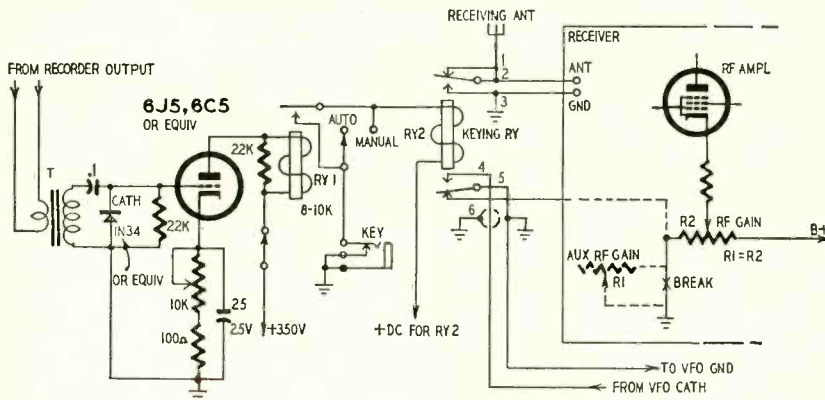

the lead of G2NS and use a tape recorder as an automatic keyer for calling. Calls such as CQ DX, CQ Nevada, CQ SS and the like are sent on a code oscillator and recorded on selected sections of the tape so they can be played back into the automatic keyer.

The diagram shows the keying system described in *The Short Wave Magazine* (London, England).

The signal from the recorder is taken from the voice-coil winding and fed into the grid of a 6J5 or similar triode used as a trigger tube. Transformer T can be an intercom input or single-ended output type with a primary of about 20,000 ohms. Output trans-

formers should be connected in reverse with the high-impedance winding feeding the grid. This increases the plate current and operates RY1. RY2 is a d.p.d.t. keying relay.

The receiver circuit is modified for break-in operation by removing the ground connection from the receiver's r.f. gain control (R2) and inserting an auxiliary control (R1) of the same resistance, as shown. R1 limits the strength of the transmitter signal to a convenient level for monitoring.

When the keying relay is operated, either with the key or automatic keyer, contacts 2 and 3 short the receiver's ground and antenna terminals, 5 and 6 open to lower the set's sensitivity and 4 and 5 close to key the v.f.o.

## IMPULSE NOISE GENERATOR

In many instances laboratories and home experimenters need an inexpensive source of ignition type impulse noise for testing noise limiters and checking noise-immunity characteristics of various TV sync circuits. This simple spark type noise generator was described in *Electronic Engineering* (London, England). The generator in

Fig. 1 consists of an a.c. type scope or TV high-voltage power transformer delivering about 5 kv, a 500- $\mu$ f high-voltage charging capacitor and a variable spark gap made from a spark plug modified as in Fig. 2. The setting of the screw varies the gap and breakdown voltage from about 1,000 to 3,000 volts.

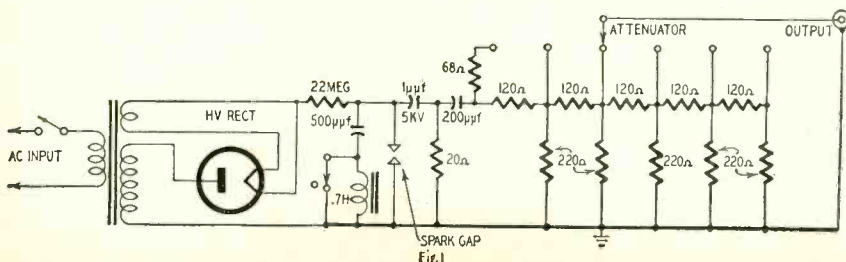

WANT POWER & VERSATILITY?

**FOLLOW THE LEADER...**



**KIT \$29.95**

**Wired \$38.95**

## 6V & 12V BATTERY ELIMINATOR & CHARGER #1050

- operates 6V and 12V auto radios for servicing and sales demonstration.
- charges 6V and 12V storage and Edison Batteries.
- operates mobile and marine receivers, transmitters, boat lights, electric trains, projection and other equipment.

### SPECIFICATIONS

- 6-Volt range: 0-8V (up to 20 Amp.)
- 12-Volt range: 0-16V (up to 10 Amp.)
- variac-type transformer for continuously variable voltage adjustment.
- reads volts and amperes at same time on 2 separate meters.
- Transformer primary and secondary fully protected.

In stock at local jobbers throughout the world. Write for free Catalog CG-9. Prices 5% higher on West Coast



84 Withers Street  
Brooklyn 11, N. Y.

**NOW COYNE TRAINS YOU IN SPARE TIME AT HOME**

# TELEVISION RADIO-ELECTRONICS

Only from famous COYNE do you get this modern up-to-the minute TV Home Training. Easy to follow instructions—fully illustrated with 2150 photos and diagrams. Not an old Radio Course with Television tacked on. Includes UHF and COLOR TV. Personal guidance by Coyne Staff. *Practical Job Guides* to help you EARN MONEY QUICKLY IN A TV-RADIO SALES AND SERVICE BUSINESS—part time or full time. COSTS MUCH LESS—pay only for training—no costly "put together kits".

### SEND COUPON FOR FREE BOOK

SEND COUPON BELOW for Free Book and full details including EASY PAYMENT PLAN. NO COST OR OBLIGATION—NO SALESMAN WILL CALL.



B. W. COOKE, Pres. **COYNE ELECTRICAL SCHOOL** FOUNDED 1899

A TECHNICAL TRADE INSTITUTE OPERATED NOT FOR PROFIT  
500 S. Paulina Dept. 65-HT4 Chicago 12, Illinois

COYNE ELECTRICAL SCHOOL  
Television Home Training Div.  
500 S. Paulina St., Chicago 12, Ill., Dept. 65-HT4  
Send FREE BOOK and details of your Television Home Training offer.

Name .....

Address .....

City ..... State .....

# Now there are 2

Rondine Jr.

2-SPEED 12" TURNTABLES by REK-O-KUT



Model L-34 for 45 and 33 1/3 rpm records

And the NEW

Model L-37 for 78 and 33 1/3 rpm records



\$49<sup>95</sup>

Slightly higher on West Coast

SEE THEM BOTH AT YOUR SOUND DEALER

or write for complete details to Dept. LJ-13  
**REK-O-KUT COMPANY**  
 38-01 Queens Blvd., Long Island City 1, N.Y.

## RADIO-ELECTRONIC CIRCUITS

When the gap is at maximum, the capacitor takes longer to charge to the gap's breakdown voltage and the frequency of the noise pulses is relatively low—as when an automobile is idling. Opening the switch cuts in a 0.7-henry inductor. This causes damped oscillations that produce a chain of lesser-amplitude pulses after each main spark discharge.

The generator should be enclosed in

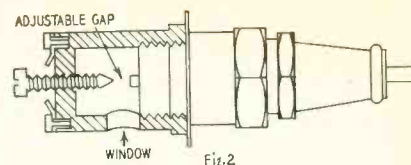

a tightly shielded box with the line cord entering through suitable filters.

## UNUSUAL FM-AM DETECTOR

A TV set designed for universal reception of European TV stations is necessarily complicated because of the differences in bandwidth standards, number of lines, video modulation polarity and sound transmission. The

is set to FM, the 120,000-ohm resistor is shorted out by S1, the FM signal is detected and a d.c. voltage is applied to the a.g.c. line. When the switch is thrown to AM, the ratio detector is unbalanced to the point that it will

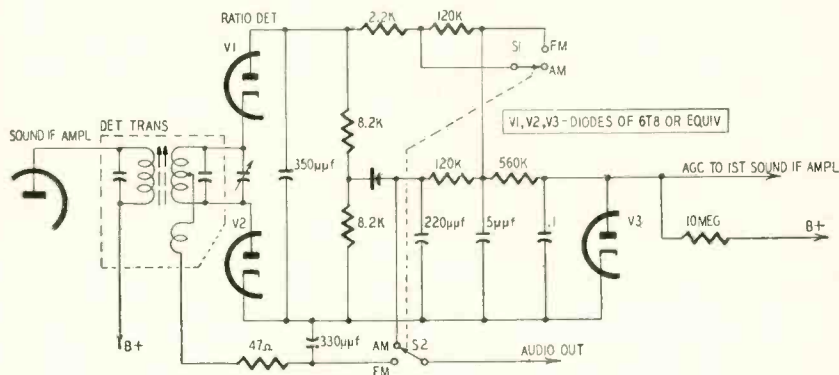

diagram shows the sound detector of a Philips multistandard receiver described in *La Radio-Télévision Professionnelle* (Paris).

V1 and V2 are in a ratio detector circuit for FM signals. When the switch

handle an AM signal. The germanium diode limits impulse type noise that exceeds the level of 100% modulation.

Experimenters will probably be able to adapt this circuit to 30-50- and 150-175-mc inexpensive FM receivers.

## AUDIO SQUELCH FOR SUPERREGENERATOR

The August, 1954, issue contained an Australian codan circuit for automatic band scanning with a 2-meter superregenerative receiver. I modified this circuit for use as an audio squelch for short-range superregenerators used on emergency and CD frequencies.

The first a.f. amplifier—a 6C4 or

equivalent—is run wide open to insure ample hiss voltage to operate the control tube. A portion of the audio voltage is tapped off and fed to the diodes of the 6AT6 control tube through a .01-μf capacitor and 22,000-ohm resistor. This voltage is rectified to provide a negative bias voltage for the triode grid. The bias voltage is filtered by R1-C1 a short time constant.

When no signal is coming in, the hiss from the superregenerator is high enough to develop sufficient bias on the 6AT6 triode to hold the relays open so the speaker voice coil is shorted. When a carrier is tuned in, the negative bias drops and the relays (RY1 and RY2) operate to remove the short from across the speaker.

When the carrier is modulated, the bias voltage varies at an audio rate because of the short time constant so RY1 chatters. However, RY2 stays closed because of the long time constant formed by the 100-μf capacitor and the resistance of the coil. The resistance of RY2 and the capacitor value were selected to hold in during normal pauses in speech. R2 is selected for positive action of RY2 while limiting current to the manufacturer's specs.

—Richard G. Strippel

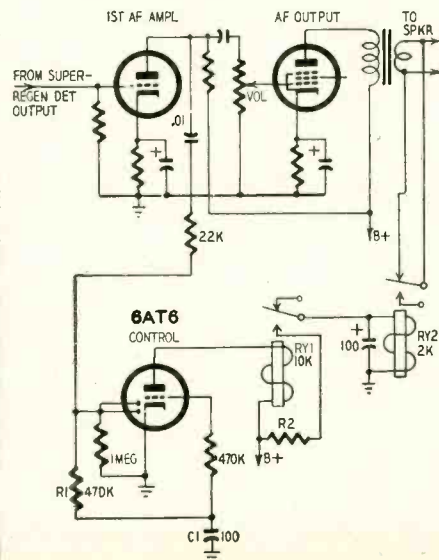

### LOSS-TYPE MODULATOR

Sometimes a modulated signal is needed for a test or experiment when a modulated-signal generator is not readily available. This device provides means for using one ordinary signal generator to modulate the signal from another. Construction is simple and most of the parts needed could be found in an experimenter's junkbox.

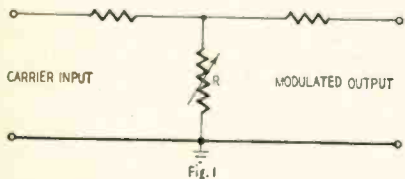

This is a loss-type modulator. Fig. 1 shows the principle used. Essentially, it is a T-attenuator in which the shunt resistor (R), is varied by the modulating signal. Thus the attenuation is varied and with it the level of output from the modulator, which is what is desired.

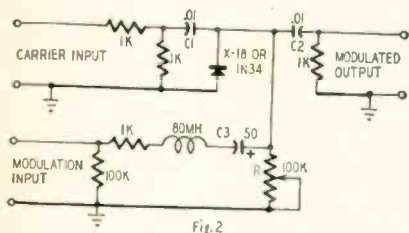

Fig. 2 shows the circuit actually used. The controlled resistance is a germanium diode (a Transistor Products X-18 was used; other types, such as 1N34 are also suitable). The carrier and modulating signals are both applied to the diode, the modulating signal controlling the resistance it offers to the carrier signal. Capacitors C1 and C2 block the modulating signal from the carrier channel, while the choke blocks the carrier frequency from the modulating signal channel. The diode's rectifying action charges C3 to a voltage that depends on the setting of potentiometer R. Thus, by controlling the point about which the diode operates, R controls the modulation. The values shown are for a 50-ke carrier. If the carrier frequency were around 500 kc or higher, as would be more usual, C1, C2 and the choke could be reduced say to one-tenth the indicated value.

In operation, the carrier signal is set at the desired level and the modulating signal is adjusted, along with R, to give the desired amount of modulation. It is helpful to observe the modulated output on an oscilloscope during adjustment. This device does not produce really high-quality modulation, but the result is still acceptable for many test purposes.

For convenience, the circuit was built in a Bud HB-1621 *Handi-Box* and equipped with three terminal post pairs (Millen 37222) for the inputs and outputs.—H. L. Armstrong **END**

## Hi-Fi and Hi-Price aren't Siamese Twins

THE NEW IMPORTED *Fen-tone*<sup>Hi-Fi</sup> IS OUT TO PROVE THIS TO YOU. NOW YOU CAN GET PROFESSIONAL FEATURES YOU ALWAYS WANTED — AT PRICES YOU WILL GLADLY PAY.

SEE THIS "BEST VALUE" SELECTION OF DANISH, ENGLISH AND W. GERMAN HI-FI EQUIPMENT AT THE CHICAGO HIGH FIDELITY SHOW SEPTEMBER 30-OCTOBER 2, ROOM 709 and THE NEW YORK AUDIO FAIR OCTOBER 13-16, ROOM 502, OR CONTACT YOUR AUDIO DISTRIBUTOR.



**REX**  
Scepticum Elmer

RECORD CHANGERS ARE PREFERRED BY OVER 85% OF THE CONTINENTAL HI-FI MANUFACTURERS.

A truly mechanical brain, plays any odd size record between 6" and 12"  
• Long professional type pick-up arm with plug-in shell to American standards • World's best shaded 4-pole phono motor • Factory tuned spring suspension double chassis • Practically free of rumble and acoustic feedback • Muting switch • Automatic shutoff • Two spindles — long for changer and short for manual player use • Many other features and models.  
Audiophile Net \$59.50

45 RPM Automatic Spindle (ADD.) Net \$3.50

### NEW *Fen-tone* D6 350 LO-Z PROFESSIONAL MAGNETIC CARTRIDGE

Works on any load over 1000 ohms • 30 mV/4.4 cm/sec. output, due to 8-poles • Highest 5x10<sup>-6</sup> cm/dyne lateral compliance • Response 20—16,000 cps flat ± 2 db then gradually rising to over 20,000 cps.

Audiophile Net:

- B&O Reversible, Silver Label (2 sapphire jewels) ..... \$ 7.95
- B&O Reversible, Gold Label (1 diamond, 1 sapphire) ..... \$19.95
- B&O Single, Silver Label (1 sapphire jewel) ..... \$ 7.50
- B&O Single, Gold Label (1 diamond jewel) ..... \$18.95



### THE NEW MINIATURE *Fen-tone* BLUE RIBBON STUDIO TYPE VELOCITY MICROPHONES. TRULY PROFESSIONAL MIKES AT INCOMPARABLE LOW PRICES.

"RESLO" DUAL IMPEDANCE MIKES — PROPER IMPEDANCE SELECTED BY PLUGGING IN PROPER CABLE. • Shockproof miniature duraluminum ribbon with no audible resonance. • Response 30 — 15,000 cps ± 2 db. • Bi-directional pattern easily changed to directional or close talk by use of internal pads. • Triple blast screening. • Sensitivity — 58 db.  
"B&O"-50 A BI-DIRECTIONAL MIKE WITH CHARACTERISTICS SIMILAR TO THE RESLO BUT WITH EVEN GREATER SENSITIVITY. INSTEAD OF PADS IT HAS A 3-WAY SWITCH: "T" (Close talk); "M" (music) and "O" (off).

Reslo "Celeste" 30/50 ohms and Hi-Z with muting switch — Audiophile Net \$48.95  
Reslo "Symphony" 250/600 ohms (no muting switch) — Audiophile Net \$48.95  
B&O-50 50 ohms impedance — Audiophile Net \$48.95

### *Fen-tone* MOTEK K5 TAPE DECK

Driven by three AC motors. • 7½ ips speed, dual tracks. • 3¾ ips conversion pulley available. • All-electrical push-button switching and braking. • Frequency response better than 50 — 10,000 cps. • WOW and FLUTTER less than .3%.  
Audiophile Net: \$59.50

### *Fen-tone* TPR-1 TAPE PREAMPLIFIER

Bias frequency 50 — 60 kc, adjustable. • Signal to noise ratio: better than — 55 db. • Power supply on separate chassis. • High impedance (1 volt) output.  
Audiophile Net: \$39.50 — In prefabricated kit form: \$34.50

THE NEW LARGE MOTEK K7 2-SPEED UNIT WILL SOON BE AVAILABLE ALSO

### *Fen-tone* "BRENELL" HI-FI TAPE DECK

A FOOLPROOF 3-SPEED UNIT FOR LIFETIME USE.

- Three speeds: 3¾ ips 7½ ips 15 ips
- Frequency Response: 50-6500 50-12000 30-15000
- Playing Time: 2 hours 1 hour ½ hour

• Three independent AC motors. • Dual tracks — 7" reels. • Positive interlock of all switching and braking mechanisms, including automatic pinch-roller and pressure pad assembly. • Instantaneous mechanical braking. • Simple two-knob operation: The left for "Fast Forward" and "Rewind" (within 45 seconds); the right for "Record/Playback" and "Off." • WOW and FLUTTER less than .2%. • High fidelity heads have mumetal shields for hum-free operation. Hi-Z Record/Playback head with adjustable azimuth, ideal for all makes of pre-recorded tapes. • Heavy Duraluminum base plate 15" x 11½". • Highest quality precision workmanship.  
Audiophile Net \$79.50

#### ATTENTION PRERECORDED TAPE USERS:

Our PRO-2 Hi-Fi Pre-amplifier for Motek and Brenell decks featuring 3 independent equalization curves is now also available.

All prices slightly higher on the West Coast.

**FENTON COMPANY**

15 MOORE STREET  
NEW YORK 4, N. Y.



# NEW RIDER BOOKS

for everyone interested in Electronics!

## "PICTURE BOOK OF TV TROUBLES"

Each volume in this series covers a different circuit! Based on troubleshooting done in the Rider lab, each shows you dozens of typical troubles, their symptoms (picture tube patterns and waveforms) and their causes. There's also a handy pull-out section in each book that shows you what the RIGHT waveforms should look like. Actually does your troubleshooting for you!

VOL. 1: Horiz. afc-osc. ckts. ....only \$1.35  
 VOL. 2: Vert. sweep-def. ckts. ....only \$1.80  
 VOL. 3: Video i-f & amp. ckts. ....only \$1.80  
 VOL. 4: AGC ckts. ....only \$1.80

## "Handbook of 630-type TV RECEIVERS"

Covers all 630-types—from the earliest to the latest! Gives the "whys" and "hows" of each section; analyzes and explains the many changes and modifications made by various manufacturers. 26 pages of troubleshooting charts—plus complete schematics of the original "630" and 2 typical revisions. A must for everyone in servicing! only \$3.50

## "SELLING YOUR TV-RADIO SERVICE"

Prepared by GE's Tube Dep't., this valuable guidebook shows you how to get more service customers through Advertising, Window & Store Displays, and Direct Mail. Includes tips on letter writing, postal regulations, addressing methods, printing economies; shows typical window display "gimmicks" and suggested store layouts. This book can make the difference between slow months and busy ones—only \$1.00

## "FM LIMITERS & DETECTORS"

A complete review of the basic concepts of these important circuits, for use by everyone from student to service technician. Includes review questions after each chapter for a quick self-check. only 90c

## "BASIC VACUUM TUBES"

A simplified introduction to the basic types of vacuum tubes, starting with a brief history of their development, and following a carefully planned, step by step examination of each of the basic types, their characteristics and construction. Many illustrations. only \$3.00

## "TV REPAIR QUESTIONS & ANSWERS"

A practical new series—specific questions and answers about servicing every section of the tv receiver, including follow-through discussions wherever needed. For easy use, chapters are arranged in the same sequence as the signal flow path.

VOLUME 1 covers FRONT ENDS .....only \$2.10  
 VOLUME 2 covers VIDEO CIRCUITS .....only \$2.10

## "SPECIALIZED AUTO RADIO MANUALS"

Complete, factory-prepared data—all the information you need for quick, profitable auto radio servicing! Each book crammed full of large, clear illustrations—each page tells you exactly what to do! Included in each volume: noise suppression, schematics, tube layout, key voltages, push-button setups, alignment, cabinet pictures, dial stringing, trimmer location, parts lists, chassis views.

VOL. 7: Automatic, Firestone, Montgomery Ward & Spiegel auto radios for any car or truck made between '48 and '51. ....only \$3.00  
 VOL. 6: Motorola radios for any car or truck made between '48 and '55. ....only \$3.00

VOLS. 1 to 5 cover all factory-installed auto radios for cars made between 1950 and 1954!

VOL. 1: Ford, Lincoln, Mercury. ....only \$3.00  
 VOL. 2: Buick, Cadillac, Oldsmobile. ....only \$3.00  
 VOL. 3: Chevrolet, Pontiac, GMC & Chevrolet trucks. ....only \$1.80

VOL. 4: Chrysler, De Soto, Dodge, Dodge trucks, Plymouth. ....only \$3.00

VOL. 5: Henry-J, Hudson, Kaiser-Frazer, Nash, Packard, Studebaker, Willys. ....only \$3.00

## ORDER TODAY!

These books are sold by parts jobbers & book stores throughout the U. S.—if your dealer doesn't have them, mail coupon today!

**JOHN F. RIDER PUBLISHER, Inc.**  
 Dept. RE-9, 480 Canal St., N. Y. 13, N. Y.

Enclosed is \$..... Send me those books whose titles I have circled above. (Add state & city sales tax where applicable.) In Canada, prices approximately 5% more.

Name.....  
 Address.....  
 City & State.....

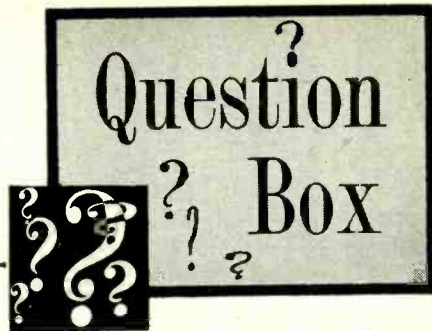

## PILOTUNER ON 30 TO 50 MC

I have a Pilotuner model T-601 that I'd like to modify for reception on 30 to 50 mc. Please show the necessary circuit changes.—Y. G. R., Minneapolis, Minn.

The diagram shows the front end of the T-601 FM tuner as modified with new coils for the 30-50-mc band. L2, L3 and L4 are each seven turns of No. 20 enameled wire closewound on CTC

generator are used for front end alignment. Use the grid-dip oscillator to adjust the trimmer and slug of L2 and the slug of L3 so the antenna and r.f. circuits tune from 30 to 50 mc. Next, adjust the oscillator trimmer and the slug in L4 for a tuning range of 40.7 to 60.7 mc.

After completing these preliminary adjustments, align the front end with

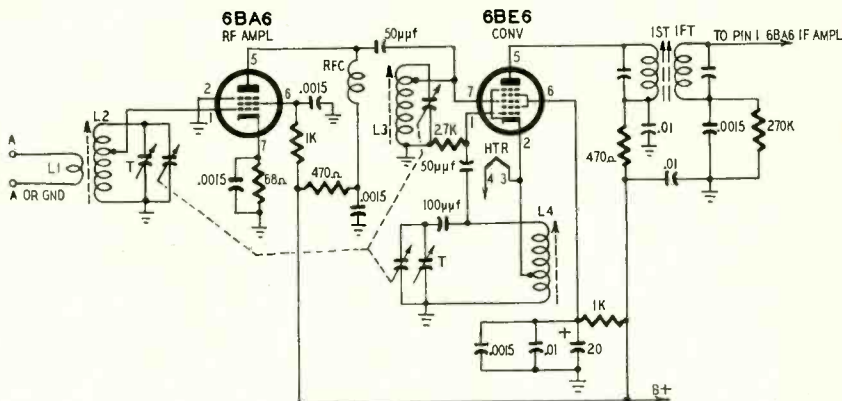

(Cambridge Thermionic Corp.) type LSM forms. Grid taps on L2 and L3 are made one turn from the top end of the winding and the cathode tap on L4 is two turns from the bottom. L1 is three turns of No. 28 enameled wire closewound over the ground end of L2 and separated from it by a double layer of cellophane tape.

A grid-dip oscillator and a signal

the signal generator. It may be necessary to replace the 100-μf fixed oscillator padder with a variable type and adjust it for good tracking.

A noise generator can be used to determine the optimum number of turns on L1, to adjust the coupling between L1 and L2 and to set the taps on L1 and L2 to provide the best signal-to-noise ratio.

## CONVERTING THE G-E 160

Frequent replacements of the vibrator and 2-volt storage battery in my G-E model 160 a.c.-battery portable radio are expensive and annoying so I'd like to convert it to a three-way type using dry batteries. Please show the circuit modifications.—P. M., South Greenburg, Pa.

Converting the set for three-way operation would require rewiring the filament circuit for series operation, installation of balancing or filament-shunt resistors and the use of 7.5- or 9-volt A batteries. We suggest two-way conversion for a.c. and dry-battery operation as shown in the diagram.

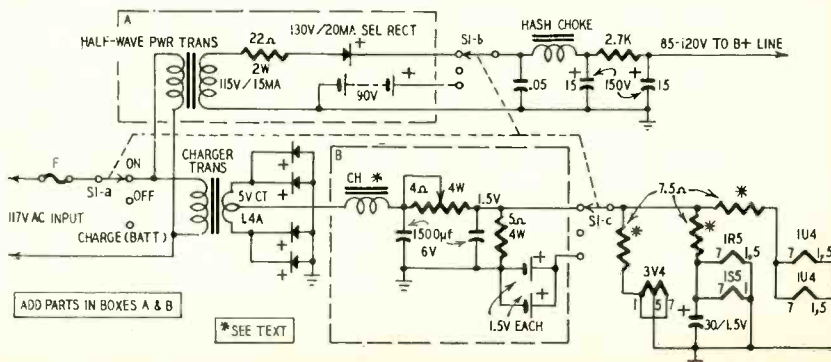

**QUESTION BOX***(Continued)*

The job is greatly simplified and filament batteries are less expensive and much easier to obtain. Components enclosed in dashed lines are added to the set. A half-wave a.c.-operated supply replaces the vibrator and its transformer. The output of the charging circuit is filtered and used to light the filaments for a.c. operation.

The vibrator, vibrator transformer and storage battery must be removed to make room for the new components and dry batteries. Study the three-circuit, three-position ON-OFF-CHARGE switch and remove all leads from S1-b, S1-c and from the CHARGE (now BATTERY) position of S1-a.

Disconnect the lead from the center tap on the vibrator transformer secondary and connect it to the arm of S1-b. Remove the vibrator transformer and install a 115-volt power transformer and rectifier connected as in box A. Connect the primaries of the power and charger transformers in parallel. Connect the positive side of the half-wave rectifier to the ON contact of S1-b and a connector for the positive B battery terminal to the BATTERY terminal of S1-b. This completes the new B plus circuit.

Install and wire the low-voltage filter enclosed in box B. Connect the ON contact of S1-c to the output of the filter and the BATTERY contact to a lead for the positive terminal of the 1.5-volt A battery.

Run a lead from the positive charging-cable connector or from the tap on the charger transformer to the choke in the low-voltage filter. This choke is made by winding as many turns of No. 22 enameled wire as possible on the core of an old a.c.-d.c. type filter choke. Remove the three 7.5-ohm filament dropping resistors and run a lead from the arm of S1-c to pin 7 on each tube socket. This completes the filament-circuit modifications.

The filament voltage must be adjusted before operating the set on a.c. Remove the tubes from the sockets and temporarily connect a 5.6-ohm 1-watt resistor from the arm of S1-c or pin 7 of one socket to ground. Adjust the 4-ohm variable resistor for exactly 1.5 volts across the 5.6-ohm unit. Remove this resistor and replace the tubes.

**GOLDEN EAR AMPLIFIER**

*An Acrosound TO-300 output transformer was specified for Milady's Golden Ear amplifier described in the April, 1954, and February, 1955, issues. Can I substitute a Stancor A-8072 or Chicago BO-13? Is there any simple way of adding a damping-factor control to this amplifier?—M. M. R., Nashville, Tenn.*

Ordinarily, it is not safe to substitute another make or type of output transformer for one specified by the designer of a high-fidelity amplifier because the circuit is often modified to fit the characteristics of the specific transformer. However, Mr. Marshall reports that he tried both these transformers in the improved versions of

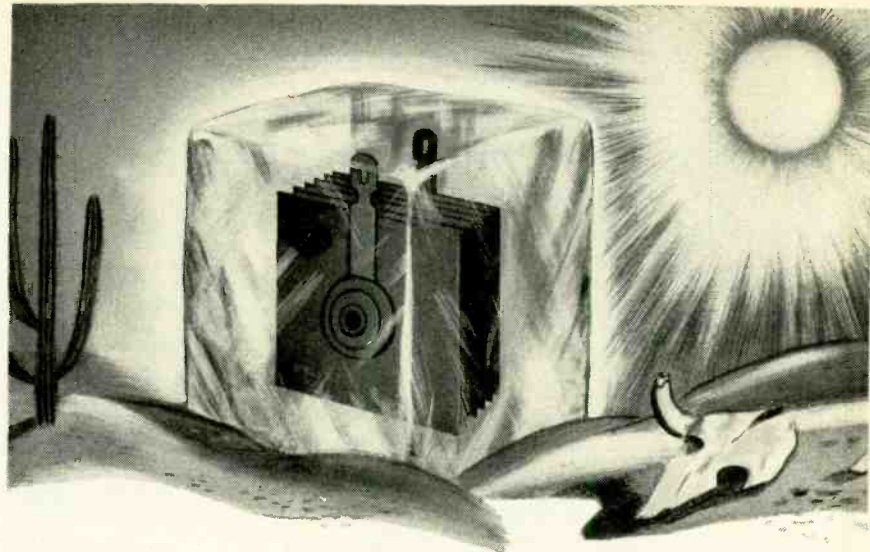

**They beat the heat in the  
sizzling southwest!**

**RADIO RECEPTOR**

**selenium rectifiers with  
"safe centers"**

Intense heat, humidity and blazing sunshine down in south Texas are *murder* on ordinary rectifiers. That's what servicemen at J. B. Penny Co., Inc., of Houston find every day when they check over ailing radio and TV sets. There's a simple solution, though. Replacements are invariably Radio Receptor rectifiers with the famous "Safe Centers."

"We've been using Radio Receptor rectifiers for over two years," says Mr. Penny, "because they take our extremes of temperature and humidity in stride, where other brands won't stand up. In our shop, selenium rectifiers are always replaced with Radio Receptor units."

The "Safe Center" feature in RRco. rectifiers means cool January performance right through the hottest months of summer. It eliminates arc-over danger, short circuits and heating at the center contact point — *Complete* protection during mounting and when in use.

You can bet on those bright green RRco. rectifiers for a sure thing, next time you need replacements. Insist on them when you order from your jobber.

For latest information of the  
Radio Receptor rectifier line  
write today to Dept. R-1.



Semiconductor Division  
**RADIO RECEPTOR COMPANY, INC.**

*In Radio and Electronics Since 1922*

SALES OFFICE: 251 WEST 19th STREET, NEW YORK 11  
WAtkins 4-3633 • Factories in Brooklyn, N. Y.

"The jack of all trades is master of none . . ."  
*That's why*

# QUAM

*Adjust-a-Cone*<sup>®</sup>  
**REPLACEMENT  
 SPEAKERS**  
 are **EXACT REPLACEMENTS**

Each one is designed to do a specific job—and to do it as well—or better—than the original speaker.

QUAM speakers are built for quality—not compromise. They are exact replacements—every one of them—with the right magnet, the right power handling capacity, and the right size to do the job you—and your customers—want them to do.

**FREE** The QUAM catalog listing over 100 exact replacement speakers.

*ask for QUAM, the quality line, for all your speaker needs*

## QUAM-NICHOLS COMPANY

236 East Marquette Road • Chicago 37, Illinois



QUESTION BOX

(Continued)

Milady's Golden Ear and Junior Golden Ear amplifiers modified as described in the article "Guiding the Golden Ears" in the February, 1955 issue.

Their use did not require any circuit changes or adjustments. Performance differed slightly in the ultra-and sub-sonic regions but stability was good and performance entirely satisfactory within audible limits.

The improved version of Milady's

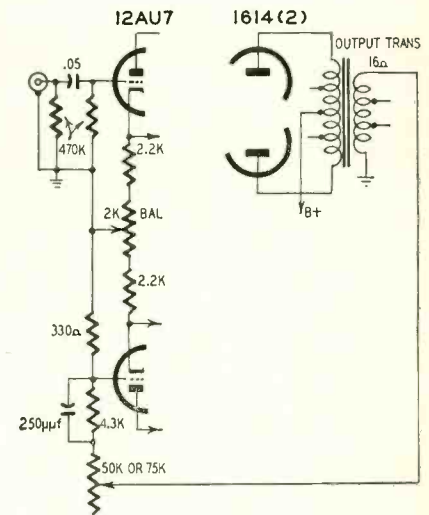

Golden Ear amplifier is easily modified to provide a considerable variation in damping factor. Add a variable resistor in series with the feedback resistor as shown in the diagram. As the resistance is increased feedback decreases and the amplifier's resistance and damping factor are varied. The variation in damping factor runs from about 10 to about 1.5. This range is sufficient to take care of almost any combination of speaker, enclosure and room acoustics. The reduction in feedback is not great enough to cause a significant rise in distortion.

Do not take out the fixed resistor in the feedback circuit. It establishes the maximum feedback that can be used with good stability. Any attempt to increase feedback beyond this point may result in oscillation which will endanger the speakers—especially tweeters.

END

## EASY TO LEARN CODE TELEVISION

It is easy to learn or increase speed with an Instructograph Code Teacher. Affords the quickest and most practical method yet developed. For beginners or advanced students. Available tapes from beginner's alphabet to typical messages on all subjects. Speed range 5 to 40 WPM. Always ready—no QRM.

**ENDORSED BY THOUSANDS!**

The Instructograph Code Teacher literally takes the place of an operator-instructor and enables anyone to learn and master code without further assistance. Thousands of successful operators have "acquired the code" with the Instructograph System. Write today for convenient rental and purchase plans.

**INSTRUCTOGRAPH COMPANY**

4701 Sheridan Rd., Dept. RC, Chicago 40, Ill.



**Big demand for graduates**

**B.S. DEGREE IN 27 MONTHS** in Electronic Engineering including Radio and TV—VHF, UHF, AM and FM. Students use over \$100,000 worth of equipment including 2 large commercial type transmitters in new TV lab. Intense specialized course includes strong basis in mathematics, science and advanced design.

Hundreds of young men each year are earning engineering degrees in this recognized institution. Start any quarter. Many earn a major part of expense in this industrial center. Low tuition. Competent instruction. Thorough, intense, practical program.

Also **B.S. DEGREE IN 27 MO.** in Aeronautical, Chemical, Civil, Electrical and Mechanical Engineering. G.I. Gov't approved. Enter Sept., Dec., March, June. Free catalog. **ENROLL NOW.**

**INDIANA TECHNICAL COLLEGE**  
 1795 E. Washington Blvd., Fort Wayne 2, Indiana

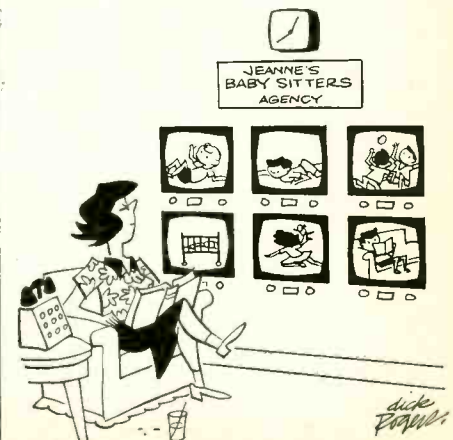

# Technotes



## FUSIBLE RESISTOR

A plug-in type fusible resistor (R501, 7.5 ohms) is used in the V-2342 and V-2343 chassis. The purpose of this resistor is to protect the selenium rectifiers and to act as a fuse in case of an overload.

The resistor may be replaced simply by inserting a new unit in the holder mounted on the TV chassis. Resistor R501 will withstand a peak current surge of approximately 5.6 amperes and will open up in case of an overload.—Westinghouse Service Manual

## INTERMITTENT MOVING CURVE

A rather exasperating moving curve was encountered recently in a Du Mont RA-166. The curve would move slowly up or slowly down the picture, depending on both time and the station being received, and for long intervals would

remain stationary as a bend in all vertical lines in the picture. The curve resembled a part of a 60-cycle hum wave and is shown in Fig. 1 in its stationary position. This resemblance plus the fact that the symptom would lock at in-

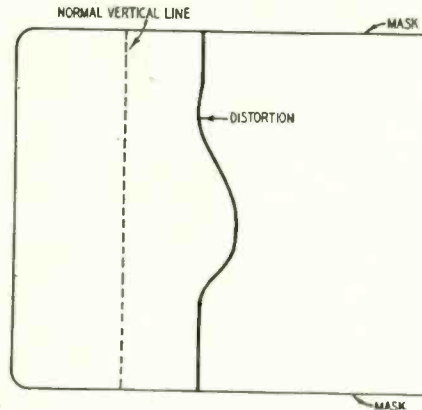

Fig. 1

tervals and on certain stations furnished the clue to the diagnosis.

The trouble was found to be caused by leakage between the grid and the heater terminals of the 6SN7 horizontal oscillator tube socket due to dust and moisture, and excessive heater-to-cathode and grid-to-cathode leakage of the horizontal oscillator. These combined to produce the trouble, which varied with the insertion of different 6SN7's in the horizontal oscillator socket. This tube substitution localized the fault to the 6SN7 circuit or near it.

Resistance checks revealed the trouble. The coupling of the two cathodes together in the cathode-coupled horizontal multivibrator circuit (Fig. 2) caused the leakage to affect the normally on tube although the ohmmeter test re-

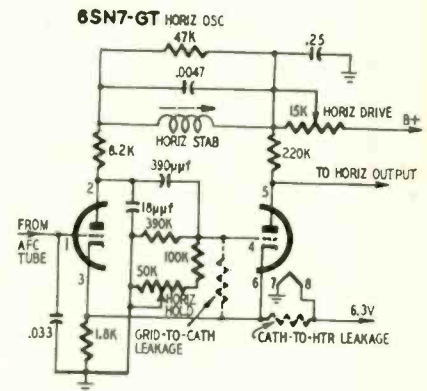

Fig. 2

**New TEST EQUIPMENT at WHOLESALE'S LOW PRICES**  
Precise Quality



**Voltage Reg. Power Supply**

Power as you want it! Supplies 140 V to over 450 V. 1% regulation at specified current durations. .01% ripple. 100 ma max current. Voltage & current metered by switches. High voltage is unreg. variable to 1000 v D.C. pos. or neg. 1 ma max. current. Low AC voltage unreg. 6.3 v., 4 amp. cap. High AC voltage of 375 v. AC, 50 ma D.C. Capacity, unreg. DC ref. voltage, low current, for ref. or screen operation. Either plus or minus 1000 volts may be used but not both simultaneously. . . . all other voltages available simultaneously. May be used for AC-DC applications.

Model 760K (KIT) **3995**  
Model 760W (Factory Wired) \$59.95

**Exclusive Precision Volt. Reg. VTVM.**

Unmatched for accuracy and compactness at this low price. Model 9071K **\$35.95** (KIT)

Model 9071-W (Factory Wired) \$49.95

**PRECISE RF, AF, TV & MARKER GENERATOR**  
110 mc on fundamentals . . . 330 mc on harmonics. Model 630 KA (KIT with pre-assembled head) **\$38.95**

Model 630W (Factory Wired) \$53.95

**PRECISE VACUUM TUBE VOLTMETER**

Proven tops in the field. Model 909K (Complete KIT) **\$25.98**

Model 909W (Factory Wired) \$37.50



**NOW! THE ONLY TUBE TESTER BELOW \$950.00 THAT TESTS BOTH Mutual Conductance (GM) And Emission**

**Exactly As The Factory Tests!**

Never before a single tube tester like the revolutionary Precision 111. It gives you the right answer on tube performance based on more than one tube application. Roll chart shows the most important single test—Mutual Conductance or Emission OR BOTH, as required. (Ordinary tube testers check tubes only 1 way.) Fast check for series string filament tubes. Filament currents and bias voltage are read directly on meter while tube is being tested. Ten switches for checking each tube element individually. Simple to use, tests ALL modern tubes. Sets up easily for testing even new tubes as developed. Rugged, light steel cabinet. Portable. Order 111-K (KIT) \$69.95. Adaptor PTA (for testing CRT) \$2.95 in KIT.

Precise Model 111-K (Complete KIT)

**69<sup>95</sup>**

Model 111-W factory wired \$139.95  
KIT adaptor PTA-W (Fact. wired) \$4.25

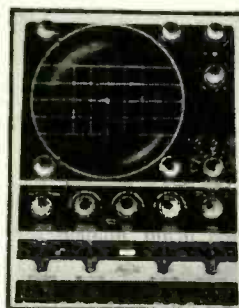

**Write for FREE FYI Cat. 236**

**NO OTHER OSCILLOSCOPE AT ANY PRICE HAS ALL THESE "PRECISE" FEATURES**

Model 300K **Amazing 7" Scope • Kit or Factory Wired \$94.95**

Complete instructions included  
Model 30-W (Fact. wired) \$199.50  
does not vary tube characteristics. HORIZ: Frequency comp. stepping attenuator in horiz. amp. P.P. Output. SYNC: Ext. Int. - or -, Int. 60 or 120 cycle. SWEEP RATE: Driven or non-driven linear sweeps. 1 cycle-80kc in 5 ranges. MAGNIFICATION: max. any part of sig. to 10 times. CALIBRATION: Int. sq. wave calib. & potent. to use scope as VTVM on peak to peak measurements. SCREEN: Edge-illum. scale & grad. may be on or off. CRT: 7" type 7JPI (green trace).

INTENSITY MOD: 2 mod. thru mod. amp. 11 x 14 x 17 in.

8 1/2" Scope

Model 308 has all features of #300, plus:  
Intensifier  
Anoda  
Hi-Lo Normal Snych.  
Voltage Regulation  
Model 308K (KIT) **\$129.50**  
Model 308W (Fact. wired) **\$229.50**

**WHOLESALE RADIO PARTS CO., INC.**  
311 WEST BALTIMORE STREET, BALTIMORE 1, MARYLAND  
Telephone: MULberry 5-2134

LABORATORY DESIGNED for  
UHF and VHF! ... It's NEW!

# MOSLEY

## 2-WAY TV ANTENNA SWITCH

- Extremely low Standing Wave Ratio — by actual test!
- Positive rotary action!
- Silver-to-silver contacts!
- Compact size!
- Solderless — easy to install!
- Low cost!

Cat. No. F-40  
List Price  
\$1.95

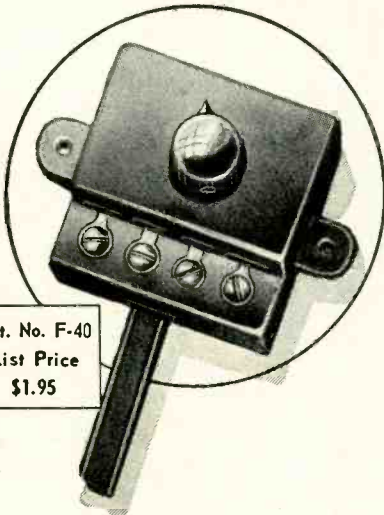

**Mosley**  
Electronics, Inc.  
8622 ST. CHARLES ROCK ROAD  
ST. LOUIS 14, MISSOURI

Another PREMIUM QUALITY MOSLEY Accessory  
for BETTER TV INSTALLATIONS!

# OSCILLOSCOPES ARE "GOLD MINES"!

... if you learn  
how to use them fully  
on all types of  
service jobs!



Learn to handle the oscilloscope fully on all types of AM, FM and TV service work—and watch your efficiency and earnings soar!

**MODERN OSCILLOSCOPES AND THEIR USES**, a fact-lamined 326-page book by Jacob H. Rutter, Jr., of the Allen B. DuMont Laboratories, contains exactly the help you need—written in a way you can clearly understand. It shows you how to use your "scope" for fast accurate work on all types of jobs from troubleshooting to re-aligning; how to make connections; how to adjust circuit components; how to set controls; and how to analyze patterns fast and accurately. 370 helpful illustrations including dozens of pattern photos make things doubly clear.

No other type of specific service training stands to mean so much to you in terms of being able to do better, faster, and more profitable work!

When, where, why and exactly how to use oscilloscopes

How to interpret oscilloscope patterns

How to handle tough jobs in less time

## PRACTICE 10 DAYS FREE!

Dept. RE-95, RINEHART & COMPANY, Inc.,  
232 Madison Ave., New York 16, N.Y.

Send MODERN OSCILLOSCOPES AND THEIR USES for 10-DAY EXAMINATION. If I decide to keep the book, I will then remit \$6.00 plus a few cents postage in full payment. If not, I will return book postpaid and owe you nothing.

Name.....

Address.....

City, Zone, State.....

Employer's Name & Address.....

OUTSIDE U.S.A.—Price \$6.50 cash only. Money back in 10 days if book is returned.

Rinehart Books are sold by leading book stores

**FREE!** a copy of  
"Forming Sheet Metal"



TELLS HOW TO MAKE  
CHASSIS - BRACKETS  
CHANNELS BOXES

with the A. E. Parker  
sheet metal folding machine

Write today for your free copy and catalog of unusual bench tests, hand tools, sheet, rivets, solvent, puncher, soldering instruments. Ask for Catalog 36

TELVAC 1412 Great Northern Bldg. Chicago 4, Ill.

## SUPER RECEPTION IN FRINGE AREAS AT BARGAIN PRICES!

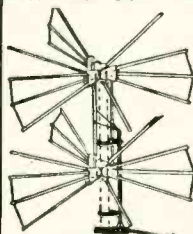

360° Super Directronic  
Electrically Rotates in  
All Directions

VHF-UHF  
CHANNELS  
2-83

Exclusive Engineering and Design—  
no tie rods. Sign cuts costs to

**\$23.50**  
Powerful, 24 element 2-bay Directronic antenna is electronically beamed to any transmitter in fringe area by 6-position selector switch. No motors or electricity. Extremely high gain. COMPLETE WITH

BEAM SELECTOR, 75' TUBULAR TRI-X CABLE UNIVERSAL U-CLAMPS. Order model AN-24.

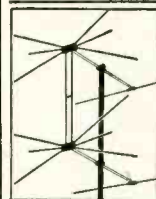

## 2 BAY 16 ELEMENT CONICAL ARRAY

**\$4.99 EACH IN** Single Lots  
LOTS OF 3 \$5.30 Each  
Hi-gain 16-element conical with sturdy 3/8" hi-tensile aluminum elements. For fringe use. Complete coverage of Ch. 2 thru 13. Packed in cartons of three 16-element arrays per carton, with tie rods. \$14.95 per carton. Single 16-element array.....\$ 5.30  
1 carton of 6 arrays..... 13.50  
4 bay stacking assembly..... 1.95  
—No. 4B.

## Super UHF RECEPTION

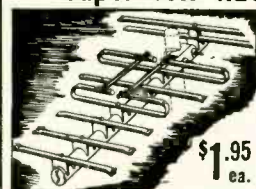

HI-GAIN  
YAGI

Provides Guaranteed Sensational UHF fringe reception. Amazing sensitivity provides up to 30 db gain, using 2, 4, or 6 bay stacked arrays. Ghosts, interference minimized or eliminated. Each serviceman's array provides 4 directors, 2 folded dipoles, 2 reflectors. And our low price insures a low cost installation. Select the model required in your area.

\$1.95  
ea.

Model  
F-7A ..... Channels 14-48  
F-7B ..... Channels 27-62  
F-7C ..... Channels 47-83  
Matched stacking bars \$0.30 pr.

**National Electronics**  
OF CLEVELAND  
**THE HOUSE OF TV VALUES**  
6608 Euclid Ave., Dept. E-9, Cleveland 3, Ohio

## NEW! WRIST RADIO



Amazingly powerful! Plays while you wear it. 400 mile reception using just its own antenna. Tunes entire broadcast band with sharp selectivity.  
**BUILD YOUR OWN**—New book has complete instructions. How-to-do-it book \$1.95 ppd. Also a basic kit consisting of attractive pre-drilled case, "outline" chassis, and all the necessary non-electronic parts and hardware \$2.98 ppd. Combination of book and basic kit, SPECIAL \$3.98 postpaid. Send postcard for FREE descriptive literature.

HUCKERT ELECTRONICS—Box 7400-C3, Washington 4, D.C.

TECHNOTES

(Continued)

vealed that the leakage happened in the normally off tube. Apparently some clipping action occurred which removed a part of the 60-cycle wave and resulted in the reproduction of only a part of it. The leakage paths were caused by the location, a bar-and-grill, and consisted of an accumulation of grease and smoke deposits on the socket. The horizontal output and the high-voltage rectifier sockets were cleaned as a precautionary measure. The owner has since installed a duct from his fresh air ventilating system and directed at the rear of the set.—James A. McRoberts

## G-E 16C103

A frequent occurrence in this set is a condition of no sound, no raster and tubes not lit. The trouble is usually a defective 20-ohm Globar resistor connected in series with the filament. Replace it with an exact duplicate. This resistor will measure 20 ohms when hot, 250 ohms cold.—Dee Bramlett, Jr.

## VERTICAL BARS

Shadow type vertical bars usually at the left of the raster in Admiral chassis 20T1, V1 and 21B1, C1, D1, H1, J1, can be minimized by one or more of the following methods:

Be certain the horizontal drive and width controls are adjusted as outlined in the service manual.

Dress the cathode lead (yellow) so it will not come close to the horizontal output tube.

Install a filter (chassis 20T1, V1) consisting of a variable inductance (width coil), .005- $\mu$ f 600-volt capacitor and 470-ohm 1-watt resistor in parallel, to terminal 8 of the horizontal output transformer. The two leads already attached to this terminal should be removed and connected to the other side of the filter. If the Admiral 79C36 output transformer is used, it may be necessary to connect two filters in series. The filter should be placed inside the high-voltage cage and not under the chassis. Then vary the inductance until the bars are eliminated or reduced.

In the remaining chassis the procedure is the same except that terminal 4 is used on the output transformer.—Admiral Radio & Television Service Bulletin

## SMALL HORIZONTAL SIZE

At normal line voltages, some Stromberg-Carlson model 421 television receivers produce second-anode voltages in excess of 18 kv, resulting in insufficient picture width. This high voltage can be reduced and sufficient width obtained by connecting a 60- $\mu$ f 3-kv mica capacitor in series with a 560-ohm resistor between terminals 3 and 7 of the horizontal output transformer. The resistor must be connected to terminal 3 and the capacitor to terminal 7 to avoid corona.

As an additional aid, the screen dropping resistor for the 6AV5 horizontal output tube should be decreased in value from 15,000 to 12,000 ohms.—Current Flashes

END

RADIO-ELECTRONICS



# Technicians News

## TECHNICIANS SPEAK UP

The Milwaukee Association of Radio and Television Services maintains a bureau to supply speakers for neighborhood clubs, church organizations, labor unions and other interested groups.

MARTS recruits speakers from its membership and supplies them with a "tested" script which incorporates the main MARTS policies and the group's ethical standards as well as other information that "99 out of 100 audiences should appreciate and find interesting."

The title of the basic speech is "How to Save Money on TV Repairs." It is said to have drawn excellent audiences wherever presented.

## ACCREDITATION PROGRAM

RETMA (Radio-Electronics-Television Manufacturers Association) has issued a booklet detailing a plan where-

by technically competent TV service technicians can be accredited for easy identification by set owners. RETMA feels that this plan will induce technicians to upgrade themselves to receive recognition and promote their services. The accreditation certificates or diplomas will carry RETMA endorsement.

Two methods of accreditation are suggested. Those who successfully complete the training and upgrading course prepared by RETMA would receive a certificate attesting to their technical competence. For technicians who already possess the necessary degree of proficiency, the booklet suggests that local advisory groups devise tests covering theory and working knowledge. The booklet, "Suggested Accreditation Program for TV Receiver Service Technicians," can be obtained from RETMA, 777 14 St., N. W., Washington 5, D. C.

## PLEADS GUILTY

A New York City service dealer charged with petty larceny, conspiracy and misleading advertising in connection with television repairs reversed his not-guilty plea to the three-count charge in favor of a lesser single-count charge of petty larceny.

The service dealer was apprehended when an employe of his was called to service a "planted" set containing one defective tube; all components were coded under police supervision. The set was returned with an \$18 repair bill, and the defective tube had been replaced. The employe turned informer and the charges against him were dismissed.

## FEWER SERVICE COMPLAINTS

The complaint situation in the TV service field has improved generally during the past year, it was revealed at the annual convention of Better Business Bureaus held recently in Minneapolis.

A survey of 78 cities showed that 46 local Better Business Bureaus had received fewer complaints, reported Kenneth Wilson, president of the National BBB and chairman of its radio-TV committee. The situation had deteriorated in 6 cities, he said, while 20 bureaus reported no change from last year. Six did not report.

The business of the convention pointed up the improvement even more than the report. Practically all com-

# LIFETIME GUARANTEED TUBES

## BRAND NEW PICTURE TUBES

● RCA Licensed ● One Year Unconditional Guarantee

TYPE	PRICE	TYPE	PRICE
10BP4	\$11.90	17BP4	\$20.63
12LP4	\$14.38	19AP4	\$24.81
14BP4	\$16.86	21AP4	\$28.79
16RP4	\$19.38	21EP4	\$28.79
16LP4	\$19.38	24AP4	\$42.50

● Picture Tubes shipped F.O.B. Harrison, N. J.

## LOOK WHAT YOU GET FREE!

### FREE BONUS BOX

With Every \$25 Order

- 1 RCA Cheater Cord
- 10 Assorted resistors
- "blank" tube cartons
- 1 6BQ6GT tube
- 1 6AU6 tube
- 1 6CB6 tube

### FREE CLOCK RADIO

With Every \$125 Purchase Within 30 Days

Wakemaster clock radio with famous Sessions clock movement wakes you to music or alarm. May be purchased outright from MAJOR BRAND for \$17.95. In ivory or rust.

### FREE GIFT CERTIFICATE\*

worth \$5 toward the purchase of any of our merchandise on future orders will be sent with any order of \$50 or more.

\*Free Gift Certificate cannot be used to obtain another certificate unless order is \$55 or more.

WE PAY ALL POSTAGE on orders shipped in USA, Territories and APO's. Send only purchase price of merchandise. Please include approximate postage on foreign shipments. All orders subject to prior sale. 25c Handling Charge on Orders under \$5. Quantity users Write For Special Discounts.

Write For FREE Tube List—Order Blank—and FREE Sample Tube Carton. We want Y-O-U On Our Mailing List!

## NEW INDOOR ANTENNA

Both U H F and V H F. Brings better reception than most outdoor antennas. Use on top of TV.

List Price \$9.95

## YOUR PRICE

Lots of 3  
**\$3.29**  
**\$3.99 each**

## THIS AD IS WORTH M-O-N-E-Y

Clip out this ad and attach it to your order. Three 6SN7GT's will be shipped FREE with any order of \$10 or more.

- Top Branded Tubes and Our Own MAJOR BRAND Label
- Each Tube Individually Boxed and Guaranteed for Life
- Over a Half Million Tubes Always in Stock
- Immediate Shipment
- Free Postage On All Orders With Full Remittance

## Here's How LIFETIME GUARANTEED TUBES

- SAVES YOU PLENTY!
- There are fewer "call backs"
- There are no "out of date" tubes
- "Peak Performance" testing in our fully equipped Testing Department before shipment guarantees quality

024	43	5AW4	75	6BL7GT	75	6X4	34	12SK7	45
1A4P	33	5J6	63	6BN6	58	6X5	34	12SN7GT	56
1A7GT	43	5T4	69	6BQ6GT	78	6X8	73	12SQ7	37
1B3GT	65	5U4G	43	6BQ7	78	6Y6G	55	12SR7	45
1C5GT	41	5F8	74	6C5G	58	7A4	45	12V6GT	45
1D5GP	43	5V4G	59	6BZ7	88	7A5	53	12X4	37
1E3GT	41	5Y3	31	6C4	37	7A6	45	14A7	42
1G6GT	41	5Y4G	36	6C5	35	7A7	43	14B6	38
1H4G	43	5Z3	41	6CB6	49	7A8	45	14Q7	50
1H5GT	47	6A7	57	6CD6G	115	7B5	39	19RC6G	115
1I6GT	47	6A8	45	6G6	48	7B6	42	19T8	65
1L4	45	6AB4	43	6E5	44	7B7	45	25A7	39
1L6	55	6AC7	67	6F5	37	7B8	45	25AV5GT	78
1L4A	57	6A7A	79	6F6	40	7C4	42	25BQ6GT	78
1LA6	47	6AG5	50	6G6	38	7C5	39	25L6GT	47
1L8A	57	6AG7	69	6H6	38	7C6	43	25W4GT	43
1LC5	49	6AH6	59	6J4	179	7C7	45	25Z5	37
1LC6	47	6AJ5	70	6J5	39	7E5	45	25Z6	37
1LD5	57	6AK5	54	6J6	47	7E6	55	27	25
1LE3	57	6AL5	39	6J7	43	7E7	70	35A5	46
1LG5	57	6A05	46	6J8G	85	7F7	59	35B5	50
1LM4	64	6AR5	46	6K6GT	37	7F8	70	35C5	50
1LN5	47	6AS5	48	6K7	39	7G7	75	35L6GT	47
1N5GT	50	6AS6	170	6K8	85	7H7	50	35W4	34
1R5	50	6AS7G	219	6L6	68	7J7	75	35Y4	34
1S5	42	6AT6	39	6L7	42	7K7	75	35Z3	39
1T4	45	6AU4GT	59	6O7	60	7L7	75	35Z5GT	34
1U4	47	6AUSGT	59	6O7	60	7M7	75	35Z6GT	39
1U5	42	6AU6	42	6S4	40	12AT6	37	50A5	29
1V4	65	6AV5GT	65	6SA7	45	12A77	66	50B5	46
1X2	61	6AV6	39	6SC7	48	12AZ7	65	50B5	50
2A3	55	6AX4GT	60	6S7	41	12BA6	41	50C5	50
2A7	57	6AX5GT	57	6S7	43	12AU7	53	50L6GT	43
2A7	57	6B4G	52	6S7	43	12AV6	61	50L6GT	43
3A4	51	6B8	69	6SK7	45	12AV7	67	75	42
3A5	50	6BA6	47	6SL7GT	55	12AX4GT	65	76	42
3AL5	45	6B7	58	6SN7GT	55	12AX7	58	77	38
3AU6	46	6BC5	47	6SQ7	39	12BA6	46	80	34
3BC5	54	6BC7	80	6SR7	42	12BA6	46	80	34
3BN6	70	6BE6	45	6S7	41	12BD6	48	80	34
3CB6	52	6BF5	40	6T4	41	12BE6	46	84/6Z4	44
3C4	46	6BF6	50	6T8	68	12BH7	60	117L7GT	109
3Q5GT	57	6BQ6G	115	6U8	75	12BY7	65	117N7GT	109
3S4	47	6B6	50	6V3	80	12BZ7	61	117P7GT	109
3V4	47	6BJ6	47	6V6GT	46	12CU6	95	117Z3	35
4BQ7	89	6BK5	68	6W4GT	39	12SA7	45	117Z3	35
4BZ7	95	6BK7	76	6W6GT	53	12S7	45	117Z6GT	63

Write Dept. 9-NE

**MAJOR BRAND TUBE CO.**  
 Romano Bldg. ESsex 4-1106 Harrison, N. J.

# Another EXCLUSIVE IJS Tube-Check

THE LOWEST PRICED QUALITY TUBE TESTER  
COMPLETELY WIRED AND FACTORY TESTED

- CHECKS ALL RECEIVING TUBES, INCLUDING THE NEW SERIES-HEATER TUBES
- CHECKS PICTURE TUBES WITH "AC-1" ADAPTER
- TESTS SHORTS... OPENS BY EMISSION... INDICATES OVERLOADS
- "E-Z READ" ILLUMINATED ROLL CHART WITH RED LINE INDICATOR
- STAINLESS STEEL PIN STRAIGHTENER SOCKETS FOR 7 & 9 PIN TUBES

SAVE \$5555 ON THIS PRECISION ENGINEERED COMPLETE TUBE TESTER (NOT A KIT) BEAUTIFUL GREY HAMMERTONE FINISH... 4 1/2" METER... PORTABLE... OPERATES ON AC LINE VOLTAGES 100 TO 130 VOLTS. STANDARD RTMA WARRANTY.



WEIGHT: 13 lbs.  
SIZE: 10" x 12" x 4 1/2"

MODEL 301

**\$39<sup>95</sup>** Dealer's Net.

Factory Wired and Tested  
"AC-1" ADAPTER - \$2.75

SOLD BY LEADING JOBBERS  
OR WRITE TO

**IJS** mfg. of CAP-CHECK-ALL-CHECK-FIL-CHECK  
**Instruments for Service Inc.**  
300 WOODCLEFT AVENUE, FREEPORT, LONG ISLAND, N. Y.

ment on TV was on selling practices: questionable price comparisons, bait ads, misleading layouts, failure to disclose obsolescence of advertised receivers and questionable trade-in allowances.

## ETHICAL \$1 TV SERVICE

The Milwaukee Association of Radio and Television Services reports a \$1 television service organization that carried on its business on strictly ethical lines. The operation was run as a survey for MARTS by a local radio-TV service shop.

The "company," Dollar TV Service, was set up on a no-overhead basis, with the bench space, tools and incidentals furnished by the shop. Only the phone number—a customer-pulling WE 3-3333—advertising, wages and actual cost of parts were charged as costs, making the setup resemble that of a home operator.

In the 3 weeks of the survey, 36 phone calls were received, leading to 16 completed jobs, 2 of which required removing sets to the shop for work that could not be done in the home.

Net income for the experiment totaled \$54.50. Expenses charged against this sum were: advertising, \$150.36; telephone, \$24; wages \$100; shop labor \$16.62; miscellaneous, \$11.56. Net loss was \$205.69, or \$12.85 on each actual service call.

Two conclusions were drawn from the experiment:

1. The response to bargain advertising (36 phone calls in 3 weeks) is not as good as it might seem from the outside.

2. It is impossible to make a profit with both low rates and high ethics—one or the other must inevitably be sacrificed.

## CERTIFICATION PLAN

A plan to certify parts jobbers who do not sell to consumers at wholesale prices and who give service dealers longer discounts than experimenters and students is under way by TISA (Television Installation Service Association), a NATESA (National Alliance of Television and Electronics Service Associations) affiliate well known to our readers.

Frank J. Moch, TISA president, said that the basis of the certification will be shopping of the jobbers. He added that those jobbers that do not fill the requirements of certification will not be named. "We are not attempting to restrict jobber sales. We have no quarrel with ham sales and with industrial sales. We even concede the right of jobbers to sell students and experimenters—so long as they are given shorter discounts than service firms. We do say that the jobbers have no right to sell to the ultimate consumer at wholesale prices."

Mr. Moch thinks it likely that the TISA certification will be adopted by other NATESA affiliates if it proves successful in the Chicago area. END



"Oh, Honey. Relax. He's obviously overjoyed about our JENSEN NEEDLE."

## ATLAS Cobra-Jectors

- wide angle dispersion
- indestructible fiber-glass
- all-weather construction



CJ-30  
Net \$24.00

Weatherproof universal line transformer, \$5.10 Net.

CJ-14  
Net \$16.80

Designed for wide angle coverage, paging, high efficiency intercom, sensitive talk-back. Tops in articulation. Convenient omni-directional mounting bracket. In appearance, they're "boobies".

SPECIFICATIONS	CJ-30	CJ-14
Input pwr (cont.)	15 w	5 w
Input imp.	4 or 8 A	4, 8 or 45 A
Response (cps)	250-9,000	400-10,000
Dispersion	120° x 60°	120° x 60°
Bell Size	14" x 6"	9 1/2" x 5 1/2"
Over-all length	14"	8 1/2"

Amazing "power packages"—use the Cobra-Jectors for the "tough" jobs.



WRITE FOR COMPLETE CATALOG  
**ATLAS SOUND CORP.**  
1444—39 St., Bklyn. 18, N. Y.  
In Canada  
Atlas Radio Corp., Ltd., Toronto, Ont.

# Patents

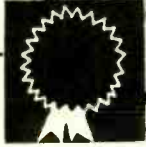

## NULL DETECTOR

Patent No. 2,702,854

William E. Woods, Haddonfield, N. J., (Assigned to RCA)

At the moment of null, this very sensitive null detector generates and delivers a pulse that can be amplified as desired. The patent description assumes a sawtooth signal but any other wave-shape can be applied. As the sawtooth goes through the transition from negative to positive

(or vice versa), a sharp pulse occurs to indicate the exact instant.

The detector includes a double-triode coupled through common cathode resistor R1 (Fig. 1). The signal feeds grids G1, G2 through a network of diodes. Output is taken at P2, the plate of the lower triode. Fig. 2 shows how voltages at G1, G2, P2 vary with signal.

While the input is negative, D1 isolates G1 but D3 conducts the negative signal to G2. D2 grounds the upper grid. D4 is blocked and has no effect. When the signal goes positive, it passes freely through D1 to grid G1. The positive signal blocks D3. At this time D2 is cut off, and D4 grounds G2. The net result is that a negative signal affects only G2, leaving G1 at ground potential.

The potential at P2 remains equal to that of the B battery except when current flows through the lower triode. Such a current cannot occur when G2 is highly negative since this will block the triode; it cannot occur when G1 is very positive either. A large current through the upper triode means a large voltage drop across R1. This would drive the common cathode very positive and have the effect of a large negative bias on G2.

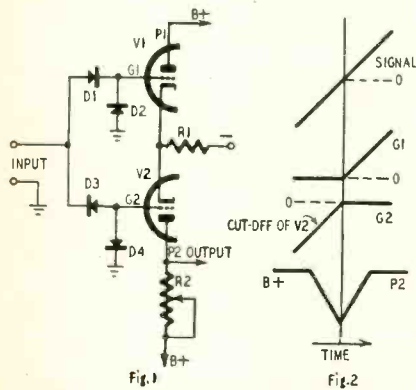

Fig. 1

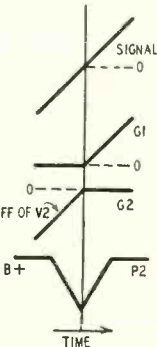

Fig. 2

The lower triode can conduct *only* when G1 and G2 are at or nearly at zero potential. Conduction is greatest when they are both zero.

## TRANSFORMERLESS AUDIO OUTPUT

Patent No. 2,705,265

Cecil T. Hall, Mount Lebanon, Pa.

In this output stage the power tubes are energized in push-pull, but they feed the load in parallel. A low-impedance load is matched without a transformer. This is a worth-while improvement because the transformer is often the biggest and most expensive component and the major source of distortion in the amplifier.

For low-impedance matching, the load is connected in the cathode return leads. The input signals to the grids must be equal and out of

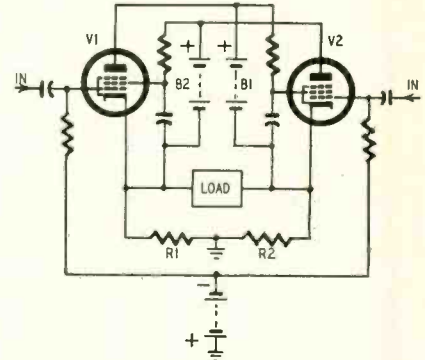

phase as in any push-pull circuit. With zero signal, V1 and V2 have equal conductivity so the stage is balanced. No voltage appears across the load. When one signal goes positive (and the other negative), the balance is destroyed. One tube will pass greater current through the load, while the other tube current decreases. Since these currents flow in opposite directions through the load, their effects are additive. The

Get This Valuable Book

# FREE



Just for Examining COYNE'S New 6-Volume Set

# "Applied Practical Radio-Television"

ON 7 DAY  
FREE  
TRIAL!

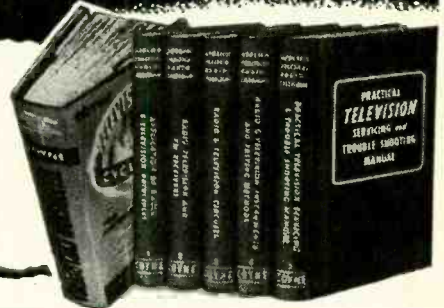

Yes, you get this big, brand new book, "150 Radio-Television Picture Patterns and Diagrams Explained", absolutely FREE! Just off the press! Gives complete 11x22" Schematic Diagrams on leading models Radio and Television Sets. Easy-to-read, large 8 1/2 x 11" pages, with full instructions on how to read and use the diagrams. A "must" in every Radio and Television service-man's repair kit. You get this valuable book as a FREE Gift for asking to see Coyne's great new 6-book set, "Applied Practical Radio-Television"!

**At Last! Money-Making "Know-How" on Transistors, Color TV and Servicing**

Coyne's great new 6-volume set gives you all the answers to servicing problems—quickly! For basic "know-how" that is easy to understand, you'll find everything you want in volumes 1 to 5 which contain over 5000 practical facts and data. They cover every step from principles to installing, servicing, trouble-shooting and aligning all types of radio and TV sets. So up-to-date it includes COLOR TV and UHF, adapters, converters. Also covers latest data on TRANSISTORS.

**Extra! 900-Page Television Cyclopeda Included**

And then, for speedy on-the-job use, you get volume 6—the famous Coyne TELEVISION CYCLOPEDIA. It answers today's television problems on servicing, alignment, installation and others. In easy-to-find ABC order, cross indexed. Use this 6 volume TV-RADIO LIBRARY free for 7 days; get the valuable Servicing Book ABSOLUTELY FREE!

Educational Book Publishing Division

**COYNE** ELECTRICAL SCHOOL  
500 S. Paulina St., Dept. 95-T1, Chicago 12, Ill.

**SEND NO MONEY!** Just mail coupon for 6-volume set on 7 days free trial. We'll include book of 150 TV-Radio Patterns & Diagrams. If you keep the set, pay \$2 in 7 days and \$2 per month until \$22.50 plus postage is paid. (Cash price \$20.95). Or you can return the library at our expense in 7 days and owe nothing. **YOU BE THE JUDGE.** Either way, the book of TV-Radio Patterns is yours FREE to keep! Offer is limited. Act NOW!

**FREE BOOK—FREE TRIAL COUPON!**

Educational Book Publishing Division  
**COYNE ELECTRICAL SCHOOL, Dept. 95-T1**  
500 S. Paulina St., Chicago 12, Ill.

YES! Send 6-volume "Applied Practical Radio-Television" for 7 days FREE TRIAL per your offer. Include TV-Radio Patterns & Diagram Book FREE.

Name \_\_\_\_\_ Age \_\_\_\_\_

Address \_\_\_\_\_

City \_\_\_\_\_ Zone \_\_\_\_\_ State \_\_\_\_\_

Where Employed \_\_\_\_\_

( ) Check here if you want library sent COD. You pay postman \$20.95 plus COD postage on delivery. 7-day money-back guarantee.



THE NEW  
**PRECISION** MODEL 120

GIVES YOU WHAT YOU WANTED  
IN A

HIGH SENSITIVITY  
MULTI-RANGE TEST SET

20,000 OHMS PER VOLT D.C.  
5,000 OHMS PER VOLT A.C.

The '120' gives you . . .

- ✓ MORE RANGES
- ✓ AN EXTRA-LOW RESISTANCE RANGE
- ✓ AN EXTRA-LOW VOLTAGE RANGE
- ✓ AN EXTENDED LOW CURRENT RANGE
- ✓ A LARGER METER SCALE FACE
- ✓ SIMPLE, POSITIVE RANGE SELECTION
- ✓ POSITIVE CONTACT JACKS and PLUGS

Compare These Wide Spread Ranges  
and Special Features:

- ★ 8 DC VOLTAGE RANGES: 20,000 ohms per volt.
- ★ 8 AC VOLTAGE RANGES: 5,000 ohms per volt. 0-1.2-3-12-60-300-600-1200-6000 volts.
- ★ 8 AC OUTPUT RANGES: same as AC volt ranges. Built-in 600 volt blocking capacitor.
- ★ 7 DC CURRENT RANGES: 0-60-300 Microamperes. 0-1.2-12-120-600 Ma. 0-12 Amperes.
- ★ 5 RESISTANCE RANGES: self-contained. 0-200-2000-200,000 ohms. 0-2-20 megohms.
- ★ 8 DECIBEL RANGES: -20 DB to +77DB. 0 DB = 1 Milliwatt, 600 ohms.
- ★ EXTRA LARGE 5 1/4" RUGGED 'PACE' METER: 40 microamperes sensitivity, 2% accuracy.
- ★ 1% MULTIPLIERS and SHUNTS: Wire-wound and deposited film types.
- ★ TWO JACKS SERVE ALL STANDARD RANGES: Separately identified and isolated jacks provide for extra high ranges.
- ★ "TRANSIT" SAFETY POSITION on range selector protects meter during transport and storage.
- ★ CUSTOM-MOLDED PHENOLIC CASE and PANEL: Compact, laboratory styled Instrument.

MODEL 120 . . . complete with internal ohmmeter batteries, banana-plug test leads and detailed operating manual. Overall case dimensions, 5 7/8 x 7 x 3 1/8" Net Price \$39.95

**PRECISION** Apparatus Co. Inc.

70-31 84th Street, Glendale 27, L. I., N. Y.

Export Division 458 Broadway, New York 13, U.S.A. • Cables—Maifhame  
In Canada: Atlas Radio Corp. Ltd. 560 King Street, W. Toronto 28

PATENTS

(Continued)

tubes supply equal power. So far as the load is concerned they are in parallel, thus lowering the output impedance.

Resistors R1, R2 form a center-tapped cathode return for the tubes. If the load itself is center-tapped, they are not needed. Two separate plate supplies (B1, B2) are required.

**MAGNETIC RATIO METER**

Patent No. 2,704,827

Norval P. Millar, Danvers, and Stephen C. Hoare, Manchester, Mass. (Assigned to G.E.)

A dual magnetic field rather than the usual single field controls this meter. This gives it greater sensitivity and versatility than the ordinary d'Arsonval instrument. Two coils (L1 and L2) produce the fields, L2 being adjustable. A small permanent magnet fixed to the bottom of the pointer provides deflection torque.

The coils are energized oppositely to strengthen the flux between them. When these fields are equal, the magnet assumes a vertical position

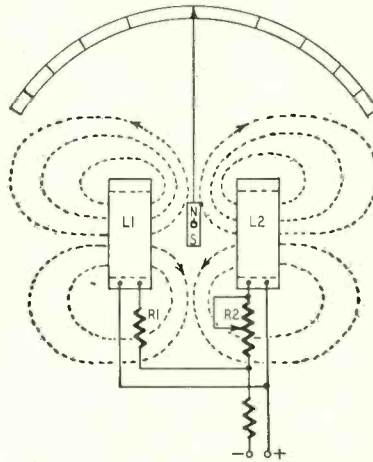

(as shown) and the pointer remains at mid-scale. If R2 is reduced, more current flows into L2, strengthening its magnetic field. This deflects the pointer counterclockwise. The instrument may be calibrated in terms of the ratio between magnetic fields. The pointer deflects to the right when L1 generates a stronger field than L2.

The meter may be used to measure temperature. For this application, R2 is a temperature-sensitive unit. Its resistance varies with temperature, thus changing the ratio between field strengths and deflecting the pointer. To measure magnets, the instrument is modified by substituting a permanent magnet for one of the coils. The meter then compares the field of the remaining coil with that of the magnet.

**ALL-R.F. RADIO RECEIVER**

Patent No. 2,706,245

Joseph L. Miller, South Haven, Mich.

Very high selectivity, sensitivity and fidelity are provided by this radio. It also reduces noise to a minimum. The front end, composed of several r.f. stages, is followed by a power r.f. stage. The tube may be type 50L6, for example, and is connected as a cathode follower. Coils

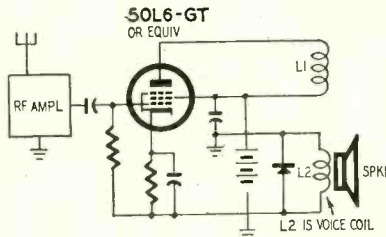

L1, L2 are coupled for negative feedback and output is taken from L2.

The diode across L2 detects the carrier and rectified r.f. is fed to the speaker. Due to its mass, the cone cannot vibrate at such high frequencies, but it can follow the wave envelope, that is, the audio modulation.

For the first time...

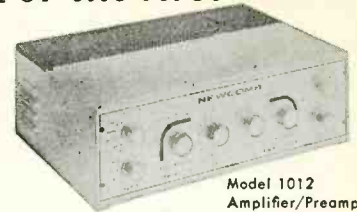

Model 1012  
Amplifier/Preamp

Everybody can own  
**HI-FI with**

**NEWCOMB**

**COMPACT**

**AMPLIFIERS**

and **FM-AM TUNERS**

**EXPENSIVE BUILT-INS  
UNNECESSARY**

Here is an entirely new concept in high fidelity enjoyment created by Newcomb, the originator of the "compact" design. Amplifier/preamp units and AM-FM tuners in beautiful new satin gold finish, so small they fit your convenient chairside table top. Makes expensive built-ins unnecessary. No technical knowledge necessary to connect. Performance to please the most ardent hi-fi fan. Combination amplifier/preamp units available in 10, 12, or 20 watt output, with all the exclusive recognized Newcomb features. Not only technically superb but audibly better.

*Economical high-efficiency AM-FM tuner, or deluxe model with many advanced features available in matching design.*

**THE YEAR'S GREATEST  
HI-FI SENSATION**

**NEWCOMB**

THE SOUND OF QUALITY SINCE 1937

**SEE YOUR NEAREST  
DEALER OR WRITE  
FOR DETAILS NOW!**

NEWCOMB, Dept. RE-9  
6824 Lexington Ave., Hollywood 38, Calif.

- Enclosed is 25c. Please send me new booklet "Hi-Fi is for Everybody."
- Send name of nearest Newcomb dealer and complete details about the Newcomb Compact.

NAME .....

ADDRESS .....

CITY..... STATE.....

**MISCELLANY**



**THE FUND REACHES  
\$11,681.36**

**HELP -  
FREDDIE-WALK  
FUND**

WE have received some very good news from Herschel Thomason, radio technician of Magnolia, Ark., who, as most readers know, is the father of 7-year-old Freddie Thomason, the little boy who was born without arms or legs. He writes as follows:

"Freddie is scheduled to receive his arm very soon and we are very happy about it. All he talks about is what he is going to do when he gets his arm, and we are confident that he will be able to master it without too much trouble.

"He is still walking quite well and can go all over the house by himself. We had a private teacher with him for his schooling this year and he did fine. He learned to read fairly well and also learned to recognize various colors. He will have the same teacher next year but after that we hope to put him in the public school here.

"When he gets the new arm, he will also get a new set of legs, and altogether they will cost about \$1,300; so you can see that we really appreciate the RADIO-ELECTRONICS Help-Freddie-Walk Fund.

We believe the letter speaks for itself. Thanks to the generosity of thousands of readers, Freddie is well on the way to becoming the healthy, constructive member of society we all want him to be. But, and it's a BIG but, the mechanical appliances upon which he will be dependent all his life cost money, lots of money. For this reason, we again ask our readers to send in their contributions as often as they can. No amount is too small to receive acknowledgment and the grateful thanks of Freddie and his entire family. *Make out all checks, money orders, etc., to Herschel Thomason.* Send all contributions to

Help-Freddie-Walk Fund  
c/o RADIO-ELECTRONICS Magazine  
25 West Broadway  
New York 7, N.Y.

RADIO - ELECTRONICS Contributions as of April 15, 1955.....	\$11,002.61
FAMILY CIRCLE Contributions.....	602.50
Anonymous, Long Beach, Calif.....	50.00
Anonymous, Gloucester City, N.J.....	5.00
G. Apear, Culver City, Calif.....	1.00
Dana A. Blodgett, Laguna Beach, Calif.....	5.00
Chase E. Brown, Indianapolis, Ind.....	5.00
Walter J. Kobiela, Minneapolis, Minn., and Nathan O. Sokol, Lexington, Mass.....	5.00
Margaret Morrissey, Worcester, Mass.....	2.00
Radio Serviceman, Cleveland, Ohio	2.00
Alexander Rys, Minneapolis, Minn.	.25
W.D.T., Lewiston, Me.....	1.00

TOTAL CONTRIBUTIONS as of July 5, 1955..... **\$11,681.36**

SEPTEMBER, 1955

**NOW 2 B&K CRT Money-Makers**

**TEST and REPAIR TV PICTURE TUBES**

**NEW DELUXE CRT 400 with 4½" Plastic Meter**

This portable Cathode Rejuvenator Tester quickly locates and corrects picture tube troubles in a few minutes, right in the home, without removing tube from set! Restores emission, stops leakage, repairs inter-element shorts and open circuits. Life-test checks gas content and predicts remaining useful tube life. Grid Cut-Off reading indicates picture quality customer can expect. Earns servicing dollars in minutes. Cuts operating costs, eliminates tube transportation. Saves money on TV set trade-in reconditioning. Pays its way from the very first day.

Weights only 5 lbs. mounted in rugged, luggage style, carrying case covered with handsome, durable leatherette. Size: 11 x 7½ x 5".

Model 400. Net \$5495

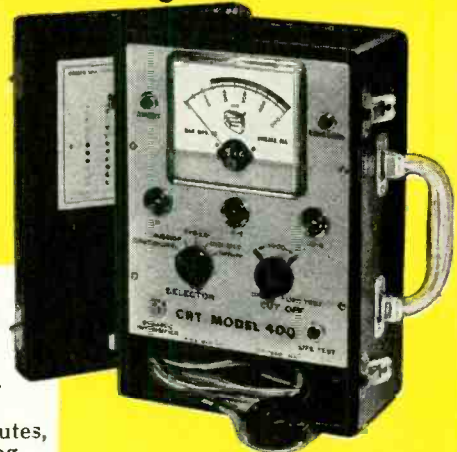

**Over 20,000 CRT'S NOW IN DAILY USE ACROSS THE NATION**



**NEW ECONOMY CRT 200**

A quick profit maker priced low enough for every serviceman to cash in on picture tube repairs. Performs most of the functions of the CRT 400. Has 3" meter. In leatherette carrying case. Size: 11 x 7½ x 5". Weighs 5 lbs.

Model 200. Net \$3995



Send for Bulletin 104-E

**B & K MANUFACTURING CO.**

3726 N. Southport Ave. • Chicago 13, Illinois



**LEARN TV in KC**

**UNIVERSAL TV FAMOUS FOR 24 YEARS**  
1,000's OF SUCCESSFUL GRADS COAST TO COAST

Easy, quick, fascinating. Learn TELEVISION in 36 short weeks of enjoyable companionship in shop training. Wonderful job opportunities. Graduates have choice of many jobs or can establish their own TV repair shop. YOU CAN START EARNING AS MUCH AS \$150 PER WEEK. NO limit as time goes on. U.T.S. is an old established school (TV exclusive for 24 years) staffed by expert instructors, headed by one of America's first TV broadcasters. Costs so little to prepare yourself for life. No previous experience needed. Fully approved for Korean Veterans. Also fully approved course in color TV (1st in U.S.) Send coupon now for FREE BOOK on TV and Electronics opportunities.

**— FILL OUT COUPON —**

**UNIVERSAL TV SCHOOL**  
1220 Admiral Boulevard, Kansas City, Missouri

PLEASE SEND ME INFORMATION FREE. Age \_\_\_\_\_

Name \_\_\_\_\_

Address \_\_\_\_\_

City \_\_\_\_\_ State \_\_\_\_\_

Check here if Korean veteran

**REPAIR TV PICTURE TUBES WITHOUT COSTLY EQUIPMENT**

Give new life to old or defective tubes. Remove shorts. Restore emission and brightness. Months of extra service.

**Complete instructions ONLY \$1**

Order now  
**TELEPARTS CO. Dept. A**  
P.O. Box 74 Providence 5, R.I.

**TRANSISTOR Personal Portable Radio Kit BATTERIES LAST 10,000 HOURS**

COMPLETE . . . Nothing else to buy  
SIMPLIFIED . . . A child can assemble it  
Screwdriver only tool needed

TRANSISTOR, diode, earphones, batteries, tuning capacitor, antenna, attractive carrying case, etc., included. Complete instructions.

**FREE** TRANSISTOR code practice oscillator kit with each TRANSISTOR radio only \$9.95 — check or money order

10-day Money-Back Guarantee

**TRANS-AIRE ELECTRONICS INC.**  
149 Broadway, Dept. R New York 6, N.Y.



Less than 1% AC hum at top load

**Model "EF"**  
continuously variable  
0-28 V up to 5 Amps  
0-14 V up to 5 Amps

# NOW! A 28 v. DC Power Supply at \$8450

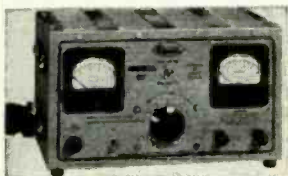

Test, service DC radio and electronic equipment

Only dual range unit with all these features at this low price. Certified proof of less than 1% AC hum at maximum load furnished with each unit. Intermittent loads up to 10 amperes. Single-knob control—easy continuous voltage adjustment as load changes. EPL cooling gives 25% extra current capacity. Write for Bulletin EFCS.

**Model "D-612"**  
0-8, 0-16 V completely variable  
0-10 Amps at 12 V continuous  
**\$39.50**

## Priced to Compete with Kits

Completely assembled 6/12 V unit has 25% more power. Heavy duty control transformer. EPL conduction cooling. Less than 5% hum over rated ranges. Certified performance chart. Write for Bulletin DC-123.

## ELECTRO PRODUCTS LABORATORIES

4501 N. Ravenswood Ave., Dept. RE-9, Chicago 40, Ill.

Canada: Atlas Radio Ltd., Toronto

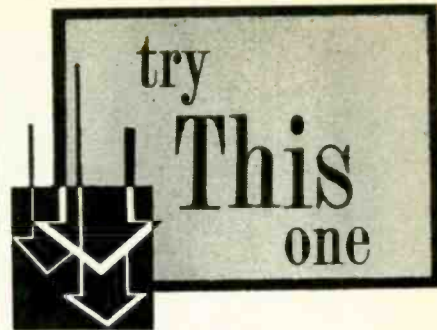

## R.F. INDICATOR

It is not easy to connect any type of r.f. or tuning indicator to a coaxial line feeding a transmitting antenna. I have solved the problem by modifying an Amphenol 83-1T tee adapter as shown. The trimmer is adjusted to vary

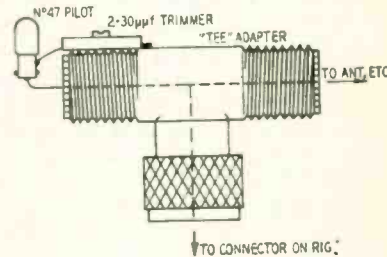

the brightness of the bulb. Transmitter controls are adjusted for maximum brightness. I use this method when tuning my Gonset Communicator.—Joseph Zukauskas

## MOUNTING HOME MIKES

A standard phone plug and an old metal music rack can be used to make a satisfactory floor stand for non-professional type microphones generally used for home recording and amusement. The drawings show the construction details.

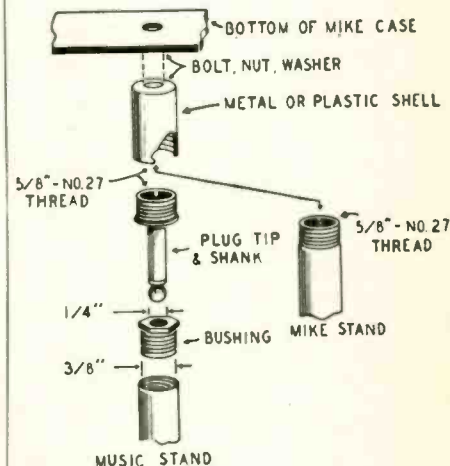

Drill a hole in the bottom of the mike case and bolt it to the shell of the phone plug. Screw or sweat a panel bearing or bushing from an old phone jack or volume control into the top of the music rack. The mike can now be mounted and removed with ease.

If you have a standard floor or table type mike stand, simply screw the phone plug onto it.—David J. Anaple

**SAVE WITH THE NEW**

**ERIE DISC and GP CERAMICON Kits**

### HERE'S WHAT YOU GET

- 1 100 High Stability ERIE Disc or Tubular Ceramicons
- 2 18 Popular Values
- 3 Handy, Convenient 18 Section Plastic Storage Case
- 4 Exceptional Value

### HERE'S WHAT YOU SAVE

REGULAR PRICE  
100 ERIE Disc or Tubular Ceramicons . . . \$15.00  
18 Section Plastic Case . . . 1.75  
Total Value \$16.75

YOU PAY . . . . . \$10.65  
YOU SAVE . . . . . \$ 6.10

ORDER NOW  
From Your  
ERIE  
DISTRIBUTOR



ERIE ELECTRONICS DISTRIBUTOR DIVISION  
ERIE RESISTOR CORPORATION  
Main Offices: ERIE, PA.  
Factories: ERIE, PA. • LONDON, ENGLAND • TRENTON, ONTARIO

When answering advertisements please mention  
**RADIO-ELECTRONICS**

### A SIMPLE PUNCH

Many times it is more desirable to punch than to drill a hole in light sheet metal and other materials. When a punch of the proper size is not available, you can make one from a broken

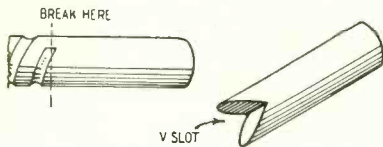

or worn out twist drill of the correct diameter.

First break off the twist or spiral portion and grind a "V" slot in the shank end as shown in the drawing. A sharp blow with a hammer on the blunt end produces a clean hole.—*Stanley Rubin*

### SERVICING HINT

Most radio-television service shops make it a regular practice to clean the cabinet of every set that comes in for servicing. Certainly most of them need it, and all customers appreciate picking up a clean shiny cabinet after a servicing job.

I have found that one of the very best tools for this job is a stiff-bristled plastic brush commonly sold in drug and dime stores as hand or finger brushes. These will clean the dirt from the embossed dials and lettering on plastic cabinets, particularly portables, better than any other device I have yet used.

Knurled dial knobs are the hardest to clean since they usually get the most handling and have sharp grooves where dirt accumulates. They can be cleaned like new by rubbing in the direction of the grooves with the plastic hand brush. No water or other cleaner is necessary, and I have never yet scratched or damaged a cabinet with this method.—*L. H. Wilson*

### TV CHASSIS SUPPORTS

Make a set of these simple chassis supports and use them to prevent tube breakage and other mechanical damage that often occurs when a heavy TV chassis tips over.

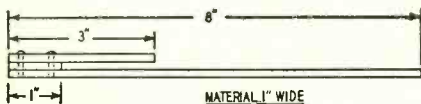

You can use any strip steel or other metal that is about 1 inch wide and heavy enough to support the chassis. Turn the chassis on its side in a convenient position and then slide the supports into position so the chassis skirt is firmly in the notch between the long and short strips.—*J. Urbanowicz*

(A somewhat similar commercial support has a hole for fastening the support to the bench, as well as a thumbscrew through the top short piece to hold the chassis.) END

# E-Z WAY HURRICANE PROOF COMMUNICATION TOWERS

Now you can have a tower that combines rugged strength with easy erection. E-Z Way Towers will stand a wind load of 60 lbs. per square ft. and with our new portable gin pole, it's easy to erect a 120 ft. tower in one piece. All work is done on the ground and this one shot erection method saves time, money and ends dangerous climbing. Find out about E-Z Way—the industry's new leader—now!

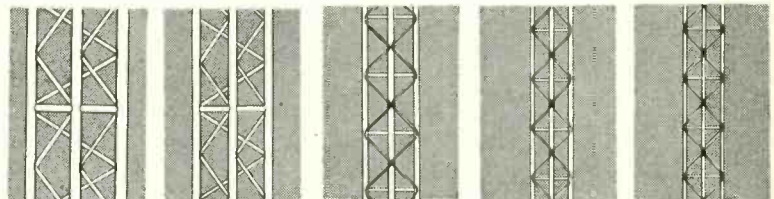

C-25	C-20	C-15	C-12	C-10
Width: 25" Legs: 2" pipe Weight per ft.: 20 lbs. Guy Spacing: 80 ft. Max. Height: 320 ft. Diag. Bracing: 3/4" pipe Horiz. Bracing: 1 1/4" pipe	Width: 20" Legs: 1 1/2" pipe Weight per ft.: 14 lbs. Guy Spacing: 60 ft. Max. Height: 250 ft. Diag. Bracing: 1/2" pipe Horiz. Bracing: 1" pipe	Width: 14" Legs: 1" pipe Weight per ft.: 8 lbs. Guy Spacing: 40 ft. Max. Height: 200 ft. Diag. Bracing: 3/8" rod Horiz. Bracing: 3/8" pipe	Width: 10 1/2" Legs: 3/4" pipe Weight per ft.: 5 1/2 lbs. Guy Spacing: 33 ft. Max. Height: 150 ft. Diag. Bracing: 3/8" Rod Horiz. Bracing: 1/2" Rod	Width: 10" Legs: 1/2" pipe Weight per ft.: 4 1/2 lbs. Guy Spacing: 27 ft. Max. Height: 120 ft. Diag. Bracing: 3/8" Rod Horiz. Bracing: 1/2" Rod

Work Platform—hooks on C-10, C-12 or C-15 towers.

C-10, C-12 & C-15 Bolt together 1 1/2" fillet on each side.

—Automatic lock for easy raising and lowering of mast when service is required.

Base plate for C-10, C-12 & C-15 has hinge for gin pole and tower.

Connecting point of C-20 and C-25 towers

When writing for catalog, specify height of tower and type of antenna (make and model) you intend to use. We also make free standing, crank-up and tilt-over towers for "Ham" rotary beams and TV antennas.

**E-Z WAY TOWERS INC.**  
**5901 E. BROADWAY PHONE 4-3916**  
**P. O. BOX 5491 TAMPA, FLORIDA**

## Important Notice to SUBSCRIBERS

If you're moving, please don't forget to send us your address as it appears on the copy of the magazine, including the numbers shown beside your name, as well as your new address. If possible, send us your address label which is pasted on the upper left hand corner of the back cover.

If we receive this information before the 20th of the month, you will continue getting the magazine without interruption.

Your cooperation will be most helpful and greatly appreciated.

Please send your new address to:

Circulation Department  
**RADIO-ELECTRONICS**  
 25 W. Broadway, New York 7, N. Y.

## HERE'S HOW TO GET YOUR START IN RADIO ELECTRONICS

More experts  
got their basic  
training from this  
big book than  
any other  
of its type!

Here's basic training  
you can really understand  
... training that can help  
fit you for a good pay  
radio-television-electronic  
career!

Ghirardi's RADIO  
PHYSICS COURSE is  
the oldest book of its kind  
... and still a best seller  
because it is so amazingly  
clear and complete. Thou-  
sands now in electronics  
got their start from this  
great book—and they'll  
recommend it to you to-  
day!

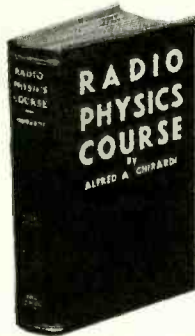

### RADIO PHYSICS COURSE

by A. A. Ghirardi

Complete, basic train-  
ing for beginners

Starts with Basic Electricity (over 300 pages)  
then takes you step by step through the entire ra-  
dio-electronics field. Covers principles, theories  
and practices that are basic to even the most mod-  
ern equipment. 972 pages; 508 pictures. 856 helpful  
self-review test questions. Price only \$6.50.

#### STUDY 10 DAYS FREE!

DEPT. RE-95, RINEHART & CO., INC.  
232 Madison Ave., New York 16, N.Y.

Send Ghirardi's RADIO PHYSICS COURSE  
home-training book for 10 days free examination.  
I will then either return book promptly or send  
you \$6.50 plus postage in full payment.

Name .....

Address .....

City, Zone, State.....

OUTSIDE U.S.A.—\$7.25 cash only. Money  
back if book is returned in 10 days.

Rinehart Books are sold by leading book stores

## See What's New in ELECTRONICS Radio • TV • High Fidelity



FREE!

### Send for NEWARK'S 1956 CATALOG

See the latest and finest equipment  
ever offered in High-Fidelity, Radio,  
TV, Amateur and Electronics. Select  
the fast, dependable way, from this  
new 260-page catalog.

# NEWARK

ELECTRIC COMPANY

Dept. RE-9, 223 W. Madison, Chicago 6, Ill.

WEST COAST BRANCH  
4736 W. Century Blvd., Inglewood, Calif.

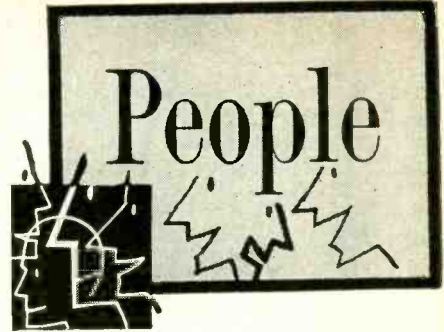

Alton K. Marsters  
was appointed to  
the new position  
of general sales  
manager of CBS-  
Hytron, Danvers,  
Mass. He comes to  
CBS-Hytron from  
Colt's Manufactur-  
ing Co.



A. K. Marsters

Vernon A. Dupy, general sales man-  
ager of United Motors Service, Division  
of General Motors, Detroit, Mich., was  
promoted to director of procurement,



V. A. Dupy



E. L. Lape

scheduling and general merchandising.  
Edward L. Lape, assistant general sales  
manager, succeeds him as general sales  
manager.

Frank Adams was  
promoted to East-  
ern sales manager  
of ORRadio Indus-  
tries, Opelika, Ala.  
He was formerly  
Mid-Atlantic rep-  
resentative. He will  
make headquarters  
in Philadelphia.



F. Adams

Sam D. Pollack was elected treasurer  
of Vaco Products, Chicago. He was  
heretofore comptroller. Harry Silver-  
stein, formerly president and treasurer,



S. D. Pollack

W. Walter Jablon  
joined Presto Re-  
cording Corp., Pa-  
ramus, N. J., as  
general sales and  
advertising man-  
ager. He was for-  
merly sales man-  
ager of Radio City  
Products.



W. W. Jablon

## Don't miss RADIO-ELECTRONICS COMING FEATURES



- ✓ Adjustment Problems in Color TV
- ✓ TV Servicing with a VTVM
- ✓ Sound Reproduction with Small Speakers
- ✓ Build This Simple Echo Unit
- ✓ Intermittent Set Tester
- ✓ Transistor Operated Geiger Counter
- ✓ Miniature Receiver for Model Control

### SUBSCRIBE NOW

### SEND ME RADIO-ELECTRONICS

Please check:

- 3 YEARS—36 Big Issues—ONLY \$8.00  
SAVES YOU \$5.05 over the single copy price!
- 2 YEARS—24 Big Issues—ONLY \$6.00  
SAVES YOU \$2.70 over the single copy price!
- 1 YEAR—12 Big Issues—ONLY \$3.50  
SAVES YOU 85c over the single copy price!

NAME (Please Print Clearly)

STREET ADDRESS

CITY ZONE STATE

I enclose \$ .....

Bill Me

Canada same as  
U. S. A. Extra postage  
per year: Pan-Amer-  
ica, 50c; all other  
foreign, \$1.00.

MAIL TO:

RADIO-  
ELECTRONICS  
25 West Broadway  
New York 7, N. Y.

# SAVE UP TO \$5.05



**PEOPLE**

(Continued)

**John Bentia**, former executive vice president of Alliance Manufacturing Co., Alliance, Ohio, was elected president and general manager of the company. He also becomes vice president of Consolidated Electronics Industries Corp., Jackson, Mich., which recently acquired Alliance.



**J. Bentia**

**Obituaries:**

**Rear Admiral Walter A. Buck**, U. S. N. retired, vice president in charge of operating services for Radio Corporation of America, died recently in his home in Wynnewood, Pa.

**Paul C. Smalley**, retired manager of the New York branch of P. R. Mallory, Indianapolis, died in Orange Memorial Hospital, Orange, N. J.

**Personnel Notes**

... **Hendrix G. Blue** joined Hallicrafters, Chicago, in the new position of sales promotion manager. He was formerly with Webster-Chicago.

... **H. Leslie Hoffman**, Hoffman Electronics Corp., was elected president of the reorganized board of directors of RETMA. Other officers include: **Leslie F. Muter**, Muter Co., treasurer; **Dr. W. R. G. Baker**, General Electric, director of the Engineering Department; **Joseph H. Gillies**, Philco, director of the Government Relations Department; **James D. Secrest**, executive vice president and secretary.

... **Larry S. Racine**, president of Chicago Standard Transformer Corp., Chicago, has taken a leave of absence due to ill health. **William J. Shea**, chairman of the board and chief executive officer, assumes the office of president. **Donald Schwennesen**, vice president in charge of engineering, becomes vice president in charge of sales and engineering in Racine's absence. **Ray Gislason** was appointed vice president in charge of all the company's manufacturing plants.

... **Ralph B. Austrian** was named West Coast manager of Allen B. Du Mont Laboratories with headquarters in Los Angeles. Since 1927 he has been active in executive capacities in radio, motion pictures and television.

... **Isaac Naeye** was appointed assistant treasurer of Philco Corp., Philadelphia. He joined the company in 1931. **John L. Esterhai**, named assistant secretary, joined the Philco Legal Department after service in World War II.

... **J. Henry Gardner** joined Jones & Laughlin Steel Corp., Pittsburgh, as administrative assistant to the director of public relations and advertising. He had been with American Radiator & Standard Sanitary Corp. **William J. Troppman**, a staff assistant, was promoted to supervisor of product advertising and promotion, and **Eugene F.**

**CASH IN NOW ON CONCORD'S  
"FESTIVAL of BARGAINS"  
GIANT FALL CATALOG  
ABSOLUTELY FREE!**

... and that's not all ...

**YOU WILL RECEIVE A SURPRISE FREE GIFT...**

... when you order from our catalog. In the past our FREE GIFTS have included a New Haven Travel-Alarm Clock, a Stratford Butane Lighter, a Tynar Miniature Camera, Waterman's Pen Set and many other useful items. So don't

miss out on this FABULOUS FREE OFFER. Help us celebrate the opening of our new store and you help yourself. Fill in the coupon below and get your "Festival of Bargains" Catalog NOW.

**SAMPLE "FESTIVAL OF BARGAINS" SPECIAL**

**\$125 PUSH BUTTON 6 Volt DELCO RADIO** **\$29.95**  
• 8 Tube Circuit  
Reg. \$125.00 Only

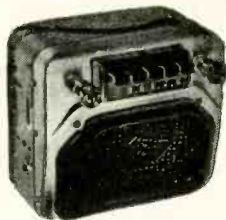

with 9 section 82" Solid Brass Whip Antenna. Measures Only 14" collapsed. Worth \$9.20

- Ideal for Cars, Boats, Trucks, Tractors, Farms, Summer Camps
- Push-Pull 6V6 Output!

There is no finer automobile radio made than GENERAL MOTORS DELCO Radio. Designed originally for use in 1953 and 1954 Packard automobiles, this DELCO Select-O-Matic is small enough and of the right size and shape to fit into the dash of almost any 1951, 1952, 1953 or 1954 General Motors car. Has 5 Push-Buttons in addition to manual tuning control. Tube line-up includes 2-6SK7, 2-6V6G, 1-6SQ7, 1-6SA7 and 1-OZ4. Large 6 x 9" speaker, push-pull 6V6 output and wide range tone control guarantee that this radio will outperform any competitive radio on the market. Size 9" H. x 10" L. x 7 1/2" Max. Depth. Control Head is 4 7/8" long x 1 7/8" high x 2" Max. Depth. Control Shaft centers are 6-11/16" apart and require 1/2" diam. holes. Shpg. wt. 19 lbs. Complete with owners' installation manual, all necessary hardware, brackets and knobs. With tubes, less escutcheon.

Stock No. P8TP ..... Reg. \$125.00 ..... Only \$29.95

**DELCO 9 Tube SELECT-O-MATIC AUTO RADIO**

9 tube DELCO Custom Auto Radio with Automatic Station Selection in addition to Push-Button and Manual Tuning!! Includes all the excellent features described above. Makes an ideal truck radio. Driver need not take eyes from road in order to change stations. Tubes include: 2-6BA6; 2-6AV6; 2-6V6GT; 1-6BE6; 1-12AU7; 1-OZ4 Rect.  
Stock No. D9TSP ..... Reg. \$135.00 ..... Your Cost \$34.95

**MAIL COUPON FOR  
BIG FREE CATALOG**

CONCORD RADIO Dept. C9  
45 Warren Street, New York 7, N.Y.  
20% deposit with C.O.D. MINIMUM ORDER \$5.00

NAME \_\_\_\_\_  
ADDRESS \_\_\_\_\_  
CITY \_\_\_\_\_ ZONE \_\_\_\_\_ STATE \_\_\_\_\_

**Concord Radio**

45 WARREN STREET, NEW YORK 7, N. Y. Dlgby 9-1132

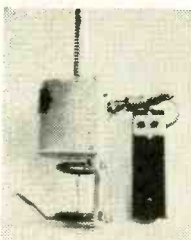

**TV  
ROTOR!  
8.95**

Uses 2 standard Flashlight Cells. Operates either direction on 2 wire Lamp Cord. Top Mast ready to

mount any balanced single Bay Antenna not a toy. Ideal for conicals, QTs, Rainbows, etc. Return if not 100% pleased! Jobbers—Dealers write for more information. Send cash check or M.O.

**KELTNER MFG. CO., Seymour, Mo.**

**NORDIC  
CUSTOM RADIOS FOR  
1952 TO 55 FORDS**

SUPERHETERODYNE • BIG 6 x 9 INCH SPEAKER • LOW BATTERY DRAIN • EASY INSTALLATION PERMEABILITY TUNER

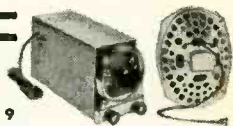

**\$38.90**

WRITE FOR LITERATURE  
**NORDIC RADIO COMPANY • BOX 582 • EVANSTON, ILL.**

**ENJOY 3 COLOR TELEVISION  
FILTER SCREEN NOW**

Changes dull eye-straining black and white pictures into beautiful color tones. Seconds to attach. No tools used. Helps eliminate glare and snow in fringe areas. Order direct. Send \$1 for screen size up to 16". \$1.25 size 17". \$1.50 size 20". \$2 size 21". \$2.50 size 24". \$3 size 27". We pay postage except on C.O.D. orders. Satisfaction guaranteed. Inquiries from dealers also welcomed.

**Zingo Electronics, Johnstown 13, New York**

# LEARN TV

the practical way--

17", 21" and 27"

## BUILD the New TRANSVISION TV KIT

Designed so that COLOR can be added

\*THIS MODEST INVESTMENT gets you started on a most fascinating project— assembling the new "E" type Transvision TV Kit in easy stages. For \$15 you get PACKAGE #1 (standard first package for all new "E" kits). This package gives you the BASIC CHASSIS and required first-stage TV COMPONENTS, with complete instructions. When ready, you order the next stage (pkg. #2), etc.

**\$15.00** ONLY gets you started\*

PROFIT 3 WAYS:

- 1 Learn TV
- 2 Save up to 50%
- 3 Prepare for COLOR TV

Shows 8 Great TV Kits:

EXCLUSIVE: Only Transvision TV Kits are adaptable to UHF. Ideal for FRINGE AREAS. No Previous Technical Knowledge required. Write now!

### FREE CATALOG

TRANSVISION THE OLDEST NAME IN TV KITS

NEW ROCHELLE, N. Y.

MAIL THIS COUPON TODAY

TRANSVISION, INC., NEW ROCHELLE, N. Y. Dept. E-9

I'm enclosing \$\_\_\_\_\_ deposit. Send standard kit PACKAGE #1, with all Instruction Material. Balance C.O.D.

Send FREE copy of your new TV Kit Catalog.

Name \_\_\_\_\_

Address \_\_\_\_\_

City \_\_\_\_\_ State \_\_\_\_\_

## GET INTO ONE OF THESE GREATER OPPORTUNITY FIELDS

# Electricity or Radio-Television

### TRAIN IN THE GREAT SHOPS OF COYNE

OLDEST, BEST EQUIPPED SCHOOL OF ITS KIND IN U. S.

Prepare for your future NOW. Get practical training in TELEVISION—RADIO—ELECTRICITY—ELECTRONICS—all vital in Industry. Prepare now for a better job that also offers a real future in the years ahead. Learn on real equipment at Coyne—no advanced education or previous experience needed

Approved for Veterans—finance plan—enroll now, pay most of tuition later. Part time employment service while training if needed.

**FREE BOOK** Clip coupon for Big Free Illustrated Book. No Salesman will call. Act NOW.

B. W. COOKE, President

## COYNE

FOUNDED 1899

A TECHNICAL TRADE INSTITUTE OPERATED NOT FOR PROFIT

500 S. PAULINA, CHICAGO, Dept. 65-81H

ELECTRICITY • TELEVISION • RADIO • REFRIGERATION • ELECTRONICS

B. W. COOKE, Pres.  
COYNE ELECTRICAL SCHOOL  
500 S. Paulina St., Chicago 12, Ill. Dept. 65-81H

Send FREE BOOK and details on:

RADIO-TELEVISION  ELECTRICITY

NAME \_\_\_\_\_

ADDRESS \_\_\_\_\_

CITY \_\_\_\_\_ STATE \_\_\_\_\_

PEOPLE (Continued)

Jannuzi, also a former staff assistant, was named supervisor of product publicity and institutional advertising.

... Leslie F. Muter, president of Muter Co., Chicago, was awarded the 1955 RETMA Medal of Honor at its 31st Annual Convention Dinner in Chicago.

... B. B. Bauer, vice president and director of research of Shure Brothers, Chicago, received the first Professional Group on Audio Achievement Award of the IRE at its Spring National Convention.

... Gen. Benjamin W. Chidlaw, U. S. Air Force retired, joined Thompson Products, Cleveland, as vice president.

... Dwight C. Baum, vice president of the First California Co. was elected a director of Phaostrom Co., South Pasadena, Calif. END

### CORRECTIONS

The single-engine plane on the first page of the article "Servicing Light Plane Radios" in the July issue is a Swift and not a Piper as stated in the caption. On the third page of the article, the photo showing the panel of an Aero Commander was inverted in some of the first issues off the presses.

These errors were spotted by Fred R. Wilson of Pinehurst, N. C., and Robert Matthews of Fort Dodge, Iowa, two sharp-eyed readers who know their planes.

The 1/2- and 1/4-watt diagonals are transposed on the resistor wattage chart in the article "How Much Will a Resistor Take" on page 56 of the July issue. We thank C. K. Well of Vallejo, Calif., for this correction.

Mr. Coates reports that the cutting templates illustrated on the third page of his article "A New Loudspeaker Enclosure" (page 32 of the June issue) should be drawn on a grid of 1/2-inch squares instead of 5/8-inch squares as specified on the drawing. END

### Radio Thirty-Five Years Ago

In Gernsback Publications

HUGO GERNSBACK Founder	
Modern Electrics .....	1908
Wireless Association of America .....	1908
Electrical Experimenter .....	1913
Radio News .....	1919
Science & Invention .....	1920
Television .....	1927
Radio-Craft .....	1929
Short-Wave Craft .....	1930
Television News .....	1931

Some of the larger libraries still have copies of ELECTRICAL EXPERIMENTER on file for interested readers.

### In September 1921 Science and Invention (formerly Electrical Experimenter)

Dempsey-Carpentier Fight via Radio-Phone, by Arthur H. Lynch

British Fliers Use Radio

Resonance Wave Coil Antennas, by J. O. Mauborgne, Major, S.C., and Guy Hill, Capt., S.C.

Radiophone and C.W. Set That Works, by Robert E. Lacault

### OPPORTUNITY ADLETS

Rates—45c per word (including name, address and initials). Minimum ad 10 words. Cash must accompany all ads except those placed by accredited agencies. Discount, 10% for 12 consecutive issues. Misleading or objectionable ads not accepted. Copy for November issue must reach us before Sept. 15, 1955.

**Radio-Electronics**

25 W. Broadway, New York 7, N. Y.

COMPLETE HIGH SCHOOL at home in spare time with 58-year-old school; texts furnished; diploma; no classes; booklet free. Write American School, Dept. X69, Drexel at 58th, Chicago 37, Ill.

HIGH-FIDELITY SPEAKERS REPAIRED. Amprite Speaker Service, 70 Vesey St., New York 7, N. Y.

TAPE RECORDERS, ACCESSORIES, BEST BUYS. Boynton Studio, 10 E. Pennsylvania, Tuckahoe, N. Y.

BUY Surplus Radio, Electronic Equipment direct from Government, List \$1.00. Box 169RAC, East Htrd 8, Conn.

\$200 WEEKLY CLEANING Venetian Blinds. Free book. Burt, 2434BX, Wichita 13, Kansas.

SPEAKER RECONING: Guaranteed workmanship. C&M Recone Co., 255 Tioea St., Trenton 9, N. J.

GEIGER COUNTER KITS \$34.50. Geiger Counter & Scintillator Diagrams Catalog Free. R. F. Chambers, 13833 San Antonio Dr., Norwalk, Calif.

RCA, Motorola, Link, GE and Kaar new and used two-way radio equipment bought and sold. Communications Associates, 138-17 Springfield Blvd., Springfield Gardens, N. Y. Phone LA 7-2727.

ALL Types TV tuners serviced within 36 hours. For information write DAN'S TV Laboratory, 2 West 183d St., N. Y. 63, N. Y.

PRINTED Circuits made from your drawings. J. C. Devlin, Trucksville, Pa.

DIAGRAMS FOR REPAIRING RADIOS \$1.00. Television \$2.00. Give Make, Model. Diagram Service, Box 672-RE, Hartford 1, Conn.

FOUR Gold Plated microphone buttons; Hundred insulated carbon resistors; 6VDC 10 I.P.M. motor or earphone for \$1.00 Postpaid. Electronic Outlet, Box 72-A, Lawrence, Mass.

\$12.00 BUYS LONG DISTANCE FM ANTENNA NOW 60% OFF. Electronic Supply Co. 128 State St., Schenectady, N. Y.

FIDELITY UNLIMITED: AUTHORIZED DISTRIBUTORS OF HIGH-FIDELITY COMPONENTS. SHIPMENTS PREPAID and INSURED. SPECIALS: NEW COLLARO RC-54 with Mounting Board, 45 spindle, dual Blank Heads, \$38.75. Accessories: RFX-050, dual sap plowing \$6.50. Diamond and sapphire Stylus \$10.75. WRITE US YOUR HI-FI REQUIREMENTS. FREE AUDIO GUIDE. COMPLETE STOCK. FIDELITY UNLIMITED, 63-03 39th Ave., WOODSIDE 77, N. Y. Dept. RE.

U. S. CIVIL SERVICE JOBS: Men-Women, 18-55. Start high as \$350.00 month. Quality NOW! 16,000 jobs open. Experience often unnecessary. Get FREE 36-page book showing jobs, salaries, requirements, sample tests. WRITE: Franklin Institute, Dept. G-54, Rochester, N. Y.

TUBES—TV, RADIO, TRANSMITTING, AND SPECIAL PURPOSE TYPES BOUGHT, SOLD AND EXCHANGED. Send details to B. N. Gensler W2LNI, 512 Broadway, N. Y. 12, N. Y.

WANTED: AN/APR-4, other "APR.", "TS-", "IE-", ARC-1, ARC-3, ART-13, RC-348, etc. Microwave Equipment. Everything Surplus. Special tubes. Tec Manuals. Lab Quality Equipment. Meters. Fast Action. Fair Treatment. Top Dollar! Littell, Fairhills Box 26, Dayton 9, Ohio.

COUNT without numbers. Logic Mirror-wise. 4 pages. Send 25c. W. J. Mallory, 616 N. 34th St., Omaha 3, Neb.

SPEAKER RECONING. low prices. Michigan Speaker Reconing Service, 930 Metropolis, Marine City, Michigan.

DIAGRAMS: Professional Model Timers, Counters, Intercoms, Organs, etc. \$1.00 each. List free. Parks, 101 S.E. 57th, Portland 15, Oregon.

POWER TRANSFORMERS REBUILT—all makes. TV-Radio or Special. Red Arrow Radio, 924 Metropolis, Marine City, Michigan.

25-50% DISCOUNT. guaranteed. Factory Fresh LP records; 60c and up; pre-recorded tapes. Send 20c for catalogue. SOUTHWEST RECORDS, 1108 Winburn, Houston, Texas.

FREE TRANSISTOR Code practice oscillator kit. See our ad in this issue—or write TRANS-AIDRE ELECTRONICS, INC. 149 Broadway Dept. R New York 6, N. Y.

TELEVISION RECEIVERS \$28.80 UP. W4API 1420 South Randolph, Arlington 4, Va.

TV TRADE-IN SETS. Philco, R.C.A., Emerson, others. List available \$17-\$17.97 up. \$20 up. Washitek Service Co., Dept. E, 956 Southern Blvd., Bronx, N. Y.

TV FM ANTENNAS. ALL TYPES INCLUDING UHF. Mounts, accessories. Lowest prices. Wholesale Supply Co., Lunenburg 2, Mass.

# Business



## Merchandising and Promotion

Simpson Electric Co., Chicago, designed a new display board on which



an actual sample of its *Midgetester* model 355 miniature volt-ohmmeter is mounted.

Permoflux Corp., Chicago, announced that its new Stereo-Vox device for simulating stereophonic reproduction from monaural sources has met with considerable success and that the company is planning a full-scale advertising and promotion program on its product.

United Motors Service, Division of General Motors, Detroit, Mich., designed a new sales stand capable of

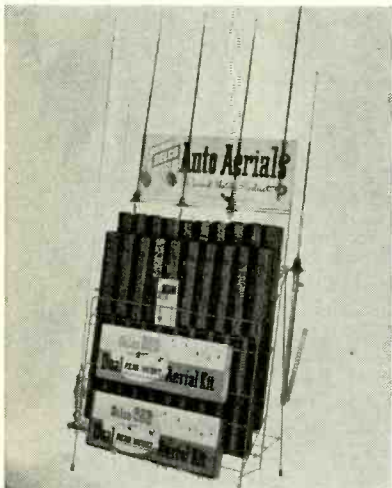

holding 30 of its new *Delco* automobile aerials.

Jensen Industries, Forest Park, Ill., designed a new combination needle storage and display cabinet to aid its

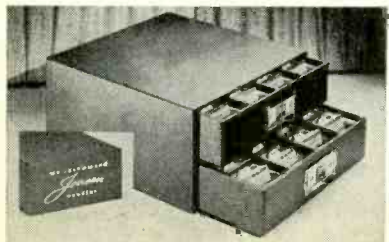

distributors and dealers in stocking and selling its phono needles.

Carter Motor Co., Chicago, developed a converter selector chart for wire and tape recorders.

JFD Manufacturing Co., Brooklyn, N. Y., introduced its new *Liberty Bell* antenna at a service meeting in Phila-



Left, to right: Doug Carpenter, JFD; Al Haas, CRTSA, Philadelphia; Paul F. Harran, WPFH-TV, Wilmington, Del.; H. Grassley, JFD Eastern sales manager.

delphia. The new antenna features a bi-directional response and was designed specifically for the Philadelphia area.

CBC Electronics, Philadelphia, is merchandising its high-fidelity interconnecting cables on a rotating counter display merchandiser.

Kay-Townes Antenna Co., Rome, Ga., is sponsoring a Golden Harvest promotion campaign on its *Big Jack* and other antennas for its dealers and their salesmen. A 1956 Cadillac sedan is the first prize.

Clarostat Manufacturing Co., Dover, N. H., is featuring a card kit which holds a selection of its power resistors.

## Production and Sales

RETMA reported the production of 3,238,820 TV sets during the first five months of 1955 compared with 2,301,055 for the 1954 period. Also 5,853,954 radios were manufactured compared with 4,048,904 in the 1954 period.

RETMA reported manufacturers' sale of 4,207,129 TV picture tubes and 185,682,583 receiving tubes during the first five months of 1955 compared to 3,275,301 picture tubes and 134,677,745 receiving tubes in 1954.

The NBC Research and Planning Department reported that there were 36,100,000 TV sets installed in the United States as of June 1.

## HERSHEL'S PRICE BUST!!!

### ALL-PURPOSE FIL. TRANSFORMER

For Model Trains, Welding, Transmitters, etc.  
PRI. 117 v. 60 cvc. sec.

6.4 v. ....12A  
6.4 v. ....10A  
5 v. ....3A  
5 v. ....3A  
5 v. ....3A  
2.5 v. ....1.75A

**\$4.95**

### MYSTERY PACKAGE ELECTRONIC PARTS

The Surprise of Your Life  
20 pounds of BRAND NEW USABLE GOVT SURPLUS Ideal gift for the ham, etc. Worth \$50. Our price

**\$3.95**

### KIT 1, HARDWARE

Over 1,000 pieces, 2 1/2 lbs. of assorted RADIO & TV HARDWARE.

**99c**

### KIT 5, RESISTORS

100 ASSORTED TYPES. Range from 1 ohm to 15 meg. 1/2 to 5 watts.

**\$1.75**

### KIT 2, CERAMICONS

100 ASSORTED Range from .75 mmfd. to 6,000 mmfd.

**\$2.50**

### KIT 6, R.F. CHOKES

25 ASSORTED Range from .5 mh. to 25 mh.

**95c**

### KIT 3, Volume Controls

25 ASSORTED Range from 2 ohm to 3 meg. Some with switch.

**\$2.75**

### KIT 7, TOGGLE & SLIDE SWITCHES

25 ASSORTED DPST, DPDT SPST, etc.

**\$3.25**

### Kit 4, Rotary Switches

25 ASSORTED TYPES. A Real Buy at only

**\$2.50**

### KIT 8, PAPER & CAN CONDENSERS

25 ASSORTED Range from 4 mfd. 150 v. to 80 mfd. 450 v.

**\$2.75**

## BUTTERFLY COND.

TYPE A Freq. Range 106 to 330 MC. 4 1/4" diameter Aluminum plates (open loop type with acorn socket mounted on stator).  
TYPE B Freq. Range 135 to 485 MC. 4 3/8" DIAMETER. Silver plated brass plates.  
TYPE C Freq. Range 300 to 1000 MC. 2 1/2" diameter. Can use 368AS tube. Silver plated.  
TYPE D Freq. Range 300 to 1000 MC. 2 1/2" diameter. Has clip for Xtal Detector.

Note: The wide frequency range available. These units made the finest tuners for ultra-high frequency transmitters, receivers, frequency meters and oscillators.

**Your Choice \$4.95**

## HI GAIN DYNAMIC MIKE KIT

Uses UTC. Transformer and Western Electric Mike. Ideal for Hams, PA. CAP, Recording, Mobile Equip.

—50 DB/80-7500 CPS. **\$1.95**  
Diagram Furnished

## RELAY SPECIALS

D.P.D.T. 3 VDC. DC Res. 11 ohms.....\$1.45  
D.P.D.T. 110 VAC 8 Amp Contacts.....1.69  
S.P.S.T., 24 VDC. Coil 270 ohms. Contacts 20 Amps, at 115 VAC. Ideal for Photo Flash equipment .....95  
Plate Sensitive Relay 7 1/2 Ma. 2000 ohm coil....1.95

TERMS: Cash with order or 25% down—Balance C.O.D. All orders shipped F.O.B. Detroit. Minimum order \$2.00.

## HERSHEL RADIO CO. Dept. B

5245 Grand River, Detroit 8, Mich.  
ALL ITEMS SHIPPED F.O.B. DETROIT

## STUDENTS! TECHNICIANS!

### REFERENCE HANDBOOK OF ENGINEERING MATHEMATICS

A concise aid to study and review  
\$1.00, postpaid

Send check or money order to:  
REFERENCE HANDBOOKS, Dept. T-10  
P. O. Box 7794, University Station, Austin, Texas

## STANDARD KITS

ASSEMBLED and CALIBRATED

Prompt guaranteed service at competitive prices. Ship us your unopened kit in its original package with a letter ordering work. We will return your professionally assembled, tested and calibrated instrument by Parcel Post. COD. RTMA guarantee.

VIG AVIONICS CORP.  
619 Sugar Creek Drive Joliet 51, Ill.

**Calendar of Events**

10th Annual Instrument Conference and Exhibit, Sept. 12-16, Shrine Exposition Hall and Auditorium, Los Angeles, Calif.  
 RETMA Symposium on Automation, Sept. 26-27, Irvine Auditorium, University of Pennsylvania, Philadelphia, Pa.  
 High-Fidelity Show, Sept. 30-Oct. 2, Palmer House, Chicago. (RADIO-ELECTRONICS will exhibit in Room 746.)  
 National Electronics Conference, Oct. 3-5, Hotel Sherman, Chicago.  
 Audio Fair, Oct. 13-16, Hotel New Yorker, New York City. (RADIO-ELECTRONICS will exhibit in room 716.)  
 1955 Radio Fall Meeting, Oct. 17-19, Hotel Syracuse, Syracuse, N. Y.  
 First Annual Technical Meeting of the IRE Professional Group on Electron Devices, Oct. 24-25, Shoreham Hotel, Washington, D. C.

**New Plants and Expansions**

Sylvania Electric Products, Parts Division, is planning a new 110,000-square-foot plastics plant and warehouse in Warren, Pa.

Allen B. Du Mont Laboratories, Clifton, N. J., formed a new Technical Products Division under the direction of Dr. P. S. Christaldi, former manager of the Instrument Division. It will make and sell products formerly handled by the Instrument and Communication Products Divisions. Du Mont is also building a new West Coast headquarters in Los Angeles.

Vokar Corp., Dexter, Mich., is tripling its present plant area to house its enlarged Engineering and Research Departments.

RETMA has moved its West Coast office to larger quarters at 7046 Hollywood Blvd., Hollywood, Calif., and its Statistical Department to the Sheraton Building, 711 14th St. N. W., Washington, D. C.

Service Instruments Co. is now located at larger quarters in Addison, Ill.

National Co., Malden, Mass., has leased additional space in Melrose, Mass., for its physics and pulse devices laboratories. Within the past year the company has more than doubled its engineering staff.

Westinghouse Electric is building an "automatic" factory at Youngwood, Pa., for the production of semiconductor devices.

Motorola Communications and Electronics Division has broken ground for a new \$1,500,000 transistor manufacturing facility in Phoenix, Ariz.

James Vibrapowr Co., Chicago, is building a new one-story factory which will triple its present space.

**Mergers**

Siegler Corp., Centralia, Ill., purchased the outstanding stock of Hallamore Manufacturing Co., Long Beach, Calif., manufacturer of electronic devices.

F. L. Jacobs Co., Detroit, automotive parts manufacturer, acquired Eicor Co., Oglesby, Ill., as an electronic product subsidiary.

Consolidated Electronics Industries

The  
 Record  
 Changer  
 with

**JPF\***  
**Collaro**

**RC-54 3 Speeds**  
*Fully Automatic*



\* *Get the whole story*

ROCKBAR CORPORATION, Dept. RJ-16  
 215 East 37th Street, New York 16, N.Y.

Tell me about JPF and the Collaro RC-54

Name.....  
 ADDRESS.....  
 City..... Zone..... State.....

**EDLIE for TOP VALUES**

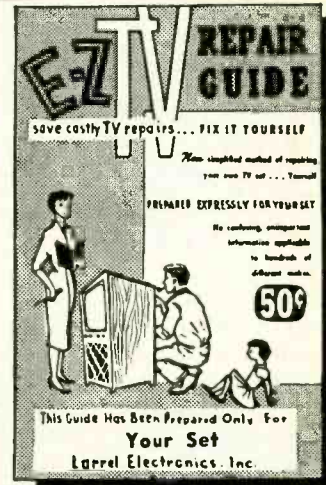

**Larrel's E-Z TV REPAIR GUIDE**

**The Only FIX-IT-YOURSELF Guide Made expressly for YOUR TV Set!**  
 Now you can save costly TV repairs with this new, simplified method which includes all necessary data for just YOUR set. No confusing, unimportant information applicable to hundreds of other makes. Simplifies detection of faulty tubes in your TV receiver quickly, accurately. It's a terrific idea—it's a terrific guide!  
 Order today and have your set back in perfect condition at once. Be sure to send us make and model of your TV when ordering.  
 For Most TV Sets—Old & New

only **50¢**

**SAVINGS ON KITS**

**5 TUBE AC/DC Superhet Kit**



Kit #1: 5 tube superhet kit. AC/DC includes all quality components required to construct this latest design, highly sensitive superhet broadcast receiver, complete with black, graining bakelite cabinet (excludes wire & solder). Kit of 5 tubes, 12AT6, 2/12BA6, 12BE6, 35W4, 50B5.

Price, Less Tubes..... **\$7.95**  
 Extra for Tubes..... **\$3.25**

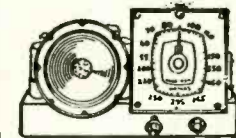

**6-TUBE RADIO KIT**

Kit #2: Low priced 6-tube kit designed for extra high sensitivity, excellent selectivity and good, rich tone quality. Uses 25L6, 25B6, 6SQ7, 6SA7, 2/6SK7 in an easily constructed circuit. Includes all parts: punched chassis, resistors, condensers, coils, sockets, PM speaker, hardware, etc.

Special closeout price. (Less tubes & cabinet)..... **\$6.95**  
 Matched set of 6 tubes for kit..... **\$3.25**

**3-Way Portable RADIO KIT**



NEW, compact, lightweight portable radio kit with the very latest super-sensitive superhet circuit. Wonderful reception from either batteries, or 115 V., 50-60 cycle AC or DC. Includes all complete parts (except wire & solder) necessary to build a great sounding radio. Also includes circuit diagrams and simplified, complete step-by-step instruction folder which makes assembling easy. Housed in a beautifully high-glossed Catalin cabinet in two delightful and distinctive colors: maroon or alabaster (Ivory). Size: 9 1/2" x 5 7/8" x 4 1/2". Includes tubes! **\$13.95**  
**BATTERY KIT:** add..... **\$2.59**

Write today for FREE Catalog. All mdse, shipped F.O.B. New York City, prices subject to change without notice. Include 20% deposit with C.D.D.'s.

**EDLIE ELECTRONICS**  
 154 Greenwich St. New York 6, N.Y.  
 DL 9-3143

**!! Save on Guaranteed Tubes !!**  
70% to 90% OFF . . . Individually

**Boxed**  
#1H4, 6D8, 6K7, 24, 26, 27, 41, 42, 55 or 89 **29c**  
#1A7, 1H5, 1H6, 1J6, 6A6, 6AT6, 6AV6, 6C4, 6C5, 6F6, 6H6, 6J7, 6SA7, 6SD7, 6SF6, 6S07, 6SK7, 6SR7, 6U5, 6U7, 6V6, 6V8, 6X5, 7A4, 7X4, 7Z4, 7Z5, 7Z6, 32, 34, 39/44, 76, 78 or 80. **ea.**  
#1X2, 1S5, 2A3, 2A6, 5W4, 6AR, 6AL5, 6AT6, 6AU6, 6AV6, 6AQ5, 6A35, 6BT, 6BA6, 6H47, 6BC5, 6BB6, 6C6, 6CB, 6D3, 6D5, 6K6, 6K7, 6N7, 6S07, 7A7, 7AG7, 7B6, 7B8, 7C5, 7C7, 7G6, 12A6, 12Q7, 12AU6, 12BA6, 12SR7, 12SQ7, 25L6. **49c**  
35B6, 50B6, 50C5, 35, 45, 71 or 77. **ea.**  
#1L4, 1L6, 1L3, 1R5, 1S4, 1T4, 384, 3VA, 6A7, 6AG5, 6N7, 12AU7, 12SA7, 12BH7, 12SK7. **59c**  
or 5B. **ea.**  
#OC3, OD3, 1LC6, 1LH4, 1N5, 2A3, 305, 5T4, 6A3, 6AC7, 6AG7, 6AK5, 6E5, 6J8, 6L6, 6T8, 7G7. **69c**  
7Q7, 12AT7 or 47. **ea.**

**TUBE CARTONS** Colored or White: prices per 100: Min (1 x 1 1/4 x 3 1/4) - \$1.45; Med (1 1/2 x 2 1/4) - \$1.20; GT (1 1/4 x 2 1/2) - \$1.15; Large (2 x 2 x 5) - \$1.98.  
**5 RPM HAYDON TIMING MOTOR (O.D. 2" x 1 1/8")** CCW rot. 24V 60 cycle. **1.95**  
**30 RPM MOTOR (115V. AC)** High torque, gear drive. 5" x 2 1/2" x 1". Double 5/32" shaft. **2.95**  
**6VDC MOTOR (Delco)** Fully cased; dustproof. 1 1/2" shaft. O.D. 2 3/4" x 4". 1500 RPM. **2.95**  
**AC-DC THERMOSTAT SWITCH** Form. closed. Opens at 115°F. 3/4" x 5/8" O.D. ea. **98c** / 1/2" O.D. **MI-FI DYNAMIC HEADPHONES** nylon cone, moving coil. W/sponge rubber cushions. **2.95**

**!! ALNICO MAGNETS !!**

Just a few of the many types always in stock  
**POLISHED BAR** 9/16" x 7/32" x 3/32" - \$1.00;  
1.00/57.50  
**"U" TYPE** 3/4" x 5/8" x 1 1/2" - ea. **49c**; 12/\$5.00  
**ROD** 1/2" x 1 1/4" x 1 1/4" - ea. **\$1.39**; 6/\$5.95  
**ROD MAGNET KIT** Set of 2 round 3/8" O.D. Bars, 4 1/2" x 1 3/8" L. Wood cased. Per set. **1.75**  
**ALNICO "CHIP" MAGNETS** small irrtex shapes, approx. 90 pcs/oz. - 15c oz.; **1.50 lb.**  
**ALNICO MAGNET ASSORTMENT** Powerful Bar, Block, "U" Rod, etc. Kit of 10 asstd. **1.98**  
(WRITE FOR LATEST ALNICO SUPPLEMENT)

**3 TUBE PHONO AMPLIFIER KIT (AC-DC)**

all parts, wiro, diagram, Lwt. fibre chassis. Less tubes **2.49**  
Set of tubes for above (50L6, 35Z5, 12SQ7) **1.69**

**5 TUBE AC/DC RADIO KIT DO IT YOURSELF!**

Highly sensitive, good tone. Includes all parts, WOOD VENEER CABINET & chassis, diagram, hardware, wire, solder. Less tubes. Kit of 5 tubes (12SA7, 12SK7, 12SQ7, 50L6, 35Z5) **\$6.95**  
**\$2.98**

**!!! HELP !!!**

**LEOTONE** yourself to MORE PARTS FOR LESS MONEY! with the "JUMBO RADIO-ELECTRONICS PARTS KIT" FULL LBS. OF: SWITCHES, CONN. P.T.C.'S, HARDWARE, RESISTORS, CAPACITORS, WIRE, PHOTOFACTS, SPEAKER ACCESSORIES, KNOBS, COILS, E.T.C., E.T.C. (shng. wt. 20 lbs) **\$3.95**  
Min. Order \$3.00—20% deposit required on all orders. Please add sufficient postage—excess refunded.  
**LEOTONE RADIO CORP.** 87 Dey Street New York 7, N. Y.

**\$3.00 FOR CARTOON IDEAS**

**RADIO-ELECTRONICS** prints several radio cartoons every month. Readers are invited to contribute humorous radio ideas which can be used in cartoon form. It is not necessary that you draw a sketch, unless you wish.  
**Address**  
**RADIO-CARTOONS, RADIO-ELECTRONICS**  
25 West Broadway, New York 7, N.Y.

**BUSINESS (Continued)**

Corp., Waterbury, Conn., purchased Alliance Manufacturing Co., Alliance, Ohio, following stockholder approval. Peoples Development Co., Columbus, Ohio, acquired a sizable stock interest in Consolidated.

Stromberg-Carlson, Rochester, N. Y., merged into General Dynamics Corp. following the approval of shareholders of both companies.

Olympic Radio & Television, Long Island City, N. Y.; Victoreen Instrument Co., Cleveland, and Nuclear-Electronics Corp., New York City, are planning a three-way merger subject to the approval of stockholders. David H. Cogan, president of Nuclear-Electronics, will be president and director of the new firm. C. W. Haller, president of Victoreen, will become vice president and director and Adolphe A. Juviler, chairman of Olympic, will become chairman and treasurer.

Shure Brothers, Chicago, manufacturer of microphone and acoustic devices, is celebrating its 30th anniversary this year.

**Business Briefs**

Hoffman Electronics Corp., Los Angeles, purchased National Fabricated Products, Chicago electronic component manufacturer.

The 1956 IRE Show will again be held in the Kingsbridge Armory and Palace, New York City, March 19-22, due to the delay in construction of the New York Coliseum.

Allen B. Du Mont Laboratories, Clifton, N. J., entered the radio and high-fidelity phonograph field.

Acro Products Co., Philadelphia, was issued a patent on its Ultra-Linear audio amplifier circuit. The company is arranging for licensing agreements with several high-fidelity amplifier manufacturers.

RETMA Service Committee Chairman H. J. Schulman, CBS-Columbia, estimated that the public had paid over \$1.5 billions for radio-TV service during the past 12 months. This is the first time gross income from servicing has equaled or exceeded income from retail sales.

Daystrom Inc., Elizabeth, N. J., (parent company of Weston Electrical Instrument and Heath Co.), spent over \$5 millions for the acquisition of new companies during the fiscal year ending March 31, 1955, and retired \$1,419,000 in long-term debts. Thomas Roy Jones, president of the company, estimated that 70% of the firm's sales this year would be in electronic and allied equipment.

Phaotron Co., South Pasadena, Calif., has established a sales target of 10 times the present volume within the next 3 years due to new products scheduled to be introduced shortly.

Perfection Mica Co., Chicago, formed a new Magnetic Shielding Division. **END**

**Gigantic SAVINGS on TUBES and Parts!**

Same Day Service • Full Year Guarantee  
All Tubes Individually Boxed • 400 Types Always in Stock  
For Quality, Performance, Dependability.

Type	Price	Type	Price	Type	Price
024M	65	6AT6	41	7E7	79
1AX2	62	6AU4GT	68	7F8	79
1B3GT	73	6AU6	46	7H7	59
1L4	59	6AU7	51	7J7	79
1L6	69	6AV5GT	83	7K7	69
1L5	59	6AV6	40	7N7	69
1L3	59	6AX7	64	7S7	65
1L5	69	6BA6	49	7Y4	79
1LH4	69	6BC5	54	12A4	60
1N5	59	6BC7	51	12AL5	37
1R5	62	6BE6	51	12AO5	52
155	51	6BG6G	1.25	12AT6	41
1U4	57	6BH6	57	12B6	59
1U5	50	6BJ6	49	12AU6	46
1X2A	68	6BK5	80	12AU7	60
2AF5	98	6BK4GT	80	12BY6	65
3A3	80	6BL7GT	91	12AV7	73
3AL5	42	6BN6	74	12AX4	67
3AU6	58	6BQ6GT	90	12X7	63
3BC5	54	6BR7	90	12B4	60
3BN6	74	6BZ7	90	12BA6	49
3CB6	54	6C4	40	12BE6	51
3C4	59	6C6	54	12BF6	39
3Q5GT	69	6C6E	1.11	12BH7	63
354	58	6CF6	64	12BQ6GT	99
3A4	59	6CR6	51	12C6	65
4BQ7	90	6CS6	51	12BZ7	65
4BZ7	96	6H6GT	41	12CR6	61
5AM6	67	6J5GT	67	12E6	51
5AN8	78	6J6	64	12SA7GT	65
5AT8	75	6K6GT	45	12S7M	67
5AW4	64	6L6	84	12S7GT	63
5J6	64	6O7	48	12S7GT	67
5T4	79	654	48	12SN7GT	59
5T8	81	6SA7GT	55	12SQ7GT	56
5U4G	59	6SH7GT	95	12V6GT	46
5U8	78	6S7GT	50	12X4	38
5V4	71	6SK7GT	53	14A7	63
5V6	75	6SL7GT	67	14B6	63
5X8	75	6SN7GT	59	14R7	79
5Y3GT	37	6SQ7GT	46	19AU4	76
6AB6	46	6T4	99	19B6G	1.39
6AC7M	86	6T8	80	19T8	69
6AD7	89	6U8	78	25AV5GT	83
6AF	90	6V6GT	50	25B0GT	98
6AG5	59	6V8	59	25Z5GT	51
6AG7M	99	6W4GT	47	25L6GT	51
6AH4	67	6WG6T	37	35B5	52
6AH6	67	6X4	65	35Z5	52
6AK5	95	6X5GT	37	35L6GT	51
6AK6	59	6X8	75	35W4	47
6A6	78	7A5	59	35Y4	54
6AN4	95	7A6	65	35Z5GT	47
6AQ5	50	7A7	69	50A5	55
6AQ6	46	7A8	68	50B5	55
6AQ7	70	7AG7	49	50C5	51
6AR4	80	7C5	69	50L6GT	61
6AS5	50	7C7	69	51Z3	43
6AS6	1.49	7E7	59	117Z3	45
				117Z6	82

**Terrific Value 8-TUBE CAR RADIO**

Made for Hudson cars. Can be installed in dash or under dash of most cars. Small size; separate P.M. speaker. Automatic push buttons. Tone control. Push-Pull 6AQ5 output.  
In original Factory Cartons. **\$29.95**  
Contains 2 6AQ5, 2 6BD6, 1 6BE6, 6C4, 6AV6, 6X4, 6 volt cars.  
Complete with knobs, mounting brackets, condensers, fuse, etc. **Lots of 3 \$27.95**  
\$85 seller.

WRITE Dept. RE-9 for FREE Tube and Parts Catalog Listing Over 400 Tube Types. Export Inquiries Invited!

**RT-24/APX-2 IFF EQUIPMENT**

44 tube transceiver with usable parts, tube sockets, relays, coax fittings, condensers, resistors, etc. 24 volt Blower motor, 24V gear train motor. Power transformer 400 to 2400 cycles. Original govt. cost \$750.00. **\$595**  
Less tubes **Same** **\$5** ea.  
Shipping weight 26 lbs.

**SPECIAL!** Same RT-24/APX-2 in sealed overseas carton complete with 44 tubes: 11-6A05; 15-6C4; 1-0D3; VR150; 1-2C26; 7-6J6; 4-9006; 1-5Y3; 1-2D21. List price of tubes alone. Ship by rail-way only. Approx. weight 30 lbs. **\$16.95** ea.

**Rad Tel TUBE CO.**  
"Integrity is Our Chief Asset!"  
TERMS: 25% deposit must accompany all orders—balance COD. All shipments FOB Irvington warehouse.  
ORDERS UNDER \$5.00—50c HANDLING CHARGE.  
PLEASE: Send full remittance. Allow for postage and save COD charges. Unused money Subject to prior sale.  
**115 COIT ST., IRVINGTON II, N. J.**

# C-D's CUB

## BEST-BAR NONE



## MOLDED TUBULAR CAPACITORS

The C-D "Cub" capacitor has proven itself the best on the market today—by out-lasting, out-performing, out-selling any other replacement capacitor for radio or TV. For consistent high quality—always rely on C-D, the only tubulars with the built-in extras required in servicing sets today. That's why distributors *who know*, carry the complete Cornell-Dubilier line.

*Special! "Cub-Kit" with bonus plastic service dispenser.*

Ask your C-D Distributor. He's listed in your local Classified Telephone Directory.

*There are more C-D capacitors in use today than any other make*



## CONSISTENTLY DEPENDABLE CORNELL-DUBILIER CAPACITORS

PLANTS IN SOUTH PLAINFIELD, N. J.; NEW BEDFORD, WORCESTER AND CAMBRIDGE, MASS.; PROVIDENCE AND HOPE VALLEY, R. I.; INDIANAPOLIS, IND.; SANFORD AND FUGAY SPRINGS, N. C.; SUBSIDIARY: THE RADIART CORPORATION CLEVELAND, O.

EDITORIAL

(Continued)

These totals are impressive. The electronics industry sold \$1,400,000,000 in end products for entertainment purposes last year, and this year is expected to attain a volume equally large. But look ahead just a few years! The average annual sale of entertainment devices, we believe, will increase to over \$1,600,000,000 a year during the 1958-60 period and by 1964 should come every close to \$2,000,000,000, an increase of over 40% in a decade.

By far the largest customer of the industry is the United States Government.

Defense purchases of electronic equipment last year are estimated at \$2,300,000,000, and the total may go up another notch to around \$2,500,000,000 in 1955. But, as the Army, Navy and Air Force become increasingly electrified, we foresee Government purchases in the vicinity of \$3,200,000,000 a year in the 1958-60 period and at over \$4,000,000,000 a year by 1964.

There is one area of electronics in which the surface has been barely scratched, where most of the development work lies ahead and which some day will compare favorably with the others in dollar volume. That is the field of electronics equipment for industry, commerce and other nonentertainment, nonmilitary uses. The figures are not too impressive now: For instance, about \$570,000,000 of sales in 1954 and an estimated \$640,000,000 in 1955. But, by 1958-60, we anticipate annual sales in the industrial-commercial field will be running at the approximate rate of \$900,000,000 and by 1964 the sales figure should be around \$1,300,000,000 to \$1,400,000,000, a gain of 130% in 10 years.

When all the foregoing is lumped together, it shows that the sale of all electronic end products in 1954 totaled about \$4,300,000,000 and that this year the aggregate will be slightly higher. In another three years or so, over the 1958-60 period, we expect the end-product total to exceed \$5,700,000,000, an increase of 33%, and that by 1964 electronic end products totaling about \$7,400,000,000 will be sold. That means an increase—within the decade—of more than 70%.

After considering all the end products manufactured in the electronics industry, there still remains a sizable business in the production and sale of components for repair, which amounted to a volume of \$670,000,000 last year and which will continue to grow as more and more end products are placed in use. These components include such things as tubes of various types, capacitors, transformers, resistors, speakers, dials, knobs, etc. It is estimated that repair parts sales this year will fall not far short of \$800,000,000, while in 1958-60 the total should reach \$1,250,000,000. By 1964, we expect this total to be in the neighborhood of \$2,300,000,000, an increase of nearly 250% in a decade.

These revenues exceeded \$2,000,000,000 in 1954 and will be on approximately the same level in 1955. By 1958-60, "markup" is expected to pass \$2,800,000,000 and should rise to around \$4,200,000,000 in 1964. At the same time, repairmen's service charges are expected to show a gradual increase from \$925,000,000 this year to \$1,400,000,000 10 years from now.

To round out the picture of the electronics industry, we must consider the broadcasting end of the business from the point of view of revenue. Television and radio broadcasting revenue in 1954 amounted to about \$1,140,000,000 and shows a slight increase this year. It is predicted, however, that they should average around \$3,000,000,000 by 1958-60 and at the end of the 10-year period are expected to top \$5,000,000,000.

Thus we see that from the standpoint of sales and revenues, the electronics industry is today virtually a \$9,000,000,000 industry. In the three-year period, 1958-60, total sales will come close to \$14,000,000,000 a year. And, 10 years from now, in 1964, we are positive we will be justified in calling electronics an industry with sales and revenues totaling over \$20,000,000,000 a year. **END**

## THE ORIGINAL

# FIL-CHECK

## \$3.25 Dealer's Net.

COMPLETE WITH LEADS

The only COMPLETE Pocket size Triple Check Instrument. A "Must" for every Serviceman's Bench and Kit!

- CHECKS ALL SERIES-HEATER FILAMENTS INCLUDING ALL RECTIFIERS
- CHECKS PICTURE TUBE
- CHECKS ANY CIRCUIT FOR CONTINUITY

Guaranteed unconditionally to give satisfactory service!

SOLD BY LEADING JOBBERS OR WRITE TO



**Instruments for Service Inc.**

380 WOODCLEFT AVENUE FREEPORT LONG ISLAND N. Y.



# technical Literature

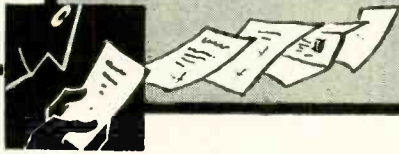

## WIRE CATALOG

*Catalog 105* covers a complete line of electrical wire, cord sets, television wire and cable and wire accessories in 36 pages.

*Columbia Wire & Supply Co., 2850 Irving Park Rd., Chicago 18, Ill.*

## INDUSTRIAL SOUND

*How RCA Sound in Industry Gets Things Done (Form 3R2478)* is a 12-page brochure describing and picturing a number of sound applications and RCA microphones, amplifiers, control cabinets and speakers.

*Engineering Products Div., Bldg. 15-1, Radio Corp. of America, Camden, N. J.*

## SMALL MOTOR SWITCHES

*Publication EC-79*, a 14-page catalog, describes Cutler-Hammer's line of toggle, rotary, door-operated, push-button, automotive, aircraft and miscellaneous switches.

*Cutler-Hammer, Inc., Milwaukee 1, Wis.*

Any or all of these catalogs, bulletins, or periodicals are available to you on request direct to the manufacturers, whose addresses are listed at the end of each item. Use your letterhead—do not use postcards. To facilitate identification, mention the issue and page of RADIO-ELECTRONICS on which the item appears.

UNLESS OTHERWISE STATED, ALL ITEMS ARE GRATIS. ALL LITERATURE OFFERS ARE VOID AFTER SIX MONTHS.

## TRANSFORMERS

Audio transformers for tubes and transistors, including miniature, sub-miniature and microminiature, as well as filament, scope, power and vibrator and special transformers; filter reactors, etc. are described in a 12-page catalog.

*Microtran Co., 84-11 Rockaway Beach Blvd., Rockaway Beach, N. Y.*

## CLAROSTAT CONTROLS

*Catalog No. 55*, 28 pages, describes Clarostat's complete line from attenuators to wire-wound controls. Dimensioned drawings, complete technical data, basing diagrams of wire-wound ballast resistors and miscellaneous information are provided.

*Clarostat Mfg. Co., Inc., Dover, N. H.*

## INTERFERENCE ELIMINATION

*Suppressing Radio Interference with Metex Electronic Weatherstrip and R.F. Gaskets* is the title of a 16-page brochure that discusses practical and

effective methods of r.f. shielding, using a special knitted braid which makes joints "r.f.-tight."

*Electronics Dept. Metal Textile Corp., Roselle, N. J. Attn.: G. P. Schreiber.*

## ANTENNA CATALOGS

Three catalogs carry information on the RMS line of TV antennas and accessories. *Catalog 55B* is a 29-page annual catalog of all RMS antennas, completely indexed and bound in 2-color cover. *Catalog 55K* describes the company's line of indoor antennas, and *Catalog 55W* is a chart highlighting a number of antennas and accessories. Intended for use as a wall chart, it is printed in three colors.

*Radio Merchandise Sales Inc., 2016 Bronzdale Ave., New York 62, N. Y. Attn.: Clifford Shearer.*

## ELECTRO-VOICE CATALOG

*Condensed Catalog No. 123* describes the company's full line of microphones for professional, amateur and special use, E-V speakers, enclosures and high-fidelity cartridges. Included is information on the Circlotron amplifier, the Compound Diffraction projector and the RME line of communications products.

*Electro-Voice, Inc., Buchanan, Mich.*

## HIGH FIDELITY

Data on speaker enclosures, coaxial and full-range loud-speakers, speaker systems, horns, networks and theatre installations is contained in *Catalog 55*. It is made up of five separate looseleaf sections in a cover with folded ends that form a pocket.

*Stephens Mfg. Corp., 8538 Warner Dr., Culver City, Calif.*

## SPEAKER SYSTEM

Four-page brochure describes the Villchur speaker system. It includes a brief description of the acoustic suspension principle, performance curves on both frequency response and harmonic distortion, model numbers and prices.

*Acoustic Research, Inc., 23 Mt. Auburn St., Cambridge 38, Mass. END*

## CORRECTION

Several readers have pointed out that there is no a.v.c. circuit in the *Midgetape* pocket tape recorder whose diagram appears on page 37 of the June issue. The manufacturer's engineers inform us that the first hundred or so Midgetapes produced had a.v.c., but this feature was discontinued in later production.

## YOU CAN Make More Money WITH AN F.C.C. COMMERCIAL OPERATOR LICENSE!

Greater ability means more pay. An F.C.C. commercial operator license is recognized as proof of technical ability and is required for many high paying jobs in radio, television, and industrial electronics. Add theoretical knowledge and an F.C.C. License to your practical experience, and make more money.

## CORRESPONDENCE OR RESIDENCE TRAINING

Grantham School of Electronics specializes in F.C.C. license training. The Grantham F.C.C. License Course is offered by correspondence and in residence. Either way, you are completely prepared, in every detail, to obtain the particular class of F.C.C. license you want. Our training includes constant practice with F.C.C.-type tests.

Regularly scheduled resident classes are held in Washington, D. C. and Hollywood, Calif. Correspondence courses are conducted from Washington. Write or phone for our free booklet with complete details.

## GRANTHAM School of Electronics

Dept. 101-8B

737 11th St. NW 5910 Sunset Blvd.  
Washington, D.C. or Hollywood 28, Calif.

(Phone: STerling 3-3614) (Phone: HOLlywood 2-1411)

## PERMO'S PROFIT EXTRAS



—help  
fill out  
your wallet

PERMO  
*Phono Needles*  
PERMO PERMO, INC.  
Chicago 26, Illinois

**INTRODUCING Stanley's Sensational Coupon Offer!**

For every dollar you spend for parts or tubes you'll receive a coupon redeemable for FREE gifts! These gifts include electrical appliances, etc. Use them or sell them over the counter.

# SAVE UP TO 90% OFF LIST PRICES ON PARTS & TUBES

Standard Brands and National Brands!

- All tubes individually boxed
- All tubes RTMA guaranteed for full year
- Same day service

TYPE	PRICE	TYPE	PRICE	TYPE	PRICE	TYPE	PRICE
024	.45	6AL7GT	.70	6SA7GT	.50	12SH7	.47
1B3GT	.79	6AS5	.50	6SC7	.50	12SJ7GT	.50
1L3	.56	6AS6	2.00	6SS7	.43	12SK7	.50
1L6	.60	6AS7G	2.25	6SH7	.45	12SL7GT	.69
1LA4	.66	6AT6	.40	6S17GT	.45	12SN7GT	.60
1LB1	.66	6AU5GT	.70	6SK7	.50	12SQ7GT	.44
1LC6	.66	6AU6	.46	6SL7GT	.70	14A5	.59
1LD5	.66	6AV5GT	.85	6SN7GT	.60	14A7	.45
1LE3	.66	6AX5GT	.59	6SN7GT	.44	14B6	.40
1LG5	.66	6B4G	.90	6V6GT	.48	14Q7	.52
1LH4	.66	6BA6	.49	6W4GT	.40	15BG6G	1.18
1LN5	.49	6BC5	.59	6W6	.60	19J6	.66
1NSGT	.55	6BE6	.50	6W6GT	.56	19T8	.70
1R4	.66	6BG6G	1.18	6X4	.35	25A7GT	1.50
1R5	.67	6BH6	.61	6X5	.39	25AV5GT	.80
1S4	.65	6BJ6	.49	6X5GT	.35	25B6G	.98
1S5	.65	6BK5	.70	6X8	.75	25B6G	.98
1T4	.65	6BK7A	.78	6Y6G	.63	25BQ6GT	.90
1U5	.50	6BN6	.74	7A4-XXL	.55	25Y5	.45
1V	.57	6BL7GT	.77	7A5	.55	25Z5	.38
1X2A	.79	6BQ6GT	.88	7A6	.47	25Z6GT	.42
2D2I	1.00	6BQ7A	.80	7A7	.46	35A5	.48
2V3G	.80	6BZ7	.90	7A8	.45	35B5	.52
2X2A	1.00	6BY5G	.60	7B5	.41	35C5	.51
3D6	.45	6C4	.39	7B7	.43	35L6GT	.48
3L4	.80	6C5	.36	7B8	.47	35W4	.39
3Q4	.62	6C6	.50	7C4	.40	35Y4	.40
3Q5GT	.63	6C6B	.55	7C5	.44	35Z3	.41
3V4	.65	6CD6G	1.18	7C6	.45	35Z6GT	.39
5T4	.70	6D6	.50	7F8	.35	50B5	.52
5U4G	.49	6E5	.46	7Y4	.46	50C5	.51
5V4G	.71	6F6	.40	12A T6	.68	50L6	.48
5Y3GT	.39	6H6GT	.40	12A U6	.46	50L6GT	.45
5Y4G	.43	6I4	2.00	12A U7	.60	75	.44
5Z3	.47	6J5GT	.40	12A V6	.46	77	.39
5Z4	.54	6J6	.49	12A X7	.90	80	.35
6A7	.59	6J7	.45	12A X7	.90	80	.35
6A8	.59	6K7	.40	12A Y7	.90	80	.35
6AB4	.48	6K6GT	.39	12BA6	.48	83V	.60
6AF4	.80	6L7	.44	12B4	.70	117L7GT	2.00
6AG5	.56	6N7	.61	12BE6	.50	117N7GT	2.00
6AH6	.80	6Q7	.45	12BH7	.70	117P7GT	2.00
6AK5	.80	6S4	.48	12BY7	.68	117Z3	.37
6AL5	.44	6S7G	.47	12SA7	.52	117Z6GT	.65

**SPECIALS TO OCT. 1st**

1A4P 12Z3  
1E7GT 24A  
IF4 26  
IG6 27  
IH4 954  
7E5 1619  
10Y 39/44

**19¢ EACH**

Special Purpose Transmitting and Cathode Ray TUBES

**PARTS SPECIALS**

Picture Tube BRIGHTENER  
Lots of 3 \$1.19

4" PM SPEAKER  
With Matching Output Transformer  
Alnico 5 magnet. Output transformer matches SOL6, etc. \$1.57

21" TV SET TABLE MODEL  
Reg. \$149.95  
**\$115.00**

AC-DC SUPERHET JEWEL 5-TUBE RADIO  
Terrific buy! Special Stanley price!  
Reg. list price \$22.95!  
**\$14.95**

Send for free premium catalogue... but better yet place your order with Stanley NOW. Start collecting these valuable coupons!

70° COSINE YOKE  
Popular TV deflection yoke. New cosine type for anti-anastigmatic focusing. Complete with leads.  
**\$2.99** ea.  
List \$10.30!

CERAMIC KIT  
Assortment of 50 ceramic condensers. Popular sizes. List price \$10.  
Lots of 5 **\$1.89** ea.

FREE with every \$25 or more order! 5-Pc. Sylvania Repair Kit. Value \$4.95. Includes: flashlight head, Philips screwdriver, flat head screwdriver, alignment tool, polystyrene case.

Our tubes come from such surplus sources as gov't agencies, receiver mfgs., etc. Most are new, balance from gov't and other equipment.

**TERMS:** 25% deposit required on all orders, balance COD. Orders under \$5.00, \$1 Service charge. Postage paid in USA on all orders accompanied by full remittance. All unused money refunded with order.

**SEND FOR PARTS AND TUBE LISTING**

Dept. RE-9 Gregory 1-2498

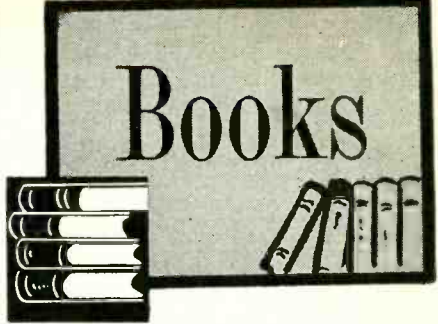

## Books

**ELECTRONIC CIRCUITS**, by Thomas L. Martin, Jr. Prentice-Hall, Inc., 70 5th Ave., New York, N. Y. 5 1/2 x 8 1/2 inches, 707 pages. \$12.

Intended for college students, engineers and physicists, this book assumes knowledge of elementary calculus and electronics. Advanced mathematical methods are avoided but, as the author states, "it is unashamedly mathematical" and he feels "under no compulsion to apologize for this." He has done an excellent job in covering such a complex subject so clearly and completely.

The book has three parts. The introduction describes equivalent circuits and theory. Laplace transforms are introduced here to be used later in the book. The reader soon finds that these are not nearly as terrifying as they sound. The second part describes class-A circuits, for example; single and multistage tube amplifiers; transistors; feedback; etc. The last part includes chapters on switches, modulators, rectifiers, triggers, oscillators. A chapter on magnetic amplifiers also appears.

—IQ

**COYNE TECHNICAL DICTIONARY**. Published by Coyne Electrical School, Chicago. Distributed by Howard W. Sams & Co., Inc., 2201 E. 46th St., Indianapolis 5, Ind. 5 1/2 x 8 inches, 160 pages. \$2.

It is disconcerting for a beginner or student of electronics to encounter technical terms he does not understand, and it helps his morale if such words can be looked up and clarified immediately. This dictionary contains 4,000 technical terms used in radio, TV, electronics and radar. They are explained clearly and completely. We noted that the latest color TV terms are well represented.

Naturally a book this size cannot include every possible word used in electronics. Superheterodyne is included but not superregeneration; tube but not transistor; Geissler tube but not Geiger counter; silicon but not germanium; carrier but not sideband. There are two and a half pages of terms beginning with "magnetic" but no sign of magnetic recording.

Much handy reference data appears at the end of the book. There are 45 pages of wire tables, transistor symbols, TV tube characteristics (up to 30-inch) and various charts.

**PRACTICAL ELECTROACOUSTICS**, by Michael Reggiger. Chemical Publishing Co., Inc., 212 5th Ave., New York, N. Y. 5 3/4 x 9 inches, 271 pages. \$10.

This is an advanced text for sound

**ANOTHER HUDSON HI-FI PRICE SENSATION!**

FABULOUS **FAIRCHILD** MODEL 215A MAGNETIC CARTRIDGE With DIAMOND Stylus

While They Last!

215A Cartridge	Regular Price \$37.50	HUDSON'S PRICE \$21.95
826 Transformer	8.75	2.95

**HUDSON'S PRICE For BOTH! \$24.90**

- Fits Most Pickups
- For 33-1/3 and 45 R.P.M.

Made by FAIRCHILD, manufacturers of the finest, highest priced audio equipment—this magnetic cartridge is recognized by Hi-Fi fans as a superb performer — and at Hudson's Terrific Low price, it's an outstanding buy — superior to any cartridge anywhere near this price in today's market.

Used with Fairchild 826 matching plug-in transformer, this superior cartridge can be used as a replacement for the G.E., Pickering, Audak, etc., giving higher quality performance at a low price. Single diamond stylus (which extends record life) has 1.0 mil diamond needle, for 33 and 45 RPM Long Playing Records. Standard mounting, fits most Record Changers and pickups without alteration. Simple mounting instructions included.

Here's your chance to convert your record changer or player to truly hi-fidelity reproduction — at less than half normal cost for this superb magnetic cartridge, with matching transformer — but Hurry! Our quantities are limited! Dept. RE-9

**Hudson** All Hi-Fi Accessories in Stock — Easy Terms Hi-Fi Trade-Ins

Adjoining Radio City 48 W. 48th St. Circle 6-4060  
Downtown N.Y.C. 212 Fulton St. New York 7, N. Y. Circle 6-4060  
In New Jersey 35 William St. Newark 2, N. J. Market 4-5154

**Joe Serviceman says:**

**"You can't get somethin' for nothin', especially Quality and Reliability"**

**QUIETROLE**  
TRADE MARK REG. U.S. PAT. OFF.

the original lubricant and cleaner for quieting noisy controls and switches, costs little more than the cheapest imitations, but the name assures you are getting the best.

**INSIST ON QUIETROLE**

THE CHOICE OF BETTER SERVICEMEN "EVERYWHERE"

manufactured by **QUIETROLE COMPANY**  
Spartanburg, South Carolina



**INTRODUCING YOUR NEW PROFIT MAKER**

**SAVE SERVICE TIME  
SELL MORE TUBES**

**MODEL GCT-5**

**SECO**  
GRID CIRCUIT  
**TUBE TESTER**

**\$29.95** Slightly higher West

Now quickly and accurately detect "positive grid" conditions in amplifier tubes used in circuits employing a high value of grid return resistance. EXCLUSIVE!



**"HARD TO FIND" TV TUBE FAULTS LOCATED FAST!**

- Poor picture contrast
- Grainy picture
- Twisting, bending or pulling of the picture
- AGC, RF, IF and Sync. Group tube faults
- Vertical jitter or bounce
- Sync. Buzz in the sound
- Any or all symptoms caused by sync. pulse compression.

Stop guessing and substitution checking, test and sell tubes with conviction on the first call, avoid embarrassing and costly callbacks.

Filament Selector Switch accommodates all the latest tubes for TV and INDUSTRIAL uses.

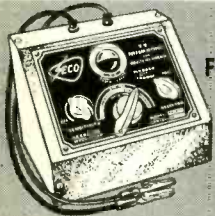

**Another Seco Exclusive!**  
**FLY BACK INTERVAL & INDUCTANCE ANALYZER**

Checks horizontal circuits without disconnecting!

For specialized applications to meet your specific need, contact:

**SECO MFG. CO.**  
5015 Penn. Ave. So.  
Minneapolis, Minn.

BOOKS (Continued)

technicians and engineers. Advanced hi-fi fans will find useful information also if they like theory and math.

The beginning chapters cover theory and characteristics of mikes and speakers. Next comes information on cross-over networks and attenuators. A chapter on magnetic structures leads later to magnetic recording. There is nothing on amplifiers, but one chapter describes specifications of PA systems for churches, schools, hospitals, etc. The Hollywood Bowl system is chosen as an example of an outdoor installation.

One chapter gives suggestions for improving studio and home acoustics.

Only tape recording is covered here. The effects of various sizes and shapes of heads are shown, together with the variations due to bias, etc.

**TRANSISTOR APPLICATIONS**, published by Raytheon. Distributed by local Raytheon tube suppliers, or direct from Dept. P-7, Raytheon Mfg. Co., Tube Operations, 55 Chapel St., Newton 58, Mass. 8 x 11 inches, 116 pages. 50¢.

Because of their small size and the simple circuits in which they operate, transistors are a "natural" for home experimenting. A corner of the kitchen table is ample space to build useful instruments and carry on interesting work. Thus, many amateurs and experimenters have done work with transistors and have developed practical devices using them. This book contains over 50 articles on actual transistorized equipment, written by experimenters for experimenters. Many are reprinted from leading radio magazines (including RADIO-ELECTRONICS).

These articles include timers, volt-meters, i.f. oscillators, modulators, a.f. filters, ham radio aids, and, of course, straight audio amplifiers. Each article contains detailed instructions and descriptions. The book should help and inspire experienced technicians as well as beginners.—IQ

**ELEMENTS OF TELEVISION SERVICING**, for Bench and Field, by Abraham Marcus and Samuel E. Gendler, Prentice-Hall, Inc., 70 5th Ave., New York, N. Y. 587 pages. \$7.35.

The field man will welcome the first servicing book to recognize him as an essential part of the servicing setup. For the term "bench and field" in the title means what it says. Section II of the book, running from page 59 to 212 and comprising Chapters 3, 4 and 5, is devoted to field servicing.

The next nine chapters deal with bench servicing of black-and-white receivers; three chapters on color TV and its service problems follow. Illustrations for the color servicing section are in full color. Two chapters in Section I describe the fundamentals of color television and reception, treating the TV signal from the viewpoint of the transmitter and receiver and describing the features and functions of the TV receiver.—FS

**AUDEL'S TV TELLS HOW TO ANSWER RADIO T.V. QUESTIONS SERVICE LIBRARY**

HERE IS LATE INFORMATION IN A HANDY FORM FOR TELEVISION AND RADIO REPAIRMEN, SERVICEMEN AND STUDENTS



**\$6** COMPLETE

**2 VOLUMES**

**AUDEL'S T.V. RADIO SERVICE LIBRARY**—Highly Endorsed—Over 1500 Pages—1048 Illustrations & Diagrams. 1001 Important Facts & Figures on Modern Television, Radio, Electronic Devices at your finger ends.

**INCLUDES TRANSISTORS** & Transistor Circuits, Record Changers, Rectifiers, P.A. Systems, Tape Recorders, Phonograph Pick-ups, F.M., Auto Radio; Radio Compass, Short Wave, Radar, etc.

**ASK TO SEE IT! IT WILL PAY TO KNOW!**  
The Basic Principles—Construction—Installation—Operation—Repairs—Trouble Shooting. Shows How to get Sharp, Clear T.V. Pictures. Install Aerials—How to Test. Explains Color Systems, Methods of Conversion, Terms, etc. Includes Ultra High Frequency—Valuable for Quick Ready Reference and Home Study.

Get this Information for Yourself.

**7 DAY TEST—PAY ONLY \$1 A Month**

**MAIL ORDER**  
AUDEL Publishers, 49 W. 23 St., N.Y. 10, N.Y.  
Mail AUDEL'S T.V. RADIO SERVICE LIBRARY (2 Volumes) \$6 on 7 days free trial. If O. K. I will remit \$1 in 7 days and \$1 monthly until \$6 is paid. Otherwise I will return them.

Name \_\_\_\_\_  
Address \_\_\_\_\_  
Occupation \_\_\_\_\_  
Employed by \_\_\_\_\_ **RE**

**SALE OF SALES**

**LOUDSPEAKERS  
TRANSFORMERS  
COILS—MIKES  
STABILIZERS—PLUGS  
VIBRATORS—ANTENNAE**

**WITH FAMOUS BRAND NAMES**

**CRESCENT THORDARSON and many other well-known brands.**

**UNMATCHED PRICES**

**LOUDSPEAKERS ..\$ .68 up**  
**OUTPUTS ..... .25 up**  
**MIKES ..... 4.95 up**  
**VIBRATORS .... 1.21 up**  
**ANTENNAE ..... .45 up**

**Send for Itemized List & be on our mailing list.**

**SCHEEL INTERNATIONAL, INC.**  
4237 N. Lincoln Ave.  
Chicago 18, Ill.  
"OUR 22ND YEAR IN BUSINESS"

# STAN-BURN E-D-A-R-K-E

## CATHODE RAY TUBE SPECIALS

ONE YEAR GUARANTEE

G.E.		STAN-BURN	
10BP4A	\$14.95	10BP4	\$10.20
10FP4A	21.10	12LP4	11.90
12KP4A	24.43	12LP4A	13.95
12LP4A	18.75	12QP4	11.90
12QP4A #1014		12JP4	11.90
Dumont	25.10	12UP4	14.50
12UP4B	34.25	14CP4	15.60
14CP4	22.50	15DP4	17.50
15DP4 #1014		16KP4	17.50
Dumont	26.75	16DP4 or A	17.50
16AP4A	34.25	16JP4 or A	17.50
16DP4A (N.U.)	25.25	16CP4 or A	17.50
16KP4 A or B	33.25	16FP4	17.50
16KP4 16RP4	24.20	16WP4	17.50
16KP4A		18AP4	17.50
(Aluminum)	28.35	18AP4A	23.00
16JP4A (N.U.)	27.95	16EP4	19.00
16LP4A	28.90	16EP4A	23.50
16WP4A	27.50	18GP4 or A	21.00
16GP4B	33.95	17BP4	18.90
17BP4A	27.50	17CP4A	21.60
17BP4B	29.75	17GP4B	22.60
17CP4	29.95	19FP4	23.00
17CP4B		19AP4	23.90
(Aluminum)	38.50	19AP4A	24.90
19AP4A	39.75	20CP4	23.95
20CP4	30.00	21EP4	25.50
20LP4	37.50	21AP4	26.50
21AP4	39.75	24AP4	49.00
21EP4	31.80		
21EP4A	36.35		
24AP4A	89.75		

Prices Subject to Change Without Notice

AUTHORIZED DISTRIBUTORS for General Electric, Kenrad, Tung-Sol, Mallcrafters, De Wald, Techmaster, Automatic and General Motors.

## PORTABLE RADIOS

JEWEL—Battery only.....	\$12.99 net
Case for same.....	1.50
Batteries.....	1.95
CABANA 3 way portable. 5 tube.....	\$16.75
Batteries.....	2.50
JEWEL 5 tube Suber Het—Red. Ivory. Walnut and Ebony.....	12.50
with Clock—5 tube AC-DC	
Ivory.....	\$15.95
Walnut.....	\$15.45

## RECORD PLAYERS

Manual 3 speed record player—single needle.....	\$14.50
Manual 3 speed with flip-over cartridge.....	\$16.95
Automatic 3 speed with VM changer.....	\$37.50

## PENTRON TAPE RECORDERS

Model CT1.....	\$81.50
Model TR4.....	119.00
Model HT225.....	140.00

(catalogs on request)

*55 FORD, PLYMOUTH, CHEV. Automatic Radio Manual Push Button.....	\$41.97
	45.47
630 ANSLEY 29 tube Chassis.....	\$115.00

TURNER AU Phono cartridge—Universal replacement.....

	\$1.59 ea. 6 @ \$1.49 ea.
VM CHANGER—with Ronette flip-over cartridge. BRAND NEW—Hi-Fi original cartons.....	\$21.49

We invite export inquiries and offers. Our export department will give special attention to expediting foreign orders at minimum commissions. We are authorized distributors for United Motors, all Delco and Gen. Motors Auto Radio parts in stock.

We also carry a complete line of popular makes of Radio Tubes at 50/10 discount. Also many other special purpose and transmitting types, and all electronic parts and equipment at lowest prices. Send us a list of your requirements for prompt quotations. Terms: 20% with order. Balance C.O.D. All prices F.O.B. NEW YORK Warehouse. Minimum order \$5.00. Write for our latest price list and Hi-Fi catalog to Dept. RE-9.

**STAN-BURN** RADIO and ELECTRONICS CO.  
1697 BROADWAY • NEW YORK 19, N. Y.

## BOOKS

(Continued)

**PROBES**, by Bruno Zucconi and Martin Clifford. Gernsback Publications, Inc., 25 W. Broadway, New York 7, N. Y. 5½ x 8½ inches, 224 pages. Soft-cover edition \$2.50, hard cover \$4.

Sweeping aside the veil of mystery so long associated with this subject, a long step has been taken by the authors in exposing the probe in its every practical form. Taking nothing for granted, the text runs the gamut from the simple crystal detector as it demodulates AM signals to the Chromatic probe and its color TV applications.

The book discusses, individually, the many probe types applicable to electronics, while simultaneously integrating them so as to maintain a very interesting continuity. The probes discussed, chapter by chapter, include the simple crystal demodulator, voltage-doubler, balanced, low-capacitance, high-voltage, isolation and direct, specialized, Chromatic and vacuum-tube types.

The probes themselves form only part of the story. Each probe discussion is expanded to include the many applications, advantages and disadvantages of that particular unit with regard to various equipment. In addition, each probe is put to work. Radio and television waveforms and circuitry are plentiful, and the authors, ever mindful of the problems of the service technician, suggest numerous techniques, do's and don't's. The chapter on specialized probes covers the less common and infrequently used types.—JK

**THE NEW HIGH-FIDELITY HANDBOOK**, by Irving Greene and James R. Radcliffe. Crown Publishers, Inc., 419 4th Ave., New York, N. Y. 193 pages. \$4.95.

Described as a practical guide for the assembly, installation, maintenance and enjoyment of high-fidelity music systems, this is one of the few books written by people who know the subject and yet express the viewpoint of the lay listener to good music. The result is that the weight of the material sometimes falls in unexpected places. For example, the where and how of the installation process may well be the most important feature of the layman's adventure in high fidelity—and it gets corresponding recognition. Fifty pages are devoted to the subject, broken down into planning the installation, problems of fashion and interior decoration, and high-fidelity furniture.

The beginner is given—in the first 70 pages of the book—an idea of what high fidelity is, what components produce it and how they work. The advanced enthusiast will be interested in the chapter devoted to plans of speaker enclosures, as well as the material on constructing crossover networks in the appendix.

There are two introductions: "Deems Taylor on High Fidelity" and "Harold C. Schonberg on The High-Fidelity Record."—FS

END

# CASH IN ON TV COLOR!

USE 10 DAYS FREE!

## "COLOR TV SERVICING"

by Walter H. Buchsbaum, author of "TV Servicing"

At Last! Your complete guide to color! Just in time for you to get the jump on competition and cash in on the color boom! Here are the latest circuits, all in dozens of easy-to-read diagrams... newest methods, laid out step by step. Latest 21" color tube data... short-cuts on how to fix every color defect fast, from RF-IF alignment to color decoder adjustment... installing tricks... new ways to save time, make money on color jobs... tested tips for matrix alignment... practical techniques you can adapt from monochrome servicing... and so much more there's no space to tell you here... PLUS 140 clear diagrams, schematics, charts and 24 FULL-COLOR PHOTOS to show you every color defect and how to cure it easily!

**CONTENTS INCLUDE:** Decoder circuits... Details of G-E, RCA, Dumont, etc., color sets & pic. tubes... 5 new installation steps... 8 performance checks... 5 ways to align IF... 4 steps in aligning bandpass... 4 ways to align chroma channel... 8 matrix alignments... 15 color-sync. steps... 7 color purity adjustments... 7 convergence checks... 8 monochrome defects and how to cure... 22 ways to cure "no color" problems... 12 "wrong color" problems & how to fix fast... 4 "impossible" defects & how to cure them.

—MAIL NOW FOR 10-DAY FREE TRIAL—

Prentice-Hall, Inc., Dept. 5744-L1  
Englewood Cliffs, New Jersey  
Rush me "COLOR TV SERVICING" for 10-Day's FREE USE. At the end of that time I'll either return book and owe nothing or send you \$2.35 first payment and then \$2 a month for 2 months until full price of \$6.35. Plus postage, is paid.

Name \_\_\_\_\_  
Address \_\_\_\_\_  
City \_\_\_\_\_ Zone \_\_\_\_\_ State \_\_\_\_\_  
Save Postage! We'll pay it if you send \$6.35 now.

## NEW TV BUSINESS

NO CALLBACKS \$1.00 in  
HEAVY SALARIES The Mall  
TRUCKS TO KEEP  
Will Bring Complete Booklet  
TELECOM, Box 926, Los Gatos, Cal.

# Easier, Faster

INSTALLATIONS WITH THE

# New LA-75 ARRESTER

LIST  
\$1.35  
Pat.  
Pending

ANOTHER  
**Radjon**

FIRST

ANOTHER  
**Radjon**

FIRST

ANOTHER  
**Radjon**

FIRST

New twin-lead grip speeds connections.

Flame-proof, waterproof. All hardware included. UL Approved indoors or out. Carry one arrester to fit all needs. Ask your distributor now.

**THE RADION CORP.**

1130 W. Wisconsin Ave.,  
Chicago 14, Ill.

# RADIO SCHOOL DIRECTORY

## RADIO-TV ELECTRONICS



CREI graduates in big demand. ECPD-Accredited Technical Institute Curriculum. New classes start monthly. Free placement service for grads. Courses: Radio Engineering, Broadcast or TV Engineering; TV, FM, AM Servicing; resident studies leading to "Associate in Applied Science" degree. Write for free catalog. Approved for vets.

**CAPITOL RADIO ENGINEERING INSTITUTE**  
Dept. RE, 3224 — 16th St., N.W., Washington 10, D.C.

**CODE SENDING RECEIVING SPEED**

Be a "key" man. Learn how to send and receive messages in code by telegraph and radio. Commerce needs thousands of men for jobs. Good pay, adventure, interesting work. Learn at home quickly through famous Candler System. Quality for Amateur or Commercial License. Write for FREE BOOK.

**CANDLER SYSTEM CO.**  
Dept. 3-K, Box 928, Denver 1, Colo., U.S.A.

**RCA INSTITUTES, INC.**

A service of Radio Corporation of America  
350 West 4th St., New York 14, N. Y.

**OFFERS COURSES IN ALL TECHNICAL PHASES OF RADIO, TELEVISION, ELECTRONICS**  
Approved for Veterans  
Write Dept. RE-55 for Catalog

**Get Your F.C.C. LICENSE Quickly!**

Guaranteed preparation, in a MINIMUM OF TIME, for F.C.C. commercial operator examinations. Our highly specialized training is available by correspondence, or in resident classes in

**WASHINGTON, D.C. and HOLLYWOOD, CALIF.**

Write for our free booklet with complete details.

**GRANTHAM School of Electronics**  
Dept. 301-P, 737 11th Street N.W., Washington 1, D.C.

**TV REPAIRMEN EARN TOP MONEY!**

IN JUST 12 MONTHS, COMPLETE TV SERVICE TRAINING, INCLUDING COLOR TV. Streamlined course gives you all essentials for a good job as service technician. Graduates in great demand; jobs are plentiful in this growing field. Other electronic courses in radio operation and maintenance. Day or evening classes. Opportunity for employment in local industry. Approved for Korean veterans.

Write for Catalog 111 Today

**INDIANAPOLIS ELECTRONIC SCHOOL**  
312 E. Washington, Indianapolis 4, Ind.

**TELEVISION**

**PREPARE FOR A GOOD JOB!**  
BROADCAST ENGINEER  
ELECTRONICS  
RADIO SERVICING

**Television Servicing**

(Approved for Veterans)  
SEND FOR FREE LITERATURE  
**BALTIMORE TECHNICAL INSTITUTE**  
1425 EUTAW PLACE, BALTIMORE 17, MD.

**GET INTO ELECTRONICS**

You can enter this uncrowded, interesting field. Defense expansion, new developments demand trained specialists. Study all phases radio & electronics theory and practice; TV; FM; broadcasting; servicing; aviation, marine, police radio. 18-month course. Graduates in demand by major companies. H.S. or equivalent required. Begin Jan., March, June, Sept. Campus life. Write for catalog.

**VALPARAISO TECHNICAL INSTITUTE**  
Dept. C Valparaiso, Ind.

**FINISH HIGH SCHOOL AT HOME!**

No classes to attend. Easy spare-time training covers big choice of subjects. Friendly instructors; standard texts. Full credit for previous schooling. Diploma awarded. Write now for FREE catalog!

**WAYNE SCHOOL Catalog HKE-1**  
2527 Sheffield Ave., Chicago 14, Illinois

**RADIO ENGINEERING DEGREE IN 27 MONTHS**

Intensive, specialized course including strong basis in mathematics and electrical engineering, advanced radio theory and design, television. Modern lab. Low tuition. Self-help opportunities. Also B.S. degree in 27 months in Aeronautical, Chemical, Civil, Electrical, and Mechanical Engineering. G.I. Gov't approved. Enter September, December, March, June. Catalog.

**INDIANA TECHNICAL COLLEGE**  
1595 E. Washington Blvd., Fort Wayne 2, Indiana

**MORE JOBS than graduates**

**Electronic Engineers**  
Excellent opportunity for professional growth and advancement.

Demand for our engineering graduates exceeds supply. Effective placement service. Study in this world-famed college established 1884. Quarters start September, January, March, June. Approved for Veterans.

**Bach. Sc. degree in 27 months**

Complete Radio Eng. course includes TV, UHF and FM. Also Mech., Civil, Elec., Chem., Aero. and Adm. Eng.; Bus. Adm., Acct. Small classes. Well-equipped labs. Modest costs. Prep. courses. Write Jean McCarthy, Director of Admissions, for Catalog, View Book and "Your Career" Book.

**TRI-STATE COLLEGE**  
2495 College Avenue, Angola, Indiana

**EARN MORE MONEY— BE A PROFESSIONAL TELEVISION SERVICE TECHNICIAN**

**GET DOWN-TO-EARTH PRACTICAL TV TRAINING WITH WTI EXPERTS FOR THE TOP PAYING \$5,000-\$10,000 PER YEAR JOBS.**

**UHF—COLOR—VHF**

Master the latest, up-to-the-minute TV and Color TV developments QUICKLY.

SEND FOR FREE BOOK TODAY!

WESTERN TV offers real experience on live equipment in our BIG SHOPS AND LABORATORIES in the shortest practical time under expert instructors. Graduates are in big demand because they have the "field experience" necessary for immediate "bench" or supervisory positions. You learn every phase of Radio and TV servicing (AM, FM, VHF, UHF). WTI men win fast promotion... can demand better pay... develop highly profitable businesses of their own with the latest and most PRACTICAL PERSONALIZED TRAINING BEHIND THEM. You concentrate all your time on being a PROFESSIONAL TV SERVICE TECHNICIAN — non-essential math and engineering theory omitted. YOU CAN EARN WHILE YOU LEARN. Special Finance Plan.

APPROVED FOR VETERANS. Find out how you can get into the TOP PAY GROUP — Send for this fact-packed book NOW!

**WESTERN TELEVISION INSTITUTE**

America's Leading Television Servicing School

SEND FOR FREE BOOK TODAY!

WESTERN TV offers real experience on live equipment in our BIG SHOPS AND LABORATORIES in the shortest practical time under expert instructors. Graduates are in big demand because they have the "field experience" necessary for immediate "bench" or supervisory positions. You learn every phase of Radio and TV servicing (AM, FM, VHF, UHF). WTI men win fast promotion... can demand better pay... develop highly profitable businesses of their own with the latest and most PRACTICAL PERSONALIZED TRAINING BEHIND THEM. You concentrate all your time on being a PROFESSIONAL TV SERVICE TECHNICIAN — non-essential math and engineering theory omitted. YOU CAN EARN WHILE YOU LEARN. Special Finance Plan.

APPROVED FOR VETERANS. Find out how you can get into the TOP PAY GROUP — Send for this fact-packed book NOW!

Western Television Institute Dept. E-9-55  
341 W. 18th St., Los Angeles 15, Calif.

Without obligation, please send FREE fully illustrated booklet. (No salesman will call.)

NAME \_\_\_\_\_ AGE \_\_\_\_\_  
ADDRESS \_\_\_\_\_  
CITY \_\_\_\_\_ ZONE \_\_\_\_\_ STATE \_\_\_\_\_

## Become an ELECTRICAL ENGINEER

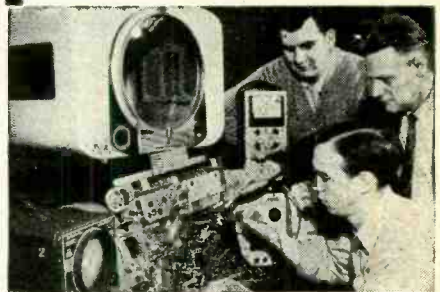

**Major in Electronics or Power BS Degree in 36 months**

Prepare now for a career as an electrical engineer or engineering technician — and take advantage of the many opportunities in these expanding fields.

You can save a year by optional year 'round study. Previous military, academic, or practical training may be evaluated for advanced credit.

### Enter Radio and Television — courses 12 to 18 months

You can be a radio technician in 12 months. In an additional 6-months you can become a radio-television technician with Associate in Applied Science degree. Color television instruction is included in this program.

These technician courses may form the first third of the program leading to a degree in Electrical Engineering. Twenty-one subjects in electronics, electronic engineering and electronic design are included in these courses. Courses also offered: radio-television service (12 mos.); electrical service (6 mos.); general preparatory (3 mos.).

Terms — September, January, April, July

Faculty of specialists. 50,000 former students—annual enrolment from 48 states, 23 foreign countries. Non-profit institution. 52nd year. Courses approved for veterans. Residence courses only.

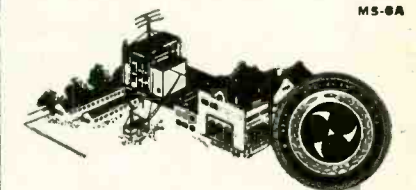

## MILWAUKEE SCHOOL OF ENGINEERING

MILWAUKEE SCHOOL OF ENGINEERING  
Dept. RE-955, 1025 N. Milwaukee Street  
Milwaukee 1, Wisconsin

Send FREE illustrated booklets

Career in Electrical Engineering.  
 Career in Radio-Television.

I am interested in \_\_\_\_\_ (name of course)

Name \_\_\_\_\_ Age \_\_\_\_\_

Address \_\_\_\_\_

City \_\_\_\_\_ Zone \_\_\_\_\_ State \_\_\_\_\_

If veteran, indicate date of discharge \_\_\_\_\_

**NOW!**

Step ahead faster  
as an  
**INDUSTRIAL  
ELECTRONICS  
TECHNICIAN**



Turn your experience into a  
big, new better-paying career!

Day by day industrial plants are adding more electronic devices—for sorting, counting, checking almost any control job you can name. Cash in on industry's great need for men who can keep these devices in top working order. Make more money, feel more secure, doing work that is second nature to you. With what you already know about electronics you have a long head start in a field just beginning to boom. GET INTO IT RIGHT NOW with the help of

**PRACTICAL INDUSTRIAL  
ELECTRONICS LIBRARY**

No long sessions on math or theory! These 4 practical volumes show you how to keep the plant's electronic equipment working . . . how to locate and correct tube and circuit troubles . . . how to install, service, and maintain even brand new equipment without being stamped by new circuits.

- 4 volumes (1390 pp., 1070 illus.); Clute's Electronics in Industry
- Miller's Maintenance Manual of Electronic Control
- Markus & Zeluff's Handbook of Industrial Electronics Circuits
- Henny & Fahnestock's Electron Tubes in Industry

**FREE TRIAL—EASY TERMS!**

McGraw-Hill Book Co. Att: H. W. Buhrow  
Industrial and Business Book Dept.  
321 W. 41st St., N.Y.C. 36

Send me the Practical Industrial Electronics Library for 10 days' examination on approval. In 10 days I will send \$2.50, then \$4.00 a month until \$22.50 is paid. (A saving of \$3.50 under the regular price of \$26.00.) Otherwise I will return books postpaid. (Print)

Name .....

Address .....

City .....

Company .....

Position .....

For price and terms outside U.S. write  
McGraw-Hill Int'l., N.Y.C. RE-9

**New Gernsback Books**

**RADIO-CONTROL HANDBOOK—**

No. 53

R/C expert Howard G. McEntee, W2SI, gives you all the necessary practice details on how to build R/C systems and mechanical components to control model planes, boats, etc. 192 Pages. 175 Illustrations.

**\$2.25**



**THE OSCILLOSCOPE—No. 52**



A practical book that tells you how to use the scope to best advantage in all types of servicing. Gives you tips on use and warns about pitfalls to avoid. 192 Pages. Over 100 illustrations.

**\$2.25**

**Gernsback Publications, Inc.**

Publishers of RADIO-ELECTRONICS

25 West Broadway New York, N.Y.

**ADVERTISING INDEX**

Radio-Electronics does not assume responsibility for any errors appearing in the index below.

Alliance Mfg. Co.	117
Allied Radio Corp.	15
American Microphone Co.	96
American Phone Corp.	132
Approved Electronics	129
Arkay Radio Kits, Inc.	136
Astron Corp.	23
Atlas Sound Corp.	148
Audel Publishers	163
B & K Mfg. Co.	151
Barjay Co.	124
Boli Telephone Labs.	26
Blomier-Tongue Lab.	98
Book-of-the-Month Club, Inc.	13
Brooks Radio & TV Corp.	127
CBS-Hytron	109
Cabinart	18
Capitol Radio Engineering Institute	103-104
Channel Master Corp.	17
Chicago Standard Transformer Co.	124
Cleveland Institute of Radio Electronics	132
Collins Audio Products	9
Concord Radio	125
Cornell-Dubilier Electric Corp.	30-31, 160
Coyne Electrical School	139, 149, 156
DeVry Technical Institute	7
Edie Electronics	158
Electro Products Labs.	152
Electro Voice, Inc.	G. Inside Back Cover
Electronic Instrument Co. (EICO)	32, 139
Electronic Measurements Corp.	133
Eric Resistor Corp.	152
E-Z Way Towers, Inc.	153
Fenton Company	141
Finney Co.	125
G. & H. Wood Products Co.	18
General Cement Manufacturing Co.	101
Grantham	161
Heath Co.	67-78
Hershel Radio	157
Hickert Electronics	146
Hudson Radio & TV	162
Hughes Research & Development Labs.	108
Indiana Technical College	144
Instructograph Co.	144
Instruments for Service, Inc.	148, 160
International Rectifier Corp.	16
Jensen Industries	148
Jones & Laughlin Steel Corp.	121
Keltner Mfg. Co.	155
Kuehne Manufacturing Co.	166
Lafayette Radio	167
La Pointe Electronics	131
Leotone Radio Corp.	159
McGraw-Hill Book Co.	166
Major Brand Tube Co.	167
Mallory, P. R. & Co.	123
Merit Coil & Transformer Co.	115
Mosley Electronics	112
Moss Electronics Distributing Co.	110-111
Musical Masterpiece Society	105
National Electronics of Cleveland	146
National Radio Institute	3, 19-20
National Schools	5
Newark Electric Co.	154
Newcomb Audio Prod. Co.	150
Nordic Radio Co.	155
Opportunity Adlets	156
Oxford Electric	130
PermaPower Co.	122
Pine Inc.	161
Permotlux Corp.	14
Phico Corporation	90-91
Pickering & Co., Inc.	12
Precision Appliance Co. Inc.	150
Prentice-Hall, Inc.	164
Progressive "Edu-Kits," Inc.	134
Pyramid Electric Co.	140
Quam-Nichols	144
Quetrol Co.	162
RCA Institutes, Inc.	11, 99, 135
Rad-Tel Tube Co.	159
Radiart Corp.	30-31
RCA Tube Div. (Radio Corporation of America)	82
Radio Receptor, Inc.	143

**RADIO SCHOOL DIRECTORY PAGE 165**

Baltimore Technical Institute	163
Candler System Co.	163
Capitol Radio Engineering Institute	163
Grantham School of Electronics	163
Indiana Technical College	97
Indianapolis Electronic School	163
Milwaukee School of Engineering	163
RCA Institutes, Inc.	164
Tri-State College	164
Valparaiso Technical Institute	164
Wayne School	164
Western Television Institute	164
Radio-Television Training Association	25
Radiom Corporation	104
Raytheon Manufacturing Co.	27
Reference Handbooks	157
Rek-O-Kut Co.	140
Rider, J. F., Publisher	142
Rinehart Books, Inc.	116, 146, 154
Rockbar Corp.	158
Rohn Manufacturing Co.	93
Sams, Howard W., & Co., Inc.	21, 24
Schedl International Inc.	163
Seco Manufacturing Inc.	163
Shure Brothers, Inc.	16
Simpson Electric Co.	163
Sprague Products Co.	28-29
Stanburn Radio & Electronics	164
Stanley Electronics Corp.	151
Supreme Publications	137
Sylvania Electric Products, Inc.	82-83, 89
Tab	168
Technical Appliance Co.	138
Telecom	164
Teleparts Co.	151
Telvac	146
Telrex Inc.	119
Trans-Aire Electronics, Inc.	151
Transvision Inc.	156
Trio Mfg. Co.	107
Tung-Sol Electric Co.	8
Turner	14
U. S. Electronic Research & Dev. Corp.	81
Universal Television School	151
Vig Avionics Corp.	157
Ward Products Corp.	114
Wayco, Inc.	95
Webster Electric Corp.	106
Weston Electrical Instrument Co.	22
Wholesale Radio Parts Co.	145
Winegard Co.	85-86
Zingo Electronics	155

**A TOWER OF  
STRENGTH**

- Safe in gales up to 80 m.p.h. without ugly, hazardous guy wires
- Free-standing to 50 feet high
- No rusting, ripping or weakened holes
- Big, safe, steel gird-around ties
- Easy installation and dismantling
- Sturdy, safe . . . on roof or ground
- Electro-plated with durable zinc for high lustre, permanent finish.

**Kuehne** \*

**TELEVISION TOWERS**

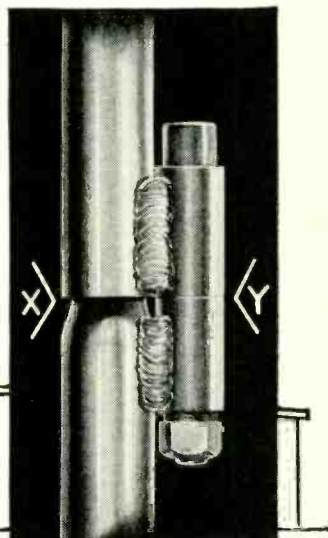

*Exclusive!* **LATERAL  
LOAD-BEARING JOINTS**  
No dangerous rust. Arrow "X" shows open-joint section. Moisture cannot get in tubing to cause interior rust.

No hazardous holes. Arrow "Y" shows lateral load bearers lifetime welded to side of each section leg with twin 1 1/8" fillets. Sections are bolted vertically. Bear 100% of load! No load on joints. No horizontal bolts to tear through. Nothing stronger or safer. Only Kuehne has it!

**KUEHNE MFG. CO.**

TV TOWER DIVISION  
MATTOON, ILLINOIS

\* Say "Kee Nee"

For catalog sheets, see your "Kee Nee" Man or write direct.

RADIO-ELECTRONICS

# LAFAYETTE'S SPECTACULAR MONEY SAVERS

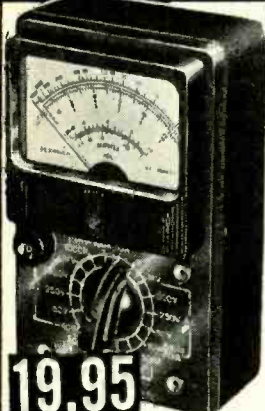

## HIGH SENSITIVITY AC-DC MULTITESTER

20,000 ohms per Volt

The new Lafayette High Sensitivity Multitester is a complete instrument (not a kit). Here is an instrument packed with every desirable feature found only in instruments costing twice as much. One of the most sensitive multitesters ever offered. 20,000 ohms per volt DC; 8,000 ohms AC, having a high sensitivity 45 microamps meter. Full scale AC-DC voltage ranges are 0-10V, 0-50V, 0-250V, 0-500V, 0-1,000V. DC current ranges 50 microamps, 2.5 ma, 25 ma, 250 ma. Resistance: 0-5K ohms, 0-50K ohms, 0-500K and 0-5 megohms. Decibel range: -20 +5 db; +5 +22 db (0 db-0.775V-600 ohms). Extreme versatility and accuracy. 1% precision resistors; 3" meter; beautiful plastic front, with metal bottom for ruggedness. Size: 3 1/2" x 5 1/2" x 2 1/2". Complete with batteries and leads. Shpg. Wt. 4 lbs.

RW-300 ..... NET 19.95  
In lots of 3 19.25

19.95

## NEW



## TRANSISTOR TYPE 2N107



\$1.25

## MAKE YOUR OWN PRINTED CIRCUIT NOTHING ELSE TO BUY!

Our Inexpensive Etched-Wire Kits Contain: Laminated Copper Boards (XXX-P); Printed Circuit Tube Sockets; Copper Etching Material and Instructions; Etch-resistant material for Circuit layouts; Eyelets and drill for connections; Scaled Layout Sheets for making your own or standard Printed Circuits. All Kits Are Supplied with Plastic Case



5001P—BASIC KIT  
Contains a complete assortment of materials needed to make a variety of etched wire Printed Circuits. Circuit Diagrams include Multimeter and 1-tube Receiver.

Only 3.75

5003P—SERVICEMAN & TECHNICIANS' KIT  
Contains three times the material of Kit 5001P with special Sockets, Connectors, and Double-faced Copper Board.

Only 9.75

5004P—PRODUCT DESIGNERS' KIT  
This special Kit enables the Manufacturer and Laboratory to make a pilot run of etched wire Printed Circuits with his own staff and facilities. Contains all the latest information, materials and methods for adapting your product to mass production techniques.

27.00

## WEBSTER • GARRARD • COLLARO 3-SPEED—HI-FI RECORD CHANGER

Now Lafayette makes it possible for you to save money on the three most popular makes of 3 speed Record changers.

**WEBCOR Diskchanger:** It's completely automatic, 33 1/3, 45 and 78 RPM, automatic shut off after last Record, balanced tone arm, etc. Size 13 1/2 x 12 x 8 1/4". Shpg. Wt. 16 lbs.

Stock No. PK-49—With Dual Turnover Cartridge..... 26.50  
Stock No. PK-46—With G.E. RPX 050 Triple Play Cartridge..... 29.50



**COLLARO, THE WORLD'S FINEST 3 SPEED INTERMIX CHANGER:** Collaro Model 3/532—3 speed Intermix changer designed and engineered to meet the most exacting requirements of the finest audio systems: While our stocks last. Shpg. Wt. 23 lbs. with G.E. RPX—050 Triple play cartridge.....Net 34.50  
With G.E. RPX—052A Triple play latest Golden Treasure cartridge with Diamond and Sapphire styli installed.....Net 44.95  
Collaro RC-54: Latest Collaro 3 speed Intermix less cartridge.....Net 47.77  
With G.E. RPX—050 Triple play cartridge.....Net 49.95  
With G.E. RPX—052A Triple play Golden Treasure cartridge with Diamond and Sapphire styli installed.....Net 59.95  
Garrard Model RC-80 3 speed Record changer less cartridge.....Net 48.51  
Model RC-80 with G.E. RPX—050 Triple play Cartridge.....Net 51.95  
Model RC-80 with G.E. RPX—052—A latest triple play Golden Treasure cartridge with Diamond and Sapphire styli installed.....Net 62.53

## TRANSISTOR PREAMP KIT HUMBLESS DISTORTIONLESS

To you the experimenter with the Lafayette transistor preamp kit you can now build a preamplifier in matter of hours at a cost considerably less than commercial vacuum tube preamps. Internal noise is essentially inaudible. Chassis only 3" x 4" x 1 1/2" in size including power supply — will supply 2000 hours of service, humless and virtually distortionless. Kit comes complete including 2 Raytheon transistors. Also 115 Page Book, 50 practical Transistor circuits with complete How-To-Do-It-Instructions.

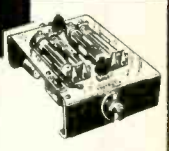

KT-66 ..... Net 7.95

## TWO TRANSISTOR RADIO KIT REGENERATIVE DETECTOR & AUDIO AMPLIFIER

This compact regenerative transistor receiver gives more than ear-phone volume on broad-cast stations located several hundred miles away. When used with a 60 foot outside antenna, stations well beyond 1000 miles have been heard. Build this receiver and acquire a real basic knowledge of transistors and their application. Kit is complete with perforated masonite bread-board, 2 G.E. Transistors and Argonne Transistor audio transformer, etc. Also includes 115 page book of practical transistor circuits with complete How-To-Do-It-Instructions.

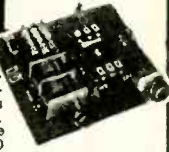

KT-67 ..... NET 10.95  
Dynamic Ear Phone (MS-72) NET.....1.95

## RAYTHEON TRANSISTORS

CK-722—Singly, each..... 2.10  
—In lots of 10, each..... 1.95  
CK-721—Singly, each..... 2.40  
—In lots of 10, each..... 2.25

## HIGH FIDELITY AMPLIFIER KIT

10 WATT — BUILT-IN PREAMPLIFIER For G.E. Reluctance Cartridge  
FREQUENCY RESPONSE 20-20,000 CYCLES



Designed for installations where high quality reproduction is required. Separate tone controls for bass and treble. Inverse feedback circuit. Specifications: Power Output 10 watts or 32 db less than 3% distortion, Frequency Response: 20 to 20,000 cps ± 1 db, Tone Control: produces maximum bass boost of + 8 db at 100 cps, Treble Control produces maximum treble boost + 10 db at 10,000 cycles, Hum: —70 db below rated output, Tube Complement: 1-6S7, 1-6SL7, 2-6V6GT, 1-5Y3GT. Power Consumption 70 watts 110-120 volts 60 cycles. Shpg. Wt. 15 lbs. Complete with 3D diagrams and instructions.

KT-23—Complete with tubes.....Net 19.95

## Lafayette Greatest Tape Buy Ever!

1200 FT. REEL  
Genuine Plastic Base  
RECORDING TAPE  
Shpg. Wt. 14 oz.

LAFAYETTE made a terrific deal with one of the leading manufacturers of recording tape to supply us with their regular tape which sells for almost twice our price. WE GUARANTEE ABSOLUTE SATISFACTION OR YOUR MONEY BACK. The finest, professional-quality recording tape obtainable. Highest performance for thousands of playings. Red Oxide Base in a smooth, uniform coating; greater signal strength; with maximum fidelity; uniform frequency response from 40-15,000 cps.

In lots of 10 rolls - 3.75 ea

\$1.89 per roll plus postage

## REMOTE CONTROL FOR SILENT TV VIEWING

For Hard-of-Hearing  
For Late Listening  
The hard-of-hearing can listen to radio or TV without turning the volume so high that others can't stand the noise. They can listen with loud speaker cut off, or if others want to listen with normal speaker volume. Excellent for noisy programs. Let the kids listen and view with speaker cut off. Comes complete with miniature phone, fits snugly in ear, 20 feet of cable and instructions.

MS-125 ..... 6.50

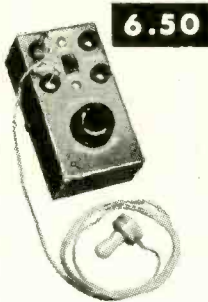

6.50

TWO CAN LISTEN WITH ADDITIONAL EAR PHONE 1.95

## High Output Dynamic Microphone

List Price \$47.00  
\$12.95

High quality Dynamic microphone exceptionally fine for Public address recording, etc. Flat response 60-10,000 cps. Impedance 40,000 ±15% at 1,000 cps. output level —55 db. Die cast metal case equipped with 6 ft. of shielded cable. Shpg. wt. 3 lbs.

PA-19—In lots of 3 ..... 12.45  
singly, ea. .... 12.95



## TOP QUALITY CRYSTAL MICROPHONE

COMPARE IT WITH ANY MIKE AT 2 to 3 TIMES THE PRICE

A quality crystal Microphone for PA systems, house recorders, etc. Frequency response 30 to 10,000 cycles. Output level —52 db. Provides ample output for use with low gain amplifiers. Complete with 5 ft. of shielded cable. Shpg. wt. 3 1/2 lbs.

PA-24—In lots of 3 ..... \$3.95  
singly, each ..... 4.25



## LAPEL MICROPHONE

REGULAR \$14.00 VALUE!  
FULL —55 db. OUTPUT LEVEL!  
IDEAL GENERAL PURPOSE MIKE!

2.95

Specially engineered crystal Microphone. Attaches to lapel. Only 1 1/2" in diameter. Exceptional frequency response. Output level —55 db. chrome plated case and clip for attaching to lapel. Includes 5 ft. of shielded cable. Shpg. wt. 1 lb.

PA-18 ..... 2.95



## PM SPEAKERS—FINE QUALITY ALNICO V MAGNET

4" P M—3.2 ohm SK-11 ..... 1.59  
5" P M—3.2 ohm SK-12 ..... 1.69  
6" P M—3.2 ohm SK-13 ..... 2.19  
6 x 9 P M—3.2 ohm SK-17 ..... 3.15  
12" P M—RCA—12 Watt—6.8 oz. ALNICO V Magnet ..... 5.25  
6.8 ohm SK-40 ..... 5.25  
12" COAXIAL P M SPEAKER SK-22 ..... 9.75

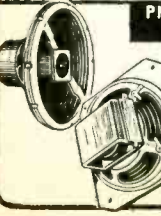

## SONOTONE 9980-S TURNOVER CERAMIC PHONO CARTRIDGE WITH DUAL SAPPHIRE NEEDLES

REPLACEMENT FOR COLUMBIA 360—VM—WEBSTER AND CRESCENT RECORD CHANGERS

SPECIFY STOCK NO. PK-40  
In lots of 5, each.... 3.50  
Singly, each.... 3.98



## FREE send for it RADIO CATALOG

GET LAFAYETTE'S NEW CATALOG PACKED WITH THE LARGEST SELECTION OF QUALITY ELECTRONICS EQUIPMENT AT BARGAIN PRICES.

**Lafayette Radio**

NEW YORK, N.Y. 100 Sixth Ave.  
BRONX, N.Y. 542 E. Fordham Rd.  
NEWARK, N.J. 24 Central Ave.  
PLAINFIELD, N.J. 139 West 2nd St.  
BOSTON, MASS. 110 Federal St.

To Speed Shipment on Your Order Please Mention DEPT. JJ

Remit by Check or Money Order. Include sufficient money for Postage. We Refund unused amounts.

# "TAB" THAT'S A BUY

NEW "TABTRON" SELENIUM BRIDGE RECTIFIERS Dated

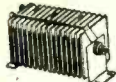

ONE YEAR GUARANTEE  
We mfg. Power Rectifiers to your specs. From 1 Amp up to and above 1000 Amps. Following list. Full Wave Bridge.

Curr. Cont.	18/14	36/28	54/42	130/100
1AMP	\$ 1.40	2.35	5.75	5.25
2AMP	2.10	2.95	5.35	10.00
3AMP	3.00	4.15	5.85	12.75
4AMP	3.75	4.35	11.35	24.75
6AMP	4.45	6.75	12.85	32.00
10AMP	6.50	12.50	19.50	41.35
12AMP	7.00	13.00	22.10	44.25
20AMP	13.05	25.05	37.25	78.50
24AMP	16.00	31.95	44.50	85.00
30AMP	19.75	33.50	56.50	109.00
36AMP	21.50	35.25	67.50	134.00
50AMP	29.50	54.35	97.35	174.00

50AMP & XFMR COMBO, Up to 28VDC at 24 Amps Cont. Duty... \$60

### New Rectifier Xfmr's

Primary 115/0 Cyc	5 Amp	\$8.65; 2/\$15.75
12 Amp	\$16.65; 2/\$29.95	
24 Amp	\$35.75; 2/\$69.95	
36 Amp	\$54.85; 2/\$109.95	
50 Amp	\$108.00; 2/\$210	

18 Volt 2 Amps \$1.98; 2/3.50  
Secondary (Dual) 115-0-115V 0-9-5-18 Volts  
1Wdngs in Series at ratings shown; Parallel  
2Xamps, Voltage 1/2 max.; Dual Pri 115 &  
220V 60 cy. Tapped 36VCT

Write for New "TABTRON" Rectifier & Power Supply Catalog PR655

### New Rectifier Chokes

CR6001 1AMP/0.1HY/1.4R/3Z	\$3.95
CR6002 2AMP/0.1HY/67R/3Z	\$5.95
CR6003 5AMP/0.1HY/67R/3Z	\$9.95
CR6004 12AMP/0.1HY/1R/12Z	\$14.95
CR6005 24A/.004HY/.025R/20Z	\$29.95

### 230 to 115V Autotransformers

For 220-240 V/50-60 cy. In. To 110-120 V or step-up w/ w/ 200V. 115V/0 Cyc.	TPA050/50W*	\$2.55
TPA075/75W*	\$3.65	
TPA100/100W*	\$4.75	
TPA200/200W*	\$5.75	
TPA250/250W*	\$6.75	
TPA500/500W* 25:TPA750/750W* 11.75		
Model TPA1000/1000W/1KW	\$16.95	
Model TPA2000/2000W/2KW	\$34.00	
\$100 Order Take 10% Disc. *Less C. P&H		

New Variable 0 to 6 & 12/0V 12A DC Power Supply  
Battery Eliminator, Charger, Model RR, Plater, Aircraft, Marine or any DC Req. Extra Hvy Dty Selenium Rectifier, Meters, ac. & V. As Designed for Cont. Service & up to 20 Amps. Includes overtemp. protection.

New Model T612V12AC ... \$29.95

## TABTRON

### NEW HIGH CURRENT POWER

SUPPLIES—ONE YEAR GTD Variable 0-28VDC. Complete w/ Built-in Full Wave Selenium Rectifier, Transformer, Variable Volt & Amp Meters, Switch, Terminals & Fuse. Housed in Heavy Duty Steel Cabinet. 115V/60cy Input, and 3 phase to order. Specify 5ix No. W-meters.  
110 or 220V†  
T28V5A 0-28 VDC at 5 Amp \$ 45  
T28V5ACC 5 Amp (1% Ripple) \$ 75  
T28V12AC 12 Amp (1% Ripple) \$145  
T28V24AC† 0-28 VDC at 24 Amp \$135  
T28V24ACC† 24 Amp (1% Ripple) \$260  
T28V50A† 0-28 VDC at 50 Amp \$260  
T28V50ACC† 50 Amp (1% Ripple) \$370  
T28V100A† 0-28 VDC at 100 Amp \$469

New! Basic Supplies, 115 VAC In.  
B115P5A 115 VDC at 5 Amp \$90.00  
B115P10A 115 VDC at 10 Amp 190.00  
B230P5A 230 VVDC at 5 Amp 188.00  
B230P10A† 230 VDC at 10 Amp 283.00  
Less Meters, † 115 or 230 VAC and 3 Phase

New Variable Voltage Xfmr's  
Superior—Gr—Staco—Utc  
0-12V 1.25A \$ 9.99  
0-135V 3A \$ 11.99  
Cased 0-135V 7.5A 21.95  
Uncased 0-135V 7.5A 17.25  
Cased 0-270V 3A 24.95  
Uncased 0-270V 3A 18.95  
Cased 0-135V 15A 41.98  
Cased 0-270V 9A 41.98  
Six or more 10% Disc

NEW! Quality VOLTAGE REGULATOR  
\$ \$ Popularly Priced \$ \$  
Only \$16.98

LINE VOLTAGE STABILIZER. Automatically Regulates line voltage for TV, RADIO or Industrial use. Insures full size, strength, & sync of TV picture regardless of live voltage. Automatically regulated. Regulator turns on & off with set or equipment.

TROUBLE FREE. QUART needs no adjustment. Universal use from 100 to 300 watts. Input 100-125V/Output 115V plus or minus 3% 50-60 Cy. SOLD WITH "TAB" MONEY BACK GUARANTEE.  
Order Six and Take 10% Discount

Money Back Guarantee (Cost of Mds. Only) \$5 Min. Order F.O.B. N.Y.C. Add Shpg. Charges or for C.O.D. 25% Dep. Tubes Gtd. via R-Exp. only. Prices subject to Change Without Notice. Phone Recorder 2-6245. CABLE: "TABPARTS"

### OIL CONDENSER BUY

4MFD 1200 VDC \$1.25  
or 10 MFD Lots of 24  
600 VDC Or Any Assortment of 24  
12 Lots @ \$1.50 ea.; Singly @ \$1.79

### TRANSFORMER SPECIAL

6.3T Volt 3 1/2 Amp CONTINUOUS DUTY  
95¢ ea. LOTS OF 25

115 VAC In. size 2-5/16H/2L/1 1/2W Hvy. Dty. Channel Mtg. 8" Wire Leads  
Lots of 12 @ \$1.00 ea.; Singly @ \$1.75 ea.

## SPECIAL "TAB" BARGAINS

Power Rheostat, 250 Ohm, 25 Watt ea. 69; 2 for \$8  
866A Kit (2) 866A Tubes, Sockets and Transformer. Special @ \$4.98  
Feeler Gauge, Precision made, .003 to 0.55. Micro Saw, Swedish Steel, non-breakable, double action cutting edge. Reg. \$12 to \$18 ea. @ \$4; 6 for \$18  
1-Crystal A Signal Generator, Xtal @ \$59  
2222-A Diode IN21 @ .20; 100/\$5  
Clamp Lamp, Adjustable, w/ Bulb & Reflector. Reg. \$12 to \$18 ea. @ \$4; 6 for \$18  
Wrench—INCA Quickie, 10 Way 1/4" to 9/16" Sq. & Hex head nuts & bolts, rustproof, brkproof. .59; 10/\$6  
Vacuum Time Delay Relays, Octal base 25 or 120V @ \$1.49; Ass'td 10 @ \$1.57  
RG59U 100 ft. @ \$5; 500 ft. @ \$22  
300 Ohm Twinex, 65 Mil Hvy Dty, 100 ft. @ \$1.19; 1000 ft. @ \$10.25  
AB "V" Transformers, Ass'td Kit 12 popular values. \$5.00 ea. Reg. Tubo 49.98 @ \$2  
Global Resistor, TAFD/3500 Ohm/500W RF w/clips. \$5.00 ea. Reg. Tubo 49.98 @ \$2  
Snoperoscope, 500 A Res Tubo @ \$6.99 ea.; 2 for \$11  
Mica Cap. .006 at 2500 WVDC @ .39; 4for \$1

## DEALERS WRITE FOR DISCOUNTS

### MICRO & MU Switches

A Mu/Leaf Sw. 3 1/2" DPNO & NC/15A @ .98c. Special 12/\$10  
B Micro Sw. Pin Plunger Special 12/\$3  
C Micro Sw. Plug SPDT/10A. .39; 10/\$3  
D Micro Sw. Plug SPNO/10A. .35; 12/\$3  
E Push Ttle. AHH DPST/12A. .35; 12/\$3  
F Micro Sw. Roller SPNC/10A. .59; 12/\$3  
G C.H. SPDT A/hp. @ .98; 6/\$5  
H A/B 1/10 A. 5. w/ SPDT 2/2.85  
"TAB" Buy Sw. SPDT & reset @ 2/\$5  
I Micro Plunger Button SPNT. .69; 12/\$6  
J Micro Sw. Cased Hvyty & Arc sup. mac'nets Plunger SPNC/30A. @ .79; 12/\$7  
K Switchette DPNO & NC @ .30; 12/\$3  
L Switchette SPNO @ .25; 15/\$3  
Start & Stop push button control @ .79; Special Deal @ 12/\$7  
Kit-8 Ass'td Types @ \$3.00  
Qty's 100 Additional 20% Discount

### RHEOSTAT BUY

15 Ohm 25W 98c; 12/\$7  
50 Ohm 25W \$1.10; 10/\$7  
75 Ohm 25W \$1.98; 10/\$14  
125 Ohm 25W \$1.10; 10/\$7  
250 Ohm 25W \$1.10; 10/\$6  
500 Ohm 25W \$1.10; 10/\$7  
1200 Ohm 25W \$2.98; 2/\$5  
5000 Ohm 25W \$1.98; 10/\$9

### NEW 212W/SEC PHOTOFLASH

AC & Dry Battery Kit  
Includes four 525MFD-450V Condensers. Total 212W/Sec's. Resistors, capacitors, rectifiers, flash tube in indicating flash green. Guide 2 1/2" Daylight Kodachrome. 240 on Ektachrome. Less Batteries. (\$5) Special. AC Only @ \$44.98  
(\$8) 90V (N60) Batteries & Box @ \$14.98

### FOTOFLASH & STROBE LAMPS

"TAB" Replaces W-Sec. Max Each  
TLW FA 104/FT118 150 5.98  
THI ANGLIO 5804X 100 10.98  
23ST GEV FT 210 200 9.98  
THVA SYLV. 4330 200 9.98  
V4X4 X400 200 10.00  
TLX DX & FA10Q 150 9.00  
TLD DX/250-350 150 10.00  
35GQTQ 300 2000 49.98  
Trigger Coil for LO Volt Flash \$1.47  
Write for "TAB" Flash Tube Data.....50c

### CIRCUIT BREAKERS

Heimann Magn Bkrs—Amps: 3, 5, 7, 9, 12, 30, 35, 40, 80, @ \$1.98 ea. 12/\$20; "TAB" Special. \$9 DACH Toggle 5W Bkrs—Amps: 3, 10, 15, 20, 25 @ 98c ea. 48 Heimann Terra 15 Amp Bkrs—Amps: 5, 10, 15, 30, 35—@ 80c ea. 10/\$7.98

### TRANSFORMERS

All 115 V 60 Cyc Input TV & CR pwr Xfmr up to 20" tubes. Hvy VOLT's to 20KV w/quad-tube chkt. All tubes, TL & FIL windgs. 5000 VDC/5MA, 300 VDC/275 Ma Full-Wave, 6-4/10 A. 5. w/ SPDT 2/2.85 Hyperslcr Core, Oil Fill \$4.98; 2 for \$8.50; 6 for \$22.00  
2500V/20MA 6.3/3.6A, 2.5V/1.75A @ \$7.98  
BC412 Scope Reprint.....\$7.98  
900V/35MA 2X2.5V/2A. XCLTNT 1800V  
DRLE TVO 2X2.5V/2A. XCLTNT 1800V  
778VCT/200MA, 2V/3A, 6.3VCT/3A, 98  
770V/2.5MA, 2.5V/3A, HVINS HMSLD Includes FILTER PARTS, 4/scope.....\$3.69

## 1st Quality • No Electrical or Mechanical Rejects

# TUBES!! "TAB" TESTED & GUARANTEED

Individually Boxed • Hickock Mu Tested • WE WHOLESALE TO SERVICEMEN, DEALERS & INDUSTRY

0A2	.74	2E5	.92	6B8	.64	6SN7	.56	12BE6	.62
0A3	.98	2V3	2.90	6B8E	.48	6SQ7	.56	12BH7	.69
0A4	1.19	6X4	1.19	6B9	.48	6X4	.56	12BD6	.69
0B3	1.19	3A4	.48	6BE6	.74	6V57	.89	12C6	.48
0C3	.88	3B4	2.70	6BE6E	.46	6V8T	4.20	12J5	.48
0C3	.88	3B4	2.70	6BE6E	.46	6V8T	4.20	12J5	.48
0C4	.50	3Q4	.46	6BH6	.52	6T7	.78	12SA7	.64
0Z4	.64	3Q5	.68	6BL7	.68	6U5	.99	12SF7	.78
1A7GT	.78	3B7	1.45	6BK7A	1.11	6U6	.68	12SH7	.62
1A4	3.95	3V4	.79	6BL7	.97	6VGT	.66	12SK7	.48
1A6A	3.75	4827	1.55	6BN6	1.19	6W4	.38	12SK7K	.48
1A6B	1.07	5A4	1.22	6B7C	.98	6X4	.42	12SL7	.36
1AX2	1.25	5A24	1.54	6C5	1.24	6T4	1.15	12K8	.48
1B3	.66	5R4YW	1.56	6C5	.68	6Z7	2.11	12Q7	.54
1C6	.68	5T4	1.48	6C6	.56	7A4	.78	12SR7	.46
1DBGT	.89	5A4	.46	6C8	.82	7A5	.74	12T3	.48
1E5	.69	5V4	1.28	6C8E	.52	7A7	.79	14A7	.89
1E7	.49	5K4G	.78	6CD6	1.08	7A8	.68	14AF7	.95
1G4GT	.69	5V3	.36	6D5	.91	7B6	.82	24A6	1.38
1G5	.69	5V4	.62	6D8	.81	7B4	.81	19T8	1.49
1GGGT	.69	5A3	1.29	6E5	1.09	7B6	.72	19V8	1.96
1H46	.49	6A5	2.98	6F5	.91	7B8	.82	24A6	1.38
1HSGT	.72	6A6	.81	6F6	.76	7C4	.68	25A6	1.79
1H8	.69	6A7	1.09	6F8	.86	7C7	.68	25B6	.99
1L6G	.78	6AG7	1.05	6G6	.92	7E6	.54	25L6	.42
1L4	.48	6AB4	.42	6H6	.74	7E7	.76	25K6	.60
1L4A	1.01	6AB7	.78	6J4	4.59	7F7	.76	25Z6	.60
1L6C	1.09	6AC5	1.19	6J5	4.22	7F8	1.18	26	.79
1L6D	.89	6AC5	1.19	6J5	4.22	7F8	1.18	26D7	.79
1L6S	.98	6AF6	1.18	6J7	.42	7J7	.90	34	.69
1L6T	.99	6AG5	1.50	6K6	4.97	7J7	1.29	35/51	.60
1LH	1.01	6AG7	1.48	6K7	4.67	7J7	1.05	35/51	.60
1LN5	.78	6A6S	.88	6L5	1.09	7X6	.89	35B5	.54
1P5	.78	6AK5	.62	6L6	.98	7Y4	.64	35C5	.71
1R4	1.19	6A4	.84	6G6	.84	7A7	1.41	19B6	1.38
1R4	.96	6A5	.42	6N7	.80	12A6	.48	35Z3	.69
1R5	.52	6A7	1.22	6P5	.99	12A8	.79	35Z4	.64
1R5	.52	6A7	1.22	6P5	.99	12A8	.79	35Z5	.64
1S5	.52	6A8	.84	6G7	.74	12A5	.52	37A4	.44
1S5	.52	6A8	.84	6G7	.74	12A5	.52	37A4	.44
1T4	.52	6A8E	2.74	6S4	.48	12A7E	.42	45Z3	.66
1T4	.52	6A8E	2.74	6S4	.48	12A7E	.42	45Z3	.66
1U4	.46	6A7	3.28	6S8	1.30	12A7T	.68	49	1.29
1U5	.48	6A7E	.42	6S7	.84	12A7	.52	10A5	.52
1U5	.48	6A7E	.42	6S7	.84	12A7	.52	10A5	.52
1X2A	.62	6A6E	.46	6S7C	.74	12A7E	.54	50C5	.60
1X2A	.62	6A6E	.46	6S7C	.74	12A7E	.54	50C5	.60
2A4	2.37	6AV6	.48	6S7G	.62	12A7	.58	50	.82
2A5	.78	6AX4	.81	6S7H	.42	12A7T	.68	76	.82
2A6	1.18	6A7	1.61	6S7	.62	12A7	.58	77	.98
2A7	.89	6B5	1.18	6SK7	.52	12B8T	.94	83V	1.22
2B7	.89	6B7	.91	6SL7	.56	12BD6	.65	117Z3	.68

THAT'S "TAB" THAT'S A BUY  
Dept. 9RE5 111 LIBERTY STREET, NEW YORK 6, N.Y., U.S.A.

### NEW 6KV HI SENSITIVITY DC & AC 27 Range MULTITESTER

"TAB" \$21.95 (Not A Kit) Lots of 3

A complete precision test instrument. 20,000 Ohms per Volt DC-10,000 Ohm D/V AC. 38 micro ampere movement. 8 easy to read scales: 0-10, 0-100, 0-1000, 0-10000 Volts AC 0-6, 30, 120, 600, 1200, 6000 Volts AC 0-6, 30, 120, 600, 1200 Volts. Current 0-60 ua, 6, 60, 600 ma. Resistance 0-8K, 80K, 800K, 8 megohms. Decibels Cal 600 ohm—20 to 6, 20, 34, 46, 60 DBS. Capacity 250 uufd to 10 mfd. Inductance 10 to 1000 millibhs. Hi accuracy. Complete w/ batteries & Leads. RF Diode Probe included for signal measurement. Sold Singly @ \$22.95 ea. HV 30,000 Volt Probe. Special \$5.95 ea.

### Pocket AC-DC MULTITESTER "TAB" 27C \$9.45 Lots of 3

Hi-accuracy precision VOM/1000 Ohms per V. Reads AC & DC Volts 0-5, 25, 250, 1000 V DCMA; 0-1, 10, 100 MA. Ohms 0-10, 100, 1K. Size 1 1/4" D, 4 1/2" L. 3 1/2" Test Leads. Singly \$9.95 (plus 40c ship in U.S.A.)

### NEW "Clip In Tip" GE Cartridges \*GE Original Boxed, \$ \$ Back Gtd

RPX050A .001 & .003...\$6.98  
RPX052A\* Gold Treas \$19.98  
RPX053A\* Gold Treas \$28.98  
RPX040A\* Single (S). 003 \$5.25  
RPX041A\* Single (S). 001 \$5.25

### Replic'mnt Needles "TETRAD" Diamond†

RPJ010A Dual (S). 001 & 003 GE.....\$1.88  
RPJ020A Dual (S). 001 & 003 GE.....\$18.99  
RPJ013A Dual (S). 001 & 003.....\$10.99  
Replic'mnts for New A Cartridges Only  
RPJ010A Dual (S). 001 & 003 GE.....\$9.99

# No dead spots No hot spots



Partial view of CDP installation at modern Lincoln Fields Race Track, located just south of Chicago at Crete, Illinois

**OFF AXIS and ON AXIS**  
Coverage is Clear, Penetrating, Uniform

# CDP

**COMPOUND  
DIFFRACTION  
PROJECTOR\***



Electro-Voice CDP Public Address Loud-speaker System was chosen for the 8,248 seat North Side Gym, Elkhart, Indiana, one of the nation's largest high school gyms. Cluster of stacked CDP's can be seen in photo taken during construction.

**Model 848 CDP:** 25 watts, 16 ohms. Conservatively rated  $\pm 5$  db from 175 to 10,000 cps. Cross-over at 1000 cps. Variable polar patterns. Size: 10 $\frac{1}{2}$  in. wide, 20 $\frac{1}{2}$  in. high, 30 in. deep over-all. List Price: \$69.50 Net Price: \$41.70

Outdoors or indoors, everyone can comfortably hear everything when you use the CDP. Listeners off the axis, where the majority of audiences are, do not have to strain to hear, while those on the axis are not assaulted by blasts of sound. The CDP provides smooth peak-free wide-range response, with 120° sound distribution at all frequencies up to 10,000 cps. Unit energy is far more efficient—there's no wasted power. You can do a better job with fewer units at less cost. CDP utilizes two coaxially mounted diffraction horns, working from both sides of a single diaphragm, plus optical slit diffraction for smooth sound dispersion. CDP delivers 2½ octaves more musical range than comparative units. Molded of glass fibers, CDP is weather-proof, blast-proof, splash-proof. Compare the CDP with any other unit in the environment in which it actually will be used—in the field or in an auditorium. Prove to yourself why it is so superior, why it is the best value ever!

\*Pat. D169,904 and Pat. Pend.



Send for CDP Public Address Handbook Bulletin No. 195. Gives complete and helpful information.

NO FINER CHOICE THAN

# Electro-Voice®

**ELECTRO-VOICE, INC. • BUCHANAN, MICHIGAN**  
Export: 13 East 40th St., New York 16, U.S.A. Cables: Arlab

# How to "tame" a TV Sync Circuit *FAST*

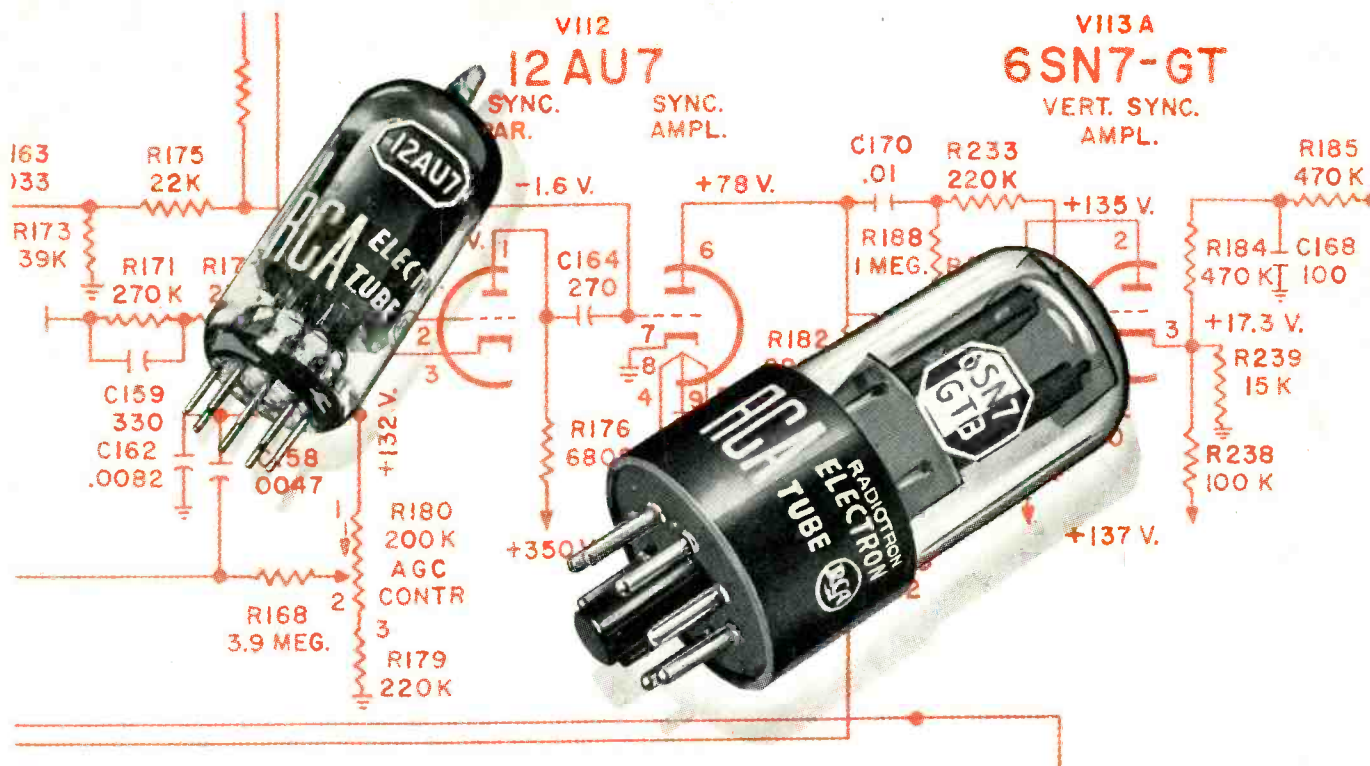

## Use RCA Tubes with Built-In Quality!

For instance, RCA-12AU7's and 6SN7-GTB's are known for their close manufacturing tolerances. Microphonics are minimized. Plate current cutoff is closely controlled. Result: High tube stability—even during variations in heater voltages!

It's a fact—you can rely on RCA Tubes to give your customers stable TV pictures. That's because RCA Tubes are designed and manufactured specifically to meet the close tolerance requirements of TV circuitry.

So, insist on RCA Receiving Tubes for *all* your service work.



**RADIO CORPORATION of AMERICA**  
ELECTRON TUBES  
HARRISON, N. J.

**First Choice for TV Circuits... dependable RCA Tubes**